

Canon

PowerShot G15

Camera User Guide

- Before use, be sure to read this guide, including the safety precautions.
- Reading this guide will help you learn to use the camera properly.
- Store this guide safely so that you can use it in the future.

ENGLISH

Package Contents

Before use, make sure the following items are included in the package. If anything is missing, contact your camera dealer.



Camera



Battery Pack
NB-10L
(with terminal cover)



Battery Charger
CB-2LC/CB-2LCE



Neck Strap
NS-DC11



DIGITAL CAMERA Solution Disk*
(CD-ROM)



Getting Started



Warranty System Booklet

- * Contains software (📖30).
- A memory card is not included.

Compatible Memory Cards

The following memory cards (sold separately) can be used, regardless of capacity.

- SD memory cards*
- SDHC memory cards*
- SDXC memory cards* 
- Eye-Fi cards

* Conforms to SD specifications. However, not all memory cards have been verified to work with the camera.

About Eye-Fi Cards

This product is not guaranteed to support Eye-Fi card functions (including wireless transfer). In case of an issue with an Eye-Fi card, please check with the card manufacturer.

Also note that an approval is required to use Eye-Fi cards in many countries or regions. Without approval, use of the card is not permitted. If it is unclear whether the card has been approved for use in the area, please check with the card manufacturer.

Preliminary Notes and Legal Information

- Take and review some test shots initially to make sure the images were recorded correctly. Please note that Canon Inc., its subsidiaries and affiliates, and its distributors are not liable for any consequential damages arising from any malfunction of a camera or accessory, including memory cards, that results in the failure of an image to be recorded or to be recorded in a way that is machine readable.
- Images recorded by the camera are intended for personal use. Refrain from unauthorized recording that infringes on copyright law, and note that even for personal use, photography may contravene copyright or other legal rights at some performances or exhibitions, or in some commercial settings.
- For information on your camera's warranty, please refer to the Warranty information provided with your camera. For Canon Customer Support, please refer to the warranty information for contact information.
- Although the LCD monitor is produced under extremely high-precision manufacturing conditions and more than 99.99% of the pixels meet design specifications, in rare cases some pixels may be defective or may appear as red or black dots. This does not indicate camera damage or affect recorded images.
- The LCD monitor may be covered with a thin plastic film for protection against scratches during shipment. If covered, remove the film before using the camera.
- When the camera is used over an extended period, it may become warm. This does not indicate damage.

Organization of Camera User Guide

The following guides are included, each used for different purposes.

Basic Guide (📖 15)

- Gives basic instructions, from initial preparations to shooting, playback, and saving on a computer

Advanced Guide (📖 41)

- Practical guide that introduces other camera basics and describes shooting and playback options

Part Names and Conventions in This Guide

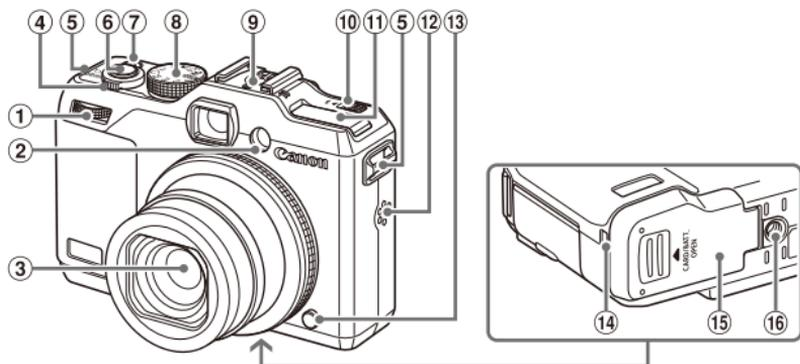

- | | |
|-----------------------------|-----------------------------|
| ① Front dial | ⑦ ON/OFF button/lamp |
| ② Lamp | ⑧ Mode dial |
| ③ Lens | ⑨ Hot shoe |
| ④ Zoom lever | ⑩ <▶⚡ (Flash up)> switch |
| Shooting: <▶ (telephoto)> / | ⑪ Flash |
| <◀ (wide angle)> | ⑫ Speaker |
| Playback: <Q (magnify)> / | ⑬ Ring release button |
| <◻ (index)> | ⑭ DC coupler cable port |
| ⑤ Strap mount | ⑮ Memory card/battery cover |
| ⑥ Shutter button | ⑯ Tripod socket |

- Shooting modes and on-screen icons and text are indicated in brackets.
- ⚠: Important information you should know
- 🖋: Notes and tips for expert camera use
- 📖xx: Pages with related information (in this example, “xx” represents a page number)
- Instructions in this guide apply to the camera under default settings.
- For convenience, all supported memory cards are simply referred to as “the memory card”.
- The tabs shown above titles indicate whether the function is used for still images, movies, or both.

Still Images : Indicates that the function is used when shooting or viewing still images.

Movies : Indicates that the function is used when shooting or viewing movies.

- The following camera buttons and controls are represented by icons.

<▲>	Up button ⑰ on back	<▼>	Down button ⑳ on back
<◀>	Left button ⑱ on back	<⦿>	Control dial ⑲ on back
<▶>	Right button ㉑ on back	<☀>	Front dial ① on front

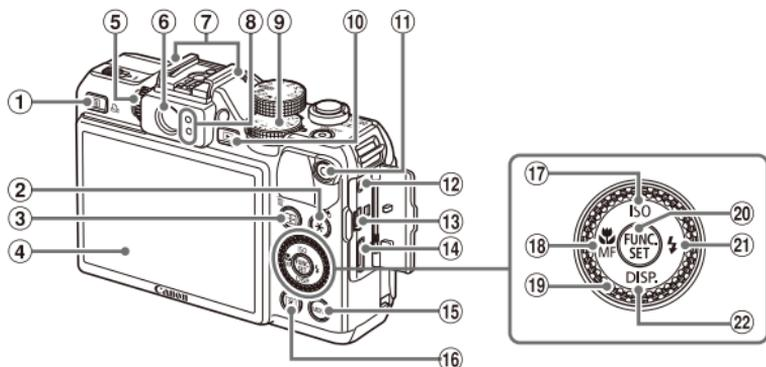

- | | |
|--|--|
| ① <S> (Shortcut) / <Print> (Direct print) button | ⑫ Remote terminal |
| ② <AE lock/FE lock> / <Filtering image display> button | ⑬ AV OUT (Audio/video output) / DIGITAL terminal |
| ③ <AF Frame Selector> / <Single image erase> button | ⑭ HDMI™ terminal |
| ④ Screen (LCD monitor) | ⑮ <MENU> button |
| ⑤ Diopter adjustment dial | ⑯ <METERING> button |
| ⑥ Viewfinder | ⑰ <ISO (ISO speed)> / Up button |
| ⑦ Microphone | ⑱ <Macro> / <MF (Manual focus)> / Left button |
| ⑧ Indicator | ⑲ Control dial |
| ⑨ Exposure compensation dial | ⑳ FUNC./SET button |
| ⑩ <Playback> button | ㉑ <Flash> / Right button |
| ⑪ Movie button | ㉒ <DISP. (Display)> / Down button |



- Turning the control dial is one way to choose setting items, switch images, and perform other operations. Most of these operations are also possible with the <▲><▼><◀><▶> buttons.
- In this guide, icons are used to represent the corresponding camera buttons and dials on which they appear or which they resemble.

Table of Contents

Package Contents	2	Image Customization Features	80
Compatible Memory Cards	2	Helpful Shooting Features	86
Preliminary Notes and Legal Information	3	Customizing Camera Operation	89
Organization of Camera User Guide	3	3 Other Shooting Modes	93
Part Names and Conventions in This Guide	4	Auto Clip Recording (Movie Digest)	94
Table of Contents	6	Specific Scenes	95
Contents: Basic Operations	8	Image Effects (Creative Filters)	99
Safety Precautions	10	Special Modes for Other Purposes	112
		Shooting Various Movies	119
Basic Guide	15	4 P Mode	123
Initial Preparations	16	Shooting in Program AE Mode (<P> Mode)	124
Trying the Camera Out	24	Image Brightness (Exposure Compensation)	125
Included Software, Manuals	30	Color and Continuous Shooting	134
Accessories	38	Shooting Range and Focusing	141
		Flash	154
Advanced Guide	41	Shooting RAW Images	159
1 Camera Basics	41	Other Settings	160
On/Off	42	5 Tv, Av, M, C1, and C2 Mode	161
Shutter Button	43	Specific Shutter Speeds (<Tv> Mode)	162
Optical Viewfinder	44	Specific Aperture Values (<Av> Mode)	163
Shooting Modes	45	Specific Shutter Speeds and Aperture Values (<M> Mode)	164
Shooting Display Options	46	Customization for Shooting Styles	166
FUNC. Menu	47		
MENU Menu	48		
Indicator Display	50		
Clock	51		
2 Smart Auto Mode	53		
Shooting (Smart Auto)	54		
Common, Convenient Features	63		
Using Face ID	69		

6 Playback Mode	173	8 Accessories	233
Viewing	174	Tips on Using Included Accessories.....	234
Browsing and Filtering Images ..	180	Optional Accessories	235
Editing Face ID Information	187	Using Optional Accessories	239
Image Viewing Options	189	Printing Images.....	259
Protecting Images.....	192	Using an Eye-Fi Card.....	274
Erasing Images.....	196		
Rotating Images.....	200	9 Appendix.....	277
Image Categories	202	Troubleshooting	278
Editing Still Images	206	On-Screen Messages	283
Editing Movies.....	213	On-Screen Information	286
7 Setting Menu.....	217	Functions and Menu Tables	290
Adjusting Basic Camera		Handling Precautions.....	302
Functions	218	Specifications.....	303
		Index	309

Contents: Basic Operations

Shoot

- Use camera-determined settings (Auto Mode) 54

Shooting people well



Portraits
(📖95)



Against Snow
(📖96)



Smooth Skin
(📖98)

Matching specific scenes



Night Scenes
(📖95)



Under Water
(📖96)



Fireworks
(📖96)

Applying special effects



Vivid Colors
(📖99)



Poster Effect
(📖99)



"Aged" Photos
(📖102)



Fish-Eye Effect
(📖103)



Miniature Effect
(📖104)



Toy Camera Effect
(📖106)



Soft Focus
(📖107)



Monochrome
(📖108)

- Focus on faces..... 54, 95, 145, 151
- Without using the flash (Flash Off)..... 25, 55
- With myself in the shot (Self-Timer).....64, 114
- Add a date stamp..... 67
- Use Face ID..... 69, 177
- Movie clips and photos together (Movie Digest)..... 94

View

- View images (Playback Mode)..... 174
- Automatic playback (Slideshow)..... 190
- On a TV..... 239
- On a computer..... 31
- Browse through images quickly..... 180
- Erase images..... 196

Shoot/View Movies

- Shoot movies.....54, 119
- View movies (Playback Mode)..... 174
- Fast-moving subjects, slow-motion playback..... 121

Print

- Print pictures..... 259

Save

- Save images to a computer..... 35

Safety Precautions

- Before using the product, please ensure that you read the safety precautions described below. Always ensure that the product is used correctly.
- The safety precautions noted on the following pages are intended to prevent injuries to yourself and other persons, or damage to the equipment.
- Be sure to also check the guides included with any separately sold accessories you use.



Warning

Denotes the possibility of serious injury or death.

- **Do not trigger the flash in close proximity to people's eyes.**

Exposure to the intense light produced by the flash could damage eyesight. In particular, remain at least 1 meter (39 inches) away from infants when using the flash.

- **Store this equipment out of the reach of children and infants.**

Strap: Putting the strap around a child's neck could result in asphyxiation.

- **Use only recommended power sources.**
- **Do not attempt to disassemble, alter or apply heat to the product.**
- **Avoid dropping or subjecting the product to severe impacts.**
- **To avoid the risk of injury, do not touch the interior of the product if it has been dropped or otherwise damaged.**
- **Stop using the product immediately if it emits smoke, a strange smell, or otherwise behaves abnormally.**
- **Do not use organic solvents such as alcohol, benzene, or thinner to clean the product.**
- **Do not let the product come into contact with water (e.g. sea water) or other liquids.**
- **Do not allow liquids or foreign objects to enter the camera.**

This could result in electrical shock or fire.

If liquids or foreign objects come into contact with the camera interior, immediately turn the camera off and remove the battery.

If the battery charger becomes wet, unplug it from the outlet and consult your camera distributor or a Canon Customer Support Help Desk.

- **Do not look through the viewfinder at bright light sources (such as the sun on a clear day).**

This could damage your eyesight.

- **Use only the recommended battery.**
- **Do not place the battery near or in direct flame.**
- **Unplug the power cord periodically, and using a dry cloth, wipe away any dust and dirt that has collected on the plug, the exterior of the power outlet, and the surrounding area.**
- **Do not handle the power cord with wet hands.**
- **Do not use the equipment in a manner that exceeds the rated capacity of the electrical outlet or wiring accessories. Do not use if the power cord or plug are damaged, or not fully plugged into the outlet.**
- **Do not allow dirt or metal objects (such as pins or keys) to contact the terminals or plug.**

The battery may explode or leak, resulting in electrical shock or fire. This could cause injury and damage the surroundings. In the event that a battery leaks and the battery electrolyte contacts eyes, mouth, skin or clothing, immediately flush with water.

- **Turn the camera off in places where camera use is prohibited.**

The electromagnetic waves emitted by the camera may interfere with the operation of electronic instruments and other devices. Exercise adequate caution when using the camera in places where use of electronic devices is restricted, such as inside airplanes and medical facilities.

- **Do not play the supplied CD-ROM(s) in any CD player that does not support data CD-ROMs.**

It is possible to suffer hearing loss from listening with headphones to the loud sounds of a CD-ROM played on an audio CD player (music player). Additionally, this could damage the speakers.



Caution

Denotes the possibility of injury.

- **When holding the camera by the strap, be careful not to bang it, subject it to strong impacts or shocks, or let it get caught on other objects.**
- **Be careful not to bump or push strongly on the lens.**

This could lead to injury or damage the camera.

- **Be careful not to subject the screen to strong impacts.**

If the screen cracks, injury may result from the broken fragments.

- **When using the flash, be careful not to cover it with your fingers or clothing.**

This could result in burns or damage to the flash.

- **Avoid using, placing or storing the product in the following places:**
 - **Places subject to strong sunlight**
 - **Places subject to temperatures above 40 °C (104 °F)**
 - **Humid or dusty areas**

These could cause leakage, overheating or an explosion of the battery, resulting in electrical shock, fire, burns or other injuries.

High temperatures may cause deformation of the camera or battery charger casing.

- **The slideshow transition effects may cause discomfort when viewed for prolonged periods.**

- **When using the separately sold optional lenses, be sure to attach them firmly.**

If the lens becomes loose and falls off, it may crack, and the shards of glass may lead to cuts.

Caution

Denotes the possibility of damage to the equipment.

- **Do not aim the camera at bright light sources (such as the sun on a clear day).**

Doing so may damage the image sensor.

- **When using the camera on a beach or at a windy location, be careful not to allow dust or sand to enter the camera.**
- **Do not push down on the flash, or pry it open.**

This may cause the product to malfunction.

- **In regular use, small amounts of smoke may be emitted from the flash.**

This is due to the high intensity of the flash burning dust and foreign materials stuck to the front of the unit. Please use a cotton swab to remove dirt, dust or other foreign matter from the flash to prevent heat build-up and damage to the unit.

- **Remove and store the battery when you are not using the camera.**

If the battery is left inside the camera, damage caused by leakage may occur.

- **Before you discard the battery, cover the terminals with tape or other insulators.**

Contacting other metal materials may lead to fire or explosions.

- **Unplug the battery charger from the power outlet after charging is complete, or when you are not using it.**
- **Do not place anything, such as cloth, on top of the battery charger while it is charging.**

Leaving the unit plugged in for a long period of time may cause it to overheat and distort, resulting in fire.

- **Do not place the battery near pets.**

Pets biting the battery could cause leakage, overheating or explosion, resulting in fire or damage.

- **When putting the camera in your bag, ensure that hard objects do not come into contact with the screen.**
- **Do not attach any hard objects to the camera.**

Doing so may cause malfunctions or damage the screen.



Basic Guide

Gives basic instructions, from initial preparations to shooting, playback, and saving on a computer

Initial Preparations

Prepare for shooting as follows.

Attaching the Strap

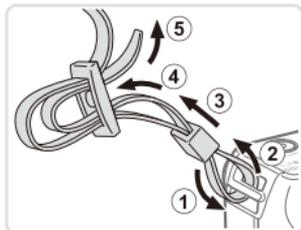

Attach the strap.

- Attach the included strap to the camera as shown.
- On the other side of the camera, attach the strap the same way.

Holding the Camera



- Place the strap around your neck.
- When shooting, keep your arms close to your body and hold the camera securely to prevent it from moving. If you have raised the flash, do not rest your fingers on it.

Charging the Battery

Before use, charge the battery with the included charger. Be sure to charge the battery initially, because the camera is not sold with the battery charged.

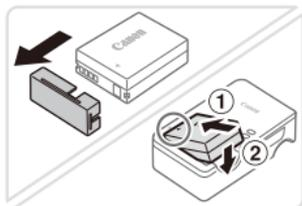

1 Remove the battery cover and insert the battery in the charger.

- Remove the cover from the battery, align the ▲ marks on the battery and charger, and insert the battery by pushing it in (①) and down (②).

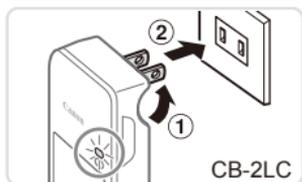

2 Charge the battery.

- CB-2LC: Flip out the plug (①) and plug the charger into a power outlet (②).
- CB-2LCE: Plug the power cord into the charger, then plug the other end into a power outlet.
- ▶ The charging lamp turns orange and charging begins.
- ▶ When the charging is finished, the lamp turns green.

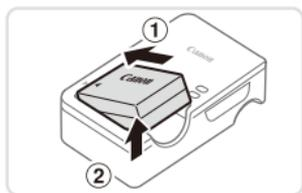
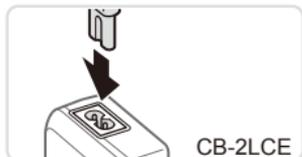

3 Remove the battery.

- After unplugging the battery charger, remove the battery by pushing it in (①) and up (②).



- To protect the battery and keep it in optimal condition, do not charge it continuously for more than 24 hours.
- For battery chargers that use a power cord, do not attach the charger or cord to other objects. Doing so could result in malfunction or damage to the product.



- For details on charging time and the number of shots and recording time possible with a fully charged battery, see "Specifications" (303).

Inserting the Battery and Memory Card

Insert the included battery and a memory card (sold separately).

Note that before using a new memory card (or a memory card formatted in another device), you should format the memory card with this camera (223).

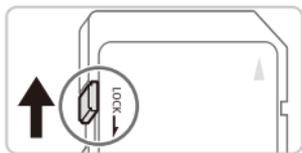

1 Check the card's write-protect tab.

- Recording is not possible on memory cards with a write-protect tab when the tab is in the locked (downward) position. Slide the tab up until it clicks into the unlocked position.

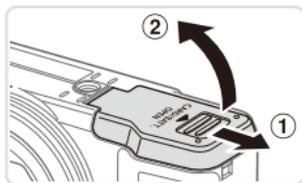

2 Open the cover.

- Slide the cover (1) and open it (2).

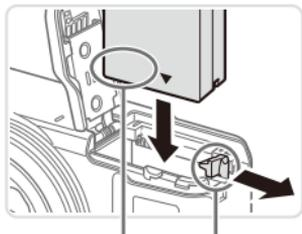

Terminals Battery Lock

3 Insert the battery.

- While pressing the battery lock in the direction of the arrow, insert the battery as shown and push it in until it clicks into the locked position.
- If you insert the battery facing the wrong way, it cannot be locked into the correct position. Always confirm that the battery is facing the right way and locks when inserted.

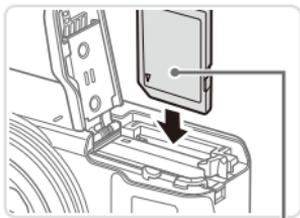

Label

4 Insert the memory card.

- Insert the memory card facing as shown until it clicks into the locked position.
- Make sure the memory card is facing the right way when you insert it. Inserting memory cards facing the wrong way may damage the camera.

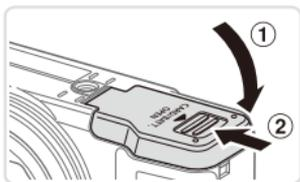

5 Close the cover.

- Lower the cover (①) and hold it down as you slide it, until it clicks into the closed position (②).



- For guidelines on how many shots or hours of recording can be saved on one memory card, see "Specifications" (📖303).

■ Removing the Battery and Memory Card

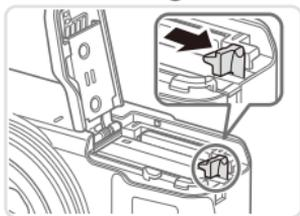

Remove the battery.

- Open the cover and press the battery lock in the direction of the arrow.
- ▶ The battery will pop up.

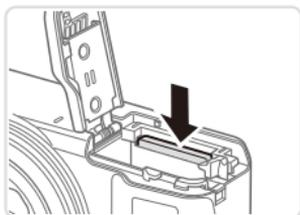

Remove the memory card.

- Push the memory card in until it clicks, and then slowly release it.
- ▶ The memory card will pop up.

■ Setting the Date and Time

Set the current date and time correctly as follows if the [Date/Time] screen is displayed when you turn the camera on. Information you specify this way is recorded in image properties when you shoot, and it is used when you manage images by shooting date or print images showing the date. You can also add a date stamp to shots, if you wish (📖67).



1 Turn the camera on.

- Press the ON/OFF button.
- ▶ The [Date/Time] screen is displayed.

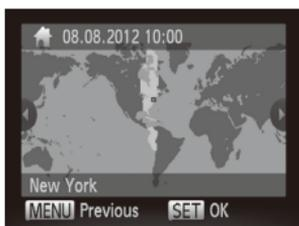
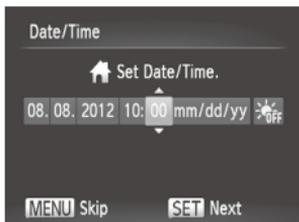

2 Set the date and time.

- Press the <◀><▶> buttons to choose an option.
- Press the <▲><▼> buttons or turn the <⦿> dial to specify the date and time.
- When finished, press the <FUNC. SET> button.

3 Set the home time zone.

- Press the <◀><▶> buttons or turn the <⦿> dial to choose your home time zone.

4 Finish the setup process.

- Press the <FUNC. SET> button when finished. After a confirmation message, the setting screen is no longer displayed.
- To turn off the camera, press the ON/OFF button.



- Unless you set the date, time, and home time zone, the [Date/Time] screen will be displayed each time you turn the camera on. Specify the correct information.



- To set daylight saving time (1 hour ahead), choose [☀️ OFF] in step 2 and then choose [☀️] by pressing the <▲><▼> buttons or turning the <⦿> dial.

Changing the Date and Time

Adjust the date and time as follows.



1 Access the camera menu.

- Press the <MENU> button.

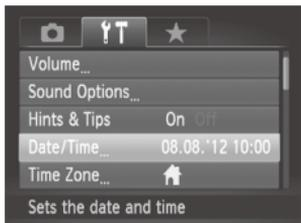

2 Choose [Date/Time].

- Move the zoom lever to choose the [Z/T] tab.
- Press the <▲><▼> buttons or turn the <DISP> dial to choose [Date/Time], and then press the <FUNC.SET> button.



3 Change the date and time.

- Follow step 2 on [p.21](#) to adjust the settings.
- Press the <MENU> button to close the menu.



- Date/time settings can be retained for about 3 weeks by the camera's built-in date/time battery (backup battery) after the battery pack is removed.
- The date/time battery will be charged in about 4 hours once you insert a charged battery or connect the camera to an AC adapter kit (sold separately, [p.235](#)), even if the camera is left off.
- Once the date/time battery is depleted, the [Date/Time] screen will be displayed when you turn the camera on. Follow the steps on [p.20](#) to set the date and time.

Display Language

Change the display language as needed.



1 Enter Playback mode.

- Press the <▶> button.



2 Access the setting screen.

- Press and hold the <FUNC SET> button, and then immediately press the <MENU> button.

English	Suomi	Magyar
Deutsch	Norsk	Türkçe
Français	Svenska	繁體中文
Nederlands	Español	한국어
Dansk	简体中文	தமிழ்
Italiano	Русский	العربية
Українська	Português	Română
B. Malaysia	Ελληνικά	فارسی
Indonesian	Polski	हिन्दी
Tiếng Việt	Čeština	日本語

3 Set the display language.

- Press the <▲><▼><◀><▶> buttons or turn the <DISP> dial to choose a language, and then press the <FUNC SET> button.
- Once the display language has been set, the setting screen is no longer displayed.



- The current time is displayed if you wait too long in step 2 after pressing the <FUNC SET> button before you press the <MENU> button. In this case, press the <FUNC SET> button to dismiss the time display and repeat step 2.
- You can also change the display language by pressing the <MENU> button and choosing [Language] on the [F1] tab.

Trying the Camera Out

Follow these instructions to turn the camera on, shoot still images or movies, and then view them.

Shooting (Smart Auto)

For fully automatic selection of the optimal settings for specific scenes, simply let the camera determine the subject and shooting conditions.



1 Turn the camera on.

- Press the ON/OFF button.
- ▶ The startup screen is displayed.



2 Enter <AUTO> mode.

- Set the mode dial to <AUTO>.
- Aim the camera at the subject. The camera will make a slight clicking noise as it determines the scene.
- ▶ Icons representing the scene and image stabilization mode are displayed in the upper right of the screen.
- ▶ Frames displayed around any detected subjects indicate that they are in focus.



3 Compose the shot.

- To zoom in and enlarge the subject, move the zoom lever toward <[📷]> (telephoto), and to zoom away from the subject, move it toward <[📷]> (wide angle).



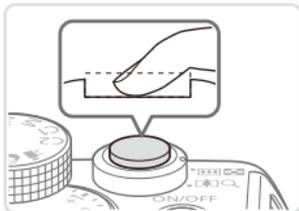
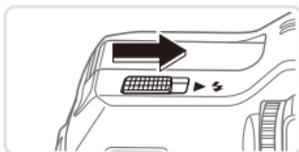
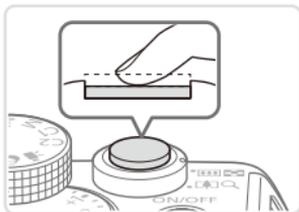

4 Shoot.

Shooting Still Images

① Focus.

- Press the shutter button lightly, halfway down. The camera beeps twice after focusing, and AF frames are displayed to indicate image areas in focus.

- If [Raise the flash] appears on the screen, move the <▶⚡> switch to raise the flash. It will fire when shooting. If you prefer not to use the flash, push it down with your finger, into the camera.

② Shoot.

- Press the shutter button all the way down.
- ▶ As the camera shoots, a shutter sound is played, and in low-light conditions when you have raised the flash, it fires automatically.
- Keep the camera still until the shutter sound ends.
- ▶ Your shot is only displayed until the camera is ready to shoot again.



Elapsed Time



Shooting Movies

① Start shooting.

- Press the movie button. The camera beeps once as recording begins, and [●Rec] is displayed with the elapsed time.
- ▶ Black bars displayed on the top and bottom edges of the screen indicate image areas not recorded.
- ▶ Frames displayed around any detected faces indicate that they are in focus.
- Once recording begins, you can take your finger off the movie button.

② Finish shooting.

- Press the movie button again to stop shooting. The camera beeps twice as recording stops.



Viewing

After shooting images or movies, you can view them on the screen as follows.



1 Enter Playback mode.

- Press the <▶> button.
- ▶ Your last shot is displayed.



2 Browse through your images.

- To view the previous image, press the <◀> button or turn the <⦿> dial counterclockwise. To view the next image, press the <▶> button or turn the <⦿> dial clockwise.
- Press and hold the <◀><▶> buttons to browse through images quickly.



- To access Scroll Display mode, turn the <⦿> dial rapidly. In this mode, turn the <⦿> dial to browse through images.
- To return to single-image display, press the <FUNC SET> button.



- Movies are identified by a [SET] icon. To play movies, go to step 3.



Volume

3 Play movies.

- Press the **<FUNC/SET>** button to access the movie control panel, choose [▶] (either press the **<◀><▶>** buttons or turn the **<DISK>** dial), and then press the **<FUNC/SET>** button again.
- ▶ Playback now begins, and after the movie is finished, [**SET** ,] is displayed.
- To adjust the volume, press the **<▲><▼>** buttons.



- To switch to Shooting mode from Playback mode, press the shutter button halfway.

Erasing the Images

You can choose and erase unneeded images one by one. Be careful when erasing images, because they cannot be recovered.

1 Choose an image to erase.

- Press the <◀><▶> buttons or turn the <●> dial to choose an image.



2 Erase the image.

- Press the <🗑> button.
- After [Erase?] is displayed, press the <◀><▶> buttons or turn the <●> dial to choose [Erase], and then press the <FUNC/SET> button.
- ▶ The current image is now erased.
- To cancel erasure, press the <◀><▶> buttons or turn the <●> dial to choose [Cancel], and then press the <FUNC/SET> button.



- You can also erase all images at once (📖 197).

Included Software, Manuals

The software and the manuals on the included disks (📖2) are introduced below, with instructions for installation, saving images to a computer, and using the manuals.

Software

After installing the software on the CD-ROM, you can do the following things on your computer.

CameraWindow

- Import images and change camera settings

ImageBrowser EX

- Manage images: view, search, and organize
- Print and edit images

Digital Photo Professional

- Browse, process and edit RAW images

Auto Update Function

Using the included software, you can update to the latest version, and download new functions via the Internet (some software excluded). Be sure to install the software on a computer with an Internet connection so you can use this function.



- Internet access is required to use this function, and any ISP account charges and access fees must be paid separately.

Manuals

Camera User Guide

- Refer to this guide for a more in-depth understanding of camera operation.

Software Guide

- Refer to this guide when using the included software. The guide can be accessed from the help system of included software (some software excluded).

System Requirements

The included software can be used on the following computers.

	Windows	Macintosh
Operating System	Windows 7 SP1 Windows Vista SP2 Windows XP SP3	Mac OS X 10.6 – 10.7
Computer	Computers running one of the above operating systems (preinstalled), with an included USB port and Internet connection*	
Processor	Still images 1.6 GHz or higher Movies Core 2 Duo 2.6 GHz or higher	Still images Core Duo 1.83 GHz or higher Movies Core 2 Duo 2.6 GHz or higher
RAM	Still images Windows 7 (64 bit): 2 GB or more Windows 7 (32 bit), Vista, XP: 1 GB or more Movies 2 GB or more	Still images Mac OS X 10.7: 2 GB or more Mac OS X 10.6: 1 GB or more Movies 2 GB or more
Interfaces	USB	
Free Hard Disk Space	640 MB or more*	750 MB or more
Display	1024 x 768 resolution or higher	

* Silverlight 4 or later (max. 100 MB) must be installed, and in Windows XP, Microsoft .NET Framework 3.0 or later (max. 500 MB) must be installed. Installation may take some time, depending on computer performance.



- Check the Canon website for the latest system requirements, including supported OS versions.

Installing the Software

Windows 7 and Mac OS X 10.6 are used here for the sake of illustration. Using the software auto update function, you can update to the latest version and download new functions via the Internet (some software excluded), so be sure to install the software on a computer with an Internet connection.

What you will need:

- Computer
- USB cable (camera end: Mini-B)
- Included CD-ROM (DIGITAL CAMERA Solution Disk) (📀2)

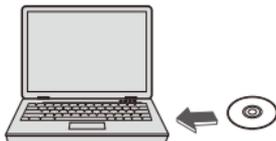

1 Insert the CD-ROM in the computer's CD/DVD-ROM drive.

- Insert the included CD-ROM (DIGITAL CAMERA Solution Disk) (📀2) in the computer's CD/DVD-ROM drive.
- On a Macintosh computer, after inserting the disc, double-click the desktop disc icon to open it, and then double-click the [🖱️] icon displayed.

2 Begin the installation.

- Click [Easy Installation] and follow the on-screen instructions to complete the installation process.



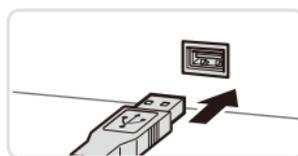
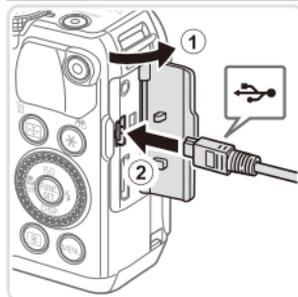

3 When a message is displayed prompting you to connect the camera, connect it to a computer.

- With the camera turned off, open the cover (①). With the smaller plug of the USB cable in the orientation shown, insert the plug fully into the camera terminal (②).
- Insert the larger plug of the USB cable in the computer's USB port. For details about USB connections on the computer, refer to the computer user manual.



4 Install the files.

- Turn the camera on, and follow the on-screen instructions to complete the installation process.
- ▶ The software will connect to the Internet to update to the latest version and download new functions. Installation may take some time, depending on computer performance and the Internet connection.
- Click [Finish] or [Restart] on the screen after installation and remove the CD-ROM when the desktop is displayed.
- Turn the camera off and disconnect the cable.



- When not connected to the Internet, there are the following limitations.
 - The screen in step 3 will not be displayed.
 - Some functions may not be installed.
- The first time you connect the camera to the computer, drivers will be installed, so it may take a few minutes until camera images are accessible.
- If you have several cameras that were bundled with ImageBrowser EX on the included CD-ROMs, be sure to use each camera with their included CD-ROM and follow the on-screen installation instructions for each. Doing so will ensure that each camera will receive the correct updates and new functions via the auto update function.

Saving Images to a Computer

Windows 7 and Mac OS X 10.6 are used here for the sake of illustration.

1 Connect the camera to the computer.

- Follow step 3 on 33 to connect the camera to a computer.



2 Turn the camera on to access CameraWindow.

- Press the button to turn the camera on.
- On a Macintosh computer, CameraWindow is displayed when a connection is established between the camera and computer.
- For Windows, follow the steps introduced below.
- In the screen that displays, click the link to modify the program.
- Choose [Downloads Images From Canon Camera using Canon CameraWindow] and then click [OK].

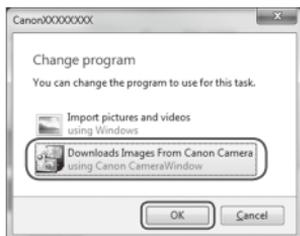

- Double click .

CameraWindow



3 Save the images to the computer.

- Click [Import Images from Camera], and then click [Import Untransferred Images].
- ▶ Images are now saved to the Pictures folder on the computer, in separate folders named by date.
- After images are saved, close CameraWindow, press the <▶> button to turn the camera off, and unplug the cable.
- For instructions on viewing images on a computer, refer to the *Software Guide* (📖 30).



- In Windows 7, if the screen in step 2 is not displayed, click the [🔍] icon in the taskbar.
- To start CameraWindow in Windows Vista or XP, click [Downloads Images From Canon Camera using Canon CameraWindow] on the screen displayed when you turn the camera on in step 2. If CameraWindow is not displayed, click the [Start] menu and choose [All Programs] ► [Canon Utilities] ► [CameraWindow] ► [CameraWindow].
- On a Macintosh computer, if CameraWindow is not displayed after step 2, click the [CameraWindow] icon in the Dock (the bar at the bottom of the desktop).
- Although you can save images to a computer simply by connecting your camera to the computer without using the included software, the following limitations apply.
 - It may take a few minutes after you connect the camera to the computer until camera images are accessible.
 - Images shot in vertical orientation may be saved in horizontal orientation.
 - RAW images (or JPEG images recorded with RAW images) may not be saved.
 - Image protection settings may be cleared from images saved to a computer.
 - Some problems may occur when saving images or image information, depending on the operating system version, the software in use, or image file sizes.
 - Some functions provided by the included software may not be available, such as editing movies or returning images to the camera.

Accessories

Included Accessories



Neck Strap
NS-DC11



Battery Pack
NB-10L*¹
(with terminal cover)



Battery Charger
CB-2LC/CB-2LCE*¹



DIGITAL
CAMERA
Solution Disk



Memory Card



Card Reader



Windows/
Macintosh
Computer



USB Cable (camera end: Mini-B)*²

Power



AC Adapter Kit
ACK-DC80

Cables



HDMI Cable HTC-100



Stereo AV Cable AVC-DC400ST



TV/Video
System

*1 Also available for purchase separately.

*2 A genuine Canon accessory is also available (Interface Cable IFC-400PCU).

*3 High-Power Flash HF-DC1 also supported.

*4 These accessories are also supported: Speedlite 580EX, 430EX, 270EX, and 220EX, Speedlite Transmitter ST-E2, Speedlite Bracket SB-E2, and Off-Camera Shoe Cord OC-E3.

*5 Requires Bracket BKT-DC1 and Off-Camera Shoe Cord OC-E3.

*6 Requires Conversion Lens Adapter LA-DC58L.

*7 Requires Filter Adapter FA-DC58D.

Flash Units



High-Power Flash
HF-DC2*3



Speedlite*4
600EX-RT, 600EX,
580EX II, 430EX II,
320EX, 270EX II



Macro Twin Lite
MT-24EX*5*6



Macro Ring Lite
MR-14EX*6

Case



Waterproof Case
WP-DC48

Soft Case
SC-DC85

Lens Accessories



Canon-brand Lens Filter
(58 mm dia.)*7



Tele-converter
TC-DC58E*6

Canon PictBridge-Compatible Printers



Other Accessories



Remote Switch RS-60E3

Use of genuine Canon accessories is recommended.

This product is designed to achieve excellent performance when used with genuine Canon accessories.

Canon shall not be liable for any damage to this product and/or accidents such as fire, etc., caused by the malfunction of non-genuine Canon accessories (e.g., a leakage and/or explosion of a battery pack). Please note that this warranty does not apply to repairs arising out of the malfunction of non-genuine Canon accessories, although you may request such repairs on a chargeable basis.

Advanced Guide

1

Camera Basics

Practical guide that introduces other camera basics and describes shooting and playback options



Shooting Mode

- Press the ON/OFF button to turn the camera on and prepare for shooting.
- To turn the camera off, press the ON/OFF button again.



Playback Mode

- Press the <▶> button to turn the camera on and view your shots.
- To turn the camera off, press the <▶> button again.



- To switch to Playback mode from Shooting mode, press the <▶> button.
- To switch to Shooting mode from Playback mode, press the shutter button halfway (📖43).
- The lens will be retracted after about one minute once the camera is in Playback mode. You can turn the camera off when the lens is retracted by pressing the <▶> button.

Power-Saving Features (Auto Power Down)

As a way to conserve battery power, the camera automatically deactivates the screen (Display Off) and then turns itself off after a specific period of inactivity.

Power Saving in Shooting Mode

The screen is automatically deactivated after about one minute of inactivity. In about two more minutes, the lens is retracted and the camera turns itself off. To activate the screen and prepare for shooting when the screen is off but the lens is still out, press the shutter button halfway (📖43).

Power Saving in Playback Mode

The camera turns itself off automatically after about five minutes of inactivity.



- Adjust the timing of automatic camera and screen deactivation as needed (📖226).
- Power saving is not active while the camera is connected to a computer (📖33).

Shutter Button

To ensure your shots are in focus, always press the shutter button lightly (halfway) initially. Once the subject is in focus, press the button all the way down to shoot.

In this manual, shutter button operations are described as pressing the button *halfway* or *all the way down*.

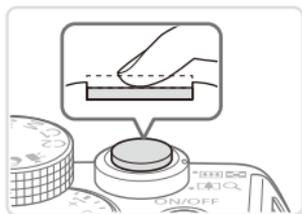

1 Press halfway. (Press lightly to focus.)

- Press the shutter button halfway. The camera beeps twice, and AF frames are displayed around image areas in focus.

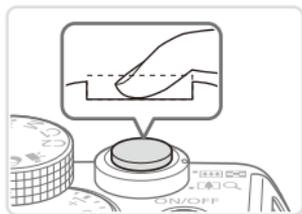

2 Press all the way down. (From the halfway position, press fully to shoot.)

- ▶ The camera shoots, as a shutter sound is played.
- Keep the camera still until the shutter sound ends.



- Images may be out of focus if you shoot without initially pressing the shutter button halfway.
- Length of shutter sound playback varies depending on the time required for the shot. It may take longer in some shooting scenes, and images will be blurry if you move the camera (or the subject moves) before the shutter sound ends.

Optical Viewfinder

To conserve battery power when shooting, you can use the optical viewfinder instead of the screen. Shoot the same way as when using the screen.

1 Deactivate the screen.

- Press the <▼> button to turn the screen off (📖 46).

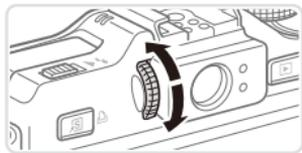

2 Adjust the diopter.

- As you look through the optical viewfinder, turn the dial one way or the other so that images look sharp.



- The area visible in the optical viewfinder may differ slightly from the image area in your shots.
- At aspect ratios other than 4:3, the area visible in the optical viewfinder differs from the image area in your shots. Check the settings before shooting.



- The lens may be partially visible through the optical viewfinder at some zoom positions.
- Although the camera automatically focuses on subjects, face detection and focusing is not possible.
- Continuous shooting is not supported in <AUTO> mode, because the camera will not determine the shooting scene.

Shooting Modes

Use the mode dial to access each shooting mode.

Auto Mode

Fully automatic shooting, with camera-determined settings (📖24, 54).

Movie Digest Mode

You can make a short movie of a day just by shooting still images (📖94).

Special Scene Mode

Shoot with optimal settings for specific scenes (📖95).

Creative Filters Mode

Add a variety of effects to images when shooting (📖99).



P, Tv, Av, M, C1, and C2 Modes

Take a variety of shots using your preferred settings (📖123, 161).

Movie Mode

For shooting movies (📖119).

You can also shoot movies when the mode dial is not set to Movie mode, simply by pressing the movie button.

Shooting Display Options

Press the <▼> button to view other information on the screen, or to hide the information. For details on the information displayed, see  286.

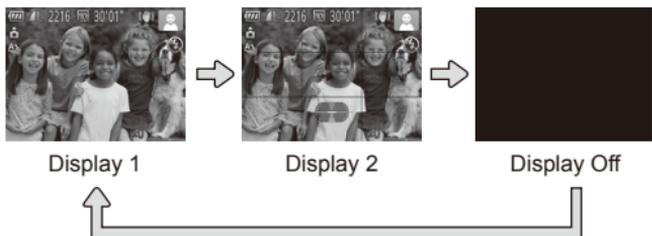

- Even if the screen is off, it will turn on when you start shooting a movie.



- Screen brightness is automatically increased by the night display function when you are shooting under low light, making it easier to check how shots are composed. However, on-screen image brightness may not match the brightness of your shots. Note that any on-screen image distortion or jerky subject motion will not affect recorded images.
- For playback display options, see  176.

FUNC. Menu

Configure commonly used shooting functions through the FUNC. menu as follows.

Note that menu items and options vary depending on the shooting mode (📖 292 – 295).



1 Access the FUNC. menu.

- Press the <FUNC. SET> button.



Options

Menu Items

2 Choose a menu item.

- Press the <▲><▼> buttons to choose a menu item.
- ▶ Available options are shown at the bottom of the screen.



3 Choose an option.

- Press the <◀><▶> buttons or turn the <DISP> dial to choose an option.
- Options labeled with a [MENU] icon can be configured by pressing the <MENU> button.



4 Finish the setup process.

- Press the <FUNC. SET> button.
- ▶ The screen before you pressed the <FUNC. SET> button in step 1 is displayed again, showing the option you configured.



- To undo any accidental setting changes, you can restore the camera's default settings (📖 231).

MENU Menu

Configure a variety of camera functions through other menus as follows. Menu items are grouped by purpose on tabs, such as shooting [📷], playback [▶], and so on. Note that available settings vary depending on the selected shooting or playback mode (📖296 – 301).



1 Access the menu.

- Press the <MENU> button.

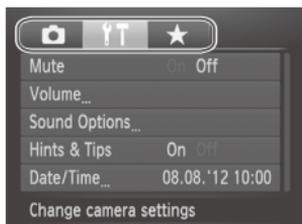

2 Choose a tab.

- Move the zoom lever to choose a tab.
- After you have pressed the <▲><▼> buttons or turned the <🔘> dial to choose a tab initially, you can switch between tabs by pressing the <◀><▶> buttons. You can also choose a tab by pressing the <✳> button.

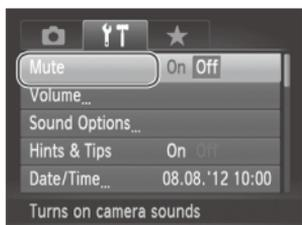

3 Choose a setting.

- Press the <▲><▼> buttons or turn the <🔘> dial to choose a setting.
- To choose settings with options not shown, first press the <FUNC SET> or <▶> button to switch screens, and then either press the <▲><▼> buttons or turn the <🔘> dial to select the setting.
- To return to the previous screen, press the <MENU> button.





4 Choose an option.

- Press the <◀>>> buttons to choose an option.



5 Finish the setup process.

- Press the <MENU> button to return to the screen displayed before you pressed the <MENU> button in step 1.



- To undo any accidental setting changes, you can restore the camera's default settings (📖231).

Indicator Display

The power lamp and indicator on the back of the camera (📖5) will light or blink depending on the camera status.

Indicator	Color	Indicator Status	Camera Status
Power Lamp	Green	On	Camera on
		Blinking	Low battery
Indicator	Green	On	Ready to shoot (when the flash is deactivated)
		Blinking	Recording/reading/transmitting images Distance warning (📖279), or cannot focus (when the flash is deactivated) (📖279)
	Orange	On	Ready to shoot (when the flash is activated)
		Blinking	Distance warning (📖279), or cannot focus (when the flash is activated) (📖279)



- When the indicator blinks green, never turn the camera off, open the memory card/battery cover, or shake or jolt the camera, which may corrupt images or damage the camera or memory card.

Clock

You can check the current time.



- Press and hold the <FUNC. SET> button.
- ▶ The current time appears.
- If you hold the camera vertically while using the clock function, it will switch to vertical display. Press the <◀▶>> buttons or turn the <DISP.> dial to change the display color.
- Press the <FUNC. SET> button again to cancel the clock display.



- When the camera is off, press and hold the <FUNC. SET> button, then press the ON/OFF button to display the clock.

2

Smart Auto Mode

Convenient mode for easy shots with greater control over shooting

Shooting (Smart Auto)

For fully automatic selection at optimal settings for specific scenes, simply let the camera determine the subject and shooting conditions.



1 Turn the camera on.

- Press the ON/OFF button.
- ▶ The startup screen is displayed.



2 Enter <AUTO> mode.

- Set the mode dial to <AUTO>.
- Aim the camera at the subject. The camera will make a slight clicking noise as it determines the scene.
- ▶ Icons representing the scene and image stabilization mode are displayed in the upper right of the screen (61).
- ▶ Frames displayed around any detected subjects indicate that they are in focus.



Zoom Bar

3 Compose the shot.

- To zoom in and enlarge the subject, move the zoom lever toward <☰> (telephoto), and to zoom away from the subject, move it toward <☷> (wide angle). (A zoom bar showing the zoom position is displayed.)



Focus Range (approx.)

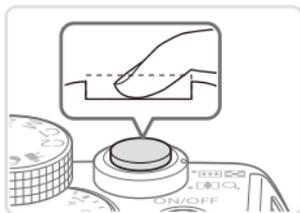
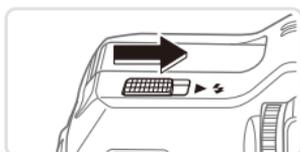

4 Shoot.

Shooting Still Images

① Focus.

- Press the shutter button halfway. The camera beeps twice after focusing, and AF frames are displayed to indicate image areas in focus.
- ▶ Several AF frames are displayed when multiple areas are in focus.

- If [Raise the flash] appears on the screen, move the $\leftarrow \rightarrow \text{⚡}>$ switch to raise the flash. It will fire when shooting. If you prefer not to use the flash, push it down with your finger, into the camera.

② Shoot.

- Press the shutter button all the way down.
- ▶ As the camera shoots, a shutter sound is played, and in low-light conditions when you have raised the flash, it fires automatically.
- Keep the camera still until the shutter sound ends.
- ▶ Your shot is only displayed until the camera is ready to shoot again.



Elapsed Time



Shooting Movies

① Start shooting.

- Press the movie button. The camera beeps once as recording begins, and [●Rec] is displayed with the elapsed time.
- ▶ Black bars displayed on the top and bottom edges of the screen indicate image areas not recorded.
- ▶ Frames displayed around any detected faces indicate that they are in focus.
- Once recording begins, you can take your finger off the movie button.

② Resize the subject and recompose the shot as needed.

- To resize the subject, do the same thing as in step 3 on [page 54](#). However, note that the sound of camera operations will be recorded.
- When you recompose shots, the focus, brightness, and colors will be automatically adjusted.

③ Finish shooting.

- Press the movie button again to stop shooting. The camera beeps twice as recording stops.
- Recording will stop automatically when the memory card becomes full.

Still Images/Movies



- To activate the screen when the camera is on but the screen is blank, press the <▼> button.
- To restore camera sound if you have accidentally deactivated it (by holding the <▼> button down while turning the camera on), press the <MENU> button and choose [Mute] on the [↑↑] tab, and then press the <◀><▶> buttons to choose [Off].

Still Images



- A flashing [📷] icon warns that images are more likely to be blurred by camera shake. In this case, mount the camera on a tripod or take other measures to keep it still.
- If your shots are dark despite the flash firing, move closer to the subject. For details on the flash range, see “Specifications” (📖303).
- The subject may be too close if the camera only beeps once when you press the shutter button halfway. For details on the focusing range (shooting range), see “Specifications” (📖303).
- To reduce red-eye and to assist in focusing, the lamp may be activated when shooting in low-light conditions.
- A blinking [⚡] icon displayed when you attempt to shoot indicates that shooting is not possible until the flash has finished recharging. Shooting can resume as soon as the flash is ready, so either press the shutter button all the way down and wait, or release it and press it again.
- The shutter sound will not be played when the Sleeping and Babies (Sleeping) icons (📖59) are displayed.



- The flash firing during shots indicates that the camera has automatically attempted to ensure optimal colors in the main subject and background (Multi-area White Balance).

Movies



- Keep your fingers away from the microphone while shooting movies. Blocking the microphone may prevent audio from being recorded or may cause the recording to sound muffled.
- Avoid touching camera controls other than the movie button when shooting movies, because sounds made by the camera will be recorded.
- To correct suboptimal image color that may occur in [1920] movie shooting (84) after you recompose shots, press the movie button to stop recording, and then press it again to resume recording.



- Audio is recorded in stereo.

Scene Icons

In **<AUTO>** mode, shooting scenes determined by the camera are indicated by the icon displayed, and corresponding settings are automatically selected for optimal focusing, subject brightness, and color. Depending on the scene, continuous images may be shot (60).

Subject	Background	Normal	Backlit	Dark*	Sunsets	Spotlights
	People					—
In Motion				—	—	—
Shadows on Face			—	—	—	—
Smiling				—	—	—
Sleeping				—	—	—
Babies				—	—	—
Smiling				—	—	—
Sleeping				—	—	—
Children (In Motion)				—	—	—
Other Subjects						
In Motion				—	—	—
At Close Range				—	—	

* Tripod Used

The background color of icons is light blue when the background is a blue sky, dark blue when the background is dark, and gray for all other backgrounds.

The background color of icons is light blue when the background is a blue sky, and gray for all other backgrounds.

- The background color of , , , , and is dark blue, and the background color of is orange.
- When shooting movies, only People, Other Subjects, and At Close Range icons will be displayed.
- When shooting with the self-timer, People (In Motion), Smiling, Sleeping, Babies (Smiling), Babies (Sleeping), Children, Other Subjects (In Motion) icons will not be displayed.

- When the drive mode is set to [□] (📖139), and when [Hg Lamp Corr.] is set to [On] and scenes are automatically corrected (📖83), Smiling, Sleeping, Babies (Smiling), Babies (Sleeping), and Children icons will not be displayed.
- If the flash is set to [⚡^A], the Backlit icons for Smiling and Children will not be displayed.
- Babies, Babies (Smiling), Babies (Sleeping), and Children icons will be displayed when [Face ID] is set to [On], and the face of a registered baby (under two years old) or child (from two to twelve years old) is detected (📖69). Confirm beforehand that the date and time are correct (📖20).



- Try shooting in <P> mode (📖123) if the scene icon does not match actual shooting conditions, or if it is not possible to shoot with your expected effect, color, or brightness.

■ Continuous Shooting Scenes

If you shoot a still image when the following scene icons are displayed, the camera will shoot continuously. If you press the shutter button halfway when one of the icons in the table below is displayed, one of the following icons will be displayed to inform you that the camera will shoot continuous images: [📷], [📷], or [📷].

Smiling (including Babies)	: Consecutive images are captured, and the camera analyzes details such as facial expressions to save the image determined to be the best.
Sleeping (including Babies)	: Beautiful shots of sleeping faces, created by combining consecutive shots to reduce camera shake and image noise. The AF assist beam will not light up, the flash will not fire, and the shutter sound will not be played.
Children	: So you don't miss a photo opportunity of children who move around, the camera will capture three consecutive images for each shot.



- In some scenes, expected images may not be saved, and images may not look as expected.
- Focus, image brightness, and color are determined by the first shot.



- When you want to shoot single images only, press the <Fn> button, choose [📷] in the menu, and then choose [□].

Image Stabilization Icons

Optimal image stabilization for the shooting conditions is automatically applied (Intelligent IS). Additionally, the following icons are displayed in <AUTO> mode.

	Image stabilization for still images		Image stabilization for movies, reducing strong camera shake, as when shooting while walking (Dynamic IS)
	Image stabilization for still images, when panning*		Image stabilization for slow camera shake, such as when shooting movies at telephoto (Powered IS)
	Image stabilization for macro shots (Hybrid IS)		No image stabilization, because the camera is mounted on a tripod or held still by other means

* Displayed when you pan, following moving subjects with the camera. When you follow subjects moving horizontally, image stabilization only counteracts vertical camera shake, and horizontal stabilization stops. Similarly, when you follow subjects moving vertically, image stabilization only counteracts horizontal camera shake.



- To cancel image stabilization, set [IS Mode] to [Off] (📖 160). In this case, an IS icon is not displayed.

On-Screen Frames

A variety of frames are displayed once the camera detects subjects you are aiming the camera at.

- A white frame is displayed around the subject (or person's face) determined by the camera to be the main subject, and gray frames are displayed around other detected faces. Frames follow moving subjects within a certain range to keep them in focus.

However, if the camera detects subject movement, only the white frame will remain on the screen.

- When you are pressing the shutter button halfway and the camera detects subject movement, a blue frame is displayed, and the focus and image brightness are constantly adjusted (Servo AF).



- Try shooting in <P> mode (📖123) if no frames are displayed, if frames are not displayed around desired subjects, or if frames are displayed on the background or similar areas.

Zooming In Closer on Subjects (Digital Zoom)

When distant subjects are too far away to enlarge using the optical zoom, use digital zoom for up to about 20x enlargement.



1 Move the zoom lever toward



- Hold the lever until zooming stops.
- ▶ Zooming stops at the largest possible zoom factor (before the image becomes noticeably grainy), which is then indicated on the screen.

2 Move the zoom lever toward



- ▶ The camera zooms in even closer on the subject.

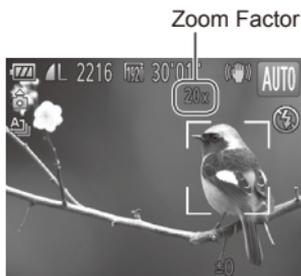

- Moving the zoom lever will display the zoom bar (which indicates the zoom position). The color of the zoom bar will change depending on the zoom range.
 - White range: optical zoom range where the image will not appear grainy.
 - Yellow range: digital zoom range where the image is not noticeably grainy (ZoomPlus).
 - Blue range: digital zoom range where the image will appear grainy.

Because the blue range will not be available at some resolution settings (81), the maximum zoom factor can be achieved by following step 1.



- Focal length when optical and digital zoom are combined is as follows (35mm film equivalent).
28 – 560 mm (28 – 140 mm with optical zoom alone)
- To deactivate digital zoom, press the <MENU> button, choose [Digital Zoom] on the [CAM] tab, and then choose [Off].

Still Images

Movies

Using the Self-Timer

With the self-timer, you can include yourself in group photos or other timed shots. The camera will shoot about 10 seconds after you press the shutter button.



1 Configure the setting.

- Press the <FUNC SET> button, choose [OFF] in the menu, and then choose the [10] option (see 47).
- ▶ Once the setting is complete, [10] is displayed.

2 Shoot.

- For Still Images: Press the shutter button halfway to focus on the subject, and then press it all the way down.
- For Movies: Press the movie button.

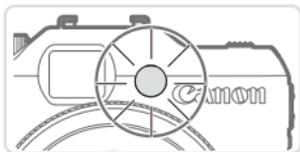

- ▶ Once you start the self-timer, the lamp will blink and the camera will play a self-timer sound.
- ▶ Two seconds before the shot, the blinking and sound will speed up. (The lamp will remain lit in case the flash fires.)
- To cancel shooting after you have triggered the self-timer, press the <MENU> button.
- To restore the original setting, choose [Off] in step 1.

Still Images

Movies

Using the Self-Timer to Avoid Camera Shake

This option delays shutter release until about two seconds after you have pressed the shutter button. If the camera is unsteady while you are pressing the shutter button, it will not affect your shot.



Configure the setting.

- Follow step 1 on [page 64](#) and choose [2].
- ▶ Once the setting is complete, [2] is displayed.
- Follow step 2 on [page 64](#) to shoot.

■ Customizing the Self-Timer

You can specify the delay (0 – 30 seconds) and number of shots (1 – 10).

1 Choose [C/C].

- Following step 1 on [p. 64](#), choose [C/C] and press the <MENU> button.

2 Configure the setting.

- Turn the <☀> dial to set the delay. Press the <◀><▶> buttons or turn the <⦿> dial to specify the number of shots, and then press the <FUNC SET> button.
- ▶ Once the setting is complete, [C/C] is displayed.
- Follow step 2 on [p. 64](#) to shoot.



- For movies shot using the self-timer, the delay represents the delay before recording begins, but the setting for the number of shots has no effect.



- When you specify multiple shots, image brightness and white balance are determined by the first shot. More time is required between shots when the flash fires or when you have specified to take many shots. Shooting will stop automatically when the memory card becomes full.
- When a delay longer than two seconds is specified, two seconds before the shot, the lamp blinking and self-timer sound will speed up. (The lamp will remain lit in case the flash fires.)

Adding a Date Stamp

The camera can add the shooting date to images, in the lower-right corner. However, note that date stamps cannot be edited or removed, so confirm beforehand that the date and time are correct (📖20).

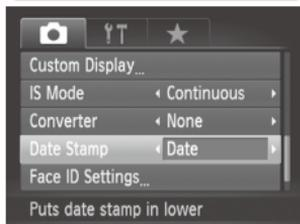
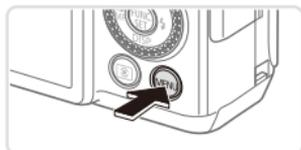

1 Configure the setting.

- Press the <MENU> button, choose [Date Stamp] on the [📷] tab, and then choose the desired option (📖48).
- ▶ Once the setting is complete, [DATE] is displayed.

2 Shoot.

- ▶ As you take shots, the camera adds the shooting date or time to the lower-right corner of images.
- To restore the original setting, choose [Off] in step 1.



- Date stamps cannot be edited or removed.



- Shots taken without adding a date stamp can be printed with one as follows. However, adding a date stamp this way to images that already have one may cause it to be printed twice.
 - Use the included software to print
For details, refer to the *Software Guide* (📖30).
 - Print using printer functions (📖259)
 - Use camera DPOF print settings (📖266) to print

Choosing Subjects to Focus On (Tracking AF)

Shoot after choosing a subject to focus on as follows.



1 Specify Tracking AF.

- Press the <▲> button.
- ▶ [□] is displayed in the center of the screen.



2 Choose a subject to focus on.

- Aim the camera so that [□] is on the desired subject, and then press the shutter button halfway.
- ▶ A blue frame is displayed, and the camera will keep the subject in focus and image brightness adjusted (Servo AF).

3 Shoot.

- Press the shutter button all the way down to shoot.
- Press the <▲> button to cancel Tracking AF.



- Tracking may not be possible when subjects are too small or move too rapidly, or when subject color or brightness matches that of the background too closely.

Using Face ID

If you register a person ahead of time, the camera will detect that person's face, and prioritize focus, brightness, and color for that person when shooting. In <AUTO> mode, the camera can detect babies and children based on registered birthdays and optimize settings for them when shooting.

This function is also useful when searching for a specific registered person among a large number of images (📖181).

Personal Information

- Information such as images of a face (face info) registered with Face ID, and personal information (name, birthday) will be saved on the camera. Additionally, when registered people are detected, their names will be recorded in still images. When using the Face ID function, be careful when sharing the camera or images with others, and when posting images online where many others can view them.
- When disposing of a camera or transferring it to another person after using Face ID, be sure to erase all information (registered faces, names, and birthdays) from the camera (📖79).

Registering Face ID Information

You can register information (face info, name, birthday) for up to 12 people to use with Face ID.



1 Access the setting screen.

- Press the <MENU> button, choose [Face ID Settings] on the [📷] tab, and then press the <FUNC. SET> button (📖48).

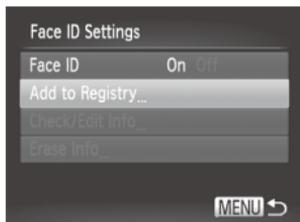

- Press the <▲><▼> buttons or turn the <⦿> dial to choose [Add to Registry], and then choose [Add a New Face].

2 Register face information.

- Aim the camera so that the face of the person you want to register is inside the gray frame at the center of the screen.
- A white frame on the person's face indicates that the face is recognized. Make sure a white frame is displayed on the face, and then shoot.
- If the face is not recognized, you cannot register face information.

3 Save the settings.

- After [Register?] is displayed, press the <◀><▶> buttons or turn the <⦿> dial to choose [OK], and then press the <FUNC. SET> button.

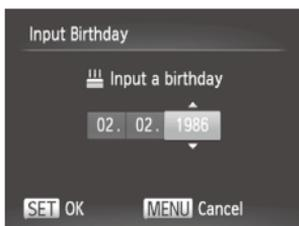
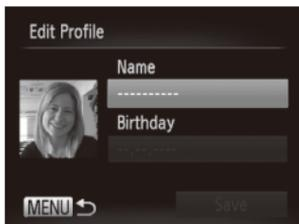

- ▶ The [Edit Profile] screen is displayed.

4 Enter a name.

- Press the <FUNC SET> button.
- Press the <▲><▼><◀><▶> buttons or turn the <●> dial to choose a character, and then press the <FUNC SET> button to enter it.
- Up to 10 characters can be used.
- To move the cursor, choose [◀] or [▶] and press the <FUNC SET> button, or turn the <☀> dial.
- To delete the previous character, either press the <🗑> button or choose [🗑] and press the <FUNC SET> button.
- Press the <MENU> button to return to the edit profile screen.

5 Enter a birthday.

- Press the <▲><▼> buttons or turn the <●> dial to choose [Birthday], and then press the <FUNC SET> button.
- Press the <◀><▶> buttons to choose a setting.
- Press the <▲><▼> buttons or turn the <●> dial to specify the date.
- When finished, press the <FUNC SET> button.



6 Save the settings.

- Press the <▲><▼> buttons or turn the <●> dial to choose [Save], and then press the <FUNC SET> button.
- After a message is displayed, press the <◀><▶> buttons or turn the <●> dial to choose [Yes], and then press the <FUNC SET> button.

7 Continue registering face information.

- To register up to 4 more points of face information (expressions or angles), repeat steps 2 – 3.
- Registered faces are more easily recognized if you add a variety of face information. In addition to a head-on angle, add a slight side angle, a shot when smiling, and shots inside and outside.



- The flash will not fire when following step 2.
- If you do not register a birthday in step 5, Babies or Children icons (📖59) will not display in <AUTO> mode.



- You can overwrite registered face info, and add face info later if you have not filled all 5 face info slots (📖76).

Shooting

If you register a person ahead of time, the camera will prioritize that person as the main subject, and optimize focus, brightness, and color for that person when shooting.



- ▶ When you point the camera toward a subject, the names of up to 3 registered people will be displayed when they are detected.
- Shoot.
- ▶ Displayed names will be recorded in still images. Even if people are detected, but their names are not displayed, the names (up to 5 people) will be recorded in the image.



- People other than those registered may be mistakenly detected as the registered person if they share similar facial features.



- Registered people may not be correctly detected if the captured image or scene differs drastically from the registered face information.
- If a registered face is not detected, or not easily detected, overwrite registered information with new face info. Registering face info right before shooting will allow for easier detection of registered faces.
- If a person is mistakenly detected as another person and you continue shooting, you can edit or erase the name recorded in the image during playback (📖187).
- Because faces of babies and children change quickly as they grow, you should update their face info regularly (📖76).
- When information display is set to off (📖46), names will not display, but will be recorded in the image.
- If you don't want names to be recorded in still images, choose [Face ID Settings] on the [📷] tab, choose [Face ID], and then choose [Off].
- You can check names recorded in images in the playback screen (simple information display) (📖174).

Checking and Editing Registered Information

Checking Registered Face ID Information

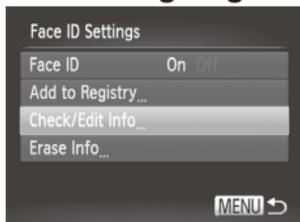

1 Access the [Check/Edit Info] screen.

- Following step 1 on 69, choose [Check/Edit Info] and press the <FUNC SET> button.



2 Choose a person to check.

- Press the <▲><▼><◀><▶> buttons or turn the <DIAL> dial to choose a person, and then press the <FUNC SET> button.

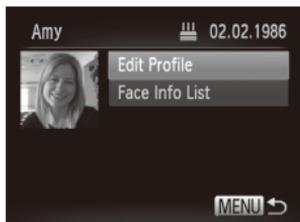

3 Check the registered information.

- Press the <▲><▼> buttons or turn the <DIAL> dial to choose an item, and then press the <FUNC SET> button.
- Check the registered information.

Changing the Name or Birthday

1 Access the [Edit Profile] screen.

- Following steps 1 – 3 on  74, choose [Edit Profile] and press the  button.

2 Input changes.

- Press the   buttons or turn the  dial to choose an item, and follow steps 4 – 5 on  71 to input changes.

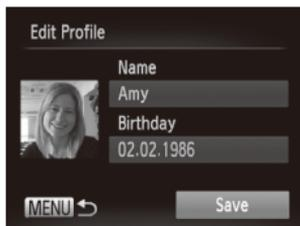

- Even if you change names in [Edit Profile], the names recorded in previously shot images will remain the same.



- You can use the included software to edit registered names. Some characters entered with the included software may not display on the camera, but will be correctly recorded in images.

Overwriting and Adding Face Information

You can overwrite existing face information with new face info. You should update face information regularly, especially with babies and children, as their faces change quickly as they grow.

You can also add face information when all 5 face info slots have not been filled.

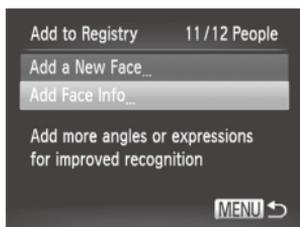

1 Access the [Add Face Info] screen.

- On the screen in step 1 on [69](#), choose [Add Face Info] and press the button.



2 Choose the name of the person to overwrite.

- Press the or turn the dial to choose the name of a person to overwrite, and then press the button.
- If 4 or less face information slots are registered, follow step 5 on [77](#) to add more face info.



3 Access the face info screen.

- Read the message that displays, press the or turn the dial to choose [OK], and then press the button.
- ▶ The face info screen is displayed.



4 Choose the face info to overwrite.

- Press the <▲><▼><◀><▶> buttons or turn the <🌀> dial to choose the face info to overwrite, and then press the <FUNC-SET> button.

5 Register face information.

- Follow steps 2 – 3 on [70](#) to shoot, and then register the new face information.
- Registered faces are more easily recognized if you add a variety of face information. In addition to a head-on angle, add a slight side angle, a shot when smiling, and shots inside and outside.



- You cannot add face information if all 5 information slots are filled. Follow the steps above to overwrite face information.
- You can follow the above steps to register new face info when there is at least one slot open, however you cannot overwrite any face information. Instead of overwriting face info, first erase unwanted existing info ([78](#)), and then register new face information ([69](#)) as needed.

Erasing Face Information

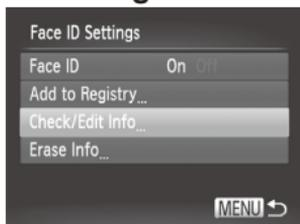

1 Access the [Check/Edit Info] screen.

- Following step 1 on [page 69](#), choose [Check/Edit Info] and press the  button.

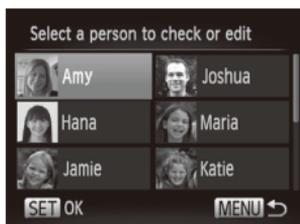

2 Choose the name of the person whose face info you want to erase.

- Press the , , , or  buttons or turn the  dial to choose the name of the person whose face info you want to erase, and then press the  button.



3 Access the [Face Info List] screen.

- Press the ,  buttons or turn the  dial to choose [Face Info List], and then press the  button.



4 Choose the face info to erase.

- Press the  button, press the , , , or  buttons or turn the  dial to choose the face info you want to erase, and then press the  button.
- After [Erase?] is displayed, press the ,  buttons or turn the  dial to choose [OK], and then press the  button.
- ▶ The selected face info will be erased.

Erasing Registered Information

You can erase information (face info, name, birthday) registered to Face ID. However, names recorded in previously shot images will not be erased.



1 Access the [Erase Info] screen.

- Follow step 1 on [page 69](#) and choose [Erase Info].



2 Choose the name of the person whose info you want to erase.

- Press the <▲><▼><◀><▶> buttons or turn the  dial to choose the name of a person to erase, and then press the  button.
- After [Erase?] is displayed, press the <◀><▶> buttons or turn the  dial to choose [OK], and then press the  button.



- If you erase a registered person's info, you will not be able to display their name ([page 46](#)), overwrite their info ([page 187](#)), or search images for them ([page 181](#)).



- You can also erase a person's name only from images ([page 188](#)).

Changing the Aspect Ratio

Change the image aspect ratio (ratio of width to height) as follows.



Configure the setting.

- Press the **<FUNC SET>** button, choose **[4:3]** in the menu, and choose the desired option (see 47).
- ▶ Once the setting is complete, the screen aspect ratio will be updated.
- To restore the original setting, repeat this process but choose **[4:3]**.

16:9	Used for display on widescreen HDTVs or similar display devices.
3:2	Same aspect ratio as 35mm film, used for printing images at 5 x 7-inch or postcard sizes.
4:3	Native aspect ratio of the camera screen, also used for display on standard-definition televisions or similar display devices, or for printing images at 3.5 x 5-inch or A-series sizes.
1:1	Square aspect ratio.
4:5	Aspect ratio commonly used for portraits.

Changing Image Resolution (Size)

Choose from 4 levels of image resolution, as follows. For guidelines on how many shots at each resolution setting can fit on a memory card, see “Specifications” (303).



Configure the setting.

- Press the <FUNC SET> button, choose [L] in the menu, and choose the desired option (47).
- ▶ The option you configured is now displayed.
- To restore the original setting, repeat this process but choose [L].

Guidelines for Choosing Resolution Based on Paper Size (for 4:3 Images)

A2 (16.5 x 23.4 in.)	L
A3 – A5 (11.7 x 16.5 – 5.8 x 8.3 in.)	M1
5 x 7 in. Postcard 3.5 x 5 in.	M2

- [S]: For e-mailing images.

Red-Eye Correction

Red-eye that occurs in the flash photography can be automatically corrected as follows.

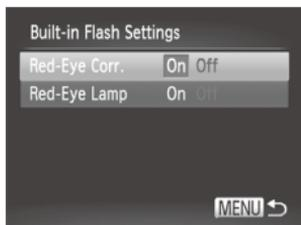
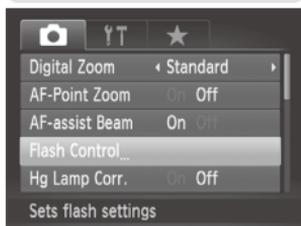

1 Access the [Built-in Flash Settings] screen.

- Press the <MENU> button, choose [Flash Control] on the [CAMERA] tab, and then press the <FUNC/SET> button (📖 48).

2 Configure the setting.

- Choose [Red-Eye Corr.], and then choose [On] (📖 48).
- ▶ Once the setting is complete, [OK] is displayed.
- To restore the original setting, repeat this process but choose [Off].



- Red-eye correction may be applied to image areas other than eyes (if the camera misinterprets red eye makeup as red pupils, for example).



- You can also correct existing images (📖 211).
- You can also access the screen in step 2 by holding down the <▶> button for at least one second.
- You can also access the screen in step 2 when the flash is up by pressing the <▶> button and immediately pressing the <MENU> button.

Correcting Greenish Image Areas from Mercury Lamps

In shots of evening scenes with subjects illuminated by mercury lamps, the subjects or background may appear to have a greenish tinge. This greenish tinge can be corrected automatically when shooting, using Multi-area White Balance.



Configure the setting.

- Press the <MENU> button, choose [Hg Lamp Corr.] on the [CAMERA] tab, and then choose [On] (48).
- ▶ Once the setting is complete, [WB] is displayed.
- To restore the original setting, repeat this process but choose [Off].



- After you are finished shooting under mercury lamps, you should set [Hg Lamp Corr.] back to [Off]. Otherwise, green hues not caused by mercury lamps may be corrected by mistake.



- Try taking some test shots first to make sure you obtain the desired results.

Changing Movie Image Quality

3 image quality settings are available. For guidelines on the maximum movie length at each level of image quality that will fit on a memory card, see “Specifications” (📖 303).



Configure the setting.

- Press the <FUNC SET> button, choose [1920] in the menu, and choose the desired option (📖 47).
- ▶ The option you configured is now displayed.
- To restore the original setting, repeat this process but choose [1920].

Image Quality	Resolution	Frame Rate	Details
[1920]	1920 x 1080*	24 fps	For shooting in Full HD
[1280]	1280 x 720	30 fps	For shooting in HD
[640]	640 x 480	30 fps	For shooting in standard definition

* Fine Detail Movie Processing (This function quickly processes a large amount of information, making it possible to record even finer details in movies.)



- In [1920] and [1280] modes, black bars displayed on the top and bottom edges of the screen indicate image areas not recorded.

Using the Wind Filter

Distorted audio caused by recording when the wind is strong can be reduced. However, the recording may sound unnatural when this option is used when there is no wind.



Configure the setting.

- Press the <MENU> button, choose [Wind Filter] on the [CAMERA] tab, and then choose [On] (p.48).
- To restore the original setting, repeat this process but choose [Off].

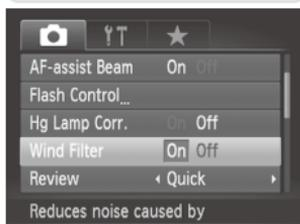

Using the Dual Axis Electronic Level

An electronic level can be displayed as a guideline to ensure the camera is level from front to back and left to right.



1 Display the electronic level.

- Press the <▼> button several times to display the electronic level.



Back or Forward
Left or Right

2 Straighten the camera.

- If the camera is tilted, move it so that the red line changes to green.



- If the electronic level is not displayed in step 1, press the <MENU> button, and on the [CAMERA] tab, choose [Custom Display]. Add a [✓] to [LV] or [RV] to choose the electronic level.
- The electronic level is not displayed during movie recording.
- If you hold the camera vertically, the orientation of the electronic level will be updated automatically to match the camera orientation.
- Calibrate the electronic level if it seems ineffective in helping you level the camera (📖228).

Magnifying the Area in Focus

You can check the focus by pressing the shutter button halfway, which will enlarge the portion of the image in focus in the AF frame.



1 Configure the setting.

- Press the <MENU> button, choose [AF-Point Zoom] on the [CAMERA] tab, and then choose [On] (📖 48).



2 Check the focus.

- Press the shutter button halfway. The face detected as the main subject is now magnified.
- To restore the original setting, choose [Off] in step 1.



- The area in focus will not be magnified when you press the shutter button halfway if a face was not detected, if the person is too close to the camera and their face is too large for the screen, or if the camera detects subject movement.



- The display will not magnify when using the digital zoom (📖 63) or Tracking AF (📖 148).

Checking for Closed Eyes

[>] is displayed when the camera detects that people may have closed their eyes.



1 Configure the setting.

- Press the <MENU> button, choose [Blink Detection] on the [>] tab, and then choose [On] ( 48).

2 Shoot.

- ▶ [>] is displayed when the camera detects a person whose eyes are closed.
- To restore the original setting, choose [Off] in step 1.



- When you have specified multiple shots in [>] mode, this function is only available for the final shot.
- This feature is not available during continuous shooting in [>] mode ( 139).
- A frame is displayed around people whose eyes are closed when you have selected 2 – 10 seconds in [Review], or if you have selected [Hold] ( 90).

Customizing Camera Operation

Customize shooting functions on the [CAMERA] tab of the menu as follows. For instructions on menu functions, see “MENU Menu” (48).

Still Images

Deactivating the AF Assist Beam

You can deactivate the lamp that normally lights up to help you focus when you press the shutter button halfway in low-light conditions.

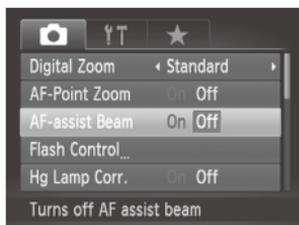

Configure the setting.

- Press the <MENU> button, choose [AF-assist Beam] on the [CAMERA] tab, and then choose [Off] (48).
- To restore the original setting, repeat this process but choose [On].

Still Images

Deactivating the Red-Eye Reduction Lamp

You can deactivate the red-eye reduction lamp that lights up to reduce red-eye when the flash is used in low-light shots.

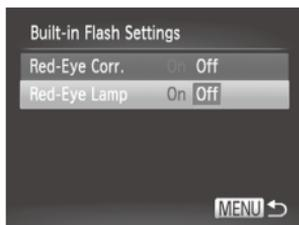

1 Access the [Built-in Flash Settings] screen.

- Press the <MENU> button, choose [Flash Control] on the [CAMERA] tab, and then press the <FUNC/SET> button (48).

2 Configure the setting.

- Choose [Red-Eye Lamp], and then choose [Off] (48).
- To restore the original setting, repeat this process but choose [On].

Changing the Image Display Period After Shots

Change how long images are displayed after shots as follows.



Configure the setting.

- Press the <MENU> button, choose [Review] on the [CAMERA] tab, and then choose the desired option (see page 48).
- To restore the original setting, repeat this process but choose [Quick].

Quick	Displays images only until you can shoot again.
2 – 10 sec.	Displays images for the specified time. Even while the shot is displayed, you can take another shot by pressing the shutter button halfway again.
Hold	Displays images until you press the shutter button halfway.
Off	No image display after shots.

Changing the Image Display Style After Shots

Change the way images are displayed after shots as follows.

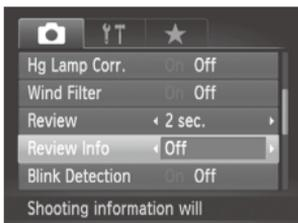

1 In [Review], choose either **2 – 10 seconds** or [Hold] (📖90).

2 Configure the setting.

- Press the <MENU> button, choose [Review Info] on the [📷] tab, and then choose the desired option (📖48).
- To restore the original setting, repeat this process but choose [Off].

Off	Displays only the image.
Detailed	Displays shooting details (📖288).
Focus Check	Shows the area in the AF frame magnified, enabling you to check the focus. Follow the steps in "Checking the Focus" (📖179).

3

Other Shooting Modes

Shoot more effectively in various scenes, and take shots enhanced with unique image effects or captured using special functions



Auto Clip Recording (Movie Digest)

You can make a short movie of a day just by shooting still images. Before each shot, the camera will automatically record a movie clip of the scene. Each clip recorded that day is combined into a single file.



1 Enter <M> mode.

- Set the mode dial to <M>.

2 Shoot.

- To shoot a still image, press the shutter button all the way down.
- ▶ Before shooting, the camera will automatically record a clip about 2 – 4 seconds long.



- Clips may not be recorded if you shoot a still image immediately after turning the camera on, choosing <M> mode, or operating the camera in other ways.
- Battery life is shorter in this mode than in <AUTO> mode, because clips are recorded for each shot.
- Any sounds from camera operations during movie recording will be included in the movie.



- Movies created in <M> mode can be viewed by date (📖185).
- Movies created in <M> mode are saved as iFrame movies (📖120).
- Although the clips recorded on a particular day are combined into a single file, individual clips (chapters) can be edited (📖215).
- Clips are saved as separate movie files in the following cases even if they were recorded on the same day in <M> mode.
 - If the movie file size reaches about 4 GB or the total recording time reaches approx. 29 minutes and 59 seconds
 - If a movie is protected (📖192)
 - If the daylight saving time (📖21) or time zone (📖220) settings have been changed
 - If a new folder is created (📖225)
- Some camera sounds will be muted. Sounds are not played when you press the shutter button halfway, use camera controls, or trigger the self-timer (📖219).

Specific Scenes

Choose a mode matching the shooting scene, and the camera will automatically configure the settings for optimal shots.



1 Enter <SCN> mode.

- Set the mode dial to <SCN>.

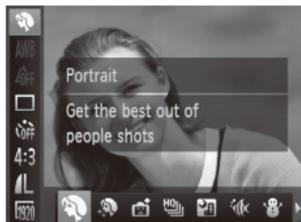

2 Choose a shooting mode.

- Press the <FUNC/SET> button, choose [P] in the menu, and then choose a shooting mode (p.47).

3 Shoot.

Still Images

Movies

Shoot portraits (Portrait)

- Take shots of people with a softening effect.



Still Images

Shoot evening scenes without using a tripod (Handheld NightScene)

- Beautiful shots of evening scenes or portraits with evening scenery in the background, without the need to hold the camera very still (as with a tripod).
- A single image is created by combining consecutive shots, reducing camera shake and image noise.





Still Images

Movies

Shoot under water (Underwater)

- Natural-colored shots of sea life and underwater scenery, when you use an optional waterproof case (📖237).
- This mode can correct white balance and match the effect of using a commercially available color-compensating filter (📖135).



Still Images

Movies

Shoot with snowy backgrounds (Snow)

- Bright, natural-colored shots of people against snowy backgrounds.



Still Images

Movies

Shoot fireworks (Fireworks)

- Vivid shots of fireworks.



- Subjects appear larger in  mode compared to other modes.
- In  and  modes, shots may look grainy because the ISO speed (📖129) is increased to suit the shooting conditions.
- Because the camera will shoot continuously in  mode, hold it steady while shooting.
- In  mode, excessive camera shake or certain shooting conditions may prevent you from obtaining the desired results.
- In  mode, mount the camera on a tripod or take other measures to keep it still and prevent camera shake. Additionally, you should set [IS Mode] to [Off] when using a tripod or other means to hold the camera still (📖160).



- When you use a tripod for evening scenes, shooting in [AUTO] mode instead of [P] mode will give better results (📖54).

Still Images

Shooting With an Underwater Focusing Range

If focusing is difficult in [i] mode (📖96) with a focus range of [AA], using a focus range designed for underwater shooting can ensure optimal underwater shots.

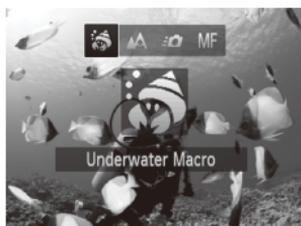

1 Configure the setting.

- Follow steps 1 – 2 on 📖95 and choose [i].
- Press the <◀> button, choose the desired focus range (either press the <◀><▶> buttons or turn the <⦿> dial), and then press the <FUNC SET> button.

2 Shoot.

Focusing Range	Description
Underwater Macro	Take close-ups of sea life, using the digital zoom for even closer shots.
Quick	Avoid missing unexpected underwater shooting opportunities when shooting subjects some distance away. Especially effective for moving subjects.
MF Manual Focus	Focus on subjects manually (📖142).

Refer to “Specifications” (📖303) for details on the range of each focus range.



- In [i] mode, optical zoom is set to maximum wide angle.
- In [i] mode, use of digital zoom may cause images to appear grainy at some resolutions (📖81).
- In [Quick] mode, subjects at close range may not be in focus. In this case, try setting the focus range to [AA].



- [i] and [Quick] are not available in [Tracking AF] AF frame mode (📖148).

Making Skin Look Smoother (Smooth Skin)

You can apply a smoothening effect when shooting images of people. The effect level and color ([Lighter Skin Tone], [Darker Skin Tone]) can be chosen as follows.

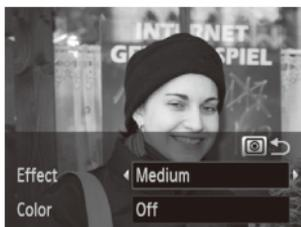

1 Choose [Smooth Skin].

- Follow steps 1 – 2 on [page 95](#) and choose [Smooth Skin].

2 Access the setting screen.

- Press the <[Smooth Skin] > button.

3 Configure the setting.

- Press the <▲><▼> buttons to choose an option. Choose the effect level (either press the <◀><▶> buttons or turn the <[Smooth Skin] > dial), and then press the <[Smooth Skin] > button.
 - ▶ A preview is shown of how your shot will look with the effect applied.

4 Shoot.



- Areas other than people's skin may be modified.
- Try taking some test shots first to make sure you obtain the desired results.



- The effect will be stronger for the face of the person detected as the main subject.

Image Effects (Creative Filters)

Add a variety of effects to images when shooting.



1 Enter <Fn> mode.

- Set the mode dial to <Fn>.

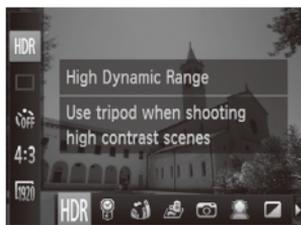

2 Choose a shooting mode.

- Press the <FUNC SET> button, choose [HDR] in the menu, and then choose a shooting mode (47).

3 Shoot.

Still Images

Movies

Shoot in vivid colors (Super Vivid)

- Shots in rich, vivid colors.



Still Images

Movies

Posterized shots (Poster Effect)

- Shots that resemble an old poster or illustration.



- In [] and [] modes, try taking some test shots first, to make sure you obtain the desired results.

Shooting High-Contrast Scenes (High Dynamic Range)

Three consecutive images are captured at different brightness levels each time you shoot, and the camera combines image areas with optimal brightness to create a single image. This mode can reduce the washed-out highlights and loss of detail in shadows that tends to occur in high-contrast shots.



1 Choose [HDR].

- Follow steps 1 – 2 on 99 and choose [HDR].

2 Hold the camera still.

- Mount the camera on a tripod or take other measures to keep it still and prevent camera shake.

3 Shoot.

- When you press the shutter button all the way down, the camera will take three shots and combine them.



- Set [IS Mode] to [Off] (160) in this mode.



- Any subject movement will cause images to look blurry.
- There will be a delay before you can shoot again, as the camera processes and combines the images.

Adding Color Effects

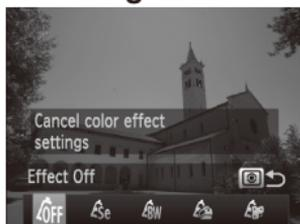

- Follow steps 1 – 2 on [page 99](#) and choose [HDR].
- Press the <[Eye]> button, choose a color effect (either press the <[Left Arrow]>[Right Arrow]> buttons or turn the [Dial], and then press the <[Eye]> button again.

Effect Off	–
Sepia	Sepia tone shots.
B/W	Black and white shots.
Super Vivid	Shots in rich, vivid colors.
Poster Effect	Shots that resemble an old poster or illustration.

Shooting with Faded Colors (Nostalgic)

This effect makes colors look faded and images look weathered, as in old photographs. Choose from five effect levels.



1 Choose [📷].

- Follow steps 1 – 2 on 99 and choose [📷].

2 Choose an effect level.

- Turn the <🌞> dial to choose an effect level.
- ▶ A preview is shown of how your shot will look with the effect applied.

3 Shoot.



- Try taking some test shots first, to make sure you obtain the desired results.



- Colors will look faded on the shooting screen, but the image aging effect is not shown. Review the image in Playback mode to see the effect (174).
- The image aging effect is not shown in movies.

Shooting with a Fish-Eye Lens Effect (Fish-eye Effect)

Shoot with the distorting effect of a fish-eye lens.



1 Choose [F].

- Follow steps 1 – 2 on 99 and choose [F].

2 Choose an effect level.

- Turn the dial to choose an effect level.
- ▶ A preview is shown of how your shot will look with the effect applied.

3 Shoot.



- Try taking some test shots first, to make sure you obtain the desired results.

Shots Resembling Miniature Models (Miniature Effect)

Creates the effect of a miniature model, by blurring image areas above and below your selected area.

You can also make movies that look like scenes in miniature models by choosing the playback speed before the movie is recorded. People and objects in the scene will move quickly during playback. Note that sound is not recorded.

1 Choose [📷].

- Follow steps 1 – 2 on  99 and choose [📷].
- ▶ A white frame is displayed, indicating the image area that will not be blurred.

2 Choose the area to keep in focus.

- Press the <> button.
- Move the zoom lever to resize the frame, and turn the <> dial to move it.



3 For movies, choose the movie playback speed.

- Turn the <> dial to choose the speed.

4 Return to the shooting screen and shoot.

- Press the <> button to return to the shooting screen, and then shoot.

Playback Speed and Estimated Playback Time (for One-Minute Clips)

Speed	Playback Time
5x	Approx. 12 sec.
10x	Approx. 6 sec.
20x	Approx. 3 sec.



- The zoom is not available when shooting movies. Be sure to set the zoom before shooting.
- Try taking some test shots first, to make sure you obtain the desired results.



- To switch the orientation of the frame to vertical, press the <◀><▶> buttons in step 2. To move the frame, press the <◀><▶> buttons again. To return the frame to horizontal orientation, press the <▲><▼> buttons.
- Holding the camera vertically will change the orientation of the frame.
- Movie image quality is [640] at an aspect ratio of [4:3] and [1280] at an aspect ratio of [16:9] (📖80). These quality settings cannot be changed.

Shooting with a Toy Camera Effect (Toy Camera Effect)

This effect makes images resemble shots from a toy camera by vignetting (darker, blurred image corners) and changing the overall color.

1 Choose [📷].

- Follow steps 1 – 2 on  99 and choose [📷].

2 Choose a color tone.

- Turn the <🌅> dial to choose a color tone.
- ▶ A preview is shown of how your shot will look with the effect applied.

3 Shoot.



Standard	Shots resemble toy camera images.
Warm	Images have a warmer tone than with [Standard].
Cool	Images have a cooler tone than with [Standard].



- Try taking some test shots first, to make sure you obtain the desired results.

Shooting With a Soft Focus Effect

This function allows you to shoot images as if a soft focus filter is attached to the camera. You can adjust the effect level as desired.



1 Choose [☉].

- Follow steps 1 – 2 on 99 and choose [☉].

2 Choose an effect level.

- Turn the < > dial to choose an effect level.
- ▶ A preview is shown of how your shot will look with the effect applied.

3 Shoot.



- Try taking some test shots first, to make sure you obtain the desired results.

Shooting in Monochrome

Shoot images in black and white, sepia, or blue and white.



1 Choose [▣].

- Follow steps 1 – 2 on 99 and choose [▣].

2 Choose a color tone.

- Turn the < > dial to choose a color tone.
- ▶ A preview is shown of how your shot will look with the effect applied.

3 Shoot.

B/W	Black and white shots.
Sepia	Sepia tone shots.
Blue	Blue and white shots.

Shooting with Color Accent

Choose a single image color to keep and change other colors to black and white.

1 Choose [A].

- Follow steps 1 – 2 on [page 99](#) and choose [A].



2 Access the setting screen.

- Press the <[OK]> button.
- ▶ The original image and the Color Accent image are displayed one after another.
- ▶ By default, green is the color that will be kept.



Recorded Color

3 Specify the color.

- Position the center frame over the color to keep, and then press the <[Left/Right]> button.
- ▶ The specified color is recorded.

4 Specify the range of colors to keep.

- Press the <[Up/Down]> buttons or turn the <[Dial]> dial to adjust the range.
- To keep only your specified color, choose a large negative value. To keep colors similar to your specified color as well, choose a large positive value.
- Press the <[OK]> button to return to the shooting screen.

5 Shoot.



- Using the flash in this mode may cause unexpected results.
- In some shooting scenes, images may look grainy and colors may not look as expected.

Shooting with Color Swap

You can replace one image color with another before shooting. Note that only one color can be replaced.

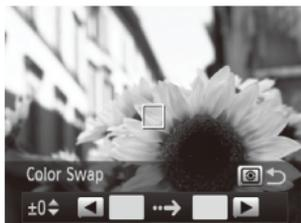

1 Choose [f/s].

- Follow steps 1 – 2 on [page 99](#) and choose [f/s].

2 Access the setting screen.

- Press the <[camera icon]> button.
- ▶ The original image and the Color Swap image are displayed one after another.
- ▶ By default, green will be replaced with gray.

3 Specify the color to replace.

- Position the center frame over the color to replace, and then press the <[left arrow]> button.
- ▶ The specified color is recorded.

4 Specify the new color.

- Position the center frame over the new color, and then press the <[right arrow]> button.
- ▶ The specified color is recorded.

5 Specify the range of colors to replace.

- Press the <▲><▼> buttons or turn the <⦿> dial to adjust the range.
- To replace only your specified color, choose a large negative value. To replace colors similar to your specified color as well, choose a large positive value.
- Press the <👁> button to return to the shooting screen.

6 Shoot.



- Using the flash in this mode may cause unexpected results.
- In some shooting scenes, images may look grainy and colors may not look as expected.

Auto Shooting After Face Detection (Smart Shutter)

Auto Shooting After Smile Detection

The camera shoots automatically after detecting a smile, even without you pressing the shutter button.



1 Choose [😊].

- Follow steps 1 – 2 on [p95](#) and choose [📷], and then press the <📷> button.
- Press the <◀><▶> buttons or turn the <🔘> dial to choose [😊], and then press the <📷> button.

▶ The camera now enters shooting standby mode, and [Smile Detection on] is displayed.

2 Aim the camera at a person.

- Each time the camera detects a smile, it will shoot after the lamp lights up.
- To pause smile detection, press the <▼> button. Press the <▶> button again to resume detection.



- Switch to another mode when you finish shooting, or the camera will continue shooting each time a smile is detected.



- You can also shoot as usual by pressing the shutter button.
- The camera can detect smiles more easily when subjects face the camera and open their mouth wide enough so that teeth are visible.
- To change the number of shots, press the <▲><▼> buttons after choosing [😊] in step 1. [Blink Detection] ([p88](#)) is only available for the final shot.

Using the Wink Self-Timer

Aim the camera at a person and press the shutter button all the way down. The camera will shoot about two seconds after a wink is detected.



1 Choose [Wink].

- Follow steps 1 – 2 on 95 and choose [Wink], and then press the <OK> button.
- Press the <Left><Right> buttons or turn the <Dial> to choose [Wink], and then press the <OK> button.

2 Compose the shot and press the shutter button halfway.

- Make sure a green frame is displayed around the face of the person who will wink.

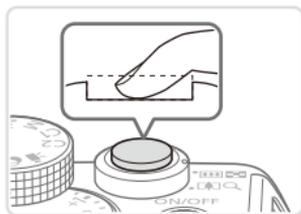

3 Press the shutter button all the way down.

- ▶ The camera now enters shooting standby mode, and [Wink to take picture] is displayed.
- ▶ The lamp blinks and the self-timer sound is played.

4 Face the camera and wink.

- ▶ The camera will shoot about two seconds after detecting a wink by the person whose face is inside the frame.
- To cancel shooting after you have triggered the self-timer, press the <MENU> button.





- If the wink is not detected, wink again slowly and deliberately.
- Winking may not be detected if eyes are obscured by hair, a hat, or glasses.
- Closing and opening both eyes at once will also be detected as a wink.
- If winking is not detected, the camera will shoot about 15 seconds later.
- To change the number of shots, press the <▲><▼> buttons after choosing [👁️] in step 1. [Blink Detection] (📖88) is only available for the final shot.
- If no one is in the shooting area when the shutter button is pressed all the way down, the camera will shoot after a person enters the shooting area and winks.

Still Images

Using the Face Self-Timer

The camera will shoot about two seconds after detecting that the face of another person (such as the photographer) has entered the shooting area (📖145). This is useful when including yourself in group photos or similar shots.



1 Choose [👁️].

- Follow steps 1 – 2 on 📖95 and choose [📷], and then press the <👁️> button.
- Press the <◀><▶> buttons or turn the <🔘> dial to choose [👁️], and then press the <👁️> button.

2 Compose the shot and press the shutter button halfway.

- Make sure a green frame is displayed around the face you focus on and white frames around other faces.

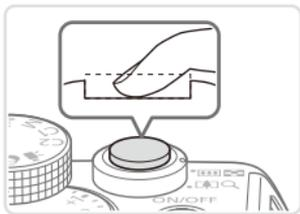

3 Press the shutter button all the way down.

- ▶ The camera now enters shooting standby mode, and [Look straight at camera to start count down] is displayed.
- ▶ The lamp blinks and the self-timer sound is played.



4 Join the subjects in the shooting area and look at the camera.

- ▶ After the camera detects a new face, the lamp blinking and self-timer sound will speed up. (When the flash fires, the lamp will remain lit.) About two seconds later, the camera will shoot.
- To cancel shooting after you have triggered the self-timer, press the <MENU> button.



- Even if your face is not detected after you join the others in the shooting area, the camera will shoot about 15 seconds later.
- To change the number of shots, press the <▲><▼> buttons after choosing [👤] in step 1. [Blink Detection] (📖88) is only available for the final shot.

High-Speed Continuous Shooting (High-speed Burst HQ)

You can shoot a series of shots in rapid succession by holding the shutter button all the way down. For details on the continuous shooting speed, see “Specifications” (📖303).

HQ: High Quality



1 Choose [HQ].

- Follow steps 1 – 2 on 📖95 and choose [HQ].

2 Shoot.

- ▶ Hold the shutter button all the way down to shoot continuously.
- Shooting stops when you release the shutter button or reach the maximum number of shots, after which [Busy] is displayed and the shots are shown in the order you took them.



- Focus, image brightness, and color are determined by the first shot.
- The screen is blank while you are shooting.
- There may be a delay after continuous shooting before you can shoot again. Note that some types of memory cards may delay your next shot even longer. SD Speed Class 6 or higher memory cards are recommended.
- Shooting may slow down depending on shooting conditions, camera settings, and the zoom position.

■ Images Displayed During Playback

Each set of images shot continuously is managed as a single group, and only the first image in that group will be displayed. To indicate that the image is part of a group, [SET 



- If you erase a grouped image (197), all images in the group are also erased. Be careful when erasing images.



- Grouped images can be played back individually (185) and ungrouped (186).
- Protecting (192) a grouped image will protect all images in the group.
- Grouped images can be viewed individually when played back using Image Search (181) or Smart Shuffle (191). In this case, images are temporarily ungrouped.
- Grouped images cannot be tagged as favorites (202), edited (200 – 211), categorized (203), printed (259), set for printing individually (268), added to a Photobook (271), Face ID information cannot be edited (187), and they cannot be assigned as a start-up image (222). To do these things, either view grouped images individually (185) or cancel grouping (186) first.

Shooting Stitch Assist Images

Shoot a large subject by taking multiple shots at various positions, and then use the included software (📖30) to combine them into a panorama.

1 Choose or .

- Follow steps 1 – 2 on 📖95 and choose  or .

2 Take the first shot.

- ▶ The first shot will determine the exposure and white balance.



3 Take additional shots.

- Compose the second shot so that it partially overlaps the image area of the first shot.
- Minor misalignment of overlapping portions will be corrected automatically when the images are combined.
- You can take up to 26 shots, the same way you took the second shot.



4 Finish shooting.

- Press the  button.

5 Use the software to combine the images.

- For instructions on merging images, refer to the *Software Guide* (📖30).



- To use AF lock, assign [AFL] to the  button (📖169).

Shooting Various Movies

Shooting Movies in <[Movie Icon]> Mode



1 Enter <[Movie Icon]> mode.

- Set the mode dial to <[Movie Icon]>.
- ▶ Black bars displayed on the top and bottom edges of the screen indicate image areas not recorded.

2 Configure the settings to suit the movie (📖 290 – 299).

3 Shoot.

- Press the movie button.
- To stop movie recording, press the movie button again.

Locking or Changing Image Brightness Before Shooting

Before shooting, you can lock the exposure or change it in 1/3-stop increments within a range of -3 to +3.

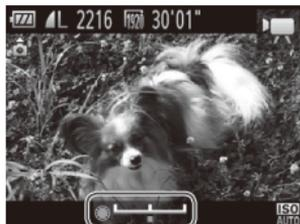

1 Lock the exposure.

- Press the <[*]> button to lock the exposure. The exposure shift bar is displayed.
- To unlock the exposure, press the <[*]> button again.

2 Adjust the exposure.

- Turn the <[Dial]> dial to adjust the exposure, as you watch the screen.

3 Shoot (📖 119).

Shooting iFrame Movies

Shoot movies that can be edited with iFrame-compatible software or devices. You can quickly edit, save, and manage iFrame movies using the included software (📖30).



1 Choose [📺].

- Set the mode dial to <📺>.
- Press the <FUNC SET> button, choose [📺] in the menu, and then choose [📺] (📖47).
- ▶ Black bars displayed on the top and bottom edges of the screen indicate image areas not recorded.

2 Shoot (📖119).



- The resolution is [1280] (📖84) and cannot be changed.
- iFrame is a video format developed by Apple.

Shooting Super Slow Motion Movies

You can shoot fast-moving subjects for playback later in slow motion. Note that sound is not recorded.

1 Choose [📷].

- Set the mode dial to <📷>.
- Press the <FUNC SET> button, choose [📷] in the menu, and then choose [📷] (📖47).



2 Choose a frame rate.

- Press the <FUNC SET> button, choose [240] in the menu, and choose the desired frame rate (📖47).
- ▶ The option you configured is now displayed.



3 Shoot (📖119).

- ▶ A bar showing the elapsed time is displayed. Maximum clip length is approx. 30 sec.

Frame Rate	Image Quality	Playback Time (For a 30-sec. Clip)
240 240 fps	320 (320 x 240)	Approx. 4 min.
120 120 fps	640 (640 x 480)	Approx. 2 min.



- Zooming is not available during recording, even if you move the zoom lever.
- Focus, exposure, and color are determined when you press the movie button.



- The movie will be played back in slow motion when you follow steps 1 – 3 on  174.
- You can change the playback speed of movies shot in [] mode by using the included software. For details, refer to the *Software Guide* ( 30).

4

P Mode

More discerning shots, in your preferred shooting style



- Instructions in this chapter apply to the camera with the mode dial set to <P> mode.
- <P>: Program AE; AE: Auto Exposure
- Before using a function introduced in this chapter in modes other than <P>, make sure the function is available in that mode (📖290 – 299).

Shooting in Program AE Mode (<P> Mode)

You can customize many function settings to suit your preferred shooting style.



1 Enter <P> mode.

- Set the mode dial to <P>.

2 Customize the settings as desired (📖 125 – 160), and then shoot.



- If adequate exposure cannot be obtained when you press the shutter button halfway, shutter speeds and aperture values are displayed in orange. To obtain adequate exposure, try adjusting the following settings.
 - Activate the flash (📖 154)
 - Change the ISO speed (📖 129)
- Movies can be recorded in <P> mode as well, by pressing the movie button. However, some FUNC. (📖 47) and Menu (📖 48) settings may be automatically adjusted for movie recording.
- For details on the shooting range in <P> mode, see “Specifications” (📖 303).

Image Brightness (Exposure Compensation)

Still Images

Adjusting Image Brightness (Exposure Compensation)

The standard exposure set by the camera can be adjusted in 1/3-stop increments, in a range of -3 to +3.



- As you watch the screen, turn the exposure compensation dial to adjust brightness.
- ▶ The correction level you specified is now displayed.

Locking Image Brightness/Exposure (AE Lock)

Before shooting, you can lock the exposure, or you can specify focus and exposure separately.



1 Lock the exposure.

- Aim the camera at the subject to shoot with the exposure locked, and then press the <★> button.
- ▶ [★] is displayed, and the exposure is locked.

2 Compose the shot and shoot.

- After one shot, AE is unlocked and [★] is no longer displayed.



- AE: Auto Exposure
- After the exposure is locked, you can adjust the combination of shutter speed and aperture value by turning the <⦿> dial (Program Shift).

Changing the Metering Method

Adjust the metering method (how brightness is measured) to suit shooting conditions as follows.



- Press the <[Evaluative icon]> button, choose the desired option (either press the <[Left/Right arrow]> buttons or turn the <[Dial]>, and then press the <[Evaluative icon]> button again.
- ▶ The option you configured is now displayed.

<input checked="" type="checkbox"/> Evaluative	For typical shooting conditions, including backlit shots. Automatically adjusts exposure to match the shooting conditions.
<input type="checkbox"/> Center Weighted Avg.	Determines the average brightness of light across the entire image area, calculated by treating brightness in the central area as more important.
<input type="checkbox"/> Spot	Metering restricted to within the [[]] (Spot AE Point frame). You can also link the Spot AE Point frame to the AF frame (see below).

Linking the Spot AE Point Frame to the AF Frame



1 Set the metering method to [⬢].

- Follow the steps on 127 to choose [⬢].

2 Configure the setting.

- Press the <MENU> button, choose [Spot AE Point] on the tab, and then choose [AF Point] (48).
- ▶ The Spot AE Point frame will now be linked to the movement of the AF frame (147).



- Not available when [AF Frame] is set to [Face AiAF] (145) or [Tracking AF] (148).

Changing the ISO Speed



- Press the <▲> button, choose an option (either press the <◀><▶> buttons or turn the <⦿> dial), and then press the <FUNC SET> button.
- ▶ The option you configured is now displayed.

ISO
AUTO

Automatically adjusts the ISO speed to suit the shooting mode and conditions.

ISO **ISO** **ISO** **ISO** **ISO**
80 100 125 160 200

Low

For shooting outdoors in fair weather.

ISO **ISO** **ISO** **ISO** **ISO** **ISO**
250 320 400 500 640 800



For shooting in cloudy conditions, or at twilight.

ISO **ISO** **ISO** **ISO** **ISO** **ISO** **ISO** **ISO** **ISO**
1000 1250 1600 2000 2500 3200 4000 5000 6400

High

For shooting night scenes, or in dark rooms.

ISO **ISO** **ISO**
8000 10000 12800



- To view the automatically set ISO speed when the camera is set to **[ISO AUTO]**, press the shutter button halfway.
- Although choosing a lower ISO speed may reduce image graininess, there may be a greater risk of subject blurriness in some shooting conditions.
- Choosing a higher ISO speed will increase shutter speed, which may reduce subject blurriness and increase the flash range. However, shots may look grainy.
- To specify **[ISO AUTO]**, press the <☉> button on the setting screen.

Adjusting the **ISO AUTO** Setting

When the camera is set to [ISO AUTO], maximum ISO speed can be specified in a range of [ISO 400] – [ISO 1600], and sensitivity can be specified in a range of three levels.

1 Access the setting screen.

- Press the <MENU> button, choose [ISO Auto Settings] on the [CAMERA] tab, and then press the <FUNC SET> button (📖48).

2 Configure the setting.

- Choose a menu item to configure, and then choose the desired option (📖48).

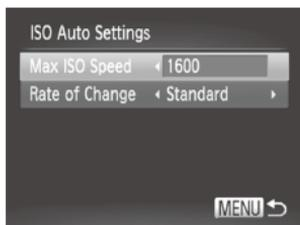

- You can also access the [ISO Auto Settings] screen when the ISO speed setting screen (📖129) is displayed, by pressing the <MENU> button.

Changing the Noise Reduction Level (High ISO NR)

You can choose from 3 levels of noise reduction: [Standard], [High], [Low]. This function is especially effective when shooting at high ISO speeds.

Choose a noise reduction level.

- Press the <MENU> button, choose [High ISO NR] on the [CAMERA] tab, and then choose the desired option (📖48).



- Not available with [RAW] or [RAW+JPEG] (📖159).

Auto Exposure Bracketing (AEB Mode)

Three consecutive images are captured at different exposure levels (standard exposure, underexposure, and then overexposure) each time you shoot. You can adjust the amount of underexposure and overexposure (relative to standard exposure) from -2 to $+2$ stops in $1/3$ -stop increments.



1 Choose [AEB].

- Press the $\langle \text{FUNC SET} \rangle$ button, choose [AEB] in the menu, and then choose [AEB] (📖47).



2 Configure the setting.

- Press the $\langle \text{MENU} \rangle$ button, and then adjust the setting by pressing the $\langle \blacktriangleleft \blacktriangleright \rangle$ buttons or turning the $\langle \text{DIAL} \rangle$ dial.



- AEB is only available in [AF-ON] mode (📖25, 55).
- Continuous shooting (📖139) is not available in this mode.



- If exposure compensation is already in use (📖125), the value specified for that function is treated as the standard exposure level for this function.
- You can also access the setting screen of step 2 by pressing the $\langle \text{MENU} \rangle$ button when the exposure compensation screen (📖125) is displayed.
- Three shots are taken, regardless of any quantity specified in [C] (📖66).
- In [Blink Detection] mode (📖88), this function is only available for the final shot.

Correcting Image Brightness (i-Contrast)

Before shooting, excessively bright or dark image areas (such as faces or backgrounds) can be detected and automatically adjusted to the optimal brightness.

To avoid washed-out highlights, specify Dynamic Range Correction. To preserve image detail in shadows, specify Shadow Correct.



- Under some shooting conditions, correction may be inaccurate or may cause images to appear grainy.



- You can also correct existing images (📖 210).
- You can customize camera operation so that turning the <☀️> or <🌑> dial adjusts DR Correction or Shadow Correct settings (📖 168).

Dynamic Range Correction (DR Correction)

Tone down bright image areas, which might otherwise look washed out, as follows.



- Press the <FUNC SET> button, choose [OFF] in the menu, and choose the desired option (📖 47).
- Once the setting is complete, [i] is displayed.

Item	Details	Available ISO Speed (📖 129)
TOFF	—	—
T AUTO	Automatic adjustment to prevent washed-out highlights	[ISO AUTO], [80] – [12800]
T 200%	Tone down highlights by about 200% relative to the brightness level of [TOFF].	[ISO AUTO], [160] – [1600]
T 400%	Tone down highlights by about 400% relative to the brightness level of [TOFF].	[ISO AUTO], [320] – [1600]

- ! ISO speed (📖 129) will be adjusted to a speed within the supported range if you have specified a value outside the supported range indicated here.

Still Images

Shadow Correct

Automatically preserve image detail in shadows as follows.



- Press the <FUNC SET> button, choose [OFF] in the menu, press the <MENU> button, and choose [AUTO] (📖 47).
- ▶ Once the setting is complete, [Ci] is displayed.

Using the ND Filter

To shoot at slower shutter speeds and smaller aperture values, use the ND filter, which reduces light intensity to 1/8 the actual level (equivalent to 3 stops).



- Press the <FUNC SET> button, choose [NOFF] in the menu, and then choose [ND] (📖 47).

- ! Mount the camera on a tripod or take other measures to keep it still and prevent camera shake. Additionally, you should set [IS Mode] to [Off] when using a tripod or other means to hold the camera still (📖 160).

Adjusting White Balance

By adjusting white balance (WB), you can make image colors look more natural for the scene you are shooting.



- Press the  button, choose [AWB] in the menu, and choose the desired option ()47).
- ▶ The option you configured is now displayed.

 Auto	Automatically sets the optimal white balance for the shooting conditions.
 Day Light	For shooting outdoors in fair weather.
 Cloudy	For shooting in cloudy conditions, in the shade, or at twilight.
 Tungsten	For shooting under ordinary incandescent (tungsten) lighting and similarly colored fluorescent lighting.
 Fluorescent	For shooting under warm-white (or similarly colored) or cool-white fluorescent lighting.
 Fluorescent H	For shooting under daylight fluorescent and similarly colored fluorescent lighting.
 Flash	For shooting with the flash.
 Underwater	Sets the optimal white balance for shooting underwater. Tones down blues to produce natural-looking colors overall.
 Custom	For manually setting a custom white balance ()135).

Custom White Balance

For image colors that look natural under the light in your shot, adjust white balance to suit the light source where you are shooting. Set the white balance under the same light source that will illuminate your shot.

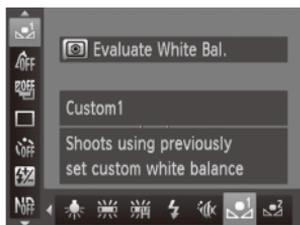

- Follow the steps on 134 and choose or .
- Aim the camera at a plain white subject, so that the entire screen is white. Press the button.
- ▶ The tint of the screen changes once the white balance data has been recorded.



- Colors may look unnatural if you change camera settings after recording white balance data.

Manually Correcting White Balance

You can manually correct white balance. This adjustment can match the effect of using a commercially available color temperature conversion filter or color-compensating filter.



1 Configure the setting.

- Follow the steps on 134 to choose the white balance option.
- Turn the dial to adjust the correction level for B and A.



2 Configure advanced settings.

- To configure more advanced settings, press the <MENU> button and turn the <☀> or <🌑> dial to adjust the correction level.
- To reset the correction level, press the <👁> button.
- Press the <MENU> button to complete the setting.



- The camera will retain white balance correction levels even if you switch to another white balance option in step 1, but correction levels will be reset if you record custom white balance data.



- B: blue; A: amber; M: magenta; G: green
- One level of blue/amber correction is equivalent to about 7 mireds on a color temperature conversion filter. (Mired: Color temperature unit representing color temperature conversion filter density)
- You can customize camera operation so that the B and A adjustment screen can be accessed simply by turning the <☀> dial (📖 168).

Changing Image Color Tones (My Colors)

Change image color tones as desired, such as converting images to sepia or black and white.

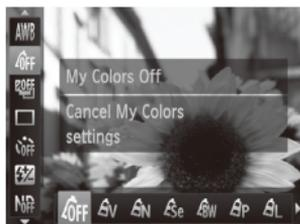

- Press the $\langle \text{FUNC SET} \rangle$ button, choose [OFF] in the menu, and choose the desired option (147).
- ▶ The option you configured is now displayed.

OFF My Colors Off	—
V Vivid	Emphasizes contrast and color saturation, making images sharper.
N Neutral	Tones down contrast and color saturation for subdued images.
Se Sepia	Creates sepia tone images.
BW B/W	Creates black and white images.
P Positive Film	Combines the effects of Vivid Blue, Vivid Green, and Vivid Red to produce intense yet natural-looking colors resembling images on positive film.
L Lighter Skin Tone	Lightens skin tones.
D Darker Skin Tone	Darkens skin tones.
B Vivid Blue	Emphasizes blues in images. Makes the sky, ocean, and other blue subjects more vivid.
G Vivid Green	Emphasizes greens in images. Makes mountains, foliage, and other green subjects more vivid.
R Vivid Red	Emphasizes reds in images. Makes red subjects more vivid.
C Custom Color	Adjust contrast, sharpness, color saturation, and other qualities as desired (138).



- White balance (📖 134) cannot be set in [A_{Se}] or [A_{BW}] modes.
- With [A_L] and [A_D] modes, colors other than people's skin tone may be modified. These settings may not produce the expected results with some skin tones.

Still Images

Movies

Custom Color

Choose the desired level of image contrast, sharpness, color saturation, red, green, blue, and skin tones in a range of 1 – 5.



1 Access the setting screen.

- Follow the steps on 📖 137 to choose [A_C], and then press the <MENU> button.

2 Configure the setting.

- Press the <▲><▼> buttons to choose an option, and then specify the value by pressing the <◀><▶> buttons or turning the <🌀> dial.
- For stronger/more intense effects (or darker skin tones), adjust the value to the right, and for weaker/lighter effects (or lighter skin tones), adjust the value to the left.
- Press the <MENU> button to complete the setting.

Continuous Shooting

Hold the shutter button all the way down to shoot continuously. For details on the continuous shooting speed, see “Specifications” (📖303).



1 Configure the setting.

- Press the <FUNC SET> button, choose [] in the menu, and choose the desired option (📖47).
- ▶ The option you configured is now displayed.

2 Shoot.

- ▶ Hold the shutter button all the way down to shoot continuously.

Mode	Description
 Continuous	Continuous shooting, with the focus and exposure determined when you press the shutter button halfway.
 Continuous Shooting AF	Continuous shooting and focusing. [AF Frame] is set to [Center] and cannot be changed.
 Continuous Shooting LV*	Continuous shooting, with the focus fixed at the position determined in manual focusing. In [] mode, focus is determined by the first shot.

* In [] mode (📖96), AF lock (📖152), or manual focus mode (📖142), [] is changed to [LV].

* For details on the continuous shooting speed in each mode, see “Specifications” (📖303).



- Cannot be used with the self-timer (📖64) or [Blink Detection] (📖88).
- Shooting may stop momentarily or continuous shooting may slow down depending on shooting conditions, camera settings, and the zoom position.
- As more shots are taken, shooting may slow down.
- Shooting may slow down if the flash fires.



- If you use Face ID (📖69) in [📺], the name recorded in the image will be fixed to the location where it is displayed in the first shot. Even if the subject moves, the name will stay fixed in the same position for any subsequent shots.

Shooting at Preset Focal Lengths (Step Zoom)

You can shoot at preset focal lengths of 28, 35, 50, 85, 100 or 140 mm (35mm film equivalent). This is convenient when you want to shoot at the angle of view of those focal lengths.

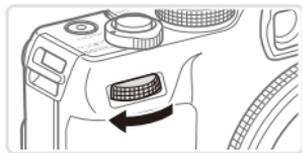

1 Assign [ZOOM] to the <sun> dial (168).

2 Choose a focal length.

- Turn the <sun> dial clockwise until it clicks to change the focal length from 28 mm to 35 mm. Keep turning the <sun> dial to increase the focal length, which changes to 50, 85, 100, and 140 mm at each click.



- Step zoom is not available when shooting movies even if you turn the <sun> dial.



- When using the digital zoom (163), turning the <sun> dial clockwise will not change the zoom factor. However, turning the <sun> dial counterclockwise will set the focal length to 140 mm.

Shooting Close-ups (Macro)

To restrict the focus to subjects at close range, set the camera to [🌻]. For details on the focusing range, see “Specifications” (📖303).



- Press the <◀> button, choose [🌻] (either press the <◀><▶> buttons or turn the <🔘> dial), and then press the <FUNC SET> button.
- ▶ Once the setting is complete, [🌻] is displayed.



- If the flash fires, vignetting may occur.
- Be careful to avoid damaging the lens.



- To prevent camera shake, try mounting the camera on a tripod and shooting with the camera set to [🌻] (📖65).

Shooting in Manual Focus Mode

When focusing is not possible in AF mode, use manual focus. You can specify the general focal position and then press the shutter button halfway to have the camera determine the optimal focal position near the position you specified. For details on the focusing range, see “Specifications” (📖303).



1 Choose [MF].

- Press the <◀> button and choose [MF], either by pressing the <◀><▶> buttons or turning the <🔘> dial. Immediately press the <FUNC SET> button.
- ▶ [MF] and the MF indicator are displayed.



MF Indicator

2 Specify the general focal position.

- Referring to the on-screen MF indicator bar (which shows the distance and focal position) and the magnified display area, press the <▲><▼> buttons or turn the <⦿> dial to specify the general focal position, and then press the <FUNC SET> button.

3 Fine-tune the focus.

- Press the shutter button halfway to have the camera fine-tune the focal position (Safety MF).
- You can also fine-tune the focus by pressing the <F/∞> button.



- AF frame mode or size cannot be changed while focusing manually (📖145). If you want to change the AF frame mode or size, cancel manual focus mode first.
- Focusing is possible when using the digital zoom (📖63) or digital tele-converter (📖144), or when using a TV as a display (📖243), but the magnified display will not appear.



- To focus more accurately, try attaching the camera to a tripod to stabilize it.
- To hide the magnified display area, press the <MENU> button and set [MF-Point Zoom] on the [📷] tab to [Off] (📖48).
- To deactivate automatic focus fine-tuning when the shutter button is pressed halfway, press the <MENU> button and set [Safety MF] on the [📷] tab to [Off] (📖48).

Digital Tele-Converter

The focal length of the lens can be increased by approximately 1.5x or 2.0x. This can reduce camera shake because the shutter speed is faster than it would be if you zoomed (including using digital zoom) in to the same zoom factor.



- Press the <MENU> button, choose [Digital Zoom] on the [📷] tab, and then choose the desired option (📖48).
- ▶ The view is enlarged and the zoom factor is displayed on the screen.



- The digital tele-converter cannot be used with digital zoom (📖63) and AF-point zoom (📖87).



- The respective focal lengths when using [1.5x] and [2.0x] are 42.0 – 210.0 mm and 56.0 – 280.0 mm (35mm film equivalent).
- The shutter speed may be equivalent when you move the zoom lever all the way toward <📷> for maximum telephoto, and when you zoom in to enlarge the subject to the same size following step 2 on 📖63.

Changing the AF Frame Mode

Change the AF (auto focus) frame mode to suit the shooting conditions as follows.



- Press the <MENU> button, choose [AF Frame] on the [CAMERA] tab, and then choose the desired option (48).

Face AiAF

- Detects people's faces, and then sets the focus, exposure (evaluative metering only), and white balance ([AWB] only).
- After you aim the camera at the subject, a white frame is displayed around the person's face determined by the camera to be the main subject, and up to two gray frames are displayed around other detected faces.
- When the camera detects movement, frames will follow moving subjects, within a certain range.
- After you press the shutter button halfway, up to nine green frames are displayed around faces in focus.



- If faces are not detected, or when only gray frames are displayed (without a white frame), up to nine green frames are displayed in the areas in focus when you press the shutter button halfway.
- If faces are not detected when Servo AF (📖 150) is set to [On], the AF frame is displayed in the center of the screen when you press the shutter button halfway.
- Examples of faces that cannot be detected:
 - Subjects that are distant or extremely close
 - Subjects that are dark or light
 - Faces in profile, at an angle, or partly hidden
- The camera may misinterpret non-human subjects as faces.
- No AF frames are displayed if the camera cannot focus when you press the shutter button halfway.

Still Images

■ FlexiZone/Center

One AF frame is displayed. Effective for reliable focusing.

With [FlexiZone], you can move and resize the AF frame (📖 147).



- A yellow AF frame is displayed with [!] if the camera cannot focus when you press the shutter button halfway. Note that AF-point zooming (📖 87) is not possible.



- To compose shots so that subjects are positioned at the edge or in a corner, first aim the camera to capture the subject in an AF frame, and then hold the shutter button halfway down. As you continue to hold the shutter button halfway, recompose the shot as desired, and then press the shutter button all the way down (Focus Lock).

Moving and Resizing AF Frames (FlexiZone)

When you want to change the position or size of the AF frame, set the AF frame mode to [FlexiZone] (📖146).



1 Prepare to move the AF frame.

- Press the  button. The AF frame turns orange.

2 Move and resize the AF frame.

- Turn the  dial to move the AF frame, or press the  buttons to move it by a smaller amount.
- To return the AF frame to the original position in the center, keep the  button held down.
- To reduce the AF frame size, press the  button. Press it again to restore it to the original size.

3 Finish the setup process.

- Press the  button.



- AF frames are displayed at normal size when you use the digital zoom (📖63) or digital tele-converter (📖144), and in manual focus mode (📖142).



- You can also link the Spot AE Point frame to the AF frame (📖128).

■ Choosing Subjects to Focus On (Tracking AF)

Shoot after choosing a subject to focus on as follows.

1 Choose [Tracking AF].

- Follow the steps on  145 to choose [Tracking AF].
- ▶ [□] is displayed in the center of the screen.

2 Choose a subject to focus on.

- Aim the camera so that [□] is on the desired subject, and then press the <-> button.



- ▶ When the subject is detected, the camera beeps and [] is displayed. Even if the subject moves, the camera will continue to track the subject within a certain range.
- ▶ If no subject is detected, [□] is displayed.
- To cancel tracking, press the <-> button again.

3 Shoot.

- Press the shutter button halfway. [] changes to a blue [], which follows the subject as the camera continues to adjust the focus and exposure (Servo AF) ( 150).
- Press the shutter button all the way down to shoot.
- ▶ Even after your shot, [] is still displayed and the camera continues to track the subject.

-
-  [Servo AF] ( 150) is set to [On] and cannot be changed.
 - Tracking may not be possible when subjects are too small or move too rapidly, or when subject color or brightness matches that of the background too closely.
 - [AF-Point Zoom] on the  tab is not available.
 -  is not available.
-



- The camera can detect subjects even if you press the shutter button halfway without pressing the  button. After your shot,  is displayed in the center of the screen.

Shooting with Servo AF

This mode helps avoid missing shots of subjects in motion, because the camera continues to focus on the subject and adjust the exposure as long as you press the shutter button halfway.



1 Configure the setting.

- Press the <MENU> button, choose [Servo AF] on the [📷] tab, and then choose [On] (📖48).

2 Focus.

- The focus and exposure are maintained where the blue AF frame is displayed while you are pressing the shutter button halfway.



- Focusing may not be possible in some shooting conditions.
- In low-light conditions, Servo AF may not be activated (AF frames may not turn blue) when you press the shutter button halfway. In this case, the focus and exposure are set according to the specified AF frame mode.
- If adequate exposure cannot be obtained, shutter speeds and aperture values are displayed in orange. Release the shutter button, and then press it halfway again.
- AF lock shooting is not available.
- [AF-Point Zoom] on the [📷] tab is not available.
- Not available when using the self-timer (📖64).

Changing the Focus Setting

You can change default camera operation of constantly focusing on subjects it is aimed at, even when the shutter button is not pressed. Instead, you can limit camera focusing to the moment you press the shutter button halfway.



- Press the <MENU> button, choose [Continuous AF] on the [CAMERA] tab, and then choose [Off] (148).

On	Helps avoid missing sudden photo opportunities, because the camera constantly focuses on subjects until you press the shutter button halfway.
Off	Conserves battery power, because the camera does not focus constantly.

Choosing a Person to Focus On (Face Select)

You can shoot after choosing a specific person's face to focus on.



1 Set the AF frame to [Face AiAF] (145).

2 Enter Face Select mode.

- Aim the camera at the person's face and press the <MENU> button.
- ▶ After [Face Select : On] is displayed, a face frame [] is displayed around the face detected as the main subject.
- Even if the subject moves, the face frame [] follows the subject within a certain range.
- If a face is not detected, [] is not displayed.



3 Choose the face to focus on.

- To switch the face frame  to another detected face, press the  button.
- After you have switched the face frame to all detected faces, [Face Select : Off] is displayed, and the specified AF frame mode screen is displayed again.

4 Shoot.

- Press the shutter button halfway. After the camera focuses,  changes to .
- Press the shutter button all the way down to shoot.

Still Images

Movies

Shooting with the AF Lock

The focus can be locked. After you lock the focus, the focal position will not change even when you release your finger from the shutter button.



1 Lock the focus.

- With the shutter button pressed halfway, press the  button.
- ▶ The focus is now locked, and [MF] and the MF indicator are displayed.
- To unlock the focus, once again hold the shutter button halfway down and press the  button.

2 Compose the shot and shoot.

Focus Bracketing (Focus-BKT Mode)

Three consecutive images are captured each time you shoot, with the first one at the focal distance you set manually and the others at farther and nearer focal positions determined by presets. The distance from your specified focus can be set in three levels.



1 Choose .

- Press the $\langle \text{FUNC SET} \rangle$ button, choose  in the menu, and then choose  ([book 47](#)).

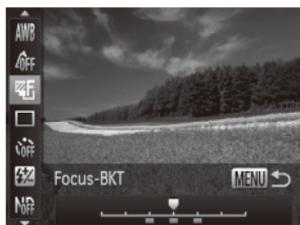

2 Configure the setting.

- Press the $\langle \text{MENU} \rangle$ button, and then adjust the setting by pressing the $\langle \leftarrow \right\rangle \langle \rightarrow \right\rangle$ buttons or turning the $\langle \text{DIAL} \rangle$ dial.



- Focus bracketing is only available in $\langle \text{MF} \rangle$ mode ([book 25](#), [55](#)).
- Continuous shooting ([book 139](#)) is not available in this mode.



- You can also access the setting screen in step 2 by choosing $\langle \text{MF} \rangle$ in step 1 on [book 142](#) and pressing the $\langle \text{MENU} \rangle$ button.
- Three shots are taken, regardless of any quantity specified in $\langle \text{C} \rangle$ ([book 66](#)).
- In $\langle \text{Blink Detection} \rangle$ mode ([book 88](#)), this function is only available for the final shot.

Activating Flash

You can have the flash fire for each shot. For details on the flash range, see “Specifications” (303).



1 Raise the flash.

- Move the <▶⚡> switch.

2 Configure the setting.

- Press the <▶> button, choose [⚡] (either press the <◀><▶> buttons or turn the <◉> dial), and then press the <◉> button.
- ▶ Once the setting is complete, [⚡] is displayed.



- The setting screen cannot be accessed by pressing the <▶> button when the flash is lowered. Move the <▶⚡> switch to raise the flash, then configure the setting.

Shooting with Slow Synchro

With this option, the flash fires to increase the brightness of the main subject (such as people) while the camera shoots at a slow shutter speed to increase the brightness of the background that is out of the flash range. For details on the flash range, see “Specifications” (📖303).



1 Raise the flash.

- Move the <▶> switch.

2 Configure the setting.

- Press the <▶> button, choose [⚡★] (either press the <◀><▶> buttons or turn the <⚙️> dial), and then press the <FUNC SET> button.
- ▶ Once the setting is complete, [⚡★] is displayed.

3 Shoot.

- Even after the flash fires, ensure that the main subject does not move until the shutter sound is finished playing.



- Mount the camera on a tripod or take other measures to keep it still and prevent camera shake. Additionally, you should set [IS Mode] to [Off] when using a tripod or other means to hold the camera still (📖160).
- The setting screen cannot be accessed by pressing the <▶> button when the flash is lowered. Move the <▶> switch to raise the flash, then configure the setting.

Adjusting the Flash Exposure Compensation

Just as with regular exposure compensation (📖 125), you can adjust the flash exposure from -2 to +2 stops, in 1/3-stop increments.



- Raise the flash, press the <▶> button and immediately turn the <☀> dial to choose the compensation level, and then press the <FUNC SET> button.
- ▶ Once the setting is complete, [±0] is displayed.



- When there is a risk of overexposure, the camera automatically adjusts the shutter speed or aperture value during the flash shots to reduce washed-out highlights and shoot at optimal exposure. However, you can deactivate automatic adjustment of the shutter speed and aperture value by accessing <MENU> (📖 48) and setting [Safety FE] in [Flash Control] on the [📷] tab to [Off].
- You can also configure the flash exposure compensation by choosing [±0] in the FUNC. menu (📖 47), or by accessing <MENU> (📖 48) and choosing [Flash Exp. Comp] in [Flash Control] on the [📷] tab.
- You can also access the [Built-in Flash Settings] <MENU> screen as follows (except when an optional external flash is mounted).
 - Press and hold the <▶> button for at least one second.
 - When the flash is up, press the <▶> button and immediately press the <MENU> button.

Shooting with the FE Lock

Just as with the AE lock (📖 126), you can lock the exposure for the flash shots.



1 Raise the flash and set it to [⚡] (📖 154).

2 Lock the flash exposure.

- Aim the camera at the subject to shoot with the exposure locked, and then press the <★> button.
- ▶ The flash fires, and when [★] is displayed, the flash output level is retained.

3 Compose the shot and shoot.

- After one shot, FE is unlocked and [★] is no longer displayed.



• FE: Flash Exposure

Changing the Flash Timing

Change the timing of the flash and shutter release as follows.



1 Access the setting screen.

- Press the <MENU> button, choose [Flash Control] on the [CAMERA] tab, and then press the <FUNC. SET> button (48).

2 Configure the setting.

- Choose [Shutter Sync.], and then choose the desired option (48).

1st-curtain	The flash fires immediately after the shutter opens.
2nd-curtain	The flash fires immediately before the shutter closes.

Shooting RAW Images

RAW images are “raw” (unprocessed) data, recorded with essentially no loss of image quality from the camera’s internal image processing. Use Digital Photo Professional (📖30) to adjust RAW images as desired with minimal loss of image quality.



- Press the  button, choose [JPEG] in the menu, and choose the desired option (📖47).

	<p>Records JPEG images. JPEG images are processed in the camera for optimal image quality and compressed to reduce file size. However, the compression process is irreversible, and images cannot be restored to their original, unprocessed state. Image processing may also cause some loss of image quality.</p>
	<p>Records RAW images. RAW images are “raw” (unprocessed) data, recorded with essentially no loss of image quality from the camera’s image processing. The data cannot be used in this state for viewing or printing on a computer. You must first use the included software (Digital Photo Professional) to convert images to ordinary JPEG or TIFF files. Images can be adjusted with minimal loss of image quality. For details on resolution and the number of shots that will fit on a card, see “Specifications” (📖303).</p>
	<p>Records two images, both a RAW image and a JPEG image, for each shot. The JPEG image can be printed or viewed on a computer without using the included software.</p>



- When transferring RAW images (or RAW and JPEG images recorded together) to a computer, always use the included software (📖30).
- Digital zoom (📖63), date stamps (📖67), and red-eye reduction (📖82) are set to [Off] in [RAW] and [RAW+JPEG] modes. Additionally, i-Contrast (📖132), My Colors (📖137) and noise reduction level (📖130) cannot be configured.



- The file extension for JPEG images is .JPG, and the extension for RAW images is .CR2.

Changing the Compression Ratio (Image Quality)

Choose from two compression ratios, as follows: [S] (Super Fine), [L] (Fine). For guidelines on how many shots at each compression ratio can fit on a memory card, see “Specifications” (303).

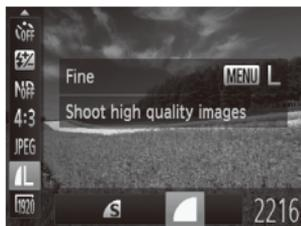

Configure the setting.

- Press the <FUNC SET> button, choose [L] in the menu, press the <MENU> button, and choose the desired option (47).

Changing the IS Mode Settings

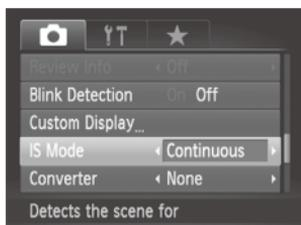

- Press the <MENU> button, choose [IS Mode] on the [CAMERA] tab, and then press the <LEFT><RIGHT> buttons to choose the desired option (48).

Continuous	Optimal image stabilization for the shooting conditions is automatically applied (Intelligent IS) (61).
Shoot Only*	Image stabilization is active only at the moment of shooting.
Off	Deactivates image stabilization.

* The setting is changed to [Continuous] for movie recording.



- If image stabilization cannot prevent camera shake, mount the camera on a tripod or take other measures to hold it still. In this case, set [IS Mode] to [Off].

5

Tv, Av, M, C1, and C2 Mode

Take smarter, more sophisticated shots, and customize the camera for your shooting style



- Instructions in this chapter apply to the camera as set to the respective mode.

Specific Shutter Speeds (<Tv> Mode)

Set your preferred shutter speed before shooting as follows. The camera automatically adjusts the aperture value to suit your shutter speed. For details on available shutter speeds, see “Specifications” (📖 303).

1 Enter <Tv> mode.

- Set the mode dial to <Tv>.

2 Set the shutter speed.

- Turn the <☀> dial to set the shutter speed.



- With shutter speeds of 1.3 seconds or slower, there will be a delay before you can shoot again, as images are processed to remove noise.
- When shooting at low shutter speeds on a tripod, you should set [IS Mode] to [Off] (📖 160).
- Maximum shutter speed with the flash is 1/2000 second. If you specify a faster speed, the camera will automatically reset the speed to 1/2000 second before shooting.
- With shutter speeds of 1.3 seconds or slower, ISO speed is [ISO 80] and cannot be changed.
- Orange display of aperture values when you press the shutter button halfway indicates that the settings deviate from standard exposure. Adjust the shutter speed until the aperture value is displayed in white, or use safety shift (📖 163).



- <Tv>: Time value
- You can customize camera operation so that turning the <☀> dial changes the shutter speed (📖 168).

Specific Aperture Values (<Av> Mode)

Set your preferred aperture value before shooting as follows. The camera automatically adjusts the shutter speed to suit your aperture value. For details on available aperture values, see “Specifications” (1303).

1 Enter <Av> mode.

- Set the mode dial to <Av>.

2 Set the aperture value.

- Turn the <Sun> dial to set the aperture value.



- Orange display of shutter speeds when you press the shutter button halfway indicates that the settings deviate from standard exposure. Adjust the aperture value until the shutter speed is displayed in white, or use safety shift (see below).



- <Av>: Aperture value (size of the opening made by the iris in the lens)
- To avoid exposure problems in <Tv> and <Av> modes, you can have the camera automatically adjust the shutter speed or aperture value, even when standard exposure cannot otherwise be obtained. Press the <MENU> button and set [Safety Shift] on the [Camera] tab to [On] (148). However, safety shift is disabled when the flash fires.
- You can customize camera operation so that turning the <Sun> dial changes the aperture value (168).

Specific Shutter Speeds and Aperture Values (<M> Mode)

Follow these steps before shooting to set your preferred shutter speed and aperture value to obtain the desired exposure.

For details on available shutter speeds and aperture values, see “Specifications” (📖303).

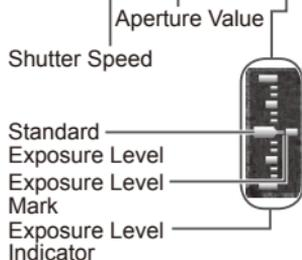

1 Enter <M> mode.

- Set the mode dial to <M>.

2 Configure the setting.

- Turn the <☀> dial to set the shutter speed, and turn the <⦿> dial to set the aperture value.
 - ▶ An exposure level mark based on your specified value is shown on the exposure level indicator for comparison to the standard exposure level.
 - ▶ The exposure level mark is shown in orange when the difference from standard exposure exceeds 2 stops. “-2” or “+2” is displayed in orange in the lower right when you press the shutter button halfway.



- After you set the shutter speed or aperture value, the exposure level may change if you adjust the zoom or recompose the shot.
- Screen brightness may change depending on your specified shutter speed or aperture value. However, screen brightness remains the same when the flash is up and the mode is set to [⚡].
- To have both the shutter speed and aperture value automatically adjusted to obtain standard exposure, hold the shutter button halfway and press the <✳> button. Note that standard exposure may not be possible with some settings.
- With shutter speeds of 1.3 seconds or slower, ISO speed is [ISO 80] and cannot be changed.



- <M>: Manual
- Calculation of standard exposure is based on the specified metering method (📖 127).
- You can customize camera operation so that turning the <☉> dial adjusts the shutter speed and turning the <☀> dial adjusts the aperture value (📖 168).

Still Images

Adjusting the Flash Output

Choose from the three flash levels in <M> mode.

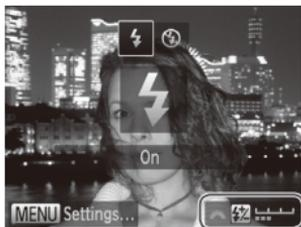

1 Enter <M> mode.

- Set the mode dial to <M>.

2 Configure the setting.

- Raise the flash, press the <▶> button and immediately turn the <☀> dial to choose the flash level, and then press the <FUNC SET> button.
- ▶ Once the setting is complete, [📷] is displayed.



- You can also set the flash level by choosing [📷] in the FUNC. menu (📖 47), or by accessing <MENU> (📖 48) and choosing [Flash Output] in [Flash Control] on the [📷] tab.
- You can set the flash level in <Tv> or <Av> mode by accessing <MENU> (📖 48), choosing [Flash Control] on the [📷] tab, and then setting [Flash Mode] to [Manual].
- You can also access the [Built-in Flash Settings] <MENU> screen as follows (except when an external flash (sold separately) is attached to the camera).
 - Press and hold the <▶> button for at least one second.
 - When the flash is up, press the <▶> button and immediately press the <MENU> button.

Customizing Display Information

Set the number of custom displays (📖46) and what information is displayed in each display when the <▼> button is pushed in shooting display.



1 Access the setting screen.

- Press the <MENU> button, choose [Custom Display] on the [📷] tab, and then press the <FUNC SET> button (📖48).

2 Choose [LCD/Viewfinder].

- Press the <▲><▼><◀><▶> buttons or turn the <DISP> dial, and then press the <FUNC SET> button to configure custom displays [📷], [📷], or [📷] which are displayed when the <▼> button is pressed.
- To deactivate a custom display, press the <FUNC SET> button to add [⊘] to [📷], [📷] or [📷].
- Note that [⊘] cannot be applied to [LCD/Viewfinder] custom display currently in use.

3 Configure the setting.

- Press the <▲><▼><◀><▶> buttons or turn the <DISP> dial to choose an item, and then press the <FUNC SET> button. Items you choose for display are labeled with [✓].
- ▶ Selected items (labeled with a [✓]) will be included in display.

Shooting Info	Displays shooting information (📖286).
Grid Lines	Displays a reference grid.
Electronic Level	Displays the electronic level (📖86).
Histogram	Displays a histogram (📖176), in <P>, <Tv>, <Av>, and <M> modes.



- Settings will not be saved if you press the shutter button halfway and return to the shooting screen from the custom display settings screen.
 - Grayed-out items can also be specified, but they may not be displayed in some shooting modes.
-



- Grid lines are not recorded in your shots.

Assigning Functions to the Front Dial and Control Dial

Assign commonly used functions to the front dial and control dial, by shooting mode.



1 Access the setting screen.

- Press the <MENU> button, choose [Set Func.] on the [CAMERA] tab, and then press the <FUNC SET> button (148).

2 Configure the setting.

- Press the <◀><▶> buttons to choose an item.
- To configure the settings, press the <▲><▼> buttons, choose an item (either press the <▲><▼><◀><▶> buttons or turn the dial), and then turn the dial to change the function.

Assignable Functions

Functions you can assign to the front dial and control dial vary depending on shooting mode. On the setting screen, you can assign aspect ratio switching (180), i-Contrast (132), white balance correction (135), or step zoom (141) to modes indicated by ★ in the following table.

Item		Shooting Mode			
		M	Av	Tv	P
Front Dial 1		Tv	Av	Tv	★
		Av, ★	★	★	★
Front Dial 2		Av	Av	Tv	★
		Tv, ★	★	★	★
Control Dial		★	★	★	★
		Av, Tv	Av	Tv	★

- <Av>: aperture value (163); <Tv>: shutter speed (162)
- When multiple functions are assigned to the dial, press the <C/C> button to switch between them.

Assigning Functions to the $\langle S \rangle$ Button



1 Access the setting screen.

- Press the $\langle \text{MENU} \rangle$ button, choose [Set Shortcut button] on the $[S]$ tab, and then press the $\langle \text{FUNC SET} \rangle$ button (📖 48).

2 Configure the setting.

- Press the $\langle \blacktriangle \rangle \langle \blacktriangledown \rangle \langle \blacktriangleleft \rangle \langle \blacktriangleright \rangle$ buttons or turn the $\langle \text{DIAL} \rangle$ to choose a function to assign, and then press the $\langle \text{FUNC SET} \rangle$ button.

3 Use the assigned function as needed.

- Press the $\langle S \rangle$ button to activate the assigned function.



- To restore default settings, choose $[S]$.
- Icons labeled with $[O]$ indicate that the function is not available in the current shooting mode or under current function conditions.
- When the $[S]$ or $[S]$ function is used, each press of the $\langle S \rangle$ button records white balance data (📖 135), and the white balance settings change to $[S]$ or $[S]$.
- When the $[AFL]$ function is used, each press of the $\langle S \rangle$ button adjusts and locks the focus, and $[AFL]$ is displayed on the screen.
- Pressing the $\langle S \rangle$ button when the $[Z]$ function is used deactivates screen display. To restore the display, do any of the following.
 - Press any button (other than the ON/OFF button)
 - Hold the camera in another orientation
 - Raise and lower the flash

Saving Shooting Settings

Save commonly used shooting modes and your configured function settings for reuse. To access saved settings later, simply turn the mode dial to <C1> or <C2>. Even settings that are usually cleared when you switch shooting modes or turn the camera off (such as self-timer settings) can be retained this way.

Settings that can be saved

- Shooting modes (<P>, <Tv>, <Av>, and <M>)
- Items set in <P>, <Tv>, <Av>, or <M> modes (📖 125 – 164)
- Shooting menu settings
- Zoom positions
- Manual focus positions (📖 142)
- My Menu settings (📖 171)

1 Enter a shooting mode with settings you want to save, and change the settings as desired.

2 Configure the setting.

- Press the <MENU> button, choose [Save Settings] on the [📷] tab, and then press the <FUNC SET> button.

3 Save the settings.

- Press the <◀><▶> buttons or turn the <DISP> dial to choose the destination, and then press the <FUNC SET> button.

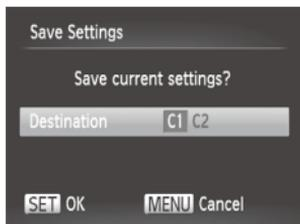
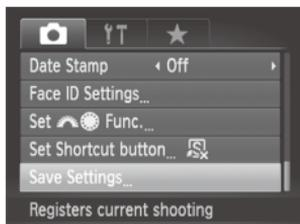

-  To edit saved settings (except their shooting mode), choose <C1> or <C2>, change the settings, and then repeat steps 2 – 3. These setting details are not applied in other shooting modes.



- To clear information you have saved to <C1> or <C2> and restore default values, turn the mode dial to <C1> or <C2> and choose [Reset All] (📖231).

Still Images

Movies

Saving Commonly Used Shooting Menus (My Menu)

Save up to five commonly used shooting menus as menus on the [★] tab, for instant access to all of these items from a single screen.

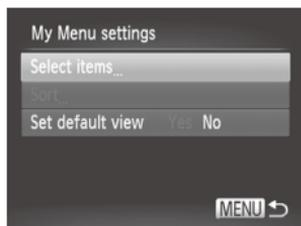

1 Access the setting screen.

- Press the <MENU> button, choose [My Menu settings] on the [★] tab, and then press the <FUNC SET> button (📖48).

2 Configure the setting.

- Press the <▲><▼> buttons or turn the <DISP> dial to choose [Select items], and then press the <FUNC SET> button.
- Press the <▲><▼> buttons or turn the <DISP> dial to choose menus to save (up to five), and then press the <FUNC SET> button.
- ▶ [✓] is displayed.
- To cancel saving, press the <FUNC SET> button. [✓] is no longer displayed.
- Press the <MENU> button.



3 Rearrange the menu list order, as needed.

- Press the <▲><▼> buttons or turn the <DISP> dial to choose [Sort], and then press the <FUNC SET> button.
- Press the <▲><▼> buttons or turn the <DISP> dial to choose a menu to move, and then press the <FUNC SET> button.
- Press the <▲><▼> buttons or turn the <DISP> dial to change the order, and then press the <FUNC SET> button.
- Press the <MENU> button.



- Grayed-out items in step 2 can also be specified, but they may not be available in some shooting modes.



- To make My Menu immediately accessible by pressing the <MENU> button in Shooting mode, choose [Set default view] and press the <◀><▶> buttons to choose [Yes].

6

Playback Mode

Have fun reviewing your shots, and browse or edit them in many ways

- To prepare the camera for these operations, press the <▶> button to enter Playback mode.



- It may not be possible to play back or edit images that were renamed or already edited on a computer, or images from other cameras.

Viewing

After shooting images or movies, you can view them on the screen as follows.



1 Enter Playback mode.

- Press the <▶> button.
- ▶ Your last shot is displayed.



2 Browse through your images.

- To view the previous image, press the <◀> button or turn the <●> dial counterclockwise. To view the next image, press the <▶> button or turn the <●> dial clockwise.
- Press and hold the <◀><▶> buttons to browse through images quickly.



- To access Scroll Display mode, turn the <●> dial rapidly. In this mode, turn the <●> dial to browse through images.
- To return to single-image display, press the <FUNC SET> button.
- To browse images grouped by shooting date, press the <▲><▼> buttons in Scroll Display mode.



- Movies are identified by a [SET] [MOVIE] icon. To play movies, go to step 3.



Volume

3 Play movies.

- To start playback, press the **<FUNC/SET>** button to access the movie control panel, choose [**▶**] (either press the **<◀><▶>** buttons or turn the **<◉>** dial), and then press the **<FUNC/SET>** button again.

4 Adjust the volume.

- Press the **<▲><▼>** buttons to adjust the volume.

5 Pause playback.

- To pause or resume playback, press the **<FUNC/SET>** button.
- ▶ After the movie is finished, [**SET**] is displayed.



- To switch to Shooting mode from Playback mode, press the shutter button halfway.
- To deactivate Scroll Display, press the **<MENU>** button, choose [Scroll Display] on the [**▶**] tab, and then choose [Off].
- If you prefer to have the most recent shot displayed when you enter Playback mode, press the **<MENU>** button, and on the [**▶**] tab, choose [Resume] and then [Last shot].
- To change the transition shown between images, press the **<MENU>** button, choose [Transition] on the [**▶**] tab, and then press the **<◀><▶>** buttons to choose the effect.

Switching Display Modes

Press the <▼> button to view other information on the screen, or to hide the information. For details on the information displayed, see [1288](#).

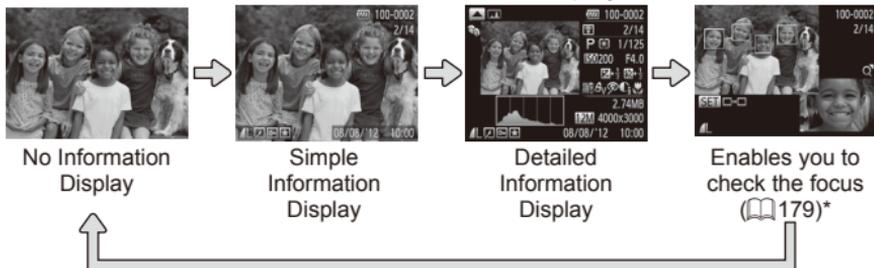

*Not shown for movies.



- Switching display modes by pressing the <▼> button is also possible immediately after you shoot, while your shot is displayed. However, simple information display is not available. To change the initial display mode, press the <MENU> button and choose [Review Info] on the [CAMERA] tab ([191](#)).

Overexposure Warning (for Image Highlights)

Washed-out highlights in the image flash on the screen in detailed information display.

Histogram

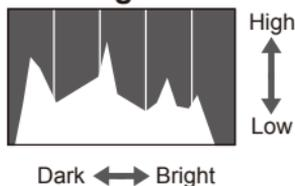

- The graph in detailed information display (see above) is a histogram showing the distribution of brightness in the image. The horizontal axis represents the degree of brightness, and the vertical axis, how much of the image is at each level of brightness. Viewing the histogram is a way to check exposure.
- The histogram can also be accessed while shooting ([166](#), [286](#)).

RGB Histogram

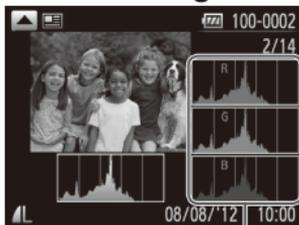

RGB Histogram

- To view an RGB histogram, press the <▲> button in detailed information display. The RGB histogram shows the distribution of shades of red, green, and blue in an image. The horizontal axis represents R, G, or B brightness, and the vertical axis, how much of the image is at that level of brightness. Viewing this histogram enables you to check image color characteristics.
- Press the <▲> button again to return to detailed information display.

Checking People Detected in Face ID

If you switch the camera to simple information display mode (📖176), the names of up to five detected people registered in Face ID (📖69) will be displayed.



Switch to simple information display mode and check.

- Press the <▼> button repeatedly until simple information display is activated, and then press the <◀><▶> buttons to choose an image.
- Names will be displayed on detected people.



- If you do not want names to display on images shot using Face ID, press the <MENU> button, choose [Face ID Info] on the [📺] tab, and then set [Name Display] to [Off].

Viewing Movie Digest Clips

View movie clips recorded automatically in [SET] mode (📖 94) on a day of still image shooting as follows.



1 Choose an image.

- Still images shot in [SET] mode are labeled with an [SET] icon.
- Choose a still image labeled with [SET] and press the <FUNC SET> button.



2 Play the clip.

- After [Play back movie?] is displayed, press the <◀><▶> buttons or turn the <DISP> dial to choose [OK], and then press the <FUNC SET> button.
- ▶ The movie clip recorded automatically on the day of still image shooting is played back, from the beginning.



- Movies created in [SET] mode can also be viewed by date (📖 185).
- After a moment, [SET] will no longer be displayed when you are using the camera with information display deactivated (📖 176).

Checking the Focus

To check the focus of your shots, you can magnify the area of the image that was in the AF frame at the time of shooting.

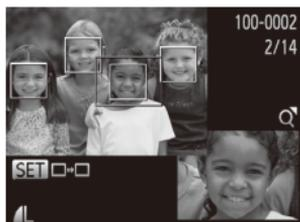

1 Access Focus Check.

- Press the <▼> button (📖 176).
- ▶ A white frame is displayed where the AF frame was when the focus was set.
- ▶ Gray frames are displayed over faces detected later, in Playback mode.
- ▶ The portion of the image in the orange frame is magnified.

2 Switch frames.

- Move the zoom lever toward <Q> once.
- ▶ The screen at left is displayed.
- To switch to a different frame when there are multiple frames, press the <FUNC/SET> button.

3 Zoom in or out, or view other image areas.

- As you examine the focus, use the zoom lever to zoom in or out. Press the <▲><▼><◀><▶> buttons to adjust the display position.
- Press the <MENU> button to restore the original display in step 1.

Navigating Through Images in an Index

By displaying multiple images in an index, you can quickly find the images you are looking for.



1 Display images in an index.

- Move the zoom lever toward  to display images in an index. Moving the lever again will increase the number of images shown.
- To display fewer images, move the zoom lever toward . Fewer images are shown each time you move the lever.



2 Choose an image.

- Turn the  dial to scroll through the images.
- Press the  buttons to choose an image.
- ▶ An orange frame is displayed around the selected image.
- Press the  button to view the selected image in single-image display.

Finding Images Matching Specified Conditions

Find desired images quickly on a memory card full of images by filtering image display according to your specified conditions. You can also protect (📖192) or delete (📖196) these images all at once.

★ Favorites	Displays images tagged as favorites (📖202).
🕒 Shot Date	Displays the images shot on a specific date.
📁 My Category	Displays the images of a specific category (📖203).
📷 Still image/Movie	Displays still images, movies, or movies shot in [📷] mode (📖94).
😊 Name	Displays images of a registered person (📖69).

Filtering Display by [★], [🕒], [📁], or [📷]



1 Choose the first condition for image display or navigation.

- In single-image display, press the <📷> button, and then press the <▲><▼> buttons to choose a display filter.
- When [★] is selected, you can view only images matching this condition by pressing the <◀><▶> buttons. To perform an action for all of these images together, press the <FUNC-SET> button and go to step 3.

2 Choose the second condition and check the images found.

- Press the <◀><▶> buttons to choose another condition. Once you turn the <●> dial, you can view the images narrowed down by your conditions.
- To cancel this mode, press the <MENU> button.
- To switch to filtered image display, press the <FUNC SET> button and go to step 3.



3 View the filtered images.

- Images matching your conditions are displayed in yellow frames. To view only these images, press the <◀><▶> buttons, or turn the <●> dial.
- To exit filtered image display, press the <⏏> button, and after [Image search canceled] is displayed, press the <FUNC SET> button.



- When the camera has found no corresponding images for some conditions, those conditions will not be available.



- Options for viewing the images found (in step 3) include “Navigating Through Images in an Index” (📖180), “Viewing Slideshows” (📖190), and “Magnifying Images” (📖189). You can protect, erase, or print all images found or add them to a photobook by choosing [Select All Images in Search] in “Protecting Images” (📖192), “Erasing All Images” (📖197), “Adding Images to the Print List (DPOF)” (📖266), or “Adding Images to a Photobook” (📖271).
- However, if you recategorize images (📖203) or edit them and save them as new images (📖206 – 214), a message is displayed and filtered image display ends.

Filtering Display by [F5]

1 Choose [F5].

- Following steps 1 – 2 on  181 – 182, choose [F5] and press the <FUNC-SET> button.

2 Choose a person.

- Press the <▲><▼><◀><▶> buttons to choose a person, and then press the <FUNC-SET> button.

3 View the filtered images.

- Follow step 3 on  182 to view the images.



- [F5] is not available unless people are registered ( 69).

Using the Front Dial to Jump

Use the front dial to find and jump between desired images quickly by filtering image display according to your specified conditions.

 Jump to Favorites	Displays images tagged as favorites (📖202).
 Jump Shot Date	Jumps to the first image in each group of images that were shot on the same date.
 Jump 10 Images	Jumps by 10 images at a time.
 Jump 100 Images	Jumps by 100 images at a time.



1 Choose a condition.

- Choose a condition (or jump method) in single-image display by turning the <🌅> dial and then pressing the <▲><▼> buttons.

2 View images matching your specified condition, or jump by the specified amount.

- Turn the <🌅> dial to view only images matching the condition or jump by the specified number of images forward or back.
- To cancel this mode, press the <MENU> button.



- Turning the <🌅> dial when browsing images in index display will jump to the previous or next image according to the jump method chosen in single-image display. However, if you have chosen [] or [], the jump method will be switched to [].

Viewing Movie Digest Movies

Movies created in [M] mode (194) can be viewed by date.



1 Choose a movie.

- Press the <MENU> button, choose [Movie Digest Playback] on the [▶] tab, and then choose the date.

2 Play the movie.

- Press the <FUNC SET> button to start playback.

Viewing Individual Images in a Group

Grouped images shot in [HQ] mode (116) are generally displayed together, but they can also be viewed individually.



1 Choose an image group.

- Press the <◀>>> buttons or turn the <●> dial to choose an image labeled [SET], and then press the <FUNC SET> button.

2 View individual images in the group.

- Pressing the <◀>>> buttons or turning the <●> dial will display only images in the group.
- Pressing the <👁> button will display [Display all images]. Press <FUNC SET> to cancel group playback.



- During group playback (step 2), you can browse through images quickly “Navigating Through Images in an Index” (📖180) and magnify them “Magnifying Images” (📖189). You can protect, erase, or print all images in a group at once or add them to a photobook by choosing [All Images in Group] in “Protecting Images” (📖192), “Erasing All Images” (📖197), “Adding Images to the Print List (DPOF)” (📖266), or “Adding Images to a Photobook” (📖271).
- To ungroup images so that you can view them individually, press the <MENU> button, choose [Group Images] on the [▶] tab, and then choose [Off] (📖48). However, grouped images cannot be ungrouped during individual playback.

Editing Face ID Information

If you notice that a name is incorrect during playback, you can change it or erase it.

However, you cannot add names for people who are not detected by Face ID (names are not displayed), and for people whose names have been erased.

Changing Names

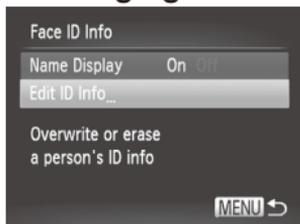

1 Access the setting screen.

- Press the <MENU> button and choose [Face ID Info] on the [▶] tab (148).
- Press the <▲><▼> buttons or turn the <⦿> dial to choose [Edit ID Info], and then press the <FUNC SET> button.

2 Choose an image.

- Following the procedure on 177, choose an image and press the <FUNC SET> button.
- An orange frame is displayed around the selected face. When multiple names are displayed in an image, press the <◀><▶> buttons or turn the <⦿> dial to choose the name to change, and then press the <FUNC SET> button.



3 Choose the item to edit.

- Press the <▲><▼><◀><▶> buttons or turn the <⦿> dial to choose [Overwrite], and then press the <FUNC SET> button.

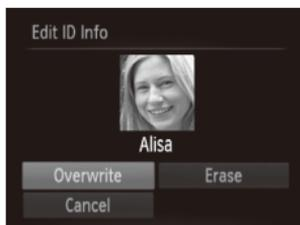

4 Choose the name of the person to overwrite.

- Follow step 2 on  76 to choose the name of the person you want to overwrite.

■ Erasing Names

- Following step 3 on  187, choose [Erase] and press the  button.
- After [Erase?] is displayed, press the <◀>▶> buttons or turn the  dial to choose [OK], and then press the  button.

Magnifying Images



Approximate Position of Displayed Area

1 Magnify an image.

- Moving the zoom lever toward **<Q>** will zoom in and magnify the image. You can magnify images up to about 10x by continuing to hold the zoom lever.
- To zoom out, move the zoom lever toward **<Q/>>**. You can return to single-image display by continuing to hold it.

2 Move the display position and switch images as needed.

- To move the display position, press the **<▲><▼><◀><▶>** buttons.
- To switch to other images while zoomed, turn the **<DISP>** dial.



- You can return to single-image display from magnified display by pressing the **<MENU>** button.

Viewing Slideshows

Automatically play back images from a memory card as follows.

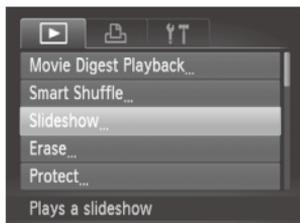

1 Access the setting screen.

- Press the <MENU> button, and then choose [Slideshow] on the [▶] tab (📖48).



2 Configure the setting.

- Choose a menu item to configure, and then choose the desired option (📖48).

3 Start automatic playback.

- Press the <▲><▼> buttons or turn the <●> dial to choose [Start], and then press the <FUNC/SET> button.
 - ▶ The slideshow will start a few seconds after [Loading image...] is displayed.
- Press the <MENU> button to stop the slideshow.



- The camera's power-saving functions (📖42) are deactivated during slideshows.



- To pause or resume slideshows, press the <FUNC/SET> button.
- You can switch to other images during playback by pressing the <◀><▶> buttons or turning the <●> dial. For fast-forward or fast-rewind, hold the <◀><▶> buttons down.
- [Play Time] cannot be modified when [Bubble] is chosen in [Effect].
- You can also start slideshows from single-image display by pressing and holding the <FUNC/SET> button and immediately pressing the <S> button.

Auto Playback of Similar Images (Smart Shuffle)

Based on the current image, the camera offers four images similar to it that you may wish to view. After you choose to view one of those images, the camera offers four more images. This is an enjoyable way to play back images in an unexpected order. Try this feature after you have taken many shots, in many kinds of scenes.



1 Choose Smart Shuffle.

- Press the <MENU> button, choose [Smart Shuffle] on the [▶] tab, and then press the <FUNC SET> button (📖 48).
- ▶ Four candidate images are displayed.

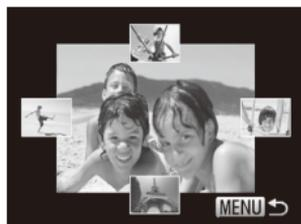

2 Choose an image.

- Press the <▲><▼><◀><▶> buttons to choose the image you want to view next.
- ▶ Your chosen image is displayed in the center, surrounded by the next four candidate images.
- For full-screen display of the center image, press the <FUNC SET> button. To restore the original display, press the <FUNC SET> button again.
- Press the <MENU> button to restore single-image display.



- Only still images shot with this camera are played back using Smart Shuffle.
- Smart Shuffle is not available in the following cases:
 - There are less than 50 shots taken with this camera
 - An unsupported image is currently displayed
 - Images are shown in filtered display (📖 181)
 - During group playback (📖 185)

Protecting Images

Protect important images to prevent accidental erasure by the camera (📖 196, 197).

Choosing a Selection Method



1 Access the setting screen.

- Press the <MENU> button and choose [Protect] on the [▶] tab (📖 48).

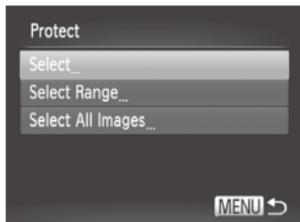

2 Choose a selection method.

- Choose a menu item and a setting as desired (📖 48).
- To return to the menu screen, press the <MENU> button.



- Protected images on a memory card will be erased if you format the card (📖 223, 224).



- Protected images cannot be erased using the camera's erasure function. To erase them this way, first cancel protection.

Choosing Images Individually

1 Choose [Select].

- Following step 2 above, choose [Select] and press the  button.



2 Choose an image.

- Press the   buttons or turn the  dial to choose an image, and then press the  button.  is displayed.
- To cancel selection, press the  button again.  is no longer displayed.
- Repeat this process to specify other images.

3 Protect the image.

- Press the  button. A confirmation message is displayed.
- Press the   buttons or turn the  dial to choose [OK], and then press the  button.



- Images will not be protected if you switch to Shooting mode or turn the camera off before finishing the setup process in step 3.

Selecting a Range

1 Choose [Select Range].

- Following step 2 on 192, choose [Select Range] and press the button.



2 Choose a starting image.

- Press the button.

- Press the buttons or turn the dial to choose an image, and then press the button.

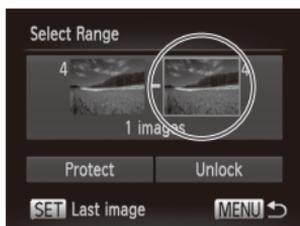

3 Choose an ending image.

- Press the button to choose [Last image], and then press the button.

- Press the buttons or turn the dial to choose an image, and then press the button.
- Images before the first image cannot be selected as the last image.



4 Protect the images.

- Press the <▼> button to choose [Protect], and then press the <FUNC SET> button.



- You can also choose the first or last image by turning the <●> dial when the top screen in steps 2 and 3 is displayed.

Specifying All Images at Once

1 Choose [Select All Images].

- Following step 2 on 192, choose [Select All Images] and press the <FUNC SET> button.

2 Protect the images.

- Press the <▲><▼> buttons or turn the <●> dial to choose [Protect], and then press the <FUNC SET> button.



- To cancel protection for groups of images, choose [Unlock] in step 4 of "Selecting a Range" or in step 2 of "Specifying All Images at Once".

Erasing Images

You can choose and erase unneeded images one by one. Be careful when erasing images, because they cannot be recovered. However, protected images (📖 192) cannot be erased.

1 Choose an image to erase.

- Press the <◀>>> buttons or turn the <🔘> dial to choose an image.

2 Erase the image.

- Press the <🗑> button.
- After [Erase?] is displayed, press the <◀>>> buttons or turn the <🔘> dial to choose [Erase], and then press the <FUNC-SET> button.
- ▶ The current image is now erased.
- To cancel erasure, press the <◀>>> buttons or turn the <🔘> dial to choose [Cancel], and then press the <FUNC-SET> button.



- Pressing the <🗑> button while [RAW+JPEG] images are displayed will give you the option of choosing [Erase RAW], [Erase JPEG], or [Erase RAW+JPEG] for deletion.

Erasing All Images

You can erase all images at once. Be careful when erasing images, because they cannot be recovered. However, protected images (📖 192) cannot be erased.

Choosing a Selection Method

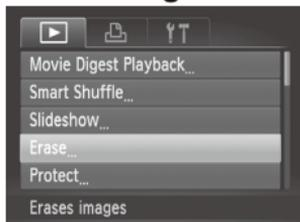

1 Access the setting screen.

- Press the <MENU> button, and then choose [Erase] on the [▶] tab (📖 48).

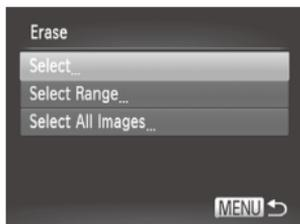

2 Choose a selection method.

- Choose a menu item and a setting as desired (📖 48).
- To return to the menu screen, press the <MENU> button.

Choosing Images Individually

1 Choose [Select].

- Following step 2 above, choose [Select] and press the <FUNC SET> button.

2 Choose an image.

- Once you follow step 2 on 📖 193 to choose an image, [✓] is displayed.
- To cancel selection, press the <FUNC SET> button again. [✓] is no longer displayed.
- Repeat this process to specify other images.





Selecting a Range



3 Erase the image.

- Press the <MENU> button. A confirmation message is displayed.
- Press the <◀><▶> buttons or turn the <◉> dial to choose [OK], and then press the <FUNC SET> button.

1 Choose [Select Range].

- Following step 2 on “Choosing a Selection Method” (📖 197), choose [Select Range] and press the <FUNC SET> button.

2 Choose images.

- Follow steps 2 – 3 on 📖 194 to specify images.

3 Erase the images.

- Press the <▼> button to choose [Erase], and then press the <FUNC SET> button.

■ Specifying All Images at Once

1 Choose [Select All Images].

- Following step 2 on “Choosing a Selection Method” (197), choose [Select All Images] and press the  button.

2 Erase the images.

- Press the <◀>▶> buttons or turn the  dial to choose [OK], and then press the  button.



Rotating Images

Change the orientation of images and save them as follows.



1 Choose [Rotate].

- Press the <MENU> button and choose [Rotate] on the [▶] tab (📖48).



2 Rotate the image.

- Press the <<>>> buttons or turn the <⦿> dial to choose an image.
- The image is rotated 90° each time you press the <FUNC SET> button.
- To return to the menu screen, press the <MENU> button.



- Movies with an image quality of [1920] or [1280] cannot be rotated.
- Rotation is not possible when [Auto Rotate] is set to [Off] (📖201).

Deactivating Auto Rotation

Follow these steps to deactivate automatic rotation by the camera, which rotates images shot in vertical orientation so they are displayed vertically on the camera.

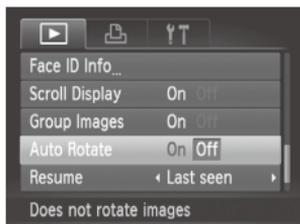

- Press the <MENU> button, choose [Auto Rotate] on the [▶] tab, and then choose [Off] (📖48).



- Images cannot be rotated (📖200) when you set [Auto Rotate] to [Off]. Additionally, images already rotated will be displayed in the original orientation.
- In Smart Shuffle (📖191) mode, even if [Auto Rotate] is set to [Off], images shot vertically will be displayed vertically, and rotated images will be displayed in the rotated orientation.

Image Categories

You can tag images as favorites or assign them to My Category (📖203) groups. By choosing a category in filtered playback, you can restrict the following operations to all of those images.

- Viewing (📖174), Viewing Slideshows (📖190), Protecting Images (📖192), Erasing Images (📖196), Adding Images to the Print List (DPOF) (📖266), Adding Images to a Photobook (📖271)

Still Images

Movies

Tagging Images as Favorites



1 Choose [Favorites].

- Press the <MENU> button and choose [Favorites] on the [▶] tab (📖48).



2 Choose an image.

- Press the <◀><▶> buttons or turn the <DISP> dial to choose an image, and then press the <FUNC SET> button. [★] is displayed.
- To untag the image, press the <FUNC SET> button again. [★] is no longer displayed.
- Repeat this process to choose additional images.



3 Finish the setup process.

- Press the <MENU> button. A confirmation message is displayed.
- Press the <◀><▶> buttons or turn the <DISP> dial to choose [OK], and then press the <FUNC SET> button.



- Images will not be tagged as favorites if you switch to Shooting mode or turn the camera off before finishing the setup process in step 3.



- Favorite images will have a three-star rating (★★★☆☆) when transferred to computers running Windows 7 or Windows Vista. (Does not apply to movies or RAW images.)

Still Images

Movies

Organizing Images by Category (My Category)

You can organize images into categories. Note that images are automatically categorized at the time of shooting, according to shooting conditions.

: Images with detected faces, or images shot in or mode.

: Images detected as , , or in <AUTO> mode, or images shot in mode.

: Images shot in , , or mode.

Choosing a Selection Method



1 Access the setting screen.

- Press the <MENU> button, and then choose [My Category] on the tab (48).

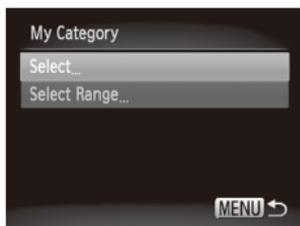

2 Choose a selection method.

- Choose a menu item and a setting as desired (48).
- To return to the menu screen, press the <MENU> button.

Choosing Images Individually

1 Choose [Select].

- Following step 2 on [page 203](#), choose [Select] and press the  button.

2 Choose an image.

- Press the   buttons or turn the  dial to choose an image.

3 Choose a category.

- Press the   buttons to choose a category and then press the  button. [✓] is displayed.
- To cancel selection, press the  button again. [✓] is no longer displayed.
- Repeat this process to choose additional images.



4 Finish the setup process.

- Press the  button. A confirmation message is displayed. Press the   buttons or turn the  dial to choose [OK], and then press the  button.



- Images will not be assigned to a category if you switch to Shooting mode or turn the camera off before finishing the setup process in step 4.

Selecting a Range

1 Choose [Select Range].

- Following step 2 on  203, choose [Select Range] and press the  button.

2 Choose images.

- Follow steps 2 – 3 on  194 to specify images.

3 Choose a category.

- Press the <▼> button to choose the type of image, and then press the <◀><▶> buttons or turn the  dial to choose a category.

4 Finish the setup process.

- Press the <▼> button to choose [Select], and then press the  button.



- You can clear the selection of all images in the [Select Range] category by choosing [Deselect] in step 4.



- Image editing (206 – 211) is only available when the memory card has sufficient free space.

Resizing Images

Save a copy of images at a lower resolution.

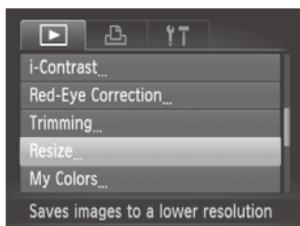

1 Choose [Resize].

- Press the <MENU> button and choose [Resize] on the [RECALL] tab (48).

2 Choose an image.

- Press the <◀><▶> buttons or turn the <DISP> dial to choose an image, and then press the <FUNC SET> button.

3 Choose an image size.

- Press the <◀><▶> buttons or turn the <DISP> dial to choose the size, and then press the <FUNC SET> button.
 - ▶ [Save new image?] is displayed.



4 Save the new image.

- Press the <◀><▶> buttons or turn the <DISP> dial to choose [OK], and then press the <FUNC SET> button.
 - ▶ The image is now saved as a new file.





5 Review the new image.

- Press the <MENU> button. [Display new image?] is displayed.
- Press the <◀>>>> buttons or turn the <⦿> dial to choose [Yes], and then press the <FUNC SET> button.
- ▶ The saved image is now displayed.



- Editing is not possible for images saved as [XS] in step 3.
- RAW images cannot be edited.



- Images cannot be resized to a higher resolution.

Cropping

You can specify a portion of an image to save as a separate image file.



1 Choose [Cropping].

- Press the <MENU> button, and then choose [Cropping] on the [▶] tab (48).

2 Choose an image.

- Press the <◀>>>> buttons or turn the <⦿> dial to choose an image, and then press the <FUNC SET> button.

Cropping Area

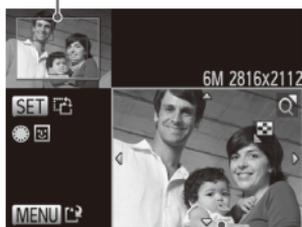

Preview of Image After Cropping

Resolution After Cropping



3 Adjust the cropping area.

- ▶ A frame is displayed around the portion of the image to be cropped.
- ▶ The original image is shown in the upper left, and a preview of the image as cropped is shown in the lower right.
- To resize the frame, move the zoom lever.
- To move the frame, press the <▲><▼><◀><▶> buttons.
- To change the frame orientation, press the <FUNC/SET> button.
- Faces detected in the image are enclosed in gray frames in the upper-left image. To crop the image based on this frame, turn the <DISP/OK> dial to switch to the other frame.
- Press the <MENU> button.

4 Save as a new image and review.

- Follow steps 4 – 5 on [206 – 207](#).



- Editing is not possible for images shot at a resolution of [**S**] ([81](#)) or resized to [**XS**] ([206](#)).
- RAW images cannot be edited.



- Images supported for cropping will have the same aspect ratio after cropping.
- Cropped images will have a smaller resolution than uncropped images.

Changing Image Color Tones (My Colors)

You can adjust image colors and then save the edited image as a separate file. For details on each option, see  137.

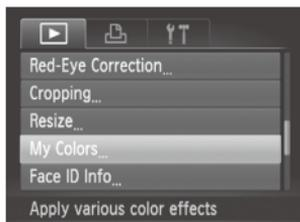

1 Choose [My Colors].

- Press the <MENU> button, and then choose [My Colors] on the  tab ( 48).

2 Choose an image.

- Press the <◀>>> buttons or turn the  dial to choose an image, and then press the  button.

3 Choose an option.

- Press the <◀>>> buttons or turn the  dial to choose an option, and then press the  button.

4 Save as a new image and review.

- Follow steps 4 – 5 on  206 – 207.



- Image quality of pictures you repeatedly edit this way will be a little lower each time, and you may not be able to obtain the desired color.
- Colors of RAW images cannot be edited.



- The color of images edited using this function may vary slightly from the color of images shot using My Colors ( 137).

Correcting Image Brightness (i-Contrast)

Excessively dark image areas (such as faces or backgrounds) can be detected and automatically adjusted to the optimal brightness. Insufficient overall image contrast is also automatically corrected, to make subjects stand out better. Choose from four correction levels, and then save the image as a separate file.

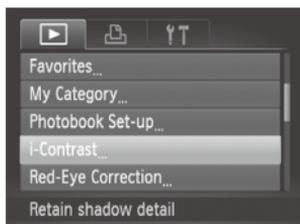

1 Choose [i-Contrast].

- Press the <MENU> button, and then choose [i-Contrast] on the [] tab (48).

2 Choose an image.

- Press the <◀>>> buttons or turn the <●> dial to choose an image, and then press the <FUNC SET> button.

3 Choose an option.

- Press the <◀>>> buttons or turn the <●> dial to choose an option, and then press the <FUNC SET> button.

4 Save as a new image and review.

- Follow steps 4 – 5 on 206 – 207.

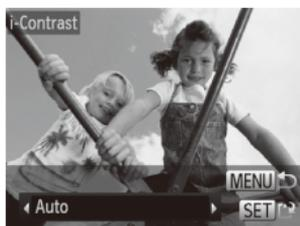

- For some images, correction may be inaccurate or may cause images to appear grainy.
- Images may look grainy after repeated editing using this function.
- RAW images cannot be edited this way.



- If [Auto] does not produce the expected results, try correcting images using [Low], [Medium], or [High].



- Some images may not be corrected accurately.
- To overwrite the original image with the corrected image, choose [Overwrite] in step 4. In this case, the original image will be erased.
- Protected images cannot be overwritten.
- RAW images cannot be edited this way.
- Red-eye correction can be applied to JPEG images shot in [RAW+JPEG], but the original image cannot be overwritten.

Editing Movies

You can cut movies to remove unneeded portions at the beginning or end.



Movie Editing Panel



Movie Editing Bar

1 Choose [✂].

- Following steps 1 – 5 on 174 – 175, choose [✂] and press the <FUNC SET> button.
- ▶ The movie editing panel and editing bar are now displayed.

2 Specify portions to cut.

- Press the <▲><▼> buttons to choose [⏪] or [⏩].
- To view the portions you can cut (identified by [⏪] on the screen), press the <◀><▶> buttons or turn the <⦿> dial to move [⏪]. Cut the beginning of the movie (from [⏪]) by choosing [⏪], and cut the end of the movie by choosing [⏩].
- Even if you move [⏪] to a position other than a [⏪] mark, choosing [⏪] will only cut the portion from the nearest [⏪] to the left, and choosing [⏩] will cut the portion from the nearest [⏪] to the right.

3 Review the edited movie.

- Press the <▲><▼> buttons to choose [▶], and then press the <FUNC SET> button. The edited movie is now played.
- To edit the movie again, repeat step 2.
- To cancel editing, press the <▲><▼> buttons to choose [↶]. Press the <FUNC SET> button, choose [OK] (either press the <◀><▶> buttons or turn the <⦿> dial), and then press the <FUNC SET> button again.



4 Save the edited movie.

- Press the <▲><▼> buttons to choose [↵], and then press the <FUNC SET> button.
- Press the <▲><▼><◀><▶> buttons or turn the <DISP> dial to choose [New File], and then press the <FUNC SET> button.
- ▶ The movie is now saved as a new file.



- To overwrite the original movie with the cut one, choose [Overwrite] in step 4. In this case, the original movie will be erased.
- [Overwrite] is only available when memory cards lack sufficient free space.
- Movies may not be saved if the battery runs out while saving is in progress.
- When editing movies, you should use a fully charged battery or an AC adapter kit (sold separately,  235).

Editing Movie Digest Clips

Individual chapters (📖 94) recorded in [📷] mode can be erased, as needed. Be careful when erasing chapters, because they cannot be recovered.



1 Select the chapter to erase.

- Follow steps 1 – 5 on 📖 174 – 175 to choose a movie recorded in [📷] mode, and then press the <F> button repeatedly to access the screen at left.
- Choose the chapter to erase by pressing the <◀> buttons or turning the <🌀> dial, and then choosing [◀] or [▶].



2 Choose [📷].

- Following steps 1 – 3 on 📖 174 – 175, choose [📷] and press the <F> button.
- ▶ The selected chapter is played back repeatedly.

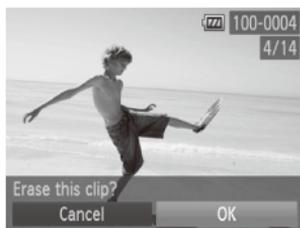

3 Confirm erasure.

- Press the <◀> buttons or turn the <🌀> dial to choose [OK], and then press the <F> button.
- ▶ The chapter is erased, and the clip is overwritten.



- [📷] is not displayed if you select a chapter when the camera is connected to a printer.

7

Setting Menu

Customize or adjust basic camera functions for greater convenience

Adjusting Basic Camera Functions

Functions can be configured on the [F/T] tab. Customize commonly used functions as desired, for greater convenience (📖 48).

Silencing Camera Operations

Silence camera sounds and movies as follows.



- Choose [Mute], and then choose [On].



- Operation can also be silenced by holding down the <▼> button as you turn the camera on.
- Sound is not played during movies if you mute camera sounds (📖 174). To restore sound during movies, press the <▲> button. Adjust volume with the <▲><▼> buttons, as needed.

Adjusting the Volume

Adjust the volume of individual camera sounds as follows.



- Choose [Volume], and then press the <FUNC SET> button.
- Choose an item, and then press the <◀><▶> buttons to adjust the volume.

Customizing Sounds

Customize camera operating sounds as follows.



- Choose [Sound Options], and then press the button.
- Choose an item, and then press the buttons to choose an option.

1, 2	Preset sounds (cannot be modified)
3	Preset sounds Can be changed by using the included software.



- The default shutter sound is used in mode (116), regardless of any changes to [Shutter Sound].

Hiding Hints and Tips

Hints and tips are normally shown when you choose FUNC. menu (47) or Menu (48) items. If you prefer, you can deactivate this information.

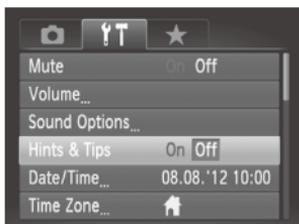

- Choose [Hints & Tips], and then choose [Off].

Date and Time

Adjust the date and time as follows.

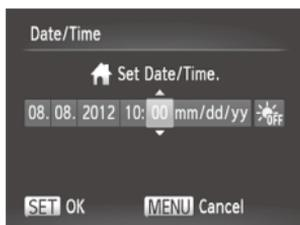

1 Access the [Date/Time] screen.

- Choose [Date/Time], and then press the <FUNC SET> button.

2 Configure the setting.

- Press the <◀><▶> buttons to choose an option, and then adjust the setting, either by pressing the <▲><▼> buttons or turning the <DISP> dial.

World Clock

To ensure that your shots will have the correct local date and time when you travel abroad, simply register the destination in advance and switch to that time zone. This convenient feature eliminates the need to change the Date/Time setting manually.

Before using the world clock, be sure to set the date and time and your home time zone (“Setting the Date and Time” (p.20)).



1 Specify your destination.

- Choose [Time Zone], and then press the <FUNC SET> button.
- Press the <▲><▼> buttons or turn the <DISP> dial to choose [✈ World], and then press the <FUNC SET> button.
- Press the <◀><▶> buttons or turn the <DISP> dial to choose the destination.
- To set daylight saving time (1 hour ahead), press the <▲><▼> buttons to choose [☀].
- Press the <FUNC SET> button.



2 Switch to the destination time zone.

- Press the <▲><▼> buttons or turn the <◉> dial to choose [World], and then press the <MENU> button.
- ▶ [] is now shown on the shooting screen (“On-Screen Information” (286)).



- Adjusting the date or time while in [] mode (22) will automatically update your [Home] time and date.

Screen Brightness

Adjust screen brightness as follows.



- Choose [LCD Brightness], and then press the <◀><▶> buttons to adjust the brightness.



- For maximum brightness, press and hold the <▼> button for at least one second when the shooting screen is displayed or when in single-image display. (This will override the [LCD Brightness] setting on the [] tab.) To restore the original brightness, press and hold the <▼> button again for at least one second or restart the camera.

Start-up Screen

Customize the start-up screen shown after you turn the camera on as follows.



- Choose [Start-up Image], and then press the button.
- Press the buttons or turn the dial to choose an option.

	No start-up image
1, 2	Preset image (cannot be modified)
3	Preset image Assign a desired shot, or use the included software to change the image.

Customizing the Start-up Screen

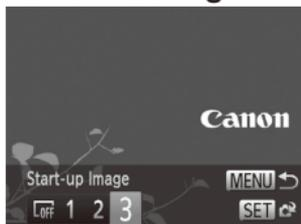

1 Access the [Start-up Image] screen in Playback mode.

- Press the button.
- Following the previous procedure, choose [3] and press the button.



2 Choose one of your shots.

- Choose an image and press the button. After [Register?] is displayed, choose [OK] (either press the buttons or turn the dial), and then press the button.



- The previous start-up setting is overwritten when you assign a new start-up image.



- You can assign the operating sounds and start-up image for your camera from the included software. Refer to the *Software Guide* (📖30) for details.

Formatting Memory Cards

Before using a new memory card or a card formatted in another device, you should format the card with this camera.

Formatting erases all data on a memory card. Before formatting, copy images on the memory card to a computer, or take other steps to back them up.

An Eye-Fi card (📖274) contains software on the card itself. Before formatting an Eye-Fi card, install the software on a computer.

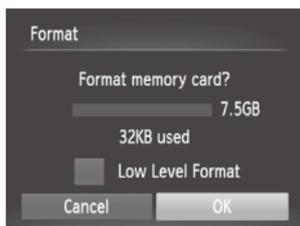

1 Access the [Format] screen.

- Choose [Format], and then press the button.

2 Choose [OK].

- Press the buttons to choose [Cancel], choose [OK] (either press the buttons or turn the dial), and then press the button.

3 Format the memory card.

- To begin the formatting process, press the buttons or turn the dial to choose [OK], and then press the button.
- When formatting is finished, [Memory card formatting complete] is displayed. Press the button.



- Formatting or erasing data on a memory card only changes file management information on the card and does not erase the data completely. When transferring or disposing of memory cards, take steps to protect personal information if necessary, as by physically destroying cards.



- The total card capacity indicated on the formatting screen may be less than the advertised capacity.

■ Low-Level Formatting

Perform low-level formatting in these cases: [Memory card error] is displayed, the camera is not working correctly, card image reading/writing is slower, continuous shooting is slower, or movie recording suddenly stops. Low-level formatting erases all data on a memory card. Before low-level formatting, copy images on the memory card to a computer, or take other steps to back them up.

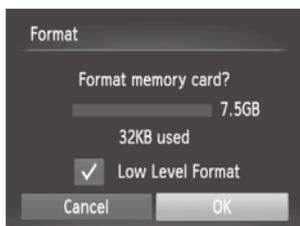

Perform low-level formatting.

- On the screen in step 2 on 223, press the <▲><▼> buttons or turn the <●> dial to choose [Low Level Format], and then select this option (mark with a [✓]) by pressing the <◀><▶> buttons.
- Follow steps 2 – 3 on 223 to continue with the formatting process.



- Low-level formatting takes longer than “Formatting Memory Cards” (223), because data is erased from all storage regions of the memory card.
- You can cancel low-level formatting in progress by choosing [Stop]. In this case, all data will be erased, but the memory card can be used normally.

File Numbering

Your shots are automatically numbered in sequential order (0001 – 9999) and saved in folders that store up to 2,000 images each. You can change how the camera assigns file numbers.



- Choose [File Numbering], and then choose an option.

Continuous	Images are numbered consecutively (until the 9999th shot is taken/saved) even if you switch memory cards.
Auto Reset	Image numbering is reset to 0001 if you switch memory cards, or when a new folder is created.



- Regardless of the option selected in this setting, shots may be numbered consecutively after the last number of existing images on newly inserted memory cards. To start saving shots from 0001, use an empty (or formatted (📖223)) memory card.
- Refer to the *Software Guide* (📖30) for information on the card folder structure and image formats.

Date-Based Image Storage

Instead of saving images in folders created each month, you can have the camera create folders each day you shoot to store shots taken that day.



- Choose [Create Folder], and then choose [Daily].
- ▶ Images will now be saved in folders created on the shooting date.

Lens Retraction Timing

The lens is normally retracted for safety about one minute after you press the button in Shooting mode (42). To have the lens retracted immediately after you press the button, set the retraction timing to [0 sec.].



- Choose [Lens Retract], and then choose [0 sec.].

Power-Saving Adjustment

Adjust the timing of automatic camera and screen deactivation (Auto Power Down and Display Off, respectively) as needed (42).

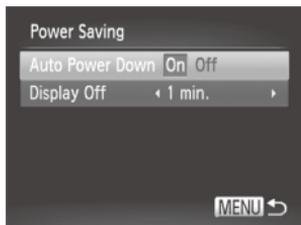

1 Access the [Power Saving] screen.

- Choose [Power Saving], and then press the button.

2 Configure the settings.

- After choosing an item, press the buttons to adjust it as needed.



- To conserve battery power, you should normally choose [On] for [Auto Power Down] and [1 min.] or less for [Display Off].



- The [Display Off] setting is applied even if you set [Auto Power Down] to [Off].

Metric/Non-Metric Display

Change the unit of measurement shown in the MF indicator (📖143) and zoom bar (📖54) from m/cm to ft/in as needed.



- Choose [Units], and then choose [ft/in].

Electronic Level Calibration

Calibrate the electronic level if it seems ineffective in helping you level the camera.



1 Make sure the camera is level.

- Place the camera on a flat surface, such as a table.

2 Access the [Electronic Level] screen.

- Choose [Electronic Level], and then press the  button.

3 Calibrate the electronic level.

- To adjust left/right tilt, choose [Horizontal Roll Calibration], and to adjust forward/backward tilt, choose [Vertical Pitch Calibration], followed by the  button. A confirmation message is displayed.
- Choose [OK], and then press the  button.

Resetting the Electronic Level

Restore the electronic level to its original state as follows. Note that this is not possible unless you have calibrated the electronic level.



- Choose [Electronic Level], and then press the  button.
- Choose [Reset], and then press the  button.
- ▶ Once the electronic level has been reset, the menu screen is displayed again.

Setting Copyright Information to Record in Images

To record the author's name and copyright details in images, set this information beforehand as follows.

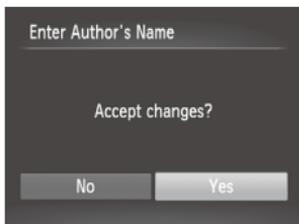
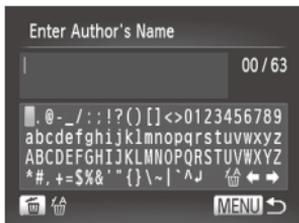

1 Access the setting screen.

- Choose [Copyright Info], and then press the button.
- Press the or turn the to choose [Enter Author's Name] or [Enter Copyright Details], and then press the button.

2 Enter a name.

- Press the or turn the to choose a character, and then press the button to enter it.
- Up to 63 characters can be used.
- Press the to delete single characters.
- Turn the or choose [] or [] and press the button to move the cursor.

3 Save the settings.

- Press the button. [Accept changes?] is displayed.
- Press the or turn the to choose [Yes], and then press the button.
- ▶ The information set here will now be recorded in images.



- To check the information entered, choose [Display Copyright Info] on the screen in step 1, and then press the  button.
- You can also use the included software ( 30) to enter, change, and delete copyright information. Some characters entered with the included software may not display on the camera, but will be correctly recorded in images.
- After saving images to a computer, you can use the software to review copyright information recorded in the images.

Deleting All Copyright Information

You can delete both the author's name and copyright details at the same time as follows.



- Follow step 1 on  229 and choose [Delete Copyright Info].
- Press the   buttons or turn the  to choose [OK], and then press the  button.



- The copyright info already recorded in images will not be deleted.

Checking Certification Logos

Some logos for certification requirements met by the camera can be viewed on the screen. Other certification logos are printed in this guide, on the camera packaging, or on the camera body.



- Choose [Certification Logo Display], and then press the  button.

Display Language

Change the display language as needed.

English	Suomi	Magyar
Deutsch	Norsk	Türkçe
Français	Svenska	繁體中文
Nederlands	Español	한국어
Dansk	简体中文	ภาษาไทย
Italiano	Русский	العربية
Українська	Português	Română
B. Malaysia	Ελληνικά	فارسی
Indonesian	Polski	हिन्दी
Tiếng Việt	Čeština	日本語

1 Access the [Language] screen.

- Choose [Language] , and then press the  button.

2 Configure the setting.

- Press the     buttons or turn the  dial to choose a language, and then press the  button.



- You can also access the [Language] screen in Playback mode by pressing and holding the  button and immediately pressing the  button.

Adjusting Other Settings

The following settings can also be adjusted on the  tab.

- [Video System] ( 243)
- [Ctrl via HDMI] ( 241)
- [Eye-Fi Settings] ( 274)

Restoring Defaults

If you accidentally change a setting, you can restore default camera settings.



1 Access the [Reset All] screen.

- Choose [Reset All], and then press the  button.

2 Restore default settings.

- Press the   buttons or turn the  dial to choose [OK], and then press the  button.

▶ Default settings are now restored.



- The following functions are not restored to default settings.
 - [↑↑] tab settings [Date/Time] (📖20), [Language] (📖23), [Time Zone] (📖220), [Video System] (📖243), and the image assigned to [Start-up Image] (📖222)
 - Information registered using Face ID (📖69)
 - Custom white balance data you have recorded (📖135)
 - Colors chosen in Color Accent (📖109) or Color Swap (📖110)
 - Shooting mode chosen in <SCN> (📖95) or <C> (📖99) mode
 - Exposure compensation (📖125) setting
 - The movie mode (📖119)
 - Calibrated value for the electronic level (📖228)
 - Copyright information (📖229)

8

Accessories

Use included accessories effectively and enjoy the camera in more ways with optional Canon accessories and other compatible accessories sold separately

Effective Battery and Charger Use

- **Charge the battery on (or immediately before) the day of use**

Charged batteries gradually lose their charge, even when they are not used.

You can easily check the charge state of the battery by attaching the cover so that ▲ is visible on a charged battery, and attaching it so that ▲ is not visible on an uncharged battery.



- **Long-term battery storage**

After using up all remaining battery power, remove the battery from the camera. Store the battery with the cover attached. Storing a partially charged battery over extended periods (about a year) may shorten its life or affect performance.

- **Using the battery charger abroad**

The charger can be used in areas with 100 – 240 V AC power (50/60 Hz). For power outlets in a different format, use a commercially available adapter for the plug. Never use an electrical transformer designed for traveling, which may damage the battery.

Optional Accessories

The following camera accessories are sold separately. Note that availability varies by area, and some accessories may no longer be available.

Power Supplies

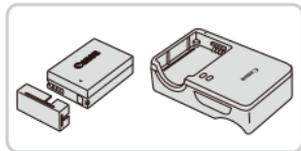

Battery Pack NB-10L

- Rechargeable lithium-ion battery

Battery Charger CB-2LC/CB-2LCE

- Charger for Battery Pack NB-10L

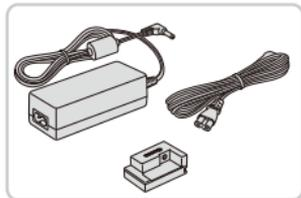

AC Adapter Kit ACK-DC80

- For powering the camera using household power. Recommended when using the camera over extended periods, or when connecting the camera to a printer or computer. Cannot be used to charge the camera battery.



- The battery charger and AC adapter kit can be used in areas with 100 – 240 V AC power (50/60 Hz).
- For power outlets in a different format, use a commercially available adapter for the plug. Never use an electrical transformer designed for traveling, which may damage the battery.

Flash Units



High-Power Flash HF-DC2

- External flash for illuminating subjects that are out of range of the built-in flash. High-Power Flash HF-DC1 can also be used.

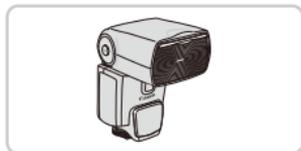

Speedlite 600EX-RT, 600EX, 580EX II, 430EX II, 320EX, 270EX II

- Shoe-mounted flash unit that enables many styles of flash photography. Speedlite 580EX, 430EX, 270EX, and 220EX are also supported.



Speedlite Bracket SB-E2

- Prevents unnatural shadows next to subjects during vertical shooting. Includes Off-Camera Shoe Cord OC-E3.



Speedlite Transmitter ST-E2

- Enables wireless control of slave Speedlite flash units (except Speedlite 270EX/220EX).

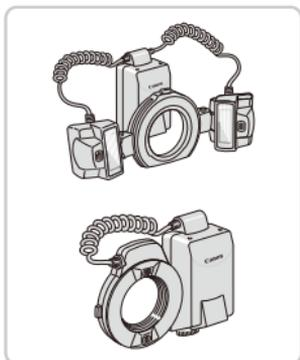

Macro Twin Lite MT-24EX

Macro Ring Lite MR-14EX

- Requires Conversion Lens Adapter LA-DC58L, Off-Camera Shoe Cord OC-E3, and Bracket BKT-DC1 (all sold separately) for attachment to the camera. Requires Conversion Lens Adapter LA-DC58L (sold separately) for attachment to the camera.



Off-Camera Shoe Cord OC-E3

- Used to attach a Macro Twin Lite flash to the camera.

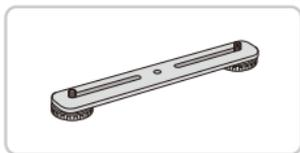

Bracket BKT-DC1

- Used to attach a Macro Twin Lite flash to the camera.

Other Accessories

Soft Case SC-DC85

- Protects the camera from dust and scratches.
Handle with care to prevent leather discoloration.

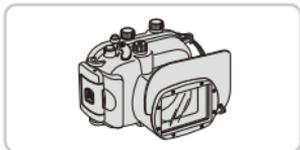

Waterproof Case WP-DC48

- For underwater photography at depths of up to 40 meters (130 ft.). Also useful for shooting in the rain, at the beach, or on ski slopes.

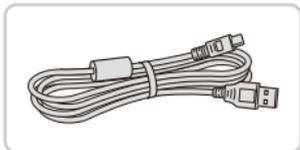

Interface Cable IFC-400PCU

- For connecting the camera to a computer or printer.

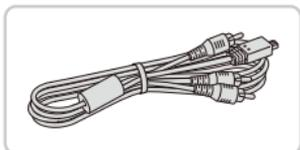

Stereo AV Cable AVC-DC400ST

- Connect the camera to a TV to enjoy playback on the larger TV screen.

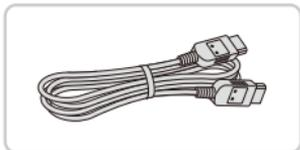

HDMI Cable HTC-100

- For connecting the camera to an HDMI input of a high-definition TV.



Tele-converter TC-DC58E

- Optional lens attached to the camera to increase the focal length by a factor of approximately 1.4x. (Includes lens hood.)



Conversion Lens Adapter LA-DC58L

- Adapter required to attach the Tele-converter or Macro Ring Lite/Macro Twin Lite flash to the camera.

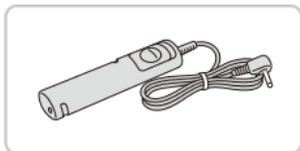

Remote Switch RS-60E3

- Enables remote shutter button operation (pressing the button halfway or all the way down).



Filter Adapter FA-DC58D

- Adapter required when mounting a 58 mm filter.

Canon Lens Filter (58 mm dia.)

- Protects the lens and enables a variety of shooting effects.

Printers

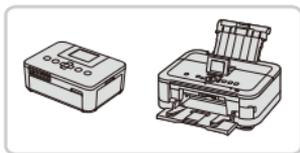

Canon PictBridge-Compatible Printers

- Printing images without a computer is possible by connecting the camera to a Canon PictBridge-compatible printer. For details, visit your nearest Canon dealer.

Using Optional Accessories

Playback on a TV

By connecting the camera to a TV, you can view your shots on the larger screen of the TV.

For details on connection or how to switch inputs, refer to the TV manual.



- Some information may not be displayed on the TV (📖288).

Playback on a High-Definition TV

Connecting the camera to an HDTV with the HDMI Cable HTC-100 (sold separately) enables you to view your shots on the larger screen of the TV. Movies shot at a resolution of [1920] or [1280] can be viewed in high-definition.

1 Make sure the camera and TV are off.

2 Connect the camera to the TV.

- On the TV, insert the cable plug fully into the HDMI input as shown.
- On the camera, open the terminal cover and insert the cable plug fully into the camera terminal.

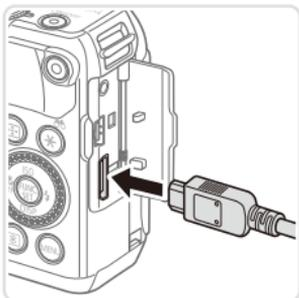
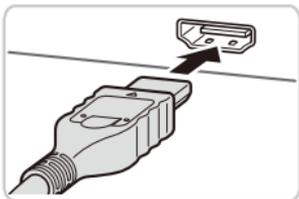



3 Turn the TV on and switch to video input.

- Switch the TV input to the video input you connected the cable to in step 2.

4 Turn the camera on.

- Press the <▶> button to turn the camera on.
- ▶ Images from the camera are now displayed on the TV. (Nothing is displayed on the camera screen.)
- When finished, turn off the camera and TV before disconnecting the cable.



- It is not possible to connect the USB cable or an optional stereo AV cable at the same time as an HDMI Cable HTC-100. Forcing the cables into the camera at the same time may damage the camera or cables.



- Camera operating sounds are not played while the camera is connected to an HDTV.

Controlling the Camera with a TV Remote

Connecting the camera to an HDMI CEC-compatible TV enables playback (including slideshow playback) using the TV remote control.

In this case, you will need to adjust some TV settings. For details, refer to the TV user manual.



1 Configure the setting.

- Press the <MENU> button, choose [Ctrl via HDMI] on the [↑↓] tab, and then choose [Enable] (📖48).

2 Connect the camera to the TV.

- Follow steps 1 – 2 on 📖239 to connect the camera to the TV.

3 Display images.

- Turn on the TV. On the camera, press the <▶> button.
 - ▶ Images from the camera are now displayed on the TV. (Nothing is displayed on the camera screen.)

4 Control the camera with the TV remote.

- Press the <◀>>> buttons on the remote to browse images.
- To display the camera control panel, press the OK/Select button. Select control panel items by pressing the <◀>>> buttons to choose an item, and then pressing the OK/Select button again.

Camera Control Panel Options Shown on the TV

	Return	Closes the menu.
	Group Playback	Displays sets of images shot in [H0] mode (116). (Only displayed when a grouped image is selected.)
	Play Movie	Starts movie playback. (Only displayed when a movie is selected.)
	Slideshow	Starts slideshow playback. To switch images during playback, press the <<>> buttons on the remote control.
	Index Playback	Displays multiple images in an index.
DISP.	Change Display	Switches display modes (46).



- Pressing the <MENU> button on the camera will switch control to the camera itself, which will prevent remote control until you return to single-image display.
- The camera may not always respond correctly even if the remote is for an HDMI CEC-compatible TV.

Playback on a Standard-Definition TV

Connecting the camera to a TV with the Stereo AV Cable AVC-DC400ST (sold separately) enables you to view your shots on the larger screen of the TV as you control the camera.

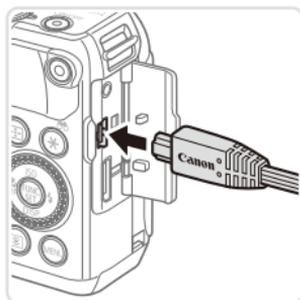
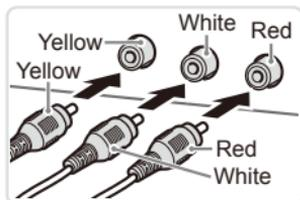

1 Make sure the camera and TV are off.

2 Connect the camera to the TV.

- On the TV, insert the cable plugs fully into the video inputs as shown.
- On the camera, open the terminal cover and insert the cable plug fully into the camera terminal.

3 Display images.

- Follow steps 3 – 4 on [p.240](#) to display images.



- Correct display is not possible unless the camera video output format (NTSC or PAL) matches the TV format. To change the video output format, press the **<MENU>** button and choose [Video System] on the **[↑]** tab.



- When the camera and TV are connected, you can also shoot while previewing shots on the larger screen of the TV. To shoot, follow the same steps as when using the camera screen. However, AF-Point Zoom ([p.87](#)), Stitch Assist ([p.118](#)) and MF-Point Zoom ([p.143](#)) are not available.

Powering the Camera with Household Power

Powering the camera with AC Adapter Kit ACK-DC80 (sold separately) eliminates the need to monitor the remaining battery level.

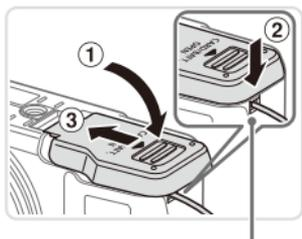
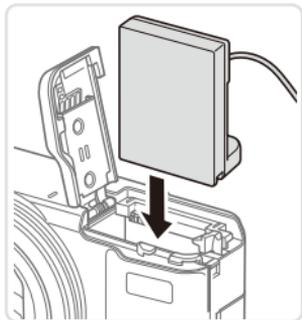
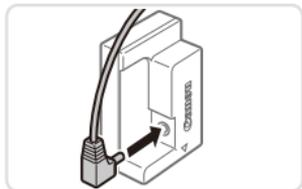

Coupler Cable Port

1 Make sure the camera is off.

2 Connect the adapter to the coupler.

- Insert the adapter plug fully into the coupler.

3 Insert the coupler.

- Follow step 2 on  18 to open the cover, and then insert the coupler as shown until it locks into place.

- Lower the cover (①), keeping the coupler cable in the coupler cable port (②).
- Slide the cover (③) until it clicks into place.

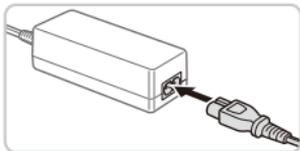

4 Connect the power cord.

- Insert one end of the power cord into the compact power adapter, and then plug the other end into a power outlet.
- Turn the camera on and use it as desired.
- When finished, turn the camera off and unplug the power cord from the outlet.



- Do not disconnect the adapter or unplug the power cord while the camera is still on. This may erase your shots or damage the camera.
- Do not attach the adapter or adapter cord to other objects. Doing so could result in malfunction or damage to the product.

Still Images

Movies

Using a Tele-converter (Sold Separately)

Attaching Tele-converter TC-DC58E and Conversion Lens Adapter LA-DC58L (both sold separately) enables you to use a focal length of 1.4x.



1 Remove the ring.

- Make sure the camera is off.
- Hold down the ring release button (1) and turn the ring in the direction of the arrow (2).
- Align the ○ mark on the ring with the ● mark on the camera, and then lift the ring off.

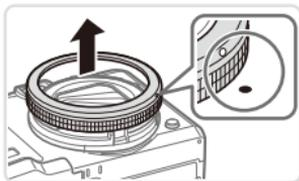

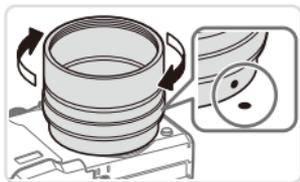

2 Attach the conversion lens adapter.

- Align the ● mark on the conversion lens adapter with the ● mark on the camera, and then turn the adapter in the direction of the arrows until it locks.
- To remove the adapter, hold down the ring release button and turn the adapter in the opposite direction.



3 Attach the tele-converter lens.

- Turn the lens in the direction of the arrow to attach it securely to the camera.

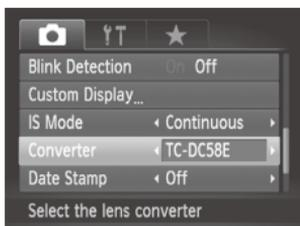

4 Specify the converter in the camera settings.

- Turn the camera on.
- Press the <MENU> button and choose [Converter] on the [CAMERA] tab. Press the <LEFT><RIGHT> buttons to choose [TC-DC58E].
- There is no need to adjust the converter setting when [IS Mode] is set to [Off].
- After removing the converter, always return the converter setting to [None].

- ❗ • Vignetting may occur (especially in the lower right) when the built-in flash is used.
- Set the camera to maximum telephoto when using the tele-converter. At other zoom positions, vignetting may occur.
- Use the LCD monitor to compose shots. The view through the viewfinder may be partially obstructed by vignetting.
- Before use, remove all dust or debris from the conversion lens with a lens blower brush.
- Stitching multiple images together accurately with the included software is not possible when shooting in [📷] or [📹] mode (📖 118) while using these lens attachments.

Still Images

Movies

Using a Lens Hood

Attaching the lens hood included with Tele-converter TC-DC58E (sold separately) can reduce the effect of extraneous light outside the angle of view when shooting backlit subjects, or when the camera is aimed toward a bright light source.

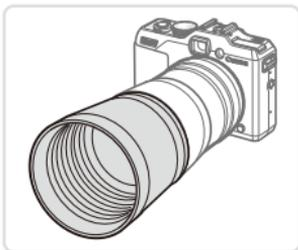

Attach the lens hood.

- Fit the lens hood over the tele-converter as shown and attach it securely.
- When the lens hood will not be used, attach it inverted.

- ❗ • Vignetting may occur if you use the built-in flash when the lens hood is attached.

Using Lens Filters (Sold Separately)

Attaching a lens filter to the camera protects the lens and allows you to shoot with various effects. To attach a lens filter, you will need Filter Adapter FA-DC58D (sold separately).

1 Remove the ring.

- Follow step 1 on  245 to remove the ring.

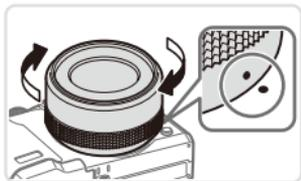

2 Attach the filter adapter.

- Align the ● mark on the filter adapter with the ● mark on the camera, and then turn the adapter in the direction of the arrows until it locks in place.
- To remove the adapter, turn off the camera, hold down the ring release button, and turn the adapter in the opposite direction.



3 Attach a filter.

- Attach the filter to the camera in the direction of the arrow.



- We recommend the use of genuine Canon filters (58 mm dia.).
- When not using auto focus to shoot, set the manual focus option [Safety MF] to [On].
- If you use the built-in flash with the filter adapter attached, portions of the image may appear darker.
- When using the filter adapter, be sure to use only one filter at a time. Attaching multiple filters, or accessories such as a heavy lens, may cause the attachments to fall off and become damaged.
- Do not grip the filter adapter tightly.
- Remove the filter adapter when not using a filter.



- The filter adapter and a lens hood cannot be attached to the camera at the same time.

Still Images

Using a Remote Switch (Sold Separately)

An optional Remote Switch RS-60E3 can be used to avoid camera shake that may otherwise occur when pressing the shutter button directly. This optional accessory is convenient when shooting at slow shutter speeds.

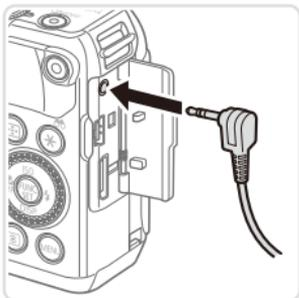

1 Connect the remote switch.

- Make sure the camera is off.
- Open the terminal cover and insert the remote switch plug.



2 Shoot.

- To shoot, press the release button on the remote switch.



- Bulb photography (long exposures) is not supported.

Using an External Flash (Sold Separately)

More sophisticated flash photography is possible with an optional Speedlite EX series flash. For movie shooting using an LED light, the optional Speedlite 320EX flash is available.

- ❗ This camera does not support some Speedlite EX series functions.
- Wireless operation of the Speedlite 600EX-RT is not supported.
- Non-EX series Canon flash units may not fire correctly or may not fire at all, in some cases.
- Use of non-Canon flash units (especially high-voltage flash units) or flash accessories may prevent normal camera operation and may damage the camera.



- Also refer to the Speedlite EX series manual for additional information.

Speedlite EX Series

These optional flash units can provide bright lighting and meet a variety of flash photography needs.



1 Attach the flash unit to the hot shoe.

2 Turn the flash on, and then turn the camera on.

- ▶ A red [⚡] icon is now displayed.
- ▶ The flash pilot lamp will light up when the flash is ready.

3 Choose shooting mode <P>, <Tv>, <Av>, or <M>.

- Flash settings can only be configured in these modes. In other modes, the flash is adjusted and fired automatically, as needed.

4 Set the white balance to [⚡] (📖 134).

5 Configure the external flash.

- Press the <MENU> button, choose [Flash Control] on the [📷] tab, and then press the <FUNC SET> button.
- Options already set on the flash itself are displayed.
- Press the <▲><▼> buttons or turn the <🔘> dial to choose an item, and then adjust the setting by pressing the <◀><▶> buttons.
- Available settings vary depending on the shooting mode and the flash attached (📖 257).

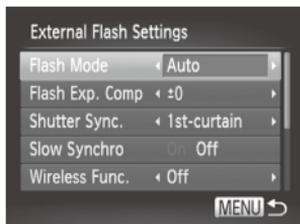

- Settings for the built-in flash cannot be configured while a Speedlite EX series flash is attached, because that setting screen is no longer accessible.
- You can also access the setting screen by pressing the <▶> button for at least one second.
- Flash settings in [📷] shooting mode can be configured just as they are in <P> mode.
- 600EX-RT/580EX II only: [Flash Control] is not available if the external flash has been set up for stroboscopic flash.
- 320EX only: Auto LED lighting is only available in low-light movie recording or in Movie mode. In this case, the [🔦] icon is shown.

Using Speedlite Bracket SB-E2 (Sold Separately)

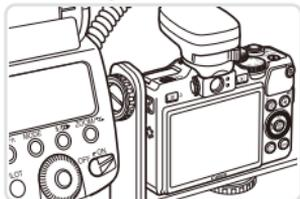

- Using the optional Speedlite Bracket SB-E2 can help prevent unnatural shadows next to subjects during vertical shooting.

Macro Ring Lite MR-14EX

These optional flash units enable many styles of macro flash photography. Requires Conversion Lens Adapter LA-DC58L (sold separately) for attachment to the camera.

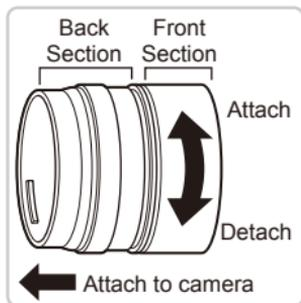

1 Prepare the conversion lens adapter.

- Rotate the conversion lens adapter in the direction indicated by the arrow to separate the front and back sections.
- Only the back section is used to attach the Macro Ring Lite MR-14EX or Macro Twin Lite MT-24EX.



2 Remove the ring.

- Make sure the camera is off.
- Hold down the ring release button (①) and turn the ring in the direction of the arrow (②).

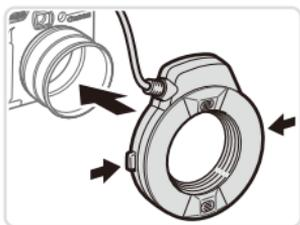
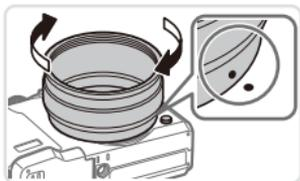
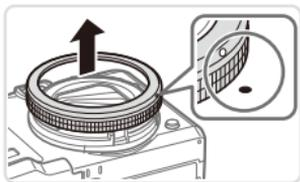

- Align the ○ mark on the ring with the ● mark on the camera, and then lift the ring off.

3 Attach the back section of the conversion lens adapter.

- Align the ● mark on the back section with the ● mark on the camera, and then turn the adapter in the direction of the arrows until it locks in place.
- To remove the adapter, hold down the ring release button and turn the adapter in the opposite direction.

4 Attach the controller to the camera.

- Attach the control component of the macro ring lite to the hot shoe on top of the camera.

5 Attach the flash unit to the conversion lens adapter.

- Press the release buttons on both sides of the macro ring lite in and attach the macro ring lite to the conversion lens adapter.

6 Choose shooting mode <P>, <Tv>, <Av>, or <M>.

- Flash settings can only be configured in these modes. In other modes, the flash is adjusted and fired automatically, as needed.

- 7 Set the white balance to [**W**] (📖 134).
- 8 Enter <🌸> mode (📖 142).
- 9 Set [ND Filter] to [On] (📖 133).
- 10 Configure the external flash.
 - Follow step 5 on 📖 251 to adjust the settings.



- Keep the macro ring lite cord away from flash heads.
- When using a tripod, adjust the position of the legs to prevent them from coming into contact with the flash heads or the bracket.
- Use the screen to compose shots, because the viewfinder cannot be used with these accessories attached.

■ Macro Twin Lite MT-24EX

These optional flash units enable many styles of macro flash photography. Requires the Conversion Lens Adapter LA-DC58L, Off-Camera Shoe Cord OC-E3, and Bracket BKT-DC1 (all sold separately) for attachment to the camera.

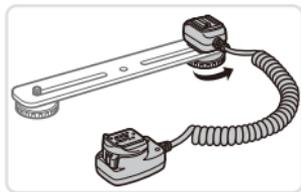

- 1 Remove the ring and attach the back section of the conversion lens adapter.
 - Follow steps 1 – 3 on 📖 252 – 253 to remove the ring, and then attach the back section of the conversion lens adapter.
- 2 Attach the off-camera shoe cord to the bracket.
 - Slide the bracket screw to the outer end of the bracket. Align the bracket screw with the tripod socket of the off-camera shoe cord, and then tighten the screw to secure it.

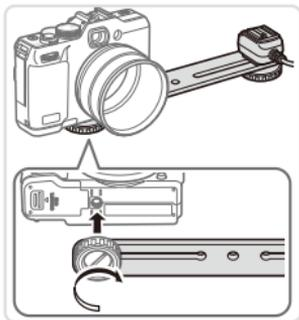

3 Attach the bracket to the camera.

- Slide the other bracket screw to the outer end of the bracket. Align the bracket screw with the tripod socket on the bottom of the camera, and then tighten the screw to secure it.

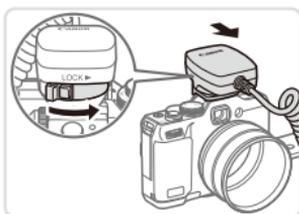

4 Attach the off-camera shoe cord to the camera.

- Attach the camera connection component of the off-camera shoe cord to the hot shoe on top of the camera.



5 Attach the controller to the off-camera shoe cord.

- Attach the controller for the macro twin lite to the flash connection component of the off-camera shoe cord.

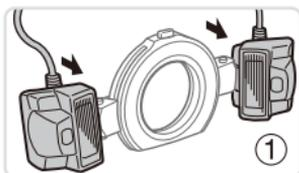

6 Attach the flash unit to the conversion lens adapter.

- Attach each flash head to the respective mount (①). Press the release button on the top of the ring in and attach the ring to the conversion lens adapter (②).

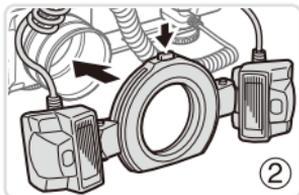

7 Configure the external flash and settings on the camera.

- Follow steps 6 – 10 on  253 – 254 to configure the setting.



- Keep cords (from the macro twin lite or the off-camera shoe cord) away from flash heads.
- When using a tripod, adjust the position of the legs to prevent them from coming into contact with the flash heads or the bracket.
- Use the screen to compose shots, because the viewfinder cannot be used with these accessories attached.

Camera Settings Available with an External Flash (Sold Separately)

The following settings are available in <P>, <Tv>, <Av>, or <M> mode. In other shooting modes, only [Red-Eye Corr.] and [Red-Eye Lamp] can be configured. (With autoflash control, the flash always fires.) However, external flash units do not fire in modes that the built-in flash does not fire (290).

Item	Options	Shooting Mode			
		P	Tv	Av	M
Flash Mode	Auto* ¹	○	○	○	–
	Manual* ²	○	○	○	○
Flash Exp. Comp* ³	–3 to +3	○	○	○	–
Flash Output* ⁴	1/128* ⁵ to 1/1 (in 1/3-stop increments)	○	○	○	○
Shutter Sync.	1st-curtain/2nd-curtain/Hi-speed	○	○	○	○
Slow Synchro	On	○	○	○	○
	Off	○	–	○	–
Wireless Func.* ⁶	On/Off	○	○	○	○
Red-Eye Corr.	On/Off	○	○	○	○
Red-Eye Lamp	On/Off	○	○	○	○
Safety FE* ⁷	On	○	○	○	–
	Off	○	○	○	○
Clear Flash Settings* ⁸		○	○	○	○

*1 E-TTL mode is used for the flash.

*2 M mode is used for the flash.

In [M] shooting mode, E-TTL mode is also available for the flash. In this case, when the flash fires, flash exposure compensation set on the flash is applied to the flash output level set on the camera.

*3 Can be configured only when [Flash Mode] is [Auto] and flash exposure compensation set on the flash is [+0]. When you adjust flash exposure compensation on 600EX-RT, 600EX, 580EX II, or 430EX II Speedlites, the camera display will be updated accordingly.

*4 Can be configured when [Flash Mode] is [Manual]. Linked to settings on the flash unit.

*5 1/64 for Speedlite 430EX II/430EX/320EX/270EX II/270EX, Macro Ring Lite MR-14EX, and Macro Twin Lite MT-24EX.

*6 For options other than On/Off, configure the setting on the flash unit itself. Not available with Speedlite 430EX II/320EX/270EX II/270EX, Macro Ring Lite MR-14EX, or Macro Twin Lite MT-24EX. When this setting is set to [On], [Shutter Sync.] cannot be set to [2nd-curtain]. (If [Shutter Sync.] is set to [2nd-curtain], it will be changed to [1st-curtain].)

*7 Can only be configured when [Flash Mode] is [Auto].

*8 Restores all default settings. You can also restore defaults for [Slow Synchro], [Safety FE], [Red-Eye Corr.], and [Red-Eye Lamp] by using [Reset All] in the [Y] menu on the camera (📖231).



- Flash settings in [A] shooting mode can be configured just as they are in <P> mode.
- In <AUTO> shooting mode, icons representing Smiling, Sleeping, Babies (Smiling), Babies (Sleeping), and Children shooting scenes determined by the camera are not displayed, and the camera does not shoot continuously (📖59).

Printing Images

Your shots can easily be printed by connecting the camera to a printer. On the camera, you can specify images to set up batch printing, prepare orders for photo development services, and prepare orders or print images for photobooks.

A Canon SELPHY CP series compact photo printer is used here for the sake of illustration. Screens displayed and available functions vary by printer. Also refer to the printer manual for additional information.

Still Images

Easy Print

Easily print your shots by connecting the camera to a PictBridge-compatible printer (sold separately) with the USB cable.

1 Make sure the camera and printer are off.

2 Connect the camera to the printer.

- Open the cover. Holding the smaller cable plug in the orientation shown, insert the plug fully into the camera terminal.
- Connect the larger cable plug to the printer. For other connection details, refer to the printer manual.

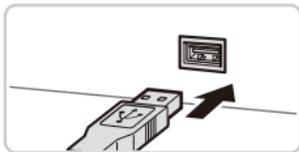
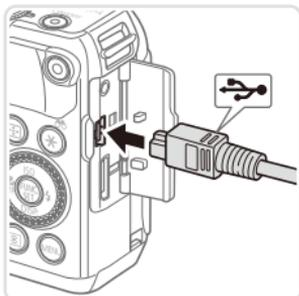

3 Turn the printer on.

4 Turn the camera on.

- Press the  button to turn the camera on.





▶ [SET] is displayed.

5 Choose an image.

- Press the <◀><▶> buttons or turn the <◉> dial to choose an image.

6 Print the image.

- Press the <🖨️> button.
- ▶ Printing now begins.
- To print other images, repeat steps 5 – 6 after printing is finished.
- When you are finished printing, turn the camera and printer off and disconnect the interface cable.



- For Canon PictBridge-compatible printers (sold separately), see 238.
- RAW images cannot be printed.

Configuring Print Settings



1 Access the printing screen.

- After following steps 1 – 5 on [p. 259](#) – [p. 260](#) to choose an image, press the **<FUNC/SET>** button to access the screen at left.

2 Configure the settings.

- Press the **<▲>****<▼>** buttons or turn the **<DISP/OK>** dial to choose an item, and then choose an option by pressing the **<◀>****<▶>** buttons.

	Default	Matches current printer settings.
	Date	Prints images with the date added.
	File No.	Prints images with the file number added.
	Both	Prints images with both the date and file number added.
	Off	–
	Default	Matches current printer settings.
	Off	–
	On	Uses information from the time of shooting to print under optimal settings.
	Red-Eye 1	Corrects red-eye.
	No. of Copies	Choose the number of copies to print.
Cropping	–	Specify a desired image area to print (p. 262).
Paper Settings	–	Specify the paper size, layout, and other details (p. 263).

Cropping Images Before Printing (Cropping)

By cropping images before printing, you can print a desired image area instead of the entire image.

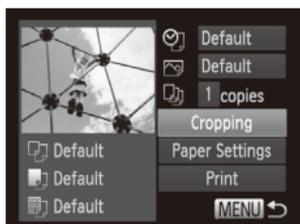

1 Choose [Cropping].

- After following step 1 on [261](#) to access the printing screen, choose [Cropping] and press the  button.
- ▶ A cropping frame is now displayed, indicating the image area to print.

2 Adjust the cropping frame as needed.

- To resize the frame, move the zoom lever.
- To move the frame, press the  buttons.
- To rotate the frame, turn the  dial.
- When finished, press the  button.

3 Print the image.

- On the screen in step 1, press the  buttons or turn the  dial to choose [Print], and then press the  button.



- Cropping may not be possible at small image sizes, or at some aspect ratios.
- Dates may not be printed correctly if you crop images shot with [Date Stamp] selected.

Choosing Paper Size and Layout Before Printing



1 Choose [Paper Settings].

- After following step 1 on [page 261](#) to access the printing screen, choose [Paper Settings] and press the  button.

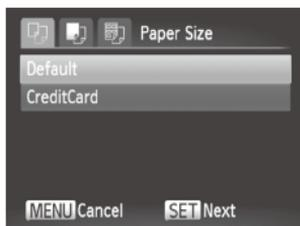

2 Choose a paper size.

- Press the   buttons or turn the  dial to choose an option, and then press the  button.

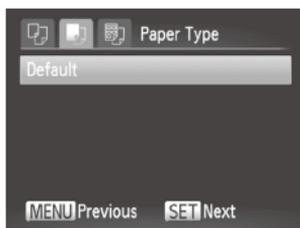

3 Choose a type of paper.

- Press the   buttons or turn the  dial to choose an option, and then press the  button.

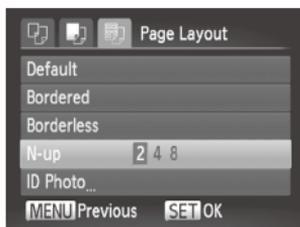

4 Choose a layout.

- Press the   buttons or turn the  dial to choose an option.
- When choosing [N-up], press the   buttons to specify the number of images per sheet.
- Press the  button.

5 Print the image.

Available Layout Options

Default	Matches current printer settings.
Bordered	Prints with blank space around the image.
Borderless	Borderless, edge-to-edge printing.
N-up	Choose how many images to print per sheet.
ID Photo	Prints images for identification purposes. Only available for images with a resolution of L and an aspect ratio of 4:3.
Fixed Size	Choose the print size. Choose from 3.5 x 5 in., postcard, or wide-format prints.

Still Images

Printing ID Photos

1 Choose [ID Photo].

- Following steps 1 – 4 on 263, choose [ID Photo] and press the button.

2 Choose the long and short side length.

- Press the buttons or turn the dial to choose an item. Choose the length by pressing the buttons, and then press the button.



3 Choose the printing area.

- Follow step 2 on 262 to choose the printing area.

4 Print the image.

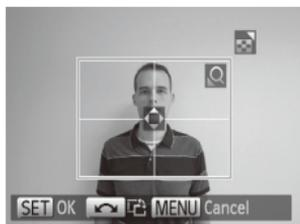

Printing Movie Scenes

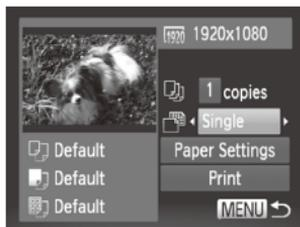

1 Access the printing screen.

- Follow steps 1 – 5 on 259 – 260 to choose a movie, and then press the <FUNC SET> button.
- Press the <◀><▶> buttons or turn the <●> dial to choose [📄], and then press the <FUNC SET> button. The screen at left is displayed.

2 Choose a printing method.

- Press the <▲><▼> buttons or turn the <●> dial to choose [📄📄], and then press the <◀><▶> buttons to choose the printing method.

3 Print the image.

Movie Printing Options

Single	Prints the current scene as a still image.
Sequence	Prints a series of scenes, a certain interval apart, on a single sheet of paper. You can also print the folder number, file number, and elapsed time for the frame by setting [Caption] to [On].



- To cancel printing in progress, press the <FUNC SET> button.
- [ID Photo] and [Sequence] cannot be chosen on Canon PictBridge-compatible printers from CP720/CP730 and earlier models.

Adding Images to the Print List (DPOF)

Batch printing (📖 270) and ordering prints from a photo development service can be set up on the camera. Choose up to 998 images on a memory card and configure relevant settings, such as the number of copies, as follows. The printing information you prepare this way will conform to DPOF (Digital Print Order Format) standards.



- RAW images cannot be included in print list.

Adding Images to the Print List via the Button

You can add images to the print list (DPOF) during playback simply by pressing the  button.



1 Choose an image.

- Press the   buttons or turn the  dial to choose an image.

2 Add the image to the print list.

- Press the  button.
- Press the   buttons to specify the number of prints. Choose [Add] by pressing the   buttons or turning the  dial, and then press the  button.
- To remove the image from the print list, repeat steps 1 – 2 but choose [Remove] by pressing the   buttons or turning the  dial, and then press the  button.



- Print list cannot be set up while the camera is connected to a printer.

Configuring Print Settings

Specify the printing format, whether to add the date or file number, and other settings as follows. These settings apply to all images in the print list.

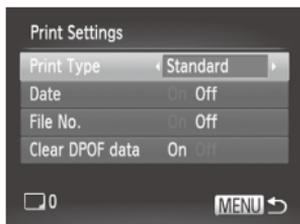

- Press the <MENU> button, and then choose [Print Settings] on the [P] tab. Choose and configure settings as desired (48).

Print Type	Standard	One image is printed per sheet.
	Index	Smaller versions of multiple images are printed per sheet.
	Both	Both standard and index formats are printed.
Date	On	Images are printed with the shooting date.
	Off	—
File No.	On	Images are printed with the file number.
	Off	—
Clear DPOF data	On	All image print list settings are cleared after printing.
	Off	—



- Not all of your DPOF settings may be applied in printing by the printer or photo development service, in some cases.
- [!] may be displayed on the camera to warn you that the memory card has print settings that were configured on another camera. Changing the print settings using this camera may overwrite all previous settings.
- Setting [Date] to [On] may cause some printers to print the date twice.



- Specifying [Index] will prevent you from choosing [On] for both [Date] and [File No.] at the same time.
- Index printing is not available on some Canon PictBridge-compatible printers (sold separately).
- The date is printed in a format matching setting details in [Date/Time] on the [↑↑] tab (📖20).

Setting Up Printing for Individual Images



1 Choose [Select Images & Qty.].

- Press the <MENU> button, choose [Select Images & Qty.] on the [📄] tab, and then press the <FUNC SET> button.

2 Choose an image.

- Press the <◀><▶> buttons or turn the <🔍> dial to choose an image, and then press the <FUNC SET> button.
 - ▶ You can now specify the number of copies.
- If you specify index printing for the image, it is labeled with a [✓] icon. To cancel index printing for the image, press the <FUNC SET> button again. [✓] is no longer displayed.



3 Specify the number of prints.

- Press the <▲><▼> buttons or turn the <FUNC SET> dial to specify the number of prints (up to 99).
- To set up printing for other images and specify the number of prints, repeat steps 2 – 3.
- Printing quantity cannot be specified for index prints. You can only choose which images to print, by following step 2.
- When finished, press the <MENU> button to return to the menu screen.

Still Images

Setting Up Printing for a Range of Images

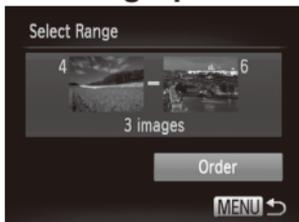

1 Choose [Select Range].

- Following step 1 on [page 268](#), choose [Select Range] and press the <FUNC SET> button.

2 Choose images.

- Follow steps 2 – 3 on [page 194](#) to specify images.

3 Configure the print settings.

- Press the <▲><▼> buttons to choose [Order], and then press the <FUNC SET> button.

Setting Up Printing for All Images



1 Choose [Select All Images].

- Following step 1 on [p. 268](#), choose [Select All Images] and press the  button.

2 Configure the print settings.

- Press the   buttons or turn the  dial to choose [OK], and then press the  button.

Clearing All Images from the Print List



1 Choose [Clear All Selections].

- Following step 1 on [p. 268](#), choose [Clear All Selections] and press the  button.

2 Confirm clearing the print list.

- Press the   buttons or turn the  dial to choose [OK], and then press the  button.

Printing Images Added to the Print List (DPOF)



- When images have been added to the print list ([pp. 266 – 270](#)), the screen at left is displayed after you connect the camera to a PictBridge-compatible printer. Press the   buttons to choose [Print now], and then simply press the  button to print the images in the print list.
- Any DPOF print job that you temporarily stop will be resumed from the next image.

Adding Images to a Photobook

Photobooks can be set up on the camera by choosing up to 998 images on a memory card and importing them into the included software on your computer, where they are stored in their own folder. This is convenient when ordering printed photobooks online or printing photobooks with your own printer.

Choosing a Selection Method



- Press the <MENU> button, choose [Photobook Set-up] on the [▶] tab, and then choose how you will select images.



- [!] may be displayed on the camera to warn you that the memory card has print settings that were configured on another camera. Changing the print settings using this camera may overwrite all previous settings.



- After importing images to your computer, also refer to the *Software Guide* (30) and the printer manual for further information.

Adding Images Individually



1 Choose [Select].

- Following the previous procedure, choose [Select] and press the **<FUNC SET>** button.



2 Choose an image.

- Press the **<◀>>▶>** buttons or turn the **<DISP>** dial to choose an image, and then press the **<FUNC SET>** button.
- [✓]** is displayed.
- To remove the image from the photobook, press the **<FUNC SET>** button again. **[✓]** is no longer displayed.
- Repeat this process to specify other images.
- When finished, press the **<MENU>** button to return to the menu screen.

Adding All Images to a Photobook



1 Choose [Select All Images].

- Following the procedure on [p. 272](#), choose [Select All Images] and press the **<FUNC SET>** button.

2 Configure the print settings.

- Press the **<◀>>▶>** buttons or turn the **<DISP>** dial to choose [OK], and then press the **<FUNC SET>** button.

Removing All Images from a Photobook



1 Choose [Clear All Selections].

- Following the procedure on [page 272](#), choose [Clear All Selections] and press the  button.

2 Confirm clearing the photobook.

- Press the   buttons or turn the  dial to choose [OK], and then press the  button.

Using an Eye-Fi Card

Before using an Eye-Fi card, always confirm that local use is permitted (📖2).

Inserting a prepared Eye-Fi card enables automatic wireless transfer of images to a computer or uploading to a photo-sharing website.

Images are transferred by the Eye-Fi card. Refer to the card's user manual or contact the manufacturer for instructions on preparing and using cards or resolving transfer problems.



- When using an Eye-Fi card, keep the following points in mind.
 - Cards may continue to transmit radio waves even when [Eye-Fi trans.] is set to [Disable] (📖276). Remove the Eye-Fi card before entering hospitals, aircraft, or other areas where transmission is prohibited.
 - When troubleshooting image transfer issues, check the card and computer settings. For details, refer to the card's user manual.
 - Poor Eye-Fi connections may cause image transfer to take a long time, and transfer may be interrupted in some cases.
 - Eye-Fi cards may become hot, due to their transfer functions.
 - Battery power will be consumed faster than in normal use.
 - Camera operation may become sluggish. To resolve this, try setting [Eye-Fi trans.] to [Disable].

Connection status of Eye-Fi cards in the camera can be checked on the shooting screen (in regular information display mode) or playback screen (in simple information display mode).

 (Gray)	Not connected	 Interrupted
 (Blinking white)	Connecting	 Not communicating
 (White)	Connected	 Error acquiring Eye-Fi card information* ²
 (Animated)	Transfer in progress* ¹	

* 1 Power saving ( 42) on the camera is temporarily disabled during image transfer.

* 2 Restart the camera. Repeated display of this icon may indicate a problem with the card.

Images labeled with a  icon have been transferred.



- Choosing  mode will interrupt the Eye-Fi connection. Although the Eye-Fi connection will be restored after you choose another shooting mode or enter Playback mode, the camera may transfer any movies made in  mode again.

Checking Connection Information

Check the access point SSID used by the Eye-Fi card or the connection status, as needed.

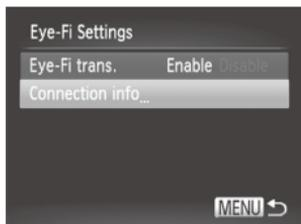

- Press the <MENU> button, choose [Eye-Fi Settings] on the [↑↑] tab, and then press the <FUNC SET> button.
- Choose [Connection info], and then press the <FUNC SET> button.
- ▶ The connection information screen is displayed.

Disabling Eye-Fi Transfer

Configure the setting as follows to disable Eye-Fi transfer by the card, if necessary.

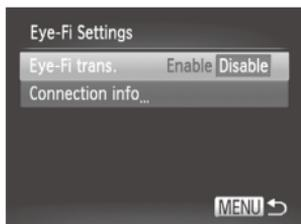

Choose [Disable] in [Eye-Fi trans.].

- Press the <MENU> button, choose [Eye-Fi Settings] on the [↑↑] tab, and then press the <FUNC SET> button.
- Choose [Eye-Fi trans.], and then choose [Disable].



- [Eye-Fi Settings] is not shown unless an Eye-Fi card is in the camera with its write-protect tab in the unlocked position. For this reason, you cannot change settings for an inserted Eye-Fi card if the write-protect tab is in the locked position.

9

Appendix

Helpful information when using the camera

Troubleshooting

If you think there is a problem with the camera, first check the following. If the items below do not solve your problem, contact a Canon Customer Support Help Desk.

Power

Nothing happens when the ON/OFF button is pressed.

- Confirm that the battery is charged (📖17).
- Confirm that the battery is inserted facing the correct way (📖18).
- Confirm that the memory card/battery cover is fully closed (📖19).
- Dirty battery terminals reduce battery performance. Try cleaning the terminals with a cotton swab and reinserting the battery a few times.

The battery is depleted quickly.

- Battery performance decreases at low temperatures. Try warming the battery a little by putting it in your pocket, for example, with the terminal cover on.
- If these measures do not help and the battery is still depleted soon after charging, it has reached the end of its life. Purchase a new battery.

The lens is not retracted.

- Do not open the memory card/battery cover while the camera is on. Close the cover, turn the camera on, and then turn it off again (📖19).

The battery is swollen.

- Battery swelling is normal and does not pose any safety concerns. However, if battery swelling prevents the battery from fitting in the camera, contact a Canon Customer Support Help Desk.

Display on a TV

Camera images look distorted or not displayed on a TV (📖243).

Shooting

Cannot shoot.

- In Playback mode (📖23), press the shutter button halfway (📖43).

Nothing is displayed (📖46, 57).

Strange display on the screen under low light (📖46).

Strange display on the screen when shooting.

Note that the following display problems are not recorded in still images but are recorded in movies.

- The screen may flicker and horizontal banding may appear under fluorescent or LED lighting.

No date stamp is added to images.

- Configure the [Date Stamp] setting (📖67). Note that date stamps are not added to images automatically, merely because you have configured the [Date/Time] setting (📖20).
- Date stamps are not added in shooting modes (📖298 – 299) in which this setting cannot be configured (📖67).

[⚡] flashes on the screen when the shutter button is pressed, and shooting is not possible (📖57).

[📷] is displayed when the shutter button is pressed halfway (📖57).

- Set [IS Mode] to [Continuous] (📖160).
- Raise the flash and set the flash mode to [⚡] (📖154).
- Increase the ISO speed (📖129).
- Mount the camera on a tripod or take other measures to keep it still. In this case, you should set [IS Mode] to [Off] (📖160).

Shots are out of focus.

- Press the shutter button halfway to focus on subjects before pressing it all the way down to shoot (📖43).
- Make sure subjects are within focusing range (📖306).
- Set [AF-assist Beam] to [On] (📖89).
- Confirm that unneeded functions such as macro are deactivated.
- Try shooting with focus lock or AF lock (📖146, 152).

No AF frames are displayed and the camera does not focus when the shutter button is pressed halfway.

- To have AF frames displayed and the camera focus correctly, try composing the shot with higher-contrast subject areas centered before you press the shutter button halfway. Otherwise, try pressing the shutter button halfway repeatedly.

Subjects in shots look too dark.

- Raise the flash and set the flash mode to [⚡] (📖154).
- Adjust brightness by using exposure compensation (📖125).
- Adjust contrast by using i-Contrast (📖132, 210).
- Use AE lock or spot metering (📖126, 127).

Subjects look too bright, highlights are washed-out.

- Lower the flash and set the flash mode to [📷] (📖25, 55).
- Adjust brightness by using exposure compensation (📖125).
- Use AE lock or spot metering (📖126, 127).
- Reduce the lighting on subjects.

Shots look too dark despite the flash firing (📖57).

- Shoot within flash range (📖306).
- Adjust brightness by using flash exposure compensation or changing the flash output level (📖156, 165).
- Increase the ISO speed (📖129).

Subjects in flash shots look too bright, highlights are washed-out.

- Shoot within flash range (📖306).
- Lower the flash and set the flash mode to [🔆] (📖25, 55).
- Adjust brightness by using flash exposure compensation or changing the flash output level (📖156, 165).

White dots or similar image artifacts appear in flash shots.

- This is caused by light from the flash reflecting off dust or airborne particles.

Shots look grainy.

- Lower the ISO speed (📖129).
- High ISO speeds in some shooting modes may cause grainy images (📖96).

Subjects are affected by red-eye (📖82).

- Set [Red-Eye Lamp] to [On] (📖89) to activate the red-eye reduction lamp (📖4) in flash shots. For best results, have subjects look at the red-eye reduction lamp. Also try increasing the lighting in indoor scenes and shooting at closer range.
- Edit images using red-eye correction (📖211).

Recording to the memory card takes too long, or continuous shooting is slower.

- Use the camera to perform low-level formatting of the memory card (📖224).

Shooting settings or FUNC. menu settings are not available.

- Available setting items vary by shooting mode. Refer to “Functions Available in Each Shooting Mode”, “FUNC. Menu”, and “Shooting Menu” (📖290 – 299).

The Babies or Children icon does not display.

- The Babies and Children icons will not display if the birthday is not set in face information (📖69). If the icons still do not display even when you set the birthday, re-register face information (📖76), or make sure that the date/time are set correctly (📖20).

Shooting Movies

The elapsed time shown is incorrect, or recording is interrupted.

- Use the camera to format the memory card, or switch to a card that supports high-speed recording. Note that even if the elapsed time display is incorrect, the length of movies on the memory card corresponds to the actual recording time (📖223, 305).

[🔴] is displayed and shooting stops automatically.

The camera's internal memory buffer filled up as the camera could not record to the memory card quickly enough. Try one of the following measures.

- Use the camera to perform low-level formatting of the memory card (📖224).
- Lower the image quality (📖84).
- Switch to a memory card that supports high-speed recording (📖305).

Zooming is not possible.

- Zooming is not possible when shooting movies in [📷] (📖104) and [📹] (📖121) modes.

Subjects look distorted.

- Subjects that pass in front of the camera quickly may look distorted. This is not a malfunction.

Playback

Playback is not possible.

- Image or movie playback may not be possible if a computer is used to rename files or alter the folder structure. Refer to the *Software Guide* (📖30) for details on folder structure and file names.

Playback stops, or audio skips.

- Switch to a memory card that you have performed low-level formatting on with the camera (📖224).
- There may be brief interruptions when playing movies copied to memory cards that have slow read speeds.
- When movies are played on a computer, frames may be dropped and audio may skip if computer performance is inadequate.

Sound is not played during movies.

- Adjust the volume (📖28, 218) if you have activated [Mute] (📖218) or the sound in the movie is faint.
- No sound is played for movies shot in [📷] (📖104) or [📹] (📖121) mode because audio is not recorded in these modes.

Computer

Cannot transfer images to a computer.

When attempting to transfer images to the computer via a cable, try reducing the transfer speed as follows.

- Press the <▶> button to enter Playback mode. Hold the <MENU> button down as you press the <▲> and <FUNC/SET> buttons at the same time. On the next screen, press the <◀><▶> buttons to choose [B], and then press the <FUNC/SET> button.

Eye-Fi Cards

Cannot transfer images (274).

On-Screen Messages

If an error message is displayed, respond as follows.

No memory card

- The memory card may be inserted facing the wrong way. Reinsert the memory card facing the correct way (📖19).

Memory card locked

- The write-protect tab of the memory card is set to the locked position. Switch the write-protect tab to the unlocked position (📖18).

Cannot record!

- Shooting was attempted without a memory card in the camera. To shoot, insert a memory card facing the correct way (📖19).

Memory card error (📖224)

- If the same error message is displayed even when you have inserted a formatted memory card facing the correct way, contact a Canon Customer Support Help Desk (📖19).

Insufficient space on card

- There is not enough free space on the memory card to shoot (📖53, 93, 123, 161) or edit images (📖206 – 211). Either erase unneeded images (📖196, 197) or insert a memory card with enough free space (📖18).

Charge the battery (📖17)

No Image.

- The memory card does not contain any images that can be displayed.

Protected! (📖192)

Unidentified Image/Incompatible JPEG/Image too large./Cannot play back AVI/RAW

- Unsupported or corrupt images cannot be displayed.
- It may not be possible to display images that were edited or renamed on a computer, or images shot with another camera.

Cannot magnify!/Cannot play back this content in Smart Shuffle/ Cannot rotate/Cannot modify image/Cannot register this image!/ Cannot modify/Cannot assign to category/Unselectable image./No identification information

- The following functions may be unavailable for images that were renamed or already edited on a computer, or images shot with another camera. Note that starred (*) functions are not available for movies. Magnify* (📖189), Smart Shuffle* (📖191), Categorize (📖203), Rotate (📖200), Edit* (📖206 – 211), Assign as Start-up Image* (📖222), Print List* (📖266), Photobook Set-up* (📖271), and Edit ID Info* (📖187 – 188).
- Grouped images cannot be processed (📖117).

Invalid selection range

- When specifying a range for image selection (📖194, 198, 205, 269), you attempted to choose an initial image that was after the final image, or vice-versa.

Exceeded selection limit

- More than 998 images were selected for Print List (📖266) or Photobook Set-up (📖271). Choose 998 images or less.
- Print List (📖266) or Photobook Set-up (📖271) settings could not be saved correctly. Reduce the number of selected images and try again.
- You attempted to choose more than 500 images in Protect (📖192), Erase (📖196), Favorites (📖202), My Category (📖203), Print List (📖266), or Photobook Set-up (📖271).

Communication error

- An excessive amount of images (approx. 1,000) on the memory card prevented printing or image transfer to a computer. To transfer the images, use a commercially available USB card reader. To print, insert the memory card directly into the printer card slot.

Naming error!

- The folder could not be created or images could not be recorded, because the highest supported folder number (999) for storing images on the card has been reached and the highest supported image number (9999) for images in folders has been reached. In the [Fn] menu, change [File Numbering] to [Auto Reset] (📖225), or format the memory card (📖223).

Lens Error

- This error may occur if the lens is held while it is moving, or when the camera is used in dusty or sandy locations.
- Frequent display of this error message may indicate camera damage. In this case, contact a Canon Customer Support Help Desk.

A camera error was detected (*error number*)

- If this error message is displayed immediately after a shot, the image may not have been saved. Switch to Playback mode to check for the image.
- Frequent display of this error message may indicate camera damage. In this case, write down the error number (*Exx*) and contact a Canon Customer Support Help Desk.

File Error

- Correct printing (📖259) may not be possible for photos from other cameras or images that have been altered using computer software, even if the camera is connected to the printer.

Print error

- Check the paper size setting (📖263). If this error message is displayed when the setting is correct, restart the printer and complete the setting on the camera again.

Ink absorber full

- Contact a Canon Customer Support Help Desk to request assistance with ink absorber replacement.

Shooting (Information Display)

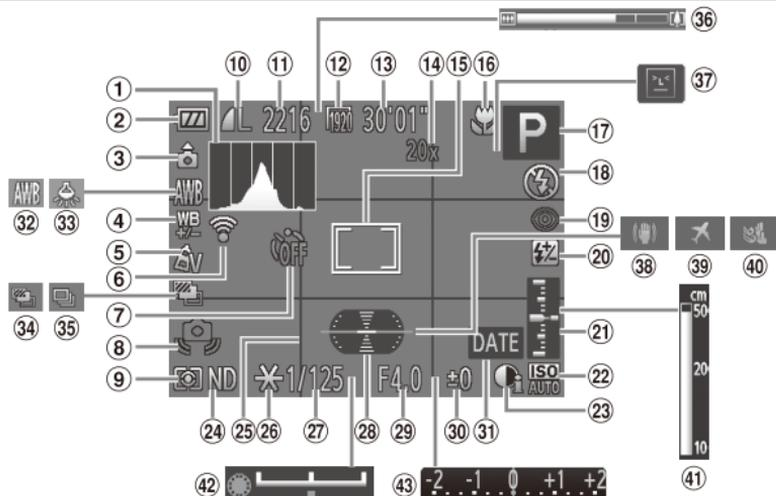

- | | | |
|--|---|-------------------------------------|
| ① Histogram (176) | ⑭ Digital zoom magnification (63), Digital tele-converter (144) | ⑳ Exposure level (164) |
| ② Battery level (287) | ⑮ AF frame (145), Spot AE point frame (127) | ㉑ ISO speed (129) |
| ③ Camera orientation* | ⑯ Focusing range (142), AF lock (152), IS mode icon (61) | ㉒ i-Contrast (132) |
| ④ White balance correction (135) | ⑰ Shooting mode (290), Scene icon (59) | ㉓ ND filter (133) |
| ⑤ My Colors (137) | ⑱ Flash mode (154), LED light (251) | ㉔ Grid lines (166) |
| ⑥ Eye-Fi connection status (274) | ㉒ Red-eye correction (82) | ㉕ AE lock (126), FE lock (157) |
| ⑦ Self-timer (64) | ㉓ Flash exposure compensation / Flash output level (156, 165) | ㉖ Shutter speed (162, 164) |
| ⑧ Camera shake warning (57) | | ㉗ Electronic level (86) |
| ⑨ Metering method (127) | | ㉘ Aperture value (163, 164) |
| ⑩ Still image compression (160), Resolution (81) | | ㉙ Exposure compensation level (125) |
| ⑪ Recordable shots (305) | | ㉚ Date stamp (67) |
| ⑫ Movie quality (84) | | ㉛ White balance (134) |
| ⑬ Remaining time (305) | | |

- ③③ Mercury lamp correction (📖83)
- ③④ AEB shooting (📖131) / Focus bracketing (📖153)
- ③⑤ Drive mode (📖139)
- ③⑥ Zoom bar (📖54)
- ③⑦ Blink detection (📖88)
- ③⑧ Image stabilization (📖160)
- ③⑨ Time zone (📖220)
- ④⑩ Wind filter (📖85)
- ④① MF indicator (📖143)
- ④② Exposure shift bar (📖119)
- ④③ Exposure compensation bar (📖125)

* 📷: Regular orientation, 📷📷: Held vertically

The camera detects the shooting orientation and adjusts settings for optimal shots. Orientation is also detected during playback, and in either orientation, the camera automatically rotates images as needed.

However, the orientation may not be detected correctly when the camera is pointed straight up or down.

Battery Level

An on-screen icon or message indicates the battery charge level.

Display	Details
	Sufficient charge
	Slightly depleted, but sufficient
 (Blinking red)	Nearly depleted – charge the battery soon
[Charge the battery]	Depleted – charge the battery immediately

Playback (Detailed Information Display)

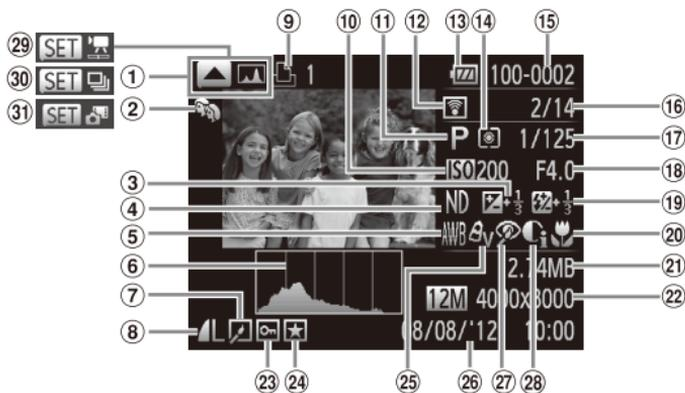

- | | | |
|--|--|--|
| ① Switch display (histogram) (176) | ⑪ Shooting mode (290) | ⑳ Focusing range (142) |
| ② My Category (203) | ⑫ Transferred via Eye-Fi (274) | ㉑ File size |
| ③ Exposure compensation level (125), Exposure shift level (119) | ⑬ Battery level (287) | ㉒ Still images: Resolution (305)
Movies: Movie length (305) |
| ④ ND filter (133) | ⑭ Metering method (127) | ㉓ Protection (192) |
| ⑤ White balance (134), White balance correction (135) | ⑮ Folder number - File number (225) | ㉔ Favorites (202) |
| ⑥ Histogram (176) | ⑯ Current image no. / Total no. of images | ㉕ My Colors (137, 209) |
| ⑦ Image editing (206 - 211) | ⑰ Shutter speed (still images) (162), Image quality / Frame rate (movies) (84) | ㉖ Shooting date/time (20) |
| ⑧ Compression (image quality) (160) / Resolution (81), RAW (159), MOV (movies) | ⑱ Aperture value (163, 164), Image quality (movies) (84) | ㉗ Red-eye correction (82, 211) |
| ⑨ Print list (266) | ㉑ Flash (154, 155), Flash exposure compensation (156) | ㉘ i-Contrast (132, 210) |
| ⑩ ISO speed (129), Playback speed (105, 121) | | ㉙ Movies (54, 174) |
| | | ㉚ Group playback (185) |
| | | ㉛ Movie Digest Playback (185) |



- Some information may not be displayed when viewing images on a TV (📖239).

Summary of Movie Control Panel in “Viewing” (📖174)

	Exit
	Play
	Slow Motion (To adjust the playback speed, press the <◀><▶> buttons or turn the <🌀> dial. No sound is played.)
	Skip Backward* (📖28, 175) or Previous Clip (📖215) (To continue skipping backward, keep holding down the <⏮> button.)
	Previous Frame (For fast-rewind, keep holding down the <⏮> button.)
	Next Frame (For fast-forward, keep holding down the <⏭> button.)
	Skip Forward* (📖28, 175) or Next Clip (📖215) (To continue skipping forward, keep holding down the <⏭> button.)
	Edit (📖213)
	Shown when you have selected a movie created in [📷] mode (📖215).
	Shown when the camera is connected to a PictBridge-compatible printer (📖259).

* Displays the frame approx. 4 sec. before or after the current frame.



- To skip forward or back during movie playback, press the <◀><▶> buttons.

Functions and Menu Tables

Functions Available in Each Shooting Mode

Function	Shooting Mode								SCN																																	
	C2	C1	M	Av	Tv	P	AUTO																																			
Exposure Compensation (📖 125)	*1	*1	-	○	○	○	-	○	○	○																																
ISO Speed (📖 129)	ISO AUTO																																									
	<table border="0"> <tr> <td>ISO 80</td><td>ISO 100</td><td>ISO 125</td><td>ISO 160</td><td>ISO 200</td><td>ISO 250</td><td>ISO 320</td><td>ISO 400</td><td>ISO 500</td><td></td><td></td> </tr> <tr> <td>ISO 640</td><td>ISO 800</td><td>ISO 1250</td><td>ISO 1600</td><td>ISO 2000</td><td>ISO 2500</td><td>ISO 3200</td><td>ISO 4000</td><td>ISO 5000</td><td></td><td></td> </tr> <tr> <td>ISO 6400</td><td>ISO 8000</td><td>ISO 10000</td><td>ISO 12800</td><td></td><td></td><td></td><td></td><td></td><td></td><td></td> </tr> </table>										ISO 80	ISO 100	ISO 125	ISO 160	ISO 200	ISO 250	ISO 320	ISO 400	ISO 500			ISO 640	ISO 800	ISO 1250	ISO 1600	ISO 2000	ISO 2500	ISO 3200	ISO 4000	ISO 5000			ISO 6400	ISO 8000	ISO 10000	ISO 12800						
ISO 80	ISO 100	ISO 125	ISO 160	ISO 200	ISO 250	ISO 320	ISO 400	ISO 500																																		
ISO 640	ISO 800	ISO 1250	ISO 1600	ISO 2000	ISO 2500	ISO 3200	ISO 4000	ISO 5000																																		
ISO 6400	ISO 8000	ISO 10000	ISO 12800																																							
White Balance Correction (📖 134)	*1	*1	○	○	○	○	-	-	-	-																																
Flash (📖 154)*3		*1	*1	-	-	-	○	○	○	○																																
		*1	*1	○	○	○	○	-	○	○																																
		*1	*1	-	○	-	○	*4	○	-																																
		*1	*1	○	○	○	○	○	○	○																																
Metering Method (📖 127)		*1	*1	○	○	○	○	○	○	○																																
		*1	*1	○	○	○	○	-	○	-																																
Shutter Speed (📖 162, 164)	*1	*1	○	-	○	-	-	-	-	-																																
Aperture Value (📖 163, 164)	*1	*1	○	○	-	-	-	-	-	-																																
Program Shift (📖 126)	○	○	-	○	○	○	-	○	-	-																																
AE Lock/FE Lock (📖 126, 157)	○	○	-	○	○	○	-	○	-	-																																
AE Lock (Movie)/Exposure Shift (📖 119)	-	-	-	-	-	-	-	-	-	-																																
AF Lock (when assigned to the <S> button) (📖 152)	○	○	○	○	○	○	-	○	○	○																																
Focusing Range (📖 97, 142, 152)		*1	*1	○	○	○	○	○	○	○																																
		*1	*1	○	○	○	○	-	○	○																																
		-	-	-	-	-	-	-	-	-																																
	MF/AF Lock	*1	*1	○	○	○	○	-	○	○																																
Move AF Frame (📖 147)	*1	*1	○	○	○	○	-	-	-	-																																
Resize AF Frame (📖 147)	*1	*1	○	○	○	○	-	○	○	-																																
Face Select (📖 151)	○	○	○	○	○	○	○	○	○	○																																
Tracking AF (📖 68)	○	○	○	○	○	○	○	-	○	-																																
Screen Display (📖 46)	Off	*1	*1	○	○	○	○	○	-	○																																
	Display 1	*1	*1	○	○	○	○	○	○	○																																
	Display 2	*1	*1	○	○	○	○	○	○	○																																

*1 Options vary depending on the assigned shooting mode.

*2 Advanced settings not available.

*3 Set to when the flash is down, but otherwise selection is possible when the flash is up.

*4 Not available, but switches to in some cases.

SCN																						
O	O	O	O	O	O	O	O	O	-	O	O	O	O	O	O	O	-	-	-	-	-	
O	O	O	O	O	O	O	O	O	O	O	O	O	O	O	O	O	O	O	O	O	O	O
-	-	-	-	-	-	-	-	-	-	-	-	-	-	-	-	-	-	-	-	-	-	
-	-	-	-	-	*2	-	-	-	-	-	-	-	-	-	-	-	-	-	-	-	-	
O	O	O	-	O	O	O	-	-	-	O	O	O	O	O	O	O	O	O	-	-	-	
O	O	O	-	O	O	O	-	O	-	O	O	O	O	O	O	O	O	O	-	-	-	
-	-	-	-	*4	-	-	-	O	-	-	-	-	-	-	-	-	-	-	-	-	-	
O	O	O	O	O	O	O	O	O	O	O	O	O	O	O	O	O	O	O	O	O	O	O
O	O	O	O	O	O	O	O	O	O	O	O	O	O	O	O	O	O	O	O	O	O	O
-	-	-	-	-	-	-	-	-	-	-	-	-	-	-	-	-	-	-	-	-	-	
-	-	-	-	-	-	-	-	-	-	-	-	-	-	-	-	-	-	-	-	-	-	
-	-	-	-	-	-	-	-	-	-	-	-	-	-	-	-	-	-	-	-	-	-	
-	-	-	-	-	-	-	-	-	-	-	-	-	-	-	-	-	-	-	-	-	-	
-	-	-	-	-	-	-	-	-	-	-	-	-	-	-	-	-	-	-	-	-	-	
-	-	-	-	-	-	-	-	-	-	-	-	-	-	-	-	-	-	-	O	O	-	
-	-	-	O	O	O	O	-	O	O	O	O	O	O	O	O	O	O	O	O	O	O	O
O	O	O	O	O	O	O	O	O	O	O	O	O	O	O	O	O	O	O	O	O	O	O
-	-	-	O	O	-	O	-	O	O	O	O	O	O	O	O	O	O	O	O	O	O	O
-	-	-	-	-	O	-	-	-	-	-	-	-	-	-	-	-	-	-	-	-	-	
-	-	-	O	O	O	O	-	-	O	O	O	O	O	O	O	O	O	O	O	O	O	O
-	-	-	-	-	-	-	-	-	-	-	-	-	-	-	-	-	-	-	-	-	-	
-	-	-	O	-	O	O	-	-	-	O	-	-	O	O	O	O	O	O	O	O	O	O
O	O	O	O	-	-	O	-	-	O	O	-	-	O	O	O	O	O	O	O	O	O	O
-	-	-	O	-	O	O	-	-	-	O	-	-	-	O	O	O	O	-	-	-	-	
-	-	-	O	-	-	O	O	-	-	-	-	-	-	-	-	-	-	-	-	-	-	
O	O	O	O	O	O	O	O	O	O	O	O	O	O	O	O	O	O	O	O	O	O	O
-	O	O	O	O	O	O	O	O	O	O	O	O	O	O	O	O	O	O	O	O	O	O

O Available or set automatically. – Not available.

FUNC. Menu

Function		Shooting Mode								SCN	
		C2	C1	M	Av	Tv	P	AUTO			
DR Correction (132)	TOFF	*1	*1	○	○	○	○	—	○	○	○
	TAUTO	*1	*1	—	○	○	○	○	—	—	—
	T200% T400%	*1	*1	○	○	○	○	—	—	—	—
Shadow Correct (133)		*1	*1	○	○	○	○	—	○	○	○
	TAUTO	*1	*1	○	○	○	○	○	○	—	—
White Balance (134)	AWB	*1	*1	○	○	○	○	○	○	○	○
		*1	*1	○	○	○	○	—	○	—	—
		*1	*1	○	○	○	○	—	○	—	—
		*1	*1	○	○	○	○	—	○	—	—
My Colors (137)		*1	*1	○	○	○	○	○	○	○	○
	AV AN AS ^{*3} AW ^{*3} AP AL AD AB AG AR AC ^{*4}	*1	*1	○	○	○	○	—	○	—	—
Bracketing (153)		*1	*1	○	○	○	○	○	○	○	○
		*1	*1	—	○	○	○	—	—	—	—
		*1	*1	○	○	○	○	—	—	—	—
Drive Mode (139)		*1	*1	○	○	○	○	○	○	○	○
		—	—	—	—	—	—	○	—	—	—
		*1	*1	○	○	○	○	—	—	○	○
Self-Timer (64)		*1	*1	○	○	○	○	○	○	○	○
		*1	*1	○	○	○	○	○	○	○	○
Self-Timer Settings (66)	Delay ^{*6}	*1	*1	○	○	○	○	○	○	○	○
	Shots ^{*7}	*1	*1	○	○	○	○	○	—	○	○

*1 Options vary depending on the assigned shooting mode.

*2 Not available in [] or [].

*3 White balance is not available.

*4 Set in a range of 1 – 5: contrast, sharpness, color saturation, red, green, blue, and skin tone.

*5 [] is set with [MF], AF lock, or [].

*6 Cannot be set to 0 seconds in modes without selection of the number of shots.

*7 One shot (cannot be modified) in modes without selection of the number of shots.

SCN																							
O	O	O	O	O	-	O	O	O	O	O	O	O	O	O	O	O	O	O	O	-	-	-	
-	-	-	-	-	O	-	-	-	-	-	-	-	-	-	-	-	-	-	-	-	-	-	
-	-	-	-	-	-	-	-	-	-	-	-	-	-	-	-	-	-	-	-	-	-	-	
O	O	O	O	O	O	O	O	O	O	O	O	O	O	O	O	O	O	O	O	-	-	-	
-	-	-	-	-	-	-	-	-	-	-	-	-	-	-	-	-	-	-	-	-	-	-	
O	O	O	O	O	O	O	O	O	O	O	O	O	O	O	O	O	O	O	O	O	O	O	
O	O	O	-	-	-	-	-	O	-	-	-	-	-	-	-	-	-	-	-	O	O	-	
O	O	O	-	-	-	-	-	O	-	-	-	-	-	-	-	-	-	-	-	-	-	-	
O	O	O	-	-	-	-	-	O	-	-	-	-	-	-	-	-	-	-	-	O	O	-	
O	O	O	-	-	O	-	-	O	-	-	-	-	-	-	-	-	-	-	-	O	O	-	
O	O	O	O	O	O	O	O	O	O	O	O	O	O	O	O	O	O	O	O	O	O	O	
O	O	O	-	-	-	-	-	O	-	-	-	-	-	-	-	-	-	-	-	O	O	-	
O	O	O	O	O	O	O	O	O	O	O	O	O	O	O	O	O	O	O	O	O	O	O	
-	-	-	-	-	-	-	-	-	-	-	-	-	-	-	-	-	-	-	-	-	-	-	
-	-	-	-	-	-	-	-	-	-	-	-	-	-	-	-	-	-	-	-	-	-	-	
O	O	O	-	O	O	O	O	O	O	O	O	O	O	O	O	O	O	O	O	O	O	O	
-	-	-	-	-	-	-	-	-	-	-	-	-	-	-	-	-	-	-	-	-	-	-	
-	-	-	O	-	O	O	O	-	-	O	O	O	O	O	O	O	O	O	O	-	-	-	
-	-	-	O	-	O	O	O	-	-	O	O	O	O	O	O	O	O	O	O	-	-	-	
O	O	O	O	O	O	O	O	O	O	O	O	O	O	O	O	O	O	O	O	O	O	O	
-	-	-	-	O	O	O	O	O	O	O	O	O	O	O	O	O	O	O	O	O	O	O	
-	-	-	-	O	O	O	O	O	O	O	O	O	O	O	O	O	O	O	O	O	O	O	
-	-	-	-	O	O	O	O	-	O	O	O	O	O	O	O	O	O	O	O	-	-	-	

O Available or set automatically. - Not available.

		Shooting Mode								SCN	
		C2	C1	M	Av	Tv	P	AUTO			
Function											
Flash Exposure Compensation (📖 156)		*1	*1	–	○	○	○	–	○	–	–
Flash Output Level (📖 165)		*1	*1	○	○	○	–	–	–	–	–
ND Filter (📖 133)	ND	*1	*1	○	○	○	○	–	○	–	–
	NFR	*1	*1	○	○	○	○	○	○	○	○
Still Image Aspect Ratio (📖 80)	16:9 3:2 4:3 1:1 4:5	*1	*1	○	○	○	○	○	–	○	–
Image Type (📖 159)	JPEG RAW JPEG	*1	*1	○	○	○	○	–	–	–	–
Resolution (📖 81)	L	*1	*1	○	○	○	○	○	○	○	○
	M1 M2	*1	*1	○	○	○	○	○	○	○	–
	S	*1	*1	○	○	○	○	○	○	○	–
Compression (📖 160)		*1	*1	○	○	○	○	–	–	–	–
		*1	*1	○	○	○	○	○	○	○	○
Movie Quality (📖 84)	1920	*1	*1	○	○	○	○	○	○	○	○
	1280	*1	*1	○	○	○	○	○	○	○	○
	640	*1	*1	○	○	○	○	○	○	○	○
		–	–	–	–	–	–	–	–	–	–

*1 Options vary depending on the assigned shooting mode.

*2 Only [4:3] and [16:9] are available.

*3 Synchronizes with the aspect ratio setting and is automatically set (📖 80).

SCN																								
										HDR														
-	-	-	-	-	-	-	-	-	-	-	-	-	-	-	-	-	-	-	-	-	-	-	-	-
-	-	-	-	-	-	-	-	-	-	-	-	-	-	-	-	-	-	-	-	-	-	-	-	-
-	-	-	-	-	-	-	-	-	-	-	-	-	-	-	-	-	-	-	-	-	○	○	○	
○	○	○	○	○	○	○	○	○	○	○	○	○	○	○	○	○	○	○	○	○	○	○	○	○
○	○	○	-	-	○	○	○	-	○	-	-	*2	-	-	○	○	○	○	-	-	-	-	-	
-	-	-	-	-	-	-	-	-	-	-	-	-	-	-	-	-	-	-	-	-	-	-	-	
○	○	○	○	○	○	○	○	○	○	○	○	○	○	○	○	○	○	○	○	○	○	○	○	○
○	○	○	-	-	○	○	○	○	-	-	-	-	-	-	-	-	-	-	-	-	○	○	○	
○	○	○	-	-	○	○	○	○	-	-	-	-	-	-	-	-	-	-	-	-	○	○	○	
-	-	-	-	-	-	-	-	-	-	-	-	-	-	-	-	-	-	-	-	-	-	-	-	
○	○	○	○	○	○	○	○	○	○	○	○	○	○	○	○	○	○	○	○	○	○	○	○	○
○	○	○	○	○	○	○	○	○	○	○	○	-	○	○	○	○	○	○	○	○	○	○	-	-
○	○	○	○	○	○	○	○	○	○	○	○	*3	○	○	○	○	○	○	○	○	○	○	-	-
○	○	○	○	○	○	○	○	○	○	○	○	*3	○	○	○	○	○	○	○	○	○	-	-	
-	-	-	-	-	-	-	-	-	-	-	-	-	-	-	-	-	-	-	-	-	-	-	○	

○ Available or set automatically. – Not available.

Shooting Menu

Function		Shooting Mode								SCN		
		C2	C1	M	Av	Tv	P	AUTO	AF	AF	AF	
AF Frame (145)	Face AiAF*1	*2	*2	○	○	○	○	○	○	○	○	○
	Tracking AF	*2	*2	○	○	○	○	*3	–	○	–	
	FlexiZone/Center*4	*2	*2	○	○	○	○	–	○	○	–	
Digital Zoom (63)	Standard	*2	*2	○	○	○	○	○	–	○	–	
	Off	*2	*2	○	○	○	○	○	○	○	○	
	Digital Tele-converter (1.5x/2.0x)	*2	*2	○	○	○	○	–	–	–	–	
AF-Point Zoom (87)	On	*2	*2	○	○	○	○	○	–	○	–	
	Off	*2	*2	○	○	○	○	○	○	○	○	
Servo AF (150)	On	*2	*2	○	○	○	○	–	–	○	–	
	Off*5	*2	*2	○	○	○	○	○	○	○	○	
Continuous AF (151)	On	*2	*2	○	○	○	○	○	○	○	○	
	Off	*2	*2	○	○	○	○	–	–	○	○	
AF-assist Beam (89)	On	*2	*2	○	○	○	○	○	○	○	○	
	Off	*2	*2	○	○	○	○	○	○	○	○	
MF-Point Zoom (142)	On	*2	*2	○	○	○	○	–	–	○	–	
	Off	*2	*2	○	○	○	○	○	○	○	○	
Safety MF (143)	On	*2	*2	○	○	○	○	–	○	○	–	
	Off	*2	*2	○	○	○	○	○	○	○	○	
Flash Control (82, 89, 156, 158, 165)	Flash Mode	Auto	*2	*2	–	○	○	○	○	○	○	○
		Manual	*2	*2	○	○	○	–	–	–	–	
	Flash Exp. Comp	*2	*2	–	○	○	○	–	○	–	–	
	Flash Output	*2	*2	○	○	○	–	–	–	–		
	Shutter Sync.	1st-curtain	*2	*2	○	○	○	○	○	○	○	○
		2nd-curtain	*2	*2	○	○	○	○	–	○	–	
	Red-Eye Corr.	On	*2	*2	○	○	○	○	○	○	○	–
		Off	*2	*2	○	○	○	○	○	○	○	○
	Red-Eye Lamp	On/Off	*2	*2	○	○	○	○	○	○	○	○
	Safety FE	On	*2	*2	–	○	○	○	○	○	○	○
Off		*2	*2	○	○	○	○	–	○	–		

*1 Operation when no faces are detected varies by shooting mode.

*2 Options vary depending on the assigned shooting mode.

*3 Only available by pressing the <▲> button (68).

*4 [FlexiZone] in <P>, <Tv>, <Av>, and <M> modes, otherwise [Center].

*5 [On] when subject movement is detected in <AUTO> mode.

SCN																								
O	O	O	O	O	-	O	-	-	O	O	-	-	O	O	O	O	O	O	O	O	O	O	O	O
-	-	-	O	-	O	O	-	-	-	O	-	-	-	-	O	O	O	O	O	-	-	-	-	-
-	-	-	O	-	O	O	O	O	-	O	O	-	O	O	O	O	O	O	O	O	O	O	O	O
O	O	O	-	-	O	O	O	-	-	-	-	-	-	-	-	-	-	-	-	O	O	-	-	-
O	O	O	O	O	O	O	O	O	O	O	O	O	O	O	O	O	O	O	O	O	O	O	O	O
-	-	-	-	-	-	-	-	-	-	-	-	-	-	-	-	-	-	-	-	-	-	-	-	-
O	O	O	O	-	O	O	-	-	O	O	-	-	-	-	O	O	O	O	O	-	-	-	-	-
O	O	O	O	O	O	O	O	O	O	O	O	O	O	O	O	O	O	O	O	O	O	O	O	O
-	-	-	-	O	O	O	-	-	O	-	-	-	-	O	O	O	O	O	-	-	-	-	-	-
O	O	O	O	O	-	O	-	O	O	O	O	O	O	O	O	O	O	O	O	O	O	O	O	O
-	O	O	O	O	O	O	O	O	O	O	O	O	O	O	O	O	O	O	O	O	O	O	O	O
-	-	-	O	-	O	O	-	-	O	O	-	-	-	O	O	O	O	O	-	-	-	-	-	-
O	O	O	O	O	O	O	O	O	O	O	O	O	O	O	O	O	O	O	O	O	O	O	O	O
-	-	-	O	O	O	O	-	-	O	O	O	O	O	O	O	O	O	O	O	O	O	O	O	O
O	O	O	O	O	O	O	O	O	O	O	O	O	O	O	O	O	O	O	O	O	O	O	O	O
O	O	O	-	O	O	O	-	O	-	O	O	O	O	O	O	O	O	O	O	-	-	-	-	-
-	-	-	-	-	-	-	-	-	-	-	-	-	-	-	-	-	-	-	-	-	-	-	-	-
-	-	-	-	-	-	-	-	-	-	-	-	-	-	-	-	-	-	-	-	-	-	-	-	-
-	-	-	-	-	-	-	-	-	-	-	-	-	-	-	-	-	-	-	-	-	-	-	-	-
O	O	O	-	O	O	O	-	O	-	O	O	O	O	O	O	O	O	O	O	-	-	-	-	-
-	-	-	-	-	-	-	-	-	-	-	-	-	-	-	-	-	-	-	-	-	-	-	-	-
O	O	O	-	O	-	O	-	-	-	-	-	-	-	-	-	-	-	-	-	-	-	-	-	-
O	O	O	-	O	O	O	-	O	-	O	O	O	O	O	O	O	O	O	O	-	-	-	-	-
O	O	O	-	O	-	O	-	O	-	O	O	O	O	O	O	O	O	O	O	-	-	-	-	-
O	O	O	-	O	O	O	-	O	-	O	O	O	O	O	O	O	O	O	O	-	-	-	-	-
-	-	-	-	-	-	-	-	-	-	-	-	-	-	-	-	-	-	-	-	-	-	-	-	-

O Available or set automatically. - Not available.

		Shooting Mode								SCN	
		C2	C1	M	Av	Tv	P	AUTO			
Function											
ISO Auto Settings (130)	Max ISO Speed	*1	*1	–	○	○	○	–	○	–	–
	Rate of Change	*1	*1	–	○	–	○	–	○	–	–
High ISO NR (130)	Low/Standard/High	*1	*1	○	○	○	○	–	–	–	–
Hg Lamp Corr. (83)	On/Off	–	–	–	–	–	○	–	–	–	–
Spot AE Point (127)	AF Point	*1	*1	○	○	○	○	–	○	–	–
	Center	*1	*1	○	○	○	○	–	–	–	–
Safety Shift (163)	On	*1	*1	–	○	○	–	–	–	–	–
	Off	*1	*1	○	○	○	○	○	○	○	○
Wind Filter (85)	On/Off	*1	*1	○	○	○	○	○	○	○	○
Review (90)	Off/Quick/2 – 10 sec./Hold	*1	*1	○	○	○	○	○	○	○	○
Review Info (91)	Off	*1	*1	○	○	○	○	○	○	○	○
	Detailed/Focus Check	*1	*1	○	○	○	○	○	○	○	○
Blink Detection (88)	On	*1	*1	○	○	○	○	○	○	○	○
	Off	*1	*1	○	○	○	○	○	○	○	○
Custom Display (166)	Shooting Info/Grid Lines/ Electronic Level/Histogram	*1	*1	○	○	○	○	○	○	○	○
	Off	*1	*1	○	○	○	○	○	○	○	○
IS Mode (160)	Continuous	*1	*1	○	○	○	○	○	○	○	○
	Shoot Only	*1	*1	○	○	○	○	–	–	○	○
Converter (245)	None/TC-DC58E	*1	*1	○	○	○	○	○	○	○	○
Date Stamp (67)	Off	*1	*1	○	○	○	○	○	○	○	○
	Date/Date & Time	*1	*1	○	○	○	○	○	○	○	–
Face ID Settings (69)		*1	*1	○	○	○	○	○	○	○	○
Set Func. (168)		*1	*1	○	○	○	○	–	–	–	–
Set Shortcut button (169)		*1	*1	○	○	○	○	○	○	○	○
Save Settings (170)		○	○	○	○	○	○	–	–	–	–

*1 Options vary depending on the assigned shooting mode.

–When using [Face ID] (69) to shoot, names will not be displayed in [], [], or [], but they will be recorded in still images.

–Setting available, but when using [Face ID] (69) to shoot, names will not be displayed in [], [], or [], and they will not be recorded in movies.

⚙️ Set up Menu

Item	Ref. Page	Item	Ref. Page
Mute	218	Lens Retract	226
Volume	218	Power Saving	42, 226
Sound Options	219	Units	227
Hints & Tips	219	Electronic Level	86
Date/Time	20	Video System	243
Time Zone	220	Ctrl via HDMI	241
LCD Brightness	221	Eye-Fi Settings	274
Start-up Image	222	Copyright Info	229
Format	223, 224	Certification Logo Display	230
File Numbering	225	Language	23
Create Folder	225	Reset All	231

★ My Menu Menu

Item	Ref. Page
My Menu settings	171

 **Playback Menu**

Item	Ref. Page	Item	Ref. Page
Movie Digest Playback	 185	Red-Eye Correction	 211
Smart Shuffle	 191	Cropping	 207
Slideshow	 190	Resize	 206
Erase	 196	My Colors	 209
Protect	 192	Face ID Info	 187
Rotate	 200	Scroll Display	 175
Favorites	 202	Group Images	 185
My Category	 203	Auto Rotate	 201
Photobook Set-up	 271	Resume	 175
i-Contrast	 210	Transition	 175

 **Print Menu**

Item	Ref. Page	Item	Ref. Page
Print	—	Select All Images	 270
Select Images & Qty.	 268	Clear All Selections	 270
Select Range	 269	Print Settings	 267

Handling Precautions

- The camera is a high-precision electronic device. Avoid dropping it or subjecting it to strong impact.
- Never bring the camera near magnets, motors, or other devices that generate strong electromagnetic fields, which may cause malfunction or erase image data.
- If water droplets or dirt adheres to the camera or screen, wipe with a dry soft cloth, such as an eyeglass cloth. Do not rub hard or apply force.
- Never use cleaners containing organic solvents to clean the camera or screen.
- Use a blower brush to remove dust from the lens. If cleaning is difficult, contact a Canon Customer Support Help Desk.
- To prevent condensation from forming on the camera after sudden temperature changes (when the camera is transferred from cold to warm environments), put the camera in an airtight, resealable plastic bag and let it gradually adjust to the temperature before removing it from the bag.
- If condensation does form on the camera, stop using it immediately. Continuing to use the camera in this state may damage it. Remove the battery and memory card, and wait until the moisture has evaporated before resuming use.

Specifications

Camera Effective Pixels (Max.)	Approx. 12.1 million pixels
Lens Focal Length	5x zoom: 6.1 (W) – 30.5 (T) mm (35mm film equivalent: 28 (W) – 140 (T) mm)
Viewfinder	Real-image type optical zoom viewfinder Dioptric Adjustment Range: –3.0 to +1.0 m ⁻¹ (dpt) Coverage: Approx. 80%
LCD Monitor	7.5 cm (3.0 in.) color TFT LCD Effective Pixels: Approx. 922,000 dots
File Format	Design rule for Camera File system, DPOF (version 1.1) compliant
Data Type	Still Images: Exif 2.3 (JPEG), RAW (CR2 (Canon Original)) Movies: MOV (Image data: H.264; Audio data: Linear PCM (stereo))
Interface	Hi-speed USB HDMI output Analog audio output (stereo) Analog video output (NTSC/PAL)
Power Source	Battery Pack NB-10L AC Adapter Kit ACK-DC80
Dimensions (Based on CIPA Guidelines)	106.6 x 75.9 x 40.1 mm (4.20 x 2.99 x 1.58 in.)
Weight (Based on CIPA Guidelines)	Approx. 352 g (approx. 12.4 oz.; including the battery and memory card) Approx. 310 g (approx. 10.9 oz.; camera body only)

Number of Shots/Recording Time, Playback Time

Number of Shots	Screen On	Approx. 350
	Screen Off	Approx. 770
Movie Recording Time*1	Screen On	Approx. 1 hour, 10 minutes
	Continuous Shooting*2	Approx. 2 hours
Playback Time		Approx. 7 hours

*1 Time under default camera settings, when normal operations are performed, such as shooting, pausing, turning the camera on and off, and zooming.

*2 Time available when shooting the maximum movie length (until recording stops automatically) repeatedly.

- The number of shots that can be taken is based on measurement guidelines of the Camera & Imaging Products Association (CIPA).
- Under some shooting conditions, the number of shots and recording time may be less than mentioned above.
- Number of shots/time with a fully charged battery.

Number of 4:3 Shots per Memory Card

Recording Pixels	Compression Ratio	Number of Shots per Memory Card (Approx. shots)	
		8 GB	32 GB
L (Large) 12M/4000x3000		1379	5568
		2192	8850
M1 (Medium 1) 6M/2816x2112		2431	9814
		3721	15020
M2 (Medium 2) 2M/1600x1200		7442	30040
		12927	52176
S (Small) 0.3M/640x480		27291	110150
		40937	165225
RAW Images 4000x3000	—	446	1804

- The values in the table are measured according to Canon standards and may change depending on the subject, memory card and camera settings.
- The values in the table are based on 4:3 aspect ratio. If the aspect ratio is changed (80), more images can be shot because the data size per image will be smaller than with 4:3 images. However, since [**M2**] 16:9 images have a setting of 1920 x 1080 pixels, their data size will be larger than 4:3 images.

Recording Time per Memory Card

Image Quality	Recording Time per Memory Card	
	8 GB	32 GB
	29 min. 39 sec.	1 hr. 59 min. 43 sec.
	42 min. 11 sec.*1	2 hr. 50 min. 19 sec.*2
	1 hr. 28 min. 59 sec.	5 hr. 59 min. 10 sec.

*1 27 min. 39 sec. for iFrame movies (120).

*2 1 hr. 51 min. 37 sec. for iFrame movies (120).

- The values in the table are measured according to Canon standards and may change depending on the subject, memory card and camera settings.
- Recording will automatically stop when the clip file size reaches 4 GB, or when the recording time reaches approximately 29 minutes and 59 seconds when shooting in [] or [], and approximately 1 hour when shooting in [].
- Recording may stop even if the maximum clip length has not been reached on some memory cards. SD Speed Class 6 or higher memory cards are recommended.

Flash Range

Maximum wide angle ()	50 cm – 7.0 m (1.6 – 23 ft.)
Maximum telephoto ()	50 cm – 4.5 m (1.6 – 15 ft.)

Shooting Range

Shooting Mode	Focusing Range	Maximum Wide Angle ()	Maximum Telephoto ()
AUTO	–	1 cm (0.4 in.) – infinity	40 cm (1.3 ft.) – infinity
Other modes		5 cm (2.0 in.) – infinity	40 cm (1.3 ft.) – infinity
		1 – 50 cm (0.4 in. – 1.6 ft.)	–
	MF+	1 cm (0.4 in.) – infinity	40 cm (1.3 ft.) – infinity
		1 – 50 cm (0.4 in. – 1.6 ft.)	–
		1.5 – 20 m (4.9 – 66 ft.)	1.5 – 20 m (4.9 – 66 ft.)

* Not available in some shooting modes.

Continuous Shooting Speed

Shooting Mode	Continuous Shooting Mode	Speed
P		Approx. 2.1 shots/sec.
		Approx. 0.9 shots/sec.
		Approx. 0.9 shots/sec.
		Approx. 10 shots/sec.

Shutter Speed

< AUTO > mode, automatically set range	1 – 1/4000 sec.
Range in all shooting modes	15 – 1/4000 sec.
< Tv > mode available values (sec.)	15, 13, 10, 8, 6, 5, 4, 3.2, 2.5, 2, 1.6, 1.3, 1, 0.8, 0.6, 0.5, 0.4, 0.3, 1/4, 1/5, 1/6, 1/8, 1/10, 1/13, 1/15, 1/20, 1/25, 1/30, 1/40, 1/50, 1/60, 1/80, 1/100, 1/125, 1/160, 1/200, 1/250, 1/320, 1/400, 1/500, 1/640, 1/800, 1/1000, 1/1250, 1/1600, 1/2000, 1/2500, 1/3200, 1/4000

Aperture

f/number	f/1.8 – f/8.0 (W), f/2.8 – f/8.0 (T)
<Av> mode available values*	f/1.8, f/2.0, f/2.2, f/2.5, f/2.8, f/3.2, f/3.5, f/4.0, f/4.5, f/5.0, f/5.6, f/6.3, f/7.1, f/8.0

* Depending on the zoom position, some aperture values may not be available.

Battery Pack NB-10L

Type:	Rechargeable lithium-ion battery
Rated Voltage:	7.4 V DC
Rated Capacity:	920 mAh
Charging Cycles:	Approx. 300 times
Operating Temperature:	0 – 40 °C (32 – 104 °F)
Dimensions:	32.5 x 45.4 x 15.1 mm (1.28 x 1.79 x 0.59 in.)
Weight:	Approx. 41 g (approx. 1.45 oz.)

Battery Charger CB-2LC/CB-2LCE

Rated Input:	100 – 240 V AC (50/60 Hz) 16 VA (100 V) – 22 VA (240 V), 0.18 A (100 V) – 0.12 A (240 V)
Rated Output:	8.4 V DC, 0.7 A
Charging Time:	Approx. 1 hour 50 min. (when using NB-10L)
Charge Indicator:	Charging: orange / Fully charged: green
Operating Temperature:	5 – 40 °C (41 – 104 °F)
Dimensions:	92.8 x 63.0 x 27.0 mm (3.65 x 2.48 x 1.06 in.)
Weight:	CB-2LC: Approx. 80 g (approx. 2.82 oz.) CB-2LCE: Approx. 74 g (approx. 2.61 oz.) (excluding power cord)

Tele-converter TC-DC58E (Sold Separately)

Zoom Factor:	1.4x
Lens Construction:	5 elements in 3 groups
Thread Diameter:	58 mm*
Max. Diameter x Length:	φ69.0 x 36.5 mm (φ2.72 x 1.44 in.)
Weight:	Approx. 165 g (approx. 5.8 oz.)

* Requires Conversion Lens Adapter LA-DC58L.

■ **Conversion Lens Adapter LA-DC58L (Sold Separately)**

Camera Mount: Bayonet
Thread Diameter: 58 mm
Max. Diameter x Length: $\phi 63.8 \times 54.8$ mm ($\phi 2.51 \times 2.16$ in.)
Weight: Approx. 36 g (approx. 1.3 oz.)

■ **Filter Adapter FA-DC58D (Sold Separately)**

Diameter x Length: $\phi 66.0 \times 46.7$ mm ($\phi 2.60 \times 1.84$ in.)
Weight: Approx. 58 g (approx. 2.0 oz.)

■ **Bracket BKT-DC1 (Sold Separately)**

Dimensions (Max.): $220.0 \times 32.0 \times 19.0$ mm ($8.66 \times 1.26 \times 0.75$ in.)
Weight: Approx. 90 g (approx. 3.2 oz.)

- All data is based on tests by Canon.
- Camera specifications or appearance are subject to change without notice

A

AC adapter kit.....	235, 244
Accessories	235
AEB mode	131
AE lock	126
AF frames.....	145, 147
AF lock.....	152
Aspect ratio.....	80
AUTO mode (shooting mode)..	24, 45, 54
Av (shooting mode)	163

B

Battery	
Charging.....	17
Level.....	287
Power saving.....	42
Battery charger	2
Black and white images.....	101, 137
Blink detection	88

C

C1/C2 (shooting mode)	170
Camera	
Reset all	231
Camera shake	160
Clock.....	51
Color Accent (shooting mode).....	109
Color Swap (shooting mode).....	110
Color (white balance).....	134
Compression ratio (image quality).....	160
Continuous shooting.....	139
High-speed burst HQ (shooting mode)	116
Creative filters (shooting mode).....	99
Cropping	207
Custom white balance	135

D

Date/time	
Adding date stamps	67
Changing	22
Date/time battery.....	22
Setting	20
World clock.....	220
Defaults → Reset all	
DIGITAL CAMERA Solution Disk.....	2
Digital tele-converter.....	144
Digital zoom.....	63
Display language.....	23
DPOF.....	266
Drive mode	139
Dynamic Range Correction	132

E

Editing	
Cropping.....	207
i-Contrast.....	210
My Colors	209
Red-eye correction.....	211
Resizing images	206
Electronic level	86
Erasing	196
Error messages	283
Exposure	
AE lock.....	126
Compensation	125
FE lock	157
Eye-Fi cards	2, 274

F

Face ID.....	69, 177
Face select	151
Face self-timer (shooting mode).....	114
Favorites.....	202
FE lock.....	157
File numbering.....	225

- Fireworks (shooting mode)..... 96
 - Fish-eye effect (shooting mode)..... 103
 - Flash
 - Deactivating flash..... 25, 55
 - Flash exposure compensation 156
 - On 154
 - Slow synchro..... 155
 - FlexiZone (AF frame mode)..... 146
 - Focus bracketing 153
 - Focus check 179
 - Focusing
 - AF frames..... 145
 - AF lock 152
 - AF-point zoom..... 87
 - Face select..... 151
 - Servo AF 150
 - Focusing range
 - Macro 142
 - Manual focus..... 142
 - Focus lock 146
 - Front dial..... 168, 184
 - FUNC. menu
 - Basic operations..... 47
 - Table..... 292
- H**
- Handheld nightscene
(shooting mode)..... 95
 - High dynamic range
(shooting mode)..... 100
 - High-speed burst HQ
(shooting mode)..... 116
 - Household power..... 244
- I**
- i-Contrast..... 132, 210
 - iFrame movies (movie mode)..... 120
 - Image quality → Compression ratio
(image quality)
- Images
 - Display period 90
 - Erasing 196
 - Playback → Viewing
 - Protecting 192
 - Indicator..... 50
 - ISO speed..... 129
- L**
- Lamp..... 89
- M**
- M (shooting mode)..... 164
 - Macro (focus mode)..... 142
 - Magnified display..... 189
 - Manual focus (focus mode) 142
 - Memory cards..... 2
 - Recording time 305
 - Menu
 - Basic operations..... 48
 - Table..... 290
 - Mercury lamp correction 83
 - Metering method..... 127
 - Miniature effect (shooting mode) 104
 - Monochrome (shooting mode)..... 108
 - Movie Digest (shooting mode)..... 94
 - Movies
 - Editing 213
 - Image quality
(resolution/frame rate)..... 84
 - Recording time 305
 - Multi-area White Balance 83
 - My Category 203
 - My Colors 137, 209
- N**
- ND filter..... 133
 - Neck strap → Strap
 - Nostalgic (shooting mode)..... 102

- P**
- P (shooting mode) 124
 - Package contents 2
 - Photobook set-up 271
 - PictBridge 238, 259
 - Playback → Viewing
 - Portrait (shooting mode) 95
 - Poster effect (shooting mode) 99
 - Power → AC adapter kit
 - Battery
 - Battery charger
 - Power saving 42
 - Printing 259
 - Program AE 124
 - Protecting 192
- R**
- RAW 159
 - Red-eye correction 82, 211
 - Reset all 231
 - Resizing images 206
 - Resolution (image size) 81
 - Rotating 200
- S**
- Screen
 - Display language 23
 - Icons 286, 288
 - Menu → FUNC. menu, Menu
 - SD/SDHC/SDXC memory cards
 - Memory cards
 - Searching 181
 - Self-timer 64
 - 2-second self-timer 65
 - Customizing the self-timer 66
 - Face self-timer (shooting mode) .. 114
 - Wink self-timer (shooting mode) .. 113
 - Sepia tone images 101, 137
 - Servo AF 150
 - Shadow Correct 133
 - Shooting
 - Shooting date/time → Date/time
 - Shooting information 166, 286
 - Slideshow 190
 - Smart Shuffle 191
 - Smart Shutter (shooting mode) 112
 - Smile (shooting mode) 112
 - Snow (shooting mode) 96
 - Soft focus (shooting mode) 107
 - Software
 - DIGITAL CAMERA Solution Disk 2
 - Installation 32
 - Saving images to a computer 35
 - Sounds 218
 - Stereo AV cable 243
 - Stitch Assist (shooting mode) 118
 - Strap 2, 16
 - Super slow motion movie (movie mode) 121
 - Super vivid (shooting mode) 99
- T**
- Terminal 33, 239, 243, 244, 259
 - Toy camera effect (shooting mode) ... 106
 - Tracking AF 68, 148
 - Traveling with the camera 220, 234
 - Troubleshooting 278
 - TV display 239
 - Tv (shooting mode) 162
- U**
- Underwater (shooting mode) 96

V

Viewfinder	44
Viewing	27
Image search	181
Index display	180
Magnified display	189
Single-image display	27
Slideshow	190
Smart Shuffle	191
TV display	239

W

White balance (color).....	134
Wink self-timer (shooting mode).....	113
World clock	220

Z

Zoom	24, 54, 63
------------	------------

CAUTION

RISK OF EXPLOSION IF BATTERY IS REPLACED BY AN INCORRECT TYPE.
DISPOSE OF USED BATTERIES ACCORDING TO LOCAL REGULATION.

Trademark Acknowledgments

- The SDXC logo is a trademark of SD-3C, LLC.
- This device incorporates exFAT technology licensed from Microsoft.
- HDMI, the HDMI logo and High-Definition Multimedia Interface are trademarks or registered trademarks of HDMI Licensing LLC.
- The iFrame logo and the iFrame symbol are trademarks of Apple Inc.

About MPEG-4 Licensing

This product is licensed under AT&T patents for the MPEG-4 standard and may be used for encoding MPEG-4 compliant video and/or decoding MPEG-4 compliant video that was encoded only (1) for a personal and non-commercial purpose or (2) by a video provider licensed under the AT&T patents to provide MPEG-4 compliant video.

No license is granted or implied for any other use for MPEG-4 standard.

* Notice displayed in English as required.

Disclaimer

- Reprinting, transmitting, or storing in a retrieval system any part of this guide without the permission of Canon is prohibited.
- Canon reserves the right to change the contents of this guide at any time without prior notice.
- Illustrations and screenshots in this guide may differ slightly from the actual equipment.
- The above items notwithstanding, Canon accepts no liability for damages due to mistaken operation of the products.

