

HG10

English

Français

Español

HD Camcorder
Instruction Manual

Caméscope HD
Manuel d'instruction

Videocámara HD
Manual de Instrucciones

Please read also the **Backup Utility** and **Digital Video Software** instruction manuals (on PDF file).

Veillez lire aussi les manuels d'instruction **Backup Utility** et **Digital Video Software** (sur fichier PDF).

Lea también los manuales de instrucciones de **Backup Utility** y **Digital Video Software** (en archivo PDF).



Important Usage Instructions

WARNING!



TO REDUCE THE RISK OF FIRE OR ELECTRIC SHOCK, DO NOT EXPOSE THIS PRODUCT TO RAIN OR MOISTURE.

WARNING!



TO REDUCE THE RISK OF ELECTRIC SHOCK AND TO REDUCE ANNOYING INTERFERENCE, USE THE RECOMMENDED ACCESSORIES ONLY.

COPYRIGHT WARNING:

Unauthorized recording of copyrighted materials may infringe on the rights of copyright owners and be contrary to copyright laws.

HD Camcorder, HG10 A systems

This device complies with Part 15 of the FCC Rules. Operation is subject to the following two conditions: (1) This device may not cause harmful interference, and (2) this device must accept any interference received, including interference that may cause undesired operation.

Note: This equipment has been tested and found to comply with the limits for class B digital device, pursuant to Part 15 of the FCC Rules. These limits are designed to provide reasonable protection against harmful interference in a residential installation. This equipment generates, uses and can radiate radio frequency energy and, if not installed and use in accordance with the instructions, may cause harmful interference to radio communications. However, there is no guarantee that interference will not occur in a particular installation. If this equipment does cause harmful interference to radio or television reception, which can be determined by turning the equipment off and on, the user is encouraged to try to correct the interference by one or more of the following measures:

- Reorient or relocate the receiving antenna.
- Increase the separation between the equipment and receiver.
- Connect the equipment into an outlet on a circuit different from that to which the receiver is connected.
- Consult the dealer or an experienced radio/TV technician for help.

The cable with the ferrite core provided with the digital video camcorder must be used with this equipment in order to comply with Class B limits in Subpart B of Part 15 of the FCC rules.

Do not make any changes or modifications to the equipment unless otherwise specified in the manual.

If such changes or modifications should be made, you could be required to stop operation of the equipment.

Canon U.S.A. Inc.

One Canon Plaza, Lake Success, NY 11042, U.S.A.

Tel No. (516)328-5600

CAUTION:

TO PREVENT ELECTRIC SHOCK, MATCH WIDE BLADE OF PLUG TO WIDE SLOT, FULLY INSERT.

Important Warning



CAUTION:

TO REDUCE THE RISK OF ELECTRIC SHOCK, DO NOT REMOVE COVER (OR BACK). NO USER-SERVICEABLE PARTS INSIDE. REFER SERVICING TO QUALIFIED SERVICE PERSONNEL.



The lightning flash with arrowhead symbol, within an equilateral triangle, is intended to alert the user to the presence of uninsulated "dangerous voltage" within the product's enclosure, that may be of sufficient magnitude to constitute a risk of electric shock to persons.

The exclamation point, within an equilateral triangle, is intended to alert the user to the presence of important operating and maintenance (servicing) instructions in the literature accompanying the product.

IMPORTANT SAFETY INSTRUCTIONS

In these safety instructions the word “product” refers to the Canon HD Camcorder HG10 A and all its accessories.

- 1** Read Instructions — All the safety and operating instructions should be read before the product is operated.
- 2** Retain Instructions — The safety and operating instructions should be retained for future reference.
- 3** Heed Warnings — All warnings on the product and in the operating instructions should be adhered to.
- 4** Follow Instructions — All operating and maintenance instructions should be followed.
- 5** Cleaning — Unplug this product from the wall outlet before cleaning. Do not use liquid or aerosol cleaners. The product should be cleaned only as recommended in this manual.
- 6** Accessories — Do not use accessories not recommended in this manual as they may be hazardous.
- 7** Avoid magnetic or electric fields — Do not use the camera close to TV transmitters, portable communication devices or other sources of electric or magnetic radiation. They may cause picture interference, or permanently damage the camera.
- 8** Water and Moisture — Hazard of electric shock — Do not use this product near water or in rainy/moist situations.
- 9** Placing or Moving — Do not place on an unstable cart, stand, tripod, bracket or table. The product may fall, causing serious injury to a child or adult, and serious damage to the product.

A product and cart combination should be moved with care. Quick stops, excessive force, and uneven surfaces may cause the product and cart combination to overturn.



- 10** Power Sources — The CA-570 Compact Power Adapter should be operated only from the type of power source indicated on the marking label. If you are not sure of the type of power supply to your home, consult your product dealer or local power company. Regarding other power sources such as battery power, refer to instructions in this manual.
- 11** Polarization — The CA-570 Compact Power Adapter is equipped with a polarized 2-prong plug (a plug having one blade wider than the other).
The 2-prong polarized plug will fit into the power outlet only one way. This is a safety feature. If you are unable to insert the plug fully into the outlet, try reversing the plug. If the plug still fails to fit, contact your electrician to replace your obsolete outlet. Do not defeat the safety purpose of the polarized plug.
- 12** Power Cord Protection — Power cords should be routed so that they are not likely to be walked on or pinched by items placed upon or against them. Pay particular attention to plugs and the point from which the cords exit the product.
- 13** Outdoor Antenna Grounding — If an outside antenna is connected to the product, be sure the antenna is grounded so as to provide some protection against voltage surges and built-up static charges. Section 810 of the National Electrical Code, ANSI / NFPA No. 70—1984, provides information with respect to proper grounding of the mast and supporting structure, grounding of the lead-in wire to an antenna discharge unit, size of grounding conductors, location of antenna discharge unit, connection to grounding electrodes, and requirements for the grounding electrode. See figure 1.

Fig. 1 EXAMPLE OF ANTENNA GROUNDING AS PER NATIONAL ELECTRICAL CODE

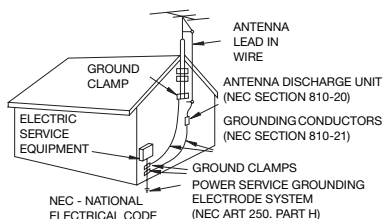

14 Lightning — For added protection of this product during a lightning storm, or when it is left unattended and unused for long periods of time, disconnect it from the wall outlet and disconnect the antenna. This will prevent damage to the product due to lightning and power-line surges.

15 Overloading — Do not overload wall outlets and extension cords as this can result in a risk of fire or electric shock.

16 Objects and Liquid Entry — Never push objects of any kind into this product through openings as they may touch dangerous voltage points or short out parts that could result in a fire or electric shock. Be careful not to spill liquid of any kind onto the product.

17 Servicing — Do not attempt to service this product yourself as opening or removing covers may expose you to dangerous voltage or other hazards. Refer all servicing to qualified service personnel.

18 Damage Requiring Service — Disconnect this product from the wall outlet and all power sources including battery, and refer servicing to qualified service personnel under the following conditions:

- When the power-supply cord or plug is damaged.
- If any liquid has been spilled onto, or objects have fallen into, the product.
- If the product has been exposed to rain or water.
- If the product does not operate normally even if you follow the operating instructions. Adjust only those controls that are covered by the operation instructions. Improper adjustment of other controls may result in damage and will often require extensive work by a qualified technician to restore the product to its normal operation.
- If the product has been dropped or the cabinet has been damaged.
- When the product exhibits a distinct change in performance. This indicates a need for service.

19 Replacement Parts — When replacement parts are required, be sure the service technician has used replacement parts that are specified by Canon or that have the same characteristics as the original part. Unauthorized substitutions may result in fire, electric shock or other hazards.

20 Safety Check — Upon completion of any service or repairs to this product, ask the service technician to perform safety checks to determine that the product is in safe operating order.

When replacement of the power supply is required, please return it to the responsible nearest Canon Service Center and please replace it with the same type number CA-570.

The Adapter can be used with a power supply between 100 and 240 V AC. For areas where 120 V AC power is not used, you will need a special plug adapter. Contact your nearest Canon Service Center for further information.

This Class B digital apparatus complies with Canadian ICES-003.

Enjoying High-Definition Video with your Camcorder

Preserve your most treasured memories, be it unforgettable scenery or cherished moments spent with family and friends, with high-definition video recordings of a quality second only to actually being there.

What is High-Definition Video?

High-definition (HD) video allows you to record video of unparalleled high quality on the built-in hard disk using the AVCHD compression. HD video is composed of 1,080 horizontal lines - that is more than twice the number of horizontal lines and approximately 4 times the number of pixels in standard-definition TV broadcasts - resulting in eye-catching colors and richly detailed video recordings.



1,080 lines



“Full HD 1080” refers to Canon camcorders compliant with high-definition video composed of 1,080 vertical pixels (scanning lines).

What is Cinema Mode?

Give your recordings a cinematic look by using the [CINE MODE] recording program (□ 51). Combine this recording program with the 24 fps progressive frame rate [PF24] (□ 46) to get the enhanced effect of the 24p Cinema Mode (□ 52).

How does the built-in hard disk enrich your shooting experience?

Because this camcorder automatically records video in unused space on the hard disk, you need not worry about accidentally recording over important videos. Not only that, you can shoot up to 9 1/2 hours of video in XP mode (□ 34). In addition, you can use the software on the **Corel Application Disc** CD-ROM to transfer your videos to a computer to back up, play and edit them. For a detailed explanation, refer to the **Corel Application Disc Installation Guide and User Manual**.

Important Notes About the Hard Disk Drive

Your hard disk camcorder allows you to shoot and store many hours of video. However, there are differences between recording onto a hard disk and recording onto other media. Make sure to follow the points below when using your camcorder. For more details, refer to *Handling Precautions* (□ 99).

Back up your recordings periodically

Make sure to transfer your movies to an external device such as a computer or digital video recorder (□ 40) and back them up on a regular basis.

Do not subject the camcorder to vibrations or strong impacts

The hard disk is a high-precision device. Vibrations, strong impacts or dropping the camcorder may result in permanent data loss.

Keep the drop sensor activated whenever possible

The drop sensor (□ 47) detects when the camcorder is dropped and activates a protection mechanism to help prevent hard disk damage. Turning this function off will disable the mechanism. Even if this function is set to [ON ON] and the camcorder is dropped, hard disk damage can occur.

Do not disconnect the power source while the HDD access indicator is on or flashing

To prevent hard disk damage, do not disconnect the power source or turn off the camcorder while the HDD access indicator is on or flashing.



Use the camcorder within its operating temperature range

If the camcorder's temperature becomes too hot or too cold, recording/playback may stop in order to prevent hard disk damage.

Do not use the camcorder at high altitudes

Turning on or using the camcorder in places with low atmospheric pressure, such as at altitudes higher than 3,000 m (9,800 ft.), may result in hard disk damage.

Initialize the hard disk when movies cannot be recorded/played back normally

As movies are recorded and deleted over time, hard disk fragmentation may occur, which may reduce performance. Initialize the hard disk should this happen.

Protect personal information on the hard disk

When the hard disk is initialized or movies are deleted, stored data is not physically erased. Remember this when disposing of the camcorder or giving it to another person.



Table of contents

■ Introduction

- 5 Enjoying High-Definition Video with your Camcorder
- 6 Important Notes About the Hard Disk Drive
- 12 About this Manual
- 13 Getting to Know the Camcorder**
- 13 Supplied Accessories
- 15 Components Guide
- 18 Screen Displays

■ Preparations

- 21 Getting Started**
- 21 Charging the Battery Pack
- 23 Preparing the Wireless Controller and Accessories
- 24 Basic Operation of the Camcorder**
- 24 Power Switch
- 24 Operating Modes
- 25 Navigation Buttons and Control Dial
- 25 Function Guide
- 26 Using the Menus
- 27 First Time Settings**
- 27 Setting the Date and Time
- 28 Changing the Language
- 28 Changing the Time Zone
- 29 Getting Ready to Start Recording**
- 29 Adjusting the Position and Brightness of the LCD Screen
- 30 Inserting and Removing a Memory Card

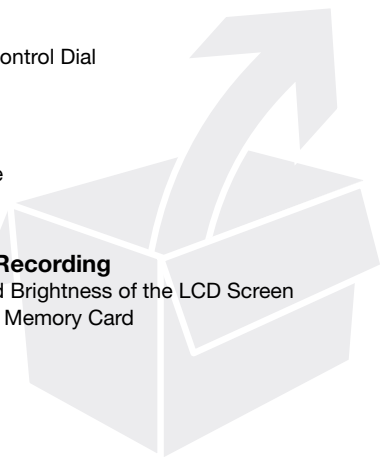

■ Video

32 Recording

- 32 Shooting Video
- 34 Selecting the Recording Mode
- 34 Zooming
- 35 Quick Start Function
- 36 Reviewing and Deleting the Last Scene Recorded

37 Playback and Video Backup

- 37 Playing Back the Video
- 37 Adjusting the Volume: Speaker and Headphones
- 40 Backing Up Videos
- 40 Searching Scenes by Date
- 41 Deleting Scenes
- 42 On-Screen Displays (Data Code)

42 Menu Options Lists

- 42 FUNC. Menu
- 44 Setup Menus
 - 44 Camera Setup (Digital Zoom, Image Stabilizer, etc.)
 - 47 Hard Disk Operations (HDD Usage Info, Initializing the Hard Disk, etc.)
 - 47 Still Image Operations (Card Initialization, etc.)
 - 48 Display Setup (LCD Brightness, Language, etc.)
 - 49 System Setup (Volume, Beep, etc.)
 - 51 Date/Time Setup

51 Additional Functions

- 51 Giving a Cinematic Look to your Recordings
- 52 Special Scene Recording Programs
- 54 **P** Flexible Recording: Changing the Aperture and Shutter Speed
- 55 Mini Video Light
- 56 Self Timer
- 56 Manual Focus Adjustment
- 57 Automatic Backlight Correction and Manual Exposure Adjustment
- 58 White Balance
- 59 Image Effects
- 60 Digital Effects
- 61 Using an External Microphone

■ Video (cont.)

63 Managing Scenes and the Hard Disk

- 63 Creating a Playlist
- 63 Moving Scenes in the Playlist
- 64 Initializing the Hard Disk

■ Photos

65 Recording

- 65 Taking Photos
- 66 Selecting Photo Size and Quality
- 67 Erasing the Last Photo Just Recorded

67 Playback

- 67 Viewing Photos
- 69 Magnifying Photos during Playback
- 69 Erasing Photos

70 Additional Functions

- 70 Flash
- 71 Continuous Shooting and Exposure Bracketing (Drive Mode)
- 72 Automatic Focus Priority
- 73 Light Metering Mode
- 73 Histogram and Other Screen Displays
- 74 Capturing a Still Image while Recording Movies
- 75 Capturing a Still Image from the Playback Scene
- 75 Protecting Photos
- 76 Initializing the Memory Card

77 Printing Photos

- 77 Printing Photos - Direct Print
- 78 Selecting the Print Settings
- 80 Trimming Settings
- 81 Print Orders



■ External Connections

83 Connecting to a TV or VCR

84 Connection Diagrams

85 Playback on a TV Screen

86 Copying your Recordings to an External Video Recorder

87 Connecting to a Computer

87 PC Connection Diagram

87 Transferring Photos - Direct Transfer

90 Transfer Orders

■ Additional Information

91 Trouble?

91 Troubleshooting

95 List of Messages

99 Do's and Don'ts

99 Handling Precautions

102 Maintenance/Others

103 Using the Camcorder Abroad

105 General Information

105 System Diagram

106 Optional Accessories

110 Product Codes

111 Specifications

113 Index

About this Manual

Thank you for purchasing the Canon HG10. Please read this manual carefully before you use the camcorder and retain it for future reference. Should your camcorder fail to operate correctly, refer to the *Troubleshooting* table (□ 91).

Conventions Used in this Manual

- **!** IMPORTANT: Precautions related to the camcorder's operation.
- **i** NOTES: Additional topics that complement the basic operating procedures.
- **✓** POINTS TO CHECK: Restrictions that apply if the function described is not available in all operating modes (the operating mode to which the camcorder should be set, etc.).
- □: Reference page number.
- The following terms are used in this manual:
 - “Screen” refers to the LCD and the viewfinder screen.
 - “Scene” refers to one movie unit from the point you press the START/STOP button to start recording until you press again to pause the recording.
 - The terms “photo” and “still image” are used interchangeably with the same meaning.
 - The terms “hard disk” and “HDD” are used interchangeably to refer to the camcorder's built-in hard disk drive.
- The photos included in this manual are simulated pictures taken with a still camera.

Menu item shown at its default position

Buttons and switches to be operated







Names of buttons and switches other than the navigation buttons are indicated within a “button” frame. For example **FUNC.**

Brackets [] and capital letters are used to refer to menu options as they are displayed on screen. In menu option lists and option tables the default value is shown in boldface. For example **[ON]**, [OFF].

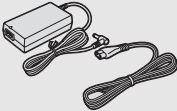
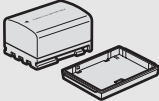
Changing the Language		
Options		
[DEUTSCH]	[ROMANA]	[English]
[ENGLISH]	[TURKCE]	[日本語]
[ESPAÑOL]	[РУССКИЙ]	[OFF]
[FRANÇAIS]	[УКРАЇНСЬКА]	[OFF]
[ITALIANO]	[한국어]	[日本語]
[POLSKI]	[ภาษาไทย]	
* Default value		
[DISPLAY SETUP]		
[LANGUAGE ENGLISH]		
[FUNC.]		

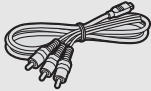
- 2 Press **▲** or **▼** to select the icon and press **Ⓜ** to open the setup menu.
- 3 Press **▲** or **▼** to select **[DISPLAY SETUP]** and press **Ⓜ**.

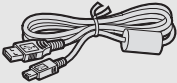
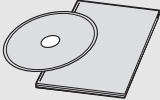
Supplied Accessories

	<p>CA-570 Compact Power Adapter (incl. power cord)</p>		<p>BP-2L13 Battery Pack</p>
<p>WL-D86 Wireless Controller</p>		<p>Lithium Button Battery CR2025 for Wireless Controller</p>	
	<p>CTC-100/S Component Cable Red • Green • Blue plugs</p>		<p>STV-250N Stereo Video Cable Yellow • Red • White plugs</p>
<p>IFC-400PCU USB Cable</p>		<p>Software CD-ROM and User Manual Corel Application Disc</p>	
	<p>Software CD-ROM* DIGITAL VIDEO Solution Disk</p>		<p>Software CD-ROM* Backup Utility</p>

* The CD-ROM includes the software instruction manual (electronic version on PDF file).

Online product registration for U.S.A. Customers only.

Register your product online at www.registercanon.com

✓ **Protect your product**

We will keep the model number and date of purchase of your new Canon product on file to help you refer to this information in the event of an insurance claim such as loss or theft.

✓ **Receive information on new products and promotions**

Upon your request, we will send you information on Canon new products and promotions.

The serial number of this product can be found at the battery attachment unit of the camcorder. Write down the number and other information here and retain this book as a permanent record of your purchase to aid identification in case of theft.

Date of Purchase:

Model Name: HG10 A

Purchased From:

Serial No.:

Dealer Address:

Dealer Phone No.:

Components Guide

Left side view

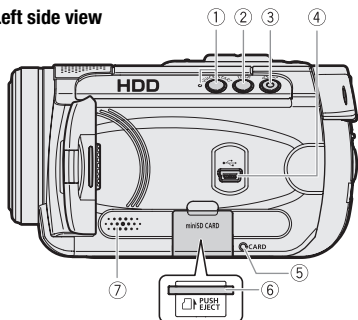

- ① QUICK START button and standby lamp (35)
- ② DISP. button (42, 73)
- ③ (print/share) button (78, 87)
- ④ USB terminal (87)
- ⑤ CARD access indicator (65)
- ⑥ Memory card slot (open the cover to access) (30)
- ⑦ Speaker (37)
- ⑧ Terminal cover
- ⑨ HDMI OUT mini terminal (84, 85)
- ⑩ COMPONENT OUT terminal (84)
- ⑪ AV OUT/ terminal (83)
- ⑫ Grip belt (23)
- ⑬ Strap mount
- ⑭ Flash (70)
- ⑮ Instant AF sensor (45)
- ⑯ MIC terminal (62)
- ⑰ Remote sensor (23)
- ⑱ Mini video light (55)

Right side view

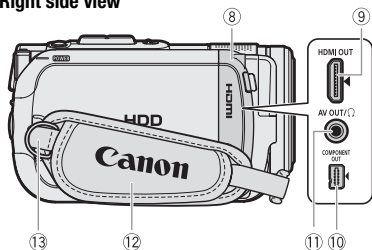

Names of buttons and switches other than the navigation buttons are indicated within a “button” frame (for example **FUNC.**).

Front view

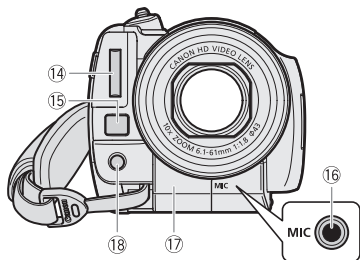

Back view

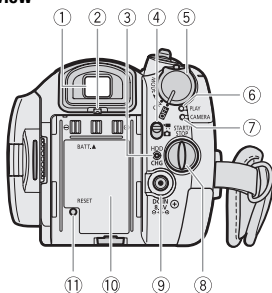

LCD panel

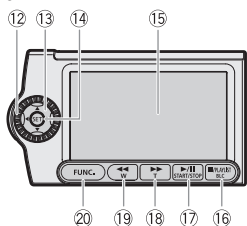

Top view

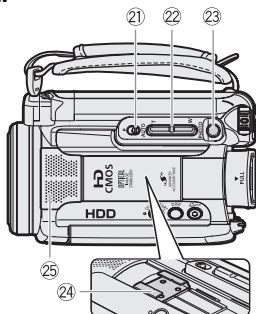

- ① Viewfinder (□ 33)
- ② Dioptic adjustment lever (□ 33)
- ③ HDD access indicator (□ 21) /
CHG (charge) indicator (□ 21)
- ④ (movies/still images) switch
(□ 24)
- ⑤ Power switch (□ 24)
- ⑥ PLAY mode indicator (green) (□ 24)
- ⑦ CAMERA mode indicator (red) (□ 24)
- ⑧ START/STOP button (□ 32)
- ⑨ DC IN terminal (□ 21)
- ⑩ Serial number
- ⑪ RESET button (□ 92)
- ⑫ Control dial (□ 25)
- ⑬ Navigation buttons (□ 25)
- ⑭ SET button (□ 25)
- ⑮ LCD screen (□ 29)
- ⑯ (stop) button (□ 37)/
PLAYLIST button (□ 63)/
BLC (backlight correction) button (□ 57)
- ⑰ (play/pause) button (□ 37)/
START/STOP button (□ 32)
- ⑱ (fast forward) button (□ 37)/
Zoom in **T** (telephoto) button (□ 34)
- ⑲ (rewind) button (□ 37)/
Zoom out **W** (wide-angle) button (□ 34)
- ⑳ FUNC. button (□ 26, 42)
- ㉑ Mode switch (□ 33)
- ㉒ Zoom lever (□ 34)
- ㉓ PHOTO button (□ 65)
- ㉔ Advanced accessory shoe (□ 61)
- ㉕ Stereo microphone

Names of buttons and switches other than the navigation buttons are indicated within a “button” frame (for example **FUNC.**).

Bottom view

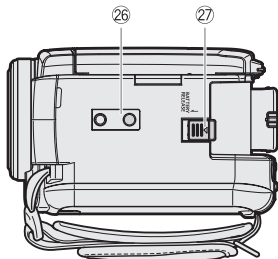

- 26 Tripod socket (□ 24)
- 27 BATTERY RELEASE switch (□ 21)

Wireless Controller WL-D86

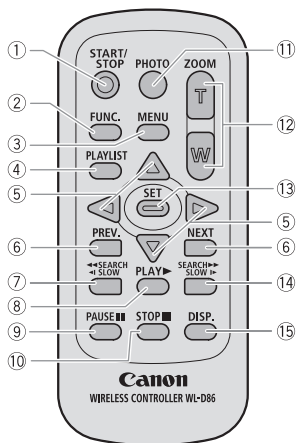

- 1 START/STOP button (□ 32)
- 2 FUNC. button (□ 26)
- 3 MENU button (□ 26)
- 4 PLAYLIST button (□ 63)
- 5 Navigation buttons (▲/▼/◀/▶)
- 6 PREV./NEXT buttons:
Scene skip (□ 38)/
Index screen page up/down (□ 37)
- 7 Reverse ◀◀ SEARCH button (□ 38) /
Reverse ◀ SLOW button (□ 38)
- 8 PLAY ▶ button (□ 37)
- 9 PAUSE ||| button (□ 37)
- 10 STOP ■ button (□ 37)
- 11 PHOTO button (□ 65)
- 12 Zoom buttons (□ 34)
- 13 SET button
- 14 Forward SEARCH ▶▶ button (□ 38) /
Forward SLOW ▶▶ button (□ 38)
- 15 DISP. (on-screen display) button
(□ 42, 73)

Screen Displays

CAMERA · Recording Movies

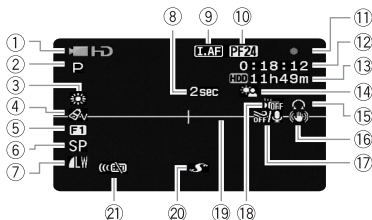

PLAY · Playing Movies (During Playback)



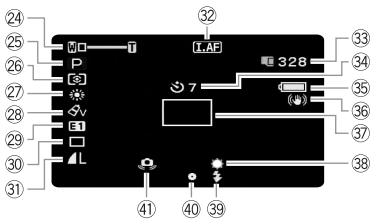

- ① Operating mode (□ 24)
- ② Recording program (□ 51, 54)
- ③ White balance (□ 58)
- ④ Image effect (□ 59)
- ⑤ Digital effects (□ 60)
- ⑥ Recording mode (□ 34)
- ⑦ Still image quality/size (simultaneous recording) (□ 74)
- ⑧ Recording reminder
- ⑨  Instant AF (□ 45), MF Manual focus (□ 56)
- ⑩ 24F progressive frame rate
- ⑪ Hard disk operation
- ⑫ Time code/Playback time (hours : minutes : seconds)
- ⑬ Remaining recording time on the hard disk
- ⑭ Backlight correction (□ 57)
- ⑮ Headphones output (□ 38)
- ⑯ Image stabilizer (□ 46)
- ⑰ Wind screen off (□ 47)
- ⑱ Drop sensor off (□ 47)
- ⑲ Level marker (□ 48)
- ⑳ Advanced accessory shoe (□ 105)
- ㉑ Remote sensor off (□ 49)
- ㉒ Scene number
- ㉓ Data code (□ 42)

CAMERA · Recording Still Images

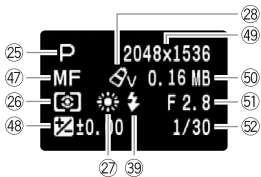
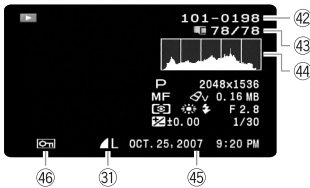

PLAY · Viewing Still Images



- 24 Zoom (□ 34), Exposure  (□ 57)
- 25 Recording program (□ 51, 54)
- 26 Light metering mode (□ 73)
- 27 White balance (□ 58)
- 28 Image effect (□ 59)
- 29 Digital effects (□ 60)
- 30 Drive mode (□ 71)
- 31 Still image quality/size (□ 66)
- 32  Instant AF (□ 45), MF Manual focus (□ 56)
- 33 Number of still images available on the memory card
- 34 Self timer (□ 56)
- 35 Remaining battery charge estimate
- 36 Image stabilizer (□ 46)
- 37 AF frame (□ 72)
- 38 Mini video light (□ 55)
- 39 Flash (□ 70)
- 40 Focus/exposure automatically set and locked (□ 65)
- 41 Camcorder shake warning (□ 44)
- 42 Image number (□ 50)
- 43 Current image / Total number of images
- 44 Histogram (□ 73)
- 45 Date and time of recording
- 46 Image protection mark (□ 75)
- 47 Manual focus (□ 56)
- 48 Manual exposure (□ 57)
- 49 Image size (□ 66)
- 50 File size
- 51 Aperture value (□ 54)
- 52 Shutter speed (□ 54)

⑧ Recording reminder

The camcorder counts from 1 to 10 seconds when you start recording. This is helpful to avoid scenes that are too short.

⑩ 24F progressive frame rate

Select the 24F progressive frame rate (📺 46) to give your recordings a cinematic look. You can combine this frame rate with the [🎬] CINE MODE] recording program (📖 51) to enhance the effect.

⑪ Hard disk operation

- Record, ● ||| Record pause,
- ▶ Playback, ||| Playback pause,
- ▶▶ Fast playback,
- ◀◀ Fast reverse playback,
- ▶ Slow playback,
- ◀ Slow reverse playback

⑬ Remaining recording time

When there is no more free space on the hard disk, "HDD END" will be displayed and the recording will stop.

③③ Number of still images available on the card

- 📷 flashing in red: No card
- 📺 in green: 6 or more images
- 📺 in yellow: 1 to 5 images
- 📺 in red: No more images can be recorded

- When viewing the still images, the display will always be in green.
- Depending on the recording conditions, the number of available still images displayed may not decrease even after a recording has been made, or may decrease by 2 still images at once.

Card access display

▶ is displayed next to the number of images available while the camcorder is writing on the memory card.

③⑤ Remaining battery charge estimate



- When 🔋 is displayed in red, replace the battery pack with a fully charged one.
- When you attach an empty battery pack, the power may turn off without displaying 🔋.
- Depending on the conditions under which the camcorder and the battery pack are used, the actual battery charge may not be indicated accurately.

④② Image number

The image number indicates the name and location of the file on the memory card. For example, the file name of image 101-0107 is "IMG_0107.JPG", stored under the folder "DCIM\101CANON".



Preparations

This chapter describes basic operations, such as navigating the menus, and first time settings to help you learn more about your camcorder.

Getting Started

Charging the Battery Pack

The camcorder can be powered with a battery pack or directly using the compact power adapter. Charge the battery pack before use.

For approximate charging times and recording/playback times with a full battery pack, refer to the tables on page 106.

Remove the battery terminal cover before attaching the battery pack

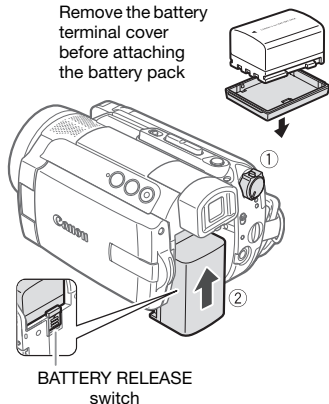

1 Turn off the camcorder.

2 Attach the battery pack to the camcorder.

Press the battery pack softly into the battery attachment unit and slide it up until it clicks in place.

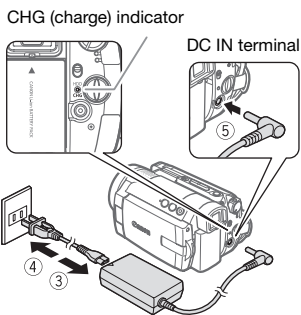

3 Connect the power cord to the compact power adapter.

4 Plug the power cord into a power outlet.

5 Connect the compact power adapter to the camcorder's DC IN terminal.

- The CHG (charge) indicator starts flashing. The indicator will stay on when the charging is completed.
- You can also use the compact power adapter without attaching a battery pack.
- When the compact power adapter is connected, the power of the battery pack will not be consumed.

ONCE THE BATTERY PACK IS FULLY CHARGED

- 1 **Disconnect the compact power adapter from the camcorder.**
- 2 **Unplug the power cord from the power outlet and the compact power adapter.**

TO REMOVE THE BATTERY PACK

Slide **BATTERY RELEASE** in the direction of the arrow and hold it pressed down. Slide the battery pack down and then pull it out.

IMPORTANT

- Turn off the camcorder before connecting or disconnecting the compact power adapter. After you turn the **POWER** switch to **OFF**, important file allocation data is updated on the hard disk. Be sure to wait until the LCD display is completely off.
- You may hear some noise from the compact power adapter during use. This is not a malfunction.
- We recommend charging the battery pack in temperatures between 10 °C and 30 °C (50 °F and 86 °F). Outside the temperature range of 0 °C to 40 °C (32 °F to 104 °F), the charging will not start.
- Do not connect to the camcorder's DC IN terminal or to the compact power adapter any electrical equipment that is not expressly recommended for use with this camcorder.
- To prevent equipment breakdowns and excessive heating, do not connect the supplied compact power adapter to voltage converters for overseas travels or special power sources such as those

on aircraft and ships, DC-AC inverters, etc.

NOTES

- The CHG (charge) indicator also serves as a rough estimate of the charge status.

Continuously on: Battery pack fully charged.

Two quick flashes at 1-second intervals: Battery pack at least 50% charged. If the indicator flashes quickly but not exactly in this pattern, refer to *Troubleshooting* (□ 91).

One flash at 1-second intervals: Battery pack less than 50% charged.

- We recommend that you prepare battery packs to last 2 to 3 times longer than you think you might need.
- **U.S.A. and Canada only:** The lithium ion/polymer battery that powers this product is recyclable. Please call 1-800-8-BATTERY for information on how to recycle this battery.



Preparing the Wireless Controller and Accessories

First, insert the supplied lithium button battery CR2025 into the wireless controller.

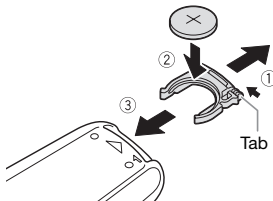

- 1 Press the tab in the direction of the arrow and pull out the battery holder.
- 2 Place the lithium button battery with the + side facing up.
- 3 Insert the battery holder.

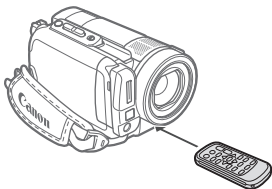

Point the wireless controller at the camcorder's remote sensor when you press the buttons.

i NOTES

- The wireless controller may not work properly when the remote sensor is situated under strong light sources or direct sunlight.
- If the wireless controller does not work, check that [WL.REMOTE] is not set to

[OFF OFF (OFF) (OFF) 49]. Otherwise, replace the battery.

- When the optional Tele-converter or Wide-converter is attached to the camcorder, it may partially obstruct the remote sensor. Use the wireless controller from a different angle.

Accessories

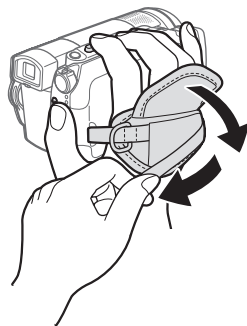

1 Fasten the grip belt.

Adjust the grip belt so that you can reach the zoom lever with your index and middle fingers, and the **START/STOP** button with your thumb.

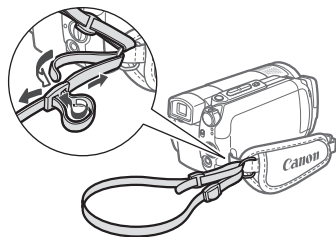

2 Attach the optional shoulder strap.

Pass the ends through the strap mount and adjust the length of the strap.

WHEN YOU MOUNT THE CAMCORDER ON A TRIPOD

Do not leave the viewfinder exposed to direct sunlight as it may melt (due to concentration of the light by the lens). Do not use tripods with fastening screws longer than 5.5 mm (0.2 in.). Doing so may damage the camcorder.

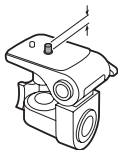

Basic Operation of the Camcorder

Power Switch

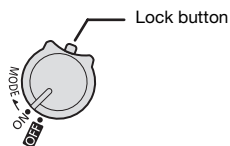

In addition to turning the camcorder on and off, the **POWER** switch also toggles the camcorder's operating mode.

To turn on the camcorder: Hold the lock button pressed down and turn the **POWER** switch to ON.

To change the operating mode: From the ON position, turn the **POWER** switch momentarily toward MODE and release it. This action will toggle the operating mode between recording (CAMERA - red indicator) and playback (PLAY - green indicator).

Operating Modes

The camcorder's operating mode is determined by the **POWER** switch and the position of the **PLAY/RECORD** switch. In this manual, **CAMERA** indicates that a function is available in the operating mode shown and **PLAY** indicates that the function is not available. When no operating mode icons are given, the



function is available in all operating modes.

Navigation Buttons and Control Dial

This camcorder is equipped with navigation buttons (▲/▼/◀/▶ buttons) and a control dial on the LCD panel to allow you to operate the various functions. The functions assigned to the navigation buttons and control dial change according to the operating mode and the camcorder's settings.

Press the navigation buttons to select an item or change settings.



Press **SET** to save the settings or confirm an action. On menu screens, this is indicated by the icon **SET**.

For many functions, turning the control dial is equivalent to pressing ◀ or ▶. For other functions, turning it is equivalent to pressing ▲ or ▼. Note that the control dial cannot be used for some functions.



Function Guide

Press **SET** to display/hide the function guide. In the illustrations of this manual, positions other than those relevant to the function explained are marked with a striped pattern.

Operating Mode	Operating Mode Indicator	Switch	Icon Display	Operation	
	CAMERA (Red)	 (Movies)		Recording movies on the hard disk	32
		 (Still images)		Recording still images on the memory card	65
	PLAY (Green)	 (Movies)	 (Green)	Playing movies from the hard disk	37
		 (Still images)	 (Blue)	Viewing still images from the memory card	67

Depending on the operating mode, these positions may be empty or show a different icon than the one on the illustration.



When the guide contains multiple "pages", [NEXT] and the page number icon (▼) will appear at the bottom position. Press ▼ to display the next "page" of the guide.

Using the Menus

Many of the camcorder's functions can be adjusted from the menus that open after pressing the FUNC. button ([FUNC.]).

For details about the available menu options and settings, refer to the *Menu Options Lists* (📖 42).

Selecting a FUNC. Menu Option

FUNC.
(📖 26)



1 Press [FUNC.].

2 Press ▲ or ▼ to select the icon of the function you want change from the left side column.

- Menu items not available will appear grayed out.
- You can also use the control dial.

3 Press ◀ or ▶ to select the desired setting from the available options at the bottom bar.

- The selected option will be highlighted in light blue.
- With some settings, you will need to make further selections and/or press [SET]. Follow the additional operation guides that will appear on the screen (such as the [SET] icon, small arrows, etc.).

4 Press [FUNC.] to save the settings and close the menu.

You can press [FUNC.] to close the menu at any time.

Selecting an Option from the Setup Menus

FUNC.
(📖 26)



1 Press [FUNC.].

2 Use the navigation buttons to select the [CAMERA] icon and press [SET].

You can also hold [FUNC.] pressed down for more than 1 second or



press **[MENU]** on the wireless controller to open directly the setup menu screen.

3 Press ▲ or ▼ to select the desired menu from the left side column and press **[SET].**

The title of the selected menu appears on top of the screen and under it the list of settings.

4 Press ▲ or ▼ to select the setting you want to change and press **[SET].**

- The orange selection bar indicates the menu setting currently selected. Items not available appear in black.
- Press ◀ to return to the menu selection screen (step 3).

5 Press ▲ or ▼ to select the desired option and press **[SET] to save the setting.**

6 Press **[FUNC.].**

You can press **[FUNC.]** to close the menu at any time.

i **NOTES**

You can also use the control dial to navigate the menus and adjust settings.

First Time Settings

Setting the Date and Time

You will need to set the date and time of the camcorder before you can start using it. The [DATE/TIME] screen will appear automatically when the camcorder's clock is not set.



When the [DATE/TIME] screen appears, the year will be displayed in orange and indicated with up/down arrows.

1 Press ▲ or ▼ to change the year and press ▶ to move to the month.

You can also use the control dial to change the year.

2 Change the rest of the fields (month, day, hour and minutes) in the same way.

3 Press ▶ to move the cursor to the [OK] button and press **[SET] to start the clock and close the menu.**

! **IMPORTANT**

- When you do not use the camcorder for about 3 months, the built-in rechargeable lithium battery may discharge completely and the date and time setting may be lost. In such case,

recharge the built-in lithium battery (□ 102) and set the time zone, date and time again.

- The date appears in a year-month-day format only in the first setup screen. In subsequent screen displays the date and time will appear as month-day-year (for example, [JAN. 1, 2007 12:00 AM]). You can change the date format (□ 51).
- You can also change the date and time later on (not during the initial setup). To open the [DATE/TIME] screen, press **[FUNC.]** and select ⇒ [DATE/TIME SETUP] ⇒ [DATE/TIME].

Changing the Language

Options

[DEUTSCH]	[ROMÂNĂ]	[ภาษาไทย]
[ENGLISH]♦	[TÜRKÇE]	[简体中文]
[ESPAÑOL]	[РУССКИЙ]	[繁體中文]
[FRANÇAIS]	[УКРАЇНСЬКА]	[한국어]
[ITALIANO]	[العربية]	[日本語]
[POLSKI]	[فارسی]	

♦ Default value

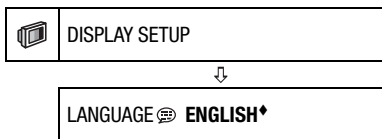

FUNC.
(□ 26)

[FUNC.]



1 Press [FUNC.]

2 Press ▲ or ▼ to select the icon and press **[SET] to open the setup menus.**

3 Press ▲ or ▼ to select [DISPLAY SETUP] and press **[SET].**

4 Press ▲ or ▼ to select [LANGUAGE] and press **[SET].**

5 Use the navigation buttons or the control dial to select the desired option and press **[SET].**

6 Press **[FUNC.] to close the menu.**

NOTES

- If you changed the language by mistake, follow the mark next to the menu item to change the setting.
- The displays **[SET]** and **[FUNC.]** that appear in some menu screens refer to the name of buttons on the camcorder and will not change, regardless of the language selected.

Changing the Time Zone

♦ Default value

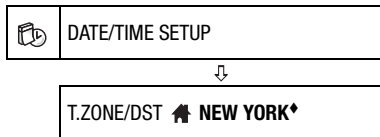

FUNC.
(□ 26)

[FUNC.]





1 Press [FUNC.]





- 2 Press ▲ or ▼ to select the  icon and press **SET** to open the setup menus.
- 3 Press ▲ or ▼ to select [DATE/TIME SETUP] and press **SET**.
- 4 Press ▲ or ▼ to select [T.ZONE/DST] and press **SET**.
The default setting is New York.

TO SET THE HOME TIME ZONE

- 5 Make sure that the  time zone is selected.
- 6 Press ◀ or ▶ to select the area that corresponds to your local time zone and press **SET**.
To adjust for daylight saving time, select the area name marked with a .
- 7 Press **FUNC.** to close the menu.

WHEN YOU TRAVEL

Select the time zone to match the local time at your destination.

- 5 Press ▼ to move the orange selection frame to the  time zone.
- 6 Press ◀ or ▶ to select the area that corresponds to the local time at your destination and press **SET**.
 - Refer to the changing date and time displayed on the screen.
 - To adjust for daylight saving time, select the area name marked with a .
- 7 Press **FUNC.** to close the menu.

Getting Ready to Start Recording

Adjusting the Position and Brightness of the LCD Screen

Rotating the LCD Panel

Open the LCD panel 90 degrees.

- You can rotate the panel 90 degrees downward.
- You can rotate the panel 180 degrees toward the lens (allowing the subject to monitor the LCD screen while you use the viewfinder). Rotating the panel 180 degrees is also useful if you wish to include yourself when recording with the self timer. This is the only case where you can use the viewfinder and the LCD screen simultaneously.

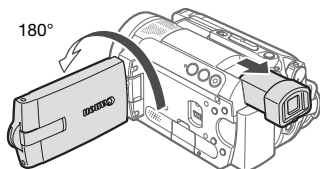
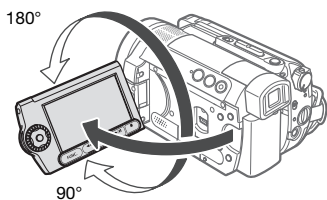

Subject can monitor the LCD screen

i NOTES

About the LCD and viewfinder screen: The screens are produced using extremely high-precision manufacturing techniques, with more than 99.99% of the pixels operating to specification. Less than 0.01% of the pixels may occasionally misfire or appear as black, red, blue or green dots. This has no effect on the recorded image and does not constitute a malfunction.

LCD Backlight

You can set the brightness of the screen to normal or bright. Doing so changes the brightness of both the LCD and viewfinder screen.

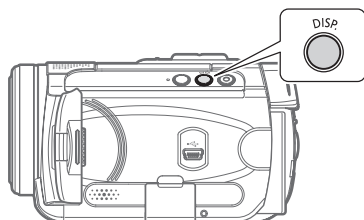

Hold **DISP.** pressed down for more than 2 seconds.

Repeat this action to toggle between the normal and bright settings.

i NOTES

- This setting does not affect the brightness of the recording.
- Using the bright setting will shorten the effective usage time of the battery pack.

Inserting and Removing a Memory Card

Only miniSD cards can be used with this camcorder.

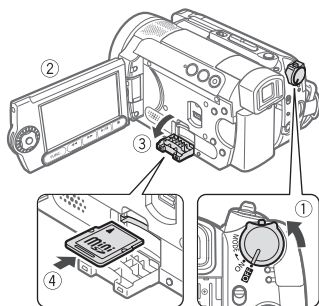

- 1 Turn off the camcorder.**
- 2 Open the LCD panel.**
- 3 Open the memory card slot cover.**
- 4 Insert the memory card straight with the miniSD label facing up, all the way into the memory card slot until it clicks.**
- 5 Close the cover.**

Do not force the cover closed if the memory card is not correctly inserted.

TO REMOVE THE MEMORY CARD

First push the memory card once to release it, and then pull the card out.

! IMPORTANT

- Make sure to initialize all memory cards before using them with this camcorder (□ 76).
- Memory cards have front and back sides that are not interchangeable. Inserting a memory card facing the wrong direction can cause a malfunction of the camcorder.

i NOTES

Compatibility with all miniSD cards cannot be guaranteed.



Video

This chapter covers functions related to shooting movies, including recording, playback, menu options, and hard disk operations.

Recording

Shooting Video

Before You Begin Recording

Make a test recording first to check if the camcorder operates correctly. If necessary, initialize the hard disk (p. 64).

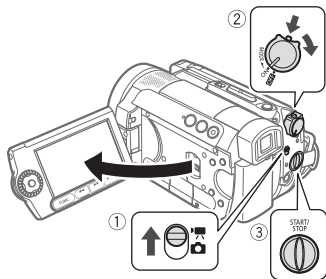

- 1 Move the switch to (Movies).
- 2 Turn the **POWER** switch to ON to set the camcorder in **CAMERA** mode. The red CAMERA indicator will turn on.

3 Press **START/STOP** to begin recording.

- The recording starts; press **START/STOP** again to pause the recording.
- You can also press **START/STOP** on the LCD panel.

WHEN YOU HAVE FINISHED RECORDING

- 1 Make sure that the HDD access indicator is off.
- 2 Turn off the camcorder.
- 3 Close the LCD panel.

! IMPORTANT

- **When recording movies, try to get a calm, stable picture.**
Excessive camcorder movement while shooting and extensive use of fast zooms and panning can result in jittery scenes. In extreme cases, the playback of such scenes may result in visually induced motion sickness. If you experience such a reaction, immediately stop the playback and take a rest break as necessary.
- Observe the following precautions while the HDD access indicator is on or flashing. Failing to do so may result in permanent data loss or hard disk damage.
 - Do not subject the camcorder to vibrations or strong impacts.
 - Do not disconnect the power source or turn off the camcorder.
 - Do not change the operating mode.



i NOTES

- **About the Power Save mode:** To save power when the camcorder is powered by a battery pack, the camcorder will automatically shut off if left without any operations for 5 minutes (□ 49). To restore the power, turn the **POWER** switch toward **MODE** and release it, or turn the **POWER** switch to **OFF** and back to **ON** again.
- When recording in very loud places (such as fireworks shows or concerts), sound may become distorted or it may not be recorded at the actual levels. This is not a malfunction.

Using the Viewfinder

When recording in bright places it may be difficult to use the LCD screen. In such case, change the brightness of the LCD screen (□ 30) or use the viewfinder instead. To use the viewfinder, keep the LCD panel closed*. Then, hold both sides of the viewfinder firmly and pull it straight out until it clicks.

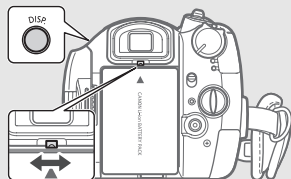

Adjust the viewfinder as necessary with the dioptic adjustment lever. You can also change the brightness of the screen (□ 30). Using the bright setting will shorten the effective usage time of the battery pack.

* The LCD screen and the viewfinder can be used simultaneously when the LCD panel is turned 180 degrees to face the subject (□ 29).

About the Mode Switch and Recording Programs

Set the mode switch to **AUTO** to let the camcorder adjust all the settings for you, allowing you to just point the camcorder and start shooting.



Set the mode switch to **P** to select one of the recording programs.

The Special Scene recording programs (□ 52) offer a convenient way to select the optimal settings to match special recording conditions. Conversely, with flexible recording programs (□ 54) you can set the shutter speed or the aperture you want, or enjoy the flexibility to change other settings.



Selecting the Recording Mode

The camcorder offers 4 recording modes. Changing the recording mode will change the recording time available on the hard disk. Select HXP or XP mode for better movie quality; select LP mode for longer recording times. The following table gives approximate recording times.

Recording Mode	Recording Time
HXP	5 hr. 30 min.
XP	9 hr. 30 min.
SP	11 hr. 30 min.
LP	15 hr.*

* Movies can be recorded continuously for about 13 hours.



◆ Default value



FUNC.
(□ 26)



- 1 Press **FUNC.**.
- 2 Press **▲** or **▼** to select the recording mode icon.
- 3 Press **◀** or **▶** to select the desired recording mode.
- 4 Press **FUNC.** again to save the setting and close the menu.

i NOTES

- Recording in LP mode gives you a longer recording time; however,

depending on the scene being recorded, the picture and sound recorded in LP mode may be distorted. We recommend using HXP or XP mode for important recordings. If necessary, initialize the hard disk (□ 64).

- The camcorder uses a variable bit rate (VBR) when encoding the video data so the actual recording times will vary depending on the content of the scenes.

Zooming

✓ POINTS TO CHECK



CAMERA : In addition to the optical zoom, digital zoom is also available (□ 45).

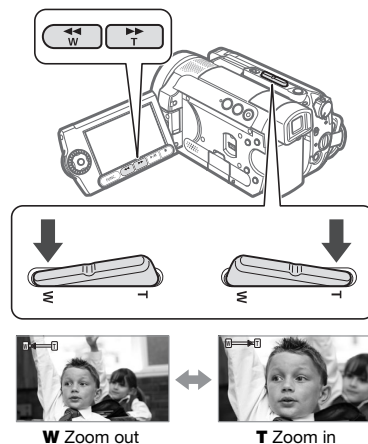



10x Optical Zoom

Press the **W** side of the zoom lever to zoom out (wide angle). Press the **T** side to zoom in (telephoto).

You can also change the zoom speed (□ 45). You can select one of three fixed zoom speeds or a variable speed that depends on how you operate the zoom lever: Press gently for a slow zoom; press harder for faster zooms.

i NOTES

- Keep at least 1 m (3.3 ft.) away from the subject. At full wide angle, you can focus on a subject as close as 1 cm (0.39 in.).
- You can also use the **T** and **W** buttons on the wireless controller or the LCD panel. The zoom speed will be the same as with the camcorder or fixed at [▶▶▶ SPEED 3] (when [VAR VARIABLE] is selected).
- When set to [VAR VARIABLE], the zoom speed will be faster in record pause mode.

Quick Start Function

When you press **QUICK START** the camcorder enters the **Q** standby mode. In standby mode the camcorder consumes only about half the power used when recording, saving energy when you are using a battery pack. Additionally, when you press **QUICK START** again the camcorder is ready to start recording within approx. 1 second, ensuring you do not miss important shooting opportunities.

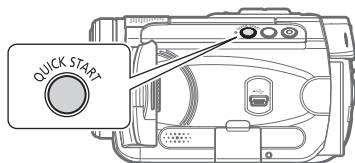

1 Press **QUICK START** firmly.

The standby lamp flashes at first while the camcorder is preparing and then stays on when it enters the standby mode.

2 When you wish to resume recording, press **QUICK START** again.

Within approx. 1 second, the camcorder is ready in record pause mode.



! IMPORTANT

During standby mode (while the standby lamp is on), do not disconnect the power source.

NOTES

- When you wake up the camcorder from standby mode, the following settings will be changed automatically:
 - Manual focus returns to automatic focus (AF).
 - Manual exposure adjustment returns to automatic exposure.
 - Zoom position returns to full wide angle **W**.
 - Automatic backlight correction deactivates.
- The camcorder will shut off if left in standby mode for 10 minutes, regardless of the [POWER SAVE] setting (□ 49). You can select the length of time until shut-off with the [STANDBY OFF] setting (□ 49).

To restore the power if the camcorder shut off, turn the **POWER** switch toward **MODE** and release it, or turn the **POWER** switch to **OFF** and back to **ON** again.

- If you perform any of the following actions while in standby mode (while the standby lamp is on), the camcorder will return to record pause mode.
 - Change the position of the  /  switch.
 - Turn the **POWER** switch toward **MODE**.

Reviewing and Deleting the Last Scene Recorded

Even in **CAMERA** mode you can play back the last scene recorded in order to check it. You can also delete the scene while reviewing it.



1 If the function guide does not appear on screen, press **SET** to display it.

2 Press **◀** to select .

- If  does not appear on the function guide, repeatedly press **▼** to display it.
- The camcorder plays back the last scene (but without sound) and returns to record pause mode.

Deleting a Scene After Recording It



After recording a scene:

1 Review the scene as described in the previous section.

2 While reviewing the scene, press **▶** to select  and press **SET**.

3 Press **▶** to select [YES] and press **SET**.

NOTES

- Avoid any other operations on the camcorder while the scene is being deleted.
- You will not be able to delete the last scene if after the scene was recorded you changed the operating mode or the camcorder was turned off.



Playback and Video Backup

Playing Back the Video

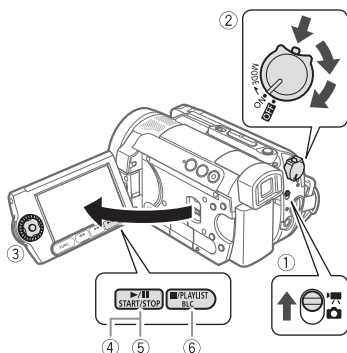

1 Move the / switch to (Movies).

2 Turn the **POWER** switch to **ON**, then turn it toward **MODE** and release it to set the camcorder in **PLAY** mode.

The green **PLAY** indicator will turn on. The scene index screen appears after a few seconds with the selection frame on the last (most recently recorded) scene.

3 Use the navigation buttons to move the selection frame to the scene you want to play back.

You can also turn the control dial to run quickly through the index screens.

4 Press to begin the playback.

Playback will start from the scene selected and continue until the end of the last scene recorded.

DURING PLAYBACK

5 Press again to pause the playback.

6 Press to stop the playback and return to the scene index screen.

NOTES

Depending on the recording conditions, you may notice brief stops in video or sound playback between scenes.

Adjusting the Volume: Speaker and Headphones

The camcorder plays the sound with the built-in speaker. When you are using the viewfinder for playback, you can connect a pair of headphones to listen to the sound. You can also use the headphones to check the audio level while recording.

Adjusting the Volume of the Speaker

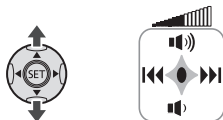

Special Playback Modes

To enter the special playback modes, you can use the buttons on the LCD panel or wireless controller (□ 17). There is no sound during the special playback modes.

Special playback mode	Initial mode	On the camcorder press...	On the wireless controller press...
Fast playback	Normal playback	◀◀ or ▶▶* Press again to increase the playback speed 5x → 15x → 60x the normal speed**	SEARCH ▶▶ or ◀◀ SEARCH
Slow playback	Playback pause	◀◀ or ▶▶* Press again to increase the playback speed 1/8 → 1/4 the normal speed	SLOW ▶ or ◀ SLOW
Skip to the beginning of: the next scene the current scene the previous scene	Normal playback	▶ ◀ ◀ twice	NEXT PREV. PREV. twice
Return to normal playback	Special playback	▶	PLAY ▶

During some special playback modes, you may notice some anomalies (blocky video artifacts, banding, etc.) in the playback picture.

* You can also use the control dial.



**The speed indicated on the screen is approximate.

1 If the function guide does not appear on screen, press **SET to display it.**

2 Press **▲ or **▼** to adjust the volume.**

- To turn off the volume completely, keep pressing **▼** until the volume icon changes to .
- You can press **SET** again to hide the function guide during playback.

Using Headphones

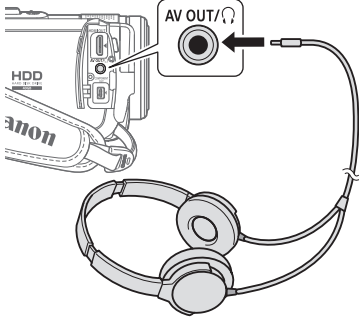

The headphones are connected to the AV OUT/ terminal, which is used for both the headphones and the audio/video output. Before connecting the headphones, follow the procedure below to change the function of the terminal from AV output to  (headphones) output and make sure the  icon appears on the screen.



FUNC.
(26)

FUNC.



- 1 Press **FUNC.**
- 2 Use the navigation buttons to select the  icon and press **SET** to open the setup menus.
- 3 Press **▲** or **▼** to select **[SYSTEM SETUP]** and press **SET**.
- 4 Press **▲** or **▼** to select **[AV/PHONES]** and press **SET**.
- 5 Press **▼** to select **[PHONES]** and press **SET**.
- 6 Press **FUNC.**
 appears.

TO ADJUST THE VOLUME OF THE HEADPHONES

In **CAMERA** mode, adjust the volume of the headphones with the **[PHONES VOL.]** setting (50). In **PLAY** mode, use the navigation buttons and the function guide following the same procedure as when adjusting the speaker's volume.

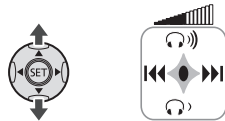

! IMPORTANT

- Do not connect the headphones to the AV OUT/PHONES terminal if the  icon does not appear on the screen. If you connect the headphones while the terminal is set to AV output, only noise will be output.
- When using headphones, make sure to lower the volume to an appropriate level.
- The sound of the built-in speaker will be muted when you close the LCD panel, when you connect the STV-250N Stereo Video Cable to the AV OUT/PHONES terminal or when **[AV/PHONES]** is set to **[PHONES]**.

i NOTES

- Use commercially available headphones with a \varnothing 3.5 mm minijack.
- When you turn off the camcorder or change the operating mode, the **[AV/PHONES]** setting in **PLAY** mode will return to **[AV AV]**.
- The volume of the headphones cannot be adjusted while recording.

Backing Up Videos

Movies recorded with this camcorder are saved to the built-in hard disk. Because space on the hard disk is limited, make sure to copy your movies to an external device and back them up on a regular basis.

Recordings made with this camcorder can be backed up using the following methods.

Copying Movies to a Computer

The supplied **Corel Application Disc** CD-ROM includes software that will allow you to select movies you recorded and transfer them to a computer. For a detailed explanation, refer to the **Corel Application Disc Installation Guide and User Manual**.

You can also use the software on the supplied **Backup Utility** CD-ROM to back up to the computer all the movies on the camcorder's built-in hard disk. For a detailed explanation, refer to the software's instruction manual (electronic version on PDF file).

Copying Movies to an External Device

Connect the camcorder to an external device such as a VCR or digital video recorder and transfer your movies.

For a detailed explanation, refer to *Copying your Recordings to an External Video Recorder* (□ 86).

Transferring Movies from a Computer

After you transfer movies to a computer, you can use the supplied **Corel Application Disc** software to select movies and transfer them back to the

camcorder. For a detailed explanation, refer to the **Corel Application Disc Installation Guide and User Manual**.

Make sure to use the software on the supplied **Backup Utility** CD-ROM to back up all of the recordings on the camcorder's hard disk in advance. If you backed up onto the computer all the movies on the camcorder using the software on the **Backup Utility** CD-ROM, you can also transfer those movies back to the camcorder. For a detailed explanation, refer to the software's instruction manual (electronic version on PDF file).

Searching Scenes by Date

You can search for all the recordings you made on a particular date, for example, to find all the movies you shot during an outing.



POINTS TO CHECK



* Original index screen only

FUNC.

(□ 26)

FUNC.



1 Press .

2 Press or **to select**

SELECT DATE and press .

- An index screen appears that displays all dates in which recordings were made. An orange selection frame appears on the day.



- The thumbnail shows a still image from the first scene recorded on that day. The number below it indicates the number of scenes taken on the selected day.

3 Press ▲ or ▼ to change the day and press ◀ or ▶ to move to the month or year.

4 Change the other fields in the same way to select the desired date and press **SET.**

An index screen will appear with the selection frame on the first scene recorded on the selected date.

i NOTES

You can also use the control dial.

Deleting Scenes

You can delete those scenes that you are not interested in keeping. Deleting scenes also allows you to free up hard disk space.

Deleting a Single Scene or All Scenes from a Selected Date

✓ POINTS TO CHECK



From the original index screen, use the navigation buttons to select a scene. Selecting [ALL SCENES (THIS DATE)] will delete all scenes recorded on the same day as the selected scene. Selecting [ONE SCENE] will delete only

the selected scene. To delete a scene only in the playlist, press **PLAYLIST** first, and then select the scene.

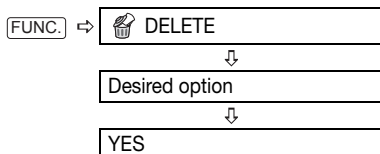

! IMPORTANT

- Be careful when deleting original recordings. Once deleted, an original scene cannot be recovered.
- Back up important scenes before deleting them.
- Do not use a computer to delete data in this camcorder.

i NOTES

- Deleting a scene from the original index screen also deletes that scene from the playlist.
- Depending on the number of scenes on the hard disk, deleting a scene may take longer than usual.
- You may not be able to delete scenes shorter than 5 seconds. To delete such scenes you must initialize the hard disk (book icon 64), in the process deleting all other recordings.
- Do not change the position of the **POWER** switch or the **PLAY/PAUSE** switch while the scene is being deleted (while the HDD access indicator is on or flashing).
- Initialize the hard disk to delete all movies and make all recordable space available again.

- When deleting a scene from the playlist index screen, only one scene can be deleted at a time.

On-Screen Displays (Data Code)

The camcorder keeps a data code containing the date and time and other camera data (shutter speed, aperture, etc.) registered at the time of recording. You can select the data to be displayed.

Turning the On-Screen Displays On/Off

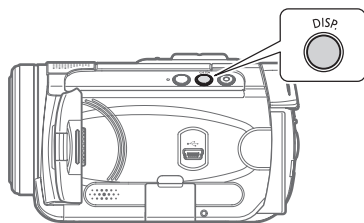

Repeatedly press **DISP** to turn the on-screen displays on/off in the following sequence:



- All displays on
- All displays off¹



- All displays on
- Data code² only
- All displays off

¹ However, the markers and the icons ● and ●|| will still appear on the screen.

² Data code: Time, date and camera data at the time of recording. The contents to be displayed can be selected with the [DATA CODE] setting (□ 48).

Menu Options Lists

Menu items not available appear grayed out in the FUNC. menu or in black in the setup menus. For details about how to select an item, refer to *Using the Menus* (□ 26).

FUNC. Menu

Recording programs (□ 51, 54)



Mode switch: **P**

- [PROGRAM AE],
- [SHUTTER-PRIO.AE],
- [APERTURE-PRIO.AE],
- [CINE MODE]*

Special Scene recording programs:

- [PORTRAIT], [SPORTS],
- [NIGHT], [SNOW], [BEACH],
- [SUNSET], [SPOTLIGHT],
- [FIREWORKS]

* [CAMERA] mode only.

Light metering mode (□ 73)



Mode switch: **P**

- [EVALUATIVE],
- [CENT.WEIGHT.AVERAGE],
- [SPOT]



White balance

(58)



Mode switch: **P**

[**AUTO**], [**DAYLIGHT**],
[**SHADE**], [**CLOUDY**],
[**TUNGSTEN**], [**FLUORESCENT**],
[**FLUORESCENT H**], [**SET**]

Image effect

(59)



Mode switch: **P**

[**IMAGE EFFECT OFF**],
[**VIVID**], [**NEUTRAL**],
[**LOW SHARPENING**],
[**SOFT SKIN DETAIL**],
[**CUSTOM**]

Digital effects

(60)



Mode switch: **P**

[**D.EFFECT OFF**], [**FADE-T**],
[**WIPE**], [**BLK&WHT**],
[**SEPIA**], [**ART**]



Mode switch: **P**

[**D.EFFECT OFF**],
[**BLK&WHT**], [**SEPIA**]

Drive mode

(71)



Mode switch: **P**

[**SINGLE**], [**CONT.SHOOT.**],
[**HISPEED CONT.SHOOT.**],
[**AEB**]

Recording mode

(34)



[**HXP HIGH QUALITY 15 Mbps**],
[**XP HIGH QUALITY 9 Mbps**],
[**SP STANDARD PLAY 7 Mbps**],
[**LP LONG PLAY 5 Mbps**]

Still image simultaneous recording

(74)



Size:

[**STILL I.REC OFF**],
[**LW 1920x1080**], [**SW 848x480**]

Quality:

[**SUPER FINE**], [**FINE**],
[**NORMAL**]

Still image size/quality

(66)



Size:

[**LW 1920x1080**], [**L 2048x1536**],
[**M 1440x1080**], [**S 640x480**]

Quality:

[**SUPER FINE**], [**FINE**],
[**NORMAL**]

ADD TO PLAYLIST

(63)



[**ALL SCENES (THIS DATE)**],
[**ONE SCENE**], [**CANCEL**]

Add scenes to the playlist. This option is available only from the original index screen.

MOVE (63)

Move a scene in the playlist. This option is available only from the playlist index screen.

DELETE (41)

[ALL SCENES (THIS DATE)],
[ONE SCENE], [CANCEL]

Delete a scene from the original index screen.

[NO], [YES]

Delete a scene from the playlist index screen.

SELECT DATE (40)

Search for all scenes recorded on a particular date. This option is available only from the original index screen.

SLIDESHOW (68)

[CANCEL], [START]

PROTECT (75)

Press **(SET)** to enter the image selection screen in order to select the still images you want to protect.

PRINT ORDER (81)

Press **(SET)** to enter the image selection screen in order to select the still images for which you want to set print orders.

TRANSFER ORDER (90)

Press **(SET)** to enter the image selection screen in order to select the still images you want to mark with a transfer order.

Setup Menus

In the setup menus, you can also use the control dial to navigate the menus and adjust settings.

CAMERA SETUP

.....

A.SL SHUTTER

Mode switch: **AUTO** or **P** (only in the [P PROGRAM AE] recording program)

[ON ON], [OFF OFF]

The camcorder automatically uses slow shutter speeds to obtain brighter recordings in places with insufficient lighting.



Operating Mode	Shutter Speed Used
CAMERA	As low as 1/30
CAMERA with [PF24 PF24] frame rate.	As low as 1/12
CAMERA	As low as 1/15

- In **CAMERA** mode, set the flash mode to (flash off).
- If a trailing afterimage appears, set the slow shutter to [**OFF** OFF].
- If (camcorder shake warning) appears, we recommend stabilizing the camcorder, for example, by mounting it on a tripod.

D.ZOOM



[**OFF** OFF], [**40x** 40X], [**200x** 200X]

Determines the operation of the digital zoom. The color of the indicator indicates the zoom as follows.

Optical Zoom	Digital Zoom	
White	Light blue	Dark blue
Up to 10x	10x - 40x	40x - 200x

- When activated, the camcorder will switch automatically to the digital zoom when you zoom in beyond the optical zoom range.
- With the digital zoom the image is digitally processed, so the image resolution will deteriorate the more you zoom in.

- The digital zoom cannot be used with the [NIGHT] recording program.

ZOOM SPEED



[**VAR VARIABLE**], [SPEED 3], [SPEED 2], [SPEED 1]

- When set to [**VAR VARIABLE**] the zoom speed depends on how you operate the zoom lever: Press lightly for a slow zoom; press harder for faster zooms.
- The fastest zoom speed can be achieved with [**VAR VARIABLE**]. Among the fixed zoom speeds, [SPEED 3] is the fastest and [SPEED 1] the slowest.

AF MODE



[**IAF INSTANT AF**], [**AF** NORMAL AF]

Select how fast the autofocus will operate.

- With [**IAF INSTANT AF**] the autofocus adjusts quickly to a new subject. This is convenient for example when changing the focus from a near subject to a far subject in the background, or when recording fast-moving subjects.
- When the optional Wide-converter or Tele-converter is attached to the camcorder, it may partially obstruct the Instant AF sensor. Set the AF mode to [**AF** NORMAL AF].

FOCUS ASSIST

Mode switch: **P**

[**ON ON**], [**OFF OFF**]

- The focus assist function magnifies the image that appears at the center of the screen to help you focus manually.
- Using the focus assist function will not affect the recordings. The focus assist function will be cancelled when you start recording.

IMG STAB

Mode switch: **P**

[**ON ON** (hand icon)], [**OFF OFF**]

The image stabilizer compensates for camcorder shake even at full telephoto.

- The image stabilizer is designed to compensate for a normal degree of camcorder shake.
- The image stabilizer cannot be turned off when the mode switch is set to **AUTO**.
- We recommend setting the image stabilizer to [**OFF OFF**] when using a tripod.

FRAME RATE

Mode switch: **P**

[**60i 60i NORMAL**], [**PF24 PF24**]

Selects the frame rate to be used when recording.

[**PF24 PF24**]: 24 frames per second, progressive.

Using this frame rate will give your recordings a cinematic look. When combined with the [**CINE MODE**] recording program (□ 51), the cinematic look will be enhanced.

AF AST LAMP

(□ 71)



[**A AUTO**], [**OFF OFF**]

FOCUS PRI.

(□ 72)



Mode switch: **P**

[**AiAF ON:AiAF**], [**ON:CENTER**], [**OFF OFF**]

REVIEW

[**OFF OFF**], [**2sec 2 sec**], [**4sec 4 sec**], [**6sec 6 sec**], [**8sec 8 sec**], [**10sec 10 sec**]

Selects the time to display a still image after it has been recorded on the memory card.

- This menu item will not be available when the drive mode (□ 71) is set to [**CONT.SHOOT.**], [**HISPEED CONT.SHOOT.**] or [**AEB**].
- If you press [**DISP.**] while reviewing a still image it will continue to be displayed indefinitely. Press [**PHOTO**] halfway to return to the normal display.

SELF TIMER

(□ 56)



[**ON ON** (smiley face)], [**OFF OFF**]



WIND SCREEN



Mode switch: **P**

[**A** **AUTO**], [**OFF** **OFF**]

The camcorder automatically reduces the background sound of wind when recording outdoors.

- The wind screen cannot be turned off when the mode switch is set to **AUTO**.
- Some low-frequency sounds will be suppressed along with the sound of wind. When recording in surroundings unaffected by wind or if you want to record low-frequency sounds, we recommend setting the wind screen to [**OFF** **OFF**].

HDD OPERATIONS

HDD USAGE INFO



Displays a screen where you can verify the approximate used hard disk space. This option is available only from the original index screen.

- Hard disk space is calculated in 0.1 GB increments and rounded off. In addition, some hard disk space is used for file management data. As a result, the total space will be slightly less than 40 GB.

INITIALIZE HDD

(64)



[NO], [YES]

Initializes the hard disk. This option is available only from the original index screen.

DROP SENSOR



[**ON** **ON**], [**OFF** **OFF**]

Detects when the camcorder is dropped and activates a protection mechanism to help prevent hard disk damage. While the mechanism is active, appears in red on the screen and playback/recording may stop. This option is available only from the original index screen.

- Keep this function set to [**ON** **ON**] in most situations. Deactivating this function can increase the likelihood of hard disk damage should the camcorder be dropped. Even if this function is set to [**ON** **ON**] and the camcorder is dropped, hard disk damage can occur.
- You can set the drop sensor to [**OFF** **OFF**] to record while, for example, riding a roller coaster. If left set to [**ON** **ON**] and the protection mechanism activates, its operation noise may be heard and recording/playback may stop.

DEL.PLAYLIST

(41)



[NO], [YES]

This option is available only in the playlist index screen.

STILL IMG OPER.

ERASE ALL ORD

(82)



[NO], [YES]

ERASE ALL **ORD** (90)



[NO], [YES]

ERASE ALL IMAGES (69)



[NO], [YES]

INITIALIZE CARD (76)



[INITIALIZE], [COMPL.INIT.], [CANCEL]

DISPLAY SETUP

BRIGHTNESS

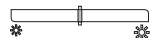

Adjusts the brightness of the LCD screen.

- Press ◀ or ▶ or use the control dial to adjust the brightness to your preference.
- Changing the brightness of the LCD screen does not affect the brightness of your recordings, that of the playback image on a TV or that of the viewfinder.

TV SCREEN



[**ON** ON], [**OFF** OFF]

When set to [**ON** ON], the camcorder's on-screen displays will appear also on the screen of a TV or monitor

connected using the STV-250N Stereo Video Cable.

DATA CODE (42)



[DATE], [TIME], [DATE & TIME], [CAMERA DATA]

Displays the date and/or time when the scene was recorded.

[CAMERA DATA]: Displays the aperture (f-stop) and shutter speed used when recording the image.

MARKERS



[**OFF** OFF], [LEVEL(WHT)], [LEVEL(GRY)], [GRID(WHT)], [GRID(GRY)]

You can display a grid or a horizontal line at the center of the screen. The markers are available in white or gray. Use the markers as a reference to make sure your subject is framed correctly (vertically and/or horizontally).

- Using the markers will not affect the recordings on the hard disk or memory card.

LANGUAGE (28)



[DEUTSCH], [**ENGLISH**], [ESPAÑOL], [FRANÇAIS], [ITALIANO], [POLSKI], [ROMÂNĂ], [TÜRKÇE], [РУССКИЙ], [УКРАЇНСЬКА], [العربية], [فارسی], [தமிழ்], [简体中文], [繁體中文], [한국어], [日本語]



DEMO MODE



[ON ON], [OFF OFF]

The demonstration mode displays the camcorder's main features. It starts automatically when the camcorder is powered with the compact power adapter if you leave it turned on for more than 5 minutes.

- To cancel the demo mode once it has started, press any button or turn off the camcorder.

SYSTEM SETUP

WL.REMOTE



[ON ON], [OFF OFF] (🔊)

Allows the camcorder to be operated with the wireless controller.

SPEAKER VOL.



Press ◀ or ▶ or use the control dial to adjust the volume of the playback. You can also adjust the volume using the function guide (📖 37).

BEEP



[🔊) HIGH VOLUME],
[🔊) LOW VOLUME], [OFF OFF]

A beep will accompany some operations like turning on the

camcorder, the self-timer countdown, etc.

POWER SAVE



[ON ON], [OFF OFF]

In order to save power when the camcorder is powered by a battery pack, it will automatically shut off if left without any operation for 5 minutes.

- Approximately 30 seconds before the camcorder shuts off, the message “⚠️ AUTO POWER OFF” will appear.
- In standby mode, the camcorder will shut off after the time selected for the [🕒 STANDBY OFF] setting.

🕒 STANDBY OFF

(📖 35)



[10min 10 min], [20min 20 min],
[30min 30 min]

Select the length of time after which the camcorder will end the standby mode and shut off automatically.

IMG QUALITY



[📷 LW SUPER FINE], [📷 LW FINE],
[📷 LW NORMAL]

Select the quality of a still image captured from a scene.

FILE NOS.**[RESET], [CONTINUOUS]**

Select the image numbering method to be used on a new memory card.

Images are automatically assigned consecutive image numbers from 0101 to 9900, and stored in folders containing up to 100 images. Folders are numbered from 101 to 998.

[RESET]: Image numbers will restart from 101-0101 every time you insert a new memory card.

[CONTINUOUS]: Image numbers will continue from the number following that of the last image recorded with the camcorder.

- If the memory card you insert already contains an image with a larger number, a new image will be assigned a number one higher than that of the last image on the memory card.
- We recommend using the [CONTINUOUS] setting.

AV/PHONES**[AV], [PHONES]****PHONES VOL.**

When [AV/PHONES] is set to [PHONES], press ◀ or ▶ or use the control dial to adjust the volume of the headphones.

 NOTES

- Lower the volume before connecting the headphones.
- In [PLAY-PAUSE] mode, you can also adjust the volume using the function guide (37).

TV TYPE**[NORMAL TV], [WIDE TV]**

In order to display the picture in full and in the correct aspect ratio, select the setting according to the type of television to which you will connect the camcorder.

[NORMAL TV]: TV sets with 4:3 aspect ratio.

[WIDE TV]: TV sets with 16:9 aspect ratio.

- The setting cannot be selected while the camcorder is connected to an HDTV using the optional HTC-100 HDMI Cable.
- When the TV type is set to [NORMAL TV], the picture displayed on the LCD screen will be smaller than the full display area.
- When the TV type is set to [NORMAL TV], still images cannot be captured from the playback scene (75).

COMP.OUT**[480i], [1080i]**

You can select the video specifications to use when connecting the camcorder to a high-definition TV using the component video connection.



[480i] 480i]: To use the 480i specification (standard definition).

[1080i] 1080i]: To use the full 1080i high definition specification.

- This setting will be unavailable while the camcorder is connected to an external device using the optional HTC-100 HDMI Cable.

HDMI STATUS



You can verify the specification of the video output signal from the HDMI OUT mini terminal.

FIRMWARE



You can verify the current version of the camcorder's firmware. This menu option is usually grayed out.

DATE/TIME SETUP



T.ZONE/DST

(28)

DATE/TIME

(27)

DATE FORMAT

[Y.M.D (2007.1.1 AM 12:00)],
[M.D,Y (JAN. 1, 2007 12:00 AM)],
[D.M.Y (1.JAN.2007 12:00 AM)]

Changes the date format for on-screen displays and for date printing.

Additional Functions

Giving a Cinematic Look to your Recordings

Give your recordings a cinematic look by using the [CINE MODE] recording program. Combine this recording program with the 24 fps progressive frame rate [PF24] to get the enhanced effect of the 24p Cinema Mode.

Using the [CINE MODE] Recording Program

With the [CINE MODE] recording program, the camcorder adjusts various image settings to give a cinematic look to your recordings.

POINTS TO CHECK



Mode switch: P

FUNC.
(26)

FUNC.



FUNC. →

Icon of the currently selected Recording Program



FUNC. ←

[CINE MODE]

Setting the 24p Cinema Mode

You can combine the [CINE MODE] recording program and the [PF24] PF24] frame rate to achieve the 24p Cinema Mode, which will enhance the cinematic look of your recordings.

POINTS TO CHECK



Mode switch: **P**

Set the recording program to [CINE MODE], as described in the previous section.

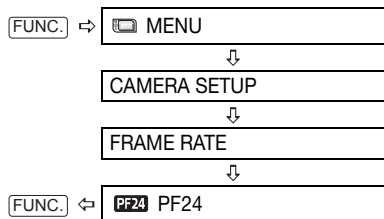

NOTES

Do not move the mode switch to **AUTO** during the actual recording of a scene; the brightness of the picture may change abruptly.

Special Scene Recording Programs

Recording in a very bright ski resort or capturing the full colors of a sunset or a fireworks display becomes as easy as selecting a Special Scene recording program. For details about the available options, refer to the sidebar on page 53.

POINTS TO CHECK



Mode switch: **P**

FUNC.
(26)

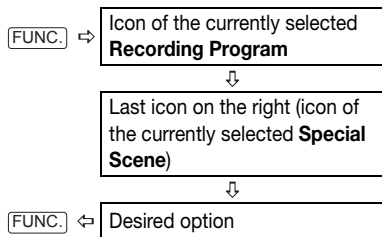



i NOTES

- Do not move the mode switch to **AUTO** during the actual recording of a scene; the brightness of the picture may change abruptly.
- [**👤** PORTRAIT]/[**🏆** SPORTS]/[**🏖️** BEACH]/[**❄️** SNOW]
 - The picture may not appear smooth during playback.
- [**👤** PORTRAIT]
 - The blur effect of the background increases the more you zoom in (**T**).
- [**🌙** NIGHT]
 - Moving subjects may leave a trailing afterimage.
 - Picture quality may not be as good as in other modes.
- White points may appear on the screen.
- Autofocus may not work as well as in other modes. In such case, adjust the focus manually.
- [**❄️** SNOW]/[**🏖️** BEACH]
 - The subject may become overexposed on cloudy days or in shaded places. Check the image on the screen.
- [**🎆** FIREWORKS]
 - To avoid camcorder shake, we recommend using a tripod. Make sure to use a tripod especially in **CAMERA** mode, as the shutter speed slows down.

[**👤** PORTRAIT]

The camcorder uses a large aperture, achieving a focus on the subject while blurring other distracting details.



[**🏖️** BEACH]

Use this mode to record on a sunny beach. It prevents the subject from being underexposed.



[**🏆** SPORTS]

Use this mode to record sports scenes such as tennis or golf.



[**🌅** SUNSET]

Use this mode to record sunsets in vibrant colors.



[**🌙** NIGHT]

Use this mode to record in dimly lit places.



[**🎆** SPOTLIGHT]

Use this mode to record spotlight scenes.



[**❄️** SNOW]

Use this mode to record in bright ski resorts. It prevents the subject from being underexposed.



[**🎆** FIREWORKS]

Use this mode to record fireworks.



P Flexible Recording: Changing the Aperture and Shutter Speed

Use the automatic exposure (AE) program or give priority to the exposure value or the shutter speed.

Use a high shutter speed to record fast moving subjects or a slow shutter speed to add motion blur, emphasizing the feel of movement.

Use low aperture values (larger lens opening) to softly blur the background in a portrait or high aperture values (smaller lens opening) to get a wider depth of field, giving a sharp focus all throughout a landscape.



POINTS TO CHECK



Mode switch: **P**

Options

◆ Default value



[ PROGRAM AE]◆
The camcorder automatically adjusts the aperture and shutter speed to obtain the optimal exposure for the subject.
[ SHUTTER-PRIO.AE]
Set the shutter speed value. The camcorder automatically sets the appropriate aperture value.
[ APERTURE-PRIO.AE]
Set the aperture value. The camcorder automatically sets the appropriate shutter speed.

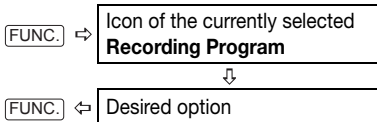

FUNC.
( 26)

FUNC.



TO SET THE SHUTTER SPEED OR APERTURE VALUE

When you select [ SHUTTER-PRIO.AE] or [ APERTURE-PRIO.AE], a numeric value will appear next to the recording program icon.

- 1 If the function guide appears on the screen, press  to hide it.**
- 2 Press  or  to adjust the shutter speed or aperture value to the desired value.**

Shutter speed guidelines

Note that on screen only the denominator is displayed – [ 250] indicates a shutter speed of 1/250 second, etc.

1/2*, 1/4*, 1/8, 1/15, 1/30	To record in dimly lit places.
1/60	To record under most ordinary conditions.
1/100	To record indoor sports scenes.
1/250, 1/500, 1/1000**	To record from within a moving car or train or to shoot fast-moving subjects such as roller coasters.
1/2000**	To record outdoor sports scenes on sunny days.

In **CAMERA**  mode, when the frame rate is set to [**PF24** PF24], the shutter speeds available will be the following: 1/6, 1/12, 1/24, 1/48, 1/60, 1/100, 1/250, 1/500, 1/1000 and 1/2000.





Available Aperture Values

[1.8]**, [2.0]**, [2.4]**, [2.8], [3.4], [4.0], [4.8], [5.6], [6.7], [8.0]

*  mode only.

**  mode only.

NOTES



- When setting a numeric value (aperture or shutter speed), the number display will flash if the aperture or shutter speed is not appropriate for the recording conditions. In such case, select a different value.
- Do not move the mode switch to **AUTO** during the actual recording of a scene; the brightness of the picture may change abruptly.
-  **SHUTTER-PRIO.AE**
 - If you use a slow shutter speed in dark places, you can obtain a brighter image, but the image quality may be lower, and the autofocus may not work well.
 - The image may flicker when recording with high shutter speeds.
 - **Recording movies under fluorescent lights:** If the screen starts to flicker, select  **SHUTTER-PRIO.AE** and set the shutter speed to 1/100.
-  **APERTURE-PRIO.AE**
 - The actual range of values available for selection will vary depending on the initial zoom position.





Mini Video Light

You can turn on the mini video light (assist lamp) at any time, regardless of the recording program.



1 If the function guide does not appear on screen, press  to display it.

2 Press  to select .

- If  does not appear on the function guide, repeatedly press  to display it.
-  appears on the screen.
- Press  again to turn the mini video light off.

TO USE THE OPTIONAL VL-3 VIDEO LIGHT

You can attach the optional VL-3 Video Light to the advanced accessory shoe if you want a more powerful video light than the built-in mini video light. For details about attaching and using the video light, refer to the instruction manual of the VL-3. When a video accessory is attached to the advanced accessory shoe,  will appear on the screen.

NOTES

- We recommend not using the mini video light while the optional Wide-converter or Tele-converter is attached; its shadow can appear on the screen.
- The built-in mini video light will be disabled automatically when you attach the optional VL-3 Video Light. To use the built-in mini video light, set the switch on the VL-3 to OFF first.

Self Timer



FUNC.
(26)

FUNC.

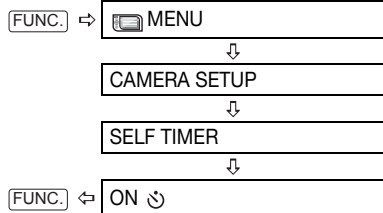

appears.

CAMERA - :

In record pause mode, press
[START/STOP].

The camcorder starts recording after a 10-second countdown*. The countdown appears on the screen.

CAMERA - :

Press [PHOTO], **first halfway to activate the autofocus and then fully.**

The camcorder will record the still image after a 10-second countdown*. The countdown appears on the screen.

* 2 seconds when using the wireless controller.

NOTES

Once the countdown has begun, you can press [START/STOP] (when recording movies), press [PHOTO] fully (when recording still images) or turn off the camcorder to cancel the self timer.

Manual Focus Adjustment

Autofocus may not work well on the following subjects. In such case, focus manually.

- Reflective surfaces
- Subjects with low contrast or without vertical lines
- Fast moving subjects
- Through wet windows
- Night scenes

POINTS TO CHECK



Adjust the zoom before you start the procedure.

Mode switch: **P**



- 1 If the function guide does not appear on screen, press** **to display it.**
- 2 Press** **to select [FOCUS].**
 - If [FOCUS] does not appear on the function guide, repeatedly press to display it.
 - "MF" appears.
- 3 Press** **or** **once to verify if the image is focused.**

The center of the screen will be magnified to help you focus more easily. You can also turn off the focus assist function (46).



4 Keep ◀ or ▶ pressed down to adjust the focus as necessary.

- You can also use the control dial to make smaller adjustments.
- Pressing ▲ to select [FOCUS] again will return the camcorder to autofocus.

5 Press .

- The focus will be locked.
- Pressing  and then ▲ to select [FOCUS] again will return the camcorder to autofocus.

Infinity Focus

Use this function when you wish to focus on faraway subjects such as mountains or fireworks.

POINTS TO CHECK



Adjust the zoom before you start the procedure.

Mode switch: **P**



1 If the function guide does not appear on screen, press  to display it.

2 Keep ▲ pressed down for more than 2 seconds.

- ∞ appears.
- Pressing ▲ to select [FOCUS] again will return the camcorder to autofocus.

- If you use the control dial, operate the zoom or press ◀ or ▶, ∞ changes to “MF” and the camcorder returns to manual focusing mode.

Automatic Backlight Correction and Manual Exposure Adjustment

At times, backlit subjects may appear too dark (underexposed) or subjects under very strong lights may appear too bright or glaring (overexposed). To correct this, you can manually adjust the exposure or use the automatic backlight correction.

POINTS TO CHECK



Mode switch: **P** (except for the [FIREWORKS] recording program).

Automatic Backlight Correction

When shooting subjects with a strong light source behind them, you can have the camcorder automatically correct for the backlight with the press of a single button.

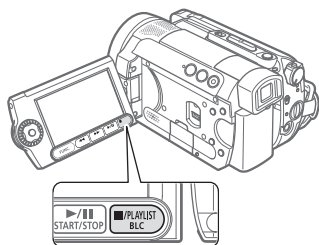

Press **[BLC]**.

-  appears.
- Press **[BLC]** again to end the backlight correction mode.

Manual Exposure Adjustment



- 1 If the function guide does not appear on screen, press **[SET]** to display it.**
- 2 Press **▲** to select **[EXP]**.**
 - If **[EXP]** does not appear on the function guide, repeatedly press **▼** to display it.
 - The exposure adjustment indicator  and the neutral value "±0" appear on the screen.
 - If you operate the zoom during exposure lock, the brightness of the image may change.
- 3 Press **◀** or **▶** to adjust the brightness of the image as required.**
 - You can also use the control dial.
 - Pressing **▲** to select **[EXP]** again will cancel the exposure lock and return the camcorder to automatic exposure.
- 4 Press **[SET]**.**
 - The exposure adjustment indicator will change to white and the exposure will be locked.
 - Pressing **[SET]** and then **▲** to select **[EXP]** again will return the camcorder to autofocus.

White Balance

The white balance function helps you to accurately reproduce colors under different lighting conditions so that white objects will always look truly white in your recordings.

POINTS TO CHECK



Mode switch: **P** (except for the Special Scene recording programs)

Options

◆ Default value

[ANWB AUTO]◆	Settings are automatically set by the camcorder. Use this setting for outdoor scenes.
[☀ DAYLIGHT]	For recording outdoors on a bright day.
[▲ SHADE]	For recording in shaded places.
[☁ CLOUDY]	For recording on a cloudy day.
[🔦 TUNGSTEN]	For recording under tungsten and tungsten type (3-wavelength) fluorescent lighting.
[🌞 FLUORESCENT]	For recording under warm white, cool white or warm white type (3-wavelength) fluorescent lighting.
[🌞 FLUORESCENT H]	For recording under daylight or daylight type (3-wavelength) fluorescent lighting.



[SET]
Use the custom white balance setting to make white subjects appear white under colored lighting.

FUNC.
(26)

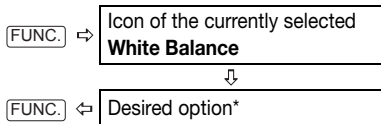

* When you select [SET], do not press [FUNC.] and continue instead with the following procedure.

TO SET THE CUSTOM WHITE BALANCE

- 1 Point the camcorder at a white object, zoom in until it fills the whole screen and press .**
When the adjustment is completed, stops flashing and stays on. The camcorder retains the custom setting even if you turn off the camcorder.
- 2 Press [FUNC.] to save the setting and close the menu.**

NOTES

- When you select the custom white balance:**
 - Set the custom white balance in a sufficiently illuminated place.
 - Turn off the digital zoom (45).
 - Reset the white balance when the lighting conditions change.
 - Depending on the light source, may keep flashing. The result will still be better than with [AUTO].

- Custom white balance may provide better results in the following cases:
 - Changing lighting conditions
 - Close-ups
 - Subjects in a single color (sky, sea or forest)
 - Under mercury lamps and certain types of fluorescent lights
- Depending on the type of fluorescent light, optimal color balance may not be obtained with [FLUORESCENT H] or [FLUORESCENT H]. If the color looks unnatural, adjust it using [AUTO] or [SET].

Image Effects

You can use the image effects to change the color saturation and contrast to record images with special color effects.

POINTS TO CHECK





Mode switch: **P** (except for the Special Scene recording programs)

Options

♦ Default value

[IMAGE EFFECT OFF] ♦
Records with no image enhancing effects.
[VIVID]
Emphasizes the contrast and color saturation.
[NEUTRAL]
Tones down the contrast and color saturation.
[LOW SHARPENING]
Records subjects with softened outlines.

[ SOFT SKIN DETAIL]
Softens the details in the skin tone area for a more complimentary appearance. To obtain the best effect, use this setting when recording a person in close-up. Note that areas similar to the skin color may lack in detail.
[ CUSTOM]
Allows you to adjust the color depth, brightness, contrast, and sharpness of the image.
[COL.DEPTH]: (-) Shallower colors, (+) Richer color tonality
[BRIGHTN.]: (-) Darker picture, (+) Brighter picture
[CONTRAST]: (-) Flatter picture, (+) More defined light and shade
[SHARPNESS]: (-) Vaguer outlines, (+) Sharper outlines

FUNC.
( 26)

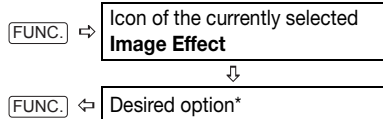

* When you select [ CUSTOM], do not press [**FUNC.**] and continue instead with the following procedure.

TO SET THE CUSTOM IMAGE EFFECT

- 1 Press [**SET**] and press **▲** or **▼** to select the custom setting options. You can also use the control dial.
- 2 Press **◀** or **▶** to adjust each setting as desired and then press [**SET**].
- 3 Press [**FUNC.**] to save the setting and close the menu.

Digital Effects

POINTS TO CHECK



Mode switch: **P**

[**CAMERA** · ] : [**E1** BLK&WHT], [**E2** SEPIA] only.

Options

◆ Default value

[ D.EFFECT OFF] ◆
Select this setting when you do not intend to use the digital effects.
[E1 FADE-T] (fade trigger), [E2 WIPE]
Select one of the faders to begin or end a scene with a fade from or to a black screen.
[E1 BLK&WHT]
Records images in black and white.
[E2 SEPIA]
Records images in sepia tones for an "old" look.
[E3 ART]
Select this effect to add "flavor" to your recordings.

NOTES

- When you apply a fader, not only the picture but also the sound will fade in or out. When you apply an effect, the sound will be recorded normally.
- The camcorder retains the last setting used even if you turn off the digital effects or change the recording program.



Setting

FUNC.
(26)



FUNC. → Icon of the currently selected
Digital Effect

FUNC. ** ← Desired fader/effect*

* You can preview the effect on the screen.

** The icon of the selected effect appears.

Applying



1 If the function guide does not appear on screen, press **SET** to display it.

2 Press **▲** to select .

- If does not appear on the function guide, repeatedly press **▼** to display it.
- The icon of the selected effect turns green.
- Press **▲** again to deactivate the fader/effect.

TO FADE IN

Press **▲** in record pause mode () , then press **START/STOP** to start recording with a fade in.

TO FADE OUT

Press **▲** while recording () , then press **START/STOP** to fade out and pause the recording.

TO ACTIVATE AN EFFECT

CAMERA : Press **▲** while recording or in record pause mode.

CAMERA : Press **▲** and then press **PHOTO** to record the still image.

Using an External Microphone

When recording in very quiet surroundings, the built-in microphone may pick up the sound of the camcorder's internal machinery. In such case, we recommend using an external microphone.

Microphones compatible with the advanced accessory shoe

You can attach to the advanced accessory shoe on the camcorder an optional DM-50 Directional Stereo Microphone or any commercially available microphone compatible with the advanced accessory shoe. For details, refer to the instruction manual of the microphone.

When attaching an accessory, first extend the viewfinder and then remove the advanced accessory shoe cover. When a compatible accessory is attached to the advanced accessory shoe, will appear on the screen.

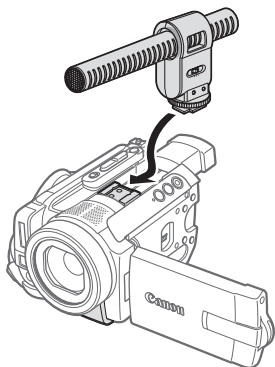

i NOTES

- Be careful when attaching a very long external microphone; it may appear on the screen.
- When the DM-50 or other microphone is connected to the camcorder, [WIND SCREEN] will automatically be set to [OFF OFF ].

Other microphones

You can also use commercially available microphones not compatible with the advanced accessory shoe, by connecting the external microphone to the MIC terminal. Use commercially available condenser microphones with their own power supply. You can connect almost any stereo microphone with a \varnothing 3.5 mm plug but the audio recording level may vary.

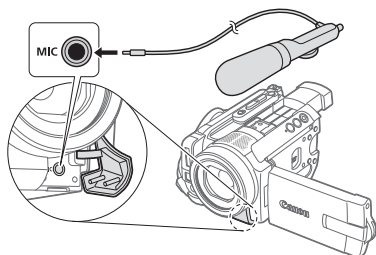



Managing Scenes and the Hard Disk

Creating a Playlist

Create a playlist to play back only the scenes you prefer and in the order of your choice. After you add scenes to the playlist, press **[PLAYLIST]** to switch between the original scenes and the playlist.

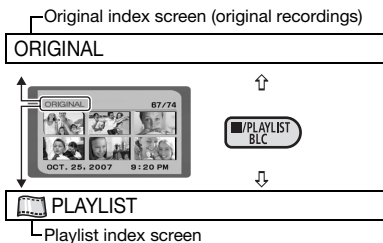

Adding Scenes to the Playlist

Select **[ALL SCENES (THIS DATE)]** to add to the playlist all scenes taken on a particular date. Select **[ONE SCENE]** to add only the selected scene.

POINTS TO CHECK



From the original index screen, use the navigation buttons to select the scene to add to the playlist. To add all scenes recorded on a particular date, select a scene recorded on that date.

FUNC.
(26)

FUNC.

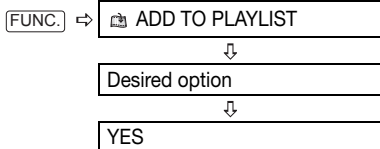

When the operation is completed “ADDED TO PLAYLIST” will be displayed. To delete scenes from the playlist, refer to *Deleting Scenes* (41).

Moving Scenes in the Playlist

POINTS TO CHECK



From the original index screen, press **[PLAYLIST]**. From the playlist index screen, use the navigation buttons to select the scene to move.

FUNC.
(26)

FUNC.

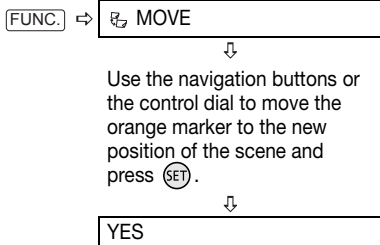

i NOTES

The numbers at the bottom indicate the scene's original position (on the left) and the marker's position (on the right).

Initializing the Hard Disk

Initializing erases all movies on the hard disk, allowing you free up space for more recordings. In addition, it reduces hard disk fragmentation, which may reduce performance and occurs as movies are recorded and deleted over time.



* Original index screen only

FUNC.

(26)

FUNC.

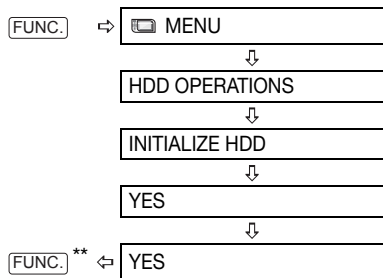

** Close the menu only after the screen display returns to the [HDD OPERATIONS] menu.

! IMPORTANT

- Initializing the hard disk will permanently erase all recordings. The lost original recordings cannot be recovered. Make sure you back up important recordings in advance using an external device.
- While initializing, do not disconnect the power source or turn off the camcorder.
- Do not use your computer to initialize the camcorder's hard disk. Doing so will result in the camcorder ceasing to function properly.



Photos

Refer to this chapter for details on shooting photos – from capturing and playing back images to printing them.

Recording

Taking Photos

Before using a memory card for the first time, be sure to initialize it with this camcorder (□ 76).

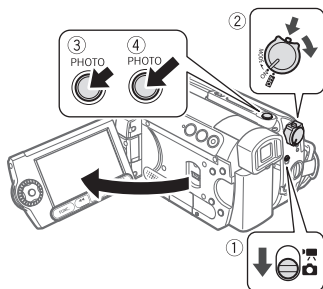

1 Move the switch to (Still images).

2 Turn the **POWER** switch to ON to set the camcorder in **CAMERA** mode.

The red **CAMERA** indicator will turn on.

3 Press **PHOTO** halfway.

- Once the focus is automatically adjusted, will turn green and one or more AF frames will appear.
- When you press **PHOTO** on the wireless controller, the still image is recorded immediately.

4 Press **PHOTO** fully.

The **CARD** access indicator will flash as the still image is being recorded.

IMPORTANT

Observe the following precautions while the card access display () appears on screen, and when the **CARD** access indicator is on or flashing. Failing to do so may result in permanent data loss.

- Do not subject the camcorder to vibrations or strong impacts.
- Do not remove the memory card.
- Do not disconnect the power source or turn off the camcorder.
- Do not change the position of the switch or the operating mode.

NOTES

- If the subject is not suitable for autofocus, turns yellow. Adjust the focus manually (□ 56).
- When the subject is too bright, “OVEREXP.” starts flashing. In such case, use the optional FS-43U II ND filter.

Selecting Photo Size and Quality

Still images are recorded on the memory card using JPEG compression. As a general rule select a larger image size for higher quality. Select the [LW 1920x1080] size for photos with an aspect ratio of 16:9.



Options

Image size options and the approximate number of still images that can be recorded on memory cards of various sizes are given in the table below.

FUNC.
(26)

FUNC.

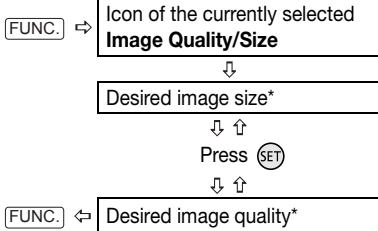

* The number displayed on the right corner indicates the approximate number of images that can be recorded with the current quality/size setting.

NOTES

- Depending on the number of images on the memory card (Windows: 1,800 images or more; Macintosh: 1,000 images or more), you may not be able to transfer images to a computer. Try using a card reader.
- Connection to a PictBridge-compatible printer will not work when the memory card contains 1,800 images or more. For best performance, we recommend keeping the number of images on the memory card under 100.

◆ Default value

Approximate number of still images on a memory card

Memory Card	32 MB			128 MB			512 MB		
LW 1920x1080	20	30	60	90	135	265	350	525	1,040
L 2048x1536◆	10	20	40	60	85	180	235	350	700
M 1440x1080	25	40	80	120	180	350	470	700	1,370
SW 848x480**	105	150	305	450	635	1,275	1,775	2,515	5,030
S 640x480	140	205	375	600	865	1,560	2,320	3,355	6,040

* : [SUPER FINE], : [FINE], : [NORMAL]

** This size is only available for recording simultaneously on the hard disk and memory card.



- When printing still images, use the following guidelines as a reference for selecting the print size.

Image Size	Recommended Use
L 2048x1536	To print photos up to A4 size.
M 1440x1080	To print photos up to L size (9 x 13 cm, 3.5 x 5 in.) or postcard size (10 x 14.8 cm, 4 x 6 in.).
S 640x480	To send images as e-mail attachments or to post on the Web.
LW 1920x1080, SW 848x480	To print photos with a 16:9 aspect ratio. Wide-sized photo paper is required.

Erasing the Last Photo Just Recorded

You can erase the still image recorded last while reviewing it within the time set for the [REVIEW] option or immediately after recording it, if [REVIEW] is set to [OFF OFF].



While reviewing the image immediately after recording:

- Press **▼** to select .
- Press **◀** or **▶** to select [ERASE] and press **(SET)**.

Playback

Viewing Photos

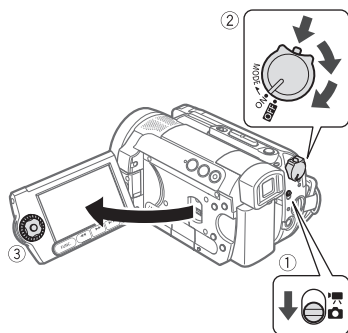

- Move the switch to (Still images).
- Turn the **POWER** switch to **ON**, then turn it toward **MODE** and release it to set the camcorder in **PLAY** mode.
The green **PLAY** indicator will turn on.
- Press **◀** or **▶** to move between images.

Image Jump Function

You can locate a specific image without having to browse all of them one by one.

TO RUN THROUGH THE STILL IMAGES

Press ◀ or ▶ and hold it down to run quickly through the still images.

TO SKIP 10 OR 100 STILL IMAGES

- 1 If the function guide does not appear on screen, press (SET) to display it.
- 2 Press ▲ to select [JUMP].

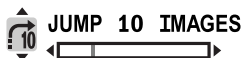

- 3 Press ▲ or ▼ to select [JUMP 10 IMAGES] or [JUMP 100 IMAGES].
- 4 Press ◀ or ▶ to jump the number of images selected and press (SET).
 - You can press (SET) again to hide the function guide.
 - You can also use the control dial.

! IMPORTANT

- Observe the following precautions while the card access display (▶) appears on screen, and when the CARD access indicator is on or flashing. Failing to do so may result in permanent data loss.
 - Do not subject the camcorder to vibrations or strong impacts.
 - Do not remove the memory card.

- Do not disconnect the power source or turn off the camcorder.
 - Do not change the position of the [CAM/VIDEO] switch or the operating mode.
- The following may not be displayed correctly.
 - Images not recorded with this camcorder.
 - Images edited on or uploaded from a computer.
 - Images whose file names have been changed.

Slideshow**FUNC.**

(26)

FUNC.



- 1 Press [FUNC].
- 2 Press ▲ or ▼ to select [SLIDESHOW] and press (SET).
You can also use the control dial.
- 3 Press ◀ or ▶ to select [START] and press (SET).
 - Images are played back one after another.
 - Press [FUNC.] to stop the slideshow.

Index Screen

- 1 Press the W side of the zoom lever.
The still images index screen appears.
- 2 Use the navigation buttons to select an image.
 - Move the green selection frame to the image you want to view.
 - You can also turn the control dial to run quickly through the index screens.
- 3 Press (SET).
The index screen closes and the selected image is displayed.



Magnifying Photos during Playback

During playback, still images can be magnified up to 5 times.

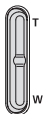

1 Press the **T** side of the zoom lever.

- The image is magnified by 2 times and a frame appears indicating the position of the magnified area.
- To further enlarge the image, press the **T** side of the zoom lever. To reduce the magnification to less than 2 times, press the **W** side of the zoom lever.
- will appear for images that cannot be enlarged.

2 Use the navigation buttons to move the frame to the part of the image you want to see enlarged.

To cancel the magnification, press the **W** side of the zoom lever until the frame disappears.

Erasing Photos

You can erase still images recorded on the memory card.

Erasing a Single Image



- 1 If the function guide does not appear on screen, press to display it.
- 2 Press to select .
- 3 Press or to select **[ERASE]** and press .

Erasing All Images

The following procedure will erase all the non-protected still images from the memory card (all images except those with the mark).



FUNC.
(26)

FUNC.

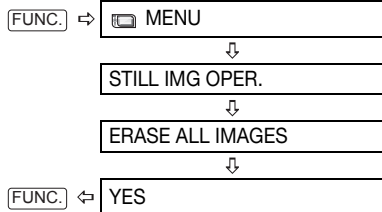

IMPORTANT

Be careful when erasing images. Erased images cannot be recovered.

NOTES

Protected images on the memory card cannot be erased.

Additional Functions

Flash

You can use the built-in flash to record still images in dark places. The flash features the red-eye reduction function.



Options

◆ Default value

⚡ (auto)◆
The flash fires automatically according to the brightness of the subject.
👁 (red-eye reduction, auto)
The flash fires automatically according to the brightness of the subject. The assist lamp lights up to reduce the red-eye effect.
⚡ (flash on)
The flash always fires.
🚫 (flash off)
The flash does not fire.



1 If the function guide does not appear on screen, press **SET** to display it.

2 Press **◀** to select ⚡.

- If ⚡ does not appear on the function guide, repeatedly press **▼** to display it.

- Repeatedly press **◀** to cycle between the flash modes.
- ⚡ disappears after 4 seconds.

3 Press **[PHOTO]**, first halfway to activate the autofocus and then fully to record the still image.

TO USE THE OPTIONAL VFL-1 VIDEO FLASH LIGHT

You can attach the optional VFL-1 Video Flash Light to the advanced accessory shoe if you want a more powerful flash than the built-in flash. The procedure for setting the flash mode is the same as described above. For details about attaching and using the flash, refer to the instruction manual of the VFL-1. The VFL-1 can also be used as a video light. When a video accessory is attached to the advanced accessory shoe, **📷** will appear on the screen.

NOTES

- The practical range of the built-in flash is approx. 1 to 2 m (3.3 to 6.6 ft.). The practical range with the VFL-1 Video Flash Light attached is approx. 1 to 4 m (3.3 to 13.1 ft.). In any case, the actual range will depend on the recording conditions.
- The range of the flash decreases in continuous shooting mode.
- For red-eye reduction to be effective, the subject needs to look at the assist lamp. The degree of reduction depends on the distance and on each individual.



- The flash will not fire in the following cases:
 - When you manually adjust the exposure in $\frac{1}{A}$ (auto) or \odot (red-eye reduction) mode.
 - During auto exposure bracketing.
 - In the [FIREWORKS] recording program.
- The flash mode cannot be selected when the exposure is locked.
- We recommend not using the flash while the optional Wide-converter or Tele-converter is attached; its shadow can appear on the screen.
- **About the AF-Assist Lamp:** While you press [PHOTO] halfway, if the subject is too dark the assist lamp may light up briefly in order to enable the camcorder to focus more accurately (AF-assist lamp). You can also set [AF AST LAMP] to [OFF OFF] so the assist lamp does not light up (p. 46).
 - The camcorder may not be able to focus even if the AF-assist lamp is on.
 - The brightness of the AF-assist lamp could be an inconvenience. Consider turning it off in public places such as restaurants.
- The built-in mini video light may be disabled automatically when you attach the optional VFL-1 Video Flash Light. To use the built-in mini video light, set the switch on the VFL-1 to OFF first.

Continuous Shooting and Exposure Bracketing (Drive Mode)

Take a series of pictures of a moving subject or record the same picture in 3 levels of exposure in order to choose later the picture you like the best.

POINTS TO CHECK



Mode switch: **P** (except for the [FIREWORKS] recording program).

Options

◆ Default value

<input type="checkbox"/> SINGLE◆
Records a single still image.
[CONT.SHOOT.] (Continuous Shooting), [HISPEED CONT.SHOOT.] (High-Speed Continuous Shooting)
Captures a series of still images as long as you hold [PHOTO] pressed down. For the number of frames per second, refer to the sidebar on page 71.

Maximum number of continuous shots

Number of frames (shots) per second	
Normal speed	3 frames
High speed	5 frames
Using the flash	2.1 frames

Maximum number of continuous shots
60 images

These figures are approximate and vary with the recording conditions and subjects. The actual number of frames per second will be lower when the shutter speed is 1/30 or slower.

[AEB] (Auto Exposure Bracketing)

The camcorder records a still image in three different exposures (dark, normal, light in 1/2 EV steps), allowing you to choose the shot you like the best.

FUNC.
(26)

FUNC.



FUNC. ⇨

Icon of the currently selected
Drive Mode



FUNC. ⇩

Desired option

CONTINUOUS SHOOTING/ HIGH-SPEED CONTINUOUS SHOOTING

1 Press [PHOTO] halfway to activate the autofocus.

2 Press [PHOTO] fully and hold it pressed down.

A series of still images will be recorded as long as you hold the button pressed.

AUTO EXPOSURE BRACKETING

Press [PHOTO], first halfway to activate the autofocus and then fully to record the still images.

Three still images in different exposures will be recorded on the memory card.

Automatic Focus Priority

When the focus priority is activated, the camcorder records a still image only after the focus has been adjusted automatically.

POINTS TO CHECK

| (24)

Mode switch at **AUTO**: The focus priority cannot be turned off.

Mode switch at **P**: You can turn off the focus priority and you can also select the AF (autofocus) frame to be used.

Options

◆ Default value

[AIAF ON:AiAF]◆

(Mode switch: P*, AUTO)

Depending on the shooting conditions, one or more AF frames out of the nine frames available are automatically selected and the focus is fixed on them.

[ON:CENTER]

(Mode switch: P*)

In this mode, a single focusing frame appears in the center of the screen and the focus is automatically fixed on it. This is convenient for making sure the focus is exactly where you want it.

[OFF OFF]

Select this option if you wish to record a still image as soon as you press [PHOTO].

* Except for the FIREWORKS recording program.



FUNC. (26)

FUNC.

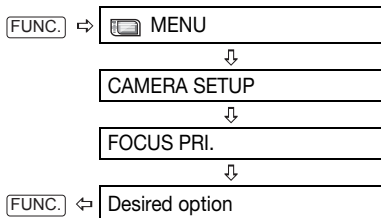

NOTES

In the FIREWORKS recording program the focus priority is automatically set to [OFF OFF].

Light Metering Mode

The camcorder measures the light reflected from the subject in order to calculate the optimal exposure settings. Depending on the subject, you may want to change the way the light is measured and evaluated.

POINTS TO CHECK



Mode switch: **P**

Options

◆ Default value

[] EVALUATIVE]◆
Appropriate for standard shooting conditions, including backlit scenes. The camcorder divides the picture into several areas and the light is measured in all of them to achieve the optimal exposure for the subject.
[<input type="checkbox"/>] CENT.WEIGHT.AVERAGE]
Averages the light metered from the entire screen, giving more weight to the subject in the center.
[<input type="checkbox"/>] SPOT]
Meters only the area within the spot AE point frame. Use this setting to adjust the exposure to match the subject in the center of the screen.

FUNC. (26)

FUNC.

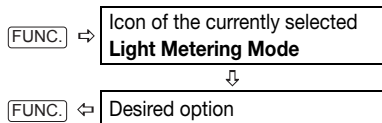

Histogram and Other Screen Displays

When viewing still images you can display the histogram and the icons of all the functions used at the time of recording. Use the histogram as a reference to verify the correct exposure of the still image.

The area to the right of the histogram represents highlights and the left side represents shadows. A still image whose histogram skews to the right is

relatively bright; while one whose histogram peaks to the left, is relatively dark.

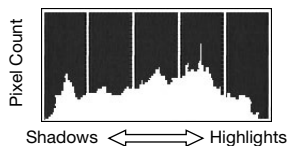

i NOTES

The histogram will appear also after reviewing a still image, while reviewing it within the time set for the [REVIEW] option (or immediately after recording it, if [REVIEW] is set to [OFF OFF]). You can choose to turn off the histogram by pressing [DISP.].

TO SELECT THE ON-SCREEN DISPLAYS

Repeatedly press [DISP.] to turn the on-screen displays on and off in the following sequence.

CAMERA

- All displays on
- All displays off¹

PLAY

- All displays on
- Regular displays only (removes the histogram and information icons)
- All displays off

¹ However, the markers and the icon and AF frames when the autofocus is locked will still appear on the screen.

Capturing a Still Image while Recording Movies

You can record still images on the memory card even while the camcorder is set to **CAMERA** mode. You can also capture simultaneously, as a still image on the memory card, the same picture you are recording as a scene on the hard disk.

POINTS TO CHECK

CAMERA **CAMERA** | **PLAY** **PLAY** (24)

Select the size and quality of the still image in record pause mode.

◆ Default value

OFF **STILL I.REC OFF**◆

FUNC.

(26)

FUNC.



FUNC. ⇨

Icon of the currently selected
**Still Image Simultaneous
Recording** option



Desired image size*



Press **SET**



FUNC. ⇨

Desired image quality*

* The number displayed on the right corner indicates the approximate number of images that can be recorded with the current quality/size setting.



Press **[PHOTO]** to capture the still image on the memory card.

The still image is recorded on the memory card while the screen continues to show the video recording.

i NOTES

- The still image cannot be recorded simultaneously on the memory card while the digital zoom or a digital effect is activated.
- To record still images we recommend using the **[CAMERA]** mode, which offers the best quality for still images.

Capturing a Still Image from the Playback Scene

You can capture frames from a scene as still images on the memory card. The size of the captured still image will be [LW 1920x1080] and it cannot be changed, but you can select the image quality. Set [TV TYPE] to [16:9 WIDE TV] before using this function (☐ 50).



(☐ 24)

FUNC.
(☐ 26)

FUNC.

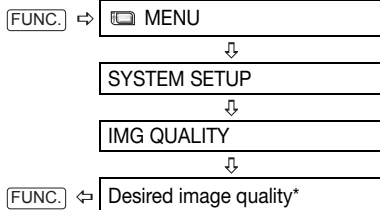

- * The number displayed at the bottom indicates the approximate number of images that can be recorded with the current quality setting.

TO CAPTURE THE STILL IMAGE

- 1 Start playback of the desired scene.
- 2 Pause the playback at the point you want to capture.
- 3 Press **[PHOTO]** fully.

i NOTES

- The data code of the still image will reflect the date and time of recording of the original scene.
- A still image captured from a scene with lots of fast movement may be blurred.

Protecting Photos

You can protect still images recorded on the memory card from accidental erasure.



(☐ 24)

FUNC.
(26)

FUNC.

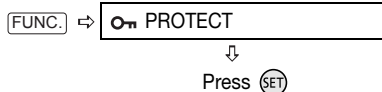

[**PROTECT**]: The image selection screen appears.

FROM THE IMAGE SELECTION SCREEN

- 1 Press **◀** or **▶** to select the still image you want to protect.
- 2 Press **SET** to protect the still image.
 appears on the bottom bar and the image cannot be erased. Press **SET** again to cancel the image protection.
- 3 Repeat steps 1-2 to protect additional images or press **FUNC.** twice to close the menu.

! IMPORTANT

Initializing the memory card (76) will permanently erase all recorded still images, even the protected ones.

Initializing the Memory Card

Initialize memory cards when you use them with this camcorder for the first time, or to erase all the still images on them.

Options

[**INITIALIZE**]

Clears the file allocation table but does not physically erase the stored data.

[**COMPL.INIT.**]

Erases all data completely.



FUNC.
(26)

FUNC.

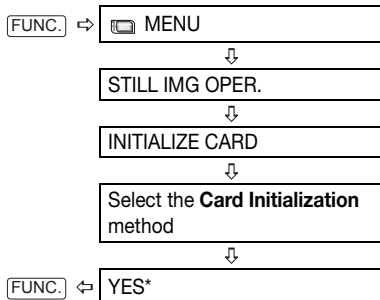

* Press **SET** to cancel the complete initialization while it is in progress. All the image files will be erased and the memory card can be used without any problem.

! IMPORTANT

Initializing the memory card will erase all still images, even the protected ones. The original still images cannot be recovered.



You can also use the following functions...

The following functions and features of the camcorder can be used either for shooting video or for taking photos.

The way to set and use them was already explained in detail, so we refer you to the relevant page in the “Video” section.

- Quick Start (□ 35)
- Zoom (□ 34)
- Special Scene recording programs (□ 52)
- Flexible recording programs (□ 54)
- Mini video light (□ 55)
- Self timer (□ 56)
- Manual focus adjustment (□ 56)
- Automatic backlight correction and manual exposure adjustment (□ 57)
- White balance (□ 58)
- Image effects (□ 59)
- Digital effects (□ 60)

Printing Photos

Printing Photos - Direct Print

The camcorder can be connected to any PictBridge-compatible printer. You can mark in advance the still images you want to print and set the desired number of copies as a print order (□ 81).

PictBridge

Canon printers: SELPHY printers of the CP, DS and ES series and PIXMA printers marked with the PictBridge logo.



Connecting the Camcorder to the Printer





1 Insert the memory card containing the still images you want to print.

2 Turn on the printer.

3 Connect the camcorder to the printer using the supplied USB cable.

- Refer to *PC Connection Diagram* (□ 87).
-  appears and changes to .
- The  (print/share) button lights up and the current print settings will be displayed for approx. 6 seconds.

! IMPORTANT

- If  continues to flash (for more than 1 minute) or if  does not appear, the camcorder is not correctly connected to the printer. In such case, disconnect the USB cable and turn off the camcorder and the printer. After a short while, turn them on again, set the camcorder to  mode and restore the connection.
- During the following operations, even if you connect a printer to the camcorder it will not be recognized.
 - Erasing all still images
 - Erasing all transfer orders
 - Erasing all print orders

i NOTES

-  will appear for images that cannot be printed.
- We recommend powering the camcorder using the compact power adapter.
- Refer also to the printer's instruction manual.

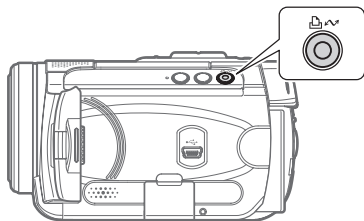

Printing with the  (Print/Share) Button

You can print a still image without changing the settings simply by pressing .



1 Press  or  to select the still image you wish to print.

2 Press .

- Printing starts. The  button flashes and stays on when the printing is completed.
- To continue printing, press  or  to select another still image.

Selecting the Print Settings

You can select the number of copies and other settings for printing. The setting options vary depending on your printer model.

Options**[PAPER]****[ PAPER SIZE]**

Available paper sizes vary depending on the printer model.

[ PAPER TYPE]

Select [PHOTO], [FAST PHOTO], [PLAIN] or [DEFAULT].

[ PAGE LAYOUT]

Select [DEFAULT] or one of the following available page layouts.

[BORDERED]: Prints the whole image area almost exactly as the recorded still image.

[BORDERLESS]: Enlarges the center portion of the still image to fit the width/height ratio of the selected paper size. The top, bottom and sides of the still image may be slightly trimmed out.

[2-UP], [4-UP], [8-UP], [9-UP], [16-UP]: Refer to the sidebar on page 79.



[☺] (Date print)
Select [ON], [OFF] or [DEFAULT].
[🖨️] (Print Effect)
The print effect can be used with printers compatible with the Image Optimize function to achieve higher quality prints. Select [ON], [OFF] or [DEFAULT]. Canon PIXMA/SELPHY DS printers: You can also select [VIVID], [NR] and [VIVID+NR].
[📄] (Number of Copies)
Select 1-99 copies.

i NOTES

Print setting options and [DEFAULT] settings vary depending on the printer model. For details, refer to the printer's instruction manual.

Printing after Changing the Print Settings



1 If the function guide does not appear on screen, press **SET** to display it.

2 Press **▼** to select .

The print settings menu appears.

Trimming settings (📄 80)
Paper settings
Current paper settings (paper size, paper type and page layout)

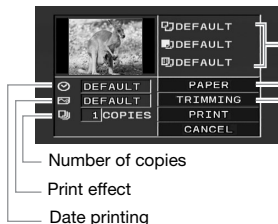

Printing Multiple Images on the Same Sheet [2-UP], [4-UP], etc.

When using Canon printers you can print the same still image multiple times on the same sheet of paper. Use the following table as a guideline for the recommended number of copies depending on the [📄 PAPER SIZE] setting.

[📄 PAPER SIZE] →	[CREDITCARD]	[9 x 13 cm]	[10 x 14.8 cm]	[A4]
Canon Printer ↓				
PIXMA SELPHY DS	-	-	2, 4, 9 or 16 ¹	4
SELPHY CP	2, 4 or 8 ²	2 or 4	2 or 4	-
SELPHY ES	2, 4 or 8 ³	2 or 4	2 or 4	-

¹ You can also use the special sticker sheets.

² When you use the wide-sized photo paper with the [DEFAULT] setting, you can also use [2-UP] or [4-UP].

³ With the [8-UP] setting, you can also use the special sticker sheets.

3 In the print settings menu, use the navigation buttons to select the setting you want to change and press **SET**.

4 Press **▲** or **▼** to select the desired setting option and press **SET**.

5 Use the navigation buttons to select **[PRINT]** and press **SET**.

- Printing starts. The print settings menu disappears when the printing is completed.
- To continue printing, press **◀** or **▶** to select another still image.

TO CANCEL THE PRINTING

1 Press **SET** while printing.

2 Select **[OK]** and press **SET**.

PRINTING ERRORS

If an error occurs while printing, an error message appears (□ 97).

- Canon's PictBridge-compatible printers: Resolve the error. When printing does not resume automatically, select **[CONTINUE]** and press **SET**. If **[CONTINUE]** cannot be selected, select **[STOP]**, press **SET** and retry printing. Refer also to the printer's instruction manual for details.
- If the error still persists and printing does not restart, disconnect the USB cable and turn off the camcorder and the printer. After a short while, turn them on again, set the camcorder to **PLAY** mode and restore the connection.

WHEN YOU HAVE FINISHED PRINTING

Disconnect the cable from the camcorder and printer and turn off the camcorder.

! IMPORTANT

- The following still images may not be printed correctly with a PictBridge-compatible printer.
 - Images created or changed on a computer and transferred to the memory card.
 - Images recorded with the camcorder but edited on a computer.
 - Images whose file names were changed.
 - Images not recorded with this camcorder.
- Observe the following precautions during printing:
 - Do not turn off the camcorder or the printer.
 - Do not change the position of the **⏪/⏩** switch.
 - Do not disconnect the USB cable.
 - Do not remove the memory card.
- If the message "BUSY" does not disappear, disconnect the USB cable and restore the connection after a short while.

Trimming Settings

Set the paper size and page layout before changing the trimming settings.

- 1** In the print settings menu (□ 79), use the navigation buttons to select **[TRIMMING]** and press **SET**. The trimming frame appears.





2 Change the size of the trimming frame.

- Press the **T** side of the zoom lever to shrink the frame, and the **W** side to enlarge it. Press **(SET)** to change the orientation of the frame (portrait/landscape).
- To cancel the trimming settings, press the **W** side of the zoom lever until the trimming frame disappears.



3 Use the navigation buttons to move the trimming frame.

4 Press **(FUNC.)** to return to the print menu.

From the print settings menu, select **[PRINT]** and press **(SET)** to print the area selected with the trimming frame.

i NOTES

- The trimming frame will initially appear in white. After applying the trimming settings, it will change to green.
- The trimming settings apply only to one image.
- The trimming settings are canceled in the following cases:
 - When you turn off the camcorder.
 - When you disconnect the USB cable.
 - When you expand the trimming frame beyond its maximum size.
 - When you change the **[PAPER SIZE]** setting.
- You may not be able to set the trimming settings for a still image not recorded with this camcorder.

Print Orders

You can mark in advance the still images you want to print and set the desired number of copies as a print order. Later, you can easily print out the print orders by connecting the camcorder to a PictBridge-compatible printer (☞ 77). You can set print orders for up to 998 still images.

Selecting Still Images for Printing (Print Order)

(✓) POINTS TO CHECK

Set the print orders before connecting the USB cable to the camcorder.



(FUNC.) (☞ 26)

(FUNC.)



↓
Press **(SET)**

(☞ 0): The image selection screen appears.

FROM THE IMAGE SELECTION SCREEN

- 1 Press ◀ or ▶ to select the still image you want to mark with a print order.**
- 2 Press **(SET)** to set the print order.**
The number of copies appears in orange in the box next to the print order symbol ☞.

3 Press ▲ or ▼ to set the number of copies desired and press **SET**.

To cancel the print order, set the number of copies to 0.

4 Repeat steps 1-3 to mark additional images with print orders or press **FUNC.** twice to close the menu.

Printing the Still Images Marked with Print Orders

FUNC.

(26)



1 Connect the camcorder to the printer using the supplied USB cable.

Refer to *PC Connection Diagram* (87).

2 Press **FUNC.**, press ▲ or ▼ to select the icon and press **SET** to open the setup menus.

3 Press ▲ or ▼ to select [] **PRINT** and press **SET**.

- The print settings menu appears.
- The error message “SET PRINT ORDER” appears if you connect a printer with direct print function and select [] **PRINT** without having set any print orders beforehand.

4 Use the navigation buttons to select [**PRINT**] and press **SET**.

Printing starts. The print settings menu disappears when the printing is completed.

NOTES

- You can also use the control dial to navigate the FUNC. and setup menus.
 - Depending on the connected printer, you can change some print settings before step 4 (78).
 - **Cancel Printing/Printing Errors** (80).
 - **Restarting Printing:** Open the print settings menu as explained in steps 2-3 above. In the print settings menu, select [RESUME]* and press **SET**. The remaining images will be printed. Printing cannot be restarted when the print order settings have been changed or if you deleted a still image with print order settings.
- * In case the print order was interrupted after the first still image, this menu option will appear as [PRINT] instead.

Erasing All Print Orders



(24)

FUNC.

(26)

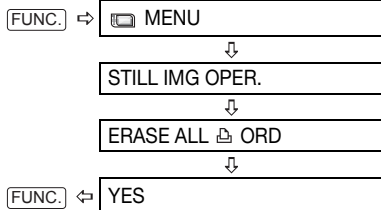



4



External Connections

This chapter explains how to connect your camcorder to an external device such as a TV, VCR, or computer.

Connecting to a TV or VCR

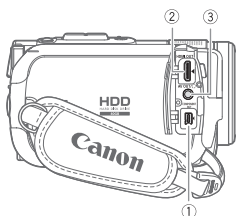

Open the terminal cover to access.

COMPONENT
OUT



① COMPONENT OUT Terminal*

The component video terminal is for video only. When you use connection type **1** do not forget the audio connections using the AV OUT/Ω terminal.

HDMI OUT



② HDMI OUT Mini Terminal*

The HDMI OUT mini terminal offers a high-quality digital connection that combines audio and video in a single convenient cable.

AV OUT/Ω



③ AV OUT/Ω Terminal

Sound from the built-in speaker will be muted while the STV-250N Stereo Video Cable is connected to the camcorder.

* When connecting a cable to the camcorder, make sure to align the triangle marks on the cable's connector and on the camcorder's terminal (▶ ◀).

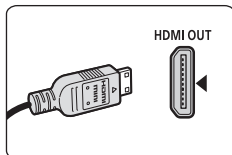
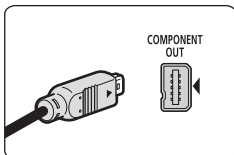

Connection Diagrams

High Definition TV Sets (HDTV)

Terminal on the Camcorder	Connecting Cable	Terminal on the Connected Device
---------------------------	------------------	----------------------------------

1 Output connection (signal flow →) to an HDTV with component video input terminals.

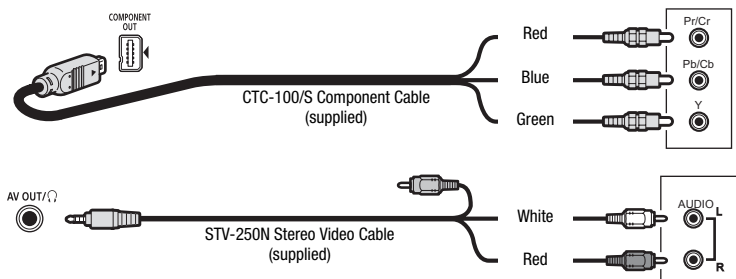

2 Output connection (signal flow →) to an HDTV with an HDMI terminal.

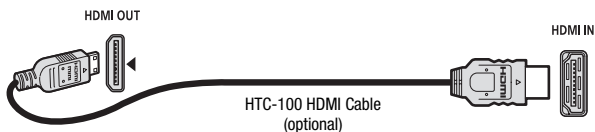

Standard Definition TV Sets

Terminal on the Camcorder	Connecting Cable	Terminal on the Connected Device
---------------------------	------------------	----------------------------------

3 Output connection (signal flow →) to a TV or VCR with AV terminals.





Playback on a TV Screen

This section explains how to play back scenes taken with this camcorder by connecting it to a TV.

The quality of the playback picture will vary depending on the connected TV and the type of connection used.

POINTS TO CHECK



Change the following settings as necessary before making the connections.

- [TV TYPE] to match the output video to the aspect ratio of the connected TV (□ 50).

- [COMP.OUT] to select the output video specifications when using connection type **1** (□ 50).
- Set [AV/PHONES] to [**AV**] AV when using connection type **3**.

Connecting

Connect the camcorder to the TV following one of the connection diagrams shown in the previous section *Connection Diagrams* (□ 84).

Playback

1 Turn on the camcorder and the connected TV or VCR.

On a TV: Select as the video input the same terminal to which you connected the camcorder.

On a VCR: Set the input selector to the external video input (usually labeled LINE IN).

About the HDMI terminal

The HDMI (High-Definition Multimedia Interface) connection –connection type **2** – is a convenient all-digital connection using a single cable for both video and audio. When you connect the camcorder to an HDTV equipped with an HDMI terminal, you can enjoy video and audio playback at the highest quality.

- The HDMI OUT mini terminal on the camcorder is for output only. Do not connect it to an HDMI output terminal on an external device, as this may damage the camcorder.
- The HDMI connection will recognize automatically the highest resolution supported by the connected HDTV, and output the optimal video signal to ensure the best viewing experience. You can confirm the current specification of the video output by checking the [HDMI STATUS] menu option (□ 51).
- Correct operation cannot be guaranteed when connecting the camcorder to DVI monitors.
- Some HDTVs have their HDCP digital content protection configured so as not to allow the playback of personal content (video recorded for personal uses). If you cannot play back the video recorded with this camcorder on your HDTV using the HDMI connection, try connecting the camcorder using the component video connection –connection type **1** – instead.
- There will be no video output from the AV OUT/Ω terminal or the COMPONENT OUT terminal while the camcorder is connected to an external device using the optional HTC-100 HDMI Cable. In such case, only audio will be output from the AV OUT/Ω terminal.

2 Start the playback of the movies

(37) or still images (67).

NOTES

- Sound from the built-in speaker will be muted while the STV-250N Stereo Video Cable is connected to the camcorder.
- We recommend powering the camcorder using the compact power adapter.
- Refer also to the instruction manual of the connected TV.
- You can play back your recordings not only on HDTVs but also on standard TVs. When you connect the camcorder to a TV using the STV-250N Stereo Video Cable, the video output will be converted to standard definition automatically, without having to change the [COMP.OUT] setting.
- If you connect to a TV using the HDMI connection –connection type – or the component video connection –connection type – you can enjoy the full resolution of high-definition TV.
- TV sets compatible with the Video ID-1 system will automatically switch to wide (16:9) mode. Otherwise, change the aspect ratio of the TV manually.

Copying your Recordings to an External Video Recorder

You can copy your recordings by connecting the camcorder to a VCR or a digital video device. Video output will be in standard definition, although the original scenes are in high definition.



Connecting

Connect the camcorder to the VCR using connection type , as shown in the previous section *Connection Diagrams* (84).

Recording

- 1 Connected device: Load a blank cassette or disc and set the device to record pause mode.**
- 2 This camcorder: Locate the scene you wish to copy and pause playback shortly before the scene.**
- 3 This camcorder: Resume the movie playback.**
- 4 Connected device: Begin recording when the scene you wish to copy appears. Stop recording when copying is complete.**
- 5 This camcorder: Stop playback.**

NOTES

- We recommend powering the camcorder using the compact power adapter.
- By default, the on-screen displays will be embedded in the output video signal, but you can change the displays by repeatedly pressing (42).

Connecting to a Computer

PC Connection Diagram

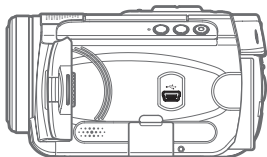

USB Terminal

Open the LCD panel to access.

Terminal on the
Camcorder

Connecting Cable

Terminal on the
Connected Device

1 Output connection (signal flow →) to a computer or PictBridge-compatible printer with an USB port.

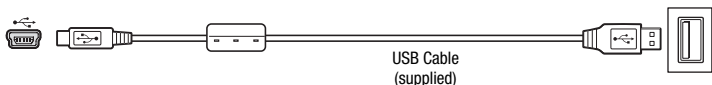

Transferring Photos - Direct Transfer

With the supplied USB cable and software (on the **DIGITAL VIDEO Solution Disk** CD-ROM) you can transfer still images to a computer simply by pressing .

Preparations

The first time you connect the camcorder to the computer, you need to install the software and set the auto-launch setting. From the second time on, just connect the camcorder to the computer using the USB cable to transfer images.

1 Install the supplied Digital Video Software.



Refer to the installation guide (separate leaflet included with the CD-ROM).

2 Set the camcorder to mode.



3 Connect the camcorder to the computer using the USB cable.

Refer to *PC Connection Diagram* ( 87).

4 Set the auto-launch setting.

- See *Starting CameraWindow* (Windows) or *Auto-downloading* (Macintosh) in the *Digital Video Software* instruction manual (electronic version on PDF file).
- The direct transfer menu appears on the camcorder screen and the   button lights up.

! IMPORTANT







- After you connect the camcorder to the computer, do not access the camcorder's hard disk directly. Doing so may corrupt the data in the camcorder and render it unusable. Use the software on the supplied **Backup Utility** CD-ROM or **Corel Application Disc** software to transfer data between the camcorder and the computer.
- When the CARD access indicator is on or flashing do not perform the following actions. Doing so may result in permanent data loss.
 - Do not subject the camcorder to vibrations or strong impacts.
 - Do not remove the memory card.
 - Do not disconnect the USB cable.
 - Do not turn off the camcorder or the computer.
 - Do not change the position of the /  switch or the operating mode.
- Operation may not work correctly depending on the software and the specifications/settings of your computer.
- If you wish to use the image files on your computer, make copies of them first. Use the copied files, retaining the originals.
- During the following operations, even if you connect the camcorder to the computer it will not be recognized.
 - Erasing all still images from the card

- Erasing all transfer orders
- Erasing all print orders

i NOTES

- We recommend powering the camcorder using the compact power adapter.
- Refer also to the computer's instruction manual.
- Users of Windows Vista, Windows XP and Mac OS X:
Your camcorder is equipped with the standard Picture Transfer Protocol (PTP) allowing you to transfer still images (JPEG only) simply by connecting the camcorder to a computer using the USB cable without having to install the supplied software.

Transferring Images



 ALL IMAGES]
Transfers all still images.
 NEW IMAGES]
Transfers only those images that have not yet been transferred to the computer.
 TRANSFER ORDERS]
Transfers still images marked with transfer orders ( 90).
 SELECT & TRANSFER]
Allows you to select the still image.
 WALLPAPER]
Allows you to select the still image and set it as your computer's desktop background.



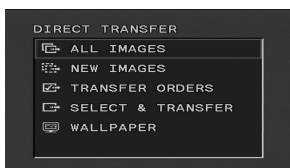
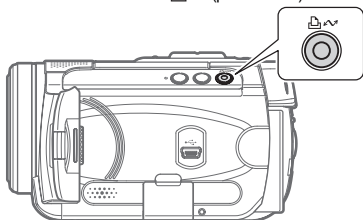

 (print/share) button



AUTOMATIC TRANSFER OPTIONS







When you select [ ALL IMAGES], [ NEW IMAGES] or [ TRANSFER ORDERS], all the relevant still images will be transferred to the computer in one batch and their thumbnails will be displayed on the computer.

Press \blacktriangle or \blacktriangledown to select a transfer option and press .





- The  button will flash while the images are being transferred.
- The camcorder returns to the transfer menu once the transfer is complete.
- To cancel the transfer, press \blacktriangleleft or \blacktriangleright to select [CANCEL] and press  or press .

MANUAL TRANSFER OPTIONS

When you select [ SELECT & TRANSFER] or [ WALLPAPER]:

- 1 Press \blacktriangle or \blacktriangledown to select a transfer option and press .**
- 2 Press \blacktriangleleft or \blacktriangleright to select the image you want to transfer and press .**
 - [ SELECT & TRANSFER]: The selected image is transferred and displayed on the computer. To continue transferring, press \blacktriangleleft or \blacktriangleright to select another image.
 - [ WALLPAPER]: The selected image is transferred to the computer and displayed as the desktop's background.
 - The  button will flash while the images are being transferred.
 - Press  to return to the transfer menu.

NOTES

- You can press  to transfer the images, instead of . With the automatic transfer options a confirmation message appears. Select [OK] and press .
- When the camcorder is connected to the computer and the image selection screen is displayed, press  to return to the transfer menu.

Transfer Orders

You can mark in advance the still images you want to transfer to the computer as transfer orders. You can set transfer orders for up to 998 still images.

Selecting Still Images to Transfer (Transfer Order)

Set the transfer orders before connecting the camcorder to the computer.



FUNC.
(book with 26)

FUNC.



FUNC. ⇨ TRANSFER ORDER



Press

: The image selection screen appears.

FROM THE IMAGE SELECTION SCREEN

- 1 Press ◀ or ▶ to select the still image you want to mark with a transfer order.
- 2 Press to set the transfer order. A checkmark ✓ appears in the box next to the transfer order symbol . Press again to cancel the transfer order.
- 3 Repeat steps 1-2 to mark additional images with transfer orders or press twice to close the menu.

Erasing All Transfer Orders



FUNC.
(book with 26)

FUNC.



FUNC. ⇨ MENU



STILL IMG OPER.



ERASE ALL ORD



FUNC. ⇨ YES



Additional Information





This chapter contains troubleshooting advice, screen messages, handling and maintenance tips, and other information.

Troubleshooting





If you have a problem with your camcorder, refer to this checklist. Consult your dealer or a Canon Service Center if the problem persists.

- Depending on the level of repair, the hard disk may be initialized or replaced, resulting in permanent data loss. Before having the camcorder repaired, back up important recordings using an external device (□ 40). Canon shall not be liable for any data loss due to repair.
- To verify a possible problem, data on the hard disk will need to be checked. However, only the minimum amount necessary will be checked and the data will not be copied or saved.



Power Source

Problem	Solution	□
<ul style="list-style-type: none"> • Camcorder will not turn on. • Camcorder switches off by itself. • Screen switches on and off. 	Battery pack is exhausted. Replace or charge the battery pack.	21
	Attach the battery pack correctly.	
The charge indicator flashes rapidly.	 (one flash at 0.5-second intervals) Charging has stopped because the compact power adapter or the battery pack is faulty. Consult a Canon Service Center.	–
	 (two quick flashes at 1-second intervals) Battery pack at least 50% charged. This is not a malfunction.	22
<ul style="list-style-type: none"> • Battery pack will not charge. • The CHG (charge) indicator flashes very slowly (about once every 2 seconds). 	Charge the battery pack in temperatures between 0 °C and 40 °C (32 °F and 104 °F).	–
	Battery packs become hot with use and may not charge. When the battery pack is outside the charging temperature range, the CHG (charge) indicator will flash irregularly. The charging will start once the battery pack temperature is below 40 °C (104 °F).	–
	The battery pack is damaged. Use a different battery pack.	–
Camcorder is on but is unresponsive.	The camcorder has exceeded its operational temperature ( appears). Turn off the camcorder and let it cool down before resuming use.	–
	The camcorder has fallen below its operational temperature ( appears). Keep it on and let it warm up. If the camcorder still does not respond, turn it off and use it in a warmer location.	–

Recording/Playback

Problem	Solution	
Buttons will not work.	Turn on the camcorder.	–
Abnormal characters appear on the screen. The camcorder does not operate properly.	Disconnect the power source and reconnect it after a short time. If the problem still persists, disconnect the power source and press the RESET button with a pointed item. Pressing the RESET button resets all settings.	–
 lights up in red.	Battery pack is exhausted. Replace or charge the battery pack.	21
The wireless controller will not work.	Set [WL.REMOTE] to [ON].	49
	Replace the battery of the wireless controller.	23
Video noise appears on screen.	When using the camcorder close to devices that emit strong electromagnetic fields (plasma TVs, cellular phones, etc.), keep a distance between the camcorder and these devices.	–
Video noise appears on the TV screen.	When using the camcorder in a room where a TV is located, keep a distance between the compact power adapter and the power or antenna cables of the TV.	–
The camcorder vibrates.	Depending on the condition of the hard disk, the camcorder might vibrate occasionally. This is not a malfunction.	–
Occasionally the operation sound can be heard.	The hard disk is activated from time to time. This is not a malfunction.	–
<ul style="list-style-type: none"> After using the camcorder for a long time, it becomes hot.  lights up in red. 	This is not a malfunction. Turn the camcorder off and let it cool for a while before resuming operation.	–
The following operations take longer than usual. <ul style="list-style-type: none"> Deleting scenes Changing between  and  modes Pausing a recording Reviewing the last scene recorded 	When the hard disk contains a large number of scenes, some operations may take longer than usual. Back up your recordings and initialize the hard disk.	40 64

Recording



Problem	Solution	
 flashes red on the screen.	The camcorder has malfunctioned. Consult a Canon Service Center.	–
Horizontal bands appear on the screen.	This is a phenomenon typical of CMOS image sensors when recording under some types of fluorescent, mercury or sodium lamps. To reduce the symptoms set the mode switch to AUTO . This is not a malfunction.	–
When a subject flits across in front of the lens, the image appears slightly bent.	This is a phenomenon typical of CMOS image sensors. When a subject crosses very quickly in front of the camcorder, the image may seem slightly warped. This is not a malfunction.	–
Image will not appear on the screen.	Set the camcorder to  mode.	32



Problem	Solution	
Pressing START/STOP will not start recording.	Set the camcorder to CAMERA mode.	32
	While a scene is being recorded on the hard disk, additional recording is not possible.	–
	The hard disk is full. Delete some recordings or initialize the hard disk to free some space.	41 64
	The hard disk contains the maximum number of scenes. Delete some recordings.	41
	Recording may not be possible while the drop protection mechanism is active (appears).	47
	The camcorder has exceeded its operational temperature (appears). Turn off the camcorder and let it cool down before resuming use.	–
	The camcorder has fallen below its operational temperature (appears). Turn it off and use it in a warmer location. Make sure to avoid a rapid temperature change.	–
Even after stopping recording, the HDD access indicator does not go off.	The scene is being recorded on the hard disk. This is not a malfunction.	32
The point where START/STOP was pressed does not match the beginning/end of the recording.	There is a slight interval between pressing START/STOP and the actual start of recording on the hard disk. This is not a malfunction.	–
The recording suddenly stops shortly after starting recording.	If recording near loud sounds or strong vibrations, move to another location.	–
	The camcorder has exceeded its operational temperature (appears). Turn off the camcorder and let it cool down before resuming use.	–
Camcorder will not focus.	Autofocus does not work on the subject. Focus manually.	56
	Adjust the viewfinder with the dioptic adjustment lever.	33
	Lens or Instant AF sensor is dirty. Clean the lens or sensor with a soft lens-cleaning cloth. Never use tissue paper to clean the lens.	102
Sound is distorted.	When recording near loud sounds (such as fireworks or concerts), sound may become distorted. This is not a malfunction.	–
Viewfinder picture is blurred.	Adjust the viewfinder with the dioptic adjustment lever.	33

Playback/Editing

Problem	Solution	
Pressing the playback button does not start playback.	Set the camcorder to PLAY mode.	37
	The camcorder has exceeded its operational temperature (appears). Turn off the camcorder and let it cool down before resuming use.	–
	The camcorder has fallen below its operational temperature (appears). Turn it off and use it in a warmer location. Make sure to avoid a rapid temperature change.	–
Occasionally the operation sound can be heard.	If the camcorder is moved suddenly while recording, sound from the hard disk may be recorded.	–



Problem	Solution	
Cannot add scenes to the playlist.	You cannot add more than 999 scenes to the playlist.	–
No sound from the built-in speaker.	Open the LCD panel.	–
	Speaker volume is turned off. Adjust the volume with the function guide in  mode.	37

Playback on a Connected TV or Other External Device

External device refers to DVD recorders, computers, and other digital devices.

Problem	Solution	
Hard disk is being accessed but image will not appear on the TV screen.	The video input on the TV is not set to the video terminal to which you connected the camcorder. Select the correct video input.	83
There is no sound from the TV.	When connecting the camcorder to an HDTV using the CTC-100/S Component Cable, make sure to connect also the audio connections using the white and red plugs of the STV-250N Stereo Video Cable.	84
The camcorder is connected using the optional HTC-100 HDMI Cable, but there is no picture or sound from the HDTV.	Disconnect the HTC-100 HDMI Cable and then restore the connection or turn the camcorder off and then on again.	–

Memory Card Operation

Problem	Solution	
Memory card cannot be inserted.	Memory card was not facing the correct direction. Turn the memory card over and insert it.	30
Cannot record on the memory card.	Memory card is full. Erase still images to free some space or replace the memory card.	69
	Memory card was not initialized. Initialize the memory card.	76
	The folder and file numbers have reached their maximum value. Set [FILE NOS.] to [RESET] and insert a new memory card.	50
	The still image simultaneous recording setting in the FUNC. menu is set to [STILL I.REC OFF]. Change the setting to take photos while recording a video.	43
	Still images cannot be captured from the playback scene when [TV TYPE] is set to [NORMAL TV]. In such case,  appears. Set [TV TYPE] to [WIDE TV].	50
Memory card cannot be played back.	Insert a memory card.	30
	Set the camcorder to  mode.	67
Image cannot be erased.	Image is protected. Cancel the protection.	75



Problem	Solution	
appears in red.	A memory card error occurred. Turn off the camcorder. Remove and reinsert the memory card and set the camcorder back to mode. If still appears in red, initialize the memory card.	76
	Memory card is full. Erase still images to free some space or replace the memory card.	69

Printing





Problem	Solution	
The printer is not operating even though the camcorder and printer are correctly connected.	Disconnect the USB cable and turn off the camcorder and the printer. After a short while, turn them on again, set the camcorder to mode and restore the connection.	-

Others

Problem	Solution	
A rattling can be heard from the camcorder.	The internal lens fixture can move when the camcorder is turned off. This is not a malfunction.	-

List of Messages

Message	Explanation	
CHANGE THE BATTERY PACK	Battery pack is exhausted. Replace or charge the battery pack.	21
CANNOT ENTER THE STANDBY MODE NOW	The camcorder cannot enter the standby mode if the remaining battery charge is too low.	35
TEMPERATURE TOO HIGH TURN OFF THE POWER AND WAIT	The camcorder has exceeded its operational temperature. Disconnect the compact power adapter and remove the battery pack. Let the camcorder cool down before resuming use.	-
TEMPERATURE TOO LOW KEEP POWER ON AND WAIT	The camcorder's temperature is too low. Keep the power on until the icon disappears.	-
TEMPERATURE TOO LOW USE IN A WARM LOCATION	The outside temperature is too low and the camcorder will not operate. Move to a location between 0 °C and 40 °C (32 °F and 104 °F).	-
TEMPERATURE TOO HIGH CANNOT RECORD	The camcorder has exceeded its operational temperature. Disconnect the compact power adapter and remove the battery pack. Let the camcorder cool down before resuming use.	-
• CANNOT RECORD • CANNOT PLAY BACK	There is a problem with the hard disk. This message can also appear if condensation has formed. Wait until the camcorder dries completely before resuming use.	- 103
REACHED THE MAXIMUM NUMBER OF SCENES	The maximum number of scenes has been reached. Delete some recordings to free some space.	41

Message	Explanation	
COULD NOT ADD TO PLAYLIST	Scene could not be added to the playlist. You cannot add more than 999 scenes to the playlist. Delete some recordings.	41
TEMPERATURE TOO HIGH CANNOT PLAY BACK	The camcorder has exceeded its operational temperature ( appears). Turn off the camcorder and let it cool down before resuming use.	–
CANNOT READ THE HARD DISK	Hard disk could not be read.	–
	This message can also appear if condensation has formed. Wait until the camcorder dries completely before resuming use.	103
	This message can also appear if the camcorder has exceeded its operational temperature ( appears). Turn off the camcorder and let it cool down before resuming use.	–
UNABLE TO RECOGNIZE THE DATA	You transferred data to the camcorder recorded in a different television system (PAL or SECAM).	–
ACCESS ERROR	There was an error when reading the hard disk or attempting to write onto it.	–
	This message can also appear if condensation has formed. Wait until the camcorder dries completely before resuming use.	103
AVOID MOVING THE CAMCORDER	Try not to move the camcorder while the image is being recorded.	–
UNABLE TO RECOVER DATA	Could not recover a corrupted file.	–
	This message can also appear if condensation has formed. Wait until the camcorder dries completely before resuming use.	103
HARD DISK FULL	The hard disk is full (“  END” appears on the screen). Delete some recordings to free some space.	41
TASK IN PROGRESS DO NOT DISCONNECT THE POWER SOURCE	The camcorder is updating the hard disk. Do not disconnect the compact power adapter or remove the battery pack.	–
DROP SENSOR IS TURNED OFF	The camcorder was turned on while [DROP SENSOR] is set to [OFF]. In such case, dropping the camcorder can increase the likelihood of hard disk damage.	47
DROP DETECTED POWER WAS TURNED OFF	When the camcorder is dropped while it is on or connected to a computer with the USB cable, the camcorder automatically turns off to protect the hard disk. This message appears the next time the camcorder is turned on. This is not a malfunction.	–
USE THE CAMCORDER TO INITIALIZE THE HARD DISK	A hard disk error occurred and data cannot be recovered. Initialize the hard disk.	64
BUFFER OVERFLOW RECORDING WAS STOPPED	Drops were detected repeatedly and the buffer became full. Move to a more stable location and allow data to be written onto the hard disk. Set [DROP SENSOR] to [OFF] if using the camcorder in a situation where drops are likely to be detected repeatedly.	47
NO CARD	There is no memory card in the camcorder.	30
NO IMAGES	No images are recorded on the memory card.	–











Message	Explanation	
CARD ERROR	A memory card error occurred. The camcorder cannot record or display the image. If after the message disappears appears in red, perform the following: Turn off the camcorder; remove and reinsert the memory card and set the camcorder back to CAMERA mode. If turns back to green you can resume recording/playback. Otherwise, initialize the memory card. (Doing so will erase all the still images on the memory card.)	76
CARD FULL	Memory card is full. Erase some images to free some space or replace the memory card.	69
THE CAMCORDER IS SET TO STILL IMAGE MODE	You pressed START/STOP while recording still images (CAMERA mode).	-
NAMING ERROR	The folder and file numbers have reached their maximum value. Set the [FILE NOS.] option to [RESET] and erase all the images on the memory card or initialize it.	-
TRANSFER ORDER ERROR	You attempted to set more than 998 transfer orders. Reduce the number of still images marked with transfer orders.	90
TOO MANY STILL IMAGES DISCONNECT USB CABLE	Disconnect the USB cable and decrease the number of still images on the memory card to fewer than 1,800. If a dialog appeared on the computer screen, close it and then reconnect the USB cable.	-
WHILE THE CAMCORDER IS CONNECTED TO A PC DO NOT DISCONNECT THE USB CABLE OR POWER SOURCE	When the camcorder is in PLAY mode and is connected to the computer with a USB cable, the camcorder cannot be operated. Disconnecting the USB cable or power source while this message appears may result in hard disk damage. Use the computer to end the connection before disconnecting the cable.	-
CANNOT TURN OFF POWER OR CHANGE MODES		
CONNECT THE COMPACT POWER ADAPTER	When the camcorder is in PLAY mode and is connected to the computer, this message will appear if the camcorder is being powered by the battery pack. Connect the compact power adapter to the camcorder.	-
BACK UP RECORDINGS REGULARLY	This message may appear when you turn on the camcorder. In the event of a malfunction, recordings may be lost so back up your recordings regularly.	40

Direct Print Related Messages

About Canon PIXMA/SELPHY DS Printers: If the printer's error indicator flashes or an error message appears on the printer's operation panel, refer to the printer's instruction manual.

Message	Explanation
PAPER ERROR	There is a problem with the paper. The paper is not correctly loaded or the paper size is wrong. Alternatively, if the paper output tray is closed, open it to print.
NO PAPER	Paper is not correctly inserted or there is no paper.

Message	Explanation
PAPER JAM	The paper jammed during printing. Select [STOP] to cancel printing. After removing the paper, set some paper again and retry printing.
INK ERROR	There is a problem with the ink. Replace the ink cartridge.
NO INK	The ink cartridge is not inserted or is out of ink.
LOW INK LEVEL	The ink cartridge needs to be replaced soon. Select [CONTINUE] to restart printing.
INK ABSORBER FULL	Select [CONTINUE] to resume printing. Consult a Canon Service Center (refer to the list included with the printer) to replace the ink absorber.
<ul style="list-style-type: none"> • FILE ERROR • CANNOT PRINT! 	You attempted to print an image that was recorded with another camcorder, has a different compression, or was edited on a computer.
COULD NOT PRINT X IMAGES	You attempted to use the print order settings to print X images that were recorded with another camcorder, with a different compression or were edited on a computer.
SET  PRINT ORDER	No still image on the memory card has been marked with a print order.
 PRINT ORDER ERROR	You attempted to set more than 998 still images in the print order.
CANNOT TRIM	You attempted to trim an image that was recorded with another camcorder.
READJUST TRIMMING	You changed the [PAPER] settings after applying the trimming settings.
PRINTER ERROR	Cancel printing. Turn off the printer and turn it back on. Check the printer status. If the error still persists, refer to the printer's instruction manual and contact the appropriate customer support center or service center.
PRINT ERROR	Cancel printing, disconnect the USB cable and turn off the printer. After a while, turn the printer back on and reconnect the USB cable. Check the printer status. When you are printing using the   button, check the print settings.
HARDWARE ERROR	Cancel printing. Turn off the printer and turn it back on. Check the printer status. If the printer is equipped with a battery, it might be exhausted. In such case, turn off the printer, replace the battery and turn it back on.
COMMUNICATION ERROR	The printer is experiencing a data transfer error. Cancel printing, disconnect the USB cable and turn off the printer. After a while, turn the printer back on and reconnect the USB cable. When you are printing using the   button, check the print settings. Or, you attempted to print from a memory card that contains a large number of images. Reduce the number of images.
CHECK PRINT SETTINGS	Current print settings cannot be used for printing with the   button.
INCOMPATIBLE PAPER SIZE	The paper settings of the camcorder conflict with the printer's settings.
PRINTER IN USE	The printer is in use. Check the printer status.
PAPER LEVER ERROR	Paper lever error occurred. Adjust the paper selection lever to the proper position.
PRINTER COVER OPEN	Close the printer cover securely.
NO PRINTHEAD	No print head is installed in the printer or the print head is defective.



Handling Precautions

Camcorder

Be sure to observe the following precautions to ensure maximum performance. Make sure to also observe the precautions pertaining to the hard disk, as hard disk damage may result in permanent data loss.

- **Back up your recordings periodically.** Make sure to transfer your movies to an external device such as a computer or digital video recorder (□ 40) and back them up on a regular basis. This will protect your important recordings in case of damage and create more free space on the hard disk. Canon shall not be liable for any data loss.
- **Do not subject the camcorder to vibrations or strong impacts.** The hard disk is a high-precision device. Vibrations, strong impacts or dropping the camcorder may result in the hard disk not being recognized or may cause recording/playback to stop unexpectedly. Be especially careful while the HDD access indicator is on or flashing. Avoid recording in very loud places. When using a shoulder strap, do not allow the camcorder to swing and hit an object.
- **Keep the drop sensor activated whenever possible.** This camcorder is equipped with a sensor that detects acceleration. Should the camcorder be dropped or subject to a

similar condition, a mechanism designed to help prevent hard disk damage will activate and recording/playback may stop or the camcorder may turn off. Deactivating this function (□ 47) can increase the likelihood of hard disk damage should the camcorder be subject to such conditions. Even if this function is set to [ON ON], hard disk damage can occur if the camcorder is dropped.

- **Do not disconnect the power source while the HDD access indicator is on or flashing.** While data is being written onto the hard disk, disconnecting the power source or turning off the camcorder may result in hard disk damage or permanent data loss.
- **Use the camcorder within its operating temperature range.** If the camcorder's temperature becomes too hot or too cold, recording/playback may stop in order to prevent hard disk damage. In such temperatures, a warning will appear on the screen.
- **Do not use the camcorder at high altitudes.** To prevent hard disk damage, do not turn on or use the camcorder at altitudes higher than 3,000 m (9,800 ft.) above sea level or in other places with low atmospheric pressure.
- **Initialize the hard disk when movies cannot be recorded/played back normally.** As movies are recorded and deleted over time, hard disk fragmentation may occur, which may

reduce performance. Initialize the hard disk should this happen (□ 64). When you initialize the hard disk, all recordings will be erased. Before doing so, back up important recordings using an external device.

- Do not carry the camcorder by the LCD panel or the viewfinder. Be careful when closing the LCD panel.
- Do not leave the camcorder in places subject to high temperatures (like the inside of a car under direct sunlight), or high humidity.
- Do not use the camcorder near strong electromagnetic fields such as above TVs, near plasma TVs or mobile phones.
- Do not point the lens or viewfinder at strong light sources. Do not leave the camcorder pointed at a bright subject.
- Do not use or store the camcorder in dusty or sandy places. The camcorder is not waterproof – avoid also water, mud or salt. If any of the above should get into the camcorder it may damage the camcorder and/or the lens.
- Be careful of heat generated by lighting equipment.
- Do not disassemble the camcorder. If the camcorder does not function properly, consult qualified service personnel.
- Handle the camcorder with care. Do not subject the camcorder to shocks or vibration as this may cause damage.

Battery Pack

DANGER!

Treat the battery pack with care.

- Keep it away from fire (or it might explode).
 - Do not expose the battery pack to temperature higher than 60 °C (140 °F). Do not leave it near a heater or inside a car in hot weather.
 - Do not try to disassemble or modify it.
 - Do not drop it or subject it to shocks.
 - Do not get it wet.
-
- Charged battery packs continue to discharge naturally. Therefore, charge them on the day of use, or the day before, to ensure a full charge.
 - Attach the terminal cover whenever a battery pack is not in use. Contact with metallic objects may cause a short circuit and damage the battery pack.
 - Dirty terminals may cause a poor contact between the battery pack and the camcorder. Wipe the terminals with a soft cloth.
 - Since storing a charged battery pack for a long time (about 1 year) can shorten its lifecycle or affect performance, we recommend to discharge the battery pack fully and to store it in a dry place at temperatures no higher than 30 °C (86 °F). If you do not use the battery pack for long periods, charge and discharge it fully at least once a year. If you have more than one battery pack, perform these precautions at the same time for all battery packs.



- Although the battery pack's operating temperature range is from 0 °C to 40 °C (32 °F to 104 °F), the optimal range is from 10 °C to 30 °C (50 °F to 86 °F). At cold temperatures, performance will temporarily decline. Warm it in your pocket before use.
- Replace the battery pack if the usable time after full charge diminishes substantially at normal temperatures.

About the battery terminal cover

The battery terminal cover has a [□]-shaped hole. This is useful when you wish to differentiate between charged and uncharged battery packs.

Back side of the battery pack



Terminal cover attached



Charged



Uncharged

Memory Card

- We recommend saving backups of memory card images on your computer. Image data may be corrupted or lost due to memory card defects or exposure to static electricity. Canon makes no warranties for corrupted or lost data.
- Do not turn off the camcorder, disconnect the power source or remove the memory card while the CARD access indicator is flashing.
- Do not use memory cards in places subject to strong magnetic fields.
- Do not leave memory cards in places subject to high humidity and high temperature.
- Do not disassemble, bend, drop, or subject memory cards to shocks and do not expose them to water.
- Do not touch or expose the terminals to dust or dirt.
- Check the direction before inserting the memory card. Forcing a memory card into the slot if it is not correctly oriented may damage the memory card or the camcorder.
- Do not attach any labels or stickers on the memory card.

Lithium Button Battery

WARNING!

- The battery used in this device may present a fire or chemical burn hazard if mishandled. Do not recharge, disassemble, heat above 100 °C (212 °F) or incinerate the battery.
- Replace the battery with a CR2025 made by Panasonic, Hitachi Maxell, Sony, Sanyo, or with Duracell2025. Use of other batteries may present a risk of fire or explosion.
- Dispose of the used battery according to applicable recycling regulations.

- Do not pick up the battery using tweezers or other metal tools as this will cause a short circuit.

- Wipe the battery with a clean dry cloth to ensure proper contact.
- Keep the battery out of the reach of children. If swallowed, seek medical assistance immediately. The battery case may break and the battery fluids may cause internal damage.
- Do not disassemble, heat or immerse the battery in water to avoid the risk of explosion.
- **For California, USA only:** The lithium battery included contains Perchlorate Material - special handling may apply. See www.dtsc.ca.gov/hazardouswaste/perchlorate for details.

Built-in Rechargeable Lithium Battery

The camcorder has a built-in rechargeable lithium battery to keep the date/time and other settings. The built-in lithium battery is recharged while you use the camcorder; however, it will become totally discharged if you do not use the camcorder for about 3 months.

To recharge the built-in lithium battery:

Connect the compact power adapter to the camcorder and leave it connected for 24 hours with the **POWER** switch set to

OFF.

Maintenance/Others

Storage

If you do not intend to use the camcorder for a long time, store it in a place free of dust, in low humidity, and at temperatures not higher than 30 °C (86 °F).

Cleaning

Camcorder Body

- Use a soft, dry cloth to clean the camcorder body. Never use chemically treated cloths or volatile solvents such as paint thinner.

Lens, Viewfinder and Instant AF Sensor

- If the lens surface or Instant AF sensor is dirty, the autofocus may not work properly.
- Remove any dust or dirt particles using a non-aerosol type blower brush.
- Use a clean, soft lens-cleaning cloth to gently wipe the lens or viewfinder. Never use tissue paper.

LCD Screen

- Clean the LCD screen using a clean, soft lens-cleaning cloth.
- Condensation may form on the surface of the screen when the temperature changes suddenly. Wipe it with a soft dry cloth.



Disposal

When you delete movies or initialize the hard disk or memory card, only the file allocation table is altered and stored data is not physically erased. Take the necessary precautions when you dispose of the camcorder or memory card, for example by physically damaging it to prevent the leakage of private data.

If giving the camcorder to another person, initialize the hard disk, fill up the hard disk with unimportant recordings, and then initialize the hard disk again. This makes recovering the original recordings very difficult.

Condensation

Moving the camcorder rapidly between hot and cold temperatures may cause condensation (water droplets) to form on its internal surfaces. Stop using the camcorder if condensation is detected. Continued use may damage the camcorder.

Condensation may form in the following cases:

- When the camcorder is moved from an air-conditioned room to a warm, humid place
- When the camcorder is moved from a cold place to a warm room
- When the camcorder is left in a humid room
- When a cold room is heated rapidly

To AVOID CONDENSATION

- Do not expose the camcorder to sudden or extreme changes in temperature.
- Place the camcorder in an airtight plastic bag and let it adjust to temperature changes slowly before removing it from the bag.

WHEN CONDENSATION IS DETECTED

The camcorder automatically shuts off. The precise time required for water droplets to evaporate will vary depending on the location and weather conditions. As a general rule, wait for 2 hours before resuming use of the camcorder.

Using the Camcorder Abroad

Power Sources

You can use the compact power adapter to operate the camcorder and to charge battery packs in any country with power supply between 100 and 240 V AC, 50/60 Hz. Consult a Canon Service Center for information on plug adapters for overseas use.

Playback on a TV Screen

You can only play back your recordings on TVs compatible with the NTSC system. The NTSC system is used in the following countries/areas:

American Samoa, Antigua, Aruba, Bahamas, Barbados, Bermuda, Bolivia, Canada, Chile, Colombia, Costa Rica,

Cuba, Ecuador, El Salvador, Greenland,
Guam, Guatemala, Haiti, Honduras,
Jamaica, Japan, Korea, Mexico,
Micronesia, Myanmar, Nicaragua,
Panama, Peru, Philippines, Puerto Rico,
Saint Kitts and Nevis, Saint Lucia, Saint
Vincent and the Grenadines, Surinam,
Taiwan, Trinidad and Tobago, USA,
Venezuela, Virgin Islands.



System Diagram (Availability differs from area to area)

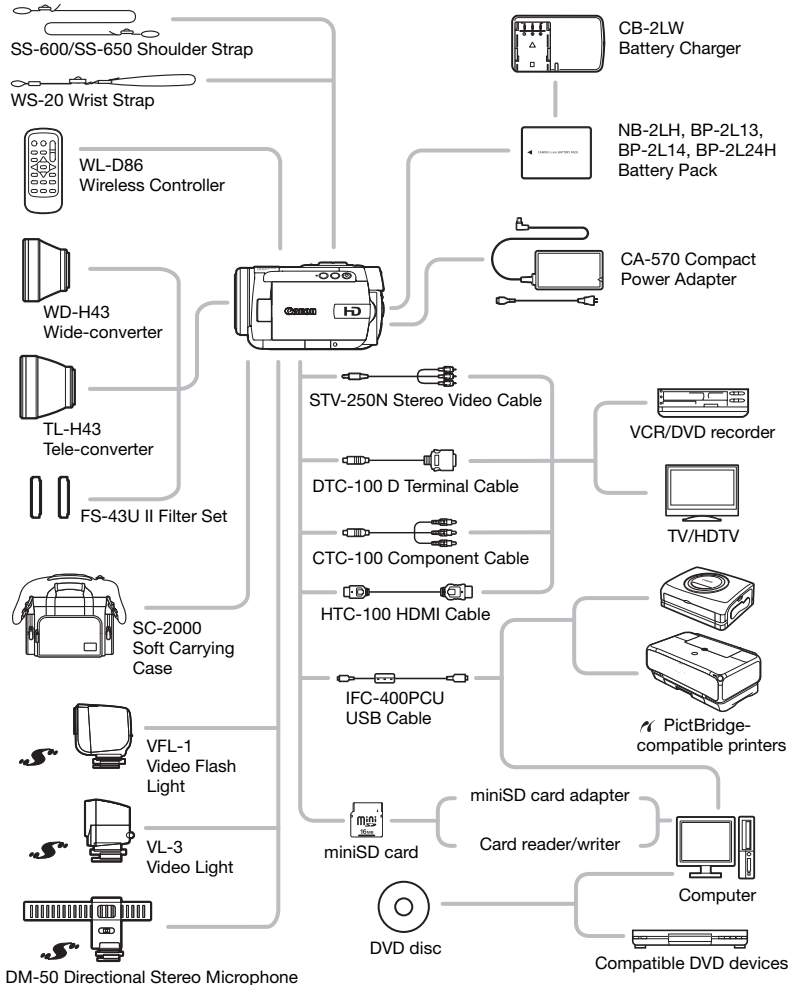

Optional Accessories

Call or visit your local retailer/dealer for genuine Canon video accessories. You can also obtain genuine accessories for your Canon camcorder by calling: 1-800-828-4040, Canon U.S.A. Information Center.

Use of genuine Canon accessories is recommended.

This product is designed to achieve excellent performance when used with genuine Canon accessories. Canon shall not be liable for any damage to this product and/or accidents such as fire, etc., caused by the malfunction of non-genuine Canon accessories (e.g., a leakage and/or explosion of a battery pack). Please note that this warranty does not apply to repairs arising out of the malfunction of non-genuine Canon accessories, although you may request such repairs on a chargeable basis.

Battery Packs

When you need extra battery packs, select one of the following models: NB-2LH, BP-2L13, BP-2L14 or BP-2L24H.

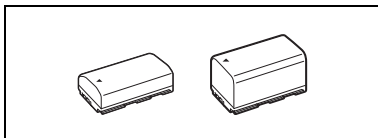

CB-2LW Battery Charger

Use the battery charger to charge the battery packs. It plugs directly into a power outlet without a cable.

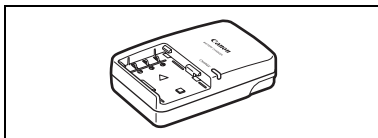

Charging Times

The charging times given in the following table are approximate and vary according to charging conditions and initial charge of the battery pack.

Battery Pack→	NB-2LH	BP-2L13	BP-2L14	BP-2L24H
Charging Conditions↓				
Using the camcorder	135 min.	210 min.	230 min.	405 min.
Using the CB-2LW Battery Charger	90 min.	175 min.	170 min.	330 min.

Recording and Playback Times

The recording and playback times given in the following table are approximate and vary according to recording mode and charging, recording or playback conditions. The effective usage time of the battery pack may decrease when recording in cold surroundings, when using the brighter screen settings, etc.



Battery Pack	NB-2LH		BP-2L13		BP-2L14		BP-2L24H	
Screen Used	Viewfinder	LCD	Viewfinder	LCD	Viewfinder	LCD	Viewfinder	LCD
Maximum Recording Time								
HXP	65 min.	65 min.	110 min.	105 min.	135 min.	125 min.	235 min.	225 min.
XP	65 min.	65 min.	115 min.	110 min.	140 min.	135 min.	240 min.	235 min.
LP	65 min.	65 min.	115 min.	110 min.	140 min.	135 min.	245 min.	235 min.
SP	65 min.	65 min.	115 min.	110 min.	140 min.	135 min.	245 min.	235 min.
Typical Recording Time*								
HXP	35 min.	35 min.	65 min.	65 min.	75 min.	75 min.	135 min.	135 min.
XP	40 min.	35 min.	65 min.	65 min.	80 min.	75 min.	140 min.	135 min.
LP	40 min.	35 min.	65 min.	65 min.	80 min.	75 min.	145 min.	135 min.
SP	40 min.	35 min.	65 min.	65 min.	80 min.	75 min.	145 min.	135 min.
Playback Time								
HXP	–	80 min.	–	140 min.	–	165 min.	–	280 min.
XP	–	80 min.	–	140 min.	–	170 min.	–	295 min.
LP	–	80 min.	–	140 min.	–	170 min.	–	305 min.
SP	–	80 min.	–	140 min.	–	170 min.	–	305 min.

* Approximate times for recording with repeated operations such as start/stop, zooming, and power on/off.

TL-H43 Tele-converter

This Tele-converter lens increases the focal length of the camcorder lens by a factor of 1.5.

- The image stabilizer is not as effective when the Tele-converter is attached.
- The minimum focusing distance at full telephoto with the TL-H43 is 3 m (9.8 ft.).
- When the Tele-converter is attached, a shadow may appear in the picture when you record with flash or assist lamp.

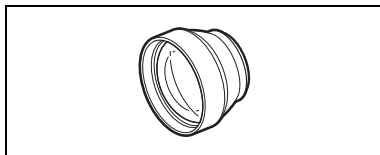

WD-H43 Wide-converter

This lens decreases focal length by a factor of 0.7, giving you a wide perspective for indoor shots or panoramic views.

- When the Wide-converter is attached, a shadow may appear in the picture when you record with flash or assist lamp.

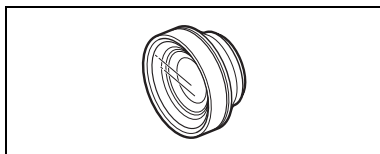

- When taking photos with a 4:3 aspect ratio with the Wide-converter attached, depending on the position of the zoom, the Wide-converter's frame may appear in the picture.

FS-43U II Filter Set

Neutral density and MC protector filters help you to control difficult lighting conditions.

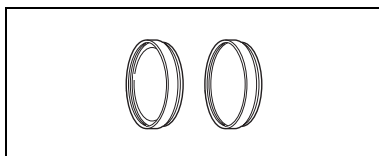

HTC-100 HDMI Cable

Use this cable to connect the camcorder to an external device using an all-digital connection, allowing you to enjoy playback at the highest quality. This cable sends both video and audio signals.

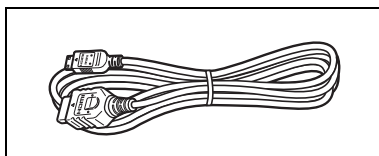

VFL-1 Video Flash Light

This video flash light allows you to record still images and movies even at night or in dark places. It attaches to the camcorder's advanced accessory shoe for cable-free operation.

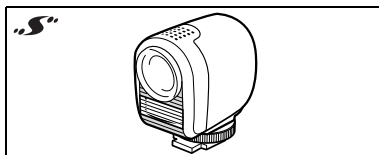

VL-3 Video Light

This video light enables you to record brightly in color even in dark places. It attaches to the camcorder's advanced accessory shoe for cable-free operation.

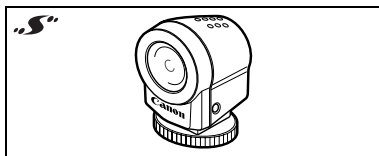

DM-50 Directional Stereo Microphone

This highly sensitive, super-directional microphone attaches to the camcorder's advanced accessory shoe. It can be used as directional microphone (monaural) or stereo microphone.

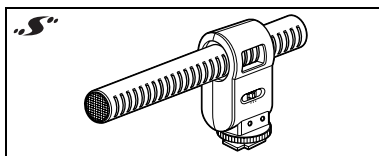



Shoulder Strap

You can attach a shoulder strap for more security and portability. Pass the ends through the strap mount and adjust the length of the strap.

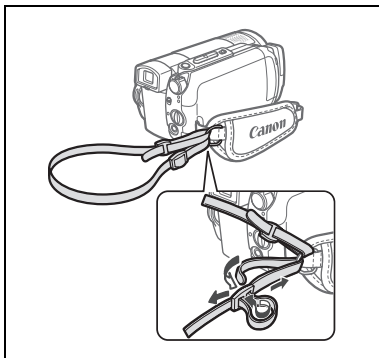

WS-20 Wrist Strap

Use this for extra additional protection for active shooting.

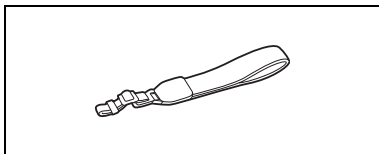

SC-2000 Soft Carrying Case

A handy camcorder bag with padded compartments and plenty of space for accessories.



This mark identifies genuine Canon video accessories. When you use Canon video equipment, we recommend Canon-brand accessories or products bearing the same mark.



Product Codes

Provided Accessories

CA-570 Compact Power Adapter	8468A002AA
BP-2L13 Battery Pack	2069B002AA
WL-D86 Wireless Controller	D83-0722-000
STV-250N Stereo Video Cable	3067A002AA (D82-0590-201)
IFC-400PCU USB Cable	9370A001AA

Optional Accessories

NB-2LH Battery Pack	9612A001AA
BP-2L14 Battery Pack	9582A002AA
BP-2L24H Battery Pack	2383B002AA
CB-2LW Battery Charger	0763B001AA
TL-H43 Tele-converter	2071B001AA
WD-H43 Wide-converter	2072B001AA
FS-43U II Filter Set	7150A004AA
HTC-100 HDMI Cable	2384B001AA
CTC-100 Component Cable	1719B001AA
WS-20 Wrist Strap	3118A002AA (D81-0190-202)
SC-2000 Soft Carrying Case	9389A001AA



Specifications

HG10

System

Recording System	AVCHD	Video compression: MPEG-4 AVC/H.264 Audio compression: Dolby Digital 2ch
Television System	1080/60i ¹	
Maximum Recording Time (approximate figures)	40 GB hard disk drive: HXP: 5 hr. 30 min., XP: 9 hr. 30 min., SP: 11 hr. 30 min., LP: 15 hr.	
Image Sensor	1/2.7-inch CMOS, approx. 2,960,000 pixels Effective pixels:	Movies: approx. 2,070,000 Still images (LW): approx. 2,070,000 Still images (L, M, S): approx. 2,760,000
LCD Screen	2.7 in., wide, TFT color, approx. 211,000 pixels	
Viewfinder	0.27 in., wide, TFT color, approx. 123,000 pixels	
Microphone	Stereo electret condenser microphone	
Lens	f=6.1-61 mm, F/1.8-3.0 (when recording movies), 10x power zoom 35 mm equivalent:	Movies: 43.6-436 mm Still images (LW): 43.6-436 mm Still images (L, M, S): 40.0-400 mm
Lens Configuration	11 elements in 9 groups (2 aspheric elements)	
Filter Diameter	43 mm	
AF System	Autofocus (TTL + external distance sensor when set to [INSTANT AF]); Manual focus available	
Minimum Focusing Distance	1 m (3.3 ft.); 1 cm (0.39 in.) on maximum wide angle	
White Balance	Auto white balance, custom white balance and preset white balance settings: DAYLIGHT, SHADE, CLOUDY, TUNGSTEN, FLUORESCENT, FLUORESCENT H	
Minimum Illumination	0.2 lx ([NIGHT] recording program, Shutter speed at 1/2) 3 lx (AUTO mode, Auto slow shutter [ON], Shutter speed at 1/30)	
Recommended Illumination	More than 100 lx	
Image Stabilization	Optical-Shift Image Stabilizer	

¹ Recordings made with the [PF24] frame rate are converted and recorded on the hard disk as 60i.

Memory Card

Recording Media	miniSD card ²
Size of Still Images	1920 x 1080, 2048 x 1536, 1440 x 1080, 640 x 480 pixels Simultaneous recording: 1920 x 1080, 848 x 480 pixels
File Format	Design rule for Camera File system (DCF), Exif 2.2 compliant ³ , DPOF compliant
Image Compression Method	JPEG (compression: Super Fine, Fine, Normal)

² This camcorder has been tested with miniSD cards up to 2 GB. Performance cannot be guaranteed for all miniSD cards.

³ This camcorder supports Exif 2.2 (also called "Exif Print"). Exif Print is a standard for enhancing the communication between camcorders and printers. By connecting to an Exif Print-compliant printer, the camcorder's image data at the time of shooting is used and optimized, yielding extremely high quality prints.

Input/Output Terminals

AV OUT/⌚ Terminal	⌀ 3.5 mm minijack; Output only (dual purpose terminal also for headphones stereo output) Video: 1 Vp-p / 75 ohms unbalanced Audio: -10 dBV (47 kohm load) / 3 kohm or less
USB Terminal	mini-B
COMPONENT OUT Terminal (Proprietary mini-D terminal)	Luminance (Y): 1 Vp-p / 75 ohms Chrominance (P _B /P _R (C _B /C _R)): ±350 mVp-p 1080i (D3) / 480i (D1) compatible
HDMI OUT Mini Terminal	HDMI type C connector (19 pins); Output only
MIC Terminal	⌀ 3.5 mm stereo minijack -57 dBV (with 600 ohm microphone) / 5 kohms or more

Power/Others

Power supply (rated)	7.4 V DC (battery pack), 8.4 V DC (compact power adapter)
Power consumption (SP mode, AF on)	4.4 W (viewfinder, normal brightness), 4.6 W (LCD screen, normal brightness)
Operating temperature	0 – 40 °C (32 – 104 °F)
Dimensions (W x H x D)	81 x 75 x 129 mm (3.2 x 3.0 x 5.1 in.) excluding the grip belt
Weight (camcorder body only)	505 g (1.1 lb.)

CA-570 Compact Power Adapter

Power supply	100 – 240 V AC, 50/60 Hz
Rated output / consumption	8.4 V DC, 1.5 A / 29 VA (100 V) – 39 VA (240 V)
Operating temperature	0 – 40 °C (32 – 104 °F)
Dimensions	52 x 29 x 90 mm (2.1 x 1.1 x 3.5 in.)
Weight	135 g (4.8 oz.)

BP-2L13 Battery Pack

Battery type	Rechargeable Lithium Ion Battery
Rated voltage	7.4 V DC
Operating temperature	0 – 40 °C (32 – 104 °F)
Battery capacity	1,200 mAh
Dimensions	33.3 x 25.8 x 45.2 mm (1.3 x 1.0 x 1.8 in.)
Weight	60 g (2.1 oz)

Weight and dimensions are approximate. Errors and omissions excepted. Subject to change without notice.



Index

24F progressive frame rate46
24p Cinema Mode52

A

Abroad, using the camcorder.103
AEB - Auto exposure bracketing71
AF-assist lamp71
Aperture (f number)54
Aspect ratio of a connected TV
(TV type)50
AUTO (recording program)33
Auto slow shutter44
Autofocus (AF)
 AF frame
 (9-point AiAF/Center point)72
 Instant AF/Normal AF45
Av (recording program)54
AV OUT/ \square terminal83
AVCHD specifications5

B

Backing up movies40
Backlight correction57
Battery pack
 Charging21
 Remaining charge indicator20
Beach (recording program)53
Beep49
Built-in backup battery102

C

Cine Mode (recording program)51
Compact power adapter21
COMPONENT OUT terminal84
Component video84
Condensation103
Connections
 to a computer87
 to a High Definition TV (HDTV)84

 to a TV/VCR83
Continuous shooting71
Control dial25

D

Data code42
Date and time27
 Date format51
 Daylight saving time28
 Time zone28
Deleting/Erasing
 Movies36, 41
 Still images67, 69
Digital effects60
Direct print77
Direct transfer87
Drive mode71
Drop sensor47

E

Error messages95
Exposure57

F

File numbers50
Fireworks (recording program)53
Flash70
Focus
 Assist functions46, 56
 Automatic45
 Focus priority72
 Manual56
Frame rate46
FUNC. menu26, 42
Function guide25

G

Grip belt23

H

Hard disk precautions99
HDMI OUT mini terminal84, 85

Headphones	38
HXP mode	34

I

Image effects	59
Image jump	67
Image stabilizer	46
Index screen	
Movies	37
Still images	68
Initializing	
Hard disk	64
Memory card	76

L

Language	28
LCD screen	29
Light metering mode	73
LP mode	34

M

Magnifying a still image	69
Maintenance	102
Manual exposure adjustment	57
Markers	48
Memory card	30, 101
Microphone	61
Mini video light	55
miniSD card	30
Mode switch	33

N

Navigation buttons	25
Night (recording program)	53

O

Onscreen display selection	42
Original recordings	63

P

P (recording program)	54
-----------------------------	----

Playback	
Movies	37
Still images	67
Playlist	63
Portrait (recording program)	53
Power save	49
Print order	81
Print/share button	78, 88
Printing still images	77
Protecting still images	75

Q

Quick Start function	35
----------------------------	----

R

Recording	
Movies	32
Still images	65
Recording data	42
Recording mode	43
Recording programs	54
Recording reminder	20
Remote sensor	23
RESET	92
Reviewing	
Movies (Record review)	36
Still images (Review)	46

S

Screen icons	18
Searching scenes by date	40
Self timer	56
Serial number	16
Setup menus	26, 44
Shutter speed	54
Simultaneous recording (hard disk/memory card)	74
Slideshow	68
Snow (recording program)	53
SP mode	34
Special Scene (recording programs) ..	52
Sports (recording program)	53
Spotlight (recording program)	53



Still image quality66
Still image size66
Sunset (recording program)53

T

Telephoto34
Transfer order90
Transferring to a computer	
Movies40
Still images40, 87
Tripod24
Troubleshooting91
Tv (recording program)54

U

USB terminal87
------------------------	-----

V

Viewfinder33
----------------------	-----

Volume	
Headphones	38
Speaker	37

W

White balance	58
Wide angle	34
Wind screen	47
Wireless controller	23

X

XP mode	34
-------------------	----

Z

Zoom	34
Digital zoom	45
Zoom speed	45

Trademark Acknowledgements

- miniSD™ is a trademark of SD Card Association.
- Microsoft, Windows and Windows Vista are trademarks or registered trademarks of Microsoft Corporation in the United States and/or other countries.
- Macintosh and Mac OS are trademarks of Apple Inc., registered in the U.S. and other countries.
- Manufactured under license from Dolby Laboratories.
“Dolby” and the double-D symbol are trademarks of Dolby Laboratories.
- “AVCHD” and the “AVCHD” logo are trademarks of Matsushita Electric Industrial Co., Ltd. and Sony Corporation.
- HDMI, the HDMI logo and High-Definition Multimedia Interface are trademarks or registered trademarks of HDMI Licensing LLC.
- Corel, the Corel logo, Ulead, the Ulead logo, Ulead DVD MovieFactory, InterVideo, the InterVideo logo, WinDVD are trademarks or registered trademarks of Corel Corporation and/or its subsidiaries.
- Other names and products not mentioned above may be trademarks or registered trademarks of their respective companies.
- This product is licensed under AT&T patents for the MPEG-4 standard and may be used for encoding MPEG-4 compliant video and/or decoding MPEG-4 compliant video that was encoded only (1) for a personal and non-commercial purpose or (2) by a video provider licensed under the AT&T patents to provide MPEG-4 compliant video. No license is granted or implied for any other use for MPEG-4 standard.



U.S.A.

CANON CONSUMER DIGITAL VIDEO EQUIPMENT LIMITED WARRANTY FOR THE UNITED STATES

The limited warranty set forth below is given by Canon U.S.A., Inc. ("Canon USA") with respect to Canon Consumer Digital Video Equipment (the "Equipment") purchased in the United States. This limited warranty is only effective upon presentation of your Bill of Sale or other proof of purchase.

The Equipment is warranted under normal, non-commercial, personal use, against defective materials or workmanship as follows:

Parts: Defective parts will be exchanged for new parts or comparable rebuilt parts for a period of ONE YEAR from the date of original purchase, except for a defective Video Head, which will be exchanged for a period of three months from the date of purchase.

Labor: For a period of ONE YEAR from the date of original purchase, labor will be provided free of charge by our factory service centers or designated service facilities located in the United States.

When returning Equipment under this warranty, you must pre-pay the shipping charges, and you must enclose the Bill of Sale or other proof of purchase with a complete explanation of the problem. During the ONE-YEAR warranty period, repairs will be made and the Equipment will be return-shipped to you free of charge. For repairs after the warranty period is over, you will be given an estimate of the cost of repair and an opportunity to approve or disapprove of the repair expense before it is incurred. If you approve, repairs will be made and the Equipment will be return-shipped to you. (shipping charges apply). If you disapprove, we will return-ship the equipment at no charge to you.

Non-Canon brand peripheral equipment and software which may be distributed with, or factory loaded on, the Equipment, are sold "AS IS" without warranty of any kind by Canon USA, including any implied warranty regarding merchantability or fitness for a particular purpose. The sole warranty with respect to such non-Canon brand items is given by the manufacturer or producer thereof. If the Equipment contains a hard disk drive, Canon USA recommends that data stored on that drive be duplicated or backed up to prevent its loss in the event of failure or other malfunction of such drive.

Canon USA shall have no responsibility under this limited warranty for use of the Equipment in conjunction with incompatible peripheral equipment and incompatible software.

In order to obtain warranty service, contact the authorized Canon retail dealer from whom you purchased the Equipment or call the CANON INFORMATION CENTER AT 1-800-OK-CANON). You will be directed to the nearest service facility for your Equipment.

This Limited Warranty covers all defects encountered in normal use of the Equipment and does not apply in the following cases:

- A) Loss or damage to the Equipment due to abuse, mishandling, accident, improper maintenance, or failure to follow operating instructions;
- B) If the Equipment is defective as a result of leaking batteries, sand, dirt or water damage;
- C) If defects or damages are caused by the use of unauthorized parts or by service other than by Canon USA's factory service centers or authorized service facilities;
- D) If the Equipment is used for commercial or industrial use.

This Limited Warranty does not cover cabinet (exterior finish), video cassette tape, head cleanings, nor does it apply to Equipment purchased outside the United States. This warranty does not cover units sold to rental firms, military operations, hotels, schools, hospitals or for other commercial, industrial, or institutional applications. These uses are covered only by such specific warranty as Canon may issue with such sales.

This Limited Warranty does not apply to accessories or consumables for the Equipment, which are sold "AS IS", without warranty of any kind by Canon USA.

Please retain this warranty card and your Bill of Sale as a permanent record of your purchase. This card is most important in order to be sure you are contacted right away should there be a safety inspection, modification or product recall under applicable laws or regulations.

NO IMPLIED WARRANTY, INCLUDING MERCHANTABILITY AND FITNESS FOR A PARTICULAR PURPOSE APPLIES TO THIS EQUIPMENT AFTER THE APPLICABLE PERIOD OF EXPRESS WARRANTY OR GUARANTY, EXCEPT AS MENTIONED ABOVE, GIVEN BY ANY PERSON, FIRM OR CORPORATION WITH RESPECT TO THIS EQUIPMENT SHALL BIND THE UNDERSIGNED (SOME STATES DO NOT ALLOW LIMITATIONS ON HOW LONG AN IMPLIED WARRANTY LASTS, SO THE ABOVE LIMITATION OR EXCLUSION MAY NOT APPLY TO YOU). CANON USA SHALL NOT BE LIABLE FOR LOSS OF REVENUES OR PROFITS, EXPENSE FOR SUBSTITUTE EQUIPMENT OR SERVICE, STORAGE CHARGES, LOSS OR CORRUPTION OF DATA, INCLUDING WITHOUT LIMITATION, LOSS OR CORRUPTION OF DATA STORED ON THE EQUIPMENTS HARD DRIVE, OR ANY OTHER SPECIAL, INCIDENTAL OR CONSEQUENTIAL DAMAGES CAUSED BY THE USE, MISUSE OR INABILITY TO USE THE EQUIPMENT, REGARDLESS OF THE LEGAL THEORY ON WHICH THE CLAIM IS BASED, AND EVEN IF CANON USA HAS BEEN ADVISED OF THE POSSIBILITY OF SUCH DAMAGES. NOR SHALL RECOVERY OF ANY KIND AGAINST CANON USA BE GREATER THAN THE PURCHASE PRICE OF THE EQUIPMENT SOLD BY CANON USA AND CAUSING THE ALLEGED DAMAGE. WITHOUT LIMITING THE FOREGOING, YOU ASSUME ALL RISK AND LIABILITY FOR LOSS, DAMAGE OR INJURY TO YOU AND YOUR PROPERTY AND TO OTHERS AND THEIR PROPERTY ARISING OUT OF USE, MISUSE OR INABILITY TO USE THE EQUIPMENT NOT CAUSED DIRECTLY BY THE NEGLIGENCE OF CANON USA. (SOME STATES DO NOT ALLOW THE EXCLUSION OR LIMITATION OF INCIDENTAL OR CONSEQUENTIAL DAMAGES, SO THE ABOVE LIMITATION MAY NOT APPLY TO YOU). THIS WARRANTY SHALL NOT EXTEND TO ANYONE OTHER THAN THE ORIGINAL PURCHASER OF THIS EQUIPMENT OR THE PERSON FOR WHOM IT WAS PURCHASED AS A GIFT.

This warranty gives you specific legal rights, and you may also have other rights which vary from state to state.

CANON U.S.A., INC.

CANADA

CANON CONSUMER DIGITAL VIDEO EQUIPMENT LIMITED WARRANTY

The limited warranty set forth below is given by Canon Canada Inc. ("Canon Canada") with respect to Canon Consumer Digital Video Equipment (the "Equipment") purchased in Canada. This limited warranty is only effective upon presentation of a bill of sale or other proof of purchase for this Equipment to a Canon Service Facility when repairs are required.

The Equipment is warranted under normal, non-commercial, personal use, against defective materials or workmanship as follows:

Parts: Defective parts will be exchanged for new parts or, at Canon Canada's option, comparable rebuilt parts for a period of one year from the date of original purchase.

Labour: For a period of one year from the date of original purchase, labour will be provided free of charge by our Canon Service Facilities in Canada.

This limited warranty covers all defects except where:

(a) The loss or damage to the product results from:

- i) accident, natural disaster, mishandling, abuse, neglect, unauthorized product modification or failure to follow instructions contained in the instruction manual;
- ii) the use of accessories, attachments, products, supplies, parts or devices with the Equipment that do not conform to Canon specifications or that cause abnormally frequent service problems;
- iii) repairs or services performed by any party other than a Canon Service Facility;
- iv) defective batteries or any exposure to water, sand or dirt;
- v) shipping (claim must be presented to the shipper);

(b) Any serial number on the video equipment is altered or removed.

(c) The Equipment is used for commercial, professional or industrial purposes.

This limited warranty does not cover the cabinet (exterior finish) of the Equipment, media, nor does it apply to Equipment purchased outside Canada. If the Equipment contains a hard disk drive, Canon Canada recommends that data stored on that drive be duplicated or backed up to prevent its loss in the event of a failure or other malfunction of such drive.

TO OBTAIN WARRANTY SERVICE

Ship your Equipment in its original carton, box or equivalent, properly packed, fully insured with shipping charges prepaid, together with a copy of your bill of sale or other proof of purchase and a description of the problem to any of the Canon Service Facilities in Canada.

LIMITATIONS

Except as otherwise required by applicable legislation, this warranty is in lieu of all other warranties, conditions, guarantees or representations, express or implied, statutory or otherwise, relative to the Equipment, including implied warranties or conditions of merchantability or fitness for a particular purpose.

Canon Canada assumes no liability for special, consequential or incidental damages, loss or corruption of data including, without limitation, data stored on the hard disk drive of the Equipment or loss that may arise, whether on account of negligence or otherwise, from the use, misuse or inability to use the Equipment (including loss of profit, revenue, media or enjoyment) or from failure to conform to any express or implied warranties, conditions, guarantees or representations. Any recovery under this limited warranty shall not exceed the purchase price of the equipment. Canon Canada does not assume or authorize any other person to assume for Canon Canada any other liability with respect to this equipment.

This warranty does not extend to any person other than the original purchaser of the Equipment or the person for whom it was purchased as a gift and states your exclusive remedy.

NOTICE TO CONSUMER

If you plan to take important videos or if the product has not been used for some time, please check all functions with the instruction book before using it.



U.S.A. **CANON U.S.A., INC. NEW JERSEY OFFICE**
100 Jamesburg Road, Jamesburg, NJ 08831 USA
CANON U.S.A., INC. CHICAGO OFFICE
100 Park Blvd., Itasca, IL 60143 USA
CANON U.S.A., INC. LOS ANGELES OFFICE
15955 Alton Parkway, Irvine, CA 92618 USA
CANON U.S.A., INC. HONOLULU OFFICE
210 Ward Avenue, Suite 200, Honolulu, HI 96814 USA

- ❖ If you have any questions, call the Canon U.S.A. Information Center toll-free at 1-800-828-4040 (U.S.A. only).

CANADA **CANON CANADA INC. NATIONAL HEADQUARTERS**
6390 Dixie Road, Mississauga, Ontario L5T 1P7
CANON CANADA INC. CALGARY
2828, 16th Street, N.E. Calgary, Alberta T2E 7K7
CANON CANADA INC. MONTREAL
5990 Côte de Liesse, Quebec H4T 1V7

- ❖ If you have any questions, call the Canon Canada Information Center toll-free at 1-800-828-4040 (CANADA only).
- ❖ Si vous avez des questions, veuillez téléphoner sans frais au Canada 1-800-828-4040 (CANADA seulement).

MEXICO **CANON MEXICANA, S. DE R.L. DE C.V.**
Periferico Sur No. 4124, Col. Ex-Rancho de Anzaldo,
C.P. 01900 México, D.F., México
CANON U.S.A., INC. NEW JERSEY OFFICE
100 Jamesburg Road, Jamesburg, NJ 08831 USA

CENTRO Y SURAMÉRICA **CANON LATIN AMERICA, INC.**
703 Waterford Way, Suite 400, Miami, FL 33126 USA

ASIA **CANON HONGKONG COMPANY LTD.**
19/F, The Metropolis Tower, 10 Metropolis Drive,
Hung Hom, Kowloon, Hong Kong

The information in this manual is verified as of 1 August 2007.
Les informations contenues dans ce manuel ont été vérifiées le 1er août 2007.
La información de este manual fue verificada el 1 de agosto de 2007.



Printed on 100% reused paper.
Document réalisé avec du papier recyclé à 100%.
Impreso en papel 100% reciclado.