



Getting Started Guía de inicio

Video Tutorials
Available

Se dispone de
tutoriales en vídeo

www.usa.canon.com/FAQVideo

RMC: K10408
RMC: K10411
RMC: K10407

1

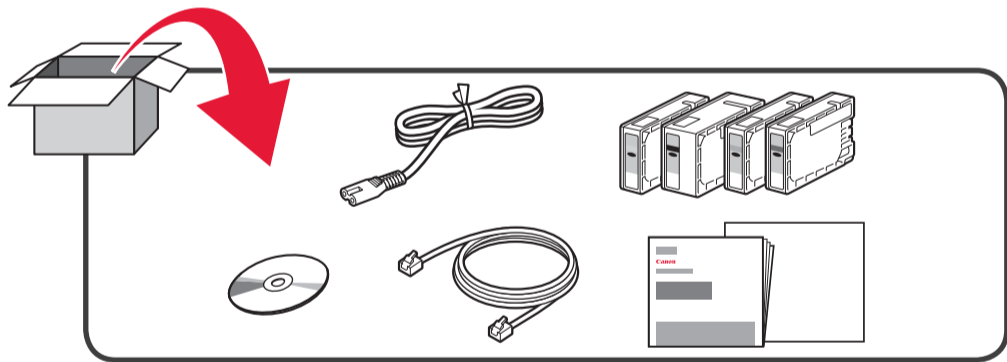

2

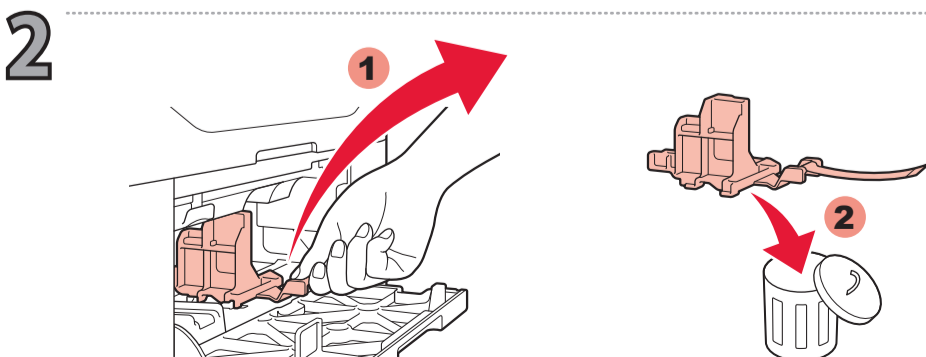
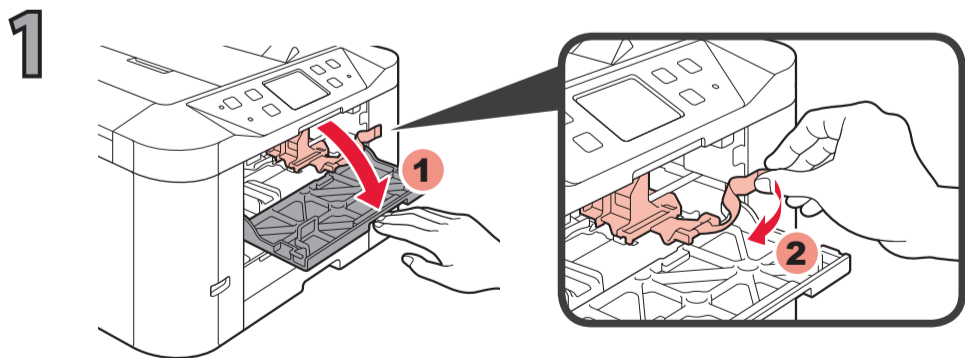

3

1

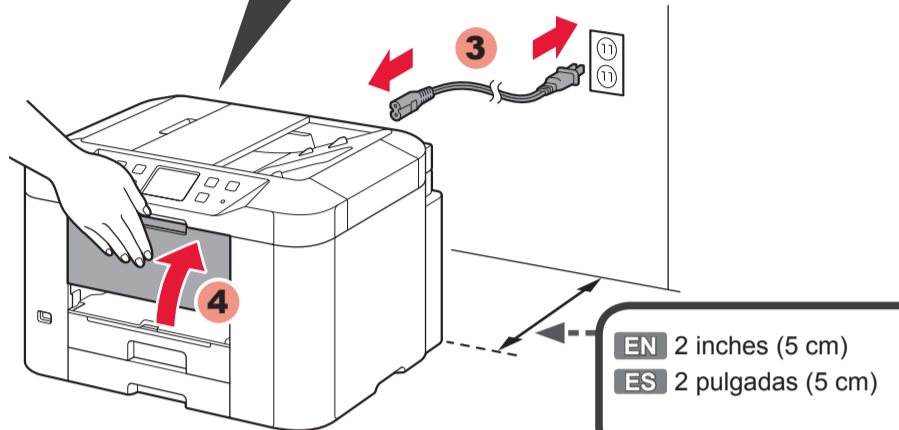
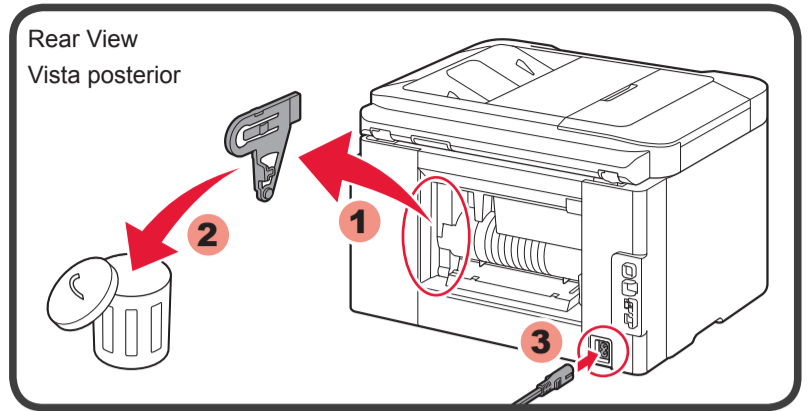

EN 2 inches (5 cm)
ES 2 pulgadas (5 cm)

EN Do not yet connect the cable except the power cord.

ES Aún no conecte el cable, excepto el cable de alimentación.

2

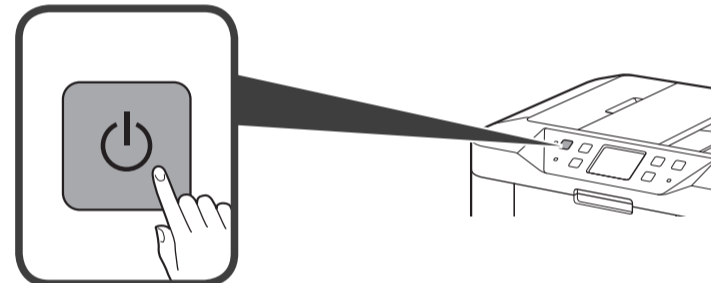

3

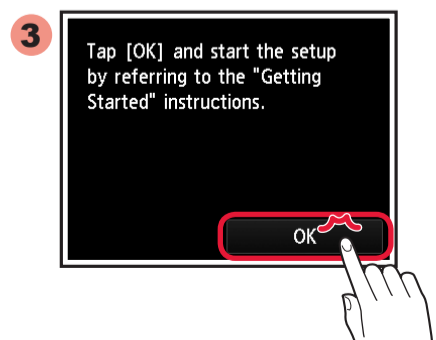
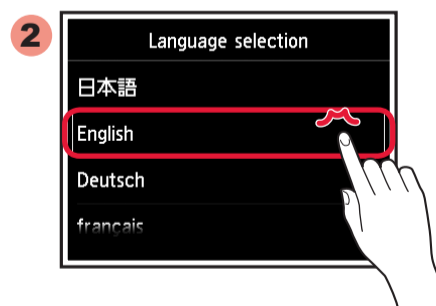
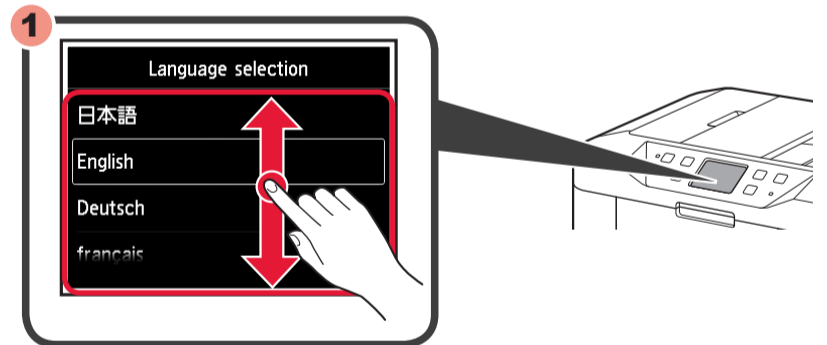

3 Tap [OK] and start the setup by referring to the "Getting Started" instructions.

4

1

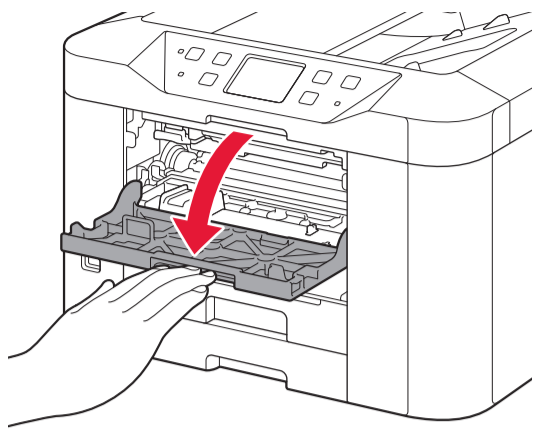

EN ⚠ Do not touch this part until it stops!
ES ⚠ ¡No toque esta pieza hasta que se detenga!

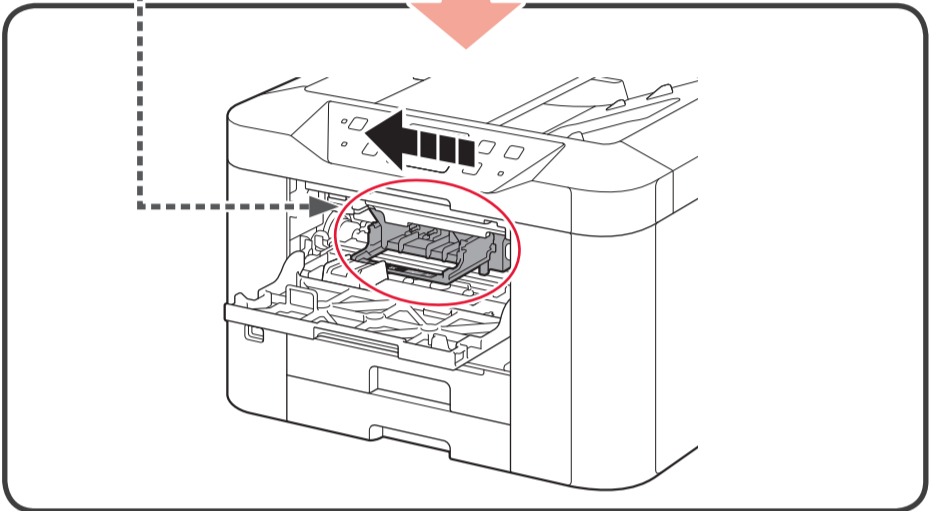

2

EN Remove the ink tank **Y** from the package.
ES Retire el depósito de tinta **Y** del envoltorio.

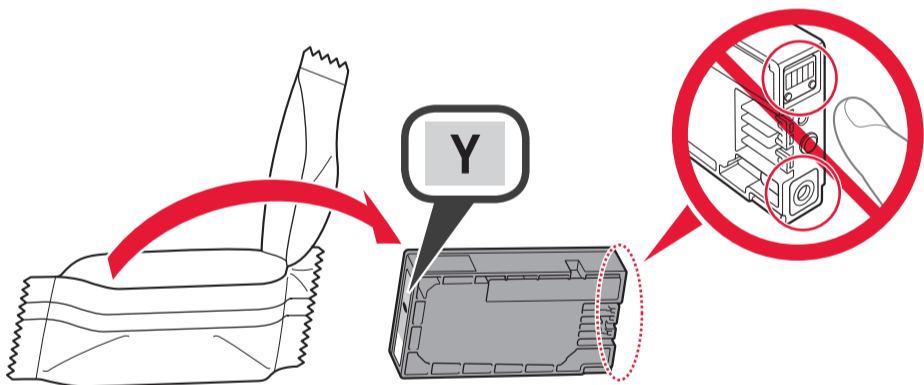

3

EN Insert the ink tank **Y** all the way and straight.
ES Inserte el depósito de tinta **Y** todo el recorrido y recto.

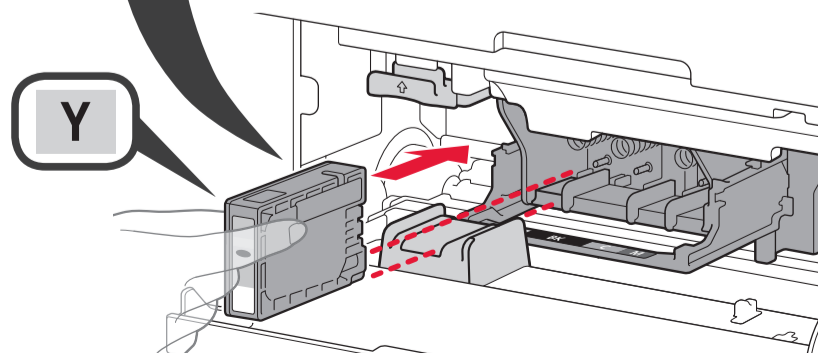
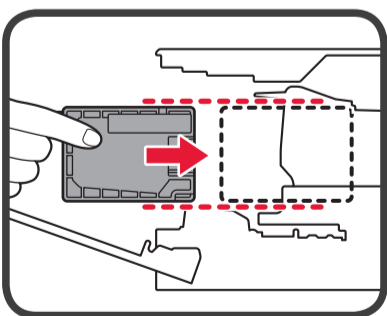

4

EN Push the ink tank firmly and all the way until it snaps into place, then follow the message displayed on the screen.

ES Empuje el depósito de tinta firmemente todo el recorrido hasta que encaje en su lugar y, a continuación, siga el mensaje que aparece en la pantalla.

1

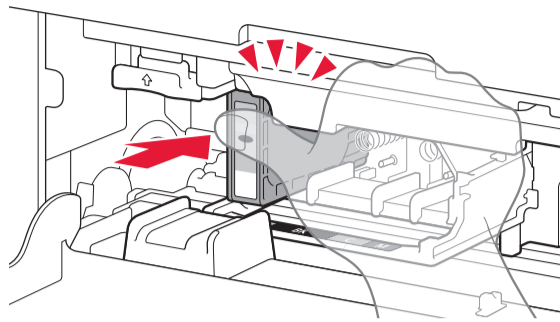

2

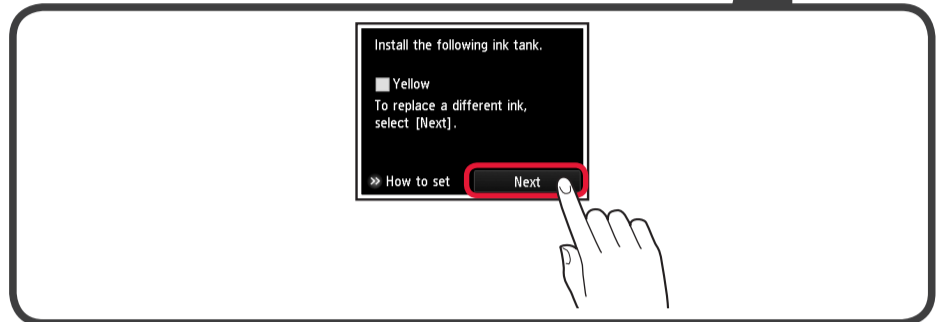
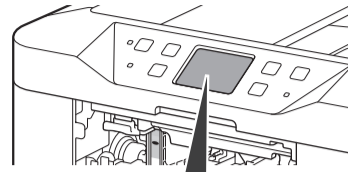

5

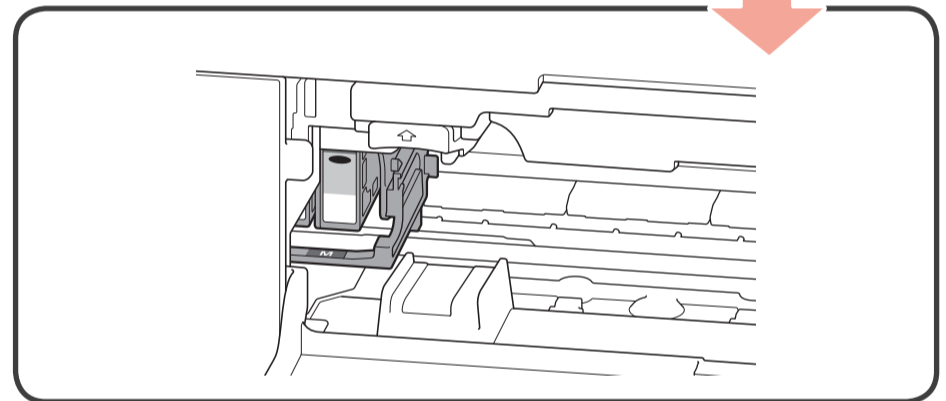

EN An installed ink tank cannot be removed until the message to replace it is displayed.

ES Un depósito de tinta instalado no se puede retirar hasta que aparece el mensaje para retirarlo.

6

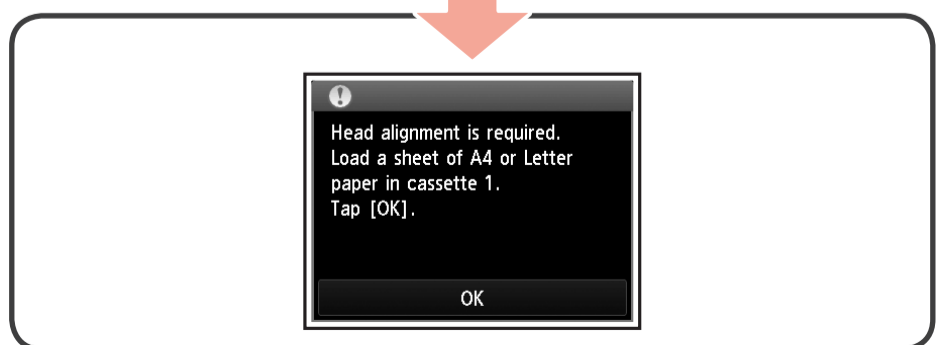

5

1

MB5000 series

MB5300 series
MB2300 series

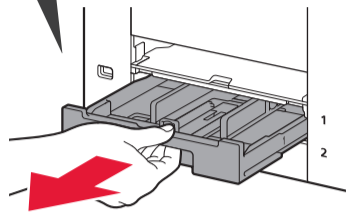
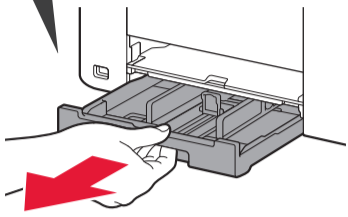
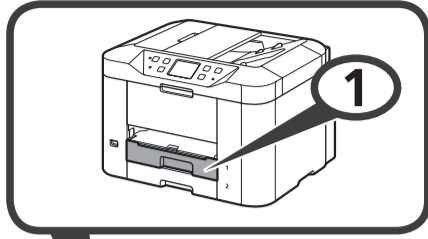
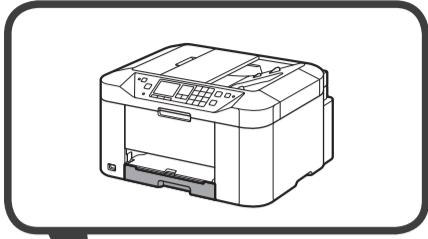

2

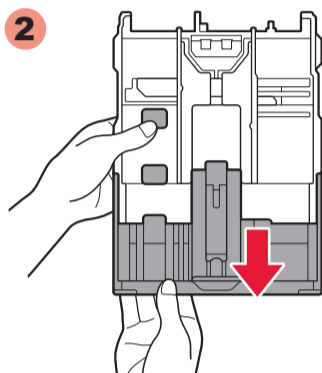
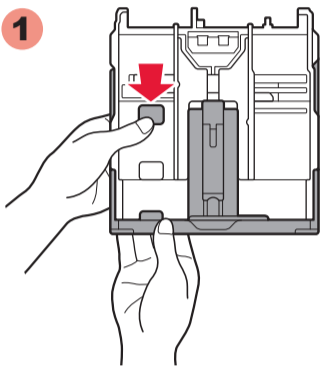

3

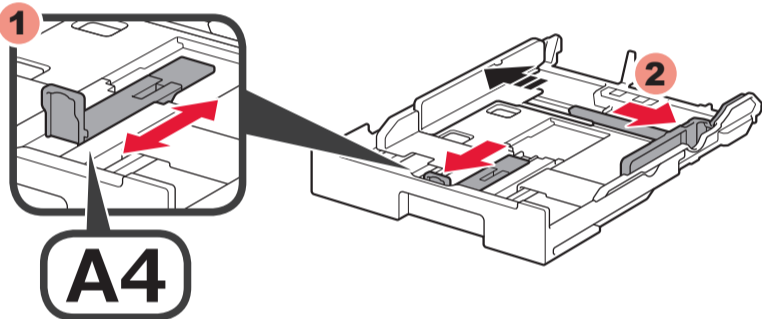

A4

4

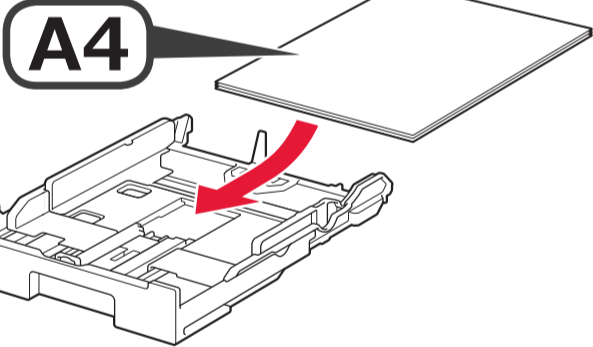

A4

- EN**
- Load paper with the print side facing down.
 - Letter size paper is also available.

- ES**
- Cargue papel con el lado de impresión hacia abajo.
 - Se dispone también de papel tamaño Carta.

5

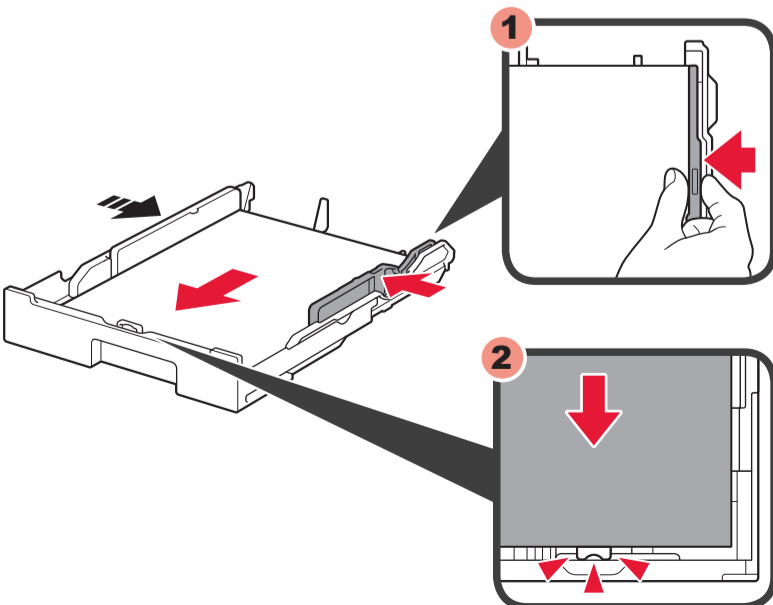

6

MB5000 series

MB5300 series
MB2300 series

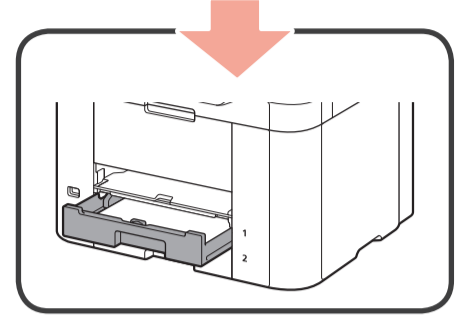
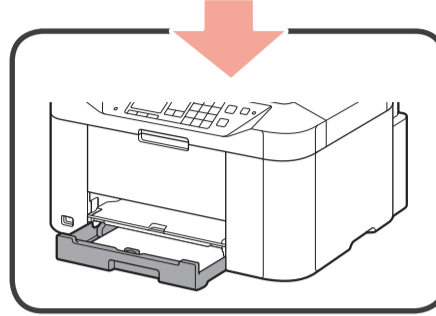
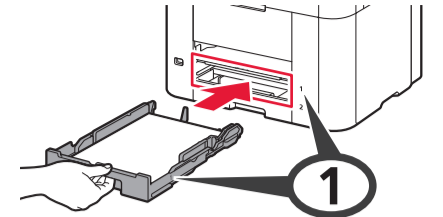
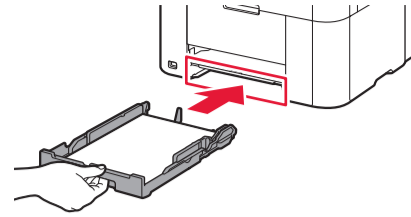

7

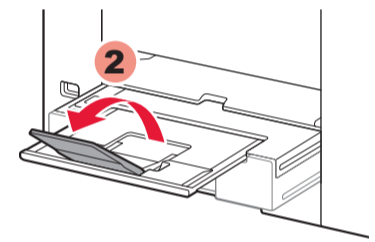
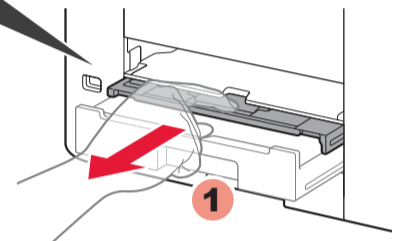
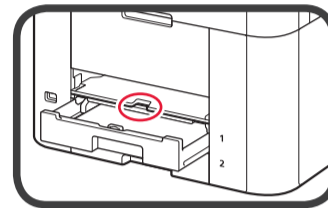

8

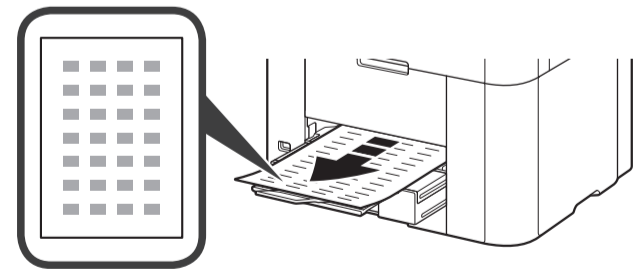

- EN**
- If an error message appears, tap **OK** to remove the error message. Redo Print Head Alignment. Then, follow the message displayed on the screen.

- ES**
- Si aparece un mensaje de error, púntee en **OK** para eliminar el mensaje de error. Repita la Alineación de los cabezales de impresión (Print Head Alignment). A continuación, siga el mensaje que aparece en la pantalla.

EN Hereafter, follow the message displayed on the screen.

ES A partir de ahí, siga el mensaje que aparece en la pantalla.

6

1

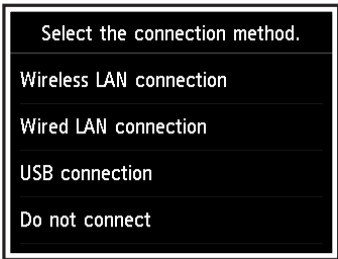

EN Refer to the following explanations of connection types and select the connection method for your devices to use.

Hereafter, follow the message displayed on the screen.

ES Consulte las siguientes explicaciones de tipos de conexiones y seleccione el método de conexión para utilizar en sus dispositivos.

A partir de ahí, siga el mensaje que aparece en la pantalla.



Wireless LAN
LAN inalámbrica

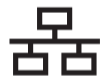
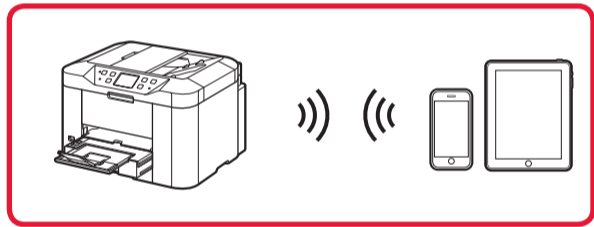
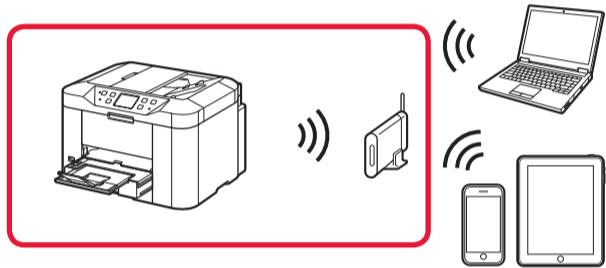

Wired LAN
LAN cableada

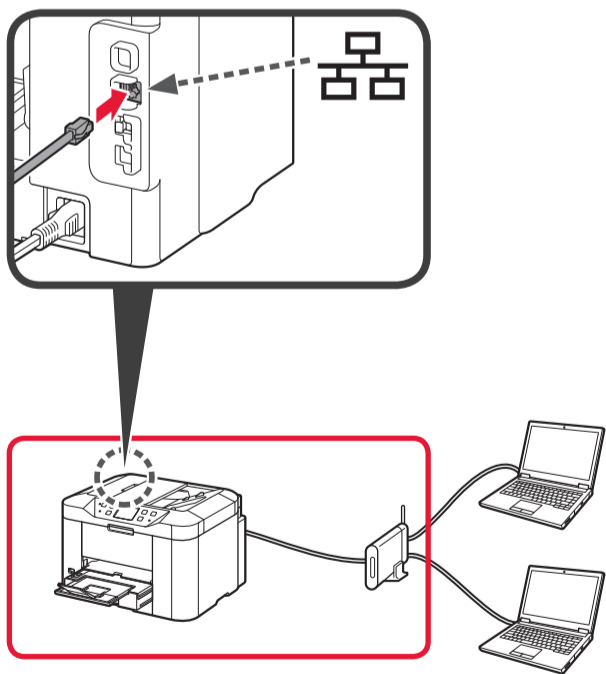

USB



2



EN Setup CD-ROM is also available for Windows PC.

ES El CD-ROM de instalación también está disponible para Windows PC.



Manuales
Manuales

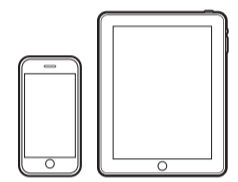

canon.com/ijsetup



How to set up the FAX
Cómo configurar el FAX

canon.com/ijsetup

EN Installed **On-screen Manual**
ES Instado en **Manual en pantalla**