

Canon

Video Display

DP-V2410

Instruction Manual

- Before use, be sure to read this guide, including the safety and handling precautions.
- Reading this guide will help you learn to use the video display properly.
- Store this guide safely so that you can use it in the future.

English

Table of Content

Introduction	4
About this manual	4
Trademarks	4
Supplied Accessories	4
Safety Precautions	5
Handling Precautions	6
Features	8
Nomenclature	9
Installation/Connection	11
How to Carry the Main Unit	11
Procedures to attach the protection panel	11
Procedures to attach/detach stands.....	12
Preventing from Tipping	13
Mounting the Main Unit on a Stand or Wall.....	14
Connecting the Main Unit to Input Devices	15
Turning on the Power	17
Turning on the Power of the Main Unit.....	17
Operating the Video Display	18
Operating the jog dial	18
Basic operations to use the OSD menu.....	18
Adjusting Image Quality While Viewing the Entire Image	20
Temporarily Saving Parameters (Anchor Point Setting).....	21
Calibration without a PC.....	22
Export/Import.....	23
Set Date/Time	25
Inputting Characters.....	25
Using the Function (F) Buttons	26
Using the Channel (CH) Button.....	27
Checking Signal Information and Status of the Main Unit.....	27
OSD Menu	28
OSD Menu Index.....	28
Adjustment.....	34
Channel Settings.....	43
Display Settings.....	45
Audio Settings.....	48
Marker Settings.....	49
Function Settings	54
System Settings	60

Signal Information.....	65
System Information	65
Main specifications/Performance.....	66
Dimensions	67
Appendix	68
Supported Signal Format	68
Image/Frame Display.....	79
Input Signals and Adjustable/Setting Item.....	82
Error Messages	83
Troubleshooting.....	85
Software Used in This Product.....	87
Index.....	89

Introduction





Thank you for purchasing the Video Display DP-V2410.

The On Screen Display (thereafter referred to OSD) default language setting is English. To change the OSD menu language setting, please refer to p. 60.

About this manual

Some of the illustration used in the manual have been simplified for clarity.

Conventions used in this manual

- : Indicates a reference page.
-  Note: Indicates a note.
-  Reference: Indicates reference information.
-  CAUTION: Indicates an item you must observe.

Trademarks

- HDMI, HDMI logo, and High-Definition Multimedia Interface are trademarks or registered trademarks of HDMI Licensing LLC in the U.S. and other countries.
- VESA is a registered trademark or trademark of Video Electronics Standards Association in the U.S. and other countries.
- Other product and company names herein are trademarks or registered trademarks of their respective owners.

Supplied Accessories

The following items are supplied with this product. Please check before using.

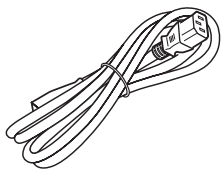

AC Power Cord HT-21

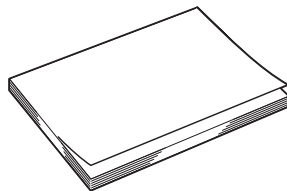

DP-V2410 Instruction Manual
(this document)

Safety Precautions

For the customers in the U.S.A.

This equipment has been tested and found to comply with the limits for a Class A digital device, pursuant to Part 15 of the FCC Rules.

These limits are designed to provide reasonable protection against harmful interference when the equipment is operated in a commercial environment. This equipment generates, uses, and can radiate radio frequency energy and, if not installed and used in accordance with the instruction manual, may cause harmful interference to radio communications. Operation of this equipment in a residential area is likely to cause harmful interference in which case the user will be required to correct the interference at his own expense.

Do not make any changes or modifications to the equipment unless otherwise specified in the manual. If such changes or modifications should be made, you could be required to stop operation of the equipment.

Use of shielded cable is required to comply with class A limits in Subpart B of Part 15 of FCC Rules.

This device complies with Part 15 of the FCC Rules. Operation is subject to the following two conditions: (1) This device may not cause harmful interference, and (2) this device must accept any interference received, including interference that may cause undesired operation.

Canon U.S.A Inc.
One Canon Park, Melville, NY 11747, U.S.A.
Tel No. (631)330-5000

For the customers in Canada

CAN ICES-3 (A) / NMB-3 (A)

For the customers in Europe

This product may cause interference if used in residential areas. Such use must be avoided unless the user takes special measures to reduce electromagnetic emissions to prevent interference to the reception of radio and television broadcasts.

CANON INC.
30-2, Shimomaruko 3-chome, Ohta-ku, Tokyo 146-8501, Japan

CANON EUROPA N.V.
Bovenkerkerweg 59, 1185 XB Amstelveen, The Netherlands



Only for European Union and EEA (Norway, Iceland and Liechtenstein)

This symbol indicates that this product is not to be disposed of with your household waste, according to the WEEE Directive (2012/19/EU) and national legislation. This product should be handed over to a designated collection point, e.g., on an authorized one-for-one basis when you buy a new similar product or to an authorized collection site for recycling waste electrical and electronic equipment (EEE). Improper handling of this type of waste could have a possible negative impact on the environment and human health due to potentially hazardous substances that are generally associated with EEE. At the same time, your cooperation in the correct disposal of this product will contribute to the effective usage of natural resources. For more information about where you can drop off your waste equipment for recycling, please contact your local city office, waste authority, approved WEEE scheme or your household waste disposal service. For more information regarding return and recycling of WEEE products, please visit

www.canon-europe.com/weee.

Handling Precautions

Places to avoid using the video display

Do not use the video display in the following places or conditions.

- Places with excessive dust or humidity
- Places that will expose the video display to direct sunlight, smoke (such as from a kerosene heater or other such source) or steam
- Near heat sources, humidifiers or flammable gas
- Near a window during rain or snow
- Near water or other places that could cause moisture to form on the video display

Screen Handling

- The screen may be damaged if it is left facing strong source of light. Please take precautions when placing it near a window.
- Do not press firmly on the screen, scratch it or place an object on the screen. It can cause non-uniformity or damage to the panel.
- The screen and cabinet may become warm during use. Note this does not constitute a malfunction.

About Backlight

The backlight has a limited service life so its brightness may degrade and color may change due to aging.

About Temporary Screen burn-in

If a stationary image is displayed for a prolonged period, screen burn-in may occur where you see remnants of what was displayed. This is a characteristic of LCD and is not a failure. However, this is only temporary and will disappear when playing video.

About the LCD screen

The screen is produced using extremely high-precision manufacturing techniques, with more than 99.99% of the pixels operating to specification. Less than 0.01% of the pixels may occasionally misfire or appear as black, red, blue or green dots. In addition, this tendency may increase through long term use due to characteristic of the LCD panel. These do not constitute a malfunction.

Condensation

If this equipment is brought into a warm room while it is cold or if the room is heated suddenly, condensation may form on the surface or inside the equipment. Note that the equipment may be damaged if it is used under such condition. If condensation has formed on the surface or inside the equipment, do not use the video display as it may get damaged. Turn the power off and wait until the condensation has evaporated before using the video display.

Cleaning

- Before cleaning, be sure to unplug the AC power supply and DC power plug from the wall outlet.
- The screen has a special surface treatment, avoid touching it directly with your hand. In addition, never affix adhesive objects such as seals.
- Never use alcohol or benzene, thinner, acidic cleaning solution, alkaline cleaning solution, abrasive or chemical wipes because these will damage the screen.
- If the screen is dirty, wipe gently with soft dry cloth such as cleaning cloth or eye glasses cleaning cloth. Wiping the screen too hard may cause unevenness on the screen or damage the LCD panel. The screen may be scratched if wiped too hard with a cleaning cloth with foreign particles attached.
- When the screen is extremely dirty, wipe with soft cloth such as cleaning cloth or eye glasses cleaning cloth moistened with water-diluted neutral detergent.
- Use a blower to remove dust from the surface of the screen.
- Wipe dirt on cabinet with a soft cloth. If the screen is very dirty, use a moistened cloth with water or mild detergent diluted with water. Do not use alcohol, benzene, paint thinner, or pesticides as they may damage the surface finish or erase characters on the cabinet.

Disposing

- Do not dispose together with normal waste. Do not include the video display in waste that will be taken to landfill.
- Observe the rules and regulations of your local authorities when disposing.

Features

Video Display DP-V2410 is a reference display suitable for video production for both digital cinema and broadcasting. The video display provides high image quality made possible by Canon's image-making technology as well as built-in performance and functions suitable for shooting video. The video display uses a 24-inch panel with 4096x2160 resolution. It is also highly portable because it is compact and light weight and can be used with a DC power supply.

Image quality and functions perfect for shooting video

- Equipped with a panel with 4096x2160 resolution and backlight system.
- High brightness is available when used in a bright place.
- High contrast of 2000:1 is provided.
- High uniformity is provided by minimizing the variation due to temperature changes and aging.
- Supports wide DCI-P3 color gamut.
- Equipped with functions to improve image quality performance.
 - Supports "Boost Contrast" to increase the brightness when used in a bright place.
 - Displays ITU-R BT.2020 color gamut at the optimum level and supports "Constant Luminance".
- Equipped with the High Dynamic Range (HDR) display function.
- Supports ACESproxy (ACES 1.0).
- Equipped with functions to assist shooting and video checking including Wave Form Monitor, Vector Scope, Screen Capture, Zoom, and False Color.
- Supports gamma equivalent to CRT standardized by ITU-R BT.1886.
- A color grading controller (Element-Tk made by Tangent Wave Ltd), external sensor, or USB memory can be connected to the USB port.
- Separately-sold Display Controller CL-01 can be connected to the LAN terminal.
- Equipped with a HDMI input terminal.

Use with other Canon equipment

- Supports 4K RAW.
- Establishes 4K RAW workflow on ACES.
- Can be used with Cinema EOS System cameras.
 - Equipped with functions to automatically display a camera's shooting information and switch image quality modes by using meta information of the camera.
 - Special gamma for "Canon Log 2" that EOS C300 Mark II has is available.
- It can display data on Canon cameras supporting HDMI Time Code output.
- Equipped with the Fan Stop function interlocked with the REC signal of Canon professional-use video cameras.

Portability

- Small, light-weight body with a 24-inch panel and weight of less than 12 kg
- High durability achieved by a metal outer covering
- The handle on the main unit is convenient for installation and transporting. The handle and adjustable two position stand provides flexible installation and high portability.
- Supports DC power supply input.

Nomenclature

■ Front face of the main unit

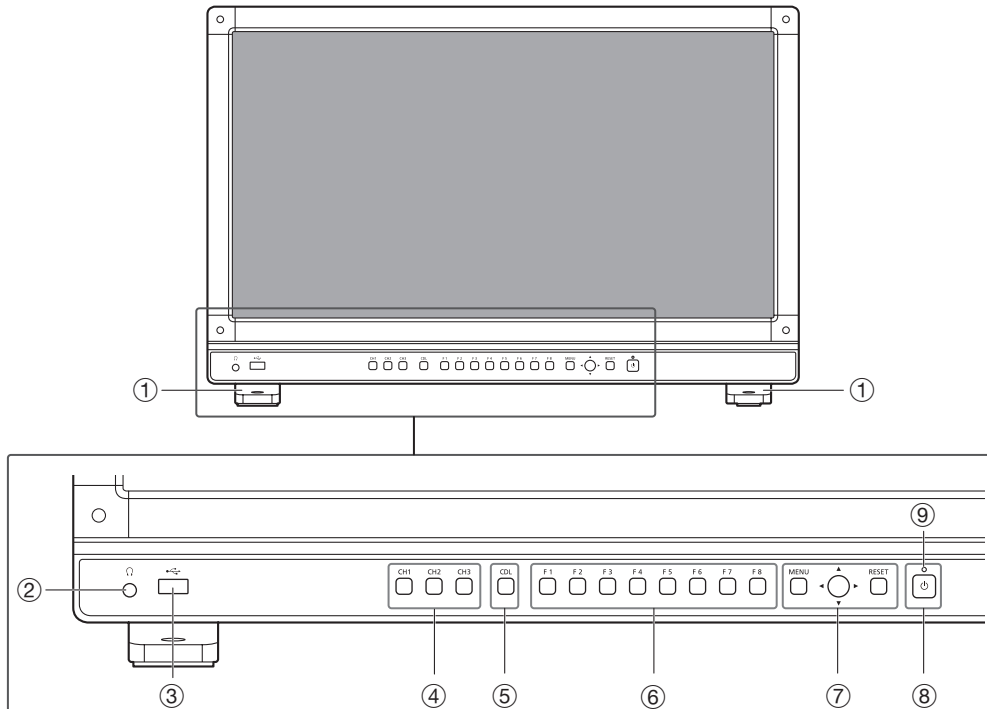

①	Stand	There are two mounting positions.	12
②	Headphone terminal	Connection for headphone set.	48
③	USB port	Connection for an external sensor for calibration (22), USB memory, HUB, or color grading controller (Element-Tk made by Tangent Wave Ltd).	-
④	CH1 to 3 buttons	Changes channel.	27
⑤	CDL button	Switches between normal and CDL mode.	-
⑥	F1 to F8 buttons	Execute the defined function. You can assign different functions on F buttons in the normal and CDL modes respectively.	26
⑦	MENU button	Opens/closes the OSD menu, or moves up one level in a menu.	18
	Jog dial	Moves the selection frame within the OSD menu, changes the settings (up/down, left/right, rotation) and determines (press) the selection.	18
	RESET button	Resets the items to be adjusted using the slider and entered characters.	18
⑧	(Power) button	Turns power On/Off.	17
⑨	Power indicator	Displays the status of the main unit. The brightness of the power indicator can be set from "Off" or "1 (dark) to 5 (brightest)" (62). Even when the power indicator is "Off", it will flash during firmware upgrade, or when an error is detected. Off: when AC or DC power supply is not connected Green lit: when an AC or DC power supply is connected and the power of the video display is on Green flash: during calibration or firmware upgrade Amber lit: during standby (an AC or DC power supply is connected and the power of the video display is off) Amber flash: when error is detected	-

■ Back face of the main unit

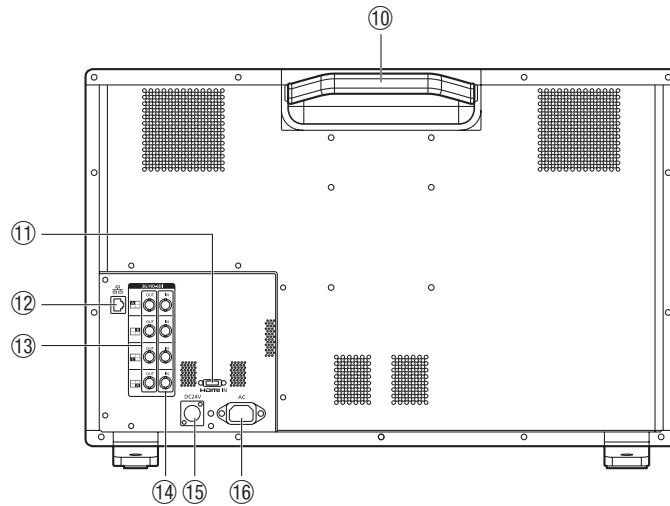

⑩	Carrying handle	Used to install, connect, or carry the unit.	11
⑪	HDMI input terminal	Used to input HDMI signals.	16
⑫	LAN (10/100 BASE) terminal	Connection for a Display Controller CL-01 (separately sold) or other equipment.	-
⑬	3G/HD-SDI output terminal	Pass through output corresponding to 3G/HD-SDI input terminal.	-
⑭	3G/HD-SDI input terminal	Used to input SDI signals.	15
⑮	DC power input terminal	Connection for DC power supply.	17
⑯	AC power input terminal	Connection for the provided AC power supply cord.	17

CAUTION

- When connecting an external sensor for calibration to the USB port, cable length must not exceed 3 m. Otherwise, communication error may occur and correct calibration may not be possible.
- For safety, do not connect any connector that may have excessive voltage to the terminal of the video display when connecting peripheral devices.
- Pass through SD-SDI signals are not output correctly.

Note

- Both FAT16 and FAT32 USB memory devices are supported.
- Proper operation cannot be guaranteed for all USB memories.
- It may take 10 seconds or more for the USB memory to be recognized. If the function to save data on a USB memory is executed during recognition, the message "Detecting USB memory" is displayed.

Installation/Connection

How to Carry the Main Unit

When lifting the video display, be sure to hold the carrying handle on the back.

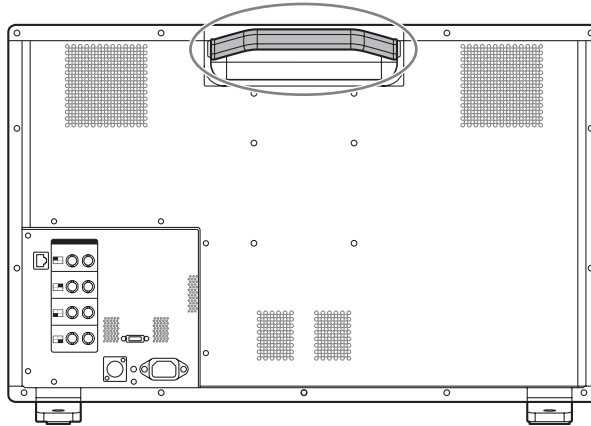

⚠ CAUTION

- When carrying the video display, handle it carefully not to touch or damage the screen.

Procedures to attach the protection panel

You can attach the protection panel to protect the screen when carrying the video display or when using it outdoors.

1. Unscrew the four screws on the front face.

Use a 1.5 mm hexagonal key.

Do not lose the removed screws. Do not use these screws for other purposes.

2. Place the protection panel by aligning its corners with the screw holes. (📖 67).

Take care when attaching the panel in order to avoid damaging it.

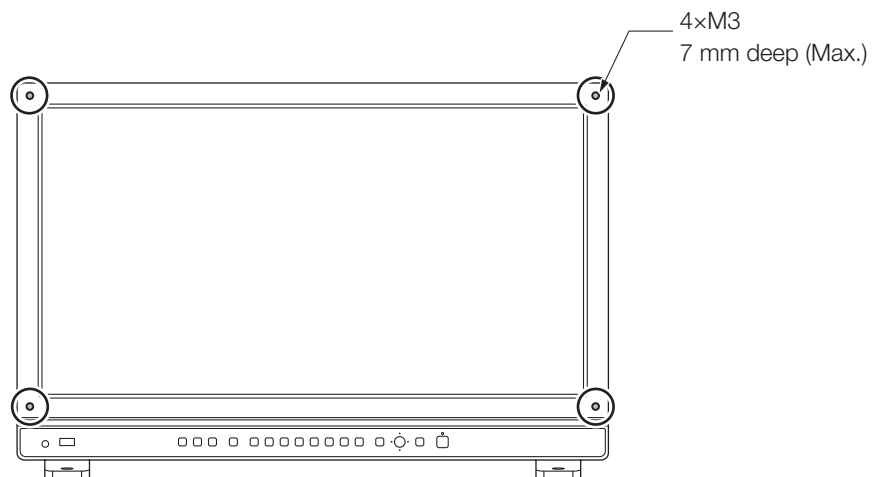

⚠ CAUTION

- Avoid touching the screen during this step as it may damage it.

Procedures to attach/detach stands

The stand can be attached in two different positions. This section describes the procedure to attach/detach the stand, to change the stand position. It also describes the procedure for installing the video display on a rack or a wall.

⚠ CAUTION

- Use a flat, clear surface when attaching/detaching the stand.
- The display can tip over if the stand has not been attached.
- Avoid touching the screen during this step as it may damage it.

■ Detaching

1. Place the display with the screen facing down on a soft cloth or cushioning material that is larger than the display.
2. Remove four fixing screws.
Do not lose the removed screws. Do not use these screws for other purposes.

■ Attaching

1. Place the display with the screen facing down on a soft cloth or cushioning material that is larger than the display.
2. Align the position of the stand and screw hole on the video display.
Align the convex part of the stand and concave part of the video display.
3. Fix the left and right stands using two fixing screws respectively.

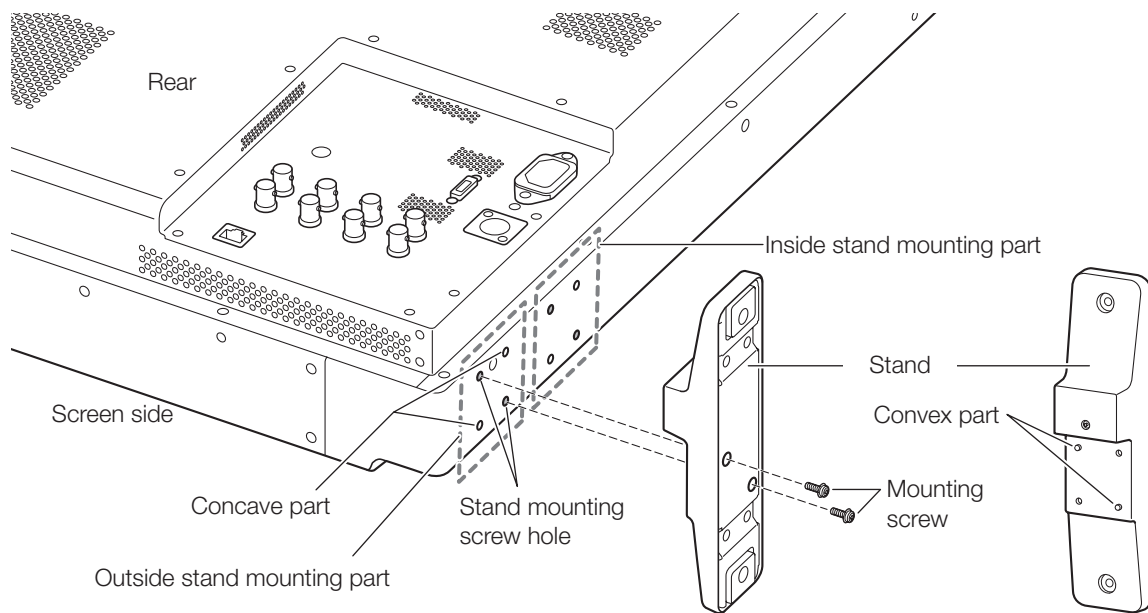

📝 Note

- It is recommended to mount both stands in either the outside or inside positions.

Preventing from Tipping

Fixing the video display using screw holes on the stands can reduce the risk of the main unit tipping over or falling.

1. Use screws that fit the screw holes.

The screw hole size is shown below.

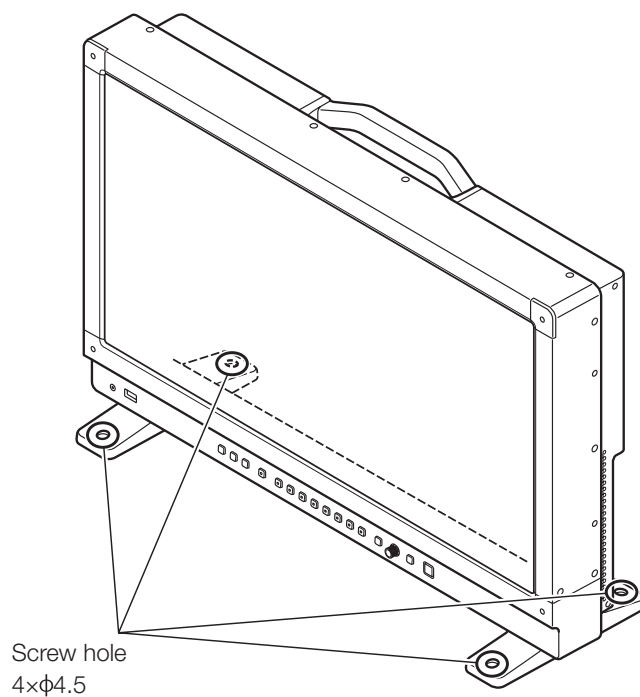

CAUTION

- When securing the main unit to a table or desk, please ensure a table or desk is strong enough to carry the weight of the main unit.
- It is recommended to obtain assistance from another person when performing this step.
- Avoid touching the screen during this step as it may damage it.

Mounting the Main Unit on a Stand or Wall

This main unit can be fitted to a stand* or to a wall mount bracket*. Remove the stands beforehand (📖 12). Screws compatible with this main unit are M4 x 7 mm (VESA Standard 100 x 100 mm).

* Commercially available.

⚠ CAUTION

- For safety, make sure to perform this step with at least two people.
- When mounting the main unit on a wall, make sure the wall has sufficient strength. If necessary, apply reinforcement. Also, make sure to check the load capacity of the stand or wall mount bracket.
- When the video display is placed on a rack or display stand and ventilation around it is blocked by equipment placed above or below or in a surrounding area, the operating temperature may increase, causing a failure or overheating. In order to maintain the operating temperature condition of the video display (0 °C to 40 °C), make a space of at least 1U (4.4 cm) above and below and at least 4 cm space from its back. Make a sufficient space from peripheral equipment, secure vents, or install a ventilation fan.
- When installing the video display on a wall, make sufficient space from the wall so that cables are not squeezed or twisted.
- When mounting a commercially available stand or wall mount bracket, be sure that they do not contact the carrying handle.
- Avoid touching the screen during this step as it may damage it.
- Make sure that the main unit does not fall during installation/removal.

1. Attach a commercially available stand or wall mount bracket using four screw holes on the back or side face of the main unit (📖 67).

The screw hole size is shown below.

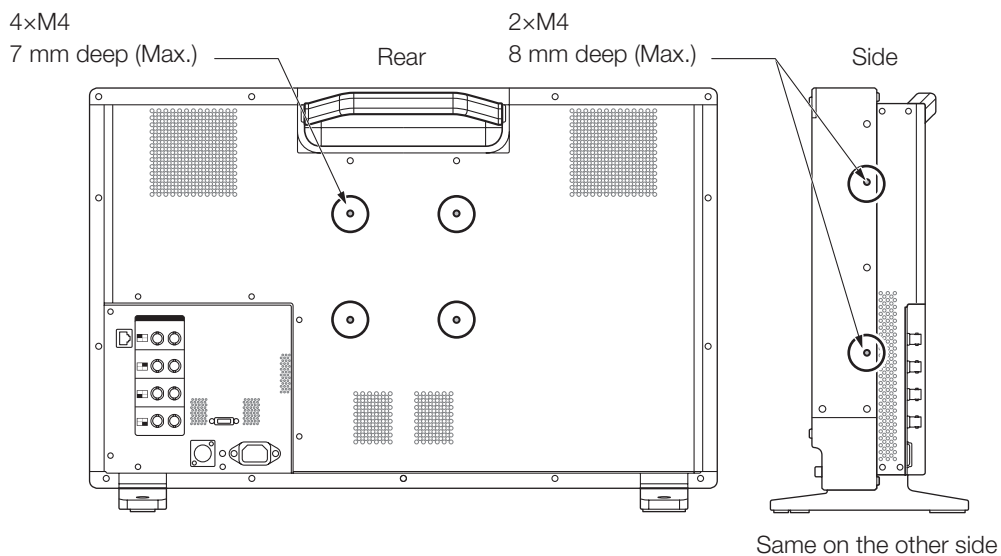

Connecting the Main Unit to Input Devices

The video display has 3G/HD-SDI and HDMI input terminals that input devices are connected to.

CAUTION

- Check that the power of the video display and input devices is switched off before connecting.

■ To input 4K signals using 3G/HD-SDI input terminal

- 3G/HD-SDI

3G/HD-SDI has four inputs which correspond to a display area. The display area icons located in the 3G/HD-SDI input terminal area show where the input video is displayed on the screen. Please ensure these are connected correctly as indicated by the icons.

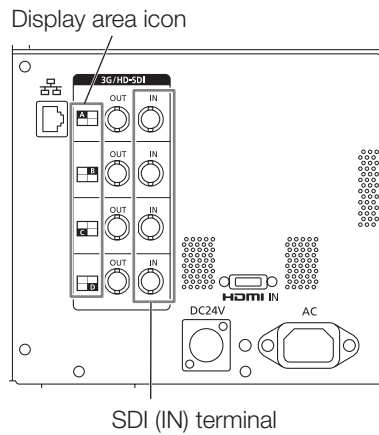

- 3G-SDI RAW

To input 3G-SDI RAW, signals with a frame rate of 30.00 P or smaller can be input using one input in Input A-D. Signals with a frame rate over 30.00 P require two inputs either Input A and Input B or Input C and Input D.

When the frequency is 30.00P or less

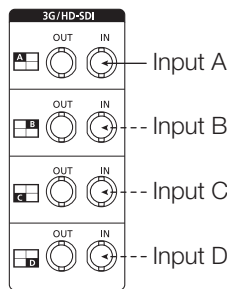

When the frequency is over 30.00P

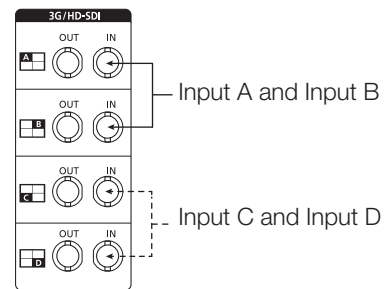

Reference

- The connection is checked using Canare Corp. BNC cable (multi) 4VS03A-5C.
- 3G-SDI RAW throughout output corresponds to the terminal. Even during full-screen display, when signals are input from Input A, connect the cable to the SDI (OUT) terminal of Input A.

■ To input signals from the HDMI input terminal

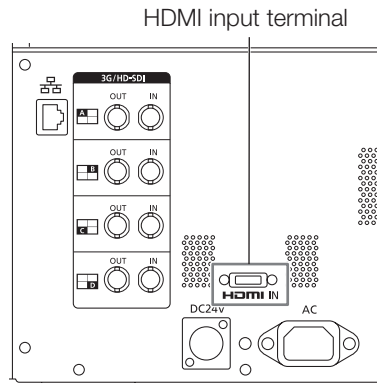

CAUTION

- Use a HDMI cable with the High Speed logo that complies with the HDMI standard. When a non-compliant HDMI standard cable is used, the video display may not work normally, for example a video becomes choppy or nothing is displayed.

Turning on the Power

This section describes how to turn on the power of the main unit.

Turning on the Power of the Main Unit

1. Plug the provided AC power cord HT-21 to the AC power supply input terminal at the rear.

The video display goes into standby and the power indicator lights up in amber.

■ When using a DC power supply

DC power supply input terminal specifications are shown below. When connected normally, the video display goes into standby and the power indicator lights up in amber.

- ❖ Check the specifications of the DC power supply input terminal and use a power supply that is compatible with the video display. Using a power supply with incompatible voltage and polarity may cause fire or electric shock.

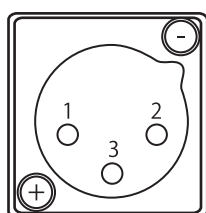

Pin No.	Signal
1	- (GND)
2	+ (24 V to 28 V, allowable current 10 A min.)
3	N.C.

2. Press the power supply button at the front.

The power indicator lights green.

CAUTION

- When using the provided power plug adapter PU-01, be sure to connect the ground terminal to the ground.
- Use a 2 m or shorter DC cord that can bear an electric current of at least 10 A. When a cable longer than 2 m is used, the video display may not work normally for example a video becomes choppy and nothing is displayed.
- Do not connect cables for audio devices or sound cables to the DC power supply input terminal, as it may cause damage to the display unit.

Note

- Warming-up is necessary to stabilize the brightness of the video display. Wait at least 10 minutes after turning on the power before using.
- When an AC power supply is connected during the use of a DC power supply, the power source is switched to the AC power supply. When this happens, the power is turned off temporarily and then turned on again.
- Refer to the Canon website for detailed information about DC power supplies for which operation has been confirmed.

Operating the Video Display

Using buttons and jog dial on the video display, you can adjust image quality and configure settings for input signals. In addition, you can assign the frequently used functions to the CH and F buttons.

Operating the jog dial

The procedures to operate the jog dial are described below.

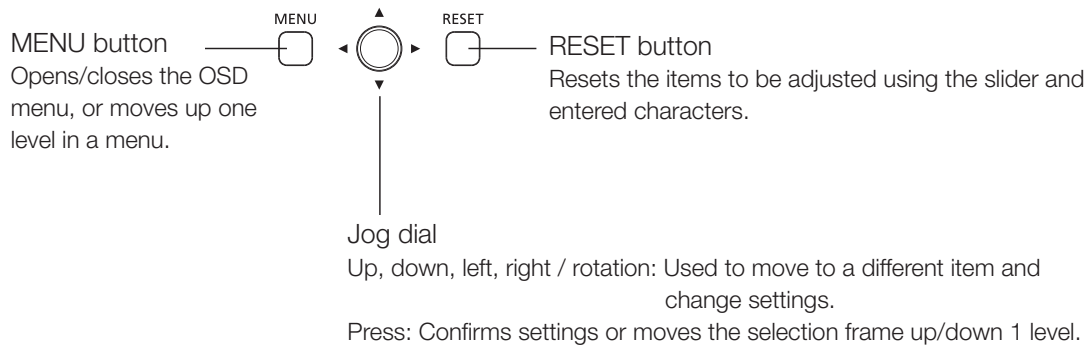

Basic operations to use the OSD menu

This section describes basic operations to use the OSD menu.

1. Press the MENU button to open the OSD menu.

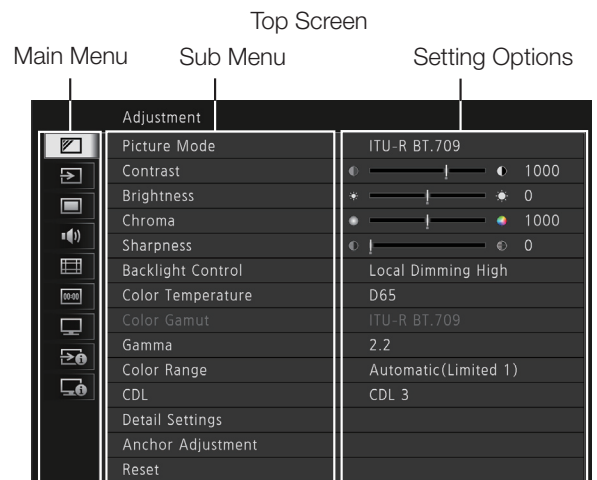

2. Select an item using the jog dial and press it to determine the selection.

The selection frame moves to sub menu.

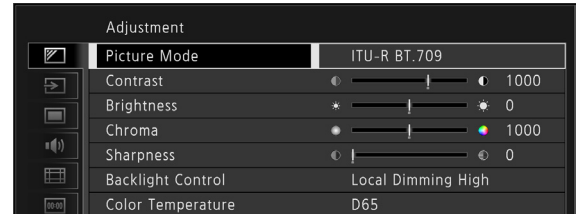

3. Select an item using the jog dial and press it to determine the selection.

The selection frame moves to setting options.

4. Select the setting using the jog dial.

Settings change according to the operation of the jog dial.

5. Press the jog dial to determine the selection.

The selection frame returns to sub menu.

6. Exit menu.

When you press the MENU button, the selection frame moves up one menu level. Move the selection frame all the way to the main menu on the top screen and then press the MENU button to exit the menu.

Note

- Press the RESET button to return "Contrast", "Brightness", "Chroma", "Sharpness", "Power", "Saturation", "Offset", and "Slope" to the factory default during adjustment. In "User 1-7" mode where you are performing calibration, the setting returns to the value after calibration instead of the factory default.
- To adjust image quality, warming-up is necessary to stabilize the brightness of the video display. Wait at least 10 minutes after turning on the power before using.
- The OSD menu and slider will disappear automatically if no operation is performed for approximately 1 minute. The F button will disappear automatically if no operation is performed for approximately 10 seconds.
- The settings that cannot be set, are grayed out.

Adjusting Image Quality While Viewing the Entire Image

You can adjust the OSD menu to display as a slider at the bottom of the screen. This allows for the image quality to be adjusted whilst it is displayed on the screen.

1. **Press the jog dial when the selection frame is on setting options.**
A slider appears at the bottom of the screen.
2. **Make adjustments using the jog dial with using the slider as guide.**
3. **When adjustments are completed, press the jog dial.**
The screen returns to the original OSD menu.



■ Adjusting "Gain R/G/B, Bias R/G/B" under "Color Temperature"

You can adjust RGB all at once or individually when the slider for adjusting "Gain R/G/B" and "Bias R/G/B" are displayed.

1. **Switch the guide in the upper right area of the slider screen using the jog dial (▲▼).**
The indication changes to "RGB", "R", "G", and "B".
2. **When adjustments are completed, press the jog dial.**
The screen returns to the original OSD menu.

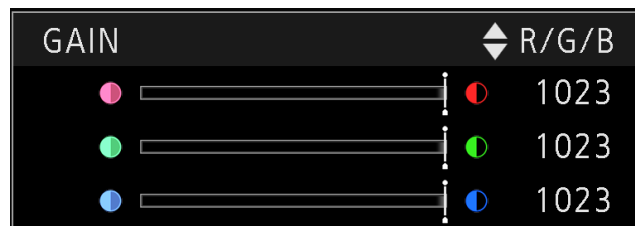

■ Adjusting "x, y" under "Color Temperature"

You can adjust "x, y" in "Color Temperature" on the color map.

1. **Adjust "x" with the ◀▶ and "y" with ▲▼.**
The adjusted value is indicated by the "○" mark on the color map.
2. **When adjustments are completed, press the jog dial.**
The screen returns to the original OSD menu.

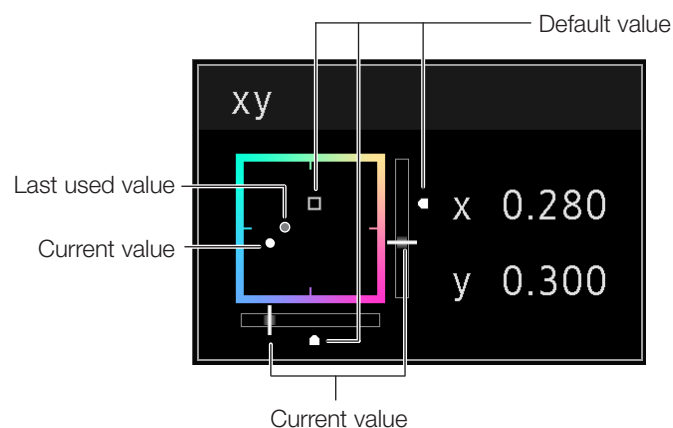

Temporarily Saving Parameters (Anchor Point Setting)

You can temporarily save parameters for "Contrast", "Brightness", "Chroma", and "Sharpness" and recover the values. See [39](#) for setting anchor points during CDL adjustment.

1. Press the MENU button to open the OSD menu.
2. Select "Adjustment" using the jog dial and press the dial to determine the selection.
The selection frame moves to sub menu.
3. Select "Anchor Adjustment" using the jog dial and press the dial to determine the selection.
When the confirmation screen appears, select "OK". The parameter is saved and sets anchor point.
4. Adjust the image quality again and press the RESET button on the video display.
Press the RESET button to return to each saved anchor point.

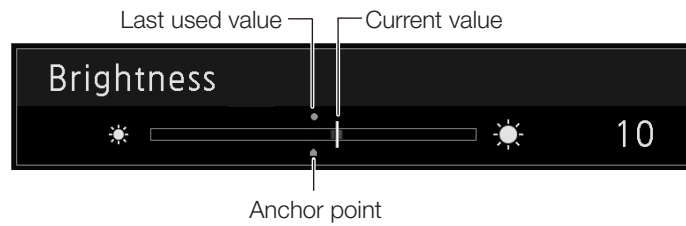

Note

- Executing "Reset" under "Adjustment" or "Reset All Settings" under "System Settings" resets saved anchor points and the settings return to their factory default values.
- When calibration is performed in "User 1-7" under "Picture Mode", the values are saved as anchor points.

Calibration without a PC (📖 40)

When "User 1-7" under "Picture Mode" is selected, you can perform calibration using an external sensor, without using the computer.

The supported external sensors are Konica Minolta Display Color Analyzers CA-310 and CA-210. Be sure to also read the instruction manual of the CA-310 and CA-210.

1. Connect the display color analyzer to the USB port of the main unit.

2. Open the OSD menu and select "Adjustment" → "Detail Settings" → "Calibration".

Set each target value.

3. Press the jog dial and select "Start".

Please follow the information indicated on the screen.

4. Initialize the sensor.

Set the mode dial of the Universal Measuring Probe to "0-CAL".

Press the jog dial of the video display, select "OK", and execute initialization.

5. Place the universal measuring probe pointing at the center of the video display.

Set the mode dial of the universal measuring probe to "MEAS" and place the probe as shown below according to the displayed content. Press the jog dial of the video display, select "OK", and execute calibration.

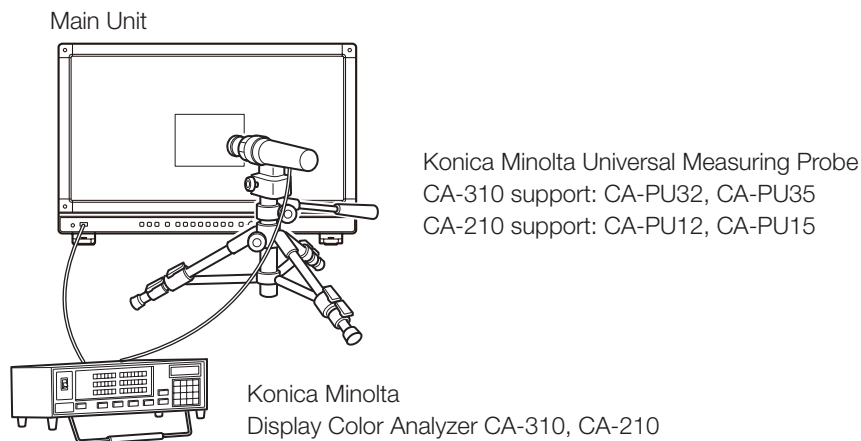

6. Finish calibration.

When the message "Calibration is completed". is displayed, press the jog dial and select "OK".

- If the message "Calibration error." is displayed.
Calibration has been terminated due to an error. The main unit returns to the state before calibration. (📖 83)
- To cancel calibration
Press the jog dial during calibration and select "Cancel". The main unit returns to the state before calibration.

Note

- Due to the characteristic of LCD panel and individual difference of CA-310 and CA-210, the calibration results may differ.
- Perform matrix calibration of the display color analyzer prior to calibration. If calibration is performed without performing matrix calibration, an error may occur. Refer to the CA-310 and CA-210 instruction manual for the detail operation.
- Warming-up is necessary to stabilize the brightness of the video display. Wait at least 10 minutes after turning on the power before calibration.
- Perform calibration in a dark room so that no external light enters the sensor. If external light enters the sensor, low brightness characteristics cannot be calibrated correctly.

Export/Import

You can export/import LUT and CDL parameters as well as main menu settings. Insert a USB memory stick into the USB port of the main unit.

■ LUT Import (39)

LUT can be imported except when "ACESproxy" is selected for "Picture Mode" or "ACESproxy" is selected for "Color Gamut".

1. Press the MENU button to open the OSD menu.
2. Select "Adjustment" → "Detail Settings" → "LUT Import" using the jog dial.
3. Select the file using the jog dial.
In the "Filename" field, search and display a file with extension ".clut" in the root folder.
4. Select the LUT file type using the jog dial.
Select the file type of the LUT by using "Gamma" or "Color Gamut".
5. Select "Select LUT" using the jog dial.
Selects User LUT 1-8.
6. Select the standard color gamut using the jog dial.
Select the color gamut used when creating the LUT (when "Color Gamut" under "LUT Type" is selected).
7. Select "Execute" using the jog dial.
When the confirmation screen appears, select "OK". Import starts.

Note

- The LUT file is proprietary to Canon Video Display. Refer to the Canon website for the file format and how to create.
- Up to 1000 LUT import files are recognized.
- You can delete the imported LUT. You can specify the name of LUT ( 39).

■ Export/Import Main Menu Settings (📖64)

1. Press the MENU button to open the OSD menu.
2. Select "System Settings" → "Export/Import".
3. Select "Export" or "Import" using the jog dial.

Exporting

- Select "Target" from "USB" or "User 1-3".
Export "USB" to the USB memory and "User 1-3" to the built-in memory of the main unit.
- Select "Filename".
Factory default is "dinfo_dpv2410.dat". You can change the name of the file to be exported to the USB memory within 16 one-byte characters including alphabetical characters, numbers, and symbols.
- Select "Execute".
When the confirmation screen appears, select "OK". Export starts.

Importing

- Select "Target" from "USB" or "User 1-3".
Specify the destination to save the file to be imported.
- Select "Filename".
- In "Settings", select "All" or "Main Menu Name".
- Select "Execute".
When the confirmation screen appears, select "OK". Import starts.

Note

- After export to "User 1-3", you can select the configurations at startup from "User 1-3" in "Power on Setting" in "System Settings" (📖64).

■ Exporting/Importing CDL Parameters (📖39)

1. Press the MENU button to open the OSD menu.
2. Select "Adjustment" → "CDL" → "Detail Settings" using the jog dial.
3. Select "CDL Export" or "CDL Import".

Exporting

- Select "CDL Preset".
- Select a file format ".ccc" or ".cdl".
- Select "Execute".
When the confirmation screen appears, select "OK". Export starts.

Importing

- Select "Filename".
- Select "CDL Preset".
- Select "Execute".
When the confirmation screen appears, select "OK". Import starts.

Note

- The exported file is automatically saved under the name "YYYYMMDDhhmmss_Preset name.ccc (cdl)".
- Up to 1000 CDL import files are recognized.

Set Date/Time (📖 62)

This section describes how to set the Date/Time. The Date/Time of this video display will be reset if the power cord is not connected for about 20 days.

1. **Press the MENU button to open the OSD menu.**
2. **Select "System Settings"→"Date/Time".**
A screen to input the Date/Time appears.
3. **Move the selection frame using the jog dial.**
Numbers change as you operate the jog dial. Repeat until you complete setting the year, month, date, hour, and minute.
4. **Press the jog dial when you are finished.**
The selection frame moves to "OK".
5. **Check the content and press the jog dial to confirm the settings.**

📘 Reference

- When selecting "Cancel" or pressing MENU button before selecting "OK", the settings will be reset and the previous screen will be displayed.

Inputting Characters

This section describes how to input the characters. Use this function to specify a channel name, a display name, or filename.

1. **Press the MENU button to open the OSD menu.**
2. **The character input screen appears automatically when character input is required.**
Move the selection frame to the location to enter characters using the jog dial (◀▶ or rotation).
3. **Select characters using the jog dial (▲▼ or rotation).**
The following characters can be selected: Press ▲▼ buttons to display them one by one. You can input up to 16 characters.

Alphanumeric characters: A to Z, a to z, 0 to 9

Symbols: , . : ; ' ` - + / = % & ! ? # _ | \$ ^ ~ @ { } [] < > () space

Some characters cannot be used for a filename. In this case, they are automatically skipped.

4. **Repeat steps 2 and 3 until the desired text has been inputted.**
5. **Press the jog dial when you are finished.**
The selection frame moves to "OK".
6. **Check the content and press the jog dial to confirm the settings.**

📘 Reference

- When selecting "Cancel" or pressing MENU button before selecting "OK", the settings will be reset and the previous screen will be displayed.
- To erase the character in the selection frame, press the RESET button of the video display.

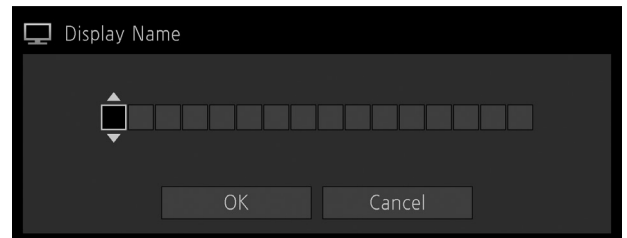

Using the Function (F) Buttons

You can assign functions to the F buttons on the video display to execute them instantly.

1. **Press the MENU button to open the OSD menu.**
2. **Select "System Settings" → "Function/Channel Button" → "Display Function" or "Display Function (CDL)" and press the jog dial to determine the selection.**
A new window opens and displays button names F1 to F8.
3. **Select the name of the button using the jog dial and press the jog dial to determine the selection.**
The selection frame moves to next OSD menu level.
4. **Select the function to assign using the jog dial.**
See "Display Function" or "Display Function (CDL)" (📖61) for the available functions.
5. **Press the jog dial to determine the selection.**
The setting is confirmed.

Reference

- Select "Function Settings" → "Various Function" and set "Function Guide" to "On". Then, you can check the list of functions assigned to F buttons on the video display by pressing the jog dial while OSD is not displayed (📖58).

Using the Channel (CH) Button

You can assign channels (various settings related to input signal) to the CH buttons on the video display and switch channels instantly.

1. **Press the MENU button to open the OSD menu.**
2. **Select "System Settings" → "Function/Channel Button" → "Display Channel" and press the jog dial to determine the selection.**
A new window opens and displays button names CH1 to CH3.
3. **Select the name of the button using the jog dial and press the jog dial to determine the selection.**
The selection frame moves to next OSD menu level.
4. **Select the channel to assign using the jog dial.**
See "Channel Settings" (📖 43) for the configurable settings.
5. **Press the jog dial to determine the selection.**
The setting is confirmed.

The following content is assigned to channel buttons on the video display by factory default.

CH	CH1	CH2	CH3
Input Configuration	3G/HD-SDI	HDMI	3G-SDI RAW
Select Input Signal	Automatic	Automatic	Automatic
Format	Automatic	Automatic	Automatic
Internal Sync	Off	Off	Off
Channel Name	(Blank)	(Blank)	(Blank)
Picture Mode	ITU-R BT.709	ITU-R BT.709	Canon Log
Color Range	Automatic	Automatic	Automatic

Checking Signal Information and Status of the Main Unit

The video display is equipped with a banner function which displays signal information or the status of the main unit.

1. **Press the jog dial when the OSD menu is closed.**
The channel name, signal information, and status of the main unit will be displayed in the banner. It will automatically disappear after 6 seconds.

Note

- For more detailed signal information, please refer to the section on "Signal Information" (📖 65).
- The "Detecting sync." banner will continue to appear until the input signal is synchronized.

OSD Menu

OSD Menu Index

Adjustment (📖 34)

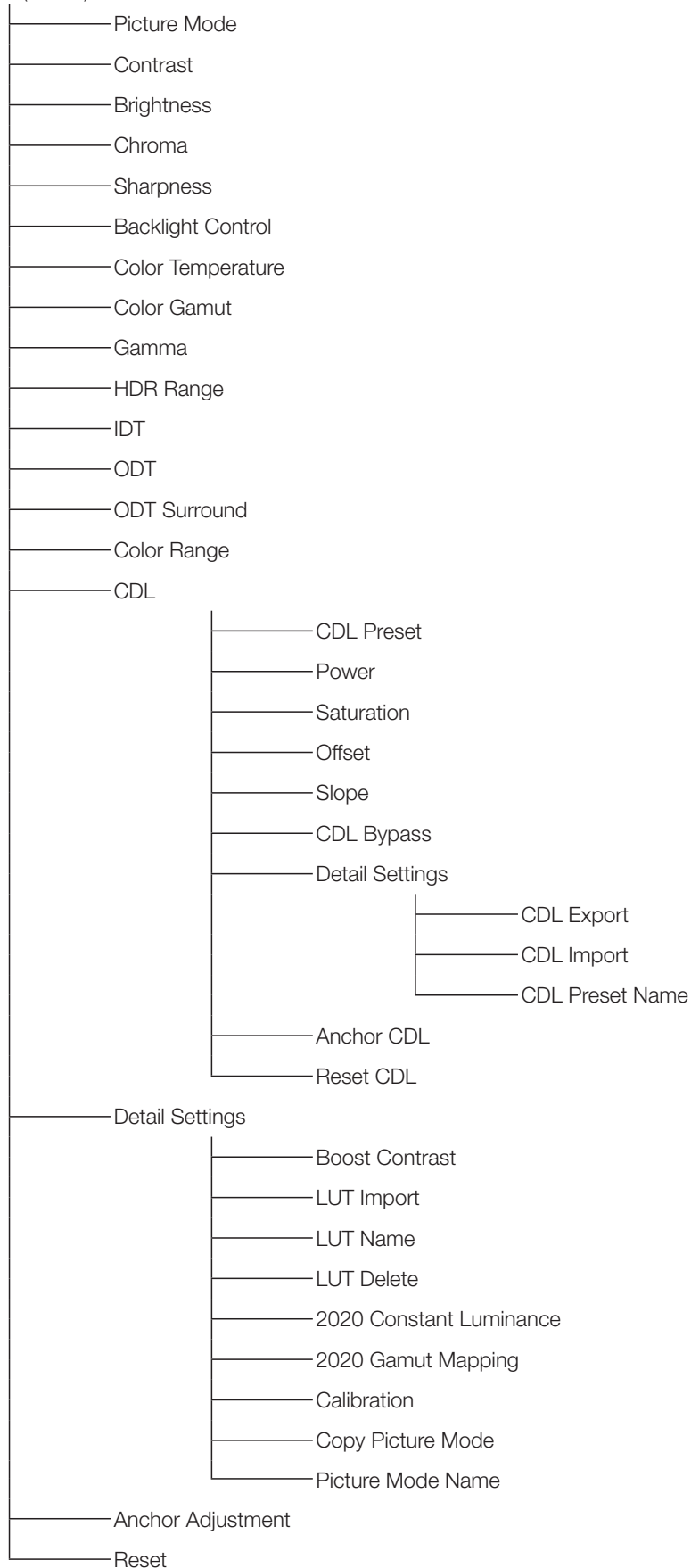

Channel Settings (43)

- Select Channel
- Input Configuration
- Select Input Signal
- Format
- Internal Sync
- Channel Name
- Picture Mode
- Color Range

Display Settings (45)

- Screen Scaling
- Zoom
- Scaling Method
- Frame Hold
- Background Color
- I/PsF
- I/P Conversion
- PsF
- Film Cadence

Audio Settings (48)

- SDI Group
- CH L/R (SDI)
- CH L/R (HDMI)
- Volume
- Audio Switch
- Select Input

Marker Settings (49)

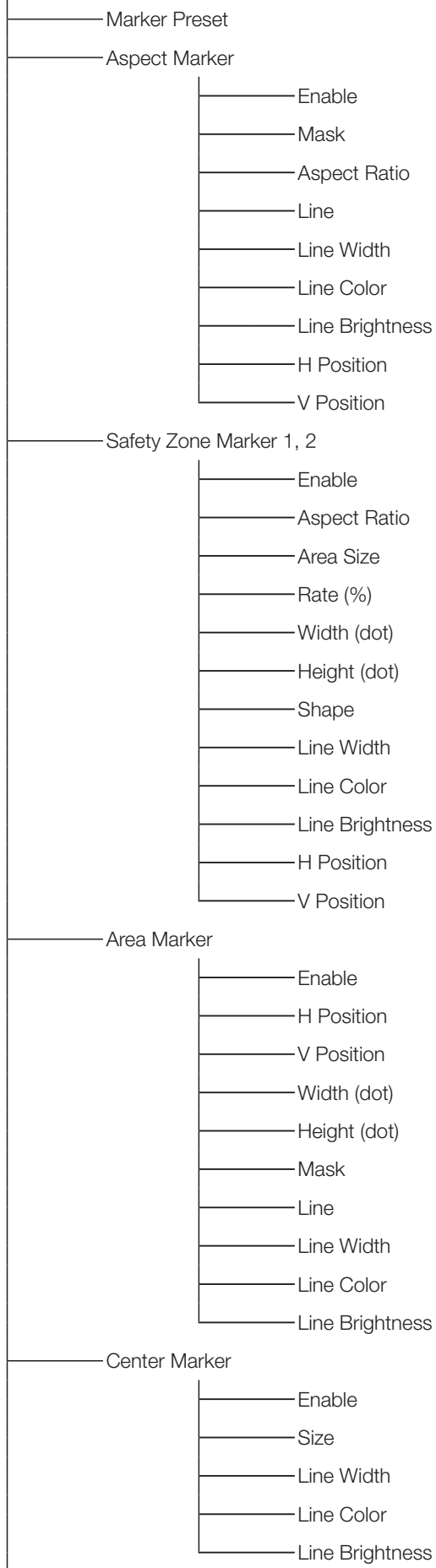

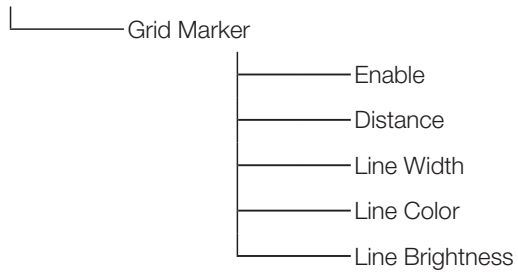

Function Settings (📖 54)

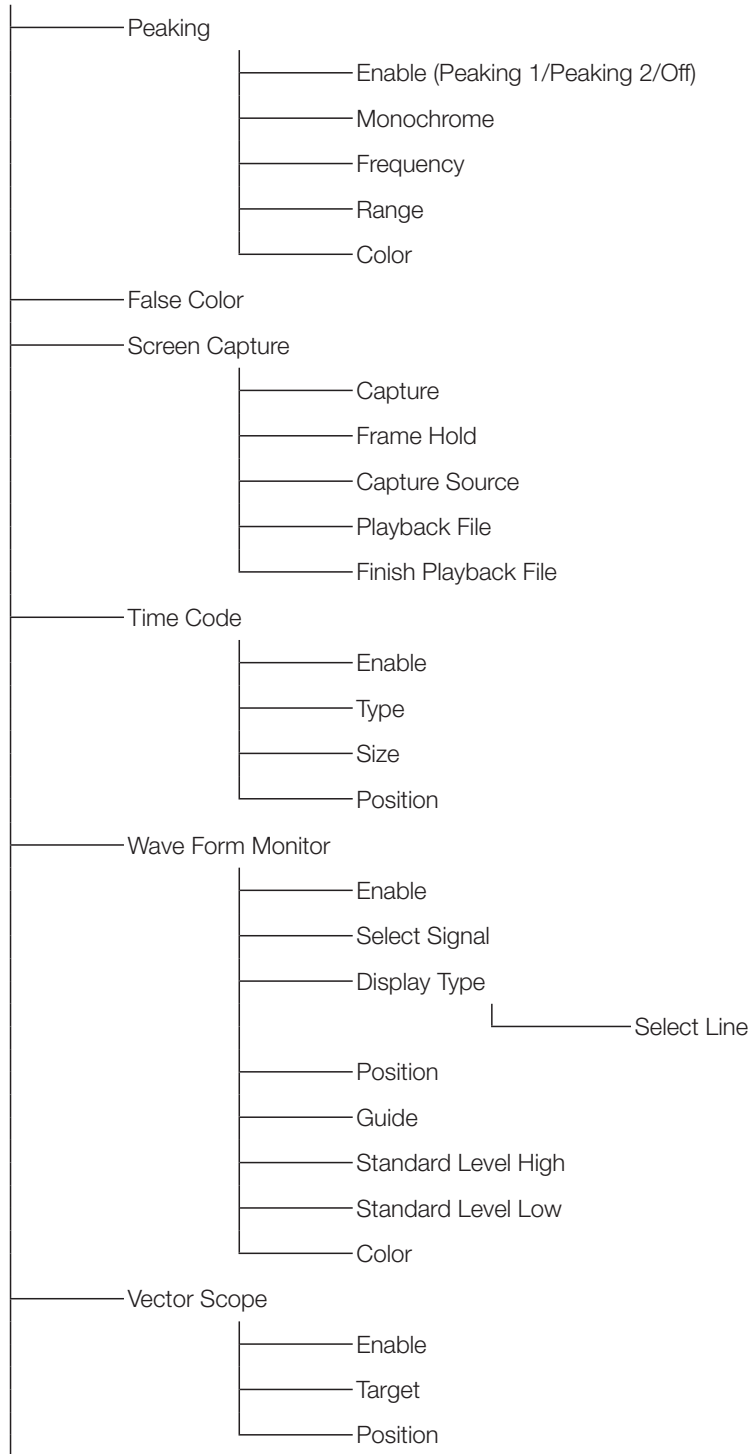

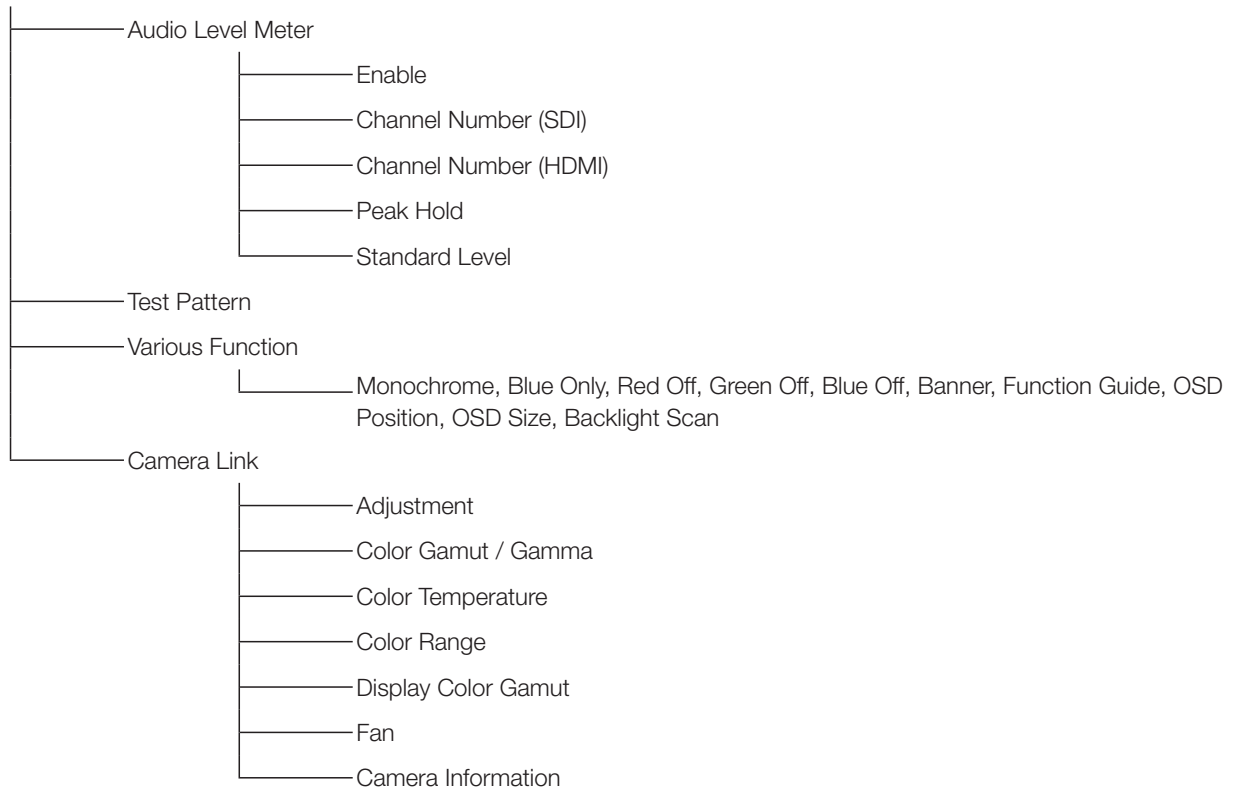

System Settings (📖 60)

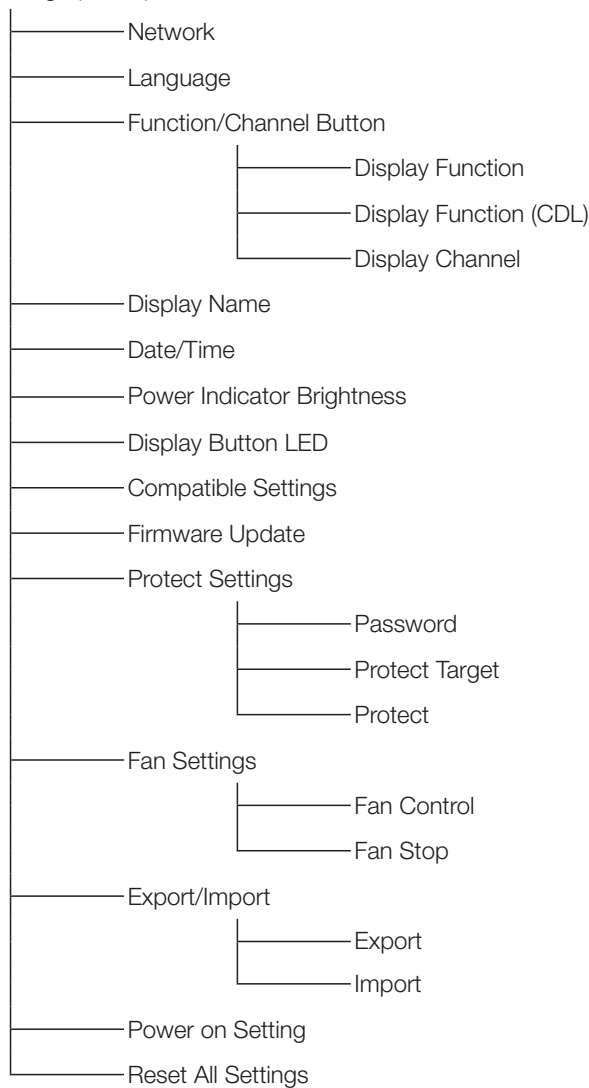

Signal Information(📖65)



- Channel
- Input Configuration
- Select Input Signal
- Format
- Resolution
- Picture Rate, I/P/PsF
- SDI Payload ID
- Video Standard
- Sampling Structure
- Bit Depth
- Picture Rate
- Scanning Method
- Link Number
- Pixel Encoding
- Color Depth
- Matrix
- RGB Range



System Information (📖65)

- Display Model Name
- Display Serial No.
- Display Firmware Ver.
- Display Usage Time
- Display IP Address
- Display Subnet Mask
- Display MAC Address

Adjustment

This menu is used to adjust the image quality and perform calibration without a PC.

Item	Setting Options (underline indicates factory default)
Picture Mode	<p>Select a preset mode. See  41, 42 for each setting.</p> <p>SMPTE-C, EBU, <u>ITU-R BT.709</u>, ITU-R BT.2020, Adobe RGB, DCI-P3: Mode set to the brightness, color temperature, gamma, and color gamut of the three primary colors chromaticity points of each standard.</p> <p>User 1-7: Custom modes. Set each item of "Adjustment". You can change the mode name within 16 one-byte characters including alphabetical characters, numbers, and symbols.</p> <p>Canon Log: Canon Log is ideal when viewing image captured with CINEMA EOS SYSTEM camera/video camera. Performs linear conversion and displays Canon Log video without having to import Viewing LUT.</p> <p>ACESproxy: A mode to display ACESproxy (ACES 1.0) videos in optimum gamma and color gamut.</p>
Contrast	<p>Adjusts the white level of the image. (Increments of 1) When "Boost Contrast" is "On", "Contrast [BOOST]" is displayed.</p> <p>0 to 1500</p> <p>❖ When "Boost Contrast" in "Detail Settings" is set to "On", the settable range is shown below.</p> <p>1500 to 4000</p>
Brightness	<p>Adjusts the black level of the image. (Increments of 1)</p> <p>-500 to 500</p>
Chroma	<p>Adjusts the color saturation of the image (color depth). (Increments of 1)</p> <p>0 to 2000</p>
Sharpness	<p>Adjusts the sharpness of the image. (Increments of 1)</p> <p>0 to 100</p>
Backlight Control	<p>Switches the backlight control method.</p> <p>Local Dimming (High, Low): Local dimming is a technology to control the amount of light emitted by the backlight for each area. The backlight of bright area is increased and the dark area is decreased according to the displayed content.</p> <p>Global Dimming: Global dimming is the ability to control the amount of light emitted by the backlight on the entire screen. If the image is dark, the whole display is darken.</p> <p>Off: No backlight dimming.</p> <p> Note</p> <ul style="list-style-type: none"> • When "Global Dimming" is selected, the contrast may change temporarily in order to maintain gradation depending on the image. If this is undesirable, turn it "Off" and see if it improves. • When "Boost Contrast" is set to "On", "Backlight Control" turns to "Off".



Item	Setting Options (underline indicates factory default)																		
Color Temperature	<p>Sets the color temperature.</p> <p>D93, D65, D61, D60, D56, D50, DCI-P3: Select from preset color temperatures.</p> <p>Gain R/G/B, Bias R/G/B: Can be adjusted in increments of 1 when a preset color temperature is selected.</p> <p>Gain R/G/B: 0 to 1023 (in increments of 1)</p> <p>Bias R/G/B: -500 to 500 (in increments of 1)</p> <p>Custom (xy): You can adjust CIE x, y in increments of 0.001.</p> <p>x: 0.260 to 0.360 (in 0.001 increments)</p> <p>y: 0.260 to 0.360 (in 0.001 increments)</p> <p> Note</p> <ul style="list-style-type: none"> • "Custom (xy)" and "Gain R/G/B" or "Bias R/G/B" cannot be selected at the same time. • If "Custom (xy)" are modified after adjusting "Gain R/G/B" or "Bias R/G/B" then both these values will return to factory default. • When "Gain R/G/B" or "Bias R/G/B" value is adjusted, an asterisk "*" is displayed by color temperature preset mode. • The displayed color coordinates (x, y) are just a guide and not guaranteed absolute values. 																		
Color Gamut	<p>Color gamut can be selected when "User 1-7" or "Canon Log" is selected for "Picture Mode".</p> <p>SMPTE-C, EBU, ITU-R BT.709, ITU-R BT.2020, Adobe RGB, DCI-P3: Color gamut compliant to each standard.</p> <p>Native: Color gamut that can be displayed by this video display.</p> <p>Cinema Gamut to 709, Cinema Gamut to 2020, Cinema Gamut to DCI, DCI-P3+ to 709, DCI-P3+ to DCI, DCI-P3 to 709, ITU-R BT.2020 to 709: Modes where the color gamut is converted to monitor Cinema Gamut, DCI-P3+, BT.2020, and DCI-P3 videos recorded by the CINEMA EOS SYSTEM EOS C500/C500PL and C300 Mark II</p> <p>ACESproxy: Displays the color gamut of ACESproxy.</p> <p>User LUT 1-8: Sets by loading an external LUT.</p> <p> Note</p> <ul style="list-style-type: none"> • For checking the video captured with Cinema EOS System, please refer to the "Parameter of Cinema EOS System and DP-V2410 (📖 58)" in "Adjustment". • When "ITU-R BT.2020", "Cinema Gamut to 709", "Cinema Gamut to 2020", "Cinema Gamut to DCI", "DCI-P3+ to 709", "DCI-P3+ to DCI", "DCI-P3 to 709", or "ITU-R BT.2020 to 709" is selected, the DP-V2410 displays images after converting the color gamut as shown below. Data outside of the color gamut after conversion is also displayed at the optimum level. <table border="1" data-bbox="619 1379 1302 1816"> <thead> <tr> <th data-bbox="619 1379 963 1458">Input video color gamut</th> <th data-bbox="963 1379 1302 1458">Color gamut after conversion on the DP-V2410</th> </tr> </thead> <tbody> <tr> <td data-bbox="619 1458 963 1503">ITU-R BT.2020</td> <td data-bbox="963 1458 1302 1503">Native</td> </tr> <tr> <td data-bbox="619 1503 963 1547">Cinema Gamut to 709</td> <td data-bbox="963 1503 1302 1547">ITU-R BT.709</td> </tr> <tr> <td data-bbox="619 1547 963 1592">Cinema Gamut to 2020</td> <td data-bbox="963 1547 1302 1592">Native</td> </tr> <tr> <td data-bbox="619 1592 963 1637">Cinema Gamut to DCI</td> <td data-bbox="963 1592 1302 1637">DCI-P3</td> </tr> <tr> <td data-bbox="619 1637 963 1682">DCI-P3+ to 709</td> <td data-bbox="963 1637 1302 1682">ITU-R BT.709</td> </tr> <tr> <td data-bbox="619 1682 963 1727">DCI-P3+ to DCI</td> <td data-bbox="963 1682 1302 1727">DCI-P3</td> </tr> <tr> <td data-bbox="619 1727 963 1771">DCI-P3 to 709</td> <td data-bbox="963 1727 1302 1771">ITU-R BT.709</td> </tr> <tr> <td data-bbox="619 1771 963 1816">ITU-R BT.2020 to 709</td> <td data-bbox="963 1771 1302 1816">ITU-R BT.709</td> </tr> </tbody> </table>	Input video color gamut	Color gamut after conversion on the DP-V2410	ITU-R BT.2020	Native	Cinema Gamut to 709	ITU-R BT.709	Cinema Gamut to 2020	Native	Cinema Gamut to DCI	DCI-P3	DCI-P3+ to 709	ITU-R BT.709	DCI-P3+ to DCI	DCI-P3	DCI-P3 to 709	ITU-R BT.709	ITU-R BT.2020 to 709	ITU-R BT.709
Input video color gamut	Color gamut after conversion on the DP-V2410																		
ITU-R BT.2020	Native																		
Cinema Gamut to 709	ITU-R BT.709																		
Cinema Gamut to 2020	Native																		
Cinema Gamut to DCI	DCI-P3																		
DCI-P3+ to 709	ITU-R BT.709																		
DCI-P3+ to DCI	DCI-P3																		
DCI-P3 to 709	ITU-R BT.709																		
ITU-R BT.2020 to 709	ITU-R BT.709																		

Item	Setting Options (underline indicates factory default)		
Gamma	<p>Sets the Gamma. 2.2, 2.35, 2.4, 2.6, ITU-R BT.1886, Canon Log, Canon Log 2: Select the preset gamma. Canon Log (HDR), Canon Log 2 (HDR), SMPTE ST 2084: Select the gamma for HDR display. User LUT 1-8: When "User 1-7" or "Canon Log" is selected for "Picture Mode", load an external LUT and configure.</p> <p>The relationship between "Color Gamut" and "Gamma" that can be selected is shown below. When "Color Gamut" is changed, gamma is changed to the underlined value (default value) only when current gamma value is not selectable.</p>		
	Picture Mode	Color Gamut	Selectable Gamma
	SMPTE-C	Cannot be selected	<u>2.2</u> , 2.35, 2.4, 2.6, ITU-R BT.1886, Canon Log, Canon Log (HDR), SMPTE ST 2084, User LUT 1- 8
	EBU		2.2, <u>2.35</u> , 2.4, 2.6, ITU-R BT.1886, Canon Log, Canon Log (HDR), SMPTE ST 2084, User LUT 1- 8
	ITU-R BT.709, ITU-R BT.2020		<u>2.2</u> , 2.35, 2.4, 2.6, ITU-R BT.1886, Canon Log, Canon Log (HDR), Canon Log 2, Canon Log 2 (HDR), SMPTE ST 2084, User LUT 1- 8
	DCI-P3		2.2, 2.35, 2.4, <u>2.6</u> , ITU-R BT.1886, Canon Log, Canon Log (HDR), Canon Log 2, Canon Log 2 (HDR), SMPTE ST 2084, User LUT 1- 8
	Adobe RGB		<u>2.2</u> , 2.35, 2.4, 2.6, ITU-R BT.1886, User LUT 1- 8
	Canon Log, User 1-7	SMPTE-C	<u>2.2</u> , 2.35, 2.4, 2.6, ITU-R BT.1886, Canon Log, Canon Log (HDR), SMPTE ST 2084, User LUT 1- 8
		EBU	2.2, <u>2.35</u> , 2.4, 2.6, ITU-R BT.1886, Canon Log, Canon Log (HDR), SMPTE ST 2084, User LUT 1- 8
		ITU-R BT.709, ITU-R BT.2020	<u>2.2</u> , 2.35, 2.4, 2.6, ITU-R BT.1886, Canon Log, Canon Log (HDR), Canon Log 2, Canon Log 2 (HDR), SMPTE ST 2084, User LUT 1- 8
		Adobe RGB	<u>2.2</u> , 2.35, 2.4, 2.6, ITU-R BT.1886, User LUT 1- 8
		DCI-P3	2.2, 2.35, 2.4, <u>2.6</u> , ITU-R BT.1886, Canon Log, Canon Log (HDR), Canon Log 2, Canon Log 2 (HDR), SMPTE ST 2084, User LUT 1- 8
		Native	<u>2.2</u> , 2.35, 2.4, 2.6, ITU-R BT.1886, SMPTE ST 2084, User LUT 1- 8
		Cinema Gamut to 709, Cinema Gamut to DCI	<u>Canon Log</u> , Canon Log (HDR), Canon Log 2, Canon Log 2 (HDR)
		Cinema Gamut to 2020	<u>Canon Log 2</u> , Canon Log 2 (HDR)
DCI-P3 to 709, ITU-R BT.2020 to 709		<u>Canon Log 2</u>	
DCI-P3+ to 709, DCI-P3+ to DCI		<u>Canon Log</u> , Canon Log (HDR)	
User LUT 1-8	<u>2.2</u> , 2.35, 2.4, 2.6, ITU-R BT.1886, User LUT 1- 8		
<p> Note</p> <ul style="list-style-type: none"> For checking the captured video with Cinema EOS System, please refer to the "Parameter of Cinema EOS System and DP-V2410 (📖 58)" in "Adjustment". 			

Item	Setting Options (<u>underline indicates factory default</u>)
HDR Range	<p>Setting is enabled when "Canon Log (HDR)", "Canon Log 2 (HDR)", or "SMPTE ST 2084" is selected for "Gamma".</p> <p>Canon Log (HDR): Sets the dynamic range to be displayed from 0 to 800% that "Canon Log" has. 100 to 800% (in 100 increments)</p> <p>Canon Log 2 (HDR): Sets the dynamic range to be displayed from 0 to 1600% that "Canon Log 2" has. 100 to 1600% (in 100 increments)</p> <p>SMPTE ST 2084: Sets the dynamic range to be displayed from 0.005 to 10,000 nit that "SMPTE ST 2084" has. 100 to 4000 (2000) nit (in 100 increments)</p> <p>❖ Setting procedures The procedures below use Canon Log (HDR) as an example. When the maximum value (800%) is specified, the 800% dynamic range of Canon Log is assigned to the dynamic range of the video display. Although the brightness in appearance lowers, you can check the dynamic range included in video signals. When 400% is specified, part exceeding 400% is clipped (gradation is saturated) and part up to 400% is assigned to the dynamic range of the video display. This is the same for Canon Log 2 (HDR). "SMPTE ST 2084" has the dynamic range of 0.005 to 10,000 nit. Therefore, when the maximum value (4000 nit) is specified, part exceeding 4000 nit is clipped and part up to 4000 nit is assigned to the dynamic range of the video display. Although the brightness in appearance lowers, you can check the dynamic range up to 4000 nit. When 1000 nit is specified, part exceeding 1000 nit is clipped and part up to 1000 nit is assigned to the dynamic range of the video display. The brightness of the video display corresponds to the value set for Contrast.</p> <p style="text-align: center;">Canon Log 800% signal (Contrast: 4000)</p> <div style="display: flex; justify-content: space-around;"> <div style="text-align: center;"> <p><u>Canon Log (HDR): Set to 800</u></p> <p>Canon Log range: 0 to 800% DP-V2410 range: 0 to 400%</p> <p>Gradation is reproduced by assigning the range to the range of the DP-V2410 (which lowers the brightness).</p> </div> <div style="text-align: center;"> <p><u>Canon Log (HDR): Set to 400</u></p> <p>Canon Log range: 0 to 800% DP-V2410 range: 0 to 400%</p> <p>Clip (Saturates gradation.)</p> <p>400% Brightness value corresponding to the contrast setting</p> </div> </div>
IDT	<p>Sets whether or not to apply IDT (Input Device Transform) to "3G-SDI RAW" signals (📖 43) when "Picture Mode" is set to "Canon Log" and "ACESproxy" is selected for "Color Gamut" or when "ACESproxy" is selected for "Picture Mode".</p> <p>Automatic: Applied automatically. Off: Not applied.</p>
ODT	<p>This is displayed instead of Gamma and Color Gamut when "Picture Mode" is set to "Canon Log" and "ACESproxy" is selected for "Color Gamut" or when "ACESproxy" is selected for "Picture Mode".</p> <p>ITU-R BT.709, ITU-R BT.2020, DCI-P3: ACESproxy is converted into respective mode.</p>

Item	Setting Options (underline indicates factory default)
ODT Surround	<p>This is displayed instead of "Gamma" and "Color Gamut" when "Picture Mode" is set to "Canon Log" and "ACESproxy" is selected for "Color Gamut" or when "ACESproxy" is selected for "Picture Mode".</p> <p>Dim Surround: Enables Dim Surround process specified by ACESproxy (ACES 1.0).</p> <p>Dark Surround: Enables Dark Surround specified by ACESproxy (ACES 1.0).</p>
Color Range	<p>Sets the quantization range for SDI and HDMI respectively.</p> <p>Automatic: Sets the range based on signal information automatically.</p> <p>Full (0-255): Sets to Black level: 0; White level: 1023 (10-bit)/4095 (12-bit).</p> <p>Limited 1 (16-235): Limits the black and white range. Black level: 64 (10-bit)/256 (12-bit) White level: 940 (10-bit)/3760 (12-bit)</p> <p>Limited 2 (16-255): Limits the black range. Black level: 64 (10-bit)/256 (12-bit) White level: 1023 (10-bit)/4095 (12-bit)</p> <p> Note</p> <ul style="list-style-type: none"> • Setting is disabled when "ACESproxy" is selected for "Picture Mode" or "ACESproxy" is selected for "Color Gamut". • Operations when "Automatic" is selected are described below. <ul style="list-style-type: none"> - When HDMI is selected, "Full (0-255)" or "Limited 1 (16-235)" is set automatically depending on HDMI signal information. - When "DCI-P3" is selected for "Picture Mode", or "DCI-P3", "Cinema Gamut to DCI" or "DCI-P3+ to DCI" is selected for "Color Gamut", "Full (0-255)" is set. - When "Canon Log" or "Canon Log 2" is selected for "Gamma", "Limited 2 (16-255)" is set. - "Limited 1 (16-235)" is set in the other cases.

Item	Setting Options (underline indicates factory default)																		
CDL	<p>Configures settings for CDL. CDL files created on Canon Video Display DP-V3010 can also be used because the file type is the same.</p> <table border="1" data-bbox="209 237 1482 1317"> <tr> <td data-bbox="209 237 416 416">CDL Preset</td> <td data-bbox="416 237 1482 416"> Sets CDL preset. Imported LUT can also be set as preset. CDL 1-15, User LUT <input checked="" type="checkbox"/> CAUTION <ul style="list-style-type: none"> When "User LUT" is selected, all "CDL" items, "Chroma", and "Blue Only" cannot be changed. </td> </tr> <tr> <td data-bbox="209 416 416 495">Power</td> <td data-bbox="416 416 1482 495"> Adjusts the gamma (in 0.01 increments). 0.50 to 4.00 (1.00) </td> </tr> <tr> <td data-bbox="209 495 416 573">Saturation</td> <td data-bbox="416 495 1482 573"> Adjusts the color saturation of the image (in 0.001 increments). 0.000 to 2.000 (1.000) </td> </tr> <tr> <td data-bbox="209 573 416 651">Offset</td> <td data-bbox="416 573 1482 651"> Adjusts the black level (in 0.001 increments). -1.000 to 1.000 (0.000) </td> </tr> <tr> <td data-bbox="209 651 416 730">Slope</td> <td data-bbox="416 651 1482 730"> Adjusts the white level (in 0.001 increments). 0.000 to 2.000 (1.000) </td> </tr> <tr> <td data-bbox="209 730 416 864">CDL Bypass</td> <td data-bbox="416 730 1482 864"> When "CDL Bypass" is set to "On", you can temporarily disable the CDL adjustment result and return to the image quality before adjustment. When the image quality has returned to the state before adjustment, you cannot adjust Power, Saturation, Offset, or Slope. On, Off </td> </tr> <tr> <td data-bbox="209 864 416 1200">Detail Settings</td> <td data-bbox="416 864 1482 1200"> CDL Export: Exports CDL parameters. CDL Preset: CDL 1 - CDL 15, All File Type: CCC, CDL Execute CDL Import: Imports CDL parameters. Filename: Select a filename. CDL Preset: CDL 1 - CDL 15 Execute CDL Preset Name: You can specify the name of preset mode within 16 one-byte characters including alphabetical characters, numbers, and symbols. </td> </tr> <tr> <td data-bbox="209 1200 416 1267">Anchor CDL</td> <td data-bbox="416 1200 1482 1267"> You can temporarily save parameters for "Power", "Saturation", "Offset", and "Slope" and recover the values. (anchor point setting). </td> </tr> <tr> <td data-bbox="209 1267 416 1317">Reset CDL</td> <td data-bbox="416 1267 1482 1317"> Resets CDL parameters. </td> </tr> </table>	CDL Preset	Sets CDL preset. Imported LUT can also be set as preset. CDL 1-15, User LUT <input checked="" type="checkbox"/> CAUTION <ul style="list-style-type: none"> When "User LUT" is selected, all "CDL" items, "Chroma", and "Blue Only" cannot be changed. 	Power	Adjusts the gamma (in 0.01 increments). 0.50 to 4.00 (1.00)	Saturation	Adjusts the color saturation of the image (in 0.001 increments). 0.000 to 2.000 (1.000)	Offset	Adjusts the black level (in 0.001 increments). -1.000 to 1.000 (0.000)	Slope	Adjusts the white level (in 0.001 increments). 0.000 to 2.000 (1.000)	CDL Bypass	When "CDL Bypass" is set to "On", you can temporarily disable the CDL adjustment result and return to the image quality before adjustment. When the image quality has returned to the state before adjustment, you cannot adjust Power, Saturation, Offset, or Slope. On, Off	Detail Settings	CDL Export: Exports CDL parameters. CDL Preset: CDL 1 - CDL 15, All File Type: CCC, CDL Execute CDL Import: Imports CDL parameters. Filename: Select a filename. CDL Preset: CDL 1 - CDL 15 Execute CDL Preset Name: You can specify the name of preset mode within 16 one-byte characters including alphabetical characters, numbers, and symbols.	Anchor CDL	You can temporarily save parameters for "Power", "Saturation", "Offset", and "Slope" and recover the values. (anchor point setting).	Reset CDL	Resets CDL parameters.
CDL Preset	Sets CDL preset. Imported LUT can also be set as preset. CDL 1-15, User LUT <input checked="" type="checkbox"/> CAUTION <ul style="list-style-type: none"> When "User LUT" is selected, all "CDL" items, "Chroma", and "Blue Only" cannot be changed. 																		
Power	Adjusts the gamma (in 0.01 increments). 0.50 to 4.00 (1.00)																		
Saturation	Adjusts the color saturation of the image (in 0.001 increments). 0.000 to 2.000 (1.000)																		
Offset	Adjusts the black level (in 0.001 increments). -1.000 to 1.000 (0.000)																		
Slope	Adjusts the white level (in 0.001 increments). 0.000 to 2.000 (1.000)																		
CDL Bypass	When "CDL Bypass" is set to "On", you can temporarily disable the CDL adjustment result and return to the image quality before adjustment. When the image quality has returned to the state before adjustment, you cannot adjust Power, Saturation, Offset, or Slope. On, Off																		
Detail Settings	CDL Export: Exports CDL parameters. CDL Preset: CDL 1 - CDL 15, All File Type: CCC, CDL Execute CDL Import: Imports CDL parameters. Filename: Select a filename. CDL Preset: CDL 1 - CDL 15 Execute CDL Preset Name: You can specify the name of preset mode within 16 one-byte characters including alphabetical characters, numbers, and symbols.																		
Anchor CDL	You can temporarily save parameters for "Power", "Saturation", "Offset", and "Slope" and recover the values. (anchor point setting).																		
Reset CDL	Resets CDL parameters.																		
Detail Settings	Sets details for Picture Mode.																		
Boost Contrast	You can increase the brightness. On: 1500 to 4000 Off: 0 to 1500																		
LUT Import	LUT can be imported except when "ACESproxy" is selected for "Picture Mode" or "ACESproxy" is selected for "Color Gamut". Filename: Select a filename. LUT Type (Gamma, Color Gamut): Select the LUT type. Select LUT: Selects User LUT 1-8. Base Color Gamut (SMPTE-C, EBU, ITU-R BT.709, Adobe RGB, DCI-P3, Native): Selects the color gamut used when creating the LUT (when "Color Gamut" under "LUT Type" is selected). Execute: Performs import.																		
LUT Name	You can specify the name of LUT within one-byte 24 characters including alphabetical characters, numbers, and symbols. LUT Type (Gamma, Color Gamut): Select the LUT type. Select LUT: Selects User LUT 1-8. Input Name: Input the LUT name.																		

Item	Setting Options (underline indicates factory default)
LUT Delete	Deletes imported LUT. LUT Type (Gamma, Color Gamut): Select the LUT type. Select LUT: Selects User LUT 1-8. Delete: Deletes LUT.
2020 Constant Luminance	Sets the color matrix conversion method to be used when "ITU-R BT.2020" is selected for "Picture Mode". Constant Luminance: YUV signals are linearly converted and then converted into RGB signals. Non-constant Luminance: YUV signals are converted into RGB signals without changing gamma 0.45.  Note <ul style="list-style-type: none"> • SD-SDI is fixed to "Non-constant Luminance".
2020 Gamut Mapping	Set this item when "ITU-R BT.2020" is selected for "Picture Mode" or when "User 1-7" or "Canon Log" is selected for "Picture Mode" and also "ITU-R BT.2020" is selected for "Color Gamut". Gamut Mapping: Mapping is performed on colors outside the native color gamut by Canon's unique method. Clipping: Colors outside the native color gamut are clipped by a general method.
Calibration	Performs calibration based on set target values when "User 1-7" is selected for "Picture Mode". Luminance: Sets the target luminance. 48 to 150 (100) cd/m² Color Temperature: Sets the target color temperature. D93, D65, D61, D60, D56, D50, DCI-P3: Select from preset color temperatures. Custom (xy): You can adjust CIE x, y in increments of 0.001. x: 0.260 to 0.360 (0.313)/y: 0.260 to 0.360 (0.329) Color Gamut: Sets the color gamut. SMPTE-C, EBU, ITU-R BT.709, ITU-R BT.2020, Adobe RGB, DCI-P3 Gamma: Sets the target gamma. 2.2, 2.35, 2.4, 2.6, ITU-R BT.1886 Start: Performs calibration.  Note <ul style="list-style-type: none"> • When "Luminance" is set to high brightness, it may be calibrated beyond the brightness adjustment range and set lower than the target value depending on the "Color Temperature" setting. In that case, set the "Luminance" again.
Copy Picture Mode	When "User 1-7" is selected for "Picture Mode", the content of the selected picture mode is copied. The following modes can be selected: Picture Mode: SMPTE-C, EBU, <u>ITU-R BT.709</u> , ITU-R BT.2020, Adobe RGB, DCI-P3, User 1-7 (other than the currently set parameter) Execute: Performs copy.
Picture Mode Name	You can change the name of "User 1-7" within 16 characters including alphabetical characters, numbers, and symbols.
Anchor Adjustment	Temporarily saves parameters for adjusting "Contrast", "Brightness", "Chroma", and "Sharpness" and recover the values (anchor point setting). OK: Performs anchor point setting. Cancel: Returns to the previous screen without setting anchor point.
Reset	Return "Picture Mode" to factory default. Note that in "User 1-7" mode where you are performing calibration, the setting returns to the value after calibration instead of the factory default. When selected, the message "Reset Adjustment settings to defaults?" appears. OK: Performs reset. Cancel: Returns to the previous screen without resetting.





The factory default settings for each "Picture Mode" is as follows:

Item	SMPTE-C	EBU	ITU-R BT. 709	ITU-R BT.2020	Adobe RGB
Contrast	1000	1000	1000	1000	1000
Brightness	0	0	0	0	0
Chroma	1000	1000	1000	1000	1000
Sharpness	0	0	0	0	0
Local Dimming	High	High	High	High	High
Color Temperature	Preset	D65	D65	D65	D65
	x	0.313	0.313	0.313	0.313
	y	0.329	0.329	0.329	0.329
	Gain R/G/B	1023	1023	1023	1023
	Bias R/G/B	0	0	0	0
Gamma	2.2	2.35	2.2	2.2	2.2
Color Gamut	SMPTE-C	EBU	ITU-R BT.709	ITU-R BT.2020	Adobe RGB
Color Range	Automatic	Automatic	Automatic	Automatic	Automatic
IDT	-	-	-	-	-
ODT	-	-	-	-	-
ODT Surround	-	-	-	-	-
CDL Preset	CDL 1	CDL 2	CDL 3	CDL 4	CDL 5
Boost Contrast	Off	Off	Off	Off	Off
2020 Constant Luminance	Non-constant Luminance	Non-constant Luminance	Non-constant Luminance	Non-constant Luminance	Non-constant Luminance
2020 Gamut Mapping	Mapping	Mapping	Mapping	Mapping	Mapping

Item		DCI-P3	User 1-7	Canon Log	ACESproxy
Contrast		480	1000	1000	480
Brightness		0	0	0	0
Chroma		1000	1000	1000	1000
Sharpness		0	0	0	0
Local Dimming		High	High	High	High
Color Temperature	Preset	DCI-P3	D65	D65	D60
	x	0.314	0.313	0.313	0.322
	y	0.351	0.329	0.329	0.338
	Gain R/G/B	1023	1023	1023	1023
	Bias R/G/B	0	0	0	0
Gamma		2.6	2.2	Canon Log	–
Color Gamut		DCI-P3	ITU-R BT.709	ITU-R BT.709	ACESproxy
Color Range		Automatic	Automatic	Automatic	Automatic
IDT		–	–	Automatic	Automatic
ODT		–	–	DCI-P3	DCI-P3
ODT Surround		–	–	Dark Surround	Dark Surround
CDL Preset		CDL 6	CDL 7-13	CDL 14	CDL 15
Boost Contrast		Off	Off	Off	Off
2020 Constant Luminance		Non-constant Luminance	Non-constant Luminance	Non-constant Luminance	Non-constant Luminance
2020 Gamut Mapping		Mapping	Mapping	Mapping	Mapping

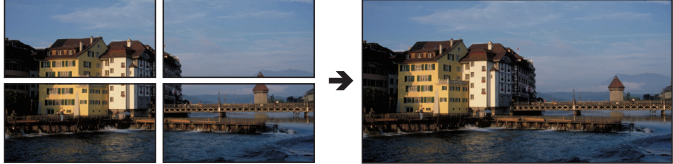
Channel Settings

This menu is used for input related settings. Select the "Select Channel" and choose a channel number from CH1 to CH30. Finally define the parameter of each of the "Channel Settings".

Item	Setting Options (underline indicates factory default)
Select Channel	<p>Display the channel number. In addition, you can assign each content of "Channel Settings" to each channel (📖 44).</p> <p>CH1 to CH30</p> <p> Note</p> <ul style="list-style-type: none"> It may take 10 seconds when switching channels.
Input Configuration	<p>Select the input. Factory default depend on the channel (📖 44).</p> <p>3G/HD-SDI, 3G-SDI RAW, SD-SDI, HDMI, — (Not set)</p>
Select Input Signal	<p>Sets the signal display method (📖 15).</p> <p>Automatic: "4K Input" and "Single Input/Dual Input" are automatically determined.</p> <p>4K Input: Displays the signal transmitted over four inputs.</p> <div data-bbox="491 741 1166 904" style="text-align: center;">  </div> <p>Single Input/Dual Input: Displays the signal of a single input (Single Input A-D) or dual input (Dual Input A, B or C, D) onto the center of the screen.</p> <div data-bbox="496 1037 810 1200" style="text-align: center;">  </div> <p> Note</p> <ul style="list-style-type: none"> For HDMI, the setting is fixed to "Automatic". For SD-SDI, only "Single Input A-D" can be selected. For "Dual Input", only "3G-SDI RAW" can be selected.
Format	<p>Sets the color format and gradation.</p> <ul style="list-style-type: none"> SDI Signal Automatic, 4:2:2 YCbCr 10-bit, 4:2:2 YCbCr 12-bit, 4:4:4 YCbCr 10-bit, 4:4:4 YCbCr 12-bit, 4:4:4 RGB 10-bit, 4:4:4 RGB 12-bit, 4:4:4 XYZ 10-bit, 4:4:4 XYZ 12-bit HDMI Signal Automatic, 4:4:4 XYZ 12/10-bit <p> Note</p> <ul style="list-style-type: none"> HD/SD-SDI is fixed to "4:2:2 YCbCr 10-bit". For "3G-SDI RAW", the setting is fixed to "Automatic". If set to "Automatic" when receiving 3G-SDI, all signals without a payload format will be rendered in "4:4:4 RGB 10-bit". In addition, if there is one Payload or more of the four inputs, they are rendered in a Payload that is selected in the order of priority A → B → C → D in the display area. To use 4:4:4 XYZ 10-bit for SDI signals, select "4:4:4 XYZ 10-bit". Then, signals will be processed as signals where XYZ data is included in RGB data output in 4:4:4 RGB 10-bit format.

Item	Setting Options (<u>underline indicates factory default</u>)
Internal Sync	Synchronizes four inputs for "4K Input". On: Force synchronization. Off: Do not force synchronization.
Channel Name	Sets the name of the selected channel. You can input up to 16 alphanumeric characters.
Picture Mode	Sets the "Picture Mode".
Color Range	<p>Sets the quantization range for SDI and HDMI respectively.</p> <p>Automatic: Sets the range based on signal information automatically.</p> <p>Full (0-255): Sets to Black level: 0; White level: 1023 (10-bit)/4095 (12-bit).</p> <p>Limited 1 (16-235): Limits the black and white range. Black level: 64 (10-bit)/256 (12-bit) White level: 940 (10-bit)/3760 (12-bit)</p> <p>Limited 2 (16-255): Limits the black range. Black level: 64 (10-bit)/256 (12-bit) White level: 1023 (10-bit)/4095 (12-bit)</p> <p> Note</p> <ul style="list-style-type: none"> Setting is disabled when "ACESproxy" is selected for "Picture Mode" or "ACESproxy" is selected for "Color Gamut". Operations when "Automatic" is selected are described below. <ul style="list-style-type: none"> When HDMI is selected, "Full (0-255)" or "Limited 1 (16-235)" is set automatically depending on HDMI signal information. When "DCI-P3" is selected for "Picture Mode", or "DCI-P3", "Cinema Gamut to DCI" or "DCI-P3+ to DCI" is selected for "Color Gamut", "Full (0-255)" is set. When "Canon Log" or "Canon Log 2" is selected for "Gamma", "Limited 2 (16-255)" is set. "Limited 1 (16-235)" is set in the other cases.





The factory default settings for each channel is shown in the following table.

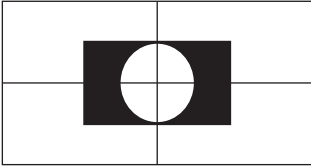
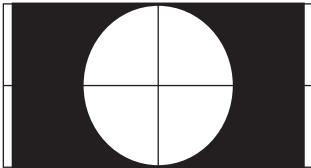
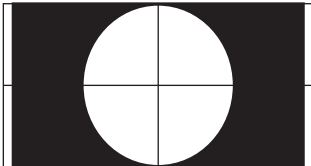

CH	CH1	CH2	CH3	CH4 to CH30
Input Configuration	3G/HD-SDI	HDMI	3G-SDI RAW	–
Select Input Signal	Automatic	Automatic	Automatic	Automatic
Format	Automatic	Automatic	Automatic	Automatic
Internal Sync	Off	Off	Off	Off
Channel Name	(Blank)	(Blank)	(Blank)	(Blank)
Picture Mode	ITU-R BT.709	ITU-R BT.709	Canon Log	ITU-R BT.709
Color Range	Automatic	Automatic	Automatic	Automatic

– : not set

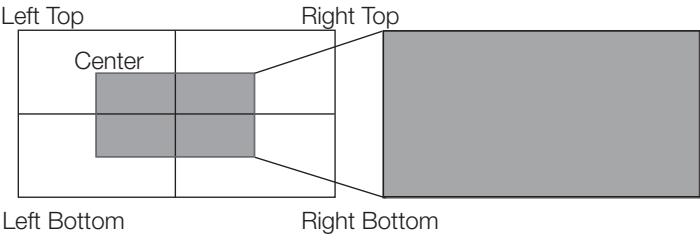
Display Settings

This menu is used to configure the display method.

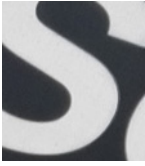
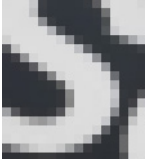
Item	Setting Options (<u>underline indicates factory default</u>)
Screen Scaling	<p>Defines how the video is scaled and displayed on the screen. Native Input Resolution: Displays the input signal without scaling.</p>  <p>1920x1080 (original)</p> <p>200%: Doubles the vertical and horizontal dimensions.</p>  <p>1920x1080→3840x2160</p> <p>Automatic: Enlarges to full screen.</p>  <p>1920x1080→3840x2160</p> <p> Note</p> <ul style="list-style-type: none"> • When "Peaking" or "False Color" is "On", the magnification is up to 200%, even if "Automatic" is selected.
Zoom	<p>When the resolution is 4096x2160 or 3840x2160, the enlarged image is displayed at the center of the screen or at the position selected screen of a 4-screen layout.</p> <p>Center, Top Left, Top Right, Bottom Left, Bottom Right, <u>Off</u></p>  <p> Note</p> <ul style="list-style-type: none"> • When HDMI is selected, only "Center" and "Off" can be selected.

Item	Setting Options (underline indicates factory default)
Scaling Method	<p>Sets the interpolation method when "Screen Scaling" is set to "200%" or "Automatic".</p> <p>Shape Trace: Canon original processing that produces smooth slopes with reduced jagged lines.</p>  <p>Bicubic: General interpolation process that uses neighboring pixel information to create interpolated pixels.</p>  <p>Nearest Neighbor: Process that uses nearest neighbor pixel information to create (copy) new pixels. This is useful as it enlarges the original pixels, thus making any jagged lines visible.</p> 
Frame Hold	<p>Pauses the video.</p> <p>On, <u>Off</u></p> <p> Note</p> <ul style="list-style-type: none"> Setting is disabled when "Peaking" is set to "On" or "False Color" is set to "On".
Background Color	<p>Sets the color of the black band to check the boundary of the black band and video image.</p> <p>White, Gray, <u>Off</u></p>
I/PsF	<p>Defines how the interlace signal or PsF signal is displayed.</p> <p>Automatic: Automatically determined based on payload and displayed. If there is no payload, the signal is displayed as an interlace signal.</p> <p>Interlace: Displayed as an interlace signal.</p> <p>PsF: Displayed as a PsF signal.</p>
I/P Conversion	<p>Sets the interlaced signal I/P conversion method.</p> <p>Image Priority: This mode gives priority to image quality. Processing time will be longer than "Speed Priority".</p> <p>Speed Priority: This mode gives priority to speed.</p>
PsF	<p>Defines how the PsF signal is displayed.</p> <p>Progressive: Interpolates giving preference to image quality by detecting paired fields.</p> <p>Interlace: Interpolates using two adjacent fields giving priority to speed.</p>

Item	Setting Options (underline indicates factory default)
Film Cadence	<p>Sets the film cadence mode (📖 82).</p> <p>2-2: Displays progressive image after conversion for 2-2 pulldown processed interlaced signal input.</p> <p>2-3: Displays progressive image after conversion for 2-3 pulldown processed interlaced signal input.</p> <p>2-3-3-2: Displays progressive image after conversion for 2-3-3-2 pulldown processed interlaced signal input.</p> <p><u>Off</u>: Does not perform film cadence mode progressive conversion.</p> <p> Note</p> <ul style="list-style-type: none"> • This can be set only when "I/P Conversion" is set to "Image Priority".





Audio Settings



This menu is used to set audio output from the headphone terminal.



Item	Setting Options (<u>underline indicates factory default</u>)
Audio Settings	Sets the headphone terminal audio.
SDI Group	Switches the audio group to be input during SDI audio input. <u>CH1-CH8, CH9-CH16</u>
CH L/R (SDI)	Sets the audio to be output from the two channels (L/R) of the headphone respectively. The options differ according to the "SDI Group" setting. When "CH1-CH8" is selected for "SDI Group": CH1-CH8 When "CH9-CH16" is selected for "SDI Group": CH9-CH16
CH L/R (HDMI)	Sets the audio to be output from the two channels (L/R) of the headphone respectively. CH1-CH8
Volume	Sets the volume. 0 to 100 (30)
Audio Switch	Sets the stereo output. <u>L R, L, R, MIX (L+R)</u>
Select Input	Sets the audio terminal to be used when "4K Input" is selected. Single Input A-D (Input A)



Marker Settings



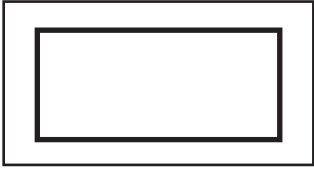

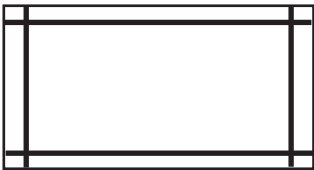
This menu is used to configure various markers.

Item	Setting Options (underline indicates factory default)
Marker Preset	Customizes markers which are assigned to markers 1 to 5. Marker 1 to 5, Off
Aspect Marker	<p>"Aspect Marker" displays a range in accordance with the specified aspect ratio.</p>  <p> Note "Aspect Marker" is not displayed in the following cases:</p> <ul style="list-style-type: none"> • When there is no signal, unsupported signal, or a channel with "Input Configuration" not set is selected • When an enlarged image is displayed • During the execution of "Playback File" under "Screen Capture" • When a "Test Pattern" is displayed
Enable	Switches the aspect marker On, Off. On, Off
Mask	<p>Switches the mask color. Mask is the blanking area outside the range of the marker.</p> <p>Black:</p>  <p>Half (50% gray):</p>  <p>Off: Turns mask off.</p>
Aspect Ratio	<p>Sets the aspect ratio of the aspect marker.</p> <p>16:9, 15:9, 14:9, 13:9, 4:3, 2.39:1, 2.35:1, 1.896:1, 1.85:1, 1.66:1, Variable</p> <p>The aspect ratio can be entered as a numeric value when you select "Variable" (0.01:1 increments). The grayed out slider becomes active and can be used to set the aspect ratio.</p> <p>1.00:1 to 3.00:1 (1.78:1)</p>
Line	Active when "Black" or "Half" is selected for "Mask". Switches lines on mask On, Off. On, Off
Line Width	Sets the thickness of the aspect marker line. Thick, Normal, Thin

Item	Setting Options (underline indicates factory default)
Line Color	Sets the color of the aspect marker line. White, Red, Green, Blue, Yellow, Cyan, Magenta
Line Brightness	Sets the brightness of the aspect marker line. High, <u>Low</u>
H Position	Changes horizontal position without changing the aspect. -65 to 65 (0)
V Position	Changes vertical position without changing the aspect. -35 to 35 (0)
Safety Zone Marker 1, 2	<p>There are two types of "Safety Zone Marker": 1 and 2, which share the same settings. A safety zone marker is used to set the safe zone of the image (actual displayed area) to check the image.</p>  <p> Note "Safety Zone Marker" is not displayed in the following cases:</p> <ul style="list-style-type: none"> • When there is no signal, unsupported signal, or a channel with "Input Configuration" not set is selected • When an enlarged image is displayed • During the execution of "Playback File" under "Screen Capture" • When a "Test Pattern" is displayed
Enable	Switches the safety zone marker On, Off. On, <u>Off</u>
Aspect Ratio	Sets the aspect ratio of the safety zone marker. <u>16:9</u>, 15:9, 14:9, 13:9, 4:3, 2.39:1, 2.35:1, 1.896:1, 1.85:1, 1.66:1, Variable The aspect ratio can be entered as a numeric value when you select "Variable" (0.01:1 increments). The grayed out slider becomes active and can be used to set the aspect ratio. 1.00:1 to 3.00:1 (<u>1.78:1</u>)
Area Size	Sets the safety zone marker area size. 80%, 88%, 90%, 93%, Variable (%), Variable (dot) When "Variable (%)" is selected, the grayed out "Rate (%)" becomes active. When "Variable (dot)" is selected, the grayed out "Width (dot)" and "Height (dot)" become active. This can be set by moving the slider.
Rate (%)	Becomes active when you select "Variable (%)" under the menu "Area Size". Move the slider to set the displayed marker area size without changing the aspect ratio in 1 % increments. 50 to 100 (80)
Width (dot)	Becomes active when you select "Variable (dot)" under the menu "Area Size". Move the slider to set the area width in 2 dot increment. 360 to 4096 (3276)
Height (dot)	Becomes active when you select "Variable (dot)" under the menu "Area Size". Move the slider to set the area height in 2 dot increment. 240 to 2160 (1728)

















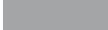











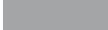





Item	Setting Options (underline indicates factory default)
Shape	<p>Sets the area shape of the safety zone marker.</p> <p>Box:</p>  <p>Bracket:</p>  <p>Enclosure:</p> 
Line Width	<p>Sets the width of the safety zone marker line.</p> <p>Thick, <u>Normal</u>, Thin</p>
Line Color	<p>Sets the color of the safety zone marker line.</p> <p><u>White</u>, Red, Green, Blue, Yellow, Cyan, Magenta</p>
Line Brightness	<p>Sets the brightness of the safety zone marker line.</p> <p>High, <u>Low</u></p>
H Position	<p>Adjusts the marker horizontal position with the set aspect and size.</p> <p>-65 to 65 (0)</p>
V Position	<p>Adjusts the marker vertical position with the set aspect and size.</p> <p>-35 to 35 (0)</p>



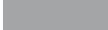

Item	Setting Options (underline indicates factory default)
Area Marker	<p>"Area Marker" is used to check a specific area using a rectangular box.</p>  <p> Note "Area Marker" is not displayed in the following cases:</p> <ul style="list-style-type: none"> • When there is no signal, unsupported signal, or a channel with "Input Configuration" not set is selected • When an enlarged image is displayed • During the execution of "Playback File" under "Screen Capture" • When a "Test Pattern" is displayed
Enable	Switches the area marker On, Off. On, Off
H Position	Sets the start position (x-coordinate) to draw the rectangle (in increments of 2). 0 to 4086 (240)
V Position	Sets the start position (y-coordinate) to draw the rectangle (in increments of 2). 0 to 2150 (120)
Width (dot)	Sets the width of the rectangle (in increments of 2). 10 to 4096 (240)
Height (dot)	Sets the height of the rectangle (in increments of 2). 10 to 2160 (120)
Mask	Switches the mask color (in the marker). Black, Half, Off
Line	Turns On/Off the outlines of the rectangular box. On, Off
Line Width	Sets the width of the area marker line. Thick, Normal, Thin
Line Color	Sets the color of the area marker line. White, Red, Green, Blue, Yellow, Cyan, Magenta
Line Brightness	Sets the brightness of the area marker line. High, Low

Item	Setting Options (underline indicates factory default)										
Center Marker	<p>"Center Marker" shows the center of the image.</p>  <p> Note</p> <ul style="list-style-type: none"> • "Center Marker" is not displayed when an enlarged image is displayed. <table border="1" data-bbox="229 539 1482 927"> <tr> <td data-bbox="229 539 384 618">Enable</td> <td data-bbox="384 539 1482 618">Switches the center marker On, Off. On, Off</td> </tr> <tr> <td data-bbox="229 618 384 696">Size</td> <td data-bbox="384 618 1482 696">Sets the size of the center marker. Large, <u>Small</u></td> </tr> <tr> <td data-bbox="229 696 384 775">Line Width</td> <td data-bbox="384 696 1482 775">Sets the width of the center marker line. Thick, <u>Normal</u>, Thin</td> </tr> <tr> <td data-bbox="229 775 384 853">Line Color</td> <td data-bbox="384 775 1482 853">Sets the color of the center marker line. <u>White</u>, Red, Green, Blue, Yellow, Cyan, Magenta</td> </tr> <tr> <td data-bbox="229 853 384 927">Line Brightness</td> <td data-bbox="384 853 1482 927">Sets the brightness of the center marker line. High, <u>Low</u></td> </tr> </table>	Enable	Switches the center marker On, Off. On, Off	Size	Sets the size of the center marker. Large, <u>Small</u>	Line Width	Sets the width of the center marker line. Thick, <u>Normal</u>, Thin	Line Color	Sets the color of the center marker line. <u>White</u>, Red, Green, Blue, Yellow, Cyan, Magenta	Line Brightness	Sets the brightness of the center marker line. High, <u>Low</u>
Enable	Switches the center marker On, Off. On, Off										
Size	Sets the size of the center marker. Large, <u>Small</u>										
Line Width	Sets the width of the center marker line. Thick, <u>Normal</u>, Thin										
Line Color	Sets the color of the center marker line. <u>White</u>, Red, Green, Blue, Yellow, Cyan, Magenta										
Line Brightness	Sets the brightness of the center marker line. High, <u>Low</u>										
Grid Marker	<p>"Grid Marker" is marker used to check the horizontal and vertical position.</p>  <p> Note</p> <ul style="list-style-type: none"> • "Grid Marker" is not displayed when an enlarged image is displayed. <table border="1" data-bbox="229 1290 1482 1675"> <tr> <td data-bbox="229 1290 384 1368">Enable</td> <td data-bbox="384 1290 1482 1368">Switches the grid marker On, Off. On, <u>Off</u></td> </tr> <tr> <td data-bbox="229 1368 384 1447">Distance</td> <td data-bbox="384 1368 1482 1447">Sets the horizontal and vertical line distance. 160 dots, <u>240 dots</u>, 320 dots</td> </tr> <tr> <td data-bbox="229 1447 384 1525">Line Width</td> <td data-bbox="384 1447 1482 1525">Sets the width of the grid marker line. Thick, <u>Normal</u>, Thin</td> </tr> <tr> <td data-bbox="229 1525 384 1603">Line Color</td> <td data-bbox="384 1525 1482 1603">Sets the color of the grid marker line. <u>White</u>, Red, Green, Blue, Yellow, Cyan, Magenta</td> </tr> <tr> <td data-bbox="229 1603 384 1675">Line Brightness</td> <td data-bbox="384 1603 1482 1675">Sets the brightness of the grid marker line. High, <u>Low</u></td> </tr> </table>	Enable	Switches the grid marker On, Off. On, <u>Off</u>	Distance	Sets the horizontal and vertical line distance. 160 dots, <u>240 dots</u>, 320 dots	Line Width	Sets the width of the grid marker line. Thick, <u>Normal</u>, Thin	Line Color	Sets the color of the grid marker line. <u>White</u>, Red, Green, Blue, Yellow, Cyan, Magenta	Line Brightness	Sets the brightness of the grid marker line. High, <u>Low</u>
Enable	Switches the grid marker On, Off. On, <u>Off</u>										
Distance	Sets the horizontal and vertical line distance. 160 dots, <u>240 dots</u>, 320 dots										
Line Width	Sets the width of the grid marker line. Thick, <u>Normal</u>, Thin										
Line Color	Sets the color of the grid marker line. <u>White</u>, Red, Green, Blue, Yellow, Cyan, Magenta										
Line Brightness	Sets the brightness of the grid marker line. High, <u>Low</u>										

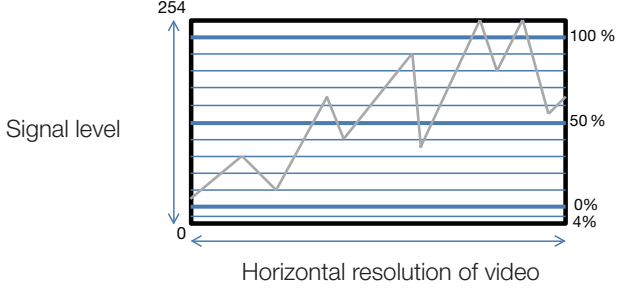

Function Settings

This menu is used to set functions to link with Cinema EOS System cameras and video assistance functions.

Item	Setting Options (<u>underline indicates factory default</u>)																																												
Peaking	<p>Customizes peakings which are assigned to Peaking 1 or Peaking 2. The outline is displayed in a color, used to check the focus.</p> <p> Note</p> <ul style="list-style-type: none"> • "Peaking" cannot be displayed during the execution of "Playback File" under "Screen Capture". 																																												
	<p>Enable</p> <p>Switches the peaking display mode and also sets peaking to Off. Peaking 1, Peaking 2, <u>Off</u></p>																																												
	<p>■ Peaking 1, 2 Monochrome: Displays video in monochrome. On, <u>Off</u> Frequency: Sets the central frequency of contour enhancement signals. Peaking 1 (High, Middle, Low), Peaking 2 (High, Middle, Low) Range: Sets the width of the range to be colored. -3 ~ +3 (<u>0</u>) Color: Sets the color to be used. White, Red, Green, Blue, Yellow, Cyan, Magenta</p>																																												
False Color	<p>When set to "On", different colors are displayed according to video's brightness level so that you can check the exposure condition easily. On, <u>Off</u> Below are details of the chart. Numbers indicate the level of Y-signals.</p> <table border="0"> <tr> <td>941</td> <td>1023</td> <td></td> <td>Red</td> </tr> <tr> <td>877</td> <td>940</td> <td></td> <td>Orange</td> </tr> <tr> <td>813</td> <td>876</td> <td></td> <td>Light orange</td> </tr> <tr> <td>749</td> <td>812</td> <td></td> <td>Yellow</td> </tr> <tr> <td>584</td> <td>748</td> <td></td> <td>Light gray</td> </tr> <tr> <td>420</td> <td>583</td> <td></td> <td>Medium gray</td> </tr> <tr> <td>256</td> <td>419</td> <td></td> <td>Dark gray</td> </tr> <tr> <td>192</td> <td>255</td> <td></td> <td>Blue</td> </tr> <tr> <td>128</td> <td>191</td> <td></td> <td>Blue purple</td> </tr> <tr> <td>64</td> <td>127</td> <td></td> <td>Light purple</td> </tr> <tr> <td>0</td> <td>63</td> <td></td> <td>Purple</td> </tr> </table> <p> Note</p> <ul style="list-style-type: none"> • "False Color" cannot be displayed during the execution of "Playback File" under "Screen Capture". 	941	1023		Red	877	940		Orange	813	876		Light orange	749	812		Yellow	584	748		Light gray	420	583		Medium gray	256	419		Dark gray	192	255		Blue	128	191		Blue purple	64	127		Light purple	0	63		Purple
941	1023		Red																																										
877	940		Orange																																										
813	876		Light orange																																										
749	812		Yellow																																										
584	748		Light gray																																										
420	583		Medium gray																																										
256	419		Dark gray																																										
192	255		Blue																																										
128	191		Blue purple																																										
64	127		Light purple																																										
0	63		Purple																																										
Screen Capture	<p>Captures the screen.</p>																																												
	<p>Capture</p> <p>Captures the screen. The data is saved under the name "YYYYMMDD_hhmmss.bmp" in the root folder of the USB memory.</p>																																												
	<p>Frame Hold</p> <p>Pauses the video. On, <u>Off</u></p>																																												
<p>Capture Source</p> <p>Selects the sources to capture. All: Everything is captured including video assistance functions such as markers and wave form monitor as well as OSD menu. Video: Only video signals are captured.</p>																																													

Item	Setting Options (underline indicates factory default)
Playback File	Plays back captured images. Select File: Selects a file. Execute: Plays back the image.  Note <ul style="list-style-type: none"> When playing back captured images on other DP-V2410 or PC, color may not be played back precisely.
Finish Playback File	Finishes playback.
Time Code	Display the time code superimposed on the SDI signal.   Note <ul style="list-style-type: none"> "Time Code" cannot be displayed when "Frame Hold" is "On", during the execution of "Playback File" under "Screen Capture", or when "Test Pattern" is displayed.
Enable	Switches the time code display On, Off. On, Off
Type	Selects the type. VITC, LTC
Size	Selects the size. Large, Small
Position	Selects the display position. Top Left, Top Right, Bottom Left, Bottom Right
Wave Form Monitor	Configures various settings for the wave form monitor. On the wave form monitor, the horizontal axis shows the horizontal resolution of the video and the vertical line shows the signal level.   Note <ul style="list-style-type: none"> When "Frame Hold", "Peaking" or "False Color" is "On", "Wave Form Monitor" can not be displayed. "Wave Form Monitor" cannot be displayed during the execution of "Playback File" under "Screen Capture", or when "Test Pattern" is displayed. When "Wave Form Monitor" is "On", "Vector Scope" is "Off".
Enable	Switches the wave form monitor On, Off. On, Off
Select Signal	Sets the waveform to be displayed. Y, Cb, Cr, R, G, B

Item	Setting Options (<u>underline indicates factory default</u>)						
Display Type	Sets the display type. When "Line" is selected, data for one line is displayed. All, <u>Line</u> Selects the line to be displayed when "Line" is selected. Select Line: <u>1</u> to 2160						
Position	Selects the display position. <u>Bottom Left</u>, <u>Bottom Right</u>						
Guide	A guide is displayed at the specified position. "Guide" is not displayed when "255" is selected. <u>1</u> to <u>255</u>						
Standard Level High	Sets the standard display level (high). "Standard Level High" is not displayed when "255" is selected. <u>190</u> to <u>255</u>						
Standard Level Low	Sets the standard display level (low). "Standard Level Low" is not displayed when "0" is selected. <u>0</u> to <u>64</u>						
Color	Sets the signals to be displayed and the color of signals exceeding the standard level. Y, Cb, Cr, R, G, B: Selects the signal. Selects the color of the selected signal. White, Red, Green, Blue, Yellow, Cyan, Magenta Default value of each signal is shown below. Y (<u>White</u>), Cb (<u>White</u>), Cr (<u>White</u>), R (<u>Red</u>), G (<u>Green</u>), B (<u>Blue</u>) Standard Level High, Standard Level Low: Selects the standard level. White, Red, Green, Blue, Yellow, Cyan, Magenta Default value of each standard level is shown below. Standard Level High (<u>Magenta</u>), Standard Level Low (<u>Cyan</u>)						
Vector Scope	<p>Configures various settings for the vector scope. Vector scope displays the intensity of color signals and hue with the horizontal axis showing the color difference signal Cb and the vertical line showing Cr.</p> <div data-bbox="635 1059 1169 1440" data-label="Figure"> </div> <p>Note</p> <ul style="list-style-type: none"> • When "Frame Hold", "Peaking" or "False Color" is "On", "Vector Scope" can not be displayed. • "Vector Scope" cannot be displayed during the execution of "Playback File" under "Screen Capture", or when "Test Pattern" is displayed. • When "Vector Scope" is "On", "Wave Form Monitor" is "Off". <table border="1" data-bbox="240 1682 1477 1906"> <tr> <td data-bbox="240 1682 411 1758">Enable</td> <td data-bbox="411 1682 1477 1758">Switches the vector scope On, Off. <u>On</u>, <u>Off</u></td> </tr> <tr> <td data-bbox="240 1758 411 1834">Target</td> <td data-bbox="411 1758 1477 1834">Sets the target. <u>75%</u>, <u>100%</u></td> </tr> <tr> <td data-bbox="240 1834 411 1906">Position</td> <td data-bbox="411 1834 1477 1906">Selects the display position. <u>Bottom Left</u>, <u>Bottom Right</u></td> </tr> </table>	Enable	Switches the vector scope On, Off. <u>On</u>, <u>Off</u>	Target	Sets the target. <u>75%</u>, <u>100%</u>	Position	Selects the display position. <u>Bottom Left</u>, <u>Bottom Right</u>
Enable	Switches the vector scope On, Off. <u>On</u>, <u>Off</u>						
Target	Sets the target. <u>75%</u>, <u>100%</u>						
Position	Selects the display position. <u>Bottom Left</u>, <u>Bottom Right</u>						

Item	Setting Options (underline indicates factory default)										
Audio Level Meter <table border="1" data-bbox="240 376 1477 920"> <tr> <td data-bbox="240 376 413 454">Enable</td> <td data-bbox="413 376 1477 454"> Switches the audio level meter On, Off. On, Off </td> </tr> <tr> <td data-bbox="240 454 413 658">Channel Number (SDI)</td> <td data-bbox="413 454 1477 658"> Sets the number of channels displayed when SDI signal is input. Options change according to the setting for "SDI Group" under "Audio Settings". When "CH1-CH8" is selected for "SDI Group": 2CH (CH1-CH2), 4CH (CH1-CH4), 6CH (CH1-CH6), 8CH (CH1-CH8) When "CH9-CH16" is selected for "SDI Group": 2CH (CH9-CH10), 4CH (CH9-CH12), 6CH (CH9-CH14), 8CH (CH9-CH16) </td> </tr> <tr> <td data-bbox="240 658 413 768">Channel Number (HDMI)</td> <td data-bbox="413 658 1477 768"> Sets the number of channels displayed when HDMI signal is input. 2CH (CH1-CH2), 4CH (CH1-CH4), 6CH (CH1-CH6), 8CH (CH1-CH8) </td> </tr> <tr> <td data-bbox="240 768 413 846">Peak Hold</td> <td data-bbox="413 768 1477 846"> When set to "On", one second of audio signal at the peak is kept. On, Off </td> </tr> <tr> <td data-bbox="240 846 413 920">Standard Level</td> <td data-bbox="413 846 1477 920"> Sets the standard level. -40 to 0 (-20) </td> </tr> </table>	Enable	Switches the audio level meter On, Off. On, Off	Channel Number (SDI)	Sets the number of channels displayed when SDI signal is input. Options change according to the setting for "SDI Group" under "Audio Settings". When "CH1-CH8" is selected for "SDI Group": 2CH (CH1-CH2), 4CH (CH1-CH4), 6CH (CH1-CH6), 8CH (CH1-CH8) When "CH9-CH16" is selected for "SDI Group": 2CH (CH9-CH10), 4CH (CH9-CH12), 6CH (CH9-CH14), 8CH (CH9-CH16)	Channel Number (HDMI)	Sets the number of channels displayed when HDMI signal is input. 2CH (CH1-CH2), 4CH (CH1-CH4), 6CH (CH1-CH6), 8CH (CH1-CH8)	Peak Hold	When set to "On", one second of audio signal at the peak is kept. On, Off	Standard Level	Sets the standard level. -40 to 0 (-20)	<p>Configures various settings for the audio level meter. Displays the audio level of the selected channel number.</p> <p> Note</p> <ul style="list-style-type: none"> "Audio Level Meter" cannot be displayed when "Frame Hold" is "On", during the execution of "Playback File" under "Screen Capture", or when "Test Pattern" is displayed.
Enable	Switches the audio level meter On, Off. On, Off										
Channel Number (SDI)	Sets the number of channels displayed when SDI signal is input. Options change according to the setting for "SDI Group" under "Audio Settings". When "CH1-CH8" is selected for "SDI Group": 2CH (CH1-CH2), 4CH (CH1-CH4), 6CH (CH1-CH6), 8CH (CH1-CH8) When "CH9-CH16" is selected for "SDI Group": 2CH (CH9-CH10), 4CH (CH9-CH12), 6CH (CH9-CH14), 8CH (CH9-CH16)										
Channel Number (HDMI)	Sets the number of channels displayed when HDMI signal is input. 2CH (CH1-CH2), 4CH (CH1-CH4), 6CH (CH1-CH6), 8CH (CH1-CH8)										
Peak Hold	When set to "On", one second of audio signal at the peak is kept. On, Off										
Standard Level	Sets the standard level. -40 to 0 (-20)										
Test Pattern	<p>Sets the test pattern built into the main unit. White, Gray (20%), Black, Red, Green, Blue, Ramp, 5 Step, Color Bars, PLUGE, Off</p> <p> Note</p> <ul style="list-style-type: none"> If the power is turned off once and then back on, the test pattern will not be displayed. The test pattern will be erased in the following cases: <ul style="list-style-type: none"> - When calibration has been started - When the channel is changed using the CH button, F button assigned for Channel UP/ Channel DOWN, or "Select Channel" under "Channel Settings" - When changing "Input Configuration" or "Select Input Signal" under "Channel Settings" - When "Reset All Settings" is executed 										

Item	Setting Options (underline indicates factory default)																																										
Various Function	<p>Displays the function list to execute functions. Monochrome (On, Off), Blue Only (On, Off), Red Off (On, Off), Green Off (On, Off), Blue Off (On, Off), Banner (On, Off)*¹, Function Guide (On, Off)*², OSD Position (Mode 1, Mode 2)*³, OSD Size (Large, Small)*⁴, Backlight Scan (High, Low, Off)</p> <p>*¹ Banner When "Banner" is set to "Off", the banner is displayed only when you press the jog dial while OSD is closed.</p> <p>*² Function Guide On: You can display the list of functions assigned to an F button on the video display by pressing the jog dial while OSD is closed. Off: Function guide is not displayed.</p> <p>*³ OSD Position Mode 1 (4096x2160): OSD is displayed in a 4096x2160 area. Mode 2 (3840x2160): OSD is displayed in a 3840x2160 area.</p> <p>*⁴ OSD Size: The size of the OSD menu can be selected from "Large" and "Small".</p>																																										
Camera Link	<p>Sets the functions to link with Cinema EOS System cameras.</p> <p>Adjustment</p> <p>Sets whether or not to link to the camera's image quality setting when "Canon Log" is selected for "Picture Mode". On, Off When "Color Gamut/Gamma", "Color Temperature", and "Color Range" are all set to "On", the following settings are configured.</p> <p>Parameter of Cinema EOS System and DP-V2410</p> <table border="1" data-bbox="424 965 1469 1514"> <thead> <tr> <th colspan="2">Cinema EOS System</th> <th colspan="4">DP-V2410</th> </tr> <tr> <th>Color Space</th> <th>Gamma</th> <th>Color Gamut</th> <th>Gamma</th> <th>Color Temperature</th> <th>Color Range</th> </tr> </thead> <tbody> <tr> <td>BT.709</td> <td rowspan="5">Canon Log</td> <td>ITU-R BT.709</td> <td rowspan="5">Canon Log</td> <td>D65</td> <td rowspan="5">Automatic</td> </tr> <tr> <td>BT.2020</td> <td>ITU-R BT.2020</td> <td>D65</td> </tr> <tr> <td rowspan="2">Cinema Gamut</td> <td>Cinema Gamut to 709</td> <td>D65</td> </tr> <tr> <td>Cinema Gamut to DCI-P3</td> <td>DCI-P3</td> </tr> <tr> <td rowspan="2">DCI-P3+</td> <td>DCI-P3+ to 709</td> <td>D65</td> </tr> <tr> <td>DCI-P3+ to DCI-P3</td> <td>DCI-P3</td> </tr> <tr> <td>BT.2020</td> <td rowspan="3">Canon Log 2</td> <td>ITU-R BT.2020</td> <td rowspan="3">Canon Log 2</td> <td>D65</td> <td rowspan="3"></td> </tr> <tr> <td rowspan="2">Cinema Gamut</td> <td>Cinema Gamut to 709</td> <td>D65</td> </tr> <tr> <td>Cinema Gamut to DCI-P3</td> <td>DCI-P3</td> </tr> </tbody> </table>	Cinema EOS System		DP-V2410				Color Space	Gamma	Color Gamut	Gamma	Color Temperature	Color Range	BT.709	Canon Log	ITU-R BT.709	Canon Log	D65	Automatic	BT.2020	ITU-R BT.2020	D65	Cinema Gamut	Cinema Gamut to 709	D65	Cinema Gamut to DCI-P3	DCI-P3	DCI-P3+	DCI-P3+ to 709	D65	DCI-P3+ to DCI-P3	DCI-P3	BT.2020	Canon Log 2	ITU-R BT.2020	Canon Log 2	D65		Cinema Gamut	Cinema Gamut to 709	D65	Cinema Gamut to DCI-P3	DCI-P3
Cinema EOS System		DP-V2410																																									
Color Space	Gamma	Color Gamut	Gamma	Color Temperature	Color Range																																						
BT.709	Canon Log	ITU-R BT.709	Canon Log	D65	Automatic																																						
BT.2020		ITU-R BT.2020		D65																																							
Cinema Gamut		Cinema Gamut to 709		D65																																							
		Cinema Gamut to DCI-P3		DCI-P3																																							
DCI-P3+		DCI-P3+ to 709		D65																																							
	DCI-P3+ to DCI-P3	DCI-P3																																									
BT.2020	Canon Log 2	ITU-R BT.2020	Canon Log 2	D65																																							
Cinema Gamut		Cinema Gamut to 709		D65																																							
		Cinema Gamut to DCI-P3		DCI-P3																																							

Item	Setting Options (underline indicates factory default)
Color Gamut / Gamma	The image quality of the display corresponds to the gamma and color gamut of the camera. <u>On</u>, Off
Color Temperature	The image quality of the display corresponds to the color temperature of the camera. <u>On</u>, Off
Color Range	The image quality of the display corresponds to the range of the camera. <u>On</u>, Off
Display Color Gamut	Sets the color gamut shown on the display when the camera's "Color Space" is set to "Cinema Gamut" or "DCI-P3+". <u>ITU-R BT.709, DCI-P3</u>
Fan	Sets whether or not to stop the fan by linking with the camera's REC signal. Set "Fan Control" under "System Settings" to "On". <u>On</u>, Off  Note <ul style="list-style-type: none"> • When set to "On", targets to be linked are REC signals that are compatible with this video display (SDI or HDMI signals of Cinema EOS System cameras and Canon professional-use video cameras). • At a room temperature (25 °C), the fan remains off for approximately one minute when the AC power supply is used and ten minutes when the DC power supply is used. Select the type of power supply according to the purposes. • If the temperature inside the main unit increases while the fan is off, the message "Fan will be rotated as the temperature is high." is displayed and the fan starts rotating approximately ten seconds later. Since the temperature of the main unit has increased, the fan rotates faster than usual. • The video display's fan may start rotating earlier than the camera because the temperature inside the main unit has increased. • The fan may not stop in some conditions, for example when used at a high temperature.
Camera Information	Sets conditions to display camera information. <u>Automatic</u> : Camera information is displayed for 4 seconds when the information has changed. On : Camera information is always displayed. Off : Camera information is not displayed.



System Settings

This menu is used to configure settings related the system of the video display.

Item	Setting Options (<u>underline indicates factory default</u>)
Network Configure an IP Address Display Subnet Mask	Configures settings for the network of the video display. Automatic: Configures an IP address automatically with DHCP/Automatic IP. Manual: Configure an IP address and subnet mask manually. 192.168.0.1 255.255.255.0
Language	Sets the language of the OSD menu and messages. English, 日本語, 簡体中文
Function/Channel Button Display Function/Display Function (CDL)	Sets the function or channel to assign to the F buttons or CH button. Sets the function to assign to the F buttons of the main unit. Select an F button and assign a function from the following list. The factory defaults for the main unit F buttons is as follow: ■ Normal mode F1 : Contrast F2 : Brightness F3 : Time Code (On, Off) F4 : WFM/VEC (On, Off) F5 : Audio Level Meter (On, Off) F6 : Zoom (On, Off) F7 : Hide OSD (On, Off) F8 : Boost Contrast (On, Off) ■ CDL mode F1 : CDL R (On, Off) F2 : CDL G (On, Off) F3 : CDL B (On, Off) F4 : CDL Power (On, Off) F5 : CDL Offset (On, Off) F6 : CDL Slope (On, Off) F7 : CDL Saturation (On, Off) F8 : CDL Bypass (On, Off) ✎ Note <ul style="list-style-type: none"> • When the "Backlight Control" setting is switched using an F button, the information is applied to "Backlight Control" in "Picture Mode". • When "Hide OSD" is set to "On", no OSD is displayed. Although operation can be performed even when OSD is hidden, OSD for the operation is not displayed.

Item	Setting Options (underline indicates factory default)												
Display Function/Display Function (CDL)	<p>The following functions can also be assigned:</p> <table border="1"> <tr> <td data-bbox="443 203 663 568">Adjustment</td> <td data-bbox="663 203 1453 568"> Picture Mode (SMPTE-C, EBU, ITU-R BT.709, ITU-R BT.2020, Adobe RGB, DCI-P3, User 1-7, Canon Log, ACESproxy) Chroma, Sharpness Backlight Control (Local Dimming (High/Low), Global Dimming, Off) Color Gamut (SMPTE-C, EBU, ITU-R BT.709, ITU-R BT.2020, Adobe RGB, DCI-P3, Native, Cinema Gamut to 709, Cinema Gamut to 2020, Cinema Gamut to DCI, DCI-P3+ to 709, DCI-P3+ to DCI, DCI-P3 to 709, ITU-R BT.2020 to 709, ACESproxy, User LUT 1-8) Gamma (2.2, 2.35, 2.4, 2.6, ITU-R BT.1886, Canon Log, Canon Log (HDR), Canon Log 2, Canon Log 2 (HDR), SMPTE ST 2084, User LUT 1-8) HDR Range </td> </tr> <tr> <td data-bbox="443 568 663 645">CDL</td> <td data-bbox="663 568 1453 645"> CDL Preset CDL SOP/Sat </td> </tr> <tr> <td data-bbox="443 645 663 757">Channel Settings</td> <td data-bbox="663 645 1453 757"> Channel UP Channel DOWN Select Input Signal (Automatic, 4K Input, Single Input/Dual Input) </td> </tr> <tr> <td data-bbox="443 757 663 869">Display Settings</td> <td data-bbox="663 757 1453 869"> Screen Scaling (Native Input Resolution, 200%, Automatic) Frame Hold (On, Off) Background Color (White, Gray, Off) </td> </tr> <tr> <td data-bbox="443 869 663 1093">Audio Settings</td> <td data-bbox="663 869 1453 1093"> SDI Group (CH1-CH8, CH9-CH16) CH L CH R Volume Audio Switch (L R, L, R, MIX(L+R)) Select Input (Single Input A-D) </td> </tr> <tr> <td data-bbox="443 1093 663 1326">Marker Settings</td> <td data-bbox="663 1093 1453 1326"> Marker Preset (Marker 1-5, Off) Aspect Marker (On, Off) Safety Zone Marker 1, 2 (On, Off) Area Marker (On, Off) Center Marker (On, Off) Grid Marker (On, Off) </td> </tr> </table>	Adjustment	Picture Mode (SMPTE-C, EBU, ITU-R BT.709, ITU-R BT.2020, Adobe RGB, DCI-P3, User 1-7, Canon Log, ACESproxy) Chroma, Sharpness Backlight Control (Local Dimming (High/Low), Global Dimming, Off) Color Gamut (SMPTE-C, EBU, ITU-R BT.709, ITU-R BT.2020, Adobe RGB, DCI-P3, Native, Cinema Gamut to 709, Cinema Gamut to 2020, Cinema Gamut to DCI, DCI-P3+ to 709, DCI-P3+ to DCI, DCI-P3 to 709, ITU-R BT.2020 to 709, ACESproxy, User LUT 1-8) Gamma (2.2, 2.35, 2.4, 2.6, ITU-R BT.1886, Canon Log, Canon Log (HDR), Canon Log 2, Canon Log 2 (HDR), SMPTE ST 2084, User LUT 1-8) HDR Range	CDL	CDL Preset CDL SOP/Sat	Channel Settings	Channel UP Channel DOWN Select Input Signal (Automatic, 4K Input, Single Input/Dual Input)	Display Settings	Screen Scaling (Native Input Resolution, 200%, Automatic) Frame Hold (On, Off) Background Color (White, Gray, Off)	Audio Settings	SDI Group (CH1-CH8, CH9-CH16) CH L CH R Volume Audio Switch (L R, L, R, MIX(L+R)) Select Input (Single Input A-D)	Marker Settings	Marker Preset (Marker 1-5, Off) Aspect Marker (On, Off) Safety Zone Marker 1, 2 (On, Off) Area Marker (On, Off) Center Marker (On, Off) Grid Marker (On, Off)
Adjustment	Picture Mode (SMPTE-C, EBU, ITU-R BT.709, ITU-R BT.2020, Adobe RGB, DCI-P3, User 1-7, Canon Log, ACESproxy) Chroma, Sharpness Backlight Control (Local Dimming (High/Low), Global Dimming, Off) Color Gamut (SMPTE-C, EBU, ITU-R BT.709, ITU-R BT.2020, Adobe RGB, DCI-P3, Native, Cinema Gamut to 709, Cinema Gamut to 2020, Cinema Gamut to DCI, DCI-P3+ to 709, DCI-P3+ to DCI, DCI-P3 to 709, ITU-R BT.2020 to 709, ACESproxy, User LUT 1-8) Gamma (2.2, 2.35, 2.4, 2.6, ITU-R BT.1886, Canon Log, Canon Log (HDR), Canon Log 2, Canon Log 2 (HDR), SMPTE ST 2084, User LUT 1-8) HDR Range												
CDL	CDL Preset CDL SOP/Sat												
Channel Settings	Channel UP Channel DOWN Select Input Signal (Automatic, 4K Input, Single Input/Dual Input)												
Display Settings	Screen Scaling (Native Input Resolution, 200%, Automatic) Frame Hold (On, Off) Background Color (White, Gray, Off)												
Audio Settings	SDI Group (CH1-CH8, CH9-CH16) CH L CH R Volume Audio Switch (L R, L, R, MIX(L+R)) Select Input (Single Input A-D)												
Marker Settings	Marker Preset (Marker 1-5, Off) Aspect Marker (On, Off) Safety Zone Marker 1, 2 (On, Off) Area Marker (On, Off) Center Marker (On, Off) Grid Marker (On, Off)												

Item		Setting Options (underline indicates factory default)	
Display Function/Display Function (CDL)	Function Settings	Peaking (Peaking 1, Peaking 2, <u>Off</u>)	
		Peaking 1 (Peaking 1, <u>Off</u>)	
		Peaking 2 (Peaking 2, <u>Off</u>)	
		False Color (On, <u>Off</u>)	
		Capture	
		Wave Form Monitor (On, <u>Off</u>)	
		WFM Select Signal (On (Y, Cb, Cr, R, G, B), <u>Off</u>)	
		Vector Scope (On, <u>Off</u>)	
		Monochrome/Blue Only/Red Off/Green Off/Blue Off (On, <u>Off</u>)	
		Backlight Scan (High, Low, <u>Off</u>)	
		Camera Information (<u>Automatic</u>, On, Off)	
	System Settings	Fan Stop (On, <u>Off</u>)	
	<p> Note</p> <ul style="list-style-type: none"> • When changing channels with "Channel UP/DOWN", the channels with "Input Configuration" (📖 43) set to "-" are skipped. • When the "Backlight Control" setting is switched using an F button, the information is applied to "Backlight Control" in "Picture Mode". Likewise, when any marker settings are changed, those changes will be applied to "Enable" under the currently selected "Marker Preset". 		
Display Channel	Sets the channel to assign to the CH button on the display. Select a CH button and register a channel number. A list of settings under the menu "Channel Settings" (📖 43) is displayed.		
Display Name	Sets the name of the main unit. You can input up to 16 alphanumeric characters.		
Date/Time	Sets the year/month/date/hour/minute.		
Power Indicator Brightness	Adjusts the brightness of the power indicator on the main unit. The greater the number is, the greater the brightness. Off, 1 to 5 (3)		
Display Button LED	Sets the F buttons and the lamp on the face. On, Off		
Compatible Settings	Sets the connection compatibility with HDMI equipment. Normal: All formats are supported. Compatible: Set this option when video is not played correctly in "Normal". "4K50.00P/60.00P" is not supported when this option is selected.		
Firmware Update	This function is used to update the video display firmware. Refer to the Canon website for detailed information.		

Item	Setting Options (<u>underline indicates factory default</u>)						
Protect Settings	<p>Locks the settings so they cannot be changed. When you press the MENU button, "Signal/System Information" appears, but other operations are grayed out because they are locked.</p> <table border="1" data-bbox="220 237 1482 651"> <tr> <td data-bbox="220 237 416 282">Password</td> <td data-bbox="416 237 1482 282">Set a password to protect settings. Use a four-digit number (0000 to 9999).</td> </tr> <tr> <td data-bbox="220 282 416 456">Protect Target</td> <td data-bbox="416 282 1482 456"> <p>Selects the target to be protected.</p> <p>Picture Mode: Select "On" to protect or "Off" to exclude settings for "Picture Mode". On, Off</p> <p>Select Channel: Select "On" to protect or "Off" to exclude settings for "Select Channel". On, Off</p> </td> </tr> <tr> <td data-bbox="220 456 416 651">Protect</td> <td data-bbox="416 456 1482 651"> <p>Select "OK" to protect. When a password has been set, enter the password and select "OK".</p> <ul style="list-style-type: none"> Unlocking Protect Settings <p>Move the selection frame to "Protect Settings" and press the SET button for approximately 3 seconds. When a password has been set, enter the password and select "OK".</p> </td> </tr> </table>	Password	Set a password to protect settings. Use a four-digit number (0000 to 9999).	Protect Target	<p>Selects the target to be protected.</p> <p>Picture Mode: Select "On" to protect or "Off" to exclude settings for "Picture Mode". On, Off</p> <p>Select Channel: Select "On" to protect or "Off" to exclude settings for "Select Channel". On, Off</p>	Protect	<p>Select "OK" to protect. When a password has been set, enter the password and select "OK".</p> <ul style="list-style-type: none"> Unlocking Protect Settings <p>Move the selection frame to "Protect Settings" and press the SET button for approximately 3 seconds. When a password has been set, enter the password and select "OK".</p>
Password	Set a password to protect settings. Use a four-digit number (0000 to 9999).						
Protect Target	<p>Selects the target to be protected.</p> <p>Picture Mode: Select "On" to protect or "Off" to exclude settings for "Picture Mode". On, Off</p> <p>Select Channel: Select "On" to protect or "Off" to exclude settings for "Select Channel". On, Off</p>						
Protect	<p>Select "OK" to protect. When a password has been set, enter the password and select "OK".</p> <ul style="list-style-type: none"> Unlocking Protect Settings <p>Move the selection frame to "Protect Settings" and press the SET button for approximately 3 seconds. When a password has been set, enter the password and select "OK".</p>						
Fan Settings	<p>Sets the operation of internal fan.</p> <table border="1" data-bbox="220 696 1482 1375"> <tr> <td data-bbox="220 696 416 804">Fan Control</td> <td data-bbox="416 696 1482 804"> <p>Makes the fan rotate faster before stopping in order to prevent the internal temperature from increasing, when the fan is stopped manually.</p> <p>On, Off</p> </td> </tr> <tr> <td data-bbox="220 804 416 1375">Fan Stop</td> <td data-bbox="416 804 1482 1375"> <p>The fan can be stopped manually when "Fan Control" is set to "On". The fan noise can be made silent when the video display is used during shooting or when silence is necessary.</p> <p>On, Off</p> <p> Note</p> <ul style="list-style-type: none"> If the message "Invalid operation due to high temperature." is displayed, the fan cannot be stopped even when "On" is selected for this item. Wait until the internal temperature lowers. At a room temperature (25 °C), the fan remains off for approximately one minute when the AC power supply is used and ten minutes when the DC power supply is used. Select the type of power supply according to the purposes. If the temperature inside the main unit increases while the fan is off, the message "Fan will be rotated as the temperature is high." is displayed and the fan starts rotating approximately ten seconds later. Since the temperature of the main unit has increased, the fan rotates faster than usual. Select "Off" to restart the fan. The fan rotates faster than usual. The fan may not stop in some conditions, for example when used at a high temperature. </td> </tr> </table>	Fan Control	<p>Makes the fan rotate faster before stopping in order to prevent the internal temperature from increasing, when the fan is stopped manually.</p> <p>On, Off</p>	Fan Stop	<p>The fan can be stopped manually when "Fan Control" is set to "On". The fan noise can be made silent when the video display is used during shooting or when silence is necessary.</p> <p>On, Off</p> <p> Note</p> <ul style="list-style-type: none"> If the message "Invalid operation due to high temperature." is displayed, the fan cannot be stopped even when "On" is selected for this item. Wait until the internal temperature lowers. At a room temperature (25 °C), the fan remains off for approximately one minute when the AC power supply is used and ten minutes when the DC power supply is used. Select the type of power supply according to the purposes. If the temperature inside the main unit increases while the fan is off, the message "Fan will be rotated as the temperature is high." is displayed and the fan starts rotating approximately ten seconds later. Since the temperature of the main unit has increased, the fan rotates faster than usual. Select "Off" to restart the fan. The fan rotates faster than usual. The fan may not stop in some conditions, for example when used at a high temperature. 		
Fan Control	<p>Makes the fan rotate faster before stopping in order to prevent the internal temperature from increasing, when the fan is stopped manually.</p> <p>On, Off</p>						
Fan Stop	<p>The fan can be stopped manually when "Fan Control" is set to "On". The fan noise can be made silent when the video display is used during shooting or when silence is necessary.</p> <p>On, Off</p> <p> Note</p> <ul style="list-style-type: none"> If the message "Invalid operation due to high temperature." is displayed, the fan cannot be stopped even when "On" is selected for this item. Wait until the internal temperature lowers. At a room temperature (25 °C), the fan remains off for approximately one minute when the AC power supply is used and ten minutes when the DC power supply is used. Select the type of power supply according to the purposes. If the temperature inside the main unit increases while the fan is off, the message "Fan will be rotated as the temperature is high." is displayed and the fan starts rotating approximately ten seconds later. Since the temperature of the main unit has increased, the fan rotates faster than usual. Select "Off" to restart the fan. The fan rotates faster than usual. The fan may not stop in some conditions, for example when used at a high temperature. 						

Item	Setting Options (<u>underline indicates factory default</u>)
Export/Import	<p>Sets the export/import main menu settings.</p> <p> Note</p> <ul style="list-style-type: none"> • The following settings cannot be exported or imported. This is also true when "All" is selected. <ul style="list-style-type: none"> - "Calibration" under "Adjustment" (including calibration results) - "Zoom" and "Frame Hold" under "Display Settings" - "Test Pattern" and "Monochrome/Blue Only/Red Off/Green Off/Blue Off" under "Function Settings", "Frame Hold" under "Screen Capture" - "Date/Time", "Fan Stop", "Export/Import" and "Power on Setting" under "System Settings" • Data exported from this video display cannot be imported to other Canon video displays except DP-V2410.
Export	<p>Target: Select the export destination.</p> <p><u>USB</u>: Export to a USB memory</p> <p>User 1-3: Export to the built-in memory of the main unit</p> <p>Filename: Factory default is "dinfo_dpv2410.dat". You can change the name of the file to be exported to the USB memory within 16 one-byte characters including alphabetical characters, numbers, and symbols.</p> <p>Execute: Performs export.</p>
Import	<p>Target: Specify the destination to save the file to be imported.</p> <p><u>USB, User 1-3</u></p> <p>Filename: Displays files with the extension ".dat" so you can select from among them.</p> <p>Settings (All, Adjustment, Channel Settings, Display Settings, Audio Settings, Marker Settings, Function Settings, System Settings): Select the settings to import.</p> <p>Execute: Performs import.</p>
Power on Setting	<p>You can select the state of the display when the power is turned on.</p> <p><u>Last memory</u>: The video display starts up with the settings last used.</p> <p>User 1-3: It starts up with the settings saved in "User 1-3" under "Export".</p>
Reset All Settings	<p>Returns all settings to factory default. When selected, the message "Reset all settings to factory defaults?" appears.</p> <p>OK: Performs reset.</p> <p>Cancel: Returns to the previous screen without resetting.</p>

Signal Information

Shows the signal information. When "Select Input Signal" is "4K Input", information for the entire signal and each input is displayed. Select a signal with the jog dial according to the guide at top right corner of the menu. When signal information has been obtained although it is not displayed on the screen, the content of the information is grayed out.

SDI Signal		HDMI Signal	
Item	Display Example	Item	Display Example
Channel	CH1	Channel	CH4
Input Configuration	3G/HD/SD-SDI (3G-SDI Level A)	Input Configuration	HDMI
Select Input Signal	4K Input	Select Input Signal	Automatic
Format	Automatic	Resolution	4096x2160
Resolution	4096x2160	Picture Rate, I/P/PsF	60.00P
Picture Rate, I/P/PsF*	24.00P	Pixel Encoding	4:2:2 YCbCr
SDI Payload ID	89 C3 46 01	Color Depth	10-bit
Video Standard	3G-SDI	Matrix	ITU-R BT.709
Sampling Structure	4:4:4:4 GBRA	RGB Range	Full
Bit Depth	10-bit		
Picture Rate	24.00		
Scanning Method	Progressive/Progressive (Transport/Picture)		
Link Number	Single/Link_1		

* When a content is grayed out, an asterisk "*" may be displayed indicating low "Picture Rate" accuracy such as "24.00P *".

System Information

Shows the video display status and network information.

Item	Display Example
Display	DP-V2410
Serial No.	000000000000
Firmware Ver.	1.0.0
Usage Time*	5 h
IP Address	192.168.0.1
Subnet Mask	255.255.255.0
MAC Address	FF:FF:FF:FF:FF:FF

* The "Usage Time" is not always "0" when you purchase the display due to factory inspection.

Main specifications/Performance

Panel		
Panel Type	IPS LCD panel	
Screen Size	24 inch (61.1 cm)	
Aspect Ratio	17:9	
Resolution	4096x2160 (8.8 megapixels)	
Active Display Area	Approximately 540.7 x 285.1 mm	
Pixel Pitch	132 μm /193 ppi	
Panel Driver	1024 gradations, 10-bit for each RGB color	
Image quality		
Brightness (Standard)	100 cd/m^2	
View Angle (Up, Down, Left, Right)	89° (contrast ratio 10 : 1 or higher)	
Surface Treatment	Anti-glare coating	
General		
Backlight Type	RGB LED, direct down type	
Power	Rated Voltage: 100 – 240 V AC Rated Frequency: 50/60 Hz 24 V – 28 V DC Max. 8.9 A, XLR terminal	
Power consumption	At maximum load (including change in brightness through aging): Approximately 210 W At factory shipment: Approximately 160 W	
Environmental Conditions	Operating	Temperature and humidity: 0 – 40 °C (32 – 104 °F), 20 – 85 %RH (no condensation) recommended: 15 – 30 °C (59 – 86 °F) Pressure: 700 – 1060 hPa
	Storage/ Transporting	Temperature and humidity: -20 – 40 °C (-4 – 104 °F), 20 – 85 %RH (no condensation) 41 – 60 °C (105 – 140 °F), 20 – 30 %RH (no condensation) Pressure: 700 – 1060 hPa
Dimensions (width x height x depth)	Including stands: Approx. 594x399x187 mm (23.4x15.7x7.4 in.) Main unit only, excluding protrusions: Approx. 594x378x106 mm (23.4x14.9x4.2 in.)	
Weight	Approximately 12 kg (26.4 lb)	
Mounting Hole Pitch	VESA standard 100 x 100 mm (3.9 x 3.9 in.)	
Interface		
Input	3G/HD/SD-SDI	4 (1 systems) BNC (75 Ω) receptacle terminal 3G-SDI: SMPTE 2048-2/274M/296/372/425-1/428-19/428-9 compliant HD-SDI: SMPTE 2048-2/274M/292-1/296/428-19/428-9 compliant SD-SDI: Compliant with SMPTE-259M
	HDMI	1 (1 system) type A terminal Contents protection standard: HDCP 2.2
Output	3G/HD-SDI	4 (1 pass-thru systems)
	Head phone	1 stereo mini jack, Supported impedance: 32 Ω to 64 Ω
Control	USB	1 USB A receptacle terminal Universal Serial Bus Specification Revision 2.0 compliant LS (Low Speed)/FS (Full Speed)/HS (High Speed) mode compatible Compliant with Enhanced Host Controller Interface Specification for Universal Serial Bus Revision 1.0
	LAN	1 RJ-45 terminal Compliant with IEEE802.3 10BASE-TX/IEEE802.3u 100BASE-TX

Dimensions

■ Main Unit

- Front

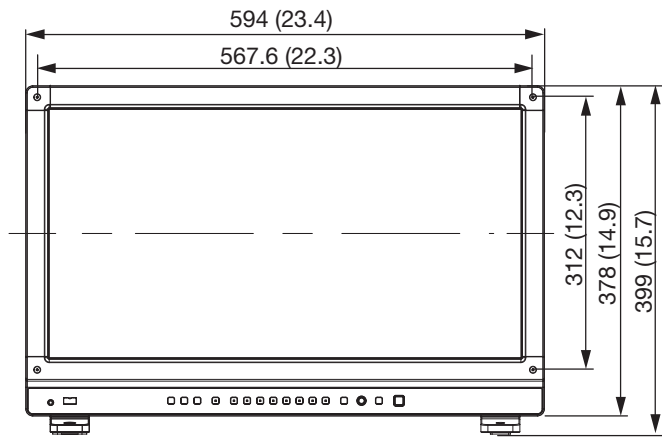

- Rear

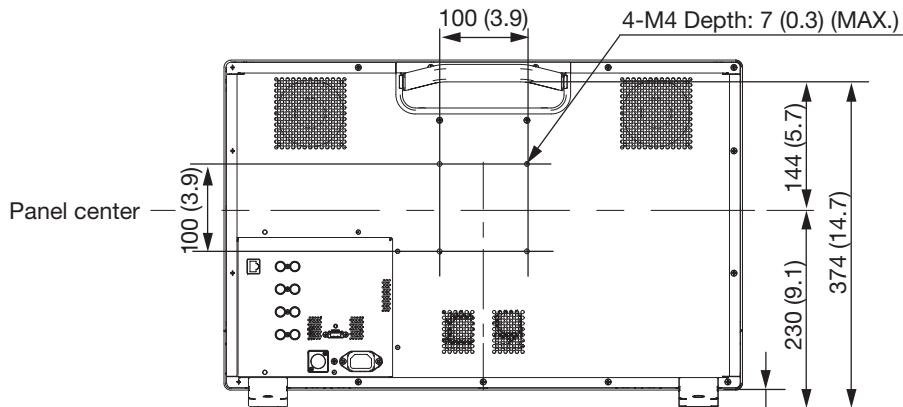

- Side

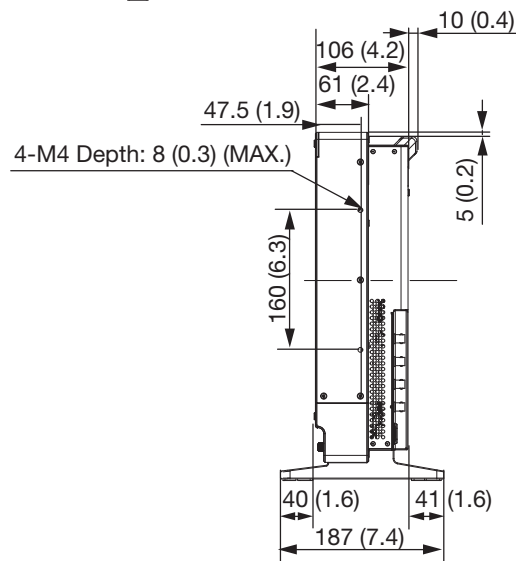

- Bottom

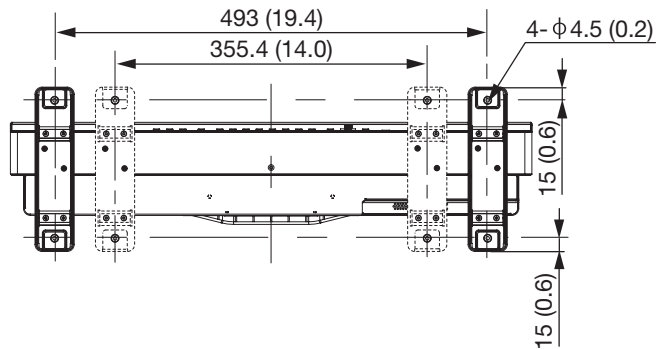

Unit: mm (inch)

Appendix

Supported Signal Format

■ SDI

Formats with "*" support audio signals.

Transmission method	Signal format	Color format	Color depth	Standards
SD-SDI x 1	720x576i 50.00 Hz	4:2:2 YCbCr	10-bit	SMPTE-259M
HD-SDI x 1	1280x720P 59.94/60.00 Hz*	4:2:2 YCbCr	10-bit	SMPTE 292-1 SMPTE 296
	1280x720P 50.00 Hz*			
	1280x720P 29.97/30.00 Hz			
	1280x720P 25.00 Hz*			
	1280x720P 23.98/24.00 Hz*			
	1920x1080i 59.94/60.00 Hz*			
	1920x1080i 50.00 Hz*			
	1920x1080P 29.97/30.00 Hz*			
	1920x1080PsF 29.97/30.00 Hz*			
	1920x1080P 25.00 Hz*			
	1920x1080PsF 25.00 Hz*			
	1920x1080P 23.98/24.00 Hz*			
	1920x1080PsF 23.98/24.00 Hz*			
	2048x1080i 59.94/60.00 Hz			SMPTE 292-1 SMPTE 428-9 SMPTE 428-19 SMPTE 2048-2
	2048x1080i 50.00 Hz			
	2048x1080P 29.97/30.00 Hz			
	2048x1080PsF 29.97/30.00 Hz			
	2048x1080P 25.00 Hz			
	2048x1080PsF 25.00 Hz			
	2048x1080P 23.98/24.00 Hz			
2048x1080PsF 23.98/24.00 Hz				
3G-SDI Level A x 1	1280x720P 59.94/60.00 Hz*	4:4:4 RGB 4:4:4 YCbCr	10-bit	SMPTE 425-1 SMPTE 296
	1280x720P 50.00 Hz*	4:4:4 RGB 4:4:4 YCbCr	10-bit	
	1280x720P 29.97/30.00 Hz	4:4:4 RGB 4:4:4 YCbCr	10-bit	
	1280x720P 25.00 Hz*	4:4:4 RGB 4:4:4 YCbCr	10-bit	
	1280x720P 23.98/24.00 Hz*	4:4:4 RGB 4:4:4 YCbCr	10-bit	
	1920x1080P 59.94/60.00 Hz*	4:2:2 YCbCr	10-bit	SMPTE 425-1 SMPTE 274M

Transmission method	Signal format	Color format	Color depth	Standards
3G-SDI Level A x 1	1920x1080i 59.94/60.00 Hz	4:4:4 RGB*	12-bit/10-bit	SMPTE 425-1 SMPTE 274M
		4:4:4 YCbCr*		
		4:2:2 YCbCr	12-bit	
	1920x1080P 50.00 Hz*	4:2:2 YCbCr	10-bit	
	1920x1080i 50.00 Hz	4:4:4 RGB*	12-bit/10-bit	
		4:4:4 YCbCr*		
		4:2:2 YCbCr	12-bit	
	1920x1080P 29.97/30.00 Hz	4:4:4 RGB	12-bit/10-bit	SMPTE 425-1 SMPTE 274M
		4:4:4 YCbCr		
		4:2:2 YCbCr	12-bit	
	1920x1080PsF 29.97/30.00 Hz	4:4:4 RGB*	10-bit	
			12-bit	
		4:4:4 YCbCr*	12-bit	
		4:4:4 YCbCr*	10-bit	
		4:2:2 YCbCr	12-bit	SMPTE 425-1 SMPTE 274M
	1920x1080P 25.00 Hz	4:4:4 RGB	12-bit/10-bit	
		4:4:4 YCbCr		
		4:2:2 YCbCr	12-bit	
	1920x1080PsF 25.00 Hz	4:4:4 RGB*	10-bit	
			12-bit	
		4:4:4 YCbCr*	12-bit	
		4:4:4 YCbCr*	10-bit	
		4:2:2 YCbCr	12-bit	SMPTE 425-1 SMPTE 274M
	1920x1080P 23.98/24.00 Hz	4:4:4 RGB*	12-bit/10-bit	
4:4:4 YCbCr*				
	4:2:2 YCbCr	12-bit		
1920x1080PsF 23.98/24.00 Hz	4:4:4 RGB	10-bit		
		12-bit		
	4:4:4 YCbCr	12-bit		
	4:4:4 YCbCr	10-bit		
	4:2:2 YCbCr	12-bit	SMPTE 425-1 SMPTE 274M	
2048x1080P 59.94/60.00 Hz	4:2:2 YCbCr	10-bit	SMPTE 425-1 SMPTE 428-9 SMPTE 428-19 SMPTE 2048-2	
2048x1080i 59.94/60.00 Hz	4:4:4 RGB	12-bit/10-bit		
	4:4:4 YCbCr			
	4:4:4 X'Y'Z'	12-bit		
	4:2:2 YCbCr			
2048x1080P 50.00 Hz	4:2:2 YCbCr	10-bit	SMPTE 425-1 SMPTE 2048-2	

Transmission method	Signal format	Color format	Color depth	Standards	
3G-SDI Level A x 1	2048x1080i 50.00 Hz	4:4:4 RGB	12-bit/10-bit		
		4:4:4 YCbCr			
		4:4:4 X'Y'Z'	12-bit		
			4:2:2 YCbCr		
		2048x1080P 47.95/48.00 Hz	4:2:2 YCbCr	10-bit	SMPTE 425-1 SMPTE 2048-2
		2048x1080P 29.97/30.00 Hz	4:4:4 RGB	12-bit/10-bit	SMPTE 425-1 SMPTE 428-9 SMPTE 428-19 SMPTE 2048-2
	4:4:4 X'Y'Z'		12-bit		
	4:4:4 YCbCr		12-bit/10-bit	SMPTE 425-1 SMPTE 2048-2	
	4:2:2 YCbCr		12-bit		
		2048x1080PsF 29.97/30.00 Hz	4:4:4 RGB	12-bit/10-bit	SMPTE 425-1 SMPTE 428-9 SMPTE 428-19 SMPTE 2048-2
	4:4:4 X'Y'Z'		12-bit		
	4:4:4 YCbCr		12-bit/10-bit	SMPTE 425-1 SMPTE 2048-2	
	4:2:2 YCbCr		12-bit		
		2048x1080P 25.00 Hz	4:4:4 RGB	12-bit/10-bit	SMPTE 425-1 SMPTE 428-9 SMPTE 428-19 SMPTE 2048-2
	4:4:4 X'Y'Z'		12-bit		
	4:4:4 YCbCr		12-bit/10-bit	SMPTE 425-1 SMPTE 2048-2	
	4:2:2 YCbCr		12-bit		
		2048x1080PsF 25.00 Hz	4:4:4 RGB	12-bit/10-bit	SMPTE 425-1 SMPTE 428-9 SMPTE 428-19 SMPTE 2048-2
	4:4:4 X'Y'Z'		12-bit		
	4:4:4 YCbCr		12-bit/10-bit	SMPTE 425-1 SMPTE 2048-2	
4:2:2 YCbCr	12-bit				
	2048x1080P 23.98/24.00 Hz	4:4:4 RGB	12-bit/10-bit	SMPTE 425-1 SMPTE 428-9 SMPTE 428-19 SMPTE 2048-2	
4:4:4 X'Y'Z'		12-bit			
4:4:4 YCbCr		12-bit/10-bit	SMPTE 425-1 SMPTE 2048-2		
4:2:2 YCbCr		12-bit			
	2048x1080PsF 23.98/24.00 Hz	4:4:4 RGB	12-bit/10-bit	SMPTE 425-1 SMPTE 428-9 SMPTE 428-19 SMPTE 2048-2	
4:4:4 X'Y'Z'		12-bit			
4:4:4 YCbCr		12-bit/10-bit	SMPTE 425-1 SMPTE 2048-2		
4:2:2 YCbCr		12-bit			

Transmission method	Signal format	Color format	Color depth	Standards
3G-SDI Level B x 1	1920x1080P 59.94/60.00 Hz	4:2:2 YCbCr	10-bit	SMPTE 425-1 SMPTE 372 SMPTE 274M
	1920x1080i 59.94/60.00 Hz	4:4:4 RGB 4:4:4 YCbCr	12-bit/10-bit	
		4:2:2 YCbCr*	12-bit	
	1920x1080P 50.00 Hz	4:2:2 YCbCr	10-bit	
	1920x1080i 50.00 Hz	4:4:4 RGB 4:4:4 YCbCr	12-bit/10-bit	
		4:2:2 YCbCr*	12-bit	
	1920x1080P 29.97/30.00 Hz	4:4:4 RGB 4:4:4 YCbCr	12-bit/10-bit	
		4:2:2 YCbCr	12-bit	
	1920x1080PsF 29.97/30.00 Hz	4:4:4 RGB 4:4:4 YCbCr	12-bit/10-bit	
		4:2:2 YCbCr	12-bit	
	1920x1080P 25.00 Hz	4:4:4 RGB 4:4:4 YCbCr	12-bit/10-bit	
		4:2:2 YCbCr	12-bit	
	1920x1080PsF 25.00 Hz	4:4:4 RGB 4:4:4 YCbCr	12-bit/10-bit	
		4:2:2 YCbCr	12-bit	
	1920x1080P 23.98/24.00 Hz	4:4:4 RGB 4:4:4 YCbCr	12-bit/10-bit	
		4:2:2 YCbCr	12-bit	
	1920x1080PsF 23.98/24.00 Hz	4:4:4 RGB 4:4:4 YCbCr	12-bit/10-bit	
		4:2:2 YCbCr	12-bit	
	2048x1080P 59.94/60.00 Hz	4:2:2 YCbCr	10-bit	SMPTE 425-1 SMPTE 372 SMPTE 428-9 SMPTE 428-19 SMPTE 2048-2
	2048x1080i 59.94/60.00 Hz	4:4:4 RGB 4:4:4 YCbCr	12-bit/10-bit	
4:4:4 X'Y'Z' 4:2:2 YCbCr		12-bit		
2048x1080P 50.00 Hz	4:2:2 YCbCr	10-bit	SMPTE 425-1 SMPTE 372 SMPTE 2048-2	
2048x1080i 50.00 Hz	4:4:4 RGB 4:4:4 YCbCr	12-bit/10-bit		
	4:4:4 X'Y'Z' 4:2:2 YCbCr	12-bit		

Transmission method	Signal format	Color format	Color depth	Standards
3G-SDI Level B x 1	2048x1080P 47.95/48.00 Hz	4:2:2 YCbCr	10-bit	SMPTE 425-1 SMPTE 372 SMPTE 2048-2
	2048x1080P 29.97/30.00 Hz	4:4:4 RGB	12-bit/10-bit	SMPTE 425-1 SMPTE 372 SMPTE 428-9 SMPTE 428-19 SMPTE 2048-2
		4:4:4 X'Y'Z'	12-bit	
		4:4:4 YCbCr	12-bit/10-bit	SMPTE 425-1 SMPTE 372 SMPTE 2048-2
		4:2:2 YCbCr	12-bit	
	2048x1080PsF 29.97/30.00 Hz	4:4:4 RGB	12-bit/10-bit	SMPTE 425-1 SMPTE 372 SMPTE 428-9 SMPTE 428-19 SMPTE 2048-2
		4:4:4 X'Y'Z'	12-bit	
		4:4:4 YCbCr	12-bit/10-bit	SMPTE 425-1 SMPTE 372 SMPTE 2048-2
		4:2:2 YCbCr	12-bit	
	2048x1080P 25.00 Hz	4:4:4 RGB	12-bit/10-bit	SMPTE 425-1 SMPTE 372 SMPTE 428-9 SMPTE 428-19 SMPTE 2048-2
		4:4:4 X'Y'Z'	12-bit	
		4:4:4 YCbCr	12-bit/10-bit	SMPTE 425-1 SMPTE 372 SMPTE 2048-2
		4:2:2 YCbCr	12-bit	
	2048x1080PsF 25.00 Hz	4:4:4 RGB	12-bit/10-bit	SMPTE 425-1 SMPTE 372 SMPTE 428-9 SMPTE 428-19 SMPTE 2048-2
		4:4:4 X'Y'Z'	12-bit	
		4:4:4 YCbCr	12-bit/10-bit	SMPTE 425-1 SMPTE 372 SMPTE 2048-2
		4:2:2 YCbCr	12-bit	
	2048x1080P 23.98/24.00 Hz	4:4:4 RGB	12-bit/10-bit	SMPTE 425-1 SMPTE 372 SMPTE 428-9 SMPTE 428-19 SMPTE 2048-2
		4:4:4 X'Y'Z'	12-bit	
		4:4:4 YCbCr	12-bit/10-bit	SMPTE 425-1 SMPTE 372 SMPTE 2048-2
4:2:2 YCbCr		12-bit		

Transmission method	Signal format	Color format	Color depth	Standards
3G-SDI Level B x 1	2048x1080PsF 23.98/24.00 Hz	4:4:4 RGB	12-bit/10-bit	SMPTE 425-1 SMPTE 372 SMPTE 428-9 SMPTE 428-19 SMPTE 2048-2
		4:4:4 X'Y'Z'	12-bit	
		4:4:4 YCbCr	12-bit/10-bit	
		4:2:2 YCbCr	12-bit	
HD-SDI x 4	3840x2160i 59.94/60.00 Hz*	4:2:2 YCbCr	10-bit	SMPTE 292-1 SMPTE 274M
	3840x2160i 50.00 Hz*			
	3840x2160P 29.97/30.00 Hz*			
	3840x2160PsF 29.97/30.00 Hz*			
	3840x2160P 25.00 Hz*			
	3840x2160PsF 25.00 Hz*			
	3840x2160P 23.98/24.00 Hz*			
	3840x2160PsF 23.98/24.00 Hz*			
	4096x2160i 59.94/60.00 Hz			SMPTE 292-1 SMPTE 428-9 SMPTE 428-19 SMPTE 2048-2
	4096x2160i 50.00 Hz			
	4096x2160P 29.97/30.00 Hz			
	4096x2160P 29.97/30.00 Hz			
	4096x2160PsF 29.97/30.00 Hz			
	4096x2160P 25.00 Hz			
	4096x2160PsF 25.00 Hz			
	4096x2160P 23.98/24.00 Hz			
4096x2160PsF 23.98/24.00 Hz				
3G-SDI Level A x 4	3840x2160P 59.94/60.00 Hz	4:2:2 YCbCr*	10-bit	SMPTE 425-1 SMPTE 274M
	3840x2160i 59.94/60.00 Hz	4:4:4 RGB*	12-bit/10-bit	
		4:4:4 YCbCr*	12-bit	
		4:2:2 YCbCr		
	3840x2160P 50.00 Hz	4:2:2 YCbCr*	12-bit	
	3840x2160i 50.00 Hz	4:4:4 RGB*	12-bit/10-bit	
		4:4:4 YCbCr*	12-bit	
		4:2:2 YCbCr		
3840x2160P 29.97/30.00 Hz	4:4:4 RGB	12-bit/10-bit		
	4:4:4 YCbCr	12-bit		

Transmission method	Signal format	Color format	Color depth	Standards
3G-SDI Level A x 4	3840x2160PsF 29.97/30.00 Hz	4:4:4 RGB*	10-bit	SMPTE 425-1 SMPTE 274M
			12-bit	
		4:4:4 YCbCr*	12-bit	SMPTE 425-1 SMPTE 274M
		4:4:4 YCbCr*	10-bit	
	4:2:2 YCbCr	12-bit		
	3840x2160P 25.00 Hz	4:4:4 RGB 4:4:4 YCbCr	12-bit/10-bit	SMPTE 425-1 SMPTE 274M
		4:2:2 YCbCr	12-bit	
	3840x2160PsF 25.00 Hz	4:4:4 RGB*	10-bit	
			12-bit	
		4:4:4 YCbCr*	12-bit	SMPTE 425-1 SMPTE 274M
		4:2:2 YCbCr	12-bit	
	3840x2160P 23.98/24.00 Hz	4:4:4 RGB* 4:4:4 YCbCr*	12-bit/10-bit	SMPTE 425-1 SMPTE 274M
		4:2:2 YCbCr	12-bit	
	3840x2160PsF 23.98/24.00 Hz	4:4:4 RGB	10-bit	
			12-bit	
		4:4:4 YCbCr	12-bit	SMPTE 425-1 SMPTE 274M
		4:2:2 YCbCr	12-bit	
	4096x2160P 59.94/60.00 Hz	4:2:2 YCbCr	10-bit	SMPTE 425-1 SMPTE 428-9 SMPTE 428-19 SMPTE 2048-2
		4096x2160i 59.94/60.00 Hz	4:4:4 RGB 4:4:4 YCbCr	12-bit/10-bit
4:4:4 X'Y'Z' 4:2:2 YCbCr	12-bit			
4096x2160P 50.00 Hz	4:2:2 YCbCr	10-bit	SMPTE 425-1 SMPTE 2048-2	
4096x2160i 50.00 Hz	4:4:4 RGB 4:4:4 YCbCr	12-bit/10-bit		
	4:4:4 X'Y'Z' 4:2:2 YCbCr	12-bit		
4096x2160P 47.95/48.00 Hz	4:2:2 YCbCr	10-bit	SMPTE 425-1 SMPTE 2048-2	

Transmission method	Signal format	Color format	Color depth	Standards
3G-SDI Level A x 4	4096x2160P 29.97/30.00 Hz	4:4:4 RGB	12-bit/10-bit	SMPTE 425-1 SMPTE 428-9 SMPTE 428-19 SMPTE 2048-2
		4:4:4 X'Y'Z'	12-bit	
		4:4:4 YCbCr	12-bit/10-bit	
		4:2:2 YCbCr	12-bit	
	4096x2160PsF 29.97/30.00 Hz	4:4:4 RGB	12-bit/10-bit	SMPTE 425-1 SMPTE 428-9 SMPTE 428-19 SMPTE 2048-2
		4:4:4 X'Y'Z'	12-bit	
		4:4:4 YCbCr	12-bit/10-bit	
		4:2:2 YCbCr	12-bit	
	4096x2160P 25.00 Hz	4:4:4 RGB	12-bit/10-bit	SMPTE 425-1 SMPTE 428-9 SMPTE 428-19 SMPTE 2048-2
		4:4:4 X'Y'Z'	12-bit	
		4:4:4 YCbCr	12-bit/10-bit	
		4:2:2 YCbCr	12-bit	
	4096x2160PsF 25.00 Hz	4:4:4 RGB	12-bit/10-bit	SMPTE 425-1 SMPTE 428-9 SMPTE 428-19 SMPTE 2048-2
		4:4:4 X'Y'Z'	12-bit	
		4:4:4 YCbCr	12-bit/10-bit	
		4:2:2 YCbCr	12-bit	
	4096x2160P 23.98/24.00 Hz	4:4:4 RGB	12-bit/10-bit	SMPTE 425-1 SMPTE 428-9 SMPTE 428-19 SMPTE 2048-2
		4:4:4 X'Y'Z'	12-bit	
		4:4:4 YCbCr	12-bit/10-bit	
		4:2:2 YCbCr	12-bit	
4096x2160PsF 23.98/24.00 Hz	4:4:4 RGB	12-bit/10-bit	SMPTE 425-1 SMPTE 428-9 SMPTE 428-19 SMPTE 2048-2	
	4:4:4 X'Y'Z'	12-bit		
	4:4:4 YCbCr	12-bit/10-bit		
	4:2:2 YCbCr	12-bit		
3G-SDI Level B x 4	3840x2160P 59.94/60.00 Hz	4:2:2 YCbCr	10-bit	SMPTE 425-1 SMPTE 372 SMPTE 274M
	3840x2160i 59.94/60.00 Hz	4:4:4 RGB	12-bit/10-bit	
		4:4:4 YCbCr		
		4:2:2 YCbCr*	12-bit	
3840x2160P 50.00 Hz	4:2:2 YCbCr	10-bit		

Transmission method	Signal format	Color format	Color depth	Standards
3G-SDI Level B x 4	3840x2160i 50.00 Hz	4:4:4 RGB	12-bit/10-bit	SMPTE 425-1 SMPTE 372 SMPTE 274M
		4:4:4 YCbCr		
	3840x2160P 29.97/30.00 Hz	4:2:2 YCbCr*	12-bit	
		4:4:4 RGB	12-bit/10-bit	
	3840x2160P 29.97/30.00 Hz	4:4:4 YCbCr	12-bit	
		4:2:2 YCbCr	12-bit	
	3840x2160PsF 29.97/30.00 Hz	4:4:4 RGB	12-bit/10-bit	
		4:4:4 YCbCr	12-bit	
	3840x2160P 25.00 Hz	4:2:2 YCbCr	12-bit	
		4:4:4 RGB	12-bit/10-bit	
	3840x2160PsF 25.00 Hz	4:4:4 YCbCr	12-bit	
		4:2:2 YCbCr	12-bit	
	3840x2160P 23.98/24.00 Hz	4:4:4 RGB	12-bit/10-bit	
		4:4:4 YCbCr	12-bit	
3840x2160PsF 23.98/24.00 Hz	4:2:2 YCbCr	12-bit		
	4:4:4 RGB	12-bit/10-bit		
4096x2160P 59.94/60.00 Hz	4:4:4 YCbCr	12-bit		
	4:2:2 YCbCr	10-bit		
4096x2160i 59.94/60.00 Hz	4:4:4 RGB	12-bit/10-bit	SMPTE 425-1 SMPTE 372 SMPTE 428-9 SMPTE 428-19 SMPTE 2048-2	
	4:4:4 YCbCr	12-bit		
4096x2160P 50.00 Hz	4:4:4 X'Y'Z'	12-bit		
	4:2:2 YCbCr	10-bit		
4096x2160i 50.00 Hz	4:4:4 RGB	12-bit/10-bit	SMPTE 425-1 SMPTE 372 SMPTE 2048-2	
	4:4:4 YCbCr	12-bit		
4096x2160P 47.95/48.00 Hz	4:4:4 X'Y'Z'	12-bit		
	4:2:2 YCbCr	10-bit		
4096x2160P 47.95/48.00 Hz	4:4:4 RGB	12-bit/10-bit	SMPTE 425-1 SMPTE 372 SMPTE 2048-2	
	4:4:4 YCbCr	12-bit		
4096x2160P 47.95/48.00 Hz	4:2:2 YCbCr	10-bit		
	4:4:4 RGB	12-bit/10-bit		
4096x2160P 47.95/48.00 Hz	4:4:4 YCbCr	12-bit		
	4:2:2 YCbCr	10-bit		

Transmission method	Signal format	Color format	Color depth	Standards
3G-SDI Level B x 4	4096x2160P 29.97/30.00 Hz	4:4:4 RGB	12-bit/10-bit	SMPTE 425-1 SMPTE 372
		4:4:4 X'Y'Z'	12-bit	SMPTE 428-9 SMPTE 428-19 SMPTE 2048-2
		4:4:4 YCbCr	12-bit/10-bit	SMPTE 425-1 SMPTE 372
		4:2:2 YCbCr	12-bit	SMPTE 2048-2
	4096x2160PsF 29.97/30.00 Hz	4:4:4 RGB	12-bit/10-bit	SMPTE 425-1 SMPTE 372
		4:4:4 X'Y'Z'	12-bit	SMPTE 428-9 SMPTE 428-19 SMPTE 2048-2
		4:4:4 YCbCr	12-bit/10-bit	SMPTE 425-1 SMPTE 372
		4:2:2 YCbCr	12-bit	SMPTE 2048-2
	4096x2160P 25.00 Hz	4:4:4 RGB	12-bit/10-bit	SMPTE 425-1 SMPTE 372
		4:4:4 X'Y'Z'	12-bit	SMPTE 428-9 SMPTE 428-19 SMPTE 2048-2
		4:4:4 YCbCr	12-bit/10-bit	SMPTE 425-1 SMPTE 372
		4:2:2 YCbCr	12-bit	SMPTE 2048-2
	4096x2160PsF 25.00 Hz	4:4:4 RGB	12-bit/10-bit	SMPTE 425-1 SMPTE 372
		4:4:4 X'Y'Z'	12-bit	SMPTE 428-9 SMPTE 428-19 SMPTE 2048-2
		4:4:4 YCbCr	12-bit/10-bit	SMPTE 425-1 SMPTE 372
		4:2:2 YCbCr	12-bit	SMPTE 2048-2
4096x2160P 23.98/24.00 Hz	4:4:4 RGB	12-bit/10-bit	SMPTE 425-1 SMPTE 372	
	4:4:4 X'Y'Z'	12-bit	SMPTE 428-9 SMPTE 428-19 SMPTE 2048-2	
	4:4:4 YCbCr	12-bit/10-bit	SMPTE 425-1 SMPTE 372	
	4:2:2 YCbCr	12-bit	SMPTE 2048-2	
4096x2160PsF 23.98/24.00 Hz	4:4:4 YCbCr	12-bit/10-bit	SMPTE 425-1 SMPTE 372	
	4:2:2 YCbCr	12-bit	SMPTE 2048-2	

■ RAW

Signal format
3840x2160P 59.94 Hz, 50.00 Hz, 29.97 Hz, 25.00 Hz, 24.00 Hz, 23.98 Hz
4096x2160P 59.94 Hz, 50.00 Hz, 29.97 Hz, 25.00 Hz, 24.00 Hz, 23.98 Hz

■ HDMI

Signal format	Color format/Color depth
640x480P 59.94/60.00 Hz	4:4:4 RGB 8-bit
800x600P 60.00 Hz	
1024x768P 60.00 Hz	
720x480P 59.94/60.00 Hz	4:4:4 RGB 12-bit/10-bit/8-bit 4:4:4 YCbCr 12-bit/10-bit/8-bit 4:2:2 YCbC 12-bit
720x576P 50.00 Hz	
1280x720P 59.94/60.00 Hz	
1280x720P 50.00 Hz	
1920x1080P 59.94/60.00 Hz	
1920x1080i 59.94/60.00 Hz	
1920x1080P 50.00 Hz	
1920x1080i 50.00 Hz	
1920x1080P 29.97/30.00 Hz	
1920x1080P 25.00 Hz	
1920x1080P 23.98/24.00 Hz	
2048x1080P 59.94/60.00 Hz	
2048x1080P 50.00 Hz	
2048x1080P 29.97/30.00 Hz	
2048x1080P 25.00 Hz	
2048x1080P 23.98/24.00 Hz	
3840x2160P 59.94/60.00 Hz	4:4:4 RGB 8-bit 4:4:4 YCbCr 8-bit 4:2:2 YCbC 12-bit 4:2:0 YCbC 12-bit/10-bit/8-bit
3840x2160P 50.00 Hz	
3840x2160P 29.97/30.00 Hz	4:4:4 RGB 12-bit/10-bit/8-bit 4:4:4 YCbCr 12-bit/10-bit/8-bit 4:2:2 YCbC 12-bit
3840x2160P 25.00 Hz	
3840x2160P 23.98/24.00 Hz	
4096x2160P 59.94/60.00 Hz	4:4:4 RGB 8-bit 4:4:4 YCbCr 8-bit 4:2:2 YCbC 12-bit 4:2:0 YCbC 12-bit/10-bit/8-bit
4096x2160P 50.00 Hz	
4096x2160P 29.97/30.00 Hz	4:4:4 RGB 12-bit/10-bit/8-bit 4:4:4 YCbCr 12-bit/10-bit/8-bit 4:2:2 YCbC 12-bit
4096x2160P 25.00 Hz	
4096x2160P 23.98/24.00 Hz	

Image/Frame Display

■ SDI

Signal system			Display Method	
720x576	50.00	i	50.00	P
1280x720	23.98/24.00	P	47.96/48.00	P*
	25.00	P	50.00	P*
	29.97/30.00	P	59.94/60.00	P*
	50.00	P	50.00	P
	59.94/60.00	P	59.94/60.00	P
1920x1080	50.00	i	50.00	P
	59.94/60.00	i	59.94/60.00	P
	23.98/24.00	PsF	47.96/48.00	P*
	25.00	PsF	50.00	P*
	29.97/30.00	PsF	59.94/60.00	P*
	23.98/24.00	P	47.96/48.00	P*
	25.00	P	50.00	P*
	29.97/30.00	P	59.94/60.00	P*
	50.00	P	50.00	P
	59.94/60.00	P	59.94/60.00	P
2048x1080	50.00	i	50.00	P
	59.94/60.00	i	59.94/60.00	P
	23.98/24.00	PsF	47.96/48.00	P*
	25.00	PsF	50.00	P*
	29.97/30.00	PsF	59.94/60.00	P*
	23.98/24.00	P	47.96/48.00	P*
	25.00	P	50.00	P*
	29.97/30.00	P	59.94/60.00	P*
	47.95/48.00	P	47.95/48.00	P
	50.00	P	50.00	P
59.94/60.00	P	59.94/60.00	P	
3840x2160	50.00	i	50.00	P
	59.94/60.00	i	59.94/60.00	P
	23.98/24.00	PsF	47.96/48.00	P*
	25.00	PsF	50.00	P*
	29.97/30.00	PsF	59.94/60.00	P*
	23.98/24.00	P	47.96/48.00	P*
	25.00	P	50.00	P*
	29.97/30.00	P	59.94/60.00	P*
	50.00	P	50.00	P
	59.94/60.00	P	59.94/60.00	P

Signal system			Display Method	
4096x2160	50.00	i	50.00	P
	59.94/60.00	i	59.94/60.00	P
	23.98/24.00	PsF	47.96/48.00	P*
	25.00	PsF	50.00	P*
	29.97/30.00	PsF	59.94/60.00	P*
	23.98/24.00	P	47.96/48.00	P*
	25.00	P	50.00	P*
	29.97/30.00	P	59.94/60.00	P*
	47.95/48.00	P	47.95/48.00	P
	50.00	P	50.00	P
	59.94/60.00	P	59.94/60.00	P

* : Displaying same frame

■ HDMI

Signal system			Display Method	
640x480	59.94/60.00	P	59.94/60.00	P
800x600	60.00	P	60.00	P
720x480P	59.94/60.00	P	59.94/60.00	P
720x576	50.00	P	50.00	P
1024x768	60.00	P	60.00	P
1280x720	59.94/60.00	P	59.94/60.00	P
1280x720	50.00	P	50.00	P
1920x1080	59.94/60.00	P	59.94/60.00	P
1920x1080	59.94/60.00	i	59.94/60.00	P
1920x1080	50.00	P	50.00	P
1920x1080	50.00	i	50.00	P
1920x1080	59.94/60.00	i	59.94/60.00	P
1920x1080	29.97/30.00	P	59.94/60.00	P*
1920x1080	25.00	P	50.00	P*
1920x1080	23.98/24.00	P	47.96/48.00	P*
2048x1080	59.94/60.00	P	59.94/60.00	P
2048x1080	50.00	P	50.00	P
2048x1080	29.97/30.00	P	59.94/60.00	P*
2048x1080	25.00	P	50.00	P*
2048x1080	23.98/24.00	P	47.96/48.00	P*
3840x2160	59.94/60.00	P	59.94/60.00	P
3840x2160	50.00	P	50.00	P
3840x2160	29.97/30.00	P	59.94/60.00	P*
3840x2160	25.00	P	50.00	P*
3840x2160	23.98/24.00	P	47.96/48.00	P*
4096x2160	59.94/60.00	P	59.94/60.00	P
4096x2160	50.00	P	50.00	P
4096x2160	29.97/30.00	P	59.94/60.00	P*
4096x2160	25.00	P	50.00	P*
4096x2160	23.98/24.00	P	47.96/48.00	P*

* : Displaying same frame

Input Signals and Adjustable/Setting Item

The following items have limitations depending on the input signals.

Setting item		Input signal		
		3G/HD/SD-SDI	3G-SDI RAW	HDMI
		YCbCr/RGB/XYZ		RGB
Adjustment	2020 Constant Luminance	● ^{*1}	●	●
Channel Settings	Select Input Signal	● ^{*2}	●	● ^{*3}
	Format	● ^{*4}	● ^{*5}	● ^{*6}
Display Settings	Zoom	●	●	● ^{*7}
	PsF	●	●	—
	Film Cadence	● ^{*8}		
Function Settings	Time Code	●	●	● ^{*9}
	Screen Capture	●	●	● ^{*10}
	Camera Link	●	● ^{*11}	● ^{*12}

-: Setting is disabled.

*1 : SD-SDI is fixed to "Non-constant Luminance".

*2 : Cannot be set to "Dual Input".

*3 : Fixed to "Automatic".

*4 : SD-SDI is fixed to "4:2:2 YCbCr 10-bit".

*5 : Fixed to "Automatic".

*6 : Only "Automatic" or "4:4:4 XYZ 10/12-bit" can be selected.

*7 : Only "Center" or "Off" can be selected.

*8 : Can be set only when "I/P Conversion" is set to "Image Priority".

*9 : Can be displayed only on Canon cameras that support HDMI time code output.

*10 : Cannot be executed when verified by HDCP.

*11 : Can be set only when "Canon Log" is set for "Picture Mode".







*12 : Can be set only for "Fan".



Error Messages

Message		Description and Action
Calibration	Failed to initialize the external sensor.	See CA-310 and CA-210 instruction manual.
	Calibration error.	<ul style="list-style-type: none"> • Check the installation and connection of the external sensor and retry (📖22). • Perform matrix calibration of CA-310 and CA-210 (📖22).
	Calibration is completed. (Brightness setting is lower than target brightness.)	Set the "Luminance" in calibration again (📖40).
	Failed to detect the external sensor. Please check the connection with the sensor.	Correctly connect the external sensor to the USB port of this main unit.
Network	Communication error.	IP address may be in conflict or there may be a network communication error. Check the network environment.
	Invalid IP Address.	Enter the correct IP address.
	Invalid Subnet Mask.	Enter the correct subnet mask.
Various settings, CDL export	The USB memory is full.	Use another USB memory or delete the content of the memory.
	Failed to write file.	The USB memory may be defective or protected. Check the USB memory.
LUT, Various settings, CDL import	(LUT Import) "LUT Type" is different. (CDL Import) "File Type" is different.	Select the correct file format.
	Failed to read file.	The USB memory may be defective or protected. Check the USB memory.
	Failed to import.	There is an error in the file to be imported. Check the file.
	No import file.	Check to see if the file has been imported to the USB memory.
Screen Capture	Failed to capture.	The USB memory may be defective or protected. Check the USB memory.
	Invalid Signal.	A screen displaying no video is being captured for example there is no signal or an unsupported signal is being input. Check the signal, input it again, and capture it.
	Copy protected signal.	The signal you tried to capture may be protected by HDCP 2.2 which is a copy prevention standard for HDMI. In this case, the signal cannot be captured. Check the HDMI signal.
	Failed to playback file.	The USB memory may be defective or protected. Check the USB memory.

Message		Description and Action
Hardware error	Backlight error.	Disconnect the power cord, reconnect it, and then turn on the power. If the message persists, contact Canon Customer Center.
	Fan error.	
	Panel error.	
	I/F error.	
	System error.	
	Invalid operation due to high temperature.	The temperature inside the main unit is high. Turn off the power and wait until the fan stops.
Input signal	No Signal	Displayed when there is no video signal input.
	Unsupported	Unsupported video signal is input. Check the supported signal format (68).
	"Input Configuration" is different from Payload.	Check the "Input Configuration" (43) and "Signal Information" (65) settings. Reset any incorrect "Input Configuration" settings.
Operation	Invalid operation.	Operation is disabled. Check the setting items.
	"Protect Settings" is on.	To use the OSD menu, move the selection frame to "Protect Settings" and press the jog dial for approximately 3 seconds.
	"CDL Bypass" is on.	When "CDL Bypass" is turned "On", you cannot adjust "Power", "Saturation", "Offset", or "Slope".
	Invalid Password.	Enter the correct password.
USB memory	USB memory is not connected.	Correctly connect the USB memory to the USB port of this main unit.
	Unsupported USB memory.	Check the USB memory format and make sure it is not protected.
DC power supply	Low Voltage.	Indicates that the input voltage of the DC power supply has become below approx. 22.5 V. Check the voltage of the DC power supply.
	Low Voltage, Turn off power.	Indicates that the input voltage of the DC power supply has become below approx. 21.0 V and the power will be turned off. Connect a 23.5 V or higher DC power supply and press the ⏻ button to turn on the power.
	Invalid Voltage, Turn off power.	Indicates that the input voltage of the DC power supply has reached approx. 35.8 V or higher. Check the input voltage of the DC power supply.

Troubleshooting

Symptom	Cause and Action	
Power does not turn on. (Power indicator does not turn on.)	<ul style="list-style-type: none"> Press the  button. 	9
	<ul style="list-style-type: none"> Check that the AC power supply or DC power cord is connected correctly. 	17
	<ul style="list-style-type: none"> Brightness of the power indicator may be turned off. Turn it on and check once more. 	62
The screen is dark.	When the power indicator does not turn on: <ul style="list-style-type: none"> Press the  button. Check that the AC power supply or DC power cord is connected correctly. 	9 17
	When the power indicator is lit orange: <ul style="list-style-type: none"> Press the  button. 	9
	When the power indicator is flashing orange: <ul style="list-style-type: none"> Flashing once every 3 seconds : Contact Canon Customer Center. Flashing twice every 3 seconds : <ul style="list-style-type: none"> Turn on the power with the  button. The temperature of the display rises (or falls) depend on operation environment. Check the environmental conditions ( 66) and do not use in direct sunlight. If the power still does not turn on, contact Canon Customer Center. 	9 66
The power suddenly goes off when a DC power supply is used.	<ul style="list-style-type: none"> Some DC power supply units turn off the voltage when a threshold value is reached. In this case, the message indicating low voltage is not displayed. Connect a charged DC power supply or AC power supply. 	—
The image does not display.	<ul style="list-style-type: none"> Set each item in "Channel Settings" according to input signal. 	43
There is a blank area when set to 4K Input.	<ul style="list-style-type: none"> There may be no input signal. Look at the display area icon in the interface area and check that the input area and signal cables are properly connected. 	15
	<ul style="list-style-type: none"> Signals with different resolution or frequency may be input from each terminal. Check the signal. 	65
Screen is too bright/dark.	<ul style="list-style-type: none"> Adjust the "Contrast" on the OSD menu. There is a limit on the service life of LCD backlight. If the screen becomes dark or starts flickering, contact Canon Customer Center. 	34
Burn-in image appears.	<ul style="list-style-type: none"> This is a characteristic of the LCD panel and you should avoid displaying stationary image for a long time. 	—
There is an unlit or red, blue, green, or white dot on screen.	<ul style="list-style-type: none"> LCD display is made of very high precision technology. It has effective pixels of 99.99% or more, but there may be black dots or red, blue, or green dots that may be always on. This is not a failure. 	—
There is an interference pattern or trace that remains when the LCD panel is pressed.	<ul style="list-style-type: none"> The symptom may be resolved by displaying a white or black image on the entire screen. 	—

Symptom	Cause and Action	
OSD menu cannot be used.	<ul style="list-style-type: none"> • Check that "Protect Settings" is not set. 	63
"Aspect Marker", " Safety Zone Marker " or "Area Marker" does not appear.	<ul style="list-style-type: none"> • A channel with no signal, unsupported signal, or with "Input Configuration" not set may be selected. Check the signal. 	65
The fan starts to rotate even when "Fan" under "Camera Link" is set to "On" or "Fan Stop" is set to "On".	<ul style="list-style-type: none"> • The fan stays off for approx. 1 minute when an AC power supply is used. To keep the fan off for a longer period, use a DC power supply. 	59
	<ul style="list-style-type: none"> • When "Fan" under "Camera Link" is set to "On", the down time may not match the camera. 	63
The fan does not stop even when "Fan" under "Camera Link" is set to "On" or "Fan Stop" is set to "On".	<ul style="list-style-type: none"> • The fan does not stop if the internal temperature of the video display is high. Configure settings after the internal temperature has lowered. 	59
	<ul style="list-style-type: none"> • The fan may not stop in some conditions, for example when used at a high temperature. Use the video display at the operating temperature ( 66) or lower. 	63
You forgot the password for "Protect Settings".	<ul style="list-style-type: none"> • Press the jog dial and the  button while the video display is in standby. The configuration will be reset to the state where no password is set. 	9
The video display does not start up in the condition that the power was turned off last time.	<ul style="list-style-type: none"> • Check the "Power on Setting" on the OSD menu. Set "Last memory" to start up the video display in the condition that the power is turned off last time. 	64

Software Used in This Product

Software installed with this product includes software modules from Canon or third parties.

Software Developed by Canon and Free Software

Software developed or created by Canon and accompanying document is protected by copyright law, terms of an international convention and any other governing laws.

This product uses software modules under copyright by third parties and distributed as free software. Some of these software modules are subject to the GNU General Public License v2 (GPL), GNU Lesser General Public License v2.1 (LGPL) or any other license.

Acquiring Source Code for Free Software

Some free software requires the acquirement of the source code of modules in order to distribute the executable form of those software modules. For information on how to acquire the source code for free software such as these and confirming terms of the GPL, LGPL and other license agreements, please check with the distributor from whom the product was purchased.

The following free software modules are installed to this product:

- linux kernel
- SquashFS
- avahi-autoipd
- busybox
- FUSE
- libxml
- glibc
- libfuse
- zlib
- JFFS2
- libupnp
- libpng

License Agreement for this Product

Obligation to Present License Agreement

The copyright holders of software modules installed with this product require its license agreement to be displayed. This license agreement is as follows:

■libupnp License

Copyright (c) 2000-2003 Intel Corporation All rights reserved.

Redistribution and use in source and binary forms, with or without modification, are permitted provided that the following conditions are met:

- * Redistributions of source code must retain the above copyright notice, this list of conditions and the following disclaimer.
- * Redistributions in binary form must reproduce the above copyright notice, this list of conditions and the following disclaimer in the documentation and/or other materials provided with the distribution.
- * Neither name of Intel Corporation nor the names of its contributors may be used to endorse or promote products derived from this software without specific prior written permission.

THIS SOFTWARE IS PROVIDED BY THE COPYRIGHT HOLDERS AND CONTRIBUTORS "AS IS" AND ANY EXPRESS OR IMPLIED WARRANTIES, INCLUDING, BUT NOT LIMITED TO, THE IMPLIED WARRANTIES OF MERCHANTABILITY AND FITNESS FOR A PARTICULAR PURPOSE ARE DISCLAIMED. IN NO EVENT SHALL INTEL OR CONTRIBUTORS BE LIABLE FOR ANY DIRECT, INDIRECT, INCIDENTAL, SPECIAL, EXEMPLARY, OR CONSEQUENTIAL DAMAGES (INCLUDING, BUT NOT LIMITED TO, PROCUREMENT OF SUBSTITUTE GOODS OR SERVICES; LOSS OF USE, DATA, OR PROFITS; OR BUSINESS INTERRUPTION) HOWEVER CAUSED AND ON ANY THEORY OF LIABILITY, WHETHER IN CONTRACT, STRICT LIABILITY, OR TORT (INCLUDING NEGLIGENCE OR OTHERWISE) ARISING IN ANY WAY OUT OF THE USE OF THIS SOFTWARE, EVEN IF ADVISED OF THE POSSIBILITY OF SUCH DAMAGE.

■libxml License

Copyright (C) 1998-2003 Daniel Veillard. All Rights Reserved.

Permission is hereby granted, free of charge, to any person obtaining a copy of this software and associated documentation files (the "Software"), to deal in the Software without restriction, including without limitation the rights to use, copy, modify, merge, publish, distribute, sublicense, and/or sell copies of the Software, and to permit persons to whom the Software is furnished to do so, subject to the following conditions:

The above copyright notice and this permission notice shall be included in all copies or substantial portions of the Software.

THE SOFTWARE IS PROVIDED "AS IS", WITHOUT WARRANTY OF ANY KIND, EXPRESS OR IMPLIED, INCLUDING BUT NOT LIMITED TO THE WARRANTIES OF MERCHANTABILITY, FITNESS FOR A PARTICULAR PURPOSE AND NONINFRINGEMENT. IN NO EVENT SHALL THE DANIEL VEILLARD BE LIABLE FOR ANY CLAIM, DAMAGES OR OTHER LIABILITY, WHETHER IN AN ACTION OF CONTRACT, TORT OR OTHERWISE, ARISING FROM, OUT OF OR IN CONNECTION WITH THE SOFTWARE OR THE USE OR OTHER DEALINGS IN THE SOFTWARE.

Except as contained in this notice, the name of Daniel Veillard shall not be used in advertising or otherwise to promote the sale, use or other dealings in this Software without prior written authorization from him.

Index

Number	
3G/HD/SD-SDI	10, 15
3G SDI RAW	10, 15
4K Input	43
5 Step (Test Pattern).....	57
200% (Screen Scaling)	45
2020 Constant Luminance	40
2020 Gamut Mapping	40

A	
ACESproxy.....	34
Adjustment	34
Adobe RGB.....	34
Anchor Adjustment.....	21, 40
Area Marker.....	52
Aspect Marker.....	49
Audio Level Meter.....	57
Audio Settings	48
Automatic (Screen Scaling).....	45

B	
Background Color	46
Backlight Control.....	34
Backlight Scan	58
Banner	58
Bias R/G/B.....	35
Bicubic	46
Black (Test Pattern).....	57
Blue Off	58
Blue Only.....	58
Blue (Test Pattern)	57
Boost Contrast	39
Brightness	34

C	
Calibration	22, 40
Camera Information.....	59
Camera Link.....	58
Canon Log, CanonLog 2	34, 36
CDL Bypass	39
CDL Export/CDL Import	24, 39
Center Marker	53
Channel Name.....	25, 44
Channel Settings	43
Channel UP/Channel DOWN	61
Chroma	34

Cinema Gamut to 709	35
Cinema Gamut to 2020	35
Cinema Gamut to DCI	35
Color Bars (Test Pattern).....	57
Color Gamut.....	35
Color Range	38, 44
Color Temperature.....	35
Compatible Settings	62
Configure an IP Address.....	60
Contrast	34
Custom (xy) (Color Temperature).....	35

D	
Date/Time	25, 62
DCI-P3	34
DCI-P3+ to 709.....	35
DCI-P3+ to DCI	35
Detail Settings	
Adjustment	39
CDL.....	39
Display Button LED	62
Display Channel.....	62
Display Function/Display Function (CDL).....	60
Display Name	25, 62
Display Settings.....	45
Dual Input.....	15, 43

E	
EBU.....	34
Export/Import	24, 64

F	
False Color	54
Fan Control.....	63
Film Cadence	47
Firmware Ver.....	65
Format.....	43
Frame Hold	46
Function/Channel Button.....	60
Function Guide	58
Function Settings.....	54

G	
Gain R/G/B.....	35
Gamma	36
Global Dimming.....	34

Gray (20%) (Test Pattern)	57
Green Off.....	58
Green (Test Pattern).....	57
Grid Marker	53

H

HDMI.....	10, 16
HDR Range	37
HD-SDI.....	10, 15
Hide OSD	60

I

IDT	37
Image Priority	46
Input Configuration	43
Internal Sync	44
I/P Conversion.....	46
I/PsF.....	46
ITU-R BT.709.....	34
ITU-R BT.1886.....	36
ITU-R BT.2020.....	34

L

LAN.....	10
Language	60
Local Dimming	34
LTC	55
Luminance.....	40
LUT Import	23, 39

M

MAC Address.....	65
Marker Preset.....	49
Marker Settings	49
Monochrome.....	58

N

Native Input Resolution (Screen Scaling)	45
Nearest Neighbor	46
Network	60

O

ODT	37
ODT Surround	38
Offset	39
OSD Menu	18, 28
OSD Position.....	58
OSD Size.....	58

P

Password	63
Peaking	54
Picture Mode.....	34
PLUGE (Test Pattern).....	57
Power.....	39
Power Indicator Brightness.....	62
Power on Setting.....	64
Protect Settings.....	63
PsF.....	46

R

Ramp (Test Pattern)	57
Red Off.....	58
Red (Test Pattern)	57
Reset.....	40
Reset All Settings	64

S

Safety Zone Marker 1, 2	50
Saturation.....	39
Scaling Method	46
Bicubic	46
Nearest Neighbor.....	46
Shape Trace.....	46
Screen Capture	54
Screen Scaling	45
200%.....	45
Automatic	45
Native Input Resolution	45
Select Channel	43
Select Input Signal.....	43
4K Input.....	43
Single Input/Dual Input.....	43
Serial No.	65
Settings.....	24, 64
Shape Trace	46
Sharpness	34
Signal Information.....	65
Single Input	43
Slope.....	39
SMPTE-C	34
Speed Priority.....	46
Subnet Mask	60
System Information.....	65
System Settings	60

T

Test Pattern 57
Time Code 55

U

Usage Time 65
USB 9, 22, 23
User 1-7 34
User LUT 35, 36

V

Various Function (Function Settings) 58
Vector Scope 56
VITC 55

W

Wave Form Monitor 55
White (Test Pattern) 57

Z

Zoom 45

**CANON PROFESSIONAL DISPLAY LIMITED WARRANTY FOR PRODUCTS PURCHASED
IN THE UNITED STATES**

The limited warranty set forth below is given by Canon U.S.A., Inc. ('Canon USA') with respect to Canon Professional Display Equipment (the 'Equipment') accompanying this limited warranty in the Equipment's original container, when purchased in the United States. This limited warranty is only effective upon presentation of your Bill of Sale or other proof of purchase.

Canon USA warrants to the original end-user purchaser, when delivered in new condition in its original container, that the Equipment will be free from defects in materials and workmanship under normal use and service for a period of ONE-YEAR from the date of original purchase. When returning Equipment under this warranty, you must pre-pay the shipping charges, and you must enclose a copy of the Bill of Sale or other proof of purchase with a complete explanation of the problem. Equipment returned to a Canon USA factory service facility, and proven to be defective upon inspection, will be, without charge,:

- (a) repaired utilizing new or comparable refurbished parts, or
- (b) exchanged for refurbished or new Equipment

as determined in the Canon USA's repair facility's sole discretion. The repaired or exchanged Equipment will be shipped back free of charge. Warranty exchange or replacement does not extend the original warranty period of the Equipment. For repairs after the warranty period has expired, an estimate of the cost of repair and an opportunity to approve or reject the repair expense before it is incurred will be provided. If you approve, repairs will be made and the Equipment will be returned at your risk and expense. If you reject, the Equipment will be returned to you at no charge to you to an address within the United States.

This limited warranty only applies if the Equipment is used in conjunction with compatible computer equipment, compatible peripheral equipment and compatible software, as to which items Canon USA will have no responsibility. Canon USA shall have no responsibility under this limited warranty for use of the Equipment in conjunction with incompatible peripheral equipment and/or incompatible software. Non-Canon brand peripheral equipment and software which may be distributed with, or be factory loaded on, the Equipment, are sold 'AS IS' without warranty of any kind by Canon USA, including any implied warranty regarding merchantability or fitness for a particular purpose. The sole warranty with respect to such non-Canon brand items is given by the manufacturer or producer thereof. If the Equipment contains a hard disk drive, Canon USA recommends that data stored on that drive be duplicated or backed up to prevent its loss in the event of failure or other malfunction of such drive.

In order to obtain warranty service, please contact the authorized Canon retail dealer from whom you purchased the Equipment or contact the CANON INFORMATION CENTER AT **855-4K-CANON** (855-452-2666) or on the internet at pro.usa.canon.com/support. You will be directed to the nearest service facility for your Equipment.

Technical support program specifics subject to change without notice.

This Limited Warranty covers all defects encountered in normal use of the Equipment and does not apply in the following cases:

- A. Loss or damage to the Equipment due to abuse, neglect, mishandling, electric current fluctuation, accident, improper maintenance, use of non-Canon accessories or failure to follow operating, maintenance or environmental instructions prescribed in Canon USA's user's manual;
- B. If the Equipment is defective as a result of sand, dirt or water damage;
- C. If defects or damages are caused by the use of parts or supplies (other than those sold by Canon USA) that cause damage to the Equipment or that cause abnormally frequent service calls or service problems;
- D. If defects or damages are caused by service other than Canon USA's factory service centers or authorized service facilities;
- E. Any internal modification to product hardware or firmware;
- F. Any maintenance of the Equipment, including any fees for such Maintenance;
- G. If the Equipment has had its serial number or dating altered or removed.

This Limited Warranty does not apply to Equipment purchased outside the United States. This Limited Warranty does not apply to accessories or consumables for the Equipment, which are sold "AS IS", without warranty of any kind by Canon USA. Please retain this warranty card and your Bill of Sale as a permanent record of your purchase. This card ensures that you are contacted promptly should there be a safety inspection, modification or product recall under applicable laws or regulations. This card ensures that you are contacted promptly should there be a safety inspection, modification or product recall under applicable laws or regulations.

NO IMPLIED WARRANTY, INCLUDING MERCHANTABILITY AND FITNESS FOR A PARTICULAR PURPOSE APPLIES TO THIS EQUIPMENT AFTER THE APPLICABLE PERIOD OF EXPRESS WARRANTY OR GUARANTY UNDER THIS WARRANTY (EXCEPT AS MENTIONED ABOVE). (SOME STATES DO NOT ALLOW LIMITATIONS ON HOW LONG AN IMPLIED WARRANTY LASTS, SO THE ABOVE LIMITATION OR EXCLUSION MAY NOT APPLY TO YOU). CANON USA SHALL NOT BE LIABLE FOR LOSS OF REVENUES OR PROFITS, EXPENSE FOR SUBSTITUTE EQUIPMENT OR SERVICE, STORAGE CHARGES, LOSS OR CORRUPTION OF DATA, INCLUDING WITHOUT LIMITATION, LOSS OR CORRUPTION OF DATA STORED ON THE EQUIPMENT'S HARD DRIVE, OR ANY OTHER SPECIAL, INCIDENTAL OR CONSEQUENTIAL DAMAGES CAUSED BY THE USE, MISUSE OR INABILITY TO USE THE EQUIPMENT, REGARDLESS OF THE LEGAL THEORY ON WHICH THE CLAIM IS BASED, AND EVEN IF CANON USA HAS BEEN ADVISED OF THE POSSIBILITY OF SUCH DAMAGES. NOR SHALL RECOVERY OF ANY KIND AGAINST CANON USA BE GREATER THAN THE PURCHASE PRICE OF THE EQUIPMENT SOLD BY CANON USA AND CAUSING THE ALLEGED DAMAGE. WITHOUT LIMITING THE FOREGOING, YOU ASSUME ALL RISK AND LIABILITY FOR LOSS, DAMAGE OR INJURY TO YOU AND YOUR PROPERTY AND TO OTHERS AND THEIR PROPERTY ARISING OUT OF USE, MISUSE OR INABILITY TO USE THE EQUIPMENT NOT CAUSED DIRECTLY BY THE NEGLIGENCE OF CANON USA (SOME STATES DO NOT ALLOW THE EXCLUSION OR LIMITATION OF INCIDENTAL OR CONSEQUENTIAL DAMAGES, SO THE ABOVE LIMITATION MAY NOT APPLY TO YOU). THIS WARRANTY SHALL NOT EXTEND TO ANYONE OTHER THAN THE ORIGINAL PURCHASER OF THIS EQUIPMENT OR THE PERSON FOR WHOM IT WAS PURCHASED AS A GIFT.

This warranty gives you specific legal rights, and you may also have other rights which vary from state to state.

CANON U.S.A., INC

CANON PROFESSIONAL DISPLAY LIMITED WARRANTY FOR PRODUCTS PURCHASED IN CANADA

The limited warranty set forth below is given by Canon Canada Inc. ('Canon Canada') with respect to Canon Professional Display Equipment (the 'Equipment') accompanying this limited warranty in the Equipment's original container, when purchased in Canada. This limited warranty is only effective upon presentation of your bill of sale or other proof of purchase.

Canon Canada warrants to the original end-user purchaser, when delivered in new condition in its original container, that the Equipment will be free from defects in materials and workmanship under normal use and service for a period of ONE YEAR from the date of original purchase. When returning Equipment under this limited warranty, you must pre-pay the shipping charges, and you must enclose a copy of the bill of sale or other proof of purchase with a complete explanation of the problem. Equipment returned to a Canon Canada factory service facility and proven to be defective upon inspection will be, without charge:

- (a) repaired utilizing new or comparable refurbished parts, or
- (b) exchanged for refurbished or new Equipment,

as determined by the Canon Canada factory service center, in its sole discretion. The repaired or exchanged Equipment will be shipped back free of charge. Warranty exchange or replacement does not extend the original warranty period of the Equipment. For repairs after the warranty period has expired, an estimate of the cost of repair and an opportunity to approve or reject the repair expense before it is incurred will be provided. If you approve the proposed repairs, repairs will be made and the Equipment will be returned at your risk and expense. If you reject the proposed repairs, the Equipment will be returned to you at no charge to you to an address within Canada.

This limited warranty only applies if the Equipment is used in conjunction with compatible computer equipment, compatible peripheral equipment and compatible software, as to which items Canon Canada will have no responsibility. Canon Canada shall have no responsibility under this limited warranty for use of the Equipment in conjunction with incompatible computer equipment, peripheral equipment and/or incompatible software. Non-Canon brand peripheral equipment and software which may be distributed with, or be factory loaded on, the Equipment, are sold 'AS IS' without warranty or condition of any kind by Canon Canada, including any implied warranty or condition regarding merchantability or fitness for a particular purpose. The sole warranty with respect to such non-Canon brand items is given by the manufacturer or producer thereof. If the Equipment contains a hard disk drive, Canon Canada recommends that data stored on that drive be duplicated or backed up to prevent its loss in the event of failure or other malfunction of such drive.

In order to obtain warranty service, please contact the authorized Canon retail dealer from whom you purchased the Equipment or contact the CANON INFORMATION CENTER at **800-667-2666** or on the internet at www.canon.ca/pro.

Technical support program specifics are subject to change without notice.

This limited warranty covers all defects encountered in normal use of the Equipment and does not apply in the following cases:

- A. Loss or damage to the Equipment due to abuse, neglect, mishandling, electric current fluctuation, accident, improper maintenance, use of non-Canon accessories or failure to follow operating, maintenance or environmental instructions prescribed in Canon Canada's users manual;
- B. If the Equipment is defective as a result of sand, dirt or water damage;
- C. If defects or damages are caused by the use of parts or supplies (other than those sold by Canon Canada) that cause damage to the Equipment or that cause abnormally frequent service calls or service problems
- D. If defects or damages are caused by service other than Canon Canada's factory service centers or authorized service facilities;
- E. Any internal modification to product hardware or firmware;
- F. Any maintenance of the Equipment, including any fees for such maintenance; or
- G. If the Equipment has had its serial number or dating altered or removed.

This limited warranty does not apply to Equipment purchased outside Canada. This limited warranty does not apply to accessories or consumables for the Equipment, which are sold "AS IS", without warranty or condition of any kind by Canon Canada. Please retain this warranty card and your bill of sale or other proof of purchase as a permanent record of your purchase. This card ensures that you are contacted promptly should there be a safety inspection, modification or product recall under applicable laws or regulations.

NO IMPLIED WARRANTY OR CONDITION, INCLUDING IN RESPECT OF THE MERCHANTABILITY AND FITNESS FOR A PARTICULAR PURPOSE, APPLIES TO THIS EQUIPMENT AFTER THE EXPIRATION OF THE APPLICABLE PERIOD OF EXPRESS WARRANTY OR GUARANTEE UNDER THIS LIMITED WARRANTY (EXCEPT AS MENTIONED ABOVE). (SOME PROVINCES DO NOT ALLOW LIMITATIONS ON HOW LONG AN IMPLIED WARRANTY LASTS, SO THE ABOVE LIMITATION OR EXCLUSION MAY NOT APPLY TO YOU). CANON CANADA SHALL NOT BE LIABLE FOR LOSS OF REVENUES OR PROFITS, EXPENSE FOR SUBSTITUTE EQUIPMENT OR SERVICE, STORAGE CHARGES, LOSS OR CORRUPTION OF DATA, INCLUDING WITHOUT LIMITATION, LOSS OR CORRUPTION OF DATA STORED ON THE EQUIPMENT'S HARD DRIVE, OR ANY OTHER SPECIAL, INCIDENTAL OR CONSEQUENTIAL DAMAGES CAUSED BY THE USE, MISUSE OR INABILITY TO USE THE EQUIPMENT, REGARDLESS OF THE LEGAL THEORY ON WHICH THE CLAIM IS BASED, AND EVEN IF CANON CANADA HAS BEEN ADVISED OF THE POSSIBILITY OF SUCH DAMAGES. NOR SHALL RECOVERY OF ANY KIND AGAINST CANON CANADA BE GREATER THAN THE PURCHASE PRICE OF THE EQUIPMENT SOLD BY CANON CANADA AND CAUSING THE ALLEGED DAMAGE. WITHOUT LIMITING THE FOREGOING, YOU ASSUME ALL RISK AND LIABILITY FOR LOSS, DAMAGE OR INJURY TO YOU AND YOUR PROPERTY AND TO OTHERS AND THEIR PROPERTY ARISING OUT OF USE, MISUSE OR INABILITY TO USE THE EQUIPMENT NOT CAUSED DIRECTLY BY THE NEGLIGENCE OF CANON CANADA (SOME PROVINCES DO NOT ALLOW THE EXCLUSION OR LIMITATION OF INCIDENTAL OR CONSEQUENTIAL DAMAGES, SO THE ABOVE LIMITATION MAY NOT APPLY TO YOU). THIS LIMITED WARRANTY SHALL NOT EXTEND TO ANYONE OTHER THAN THE ORIGINAL PURCHASER OF THIS EQUIPMENT OR THE PERSON FOR WHOM IT WAS PURCHASED AS A GIFT.

This limited warranty gives you specific legal rights, and you may also have other rights which vary from province to province.

CANON CANADA INC.



Canon Inc. 30-2, Shimomaruko 3-chome, Ohta-ku, Tokyo 146-8501, Japan

AUSTRALIA www.canon.com.au

Canon Australia Pty Ltd

☎ 13-13-83 (within Australia only)

☎ (61) 02-9805-2000

CANADA

CANON CANADA INC.

<http://www.canon.ca/pro>

❖ Professional Product Support / Soutien des produits professionnels

☎ (800) 667-2666

CENTRO Y SURAMÉRICA

CANON LATIN AMERICA, INC.

<http://www.cla.canon.com>

EUROPE www.canon-europa.com

Canon Europa N.V.

Bovenkerkerweg 59,

1185 XB Amstelveen, The Netherlands

MÉXICO

CANON MEXICANA, S DE RL DE CV

<http://www.canon.com.mx>

☎ 52 (55) 5249-4900

NEW ZEALAND www.canon.co.nz

Canon New Zealand Ltd

☎ 0800-222-666 (within New Zealand only)

☎ (64) 09-489-0300

UNITED KINGDOM www.canon.co.uk

Canon UK Ltd

CCI Service Centre, Unit 130, Centennial Park,
Borehamwood, Hertfordshire, WD6 3SE

☎ 0844-369-0100

USA

CANON U.S.A., INC.

<http://pro.usa.canon.com>

<http://pro.usa.canon.com/support>

☎ (855) 4K-CANON (855-452-2666)
(USA only)

캐논코리아컨슈머이미징㈜

<http://www.canon-ci.co.kr>

서울특별시 강남구 테헤란로607, 캐논빌딩 5층
대표전화+82(0)2-1588-8133

Canon Korea Consumer Imaging Inc.

<http://www.canon-ci.co.kr>

5F, Canon Bldg, 607, Teheran-ro, Gangnam-gu,
Seoul, Korea

☎ +82(0)2-1588-8133

Visit your local Canon Web site to download the latest version of this instruction manual.