



Windows

Generic Plus PCL6 Printer Driver

User's Guide

Contents

Introduction	2
How to Use the Manual	3
Notations Used in the Manual	4
Disclaimers	5
Copyright	6
Trademarks	7
About This Driver	9
Before Use	12
How to Refer to the Manual of the Device	14
Activation of Encrypted Secure Print/Access Management System	16
Printing	18
Printing from a Computer	19
Scaling	22
Watermark Printing	23
Poster Printing	24
Printing Over a Fixed Form	28
Attaching Encryption When Printing	30
Putting Print Jobs on Hold	31
Storing Print Data	32
Priority Printing	33
Changing the Default Settings	34
Creating a Booklet When Printing	36
Booklet Printing	37
Creating a Booklet in Sets	38
Correcting Displacement During Booklet Printing	39
Saddle Stitched Booklet Printing	40
Saddle Press Processing When Creating Saddle Stitched Booklets	41
Trimming Pages When Creating Saddle Stitched Booklets	42
Perfect Binding	43
Using Various Types of Paper	45
Registering Custom Paper Sizes	46
Inserting Sheets Between Transparencies	47
Inserting Sheets	48

Inserting Tab Paper	49
Printing on Tab Paper	51
Adding Cover Sheets	52
Printing Multiple Files Together	54
About the [Edit and Preview] Function	55
Printing Files Together	56
Checking the Print Preview	58
Changing the Print Settings of the Combined File	60
Editing Favorite Settings	63
Registering Favorite Settings	64
Editing the Favorite Settings List	65
Coordinating with the Device Functions	68
Setting Device Information	69
Device Functions Settings	74
Paper Sources and Output Destinations Settings	75
Exporting a Configuration Profile	84
Importing a Configuration Profile	86
List of Configuration Profiles	89
Setting the Authentication Function	91
Setting the User Name	93
Settings List	95
Common Settings for All Sheets	96
[Basic Settings] Sheet	99
[Page Setup] Sheet	102
[Finishing] Sheet	105
[Paper Source] Sheet	112
[Quality] Sheet	115
[Device Settings] Sheet	120
[Profile] Sheet	125
Canon PageComposer	127
Troubleshooting	131
Driver settings cannot be set	132
Print results are unsatisfactory	133
Printing takes a long time	135
Print results are too dark or too bright	136
Overlay printing will not execute	137
Cannot use the acquire device information function or authentication function	138

Introduction

Introduction	2
How to Use the Manual	3
Notations Used in the Manual	4
Disclaimers	5
Copyright	6
Trademarks	7

Introduction

- ▶ **How to Use the Manual(P. 3)**
- ▶ **Disclaimers(P. 5)**
- ▶ **Copyright(P. 6)**
- ▶ **Trademarks(P. 7)**

How to Use the Manual

This explains things that you need to know in order to use this manual.

▶ **Notations Used in the Manual(P. 4)**

Notations Used in the Manual

This explains symbols and settings used in this manual.

Symbols Used in This Manual

In this manual, explanations of items and operations that must be followed while using the driver are set forth the symbols that indicate the following.



IMPORTANT

- Indicates operational requirements and restrictions. Be sure to read these items carefully to operate the product correctly, and avoid damage to the product.



NOTE

- Indicates a clarification of an operation, or contains additional explanations for a procedure. Reading these notes is highly recommended.

About Settings

In this manual, setting names displayed on the computer screen are represented as shown in the following examples.

Example:

[Print]

[OK]

Disclaimers

The information in this document is subject to change without notice.

CANON INC. MAKES NO WARRANTY OF ANY KIND WITH REGARD TO THIS MATERIAL, EITHER EXPRESS OR IMPLIED, EXCEPT AS PROVIDED HEREIN, INCLUDING WITHOUT LIMITATION, THEREOF, WARRANTIES AS TO MARKETABILITY, MERCHANTABILITY, FITNESS FOR A PARTICULAR PURPOSE OF USE OR NON-INFRINGEMENT. CANON INC. SHALL NOT BE LIABLE FOR ANY DIRECT, INCIDENTAL, OR CONSEQUENTIAL DAMAGES OF ANY NATURE, OR LOSSES OR EXPENSES RESULTING FROM THE USE OF THIS MATERIAL.

Copyright

Copyright CANON INC. 2018

No part of this publication may be reproduced, transmitted, transcribed, stored in a retrieval system, or translated into any language or computer language in any form or by any means, electronic, mechanical, magnetic, optical, chemical, manual, or otherwise, without the prior written permission of Canon Inc.

Trademarks

Microsoft and Windows are either registered trademarks or trademarks of Microsoft Corporation in the United States and/or other countries.

macOS is a trademark of Apple Inc.

Other product and company names herein may be the trademarks of their respective owners.

About This Driver

About This Driver 9

About This Driver

This is a generic printer driver that supports various devices. You can use the same driver for all printer models by changing the settings for the printing port and device information.

Features

- Information regarding the functions and options of the device are collectively defined in a "configuration profile." By switching "configuration profiles," you can switch the driver settings screen to match the functions of the device.
- You do not need to reinstall the driver when you add or replace a device.

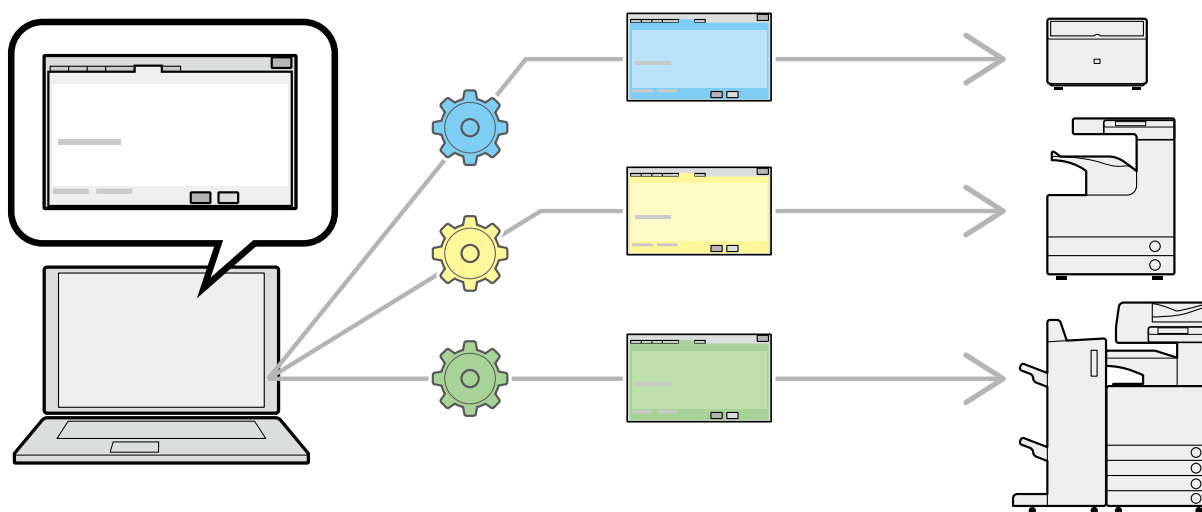

Utilizing Configuration Profiles

Configuration profiles corresponding to each printer model have been prepared beforehand. You can customize and use a configuration profile corresponding to your printer operation management.

By applying a configuration profile to the driver, the settings in the [Device Settings] sheet can be changed and the functions specific to the device can be set. You can also export and save the function and option settings for the device in the [Device Settings] sheet as a configuration profile.

Examples of How to Utilize Configuration Profiles

- **Making a driver settings screen for the printer model you are using**

When you can acquire the printer model information from the device, a configuration profile is applied automatically and the settings screen changes to match the device. When you cannot acquire the information, apply a configuration profile manually.

- **Efficiently configuring driver settings for multiple computers**

You can export and save the device function and options settings of the [Device Settings] sheet as a configuration profile. The device information of drivers used in other computers can be easily batch set by importing the exported configuration profile.

If you cannot acquire the device information, you can apply it by importing a configuration profile exported in an environment where the information could be acquired.

Related Topics

- [Setting Device Information\(P. 69\)](#)

- ▶ **Importing a Configuration Profile(P. 86)**
- ▶ **Exporting a Configuration Profile(P. 84)**

Before Use

Before Use 12

Before Use

- When using this driver, the following restrictions apply.
 - In order to set and print with the functions supported by the printer model you are using, you need to set a configuration profile suitable for the printer model and set the option status of the device. You can configure these settings in the [Device Settings] sheet.
 - If you set functions in the driver that are not available for the device you are using, it may result in unintended print results.
 - If you specify color printing for a black and white printer, the print data will be output in black and white, but the print quality may deteriorate and printing may take some time.
 - If you set functions that are not supported by this driver on the control panel of the device you are using, those functions are enabled when printing.
 - Depending on the combination of the device and options you are using, you may not be able to identify the attached options in the [Device Settings] sheet > [] (Retrieve Device Status Information). To use the options that cannot be identified, configure the settings manually in the [Device Settings] sheet.
- The newest driver software is posted on the Canon web site. Please verify the operating environment etc. and download the appropriate software as required.
Canon Global Site: <http://www.canon.com/>
- The functions that you can use may vary according to the following conditions.
 - The device you are using and its settings
 - The firmware version of the device
 - The option structure
 - The driver version
 - The computer environment you are using
- When printing from a Windows Store app, because you cannot display the print settings screen of the driver, the number of functions you can set is limited.
- The screen content, procedures, etc. displayed and described in the manual may differ from those actually displayed.
- In this manual, examples using Windows 10 are explained.

How to Refer to the Manual of the Device

How to Refer to the Manual of the Device 14

How to Refer to the Manual of the Device

There are cases when, in order to use the functions of this driver, operations must be carried out at the device beforehand.

For information about how to operate the device, refer to the manual of the device.

Activation of Encrypted Secure Print/Access Management System

Activation of Encrypted Secure Print/Access Management System 16

Activation of Encrypted Secure Print/Access Management System

To use Encrypted Secure Print and the Access Management System, it is necessary to enable each function on the [Device Settings] sheet.

Set [Details] > [Other Settings] > [Encrypted Secure Print]/[Access Management System] to [Enabled] on the [Device Settings] sheet. Each function is then displayed on a settings sheet when the printer properties screen is closed and opened again. Set each function on the displayed [Encrypted-P] sheet/[AMS] sheet. For details on the settings for each sheet, see the help for each sheet.



NOTE

- This functions can only be used when the driver display language is set to one of the following languages.
English / Japanese / French / German / Italian / Spanish
When the Access Management System is enabled, the driver display language can only be switched to the above languages.

Printing

Printing	18
Printing from a Computer	19
Scaling	22
Watermark Printing	23
Poster Printing	24
Printing Over a Fixed Form	28
Attaching Encryption When Printing	30
Putting Print Jobs on Hold	31
Storing Print Data	32
Priority Printing	33
Changing the Default Settings	34

Printing

- ▶ **Printing from a Computer(P. 19)**
- ▶ **Scaling(P. 22)**
- ▶ **Watermark Printing(P. 23)**
- ▶ **Poster Printing(P. 24)**
- ▶ **Printing Over a Fixed Form(P. 28)**
- ▶ **Attaching Encryption When Printing(P. 30)**
- ▶ **Putting Print Jobs on Hold(P. 31)**
- ▶ **Storing Print Data(P. 32)**
- ▶ **Priority Printing(P. 33)**
- ▶ **Changing the Default Settings(P. 34)**

Printing from a Computer

This explains the basic procedure for printing configuring the printer driver settings.



NOTE

- When using a device connected via a WSD port, enable [Use WSD] at the device.

1 Select [Print] from the menu of the application.

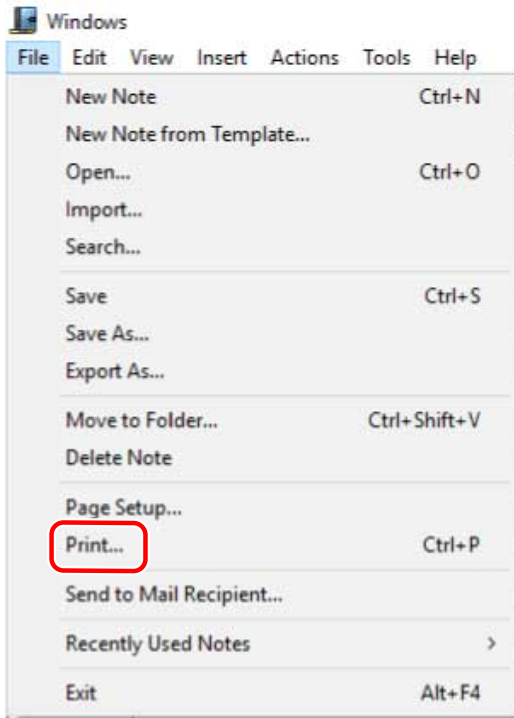

2 In the print screen, select the device you are using → click [Preferences], [Printer properties], or [Properties].

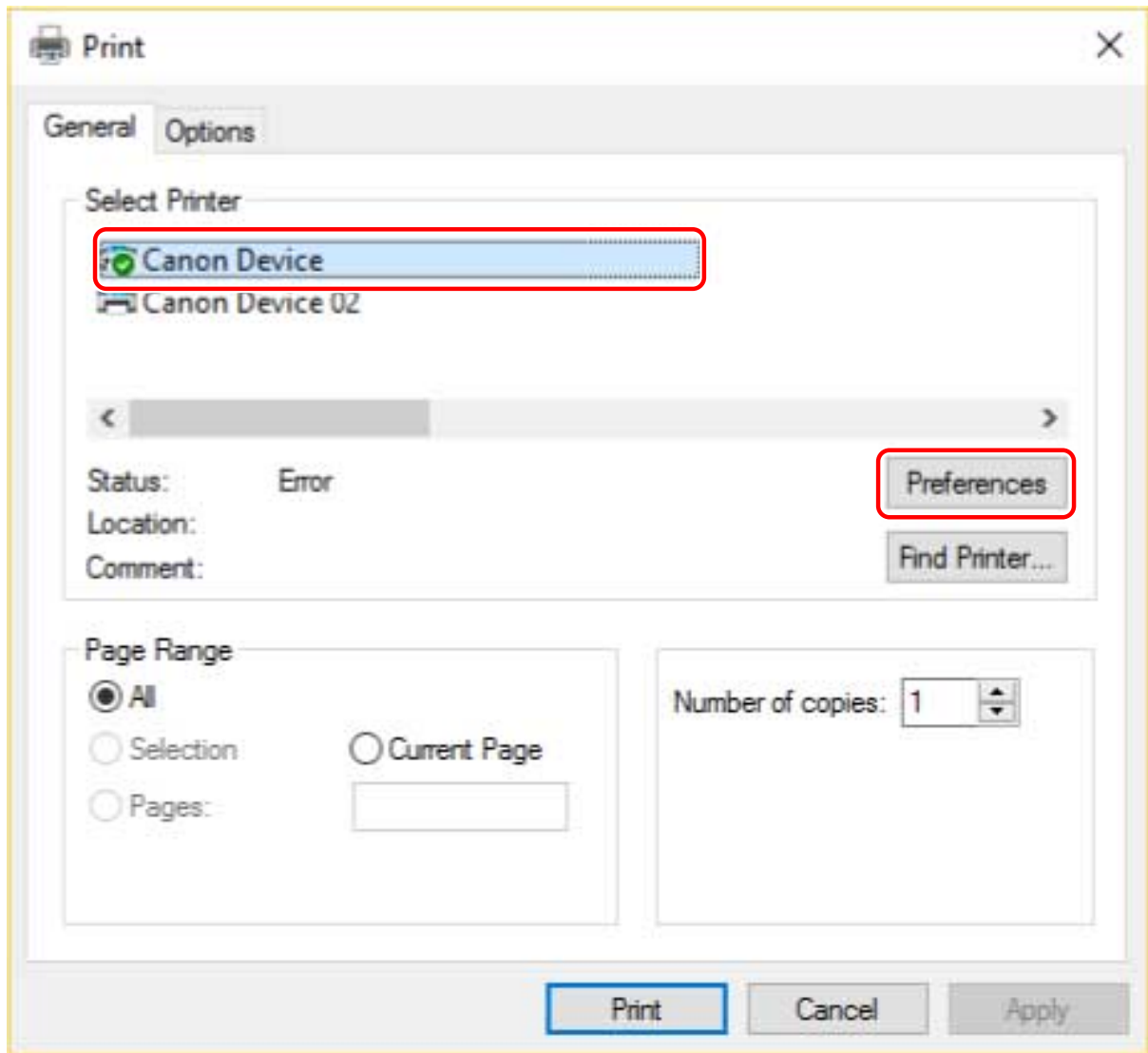

3 In the print settings screen of the driver, set the required items.

If necessary, switch sheets and configure relevant settings.

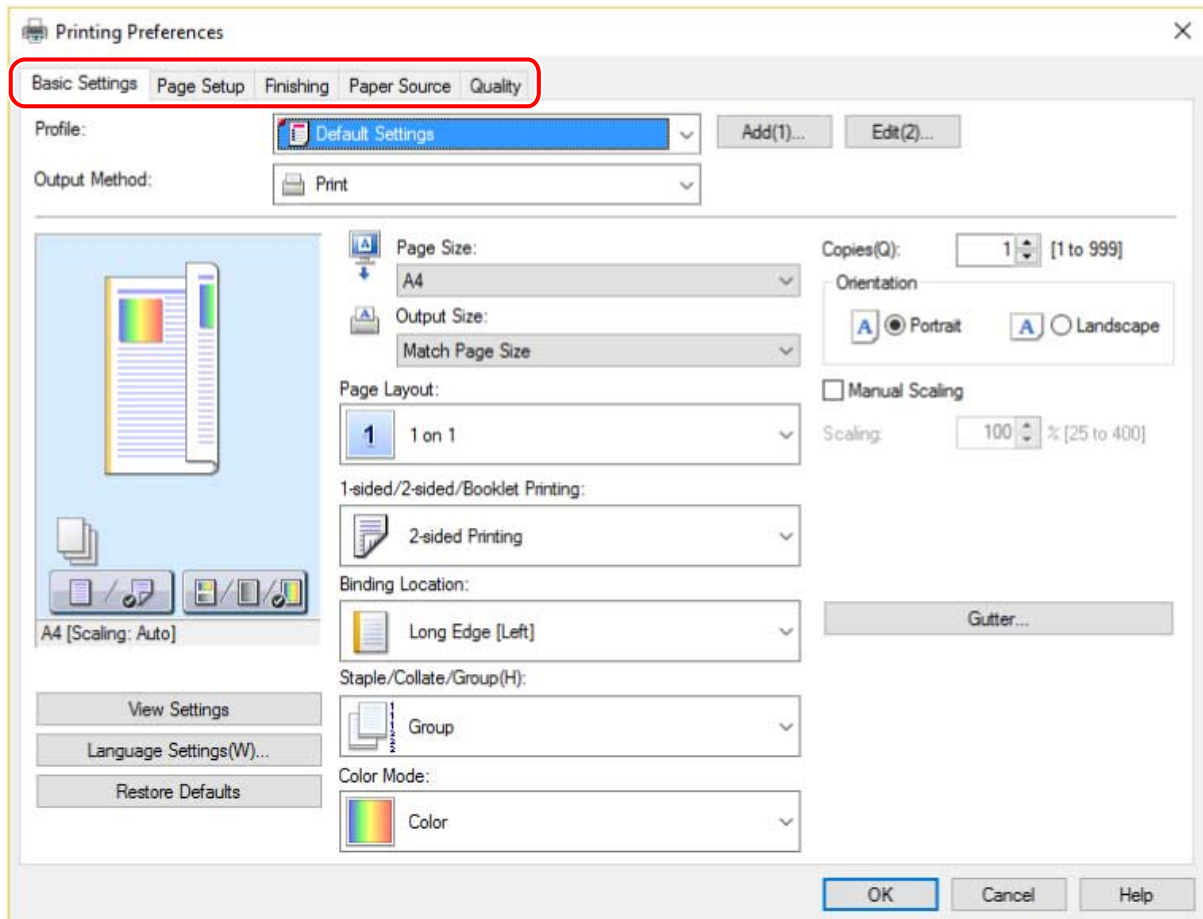
**NOTE**

- If the function you want to use is not displayed in the print settings screen, configure the print settings after enabling the functions of the device by acquiring the device information etc.

4 Click [OK].

5 In the print screen, click [Print] or [OK].

Related Topics

- ▶ [About This Driver\(P. 9\)](#)
- ▶ [Changing the Default Settings\(P. 34\)](#)
- ▶ [Setting Device Information\(P. 69\)](#)
- ▶ [Driver settings cannot be set\(P. 132\)](#)

Scaling

You can enlarge or reduce the print data when printing.

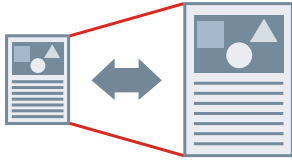

To Scale to the Output Page Size

- 1** Display the [Basic Settings] or [Page Setup] sheet.
- 2** Select the paper size set in the application from [Page Size].
- 3** Select the paper size you want to print on from [Output Size].

To Specify a Desired Scale

- 1** Display the [Basic Settings] or [Page Setup] sheet.
- 2** Select [Manual Scaling] → specify the magnification in [Scaling].

Related Topics

- ▶ [Basic Settings] Sheet(P. 99)
- ▶ [Page Setup] Sheet(P. 102)
- ▶ Registering Custom Paper Sizes(P. 46)
- ▶ Driver settings cannot be set(P. 132)

Watermark Printing

You can superimpose and print semi-transparent characters such as [TOP SECRET] or [DRAFT] over print data.

You can also create new watermarks.

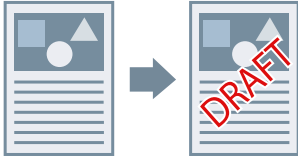

To Attach and Print a Watermark

- 1** Display the [Page Setup] sheet.
- 2** Select [Watermark] → select a watermark name.

To Create New Watermarks

- 1** Display the [Page Setup] sheet.
- 2** Select [Watermark] → click [Edit Watermark].
- 3** In the [Edit Watermark] dialog box, click [Add] → enter a name in [Name].
- 4** In [Attributes], set the characters and attributes for the watermark.
- 5** In [Alignment], set the positioning of the watermark.
- 6** In [Print Style], set the border and superimposition of the watermark → click [OK].
- 7** In the [Edit Watermark] dialog box, click [OK].

The created watermark is added to the list in the [Page Setup] sheet > [Watermark].

Related Topics

- 🔗 [Page Setup] Sheet(P. 102)

Poster Printing

You can enlarge the print data of one page and print it over multiple sheets of paper. When the output sheets are joined together, they form a large print like a poster.

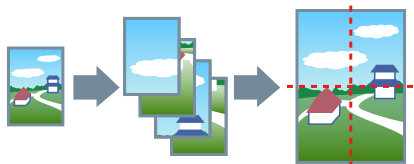

This topic also introduces poster printing setting and output examples.

▶ **Poster Printing Setting and Output Examples(P. 24)**

To Perform Poster Printing

- 1** Display the [Basic Settings] sheet.
- 2** Select [1-sided Printing] from [1-sided/2-sided/Booklet Printing].
- 3** Display the [Basic Settings] or [Page Setup] sheet.
- 4** Select [Poster [N x N]] from [Page Layout].
 N x N represents the number of sheets of paper over which the print data will be divided and printed.
 When printing with border lines, or when setting margins or the range of pages to be printed, perform the following procedure.
- 5** Click [Poster Details].
- 6** In the [Poster Details] dialog box, set any necessary items → click [OK].

Poster Printing Setting and Output Examples

This shows combinations of setting examples and output results relating to poster printing. The setting examples are shown in combination with the setting state in the [Poster Details] dialog box whenever required.

Setting Example 1.

- [Basic Settings] sheet > [Orientation]: [Portrait]
- [Basic Settings] or [Page Setup] sheet > [Page Layout]: [Poster [1 x 2]]

Output Result

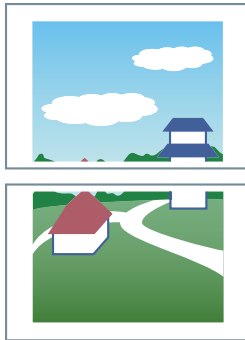

Setting Example 2.

- [Basic Settings] or [Page Setup] sheet > [Page Layout]: [Poster [2 x 2]]
- [Poster Details] dialog box > [Pages to Print] > [Specify Pages]: [2] and [4]

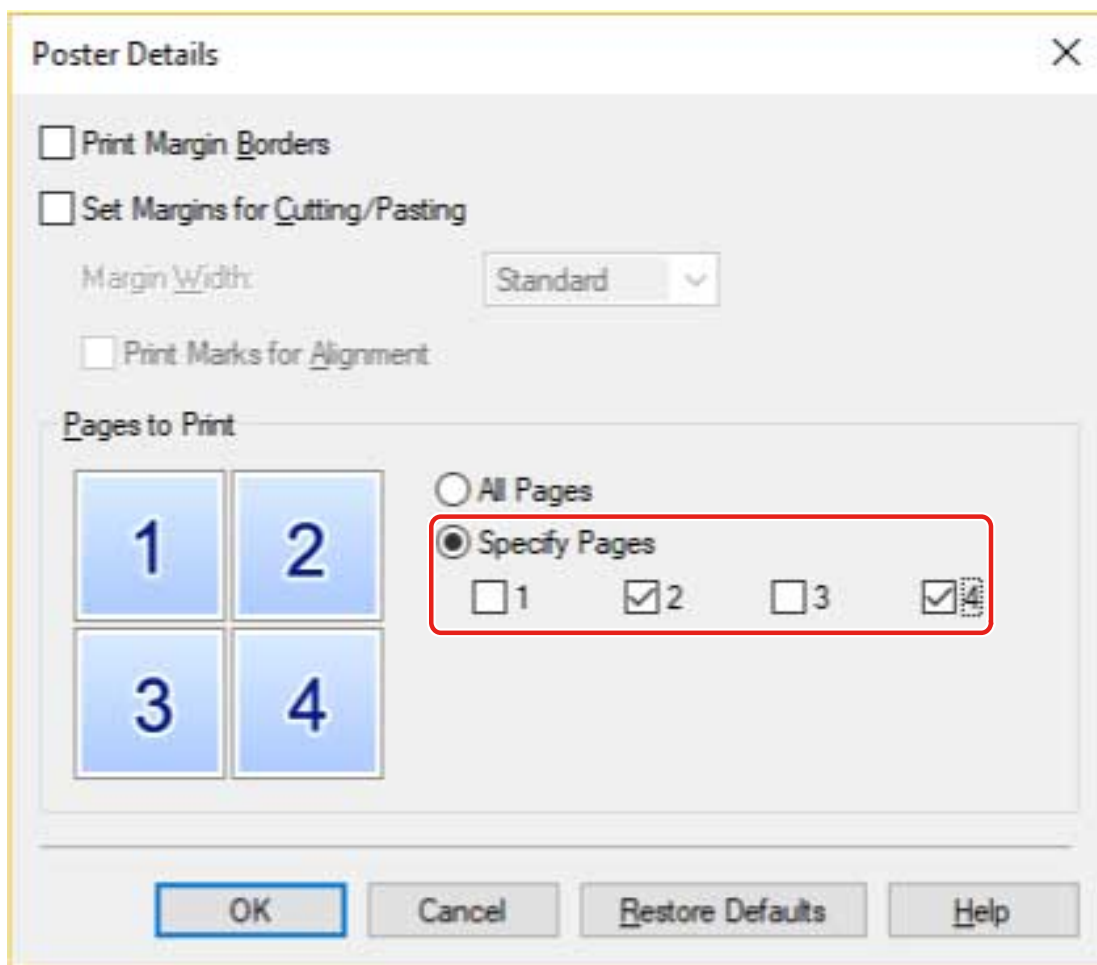

Output Result

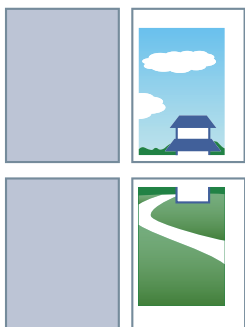

Setting Example 3.

- [Basic Settings] or [Page Setup] sheet > [Page Layout]: [Poster [2 x 2]]
- [Poster Details] dialog box: [Print Margin Borders], [Set Margins for Cutting/Pasting], and [Print Marks for Alignment]

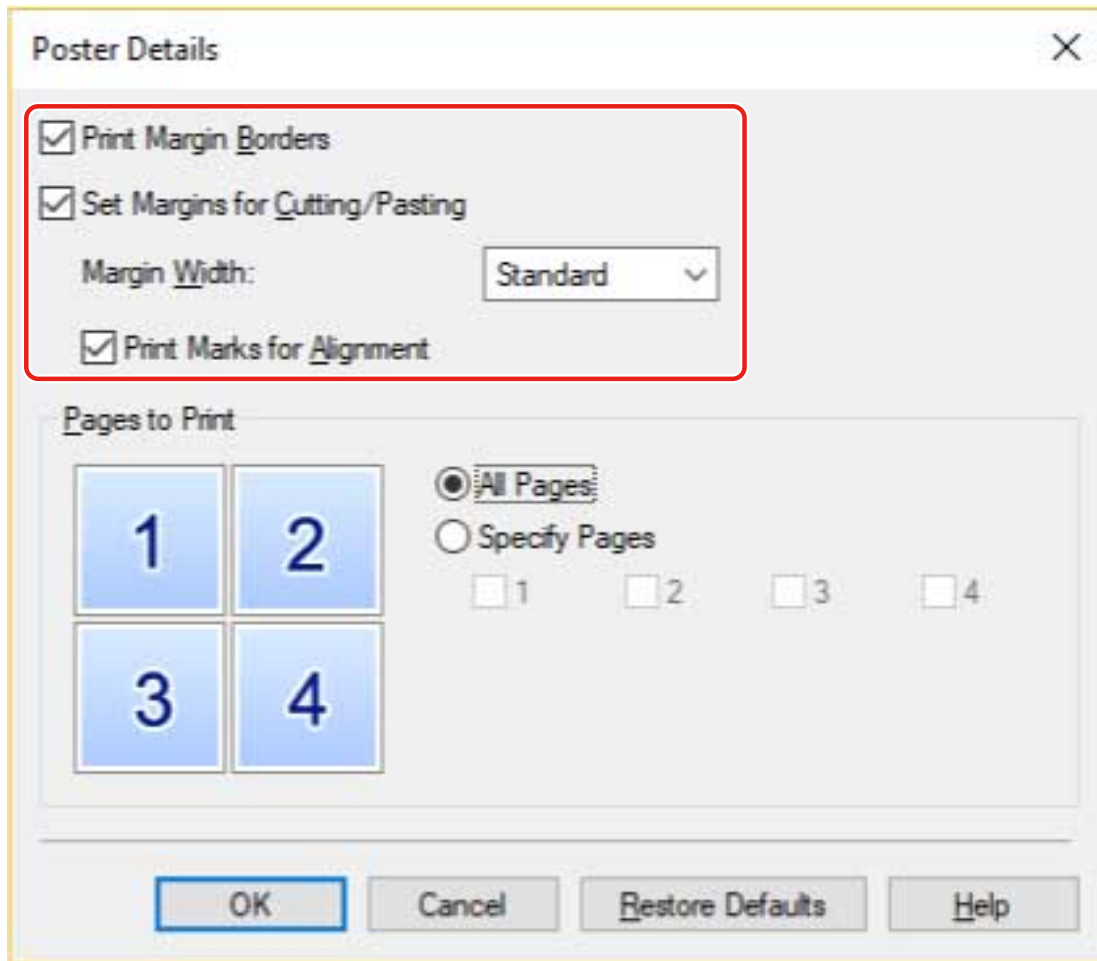

Output Result

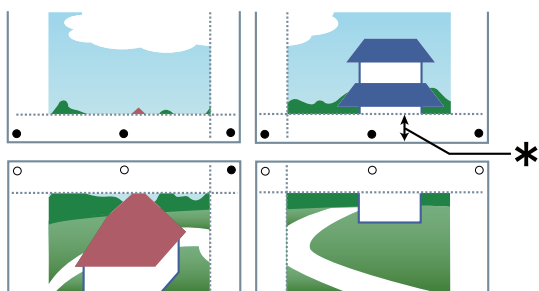

Legend

Broken line: border

○ : paste mark

● : cut mark

* : the margin set for [Margin Width] (10 mm (0.39 inches) when [Standard] is selected.)

Related Topics

- [Basic Settings] Sheet(P. 99)

▶ [Page Setup] Sheet(P. 102)

Printing Over a Fixed Form

You can print data overlapping a fixed form stored in the device. This function is known as overlay printing.

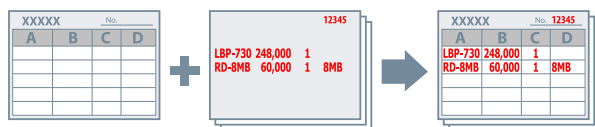

To Save a Fixed Form in the Computer or the Device

- 1 Display the [Page Setup] sheet.
- 2 Click [Page Options].
- 3 In the [Page Options] dialog box, display the [Overlay] sheet.
- 4 Select [Processing Method] > [Create a Form File] → select a destination from [Store in] → specify a file name.
 If you select [Host] from [Store in], click [Browse] → select a file name → click [Save]. Enter titles in [Title] and [Sub-title] as necessary.
 If you select [Device] from [Store in], enter a file name in [File Name].
- 5 Click [OK].

To Perform Overlay Printing

- 1 Display the [Page Setup] sheet.
- 2 Click [Page Options].
- 3 In the [Page Options] dialog box, display the [Overlay] sheet.
- 4 Select [Processing Method] > [Use Overlay Printing] → select the form file to use from [Form File to Use].
 If you select [Form File on Host] from [Form File to Use], click [Browse] → select a file name → click [Open]. Enter text in [File Info], as necessary.

If you select [Form File on Device] from [Form File to Use], click [Retrieve Form File Information] → select a file name from [File List] → select which side to apply overlay printing to in [Apply to] when performing two-sided printing. When you cannot acquire information from the device, enter the form file name in [File Name].

5 Click [OK].

Related Topics

- ▶ **[Page Setup] Sheet(P. 102)**
- ▶ **Overlay printing will not execute(P. 137)**

Attaching Encryption When Printing

You can attach a PIN to print data and save it in the device. When you print the saved data, enter the PIN in the control panel of the device. This function is useful when printing confidential documents etc.

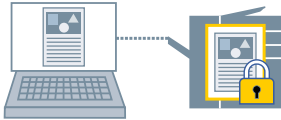

NOTE

- If you register the PIN used in secured printing as a default setting, you can reduce the effort required to configure settings when printing.

- 1** Display the [Basic Settings], [Page Setup], [Finishing], [Paper Source], or [Quality] sheet.
- 2** Select [Secure Print] from [Output Method] → click [Yes].
- 3** In the [Secure Print Details] dialog box, enter [User Name] and [PIN] → click [OK].

If the [Confirm PIN] dialog box is displayed when performing secured printing, confirm or set the data name, user name, and PIN.

Related Topics

- ▶ [Common Settings for All Sheets\(P. 96\)](#)
- ▶ [Changing the Default Settings\(P. 34\)](#)

Putting Print Jobs on Hold

You can send print data to a hold queue (temporary storage area) in the device. You can also change the print order or settings of the stored data from the control panel of the device or the Remote UI.

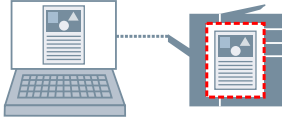

- 1 Display the [Basic Settings], [Page Setup], [Finishing], [Paper Source], or [Quality] sheet.**
- 2 Select [Hold] from [Output Method] → click [Details].**
- 3 In the [Hold Details] dialog box, set the name of data.**
If you want to specify a desired name, select [Name of Data to Hold] > [Enter Name] → enter the name in [Name].
- 4 Click [OK].**

When performing hold printing, you can confirm or set the name of data in the displayed dialog box.

Related Topics

- ▶ [Common Settings for All Sheets\(P. 96\)](#)
- ▶ [Changing the Default Settings\(P. 34\)](#)

Storing Print Data

You can store the print data in a box in the device. You can also change the settings of or combine the stored data with other stored data from the control panel of the device or the Remote UI.

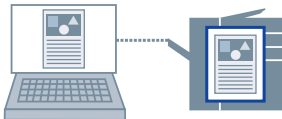

NOTE

- If you register the box number used in stored printing as a default setting, you can reduce the effort required to configure settings when printing.

- 1 Display the [Basic Settings], [Page Setup], [Finishing], [Paper Source], or [Quality] sheet.**
- 2 Select [Store] from [Output Method] → click [Yes].**
- 3 In the [Store Details] dialog box, set the name of data.**
If you want to specify a desired name, select [Data Name] > [Enter Name] → enter the name in [Name].
- 4 Click [Retrieve Mail Box Information] → select a storage destination from [Mail Boxes].**
You can select multiple boxes by pressing the [Ctrl] or [Shift] key.
- 5 Click [OK].**

Related Topics

- ▶ [Common Settings for All Sheets\(P. 96\)](#)
- ▶ [Changing the Default Settings\(P. 34\)](#)

Priority Printing

You can print a document with higher priority than other print jobs that are in a standby state in the device.

When performing priority printing, if there is a print job being processed at the device, priority printing is started as soon as that job is finished.

- 1** Display the [Basic Settings], [Page Setup], [Finishing], [Paper Source], or [Quality] sheet.
- 2** Select [Promote Print] from [Output Method].

Related Topics

- [Common Settings for All Sheets\(P. 96\)](#)

Changing the Default Settings

You can change the default settings to desired print settings. If you change them to settings that you use frequently, you can reduce the effort required to configure settings when printing.

1 Display [Devices and Printers] from the [Control Panel] of Windows.

2 Right-click the icon of the device you are going to set → select [Printing Preferences] from the displayed menu.

If you are using the driver with multiple device models, select the model you are going to set after selecting [Printing Preferences].

3 In the print settings screen of the driver, set the required items.

If necessary, switch sheets and configure relevant settings.

4 Click [OK].

Creating a Booklet When Printing

Creating a Booklet When Printing	36
Booklet Printing	37
Creating a Booklet in Sets	38
Correcting Displacement During Booklet Printing	39
Saddle Stitched Booklet Printing	40
Saddle Press Processing When Creating Saddle Stitched Booklets	41
Trimming Pages When Creating Saddle Stitched Booklets	42
Perfect Binding	43

Creating a Booklet When Printing

- ▶ **Booklet Printing(P. 37)**
- ▶ **Creating a Booklet in Sets(P. 38)**
- ▶ **Correcting Displacement During Booklet Printing(P. 39)**
- ▶ **Saddle Stitched Booklet Printing(P. 40)**
- ▶ **Saddle Press Processing When Creating Saddle Stitched Booklets(P. 41)**
- ▶ **Trimming Pages When Creating Saddle Stitched Booklets(P. 42)**
- ▶ **Perfect Binding(P. 43)**

Booklet Printing

You can print with the pages automatically arranged so they create a booklet when folded in half.

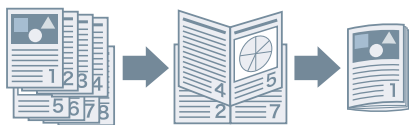

- 1** Display the [Basic Settings] or [Finishing] sheet.
- 2** Select [Booklet Printing] from [1-sided/2-sided/Booklet Printing] or [Print Style].
To set the binding position and gutter, follow the procedure below.
- 3** Click [Booklet].
- 4** In the [Detailed Settings for Booklet] dialog box, select the binding position from [Book Opening].
- 5** Select [Specify Booklet Gutter] → specify a gutter width in [Booklet Gutter].
- 6** Click [OK].

Related Topics

- ▶ [Basic Settings] Sheet(P. 99)
- ▶ [Finishing] Sheet(P. 105)
- ▶ Creating a Booklet in Sets(P. 38)
- ▶ Correcting Displacement During Booklet Printing(P. 39)
- ▶ Saddle Stitched Booklet Printing(P. 40)

Creating a Booklet in Sets

When creating a booklet from a document with a large number of pages, you can divide the pages into multiple sets and print them.



- 1** Display the [Basic Settings] or [Finishing] sheet.
- 2** Select [Booklet Printing] from [1-sided/2-sided/Booklet Printing] or [Print Style].
- 3** Click [Booklet].
- 4** Select [Booklet Printing Method] > [Divide into Sets].
- 5** Specify the number of pages contained in each set in [Sheets per Set].
- 6** Click [OK].

Related Topics

- ▶ [Basic Settings] Sheet(P. 99)
- ▶ [Finishing] Sheet(P. 105)
- ▶ Booklet Printing(P. 37)

Correcting Displacement During Booklet Printing

You can create and print a booklet while correcting the displacement between outer and inner pages that occurs during booklet printing. If you trim the edges of the pages using a trimmer, you can adjust the amount of margin so that the position of the print data on the page does not deviate between pages.

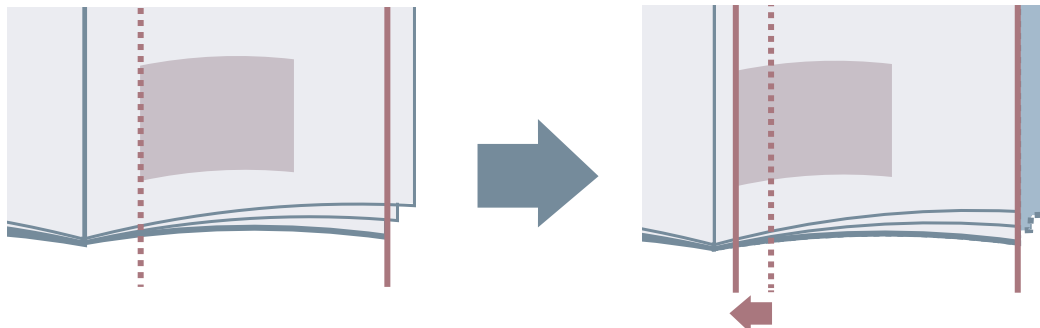

- 1** Display the [Basic Settings] or [Finishing] sheet.
- 2** Select [Booklet Printing] from [1-sided/2-sided/Booklet Printing] or [Print Style].
- 3** Click [Booklet].
- 4** Select [Booklet Printing Process] > [With Device Settings].
- 5** Select [Use Creep (Displacement) Correction] → select a correction method in [Displacement Correction Method].
If you select [Manual Correction], specify the amount of print area displacement between the outermost page and centermost page in [Correction Width].
- 6** Click [OK].

Related Topics

- ▶ [Basic Settings] Sheet(P. 99)
- ▶ [Finishing] Sheet(P. 105)
- ▶ Booklet Printing(P. 37)

Saddle Stitched Booklet Printing

When creating and printing a booklet, you can output pages that are stapled in the center. Depending on the device, you can also trim and align the edges of the pages.

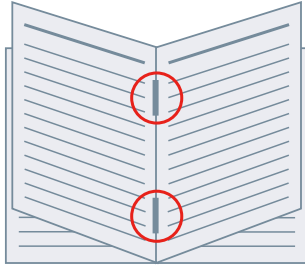

- 1** Display the [Basic Settings] or [Finishing] sheet.
- 2** Select [Booklet Printing] from [1-sided/2-sided/Booklet Printing] or [Print Style].
- 3** Select a finishing method from [Saddle Stitch Setting].
If you select [Fold + Saddle Stitch + Trim]/[Fold + Trim] from [Saddle Stitch Setting], perform the following procedure.
- 4** Display the [Finishing] sheet.
- 5** Select a trim width adjustment method from [Trim Settings] → specify the values according to the method that you select.

Related Topics

- ▶ [Basic Settings] Sheet(P. 99)
- ▶ [Finishing] Sheet(P. 105)
- ▶ Booklet Printing(P. 37)
- ▶ Saddle Press Processing When Creating Saddle Stitched Booklets(P. 41)
- ▶ Trimming Pages When Creating Saddle Stitched Booklets(P. 42)

Saddle Press Processing When Creating Saddle Stitched Booklets

When performing saddle stitched booklet printing, you can press the bound portion so that it is flattened.

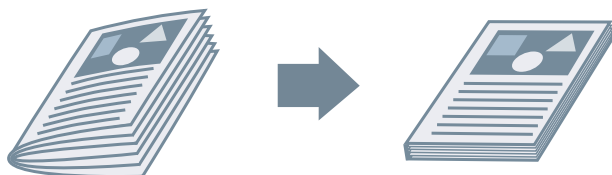

- 1** Display the [Basic Settings] or [Finishing] sheet.
- 2** Select [Booklet Printing] from [1-sided/2-sided/Booklet Printing] or [Print Style].
- 3** Select a finishing method from [Saddle Stitch Setting].
If you select [Fold + Saddle Stitch + Trim]/[Fold + Trim] from [Saddle Stitch Setting], set the trim width adjustment method in the [Finishing] sheet.
- 4** Click [Booklet].
- 5** Select [Saddle Press] → specify the force of saddle press processing in [Saddle Press Adjustment].
- 6** Click [OK].

Related Topics

- ▶ [Basic Settings] Sheet(P. 99)
- ▶ [Finishing] Sheet(P. 105)
- ▶ Saddle Stitched Booklet Printing(P. 40)

Trimming Pages When Creating Saddle Stitched Booklets

When performing saddle stitched booklet printing, you can trim and align the edges of the pages.

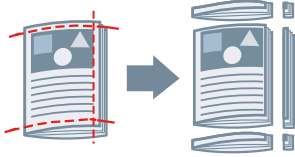

- 1** Display the [Finishing] sheet.
- 2** Select [Booklet Printing] from [Print Style].
- 3** Select [Fold + Saddle Stitch + Trim]/[Fold + Trim] from [Saddle Stitch Setting].
- 4** Select a trim width adjustment method from [Trim Settings] → specify the values according to the method that you select.

Related Topics

- ▶ [Basic Settings] Sheet(P. 99)
- ▶ [Finishing] Sheet(P. 105)
- ▶ Saddle Stitched Booklet Printing(P. 40)

Perfect Binding

You can apply glue to the gutter side of the contents and encloses them in a cover to create a booklet.

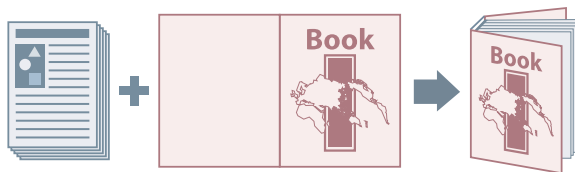

- 1** Display the [Finishing] sheet.
- 2** Select [Perfect Binding [1-sided]] or [Perfect Binding [2-sided]] from [Print Style].
- 3** Confirm the content of [Setting List].
- 4** If you want to change the settings, click [Perfect Binding Settings] → set the required items.
 When printing on a cover, select [Lay out Data the Same Size as Cover] from [Perfect Bound Cover Settings] > [Print Style] → specify [Front Cover Print Side]/[Back Cover Print Side].
 When adjusting the finishing size, click [Finishing Adjustment] → configure the appropriate settings → click [OK].
- 5** Click [OK].

Related Topics

- ▶ [Finishing] Sheet(P. 105)

Using Various Types of Paper

Using Various Types of Paper	45
Registering Custom Paper Sizes	46
Inserting Sheets Between Transparencies	47
Inserting Sheets	48
Inserting Tab Paper	49
Printing on Tab Paper	51
Adding Cover Sheets	52

Using Various Types of Paper

- ▶ **Registering Custom Paper Sizes(P. 46)**
- ▶ **Inserting Sheets Between Transparencies(P. 47)**
- ▶ **Inserting Sheets(P. 48)**
- ▶ **Inserting Tab Paper(P. 49)**
- ▶ **Printing on Tab Paper(P. 51)**
- ▶ **Adding Cover Sheets(P. 52)**

Registering Custom Paper Sizes

You can register a desired paper size and use it for printing. You can also use registered custom paper sizes to print with other devices from the computer you are using.

- 1** Display [Devices and Printers] from the [Control Panel] of Windows.
- 2** Right-click the icon of the device you are going to set → select [Printing Preferences] from the displayed menu.
- 3** Display the [Page Setup] sheet.
- 4** Click [Custom Paper Size].
- 5** In the [Custom Paper Size Settings] dialog box, set [Name of Custom Paper Size], [Unit], and [Paper Size] → click [Register].
- 6** Click [OK].

Related Topics

- ▶ [Page Setup] Sheet(P. 102)

Inserting Sheets Between Transparencies

You can print with sheets of paper inserted between transparencies. You can also print on the inserted sheets.

- 1 Display the [Paper Source] sheet.**
- 2 Select [Select by] > [Paper Source]/[Paper Type].**
- 3 Select [Transparency Cover Sheets] from [Paper Selection].**
- 4 Set [Cover Sheets] and [Transparencies].**

If you select [Select by] > [Paper Source], select the paper source in which the paper to be used is set.
If you select [Select by] > [Paper Type], select the type of paper to be used.
- 5 If you also want to print on inserted sheets, select [Print on Cover Sheets].**
- 6 Click [OK].**

Related Topics

- [▶ \[Paper Source\] Sheet\(P. 112\)](#)

Inserting Sheets

You can insert sheets of paper between specified pages.



- 1** Display the [Paper Source] sheet.
- 2** Select [Select by] > [Paper Source] or [Paper Type].
- 3** Select [Insert Sheets] from [Paper Selection] → click [Insert Sheets Settings].
- 4** In the [Insert Sheets Settings] dialog box, select [Inserted Sheets] from [Sheets to Insert].
- 5** Set [Paper Source], [Print on], and [Insert] → click [Add].
The settings for inserting sheets are added to [Setting List].
- 6** Click [OK].
- 7** Select the paper for content pages from [Original Paper Source] or [Original Paper Type].

Related Topics

- ▶ [Paper Source] Sheet(P. 112)
- ▶ Inserting Tab Paper(P. 49)

Inserting Tab Paper

You can insert tab paper between specified pages. You can also print on the tab part.



- 1** Display the [Paper Source] sheet.
- 2** Select [Select by] > [Paper Source] or [Paper Type].
- 3** Select [Insert Sheets] from [Paper Selection] → click [Insert Sheets Settings].
- 4** In the [Insert Sheets Settings] dialog box, select [Tab Paper] from [Sheets to Insert].
- 5** Set [Paper Source], [Print on], and [Insert].
- 6** If you want to change the paper type of the tab paper, click [Tab Paper] > [Settings] → select the paper type to be used from [Paper Type] → click [OK].
To set the print position on the tab paper, follow the procedure below.
- 7** Click [Tab Details].
- 8** In the [Tab Details] dialog box, set [Printing Position on Tab] → click [OK].
To shift the print data to the tab part, select [Offset Printing Position] → specify the distance to shift the data in [Offset Width] → click [OK].
To print the print data without shifting it, select [Do Not Offset Printing Position] → select the tab paper size from [Tab Paper Size] → click [OK].
- 9** In the [Insert Sheets Settings] dialog box, click [OK].
- 10** Select the paper for content pages from [Original Paper Source] or [Original Paper Type].

Related Topics

- 🔍 [Paper Source] Sheet(P. 112)

▶ **Printing on Tab Paper(P. 51)**

Printing on Tab Paper

You can print on the tab part of tab paper.

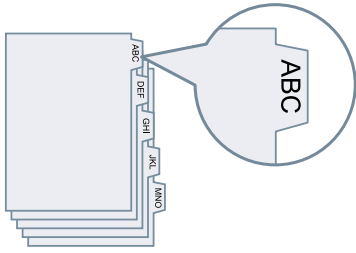

- 1** Display the [Paper Source] sheet.
- 2** Select [Select by] > [Paper Type].
- 3** Click [Paper Type] > [Settings].
- 4** In the [Paper Type Settings] dialog box, select tab paper from [Paper Type] → click [OK].

To set the print position on the tab paper, follow the procedure below.

- 5** Click [Tab Details].
- 6** In the [Tab Details] dialog box, set [Printing Position on Tab] → click [OK].

To shift the print data to the tab part, select [Offset Printing Position] → specify the distance to shift the data in [Offset Width] → click [OK].

To print the print data without shifting it, select [Do Not Offset Printing Position] → select the tab paper size from [Tab Paper Size] → click [OK].

Related Topics

- ▶ [Paper Source] Sheet(P. 112)
- ▶ Inserting Tab Paper(P. 49)

Adding Cover Sheets

You can add front and back covers to print data. You can also use paper that differs from that of the content pages, and specify which side(s) of the cover(s) to print on.



- 1** Display the [Paper Source] sheet.
- 2** Click [Front/Back Cover Settings].
- 3** In the [Front/Back Cover Settings] dialog box, select the cover(s) to add from [Cover Settings].
- 4** If you want to set the front cover, set [Front Cover] > [Paper Source] and [Print on].
- 5** If you want to set the back cover, set [Back Cover] > [Paper Source] and [Print on].
- 6** Click [OK].

Related Topics

- 🔍 [Paper Source] Sheet(P. 112)

Printing Multiple Files Together

Printing Multiple Files Together	54
About the [Edit and Preview] Function	55
Printing Files Together	56
Checking the Print Preview	58
Changing the Print Settings of the Combined File	60

Printing Multiple Files Together

- ▶ **About the [Edit and Preview] Function(P. 55)**
- ▶ **Printing Files Together(P. 56)**
- ▶ **Checking the Print Preview(P. 58)**
- ▶ **Changing the Print Settings of the Combined File(P. 60)**

About the [Edit and Preview] Function

The [Edit and Preview] Function allows you to combine multiple files into one for printing.

You can set the [Edit and Preview] function from [Output Method] in each sheet of the print settings screen.

When you click the print button of an application, the Canon PageComposer main screen opens, and you can also do the following:

- Preview the print data for confirmation
- Change the print settings after checking the preview
- Delete unnecessary pages
- Perform proof printing
- Combine data created with different applications into one file for printing
- Unify the print settings when combining multiple files



Related Topics

- ▶ [Common Settings for All Sheets\(P. 96\)](#)
- ▶ [Canon PageComposer\(P. 127\)](#)
- ▶ [Printing Files Together\(P. 56\)](#)
- ▶ [Checking the Print Preview\(P. 58\)](#)
- ▶ [Changing the Print Settings of the Combined File\(P. 60\)](#)

Printing Files Together

You can combine multiple files into one file and print it. You can change the print settings for editing the combined file using Canon PageComposer.

Here, the procedure for performing operations from the icons in the toolbar of Canon PageComposer will be explained. You can also perform operations from the menu.

1 Display the [Basic Settings], [Page Setup], [Finishing], [Paper Source], or [Quality] sheet.

2 Select [Edit and Preview] from [Output Method] → click [OK].

If you want to set the output method for the combined file, click [Details] → select the output method from [Output Method After Edit and Preview] → click [OK].

3 Click [OK] → click [Print] or [OK] in the print screen.

The Canon PageComposer main screen is displayed.

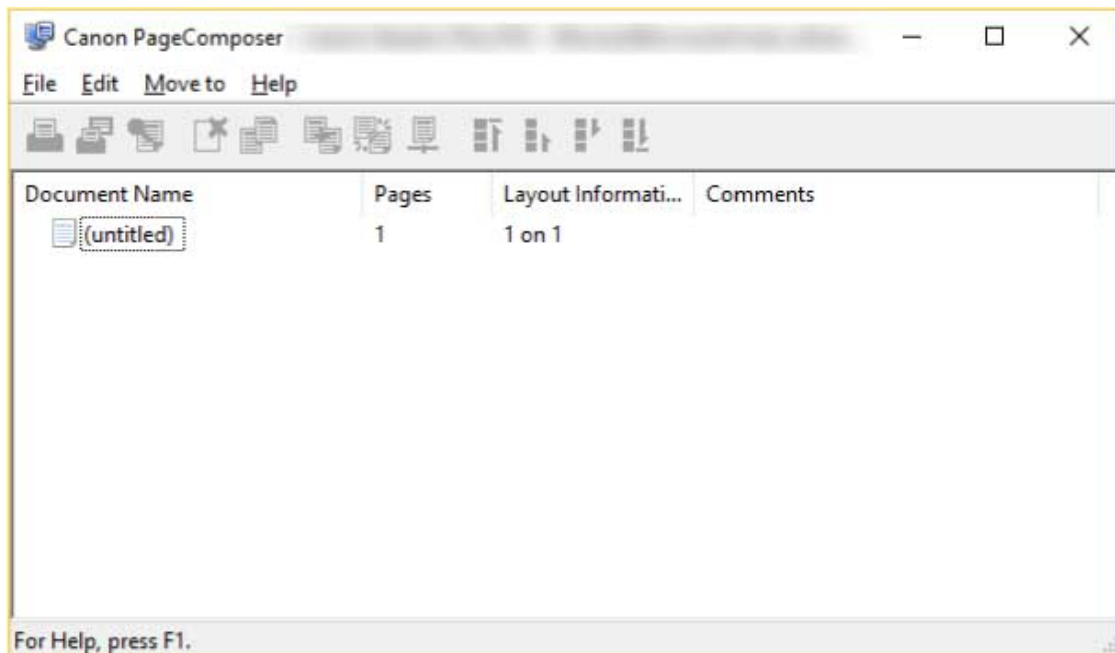

4 Repeat steps 1 to 3 for each file you want to combine.

5 In the Canon PageComposer main screen, select the files you want to combine from the list → click [] (Combine Documents).

6 In the [Combine] dialog box, set a name in [Document Name] if required.

7 If you want to change the print settings, click [Print Settings] sheet → set the required items → click [Combine].

You can check the current settings in the preview.

If you want to delete a page, select the page in the preview → click [Delete].

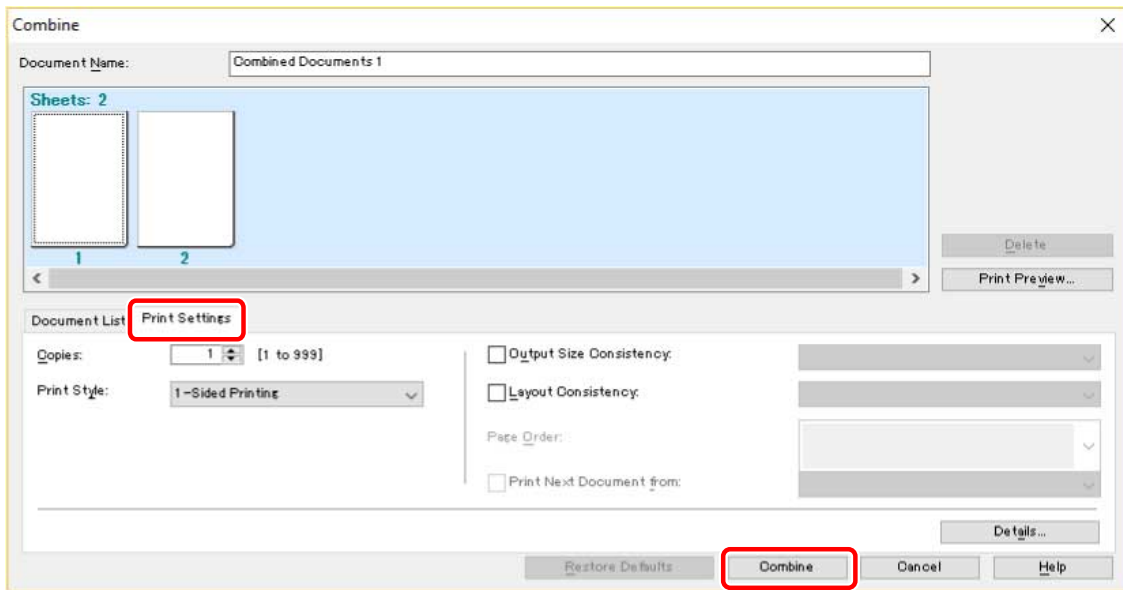

- 8** In the Canon PageComposer main screen, select the combined file → click [] (Print).

Related Topics

- ▶ Common Settings for All Sheets(P. 96)
- ▶ Canon PageComposer(P. 127)
- ▶ Checking the Print Preview(P. 58)
- ▶ Changing the Print Settings of the Combined File(P. 60)

Checking the Print Preview

You can preview the print data and check the page layout settings before printing.

Here, the procedure for performing operations from the icons in the toolbar of Canon PageComposer will be explained. You can also perform operations from the menu.

1 Display the [Basic Settings], [Page Setup], [Finishing], [Paper Source], or [Quality] sheet.

2 Select [Edit and Preview] from [Output Method] → click [OK].

If you want to set the output method after combining files, click [Details] → select the output method from [Output Method After Edit and Preview] → click [OK].

3 Click [OK] → click [Print] or [OK] in the print screen.

The Canon PageComposer main screen is displayed.

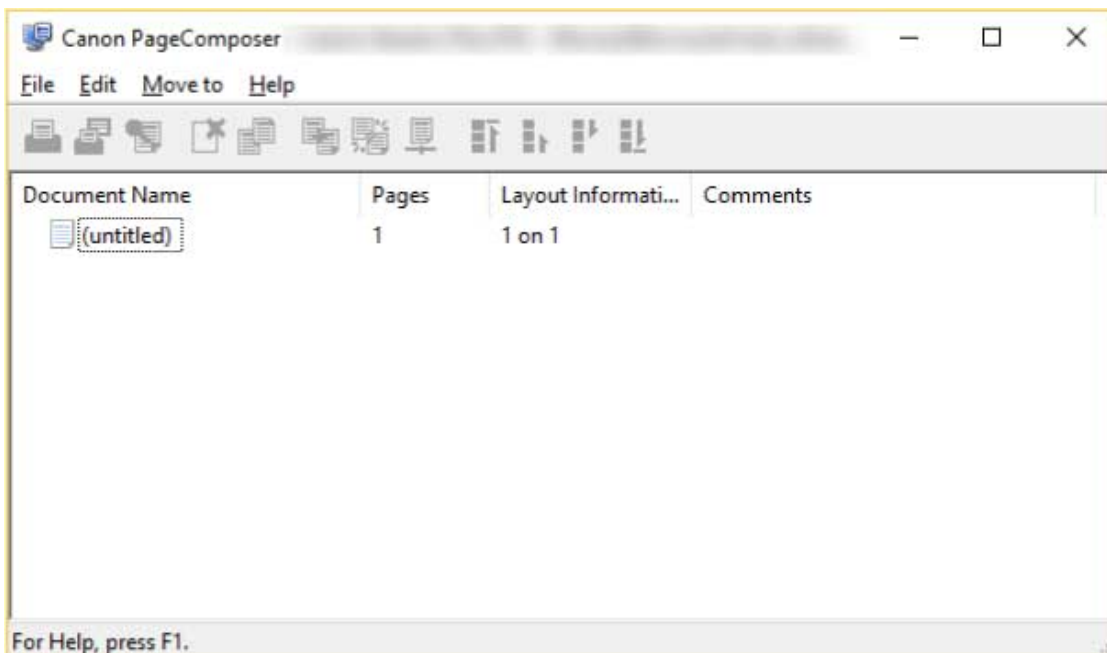

4 In the Canon PageComposer main screen, select the file whose print preview you want to check from the list → click [] (Print Preview).

5 In the [Print Preview] dialog box, check the preview → click [Close].

Click [] (Next) to display the next page.

Click the page image to zoom in or out.

Related Topics

- Common Settings for All Sheets(P. 96)

- ▶ **Canon PageComposer(P. 127)**
- ▶ **Printing Files Together(P. 56)**
- ▶ **Print results are unsatisfactory(P. 133)**

Changing the Print Settings of the Combined File

You can change the print settings of the combined file using Canon PageComposer. When editing files with different page sizes or layouts, you can unify the settings.

Here, the procedure for performing operations from the icons in the toolbar of Canon PageComposer will be explained. You can also perform operations from the menu.

- 1** In the Canon PageComposer main screen, select the file whose settings you want to change from the list → click [] (Change Print Settings).
- 2** In the [Change Print Settings] dialog box, set a name in [Document Name] if required.
- 3** Click [Print Settings] sheet → set the required items.

If you want to unify the output size settings, select [Output Size Consistency] → select a paper size.

If you want to unify the page layout settings, select [Layout Consistency] → select a layout setting.

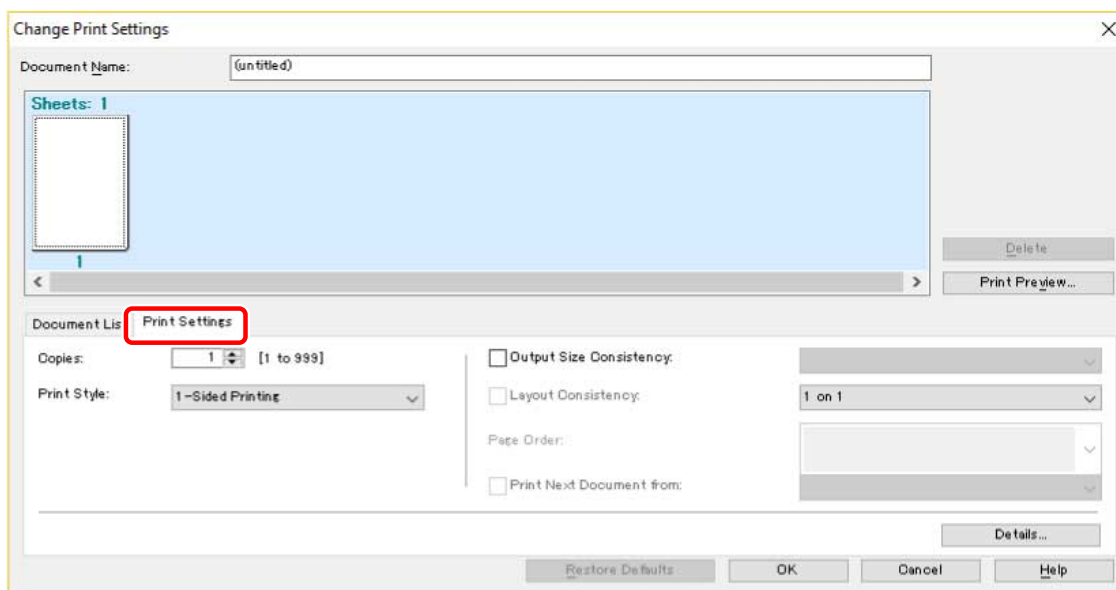

- 4** If you want to set where to start printing the next file from when combining files, select [Print Next Document from] → select an item.
- 5** If you want to specify detailed settings in the print settings screen of the driver, click [Details] → specify the relevant settings → click [OK].
- 6** In the [Change Print Settings] dialog box, click [OK].

Related Topics

- ▶ Canon PageComposer(P. 127)

▶ **Printing Files Together(P. 56)**

Editing Favorite Settings

Editing Favorite Settings	63
Registering Favorite Settings	64
Editing the Favorite Settings List	65

Editing Favorite Settings

- ▶ **Registering Favorite Settings(P. 64)**
- ▶ **Editing the Favorite Settings List(P. 65)**

Registering Favorite Settings

You can register frequently used settings as a profile.

1 Display the [Basic Settings], [Page Setup], [Finishing], [Paper Source], or [Quality] sheet
→ configure the settings you want to register.

2 Click [Add] to the right of [Profile].

3 In the [Add Profile] dialog box, set [Name] and [Icon].

Enter a comment in [Comment] if required.

4 Click [OK].

The new profile is added to [Profile]. You can apply registered print settings by simply selecting an item from [Profile].

Related Topics

🔗 [Common Settings for All Sheets\(P. 96\)](#)

Editing the Favorite Settings List

You can edit the [Profile] list, and import or export it to be used on other computers.

To Edit the [Profile] List

- 1** Display the [Basic Settings], [Page Setup], [Finishing], [Paper Source], or [Quality] sheet.
- 2** Click [Edit] to the right of [Profile].
- 3** In the [Edit Profile] dialog box, select the profile you want to edit from [Profile List] → set [Name] and [Icon].
Enter a comment in [Comment] if required.
If you want to delete a profile, select the profile from [Profile List] → click [Delete] → click [Yes].
- 4** Click [OK].

To Export a Profile

- 1** Display the [Basic Settings], [Page Setup], [Finishing], [Paper Source], or [Quality] sheet.
- 2** Click [Edit] to the right of [Profile].
- 3** In the [Edit Profile] dialog box, select the profile you want to export from [Profile List] → click [Export].
- 4** Specify the storage location and file name → click [Save] or [OK].
- 5** Click [OK].
The selected profile is saved as a "*.cfg" file.

To Import a Profile

- 1** Display the [Basic Settings], [Page Setup], [Finishing], [Paper Source], or [Quality] sheet.

- 2** Click [Edit] to the right of [Profile].
- 3** In the [Edit Profile] dialog box, click [Import] → select a profile file to be imported → click [Open].
- 4** Click [OK].

Related Topics

- ▶ [Common Settings for All Sheets\(P. 96\)](#)
- ▶ [Registering Favorite Settings\(P. 64\)](#)

Coordinating with the Device Functions

Coordinating with the Device Functions	68
Setting Device Information	69
Device Functions Settings	74
Paper Sources and Output Destinations Settings	75
Exporting a Configuration Profile	84
Importing a Configuration Profile	86
List of Configuration Profiles	89
Setting the Authentication Function	91
Setting the User Name	93

Coordinating with the Device Functions

- ▶ **Setting Device Information(P. 69)**
- ▶ **Device Functions Settings(P. 74)**
- ▶ **Paper Sources and Output Destinations Settings(P. 75)**
- ▶ **Exporting a Configuration Profile(P. 84)**
- ▶ **Importing a Configuration Profile(P. 86)**
- ▶ **List of Configuration Profiles(P. 89)**
- ▶ **Setting the Authentication Function(P. 91)**
- ▶ **Setting the User Name(P. 93)**

Setting Device Information

This explains the procedure for setting options installed in the device and making functions exclusive to the device usable.

First, select the configuration file that matches the printer model on the [Device Settings] sheet. The settings for using the device functions are displayed on the [Device Settings] sheet. Next, set the device function and option information. If you can use the acquire device information function, the function and option information of the device can be set automatically.

Perform a response according to the situation as shown below.

- **If you installed using the installer with a network connection:**

Normally, when installing, device information is acquired, and the configuration profile and device function and option information is automatically set. According to the following procedure, check that the configuration profile that matches the printer model is applied and that [Device Information] is set to [Auto].

- **If you installed using the installer with a USB connection:**

During installation, the configuration profile corresponding to the printer model is automatically set. The acquire device information function is not supported in USB environments. According to the following procedure, check that the configuration profile that matches the printer model is applied and set the device function and option information manually.

- **If the device information was not acquired during installation, or if you cannot use the device functions and options:**

According to the following procedure, set the configuration profile and device function and option information automatically or manually.

- **If you have added an option to the device:**

According to the following procedure, check that the configuration profile that matches the printer model is applied and set the added option automatically or manually.

- **If you change the printer model you are using:**

After changing the port, and set the configuration profile and device function and option information automatically or manually, according to the following procedure.

Prerequisites

- Settings at the device
 - If the device is connected via a WSD port, [Use WSD Browsing] is already set to on.
 - If the device is connected by specifying a standard TCP/IP port, [Retrieve Printer Mngt. Information from Host] is already set to on.

For details, refer to the manual of the device.

- When starting the computer, log on as a member of Administrators.
- When changing the printer model you are using, change the settings for the printing port.

Procedures

- 1 Display [Devices and Printers] from the [Control Panel] of Windows.**
- 2 Right-click the icon of the device you are going to set → select [Printer properties] from the displayed menu.**

If you are using the driver with multiple device models, select the model you are going to set after selecting [Printer properties].

3 Display the [Device Settings] sheet.

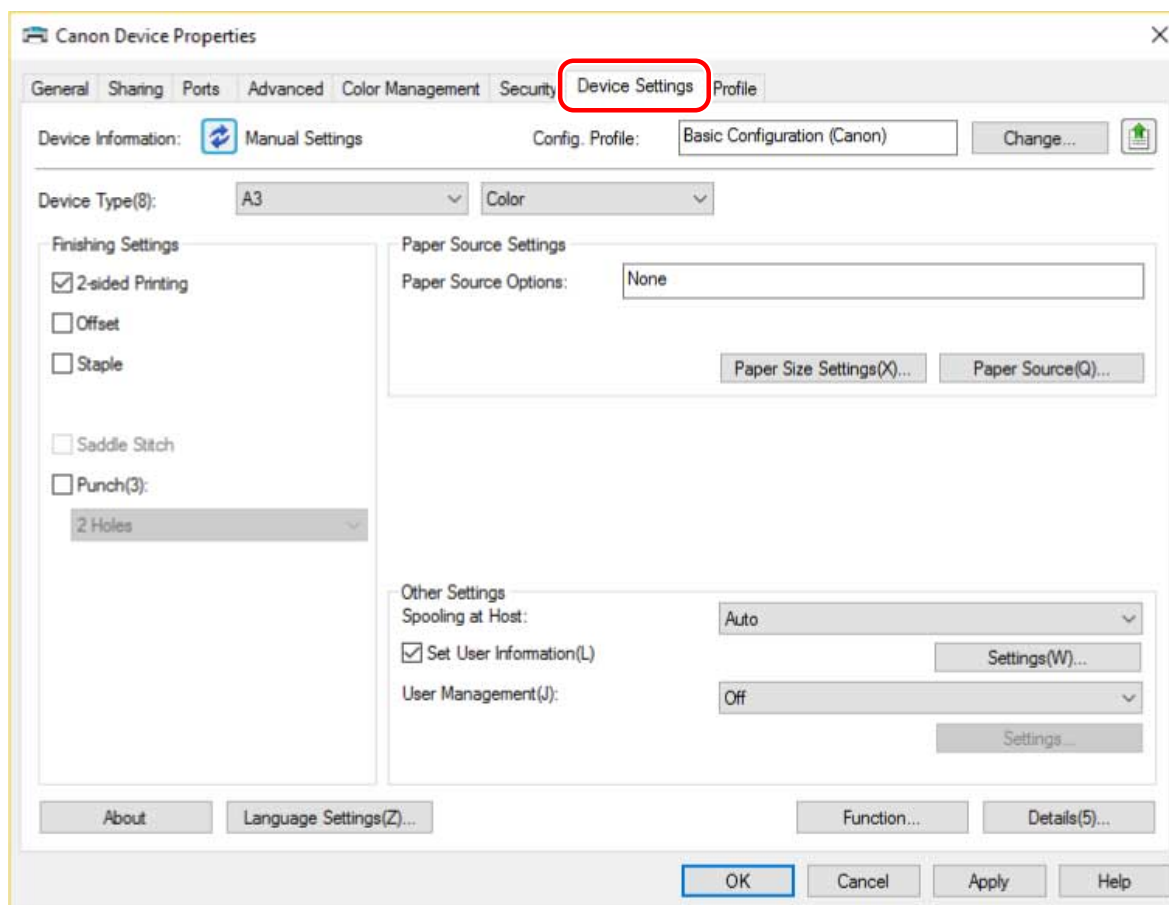

4 Check whether the configuration profile is suitable for the device you are using → if it does not match printer model, click [Change].

If a configuration profile that matches the printer model is set, skip to step 6.(P. 72)

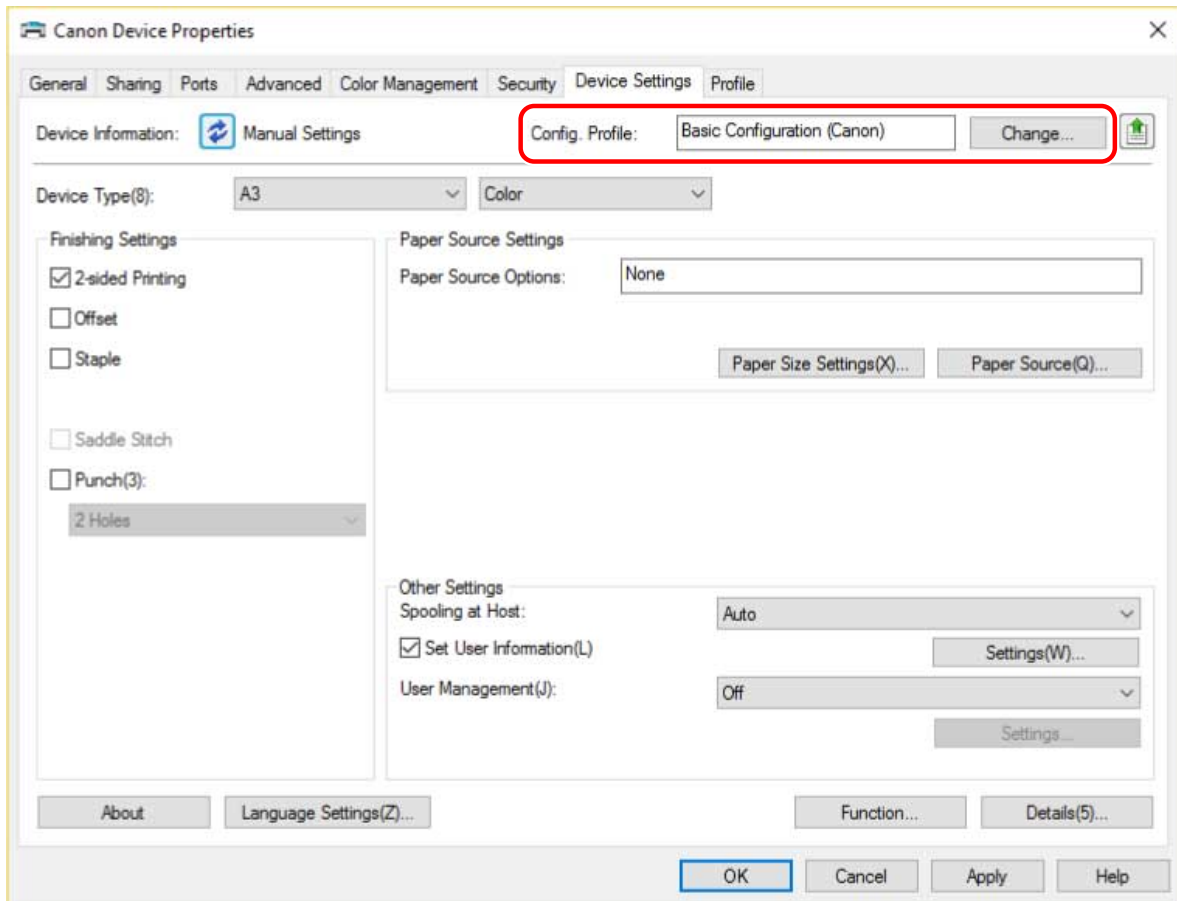

! IMPORTANT

- If you have not selected a configuration profile suitable for the device you are using, the device information may not be appropriately applied and some of the functions of the device may not be usable. Select a suitable configuration profile to display the required settings in the [Device Settings] sheet. Settings not displayed in the [Device Settings] sheet have not had the acquired device information applied to them.

5 Select [Select Configuration Profile Suitable for Your Device Automatically] → click [OK].

Only when the device is offline or you need to select a configuration profile manually, select [Select Manually] → select a configuration profile from [Configuration Profile] → click [OK].

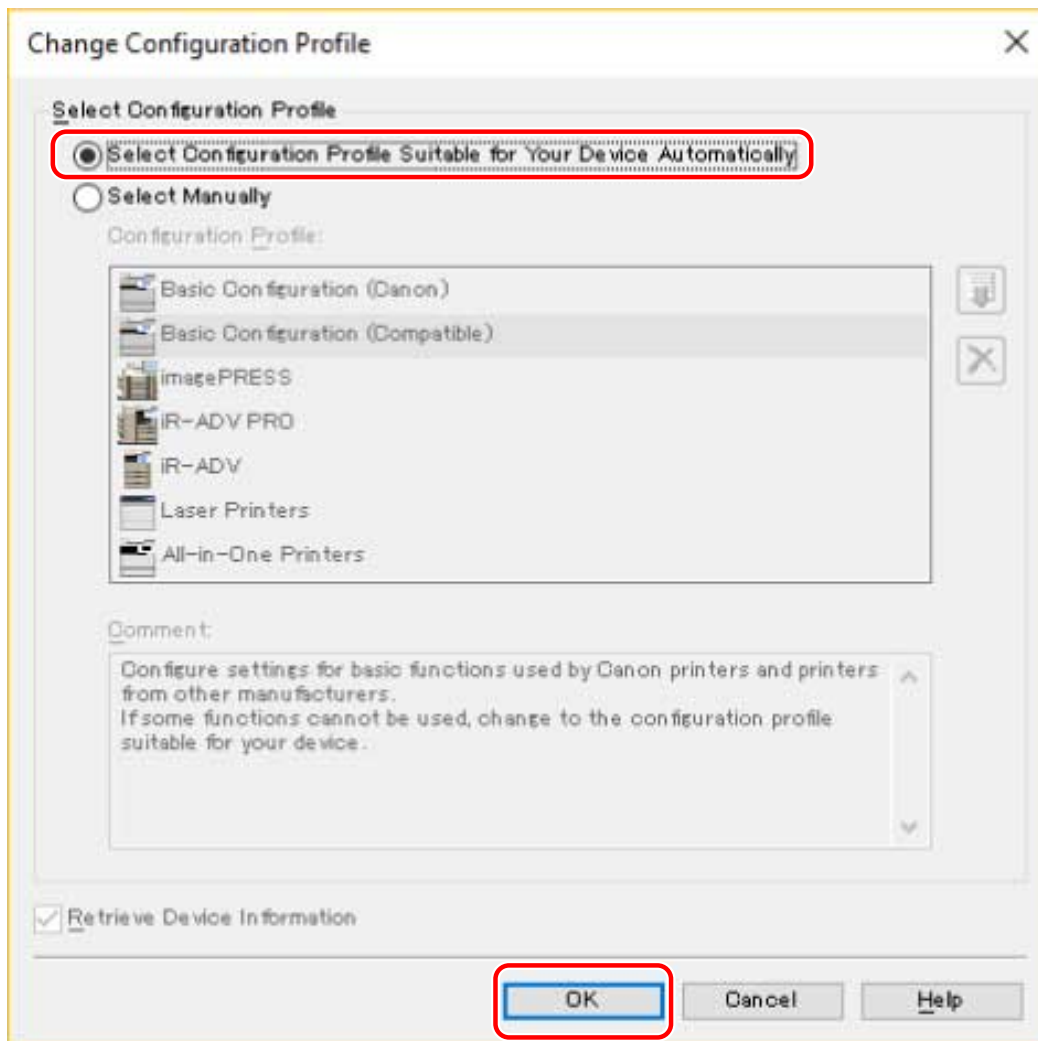

6 Confirm that [Device Information] is set to [Auto] → click [OK].

If [Device Information] is set to [Auto], the device information is acquired and the device function and option information is set automatically.

If you want to acquire the device information again when you have added an option etc., click [] (Retrieve Device Status Information).

If [Device Information] is set to [Manual Settings], the device information is not acquired. Set the options attached to the device and the functions supported by the device manually.

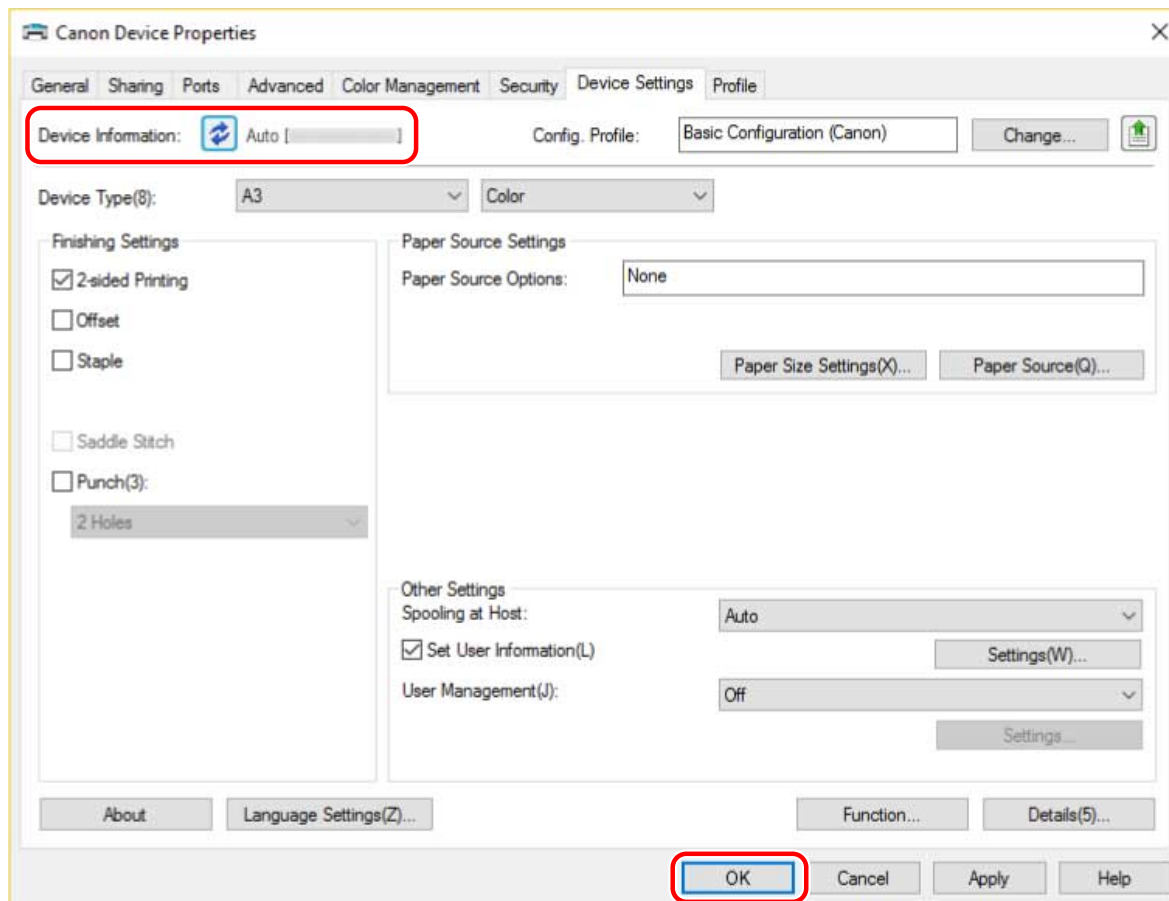
**NOTE**

- Even if you can use the acquire device information function, some device information must be set manually. For details, refer to the explanation of the device functions settings.
- In any of the following cases, there is a possibility that you may not be able to acquire some of the device information. If that happens, set the options manually.
 - When using a USB connection
 - When using a device or port that cannot acquire device information
 - When the configuration profile is set to [Basic Configuration (Compatible)]
- You can export and save the device information settings in the [Device Settings] sheet as a configuration profile. By importing the exported configuration profile, you can set all of the device information at once.

Related Topics

- ▶ [Device Settings] Sheet(P. 120)
- ▶ Device Functions Settings(P. 74)
- ▶ Paper Sources and Output Destinations Settings(P. 75)
- ▶ Importing a Configuration Profile(P. 86)
- ▶ Cannot use the acquire device information function or authentication function(P. 138)

Device Functions Settings

Settings suitable for the device are required to use unique device functions. If device information is retrieved during installation, settings suitable for the device are automatically applied to the driver.

However, the optimal settings may not be applied for the following functions. Check that the settings suitable for the device have been applied before using these functions.

Functions that may require settings to be configured manually

- [Config. Profile]
- [Paper Size Settings] > [Paper Size to Use as Custom Paper Size]
- [Other Settings]
 - [Spooling at Host]
 - [Set User Information]
 - [User Management] > [Department ID Management] > [Settings]
- [Details] > items with []



NOTE

- When connected by a TCP/IP or IPP network, the device information can be acquired only by the driver.
- In a print server environment, the device information can be acquired when the "Canon Driver Information Assist Service" is installed in the server computer. You can install the service using the driver installer.
- When using a USB Connection, the device information cannot be acquired. Set the device functions and installed options manually.

Related Topics

- ▶ [\[Device Settings\] Sheet\(P. 120\)](#)
- ▶ [Paper Sources and Output Destinations Settings\(P. 75\)](#)
- ▶ [Cannot use the acquire device information function or authentication function\(P. 138\)](#)

Paper Sources and Output Destinations Settings

This explains the mapping between the driver settings and paper source and output destination options. Refer to the device settings of the configuration profile selected for [Config. Profile] in the [Device Settings] sheet.

If [Fiery Print Controller] or [Basic Configuration (Canon)] is selected for [Config. Profile], refer to the settings for the printer model you are using.

- ▶ Laser Printers(P. 75)
- ▶ iR-ADV(P. 76)
- ▶ iR-ADV PRO(P. 78)
- ▶ imagePRESS(P. 80)
- ▶ All-in-One Printers(P. 82)

 **NOTE**

- Some options may not be usable depending on the driver and device you are using.

Laser Printers

Paper Source Settings

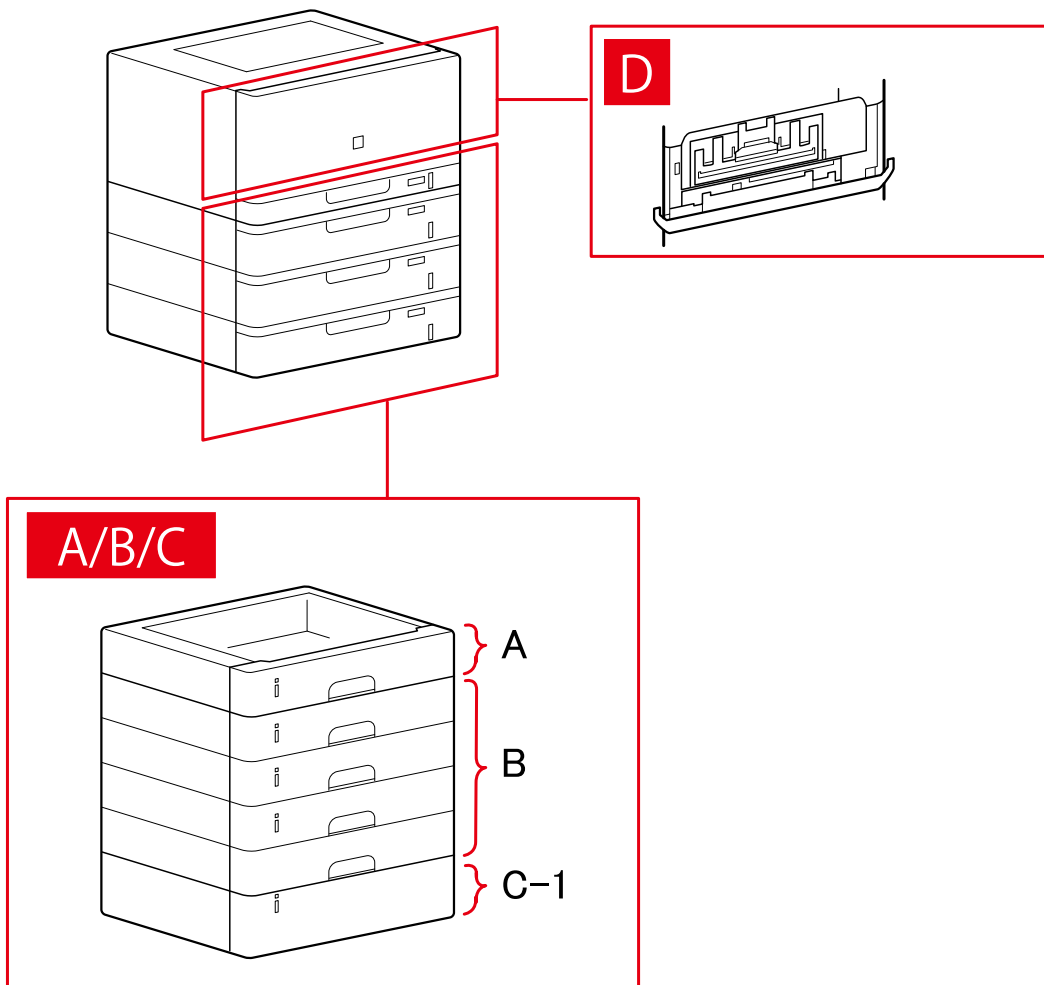

[Paper Source] Dialog Box

[Standard Paper Source]

A-1 [Drawer x 1]

[Optional Drawer/Cassette]

B-1 [Drawer x 1]

B-2 [Drawer x 2]

B-3 [Drawer x 3]

B-4 [Drawer x 4]

[Optional Deck]

C-1 [Paper Deck Unit]

D [Envelope Tray]

iR-ADV

Paper Source Settings

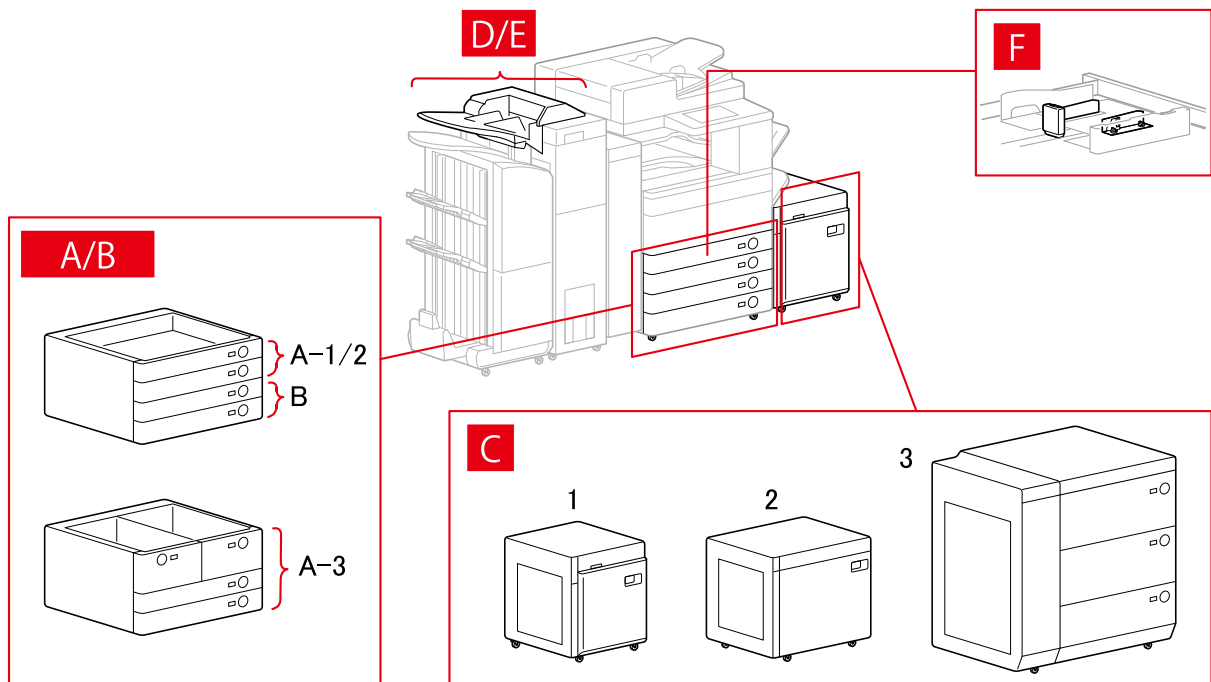

[Paper Source] Dialog Box

[Standard Paper Source]

A-1 [Drawer x 1]

A-2 [Drawer x 2]

A-3 [Deck x 2 + Drawer x 2]

[Optional Drawer/Cassette]

- B-1 [Drawer x 1]
- B-2 [Drawer x 2]
- B-3 [Drawer x 3]
- B-4 [1-Cassette Feeding Unit]
- B-5 [2-Cassette Feeding Unit]
- B-6 [3-Cassette Feeding Unit]
- B-7 [High Capacity Cassette Feeding Unit]

[Optional Deck]

- C-1 [Paper Deck Unit]
- C-2 [POD Deck Lite]
- C-3 [Multi-drawer Paper Deck]

[Inserter]

- D-1 [Document Insertion Unit (Tray x 2)]
- D-2 [Inserter of Paper Folding Unit/Document Insertion Unit (Tray x 1)]

E [Inserters of Paper Folding Unit]

[Envelope Feeder]

- F-1 [Drawer 1]
- F-2 [Drawer 2]

Output Destinations Settings

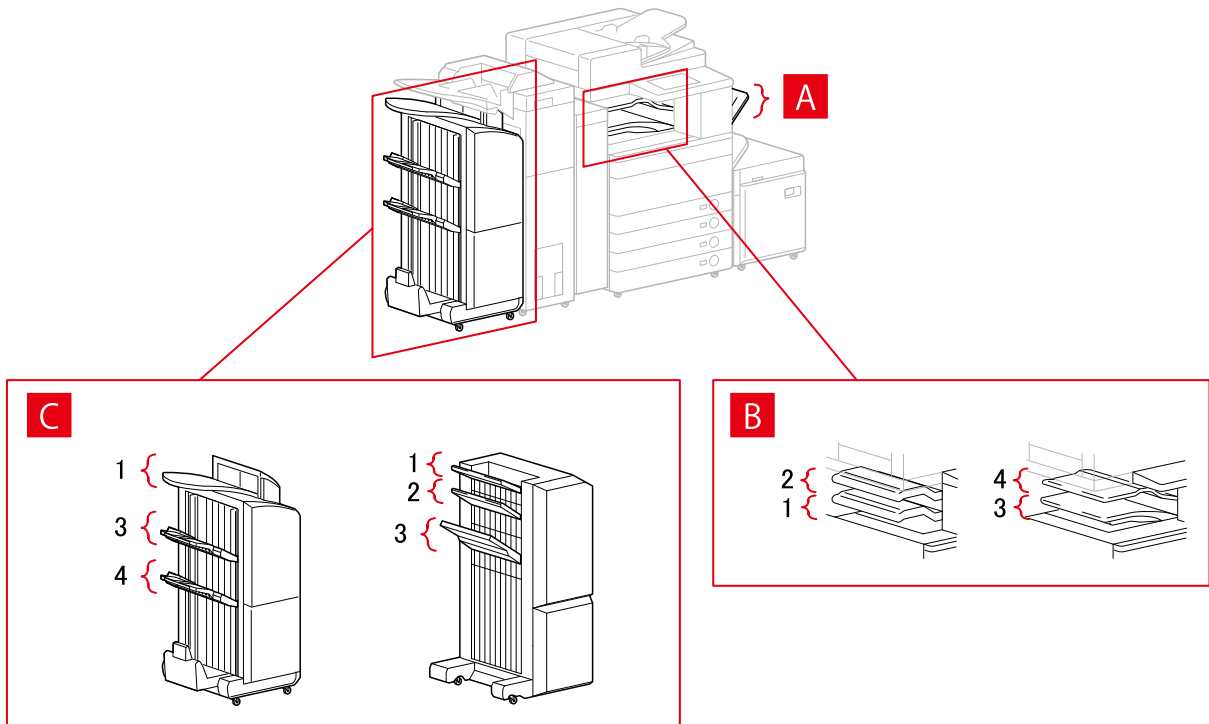

[Paper Output Settings] Dialog Box

- A-1 [Copy Tray]
- B-1 [Inner Finisher Tray]
- B-2 [Inner Finisher Additional Tray]
- B-3 [Inner Tray 1]
- B-4 [Inner Tray 2]
- C-1 [Finisher Tray 1 [No Collating]]
- C-2 [Finisher Tray 2 [No Collating]]
- C-3 [Finisher Tray 1]
- C-4 [Finisher Tray 2]

iR-ADV PRO

Paper Source Settings

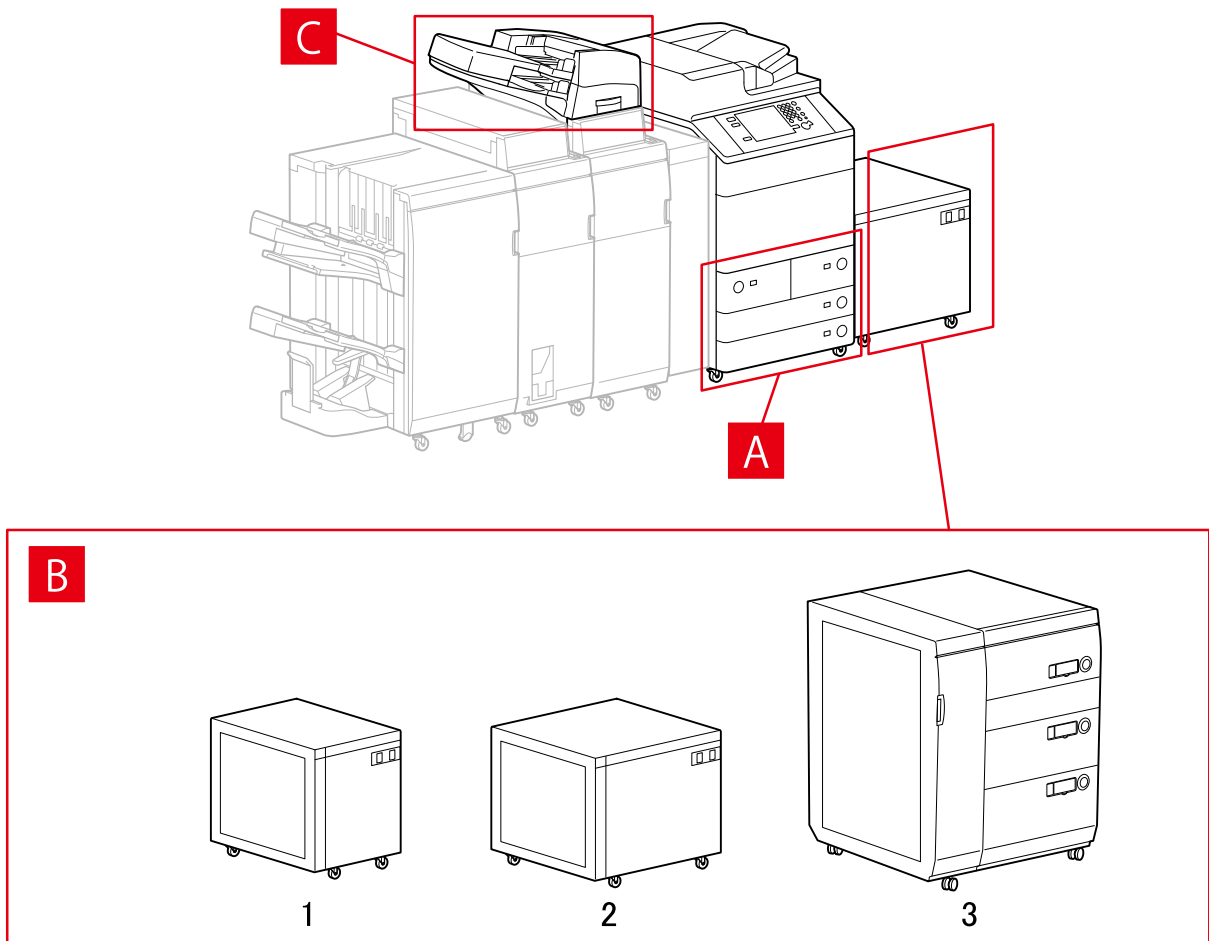

[Paper Source] Dialog Box

[Standard Paper Source]

- A-1 [Deck x 2 + Drawer x 2]

[Optional Deck]

- B-1 [Paper Deck Unit]
- B-2 [POD Deck Lite]
- B-3 [Multi-drawer Paper Deck]

[Inserter]

- C-1 [Document Insertion Unit]
- C-2 [Document Insertion Unit (Tray x 2)]
- C-3 [Inserter of Paper Folding Unit/Document Insertion Unit (Tray x 1)]

Output Destinations Settings

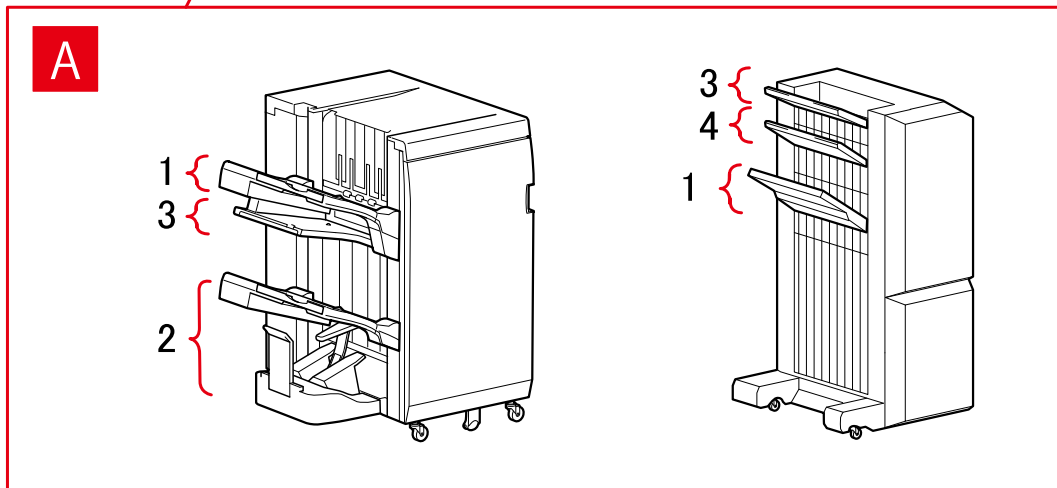
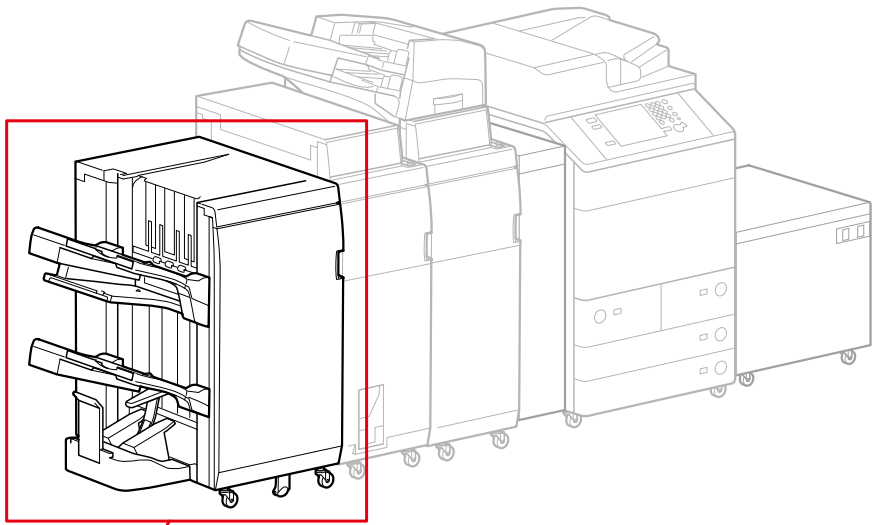

[Paper Output Settings] Dialog Box

Finisher Tray

- A-1 [Finisher Tray 1]
- A-2 [Finisher Tray 2]
- A-3 [Finisher Tray 1 [No Collating]]
- A-4 [Finisher Tray 2 [No Collating]]

imagePRESS

Paper Source Settings

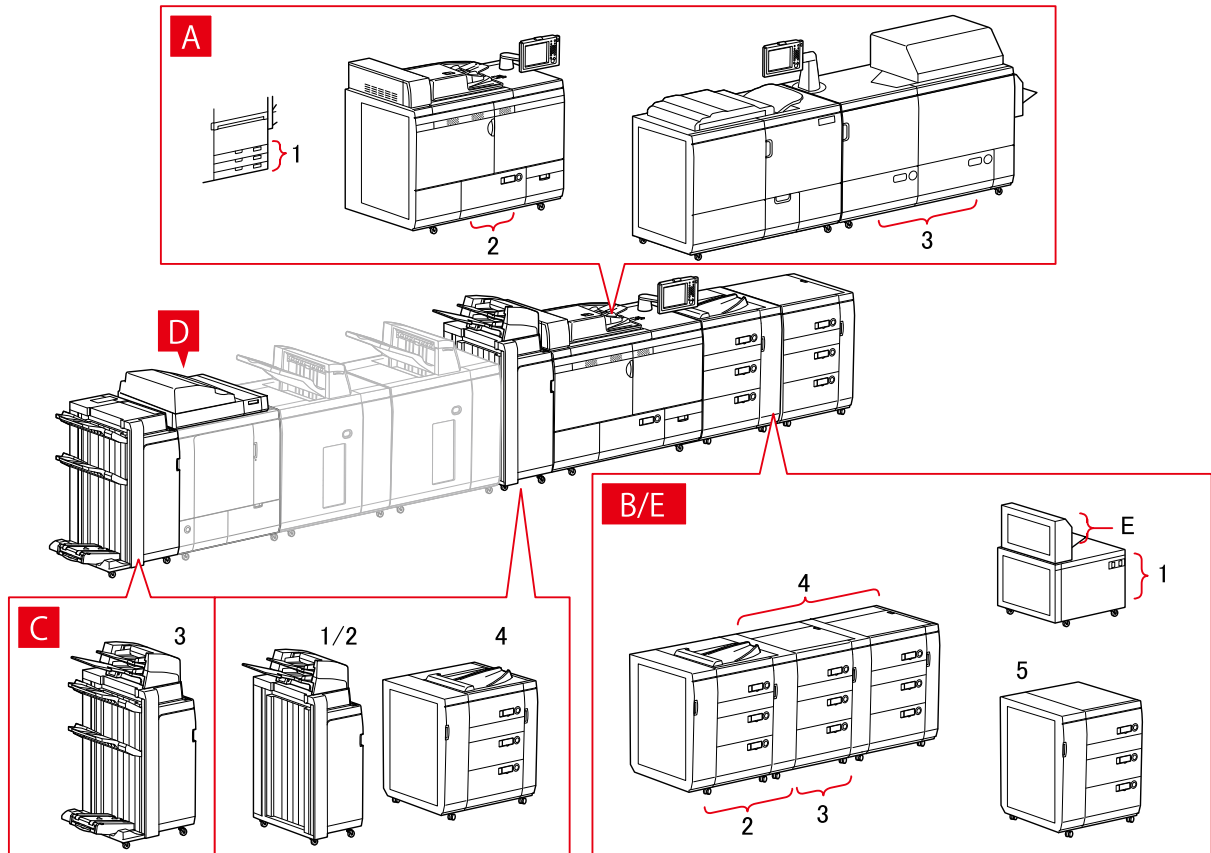

[Paper Source] Dialog Box

[Standard Paper Source]

- A-1 [Drawer x 3]
- A-2 [Deck x 1]
- A-3 [Deck x 2]

[Optional Deck]

- B-1 [POD Deck Lite]
- B-2 [POD Deck]
- B-3 [POD Deck + Secondary POD Deck]
- B-4 [POD Deck + Secondary POD Deck x 2]
- B-5 [Multi-drawer Paper Deck]

[Inserter]

- C-1 [Document Insertion Unit]
- C-2 [Document Insertion Unit (Tray x 2)]
- C-3 [Document Insertion Unit [iPR C7010VP/6010]]
- C-4 [Multi Drawer Document Insertion Unit]

D [Inserters of Perfect Binder]

E [Multi-purpose Tray]

Output Destinations Settings

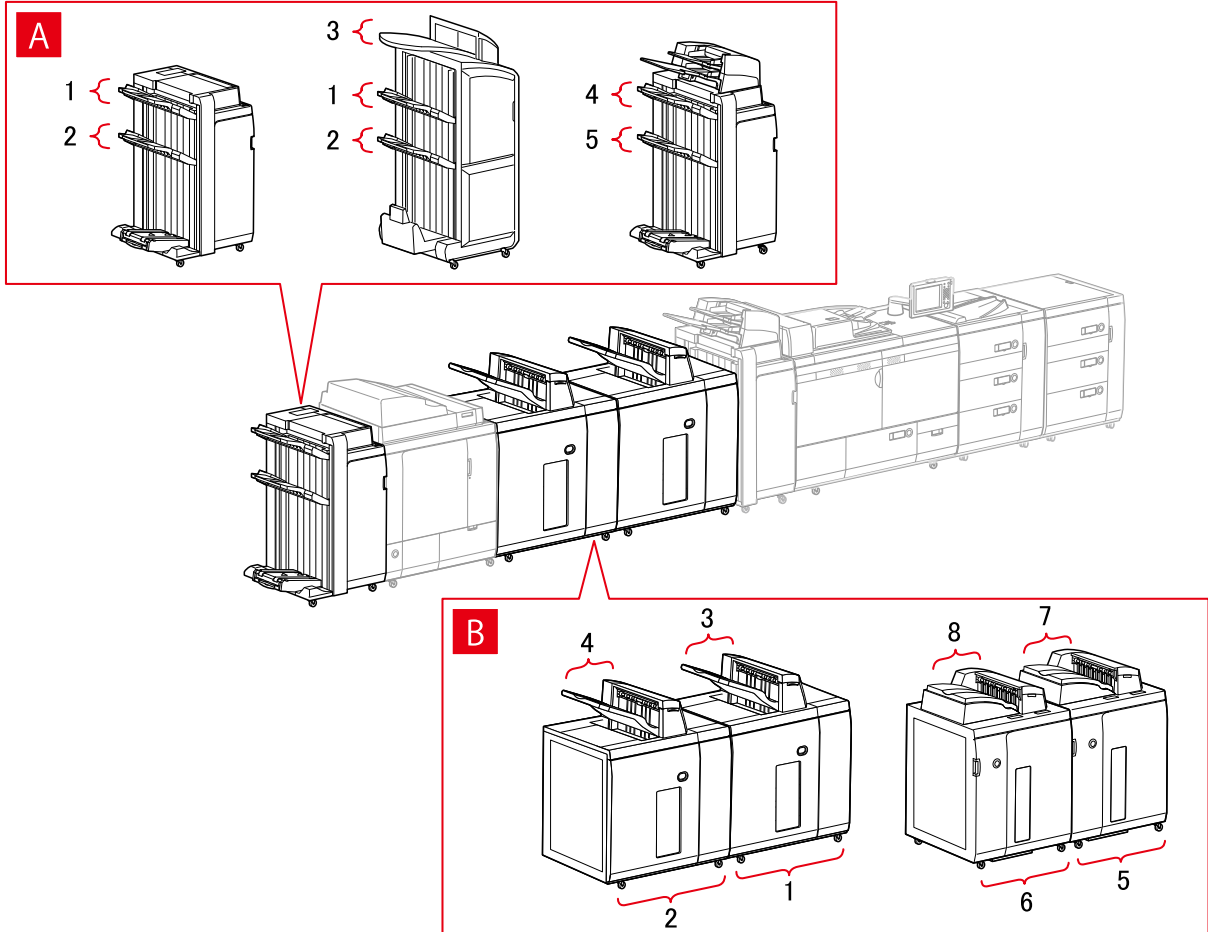

[Paper Output Settings] Dialog Box

Finisher Tray

- A-1 [Finisher Tray 1]
- A-2 [Finisher Tray 2]
- A-3 [Finisher Tray 1 [No Collating]]
- A-4 [Finisher Tray 1 [iPR C7010VP/6010]]
- A-5 [Finisher Tray 2 [iPR C7010VP/6010]]

Stacker

- B-1 [Stacker a [Stack]]
- B-2 [Stacker b [Stack]]
- B-3 [Stacker a [Output Tray]]
- B-4 [Stacker b [Output Tray]]
- B-5 [Stacker a [Stack] [iPR C7010VP/6010]]
- B-6 [Stacker b [Stack] [iPR C7010VP/6010]]

B-7 [Stacker a [Output Tray] [iPR C7010VP/6010]]

B-8 [Stacker b [Output Tray] [iPR C7010VP/6010]]

All-in-One Printers

Paper Source Settings

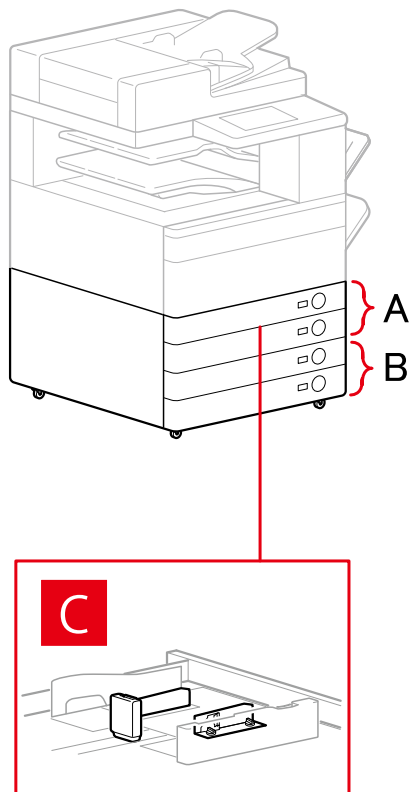

[Paper Source] Dialog Box

[Standard Paper Source]

A-1 [Drawer x 1]

A-2 [Drawer x 2]

[Optional Drawer/Cassette]

B-1 [Drawer x 1]

B-2 [Drawer x 2]

B-3 [Drawer x 3]

B-4 [1-Cassette Feeding Unit]

B-5 [2-Cassette Feeding Unit]

B-6 [3-Cassette Feeding Unit]

[Envelope Feeder]

C-1 [Drawer 1]

C-2 [Drawer 2]

Output Destinations Settings

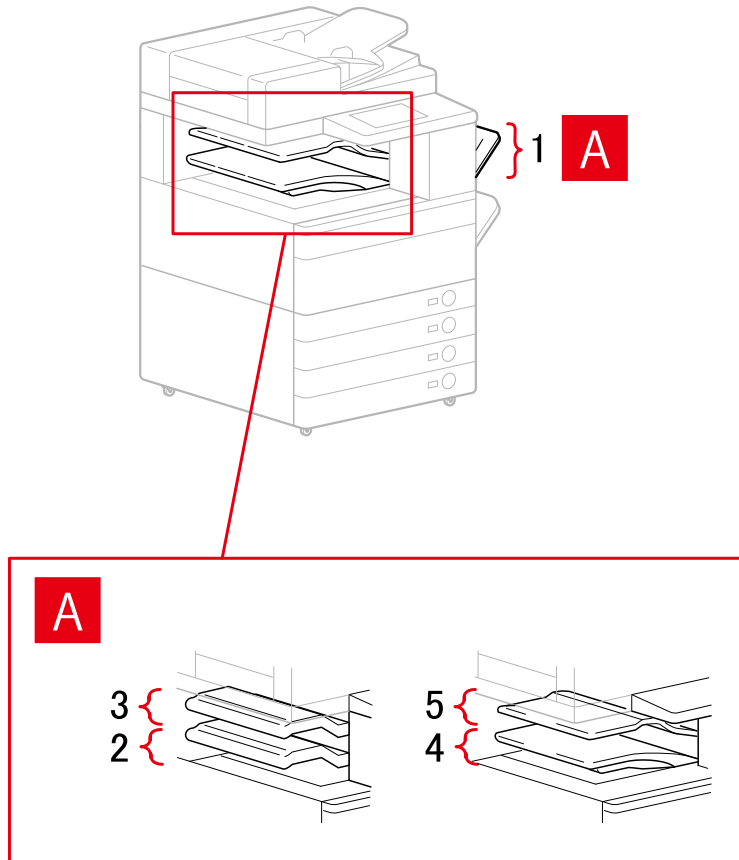

[Paper Output Settings] Dialog Box

- A-1 [Copy Tray]
- A-2 [Inner Finisher Tray]
- A-3 [Inner Finisher Additional Tray]
- A-4 [Inner Tray 1]
- A-5 [Inner Tray 2]

Related Topics

- [Device Settings] Sheet(P. 120)

Exporting a Configuration Profile

The settings in the [Device Settings] sheet can be exported and saved as a configuration profile file (*.typ). You can configure the same settings by importing the exported configuration profile.

This function is useful when streamlining driver settings for multiple computers or changing the items that can be set for each user.



NOTE

- You can import an exported configuration profile by clicking [Change] > [] (Import Configuration Profile) in the [Device Settings] sheet or by using the driver installer.

Prerequisites

- Settings at the device
 - If the device is connected via a WSD port, [Use WSD Browsing] is already set to on.
 - If the device is connected by specifying a standard TCP/IP port, [Retrieve Printer Mngt. Information from Host] is already set to on.
 For details, refer to the manual of the device.
- When starting the computer, log on as a member of Administrators.

Procedures

- 1 Display [Devices and Printers] from the [Control Panel] of Windows.**
- 2 Right-click the icon of the device you are going to set → select [Printer properties] from the displayed menu.**
If you are using the driver with multiple device models, select the model you are going to set after selecting [Printer properties].
- 3 Click the [Device Settings] sheet.**
- 4 Check the displayed settings and option status → set the options manually as required.**
- 5 Click [] (Export).**
- 6 In the [Export Configuration Profile] dialog box, set [Name] and [Icon].**
Enter a comment in [Comment] if required.

7 Click [Export] → specify the storage location and file name → click [Save] or [OK].

Related Topics

- ▶ [Device Settings] Sheet(P. 120)
- ▶ Importing a Configuration Profile(P. 86)

Importing a Configuration Profile

This explains the procedure for importing an exported configuration profile file (*.typ) and setting the device information.

If you cannot acquire the device information, you can apply it by importing a configuration profile exported in an environment where the information could be acquired.



IMPORTANT

- If a configuration profile suitable for the device you are using is not selected, some of the device functions may not be usable.

Prerequisites

- Settings at the device
 - If the device is connected via a WSD port, [Use WSD Browsing] is already set to on.
 - If the device is connected by specifying a standard TCP/IP port, [Retrieve Printer Mngt. Information from Host] is already set to on.For details, refer to the manual of the device.
- When starting the computer, log on as a member of Administrators.

Procedures

1 Display [Devices and Printers] from the [Control Panel] of Windows.

2 Right-click the icon of the device you are going to set → select [Printer properties] from the displayed menu.

If you are using the driver with multiple device models, select the model you are going to set after selecting [Printer properties].

3 Display the [Device Settings] sheet → click [Change].

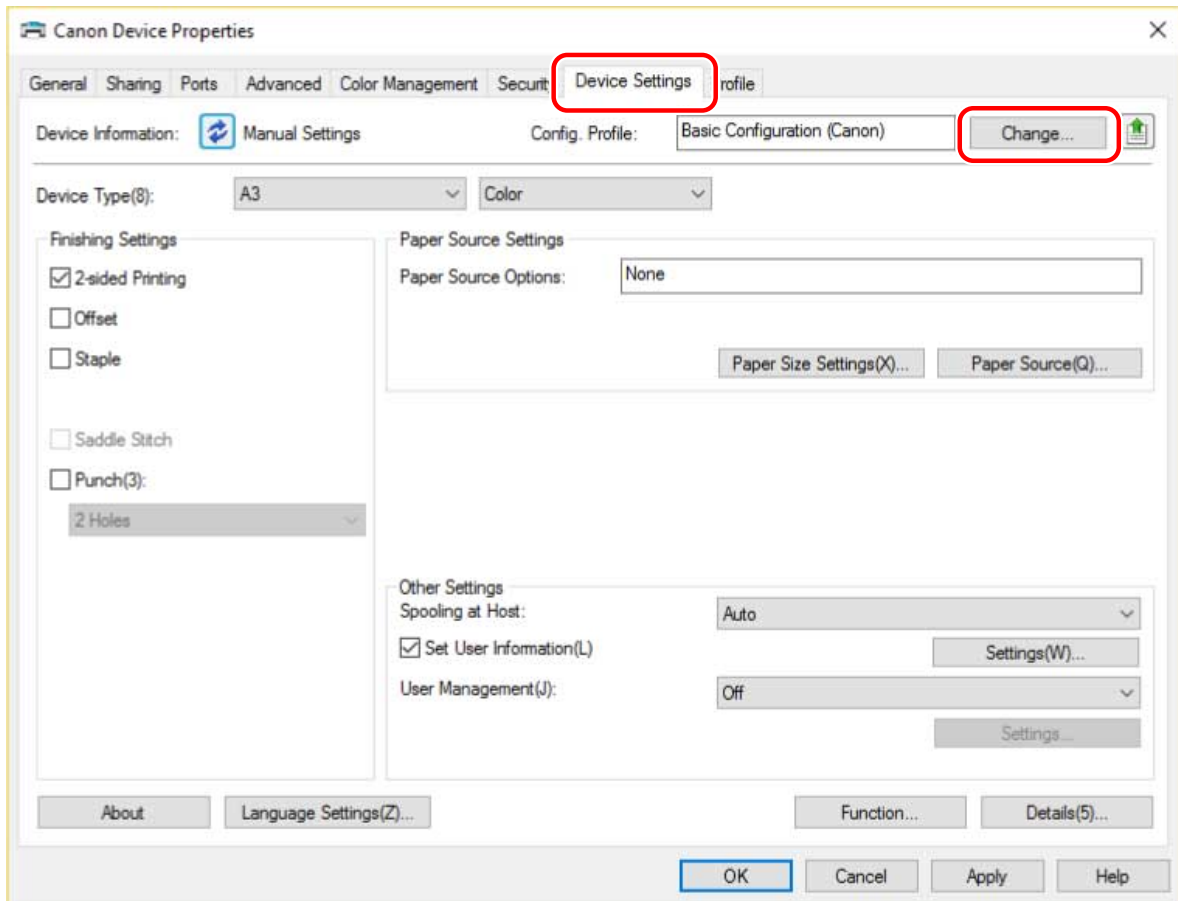

4 Select [Select Manually] → click [] (Import Configuration Profile).

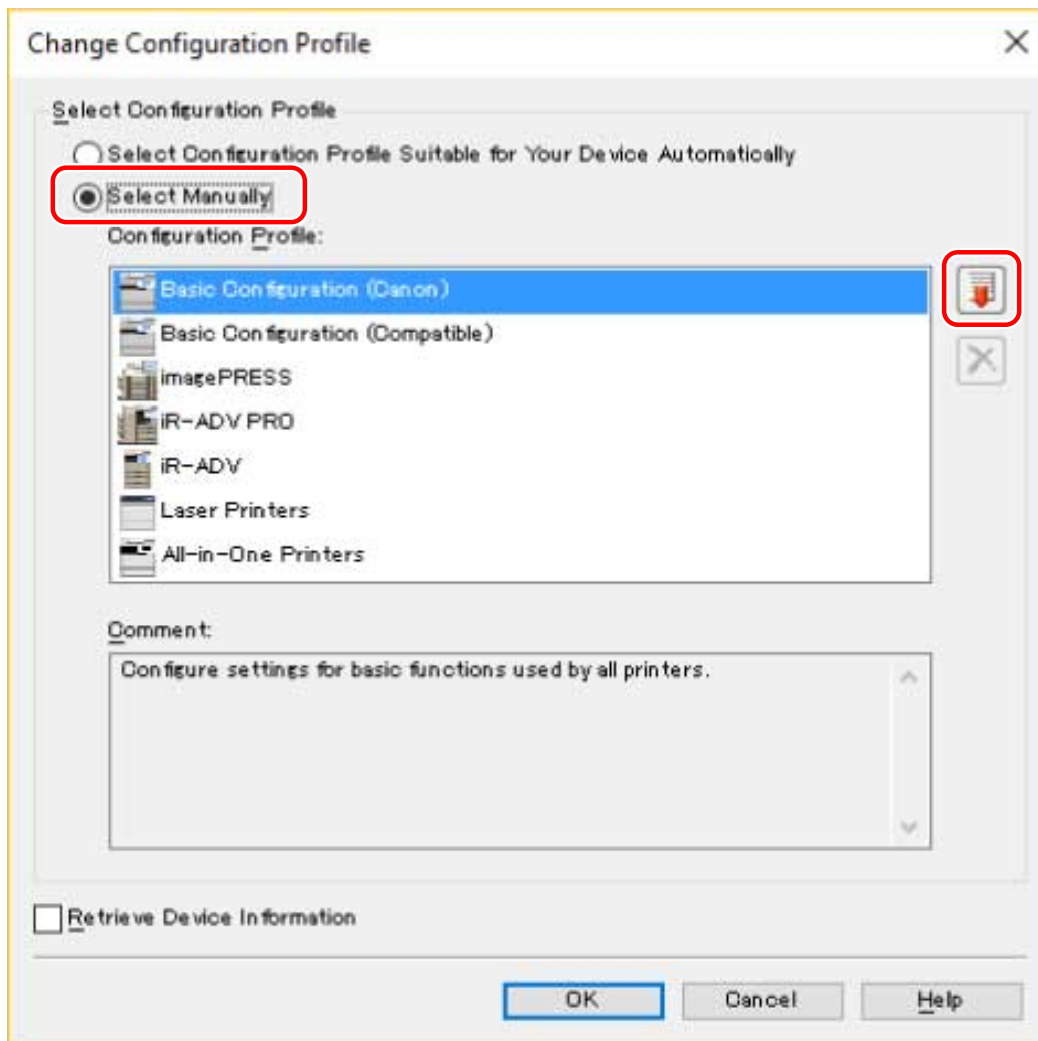

5 Select the configuration profile file to import → click [Open].

6 Click [OK] → click [OK] in the [Device Settings] sheet.

Related Topics

- ▶ [Device Settings] Sheet(P. 120)
- ▶ Exporting a Configuration Profile(P. 84)

List of Configuration Profiles

If device information cannot be acquired, the configuration profile must be set manually. See the following table for supported combinations of printer models and configuration profiles.

If the configuration profile supported by the printer models you are using is not displayed, set [Details] > [Other Settings] > [Display Custom Configuration Profile] to [On] on the [Device Settings] sheet.

List of Configuration Profiles

Model Name	Supported Configuration Profile
LBP310	Laser Printers (Custom 002)
LBP311	
LBP312	
LBP612C	All-in-One Printers (Custom 006)
LBP613C	
LBP653C	All-in-One Printers (Custom 007)
LBP654C	
MF633C	All-in-One Printers (Custom 008)
MF635C	
MF732C	All-in-One Printers (Custom 009)
MF734C	
MF735C	
iR C3020	All-in-One Printers (Custom 010)
iR C3025	
iR-ADV 4525	iR-ADV (Custom 001)
iR-ADV 4535	
iR-ADV 4545	
iR-ADV 4551	
iR-ADV 6560	iR-ADV (Custom 002)
iR-ADV 6575	
iR-ADV 6555	
iR-ADV 6565	
iR-ADV C3520	iR-ADV (Custom 003)
iR-ADV C3525	
iR-ADV C3530	
iR-ADV C355	iR-ADV (Custom 004)
iR-ADV C356	
iR-ADV C255	
iR-ADV C256	
iR-ADV C5550	iR-ADV (Custom 005)
iR-ADV C5560	
iR-ADV C5535	

Coordinating with the Device Functions

Model Name	Supported Configuration Profile
iR-ADV C5540	
iR-ADV 8505	iR-ADV PRO (Custom 001)
iR-ADV 8585	
iR-ADV 8595	
iR-ADV C7565	iR-ADV PRO (Custom 002)
iR-ADV C7580	
iR-ADV C7570	
iPR C650	imagePRESS (Custom 001)
iPR C850	imagePRESS (Custom 002)
iPR C750	
iPR C850-G200	Fiery Print Controller (Custom 001)
iPR C750-G200	
iPR C650-G200	Fiery Print Controller (Custom 002)
iPR C65-G200	
iR-ADV C7500s-N1	Fiery Print Controller (Custom 003)
LBP251	All-in-One Printers
LBP252	
LBP253	
LBP8900	iR-ADV
LBP9900C	
LBP9950C	
Other imagePRESS printers	imagePRESS
Other iR-ADV PRO printers	iR-ADV PRO
Other iR-ADV printers	iR-ADV
Other Laser Printers	Laser Printers
Other All-in-One Printers	All-in-One Printers
Other printers with a Fiery Print Controller	Fiery Print Controller

Setting the Authentication Function

You can manage printing by means of the department ID management function or the user authentication function.



Prerequisites

- When starting the computer, log on as a member of Administrators.

Procedures

- 1 Display [Devices and Printers] from the [Control Panel] of Windows.**
- 2 Right-click the icon of the device you are going to set → select [Printer properties] from the displayed menu.**
If you are using the driver with multiple device models, select the model you are going to set after selecting [Printer properties].
- 3 Click the [Device Settings] sheet.**
- 4 Select the authentication function you want to use from [User Management] → click [Settings].**
- 5 Select [Allow PIN Setting]/[Allow Password Settings] → enter the authentication information.**
To use the department ID management function, enter the information in [Department ID] and [PIN].
To use the user authentication function, enter the information in [User Name] and [Password].
If you want to check that the authentication information set in the device and the entered content match, click [Verify].
- 6 Set the relevant settings → click [OK].**
- 7 Click [Apply] in the [Device Settings] sheet.**
If the [Confirm Department ID/PIN]/[Confirm User Name/Password] dialog box is displayed when printing, confirm or set the authentication information.

Related Topics

- ▶ [Device Settings] Sheet(P. 120)

Setting the User Name

You can set a user name for print jobs and a PIN for secured printing. The set user name is displayed on the control panel of the device, and is printed as the user name for headers or footers.



Prerequisites

- When starting the computer, log on as a member of Administrators.

Procedures

- 1 Display [Devices and Printers] from the [Control Panel] of Windows.**
- 2 Right-click the icon of the device you are going to set → select [Printer properties] from the displayed menu.**
If you are using the driver with multiple device models, select the model you are going to set after selecting [Printer properties].
- 3 Click the [Device Settings] sheet.**
- 4 Select [Set User Information] → click [Settings].**
- 5 Enter the user information in [User Name] and [PIN for Secure Print] → click [OK].**
If you want to change the default user name setting, click [Default Value Settings] → set [Name to Set for User Name] → click [OK].
If you want to prevent changes to user names: Click [Default Value Settings] → select [Do Not Allow User Name Changes] → click [OK].
- 6 Click [Apply] in the [Device Settings] sheet.**

Related Topics

- [Device Settings] Sheet(P. 120)

Settings List

Settings List	95
Common Settings for All Sheets	96
[Basic Settings] Sheet	99
[Page Setup] Sheet	102
[Finishing] Sheet	105
[Paper Source] Sheet	112
[Quality] Sheet	115
[Device Settings] Sheet	120
[Profile] Sheet	125
Canon PageComposer	127

Settings List

- ▶ **Common Settings for All Sheets(P. 96)**
- ▶ **[Basic Settings] Sheet(P. 99)**
- ▶ **[Page Setup] Sheet(P. 102)**
- ▶ **[Finishing] Sheet(P. 105)**
- ▶ **[Paper Source] Sheet(P. 112)**
- ▶ **[Quality] Sheet(P. 115)**
- ▶ **[Device Settings] Sheet(P. 120)**
- ▶ **[Profile] Sheet(P. 125)**
- ▶ **Canon PageComposer(P. 127)**

Common Settings for All Sheets

This explains what you can do from any one of the [Basic Settings], [Page Setup], [Finishing], [Paper Source], or [Quality] sheets.

[Profile]

Applies registered settings as selecting a profile. You can register frequently used settings as a profile.

[Add] > [Add Profile] Dialog Box

Registers the current print settings as a profile. Set [Name] and [Icon]. Enter a comment in [Comment] if required. If you want to check the current settings in a list, click [View Settings].

[Edit] > [Edit Profile] Dialog Box

Enables you to edit, import, and export profiles.

[Profile List]

Displays registered profiles as a list. You can change the order by selecting a profile and clicking []

(Move Up) or [] (Move Down).

[View Settings]

Displays the content of the selected profile as a list.

[Delete]

Deletes the selected profile.

[Name], [Icon], [Comment]

Displays the name, icon, and comment of the selected profile. You can edit the name, icon, and comment of user-registered profiles.

[Import]

Imports a profile saved as a "*.cfg" file and adds it to [Profile List].

[Export]

Exports the profile selected in [Profile List] and saves it as a "*.cfg" file.

[Apply Settings from Application]

Gives priority to the [Page Size], [Orientation], and [Copies] settings from the application over the driver settings.



NOTE

- Profiles with a red dot (●) next to them are pre-registered profiles and cannot be edited or deleted.

[Output Method]

Switches the method for outputting print data. You can save the data to the device, move a print job in the print queue ahead of other jobs and print it, etc.

[Print]

Performs normal printing.

[Hold]

Saves print data in a hold queue (temporary storage area) in the device. You can change the print order or settings of the stored data from the control panel of the device or the Remote UI.

[Details] > [Hold Details] Dialog Box

Enables you to set the name of data.

[Secure Print]

Attaches a PIN to print data and saves it in the device. The saved data can be printed by entering the PIN in the control panel of the device.

[Details] > [Secure Print Details] Dialog Box

Enables you to set the user name and PIN.

[Confirm PIN] Dialog Box

Enables you to confirm or set a name for the print data, user name, and PIN when printing.

[Store]

Stores the print data to a box in the device. You can change the settings of or combine the stored data with other stored data from the control panel of the device or the Remote UI.

[Details] > [Store Details] Dialog Box

Enables you to set the storage destination.

[Promote Print]

Gives print data priority over other print data that is waiting to be printed by the device.

[Scheduled Print]

Starts printing at the specified time.

[Details] > [Scheduled Print Details] Dialog Box

Sets the time to start printing.

[Edit and Preview]

Enables you to combine multiple files into one for printing. You can also preview the print data for confirmation and change the print settings. If you want to lock the setting, display the print settings screen from [Devices and Printers], select [Lock] to the right of [Edit and Preview]. This function is useful for restricting the output methods of clients in a shared printer environment.

[Details] > [Edit and Preview Details] Dialog Box

Enables you to set the output method after Edit and Preview.

[Settings Preview]

Displays the current print settings in a preview. You can set basic print functions by clicking on the preview.

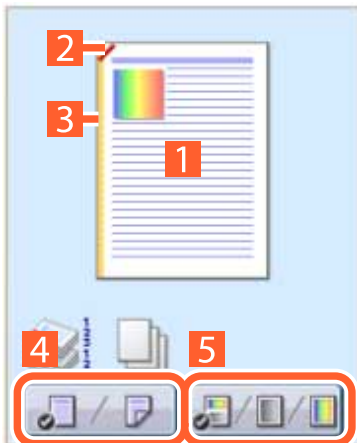
**1 N on 1 printing**

Arranges N pages of print data on each sheet of paper.

2 Stapling

Click where you want the page to be stapled.

3 Binding location

Click the edge of the page where you want to set the binding location.

4 Switch between 1-sided printing and 2-sided printing

5 Switch between color and black and white printing (color printers only)



NOTE

- In the [Quality] sheet, the current settings for [Objective] is displayed in the preview.

[View Settings] > [View Settings] Dialog Box

Displays the current driver settings in a list.

[Language Settings] > [Language Settings] Dialog Box

Enables you to switch the display language.

Related Topics

- ▶ **About the [Edit and Preview] Function(P. 55)**
- ▶ **Printing Files Together(P. 56)**
- ▶ **Attaching Encryption When Printing(P. 30)**
- ▶ **Putting Print Jobs on Hold(P. 31)**
- ▶ **Storing Print Data(P. 32)**
- ▶ **Priority Printing(P. 33)**
- ▶ **Registering Favorite Settings(P. 64)**
- ▶ **Editing the Favorite Settings List(P. 65)**

[Basic Settings] Sheet

You can set basic print functions.

[Page Size]

Displays the paper size of the print data prepared in the application.

[Output Size]

Specifies the actual paper size to be printed on. If you select a size that differs from [Page Size], the print data is enlarged or reduced to fit the set page size when printing.

[Copies]

Specifies the number of copies to be printed.

[Orientation]

Specifies the orientation of print data.

[Page Layout]

Specifies how many pages to print on each sheet of paper.

[Manual Scaling]

Specifies an enlargement or reduction ratio for printing.

[Use 1 on 1 for Single-Page Data]

When printing multiple pages on each sheet, prints single page data over one sheet.

[1-sided/2-sided/Booklet Printing]

Specifies a method for outputting print data.

[Booklet] > [Detailed Settings for Booklet] Dialog Box

Enables you to set detailed settings such as gutter, displacement correction for booklet printing.

[Booklet Printing Process]

Switches the settings to be applied. Select [With Driver Settings] when using driver functions such as dividing the document into sets, gutter settings, etc. Select [With Device Settings] when using the creep (displacement) correction function.

[Booklet Printing Method]

Switches the booklet printing method. When creating a booklet in multiple sets, select [Divide into Sets] and then specify how many sheets are in each set in [Sheets per Set].

[Book Opening]

Specifies the direction the booklet opens.

[Specify Booklet Gutter]

Specifies the gutter width.

[Use Creep (Displacement) Correction]

Corrects displacement between outer and inner pages that occurs during booklet printing. Select a correction method from [Displacement Correction Method]. When specifying the displacement width of the print area between the outermost page and centermost page, select [Manual Correction] and specify a correction amount in [Correction Width].

[Saddle Press]

Presses the pages so that they are flattened when using saddle stitching with booklet printing. You can adjust the strength of the press by setting [Saddle Press Adjustment].

[Saddle Stitch Setting]

Prints a booklet folded in half and stapled in the middle. When trimming to align the edges of the pages, select [Fold + Saddle Stitch + Trim]/[Fold + Trim], and then set [Trim Settings] in the [Finishing] sheet.

[Binding Location]

Sets the edge of the paper to bind.

If you change [Orientation] in the [Basic Settings]/[Page Setup] sheet, [Binding Location] is changed to the left or top. The long edge/short edge positional relationship is maintained.

[Gutter] > [Gutter Settings] Dialog Box

Enables you to set the gutter width.

[Staple/Collate/Group]

Sets the order of pages and whether to staple the pages when printing multiple copies.



Collate

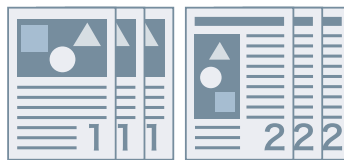

Group

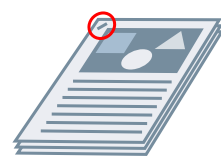
Staple
Eco (Staple-Free)**[Collate]**

Outputs the specified number of copies in page order.

[Group]

Outputs the specified number of copies with all pages having the same page number grouped together.

[Staple + Collate]/[Eco (Staple-Free) + Collate]/[Staple + Group]/[Eco (Staple-Free) + Group]

Outputs the pages in the order specified for [Collate] or [Group] stapled together. "Eco (Staple-Free)" is a method of fixing pages together without using staples, and can be used when a finisher that supports binding without staples is installed.

[Staple Position] > [Staple Position] Dialog Box

Enables you to set the position of the staple(s).

[Color Mode]

Switches between printing in color or in black-and-white. To detect automatically whether each page should be printed in color or in black-and-white, select [Auto [Color/B&W]].

[Restore Defaults]

Returns all the print settings of the driver to their default values.

Related Topics

- ▶ **Common Settings for All Sheets(P. 96)**
- ▶ **Scaling(P. 22)**
- ▶ **Poster Printing(P. 24)**
- ▶ **Booklet Printing(P. 37)**
- ▶ **Saddle Stitched Booklet Printing(P. 40)**
- ▶ **Driver settings cannot be set(P. 132)**
- ▶ **Print results are unsatisfactory(P. 133)**

[Page Setup] Sheet

You can set the page size, print orientation, layout options, etc.

[Page Size]

Displays the paper size of the print data prepared in the application.

[Output Size]

Specifies the actual paper size to be printed on. If you select a size that differs from [Page Size], the print data is enlarged or reduced to fit the set page size when printing.

[Copies]

Specifies the number of copies to be printed.

[Orientation]

Specifies the orientation of print data.

[Page Layout]

Specifies how many pages to print on each sheet of paper.

[Poster Details] > [Poster Details] Dialog Box

Enables you to set detailed settings when printing a poster.

The poster printing function enlarges the print data of one page and prints it over multiple sheets of paper. When the output sheets are joined together, they form a large print like a poster.

[Print Margin Borders]

Prints borders with other sheets as a guide to paste sheets together.

[Set Margins for Cutting/Pasting]

Sets margins for cutting or pasting. Select a width from [Margin Width]. When printing marks indicating the cutout or margin section(s), select [Print Marks for Alignment].

[Pages to Print]

Specifies the page(s) to print.

[Page Order]

Specifies the page order to print.

[Manual Scaling]

Specifies an enlargement or reduction ratio for printing.

[Use 1 on 1 for Single-Page Data]

When printing multiple pages on each sheet, prints single page data over one sheet.

[Watermark]

Superimposes and prints semi-transparent characters such as [TOP SECRET] or [DRAFT] over print data.

[Edit Watermark] > [Edit Watermark] Dialog Box

Enables you to create and add a new watermark.

[Watermark List]

Displays registered watermarks as a list. When selecting a watermark, a preview is displayed to the left.

[Add]

Adds a new watermark to [Watermark List] as [Untitled]. You can set the name of the watermark in [Name] and its settings in the [Attributes], [Alignment], and [Print Style] sheets.

[Delete]

Deletes the selected watermark.

[Name]

Displays the name of the watermark selected in [Watermark List]. When adding a new watermark, enter the name of the watermark.

[Attributes] Sheet

Specifies the settings relating to the text in a watermark.

[Alignment] Sheet

[Position] specifies the position of the watermark as coordinates relative to the center (0) of the document. [Tilt] sets the angle of the watermark.

[Print Style] Sheet

[Watermark Border] sets whether a frame is printed around the text. [Watermark Position] sets the overlap position with respect to the print data. When printing the watermark on only the first page, select [Print on First Page Only].

[Custom Paper Size] > [Custom Paper Size Settings] Dialog Box

Enables you to register a desired paper size and use it for printing. Papers with a red dot (●) next to them are standard paper sizes and cannot be edited or deleted.

[Page Options] > [Page Options] Dialog Box

Specifies layout options such as borders, date, page numbers, etc. and overlay printing settings.

This also enables a document name, computer name, and print time to be inserted. The display format for dates and times depends on the settings of the operating system.

[Format Settings] > [Format Settings] Dialog Box

Enables you to configure font settings when printing the date, user name, and/or page numbers.

[Restore Defaults]

Returns all the settings to their default values.

Related Topics

- ▶ **Common Settings for All Sheets(P. 96)**
- ▶ **Scaling(P. 22)**
- ▶ **Watermark Printing(P. 23)**

- ▶ **Poster Printing(P. 24)**
- ▶ **Printing Over a Fixed Form(P. 28)**
- ▶ **Registering Custom Paper Sizes(P. 46)**
- ▶ **Driver settings cannot be set(P. 132)**
- ▶ **Print results are unsatisfactory(P. 133)**
- ▶ **Overlay printing will not execute(P. 137)**

[Finishing] Sheet

You can configure settings relating to layout printing and finishing such as sorting, collating, stapling, etc.

[Print Style]

Specifies a method for outputting print data. According to what you select for [Print Style], the displayed settings change as follows.

- ▶ When [1-sided Printing] or [2-sided Printing] is selected(P. 105)
- ▶ When [Booklet Printing] is selected(P. 107)
- ▶ When [Perfect Binding [1-sided]] or [Perfect Binding [2-sided]] is selected(P. 108)

When [1-sided Printing] or [2-sided Printing] is selected

[Print with Mixed Paper Sizes/Orientations]/[Print in Different Orientations]

Enables you to print data in which the size and orientation differ from page to page.

[Details] > [Detailed Settings] Dialog Box

Enables you to set the combination of sizes and alignment method of pages.

[Binding Location]

Sets the edge of the paper to bind.

If you change [Orientation] in the [Basic Settings]/[Page Setup] sheet, [Binding Location] is changed to the left or top. The long edge/short edge positional relationship is maintained.

[Gutter] > [Gutter Settings] Dialog Box

Enables you to set the gutter width.

[Finishing]

Sets the order of pages and whether to staple the pages when printing multiple copies.

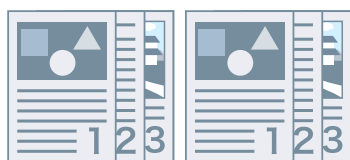

Collate

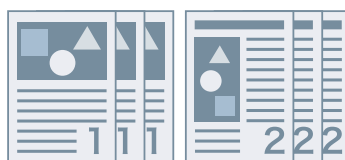

Group



Offset



Rotate



Hole Punch



Staple
Eco (Staple-Free)

[Collate]

Outputs the specified number of copies in page order.

[Group]

Outputs the specified number of copies with all pages having the same page number grouped together.

[Staple + Collate]/[Eco (Staple-Free) + Collate]/[Staple + Group]/[Eco (Staple-Free) + Group]

Outputs the pages in the order specified for [Collate] or [Group] stapled together. "Eco (Staple-Free)" is a method of fixing pages together without using staples, and can be used when a finisher that supports binding without staples is installed.

[Staple Position] > [Staple Position] Dialog Box

Enables you to set the position of the staple(s).

[Offset]

Outputs each copy separately. You can set how many copies are offset in [Number of Copies for Offset].

[Rotate]

Outputs each copy at a 90 degree angle relative to the copy before and after it.

[Hole Punch]

Outputs the document with multiple holes for ring binding.

[Fold]

Folds pages into one of a variety of forms when outputting them.

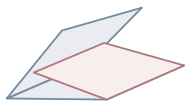

C-fold

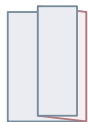

Z-fold

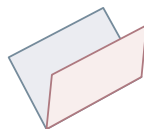

Half Fold (Saddle Fold)

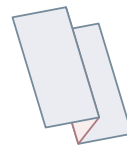

Accordion Z-fold

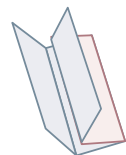

Double Parallel Fold

[Fold Details] > [Fold Details] Dialog Box

Enables you to set the fold direction.

[Paper Output]

Specifies a printed paper output destination.

[Stack Details] > [Stack Details] Dialog Box

Enables you to set the number of copies to output and the automatic ejection timing.

When [Booklet Printing] is selected

[Booklet] > [Detailed Settings for Booklet] Dialog Box

Enables you to set detailed settings for booklet printing such as gutters and displacement correction.

[Booklet Printing Process]

Switches the settings to be applied. Select [With Driver Settings] when using driver functions such as dividing the document into sets, gutter settings, etc. Select [With Device Settings] when using the creep (displacement) correction function.

[Booklet Printing Method]

Switches the booklet printing method. When creating a booklet in multiple sets, select [Divide into Sets] and then specify how many sheets are in each set in [Sheets per Set].

[Book Opening]

Specifies the direction in which the booklet opens.

[Specify Booklet Gutter]

Specifies the gutter width.

[Use Creep (Displacement) Correction]

Corrects displacement between outer and inner pages that occurs during booklet printing. Select a correction method from [Displacement Correction Method]. When specifying the displacement width of the print area between the outermost page and centermost page, select [Manual Correction] and specify a correction amount in [Correction Width].

[Saddle Press]

Presses the pages so that they are flattened when using saddle stitching with booklet printing. You can adjust the strength of the press by setting [Saddle Press Adjustment].

[Saddle Stitch Setting]

Prints a booklet folded in half and stapled in the middle. When trimming to align the edges of the pages, select [Fold + Saddle Stitch + Trim], and then set [Trim Settings] in the [Finishing] sheet.

[Crease Settings] > [Crease Settings] Dialog Box

Enables you to specify the target sheets when creasing to facilitate folding.

[Trim Settings]

Switches the trim width adjustment method.

[Apply Device Settings]

Follows the device setting.

[Specify Trim Width of Fore]

Trims the opening edges only. You can specify a desired trimming width.

[Specify Trim Width of Fore and Top/Bottom]

Trims the opening, top, and bottom edges. You can specify a desired trimming width.

[Specify Finishing Width]

Trims by automatically adjusting to the specified finishing width.

[Specify Finishing Width and Height]

Trims by automatically adjusting to the specified finishing width and height.

[Offset]

Outputs each copy separately. You can set how many copies are offset in [Number of Copies for Offset].

When [Perfect Binding [1-sided]] or [Perfect Binding [2-sided]] is selected

[Setting List]

Displays the current settings for perfect printing in a list.

[Perfect Binding Settings] > [Perfect Binding Settings] Dialog Box

Enables you to set the paper size, covers, and finishing size for perfect binding.

[Book Opening]

Specifies the direction the booklet opens.

[Perfect Bound Cover Settings]

Specifies the paper size and paper source of covers. When printing on covers, select [Lay out Data the Same Size as Cover] for [Print Style], and specify [Front Cover Print Side] and [Back Cover Print Side].

[Content Page Size]

Specifies the paper size for printing the content pages.

[Specify Finishing by]

Switches the adjustment method. When specifying the trim widths, select [Trim Width] and specify [Trim Width of Fore] and [Trim Width of Top/Bottom].

[Finishing Size]

Specifies the final finished size for perfect binding.

[Finishing Adjustment] > [Finishing Adjustment] Dialog Box

Enables you to adjust the printing position for content pages and covers, and the trimming angle and locations.

[Advanced Settings] > [Advanced Settings] Dialog Box

Enables you to set detailed finishing settings. Select the setting item you want to specify in [List of Settings], and select a setting from the drop-down list.

[Print Banner Page]

Prints a banner page showing the user's login name, the time the print job was printed, and the document file name.

[Details] > [Banner Page Print Details] Dialog Box

Enables you to set the paper source or paper type of a banner page.

[Expand Print Region and Print]

Expands the print area when printing.

[Detect Paper Size in Tray]

Checks the print data and paper size in the paper source tray, and displays a message on the control panel of the device if they do not match. This function is useful if you want to continue printing with a different paper size.

[Set Margin to 1/6 Inches]

Prints with a 1/6 inch margin on the top, bottom, left, and right edges of the page.

[Rotate Print Data 180 Degrees]

This function is useful when you want to print on tab paper, envelopes, etc. that need to be fed in a specific direction.

[Line Refinement]

Thickens thin lines when printing. This function is useful when printing small text and barcodes. This setting may be disabled when the resolution is set to 600 dpi.

[Skip Blank Pages Mode]

Enables you to set whether pages that contain no print data are output as blank pages.

[Auto 1]

Skips blank pages. When performing 2-sided printing, page layout is given priority.

[Auto 2]

Skips blank pages. Because priority is given to skipping blank pages when performing 2-sided printing, the page layout may be incorrect.

[Off]

Outputs blank pages.

[Face Up/Face Down]

Enables you to set whether a document will be output face up or face down.

[Printer Default]

Uses the printer setting.

[Face Down [Normal Output Order]]

Outputs the document with the printed surface face down in order starting from the first page.

[Face Up [Reverse Output Order]]

When printing on one side, outputs the document with the printed surface page up in order from the first page. When printing on both sides, outputs the document with odd numbered pages face up in order from the first sheet.

[Output Order]

Sets the page order in which the document is output.

[Print on Back Sides]

Enables you to configure the layout of the reverse side of a sheet of paper when printing portrait print data on one side of the sheet, and landscape print data on the other side.

[Rotate Pages for Layout]

Rotates the pages according to the orientation of the first page and aligns the size of each page when performing N on 1 printing or booklet printing of print data with pages whose orientation varies.

[Details] > [Rotate Pages for Layout Details] Dialog Box

Enables you to set a rotation direction.

[Auto]

Prints with the second page onward automatically rotated 90 degrees to the left or 90 degrees to the right according to the orientation of the first page.

[Right 90 Degrees]

Prints with pages whose orientation differs from the first page rotated 90 degrees to the right.

[Left 90 Degrees]

Prints with pages whose orientation differs from the first page rotated 90 degrees to the left.

[Secure Printing Function of Device]

Embeds restriction and tracking information into the print data as a dot pattern. This function is useful when printing confidential documents.

[Copy Set Numbering]

Enables you to print a serial number in semi-transparent text on each copy when you are printing several copies of a document. This function is useful when printing confidential documents. The serial number is printed in five positions, on the upper left, upper right, lower left, lower right, and center of the page.

[Details] > [Copy Set Numbering Details] Dialog Box

Enables you to set the starting number.

[Image Refinement]

Enables you to set whether to use smoothing processing, which adjusts the contours of text and diagrams to make them smoother. If you select [Printer Default], the default setting of the device is used.

[Image Special Process]

If bold characters or centers of lines are missing from printed data, select [Level 1]. If this does not solve the problem, select [Level 2].

[Special Print Adjustment A], [Special Print Adjustment B], [Special Print Adjustment C], [Blurry Image Correction], [Quiet Mode]

If lines appear in the printed output, you can adjust the print settings to compensate.

[Special Print Adjustment A]/[Blurry Image Correction] thins out the dots when printing. Try [Mode 1] first.

[Special Print Adjustment B] strengthens toner fixing. Try [Mode 1] first.

[Special Print Adjustment C]/[Quiet Mode] reduces the print speed.

Using the [Special Print Adjustment A] function may result in thinner print density and rough print results.

[Special Smoothing Mode]

Smooths the contours of text, lines, and diagrams, and internal gradations.

[Printer Default]

Uses the default setting of the device.

[Mode 1]

Prints the edges of dark colored text, lines, and diagrams smoothly. Normally, you should print with the [Mode 1] setting.

[Mode 2]

Prints not only the edges, but also the interior halftones of diagrams smoothly. If the interior halftones of dark colored large text and broad lines exhibit color shift and do not print smoothly with the [Mode 1] setting, try printing with [Mode 2].

[Mode 3]

Prints dark colored text and lines smoothly on halftone backgrounds. If the interior halftones of dark colored large text and broad lines exhibit color shift, and the edges of light colored text and lines are uneven and do not print smoothly with the [Mode 1] setting, try printing with [Mode 3].

[Mode 4]

Prints the edges of a variety of objects smoothly. If the edges of light colored large text and broad lines are uneven and do not print smoothly with the [Mode 1] setting, try printing with [Mode 4].

[Mode 5]

Prints images and halftone objects evenly. If the color bands of images, diagrams, and gradations are uneven, and shading patterns do not print uniformly with the [Mode 1] setting, try printing with [Mode 5].

[Mode 6]

Prints entire objects smoothly. If there is halftone shift and unevenness throughout images with the [Mode 1] setting, try printing with [Mode 6].

[Curl Correction]

If curling occurs, causing paper jams, use this function to alleviate the curling.

[Wrinkle Correction]

If wrinkling occurs, causing paper jams, use this function to alleviate the wrinkling. Try [Mode 1] first.

Depending on the printer model, [Mode 1] corrects wrinkles when printing with envelopes, and [Mode 2] when printing with paper whose edges are moist.

[EMF Spooling]

Spools print data in EMF format. When printing from an application, this shortens the time taken for the application to send the data to the printer.

When spooling in EMF format, problems such as the printed result differing from the image shown on the monitor, and more time being required for printing than normal, may occur depending on the application being used. If such problems occur, change the setting for [EMF Spooling] to [Off].

[Print Mixed Color/B&W Documents at High Speed]

This function reduces the print time when printing data that contains a mixture of color pages and grayscale (black and white) pages.

[Print Last Page in 1-sided Mode When 2-sided Printing is Set]

When using 2-sided printing to output print data containing an odd number of pages, this function prints the last page in 1-sided print mode to reduce the print time.

[Special Print Mode]

Enables you to set a special print mode for adjusting text and lines so that they print more clearly. This function is useful for printing barcodes, text, and images in documents that have strong contrast.

[Barcode Adjustment Mode]

In cases where barcode printing is unsatisfactory, such as when a barcode on a printed article is unreadable, this function adjusts the thickness of the printed lines.

[Special Print Mode [Plain Paper]]

Solves fixing problems such as curling when printing with plain paper.

[Printing Start Position Settings]

Shifts the starting point for printing data in the long edge (upward) and short edge (rightward) directions. This function is useful for adjusting margins when the widths of the top and bottom margins and right and left margins differ, and for hiding the header information of faxes.

[Details] > [Printing Start Position Details] Dialog Box

Enables you to specify print starting positions.

[Increase Print Speed for Forms]

Use this function with the [Printer Default] setting.

[Restore Defaults]

Returns all the settings to their default values.

Related Topics

- ▶ **Common Settings for All Sheets(P. 96)**
- ▶ **Booklet Printing(P. 37)**
- ▶ **Saddle Stitched Booklet Printing(P. 40)**
- ▶ **Perfect Binding(P. 43)**
- ▶ **Driver settings cannot be set(P. 132)**
- ▶ **Print results are unsatisfactory(P. 133)**
- ▶ **Printing takes a long time(P. 135)**

[Paper Source] Sheet

You can set the paper type and paper source.

[Select by]

Selects whether to specify the paper to print on by paper source or by paper type.

[Paper Selection]

Specifies the paper source method depending on the page.

[Paper Source]

Specifies the paper to print on by paper source.

[Paper Type]

Specifies the paper to print on by paper type.

[Settings] > [Paper Type Settings] Dialog Box

Enables you to change the paper type. When acquiring the paper type information from the device, click [Retrieve Paper Information].

[Insert Sheets Settings] > [Insert Sheets Settings] Dialog Box

Enables you to configure settings relating to inserted sheets.

[Setting List]

Displays the sheets to be inserted and their positions in a list.

[Delete]

Deletes the selected sheet insertion settings from [Setting List].

[Sheets to Insert]

Specifies the paper type of the sheets to be inserted.

[Paper Source]

Specifies the paper source of the sheets to be inserted.

[Print on]

Prints on the selected side(s) of sheets to be inserted.

[Insert]

Inserts sheets for separating the document into sections.

[Tab Paper]

Inserts tab paper into the document.

[Settings] > [Paper Type Settings] Dialog Box

Enables you to change the paper type of the tab paper.

[Tab Details] > [Tab Details] Dialog Box

Enables you to set the printing position on the tab papers.

[Add]

Adds the sheet insertion settings to [Setting List].

[Original Paper Source]

Specifies the paper source for print data.

[Original Paper Type]

Specifies the paper type for print data.

[Cover Sheets]

Specifies the paper source or paper type used for cover sheets to insert between transparencies. When selecting various paper types registered in the device, click [Settings].

[Transparencies]

Specifies the paper source or paper type used for transparencies. When selecting various paper types registered in the device, click [Settings].

[Tab Details] > [Tab Details] Dialog Box

Enables you to set the printing position on the tab papers.

[Paper Source Information] > [Paper Source Information] Dialog Box

Displays information about the paper set in the paper sources. To acquire the paper source information from the device, click [Retrieve Paper Source Information].

[Carbon Copy]

Prints one copy of the same document from multiple specified paper sources.

This enables you to print to different types of paper at the same time, such as high quality paper and recycled paper.

[Settings] > [Carbon Copy Settings] Dialog Box

Selects the paper source to print from.

[Front/Back Cover Settings] > [Front/Back Cover Settings] Dialog Box

Inserts front and back covers. You can also set the paper source of the front and back covers and whether to print on them.

[Print on the Other Side]

If you want to print on both sides of paper fed manually into the stack bypass or multi-purpose tray, select this function to print on the other side of the paper.

[Restore Defaults]

Returns all the settings to their default values.

Related Topics

- ▶ [Common Settings for All Sheets\(P. 96\)](#)
- ▶ [Inserting Sheets\(P. 48\)](#)
- ▶ [Inserting Tab Paper\(P. 49\)](#)
- ▶ [Printing on Tab Paper\(P. 51\)](#)
- ▶ [Adding Cover Sheets\(P. 52\)](#)

[Quality] Sheet

You can set detailed print quality settings.

[Objective]

Enables you to set a print quality mode that matches the purpose of the print data by simply selecting a setting.

[Advanced Settings] > [Advanced Settings] Dialog Box

Enables you to set print quality details such as resolution, gradation, toner amount, etc.

[Rendering Rate]

Sets the image rasterizing method for print data.

[1 BPP [Enhanced]]

Expresses gradation as halftones and prints at high speed. Prints characters and thin lines in black.

[24 BPP]

Takes longer to print than [1 BPP [Enhanced]], but prints higher quality.

[Resolution]

Sets the print resolution.

[Gradation]

Sets the gradation method. [High 2] uses finer gradations than [High 1] to smooth gradations.

[Halftones]

Sets dither patterns for representing halftones (areas between dark areas and light areas).

[Printer Default]

Uses the settings of the device.

[Resolution]

Gives priority to resolution and prints contours smoothly.

[Gradation]

Gives priority to gradation and prints gradations smoothly.

[Error Diffusion]

Prints small characters and thin lines finely.

[Pattern 1] to [Pattern 7]

Applies the following halftone processing settings independently to text, graphic, and image data.

Where there are 7 patterns:

	Text	Graphics	Images
Pattern 1	Error Diffusion	Error Diffusion	Resolution
Pattern 2	Error Diffusion	Error Diffusion	Gradation
Pattern 3	Error Diffusion	Resolution	Resolution
Pattern 4	Error Diffusion	Gradation	Gradation
Pattern 5	Resolution	Resolution	Gradation
Pattern 6	Resolution	Gradation	Gradation
Pattern 7	Error Diffusion	Resolution	Gradation

Where there are 6 patterns:

	Text	Graphics	Images
Pattern 1	Resolution	Resolution	Gradation
Pattern 2	Resolution	Gradation	Gradation
Pattern 3	Resolution	Gradation	Resolution
Pattern 4	Gradation	Resolution	Resolution
Pattern 5	Gradation	Resolution	Gradation
Pattern 6	Gradation	Gradation	Resolution

Where there are 5 patterns:

	Text	Graphics	Images
Pattern 1	High Resolution/Resolution	Gradation	Color Tone
Pattern 2	Resolution	Color Tone	Color Tone
Pattern 3	Gradation	Gradation	Gradation
Pattern 4	High Resolution/Resolution	High Resolution/Resolution	Gradation
Pattern 5	Color Tone	Color Tone	Color Tone

[Retrieve Calibration Information When Printing]

Obtains calibration information from the device and adjusts colors automatically.

[Toner Save]

Thins out the print data to save toner.

[Toner Density]

Adjusts the toner density.

[Details] > [Toner Density Details] Dialog Box

Enables you to adjust the density of each color.

[Advanced Smoothing]

Creates smooths gradations. [Smooth 2] performs stronger smoothing processing than [Smooth 1].

[Toner Volume Correction]

Adjusts the amount of toner to match the content of the print data. [Gradation Priority] uses the optimum amount of toner for print data that includes large amounts of graphics and CG gradations. [Text Priority] uses the optimum amount of toner for print data that contains mainly text.

[Line Control]

Improves reproduction of text and lines. [Resolution Priority] gives priority to resolution. [Gradation Priority] gives priority to gradation.

[Sharpness]

Adjusts the sharpness of the contours of images.

[Sharpness (Photo)]

Strengthens the contours of images.

[Use Printer Fonts]

Use the TrueType fonts that reside within the device.

[TrueType Mode]

Sets the method used to print TrueType fonts. [Download as TrueType] sends TrueType fonts directly to the device where they are rasterized. [Download as Bit Image] rasterizes all TrueType fonts automatically and sends them as bitmapped data to the device.

[Dither Image Data on Device]

Performs dithering of image data at the device.

[Density Fine Adjustment]

Adjusts the print density for small-sized text and thin lines. This function is useful for correcting "cracks" in text and lines.

[Gray Compensation]

Prints black and gray data reliably in black and gray.

[Line Control [Gray Compensation]]

Improves reproduction of text and lines.

[Gradation Smoothing]

Prints transitions between colors in gradations smoothly. [Smooth 2] performs a stronger smoothing process than [Smooth 1].

[Image Compression]

Adjusts the print data compression ratio when sending it to the device, and prints with priority given to either image quality or print speed.

[Image Compression Optimization]

Uses an optimization method that switches between irreversible and reversible, or uses a uniform compression method without optimization. If the image is compressed with optimization, JPEG block noise is suppressed.

[Compression Processing for Data Transfer]

Switches between giving priority to image quality and giving priority to speed when compressing and transferring image data.

[POP Printing Optimization]

Increases the amount of toner to print POP advertisements and images clearly.

This function can only be used when a configuration profile that supports Laser Printers is selected in [Config. Profile]. The following items must also be set in advance.

- [Device Settings] Sheet
 - Enable [[POP Printing Optimization] Function] on the [Details] > [Quality] sheet
- [Basic Settings]/[Finishing] Sheet
 - Select [1-sided Printing] in [1-sided/2-sided/Booklet Printing] or [Print Style]
- [Quality] Sheet
 - Select [Manual Color Settings]
 - Select [Device Matching Mode] or [No Driver Matching] in [Matching Mode] on the [Color Settings] > [Matching] sheet
 - Select [Auto [Color/B&W]] or [Color] in [Color Mode]

[Width Adjustment]

Adjusts the thickness of specific objects such as text and lines.

[Trapping]

Performs an overlapping process at the borders between text or graphics and the background to prevent white lines around the edge portions of the text or graphics.

[Details] > [Trapping Details] Dialog Box

Enables you to set the trapping width and density.

[Adjust Toner Volume Used for Color Printing]

Adjusts the amount of toner to prevent too much toner being used when color printing. [Level 1] slightly reduces the amount of toner in areas of strong color. [Level 2] reduces the amount of toner overall.

[Use Driver Grayscale Conversion When B&W Printing]

Gives the driver grayscale conversion priority over the conversion of the application when black-and-white printing.

[CanoFine]

Adjusts the contrast and color balance of images to print distinct images.

[Details] > [CanoFine Details] Dialog Box

Enables you to set the print processing method using the [CanoFine] function.

[Color Mode]

Switches between printing in color or in black-and-white. To detect automatically whether each page should be printed in color or in black-and-white, select [Auto [Color/B&W]].

[Manual Color Settings]/[Manual Grayscale Settings] > [Color Settings]/[Grayscale Settings] Dialog Box

Enables you to adjust color, brightness, contrast, and color matching.

[Color Adjustment]/[Grayscale Adjustment] Sheet**[Original]/[Preview]**

Enables you to check the adjusted image.

[Increase (Color)]

Adjusts the color. Click and drag the image toward the color(s) you want to strengthen.

[Brightness]

Adjusts the brightness. Use the side bar to lighten or darken the image.

[Contrast]

Adjusts the contrast. Use the side bar to increase or decrease the contrast of the image.

[Restore Defaults]

Returns all the settings to their default values.

[Matching] Sheet**[Matching Mode]**

Sets whether to perform color matching on the device side or the driver side, or whether color matching is not performed by the driver.

[Application Color Matching Priority]

Gives priority over the application settings when performing matching processing.

[Matching Method]

Sets what factor is prioritized when matching.

[Monitor Profile]

Enables you to select the setting suitable for your monitor when [Device Matching Mode] is selected for [Matching Mode]. If several gamma values are provided for one option, to obtain better results select the higher gamma value if the printed image is lighter than that of the monitor.

[Gamma]

Enables you to adjust gamma when [Gamma Adjustment by Host]/[Gamma Adjustment by Device] is selected for [Matching Mode].

[Retrieve Calibration Information]

Retrieves calibration information from the device to automatically adjust the color when printing.

[Add-in Information]

Displays information concerning add-in modules (expanded functions) added to the driver.

[About]

Displays the version of the driver.

[Restore Defaults]

Returns all the settings to their default values.

Related Topics

- ▶ **Common Settings for All Sheets(P. 96)**
- ▶ **Print results are too dark or too bright(P. 136)**

[Device Settings] Sheet

You can configure device option settings and administrator settings.

[Device Information]

Displays whether the device status is set automatically or manually. When acquiring the device information and applying it to the settings in the [Device Settings] sheet, click [] (Retrieve Device Status Information).



NOTE

- If you select [On] from [Other Settings] > [Change Configuration Profile When Retrieving Device Information] in the [Detailed Settings] dialog box, the configuration profile is automatically changed according to the retrieved device information.

[Config. Profile]

Displays the applied configuration profile.

[Change] > [Change Configuration Profile] Dialog Box

Enables you to change or import a configuration profile.

[Select Configuration Profile]

[Select Configuration Profile Suitable for Your Device Automatically]

Sets the configuration profile suitable for the printer model you are using.

[Select Manually]

Enables you to manually set a configuration profile.

[] (Import Configuration Profile)

Imports an exported configuration profile file (*.typ).

[] (Delete)

Deletes the imported configuration profile selected from [Configuration Profile].

[Retrieve Device Information]

Acquires the device information and applies it to the settings in the [Device Settings] sheet.



NOTE

- If device information cannot be acquired, the configuration profile must be set manually. See the following topic for supported combinations of printer models and configuration profiles.

▶ [List of Configuration Profiles\(P. 89\)](#)

[] (Export) > [Export Configuration Profile] Dialog Box

Enables you to export and save the current settings in the [Device Settings] sheet as a configuration profile file (*.typ).

[Device Type]

Sets the type of device.

[Finishing Settings]

Sets the finishing functions of the device.

[Paper Source Settings]

Displays the paper source options attached to the device.

[Form to Tray Assignment] > [Form to Tray Assignment] Dialog Box

Enables you to set the paper size and paper type set in each paper source.

[Paper Size Settings] > [Paper Size Settings] Dialog Box

Enables you to set paper sizes to be used.

[Paper Source] > [Paper Source] Dialog Box

Enables you to set the paper source options attached to the device.

[Output Settings]

Displays the paper output options attached to the device.

[Paper Output Settings] > [Paper Output Settings] Dialog Box

Enables you to set the paper output options attached to the device.

[Other Settings]

Enables you to configure administrator settings relating to the device.

[Spooling at Host]

Sets whether processing of the print data is performed at the host (computer) or at the device. If you select [Auto], processing is performed at the device when it is possible using only the device functions, increasing the print speed.

[Set User Information]

Enables you to set a user name to be used for print jobs and the PIN used in secured printing.

[Settings] > [User Information Settings] Dialog Box

[User Name]

Sets a user name to be used for print jobs.

[PIN for Secure Print]

Sets a PIN for secured printing.

[Always Confirm User Information When Performing Secure Print]

Displays the [Confirm PIN] dialog box for confirming or setting a name for the print data, user name, and PIN when performing secured printing.

[Confirm User Name When Printing]

Displays the [Confirm User Name] dialog box for confirming or setting a user name when printing.

[Display Previously Entered Information When Confirming]

Displays confirmation dialog boxes with the user name and PIN you entered last time automatically entered.

[User Name Management]/[Default Value Settings] > [User Name Management]/[Default Value Settings] Dialog Box

Enables you to configure the default settings for the user name and PIN.

[Name to Set for User Name]

Enables you to specify the Windows logon name, computer name, or any desired name for the user name.

[PIN for Secure Print]

Set a PIN for secured printing.

[Always Confirm User Information When Performing Secure Print]

Displays the [Confirm PIN] dialog box for confirming or setting a name for the print data, user name, and PIN when performing secured printing.

[Confirm User Name When Printing]

Displays the [Confirm User Name] dialog box for confirming or setting a user name when printing.

[Do Not Allow User Name Changes]

Prohibits changes to the user name in the [User Information Settings] dialog box.

[Fix [User Information Settings]-[Always Confirm User Information When Performing Secure Print] Setting]

Fixes the [Always Confirm User Information When Performing Secure Print] setting to the setting set in the [Default Value Settings] dialog box.

[Fix [User Information Settings]-[Confirm User Name When Printing] Setting]

Fixes the [Confirm User Name When Printing] setting to the setting set in the [User Name Management] or [Default Value Settings] dialog box.

[User Management]

Sets the type of authentication function to use.

[Settings] > [Department ID/PIN Settings] Dialog Box

Enables you to configure the detailed settings when you select [Department ID Management] from [User Management].

[Allow PIN Setting]

Enables you to set the PIN in this dialog box. In a shared printer environment, deselect this item at the server if you want to disable PIN or password settings at the client computers.

[Department ID]

Sets the department ID which has been set at the device.

[PIN]

Sets a PIN for the department ID management. If the PIN has not been set at the device, leave this box blank.

[Verify]

Verifies whether the entered department ID and PIN match those set at the device.

[Confirm Department ID/PIN When Printing]

Displays the [Confirm Department ID/PIN] dialog box for confirming or setting the department ID and the PIN when printing.

[Do Not Use Department ID Management When B&W Printing]

Enables you to print without applying department ID management when printing in black and white.

[Authenticate Department ID/PIN at Device]

Performs authentication of the department ID and PIN at the device.

[Settings] > [User Authentication Settings] Dialog Box

Enables you to configure the detailed settings when you select [User Authentication] from [User Management].

[Allow Password Settings]

Enables you to set a password. If you do not set a password here, input the password when printing.

[User Name]

Sets a user name to be used for user authentication.

[Password]

Sets a password for user authentication. If the password has not been set at the device, leave this box blank.

[Verify]

Verifies whether the entered password matches that set at the device.

[Confirm Authentication Information When Printing]

Displays the [Confirm User Name/Password] dialog box for confirming or setting authentication information when printing.

[Perform Authentication at Device]

Performs the authentication process at the device.

[Secure Printing Function of Device]

Embeds restriction and tracking information into the print data as a dot pattern when using the job lock extension kit.

[About]

Displays the version of the driver.

[Language Settings] > [Language Settings] Dialog Box

Enables you to switch the display language.



[Add-in Information]

Displays information concerning add-in modules (expanded functions) added to the driver.

[Function] > [Device Function Settings] Dialog Box

Displays the controller function ID and function version of the device. You can also set a name for the device.

[Details] > [Detailed Settings] Dialog Box

Enables you to configure the settings in the print settings screen of the driver. Items with [] are set automatically by the acquire device information function. Items with [] may require settings to be configured manually.

**IMPORTANT**

- If you set a paper source that is not installed in the device, paper will be supplied from the device's priority paper source.
- If the paper source you have specified and the paper size/type do not match, an error will occur.
- If you specify [Finishing Settings] (2-sided printing, stapling, etc.) functions for a device that does not have those functions, printing will be performed without those functions. For example, if you specify 2-sided printing for a device that does not support 2-sided printing, the data will be printed on one side of the paper.
- If you select [Store] from [Output Method] when printing from a device that does not support box storage, the data will be printed normally. If an error is displayed on the touch panel display of the device and the device goes offline, the data is printed when the device goes online again.

- [If you set the department ID management function or the user authentication function when printing for a device that does not have those functions, an error will occur.](#)



Related Topics

- ▶ [Setting Device Information\(P. 69\)](#)
- ▶ [Device Functions Settings\(P. 74\)](#)
- ▶ [Paper Sources and Output Destinations Settings\(P. 75\)](#)
- ▶ [Importing a Configuration Profile\(P. 86\)](#)
- ▶ [Exporting a Configuration Profile\(P. 84\)](#)
- ▶ [Setting the Authentication Function\(P. 91\)](#)
- ▶ [Setting the User Name\(P. 93\)](#)
- ▶ [Driver settings cannot be set\(P. 132\)](#)
- ▶ [Cannot use the acquire device information function or authentication function\(P. 138\)](#)

[Profile] Sheet

You can edit, import, and export profiles. If you edit profiles on the server side in a shared printer environment, the changes are reflected in the client profiles.

[Profile List]

Displays registered profiles as a list. You can change the order by selecting a profile and clicking [] (Move Up) or [] (Move Down).



NOTE

- Profiles with a red dot (●) next to them are pre-registered profiles and cannot be edited or deleted.

[View Settings]

Displays the content of the selected profile as a list.

[Add]/[Edit] > [Add/Edit Profile] Dialog Box

Enables you to add a new profile or edit the settings of a user-registered profile. Set [Name] and [Icon]. Enter a comment in [Comment] if required. Switch sheets and configure relevant settings. If you want to check the current settings in a list, click [View Settings].

[Edit]

Enables you to edit the settings of a user-registered profile.

[Delete]

Deletes the selected profile.

[Name], [Comment]

Displays the name and comment of the selected profile. You can edit the name and comment of user-registered profiles.

[Import]

Imports a profile saved as a "*.cfg" file and adds it to [Profile List].

[Export]

Exports the profile selected in [Profile List] and saves it as a "*.cfg" file.

[Define Document Property]

Allows settings in the print settings screen of the driver. This function is useful when restricting usage of the print settings in client computers in a shared printer environment.

If you deselect the following settings at the server, the settings of all client computers are fixed at those configured at the server.

[Allow Profile Selection]

Enables you to select profiles in the print settings screen.

[Allow Editing of Settings]

Enables you to configure print settings other than selecting profiles in the print settings screen. This setting can be selected when [Allow Profile Selection] is selected.

Related Topics

- ▶ [Driver settings cannot be set\(P. 132\)](#)

Canon PageComposer

You can combine multiple files created with different applications into one file for printing.

The Canon PageComposer main screen opens when you print using the [Edit and Preview] function of the driver.

[File] Menu

[Print]/[] (Print)

Prints the selected file(s).

[Print Sample]/[] (Print Sample)

Performs proof printing of the selected file(s).

[Print Preview]/[] (Print Preview)

Displays a print preview of the selected file.

[Exit]

Closes the Canon PageComposer main screen.

[Edit] Menu

[Delete]/[] (Delete Document)

Deletes the selected file(s).

[Duplicate]/[] (Duplicate Document)

Duplicates the selected file(s).

[Combine]/[] (Combine Documents) > [Combine] Dialog Box

Combines the selected multiple files into one, and enables you to specify a name and configure the settings of the combined file.

Displays the current settings for each page as thumbnail images.

[Document Name]

Sets the name of the combined file.

[Delete]

Deletes the selected page.

[Print Preview]

Displays a print preview of the selected page.

[Document List] Sheet

Changes the order of files in the combined file or deletes a file from the combined file.

[Print Settings] Sheet

Changes the print settings of the combined file. When unifying the output size settings, select [Output Size Consistency]. When unifying the page layout settings, select [Layout Consistency].

If you want to specify detailed settings in the print settings screen of the driver, click [Details].

[Separate]/[] (Separate Documents)

Separates the selected file you have combined.

[Change Print Settings]/[] (Change Print Settings) > [Change Print Settings] Dialog Box

Changes the name and settings of the selected file.

Displays the current settings for each page as thumbnail images.

[Document Name]

Sets the name of the file.

[Delete]

Deletes the selected page.

[Print Preview]

Displays a print preview of the selected page.

[Document List] Sheet

Changes the order of files when combining multiple files or deletes a file from the combined file.

[Print Settings] Sheet

Changes the print settings of the file.

[Copies]

Specifies the number of copies to be printed.

[Print Style]

Specifies a method for outputting print data.

[Staple]

Outputs the pages stapled together.

[Saddle Stitch]

Prints a booklet folded in half and stapled in the middle.

[Output Size Consistency]

Enables you to use the paper of the same size selected from the drop-down list box for a combined file consisting of files with different page sizes.

[Layout Consistency]

Enables you to set a single layout selected from the drop-down list box for a combined file consisting of files with different layout.

[Page Order]

Specifies the page order to print.

[Print Next Document from]

Enables you to set where to start printing the next file from when combining files.

[Details]

Enables you to specify detailed settings in the print settings screen of the driver.

[Select All]

Selects all files in the list.

[Move to] Menu

[Top]/[Previous]/[Next]/[Last]



Allows you to change the order by moving the selected file(s).

[Help] Menu

[Help]

Displays the online help.

[About]

Displays the version of Canon PageComposer.

Related Topics

- ▶ **About the [Edit and Preview] Function(P. 55)**
- ▶ **Printing Files Together(P. 56)**
- ▶ **Checking the Print Preview(P. 58)**
- ▶ **Changing the Print Settings of the Combined File(P. 60)**

Troubleshooting

Troubleshooting	131
Driver settings cannot be set	132
Print results are unsatisfactory	133
Printing takes a long time	135
Print results are too dark or too bright	136
Overlay printing will not execute	137
Cannot use the acquire device information function or authentication function	138

Troubleshooting

This explains solutions to common problems.

- ▶ **Driver settings cannot be set(P. 132)**
- ▶ **Print results are unsatisfactory(P. 133)**
- ▶ **Printing takes a long time(P. 135)**
- ▶ **Print results are too dark or too bright(P. 136)**
- ▶ **Overlay printing will not execute(P. 137)**
- ▶ **Cannot use the acquire device information function or authentication function(P. 138)**

Driver settings cannot be set

Page size, orientation, paper selection settings are not valid

Cause

Depending on the application you are using, the settings corresponding to these in the application are given priority over the driver settings.

Remedy

Configure these settings in the application.

The [Device Settings] and [Profile] sheet can be displayed, but settings are unavailable

Cause

Your account does not have full control permission for the printer.

Remedy

Logon to the computer as a member of Administrators. Contact your system administrator for further information.

Functions supported by the device are not displayed in the [Device Settings] sheet

Cause

The appropriate configuration profile has not been set.

Remedy

Set the proper configuration profile for the printer model you are using.

If device information cannot be acquired, the configuration profile must be set manually. See the following topic for supported combinations of printer models and configuration profiles.

- ▶ [List of Configuration Profiles\(P. 89\)](#)

Related Topics

- ▶ [Printing from a Computer\(P. 19\)](#)

Print results are unsatisfactory

Page layout is not correct

If the printing area on the page is not positioned correctly, or if part of the printed area is missing, check the following.

Cause 1.

Print data is not set in the printable area.

Remedy

Confirm the printable area of the device, and correct the print data in the application you are using.

Cause 2.

The [Output Size] settings in the [Basic Settings] or [Page Setup] sheet does not match the actual size of the paper loaded in the device.

Remedy

Confirm that the [Output Size] setting matches the size of the paper in the device.

Cause 3.

The magnification ratio is not set properly for the print data.

Remedy

Change the settings in the [Basic Settings] or [Page Setup] sheet > [Manual Scaling] > [Scaling].

Cause 4.

The gutter setting is too large, so that there is not enough space on the page for the printout.

Remedy

Change the settings in the [Finishing] sheet > [Gutter].

Part of the printout does not match what you see on the screen

Cause

The application uses EMF format data which cannot be processed by page printers.

Remedy

In the [Finishing] sheet, click [Advanced Settings], and then select [On] from [EMF Spooling].

Related Topics

- ▶ [\[Basic Settings\] Sheet\(P. 99\)](#)
- ▶ [\[Page Setup\] Sheet\(P. 102\)](#)
- ▶ [\[Finishing\] Sheet\(P. 105\)](#)

Printing takes a long time

Cause

The application uses EMF format data which cannot be processed by page printers.

Remedy

In the [Finishing] sheet, click [Advanced Settings], and then select [On] from [EMF Spooling].

Related Topics

▶ [\[Finishing\] Sheet\(P. 105\)](#)

Print results are too dark or too bright

Cause

The colors on the computer monitor and in the print results differ because their color representation methods differ.

Remedy

Change the color settings according to the following procedure.

(1) Display the [Quality] sheet.

(2) Select [Manual Color Settings] or [Manual Grayscale Settings] → click [Color Settings]/[Grayscale Settings].

(3) In the [Color Adjustment]/[Grayscale Adjustment] sheet, adjust the brightness with the slide bar.

Related Topics

▶ [Quality] Sheet(P. 115)

Overlay printing will not execute

Cannot perform overlay printing

Cause

The resolution of the print data differs from that of the form file.

Remedy

Set the same resolution as the form file in the [Quality] sheet > [Advanced Settings] > [Resolution].

Cannot use previously stored overlay form

Cause

The overlay print settings are not configured correctly.

Remedy

Check the settings according to the following procedure.

- (1) Display the [Page Setup] sheet.
- (2) Click [Page Options].
- (3) In the [Page Options] sheet, display the [Overlay] sheet.
- (4) Confirm that [Processing Method] > [Use Overlay Printing] is selected.

Related Topics

- ▶ [Page Setup] Sheet(P. 102)
- ▶ [Quality] Sheet(P. 115)

Cannot use the acquire device information function or authentication function

If you cannot acquire the device information, or cannot use the department ID management function or the user authentication function in the [Device Settings] sheet, check the following.

Cause 1.

The device is turned off, or the cable is not plugged in properly.

Remedy

Check the status of the device.

Cause 2.

The settings for your connection environment have not been configured correctly.

Remedy

Confirm the printable area of the device, and correct the print data in the application you are using.

In a print server environment

- Install the "Canon Driver Information Assist Service" in the server computer using the driver installer.
- Install TCP/IP as a protocol in your environment from the CD-ROM for the operating system you are using.

When using a USB connection or using a port connection environment in which you cannot use these functions

Use another connection environment such as TCP/IP network connection, etc.

You cannot use these functions with the following port connection environments:

- An environment in which computers are directly connected to the printer using SMB.
- An environment in which [Enable printer pooling] is selected in the [Ports] sheet of the printer properties screen.
- An environment in which computers are connected to the printer using Web Services on Devices (WSD) ports.

Cause 3.

The name of the device is too long.

Remedy

Confirm that the number of characters in the name of the printer do not exceed the following values. If they do, change the name in the [General] or [Sharing] sheet of the printer properties screen.

- Name to share the printer with: 260 characters or less.
- Printer name: 209 characters or less.

This Font Software is licensed under the SIL Open Font License, Version 1.1.

This license is copied below, and is also available with a FAQ at: <http://scripts.sil.org/OFL>

SIL OPEN FONT LICENSE Version 1.1 - 26 February 2007

PREAMBLE

The goals of the Open Font License (OFL) are to stimulate worldwide development of collaborative font projects, to support the font creation efforts of academic and linguistic communities, and to provide a free and open framework in which fonts may be shared and improved in partnership with others.

The OFL allows the licensed fonts to be used, studied, modified and redistributed freely as long as they are not sold by themselves. The fonts, including any derivative works, can be bundled, embedded, redistributed and/or sold with any software provided that any reserved names are not used by derivative works. The fonts and derivatives, however, cannot be released under any other type of license. The requirement for fonts to remain under this license does not apply to any document created using the fonts or their derivatives.

DEFINITIONS

"Font Software" refers to the set of files released by the Copyright Holder(s) under this license and clearly marked as such. This may include source files, build scripts and documentation.

"Reserved Font Name" refers to any names specified as such after the copyright statement(s).

"Original Version" refers to the collection of Font Software components as distributed by the Copyright Holder(s).

"Modified Version" refers to any derivative made by adding to, deleting, or substituting -- in part or in whole -- any of the components of the Original Version, by changing formats or by porting the Font Software to a new environment.

"Author" refers to any designer, engineer, programmer, technical writer or other person who contributed to the Font Software.

PERMISSION & CONDITIONS

Permission is hereby granted, free of charge, to any person obtaining a copy of the Font Software, to use, study, copy, merge, embed, modify, redistribute, and sell modified and unmodified copies of the Font Software, subject to the following conditions:

- 1) Neither the Font Software nor any of its individual components, in Original or Modified Versions, may be sold by itself.
- 2) Original or Modified Versions of the Font Software may be bundled, redistributed and/or sold with any software, provided that each copy contains the above copyright notice and this license. These can be included either as stand-alone text files, human-readable headers or in the appropriate machine-readable metadata fields within text or binary files as long as those fields can be easily viewed by the user.
- 3) No Modified Version of the Font Software may use the Reserved Font Name(s) unless explicit written permission is granted by the corresponding Copyright Holder. This restriction only applies to the primary font name as presented to the users.
- 4) The name(s) of the Copyright Holder(s) or the Author(s) of the Font Software shall not be used to promote, endorse or advertise any Modified Version, except to acknowledge the contribution(s) of the Copyright Holder(s) and the Author(s) or with their explicit written permission.
- 5) The Font Software, modified or unmodified, in part or in whole, must be distributed entirely under this license, and must not be distributed under any other license. The requirement for fonts to remain under this license does not apply to any document created using the Font Software.

TERMINATION

This license becomes null and void if any of the above conditions are not met.

DISCLAIMER

THE FONT SOFTWARE IS PROVIDED "AS IS", WITHOUT WARRANTY OF ANY KIND, EXPRESS OR IMPLIED, INCLUDING BUT NOT LIMITED TO ANY WARRANTIES OF MERCHANTABILITY, FITNESS FOR A PARTICULAR PURPOSE AND NONINFRINGEMENT OF COPYRIGHT, PATENT, TRADEMARK, OR OTHER RIGHT. IN NO EVENT SHALL THE COPYRIGHT HOLDER BE LIABLE FOR ANY CLAIM, DAMAGES OR OTHER LIABILITY, INCLUDING ANY GENERAL, SPECIAL, INDIRECT, INCIDENTAL, OR CONSEQUENTIAL DAMAGES, WHETHER IN AN ACTION OF CONTRACT, TORT OR OTHERWISE, ARISING FROM, OUT OF THE USE OR INABILITY TO USE THE FONT SOFTWARE OR FROM OTHER DEALINGS IN THE FONT SOFTWARE.