

Canon

Digital Video Camcorder
Instruction Manual

English

Caméscope Numérique
Manuel d'instruction

Français

Videocámara digital
Manual de Instrucciones

Español

ZR 850 / ZR 830

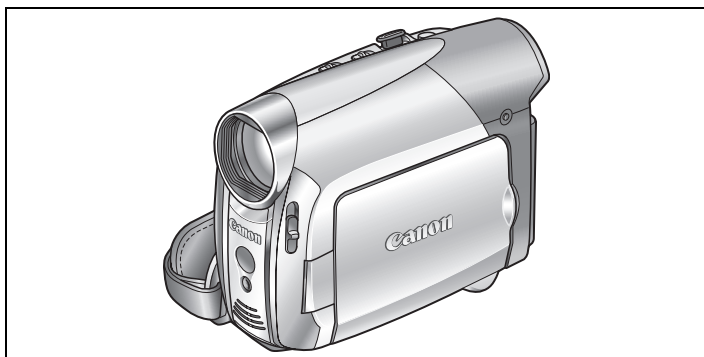

Mini **DV** Digital
 Video
 Cassette

PictBridge

Please read also the following instruction manual (electronic version on PDF file). For further details refer to the installation guide.

Veuillez lire aussi le manuel d'instruction suivant (version électronique sur fichier PDF). Pour d'autres détails référez-vous au guide d'installation.

Lea también el siguiente manual de instrucciones (versión electrónica en archivo PDF). Para mayores detalles, refiérase a la guía de instalación.



• **Digital Video Software**

NTSC

Cleaning the Video Heads

Digital video camcorders record video signals on the tape in very thin lines (as thin as 1/8 of the width of a hair). The following symptoms may appear if the video heads become dirty even a little.

- Mosaic or other blocky video artifacts (Fig. 1) or banding (Fig. 2) appear on the picture during playback.
- Sound becomes distorted, or there is no sound during playback.
- The message "HEADS DIRTY, USE CLEANING CASSETTE" appears.



Fig. 1

If such symptoms appear, clean the video heads with the Canon DVM-CL Digital Video Head Cleaning Cassette* or a commercially available dry cleaning cassette.

If the symptoms reappear shortly after the cleaning, the videocassette may be defective. Stop using it.

* Availability differs from area to area.



Fig. 2

Video heads may become dirty under the following conditions:

- When using the camcorder in humid or hot places.
- When using cassettes with damaged or dirty tape.
- When using the camcorder in dusty places.
- When using the video heads without cleaning them for a long time.

i NOTES

- Before you make important recordings, clean the video heads and make a test recording first. We also recommend cleaning the video heads after use, before storing the camcorder.
- Do not use wet type cleaning cassettes as this may damage the camcorder.
- Even after cleaning the video heads you may not be able to play back correctly tapes that were recorded with dirty video heads.

Important Usage Instructions

WARNING!



TO REDUCE THE RISK OF FIRE OR ELECTRIC SHOCK, DO NOT EXPOSE THIS APPARATUS TO RAIN OR MOISTURE.

For Canada only:

TO REDUCE THE RISK OF ELECTRIC SHOCK, DO NOT EXPOSE THIS PRODUCT TO DRIPPING OR SPLASHING.

WARNING!



TO REDUCE THE RISK OF ELECTRIC SHOCK AND TO REDUCE ANNOYING INTERFERENCE, USE THE RECOMMENDED ACCESSORIES ONLY.

COPYRIGHT WARNING:

Unauthorized recording of copyrighted materials may infringe on the rights of copyright owners and be contrary to copyright laws.

Digital Video Camcorder, ZR850/ZR830 A systems

This device complies with Part 15 of the FCC Rules. Operation is subject to the following two conditions: (1) This device may not cause harmful interference, and (2) this device must accept any interference received, including interference that may cause undesired operation.

Note: This equipment has been tested and found to comply with the limits for class B digital device, pursuant to Part 15 of the FCC Rules. These limits are designed to provide reasonable protection against harmful interference in a residential installation. This equipment generates, uses and can radiate radio frequency energy and, if not installed and use in accordance with the instructions, may cause harmful interference to radio communications. However, there is no guarantee that interference will not occur in a particular installation. If this equipment does cause harmful interference to radio or television reception, which can be determined by turning the equipment off and on, the user is encouraged to try to correct the interference by one or more of the following measures:

- Reorient or relocate the receiving antenna.
- Increase the separation between the equipment and receiver.
- Connect the equipment into an outlet on a circuit different from that to which the receiver is connected.
- Consult the dealer or an experienced radio/TV technician for help.

Use of shielded cable is required to comply with class B limits in Subpart B of Part 15 of FCC Rules.

Do not make any changes or modifications to the equipment unless otherwise specified in the manual.

If such changes or modifications should be made, you could be required to stop operation of the equipment.

Canon U.S.A. Inc.

One Canon Plaza, Lake Success, NY 11042, U.S.A.

Tel No. (516)328-5600

Important Warning



The lightning flash with arrowhead symbol, within an equilateral triangle, is intended to alert the user to the presence of uninsulated "dangerous voltage" within the product's enclosure, that may be of sufficient magnitude to constitute a risk of electric shock to persons.

CAUTION:

TO REDUCE THE RISK OF ELECTRIC SHOCK, DO NOT REMOVE COVER (OR BACK). NO USER-SERVICEABLE PARTS INSIDE. REFER SERVICING TO QUALIFIED SERVICE PERSONNEL.



The exclamation point, within an equilateral triangle, is intended to alert the user to the presence of important operating and maintenance (servicing) instructions in the literature accompanying the product.

IMPORTANT SAFETY INSTRUCTIONS

In these safety instructions the word "apparatus" or "product" refers to the Canon Digital Video Camcorder ZR850/ZR830 A and all its accessories.

- 1 Read these instructions.
- 2 Keep these instructions.
- 3 Heed all warnings.
- 4 Follow all instructions.
- 5 Do not use this apparatus near water.
- 6 Clean only with dry cloth.
- 7 Do not install near any heat sources such as radiators, heat registers, stoves, or other apparatus (including amplifiers) that produce heat.
- 8 Protect the power cord from being walked on or pinched particularly at plugs, convenience receptacles, and the point where they exit from the apparatus.
- 9 Unplug this apparatus during lightning storms or when unused for long periods of time.
- 10 Read instructions — All the safety and operating instructions should be read before the product is operated.
- 11 Retain instructions — The safety and operating instructions should be retained for future reference.
- 12 Heed Warnings — All warnings on the product and in the operating instructions should be adhered to.
- 13 Follow instructions — All operating and maintenance instructions should be followed.
- 14 Cleaning — Unplug this product from the wall outlet before cleaning. Do not use liquid or aerosol cleaners. The product should be cleaned only as recommended in this manual.
- 15 Avoid magnetic or electric fields — Do not use the camera close to TV transmitters, portable communication devices or other sources of electric or magnetic radiation. They may cause picture interference, or permanently damage the camera.
- 16 Water and Moisture — Hazard of electric shock — Do not use this product near water or in rainy/moist situations.
- 17 Placing or Moving — Do not place on an unstable cart, stand, tripod, bracket or table. The product may fall, causing serious injury to a child or adult, and serious damage to the product. A product and cart combination should be moved with care. Quick stops, excessive force, and uneven surfaces may cause the product and cart combination to overturn.
- 18 Power Sources — The product should be operated only from the type of power source indicated on the marking label. If you are not sure of the type of power supply to your home, consult your product dealer or local power company. Regarding other power sources such as battery power, refer to instructions in this manual.
- 19 Overloading — Do not overload wall outlets and extension cords as this can result in a risk of fire or electric shock.
- 20 Objects and Liquid Entry — Never push objects of any kind into this product through openings as they may touch dangerous voltage points or short out parts that could result in a fire or electric shock. Be careful not to spill liquid of any kind onto the product.
- 21 Servicing — Do not attempt to service this product yourself as opening or removing covers may expose you to dangerous voltage or other hazards. Refer all servicing to qualified service personnel.
- 22 Power Sources — The CA-590 Compact Power Adapter should be operated only from the type of power source indicated on the marking label. If you are not sure of the type of power supply to your home, consult your product dealer or local power company. Regarding other power sources such as battery power, refer to instructions in this manual.
- 23 Lightning — For added protection of this product during a lightning storm, or when it is left unattended and unused for long periods of time, disconnect it from the wall outlet and disconnect the antenna. This will prevent damage to the product due to lightning and power-line surges.
- 24 Overloading — Do not overload wall outlets and extension cords as this can result in a risk of fire or electric shock.

- 25** Damage Requiring Service — Disconnect this product from the wall outlet and all power sources including battery, and refer servicing to qualified service personnel under the following conditions:
- When the plug is damaged.
 - If any liquid has been spilled onto, or objects have fallen into, the product.
 - If the product has been exposed to rain or water.
 - If the product does not operate normally even if you follow the operating instructions. Adjust only those controls that are covered by the operation instructions. Improper adjustment of other controls may result in damage and will often require extensive work by a qualified technician to restore the product to its normal operation.
 - If the product has been dropped or the cabinet has been damaged.
 - When the product exhibits a distinct change in performance. This indicates a need for service.
- 26** Replacement Parts — When replacement parts are required, be sure the service technician has used replacement parts that are specified by Canon or that have the same characteristics as the original part. Unauthorized substitutions may result in fire, electric shock or other hazards.
- 27** Safety Check — Upon completion of any service or repairs to this product, ask the service technician to perform safety checks to determine that the product is in safe operating order.

When replacement of the power supply is required, please return it to the responsible nearest Canon Service Center and please replace it with the same type number CA-590.

This Class B digital apparatus complies with Canadian ICES-003.

The Mains plug is used as the disconnect device. The Mains plug shall remain readily operable to disconnect the plug in case of an accident.

The adapter can be used with a power supply between 100 and 240 V AC. For areas where 120 V AC power is not used, you will need a special plug adapter. Contact your nearest Canon Service Center for further information.
The adapter is not intended to be serviced. Should the product cease to function in its intended manner, it should be returned to the manufacturer or be discarded.

Table of contents

Introduction

About this Manual	9
-------------------------	---

Getting to Know the Camcorder

Supplied Accessories	11
Components Guide	12
Screen Displays	15

Preparations

Getting Started

Charging the Battery Pack	19
Installing the Backup Battery	21
Inserting and Removing a Tape	21
Inserting and Removing a Memory Card	22
Preparing the Camcorder	22
The Wireless Controller	23
Adjusting the LCD Screen	23

Using the Menus

Selecting a FUNC. Menu Option	24
Selecting an Option from the Setup Menus	25

First Time Settings

Changing the Language	26
Changing the Time Zone	26
Setting the Date and Time	27

Basic Functions

Recording

Recording Movies	28
Recording Still Images on the Memory Card	29
Recording Movie Clips on the Memory Card	30
Zooming	31
Quick Start Function	31



Playback

Playing Back Movies	32
Returning to a Pre-marked Position	33
Locating the End of the Last Scene	34
Locating Scenes by Recording Date	34
Playing Back Still Images and Movie Clips from a Memory Card	34
Magnifying the Playback Image	36

Advanced Functions

Menu Options Lists

FUNC. Menu	37
Setup menus	39
Camera Setup (Digital Zoom, Image Stabilizer, etc.)	39
VCR Setup (Recording Mode, TV Type, etc.)	40
Audio Setup (Audio Mode, Wind Screen, etc.)	41
Card Operations (Initialization, Erase All Images, etc.)	41
Display Setup (LCD Brightness, Language, etc.)	42

System Setup (Beep, etc.)	43
Date/Time Setup	44
Recording Programs	
Using the Recording Programs	45
[]: Changing the Shutter Speed and Special Scene Programs.....	46
Adjusting the Picture: Exposure, Focus and Color	
Manual Exposure Adjustment.....	47
Manual Focus Adjustment.....	48
White Balance	49
Image Effects.....	50
Audio Recording and Playback	
Audio Recording Mode	50
Audio Playback Modes	51
Recording Options using the Memory Card	
Selecting the Size and Quality of Still Images	52
Selecting the Size of Movie Clips on the Memory Card	53
Capturing a Still Image while Recording Movies	53
Capturing a Still Image or Movie Clip from the Playback Picture	54
Automatic Focus Priority.....	54
Other Functions	
Data Code	55
 LED Light	56
Self Timer	56
Digital Effects.....	56
Editing Functions	
Still Image Options	
Erasing Still Images	60
Protecting Still Images	61
Initializing the Memory Card	62
External Connections	
Connecting to a TV or VCR	
Connection Diagrams	63
Playback on a TV Screen	64
Recording to a VCR or Digital Video Recorder	64
Digital Video Dubbing	65
Audio Dubbing	66
Connecting to a Computer	
PC Connection Diagrams	68
Transferring Video Recordings	69
Transferring Still Images or Movie Clips – Direct Transfer	69
Transfer Orders	71
Connecting to a Printer	
Printing Still Images – Direct Print	72
Selecting the Print Settings	73
Print Orders	75

Additional Information

Trouble?

Troubleshooting	77
List of Messages	80

Do's and Don'ts

Handling Precautions	83
Maintenance/Others	86
Using the Camcorder Abroad	87



General Information

System Diagram	88
Optional Accessories	89
Product Codes	91
Specifications	92
Index	94

About this Manual

Thank you for purchasing the Canon ZR850/ZR830. Please read this manual carefully before you use the camcorder and retain it for future reference. Should your camcorder fail to operate correctly, refer to the *Troubleshooting* table (□ 77).

Conventions Used in the Manual

-  **IMPORTANT:** Precautions related to the camcorder's operation.
-  **NOTES:** Additional topics that complement the basic operating procedures.
-  **POINTS TO CHECK:** Restrictions that apply if the function described is not available in all operating modes (the operating mode to which the camcorder should be set, etc.).
- □ : Reference page number.
- **ZR850** : Option or feature that applies to or is available only with a specific model.
- "Screen" refers to the LCD and the viewfinder screen.
- The photos included in the manual are simulated pictures taken with a still camera. Note that unless indicated otherwise, illustrations in this manual refer to the **ZR850** model.

Menu item shown at its default position

Buttons and switches to be operated

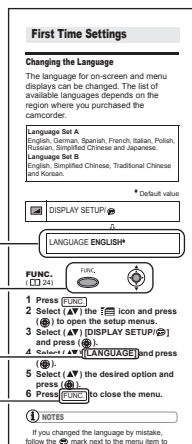

Brackets [] and capital letters are used to refer to menu options as they are displayed on screen. Menu options in boldface indicate the default setting (for example **[ON]**, **[OFF]**).

Names of buttons and switches other than the joystick are indicated within a "button" frame (for example **[FUNC.]**).







About the Joystick and the Joystick Guide





The mini joystick allows you to control many of the camcorder's operations and to make selections and changes in the camcorder's menus.













 	Push the joystick up, down, left or right (▲▼, ◀▶) to select an item or change settings.
	Press the joystick itself (⊙) to save the settings or confirm an action. On menu screens, this is indicated by the joystick icon ◀▶⊙.

The functions assigned to the joystick change according to the operation mode. You can display the joystick guide to remind you of the joystick's functions in each operating mode.

Recording movies: 	Playing back movies: 	Recording still images: 	Playing back still images: 
--	---	--	---

About the Operating Modes







The camcorder's operating mode is determined by the positions of the **POWER** switch and the  /  switch. In the manual,  indicates that a function is available in the operating mode shown and  indicates that the function is not available. When no operating mode icons are given, the function is available in all operating modes.

Operating Mode	POWER Switch	 /  Switch	Icon Display	Operation	
	CAMERA	 (Tape)		Recording movies on the tape	28
	PLAY			Playing movies from the tape	32
	CAMERA	 (Memory card)		Recording still images or movie clips on the memory card	29
	PLAY			Playing back still images or movie clips from the memory card	34

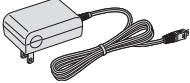
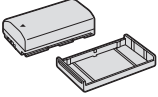
Trademark Acknowledgements

- Mini  is a trademark.
- The SD logo is a trademark. The SDHC logo is a trademark.
- Windows® is a registered trademark of Microsoft Corporation in the United States and/or other countries.
- Macintosh and Mac OS are trademarks of Apple Computer, Inc., registered in the United States and other countries.
- Other names and products not mentioned above may be trademarks or registered trademarks of their respective companies.

Supplied Accessories

<p>CA-590 Compact Power Adapter</p> 	<p>BP-2L5 Battery Pack</p> 	<p>Lithium Button Battery CR1616</p> 	<p>STV-250N Stereo Video Cable</p> 
<p>WL-D85 Wireless Controller</p> 	<p>Lithium Button Battery CR2025 for Wireless Controller</p> 	<p>IFC-300PCU USB Cable</p> 	<p>DIGITAL VIDEO SOLUTION DISK Software CD-ROM*</p> 

* Includes the electronic version of the *Digital Video Software* instruction manual on PDF file.

Online product registration for U.S.A. Customers only.

Register your product online at www.registercanon.com

✓ **Protect your product**

We will keep the model number and date of purchase of your new Canon product on file to help you refer to this information in the event of an insurance claim such as loss or theft.

✓ **Receive information on new products and promotions**

Upon your request, we will send you information on Canon new products and promotions.

The serial number of this product can be found at the battery attachment unit of the camcorder. Write down the number and other information here and retain this book as a permanent record of your purchase to aid identification in case of theft.

Date of Purchase:

Model Name: ZR850/ZR830 A

Purchased From:

Serial No.:

Dealer Address:

Dealer Phone No.:

Components Guide

Left side view

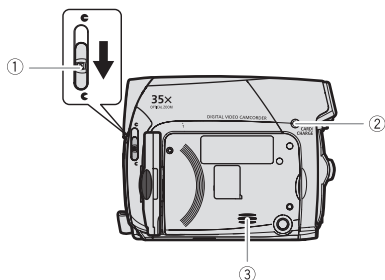

- ① Lens cover switch (☐ 28, 29)
(☐ open, ☐ closed)
- ② CARD access indicator (☐ 29, 30)/
CHARGE indicator (☐ 19)
- ③ Speaker
- ④ Memory card slot (☐ 22)
- ⑤ AV terminal (☐ 63)
- ⑥ USB terminal (☐ 68)
- ⑦ DV terminal (☐ 63, 68)
- ⑧ Terminal cover
- ⑨ Grip belt (☐ 22)
- ⑩ Strap mount (☐ 90)
- ⑪ Lock button

Right Side View

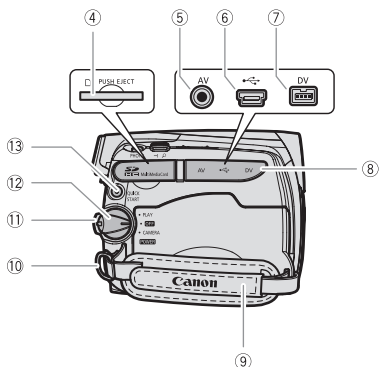

- ⑫ **POWER** switch (☐ 10)
- ⑬ **QUICK START** button (☐ 31)
- ⑭ Remote sensor (☐ 23)
- ⑮ **ZR850** LED light (assist lamp) (☐ 56)
- ⑯ Stereo microphone

Names of buttons and switches other than the joystick are indicated within a "button" frame (for example **[FUNC.]**).

Front view

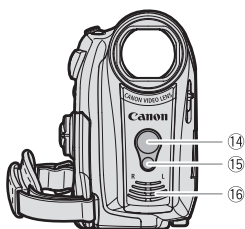

Back view

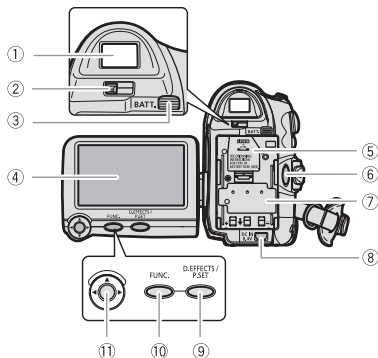

- ① Viewfinder (22)
- ② Dioptic adjustment lever (22)
- ③ BATT. (battery release) switch (19)
- ④ LCD screen (23)
- ⑤ Backup battery compartment (30)
- ⑥ Start/stop button (28, 29)
- ⑦ Serial number, Battery attachment unit (19)
- ⑧ DC IN terminal (19)
- ⑨ D.EFFECTS button (56)/ P.SET button (72)
- ⑩ FUNC. button (24, 37)
- ⑪ Joystick (9)
- ⑫ PHOTO button (29)
- ⑬ Zoom lever (31)
- ⑭ Mode switch (45)

Top view

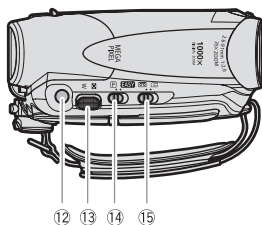

- ⑫ PHOTO button (29)
- ⑬ Zoom lever (31)
- ⑭ Mode switch (45)
- EASY** Easy recording
- P** Recording programs
- ⑮ / (tape/card) switch (10)
- ⑯ Cassette compartment (21)
- ⑰ OPEN/EJECT switch (21)
- ⑱ Cassette compartment cover (21)
- ⑲ Tripod socket (29)

Bottom view

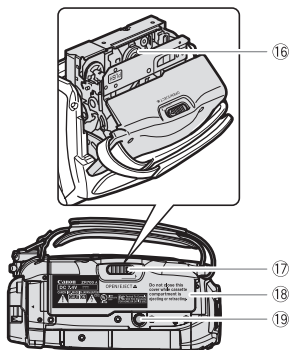

Names of buttons and switches other than the joystick are indicated within a "button" frame (for example **FUNC.**).

Wireless Controller WL-D85

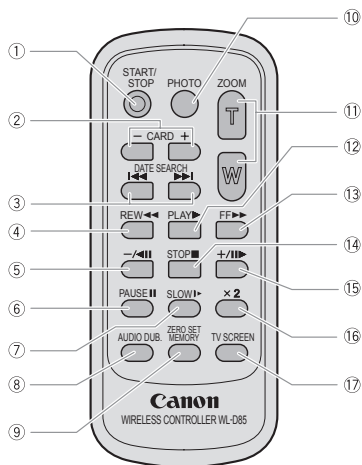

- ① START/STOP button (□ 28)
- ② CARD -/+ buttons (□ 34)
- ③ DATE SEARCH ◀▶ buttons (□ 34)
- ④ REW ◀ button (□ 32)
- ⑤ -/◀ button (□ 32)
- ⑥ PAUSE || button (□ 32)
- ⑦ SLOW ▶ button (□ 32)
- ⑧ AUDIO DUB. button (□ 66)
- ⑨ ZERO SET MEMORY button (□ 33)
- ⑩ PHOTO button (□ 29)
- ⑪ Zoom buttons (□ 31)
- ⑫ PLAY ▶ button (□ 32)
- ⑬ FF ▶▶ button (□ 32)
- ⑭ STOP ■ button (□ 32)
- ⑮ +/▶ button (□ 32)
- ⑯ x2 button (□ 32)
- ⑰ TV SCREEN button (□ 42)





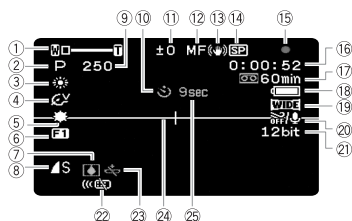



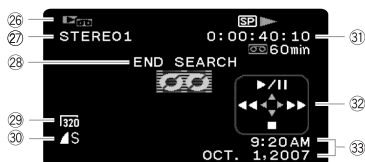





















Screen Displays

CAMERA Recording Movies



PLAY Playing Movies



- ① Zoom () 31, Exposure   ( 47)
- ② Recording program ( 45)
- ③ White balance ( 49)
- ④ Image effect ( 50)
- ⑤  LED light ( 56)
- ⑥ Digital effects ( 56)
- ⑦ Condensation warning ( 86)
- ⑧ Still image quality/size (simultaneous recording) ( 53)
- ⑨ Shutter speed ( 46)
- ⑩ Self timer ( 56)
- ⑪ Exposure adjustment ( 47)
- ⑫ Manual focus ( 48)
- ⑬ Image stabilizer ( 40)
- ⑭ Recording mode ( 40)
- ⑮ Tape operation
- ⑯ Time code (hours : minutes : seconds)
- ⑰ Remaining tape
- ⑱ Widescreen 16:9 mode ( 40)
- ⑲ Wind screen off ( 41)
- ⑳ Audio recording mode ( 50)
- ㉑ Remote sensor off ( 43)
- ㉒ Backup battery warning
- ㉓ Level marker ( 42)
- ㉔ Recording reminder
- ㉕ Operating mode ( 10)
- ㉖ Audio playback mode ( 51)
- ㉗ Search function display
END SEARCH ( 34)/DATE SEARCH ( 34)
- ㉘ Movie size for capturing video on the memory card ( 54)
- ㉙ Quality/size for capturing still images ( 54)
- ㉚ Playback time
(hours : minutes : seconds : frames)
- ㉛ Joystick guide ( 9)
- ㉜ Data code ( 55)

15 Tape operation

- Record, ● || Record pause,
- Stop, ▲ Eject,
- ▶▶ Fast forward, ◀◀ Rewind,
- ▶ Playback, ▶ || Playback pause,
- || ◀ Reverse playback pause,
- x1 ▶ Playback (normal speed),
- ◀x1 Reverse playback (normal speed),
- x2 ▶ Playback (double speed),
- ◀x2 Reverse playback (double speed),
- ▶▶ Fast forward playback,
- ◀◀ Rewind playback,
- ▶ Slow playback,
- ◀ Slow reverse playback,
- || Frame advance,
- ◀ Frame reverse,
- ◀◀/▶▶ Date search (□ 34),
- ◀◀/▶▶ Zero set memory (□ 33)

17 Remaining tape

Indicates the remaining time of the tape in minutes. "00" moves during recording. When the tape reaches its end, the display changes to "00 END".

- When the time left is less than 15 seconds, the remaining tape time may not appear.
- Depending on the type of tape, the remaining time displayed may not be correct. In any case, you will be able to record on the tape the number of minutes that appears on the videocassette's label (for example, 85 minutes).

18 Remaining battery charge



- When "⚡" starts flashing in red replace the battery pack with a fully charged one.
- When you attach an empty battery pack, the power may turn off without displaying "⚡".
- Depending on the conditions under which the camcorder and the battery pack are used, the actual battery charge may not be indicated accurately.

23 Backup battery warning

⚡ flashes in red when the lithium button battery is not installed, or when it needs to be replaced.

25 Recording reminder

The camcorder counts from 1 to 10 seconds when you start recording. This is helpful to avoid scenes that are too short.

CAMERA Recording Still Images

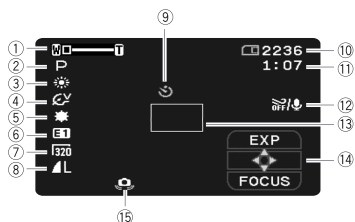

- ① Zoom (31), Exposure (47)
- ② Recording program (45)
- ③ White balance (49)
- ④ Image effect (50)
- ⑤ **LED** LED light (56)
- ⑥ Digital effects (56)
- ⑦ Movie clip size (movie recorded on the memory card) (29)
- ⑧ Still image quality/size (52)
- ⑨ Self timer (56)
- ⑩ Number of still images available on the memory card
- ⑪ Movie recording time available on the memory card
- ⑫ Wind screen off (41)
- ⑬ AF frame (54)
- ⑭ Joystick guide (56)
- ⑮ Camcorder shake warning (39)

PLAY Viewing Still Images

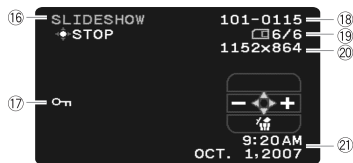

- ⑬ Slideshow (35)
- ⑭ Image protection mark (61)
- ⑮ Image number (44)
- ⑯ Current image /Total number of images
- ⑰ Still image size
- ⑱ Data code (55)
- ⑲ Movie clip length (movie recorded on the memory card)



⑩ Number of still images available on the memory card

Depending on the recording conditions, the number of available still images displayed may not decrease even after a recording has been made, or may decrease by 2 still images at once.

Card Access Display

“▶ ” is displayed next to the number of images available while the camcorder is writing on the memory card.

⑪ Movie recording time on the memory card

Indicates the remaining time in hours : minutes. At less than 1 minute, the remaining time will be displayed in 10-second steps, at less than 10 seconds in 1-second steps.

- Depending on the recording conditions, the actual remaining time may not be indicated accurately.

Getting Started

Charging the Battery Pack

The camcorder can be powered with a battery pack or directly using the compact power adapter. Charge the battery pack before use.

Remove the battery terminal cover before attaching the battery

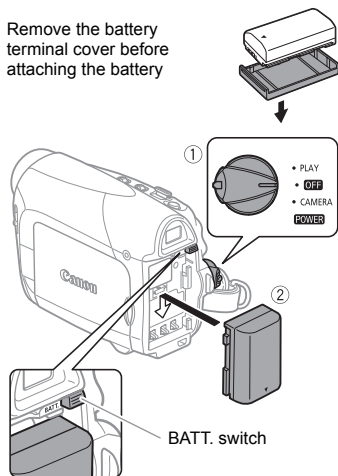

- 1 Turn off the camcorder.
- 2 Attach the battery pack to the camcorder.
 - Press the battery pack lightly and slide it down until it clicks.

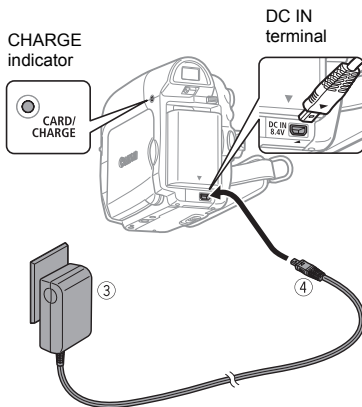

- 3 Plug the compact power adapter into a power outlet.
- 4 Connect the compact power adapter to the camcorder's DC IN terminal.
 - The CHARGE indicator starts flashing. The indicator will stay on when the charging is completed.
 - You can also use the compact power adapter without attaching a battery pack.
 - When the compact power adapter is connected, even if a battery is attached its power will not be consumed.

ONCE THE BATTERY IS FULLY CHARGED

- 1 Disconnect the compact power adapter from the camcorder.
- 2 Unplug the compact power adapter from the power outlet.

TO REMOVE THE BATTERY PACK

Press **BATT.** to release the battery pack. Lift the battery pack and then pull it out.

! IMPORTANT

- You may hear some noise from the compact power adapter during use. This is not a malfunction.
- We recommend charging the battery pack in temperatures between 10 °C and 30 °C (50 °F and 86 °F). Outside the temperature range of 0 °C to 40 °C (32 °F to 104 °F), the charging will not start.
- Do not connect to the camcorder's DC IN terminal or to the compact power adapter any electrical equipment that is not expressly recommended for use with this camcorder.
- To prevent equipment breakdowns and excessive heating, do not connect the supplied compact power adapter to voltage converters for overseas travels or special power sources such as those on aircraft and ships, DC-AC inverters, etc.

i NOTES

- The CHARGE indicator also serves as a rough estimate of the battery charge status. Continuously on: Battery fully charged. Flashes approx. twice per second: Battery over 50% charged. Flashes approx. once per second: Battery less than 50% charged.
- The charging time will vary depending on the surrounding temperature and the battery pack's initial charge condition. In cold places, the effective usage time of the battery will decrease.
- We recommend that you prepare battery packs 2 to 3 times longer than you think you might need.
- **U.S.A. and Canada only:** The lithium ion/polymer battery that powers this product is recyclable. Please call 1-800-8-BATTERY for information on how to recycle this battery.

**Charging, Recording and Playback Times**

The times given in the table below are approximate and vary depending on the actual charging, recording or playback conditions.

Battery Pack	BP-2L5	NB-2L	NB-2LH	BP-2L12	BP-2L14
Charging Time	145 min.	150 min.	160 min.	240 min.	285 min.

ZR850 Maximum Recording Times

Viewfinder	95 min.	105 min.	125 min.	225 min.	275 min.
LCD [NORMAL]	90 min.	105 min.	125 min.	225 min.	275 min.
LCD [BRIGHT]	90 min.	105 min.	125 min.	215 min.	265 min.

Typical Recording Times*

Viewfinder	50 min.	55 min.	70 min.	120 min.	150 min.
LCD [NORMAL]	50 min.	55 min.	70 min.	120 min.	150 min.
LCD [BRIGHT]	45 min.	50 min.	65 min.	115 min.	140 min.
Playback Times	105 min.	120 min.	145 min.	255 min.	310 min.

ZR30 Maximum Recording Times

Viewfinder	105 min.	120 min.	145 min.	250 min.	305 min.
LCD [NORMAL]	100 min.	120 min.	145 min.	245 min.	300 min.
LCD [BRIGHT]	95 min.	110 min.	135 min.	230 min.	280 min.

Typical Recording Times*

Viewfinder	60 min.	65 min.	80 min.	135 min.	165 min.
LCD [NORMAL]	55 min.	65 min.	80 min.	130 min.	165 min.
LCD [BRIGHT]	50 min.	60 min.	75 min.	125 min.	155 min.
Playback Times	110 min.	125 min.	150 min.	265 min.	320 min.

* Approximate times for recording with repeated operations such as start/stop, zooming, power on/off.

Installing the Backup Battery

The backup battery (lithium button battery CR1616) allows the camcorder to retain the date, time ( 26) and other camcorder settings while the power source is disconnected. Connect a power source to the camcorder when replacing the backup battery to retain the settings.

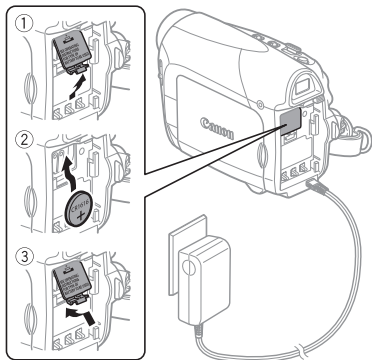

- 1 If a battery pack is attached, remove it first.
- 2 Open the backup battery cover.
- 3 Insert the backup battery with the + side facing out.

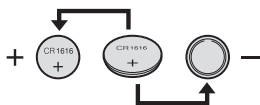

- 4 Close the cover.



NOTES

The backup battery has a life span of about a year.  flashes in red to inform you that it needs to be replaced.

Inserting and Removing a Tape

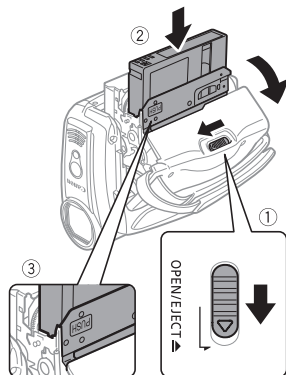
Use only videocassettes marked with the  logo.



- 1 Slide  fully in the direction of the arrow and open the cassette compartment cover. The cassette compartment opens automatically.
- 2 Insert the cassette.
 - Insert the cassette with the window facing the grip belt.
 - To remove a cassette pull it straight out.
- 3 Press the  mark on the cassette compartment until it clicks.

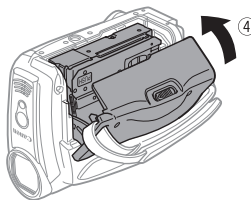

- 4 Wait for the cassette compartment to retract automatically and close the cassette compartment cover.

! IMPORTANT

- Do not interfere with the cassette compartment while it is opening or closing automatically, or attempt to close the cover before the cassette compartment has fully retracted.
- Be careful not to get your fingers caught in the cassette compartment cover.

i NOTES

If the camcorder is connected to a power source, cassettes can be inserted/removed even if the **POWER** switch is set to **OFF**.

Inserting and Removing a Memory Card

You can use commercially available  SDHC memory cards,  SD memory cards or MultiMedia cards (MMC) with this camcorder.

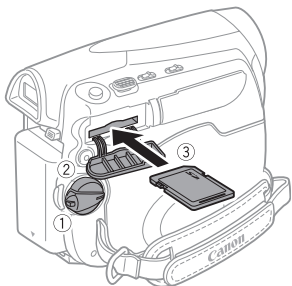

- 1 Turn off the camcorder.
- 2 Open the memory card slot cover.
- 3 Insert the memory card straight all the way into the memory card slot.
- 4 Close the cover.

Do not force the cover closed if the memory card is not correctly inserted.

TO REMOVE THE MEMORY CARD

First push the memory card once to release it, and then pull the card out.

! IMPORTANT

- Make sure to initialize all memory cards before using them with this camcorder for the first time (□ 62).
- Memory cards have front and back sides that are not interchangeable. Inserting a memory card facing the wrong direction can cause a malfunction of the camcorder.

i NOTES

- Proper operation cannot be guaranteed for all memory cards.
- **About SDHC Memory Cards:** SDHC (SD High Capacity) is the new type of SD memory cards with capacities over 2 GB. Please note that the specifications of SDHC memory cards are different from those of regular SD cards and you will not be able to use memory cards of over 2 GB with devices that do not support SDHC. However, SDHC devices (including this camcorder) are backward compatible and you can use regular SD cards with them.

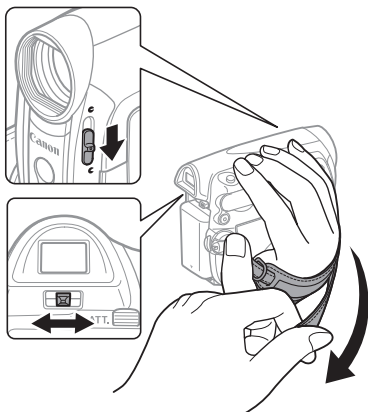
Preparing the Camcorder

- 1 Turn on the camcorder.
- 2 Move the lens cover switch down to  to open the lens cover.

3 Adjust the viewfinder.

Keep the LCD panel closed to use the viewfinder and adjust the dioptic adjustment lever as necessary.

4 Fasten the grip belt.

Adjust the grip belt so that you can reach the zoom lever with your index finger, and the start/stop button with your thumb.

Point the controller at the camcorder's remote sensor when you press the buttons.

i NOTES

- The wireless controller may not work properly when the remote sensor is situated under strong light sources or direct sunlight.
- If the wireless controller does not work, check that [WL.REMOTE] is not set to [OFF (OFF)] (□ 43). Otherwise, replace the battery.

The Wireless Controller

Inserting the Battery

(Lithium Button Battery CR2025)

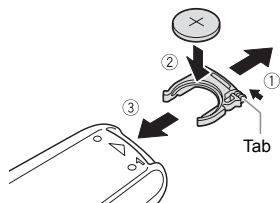

- 1 Press the tab in the direction of the arrow and pull out the battery holder.
- 2 Place the lithium button battery with the + side facing up.
- 3 Insert the battery holder.

Using the Wireless Controller

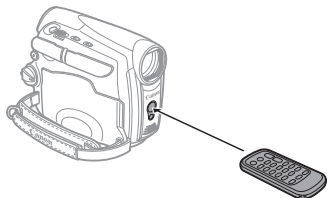

Adjusting the LCD Screen

Rotating the LCD Panel

Open the LCD panel 90 degrees.

You can rotate the panel 90 degrees downward.

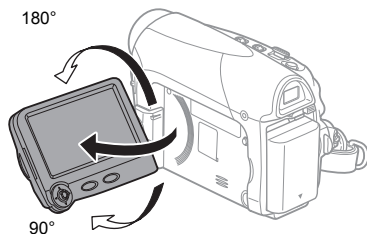

You can rotate the panel 180 degrees toward the lens (allowing the subject to monitor the LCD screen while you use the viewfinder). Rotating the panel 180 degrees is also useful if you wish to include yourself when recording with the self timer.

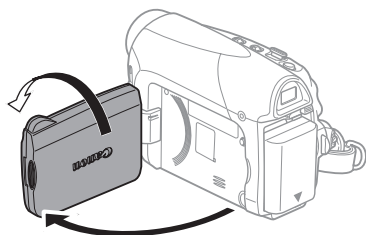

Subject can monitor the LCD screen

LCD Backlight

You can set the brightness of the LCD screen at normal or bright.

FUNC.
(24)

FUNC.



- 1 Press **FUNC.**
- 2 Select (**▲▼**) the icon and press (**⊙**) to open the setup menus.
- 3 Select (**▲▼**) [**DISPLAY SETUP/**] and press (**⊙**).
- 4 Select (**▲▼**) [**BACKLIGHT**] and press (**⊙**).
- 5 Select (**▲▼**) the desired option and press (**⊙**).
- 6 Press **FUNC.** to close the menu.

NOTES

- This setting does not affect the brightness of the recording or the viewfinder screen.
- Using the [BRIGHT] setting will shorten the effective usage time of the battery pack.

Using the Menu

Many of the camcorder's functions can be adjusted from the menus that open after pressing the **FUNC.** button (). For details about the available menu options and settings, refer to *Menu Options Lists* (37).

Selecting a FUNC. Menu Option

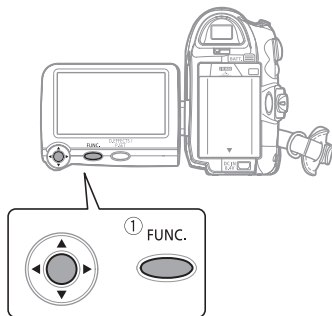

- 1 Press **FUNC.**
- 2 Select (**▲▼**) the icon of the function you want to change from the left side column.
- 3 Select (**◀▶**) the desired setting from the available options at the bottom bar.

The selected option will be highlighted in light blue. Menu items not available will appear grayed out.

4 Press **[FUNC.]** to save the settings and close the menu.

- You can press **[FUNC.]** to close the menu at any time.
- With some settings you will need to press (⊕) and make further selections. Follow the additional operation guides that will appear on the screen (such as the joystick icon ⊕, small arrows, etc.).

Selecting an Option from the Setup Menus

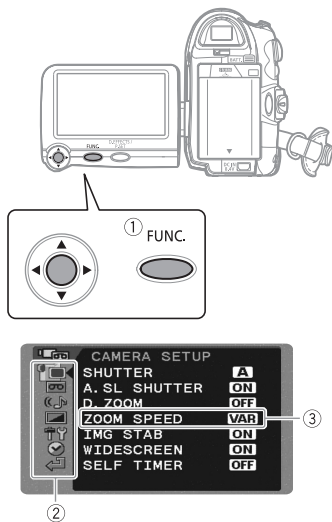

1 Press **[FUNC.]**.

2 Select (▲▼) the icon and press (⊕) to open the setup menus.

You can also hold **[FUNC.]** pressed down for more than 2 seconds to open directly the setup menu screen.

3 Select (▲▼) the desired menu from the left side column and press (⊕).

The title of the selected menu appears on top of the screen and under it the list of settings.

4 Select (▲▼) the setting you want to change and press (⊕).

• An orange frame will indicate the menu item currently selected. Menu items not available will appear grayed out.

• To return to the menu selection screen, select (▼) [ RETURN] and press (⊕).

5 Select (▲▼) the desired option and press (⊕) to save the setting.

6 Press **[FUNC.]**.

You can press **[FUNC.]** to close the menu at any time.

First Time Settings

Changing the Language

The language for on-screen and menu displays can be changed. The list of available languages depends on the region where you purchased the camcorder.

Language Set A

English, German, Spanish, French, Italian, Polish, Russian, Simplified Chinese and Japanese.

Language Set B

English, Simplified Chinese, Traditional Chinese and Korean.

◆ Default value

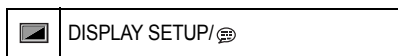

LANGUAGE ENGLISH*

FUNC.
(24)

FUNC.



- 1 Press **FUNC.**.
- 2 Select (**▲▼**) the icon and press (**⊗**) to open the setup menus.
- 3 Select (**▲▼**) [DISPLAY SETUP/🗨️] and press (**⊗**).
- 4 Select (**▲▼**) [LANGUAGE] and press (**⊗**).
- 5 Select (**▲▼**) the desired option and press (**⊗**).
- 6 Press **FUNC.** to close the menu.

NOTES

- If you changed the language by mistake, follow the mark next to the menu item to change the setting.
- The displays **FUNC.** and **PSET** that appear in some print-related screens refer to the name

of buttons on the camcorder and will not change, regardless of the language selected.

Changing the Time Zone

◆ Default value

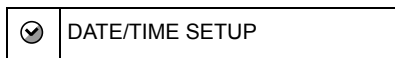

T.ZONE/DST NEW YORK*

FUNC.
(24)

FUNC.



- 1 Press **FUNC.**.
- 2 Select (**▲▼**) the icon and press (**⊗**) to open the setup menus.
- 3 Select (**▲▼**) [DATE/TIME SETUP] and press (**⊗**).
- 4 Select (**▲▼**) [T.ZONE/DST] and press (**⊗**).
The time zone setting appears. The default setting is New York or Singapore, depending on the region of purchase.
- 5 Select (**▲▼**) your time zone and press (**⊗**).
To adjust for daylight saving time, select the time zone with the mark next to the area.
- 6 Press **FUNC.** to close the menu.

Time Zones

Once you have set the time zone, date and time, you do not need to reset the clock every time you travel to another time zone. Select the time zone referring to the date and time displayed on the screen.

Setting the Date and Time

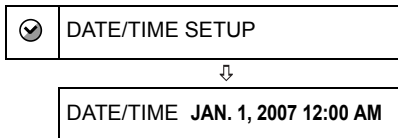

FUNC.
(24)



- 1 Press **FUNC.**.
- 2 Select (**▲▼**) the icon and press () to open the setup menus.
- 3 Select (**▲▼**) **[DATE/TIME SETUP]** and press () .
- 4 Select (**▲▼**) **[DATE/TIME]** and press () .
Blinking arrows will be displayed around the first field of the date.
- 5 Change each field of the date and time with the joystick's (**▲▼**) and move (**▶**) to the next field.
- 6 Press () to start the clock.
- 7 Press **FUNC.** to close the menu.

NOTES

You can also change the date format (44).





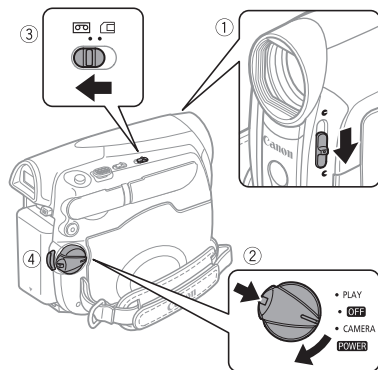

Recording

Recording Movies

Before You Begin Recording







Make a test recording first to check if the camcorder operates correctly. If necessary, clean the video heads ( 2).

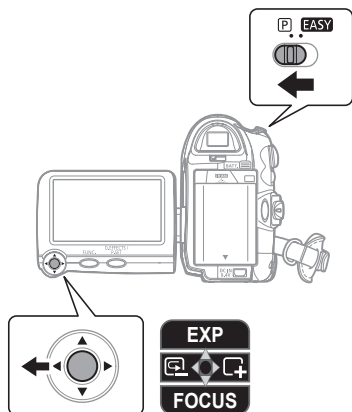

- 1 Move the lens cover switch down to  to open the lens cover.
- 2 Holding the lock button pressed down, set the **POWER** switch to **CAMERA**.
- 3 Move the  /  switch to  (tape).
- 4 Press  to begin recording. Press  again to pause the recording.

TO REVIEW THE LAST SCENE RECORDED



- 1 Set the mode switch to **P**.
- 2 If the joystick guide does not appear on screen, press  to display it.
- 3 Push the joystick () momentarily towards  and release it.
 - The camcorder will play back a few seconds of the last recording made and return to record pause mode.
 - You can also hold the joystick pressed () towards  or () towards  to play back the tape (reverse or forward respectively) to locate the point where you want to start recording.

WHEN YOU HAVE FINISHED RECORDING

- 1 Close the lens cover and the LCD panel.
- 2 Turn off the camcorder.
- 3 Remove the tape.
- 4 Disconnect the power source and remove the battery pack.

i NOTES

● **About the recording time:** By changing the recording mode you can change the video quality and as a result, also the available recording time (□ 40).

● Previous recordings overwritten by a new recording cannot be recovered. Before you start recording, search for the end of the last recording (□ 34).

● To protect the tape and video heads, the camcorder will enter the stop mode (■) if left in record pause (● ||) mode for 4 minutes 30 seconds. To resume recording press [Start/Stop].

● When recording in very loud places (such as fireworks shows or concerts), sound may become distorted or it may not be recorded at the actual levels. This is not a malfunction.

● **About the Power Save mode:** To save power when the camcorder is powered by a battery pack, the camcorder will automatically shut off if left without any operations for 5 minutes (□ 43). To restore the power, turn the camcorder off and then on again.

● **About the LCD and viewfinder screen:** The screens are produced using extremely high-precision manufacturing techniques, with more than 99.99% of the pixels operating to specification. Less than 0.01% of the pixels may occasionally misfire or appear as black, red, blue or green dots. This has no effect on the recorded image and does not constitute a malfunction.

● **When using a tripod:** Do not leave the viewfinder exposed to direct sunlight as it may melt (due to concentration of the light by the lens). Do not use tripods with fastening screws longer than 5.5 mm (0.2 inch). Doing so may damage the camcorder.

● **When recording movies, try to get a calm, stable picture.**

Excessive camcorder movement while shooting and extensive use of fast zooms and panning can result in fidgety, jittery scenes. In extreme cases the playback of such scenes may result in visually induced motion sickness. If you experience such a reaction, immediately stop the playback and take a rest break as necessary.

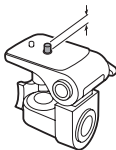

Recording Still Images on the Memory Card

Before using a memory card for the first time, be sure to initialize it with this camcorder (□ 62).

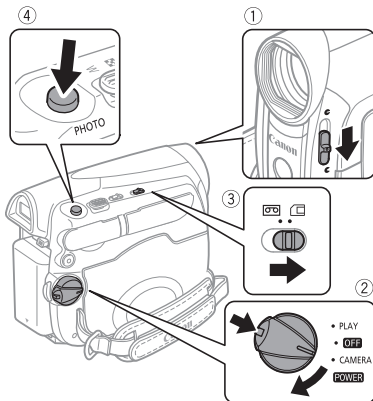

- 1 Move the lens cover switch down to to open the lens cover.
- 2 Holding the lock button pressed down, set the **POWER** switch to **CAMERA**.
- 3 Move the switch to (memory card).
- 4 Press **PHOTO**.
 - Once the focus is automatically adjusted, ● will turn green and one or more AF frames will appear.
 - The **CARD** access indicator will flash as the image is being recorded.

! IMPORTANT

Avoid the following actions while the card access display (▶ □) appears on screen and when the CARD access indicator is on or flashing. Failing to do so may result in permanent data loss.

- Do not open the memory card slot cover and do not remove the memory card.
- Do not disconnect the power source or turn off the camcorder.
- Do not change the position of the / switch or the operating mode.

i NOTES

If the subject is not suitable for autofocus, ● turns yellow. Adjust the focus manually (□ 48).

Recording Movie Clips on the Memory Card

You can record Motion JPEG movie clips on the memory card. The sound for the movies on the memory card will be monaural.



- 1 Move the lens cover switch down to to open the lens cover.
- 2 Holding the lock button pressed down, set the **POWER** switch to **CAMERA**.
- 3 Move the / switch to (memory card).

TO SELECT THE MOVIE CLIP SIZE

- 4 Press **[FUNC.]**.
- 5 Select (▲▼) [**MOVIE REC OFF**] and select (◀▶) the desired movie size.

The number displayed on the right corner indicates the approximate recording time available on the memory card.

- 6 Press **[FUNC.]** to close the menu.

TO RECORD THE MOVIE CLIP

- 7 Press **[Start/Stop]** to begin recording.
 - Press **[Start/Stop]** again to pause the recording.
 - **SD/SDHC memory cards:** You can record until "CARD FULL" appears (approx. 33 minutes with a 512 MB SD Memory Card). **MultiMedia cards:** The recording time is limited to 10 seconds at [320x240] or 30 seconds at [160x120].

! IMPORTANT

Avoid the following actions while the card access display (▶ □) appears on screen and when the CARD access indicator is on or flashing. Failing to do so may result in permanent data loss.

- Do not open the memory card slot cover and do not remove the memory card.
- Do not disconnect the power source or turn off the camcorder.
- Do not change the position of the / switch or the operating mode.
- Do not insert/remove a tape while recording movie clips on the memory card.

i NOTES

We recommend using a Canon SD Memory Card, or an SD Memory Card with a transfer rate of more than 2 MB/sec., after having initialized it with this camcorder. With memory cards not initialized with this camcorder, or after repeated times of recording/erasing the card, the writing speed may fall and the recording may stop.

Windows XP users: When you plan to connect the camcorder to a computer, keep the length of one movie clip shorter than approx. 12 minutes at [320x240] or 35 minutes at [160x120].

Zooming

POINTS TO CHECK



CAMERA: In addition to the 35x optical zoom, the digital zoom (up to 1000x) is also available (39).

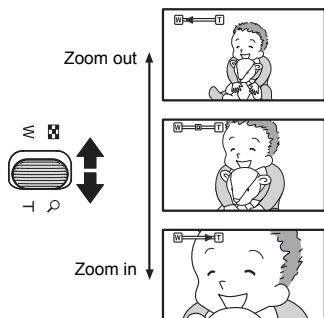

35x Optical Zoom

Move the zoom lever toward **W** to zoom out (wide-angle). Move it toward **T** to zoom in (telephoto).

You can also change the zoom speed (39). You can select one of three fixed zoom speeds or a variable speed that depends on how you operate the zoom lever: Press gently for a slow zoom; press harder for faster zooms.

NOTES

- You can also use the **T** and **W** buttons on the wireless controller. The zoom speed with the wireless controller will be the same as with the camcorder (when one of the fixed zoom speed levels is selected) or fixed at [SPEED 3] (when [VARIABLE] is selected).

- When set to [VARIABLE], the zoom speed will be faster in the record pause mode.

- Keep at least 1 m (3.3 ft.) to the subject. At wide-angle, you can focus on a subject as close as 1 cm (0.39 in.).

Quick Start Function

Using the Quick Start function, you'll never have to miss out on those great and fleeting opportunities to take a picture or record video. When you press **QUICK START** instead of turning off the camcorder, you can get it ready to start recording within approx. 1 second.

POINTS TO CHECK



CAMERA: You cannot enter the Quick-Start ready mode while recording.

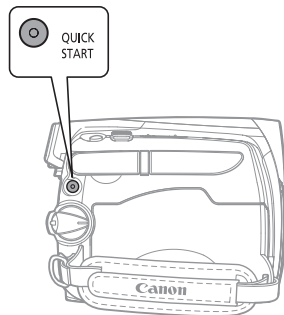

1 Press **QUICK START**.

- The **QUICK START** button lights up to signal that the camcorder is Quick-Start ready – “ready and waiting” to start recording.
- Sometimes the **QUICK START** button will flash as the camcorder completes some preparations. The camcorder is Quick-Start ready when the button stops flashing and stays on.

2 When you wish to resume recording, press **QUICK START** again.

Within approx. 1 second, the camcorder is ready in record pause mode.

i NOTES

● When you wake up the camcorder from Quick Start mode, the following settings will be changed automatically.

- Manual focus returns to automatic focus (AF).
- Manual exposure adjustment returns to automatic exposure.

- Zoom position returns to full wide angle **W**.

● In Quick-Start ready mode, the camcorder consumes only half the power used while recording. Using this mode you can save energy when using a battery pack.

● While the camcorder is in Quick-Start ready mode (QUICK START button lit up):

- If you change the position of the / switch, the camcorder will shut off. To restore the power, turn the camcorder off and then on again.
- The camcorder will shut off if left in the Quick-Start ready mode for 30 minutes, regardless of the [POWER SAVE] setting (43). To restore the power, turn the camcorder off and then on again.
- If you open the cassette compartment cover, the camcorder will return to record pause mode.

Playback

Playing Back Movies

Play back the tape on the LCD display or close the LCD panel to use the viewfinder. You can also turn the LCD panel and close it with the screen facing out.

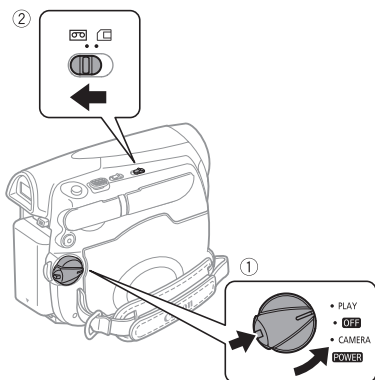

1 Holding the lock button pressed down, set the **POWER** switch to **PLAY**.

2 Move the / switch to (tape).

3 If the joystick guide does not appear on screen, press () to display it.

4 Locate the point where you want to begin the playback.

Push the joystick () towards to rewind the tape or () towards to fast forward.

- 5 Push the joystick (▲) towards ►/|| to begin the playback.**

DURING PLAYBACK







- 6 Push the joystick (▲) towards ►/|| again to pause the playback.**
- 7 Push the joystick (▼) towards ■ to stop the playback.**

TO ADJUST THE VOLUME



- 1 Press [FUNC].**
- 2 Select (▲▼) [M] SPEAKER VOLUME] and adjust (◀▶) the volume.**
- The sound from the built-in speaker will be muted when you close the LCD panel or while the STV-250N Stereo Video Cable is connected to the AV terminal.
 - If you turn off the volume completely, the icon will change to .
- 3 Press [FUNC] to close the menu.**

SPECIAL PLAYBACK MODES

To operate the special playback modes use the buttons on the wireless controller. There is no sound during the special playback modes. To return to normal playback, push the joystick (▲) towards ►/|| or press  on the wireless controller.

- Fast Playback:** Push the joystick (◀) towards ◀◀ or (▶) towards ▶▶. Hold the joystick pressed down to rewind/fast forward the tape while continuing the playback. You can also press and hold  or  on the wireless controller.
- Reverse Playback:** During normal playback press .
- Frame Reverse/Advance:** During playback pause press . Keep pressed for continuous frame-by-frame playback.
- Slow Playback:** During normal or reverse playback press .
- Double Speed Playback:** During normal or reverse playback press .







NOTES

- You can display the date and time of the recording ( 55).
- During some special playback modes, you may notice some video problems (blocky video artifacts, banding, etc.) in the playback picture.
- To protect the tape and video heads, the camcorder will enter the stop mode () if left in playback pause (►||) mode for 4 minutes 30 seconds. To resume the playback push the joystick (▲) towards ►/||.

Returning to a Pre-marked Position

If you wish to return to a particular scene later, mark the point with the zero set memory and the tape will stop at that point when you rewind/fast forward the tape.



- While recording or during playback, press [ZERO SET MEMORY] on the wireless controller at the point you wish to return to later.**
 - The time code changes to "0:00:00 .
 - Press [ZERO SET MEMORY] again to cancel the memory.
- If you marked the zero memory while recording, set the camcorder to [PLAY] mode. If you marked the zero memory during playback, press .**
- Press  to locate the zero mark.**
 - If the tape counter shows a negative number, press  instead.
 -  appears and the camcorder rewinds/fast forwards the tape.
 - The tape stops at or near the zero mark,  disappears and the correct time code will be displayed again.

i NOTES

If there are blank sections between recordings, the zero set memory may not work correctly.

Locating the End of the Last Scene

After playing back a tape, use this function to locate the end of the last scene recorded in order to continue recording from that point.

✓ POINTS TO CHECK

Stop the playback before using this function.

FUNC.
(24)

FUNC.



- 1 Press **FUNC.**.
- 2 Select (**▲▼**) [**→| END SEARCH**] and press (**⊗**).
- 3 Select (**◀▶**) [**EXECUTE**] and press (**⊗**).
 - "END SEARCH" appears.
 - The camcorder rewinds/fast forwards the tape, plays back the last few seconds of the recording and stops the tape.
 - To cancel the search push the joystick (**▼**) towards **■**.

i NOTES

- End search cannot be used once you remove the cassette.
- If there are blank sections between recordings, the end search may not work correctly.
- You cannot use the end search to locate the end of a scene that was audio dubbed.

Locating Scenes by Recording Date

You can locate the change of the date/time zone with the date search function.



Press **◀◀** or **▶▶** on the wireless controller.

- Press more than once to search for further date changes (up to 10 times).
- To cancel the search press **STOP**.

i NOTES

- Recordings shorter than 1 minute per date/time zone cannot be located with this function.
- Date search may not function if the data code is not correctly displayed.

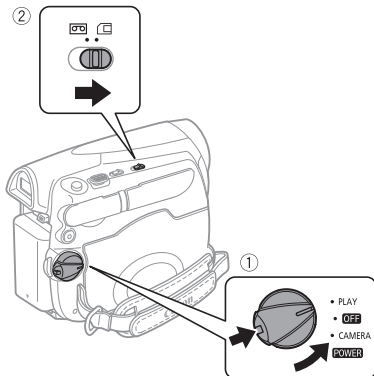
Playing Back Still Images and Movie Clips from a Memory Card

- 1 Holding the lock button pressed down, set the **POWER** switch to **PLAY**.

2 Move the  /  switch to  (memory card).

To VIEW STILL IMAGES



3 If the joystick guide does not appear on screen, press  to display it.





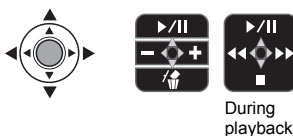



4 Push the joystick () to move between the images.

To PLAY BACK MOVIE CLIPS





During playback

5 Push the joystick () towards  to begin the playback.

- Push the joystick () towards  again to pause/resume the playback.
- Push the joystick () and hold it pressed towards  or  to rewind/fast forward the movie clip. You can also press and hold  or  on the wireless controller.
- Push the joystick () towards  to stop the playback.
- When the movie playback ends or is stopped, the first frame of the movie appears as a still image.

! IMPORTANT

- Avoid the following actions while the card access display  appears on screen, and when the CARD access indicator is on or flashing. Failing to do so may result in permanent data loss.
- Do not open the memory card slot cover and do not remove the memory card.
- Do not disconnect the power source or turn off the camcorder.

- Do not change the position of the  /  switch or the operating mode.



- The following may not be displayed correctly.
- Images not recorded with this camcorder.
- Images edited on or uploaded from a computer (except for the sample images for the Card Mix function ( 58)).
- Images whose file names have been changed.

Image Jump

You can jump ahead to a specific image without having to browse all images one by one. With movie clips, you can only start the image jump in stop mode (when the first frame appears as a still image).

Push the joystick () and hold it pressed down. Release the joystick when the image number gets to the image you want to display.



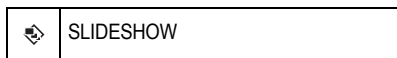

Slideshow



FUNC.
( 24)





FUNC.



- 1 Press .**
- 2 Select () [ SLIDESHOW] and press .**

- The still images and movie clips on the memory card are played back in sequence.
- Press () to stop the slideshow.

Index Screen

- 1 Move the zoom lever toward **W**.**
The index screen appears. Movies on the memory card are marked with a .
- 2 Select (, ) an image.**
Move the cursor  to the image you want to view.

3 Move the zoom lever toward **T**.

The index screen closes and the selected image is displayed.

Magnifying the Playback Image

During playback, movies and still images can be magnified up to 5 times. You can also select the area to be magnified.

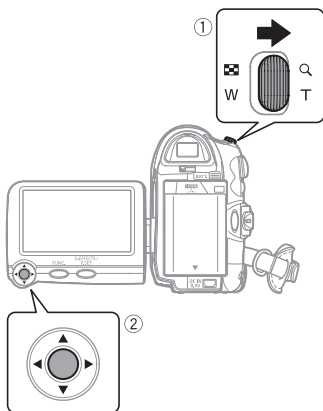

1 Move the zoom lever toward **T**.

- The image is magnified by 2 times and a frame appears indicating the position of the magnified area.
- To further enlarge the image, move the zoom lever toward **T**. To reduce the magnification, move the zoom lever toward **W**.
- ✖ will appear for images that cannot be enlarged.

2 Select (▲▼, ◀▶) the enlarged area of the picture with the joystick.

To cancel the magnification, move the zoom lever toward **W** until the frame disappears.

! IMPORTANT

- Movie clips on the memory card cannot be magnified.
- While the magnification position frame is displayed, it will replace the joystick guide. Cancel the magnification to return to normal playback of movies or still images.

Menu Options Lists

Menu items not available appear grayed out. For details about how to select an item, refer to *Using the Menus* (□ 24).

FUNC. Menu

Recording programs

(□ 45)



Mode switch: [P]

[P PROGRAM AE], [P PORTRAIT],
[S SPORTS], [N NIGHT], [W SNOW],
[B BEACH], [SUNSET],
[A SPOTLIGHT], [F FIREWORKS]

White balance

(□ 49)



Mode switch: [P]

[A AUTO], [S DAYLIGHT],
[T TUNGSTEN], [S SET]

Image effect

(□ 50)



Mode switch: [P]

[OFF IMAGE EFFECT OFF], [V VIVID],
[N NEUTRAL],
[S SOFT SKIN DETAIL]

ZR 850

Led Light

(□ 56)



[OFF LIGHT OFF], [ON LIGHT ON]

Digital effects

(□ 56)



Mode switch: [P]

[OFF D.EFFECT OFF], [F FADER],
[E EFFECT], [I CARD MIX]



Mode switch: [P]

[OFF D.EFFECT OFF], [BLK&WHT]



Mode switch: [P]

[OFF D.EFFECT OFF], [F FADER],
[E EFFECT]

Still image simultaneous recording

(□ 53)



[OFF STILL I.REC OFF],
[S FINE/640x480],
[S NORMAL/640x480]

Movie Clip Size

(□ 30, 54)



[OFF MOVIE REC OFF],
[320 320x240], [160 160x120]



[320 320x240], [160 160x120]

Still image size/quality

(52)



Size:

[Z R850] [L 1152x864],**[Z R830] [L 1024x768],****[S 640x480]**

Quality:

[▲ SUPER FINE], [▲ FINE],**[▲ NORMAL]****Still image capturing**

(54)

**[▲ S S.FINE/640x480],****[▲ S FINE/640x480],****[▲ S NORMAL/640x480]****SPEAKER VOLUME**

(32)



Adjust (◀▶) the volume with the joystick.

REC PAUSE

(65)



Press (⊕) to enter the record pause mode.

END SEARCH

(34)



Press (⊕) to search.

SLIDESHOW

(35)



Press (⊕) to start.

Still Image Protect

(61)



[OFF] PROTECT OFF],

[ON] PROTECT ON]

Protect a still image on the memory card.

[CAMERA:]: This option will appear only when you press [FUNC.] within the time set for the [REVIEW] option (or immediately after recording the still image, if set to [OFF] OFF).

PRINT ORDER

(75)



[0] - [99] COPIES

Set a print order for a still image on the memory card.

Transfer Order

(71)



[OFF] TRANS.ORDER OFF],

[ON] TRANS.ORDER ON]

Set a transfer order for a still image on the memory card.

Setup menus

CAMERA SETUP

SHUTTER

(46)



Mode switch: [P]

Recording program: [P PROGRAM AE]

[A AUTO], [1/60], [1/100], [1/250], [1/500], [1/1000] [1/2000]



Mode switch: [P]

Recording program: [P PROGRAM AE]

[A AUTO], [1/60], [1/100], [1/250]

A.SL SHUTTER



[ON ON], [OFF OFF]

The camcorder automatically uses slow shutter speeds to obtain brighter recordings in places with insufficient lighting.

- The camcorder uses shutter speeds down to 1/30 (1/15 in **CAMERA-C** mode).
- If a trailing afterimage appears, set the slow shutter to [OFF OFF].
- If  (camcorder shake warning) appears, we recommend stabilizing the camcorder, for example, by mounting it on a tripod.

D.ZOOM



[OFF OFF], [105x 105X], [1000x 1000X]

Determines the operation of the digital zoom.

- When activated, the camcorder will switch automatically to the digital zoom when you zoom in beyond the optical zoom range.

- With the digital zoom the image is digitally processed, so the image resolution will deteriorate the more you zoom in.

- The digital zoom indicator will appear in light blue from 35x up to 105x and dark blue from 105x up to 1000x.

- The digital zoom cannot be used with the [NIGHT] recording program.

ZOOM SPEED



[VAR. VARIABLE], [SPEED 3], [SPEED 2], [SPEED 1]

- When set to [VAR. VARIABLE] the zoom speed depends on how you operate the zoom lever: Press lightly for a slow zoom; press harder for faster zooms.

- The fastest zoom speed can be achieved with [VAR. VARIABLE]. Among the fixed zoom speeds, [SPEED 3] is the fastest and [SPEED 1] the slowest.

FOCUS PRI.

(54)



Mode switch: [P]



[AIAF ON:AiAF], [ON:CENTER], [OFF OFF]

REVIEW



[OFF OFF], [2s 2sec], [4s 4sec], [6s 6sec], [8s 8sec], [10s 10sec]

Selects the time to display a still image after it has been recorded.

- You can erase ( 60) or protect ( 61) the image if you press **[FUNC.]** while you are reviewing the image (or immediately after recording it, if set to **[OFF OFF]**).

IMG STAB



Mode switch: **[P]**

[ON ON], **[OFF OFF]**

The image stabilizer compensates for camcorder shake even at full telephoto.

- The image stabilizer is designed to compensate for a normal degree of camcorder shake.
- The image stabilizer may not be effective when recording in dark places using the **[NIGHT]** recording program.
- The image stabilizer cannot be turned off when the mode switch is set to **EASY**.
- We recommend setting the image stabilizer to **[OFF OFF]** when using a tripod.

WIDESCREEN



[ON ON], **[OFF OFF]**

The camcorder uses the full width of the CCD providing high-resolution 16:9 recording.

- Since the displays on the camcorder have an aspect ratio of 16:9, recordings with a 4:3 aspect ratio will appear in the center of the screen with black sidebars.
- A still image cannot be simultaneously recorded on the memory card while recording movies in widescreen (16:9) mode.
- **Playing back a widescreen recording:** TV sets compatible with the Video ID-1 system will automatically switch to wide (16:9) mode. Otherwise, change the aspect ratio of the TV manually. To play

back on a TV with normal aspect ratio (4:3) change the **[TV TYPE]** setting accordingly ( 40).

SELF TIMER

( 56)



[ON ON], **[OFF OFF]**

VCR SETUP

REC MODE



[SP STD PLAY], **[LP LONG PLAY]**

- Recording in LP mode extends the available recording time on the tape 1.5 times.
- Depending on the condition of the tape (long usage, imperfections, etc.) you may notice some video problems (blocky video artifacts, banding, etc.) in the playback picture when playing back recordings made in LP mode. We recommend using the SP mode for important recordings.
- Audio cannot be dubbed on tapes recorded in LP mode.
- If you make recordings in both SP and LP modes on the same tape, during playback you may notice some video problems in the picture at the point where the recording mode changes.
- When playing back in this camcorder tapes recorded in LP mode with other devices or vice versa, you may notice some problems in the playback picture or the sound may stop briefly.

TV TYPE



[4:3 NORMAL TV], **[16:9 WIDE TV]**

In order to display the picture in full and in the correct aspect ratio, select the setting

according to the type of television to which you will connect the camcorder.

[NORMAL TV]: TV sets with 4:3 aspect ratio.

[WIDE TV]: TV sets with 16:9 aspect ratio.

AUDIO SETUP

OUTPUT CH (51)



[L/R], [L/L], [R/R]

ZR850

AUDIO DUB. (66)



[AV AUDIO IN], [MIC MIC.IN]

WIND SCREEN



* **ZR850** : **PLAY** only when dubbing audio with the built-in microphone.

Mode switch: **P**

[**A** AUTO], [**OFF** OFF]

The camcorder automatically reduces the background sound of wind when recording outdoors.

● The wind screen cannot be turned off when the mode switch is set to **EASY**.

12bit AUDIO (51)



[ST-1 STEREO1], [ST-2 STEREO2], [1:1 MIX/FIXED], [MIX/VAR.]

MIX BALANCE (51)



ST-1 ST-2

When [12bit AUDIO] is set to [MIX/VAR.], adjust (◀▶) the sound balance with the joystick.

● The camcorder will retain the audio balance adjustment, however if you turn off the camcorder, [12bit AUDIO] will be reset to [ST-1 STEREO1].

AUDIO MODE



[16bit 16bit], [12bit 12bit]

CARD OPERATIONS

PRINT ORD.ALL ERASE (75)



[NO], [YES]

TRANS.ORD.ALL ERASE (72)



[NO], [YES]

ERASE ALL IMAGES (60)



[NO], [YES]

INITIALIZE (62)



[NO], [YES]

* The following options are available only when you press **[FUNC.]** in the index screen.

→ PROTECT*

 (p. 61)

Press **()** to protect the image.

→ PRINT ORDER*

 (p. 75)

Press **()** to set the print order.

→ TRANSFER ORDER*

 (p. 71)

Press **()** to set the transfer order.

■ DISPLAY SETUP

BRIGHTNESS





Adjust (**◀▶**) the brightness of the LCD display with the joystick.

- Changing the brightness of the LCD display does not affect that of the viewfinder or the recordings.

BACKLIGHT

 (p. 24)

[ NORMAL]*, [ BRIGHT]

* The default setting is [** BRIGHT**] when you power the camcorder using the compact power adapter.

TV SCREEN



[ON ON], [OFF OFF]







[ON ON], [OFF OFF]

When set to **[ON ON]**, the camcorder's on-screen displays will appear also on the screen of a connected TV or monitor.

When the date and time are displayed on the camcorder's screen they will also appear on a connected TV regardless of the **[TV SCREEN]** setting. Turn off the date/time display with the **[DATA CODE]** setting (p. 43).

MARKERS



[OFF OFF], [ LEVEL(WHT)], [ LEVEL(GRY)], [ GRID(WHT)], [ GRID(GRY)]

You can display a grid or a horizontal line at the center of the screen. The markers are available in white or gray. Use the markers as a reference to make sure your subject is framed correctly (vertically and/or horizontally).

- Using the markers will not affect the recordings on the tape or memory card.

DISPLAYS



[ON ON], [OFF OFF<PLAYBK>]

You can hide the on-screen displays to show only the playback picture on the full screen.

- Tape operation displays appear for 2 seconds.

- Warning messages, the data code (if activated), and displays on the index screen will appear regardless of the setting.
- All on-screen displays will appear while the playback image is magnified or a digital effect is activated.

6SEC.DATE

[**ON** ON], [**OFF** OFF]

When you start playing back a tape or when the date of the recording changes, the date and time will be displayed for 6 seconds.

DATA CODE

(55)



[**OFF** OFF], [DATE], [TIME],
[DATE & TIME]

LANGUAGE

(26)



The list of available languages depends on the region where you purchased the camcorder.

Language Set A:

[DEUTSCH], [ENGLISH], [ESPAÑOL],
[FRANÇAIS], [ITALIANO], [POLSKI],
[РУССКИЙ], [简体中文], [日本語]

Language Set B:

[ENGLISH], [简体中文], [繁體中文], [한국어]

DEMO MODE

[**ON** ON], [**OFF** OFF]

The demonstration mode displays the camcorder's main features. It starts

automatically when the camcorder is powered with the power adapter if you leave it turned on without loading a recording media for more than 5 minutes.

- To cancel the demo mode once it started, press any button, turn off the camcorder or insert a videocassette.

SYSTEM SETUP**WL.REMOTE**

[**ON** ON], [**OFF** OFF ()]

Allows the camcorder to be operated with the wireless controller.

BEEP

[HIGH VOLUME],
[LOW VOLUME], [**OFF** OFF]

A beep will accompany some operations like turning on the camcorder, the self-timer countdown, etc. It also serves as a warning beep under unusual conditions.

POWER SAVE

[**ON** ON], [**OFF** OFF]

In order to save power when the camcorder is powered by a battery pack, it will automatically shut off if left without any operation for five minutes. Approximately 30 seconds before the camcorder shuts off, the message " AUTO POWER OFF " will appear.

FILE NOS.

[RESET], [CONTINUOUS]

Select the image numbering method to be used when you insert a new memory card.

Images are automatically assigned consecutive image numbers from 0101 to 9900, and stored in folders containing up to 100 images. Folders are numbered from 101 to 998.

[RESET]: Image numbers will restart from 101-0101 every time you insert a new memory card.

[CONTINUOUS]: Image numbers will continue from the number following that of the last image recorded with the camcorder.

- If the memory card you insert already contains an image with a larger number, a new image will be assigned a number one higher than that of the last image on the memory card.

- We recommend using the [CONTINUOUS] setting.

FIRMWARE

You can verify the current version of the camcorder's firmware. This menu option is usually grayed out.

DATE/TIME SETUP



T.ZONE/DST (□ 26)

DATE/TIME (□ 27)

DATE FORMAT

[Y.M.D (2007.1.1 AM 12:00)],
[M.D,Y (JAN. 1, 2007 12:00 AM)],
 [D.M.Y (1.JAN.2007 12:00 AM)]
 Changes the date format for on-screen displays and for date printing.

Using the Recording Programs



EASY Easy Recording

The camcorder adjusts the focus, exposure and other settings automatically, allowing you to just point and shoot.



[P] Recording Programs (46)

[P PROGRAM AE]

The camcorder sets the aperture and shutter speed.



[NIGHT]

Use this mode to record in low-light conditions.



[SUNSET]

Use this mode to record sunsets in vibrant colors.



[PORTRAIT]

The camcorder uses a large aperture, achieving a focus on the subject while blurring other distracting details.



[SNOW]

Use this mode to record in bright ski resorts. It prevents the subject from being underexposed.



[SPOTLIGHT]

Use this mode to record spotlit scenes.



[SPORTS]

Use this mode to record sports scenes such as tennis or golf.



[BEACH]

Use this mode to record on a sunny beach. It prevents the subject from being underexposed.



[FIREWORKS]

Use this mode to record fireworks.



P: Changing the Shutter Speed and Special Scene Programs

Use the automatic exposure (AE) program to set the shutter speed or select one of the special scene recording programs.

POINTS TO CHECK



Mode switch: P

P EASY



FUNC.
(24)

FUNC.



FUNC. →

Icon of the currently selected
Recording Program



FUNC. ←

Desired option

TO SET THE SHUTTER SPEED IN THE [P PROGRAM AE] RECORDING PROGRAM

FUNC. →

MENU



CAMERA SETUP



SHUTTER



FUNC. ←

Desired option

Shutter speed guidelines

1/60
1/60
For general recordings.
1/100
1/100
For recording indoor sports scenes.
1/250, 1/500, 1/1000
1/250
For recording from within a car or train, or for recording moving subjects such as roller coasters.
1/2000
For recording outdoor sports such as golf or tennis on sunny days.

Note that on screen only the denominator is displayed – “P 250” indicates a shutter speed of 1/250, etc.

NOTES

- Do not change the position of the mode switch while recording as the brightness of the image may change abruptly.
- [P PROGRAM AE]
 - When setting the shutter speed, the number displayed will flash if the value selected is not appropriate for the recording conditions. In such case, select a different value.
 - If you use a slow shutter speed in dark places, you can obtain a brighter image, but the image quality may be lower, and the autofocus may not work well.
 - The image may flicker when recording with high shutter speeds.
 - Recording movies under fluorescent lights:** If the screen starts to flicker, select [P PROGRAM AE] and set the shutter speed to 1/100.
 - The shutter speed resets to [A] AUTO when you set the mode switch to EASY or change the recording program.
- [P PORTRAIT]/[P SPORTS]/[P BEACH]/[P SNOW]
 - The picture may not appear smooth during playback.

● [P] PORTRAIT

- The blur effect of the background increases the more you zoom in (T).

● [N] NIGHT

- Moving subjects may leave a trailing afterimage.

- Picture quality may not be as good as in other modes.

- White points may appear on the screen.

- Autofocus may not work as well as in other modes. In such case, adjust the focus manually.

● [S] SNOW/[B] BEACH

- The subject may become overexposed on cloudy days or in shaded places. Check the image on the screen.

● [F] FIREWORKS

- To avoid camcorder shake, we recommend using a tripod. Make sure to use a tripod especially in [CAMERA] mode, as the shutter speed slows down.

Adjusting the Picture: Exposure, Focus and Color

Manual Exposure Adjustment

At times, backlit subjects may appear too dark (underexposed) or subjects under very strong lights may appear too bright or glaring (overexposed). To correct this, you can manually adjust the exposure.

POINTS TO CHECK



Mode switch: [P] (except for the [F] FIREWORKS recording program).



- 1 If the joystick guide does not appear on screen, press (⊙) to display it.**
- 2 Push the joystick (▲) towards [EXP].**
 - [EXP] on the joystick guide changes to light blue and the exposure adjustment indicator  and the neutral value "±0" appear on the screen.
 - If you operate the zoom during exposure lock, the brightness of the image may change.
- 3 Adjust (◀▶) the brightness of the image as required.**
 - The adjustment range and the length of the exposure adjustment indicator will vary depending on the initial brightness of the picture.
 - Pushing the joystick (▲) towards [EXP] again will return the camcorder to automatic exposure.
- 4 Push the joystick (▼) towards [BACK] to save the exposure setting.**

Manual Focus Adjustment

Autofocus may not work well on the following subjects. In such case, focus manually.

Reflective surfaces



Subjects with low contrast or without vertical lines



Fast moving subjects



Through wet windows



Night scenes



POINTS TO CHECK



(10)

Mode switch: [P]



1 Adjust the zoom.

2 If the joystick guide does not appear on screen, press () to display it.

3 Push the joystick (▼) towards [FOCUS] to activate the manual focus.

[FOCUS] on the joystick guide will be displayed in light blue and "MF" appears on the screen.

4 Adjust (◀▶) the focus as necessary.

- Push the joystick (▶) towards ▲ for a farther focal distance or push it (◀) towards ■ for a closer focal distance.
- Pushing the joystick (▼) towards [FOCUS] again will return the camcorder to autofocus.

5 Push the joystick (▲) towards [BACK] to save the focus adjustment.

NOTES

The camcorder will automatically return to autofocus when you set the mode switch to **EASY**.

Infinity Focus

Use this function when you wish to focus on faraway subjects such as mountains or fireworks.



1 Adjust the zoom.

2 Keep the joystick pushed (▼) towards [FOCUS] for more than 2 seconds.

- ∞ appears.
- Pushing the joystick (▼) towards [FOCUS] again will return the camcorder to autofocus.
- Operating the zoom or the joystick (◀▶) will return the camcorder to manual focus adjustment.

3 Push the joystick (▲) towards [BACK] to save the focus adjustment.

White Balance

The white balance function helps you accurately reproduce colors under different lighting conditions so that white objects will always look truly white in your recordings.



POINTS TO CHECK



(10)

Mode switch: [P]

Options

◆ Default value

[AWB AUTO]*
Settings are automatically set by the camcorder. Use this setting for outdoor scenes.
[DAY DAYLIGHT]
For recording outdoors on a bright day.
[TUNG TUNGSTEN]
For recording under tungsten and tungsten type (3-wavelength) fluorescent lighting.
[SET]
Use the custom white balance for special situations not covered by the other options. The custom white balance will ensure that white subjects appear white under various lighting conditions.

FUNC.
(24)

FUNC.



[FUNC.] →

Icon of the currently selected **White Balance**



[FUNC.] ←

Desired option*

* When you select [**SET**], do not press [FUNC.] and continue instead with the procedure below.

TO SET THE CUSTOM WHITE BALANCE

1 Point the camcorder at a white object, zoom in until it fills the whole screen and press ().

When the adjustment is completed, stops flashing and stays on. The camcorder retains the custom setting even if you turn off the camcorder.

2 Press [FUNC.] to save the setting and close the menu.



NOTES

- When you select the custom white balance [SET]:
 - Make the white balance adjustment in a place with sufficient light.
 - Set [D.ZOOM] to [**OFF** OFF] (39).
 - Readjust the white balance if the lighting conditions change.
 - Very rarely and depending on the light source, may keep on flashing instead of staying on. Even in that case, the white balance would be properly adjusted and the results should be better than with [**AWB** AUTO].
- Custom white balance may provide better results in the following cases:
 - Changing lighting conditions
 - Close-ups
 - Subjects in a single color (sky, sea or forest)
 - Under mercury lamps and certain types of fluorescent lights

Image Effects

You can use the image effects to change the color saturation and contrast to obtain different results.

 **POINTS TO CHECK**

CAMERA  | **CAMERA**  | **PLAY**  | **PLAY**  (10)

Mode switch: **P**

Options

◆ Default value

[OFF IMAGE EFFECT OFF] ◆
Records with no image enhancing effects.
[VIVID]
Emphasizes the contrast and color saturation.
[NEUTRAL]
Tones down the contrast and color saturation.
[SOFT SKIN DETAIL]
Softens the details in the skin tone area for a more complimentary appearance.

FUNC.
(24)

FUNC.



FUNC. ⇨ Icon of the currently selected **Image Effect**



FUNC. ⇐ Desired option

Audio Recording and Playback

Audio Recording Mode

You can change the quality of the audio recording.

 **POINTS TO CHECK**

CAMERA  | **CAMERA**  | **PLAY**  | **PLAY**  (10)

Options

◆ Default value

[16bit 16bit]
Records audio at the highest quality.
[12bit 12bit] ◆
Records audio on 2 channels (Stereo 1) leaving 2 channels free (Stereo 2) for audio dubbing or for adding a sound track later.

FUNC.
(24)

FUNC.



FUNC. ⇨ **MENU**



AUDIO SETUP



AUDIO MODE



FUNC. ⇐ Desired option

ABOUT THE WIND SCREEN

The camcorder automatically reduces the background sound of wind, but you can turn the wind screen off when you want the microphone to be as sensitive as possible (41).

Audio Playback Modes

Selecting the Audio Channel

You can select the audio channel to play back when playing back a tape with audio recorded on two channels (either stereo sound or bilingual audio signals).



POINTS TO CHECK



(10)

Options

◆ Default value

[L/R]◆

Left and Right channels (stereo) / Main + Sub signals (bilingual).

[L/L]

Left channel only (stereo) / Main signal only (bilingual).

[R/R]

Right channel only (stereo) / Sub signal only (bilingual).

FUNC.
(24)

FUNC.



FUNC. →

MENU



AUDIO SETUP



OUTPUT CH



FUNC. ←

Desired option



POINTS TO CHECK



(10)

Options

◆ Default value

[ST-1 STEREO1]◆

Original sound only.

[ST-2 STEREO2]

Dubbed audio only.

[1:1 MIX/FIXED]

Mixed audio with the original sound and the dubbed audio at the same level.

[MIX/VAR.]

Mixed audio where the balance between the original sound (ST-1) and the dubbed audio (ST-2) can be adjusted.

FUNC.
(24)

FUNC.



FUNC. →

MENU



AUDIO SETUP



12bit AUDIO



FUNC. ←

Desired option*

* When you select [MIX/VAR.], adjust the mix balance with the [MIX BALANCE] setting (41).

Selecting the Audio Track on a Tape with Dubbed Audio

You can select the audio track to play back when playing back a tape that has a dubbed audio track (Stereo 2) in addition to the original recorded audio (Stereo 1).

Recording Options using the Memory Card

Selecting the Size and Quality of Still Images

Still images are recorded on the memory card using the JPEG (Joint Photographic Experts Group) compression. As a general rule select a larger image size for higher quality.



Options

Approximate number of still images that can be recorded on different sizes of memory cards with the following quality settings:

: [SUPER FINE],
 : [FINE],
 : [NORMAL].

On a 32 MB memory card

Image Size			
ZR850 L 1152x864	40	65	130
ZR830 L 1024x768	50	75	150
S 640x480	140	200	365

On a 128 MB memory card

Image Size			
ZR850 L 1152x864	185	280	545
ZR830 L 1024x768	220	330	635
S 640x480	585	850	1,530

On a 512 MB memory card

Image Size			
ZR850 L 1152x864	735	1,115	2,155
ZR830 L 1024x768	885	1,310	2,515
S 640x480	2,320	3,355	6,040

♦ Default value with the **ZR850**

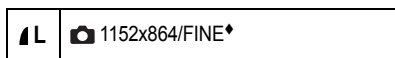

FUNC.
(24)

FUNC.



FUNC. ⇨

Icon of the currently selected
Image Quality/Size



Desired image size*



Press



FUNC. ⇐

Desired image quality*

* The number displayed on the right corner indicates the approximate number of images that can be recorded with the current quality/size setting.

NOTES

- Depending on the number of images on the memory card (Windows: more than 1,800 images; Macintosh: more than 1,000 images), you may not be able to download images to a computer. Try using a card reader.
- Connection to a PictBridge compatible printer will not work when the memory card contains more than 1,800 images. For best performance, we recommend to keep the number of images on the memory card under 100.

Selecting the Size of Movie Clips on the Memory Card

Movies are recorded on the memory card using the Motion-JPEG compression. The sound for these movie clips is monaural.



Options

Approximate recording time available on different sizes of memory cards.

[1320] [320x240]

File Size per Second: Approx. 250 KB.

Memory Card	Recording Time
32 MB	2 min.
128 MB	8 min.
512 MB	33 min.

[160] [160x120]

File Size per Second: Approx. 120 KB.

Memory Card	Recording Time
32 MB	4 min.
128 MB	18 min.
512 MB	70 min.

◆ Default value



* In [PLAY] mode, the default is

[1320] [320x240].



[FUNC.] ⇒ Icon of the currently selected **Movie Size**

[FUNC.] ⇐ Desired option

Capturing a Still Image while Recording Movies

While you are recording a movie on the tape you can simultaneously capture the same picture as a still image on the memory card without interrupting your recording to change modes. The size of the still image will be S 640x480 and cannot be changed but the quality of the still image can be selected.



Select the size and quality of the still image in record pause mode before you start recording.

◆ Default value

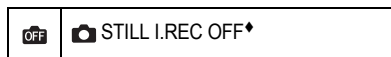

[FUNC.] ⇒ Icon of the currently selected **Still Image Simultaneous Recording** option

[FUNC.] ⇐ Desired image quality*

* The number displayed on the right corner indicates the approximate number of images that can be recorded with the current quality/size setting.

TO CAPTURE THE STILL IMAGE

While you are recording a movie, press [PHOTO].

The still image is recorded on the memory card while the screen continues to show the video recording.

i NOTES

- The still image cannot be recorded on the memory card while recording in widescreen (16:9) mode or while a digital effect is activated.
- To record still images we recommend using the **CAMERA** mode, which offers the best quality for still images.

Capturing a Still Image or Movie Clip from the Playback Picture

While you are playing back a tape you can capture the picture as a still image or as a movie clip on the memory card. The size of the still image will be [S 640x480] and cannot be changed.

Select the quality of the still image with the procedure below. Refer to *Selecting the Size of Movie Clips on the Memory Card* (□ 53) to select the size of the movie clip.



FUNC.
(□ 24)

FUNC.



FUNC. →

Icon of the currently selected
Still Image Capturing option



FUNC. ←

Desired image quality

TO CAPTURE A STILL IMAGE

During playback or in playback pause mode, press **[PHOTO]**.

TO CAPTURE A MOVIE CLIP

During Playback or in playback pause mode, press **[Start/Stop]**.

Press **[Start/Stop]** again to stop the recording.

i NOTES

The data code of the captured still image/movie clip will reflect the date and time when it was recorded on the memory card.

Automatic Focus Priority

When the focus priority is activated, the camcorder records a still image only after the focus has been adjusted automatically. When the mode switch is set to **[P]**, you can also select the AF (autofocus) frame.



Options

♦ Default value

[AIRAF ON:AiAF]♦
(Mode switch: **[P]***, **EASY**)

Depending on the shooting conditions, one or more AF frames out of the nine frames available are automatically selected and the focus is fixed on them.

[ON: CENTER]
(Mode switch: **[P]***)

A single focusing frame appears in the center of the screen and the focus is automatically fixed on the center AF frame. This is convenient for making sure the focus is exactly where you want it.

[OFF OFF]
(Mode switch: **[P]**)

Select this option if you wish to record a still image as soon as you press **[PHOTO]**. The focus priority cannot be turned off when the mode switch is set to **EASY**.

* Except for the **[FIREWORKS]** recording program.

FUNC.
(24)

FUNC.

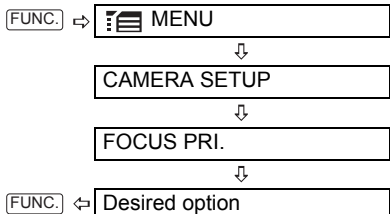

i NOTES

- In the [FIREWORKS] recording program the focus priority is automatically set to [OFF].

Other Functions

Data Code

The camcorder keeps a data code containing the date and time of recording. You can select the data to be displayed.



Options

◆ Default value

[OFF]	◆
No data code display.	
[DATE], [TIME]	
Displays the date or time when the scene or still image was recorded.	
[DATE & TIME]	
Displays both the date and time of the recording.	

FUNC.
(24)

FUNC.

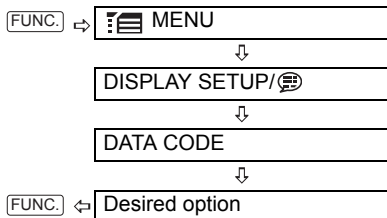

ZR850 LED Light

You can turn on the LED light (assist lamp) at any time, regardless of the recording program.



FUNC.
(24)

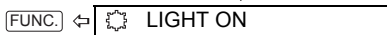
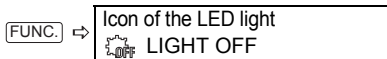

- appears on the screen.
- Select [LIGHT OFF] to turn the LED light off.

- appears.
- Set [SELF TIMER] to [OFF] to cancel the self timer.

CAMERA :

Press .

The camcorder starts recording after a 10-second countdown*. The countdown appears on the screen.

CAMERA :

Press to record the still image.

The camcorder will record the still image after a 10-second countdown*. The countdown appears on the screen.

*2 seconds when using the wireless controller.

NOTES

Once the countdown has begun, you can also press (when recording movies) or press fully (when recording still images) to cancel the self timer. The self timer will also be canceled if you turn off the camcorder.

Self Timer



CAMERA : Set the camcorder in record pause mode.

FUNC.
(24)

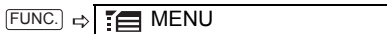

CAMERA SETUP

SELF TIMER

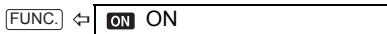

Digital Effects

FADERS

Begin or end scenes with a fade to or from black. You can preview the effect on the display.

[FADE-T] (fade trigger)	[WIPE]
[CORNER] (corner wipe)	[JUMP]
[FLIP]	[PUZZLE]
[ZIGZAG]	[BEAM]
[TIDE]	

[EFFECT] Effects

Add flavor to your recordings. Sound will be recorded normally. You can preview the effect on the display.

[1] [BLK&WHT] (black and white)	[2] [SEPIA]
[3] [ART]	[4] [MOSAIC]
[5] [BALL]	[6] [CUBE]
[7] [WAVE]	[8] [COLOR M.] (color mask)
[9] [MIRROR]	

[CARD MIX] Card Mix (58)

Combines a still image from the memory card with your recording.

Selecting a Fader / Effect

POINTS TO CHECK

CAMERA CAMERA | PLAY PLAY (10)

Mode switch: [P]

CAMERA: [1] BLK&WHT only.
♦ Default value

[EFFECT OFF] D.EFFECT OFF♦

FUNC.
(24)



Setting

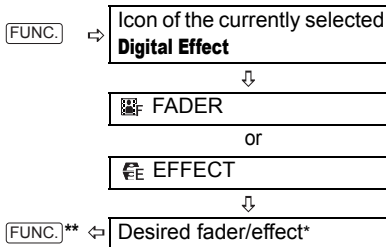

* You can preview the effect on the screen before pressing ().

** The icon of the selected effect appears.

Applying

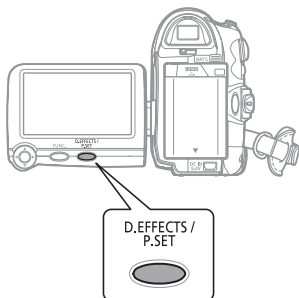

1 Press [D.EFFECTS] to activate the fader/effect.

- The icon of the selected effect turns green.
- Press [D.EFFECTS] again to deactivate the fader/effect.

TO FADE IN

Press [D.EFFECTS] ...

[CAMERA]: ...in record pause mode, then press [Start/Stop] to start recording with a fade in.

[PLAY]: ...in playback pause mode, then push the joystick (▲) towards ►/|| to fade in and start the playback.

To FADE OUT

Press **[D.EFFECTS]** ...

[CAMERA] : ...while recording, then press **[Start/Stop]** to fade out and pause the recording.

[PLAY] : ...during playback, then push the joystick (**▲**) towards **▶/||** to fade out and pause the playback.

To ACTIVATE AN EFFECT

Press **[D.EFFECTS]** ...

[CAMERA] : ...while recording or in record pause mode.

[PLAY] : ...during playback.

[CAMERA] : ...and then press **[PHOTO]** to record the still image in black and white.

NOTES

- When you are not using the digital effect, select **[D.EFFECT OFF]**.
- The camcorder retains the setting last used even if you turn off the digital effects or change the recording program.
- The digital effects are not available when **[TV TYPE]** is set to **[NORMAL TV]** and the stereo video cable is connected to the AV terminal.

Combining Images (Card Mix)

You can choose one of the sample images (including picture frames and backgrounds) from the collection on the supplied DIGITAL VIDEO SOLUTION DISK and combine it with your live video recording to add a note of playfulness to your movies.

The card mix combines illustrations or titles with your recordings. The live video recording will appear instead of the light area of the card mix image.

Mix level adjustment: Light area of the still image.



POINTS TO CHECK



Upload to the memory card a sample image from the supplied DIGITAL VIDEO SOLUTION DISK software CD-ROM. Refer to *Adding Still Images from your Computer to the Memory Card* in the electronic instruction manual (PDF file) included on the same CD-ROM.

Mode switch: **[P]**

◆ Default value

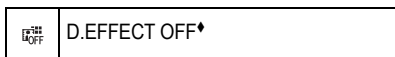

FUNC.
(**24**)

FUNC.



Setting

FUNC. ⇨

Icon of the currently selected
Digital Effect



CARD MIX

TO SET THE CARD MIX

- 1 Select (**▲▼**) **[IMAGE SELECT]** and then select (**◀▶**) the still image you want to combine.
- 2 If you want to adjust the mix level, select (**▲▼**) **[MIX LEVEL]** and set (**◀▶**) the level preferred.
- 3 Press (**⊗**) to save the settings and press **[FUNC.]** to close the menu. **[FUNC.]** appears.

Applying

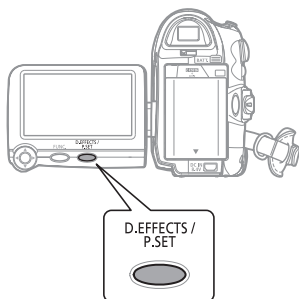

Press **D.EFFECTS**.

- The  changes to green and the combined image appears.
- Still images cannot be recorded on the memory card while the Card Mix function is activated.

Still Image Options

Erasing Still Images

IMPORTANT

Be careful when erasing images. Erased images cannot be recovered.

NOTES

- Protected images cannot be erased.
- Movie clips on the memory card can only be erased when the first scene is displayed as a still image (not during playback).

Erasing a Single Image



- 1 If the joystick guide does not appear on screen, press (⊙) to display it.
- 2 Select (◀▶) the image you want to erase.
- 3 Push the joystick (▼) towards (🗑️) to erase the image.
- 4 Select (◀▶) [ERASE] and press (⊙).

Erasing a Single Image Just After Recording



You can erase the last recorded still image while reviewing it within the time set for the [REVIEW] option (or immediately after recording it, if [REVIEW] is set to [OFF OFF]).

FUNC.
(24)

FUNC.



While reviewing the image immediately after recording:

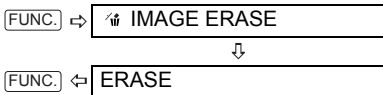

Erasing All Images



FUNC.
(24)

FUNC.

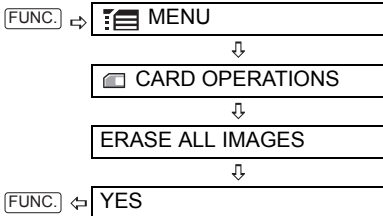

Protecting Still Images

You can protect still images from accidental erasure.

IMPORTANT

Initializing the memory card ( 62) will permanently erase all recorded still images, even the protected ones.

NOTES

Movie clips on the memory card can only be protected when the first scene is displayed as a still image (not during playback).

Protecting a Single Image



FUNC.
( 24)



FUNC. → **OFF** PROTECT OFF



FUNC. ← PROTECT ON*

On appears and the image cannot be erased.

* To cancel the image protection, select [PROTECT OFF] instead.

Protecting a Single Image Just After Recording



You can protect the last recorded still image while reviewing it within the time set for the [REVIEW] option (or immediately after recording it, if [REVIEW] is set to [OFF OFF]).

FUNC.
( 24)

FUNC.



FUNC. → **OFF** PROTECT OFF



FUNC. ← PROTECT ON*

On appears and the image cannot be erased.

* To cancel the image protection, select [PROTECT OFF] instead.

Protecting Still Images from the Index Screen



Move the zoom lever toward **W** to enter the still image index screen.

FUNC.
(24)

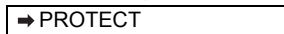

Bring (▲▼, ◀▶) the cursor
to the image you want to
protect and press (⊙).*

FUNC.** ←

Repeat this step to protect
additional images.

* **⊙** appears on protected images. Press
(⊙) again to cancel the protection.

**After closing the menu the camcorder returns
to the index screen.

Initializing the Memory Card

Initialize new memory cards when you use them for the first time. You may also have to initialize a card if you get the “CARD ERROR” message or you may choose to do so to erase all data recorded on it.

! IMPORTANT

- Initializing the memory card will erase all still images and movie clips, even the protected ones. The original image files cannot be recovered.
- Initialize all memory cards before using them with this camcorder.



FUNC.
(24)

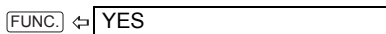
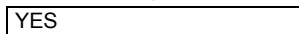
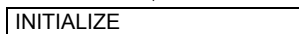
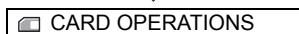

Connecting to a TV or VCR

Connection Diagrams

Turn off all the devices when making the connections and refer also to the instruction manual of the connected device.

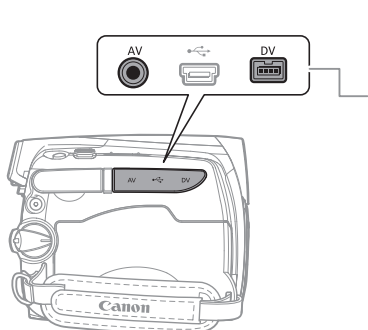

	AV Terminal
	DV Terminal Check the type and orientation of the terminal and make sure you connect the DV cable properly.

Terminal on the Camcorder	Connecting Cable	Terminal on the Connected Device
---------------------------	------------------	----------------------------------

- 1** Output connection (Signal Flow →) to a TV or VCR with AV Terminals.
ZR850 Input connection (Audio only, Signal flow ←) from an analog source for audio dubbing.

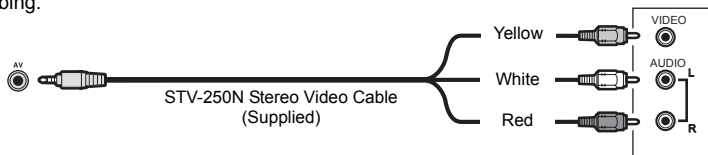

- 2** Output connection (Signal Flow →) to an HDTV with a DV (IEEE1394) terminal.
 Input connection (Signal Flow ←) from a TV or other digital video source with a DV (IEEE1394) output.

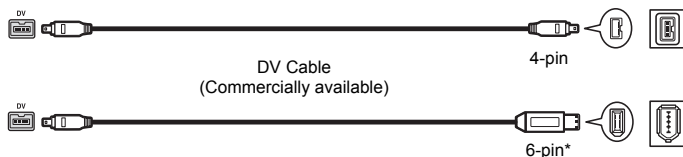

* Be careful to correctly insert the 6-pin plug into the DV terminal. Inserting it in the wrong direction can result in damage to the camcorder.

Playback on a TV Screen

The quality of the playback picture will vary depending on the connected TV and the type of connection used.



Before making the connections, select the [TV TYPE] setting according to the TV set to which you will connect the camcorder (□ 40).

Connecting

Connect the camcorder to the TV following one of the connection diagrams shown in the previous section *Connection Diagrams* (□ 63).

Playback

- 1 Turn on the camcorder and the connected TV or VCR.**
On a TV: Set the input selector to VIDEO. On a VCR: Set the input selector to LINE (IN).
- 2 Start the playback of the movies** (□ 32) **or still images** (□ 34).

i NOTES

- Turn off all the devices before starting the connections.
- We recommend powering the camcorder using the compact power adapter.

Recording to a VCR or Digital Video Recorder

You can copy your recordings by connecting the camcorder to a VCR or a digital video device. When recording to a digital video recorder using the DV terminal, you can copy recordings with

virtually no generation loss in video and sound quality.

Connect the camcorder to the external device following one of the connection diagrams shown in the previous section *Connection Diagrams* (□ 63).



Connecting

Connect the camcorder to a VCR or other analog device using connection type **1**, or to a DVD recorder or other digital recording device using connection type **2**, as shown in the previous section *Connection Diagrams* (□ 63).

Recording

- 1 This camcorder: Load the recorded cassette.**
- 2 Connected device: Load a blank cassette or disc and set the device to record pause mode.**
- 3 This camcorder: Locate the scene you wish to copy and pause the playback shortly before the scene.**
- 4 This camcorder: Resume the movie playback.**
When using an analog connection you can include in the copy also the date/time of the original recording (□ 55).
- 5 Connected device: Begin recording when the scene you wish to copy appears. Stop recording when copying is complete.**
- 6 This camcorder: Stop playback.**

i NOTES

- We recommend powering the camcorder using the compact power adapter.
- When recording to a VCR using an analog connection—connection type **1** (□ 63)—, the quality of the edited tape will be lower than the original.

- When recording to a digital video recorder using the DV terminal –connection type 2 (□ 63)–:
 - If the picture does not appear, disconnect the DV cable and restore the connection after a short while or turn the camcorder off and then on again.
 - Proper operation cannot be guaranteed for all digital devices equipped with a DV terminal. If the operation does not work, use the AV terminal.



- 6 When the scene you wish to record appears, push the joystick (▲) towards ●/|| to begin recording. Recording starts.
- 7 While recording, push the joystick (▲) towards ●/|| to pause the recording. In record pause, push the joystick (▲) towards ●/|| again to resume recording.
- 8 Push the joystick (▼) towards ■ to stop recording.
- 9 Connected device: Stop the playback.

Digital Video Dubbing

You can input video from other digital video devices and record the input video on the tape in the camcorder.



Connecting

Connect the camcorder to the video input source using the digital connection –connection type 2 (□ 63)– shown in the previous section *Connection Diagrams*.

Dubbing

FUNC.
(□ 24)



- 1 Load a blank cassette in this camcorder.
- 2 Connected device: Load the recorded cassette or disc.
- 3 Press [FUNC.], select (▲▼) [● || REC PAUSE] and press (⊗).
- 4 Select (◀▶) [EXECUTE] and press (⊗).
- 5 Connected device: Start the playback. In record pause mode and while recording you can check the picture on the camcorder's screen.

IMPORTANT

- Blank sections may be recorded as anomalous picture.
- If the picture does not appear, disconnect the DV cable and restore the connection after a short while or turn the camcorder off and then on again.
- Do not connect any devices to the camcorder's USB terminal while an external device is connected to the DV terminal.
- You can only record video signals in DV standard (standard definition, SP or LP mode) from devices carrying the DV logo. Note that signals from identically shaped DV (IEEE1394) terminals may be in different video standards.

NOTES

We recommend powering the camcorder using the compact power adapter.

Copyright Signal

Certain software tapes are copyright protected. If you attempt to play back such tape, "COPYRIGHT PROTECTED PLAYBACK IS RESTRICTED" appears and you will not be able to view the contents of

the tape. If you attempt to record from such tape via the HDV/DV terminal, "COPYRIGHT PROTECTED DUBBING RESTRICTED" appears and you will not be able to record the contents of the tape.

Audio Dubbing

You can add sound to a recording using the built-in microphone.

ZR850 only: You can also record additional sound from external audio devices.

ZR850

Connecting an External Audio Device

Connect the external audio device (CD player, etc.) to the camcorder using connection type **1** (□ 63). Connect only the audio plugs (red and white) of the STV-250N Stereo Video Cable and leave the yellow video plug unconnected.

Refer also to the instruction manual of the connected device.

ZR850 To SELECT THE AUDIO SOURCE



Options

♦ Default value

[AV AUDIO IN]♦
Dub audio from an external analog device.
[MIC MIC.IN]
Dub audio using the built-in microphone.

FUNC.
(□ 24)

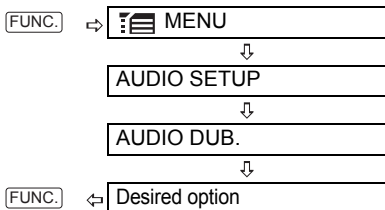

Dubbing



POINTS TO CHECK

You can only dub audio on tapes recorded in SD mode with [12bit 12bit] audio. This function is operated with the wireless controller.

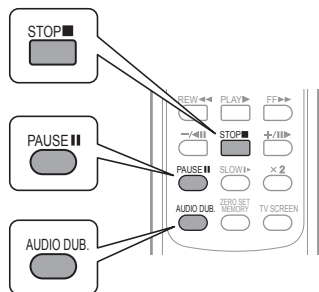

1 Locate the scene you wish to start audio dubbing.

Before locating the starting point, you can also set the zero set memory (□ 33) at the point where you want the audio dubbing to end. The camcorder will automatically stop audio dubbing at that point.

- Press [PAUSE] .
- Press [AUDIO DUB.] .

"AUDIO DUB." and appear.

4 Press [PAUSE] to begin dubbing.

- **ZR850** Audio device: Begin playback.
- Microphone: Speak into the microphone.

5 Press [STOP] to stop dubbing.

- **ZR850** Audio device: Stop playback.

! IMPORTANT

- Audio dubbing will stop if the tape has a blank section or a section recorded in LP mode or [16bit 16bit] audio.
- You cannot use the DV terminal for audio dubbing.
- The quality of the dubbed sound will not be as good when dubbing audio to a tape that was not recorded with this camcorder or after having dubbed audio over the same scene more than 3 times.

i NOTES

- While dubbing audio using the built-in microphone: You can connect the camcorder to a TV to check the picture on the TV screen and check the sound through headphones connected to the TV.
- **ZR850** While dubbing audio using an external audio device: You can check the picture on the camcorder's LCD screen and the sound through the built-in speaker or the audio device.



TO SELECT THE AUDIO TRACK FOR PLAYBACK

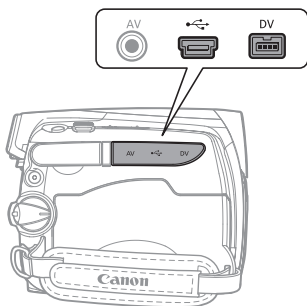

You can select the audio track that will be played when playing back a tape that was audio dubbed (51).

Connecting to a Computer

PC Connection Diagrams



 <p>DV</p>	<p>DV Terminal Check the type and orientation of the terminal and make sure you connect the DV cable properly.</p>
 <p>USB</p>	<p>USB Terminal Open the terminal cover to access.</p>

Terminal on the Camcorder	Connecting Cable	Terminal on the Connected Device
<p>1 Output connection (Signal Flow →) to a computer with a DV (IEEE1394) terminal or a DV capture board.</p>	<p>DV Cable (Commercially available)</p>	<p>4-pin </p> <p>6-pin* </p> <p>* Be careful to correctly insert the 6-pin plug into the DV terminal. Inserting it in the wrong direction can result in damage to the camcorder.</p>
<p>2 Output connection (Signal Flow →) to a PC or PictBridge compatible printer with an USB port.</p>	<p>USB Cable (Supplied)</p>	



Transferring Video Recordings

You can transfer recordings to a computer using the DV terminal.

Equipment and System Requirements

- A computer equipped with an IEEE1394 (DV) terminal or an IEEE1394 (DV) capturing board.
 - A DV cable (commercially available).
 - Video Editing Software.
 - The appropriate driver
- A driver is preinstalled on Windows operating systems later than Windows 98 Second Edition and Mac operating systems later than Mac OS 9, and will be installed automatically.

Connecting

- 1 **Start the computer.**
- 2 **Set the camcorder to  mode.**
- 3 **Connect the camcorder to the computer using the digital connection –connection type  ( 68)– shown in the previous section *PC Connection Diagrams*.**
- 4 **Start the video editing software.**
Refer to the instruction manual of the editing software.

IMPORTANT

- The video transfer may not work correctly depending on the software and the specifications/settings of your computer.
- If the computer freezes while the camcorder is connected to it, disconnect the DV cable and turn off the camcorder and the computer. After a short while, turn them on again, set the camcorder to  mode and restore the connection.
- Before connecting the camcorder to the computer using a DV cable, make sure that the camcorder and computer are not connected

with a USB cable, and that no other IEEE1394 device is connected to the computer.

- Depending on the video editing software, you may need to set the **POWER** switch on the camcorder to a mode other than PLAY. Refer to the instruction manual of the editing software.

NOTES

- We recommend powering the camcorder using the compact power adapter.
- Refer also to the instruction manual of the computer.
- The programs ZoomBrowser EX and Image Browser included with the supplied CD-ROM can only be used to transfer still images recorded on the memory card. Video recordings on the tape cannot be transferred to the computer using the software included with the supplied CD-ROM.

Transferring Still Images or Movie Clips – Direct Transfer

You can transfer still images and movie clips recorded on the memory card to a computer using the supplied USB cable and the Digital Video Software included in the software CD-ROM.

Preparations

The first time you connect the camcorder to the computer, you need to install the software and set the auto-launch setting. From the second time on, you will only need to connect the camcorder to the computer to transfer images.

1 Install the supplied Digital Video Software.

See *Installing the Digital Video Software* in the *Digital Video Software* instruction manual (electronic version on PDF file).

2 Set the camcorder to mode.

3 Connect the camcorder to the computer using the USB connection –connection type (□ 68)– shown in the previous section **PC Connection Diagrams**.



See *Connecting the Camcorder to a Computer* in the *Digital Video Software* instruction manual (electronic version on PDF file).

4 Set the auto-launch setting.

- See *Starting CameraWindow* (Windows) or *Auto-downloading* (Macintosh) in the *Digital Video Software* instruction manual (electronic version on PDF file).

- The direct transfer menu appears on the camcorder screen.

! IMPORTANT





- When the CARD access indicator is on or flashing do not perform the following actions. Doing so may result in permanent data loss.
 - Do not open the memory card slot cover and do not remove the memory card.
 - Do not disconnect the USB cable.
 - Do not turn off the camcorder or the computer.
 - Do not change the position of the  /  switch or the operating mode.
- Operation may not work correctly depending on the software and the specifications/settings of your computer.
- The image files on your memory card are valuable, original data files. If you wish to use the image files on your computer, make copies of them first, and use the copied file, retaining the original.

i NOTES

- We recommend powering the camcorder using the compact power adapter.
- Refer also to the computer's instruction manual.
- Users of Windows XP and Mac OS X: Your camcorder is equipped with the standard Picture Transfer Protocol (PTP) allowing you to download still images (JPEG only) simply by connecting the camcorder to a computer using

the USB cable without installing the software from the supplied software CD-ROM.

Transferring Images

 ALL IMAGES...]	Transfers all images to the computer.
 NEW IMAGES...]	Transfers only those images that have not yet been transferred to the computer.
 TRANSFER ORDERS...]	Transfers images with transfer orders (□ 71) to the computer.
 SELECT & TRANSFER...]	Allows you to select the still image you want to transfer to the computer.
 WALLPAPER...]	Allows you to select the still image you want to transfer and set it as your computer's desktop background.

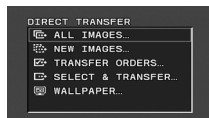
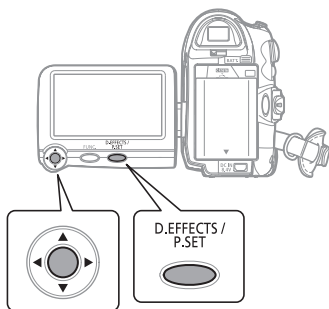

1 Select (▲▼) a transfer option and press (⊗).

IF YOU SELECT [CAMERA ALL IMAGES], [CAMERA NEW IMAGES] OR [CAMERA TRANSFER ORDERS]

2 In the confirmation screen, select (◀▶) [OK] and press (⊗).

- The images are transferred and displayed on the computer.
- The camcorder returns to the transfer menu once the transfer is complete.
- To cancel the transfer, select (◀▶) [CANCEL] and press (⊗), or press [FUNC.].

IF YOU SELECT [CAMERA SELECT & TRANSFER] OR [CAMERA WALLPAPER]

2 Select (◀▶) the image you wish to transfer and press (⊗).

- [CAMERA SELECT & TRANSFER]: The selected image is transferred and displayed on the computer. To continue transferring, select another image.
- [CAMERA WALLPAPER]: The selected image is transferred to the computer and displayed as the desktop's background.
- Press [FUNC.] to return to the transfer menu.

i NOTES

When the camcorder is connected to the computer and the image selection screen is displayed, press [FUNC.] to return to the transfer menu.

Transfer Orders

You can mark the still images you want to transfer to the computer as a transfer order. You can set transfer orders for up to 998 still images.

Selecting Still Images to Transfer (Transfer Order)

Do not connect the USB cable to the camcorder while setting the transfer orders.



FUNC.
(10/24)

FUNC.



[FUNC.] → [TRANS.ORDER OFF]



[FUNC.] ← [TRANS.ORDER ON*]

* To cancel a transfer order, select [TRANS. ORDER OFF] instead.

Setting Transfer Orders from the Index Screen



Move the zoom lever toward **W** to enter the still image index screen.

FUNC.
(10/24)

FUNC.



FUNC. → CARD OPERATIONS



→ TRANSFER ORDER



Bring (▲▼, ◀▶) the cursor
 to the image you want to
 transfer and press (⊗).*

FUNC. ** ← Repeat this step to set
 transfer orders for additional
 images.

* appears on images marked with a
 transfer order. Press (⊗) to cancel the
 transfer order.

** After closing the menu the camcorder
 returns to the index screen.

Erasing All Transfer Orders

CAMERA CAMERA | PLAY PLAY (10)

FUNC.
 (24)

FUNC.



FUNC. → MENU



CARD OPERATIONS



TRANS. ORD. ALL ERASE



FUNC. ← YES

Connecting to a Printer

Printing Still Images – Direct Print



The camcorder can be connected to any PictBridge compatible printer. You can mark the still images you want to print and set the desired number of copies as a print order (75).

Canon printers: SELPHY CP and SELPHY DS printers and PIXMA printers marked with the PictBridge logo.

Connecting the Camcorder to the Printer

CAMERA CAMERA | PLAY PLAY (10)

- 1 Insert the memory card containing the still images you want to print.
- 2 Turn on the printer.
- 3 Connect the camcorder to the printer using the USB connection –connection type (68)– shown in the previous section *PC Connection Diagrams*.
 appears and changes to .

! IMPORTANT

If continues to flash (for more than 1 minute) or if does not appear, the camcorder is not correctly connected to the printer. In such case, disconnect the USB cable and turn off the camcorder and the printer. After a short while, turn them on again, set the camcorder to mode and restore the connection.

i NOTES

- will appear for images that cannot be printed.
- We recommend powering the camcorder using the compact power adapter.
- Refer also to the printer's instruction manual.

Selecting the Print Settings

You can select the number of copies and other settings for printing. The setting options vary depending on your printer model.

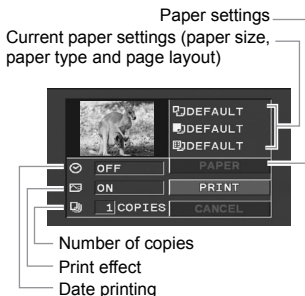

Options

[PAPER]

[PAPER SIZE]

Available paper sizes vary depending on the printer model.

[PAPER TYPE]

Select [PHOTO], [FAST PHOTO] or [DEFAULT].

[PAGE LAYOUT]

Select [DEFAULT] or one of the following available page layouts.

[BORDERED]: Prints the whole image area almost exactly as the recorded still image.

[BORDERLESS]: Enlarges the center portion of the still image to fit the width/height ratio of the selected paper size. The top, bottom and sides of the still image may be slightly trimmed out.

[2-UP], [4-UP], [8-UP], [9-UP], [16-UP]: Prints multiple small copies of the same still image on one sheet of paper.

[Date print]

Select [ON], [OFF] or [DEFAULT].

[Print Effect]

The print effect can be used with printers compatible with the Image Optimize function to achieve higher quality prints. Select [ON], [OFF] or [DEFAULT].

Canon PIXMA/SELPHY DS printers: You can also select [VIVID], [NR] and [VIVID+NR].

[Number of Copies]

Select 1-99 copies.

NOTES

- Print setting options and [DEFAULT] settings vary depending on the printer model. For details, refer to the printer's instruction manual.
- **Canon PIXMA/SELPHY DS Printers:**
 - When the paper size is set to [10 x 14.8 cm] you can print multiple small copies on a single print by selecting 2-, 4-, 9- or [16-UP]. You can also use this setting to print on the specially designed photo stickers sheets.
 - When the paper size is set to [A4] you can print 4 copies on the same sheet by selecting [4-UP].
- **Canon PIXMA/SELPHY CP Printers:**
 - When the paper size is set to [CREDITCARD] you can print multiple small copies on a single print by selecting 2-, 4-, or [8-UP]. You can also use [8-UP] to print on the specially designed photo stickers sheets.
 - When the paper size is set to [10 x 14.8 cm] or [9 x 13 cm] you can print 2 or 4 copies on the same sheet by selecting [2-UP] or [4-UP].
 - When you are using the specially designed wide-sized photo paper you can set the paper size to [DEFAULT] and print 2 or 4 copies on the same sheet by selecting [2-UP] or [4-UP].

Printing after Changing the Print Settings

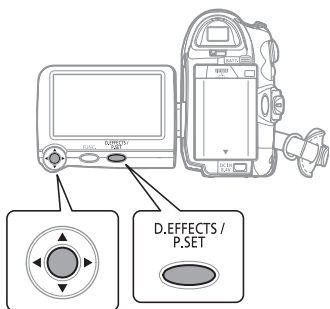

1 Press [P.SET].

- The print setting menu appears.
- Depending on the printer, the message "BUSY." may appear before the camcorder displays the print setting menu.

2 In the print settings menu, select (▲▼, ◀▶) the setting you want to change and press (⊗).

3 Select (▲▼) the desired setting option and press (⊗).

4 Select (▲▼) [PRINT] and press (⊗).

- Printing starts. The print setting menu disappears when the printing is completed.
- To continue printing, select another still image.

TO CANCEL THE PRINTING

Press (⊗) while printing. A confirmation dialog appears. Select [OK] and press (⊗). With Canon's PictBridge compatible printers, the printing will stop immediately (even if not completed) and the paper will be fed through.

PRINTING ERRORS

If an error occurs during the printing process, an error message appears (□ 81).

- Canon's PictBridge compatible printers: Resolve the error. When printing does not resume automatically, select [CONTINUE] and press (⊗). If [CONTINUE] cannot be selected, select [STOP], press (⊗) and retry printing.

Refer also to the printer's instruction manual for details.

- If the error still persists and printing does not restart, disconnect the USB cable and turn off the camcorder and the printer. After a short while, turn them on again, set the camcorder to **PLAY** mode and restore the connection.

WHEN YOU HAVE FINISHED PRINTING

Disconnect the cable from the camcorder and printer and turn off the camcorder.

! IMPORTANT

- The following still images may not be correctly printed with a PictBridge compatible printer.
 - Images created or changed on a computer and transferred to the memory card.
 - Images recorded with the camcorder but edited on a computer.
 - Images whose file names were changed.
 - Images not recorded with this camcorder.
- Observe the following precautions during printing:
 - Do not turn off the camcorder or the printer.
 - Do not change the position of the / switch.
 - Do not disconnect the USB cable.
 - Do not remove the memory card.
- If the message "BUSY." does not disappear, disconnect the USB cable and restore the connection after a short while.

Print Orders

You can mark the still images you want to print and set the desired number of copies as a print order. These print order settings are compatible with the Digital Print Order Format (DPOF) standards and can be used for printing on DPOF compatible printers (p 72). You can set print orders for up to 998 still images.

Selecting Still Images for Printing (Print Order)

Do not connect the USB cable to the camcorder while setting the print orders.



FUNC.
(p 24)

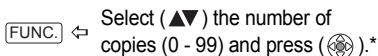
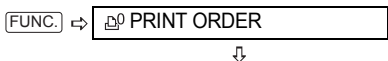

* To cancel the print order, set the number of copies to 0.

Setting Print Orders from the Index Screen



Move the zoom lever toward **W** to enter the still image index screen.

FUNC.
(p 24)

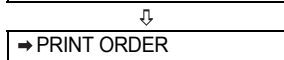
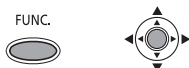

Bring (▲▼, ◀▶) the cursor  to the image you want to print and press (⊗).

Set (▲▼) the desired number of copies and press (⊗).*

FUNC.** ← Repeat these steps to set print orders for additional images.

*  and the number of copies appear on images marked with a print order. To cancel the print order set (▲▼) the number of copies to 0.

**After closing the menu the camcorder returns to the index screen.

Erasing All Print Orders



FUNC.
(p 24)

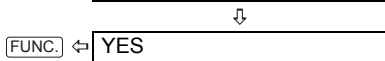
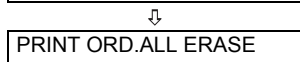
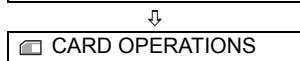
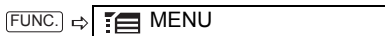

Printing

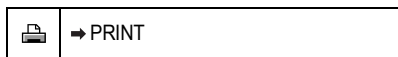

FUNC.

(24)

FUNC.



1 Connect the camcorder to the printer using the USB connection – connection type (68)– shown in the previous section **PC Connection Diagrams**.

2 Press **[FUNC.]**, select (**▲▼**) [**☰☷** **MENU**] and press (**⊗**).

3 Select (**▲▼**) [**☰** **→ PRINT**] and press (**⊗**).

- The print setting menu appears.
- The error message “SET PRINT ORDER” appears if you connect a printer with direct print function and select [**→ PRINT**] without having set any print orders.

4 Make sure that **[PRINT]** is selected and press (**⊗**).

Printing starts. The print setting menu disappears when the printing is completed.

NOTES

● Depending on the connected printer, you can change some print settings before step 4 (73).

● **Cancel Printing/Printing Errors** (74).

● **Restarting Printing:** Open the print menu as explained in steps 2-3 above. Select **[RESUME]** in the print setting menu and press (**⊗**). The remaining images will be printed.

Printing cannot be restarted when the print order settings have been changed or if you deleted a still image with print order settings.



Troubleshooting

If you have a problem with your camcorder, refer to this checklist. Consult your dealer or a Canon Service Center if the problem persists.

Power Source



Problem	Solution	
<ul style="list-style-type: none"> • Camcorder will not turn on. • The camcorder switches off by itself. • The cassette compartment cover will not open. • The cassette compartment stopped half way while inserting/removing a tape. • The LCD/viewfinder switches on and off. 	Battery pack is exhausted. Replace or charge the battery pack.	19
	Attach the battery pack correctly.	
	Use the compact power adapter.	
Battery pack will not charge.	Charge the battery pack in temperatures between 0 °C and 40 °C (32 °F and 104 °F).	–
	Battery packs become hot with use and may not charge. When the battery pack is outside the charging temperature range, the CHG (charge) indicator will flash irregularly. The charging will start once the battery pack temperature is below 40 °C (104 °F).	–
	The battery pack is damaged. Use a different battery pack.	–
	If you connect a faulty power adapter or battery pack, the CHARGE indicator flashes approx. twice per second and the charging stops.	–
	Check that the compact power adapter is correctly connected to the camcorder.	–

Recording/Playback



Problem	Solution	
Buttons will not work.	Turn on the camcorder.	–
	Load a cassette.	21
Abnormal characters appear on the screen. The camcorder does not operate properly.	Disconnect the power source and reconnect it after a short time. If the problem still persists, disconnect all power sources (including the battery pack and the backup battery). This will reset all the camcorder's settings.	–
"  " flashes on the screen.	Load a cassette.	21
"  " flashes on the screen.	Battery pack is exhausted. Replace or charge the battery pack.	19
"  " flashes on the screen.	Condensation is detected. See reference page.	86
"REMOVE THE CASSETTE" appears on the screen.	Remove the cassette and reinsert it.	21
The wireless controller will not work.	Set [WL.REMOTE] to [ON].	43
	The battery of the wireless controller is exhausted. Replace the battery.	23

Problem	Solution	
Video noise appears on screen.	When using the camcorder in a room where a plasma TV is located, keep a distance between the camcorder and the plasma TV.	–
Video noise appears on the TV screen.	When using the camcorder in a room where a TV is located, keep a distance between the compact power adapter and the power or antenna cables of the TV.	–
The tape stops during record pause or playback pause.	To protect the tape and video heads, the camcorder will enter the stop mode (■) if left in playback pause (▶) or record pause (●) mode for 4 minutes 30 seconds. To resume the operation press [Start/Stop] (when recording) or push the joystick (▲) towards ▶/ (during playback).	–

Recording



Problem	Solution	
Image will not appear on the screen.	Set the camcorder to  .	28
"SET THE TIME ZONE, DATE AND TIME" appears on the screen.	Set the time zone, date and time.	26
	Replace the backup lithium battery and set the time zone, date and time.	21
Pressing the start/stop button will not start recording.	Set the camcorder to  .	28
	Load a cassette.	21
	Tape reached the end ("END" appears on the screen). Rewind the tape or replace the cassette.	21
	Cassette is protected ("P" flashes on the screen). Change the position of the protect switch.	84
Camcorder will not focus.	Autofocus does not work on that subject. Focus manually.	48
	If you are using the viewfinder, adjust it with the dioptic adjustment lever.	23
	Lens is dirty. Clean the lens with a soft lens-cleaning cloth. Never use tissue paper to clean the lens.	86
Sound is distorted.	When recording near loud sounds (such as fireworks or concerts), sound may become distorted.	–
Viewfinder picture is blurred.	Adjust the viewfinder with the dioptic adjustment lever.	23

Playback

Problem	Solution	
During playback there is video noise.	Video heads are dirty. Clean the video heads.	2
Pressing the playback button does not start playback.	Load a cassette.	21
	Set the camcorder to  .	32
	Tape reached the end ("END" appears on the screen). Rewind the tape.	21

Problem	Solution	
No sound from the built-in speaker.	Open the LCD panel.	–
	Speaker volume is turned off. Adjust the volume with the [SPEAKER VOLUME] setting.	33
Image will not appear on the TV screen.	Check again that the camcorder is properly connected to the TV.	63
Tape is running, but image will not appear on the TV screen.	TV/VIDEO selector on the TV is not set to VIDEO. Set the selector to VIDEO.	64
	Video heads are dirty. Clean the video heads.	2
	You attempted to play back or dub copyright a protected tape. Stop playback/dubbing.	65

Memory Card Operation

Problem	Solution	
Memory card cannot be inserted.	Memory card was not facing the correct direction. Turn the memory card over and reinsert it.	22
Cannot record on the memory card.	Memory card is full. Erase still images to free some space or replace the memory card.	60
	Memory card was not initialized. Initialize the memory card.	62
	The folder and file numbers have reached their maximum value. Set [FILE NOS.] to [RESET] and insert a new memory card.	44
Memory card cannot be played back.	Set the camcorder to  .	34
Image cannot be erased.	Image is protected. Cancel the protection.	61
	The write-protect switch on an SD or SDHC memory card is set to prevent accidental erasure. Change the position of the write-protect switch.	–
"  " flashes in red.	Card error occurred. Turn off the camcorder. Remove and reinsert the memory card. Initialize the memory card if flashing persists.	62



Printing



Problem	Solution	
The printer is not operating even though the camcorder and printer are correctly connected.	Disconnect the USB cable and turn off the camcorder and the printer. After a short while, turn them on again, set the camcorder to  mode and restore the connection.	–

Editing

Problem	Solution	
Cannot record with this camcorder video input from an external video device connected using a DV cable.	Wrong signal standard. Refer also to the instruction manual of the connected device.	–

List of Messages

Message	Explanation/Solution	
SET THE TIME ZONE, DATE AND TIME	You have not set the time zone, date and time. This message appears each time you turn the power on until you set the time zone, date and time.	26
CHANGE THE BATTERY PACK	Battery pack is exhausted. Replace or charge the battery pack.	19
THE TAPE IS SET FOR ERASURE PREVENTION	Cassette is protected. Replace the cassette or change the position of the protect switch.	84
REMOVE THE CASSETTE	Camcorder stopped operating to protect the tape. Remove the cassette and reinsert it.	21
CHECK THE INPUT	The DV cable is not correctly connected to the DV terminal, or the connected digital device is turned off.	63
	The video input signal is in a different television system (PAL or SECAM).	–
CONDENSATION HAS BEEN DETECTED	Condensation has been detected in the camcorder.	86
CONDENSATION HAS BEEN DETECTED REMOVE THE CASSETTE	Condensation has been detected in the camcorder. Remove the cassette.	86
TAPE END	Tape reached the end. Rewind the tape or replace the cassette.	–
CHECK THE CASSETTE [REC MODE]	You attempted to dub audio on a tape recorded in a recording mode other than SP.	66
CHECK THE CASSETTE [AUDIO MODE]	You attempted to dub audio on a tape recorded with an audio mode other than [ 16bit].	66
CHECK THE CASSETTE [BLANK]	You attempted to dub audio on a tape with a blank section.	66
CHECK THE CASSETTE [INCORRECT TAPE SPECIFICATION]	You attempted to dub audio on a tape recorded in HD standard.	–
INCORRECT TAPE SPECIFICATION	You attempted to play back a tape recorded in a different television system (PAL or SECAM) or in a recording standard not supported by this camcorder.	–
INPUT SIGNAL NOT SUPPORTED	The digital device connected with the DV cable is incompatible with the camcorder.	–
HEADS DIRTY, USE CLEANING CASSETTE	Video heads are dirty. Clean the video heads.	2
COPYRIGHT PROTECTED PLAYBACK IS RESTRICTED	You attempted to play back a copyright protected tape.	65
COPYRIGHT PROTECTED DUBBING RESTRICTED	You attempted to dub a copyright protected tape. May also appear when an anomalous signal is received during analog line-in recording.	65
NO CARD	Memory card not is inserted into the camcorder.	22
NO IMAGES	No images are recorded on the memory card.	–



Message	Explanation/Solution	
CARD ERROR	A memory card error occurred. The camcorder cannot record or display the image. The error may be temporary. If the message disappears after 4 seconds and "□" flashes red, turn the camcorder off, remove the card and reinsert the card. If "□" changes to green, you can continue recording/playback.	–
CARD FULL	Memory card is full. Erase some images to free some space or replace the memory card.	60
THE CARD IS SET FOR ERASURE PREVENTION	The write-protect switch on an SD or SDHC memory card is set to prevent accidental erasure. Change the position of the write-protect switch.	–
NAMING ERROR	The folder and file numbers have reached their maximum value. Set the [FILE NOS.] option to [RESET] and erase all the images on the memory card or initialize it.	60 62
UNIDENTIFIABLE IMAGE	The image file is corrupted or it was saved using a compression method other than that compatible with this camcorder (JPEG).	–
 TRANSFER ORDER ERROR	You attempted to set more than 998 transfer orders.	71
 PRINT ORDER ERROR	You attempted to set more than 998 still images in the print order.	75
CANNOT TRANSFER!	You attempted to transfer a still image that cannot be displayed with this camcorder.	–
THIS IMAGE CANNOT BE RECORDED	Some analog images cannot be recorded on the memory card depending on the signal.	–
TOO MANY STILL IMAGES DISCONNECT USB CABLE	Disconnect the USB cable and decrease the number of still images on the memory card to less than 1800. If a dialog appeared on the computer screen, close it and then restore the connection.	–

Direct Print Related Messages

NOTES

About Canon PIXMA/SELPHY DS Printers: If the printer's error indicator flashes or an error message appears on the printer's operation panel, refer to the printer's instruction manual.

Message	Explanation/Solution
PAPER ERROR	There is a problem with the paper. The paper is not correctly loaded or the paper size is wrong. Alternatively, if the paper output tray is closed, open it to print.
NO PAPER	Paper is not correctly inserted or there is no paper.
PAPER JAM	The paper jammed during printing. Select [STOP] to cancel printing. After removing the paper, set some paper again and retry printing.
INK ERROR	There is a problem with the ink.
NO INK	The ink cartridge is not inserted or is out of ink.

Message	Explanation/Solution
LOW INK LEVEL	The ink cartridge needs to be replaced soon. Select [CONTINUE] to restart printing.
INK ABSORBER FULL	Select [CONTINUE] to resume printing. Contact a Canon Service Center (refer to the list included with the printer) to replace the ink absorber.
<ul style="list-style-type: none"> • FILE ERROR • CANNOT PRINT! 	You attempted to print an image that was recorded with another camcorder, with a different compression, or was edited on a computer.
SET  PRINT ORDER	No still image on the memory card has been marked with a print order.
PRINTER ERROR	Cancel printing. Turn the printer off and then on again. Check the printer status. If the error still persists, refer to the printer's instruction manual and contact the appropriate customer support center or service center.
PRINT ERROR	Cancel printing, disconnect the USB cable and turn off the printer. After a while, turn the printer back on and reconnect the USB cable. Check the printer status.
HARDWARE ERROR	Cancel printing. Turn off the printer and turn it back on. Check the printer status. If the printer is equipped with a battery, it might be exhausted. In such case, turn off the printer, replace the battery and turn it back on.
COMMUNICATION ERROR	The printer is experiencing a data transfer error. Cancel printing. Disconnect the USB cable and turn off the camcorder and the printer. After a short while, turn them on again, set the camcorder to  mode and restore the connection. If you attempted to print from a memory card that contains a large number of images, reduce the number of images.
PRINTER IN USE	The printer is in use. Check the printer status.
PAPER LEVER ERROR	Paper lever error occurred. Adjust the paper selection lever to the proper position.
PRINTER COVER OPEN	Close the printer cover securely.
NO PRINTHEAD	No print head is installed in the printer or the print head is defective.

Handling Precautions

Camcorder

- Do not carry the camcorder by the LCD panel. Be careful when closing the LCD panel.
- Do not leave the camcorder in places subject to high temperatures (like the inside of a car under direct sunlight), or high humidity.
- Do not use the camcorder near strong electric or magnetic fields such as above TVs, near plasma TVs or mobile phones.
- Do not point the lens or viewfinder at strong light sources. Do not leave the camcorder pointed at a bright subject.
- Do not use or store the camcorder in dusty or sandy places. The camcorder is not waterproof – avoid also water, mud or salt. If any of the above should get into the camcorder it may damage the camcorder and/or the lens.
- Be careful of heat generated by lighting equipment.
- Do not disassemble the camcorder. If the camcorder does not function properly, consult qualified service personnel.
- Handle the camcorder with care. Do not subject the camcorder to shocks or vibration as this may cause damage.

Battery Pack

DANGER!

Treat the battery pack with care.

- Keep it away from fire (or it might explode).
- Do not expose the battery pack to temperature higher than 60 °C (140 °F). Do not leave it near a heater or inside a car in hot weather.
- Do not try to disassemble or modify it.
- Do not drop or knock it.
- Do not get it wet.

- Charged battery packs continue to discharge naturally. Therefore, charge them on the day of use, or the day before, to ensure a full charge.
- Attach the terminal cover whenever a battery pack is not in use. Contact with metallic objects may cause a short circuit and damage the battery pack.
- Dirty terminals may cause a poor contact between the battery pack and the camcorder. Wipe the terminals with a soft cloth.
- Since storing a charged battery pack for a long time (about 1 year) can shorten its lifecycle or affect performance, we recommend to discharge the battery pack fully and to store it in a dry place at temperatures no higher than 30 °C (86 °F). If you do not use the battery pack for long periods, charge and discharge it fully at least once a year. If you have more than one battery pack, perform these precautions at the same time for all battery packs.
- Although the battery pack's operating temperature range is from 0 °C to 40 °C (32 °F to 104 °F), the optimal range is from 10 °C to 30 °C (50 °F to 86 °F). At cold temperatures, performance will temporarily decline. Warm it in your pocket before use.

- Replace the battery pack if the usable time after full charge diminishes substantially at normal temperatures.

About the battery terminal cover

The battery terminal cover has a [□]-shaped hole. This is useful when you wish to differentiate between charged and uncharged battery packs.

Back side of the battery pack

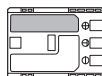

Terminal cover attached
Charged



Uncharged

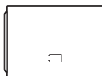

Cassette

- Rewind tapes after use. A slack or damaged tape may cause video problems and/or audio distortions during playback.
- Return cassettes to the case and store them upright. Rewind tapes from time to time if they are stored for a long time.
- Do not leave the cassette in the camcorder after use.
- Do not use spliced tapes or nonstandard cassettes as they may damage the camcorder.
- Do not use tapes that have been jammed as video heads may become dirty.
- Do not insert anything into the small holes of the cassette, or cover them with cellophane tape.
- Handle cassettes with care. Do not drop or subject them to severe impact as this may damage the cassettes.

- With cassettes equipped with a memory function, metal plated terminals may become dirty with use. Clean the terminals with a cotton swab after about 10 times of removing and reinserting the cassette. The memory function is not supported by the camcorder.

Protecting Tapes from Accidental Erasure

To protect your recordings from accidental erasure, slide the tab on the cassette to SAVE or ERASE OFF.

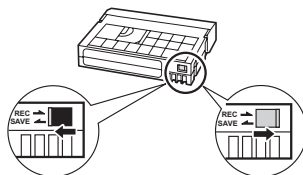

Memory Card

- We recommend saving backups of memory card images on your computer. Image data may be corrupted or lost due to memory card defects or exposure to static electricity. Canon Inc. makes no warranties for corrupted or lost data.
- Do not turn off the camcorder, disconnect the power source or remove the memory card while the CARD access indicator is flashing.
- Do not use memory cards in places subject to strong magnetic fields.
- Do not leave memory cards in places subject to high humidity and high temperature.
- Do not disassemble, bend, drop, or subject memory cards to shocks and do not expose them to water.
- Do not touch or expose the terminals to dust or dirt.
- Check the direction before inserting the memory card. Forcing a memory card into

the slot if it is not correctly oriented may damage the memory card or the camcorder.

- Do not attach any labels or stickers on the memory card.
- When you erase image files or initialize the memory card, only the file allocation table is altered and the data itself is not actually deleted. Take the necessary precautions when you dispose of the memory card, for example by physically damaging it to prevent the leakage of private data.

- Keep the battery out of the reach of children. If swallowed, seek medical assistance immediately. The battery case may break and the battery fluids may cause internal damage.

- Do not disassemble, heat or immerse the battery in water to avoid the risk of explosion.

- **For California, USA only:** Included lithium battery contains Perchlorate Material – special handling may apply. See www.dtsc.ca.gov/hazardouswaste/perchlorate for details.

Lithium Button Battery

WARNING!

- The battery used in this device may present a fire or chemical burn hazard if mishandled. Do not recharge, disassemble, heat above 100 °C (212 °F) or incinerate the battery.

Backup battery CR1616:

- Replace the battery with a CR1616 made by Panasonic, Hitachi Maxell, Sony, Toshiba, Varta or Renata. Use of other batteries may present a risk of fire or explosion.

Lithium battery for the wireless controller CR2025:

- Replace the battery with a CR2025 made by Panasonic, Hitachi Maxell, Sony, Sanyo, or with Duracell2025. Use of other batteries may present a risk of fire or explosion.
- Dispose of the used battery according to applicable recycling regulations.

- Do not pick up the battery using tweezers or other metal tools as this will cause a short circuit.
- Wipe the battery with a clean dry cloth to ensure proper contact.

Maintenance/Others

Cleaning the Camcorder

Camcorder Body

- Use a soft, dry cloth to clean the camcorder body. Never use chemically treated cloth or volatile solvents such as paint thinner.

Lens and Viewfinder

- If the lens surface is dirty, the autofocus may not work properly.
- Remove any dust or dirt particles using a non-aerosol type blower brush.
- Use a clean, soft lens-cleaning cloth to gently wipe the lens or viewfinder. Never use tissue paper.

LCD Screen

- Clean the LCD screen using a clean, soft lens-cleaning cloth.
- Condensation may form on the surface of the screen when the temperature changes suddenly. Wipe it with a soft dry cloth.

Storage

- If you do not intend to use the camcorder for a long time, store it in a place free of dust, in low humidity, and at temperatures not higher than 30 °C (86 °F).

Condensation

Moving the camcorder rapidly between hot and cold temperatures may cause condensation (water droplets) to form on its internal surfaces. Stop using the camcorder if condensation is detected. Continued use may damage the camcorder.

Condensation may form in the following cases:

When the camcorder is moved from an air-conditioned room to a warm, humid place

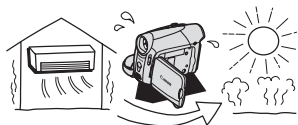

When the camcorder is moved from a cold place to a warm room

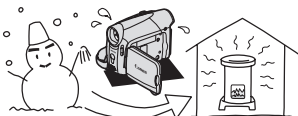

When the camcorder is left in a humid room

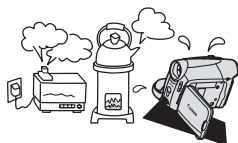



When a cold room is heated rapidly



TO AVOID CONDENSATION

- Do not expose the camcorder to sudden or extreme changes in temperature.
- Remove the cassette, place the camcorder in an airtight plastic bag and let it adjust to temperature changes slowly before removing it from the bag.

WHEN CONDENSATION IS DETECTED

- The camcorder automatically shuts off, the warning message "CONDENSATION HAS BEEN DETECTED" appears for approx. 4 seconds and  starts flashing.
- If a cassette is loaded, the warning message "REMOVE THE CASSETTE" appears and  starts flashing. Remove the cassette immediately and leave the cassette compartment open. Leaving the cassette in the camcorder may damage the tape.
- A cassette cannot be loaded when condensation is detected.

RESUMING USE

- The precise time required for water droplets to evaporate will vary depending on the location and weather conditions. After the condensation warning stops flashing, wait for 1 more hour before resuming use.

Using the Camcorder Abroad

Power Sources

You can use the compact power adapter to operate the camcorder and to charge battery packs in any country with power supply between 100 and 240 V AC, 50/60 Hz. Consult the Canon Service Center for information on plug adapters for overseas use.

Playback on a TV Screen

You can only play back your recordings on TVs compatible with the NTSC system. The NTSC system is used in the following countries/areas:

American Samoa, Antigua, Aruba, Bahamas, Barbados, Bermuda, Bolivia, Canada, Chile, Colombia, Costa Rica, Cuba, Ecuador, El Salvador, Guam, Guatemala, Greenland, Haiti, Honduras, Jamaica, Japan, Korea, Mexico, Micronesia, Myanmar, Nicaragua, Panama, Peru, Philippines, Puerto Rico, Saint Kitts and Nevis, Saint Lucia, Saint Vincent and the Grenadines, Surinam, Taiwan, Trinidad and Tobago, USA, Venezuela, Virgin Islands.

System Diagram (Availability differs from area to area)

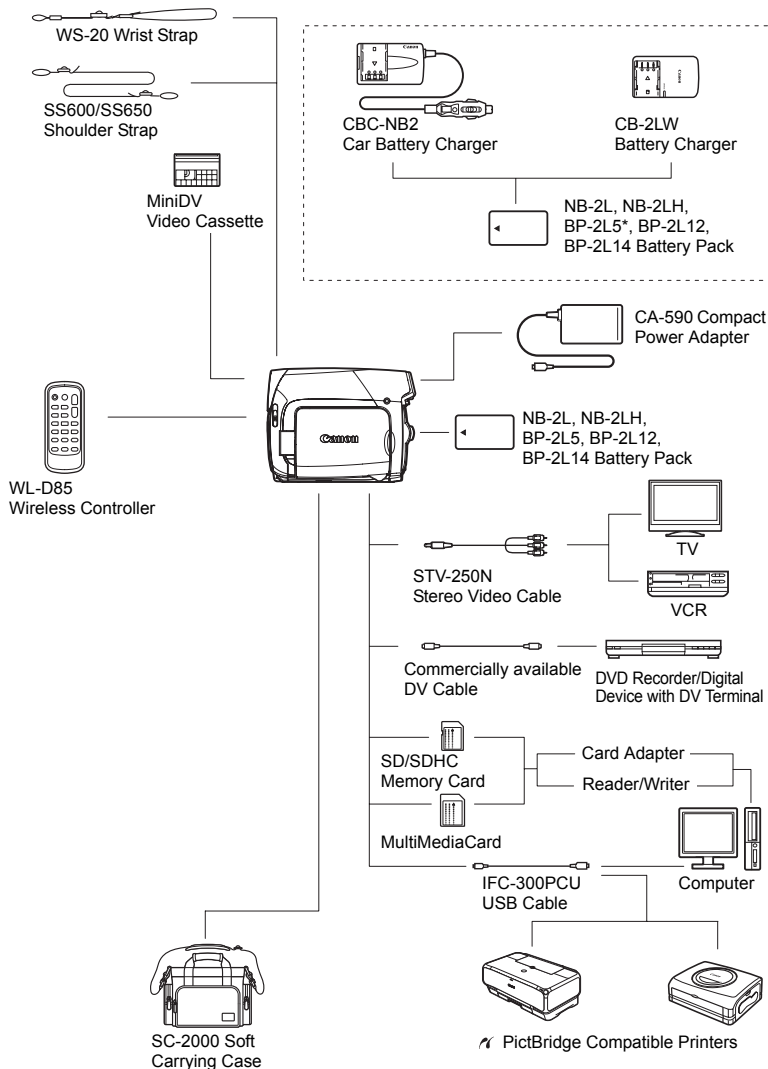

* The BP-2L5 is not available as a separate optional accessory.

Optional Accessories

Call or visit your local retailer/dealer for genuine Canon video accessories. You can also obtain genuine accessories for your Canon camcorder by calling: 1-800-828-4040, Canon U.S.A. Information Center.

Use of genuine Canon accessories is recommended.

This product is designed to achieve excellent performance when used with genuine Canon accessories. Canon shall not be liable for any damage to this product and/or accidents such as fire, etc., caused by the malfunction of non-genuine Canon accessories (e.g., a leakage and/or explosion of a battery pack). Please note that this warranty does not apply to repairs arising out of the malfunction of non-genuine Canon accessories, although you may request such repairs on a chargeable basis.

Battery Packs

When you need extra battery packs, select one of the following models: NB-2L, NB-2LH, BP-2L12, BP-2L14.

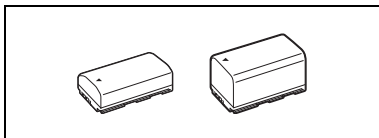

CB-2LW Battery Charger

Use the battery charger for charging the battery packs. It plugs directly into a power outlet without a cable.

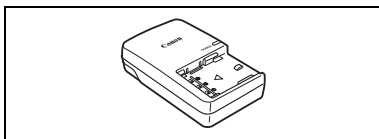

Battery Pack	Charging Time*
BP-2L5	70 min.
NB-2L	80 min.
NB-2LH	90 min.
BP-2L12	150 min.
BP-2L14	170 min.

* Charging time varies according to the charging condition.

CBC-NB2 Car Battery Charger

Use the car battery charger to charge battery packs on the move. The car battery cable plugs into your car's cigarette lighter and runs off a 12-24 V DC negative ground battery.

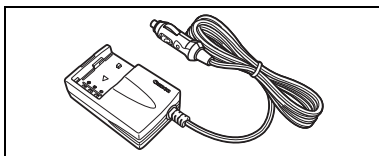

Shoulder Strap

You can attach a shoulder strap for more security and portability.

Pass the ends through the strap mount and adjust the length of the strap.

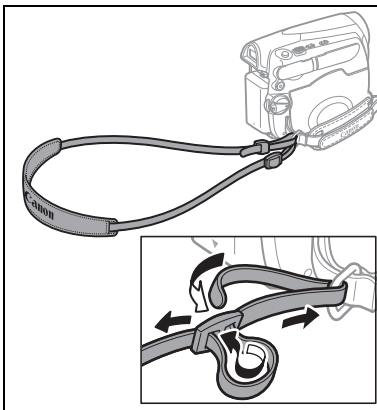
**WS-20 Wrist Strap**

Use this for extra additional protection for active shooting.

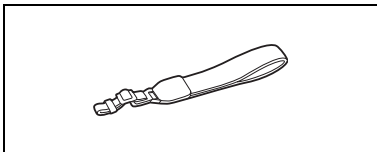
**SC-2000 Soft Carrying Case**

A handy camcorder bag with padded compartments and plenty of space for accessories.



This mark identifies genuine Canon video accessories. When you use Canon video equipment, we recommend Canon-brand accessories or products bearing the same mark.



Product Codes**Provided Accessories**

CA-590 Compact Power Adapter	D85-1671-000
WL-D85 Wireless Controller	D83-0712-000
STV-250N Stereo Video Cable	3067A002AA (D82-0590-201)
IFC-300PCU USB Cable	6906A001AA

Optional Accessories

BP-2L12 Battery Pack	7871A002AA
BP-2L14 Battery Pack	9582A002AA
NB-2L Battery Pack	7302A001AA
CB-2LW Battery Charger	0763B001AA
CBC-NB2 Car Battery Charger	7873A002AA
WS-20 Wrist Strap	3118A002AA (D81-0190-202)
SC-2000 Soft Carrying Case	9389A001AA
DVM-CL DV Cleaning Cassette	3134A002AA (D36-0032-201)

Specifications

ZR850/ZR830

System	
Video Recording System	2 rotary heads, helical scanning DV system (consumer digital VCR SD system), digital component recording
Audio Recording System	PCM digital sound: 16 bit (48 kHz/2 channels); 12 bit (32 kHz)
Television System	EIA standard (525 lines, 60 fields) NTSC color signal
Image Sensor	1/6-inch CCD, ZR850 approx. 1,070,000 pixels ZR830 approx. 680,000 pixels ZR850 Effective pixels 16:9 Movies (Image stabilizer [ON]) approx. 550,000 pixels 16:9 Movies (Image stabilizer [OFF]) approx. 710,000 pixels 4:3 Movies approx. 690,000 pixels Still images approx. 800,000 pixels ZR830 Effective pixels 16:9 Movies (Image stabilizer [ON]) approx. 360,000 pixels 16:9 Movies (Image stabilizer [OFF]) approx. 450,000 pixels 4:3 Movies approx. 340,000 pixels Still images approx. 450,000 pixels
Compatible Tapes	Videocassettes bearing the TM IX mark
Tape Speed	SP: 18.81 mm/s (0.74 ips); LP: 12.56 mm/s (0.49 ips)
Maximum Recording Time (60 min. tape)	SP: 60 minutes; LP: 90 minutes
LCD Screen	2.7 in., wide, TFT color, approx. 112,000 pixels
Viewfinder	0.35 in., wide, TFT color, approx. 114,000 pixels
Microphone	Stereo electret condenser microphone
Lens	f=2.6–91 mm, F/2.0–5.0, 35x power zoom ZR850 35 mm equivalent: 16:9 Movies (Image stabilizer [ON]) 47.1–1,649 16:9 Movies (Image stabilizer [OFF]) 41.7–1,460 4:3 Movies 44.6–1,561 Still images 41.5–1,453 ZR830 35 mm equivalent: 16:9 Movies (Image stabilizer [ON]) 45.8–1,603 16:9 Movies (Image stabilizer [OFF]) 41.0–1,435 4:3 Movies 49.8–1,743 Still images 43.6–1,526
Lens Configuration	10 elements in 8 groups
AF system	TTL autofocus, manual focus available
Minimum Focusing Distance	1 m (3.3 ft.); 1 cm (0.39 in.) on maximum wide angle
White Balance	Auto white balance, preset white balance (DAYLIGHT, TUNGSTEN) or custom white balance
Minimum Illumination	2 lx ([NIGHT] recording program, Shutter speed at 1/8) 8 lx (Easy recording mode, Auto slow shutter [ON], Shutter speed at 1/30)
Recommended Illumination	More than 100 lx
Image Stabilization	Electronic
Memory Card	
Recording Media	SDHC (SD High Capacity) memory card, SD memory card, MultiMedia Card (MMC)*
Size of Still Images	1,152 x 864 (ZR850 only), 1,024 x 768 (ZR830 only), 640 x 480 pixels

Size of Movie Clips	320 x 240, 160 x 120 pixels; 15 frames/sec.
File Format	Design rule for Camera File system (DCF), Exif 2.2** compliant, DPOF compliant
Image Compression Method	Still images: JPEG (compression: Super Fine, Fine, Normal) Movie clips: Video - Motion JPEG, Audio - WAVE (monaural)

* This camcorder has been tested with SD memory cards up to 2 GB. Performance cannot be guaranteed for all memory cards.

** This camcorder supports Exif 2.2 (also called "Exif Print"). Exif Print is a standard for enhancing the communication between camcorders and printers. By connecting to an Exif Print-compliant printer, the camcorder's image data at the time of shooting is used and optimized, yielding extremely high quality prints.

Input/Output Terminals

AV Terminal	Ø3.5 mm minijack, ZR850 : Video output only, Audio input/output; ZR830 : output only Video: 1 Vp-p/75 ohms unbalanced Audio output: -10 dBV (47 kohms load/3 kohms or less) Audio input: -10 dBV/40 kohms or more (ZR850 only)
DV Terminal	4 pin (IEEE1394 standard), input/output
USB Terminal	mini-B

Power/Others

Power supply (rated)	7.4 V DC (battery pack), 8.4 V DC (compact power adapter)
Power consumption (AF on)	ZR850 2.3 W, ZR830 2.1 W
Operating temperature	0 – 40 °C (32 – 104 °F)
Dimensions (W x H x D)	57 x 92 x 119 mm (2.2 x 3.6 x 4.7 in.) excluding the grip belt
Weight (camcorder body only)	380 g (13.4 oz.)

CA-590 Compact Power Adapter

Power input	100 – 240 V AC, 50/60 Hz, 0.14 – 0.08 A
Rated output	8.4 V DC, 0.6 A
Operating temperature	0 – 40 °C (32 – 104 °F)
Dimensions	46 x 26 x 70 mm (1.8 x 1.0 x 2.8 in.)
Weight	95 g (3.4 oz.)

BP-2L5 Battery Pack

Battery type	Rechargeable Lithium Ion Battery
Rated voltage	7.4 V DC
Operating temperature	0 – 40 °C (32 – 104 °F)
Battery capacity	530 mAh
Dimensions	33.3 x 16.2 x 45.2 mm (1.3 x 0.64 x 1.8 in.)
Weight	40 g (1.4 oz.)

Weight and dimensions are approximate. Errors and omissions excepted. Subject to change without notice.

Index

16:9 aspect ratio	54
6-second auto date	43
9 Point AiAF (Autofocus)	54

A

Abroad, using the camcorder	87
AF assist lamp*	56
Audio dubbing	66
Audio mode	50
Audio output channel	51
Auto slow shutter	39
Autofocus (AF)	54
AV terminal	63

B

Backup battery	21
Battery pack, charging	19
Battery pack, remaining charge	16
Beach (recording program)	45
Beep	43

C

Card mix	58
Center point (autofocus)	54
Compact power adapter	19
Condensation	86
Connection to a computer	68
Connection to a TV/VCR	63

D

Data code	55
Date and time	27
Date search	34
Daylight saving time	26
Digital effects	56
Digital video input (DV dubbing)	65
Digital zoom	39
Direct print	72
Direct transfer	69
DV terminal	63, 68

E

Easy recording (recording program)	45
Effects	57

End Search	34
Erasing still images/movie clips	60
Error messages	80

F

Faders	56
File numbers	44
Fireworks (recording program)	45
Focus	48
Focus priority	54
FUNC. menu	24, 37

G

Grip belt	23
-----------	----

I

Image effects	50
Image jump	35
Image stabilizer	40
Index screen	35
Initialization - Memory card	62

J

Joystick	9
Joystick guide	9

L

Language	26
LCD backlight	24
LCD screen	23
LED light*	56
LP mode	40

M

Magnifying the playback image	36
Maintenance	86
Manual exposure adjustment	47
Memory card	22, 84
Mode switch	45
Movie clip size	53
Movie clips on the memory card	30

N

Night (recording program)	45
Normal TV (4:3)	40

P

P (recording program) 46
 Playback - Movie clips 34
 Playback - Movies 32
 Playback - Still images 34
 Portrait (recording program) 45
 Power save 43
 Print order 75
 Printing still images 72
 Protecting still images/movie clips 61

R

Recording - Movie clips 30
 Recording - Movies 28
 Recording - Still images 29
 Recording mode 40
 Recording programs 45
 Recording reminder 16
 Remaining tape indicator 16
 Remote sensor 23
 Reviewing - Movies (Record review) 28
 Reviewing - Still images 39

S

Screen displays 15
 Screen markers 42
 SD/SDHC card 22, 84
 Selecting the on-screen displays 55
 Self timer 56
 Serial number 12
 Setup menus 25
 Shoulder strap 90
 Shutter speed 46
 Simultaneous recording
 (tape/memory card) 53
 Slideshow 35
 Snow (recording program) 45

SP mode 40
 Sports (recording program) 45
 Spotlight (recording program) 45
 Still image quality 52
 Still image size 52
 Sunset (recording program) 45

T

Telephone 31
 Time zone 26
 Transfer order 71
 Transferring still images 69
 Tripod 29
 Troubleshooting 77

U

USB terminal 68

V

Video heads, cleaning 2
 Videocassettes 21, 84
 Viewfinder, dioptic adjustment 23
 Volume 33

W

White balance 49
 Wide angle 31
 Wide TV (16:9) 40
 Widescreen 40
 Wind screen 41
 Wireless controller 23

Z

Zero set memory 33
 Zoom 31
 Zoom speed 31, 39

* **ZR850** only.

U.S.A.**CANON CONSUMER DIGITAL VIDEO EQUIPMENT LIMITED WARRANTY FOR THE UNITED STATES**

The warranty set forward below is given by Canon U.S.A., Inc. with respect to equipment purchased in the United States. The limited warranty is only effective upon presentation of your Bill of Sale or other proof of purchase. Canon consumer digital video equipment is warranted under normal, non-commercial, personal use, against defective materials or workmanship as follows:

Parts: Defective parts will be exchanged for new parts or comparable rebuilt parts for a period of ONE YEAR from the date of original purchase, except for a defective Video Head, which will be exchanged for a period of three months from the date of purchase.

Labor: For a period of ONE YEAR from the date of original purchase, labor will be provided free of charge by our factory service centers or designated service facilities located in the United States.

When returning equipment under this warranty, you must pre-pay the shipping charges, and you must enclose the Bill of Sale or other proof of purchase with a complete explanation of the problem. During your ONE-YEAR warranty period, repairs will be made and the equipment return-shipped to you free of charge. After your warranty period is over, you will be given an estimate of the cost of repair and an opportunity to approve or disapprove of the repair expense before it is incurred. If you approve, repairs will be made and the equipment return-shipped to you. (shipping charges apply). If you disapprove, we will return-ship the equipment at no charge to you.

Non-Canon brand peripheral equipment and software which may be distributed with Canon DV camcorders are sold "AS IS" without warranty of any kind by CUSA, including any implied warranty regarding merchantability or fitness for a particular purpose. The sole warranty with respect to such non-Canon brand items is given by the manufacturer or producer thereof.

CUSA shall have no responsibility under this limited warranty for use of Canon DV Camcorders in conjunction with incompatible peripheral equipment and incompatible software.

In order to obtain warranty service, contact the authorized Canon retail dealer from whom you purchased the DV Camcorder or call the CANON INFORMATION CENTER AT 1-800-828-4040). You will be directed to the nearest service facility for your product.

This Limited Warranty covers all defects encountered in normal use of the equipment and does not apply in the following cases:

- A) Loss or damage to the equipment due to abuse, mishandling, accident, improper maintenance, or failure to follow operating instructions;
- B) If the equipment is defective as a result of leaking batteries, sand, dirt or water damage;
- C) If defects or damages are caused by the use of unauthorized parts or by service other than our authorized agent;
- D) If the equipment is used for commercial or industrial use.

This Limited Warranty does not cover cabinet (exterior finish), video cassette tape, head cleanings, nor does it apply to equipment purchased outside the United States. This warranty does not cover units sold to rental firms, military operations, hotels, schools, hospitals or for other commercial, industrial, or institutional applications. These uses are covered only by such specific warranty as Canon may issue with such sales.

This Limited Warranty does not apply to accessories or consumables for the DV Camcorder, which are sold "AS IS", without warranty of any kind by CUSA.

Please retain this warranty card and your Bill of Sale as a permanent record of your purchase. This card is most important in order to be sure you are contacted right away should there be a safety inspection, modification or product recall under applicable laws or regulations.

NO IMPLIED WARRANTY, INCLUDING MERCHANTABILITY AND FITNESS FOR A PARTICULAR PURPOSE APPLIES TO THIS EQUIPMENT AFTER THE APPLICABLE PERIOD OF EXPRESS WARRANTY OR GUARANTY, EXCEPT AS MENTIONED ABOVE, GIVEN BY ANY PERSON, FIRM OR CORPORATION WITH RESPECT TO THIS EQUIPMENT SHALL BIND THE UNDERSIGNED. (SOME STATES DO NOT ALLOW LIMITATIONS ON HOW LONG AN IMPLIED WARRANTY LASTS, SO THE ABOVE LIMITATION OR EXCLUSION MAY NOT APPLY TO YOU). CUSA SHALL NOT BE LIABLE FOR LOSS OF REVENUES OR PROFITS, EXPENSE FOR SUBSTITUTE EQUIPMENT OR SERVICE, STORAGE CHARGES, LOSS OF DATA, OR ANY OTHER SPECIAL, INCIDENTAL OR CONSEQUENTIAL DAMAGES CAUSED BY THE USE, MISUSE OR INABILITY TO USE THE DV CAMCORDER, REGARDLESS OF THE LEGAL THEORY ON WHICH THE CLAIM IS BASED, AND EVEN IF CUSA HAS BEEN ADVISED OF THE POSSIBILITY OF SUCH DAMAGES. NOR SHALL RECOVERY OF ANY KIND AGAINST CUSA BE GREATER THAN THE PURCHASE PRICE OF THE DV CAMCORDER SOLD BY CUSA AND CAUSING THE ALLEGED DAMAGE. WITHOUT LIMITING THE FOREGOING, YOU ASSUME ALL RISK AND LIABILITY FOR LOSS, DAMAGE OR INJURY TO YOU AND YOUR PROPERTY AND TO OTHERS AND THEIR PROPERTY ARISING OUT OF USE, MISUSE OR INABILITY TO USE THE DV CAMCORDER NOT CAUSED DIRECTLY BY THE NEGLIGENCE OF CUSA. (SOME STATES DO NOT ALLOW THE EXCLUSION OR LIMITATION OF INCIDENTAL OR CONSEQUENTIAL DAMAGES, SO THE ABOVE LIMITATION MAY NOT APPLY TO YOU). THIS WARRANTY SHALL NOT EXTEND TO ANYONE OTHER THAN THE ORIGINAL PURCHASER OF THIS EQUIPMENT OR THE PERSON FOR WHOM IT WAS PURCHASED AS A GIFT.

This warranty gives you specific legal rights, and you may also have other rights which vary from state to state. CANON U.S.A., INC.

CANADA**CANON CONSUMER DIGITAL VIDEO EQUIPMENT LIMITED WARRANTY**

The limited warranty set forth below is given by Canon Canada Inc. ("Canon Canada") with respect to Canon digital video equipment purchased in Canada. This limited warranty is only effective upon presentation of a bill of sale or other proof of purchase for this Canon digital video equipment to a Canon Service Facility when repairs are required.

Canon consumer video digital equipment is warranted under normal, non-commercial, personal use, against defective materials or workmanship as follows:

Parts: Defective parts will be exchanged for new parts or, at Canon Canada's option, comparable rebuilt parts for a period of one year from the date of original purchase, except Video Heads which will be exchanged for a period of 3 months from the date of purchase.

Labour: For a period of one year from the date of original purchase, labour will be provided free of charge by our Canon Service Facilities in Canada.

This limited warranty covers all defects except where:

(a) The loss or damage to the product results from:

- i) accident, natural disaster, mishandling, abuse, neglect, unauthorized product modification or failure to follow instructions contained in the instruction manual;
- ii) the use of accessories, attachments, products, supplies, parts or devices with this Canon product that do not conform to Canon specifications or that cause abnormally frequent service problems;
- iii) repairs or services performed by any party other than a Canon Service Facility;
- iv) defective batteries or any exposure to water, sand or dirt;
- v) shipping (claim must be presented to the shipper);

(b) Any serial number on the video equipment is altered or removed.

(c) The digital video equipment is used for commercial, professional or industrial purposes.

This limited warranty does not cover the cabinet (exterior finish) of the digital video equipment, video cassette tapes, head cleanings, nor does it apply to digital video equipment purchased outside Canada.

TO OBTAIN WARRANTY SERVICE

Ship your Canon digital video equipment in its original carton, box or equivalent, properly packed, fully insured with shipping charges prepaid, together with a copy of your bill of sale or other proof of purchase and a description of the problem to any of the Canon Service Facilities in Canada.

LIMITATIONS

Except as otherwise required by applicable legislation, this warranty is in lieu of all other warranties, conditions, guarantees or representations, express or implied, statutory or otherwise, relative to this Canon product, including implied warranties or conditions of merchantability or fitness for a particular purpose.

Canon Canada assumes no liability for special, consequential or incidental damages or loss that may arise, whether on account of negligence or otherwise, from the use, misuse or inability to use this Canon product (including loss of profit, revenue, video tapes or enjoyment) or from failure to conform to any express or implied warranties, conditions, guarantees or representations. Any recovery under this limited warranty shall not exceed the purchase price of the product. Canon Canada does not assume or authorize any other person to assume for Canon Canada any other liability with respect to this Canon product.

This warranty does not extend to any person other than the original purchaser of this Canon product or the person for whom it was purchased as a gift and states your exclusive remedy.

NOTICE TO CONSUMER

If you plan to take important videos or if the product has not been used for some time, please check all functions with the instruction book before using it.



CANON INC.

U.S.A.

CANON U.S.A., INC. NEW JERSEY OFFICE
100 Jamesburg Road, Jamesburg, NJ 08831 USA

CANON U.S.A., INC. CHICAGO OFFICE
100 Park Blvd., Itasca, IL 60143 USA

CANON U.S.A., INC. LOS ANGELES OFFICE
15955 Alton Parkway, Irvine, CA 92618 USA

CANON U.S.A., INC. HONOLULU OFFICE
210 Ward Avenue, Suite 200, Honolulu, HI 96814 USA

- If you have any questions, call the Canon U.S.A. Information Center toll-free at 1-800-828-4040 (U.S.A. only).

CANADA

CANON CANADA INC. NATIONAL HEADQUARTERS
6390 Dixie Road, Mississauga, Ontario L5T 1P7

CANON CANADA INC. CALGARY
2828, 16th Street, N.E. Calgary, Alberta T2E 7K7

CANON CANADA INC. MONTREAL
5990 Côte de Liesse, Quebec H4T 1V7

- If you have any questions, call the Canon Canada Information Center toll-free at 1-800-828-4040 (CANADA only).

- Si vous avez des questions, veuillez téléphoner sans frais au Canada 1-800-828-4040 (CANADA seulement).

MEXICO

CANON MEXICANA, S. DE R.L. DE C.V.
Periférico Sur No. 4124 Col. Ex-Rancho de Anzaldo C.P. 01900
México, D.F., México

CANON U.S.A., INC. NEW JERSEY OFFICE
100 Jamesburg Road, Jamesburg, NJ 08831 USA

CENTRO Y SURAMÉRICA

CANON LATIN AMERICA, INC.
703 Waterford Way Suite 400 Miami, FL 33126 USA

ASIA

CANON HONGKONG COMPANY LTD.
19/F, The Metropolis Tower, 10 Metropolis Drive, Hunghom, Kowloon,
Hong Kong

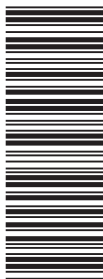

The information on this manual is verified as of January 1st, 2007.
Les informations contenues dans ce manuel ont été vérifiées le 1er janvier 2007.
La información de este manual fue verificada el 1 de enero de 2007.



Printed on 100% reused paper.
Document réalisé avec du papier recyclé à 100%.
El papel aquí utilizado es 100% reciclado.