

Canon

EOS 1300

EOS 1300D (W)



Instruction Manual

Instruction manuals (PDF files) and software can be downloaded from the Canon website (p.4, 315).

www.canon.com/icpd

ENGLISH

Introduction

The EOS 1300D (W) is a digital single-lens reflex camera featuring a fine-detail CMOS sensor with approx. 18.0 effective megapixels, DIGIC 4+, high-precision and high-speed 9-point AF, approx. 3.0 fps continuous shooting, Live View shooting, Full High-Definition (Full HD) movie shooting, and wireless functions (Wi-Fi/NFC).

Before Starting to Shoot, Be Sure to Read the Following

To avoid botched pictures and accidents, first read the “Safety Precautions” (p.20-22) and “Handling Precautions” (p.23-25). Also, read this manual carefully to ensure that you use the camera correctly.

Refer to This Manual while Using the Camera to Further Familiarize Yourself with the Camera

While reading this manual, take a few test shots and see how they come out. You can then better understand the camera. Be sure to store this manual safely, too, so that you can refer to it again when necessary.

Testing the Camera Before Use and Liability

After shooting, play images back and check whether they have been properly recorded. If the camera or memory card is faulty and the images cannot be recorded or downloaded to a computer, Canon cannot be held liable for any loss or inconvenience caused.

Copyrights

Copyright laws in your country may prohibit the use of your recorded images or copyrighted music and images with music in the memory card for anything other than private enjoyment. Also be aware that certain public performances, exhibitions, etc., may prohibit photography even for private enjoyment.

Item Check List

Before starting, check that all the following items are included with your camera. If anything is missing, contact your dealer.

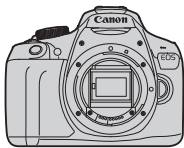

Camera

(with eyecup and body cap)



Battery Pack LP-E10
(with protective cover)



Battery Charger
LC-E10/LC-E10E*



Strap



Interface Cable

* Battery Charger LC-E10 or LC-E10E is provided. (The LC-E10E comes with a power cord.)

- The Instruction Manuals provided are listed on the next page.
- If you purchased a Lens Kit, check that the lenses are included.
- Depending on the Lens Kit type, lens instruction manuals may also be included.
- Be careful not to lose any of the above items.



When you need Lens Instruction Manuals, download them from the Canon website (p.4).

The lens instruction manuals (PDF) are for lenses sold individually. Note that when purchasing the Lens Kit, some of the accessories included with the lens may not match those listed in the Lens Instruction Manual.

Instruction Manuals



Camera and Wireless Function Basic Instruction Manual

The booklet is the Basic Instruction Manual.
More detailed Instruction Manuals (PDF files) can be downloaded from the Canon website.

Downloading and Viewing the Instruction Manuals (PDF Files)

1 Download the Instruction Manuals (PDF files).

- Connect to the Internet and access the following Canon website.
www.canon.com/icpd
- Select your country or region of residence and download the Instruction Manuals.

Instruction Manuals Available for Download

- Camera Instruction Manual
- Wireless Function Instruction Manual
- Camera and Wireless Function Basic Instruction Manual
- Lens Instruction Manuals
- Software Instruction Manuals

2 View the Instruction Manuals (PDF files).

- Double-click a downloaded Instruction Manual (PDF file) to open it.
- To view the Instruction Manuals (PDF files), Adobe Acrobat Reader DC or other Adobe PDF viewer (most recent version recommended) is required.
- Adobe Acrobat Reader DC can be downloaded free from the Internet.
- To learn how to use a PDF viewer, refer to its Help section.



Software can be downloaded from the Canon website (p.315).

Compatible Cards

The following cards can be used with the camera regardless of capacity: **If the card is new or was previously formatted by another camera or computer, it is recommended that you format the card with this camera** (p.52).

- SD memory cards
- SDHC memory cards
- SDXC memory cards



The camera can use UHS-I cards, but since it is not compatible with the UHS-I standard, reading/writing speeds will be equivalent to SD Speed Class 10 at most.

Cards that Can Record Movies

When shooting movies, use a large-capacity SD card rated SD Speed Class 6 “CLASS 6” or higher.

- If you use a slow-writing card when shooting movies, the movie may not be recorded properly. Also, if you play back a movie on a card with a slow reading speed, the movie may not play back properly.
- To check the card’s reading/writing speed, refer to the card manufacturer’s website.



In this manual, “card” refers to SD memory cards, SDHC memory cards, and SDXC memory cards.

* **The camera does not come with a card for recording images/movies.** Please purchase it separately.

Quick Start Guide

1

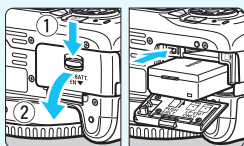

Insert the battery (p.36).

- To charge the battery, see page 34.

2

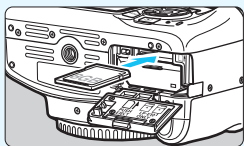

Insert the card (p.36).

- With the card's label facing toward the back of the camera, insert it into the card slot.

3

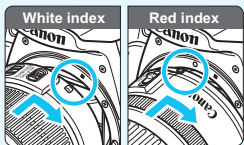

Attach the lens (p.44).

- Align the lens's white or red mount index with the camera's mount index of the same color.

4

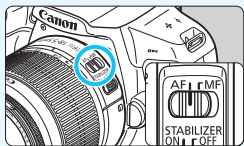

Set the lens's focus mode switch to <AF> (p.44).

5

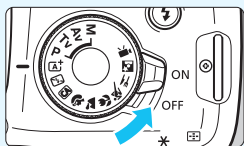

Set the power switch to <ON> (p.39).

- When the LCD monitor displays the date/time/zone setting screens, see page 41.

6

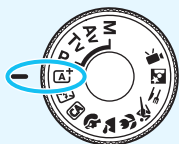

Set the Mode Dial to <AI+> (Scene Intelligent Auto) (p.58).

- All the necessary camera settings will be set automatically.

7



Focus on the subject (p.47).

- Look through the viewfinder and aim the viewfinder center over the subject.
- Press the shutter button halfway, and the camera will focus on the subject.
- If necessary, the built-in flash will be raised.

8

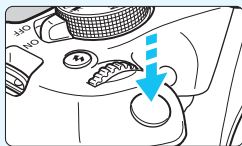

Take the picture (p.47).

- Press the shutter button completely to take the picture.

9





Review the picture.

- The captured image will be displayed for approx. 2 sec. on the LCD monitor.
- To display the image again, press the <▶> button (p.83).

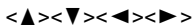

- To shoot while looking at the LCD monitor, see “Live View Shooting” (p.139).
- To view the images captured so far, see “Image Playback” (p.83).
- To delete an image, see “Erasing Images” (p.230).

Conventions Used in this Manual

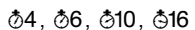
Icons in this Manual

-  : Indicates the Main Dial.
-  : Indicates the <⬅➡> cross keys on the top, bottom, left, and right.
-  : Indicates the Setting button.
-  : Indicates that each function remains active for approx. 4 sec., 6 sec., 10 sec., or 16 sec. after you let go of the button.

* In addition to the above, the icons and symbols used on the camera's buttons and displayed on the LCD monitor are also used in this manual when discussing relevant operations and functionality.

- MENU** : Indicates a function that can be changed by pressing the <MENU> button to change its settings.
- ★ : When shown on the upper right of a page, it indicates that the function is available only in the Creative Zone modes (p.30).
- (p.**): Reference page numbers for more information.
-  : Warning to prevent shooting problems.
-  : Supplemental information.
-  : Tips or advice for better shooting.
- ?: Troubleshooting advice.

Basic Assumptions

- All operations explained in this manual assume that the power switch is set to <ON> (p.39).
- It is assumed that all the menu settings and Custom Functions are set to their defaults.
- The illustrations in this manual show the camera attached with the EF-S18-55mm f/3.5-5.6 IS II lens as an example.

Chapters

For first-time DSLR users, Chapters 1 and 2 explain the camera's basic operations and shooting procedures.

| | | |
|-----------|--|-----|
| | Introduction | 2 |
| 1 | Getting Started | 33 |
| 2 | Basic Shooting and Image Playback | 57 |
| 3 | Creative Shooting | 85 |
| 4 | Advanced Shooting | 107 |
| 5 | Shooting with the LCD Monitor (Live View Shooting) | 139 |
| 6 | Shooting Movies | 159 |
| 7 | Handy Features | 183 |
| 8 | Image Playback | 207 |
| 9 | Post-Processing Images | 235 |
| 10 | Printing Images | 241 |
| 11 | Customizing the Camera | 257 |
| 12 | Reference | 269 |
| 13 | Software Start Guide / Downloading Images to a Computer | 313 |



Contents at a Glance

Shooting

- **Shoot automatically** → **p.57-82** (Basic Zone modes)
- **Shoot continuously** → **p.102** (📷 Continuous shooting)
- **Take a picture of yourself in a group** → **p.103** (🕒 Self-timer)
- **Freeze the action** → **p.108** (Tv Shutter-priority AE)
- **Blur the action**
- **Blur the background** → **p.64** (📷 Creative Auto)
- **Keep the background in sharp focus** → **p.110** (Av Aperture-priority AE)
- **Adjust the image brightness (exposure)** → **p.116** (Exposure compensation)
- **Shoot in low light** → **p.58, 104** (📷 Flash photography)
p.92 (ISO speed setting)
- **Shoot without flash** → **p.63** (📷 Flash Off)
→ **p.75** (📷 Flash Off)
- **Shoot fireworks at night** → **p.114** (Bulb exposure)
- **Shoot while viewing the LCD monitor** → **p.139** (📷 Live View shooting)
- **Shoot movies** → **p.159** (🎬 Movie shooting)

Image Quality

- **Shoot with image effects matching the subject** → **p.95** (Picture Style)
- **Make a large-size print of the picture** → **p.88** (📷 L, 📷 L, RAW)





- **Take many pictures** → **p.88** (▲ S1, ■ S1, S2, S3)

Focusing

- **Change the point of focus** → **p.99** (☒ AF point selection)
- **Shoot a moving subject** → **p.70, 98** (AI Servo AF)

Playback

- **View the images on the camera** → **p.83** (▶ Playback)
- **Search for pictures quickly** → **p.208** (☒ Index display)
→ **p.209** (📄 Image browsing)
- **Rate images** → **p.212** (Ratings)
- **Prevent important images from accidental deletion** → **p.228** (☒ Image protect)
- **Delete unnecessary images** → **p.230** (🗑 Delete)
- **Auto play back photos and movies** → **p.222** (Slide show)
- **View the photos or movies on a TV set** → **p.226** (TV set)
- **Adjust the LCD monitor brightness** → **p.185** (LCD monitor brightness)
- **Apply special effect to images** → **p.236** (Creative filters)

Printing

- **Print pictures easily** → **p.241** (Direct printing)



Index to Features

Power

- **Battery**
 - Charging → p.34
 - Installing/Removing → p.36
 - Battery level → p.40
- **Household power outlet** → p.270
- **Auto power off** → p.39

Cards

- **Installing/Removing** → p.36
- **Formatting** → p.52
- **Release shutter without card** → p.184

Lens

- **Attaching/Detaching** → p.44
- **Zoom** → p.45

Basic Settings

- **Dioptic adjustment** → p.46
- **Language** → p.43
- **Date/Time/Zone** → p.41
- **Beeper** → p.184
- **LCD off/on button** → p.197
- **LCD brightness adjustment** → p.185

Recording Images

- **Creating/Selecting a folder** → p.186
- **File numbering** → p.188

Image Quality

- **Image-recording quality** → p.88
- **Picture Style** → p.95
- **White balance** → p.131
- **Color space** → p.137
- **Image enhancement features**
 - Auto Lighting Optimizer → p.123
 - Lens peripheral illumination correction → p.124
 - Noise reduction for long exposures → p.262
 - Noise reduction for high ISO speeds → p.263
 - Highlight tone priority → p.263

AF

- **AF operation** → p.97
- **AF point selection** → p.99
- **Manual focusing** → p.101

Drive

- **Drive mode** → p.28
- **Continuous shooting** → p.102
- **Self-timer** → p.103
- **Maximum burst** → p.90

Shooting

- **Shooting mode** → p.30
- **ISO speed** → p.92
- **Feature guide** → p.55
- **Bulb** → p.114
- **Metering mode** → p.115
- **Quick Control** → p.48

Exposure

- Exposure compensation → p.116
- AEB → p.118
- AE lock → p.120

Flash

- Built-in flash → p.104
 - Flash exposure compensation → p.117
 - FE lock → p.121
- External flash → p.272
- Flash control → p.198

Live View Shooting

- Live View shooting → p.139
- Autofocusing (AF) methods → p.148
- Aspect ratio → p.146
- Grid → p.145
- Quick Control → p.144

Movie Shooting

- Movie shooting → p.159
- Sound recording → p.178
- Grid → p.179
- Manual exposure → p.162
- Quick Control → p.167
- Video snapshot → p.170

Playback

- Image review time → p.184
- Single-image display → p.83
- Shooting information display → p.232
- Index display → p.208

- Image browsing (Jump display) → p.209
- Magnified view → p.210
- Image rotate → p.211
- Rating → p.212
- Movie playback → p.218
- Editing out movie's first/last scene → p.220
- Slide show → p.222
- Viewing images on a TV set → p.226
- Protect → p.228
- Erase → p.230
- Quick Control → p.214

Image Editing

- Creative filters → p.236
- Resize → p.239

Printing

- PictBridge → p.244
- Print Order (DPOF) → p.251
- Photobook Set-up → p.255

Customization

- Custom Functions (C.Fn) → p.258
- My Menu → p.267

Software

- Software Start Guide → p.314
- Software Instruction Manuals → p.316

Wireless Functions

- Wireless Function Instruction Manual













Contents

| | |
|--------------------------------------|----------|
| Introduction | 2 |
| Item Check List..... | 3 |
| Instruction Manuals | 4 |
| Compatible Cards..... | 5 |
| Quick Start Guide | 6 |
| Conventions Used in this Manual..... | 8 |
| Chapters..... | 9 |
| Contents at a Glance..... | 10 |
| Index to Features | 12 |
| Safety Precautions | 20 |
| Handling Precautions | 23 |
| Nomenclature | 26 |





1 Getting Started **33**





| | |
|---|----|
| Charging the Battery | 34 |
| Installing and Removing the Battery and Card..... | 36 |
| Turning on the Power | 39 |
| Setting the Date, Time, and Zone..... | 41 |
| Selecting the Interface Language..... | 43 |
| Attaching and Detaching a Lens..... | 44 |
| Basic Operation..... | 46 |
| Q Quick Control for Shooting Functions | 48 |
| MENU Menu Operations..... | 50 |
| Formatting the Card | 52 |
| Switching the LCD Monitor Display | 54 |
| Feature Guide | 55 |

2 Basic Shooting and Image Playback 57

| | |
|---|----|
|  Fully Automatic Shooting (Scene Intelligent Auto) | 58 |
|  Full Auto Techniques (Scene Intelligent Auto)..... | 61 |
|  Disabling Flash | 63 |
|  Creative Auto Shooting..... | 64 |
|  Shooting Portraits | 67 |
|  Shooting Landscapes | 68 |
|  Shooting Close-ups..... | 69 |
|  Shooting Moving Subjects | 70 |
|  Shooting Food | 71 |
|  Shooting Night Portraits | 72 |
|  Quick Control..... | 74 |
| Shooting with Ambience Selection..... | 76 |
| Shooting by Lighting or Scene Type | 80 |
|  Image Playback | 83 |

3 Creative Shooting 85

| | |
|---|-----|
| P : Program AE..... | 86 |
| Setting the Image-Recording Quality | 88 |
| ISO: Changing the ISO Speed to Suit the Light Level..... | 92 |
|  Selecting Optimal Image Characteristics for the Subject (Picture Style)..... | 95 |
| AF: Changing the Autofocus Operation (AF operation) | 97 |
|  Selecting the AF Point | 99 |
| Subjects Difficult to Focus on..... | 101 |
| MF: Manual Focus | 101 |
|  Continuous Shooting | 102 |
|  Using the Self-timer | 103 |
|  Using the Built-in Flash | 104 |

















| | | |
|----------|--|------------|
| 4 | Advanced Shooting | 107 |
| | Tv : Conveying the Subject's Movement | 108 |
| | Av : Changing the Depth of Field | 110 |
| | Depth-of-Field Preview | 112 |
| | M : Manual Exposure | 113 |
| |  Changing the Metering Mode | 115 |
| | Setting Exposure Compensation | 116 |
| | Auto Exposure Bracketing | 118 |
| | * Locking the Exposure | 120 |
| | * Locking the Flash Exposure | 121 |
| | Auto Correction of Brightness and Contrast (Auto Lighting Optimizer) ... | 123 |
| | Correcting the Image's Dark Corners | 124 |
| |  Customizing Image Characteristics (Picture Style) | 126 |
| |  Registering Preferred Image Characteristics (Picture Style)... | 129 |
| | WB : Matching the Light Source (White balance) | 131 |
| |  Adjusting the Color Tone for the Light Source | 135 |
| | Setting the Color Reproduction Range (Color space) | 137 |
| 5 | Shooting with the LCD Monitor (Live View Shooting) | 139 |
| |  Shooting with the LCD Monitor | 140 |
| | Shooting Function Settings | 144 |
| | Menu Function Settings | 145 |
| | Using AF to Focus (AF Method) | 148 |
| | MF : Focusing Manually | 156 |



6 Shooting Movies 159

| | |
|--|-----|
| 📽 Shooting Movies | 160 |
| Autoexposure Shooting | 160 |
| Manual Exposure Shooting | 162 |
| Shooting Function Settings | 167 |
| Setting the Movie Recording Size | 168 |
| Shooting Video Snapshots | 170 |
| Menu Function Settings | 176 |

7 Handy Features 183

| | |
|--|-----|
| Handy Features | 184 |
| Disabling the Beeper | 184 |
| Card Reminder | 184 |
| Setting the Image Review Time | 184 |
| Setting the Auto Power-off Time | 185 |
| Adjusting the LCD Monitor Brightness | 185 |
| Creating and Selecting a Folder | 186 |
| File Numbering Methods | 188 |
| Setting Copyright Information | 190 |
| Auto Rotation of Vertical Images | 192 |
| Checking Camera Settings | 193 |
| Reverting the Camera to the Default Settings | 194 |
| Turning the LCD Monitor Off/On | 197 |
| Changing the Shooting Settings Screen Color | 197 |
| Setting the Flash | 198 |
| Appending Dust Delete Data | 202 |
| Manual Sensor Cleaning | 204 |

| | | |
|-----------|--|------------|
| 8 | Image Playback | 207 |
| |  Searching for Images Quickly | 208 |
| |  /  Magnified View | 210 |
| |  Rotating the Image | 211 |
| | Setting Ratings | 212 |
| |  Quick Control for Playback | 214 |
| |  Enjoying Movies | 216 |
| |  Playing Back Movies | 218 |
| |  Editing a Movie's First and Last Scenes | 220 |
| | Slide Show (Auto Playback) | 222 |
| | Viewing Images on a TV Set | 226 |
| |  Protecting Images | 228 |
| |  Erasing Images | 230 |
| | DISP. Shooting Information Display | 232 |
| 9 | Post-Processing Images | 235 |
| |  Applying Creative Filters | 236 |
| |  Resizing JPEG Images | 239 |
| 10 | Printing Images | 241 |
| | Preparing to Print | 242 |
| |  Printing | 244 |
| | Cropping the Image | 249 |
| |  Digital Print Order Format (DPOF) | 251 |
| |  Direct Printing of Print-Ordered Images | 254 |
| |  Specifying Images for a Photobook | 255 |

| | | |
|-----------|--|------------|
| 11 | Customizing the Camera | 257 |
| | Setting Custom Functions..... | 258 |
| | Custom Function Settings..... | 260 |
| | C.Fn I: Exposure | 260 |
| | C.Fn II: Image | 262 |
| | C.Fn III: Autofocus/Drive | 264 |
| | C.Fn IV: Operation/Others..... | 265 |
| | Registering My Menu | 267 |
| 12 | Reference | 269 |
| | Using a Household Power Outlet..... | 270 |
| |  Using a Remote Switch..... | 271 |
| | External Speedlites | 272 |
| |  Using Eye-Fi Cards | 274 |
| | Function Availability Table by Shooting Mode..... | 276 |
| | System Map | 278 |
| | Menu Settings | 280 |
| | Troubleshooting Guide..... | 286 |
| | Error Codes..... | 298 |
| | Specifications | 299 |
| 13 | Software Start Guide / | |
| | Downloading Images to a Computer | 313 |
| | Software Start Guide..... | 314 |
| | Downloading and Viewing the Software Instruction Manuals (PDF Files)..... | 316 |
| | Downloading Images to a Computer..... | 317 |
| | Index | 319 |

Safety Precautions

The following precautions are provided to prevent harm or injury to yourself and others. Make sure to thoroughly understand and follow these precautions before using the product.

If you experience any malfunctions, problems, or damage to the product, contact the nearest Canon Service Center or the dealer from whom you purchased the product.



Warnings: Follow the warnings below. Otherwise, death or serious injuries may result.

- To prevent fire, excessive heat, chemical leakage, explosions, and electrical shock, follow the safeguards below:
 - Do not use any batteries, power sources, or accessories not specified in the Instruction Manual. Do not use any home-made or modified batteries, or the product if it is damaged.
 - Do not short-circuit, disassemble, or modify the battery. Do not apply heat or solder to the battery. Do not expose the battery to fire or water. Do not subject the battery to strong physical shock.
 - Do not insert the battery's plus and minus ends incorrectly.
 - Do not recharge the battery in temperatures outside the allowable charging (working) temperature range. Also, do not exceed the recharge time indicated in the Instruction Manual.
 - Do not insert any foreign metallic objects into the electrical contacts of the camera, accessories, connecting cables, etc.
- When disposing of a battery, insulate the electrical contacts with tape. Contact with other metallic objects or batteries may cause a fire or an explosion.
- If excessive heat, smoke, or fumes are emitted when recharging the battery, immediately unplug the battery charger from the power outlet to stop recharging. Otherwise, it may cause a fire, heat damage, or electrical shock.
- If the battery leaks, changes color, deforms, or emits smoke or fumes, remove it immediately. Be careful not to get burned in the process. It may cause a fire, electrical shock or burns if you keep using it.
- Prevent any battery leakage from contacting your eyes, skin, and clothing. It can cause blindness or skin problems. If the battery leakage comes in contact with your eyes, skin, or clothing, flush the affected area with lots of clean water without rubbing it. See a physician immediately.
- Do not leave any cords near a heat source. It can deform the cord or melt the insulation and cause a fire or electrical shock.
- Do not hold the camera in the same position for long periods of time. Even if the camera does not feel too hot, prolonged contact with the same body part may cause skin redness or blistering due to low-temperature contact burns. Using a tripod is recommended for people with circulation problems or very sensitive skin, or when using the camera in very hot places.
- Do not fire the flash at anyone driving a car or other vehicle. It may cause an accident.

- When the camera or accessories are not in use, make sure to remove the battery, and disconnect the power plug and connecting cables from the equipment before storing. This is to prevent electrical shock, excessive heat, fire, and corrosion.
- Do not use the equipment where there is flammable gas. This is to prevent an explosion or a fire.
- If you drop the equipment and the casing breaks open to expose the internal parts, do not touch the exposed internal parts. There is a possibility of an electrical shock.
- Do not disassemble or modify the equipment. High-voltage internal parts can cause electrical shock.
- Do not look at the sun or an extremely bright light source through the camera or lens. Doing so may damage your vision.
- Keep equipment out of the reach of children and infants, including when in use. Straps or cords may accidentally cause choking, electrical shock, or injury. Choking or injury may also occur if a child or infant accidentally swallows a camera part or accessory. If a child or infant swallows a part or accessory, consult a physician immediately.
- Do not use or store the equipment in dusty or humid places. Likewise, keep the battery away from metallic items and store it with its protective cover attached to prevent short-circuit. This is to prevent fire, excessive heat, electrical shock, and burns.
- Before using the camera inside an airplane or hospital, check if it is allowed. Electromagnetic waves emitted by the camera may interfere with the plane's instruments or the hospital's medical equipment.
- To prevent a fire and electrical shock, follow the safeguards below:
 - Always insert the power plug all the way in.
 - Do not handle a power plug with wet hands.
 - When unplugging a power plug, grasp and pull the plug instead of the cord.
 - Do not scratch, cut, or excessively bend the cord or put a heavy object on the cord. Also, do not twist or tie the cords.
 - Do not connect too many power plugs to the same power outlet.
 - Do not use a cord whose wire is broken or insulation is damaged.
- Unplug the power plug periodically and clean off the dust around the power outlet with a dry cloth. If the surrounding is dusty, humid, or oily, the dust on the power outlet may become moist and short-circuit the outlet, causing a fire.
- Do not connect the battery directly to an electrical outlet or a car's cigarette lighter outlet. The battery may leak, generate excessive heat or explode, causing fire, burns, or injuries.
- A thorough explanation of how to use the product by an adult is required when the product is used by children. Supervise children while they are using the product. Incorrect usage may result in electrical shock or injury.
- Do not leave a lens or lens-attached camera in the sun without the lens cap attached. Otherwise, the lens may concentrate the sun's rays and cause a fire.
- Do not cover or wrap the product with a cloth. Doing so may trap heat within and cause the casing to deform or catch fire.
- Be careful not to get the camera wet. If you drop the product in the water or if water or metal get inside the product, promptly remove the battery. This is to prevent fire, electrical shock, and burns.
- Do not use paint thinner, benzene, or other organic solvents to clean the product. Doing so may cause fire or a health hazard.



Cautions: Follow the cautions below. Otherwise, physical injury or property damage may result.

- Do not use or store the product in a high-temperature location such as inside a car under the hot sun. The product may become hot and cause burns. Doing so may also cause battery leakage or explosion, which will degrade the performance or shorten the life of the product.
- Do not carry the camera around when it is attached to a tripod. Doing so may cause an injury or an accident. Also make sure the tripod is sturdy enough to support the camera and lens.
- Do not leave the product in a low-temperature environment for an extended period of time. The product will become cold and may cause injury when touched.
- Do not fire the flash near the eyes. It may hurt the eyes.

Handling Precautions

Camera Care

- This camera is a precision instrument. Do not drop it or subject it to physical shock.
- The camera is not waterproof and cannot be used underwater. If you accidentally drop the camera into water, promptly consult the nearest Canon Service Center. Wipe off any water droplets with a dry and clean cloth. If the camera has been exposed to salty air, wipe it with a well-wrung wet cloth.
- Never leave the camera near anything having a strong magnetic field such as a magnet or electric motor. Also, avoid using or leaving the camera near anything emitting strong radio waves, such as a large antenna. Strong magnetic fields can cause camera misoperation or destroy image data.
- Do not leave the camera in excessive heat, such as in a car in direct sunlight.
- The camera contains precision electronic circuitry. Never attempt to disassemble the camera yourself.
- Do not block the built-in flash or mirror operation with your finger, etc. Doing so may cause a malfunction.
- Use only a commercially-available blower to blow away dust when it adheres to the lens, viewfinder, reflex mirror, focusing screen, etc. Do not use cleaners that contain organic solvents to clean the camera body or lens. For stubborn dirt, take the camera to the nearest Canon Service Center.
- Do not touch the camera's electrical contacts with your fingers. This is to prevent the contacts from corroding. Corroded contacts may cause camera misoperation.
- If the camera is suddenly brought in from the cold into a warm room, condensation may form on the camera and internal parts. To prevent condensation, first put the camera in a sealed plastic bag and let it adjust to the warmer temperature before taking it out of the bag.

- If condensation forms on the camera, do not use the camera. This is to avoid damaging the camera. If there is condensation, remove the lens, card and battery from the camera, and wait until condensation has evaporated before using the camera.
- If the camera will not be used for an extended period, remove the battery and store the camera in a cool, dry, well-ventilated location. Even while the camera is in storage, press the shutter button a few times once in a while to check that the camera is still working.
- Avoid storing the camera where there are chemicals that result in rust and corrosion such as in a chemical lab.
- If the camera has not been used for an extended period, test all its functions before using it. If you have not used the camera for some time or if there is an important shoot such as a foreign trip coming up, have the camera checked by your nearest Canon Service Center or check the camera yourself and make sure it is working properly.
- If you use continuous shooting, Live View shooting, or movie shooting for a prolonged period, the camera may become hot. This is not a malfunction.
- If there is a bright light source inside or outside the image area, ghosting may occur.

LCD Monitor

- Although the LCD monitor is manufactured with very high precision technology with over 99.99% effective pixels, there may be a few dead pixels displaying only black or red, etc. among the remaining 0.01% or less pixels. Dead pixels are not a malfunction. They do not affect the images recorded.
- If the LCD monitor is left on for a prolonged period, screen burn-in may occur where you see remnants of what was displayed. However, this is only temporary and will disappear when the camera is left unused for a few days.
- The LCD monitor display may seem slow in low temperatures, or look black in high temperatures. It will return to normal at room temperature.

Cards

To protect the card and its recorded data, note the following:

- Do not drop, bend, or wet the card. Do not subject it to excessive force, physical shock, or vibration.
- Do not touch the card's electronic contacts with your fingers or anything metallic.
- Do not affix any stickers, etc., on the card.
- Do not store or use the card near anything that has a strong magnetic field, such as a TV set, speakers, or magnets. Also avoid places prone to having static electricity.
- Do not leave the card in direct sunlight or near a heat source.
- Store the card in a case, etc.
- Do not store the card in hot, dusty, or humid locations.

Lens

After detaching the lens from the camera, put down the lens with the rear end up and attach the rear lens cap to avoid scratching the lens surface and electrical contacts.

Smudges Adhering to the Front of the Sensor

Besides dust entering the camera from outside, in rare cases lubricant from the camera's internal parts may adhere to the front of the sensor. If visible spots remain on the image, having the sensor cleaned by a Canon Service Center is recommended.



Nomenclature

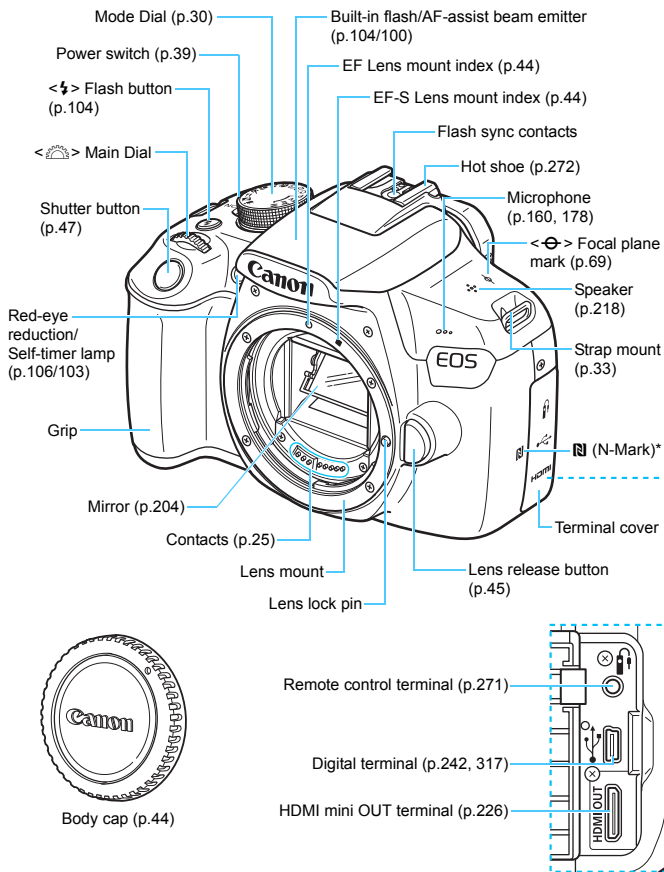

* Used for wireless connections via the NFC function.

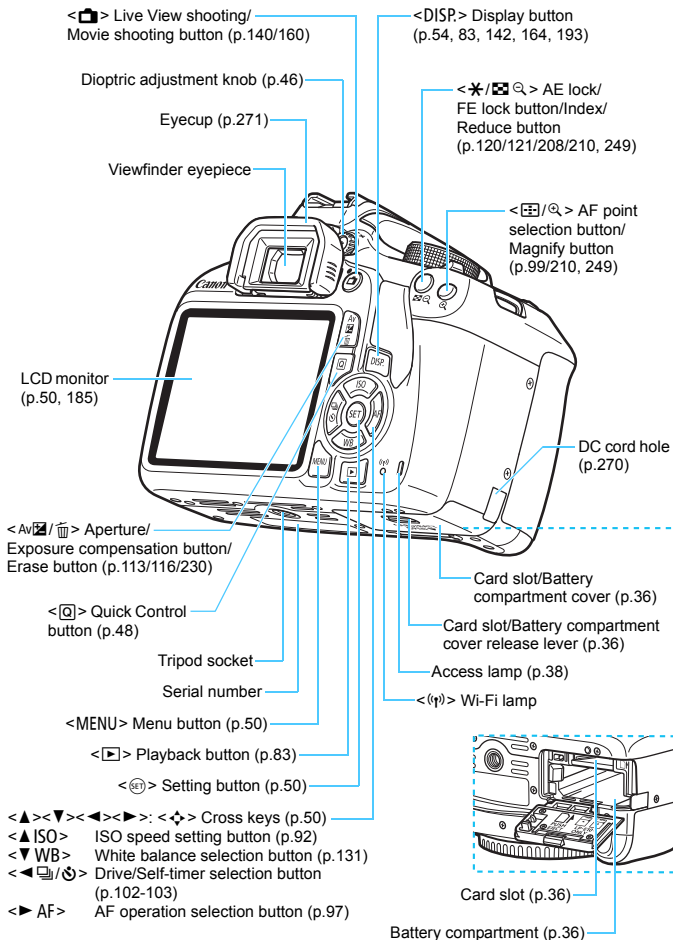

Shooting Function Settings (in Creative Zone modes, p.30)

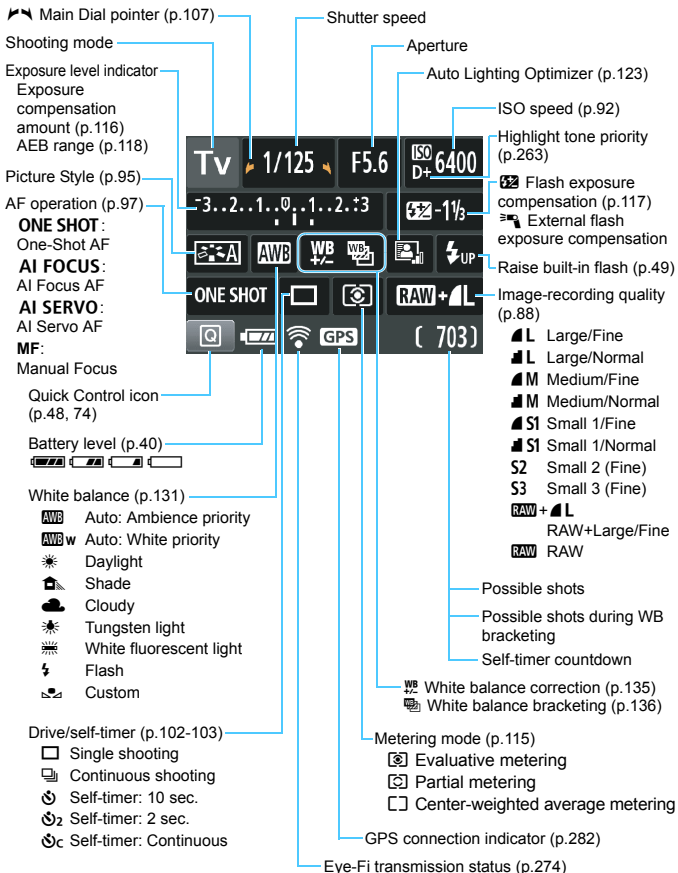

The display will show only the settings currently applied.

Viewfinder Information

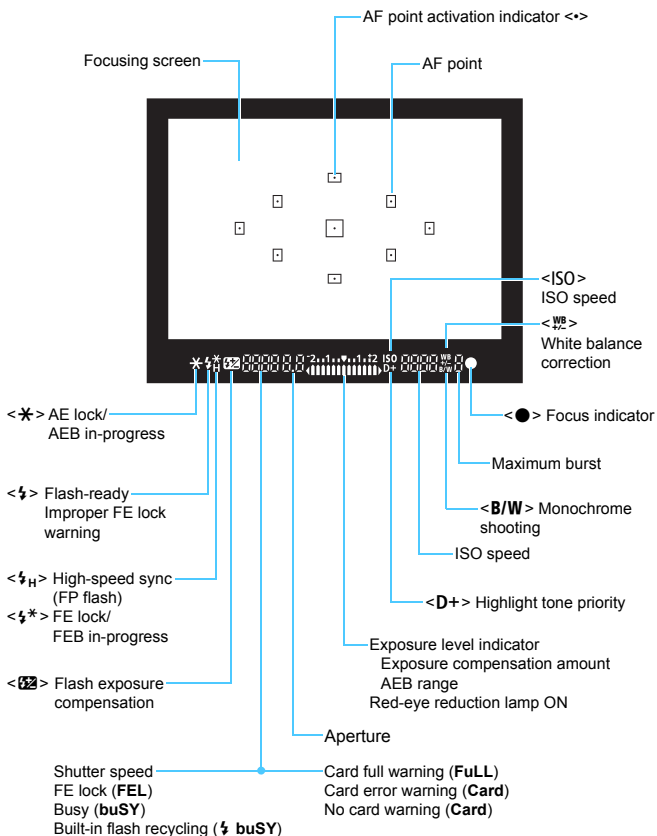

The display will show only the settings currently applied.

Mode Dial

The Mode Dial includes the Basic Zone modes, Creative Zone modes, and the Movie shooting mode.

Creative Zone

These modes give you more control for shooting various subjects as desired.

- P** : Program AE (p.86)
- Tv** : Shutter-priority AE (p.108)
- Av** : Aperture-priority AE (p.110)
- M** : Manual exposure (p.113)

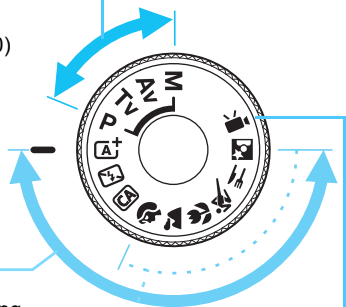

Basic Zone

All you do is press the shutter button. The camera sets everything to suit the subject or scene for shooting.

- A+** : Scene Intelligent Auto (p.58)
- A-** : Flash Off (p.63)
- CA** : Creative Auto (p.64)

Movie Shooting
(p.159)

Image Zone

- Portrait** (p.67)
- Landscape** (p.68)
- Close-up** (p.69)
- Sports** (p.70)
- Food** (p.71)
- Night Portrait** (p.72)

Battery Charger LC-E10

Charger for Battery Pack LP-E10 (p.34)

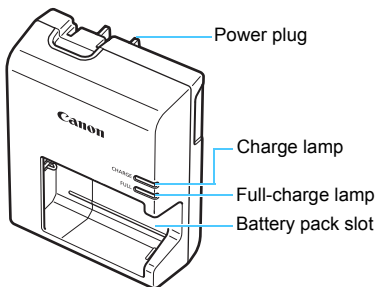

**IMPORTANT SAFETY INSTRUCTIONS-SAVE THESE INSTRUCTIONS.
DANGER-TO REDUCE THE RISK OF FIRE OR ELECTRIC SHOCK,
CAREFULLY FOLLOW THESE INSTRUCTIONS.**

For connection to a supply not in the U.S.A., use an attachment plug adapter of the proper configuration for the power outlet, if needed.

Battery Charger LC-E10E

Charger for Battery Pack LP-E10 (p.34).

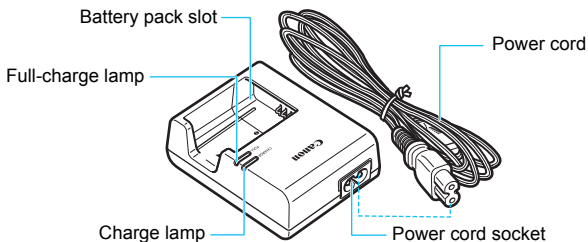



1

Getting Started

This chapter explains preparatory steps before you start shooting and basic camera operations.

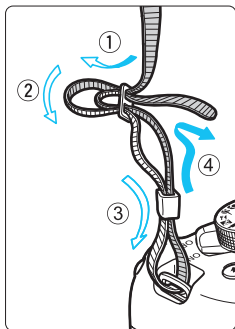

Attaching the Strap

Pass the end of the strap through the camera's strap mount eyelet from the bottom. Then pass it through the strap's buckle as shown in the illustration. Pull the strap to take up any slack and make sure the strap will not loosen from the buckle.

- The eyepiece cover is attached to the strap (p.271).

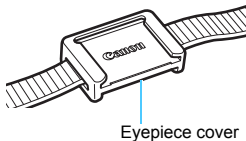

Charging the Battery

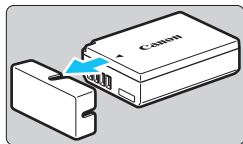

- 1 Remove the protective cover.**
- Detach the protective cover provided with the battery.

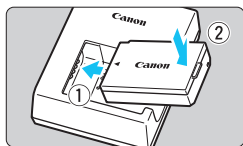

- 2 Attach the battery.**
- As shown in the illustration, attach the battery securely to the charger.
 - To detach the battery, follow the above procedure in reverse.

LC-E10

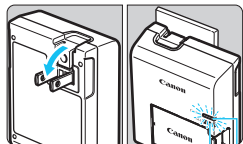

- 3 Recharge the battery.**
For LC-E10

- As shown by the arrow, flip out the battery charger's prongs and insert the prongs into a power outlet.

Full-charge lamp

Charge lamp

LC-E10E

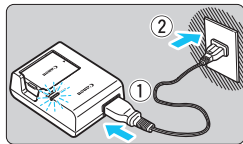

For LC-E10E

- Connect the power cord to the charger and insert the plug into a power outlet.
- ▶ Recharging starts and the charge lamp lights up in orange.
- ▶ When the battery is fully recharged, the full-charge lamp will light up in green.

- It takes approx. 2 hours to fully recharge a completely exhausted battery at room temperature (23°C / 73°F). The time required to recharge the battery will vary greatly depending on the ambient temperature and the battery's remaining capacity.
- For safety reasons, recharging in low temperatures (6°C - 10°C / 43°F - 50°F) will take longer (up to approx. 4 hours).



Tips for Using the Battery and Charger

- **Upon purchase, the battery is not fully charged.**
Charge the battery before use.
 - **Recharge the battery on the day before or on the day it is to be used.**
Even during storage, a charged battery will gradually drain and lose its capacity.
 - **After recharging the battery, detach it and disconnect the charger from the power outlet.**
 - **When not using the camera, remove the battery.**
If the battery is left in the camera for a prolonged period, a small amount of power current is released, resulting in excess discharge and shorter battery life. Store the battery with the protective cover (provided) attached. Storing the battery when it is fully charged may lower the battery's performance.
 - **The battery charger can also be used in foreign countries.**
The battery charger is compatible with a 100 V AC to 240 V AC 50/60 Hz power source. If necessary, attach a commercially-available plug adapter for the respective country or region. Do not attach any portable voltage transformer to the battery charger. Doing so can damage the battery charger.
 - **If the battery becomes exhausted quickly even after being fully charged, the battery has reached the end of its service life.**
Purchase a new battery.
-
- After disconnecting the charger's power plug, do not touch the prongs for at least 3 sec.
 - Do not charge any battery other than a Battery Pack LP-E10.
 - Battery Pack LP-E10 is dedicated to Canon products only. Using it with an incompatible battery charger or product may result in malfunction or accidents for which Canon cannot be held liable.

Installing and Removing the Battery and Card

Load a fully charged Battery Pack LP-E10 into the camera. You can use an SD, SDHC, or SDXC memory card (sold separately) with the camera. The captured images are recorded onto the card.

- ⚠ Make sure the card's write-protect switch is set upward to enable writing and erasing.**

Installing the Battery and Card

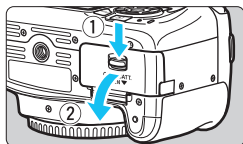

1 Open the cover.

- Slide the lever as shown by the arrows and open the cover.

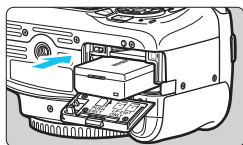

2 Insert the battery.

- Insert the end with the electrical contacts.
- Insert the battery until it locks in place.

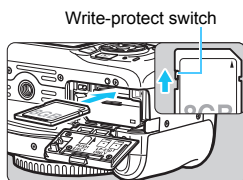

3 Insert the card.

- As shown by the illustration, face the card's label side toward the back of the camera and insert it until it clicks in place.

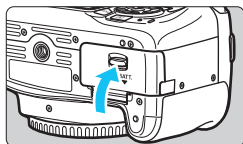

4 Close the cover.

- Press the cover until it snaps shut.
- When you set the power switch to <ON>, the number of possible shots (p.40) will be displayed on the LCD monitor.



After opening the card slot/battery compartment cover, be careful not to forcefully swing it back further. Otherwise, the hinge may break.



- The number of possible shots depends on the remaining capacity of the card, image-recording quality, ISO speed, etc.
- Setting [📷 1: Release shutter without card] to [Disable] will prevent you from shooting without a card inserted (p.184).

Removing the Battery and Card

1 Set the power switch to <OFF>
(p.39).

2 Open the cover.

- Make sure the access lamp is off, then open the cover.
- If [Recording...] is displayed, close the cover.

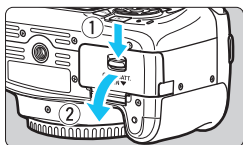

3 Remove the battery.

- Press the battery lock lever as shown by the arrow and remove the battery.
- To prevent short circuiting of the electrical contacts, be sure to attach the provided protective cover (p.34) to the battery.

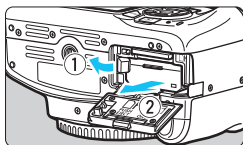

4 Remove the card.

- Gently push in the card, then let go to eject it.
- Pull the card straight out.

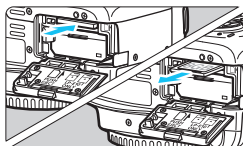

5 Close the cover.

- Press the cover until it snaps shut.



- **When the access lamp is lit or blinking, it indicates that images are being written to, read from, or erased from the card, or data is being transferred. Do not open the card slot/battery compartment cover. Also, never do any of the following while the access lamp is lit or blinking. Otherwise, it can damage the image data, card, or camera.**
 - **Removing the card.**
 - **Removing the battery.**
 - **Shaking or banging the camera around.**
 - **Unplugging and connecting a power cord** (when household power outlet accessories (sold separately, p.270) are used).
- If the card already contains recorded images, the image number may not start from 0001 (p.188).
- If a card-related error message is displayed on the LCD monitor, remove and reinsert the card. If the error persists, use a different card. If you can transfer all the images on the card to a computer, transfer all the images and then format the card with the camera (p.52). The card may then return to normal.
- Do not touch the card's contacts with your fingers or metal objects. Do not expose the contacts to dust or water. If a smudge adheres to the contacts, contact failure may result.
- Multimedia cards (MMC) cannot be used (card error will be displayed).

Turning on the Power

If you turn on the power and the date/time/zone setting screen appears, see page 41 to set the date/time/zone.

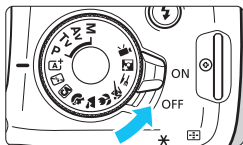

- <ON> : The camera turns on.
- <OFF> : The camera is turned off and does not function. Set to this position when not using the camera.

MENU Auto Power Off

- To save battery power, the camera turns off automatically after approx. 30 seconds of non-operation. To turn on the camera again, just press the shutter button halfway (p.47).
- You can change the auto power off time with [**F1: Auto power off**] (p.185).







If you set the power switch to <OFF> while an image is being recorded to the card, [**Recording...**] will be displayed and the power will turn off after the recording finishes.

Battery Level Indicator

When the power is turned on, the battery level will be indicated in one of the four levels.



-  : Battery level is sufficient.
-  : Battery level is low, but the camera can still be used.
-  : Battery will be exhausted soon. (Blinks)
-  : Recharge the battery.

Number of Possible Shots (Approx. number of shots)

| Temperature | Room Temperature (23°C / 73°F) | Low Temperatures (0°C / 32°F) |
|---------------|-----------------------------------|----------------------------------|
| No Flash | 600 | 580 |
| 50% Flash Use | 500 | 410 |

- The figures above are based on a fully-charged Battery Pack LP-E10, no Live View shooting, and CIPA (Camera & Imaging Products Association) testing standards.



- Doing any of the following will exhaust the battery faster:
 - Pressing the shutter button halfway for a prolonged period.
 - Activating the AF frequently without taking a picture.
 - Using the lens Image Stabilizer.
 - Using the LCD monitor frequently.
- The number of possible shots may decrease depending on the actual shooting conditions.
- The lens operation is powered by the camera's battery. Some lenses may exhaust the battery faster than others.
- For the number of possible shots with Live View shooting, see page 141.

MENU Setting the Date, Time, and Zone

When you turn on the power for the first time or if the date/time/zone have been reset, the date/time/zone setting screen will appear. Follow the steps below to set the time zone first. Set the camera to the time zone in which you currently live so that, when you travel, you can simply change the setting to the correct time zone for your destination, and the camera will automatically adjust the date/time.

Note that the date/time appended to recorded images will be based on this date/time setting. Be sure to set the correct date/time.

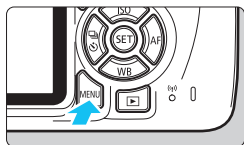

1 Display the menu screen.

- Press the <MENU> button to display the menu screen.



2 Under the [2] tab, select [Date/Time/Zone].

- Press the <◀> <▶> keys to select the [2] tab.
- Press the <▲> <▼> keys to select [Date/Time/Zone], then press <SET>.

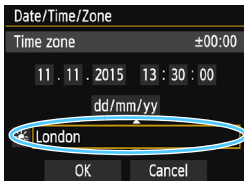

3 Set the time zone.

- [London] is set by default.
- Press the <◀> <▶> keys to select the time zone box.
- Press <SET> so <□> is displayed.
- Press the <▲> <▼> keys to select the time zone, then press <SET>.
(Returns to <□>.)



- The menu setting procedure is explained on pages 50-51.
- In step 3, the time displayed on the upper right of the screen is the time difference compared with Coordinated Universal Time (UTC). If you do not see your time zone, set the time zone while referring to the difference with UTC.

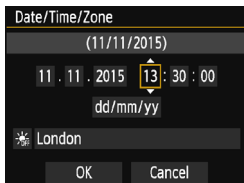

4 Set the date and time.

- Press the <◀> <▶> keys to select the number.
- Press <SET> so <☐> is displayed.
- Press the <▲> <▼> keys to set the number, then press <SET>. (Returns to <☐>.)

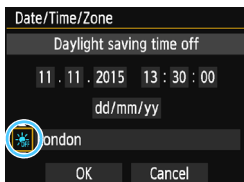

5 Set the daylight saving time.

- Set it if necessary.
- Press the <◀> <▶> keys to select [☀].
- Press <SET> so <☐> is displayed.
- Press the <▲> <▼> keys to select [☀], then press <SET>.
- When the daylight saving time is set to [☀], the time set in step 4 will advance by 1 hour. If [☀] is set, the daylight saving time will be canceled and the time will go back by 1 hour.

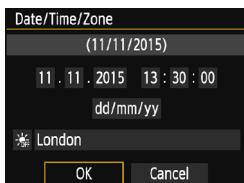

6 Exit the setting.

- Press the <◀> <▶> keys to select [OK], then press <SET>.
- ▶ The date/time/zone and daylight saving time will be set and the menu will reappear.

! The date/time/zone settings may be reset in the following cases. If this happens, set the date/time/zone again.

- When the camera is stored without the battery.
- When the camera's battery becomes exhausted.
- When the camera is exposed to below freezing temperatures for a prolonged period.

- The date/time that was set will start from when you press <SET> in step 6.
- After changing the time zone, check that the correct date and time are set.

MENU Selecting the Interface Language

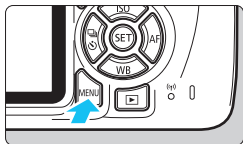

1 Display the menu screen.

- Press the <MENU> button to display the menu screen.

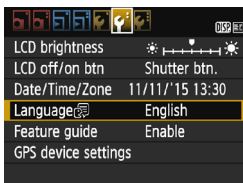

2 Under the [F2] tab, select [Language].

- Press the <<<> >>> keys to select the [F2] tab.
- Press the <▲> <▼> keys to select the [Language], then press <SET>.

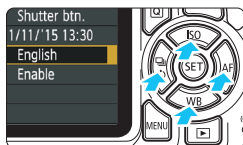

3 Set the desired language.

- Press the <▲> <▼> keys to select the language, then press <SET>.
- ▶ The interface language will change.

| | | |
|----------------|----------|---------|
| English | Norsk | Română |
| Deutsch | Svenska | Türkçe |
| Français | Español | العربية |
| Nederlands | Ελληνικά | ગુજરાતી |
| Dansk | Русский | 繁體中文 |
| Português | Polski | 繁體中文 |
| Suomi | Čeština | 한국어 |
| Italiano | Magyar | 日本語 |
| Українська | | |

Attaching and Detaching a Lens

The camera is compatible with all Canon EF and EF-S lenses. **The camera cannot be used with EF-M lenses.**

Attaching a Lens

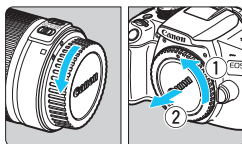

1 Remove the caps.

- Remove the rear lens cap and the body cap by turning them as shown by the arrows.

White index

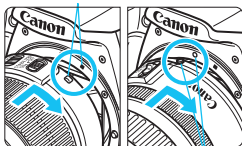

2 Attach the lens.

- Align the lens's red or white index with the camera's index matching the same color. Turn the lens as shown by the arrow until it clicks in place.

Red index

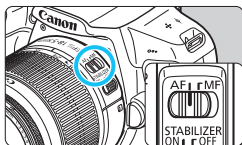

3 Set the lens's focus mode switch to <AF>.

- <AF> stands for autofocus.
- If it is set to <MF> (manual focus), autofocus will not operate.

4 Remove the front lens cap.

Minimizing Dust

- When changing lenses, do it quickly in a place with minimal dust.
- When storing the camera without a lens attached, be sure to attach the body cap to the camera.
- Remove dust on the body cap before attaching it.

Zooming

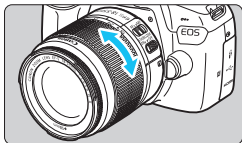

Turn the zoom ring on the lens with your fingers.

- If you want to zoom, do it before focusing. Turning the zoom ring after achieving focus may throw off the focus.

Detaching the Lens

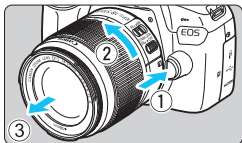

While pressing the lens release button, turn the lens as shown by the arrow.

- Turn the lens until it stops, then detach it.
- Attach the rear lens cap to the detached lens.



- Do not look at the sun directly through any lens. Doing so may cause loss of vision.
- **When attaching or detaching a lens, set the camera's power switch to <OFF>.**
- If the front part (focusing ring) of the lens rotates during autofocus, do not touch the rotating part.
- During viewfinder shooting or Live View shooting, if you use a TS-E lens (except the TS-E17mm f/4L or TS-E24mm f/3.5L II) and shift or tilt the lens or use an Extension Tube, the standard exposure may not be obtained or the exposure may be irregular.



Angle of View

Since the image sensor size is smaller than the 35mm film format, the angle of view of an attached lens will be equivalent to that of a lens with approx. 1.6x of the focal length indicated.



- Image sensor size (Approx.)
(22.3 x 14.9 mm / 0.88 x 0.59 in.)
- 35mm film size
(36 x 24 mm / 1.42 x 0.94 in.)

Basic Operation

Adjusting the Viewfinder Clarity

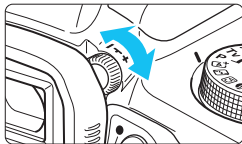

Turn the dioptic adjustment knob.

- Turn the knob left or right so that the AF points (nine boxes) in the viewfinder look the sharpest.
- If the knob is difficult to turn, remove the eyecup (p.271).

 If the camera dioptic adjustment still cannot provide a sharp viewfinder image, using E-series Dioptic Adjustment Lenses (sold separately) is recommended.

Holding the Camera

To obtain sharp images, hold the camera still to minimize camera shake.

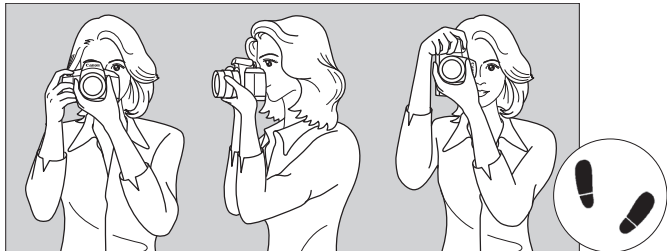

Horizontal shooting

Vertical shooting

1. Wrap your right hand around the camera grip firmly.
2. Hold the lens bottom with your left hand.
3. Rest your hand's right index finger lightly on the shutter button.
4. Press your arms and elbows lightly against the front of your body.
5. To maintain a stable stance, place one foot slightly ahead of the other.
6. Press the camera against your face and look through the viewfinder.

 To shoot while looking at the LCD monitor, see page 139.

Shutter Button

The shutter button has two steps. You can press the shutter button halfway. Then you can further press the shutter button completely.



Pressing Halfway

This activates autofocus and the automatic exposure system that sets the shutter speed and aperture.

The exposure setting (shutter speed and aperture) is displayed in the viewfinder (4s).

While you press the shutter button halfway, the LCD monitor will turn off (p.197).

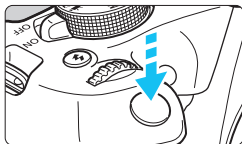

Pressing Completely

This releases the shutter and takes the picture.

Preventing Camera Shake

Hand-held camera movement during the moment of exposure is called camera shake. It can cause blurred pictures. To prevent camera shake, note the following:

- Hold and steady the camera as shown on the preceding page.
- Press the shutter button halfway to autofocus, then slowly press the shutter button completely.



- If you press the shutter button completely without pressing it halfway first, or if you press the shutter button halfway and then press it completely immediately, the camera will take a moment before it takes the picture.
- Even during menu display, image playback, or image recording, you can instantly go back to shooting-ready by pressing the shutter button halfway.

Q Quick Control for Shooting Functions

You can directly select and set the shooting functions displayed on the LCD monitor. This is called Quick Control.



1 Press the **<Q>** button.

- ▶ The Quick Control screen will appear (⌚10).

2 Set the desired function.

- Press the **<⬆>** cross keys to select a function.
- ▶ The settings of the selected function and Feature guide (p.55) will appear.
- Turn the **<⚙>** dial to change the setting.
- You can also select from a list by selecting a function and pressing **<SET>**.

Basic Zone modes



Creative Zone modes

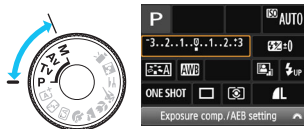

3 Take the picture.

- Press the shutter button completely to take the picture.
- ▶ The captured image will be displayed.

 For the functions settable in Basic Zone modes and their setting procedures, see page 74.

Sample Quick Control Screen

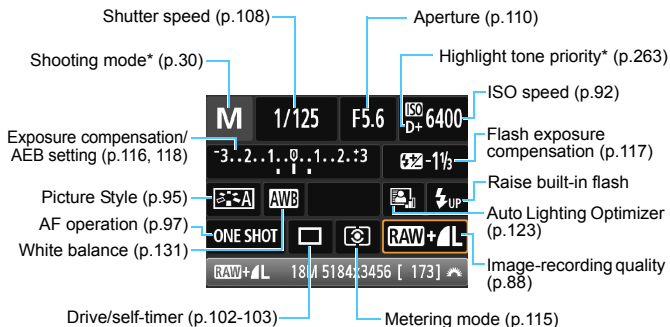

- Functions marked with an asterisk * cannot be set with the Quick Control.
- When you select <UP> and press <SET>, the built-in flash will be raised.

Function Setting Screen

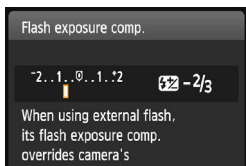

- Select the desired function and press <SET>. The function's setting screen will appear.
- Press the <<> <>> keys or turn the <DISP.> dial to change some of the settings. Also, some functions can be set by pressing the <DISP.> button.
- Press <SET> to finalize the setting and return to the Quick Control screen.

MENU Menu Operations

You can set various settings with the menus such as the image-recording quality, date and time, etc.

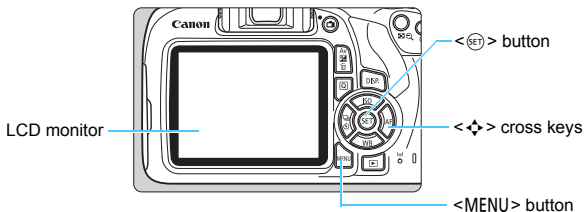

Menu Screen

The menu tabs and items displayed will differ depending on the shooting mode.

Basic Zone modes

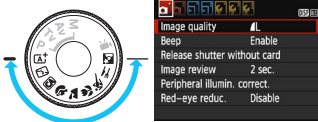

Movie shooting mode

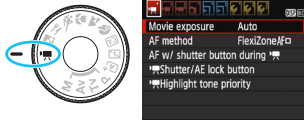

Creative Zone modes

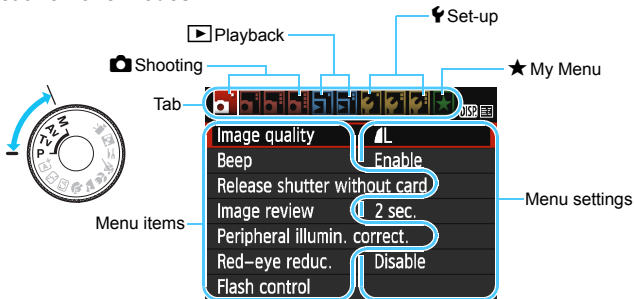

Menu Setting Procedure

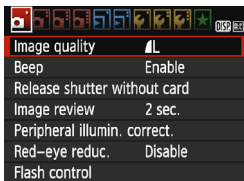

1 Display the menu screen.

- Press the <MENU> button to display the menu screen.

2 Select a tab.

- Press the <◀> <▶> cross keys to select a tab (group of functions).
- For example, in this manual, “the [📷 3] tab” refers to the screen displayed when the third 📷 (Shooting) tab from the left [📷] is selected.



3 Select the desired item.

- Press the <▲> <▼> cross keys to select the item, then press <SET>.



4 Select the setting.

- Press the <▲> <▼> or <◀> <▶> cross keys to select the desired setting. (Some settings require you to press either the <▲> <▼> or <◀> <▶> keys to select those settings.)
- The current setting is indicated in blue.



5 Set the desired setting.

- Press <SET> to set it.

6 Exit the setting.

- Press the <MENU> button to return to the shooting function settings display.



- In step 2, you can also turn the <📷> dial to select a menu tab.
- The explanation of menu functions hereafter assumes that you have pressed the <MENU> button to display the menu screen.
- To cancel the operation, press the <MENU> button.
- For details about each menu item, see page 280.

MENU Formatting the Card

If the card is new or was previously formatted by another camera or computer, format the card with this camera.

! When the card is formatted, all images and data on the card will be erased. Even protected images will be erased, so make sure there is nothing you need to keep. If necessary, transfer the images and data to a computer, etc., before formatting the card.

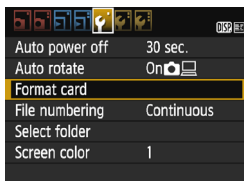

1 Select [Format card].

- Under the [**1**] tab, select [**Format card**], then press <SET>.

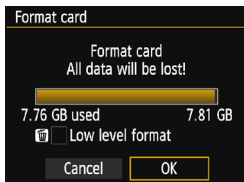

2 Format the card.

- Select [**OK**], then press <SET>.
- ▶ The card will be formatted.
- ▶ When the formatting is completed, the menu will reappear.

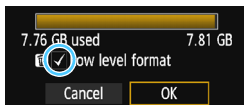

- For low-level formatting, press the <☑> button to add a checkmark [✓] to [**Low level format**], then select [**OK**].



Format the card in the following cases:

- The card is new.
- The card was formatted by a different camera or a computer.
- The card is full with images or data.
- A card-related error is displayed (p.298).

Low-level Formatting

- Perform low-level formatting if the card's recording or reading speed seems slow or if you want to totally erase data on the card.
- Since low-level formatting will format all recordable sectors on the card, the formatting will take slightly longer than normal formatting.
- You can stop the low-level formatting by selecting **[Cancel]**. Even in this case, normal formatting will be completed and you can use the card as usual.



- When the card is formatted or data is erased, only the file management information is changed. The actual data is not completely erased. Be aware of this when selling or discarding the card. When discarding the card, execute low-level formatting or destroy the card physically to prevent the personal data from being leaked.
- **Before using a new Eye-Fi card, the software on the card must be installed on your computer. Then format the card with the camera.**



- The card capacity displayed on the card format screen may be smaller than the capacity indicated on the card.
- This device incorporates exFAT technology licensed from Microsoft.

Switching the LCD Monitor Display

The LCD monitor can display the shooting settings screen, menu screen, captured images, etc.

Shooting Function Settings

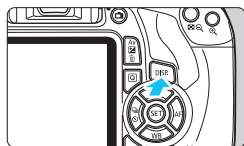

- When you turn on the power, the shooting settings will be displayed.
- **When you press the shutter button halfway, the display will turn off. And when you let go of the shutter button, the display will turn on.**
- **You can also turn off the display by pressing the <DISP.> button.** Press the button again to turn on the display.

Menu Functions

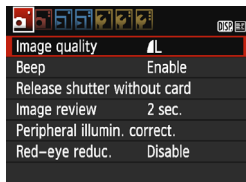

- Appears when you press the <MENU> button. Press the button again to return to the shooting settings screen.

Captured Image



- Appears when you press the <▶> button. Press the button again to return to the shooting settings screen.

- You can set [**2: LCD off/on btn**] so that the shooting settings display does not keep turning off and on (p.197).
- Even when the menu screen or captured image is displayed, pressing the shutter button will enable you to shoot immediately.

Feature Guide

The Feature guide appears when you change the shooting mode or set a shooting function, Live View shooting, movie shooting, or Quick Control for playback, and displays a brief description of that mode, function or option. It also displays a description when you select a function or option with the Quick Control. The Feature guide turns off when you further proceed with any operation.

● Shooting mode (Sample)

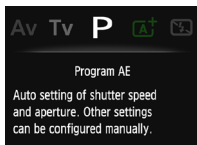
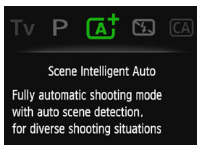

● Quick Control (Sample)

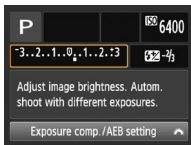

Shooting settings



Live View shooting



Playback

MENU Disabling the Feature Guide

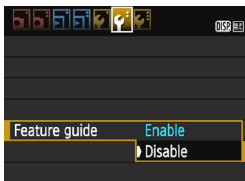

Select [Feature guide].

- Under the [F2] tab, select [Feature guide], then press <SET>.
- Select [Disable], then press <SET>.



2

Basic Shooting and Image Playback

This chapter explains how to use the Basic Zone modes on the Mode Dial for best results and how to play back images.

With Basic Zone modes, all you do is point and shoot while the camera sets everything automatically (p.75, 276). Also, to prevent botched pictures due to mistaken operations, advanced shooting function settings cannot be changed.

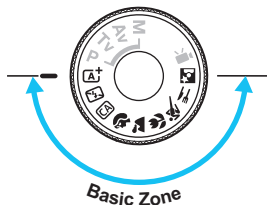

Auto Lighting Optimizer

In Basic Zone modes, the Auto Lighting Optimizer (p.123) will adjust the image automatically to obtain the optimum brightness and contrast. It is also enabled by default in Creative Zone modes.

[A+] Fully Automatic Shooting (Scene Intelligent Auto) ■

<[A+]> is a fully automatic mode. The camera analyzes the scene and sets the optimum settings automatically. It also adjusts focus automatically by detecting whether the subject is still or moving (p.61).



1 Set the Mode Dial to <[A+]>.

AF point

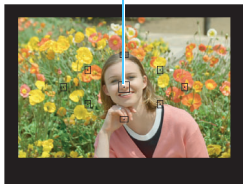

2 Aim any AF point over the subject.

- All the AF points will be used to focus, and the camera will focus on the closest object.
- Aiming the center AF point over the subject will make focusing easier.

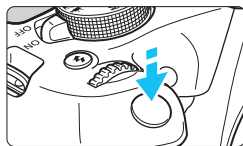

3 Focus on the subject.

- Press the shutter button halfway. The lens focusing ring will rotate to focus.
- ▶ The dot inside the AF point achieving focus flashes briefly in red. At the same time, the beeper will sound and the focus indicator **<●>** in the viewfinder will light up.
- ▶ If necessary, the built-in flash will be raised automatically.



Focus indicator



4 Take the picture.

- Press the shutter button completely to take the picture.
- ▶ The captured image will be displayed for approx. 2 sec. on the LCD monitor.
- After you finish shooting, push down the built-in flash with your fingers.



The **<A⁺>** mode makes the colors look more impressive in nature, outdoor, and sunset scenes. If you did not obtain the desired color tones, change the mode to a Creative Zone mode and select a Picture Style other than **<A>**, then shoot again (p.95).

? FAQ

- **The focus indicator **<●>** blinks and focus is not achieved.**
Aim the AF point over an area with good contrast, then press the shutter button halfway (p.47). If you are too close to the subject, move away and try again.
- **Multiple AF points flash simultaneously.**
This indicates that focus is achieved at all those AF points. When the AF point covering the desired subject flashes, take the picture.
- **The beeper continues to beep softly. (The focus indicator **<●>** does not light up.)**
It indicates that the camera is focusing continuously on a moving subject. (The focus indicator **<●>** does not light up.) You can take sharp pictures of a moving subject.
Note that the focus lock (p.61) will not work in this case.
- **Pressing the shutter button halfway does not focus on the subject.**
If the focus mode switch on the lens is set to **<MF>** (manual focus), set it to **<AF>** (autofocus).

- **The flash fired even though it was daylight.**

For a backlit subject, the flash may fire to help lighten the subject's dark areas. If you do not want the flash to fire, use the Flash off mode (p.63). Other than the flash setting, the camera will shoot with the same settings as with **A⁺**.

- **The flash fired and the picture came out extremely bright.**

Move further away from the subject and shoot. When shooting flash photography, if the subject is too close to the camera, the picture may come out extremely bright (overexposure).

- **In low light, the built-in flash fired a series of flashes.**

Pressing the shutter button halfway may trigger the built-in flash to fire a series of flashes to assist autofocusing. This is called the AF-assist beam. Its effective range is approx. 4 meters / 13.1 feet.

- **When flash was used, the bottom part of the picture came out unnaturally dark.**

The shadow of the lens barrel was captured in the picture because the subject was too close to the camera. Move further away from the subject and shoot. If a hood is attached to the lens, remove it before taking the flash picture.

[A⁺] Full Auto Techniques (Scene Intelligent Auto) ■

Recomposing the Shot



Depending on the scene, position the subject toward the left or right to create a balanced background and good perspective.

In the <[A⁺]> mode, pressing the shutter button halfway to focus on a still subject will lock the focus on that subject. Recompose the shot while keeping the shutter button pressed halfway, and then press the shutter button completely to take the picture. This is called “focus lock”. Focus lock is also possible in other Basic Zone modes (except <[A] >).

Shooting a Moving Subject



In the <[A⁺]> mode, if the subject moves (distance to camera changes) while or after you focus, AI Servo AF will take effect to focus on the subject continuously. (The beeper will continue beeping softly.) As long as you keep aiming the AF point on the subject while pressing the shutter button halfway, the focusing will be continuous. When you want to take the picture, press the shutter button completely.

Live View Shooting

You can shoot while viewing the image on the LCD monitor. This is called “Live View shooting”. For details, see page 139.



1 Display the Live View image on the LCD monitor.

- Press the <Live View button>.
- ▶ The Live View image will appear on the LCD monitor.



2 Focus on the subject.

- Aim the center AF point <Center AF point> on the subject.
- Press the shutter button halfway to focus.
- ▶ When focus is achieved, the AF point will turn green and the beeper will sound.
- ▶ If necessary, the built-in flash will be raised automatically.

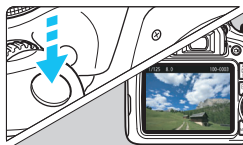

3 Take the picture.

- Press the shutter button completely.
- ▶ The picture is taken and the captured image is displayed on the LCD monitor.
- ▶ When the playback display ends, the camera will return to Live View shooting automatically.
- Press the <Live View button> to exit the Live View shooting.

Disabling Flash

The camera analyzes the scene and sets the optimum settings automatically. In places where flash photography is prohibited such as in a museum or an aquarium, use the (Flash Off) mode. This mode is also effective for capturing the particular ambience of a scene, such as candlelight scenes.

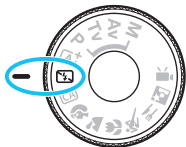

Shooting Tips

- **Prevent camera shake if the numeric display (shutter speed) in the viewfinder blinks.**
Under low light when camera shake is prone to occur, the viewfinder's shutter speed display will blink. Hold the camera steady or use a tripod. When using a zoom lens, use a wide angle to reduce blur caused by camera shake even with handheld shooting.
- **When shooting portraits without flash.**
In low-light conditions, tell the subject to keep still until the picture is taken. Any movement by the subject during shooting may result in the subject being blurred in the picture.

CA Creative Auto Shooting

In the <CA> mode, you can easily change the depth of field, drive/self-timer, and flash firing. You can also select and shoot with the ambience you want to convey in your images. The default settings are the same as the <A+> mode.

* CA stands for Creative Auto.



1 Set the Mode Dial to <CA>.

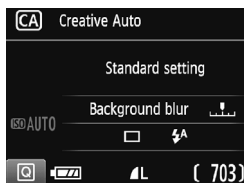

2 Press the <Q> button (10).

▶ The Quick Control screen will appear.

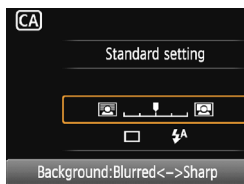

3 Set the desired function.

- Press the <4-way> cross keys to select a function.
- ▶ The settings of the selected function and Feature guide (p.55) will appear.
- For the setting procedure and details on each function, see pages 65-66.

4 Take the picture.

- Press the shutter button completely to take the picture.

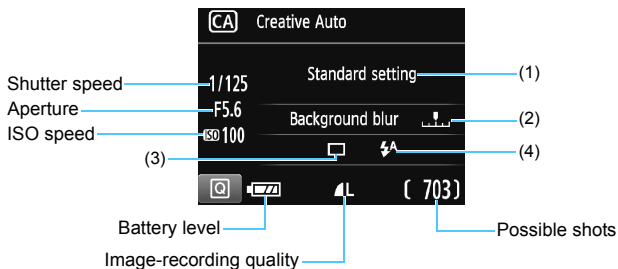

Pressing the **<Q>** button enables you to set the following:

(1) Ambience-based shots

You can select and shoot with the ambience you want to convey in your images. Press the **<◀>** **<▶>** keys or turn the **<☀>** dial to select the ambience. You can also select it from a list by pressing **<SET>**. For details, see page 76.





(2) Blurring/sharpening the background



If you move the index mark toward the left, the background will look more blurred. If you move it toward the right, the background will look more in focus. If you want to blur the background, see “Shooting Portraits” on page 67. Press the **<◀>** **<▶>** keys or turn the **<☀>** dial to select the desired degree of blur.

Depending on the lens and shooting conditions, the background may not look so blurred.

This function cannot be set if you use flash. Also, the setting will not be applied if **<⚡>** has been selected and the flash is fired.

(3) Drive/self-timer: Press  and set it with the   keys or  dial.



 **Single shooting:** Shoot one image at a time.





 **Continuous shooting:**

While you hold down the shutter button completely, shots will be taken continuously. You can shoot up to approx. 3 shots per second.

 **Self-timer: 10 sec. :** The picture is taken 10 seconds after you press the shutter button.

 **Self-timer: Continuous:**

Press the   keys to set the number of multiple shots (2 to 10) to be taken with the self-timer. 10 seconds after you press the shutter button, the set number of multiple shots will be taken.



(4) Built-in flash firing: Press  and set it with the   keys or  dial.

 **Auto built-in flash :** The flash fires automatically when necessary.

 **Built-in flash on :** The flash fires at all times.

 **Built-in flash off :** The flash is disabled.



- When using the self-timer, see the  notes on page 103.
- When using , see "Disabling Flash" on page 63.

Shooting Portraits

The <> (Portrait) mode blurs the background to make the human subject stand out. It also makes skin tones and hair look softer.

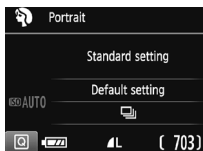
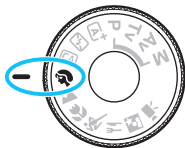

Shooting Tips

- **Select the location where the distance between the subject and the background is the farthest.**

The further the distance between the subject and background, the more blurred the background will look. The subject will also stand out better against an uncluttered dark background.

- **Use a telephoto lens.**

If you have a zoom lens, use the telephoto end to fill the frame with the subject from the waist up. Move in closer if necessary.

- **Focus on the face.**

Check that the AF point covering the face lights up. For close-ups of the face, focus on the eyes.



- If you hold down the shutter button, you can shoot continuously (max. approx. 3 shots/sec.) to capture changes in the subject's facial expression and pose.
- If necessary, the built-in flash will fire automatically.

Shooting Landscapes

Use the <  > (Landscape) mode for wide scenery or to have everything in focus from near to far. For vivid blues and greens, and very sharp and crisp images.

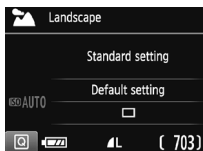
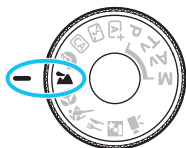

Shooting Tips

- **With a zoom lens, use the wide-angle end.**

When using the wide-angle end of a zoom lens, objects near and far will be in focus better than at the telephoto end. It also adds breadth to landscapes.

- **When shooting night scenes.**

Since the built-in flash will be disabled, this mode <  > is also good for night scenes.

Use a tripod to prevent camera shake.

If you want to shoot a person against a night scene, set the Mode Dial to <  > (Night Portrait) and use a tripod (p.72).



- The built-in flash will not fire even in backlit or low-light conditions.
- If you are using an external Speedlite, the Speedlite will fire.

Shooting Close-ups

When you want to shoot flowers or small things up close, use the <🌸> (Close-up) mode. To make small things appear much larger, use a macro lens (sold separately).

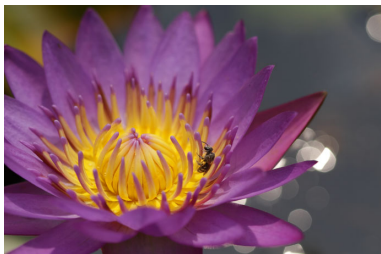
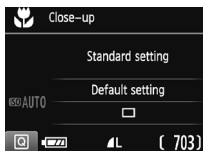

Shooting Tips

- **Use a simple background.**

A simple background makes small objects such as flowers stand out better.

- **Move in as close as possible to the subject.**

Check the lens for its minimum focusing distance. Some lenses have indications such as <MACRO 0.25m/0.8ft> on them. The lens minimum focusing distance is measured from the <⊕> (focal plane) mark on the top of the camera to the subject. If you are too close to the subject, the focus indicator <●> will blink.

If you use flash and the bottom part of the picture comes out unnaturally dark, move away from the subject and try again.

- **With a zoom lens, use the telephoto end.**

If you have a zoom lens, using the telephoto end will make the subject look larger.



If necessary, the built-in flash will fire automatically.

Shooting Moving Subjects

Use the  (Sports) mode to shoot a moving subject, such as a running person or a moving vehicle.

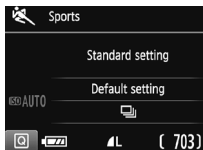
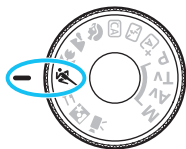

Shooting Tips

● Use a telephoto lens.

The use of a telephoto lens is recommended for shooting from a distance.

● Use the center AF point to focus.

Aim the center AF point over the subject, then press the shutter button halfway to autofocus. During autofocusing, the beeper will continue beeping softly. If focus cannot be achieved, the focus indicator  will blink.

When you want to take the picture, press the shutter button completely. If you hold down the shutter button, you can shoot continuously (max. approx. 3 shots/sec.) while maintaining autofocusing to capture changes in the subject's movement.

-  ● The built-in flash will not fire even in backlit or low-light conditions.
- Under low light when camera shake tends to occur, the viewfinder's shutter speed display on the bottom left will blink. Hold the camera steady and shoot.
- If you are using an external Speedlite, the Speedlite will fire.

🍴 Shooting Food

When shooting food, use <🍴> (Food). The photo will look bright and appetizing. Also, depending on the light source, the reddish tinge will be suppressed in the pictures taken under tungsten lights, etc.

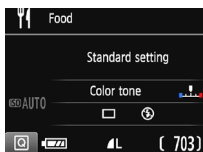
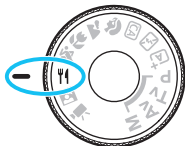

💡 Shooting Tips

- **Change the color tone.**

You can change [Color tone]. To increase the food's reddish tinge, set it toward [Warm]. Set it toward [Cool] if it looks too red.

- **Avoid using flash.**

If you use flash, the light may reflect off the dish or food and results in unnatural shadows. By default, <🚫> (Built-in flash off) is set. Try to prevent camera shake when shooting in low-light conditions.



- Since this mode lets you shoot the food in appetizing color tones, human subjects may be shot in an unsuitable skin tone.
- The warm color cast of subjects may fade.
- When multiple light sources are included on the screen, the warm color cast of the picture may not be lessened.
- If you use flash, the [Color tone] setting will switch to the standard setting.

Shooting Night Portraits

To shoot people at night and obtain a natural-looking night scene in the background, use the  (Night Portrait) mode. Using a tripod is recommended.

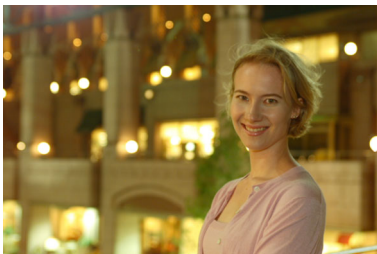
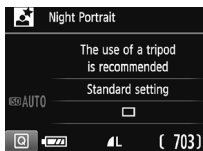
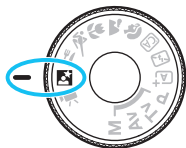

Shooting Tips

- **Use a wide-angle lens and a tripod.**

When using a zoom lens, use the wide-angle end to obtain a wide night view. Also, use a tripod to prevent camera shake.

- **Check the subject's brightness.**

Under low light, the built-in flash will fire automatically to obtain a good exposure of the subject.

It is recommended to play back the image after shooting to check the image brightness. If the subject looks dark, move nearer and shoot again.

- **Also shoot with the  (Scene Intelligent Auto) mode.**

Since camera shake is prone to occur with night shots, shooting also in the  mode is recommended.



During Live View shooting, it may be difficult to focus on dots of light such as in a night scene. In such a case, it is recommended that you set the AF method to [**Quick mode**] and shoot. If it is still difficult to focus, set the lens's focus mode switch to <MF> and focus manually.



- Tell the subject to keep still even after the flash fires.
- If you use the self-timer together with flash, the self-timer lamp will light up briefly after the picture is taken.

Q Quick Control

In Basic Zone modes, when the shooting function settings are displayed, you can press the **<Q>** button to display the Quick Control screen. The tables on the next page show the functions that can be set with the Quick Control screen in each Basic Zone mode.

Example: Portrait mode

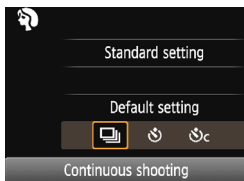
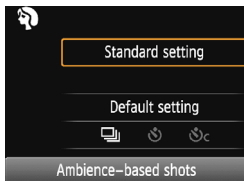

1 Set the Mode Dial to a Basic Zone mode.

2 Press the **<Q>** button (ⓘ10).

- ▶ The Quick Control screen will appear.

3 Set the desired function.

- Press the **<⬆>** cross keys to select a function. (This step is not necessary in the **[A+]/[S]** mode.)
 - ▶ The settings of the selected function and Feature guide (p.55) will appear.
- Press the **<◀>** **<▶>** keys or turn the **<☀>** dial to change some of the settings.
- You can also select from a list by selecting a function and pressing **<SET>**.

Settable Functions in Basic Zone Modes

●: Default setting ○: User selectable □: Not selectable

| Function | | | | | | | | | | |
|---|---------------------------------|---|---|---|---|---|---|---|---|---|
| Drive/ self-timer (p.102-103) | : Single shooting | ● | ● | ● | □ | ● | ● | □ | ● | ● |
| | : Continuous shooting | □ | □ | ○ | ● | □ | □ | ● | □ | □ |
| | : 10 sec. | ○ | ○ | ○ | ○ | ○ | ○ | ○ | ○ | ○ |
| | : Continuous shooting* | ○ | ○ | ○ | ○ | ○ | ○ | ○ | ○ | ○ |
| Built-in flash firing | : Automatic firing | ● | □ | ● | ● | □ | ● | □ | □ | ● |
| | : Flash on (Fires at all times) | □ | □ | ○ | □ | □ | □ | □ | ○ | □ |
| | : Flash off | □ | ● | ○ | □ | ● | □ | ● | ● | □ |
| Ambience-based shots (p.76) | | □ | □ | ○ | ○ | ○ | ○ | ○ | ○ | ○ |
| Light/scene-based shots (p.80) | | □ | □ | □ | ○ | ○ | ○ | ○ | □ | □ |
| Blurring/sharpening the background (p.65) | | □ | □ | ○ | □ | □ | □ | □ | □ | □ |
| Color tone (p.71) | | □ | □ | □ | □ | □ | □ | □ | ○ | □ |

* Use the <▲> <▼> keys to set the number of continuous shots.



If you change the shooting mode or set the power switch to <OFF>, all the functions will revert to the default settings (except the self-timer).

Shooting with Ambience Selection

Except in the <A+> and <A-> Basic Zone modes, you can select the ambience for shooting.

| Ambience | A+ | A- | CA | 👤 | 🏔️ | 🌿 | 🌊 | 🍴 | 🏠 | Ambience Effect |
|----------------------|----|----|----|---|----|---|---|---|---|-------------------------|
| (1) Standard setting | | | ○ | ○ | ○ | ○ | ○ | ○ | ○ | No setting |
| (2) Vivid | | | ○ | ○ | ○ | ○ | ○ | | ○ | Low / Standard / Strong |
| (3) Soft | | | ○ | ○ | ○ | ○ | ○ | | ○ | Low / Standard / Strong |
| (4) Warm | | | ○ | ○ | ○ | ○ | ○ | | ○ | Low / Standard / Strong |
| (5) Intense | | | ○ | ○ | ○ | ○ | ○ | | ○ | Low / Standard / Strong |
| (6) Cool | | | ○ | ○ | ○ | ○ | ○ | | ○ | Low / Standard / Strong |
| (7) Brighter | | | ○ | ○ | ○ | ○ | ○ | ○ | ○ | Low / Medium / High |
| (8) Darker | | | ○ | ○ | ○ | ○ | ○ | ○ | ○ | Low / Medium / High |
| (9) Monochrome | | | ○ | ○ | ○ | ○ | ○ | ○ | ○ | Blue / B/W / Sepia |

1 Set the Mode Dial to any of the following modes: <CA>, <👤>, <🏔️>, <🌿>, <🌊>, <🍴>, or <🏠>.

2 Display the Live View image.

- Press the <📷> button to display the Live View image.



3 With Quick Control, select the desired ambience.

- Press the <Q> button (🕒10).
- Press the <▲> <▼> keys to select [Standard setting]. [Ambience-based shots] will appear on the screen.
- Press the <◀> <▶> keys or turn the <🌞> dial to select the ambience.
- ▶ The LCD monitor will display how the image will look with the selected ambience.





4 Set the ambience effect.

- Press the <▲> <▼> keys to select the effect so that **[Effect]** appears at the bottom.
- Press the <◀> <▶> keys or turn the <☀> dial to select the desired effect.

5 Take the picture.

- Press the shutter button completely to take the picture.
- To return to viewfinder shooting, press the <📷> button to exit Live View shooting. Then press the shutter button completely to take the picture.
- If you change the shooting mode or set the power switch to <OFF>, the setting will revert back to **[Standard setting]**.



- The Live View image shown with the ambience setting applied will not look exactly the same as the actual photo.
- Using flash may reduce the ambience effect.
- In bright outdoors, the Live View image you see on the LCD monitor may not have exactly the same brightness or ambience as the actual image. Set [**Y2: LCD brightness**] to 4, and look at the Live View image so that the LCD monitor is unaffected by outside light.



If you do not want the Live View image to be displayed when setting functions, press the <Q> button after step 1 and set **[Ambience-based shots]** and **[Effect]**.

Ambience Settings

(1) **Standard setting**

Standard image characteristics for the respective shooting mode.

Note that <👤> has image characteristics geared for portraits and <🏞️> is geared for landscapes. Each ambience is a modification of the respective shooting mode's image characteristics.

(2) **Vivid**

The subject will look sharp and vivid. It makes the photo look more impressive than with **[Standard setting]**.

(3) **Soft**

The subject will look softer and more dainty. Good for portraits, pets, flowers, etc.

(4) **Warm**

The subject will look softer with warmer colors. Good for portraits, pets, and other subjects to which you want to give a warm look.

(5) **Intense**

While the overall brightness is slightly lowered, the subject is emphasized for a more intense feeling. Makes the human or living subject stand out more.

(6) **Cool**

The overall brightness is slightly lowered with a cooler color cast. A subject in the shade will look more calm and impressive.

(7) **Brighter**

The picture will look brighter.

(8) **Darker**

The picture will look darker.

(9) **Monochrome**

The picture will be monochrome. You can select the monochrome color to be blue, black and white, or sepia. When **[Monochrome]** is selected, **<B/W>** will appear in the viewfinder.

Shooting by Lighting or Scene Type

In the <📷>, <🏞️>, <🌳>, and <🌧️> Basic Zone modes, you can shoot with the settings matching the lighting or scene type. Normally, [Default setting] is adequate, but if the settings match the lighting condition or scene, the picture will look more accurate to your eyes.

For Live View shooting, if you set both [Light/scene-based shots] and [Ambience-based shots] (p.76), you should first set [Light/scene-based shots]. This will make it easier to see the resulting effect on the LCD monitor.

| Lighting or Scene | A+ | 📷 | CA | 📷 | 🏞️ | 🌳 | 🌧️ | 🍴 | 📷 |
|-----------------------|----|---|----|---|----|---|----|---|---|
| (1) Default setting | | | | ○ | ○ | ○ | ○ | | |
| (2) Daylight | | | | ○ | ○ | ○ | ○ | | |
| (3) Shade | | | | ○ | ○ | ○ | ○ | | |
| (4) Cloudy | | | | ○ | ○ | ○ | ○ | | |
| (5) Tungsten light | | | | ○ | | ○ | ○ | | |
| (6) Fluorescent light | | | | ○ | | ○ | ○ | | |
| (7) Sunset | | | | ○ | ○ | ○ | ○ | | |

1 Set the Mode Dial to any of the following modes: <📷>, <🏞️>, <🌳>, or <🌧️>.

2 Display the Live View image.

- Press the <📷> button to display the Live View image.





3 With Quick Control, select the lighting or scene type.

- Press the <Q> button (☉10).
- Press the <▲> <▼> keys to select [Default setting]. [Light/scene-based shots] will appear on the screen.
- Press the <◀> <▶> keys or turn the <☉> dial to select the lighting or scene type.
- ▶ The resulting image with the selected lighting or scene type will be displayed.

4 Take the picture.

- Press the shutter button completely to take the picture.
- To return to viewfinder shooting, press the <📷> button to exit Live View shooting. Then press the shutter button completely to take the picture.
- If you change the shooting mode or set the power switch to <OFF>, the setting will revert back to [Default setting].



- If you use flash, the setting will switch to [Default setting]. (However, the shooting information will display the lighting or scene type that is set.)
- If you want to set this function together with [Ambience-based shots], set the lighting or scene type that best matches the ambience you have set. In the case of [Sunset], for example, warm colors will become prominent so the ambience you set may not work well.



If you do not want the Live View image to be displayed when setting functions, press the <Q> button after step 1 and set [Light/scene-based shots].

Lighting or Scene Type Settings

(1) **Default setting**

Default setting suited for most subjects.

(2) **Daylight**

For subjects under sunlight. Gives more natural-looking blue skies and greenery and reproduces light-colored flowers better.

(3) **Shade**

For subjects in the shade. Suitable for skin tones, which may look too bluish, and for light-colored flowers.

(4) **Cloudy**

For subjects under overcast skies. Makes skin tones and landscapes, which may otherwise look dull on a cloudy day, look warmer. Also effective for light-colored flowers.

(5) **Tungsten light**

For subjects lit under tungsten lighting. Reduces the reddish-orange color cast caused by tungsten lighting.

(6) **Fluorescent light**

For subjects under fluorescent lighting. Suited for all types of fluorescent lighting.

(7) **Sunset**

Suitable when you want to capture the sunset's impressive colors.

▶ Image Playback

The easiest way to play back images is explained below. For more details on the playback procedure, see page 207.



1 Play back the image.

- Press the <▶> button.
- ▶ The last image captured or played back will appear.



2 Select an image.

- To view images starting with the last captured image, press the <◀> key. To view images starting with the first (oldest) image, press the <▶> key.
- Each time you press the <DISP.> button, the information display will change.



Basic information display



Basic information + Image quality/Playback number

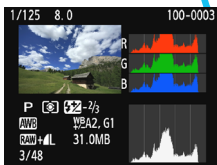

Histogram

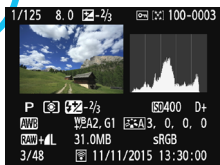

Shooting information display

3 Exit the image playback.

- Press the <▶> button to exit the image playback and return to the shooting function settings display.



3

Creative Shooting

In the Basic Zone modes, to prevent spoiled shots, most advanced functions are set automatically and cannot be changed. In the <P> (Program AE) mode, you can set various functions and be more creative.

- In the <P> mode, the camera sets the shutter speed and aperture automatically to obtain the standard exposure.
- The difference between the Basic Zone modes and <P> is explained on pages 276-277.
- The functions explained in this chapter can also be used in the <Tv>, <Av>, and <M> modes explained in Chapter 4.
- The ☆ icon at the upper right of the page title indicates that the function is available only in Creative Zone modes (p.30).

P: Program AE

The camera automatically sets the shutter speed and aperture to suit the subject's brightness. This is called Program AE.

* <P> stands for Program.

* AE stands for Auto Exposure.



1 Set the Mode Dial to <P>.



2 Focus on the subject.

- Look through the viewfinder and aim the selected AF point over the subject. Then press the shutter button halfway.
- ▶ The dot inside the AF point achieving focus lights up briefly in red, and the focus indicator <●> on the viewfinder's bottom right lights up (in One-Shot AF mode).
- ▶ The shutter speed and aperture will be set automatically and displayed in the viewfinder.



3 Check the display.

- The standard exposure will be obtained as long as the shutter speed and aperture display do not blink.

4 Take the picture.

- Compose the shot and press the shutter button completely.



Shooting Tips

● Change the ISO speed. Use the built-in flash.

To match the subject and ambient lighting level, you can change the ISO speed (p.92) or use the built-in flash (p.104). In the <P> mode, the built-in flash will not fire automatically. When indoors or during low light shooting, it is recommended that you press the <⚡> (flash) button to raise the built-in flash. (You can also raise the built-in flash by selecting <⚡_{UP}> with the Quick Control.)

● Change the program using Program shift.

After pressing the shutter button halfway, turn the <PROGRAM> dial to change the shutter speed and aperture setting combination (program). Program shift is canceled automatically after the picture is taken. Program shift is not possible with flash.

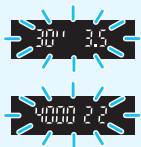

- If the "30"" shutter speed and the lowest f/number blink, it indicates underexposure. Increase the ISO speed or use flash.
- If the "4000" shutter speed and the highest f/number blink, it indicates overexposure. Decrease the ISO speed.



Differences Between <P> and <A+>

In the <A+> mode, many functions, such as the AF operation and metering mode, are set automatically to prevent spoiled shots. The functions you can set are limited. With <P> mode, only the shutter speed and aperture are set automatically. You can freely set the AF operation, metering mode, and other functions (p.276).

MENU Setting the Image-Recording Quality

You can select the pixel count and the image quality. Ten image-recording quality settings are provided: **L**, **L**, **M**, **M**, **S1**, **S1**, **S2**, **S3**, **RAW** + **L**, **RAW**.

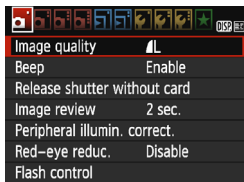

1 Select the image-recording quality.

- Under the [**1**] tab, select [**Image quality**], then press <SET>.
- ▶ [**Image quality**] will appear.

Pixels recorded (pixel count)

Possible shots

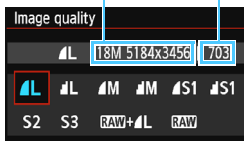

2 Set the image-recording quality.

- The respective quality's pixel count and number of possible shots will be displayed to help you select the desired quality. Then press <SET>.

Guide to Image-Recording Quality Settings (Approx.)

| Image Quality | | | Pixels Recorded (megapixels) | File Size (MB) | Possible Shots | Maximum Burst | |
|---------------|----------------|------|------------------------------|----------------|---------------------|--------------------|----------|
| L | High quality | JPEG | Approx. 17.9 (18M) | 6.4 | 1110 | 1110 | |
| | | | | 3.2 | 2190 | 2190 | |
| M | Medium quality | | Approx. 8.0 (8.0M) | 3.4 | 2100 | 2100 | |
| | | | | 1.7 | 4100 | 4100 | |
| S1 | Low quality | | Approx. 4.5 (4.5M) | 2.2 | 3270 | 3270 | |
| | | | | 1.1 | 6210 | 6210 | |
| S2 | | | Approx. 2.5 (2.5M) | 1.3 | 5440 | 5440 | |
| | | | | S3 | Approx. 0.35 (0.3M) | 0.3 | 21060 |
| RAW + L | | | High quality | | | Approx. 17.9 (18M) | 24.5+6.4 |
| RAW | | | | 24.5 | 290 | | 6 |

* The file size, possible shots, and maximum burst during continuous shooting are based on Canon's testing standards (3:2 aspect ratio, ISO 100 and Standard Picture Style) using an 8 GB card. **These figures will vary by the subject, card brand, aspect ratio, ISO speed, Picture Style, Custom Functions, and other settings.**

? FAQ

- **I want to select the image-recording quality matching the paper size for printing.**

Paper size

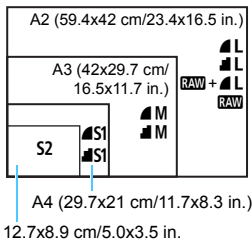

Refer to the diagram on the left when choosing the image-recording quality. If you want to crop the image, selecting a higher quality (more pixels) such as **L**, **L**, **RAW**+**L**, or **RAW** is recommended. **S2** is suitable for playing back the image with a digital photo frame. **S3** is suitable for emailing the image or using it on a website.

- **What's the difference between **L** and **L**?**

These settings indicate the different levels of image quality caused by different compression rates. The **L** setting produces a higher image quality with the same number of pixels. Although **L** produces a slightly lower image quality, this allows more images to be saved on the card. Both **S2** and **S3** have **L** (Fine) quality.

- **I was able to take more shots than the number of possible shots indicated.**

Depending on the shooting conditions, you may be able to take more shots than is indicated. It may also be fewer than indicated. The number of possible shots displayed is only approximate.

- **Does the camera display the maximum burst?**

The maximum burst is displayed on the viewfinder's right side. Since it is only a single-digit indicator **0 - 9**, any number higher than 8 will be displayed only as "**9**". Note that this number will also be displayed even when no card is installed in the camera. Be careful not to shoot without a card in the camera.

- **When should I use **RAW**?**

RAW images must be processed on a computer. For details, see "**RAW**" and "**RAW**+**L**" on the next page.

RAW

RAW is the raw image data before it is made into **L** or other images. **RAW** images cannot be viewed on a computer without the use of EOS software, such as Digital Photo Professional (p.314). However, you can perform various adjustments on them that are impossible with other image types such as **L**. **RAW** is effective when you want to precisely adjust the image yourself or shoot an important subject.

RAW + L

RAW + L records a **RAW** image and a **L** image with a single shot. The two images are saved to the card simultaneously. The two images will be saved in the same folder with the same file numbers (file extension .JPG for JPEG and .CR2 for RAW). **L** images can be viewed or printed even with a computer which does not have the EOS software installed.

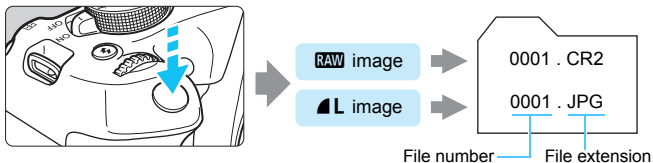
**RAW Image Processing Software**

- To display RAW images on a computer, using Digital Photo Professional (DPP, EOS software) is recommended (p.314).
- Previous versions of DPP Ver.4.x cannot process RAW images taken with this camera. If a previous version of DPP Ver.4.x is installed on your computer, obtain and install the latest version of DPP from the Canon website to update it (p.315). (The previous version will be overwritten.) Note that DPP Ver.3.x or earlier cannot process RAW images taken with this camera.
- Commercially-available software may not be able to display RAW images taken with this camera. For compatibility information, contact the software manufacturer.

ISO: Changing the ISO Speed to Suit the Light Level ☆

Set the ISO speed (image sensor's sensitivity to light) to suit the ambient light level. In Basic Zone modes, the ISO speed is set automatically (p.93).

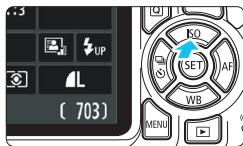

1 Press the <▲ ISO> button.

- ▶ [ISO speed] will appear.

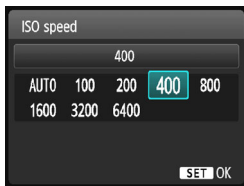

2 Set the ISO speed.

- Press the <◀> <▶> keys or turn the <⚙️> dial to select the desired ISO speed, then press <Ⓢ>.
- With [AUTO] selected, the ISO speed will be set automatically (p.93).

ISO Speed Guide

| ISO Speed | Shooting Situation (No flash) | Flash Range |
|------------------------|----------------------------------|--|
| ISO 100 - ISO 400 | Sunny outdoors | The higher the ISO speed, the farther the flash range will extend (p.105). |
| ISO 400 - ISO 1600 | Overcast skies or evening time | |
| ISO 1600 - ISO 6400, H | Dark indoors or night | |

* High ISO speeds will result in grainier images.



- Under [**⚡3: Custom Functions (C.Fn)**], if [**2: ISO expansion**] is set to [**1: On**], "H" (equivalent to ISO 12800) can also be selected (p.260).
- Under [**⚡3: Custom Functions (C.Fn)**], if [**10: Flash button function**] is set to [**1: ISO speed**], you can set the ISO speed with the <⚡> button.



- Under [**⚡3: Custom Functions (C.Fn)**], if [**6: Highlight tone priority**] is set to [**1: Enable**], ISO 100 and "H" (equivalent to ISO 12800) cannot be selected (p.263).
- Shooting in high temperatures may result in images that look grainier. Long exposures can also cause irregular colors in the image.



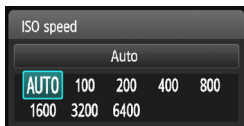

- When you shoot at high ISO speeds, noise (such as dots of light and banding) may become noticeable.
- If you use a high ISO speed and flash to shoot a close subject, overexposure may result.
- As “H” (equivalent to ISO 12800) is an expanded ISO speed setting, noise (such as dots of light and banding) and irregular colors will be more noticeable, and the resolution will be lower than usual.

ISO [AUTO]



If the ISO speed is set to **[AUTO]**, the actual ISO speed setting will be displayed when you press the shutter button halfway. As indicated on the next page, the ISO speed will be set automatically to suit the shooting mode.

| Shooting Mode | ISO Speed Setting |
|--|---|
|  | Automatically set within ISO 100 - ISO 3200 |
| P/Tv/Av/M | Automatically set within ISO 100 - ISO 6400 ^{*1} |
|  | ISO 100 |
| With flash | ISO 800 ^{*2*3*4*5} |
| With bulb exposures | ISO 800 ^{*5} |

*1: Depends on the maximum ISO speed limit set.

*2: If fill-in flash will cause overexposure, ISO speed may be reduced, down to a possible minimum of ISO 100.

*3: If bounce flash is used with an external Speedlite in a Basic Zone (except) mode or <P>, ISO 800 - ISO 1600 (or up to the maximum limit) will be set automatically.

*4: Fixed at ISO 400 in mode. If bounce flash is used with an external Speedlite in mode, ISO 400 - ISO 1600 will be set automatically.

*5: Fixed at ISO 400 if the maximum limit is ISO 400.

- When **[AUTO]** is set, the ISO speed is indicated in whole-stop increments. However, the ISO speed is actually set in finer increments. Therefore, in the image's shooting information (p.232), you may find an ISO speed such as ISO 125 or ISO 640 displayed as the ISO speed.
- In the mode, an ISO speed other than ISO 100 may be displayed, but the actual ISO speed used is the one shown in the table above.

[MENU] Setting the Maximum ISO Speed for **[AUTO]**[☆]

For ISO Auto, you can set the maximum ISO speed limit within ISO 400 - ISO 6400.



Under the [ 3] tab, select **[ISO Auto]**, then press . Select the ISO speed, then press .

Selecting Optimal Image Characteristics for the Subject ☆

By selecting a Picture Style, you can obtain image characteristics matching your photographic expression or the subject. In Basic Zone modes, you cannot select the Picture Style.

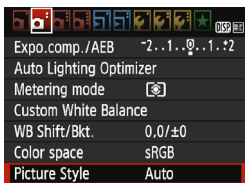

1 Select [Picture Style].

- Under the [CAMERA] tab, select [Picture Style], then press <SET>.
- ▶ The Picture Style selection screen will appear.

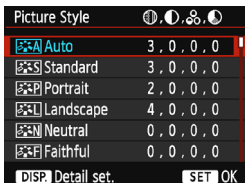

2 Select a Picture Style.

- Press the <▲> <▼> keys to select a Picture Style, then press <SET>.
- The Picture Style will be set and the menu will reappear.

Picture Style Characteristics

[A] Auto

The color tone will be adjusted automatically to suit the scene. The colors will look vivid for blue skies, greenery and sunsets, particularly in nature, outdoor and sunset scenes.

If the desired color tone is not obtained with [Auto], use another Picture Style.

[S] Standard

The image looks vivid, sharp, and crisp. This is a general-purpose Picture Style suitable for most scenes.

[P] Portrait

For nice skin tones. The image looks softer. Suited for close-up portraits.

By changing the [Color tone] (p.127), you can adjust the skin tone.

Landscape

For vivid blues and greens, and very sharp and crisp images. Effective for impressive landscapes.

Neutral

This Picture Style is for users who prefer to process images with their computer. For natural colors and subdued images with modest brightness and color saturation.

Faithful

This Picture Style is for users who prefer to process images with their computer. The color of a subject that is captured in sunlight at a color temperature of 5200K will be adjusted to match the subject's colorimetric color. For subdued images with modest brightness and color saturation.

Monochrome

Creates black-and-white images.



Black-and-white images shot in formats other than **RAW** cannot be reverted to color. Be careful not to leave the **[Monochrome]** setting on when you want to shoot photos in color again. When **[Monochrome]** is selected, **<B/W>** will appear in the viewfinder.

User Def. 1-3

You can register a base style such as **[Portrait]**, **[Landscape]**, a Picture Style file, etc., and adjust it as desired (p.129). Any User Defined Picture Style that has not been set will have the same default settings as the **[Auto]** Picture Style.

AF: Changing the Autofocus Operation [☆]

You can select the AF (autofocus) operation characteristics suiting the shooting conditions or subject. In Basic Zone modes, the optimum AF operation is set automatically for the respective shooting mode.

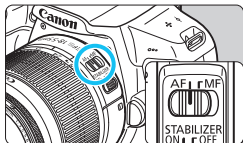

- 1 Set the lens's focus mode switch to <AF>.

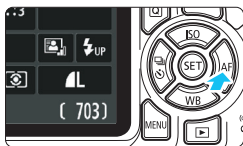

- 2 Press the <▶ AF> button.
▶ [AF operation] will appear.

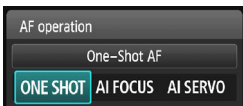

- 3 Select the AF operation.
 - Press the <<▶> <▶> keys or turn the <◀▶▶▶▶> dial to select the desired AF operation, then press <Ⓢ>.

- 4 Focus on the subject.
 - Aim the AF point over the subject and press the shutter button halfway. The camera will then autofocus in the selected AF operation.

One-Shot AF for Still Subjects

Suited for still subjects. When you press the shutter button halfway, the camera will focus only once.

- When focus is achieved, the dot inside the AF point achieving focus lights up briefly in red, and the focus indicator <●> appears in the viewfinder.
- With evaluative metering (p.115), the exposure setting will be set at the same time focus is achieved.
- While you hold down the shutter button halfway, the focus will be locked. You can then recompose the shot if desired.

- 
- If focus cannot be achieved, the focus indicator <●> in the viewfinder will blink. If this occurs, the picture cannot be taken even if the shutter button is pressed completely. Recompose the shot and try to focus again, or see “Subjects Difficult to Focus on” (p.101).
 - If [📷 1: Beep] is set to [Disable], the beeper will not sound when focus is achieved.

AI Servo AF for Moving Subjects

This AF operation is suited for moving subjects when the focusing distance keeps changing. While you hold down the shutter button halfway, the camera will keep focusing on the subject continuously.

- The exposure is set at the moment the picture is taken.
- When the AF point selection (p.99) is automatic, the camera first uses the center AF point to focus. During autofocusing, if the subject moves away from the center AF point, focus tracking continues as long as the subject is covered by another AF point.



With AI Servo AF, the beeper will not sound even when focus is achieved. Also, the focus indicator <●> in the viewfinder will not light up.

AI Focus AF for Switching the AF Operation Automatically

AI Focus AF switches the AF operation from One-Shot AF to AI Servo AF automatically if a still subject starts moving.

- After the subject is focused in One-Shot AF, if the subject starts moving, the camera will detect the movement, change the AF operation automatically to AI Servo AF, and start tracking the moving subject.



When focus is achieved in the AI Focus AF operation with the Servo mode active, the beeper will sound softly. However, the focus indicator <●> in the viewfinder will not light up. Note that focus will not be locked in this case.

Selecting the AF Point [☆]

In Basic Zone modes, the camera will normally focus on the closest subject automatically. Therefore, it may not always focus on your target subject.

In the <P>, <Tv>, <Av>, and <M> modes, you can select one AF point and focus only on the area covered by that AF point.

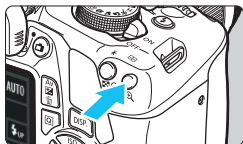

1 Press the button ().

- ▶ The selected AF point will be displayed on the LCD monitor and in the viewfinder.



2 Select the AF point.

- Use the <⬆️> cross keys to select the AF point.
- While looking through the viewfinder, you can select the AF point by turning the <🌓> dial until the desired AF point lights up in red.
- When all the AF points light up, automatic AF point selection will be set. The AF point will be selected automatically to focus on the subject.
- Pressing <📷> toggles the AF point selection between the center AF point and automatic AF point selection.

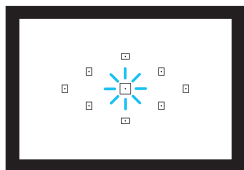

3 Focus on the subject.

- Aim the selected AF point over the subject and press the shutter button halfway to focus.

Shooting Tips

- **When shooting a portrait up close, use One-Shot AF and focus on the eyes.**
If you focus on the eyes first, you can then recompose and the face will remain sharp.
- **If it is difficult to focus, select and use the center AF point.**
The center AF point is the most sensitive among the nine AF points.
- **To make it easier to focus on a moving subject, set the camera to automatic AF point selection and AI Servo AF (p.98).**
The center AF point will first be used to focus on the subject. During autofocusing, if the subject moves away from the center AF point, focus tracking continues as long as the subject is covered by another AF point.

AF-Assist Beam with the Built-in Flash

Under low-light conditions, when you press the shutter button halfway, the built-in flash may fire a brief burst of flashes. This illuminates the subject to help autofocusing.

- AF-assist beam will not be emitted from the built-in flash in <[M]>, <[A]>, or <[S]> mode, or when **[Built-in flash firing]** is set to <[ON]> in <[CA]> or <[P]> mode.
- The AF-assist beam will not be emitted with AI Servo AF operation.
- The effective range of the AF-assist beam emitted by the built-in flash is approx. 4 meters / 13.1 feet.
- In Creative Zone modes, when you raise the built-in flash with the <[L]> button (p.104), the AF-assist beam will be emitted when necessary. Note that depending on the setting for **[7: AF-assist beam firing]** under **[43: Custom Functions (C.Fn)]**, AF-assist beam will not be emitted (p.264).

- If you use an Extender (sold separately) and the maximum aperture becomes higher than f/5.6, AF shooting will not be possible (except in **[FlexiZone - Single]** and **[Live mode]** during Live View shooting). For details, refer to the Extender's instruction manual.

Subjects Difficult to Focus on

Autofocus can fail to achieve focus (viewfinder's focus indicator <●> blinks) with certain subjects such as the following:

- Subjects with very low contrast
(Example: Blue skies, solid-color flat surfaces, etc.)
- Subjects in very low light
- Strongly backlit and reflective subjects
(Example: Cars with highly reflective bodies, etc.)
- Near and distant subjects framed close to an AF point
(Example: Animals in cages, etc.)
- Subjects such as dots of light framed close to an AF point
(Example: Night scenes, etc.)
- Repetitive patterns
(Example: Skyscraper windows, computer keyboards, etc.)

In such cases, focus by doing either of the following:

- (1) With One-Shot AF, focus on an object at the same distance as the subject and lock the focus, then recompose the shot (p.61).
- (2) Set the lens's focus mode switch to <MF> and focus manually.



- Depending on the subject, focus may be achieved by slightly recomposing the shot and performing AF operation again.
- For subjects difficult to focus on during Live View shooting with [FlexiZone - Single] and [Live mode], see page 152.

MF: Manual Focus

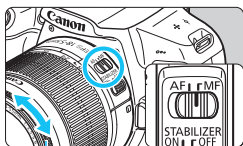

Focusing ring

1 Set the lens's focus mode switch to <MF>.

2 Focus on the subject.

- Focus by turning the lens's focusing ring until the subject looks sharp in the viewfinder.



If you press the shutter button halfway during manual focusing, the AF point achieving focus will light up briefly in red, the beeper will sound, and the focus indicator <●> in the viewfinder will light up.

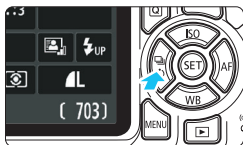

Continuous Shooting ☆

You can shoot up to approx. 3 shots per second. This is effective for shooting a child running toward you or capturing different facial expressions.



1 Press the <◀   > button.

2 Select < >.

- Press the <◀> <▶> keys or turn the < > dial to select continuous shooting < >, then press < >.

3 Take the picture.

- The camera shoots continuously while you hold down the shutter button completely.

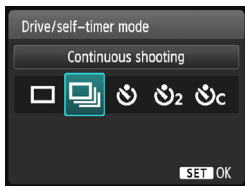

Shooting Tips

Also set the AF operation (p.97) matching the subject.

• **For a moving subject**

When AI Servo AF is set, focusing will be continuous during continuous shooting.

• **For a still subject**

When One-Shot AF is set, the camera will focus only once during continuous shooting.

- Under [ **3: Custom Functions (C.Fn)**], if [**5: High ISO speed noise reduct'n**] is set to [**2: Strong**] (p.263), the maximum burst during continuous shooting will greatly decrease. Also, the continuous shooting speed may be slower.
- The continuous shooting speed may become slower if the remaining battery level is low or if you shoot under low-light conditions.
- In AI Servo AF operation, the continuous shooting speed may become slightly slower depending on the subject and the lens used.

Using the Self-timer

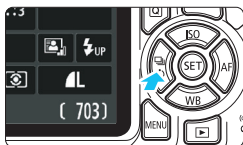

1 Press the **<◀ [] ▶>** button.

2 Select the self-timer.

- Press the **<◀> <▶>** keys or turn the **< [] >** dial to select the self-timer, then press **< [] >**.

[] : Shoot in approx. 10 sec.

[]₂ : Shoot in approx. 2 sec. [★]

[]_C : Take the set number of shots continuously in approx. 10 sec.

[]_C Press the **<▲> <▼>** keys to set the number of multiple shots (2 to 10) to be taken with the self-timer.

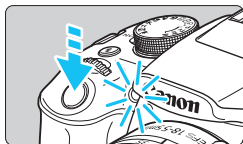
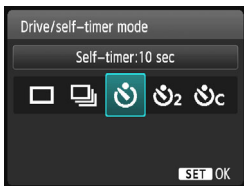

3 Take the picture.

- Look through the viewfinder, focus on the subject, then press the shutter button completely.

- ▶ You can check the self-timer operation with the self-timer lamp, beeper, and countdown display (in seconds) on the LCD monitor.
- ▶ 2 sec. before the picture is taken, the self-timer lamp will light up and the beeper will sound faster.



- With **< []_C >**, the interval between the multiple shots may be prolonged depending on the shooting functions settings such as the image-recording quality or flash.
- If you do not look through the viewfinder when you press the shutter button, attach the eyepiece cover (p.271). If stray light enters the viewfinder when the picture is taken, it may throw off the exposure.



- After taking self-timer shots, playing back the image (p.83) to check focus and exposure is recommended.
- When using the self-timer to shoot yourself, use focus lock (p.61) on an object at the same distance as where you will stand.
- To cancel the self-timer after it starts, press the **<◀ [] ▶>** button.

⚡ Using the Built-in Flash

In indoor, low light or backlit conditions in daylight, just raise the built-in flash and press the shutter button to take flash pictures. In the <P> mode, the shutter speed (1/60 sec. - 1/200 sec.) will be set automatically to prevent camera shake.

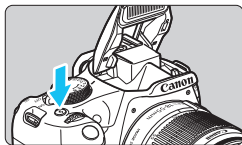

1 Press the <⚡> button.

- In Creative Zone modes, you can press the <⚡> button anytime to take flash pictures.
- While the flash is recycling, “⚡buSY” is displayed in the viewfinder, and [BUSY⚡] is displayed on the LCD monitor.



2 Press the shutter button halfway.

- In the bottom left of the viewfinder, check that the <⚡> icon is lit.

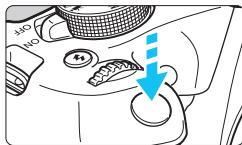

3 Take the picture.

- When focus is achieved and you press the shutter button completely, the flash will fire for the picture.



Shooting Tips

● In bright light, decrease the ISO speed.

If the exposure setting in the viewfinder blinks, decrease the ISO speed.

● Detach the lens hood. Do not get too close to the subject.

If the lens has a hood attached or you are too close to the subject, the bottom of the picture may look dark due to the obstructed flash. For important shots, check the image on the LCD monitor to make sure the flash exposure looks natural (not dark at the bottom).

Effective Range of Built-in Flash (Approx. in meters / feet)

| ISO Speed (p.92) | EF-S18-55mm f/3.5-5.6 IS II | |
|---------------------|-----------------------------|-------------------------|
| | Wide Angle | Telephoto |
| | f/3.5 | f/5.6 |
| ISO 100 | 1 - 2.6 / 3.3 - 8.5 | 1 - 1.6 / 3.3 - 5.2 |
| ISO 400 | 1 - 5.3 / 3.3 - 17.4 | 1 - 3.3 / 3.3 - 10.8 |
| ISO 800/AUTO* | 1 - 7.4 / 3.3 - 24.3 | 1 - 4.6 / 3.3 - 15.1 |
| ISO 1600 | 1.3 - 10.5 / 4.3 - 34.4 | 1 - 6.6 / 3.3 - 21.7 |
| ISO 6400 | 2.6 - 21.0 / 8.5 - 68.9 | 1.6 - 13.1 / 5.2 - 43.0 |

* For fill-in flash, the ISO speed may be set lower than ISO 800.



- When a high ISO speed is set and focusing distance is long, appropriate exposure may not be obtained depending on the subject conditions, etc.
- Do not perform flash photography when the built-in flash is held down with your finger or not fully raised for some other reason.

MENU Red-eye Reduction

Using the red-eye reduction lamp before taking a flash picture can reduce red eye.

Red-eye reduction will function in any shooting mode except <[M]>, <[A]>, <[S]>, or <[M]>.

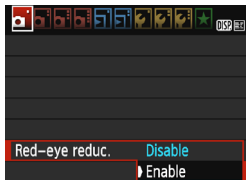

- Under the [**1**] tab, select [**Red-eye reduc.**], then press <[SET]>.
- Select [**Enable**], then press <[SET]>.
- For flash photography, when you press the shutter button halfway, the red-eye reduction lamp will light up. Then when you press the shutter button completely, the picture will be taken.

- The red-eye reduction feature is more effective when the subject looks at the red-eye reduction lamp, when the room is well lit, or when you are close to the subject.
- When you press the shutter button halfway, the scale display on the bottom of the viewfinder will shrink and turn off. For best results, take the picture after this scale display turns off.
- The effectiveness of red-eye reduction varies depending on the individual subject.



4

Advanced Shooting

This chapter builds on Chapter 3 and introduces more ways to shoot creatively.

- The first half of this chapter explains how to use the <Tv>, <Av>, and <M> modes on the Mode Dial.
- All the functions explained in Chapter 3 can also be used in the <Tv>, <Av>, and <M> modes.
- To see which functions can be used in each shooting mode, see page 276.
- The ☆ icon at the upper right of the page title indicates that the function is available only in Creative Zone modes (p.30).

Main Dial Pointer



The pointer icon <👉> displayed together with the shutter speed, aperture setting, or exposure compensation amount indicates that you can turn the <👉> dial to adjust the respective setting.

Tv: Conveying the Subject's Movement

You can either freeze the action or create motion blur with the <Tv> (Shutter-priority AE) mode on the Mode Dial.

* <Tv> stands for Time value.



Blurred motion
(Slow shutter speed: 1/30 sec.)



Frozen motion
(Fast shutter speed: 1/2000 sec.)



1 Set the Mode Dial to <Tv>.



2 Set the desired shutter speed.

- See “Shooting Tips” for advice on setting the shutter speed.
- Turning the <shutter speed dial> to the right sets a faster shutter speed, and turning it to the left sets a slower one.



3 Take the picture.

- When you focus and press the shutter button completely, the picture will be taken at the selected shutter speed.



Shutter Speed Display

The LCD monitor displays the shutter speed as a fraction. However, the viewfinder displays only the denominator. “0”5” indicates 0.5 sec. and “15”” is 15 sec.



Shooting Tips

- **To freeze the motion of a fast-moving subject**
Use a fast shutter speed such as 1/4000 sec. to 1/500 sec.
- **To blur a running child or animal and convey an impression of motion**
Use a medium shutter speed such as 1/250 sec. to 1/30 sec. Follow the moving subject through the viewfinder and press the shutter button to take the picture. If you use a telephoto lens, hold it steady to prevent camera shake.
- **To blur a flowing river or fountain**
Use a slow shutter speed of 1/30 sec. or slower. Use a tripod to prevent hand-held camera shake.
- **Set the shutter speed so that the aperture display does not blink.**

If you press the shutter button halfway and change the shutter speed while the aperture is displayed, the aperture display will also change to maintain the same exposure (amount of light reaching the image sensor). If you exceed the adjustable aperture range, the aperture display will blink to indicate that the standard exposure cannot be obtained.

If the exposure will be too dark, the maximum aperture (lowest f/ number) will blink. If this happens, turn the  dial to the left to set a slower shutter speed or increase the ISO speed.

If the exposure will be too bright, the minimum aperture (highest f/ number) will blink. If this happens, turn the  dial to the right to set a faster shutter speed or decrease the ISO speed.



⚡ Using the Built-in Flash

To obtain the correct flash exposure, the flash output will be set automatically (autoflash exposure) to match the automatically-set aperture. The shutter speed can be set from 1/200 sec. to 30 sec.

Av: Changing the Depth of Field

To blur the background or to make everything near and far look sharp, set the Mode Dial to **<Av>** (Aperture-priority AE) to adjust the depth of field (range of acceptable focus).

* **<Av>** stands for Aperture value, which is the size of the diaphragm hole inside the lens.



Blurred background
(With a low aperture f/number: f/5.6)



Sharp foreground and background
(With a high aperture f/number: f/32)

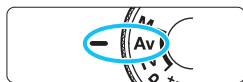

1 Set the Mode Dial to **<Av>**.

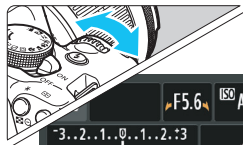

2 Set the desired aperture.

- The higher the f/number, the wider the depth of field where sharper focus is obtained in both the foreground and background.
- Turning the  dial to the right will set a higher f/number (smaller aperture opening), and turning it to the left will set a lower f/number (larger aperture opening).



3 Take the picture.

- Focus and press the shutter button completely. The picture will be taken with the selected aperture.



Aperture Display

The higher the f/number, the smaller the aperture opening will be. The f/number displayed will differ depending on the lens. If no lens is attached to the camera, "00" will be displayed for the aperture.



Shooting Tips

- **When using an aperture with a high f/number or shooting in low light scenes, note that camera shake can occur.**

A higher aperture f/number will make the shutter speed slower.

Under low light, the shutter speed can be as long as 30 sec. In such cases, increase the ISO speed and hold the camera steady or use a tripod.

- **The depth of field depends not only on the aperture, but also on the lens and on the subject distance.**

Since wide-angle lenses have a wide depth of field (range of acceptable focus in front of and behind the point of focus), you need not set a high aperture f/number to obtain a sharp picture from the foreground to the background. On the other hand, a telephoto lens has a narrow depth of field.

And the closer the subject, the narrower the depth of field. A farther subject will have a wider depth of field.

- **Set the aperture so that the shutter speed display does not blink.**

If you press the shutter button halfway and change the aperture while the shutter speed is displayed, the shutter speed display will also change to maintain the same exposure (amount of light reaching the image sensor). If you exceed the adjustable shutter speed range, the shutter speed display will blink to indicate that the standard exposure cannot be obtained.

If the picture will be too dark, the “30” (30 sec.) shutter speed display will blink. If this happens, turn the dial to the left to set a lower f/number or increase the ISO speed.

If the picture will be too bright, the “4000” (1/4000 sec.) shutter speed display will blink. If this happens, turn the dial to the right to set a higher f/number or decrease the ISO speed.



⚡ Using the Built-in Flash

To obtain a correct flash exposure, the flash output will be set automatically to match the set aperture (autoflash exposure). The shutter speed will be set automatically between 1/200 sec. - 30 sec. to suit the scene's brightness.

In low light, the main subject is exposed with the auto flash metering, and the background is exposed with a slow shutter speed set automatically. Both the subject and background look properly exposed with a touch of atmosphere (automatic slow-speed flash sync). If you are handholding the camera, keep it steady to prevent camera shake. Using a tripod is recommended.

To prevent a slow shutter speed, under [**⚡3: Custom Functions (C.Fn)**], set [**3: Flash sync. speed in Av mode**] to [**1: 1/200-1/60sec. auto**] or [**2: 1/200sec. (fixed)**] (p.261).

MENU Depth-of-Field Preview [☆]

The aperture opening (diaphragm) changes only at the moment when the picture is taken. Otherwise, the aperture remains fully open. Therefore, when you look at the scene through the viewfinder or on the LCD monitor, the depth of field will look narrow. With the procedure below, you can check the depth of field before taking the picture.

1 Enable depth-of-field preview to be used.

- Under [**⚡3: Custom Functions (C.Fn)**], set [**9: Assign SET button**] to [**4: Depth-of-field preview**] (p.266).
- For details about Custom Function settings, see page 258.

2 Exit the menu.

- Press the <MENU> button two times to exit the menu.

3 Press the <ⓈET> button.

- ▶ The aperture will be stopped down so you can see the depth of field.



While looking at the Live View image (p.140) and holding down the <ⓈET> button, you can change the aperture and see how the depth of field changes.

M: Manual Exposure

You can set both the shutter speed and aperture manually as desired. While referring to the exposure level indicator in the viewfinder, you can set the exposure as desired. This method is called manual exposure.

* <M> stands for Manual.

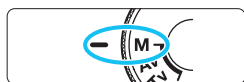

1 Set the Mode Dial to <M>.



2 Set the ISO speed (p.92).

3 Set the shutter speed and aperture.

- To set the shutter speed, turn the < [gear] > dial.
- To set the aperture, hold down the <Av [gear] > button and turn the < [gear] > dial.

Standard exposure index



Exposure level mark

4 Focus on the subject.

- Press the shutter button halfway.
- ▶ The exposure setting will be displayed in the viewfinder.
- The exposure level mark < [gear] > indicates how far the current exposure level is from the standard exposure level.

5 Set the exposure and take the picture.

- Set the shutter speed and aperture as desired.
- If the exposure level exceeds ± 2 stops from the standard exposure, the end of the exposure level indicator will display < [gear] > or < [gear] > in the viewfinder. (On the LCD monitor, if the exposure level exceeds ± 3 stops, the < [gear] > icon will blink at where < -3 > or < +3 > is displayed.)



- If [2: Auto Lighting Optimizer] (p.123) is set to any setting other than [Disable], the image may still look bright even if a darker exposure has been set.
- If ISO Auto is set, the ISO speed setting will change to suit the shutter speed and aperture in order to obtain the standard exposure. Therefore, you may not obtain the desired exposure effect.

⚡ Using the Built-in Flash

To obtain a correct flash exposure, the flash output will be set automatically (autoflash exposure) to match the manually-set aperture. The shutter speed can be set from 1/200 sec. to 30 sec. or to bulb.

BULB: Bulb Exposures

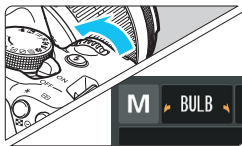

Elapsed exposure time

A bulb exposure keeps the shutter open for as long as you hold down the shutter button. It can be used to shoot fireworks and other subjects requiring long exposures.

In step 3 on the preceding page, turn the <☀> dial to the left to set <BULB>.

The elapsed exposure time will be displayed on the LCD monitor.

- ⚠ Do not point the camera toward an intense light source, such as the sun or an intense artificial light source. Doing so may damage the image sensor or the camera's internal components.
- Since bulb exposures produce more noise than usual, the image may look slightly grainy.
- You can reduce the noise due to long exposures by setting [4: Long exp. noise reduction] under [⚡3: Custom Functions (C.Fn)] to [1: Auto] or [2: On] (p.262).
- If ISO Auto is set for a bulb exposure, the ISO speed will be fixed at ISO 800 (p.94).



📷 For bulb exposures, using a tripod and a remote switch (sold separately, p.271) is recommended.

Changing the Metering Mode ☆

Three methods (metering modes) to measure the subject's brightness are provided. Normally, evaluative metering is recommended.

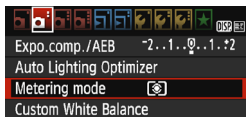
In Basic Zone modes, metering mode is set automatically.



- 1 Select [Metering mode].**
 - Under the [2] tab, select [**Metering mode**], then press < >.

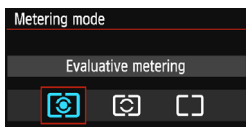

- 2 Set the metering mode.**
 - Select the desired metering mode, then press < >.

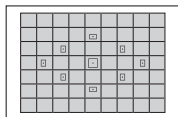

Evaluative metering

General-purpose metering mode suited even for backlit subjects. The camera sets the exposure automatically to suit the scene.

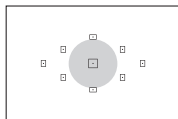



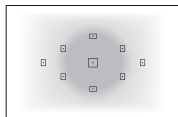

Partial metering

Effective where there are much brighter lights around the subject due to backlight, etc. The gray area in the left figure is where the brightness is metered to obtain the standard exposure.



Center-weighted average metering

The brightness is metered at the image center and then averaged for the entire scene. This metering mode is for advanced users.

 With  (Evaluative metering), the exposure setting will be locked when you press the shutter halfway and focus is achieved. In the  (Partial metering) and  (Center-weighted average metering) modes, the exposure is set at the moment the picture is taken. (Pressing the shutter button halfway does not lock the exposure.)

Setting Exposure Compensation ☆

Av Setting Exposure Compensation

Set exposure compensation if the exposure (without flash) does not come out as desired. This feature can be used in Creative Zone modes (except <M>). You can set the exposure compensation up to ± 5 stops in 1/3-stop increments.





Increased exposure for a brighter image



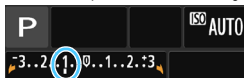

Decreased exposure for a darker image



Making it brighter

Hold down the <Av  > button and turn the < > dial to the right (increased exposure).

Making it darker

Hold down the <Av  > button and turn the < > dial to the left (decreased exposure).

- ▶ As shown in the figure, the exposure level is displayed on the LCD monitor and in the viewfinder.

- **After taking the picture, cancel the exposure compensation by setting it back to 0.**



Dark exposure



Increased exposure for a brighter image

- The exposure compensation amount displayed in the viewfinder goes up to only ± 2 stops. If the exposure compensation amount exceeds ± 2 stops, the end of the exposure level indicator will display <◀> or <▶>.
- If you want to set exposure compensation exceeding ± 2 stops, setting it with [ 2: Expo.comp./AEB] (p.118) or with the Quick Control (p.48) is recommended.

Setting Flash Exposure Compensation

Set flash exposure compensation if the flash exposure of the subject does not come out as desired. You can set the flash exposure compensation up to ± 2 stops in 1/3-stop increments.



1 Press the <Q> button (.

- ▶ The Quick Control screen will appear (p.48).



2 Select [.

- Press the <⬆> cross keys to select [*].
- ▶ [Flash exposure comp.] will be displayed at the bottom.



3 Set the flash exposure compensation amount.

- If the exposure is too dark, turn the <⦿> dial to the right (for increased exposure).
If the exposure is too bright, turn the <⦿> dial to the left (for decreased exposure).

- ▶ When you press the shutter button halfway, the <⚡> icon will appear in the viewfinder.
- **After taking the picture, cancel the flash exposure compensation by setting it back to 0.**



If [**2: Auto Lighting Optimizer**] (p.123) is set to any setting other than [**Disable**], the image may still look bright even if a decreased exposure compensation or decreased flash exposure compensation is set.



You can also set flash exposure compensation with [**Built-in flash func. setting**] in [**1: Flash control**] (p.199).

MENU Auto Exposure Bracketing ☆

This feature takes exposure compensation a step further by varying the exposure automatically (up to ± 2 stops in $1/3$ -stop increments) with three shots as shown below. You can then choose the best exposure. This is called AEB (Auto Exposure Bracketing).

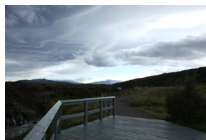

Standard exposure

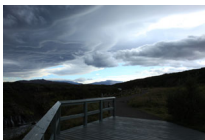

Darker exposure
(Decreased exposure)

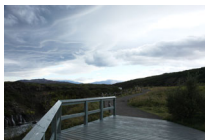

Brighter exposure
(Increased exposure)

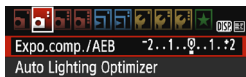

1 Select [Expo.comp./AEB].

- Under the [CAMERA] tab, select [Expo.comp./AEB], then press <SET>.

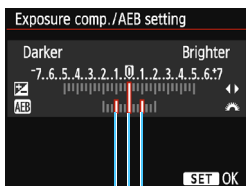

AEB range

2 Set the AEB range.

- Turn the <WHEEL> dial to set the AEB range.
- Press the <LEFT> <RIGHT> keys to set the exposure compensation amount. If AEB is combined with exposure compensation, AEB will be applied centering on level of exposure compensation.
- Press <SET> to set it.
- When you press the <MENU> button to exit the menu, the AEB range will be displayed on the LCD monitor.



3 Take the picture.

- Focus and press the shutter button completely. The three bracketed shots will be taken in this sequence: standard exposure, decreased exposure, and increased exposure.

Canceling AEB

- Follow steps 1 and 2 to turn off the AEB range display.
- The AEB setting will also be canceled automatically if the power switch is set to <OFF>, flash recycling is completed, etc.



Shooting Tips

● Using AEB with continuous shooting

If <[]> continuous shooting (p.102) is set and you press the shutter button completely, the three bracketed shots will be taken continuously in this sequence: standard exposure, decreased exposure, and increased exposure.

● Using AEB with single shooting (□)

Press the shutter button three times to take the three bracketed shots. The three bracketed shots will be taken in the following sequence: standard exposure, decreased exposure, and increased exposure.

● Using AEB with the self-timer

With the self-timer <[]> <[]₂> (p.103), you can take three continuous shots after a delay of approx. 10 sec. or approx. 2 sec. With <[]> (p.103) set, the number of continuous shots will be three times the number set.



- AEB will not work with flash or bulb exposures.
- If []2: Auto Lighting Optimizer (p.123) is set to any setting other than [Disable], the effect of AEB may be reduced.

* Locking the Exposure ☆

You can lock the exposure when the area of focus is to be different from the exposure metering area or when you want to take multiple shots at the same exposure setting. Press the < * > button to lock the exposure, then recompose and take the picture. This is called AE lock. It is effective for shooting backlit subjects, etc.

1 Focus on the subject.

- Press the shutter button halfway.
- ▶ The exposure setting will be displayed.

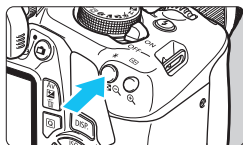

2 Press the < * > button (ⓘ4).

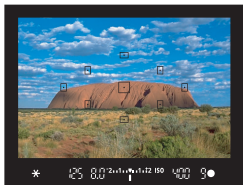

- ▶ The < * > icon lights up in the viewfinder to indicate that the exposure setting is locked (AE lock).
- Each time you press the < * > button, the current exposure setting is locked.



3 Recompose and take the picture.

- If you want to take more pictures while maintaining the AE lock, keep holding down the < * > button and press the shutter button to take another picture.

AE Lock Effects

| Metering Mode (p.115) | AF Point Selection Method (p.99) | |
|---|---|--|
| | Automatic Selection | Manual Selection |
|  | AE lock is applied at the AF point that achieved focus. | AE lock is applied at the selected AF point. |
|  | AE lock is applied to the center AF point. | |

* When the lens's focus mode switch is set to <MF>, AE lock is applied to the center AF point.



AE lock is not possible with bulb exposures.

✳ Locking the Flash Exposure ☆

If the subject is on the side of the frame and you use flash, the subject may turn out to be too bright or dark depending on the background, etc. Use FE lock in such a case. After setting the proper flash exposure for the subject, you can recompose (put the subject toward the side) and shoot. This feature can also be used with a Canon EX-series Speedlite. * FE stands for Flash Exposure.

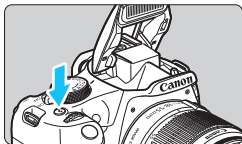

1 Press the <⚡> button.

- ▶ The built-in flash will be raised.
- Press the shutter button halfway and look in the viewfinder to check that the <⚡> icon is lit.



2 Focus on the subject.

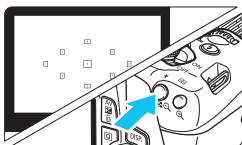

3 Press the <✳> button (Ⓜ16).

- Aim the viewfinder center over the subject where you want to lock the flash exposure, then press the <✳> button.
- ▶ The flash will fire a preflash and the required flash output is calculated and retained in memory.
- ▶ In the viewfinder, "FEL" is displayed for a moment and <⚡✳> will light up.
- Each time you press the <✳> button, a preflash is fired and the required flash output is calculated and retained in memory.



4 Take the picture.

- Compose the shot and press the shutter button completely.
- ▶ The flash is fired, and the picture is taken.



* Locking the Flash Exposure *

- If the subject is too far away and beyond the effective range of the flash, the <⚡> icon will blink. Move closer to the subject and repeat steps 2 to 4.
- FE lock is not possible during Live View shooting.

MENU Auto Correction of Brightness and Contrast ☆

If the image comes out dark or the contrast is low, the brightness and contrast can be corrected automatically. This function is called Auto Lighting Optimizer. The default setting is [Standard]. With JPEG images, the correction is applied when the image is captured. In Basic Zone modes, [Standard] is set automatically.

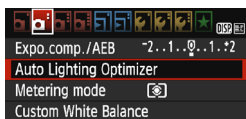

1 Select [Auto Lighting Optimizer].

- Under the [2] tab, select [Auto Lighting Optimizer], then press <SET>.

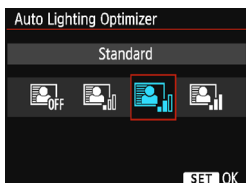

2 Select the setting.

- Select the desired setting, then press <SET>.

3 Take the picture.

- The image will be recorded with the brightness and contrast corrected if necessary.

- Under [3: Custom Functions (C.Fn)], if [6: Highlight tone priority] is set to [1: Enable], the Auto Lighting Optimizer will be set automatically to [Disable] and the setting cannot be changed.
- If the Auto Lighting Optimizer's effect is too strong and the image is too bright, set [Low] or [Disable].
- If a setting other than [Disable] is set and you use exposure compensation or flash exposure compensation to darken the exposure, the image may still come out bright. If you want a darker exposure, set this function to [Disable].
- Depending on the shooting conditions, noise may increase.

MENU Correcting the Image's Dark Corners

Due to the lens characteristics, the four corners of the picture may look darker. This phenomenon is called lens light fall-off or drop in peripheral illumination and can be corrected. The default setting is **[Enable]**. With JPEG images, the correction is applied when the image is captured. For RAW images, it can be corrected with Digital Photo Professional (EOS software, p.314).

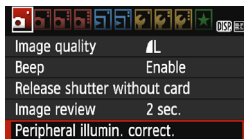

1 Select **[Peripheral illumin. correct.]**.

- Under the [**1**] tab, select **[Peripheral illumin. correct.]**, then press **<SET>**.

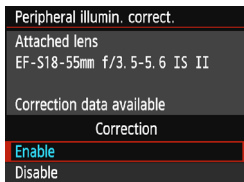

2 Select the setting.

- Check that **[Correction data available]** is displayed for the attached lens.
- If **[Correction data not available]** is displayed, see “Lens Correction Data” on the next page.
- Select **[Enable]**, then press **<SET>**.

3 Take the picture.

- The image will be recorded with the peripheral illumination corrected.



Correction disabled



Correction enabled

Lens Correction Data

The camera already contains lens peripheral illumination correction data for approx. 30 lenses. In step 2, if you select **[Enable]**, the peripheral illumination correction will be applied automatically for any lens whose correction data has been registered in the camera.

With EOS Utility (EOS software, p.314), you can check which lenses have their correction data registered in the camera. You can also register the correction data for unregistered lenses. For details, refer to the EOS Utility Instruction Manual.



- Peripheral illumination correction cannot be applied to JPEG images already taken.
- Depending on shooting conditions, noise may appear on the image periphery.
- When using a non-Canon lens, setting the corrections to **[Disable]** is recommended, even if **[Correction data available]** is displayed.
- If you use the magnified view during Live View shooting, the peripheral illumination correction will not be reflected in the image displayed on the screen.



- If the effect of the correction is not visible, magnify the image after shooting and check it again.
- Corrections can be applied even when an Extender or Life-size Converter is attached.
- If the correction data for the attached lens is not registered to the camera, the result will be the same as when the correction is set to **[Disable]**.
- The correction amount applied will be lower than the maximum correction amount settable with Digital Photo Professional (EOS software).
- The correction amount will be less if the lens used does not have distance information.
- The higher the ISO speed, the lower the correction amount will be.

Customizing Image Characteristics ☆

You can customize a Picture Style by adjusting individual parameters such as **[Sharpness]** and **[Contrast]** from the default. To see the resulting effects, take test shots. To customize **[Monochrome]**, see page 128.

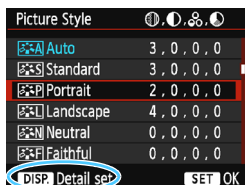

1 Select [Picture Style].

- Under the [**2**] tab, select **[Picture Style]**, then press **<SET>**.
- ▶ The Picture Style selection screen will appear.

2 Select a Picture Style.

- ▶ Select a Picture Style, then press the **<DISP.>** button.

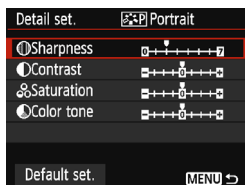

3 Select a parameter.

- Select a parameter such as **[Sharpness]**, then press **<SET>**.

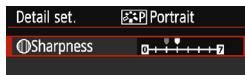

4 Set the parameter.

- Press the **<◀>** keys to adjust the parameter as desired, then press **<SET>**.
- Press the **<MENU>** button to save the adjusted parameters. The Picture Style selection screen will reappear.
- ▶ Any parameter settings different from the default will be displayed in blue.



- By selecting **[Default set.]** in step 3, you can revert the parameter settings of the respective Picture Style to their defaults.
- To shoot with the Picture Style you adjusted, follow step 2 on page 95 to select the adjusted Picture Style, then shoot.

Parameter Settings and Effects

Sharpness

Adjusts the sharpness of the subject.

To make it less sharp, set it toward the **0** end. The closer it is to **0**, the softer the image will look.

To make it sharper, set it toward the **7** end. The closer it is to **7**, the sharper the image will look.

Contrast

Adjusts the image contrast and the vividness of colors.

To decrease the contrast, set it toward the minus end. The closer it is to **-**, the more muted the image will look.

To increase the contrast, set it toward the plus end. The closer it is to **+**, the crisper the image will look.

Saturation

Adjusts the color saturation in the image.

To decrease the color saturation, set it toward the minus end.

The closer it is to **-**, the more diluted the colors will look.

To increase the color saturation, set it toward the plus end. The closer it is to **+**, the bolder the colors will look.

Color tone

Adjusts the color tone of skin.

To make the skin tone redder, set it toward the minus end. The closer it is to **-**, the redder the skin tone will look.

To reduce skin redness, set it toward the plus end. The closer it is to **+**, the more yellow the skin tone will look.

Monochrome Adjustment

For Monochrome, you can also set **[Filter effect]** and **[Toning effect]** in addition to **[Sharpness]** and **[Contrast]** explained on the preceding page.

Filter Effect

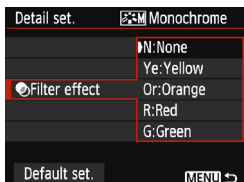

With a filter effect applied to a monochrome image, you can make white clouds or green trees stand out more.

| Filter | Sample Effects |
|------------|--|
| N: None | Normal black-and-white image with no filter effects. |
| Ye: Yellow | The blue sky will look more natural, and the white clouds will look crisper. |
| Or: Orange | The blue sky will look slightly darker. The sunset will look more brilliant. |
| R: Red | The blue sky will look quite dark. Fall leaves will look crisper and brighter. |
| G: Green | Skin tones and lips will appear muted. Green tree leaves will look crisper and brighter. |

Increasing the **[Contrast]** will make the filter effect more pronounced.

Toning Effect

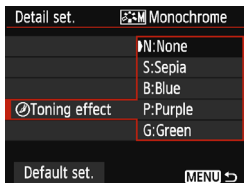

By applying a toning effect, you can create a monochrome image in that color. It can make the image look more impressive.

The following can be selected: **[N:None]**, **[S:Sepia]**, **[B:Blue]**, **[P:Purple]** or **[G:Green]**.

🔧 Registering Preferred Image Characteristics ☆

You can select a base Picture Style such as [Portrait] or [Landscape], adjust its parameters as desired and register it under [User Def. 1], [User Def. 2], or [User Def. 3].

You can create multiple Picture Styles with different settings for parameters such as sharpness and contrast.

You can also adjust the parameters of a Picture Style that is registered to the camera with EOS Utility (EOS software, p.314).

1 Select [Picture Style].

- Under the [📷2] tab, select [Picture Style], then press <SET>.
- ▶ The Picture Style selection screen will appear.

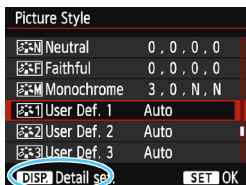

2 Select [User Def. *].

- Select [User Def. *], then press the <DISP.> button.
- ▶ The Detail setting screen will appear.

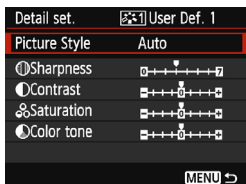

3 Press <SET>.

- With [Picture Style] selected, press <SET>.

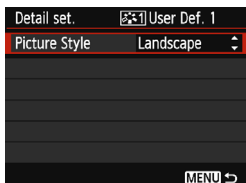

4 Select the base Picture Style.

- Press the <▲> <▼> keys to select the base Picture Style, then press <SET>.
- To adjust the parameters of a Picture Style that is registered to the camera with EOS Utility (EOS software), select the Picture Style here.

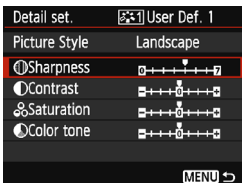

5 Select a parameter.

- Select a parameter such as **[Sharpness]**, then press **<SET>**.

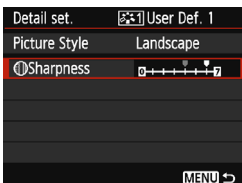

6 Set the parameter.

- Press the **<◀>** **<▶>** keys to adjust the parameter as desired, then press **<SET>**.
- For details, see “Customizing Image Characteristics” on pages 126-128.
- Press the **<MENU>** button to register the modified Picture Style. The Picture Style selection screen will then reappear.
- ▶ The base Picture Style will be indicated on the right of **[User Def. *]**.
- ▶ If the settings in a Picture Style registered under **[User Def. *]** have been modified from the base Picture Style settings, the Picture Style's name will be displayed in blue.

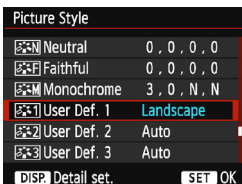

- ❗ ● If a Picture Style has already been registered under **[User Def. *]**, changing the base Picture Style in step 4 will nullify the parameter settings of the registered Picture Style.
- If you perform **[Clear all camera settings]** (p.194), all the **[User Def. *]** settings will revert to their defaults. Any Picture Style registered via EOS Utility (EOS software) will have only its modified parameters reverted to the default setting.

- 📄 ● To shoot with a registered Picture Style, follow step 2 on page 95 to select **[User Def. *]**, then shoot.
- Regarding the procedure to register a Picture Style file to the camera, refer to the EOS Utility Instruction Manual.

WB: Matching the Light Source ☆

The function adjusting the color tone so that white objects look white in the picture is called white balance (WB). Normally, the Auto [AWB] (Ambience priority) or [AWB w] (White priority) setting will obtain the correct white balance. If natural-looking colors cannot be obtained with Auto, you can select the white balance to match the light source or set it manually by shooting a white object.

In Basic Zone modes, [AWB] (Ambience priority) is set automatically. (In the <M> mode, [AWB w] (White priority) is set.)

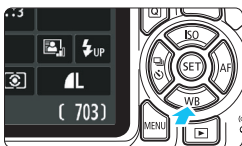

- 1 Press the <WB> button.
 - ▶ [White balance] will appear.

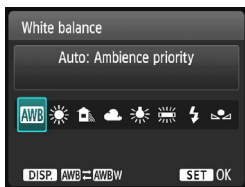

- 2 Select a white balance setting.
 - Press the <Left> <Right> keys or turn the <WB> dial to select the desired setting, then press <SET>.
 - The “Approx. ****K” (K: Kelvin) displayed for the white balance settings <Sun>, <House>, <Cloud>, <Sun with rays> or <Moon> is the respective color temperature.

AWB Setting the Auto White Balance

With [AWB] (Ambience priority), you can increase the intensity of the image's warm color cast when shooting a tungsten-light scene. If you select [AWBw] (White priority), you can reduce the intensity of the image's warm color cast.

If you want to match the Auto white balance of previous EOS camera models, select [AWB] (Ambience priority).

1 Press the <▼ WB> button.

- ▶ [White balance] will appear.

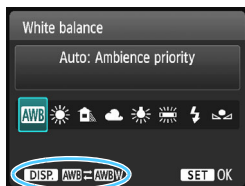

2 Select [AWB].

- Select [AWB], then press the <DISP.> button.

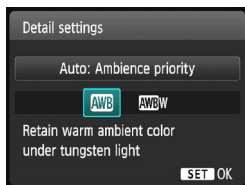

3 Select the desired item.

- Select [Auto: Ambience priority] or [Auto: White priority], then press <SET>.

AWB : Auto: Ambience priority

AWBw : Auto: White priority

⚠ Cautions for Setting [AWBw] (White priority)

- The warm color cast of subjects may fade.
- When multiple light sources are included on the screen, the warm color cast of the picture may not be lessened.
- When using flash, the color tone will be the same as [AWB] (Ambience priority).

Custom White Balance

Custom white balance enables you to manually set the white balance for a specific light source. Make sure to perform this procedure under the light source at the actual location of the shoot.

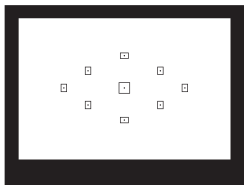

1 Shoot a white object.

- A plain, white object should fill the viewfinder's center.
- Focus manually and shoot with the standard exposure set for the white object.
- You can use any white balance setting.

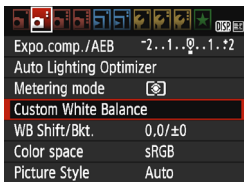

2 Select [Custom White Balance].

- Under the [2] tab, select [Custom White Balance], then press <SET>.
- ▶ The custom white balance selection screen will appear.



3 Import the white balance data.

- Select the image that was captured in step 1, then press <SET>.
- ▶ On the dialog screen that appears, select [OK] and the data will be imported.
- When the menu reappears, press the <MENU> button to exit the menu.

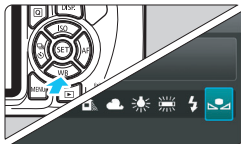

4 Select [☰] (Custom).

- Press the <▼ WB> button.
- Select [☰] (Custom), then press <SET>.

- If the exposure obtained in step 1 differs greatly from the standard exposure, a correct white balance may not be obtained.
- In step 3, the following images cannot be selected: Images captured with the Picture Style set to **[Monochrome]** (p.96), images processed with a Creative filter, or images shot with another camera.

- Instead of a white object, a gray chart or 18% gray reflector (commercially-available) can produce a more accurate white balance.
- The personal white balance registered with EOS Utility (EOS software, p.314) will be registered under [☰]. If you perform step 3, the data for the registered personal white balance will be erased.

WB \pm Adjusting the Color Tone for the Light Source ☆

You can correct the white balance that is set. This adjustment will have the same effect as using a commercially-available color temperature conversion filter or color compensating filter. Each color can be corrected to one of nine levels.

This function is for advanced users, particularly for those users who understand the use of color temperature conversion and color compensating filters and their effects.

White Balance Correction

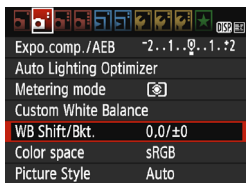

1 Select [WB Shift/Bkt.].

- Under the [CAMERA] tab, select [WB Shift/Bkt.], then press <SET>.
- The WB correction/WB bracketing screen will appear.

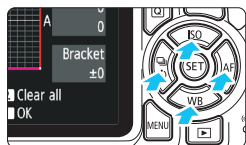

2 Set the white balance correction.

- Press the <◇> cross keys to move the "■" mark to the desired position.
- B is for blue, A for amber, M for magenta, and G for green. The image's color balance will be adjusted toward the color in the direction of the move.
- On the right of the screen, "Shift" indicates the direction and correction amount, respectively.
- Pressing the <DISP.> button will cancel all the [WB Shift/Bkt.] settings.
- Press <SET> to exit the setting and return to the menu.

Sample setting: A2, G1

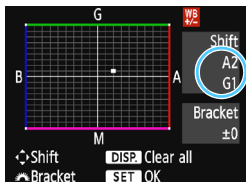

- When the white balance is corrected, <WB> will be displayed in the viewfinder and on the LCD monitor.
- One level of the blue/amber correction is equivalent to approx. 5 mireds of a color temperature conversion filter. (Mired: Measuring unit indicating the density of a color temperature conversion filter.)

White Balance Auto Bracketing

With just one shot, three images with different color tones can be recorded simultaneously. Based on the color temperature of the current white balance setting, the image will be bracketed with a blue/amber bias or magenta/green bias. This is called white balance bracketing (WB Bkt.). White balance bracketing is possible up to ± 3 levels in single-level increments.



B/A bias ± 3 levels

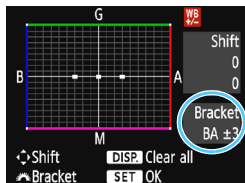

Set the white balance bracketing amount.

- In step 2 for “White Balance Correction”, when you turn the  dial, the “■” mark on the screen will change to “■■■” (3 points). Turning the dial to the right sets the B/A bracketing, and turning it to the left sets the M/G bracketing.
- ▶ On the right, “Bracket” indicates the bracketing direction and correction amount.
- Pressing the <DISP.> button will cancel all the [WB Shift/Bkt.] settings.
- Press <SET> to exit the setting and return to the menu.

Bracketing Sequence

The images will be bracketed in the following sequence: 1. Standard white balance, 2. Blue (B) bias, and 3. Amber (A) bias, or 1. Standard white balance, 2. Magenta (M) bias, and 3. Green (G) bias.

 During WB bracketing, the maximum burst for continuous shooting will be lower and the number of possible shots will also decrease to approx. one-third the normal number.

- You can also set white balance correction and AEB together with white balance bracketing. If you set AEB in combination with white balance bracketing, a total of nine images will be recorded for a single shot.
- Since three images are recorded for one shot, it takes longer to record the image on the card.
- During Live View shooting, the white balance icon will blink.
- “Bkt.” stands for bracketing.

MENU Setting the Color Reproduction Range ☆

The range of reproducible colors is called “color space”. With this camera, you can set the color space for captured images to sRGB or Adobe RGB. For normal shooting, sRGB is recommended. In Basic Zone modes, sRGB is set automatically.

1 Select [Color space].

- Under the [CAMERA 2] tab, select [Color space], then press <SET>.



2 Set the desired color space.

- Select [sRGB] or [Adobe RGB], then press <SET>.

Adobe RGB

This color space is mainly used for commercial printing and other industrial uses. This setting is not recommended if you are not familiar with image processing, Adobe RGB, and Design rule for Camera File System 2.0 (Exif 2.21 or higher). The image will look very subdued in a sRGB computer environment and with printers not compliant to Design rule for Camera File System 2.0 (Exif 2.21 or higher). Post-processing of the image with computer software will therefore be required.



- If the captured still photo was shot in the Adobe RGB color space, the first character in the file name will be an underscore “_”.
- The ICC profile is not appended. For explanations about the ICC profile, refer to the Digital Photo Professional Instruction Manual.



5

Shooting with the LCD Monitor (Live View Shooting)

You can shoot while viewing the picture on the camera's LCD monitor. This is called "Live View shooting".

Live View shooting is effective for still subjects which do not move.

If you handhold the camera and shoot while viewing the LCD monitor, camera shake can cause blurred images. Using a tripod is recommended.



Remote Live View Shooting

With EOS Utility (EOS software, p.314) installed on your computer, you can connect the camera to the computer and shoot remotely while viewing the computer screen. For details, refer to the EOS Utility Instruction Manual.

Shooting with the LCD Monitor



1 Display the Live View image.

- Press the button.
- ▶ The Live View image will appear on the LCD monitor.
- The Live View image will closely reflect the brightness level of the actual image you capture.



2 Focus on the subject.

- When you press the shutter button halfway, the camera will focus with the current AF method (p.148).

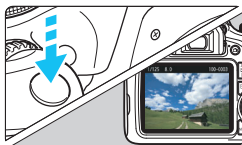

3 Take the picture.

- Press the shutter button completely.
- ▶ The picture is taken and the captured image is displayed on the LCD monitor.
- ▶ When the playback display ends, the camera will return to Live View shooting automatically.
- Press the button to exit the Live View shooting.

- The image's field of view is approx. 100% (with the image-recording quality set to JPEG).
- During Live View shooting, the camera will shoot with One-Shot AF (p.97) in all shooting modes.
- The metering mode will be fixed to evaluative metering for Live View shooting.
- In Creative Zone modes, you can check the depth of field by setting [9: Assign SET button] under [43: Custom Functions (C.Fn)] to [4: Depth-of-field preview] and pressing .
- During continuous shooting, the exposure set for the first shot will also be applied to the subsequent shots.

Enabling Live View Shooting

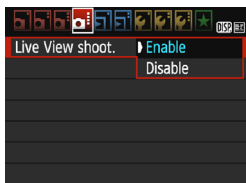

Set [**Live View shoot.**] to [**Enable**]. In Basic Zone modes, the Live View menu options will be displayed under [**2**], and in Creative Zone modes, they will be displayed under [**4**].

Number of Possible Shots with Live View Shooting

(Approx. number of shots)

| Temperature | Room Temperature (23°C / 73°F) | Low Temperatures (0°C / 32°F) |
|---------------|-----------------------------------|----------------------------------|
| No Flash | 190 | 180 |
| 50% Flash Use | 180 | 170 |

- The figures above are based on a fully-charged Battery Pack LP-E10 and CIPA (Camera & Imaging Products Association) testing standards.
- With a fully-charged Battery Pack LP-E10, continuous Live View shooting is possible for approx. 1 hr. 25 min. at room temperature (23°C / 73°F).



- Do not point the camera toward an intense light source, such as the sun or an intense artificial light source. Doing so may damage the image sensor or the camera's internal components.
- **General Live View Shooting Cautions are on pages 157-158.**



- When flash is used, there will be two shutter sounds, but only one shot will be taken. Also, the time it takes to capture an image after you press the shutter button completely will be slightly longer than with viewfinder shooting.
- If the camera is not operated for a prolonged period, the power will turn off automatically after the time set in [**1: Auto power off**] (p.185). If [**1: Auto power off**] is set to [**Disable**], Live View shooting will end automatically after approx. 30 min. (camera power remains on).
- With an HDMI cable (sold separately), you can display the Live View image on a TV set (p.226). Note that no sound will be output.

Information Display

- Each time you press the <DISP.> button, the information display will change.

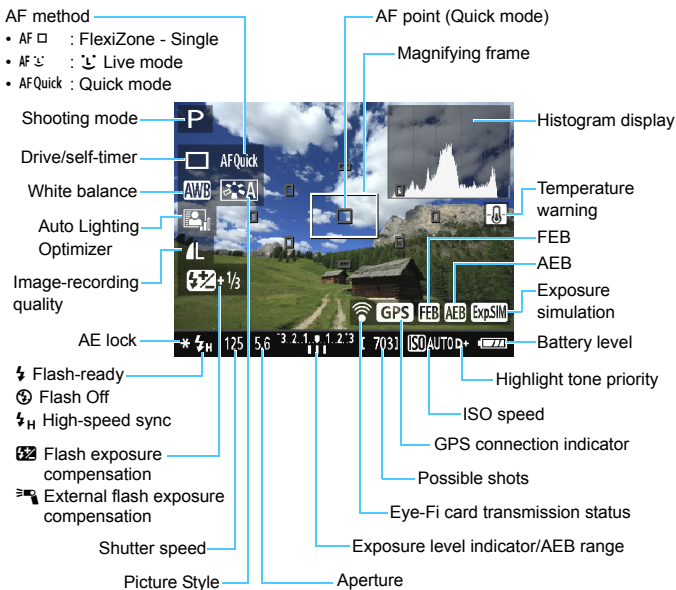

- When <Exp.SIM> is displayed in white, it indicates that the Live View image brightness is close to what the captured image will look like.
- If <Exp.SIM> is blinking, it indicates that the Live View image is displayed at a brightness that differs from the actual shooting result because of low- or bright-light conditions. However, the actual image recorded will reflect the exposure setting. Note that noise may be more noticeable than the actual image recorded.
- If flash is used or bulb exposure is set, the <Exp.SIM> icon and histogram will be grayed out (for your reference). The histogram may not be properly displayed in low- or bright-light conditions.

Final Image Simulation

Final image simulation is a function that shows the Live View image as it will look with the current settings for Picture Style, white balance, and other shooting functions applied.

During shooting, the Live View image will automatically reflect the function settings listed below. However, it may be slightly different from the resulting image.

Final Image Simulation During Live View Shooting

- Picture Style
 - * All settings such as sharpness, contrast, color saturation, and color tone will be reflected.
- White balance
- White balance correction
- Ambience-based shots
- Lighting/scene based shots
- Color tone (in <P> mode)
- Exposure
- Depth of field (with C.Fn-9-4 set and <SET> ON)
- Auto Lighting Optimizer
- Peripheral illumination correction
- Highlight tone priority
- Aspect ratio (shooting range confirmation)

Shooting Function Settings

Function settings particular to Live View shooting are explained here.

Q Quick Control

If you press the **<Q>** button while the image is displayed on the LCD monitor in a Creative Zone mode, you can set any of the following: **AF method**, **Drive/self-timer**, White balance, Picture Style, Auto Lighting Optimizer, Image-recording quality, and ISO speed. In Basic Zone modes, you can set the functions shown in the table on page 75, as well as the functions in bold above.

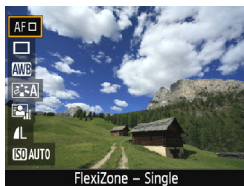

1 Press the **<Q>** button.

- ▶ The functions settable with Quick Control will appear on the left of the screen.
- If the AF method is **<AFQuick>**, the AF point will also be displayed. You can also select the AF point (p.154).

2 Select a function and set it.

- Press the **<▲>** **<▼>** keys to select a function.
- ▶ The settings of the selected function and Feature guide (p.55) will appear.
- Press the **<◀>** **<▶>** keys or turn the **<☀>** dial to set the function. Pressing **<SET>** will display the respective function setting screen.
- To set Auto white balance, select **[AWB]**, press **<SET>**, then press the **<DISP.>** button.

3 Exit the setting.

- Press the **<Q>** button to return to Live View shooting.

 In Creative Zone modes, if **[10: Flash button function]** is set to **[1: ISO speed]** under **[F3: Custom Functions (C.Fn)]**, you can raise the built-in flash with Quick Control. The ISO speed will be set with the **<⚡>** button.

Menu Function Settings

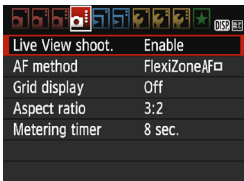

The menu options displayed are as follows.

The settable functions on this menu screen apply only to Live View shooting. They do not work with viewfinder shooting (settings are disabled).

In Basic Zone modes, the Live View menu options will be displayed under [📷2], and in Creative Zone modes, they will be displayed under [📷4].

● Live View shooting

You can set Live View shooting to [Enable] or [Disable].

● AF method

You can select [FlexiZone - Single], [L Live mode], or [Quick mode]. See pages 148-155 for more about the AF method.

● Grid display

With [Grid 1⇄] or [Grid 2###], you can display grid lines. You can check horizontal or vertical tilt when shooting.

● Aspect ratio [★]

The image's aspect ratio can be set to [3:2], [4:3], [16:9], or [1:1].

The area surrounding the Live View image is masked in black when the following aspect ratios are set: [4:3] [16:9] [1:1].

JPEG images will be saved with the set aspect ratio. RAW images will always be saved with the [3:2] aspect ratio. The selected aspect ratio information is added to the RAW image file. When you process the RAW image with the EOS software, this allows you to generate an image with the same aspect ratio that was set for shooting. In the case of the [4:3], [16:9], and [1:1] aspect ratios, the lines to indicate the aspect ratio will appear during image playback, but they are not actually drawn on the image.

| Image Quality | Aspect Ratio and Pixel Count (Approx.) | | | |
|---------------|--|--------------------------------|---------------------------------|--------------------------------|
| | 3:2 | 4:3 | 16:9 | 1:1 |
| L | 5184x3456 (17.9 megapixels) | 4608x3456 (16.0 megapixels) | 5184x2912* (15.1 megapixels) | 3456x3456 (11.9 megapixels) |
| M | 3456x2304 (8.0 megapixels) | 3072x2304 (7.0 megapixels) | 3456x1944 (6.7 megapixels) | 2304x2304 (5.3 megapixels) |
| S1 | 2592x1728 (4.5 megapixels) | 2304x1728 (4.0 megapixels) | 2592x1456* (3.8 megapixels) | 1728x1728 (3.0 megapixels) |
| S2 | 1920x1280 (2.5 megapixels) | 1696x1280* (2.2 megapixels) | 1920x1080 (2.1 megapixels) | 1280x1280 (1.6 megapixels) |
| S3 | 720x480 (350,000 pixels) | 640x480 (310,000 pixels) | 720x400* (290,000 pixels) | 480x480 (230,000 pixels) |

- The asterisked image-recording quality settings do not match the respective aspect ratio exactly.
- The shooting range displayed for the asterisked aspect ratio is slightly larger than the recorded area. Check the captured images on the LCD monitor when shooting.
- If you use a different camera to directly print images shot with this camera in the 1:1 aspect ratio, the images may not be correctly printed.

- **Metering timer**[☆]

You can change how long the exposure setting is displayed (AE lock time). In Basic Zone modes, metering timer is fixed at 8 sec.



Any of the following operations will stop Live View shooting. To start Live View shooting again, press the < > button again.

- Selecting [**3: Dust Delete Data**], [**2: Clean manually**], [**3: Clear settings**], or [**3: Firmware Ver.**]
- Switching the shooting mode (between a Basic Zone mode and a Creative Zone mode).

Using AF to Focus (AF Method)

Selecting the AF Method

You can select an AF method to suit the shooting conditions and your subject. The following AF methods are provided: [**FlexiZone - Single**], [**Live mode**] (face detection, p.149), and [**Quick mode**] (p.154). If you want to achieve precise focus, set the lens's focus mode switch to <MF>, magnify the image, and focus manually (p.156).

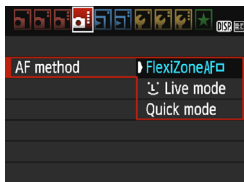

Select the AF method.

- Under the [**4**] tab, select [**AF method**]. (In Basic Zone modes, it is under the [**2**] tab.)
- Select the desired AF method, then press <SET>.
- While the Live View image is displayed, you can also press the <Q> button to select the AF method with the Quick Control (p.144).

FlexiZone - Single: AF □

The image sensor is used to focus. Although AF is possible with the Live View image displayed, **the AF operation will take longer than with the Quick mode**. Also, achieving focus may be more difficult than with the Quick mode.



AF point

1 Display the Live View image.

- Press the <LIVE VIEW> button.
- ▶ The Live View image will appear on the LCD monitor.
- ▶ The AF point <□> will appear.

2 Move the AF point.

- Press the <DIRECTIONAL KEYS> cross keys to move the AF point to where you want to focus. (It cannot be moved to the edge of the screen.)
- Press <SET> to return the AF point to the center. (If C.Fn-9 is set, hold down the <Av/ISO/AF-ON/AF-ON> button and press <SET>.)

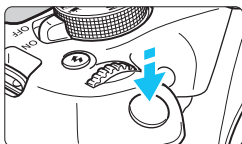

3 Focus on the subject.

- Aim the AF point over the subject and press the shutter button halfway.
- ▶ When focus is achieved, the AF point will turn green and the beeper will sound.
- ▶ If focus is not achieved, the AF point will turn orange.



4 Take the picture.

- Check the focus and exposure, then press the shutter button completely to take the picture (p.140).

☺ (Face detection) Live Mode: AF ☺

Human faces are detected and focused on with the same AF method as FlexiZone - Single. Have the person whose picture you want to take face the camera.



1 Display the Live View image.

- Press the <📷> button.
- ▶ The Live View image will appear on the LCD monitor.

2 Check the AF point.

- When a face is detected, the <☺> frame will appear on the face for focusing.
- If multiple faces are detected, <☺☺> will be displayed. Use the <◀> <▶> keys to move the <☺> frame over the face you want to focus on.

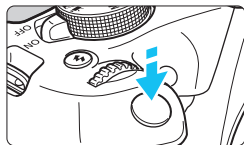

3 Focus on the subject.

- Press the shutter button halfway and the camera will focus on the face covered by the <[]> frame.
- ▶ When focus is achieved, the AF point will turn green and the beeper will sound.
- ▶ If focus is not achieved, the AF point will turn orange.
- If a face cannot be detected, the AF point <[]> will be displayed and AF will be executed at the center.



4 Take the picture.

- Check the focus and exposure, then press the shutter button completely to take the picture (p.140).

- If the subject's face is significantly out of focus, face detection will not be possible. If the lens enables manual focusing even while the lens's focus mode switch is set to <AF>, turn the focusing ring to attain rough focus. The face will then be detected and <[]> will be displayed.
- An object other than a human face may be detected as a face.
- Face detection will not work if the face is very small or large in the picture, too bright or too dark, tilted horizontally or diagonally, or partially hidden.
- The <[]> may cover only a part of the face.

- When you press <[SET]>, the AF method will switch to **[FlexiZone - Single]** (p.148). You can press the <[]> cross keys to move the AF point. Press <[SET]> again to return to **[Live Mode]** (Face detection). (If C.Fn-9 is set, hold down the <[Av]/[]> button and press <[SET]>.)
- Since AF is not possible with a face detected near the edge of the picture, the <[]> will be grayed out. Then if you press the shutter button halfway, the center AF point <[]> will be used to focus.

Notes for [FlexiZone - Single] and [Live mode]

AF Operation

- Focusing will take longer than with [Quick mode].
- Even when focus is achieved, pressing the shutter button halfway will focus again.
- You cannot focus on a moving subject continuously.
- The image brightness may change during and after the AF operation.
- If the light source changes while the Live View image is displayed, the screen may flicker and focusing may be difficult. If this happens, exit Live View shooting and execute AF under the actual light source.

Magnified View

- When [FlexiZone - Single] is set and you press the <Q> button, the area covered by the AF point will be magnified. Press the shutter button halfway to focus in the magnified view. This is effective when the camera is attached to a tripod and you need to attain very precise focus. If focusing is difficult in magnified view, return to the normal display and use AF. Note that the AF speed may differ between the normal and magnified views.
- If you magnify the view after focusing with [FlexiZone - Single] in the normal view, precise focus may not be achieved.
- If [Live mode] is set, magnified view is not possible.

Shooting Conditions that Make Focusing Difficult

- Low-contrast subjects such as the blue sky, solid-color flat surfaces or when highlight or shadow details are lost.
- Subjects in low light.
- Stripes and other patterns where there is contrast only in the horizontal direction.
- Subjects with repetitive patterns (Example: Skyscraper windows, computer keyboards, etc.).
- Fine lines and subject outlines.
- Under a light source whose brightness, color, or pattern keeps changing.
- Night scenes or points of light.
- The image flickers under fluorescent or LED lighting.
- Extremely small subjects.
- Subjects at the edge of the picture.
- Strongly backlit or reflective subjects (Example: Car with a highly reflective body, etc.).
- The AF point covers both near and distant subjects (Example: Animal in a cage, etc.).
- Subjects that keep moving within the AF point and cannot keep still due to camera shake or subject blur.
- A subject approaching or moving away from the camera.
- Autofocusing while the subject is very far out of focus.
- Soft focus effect is applied with a soft focus lens.
- A special effect filter is used.
- Noise (dots of light, banding, etc.) appears on the screen during AF.



- If focus is not achieved with the shooting conditions on the preceding page, set the lens's focus mode switch to **<MF>** and focus manually.
- If you use AF with any of the following lenses, using [**Quick mode**] is recommended. Autofocusing with [**FlexiZone - Single**] or [**Live mode**] may take longer or correct focus may not be achieved.
EF50mm f/1.4 USM, EF50mm f/1.8 II, EF50mm f/2.5 Compact Macro,
EF100mm f/2.8 Macro USM, EF75-300mm f/4-5.6 III,
EF75-300mm f/4-5.6 III USM
For information on other lenses, refer to the Canon website.



- If you shoot a peripheral subject and it is slightly out of focus, aim the center AF point over the subject to focus, focus again and then take the picture.
- The AF-assist beam will not be emitted. However, if an EX-series Speedlite (sold separately) equipped with an LED light is used, the LED light will turn on for AF-assist when necessary.
- In magnified view, focusing may be difficult due to camera shake. Using a tripod is recommended.

Quick Mode: AFQuick

The dedicated AF sensor is used to focus in One-Shot AF (p.97), using the same AF method as with viewfinder shooting.

Although you can focus on the target subject quickly, **the Live View image will be interrupted momentarily during the AF operation.**

You can use nine AF points to focus (automatic selection). You can also select one AF point to focus and focus only on the area covered by that AF point (manual selection).

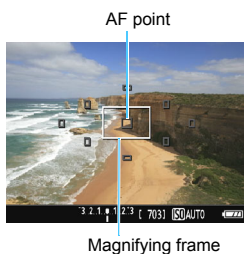



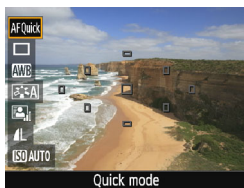

1 Display the Live View image.

- Press the <  > button.
- ▶ The Live View image will appear on the LCD monitor.
- The small boxes on the screen are the AF points, and the larger box is the magnifying frame.



2 Select the AF point. ☆

- Press the <  > button ( 10) to display the Quick Control screen.
- ▶ The settable functions will be displayed on the left of the screen.
- Press the <  > <  > keys to make the AF point selectable.
- Turn the <  > dial to select the AF point.



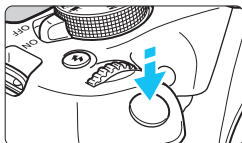

3 Focus on the subject.

- Aim the AF point over the subject and press the shutter button halfway.
- ▶ The Live View image will turn off, the reflex mirror will go back down, and AF will be executed. (No picture is taken.)
- ▶ When focus is achieved, the AF point that achieved focus will turn green and the Live View image will reappear.
- ▶ If focus is not achieved, the AF point will turn orange and blink.

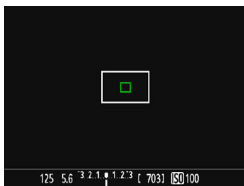

4 Take the picture.

- Check the focus and exposure, then press the shutter button completely to take the picture (p.140).

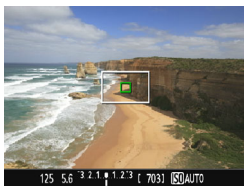

You cannot take a picture during autofocusing. Take the picture while the Live View image is displayed.

MF: Focusing Manually

You can magnify the image and focus precisely with manual focus.

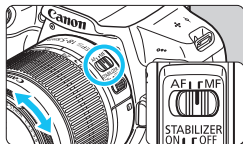

1 Set the lens's focus mode switch to <MF>.

- Turn the lens focusing ring to focus roughly.

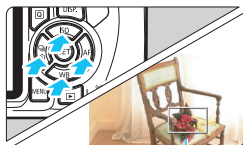

Magnifying frame

2 Move the magnifying frame.

- Press the <⬆> cross keys to move the magnifying frame to the position where you want to focus.
- Press <SET> to return the magnifying frame to the center. (If C.Fn-9 is set, hold down the <Av/☒/☒> button and press <SET>.)

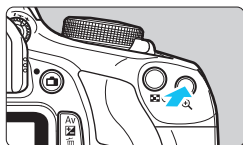

3 Magnify the image.

- Press the <Q> button.
- ▶ The area within the magnifying frame will be magnified.
- Each time you press the <Q> button, the magnification of the image will change in the following sequence:

→ 5x → 10x → Normal view



AE lock

Magnified area position

Magnification

4 Focus manually.

- While looking at the magnified image, turn the lens focusing ring to focus.
- After achieving focus, press the <Q> button to return to the normal view.

5 Take the picture.

- Check the focus and exposure, then press the shutter button to take the picture (p.140).



General Live View Shooting Cautions

Image Quality

- When you shoot at high ISO speeds, noise (such as dots of light and banding) may become noticeable.
- Shooting in high temperatures may cause noise and irregular colors in the image.
- If Live View shooting is used continuously for a prolonged period, the camera's internal temperature may rise, and image quality may deteriorate. Always exit Live View shooting when you are not shooting.
- If you shoot a long exposure while the camera's internal temperature is high, image quality may deteriorate. Exit Live View shooting and wait a few minutes before shooting again.

White and Red Internal Temperature Warning Icons

- If the camera's internal temperature increases due to prolonged Live View shooting or under a high ambient temperature, a white or red icon will appear.
- The white icon indicates that the image quality of still photos will deteriorate. It is recommended that you temporarily exit Live View shooting and allow the camera to cool down before shooting again.
- The red icon indicates that the Live View shooting will soon stop automatically. If this happens, you will not be able to shoot again until the camera's internal temperature decreases. Exit the Live View shooting or turn off the power and let the camera rest for a while.
- Using Live View shooting at a high temperature for a prolonged period will cause the or icon to appear earlier. When you are not shooting, always turn off the camera.
- If the camera's internal temperature is high, the quality of images shot with high ISO speed or long exposure may deteriorate even before the white icon is displayed.

Shooting Results

- If you take the picture in magnified view, the exposure may not come out as desired. Return to the normal view before taking the picture. In magnified view, the shutter speed and aperture will be displayed in orange. Even if you take the picture in magnified view, the image area for the normal view will be captured.
- If you use a TS-E lens (except the TS-E17mm f/4L or TS-E24mm f/3.5L II) and shift or tilt the lens or use an Extension Tube, the standard exposure may not be obtained or an irregular exposure may result.

General Live View Shooting Cautions

Live View Image

- Under low- or bright-light conditions, the Live View image may not reflect the brightness of the captured image.
- Even if a low ISO speed is set, noise may be noticeable in the displayed Live View image under low light. However, when you shoot, the image recorded will have less noise. (The image quality of the Live View image is different from that of the recorded image.)
- If the light source (illumination) within the image changes, the screen may flicker. If this happens, exit Live View shooting and resume Live View shooting under the actual light source.
- If you point the camera in a different direction, it may throw off the Live View image's correct brightness momentarily. Wait until the brightness level stabilizes before shooting.
- If there is a very bright light source in the image, the bright area may appear black on the LCD monitor. However, the actual captured image will correctly show the bright area.
- In low light, if you set the [ 2: LCD brightness] to a bright setting, noise or irregular colors may appear in the Live View image. However, the noise or irregular colors will not be recorded in the captured image.
- When you magnify the image, the image sharpness may look more pronounced than in the actual image.

Custom Functions

- During Live View shooting, some Custom Function settings will not take effect (p.259).

Lens and Flash

- During Live View shooting, focus preset for super telephoto lenses cannot be used.
- FE lock will not work when the built-in flash or an external Speedlite is used. Modeling flash will not work if an external Speedlite is used.

Do not hold the camera in the same position for long periods of time.

Even if the camera does not feel too hot, prolonged contact with the same body part may cause skin redness or blistering due to low-temperature contact burns. Using a tripod is recommended for people with circulation problems or very sensitive skin, or when using the camera in very hot places.

6

Shooting Movies

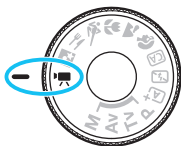

Movie shooting is enabled by setting the Mode Dial to . The movie recording format will be MOV.

- For cards that can record movies, see page 5.



Full HD 1080

Full HD 1080 indicates compatibility with High-Definition featuring 1080 vertical pixels (scanning lines).



Shooting Movies

Connecting the camera to a TV set is recommended to play back the movies shot (p.226).

Autoexposure Shooting



1 Set the Mode Dial to <Movie>.

- ▶ The reflex mirror will make a sound, then the image will appear on the LCD monitor.

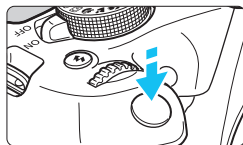

2 Focus on the subject.

- Before shooting a movie, focus with AF or manual focus (p.148-156).
- When you press the shutter button halfway, the camera will focus with the current AF method.



3 Shoot the movie.

- Press the <Movie> button to start shooting a movie. To stop movie shooting, press <Movie> again.
- ▶ While the movie is being shot, the [●] mark will be displayed on the upper right of the screen.
- ▶ Sound will be recorded by the built-in microphone.

Recording movie

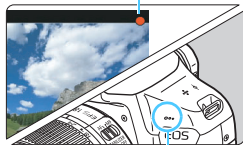

Built-in microphone



- **General Movie Shooting Cautions are on pages 181-182.**
- **If necessary, also read General Live View Shooting Cautions on pages 157-158.**



- The ISO speed (ISO 100 - ISO 6400), shutter speed, and aperture are set automatically.
- You can press the < * > button (p.120) to lock the exposure (AE lock). The exposure setting will be displayed for the number of seconds set with [**2: Metering timer**]. After applying AE lock during movie shooting, you can cancel it by pressing the < [] > button. (AE lock setting is retained until you press the < [] > button.)
- By holding down the < Av [] > button and turning the < [] > dial, you can set the exposure compensation.
- If you shoot a movie with autoexposure, the ISO speed, shutter speed, and aperture will not be recorded in the movie's Exif information.
- With autoexposure movie shooting, the camera will automatically turn on the Speedlite's LED light under low-light conditions. For details, refer to the Speedlite's instruction manual.

Manual Exposure Shooting

You can manually set the shutter speed, aperture, and ISO speed for movie shooting. Using manual exposure to shoot movies is for advanced users.



1 Set the Mode Dial to ''.>

- ▶ The reflex mirror will make a sound, then the image will appear on the LCD monitor.



2 Select [Movie exposure].>

- Press the <MENU> button and under the [1] tab, select [Movie exposure], then press .



3 Select [Manual].>

- ▶ Select [Manual], then press .

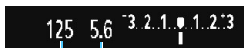

4 Set the shutter speed and aperture.>

- To set the shutter speed, turn the dial. The settable shutter speeds vary depending on the frame rate .
 - : 1/4000 sec. - 1/30 sec.
 - : 1/4000 sec. - 1/60 sec.
- To set the aperture, hold down the button and turn the dial.

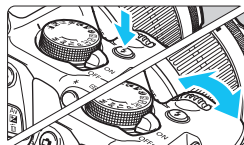

5 Set the ISO speed.>

- Press the button and press the keys or turn the dial to select the ISO speed.
- For details on the ISO speed, see the next page.

6 Focus and shoot the movie.

- The procedure is the same as steps 2 and 3 for “Autoexposure Shooting” (p.160).

ISO Speed During Manual Exposure Shooting

- With [Auto], the ISO speed will be set automatically within ISO 100 - ISO 6400.
- You can set the ISO speed manually within ISO 100 - ISO 6400 in whole-stop increments.
- If [**1**: **Highlight tone priority**] is set to [Enable], the ISO speed will be ISO 200 - ISO 6400.



- AE lock and exposure compensation cannot be set.
- Changing the shutter speed or aperture during movie shooting is not recommended since the changes in the exposure will be recorded.
- If you change the shutter speed while shooting a movie under fluorescent or LED lighting, image flicker may be recorded.



- With ISO Auto, the movie shooting can record a suitable exposure even when the ambient brightness changes.
- By pressing the <DISP.> button, you can display the histogram.
- When shooting a movie of a moving subject, a shutter speed of 1/30 sec. to 1/125 sec. is recommended. The faster the shutter speed, the less smooth the subject's movement will look.

Information Display

- Each time you press the <DISP.> button, the information display will change.

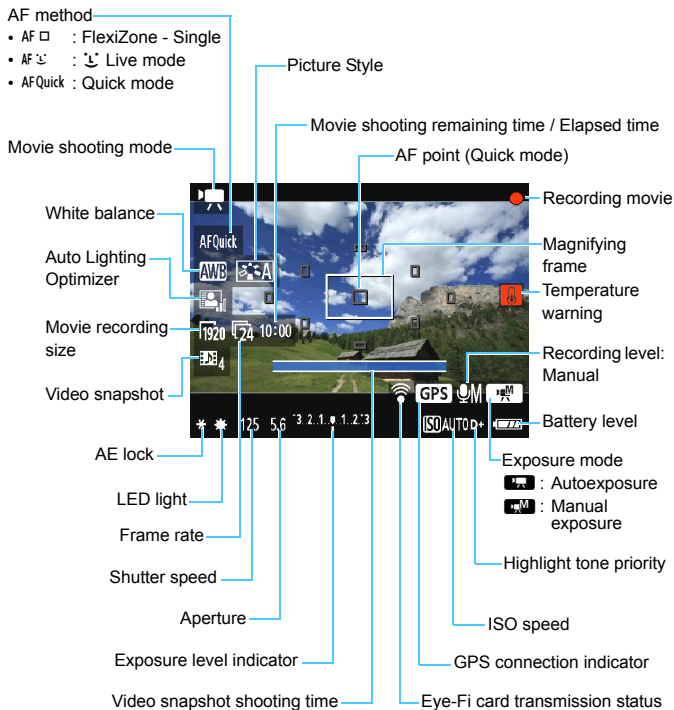

- If there is no card in the camera, the movie shooting remaining time will be displayed in red.
- When movie shooting starts, the movie shooting remaining time will change to the elapsed time.

Notes for Movie Shooting



Do not hold the camera in the same position for long periods of time.

Even if the camera does not feel too hot, prolonged contact with the same body part may cause skin redness or blistering due to low-temperature contact burns. Using a tripod is recommended for people with circulation problems or very sensitive skin, or when using the camera in very hot places.



- When [**1: AF w/ shutter button during**] is set to [Enable] (p.176), pressing the shutter button halfway during movie shooting will perform autofocus. However, the following may occur.
 - Focus may become far off momentarily.
 - The brightness of the recorded movie may change.
 - The recorded movie may be momentarily still.
 - The movie may record the lens operation sound.
- Do not point the camera toward an intense light source, such as the sun or an intense artificial light source. Doing so may damage the image sensor or the camera's internal components.
- If <AWB> or <AWB w> is set and the ISO speed or aperture changes during movie shooting, the white balance may also change.
- If you shoot a movie under fluorescent or LED lighting, the movie may flicker.
- Shooting a few test movies is recommended where you will perform zooming during movie shooting. Zooming during movie shooting may result in recording of changes in exposure or mechanical sound of the lens, or images may be out of focus.
- During movie shooting, you cannot magnify the image even if you press the <Q> button.
- If you connect or disconnect the HDMI cable during movie shooting, the movie shooting will end.
- Be careful not to cover the built-in microphone (p.160) with your finger, etc.
- **General Movie Shooting Cautions are on pages 181-182.**
- **If necessary, also read General Live View Shooting Cautions on pages 157-158.**



- Movie-related settings are under the [M1], [M2], and [M3] tabs (p.176).
- A movie file is recorded each time you shoot a movie (p.169).
- The movie image's field of view is approx. 100% (with movie recording size set to [F20]).
- Monaural sound is recorded by the camera's built-in microphone (p.160).
- With a fully-charged Battery Pack LP-E10, the total movie shooting time will be as follows: approx. 1 hr. 15 min. at room temperature (23°C/73°F), and approx. 1 hr. 10 min. at low temperatures (0°C/32°F).
- During movie shooting, focus preset for super telephoto lenses cannot be used.

Final Image Simulation

Final image simulation is a function that shows the movie as it will look with the current settings for Picture Style, white balance and other shooting functions applied.

During movie shooting, the image displayed will automatically show the effects of the settings listed below.

Final Image Simulation for Movie Shooting

- Picture Style
 - * All settings such as sharpness, contrast, color saturation, and color tone will be reflected.
- White balance
- Exposure
- Depth of field
- Auto Lighting Optimizer
- Peripheral illumination correction
- Highlight tone priority

Still Photo Shooting

Still photo shooting is not possible in movie shooting mode. To shoot still photos, turn the Mode Dial to change the shooting mode.

Shooting Function Settings

Function settings particular to movie shooting are explained here.

Quick Control



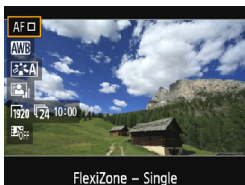





If you press the  button while the image is displayed on the LCD monitor, you can set any of the following: AF method, White balance, Picture Style, Auto Lighting Optimizer, Movie-recording size, and Video snapshot.



1 Press the button ()

- ▶ The settable functions will be displayed.
- If the AF method is , the AF point will also be displayed. You can also select the AF point (p.154).

2 Select a function and set it.

- Press the   keys to select a function.
- ▶ The settings of the selected function and Feature guide (p.55) will appear.
- Press the   keys or turn the  dial to set the function. Pressing  will display the respective function setting screen.
- To set Auto white balance, select , press , then press the .

3 Exit the setting.

- Press the  button to return to movie shooting.



For manual exposures, ISO speed can also be set.

MENU Setting the Movie Recording Size

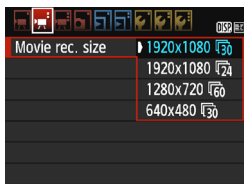

The menu option [**2: Movie rec. size**] enables you to select the movie's image size [****x****] and frame rate [**/**] (frames recorded per second). The **/** (frame rate) switches automatically depending on the [**2: Video system**] setting.

● Image Size

- [**1920x1080**] (**1920**) : Full High-Definition (Full HD) recording quality. The aspect ratio is 16:9.
- [**1280x720**] (**1280**) : High-Definition (HD) recording quality. The aspect ratio is 16:9.
- [**640x480**] (**640**) : Standard-definition recording quality. The aspect ratio is 4:3.

● Frame Rate (fps: frame per second)

- 30/60** : For areas where the TV system is NTSC (North America, Japan, South Korea, Mexico, etc.).
- 25/50** : For areas where the TV system is PAL (Europe, Russia, China, Australia, etc.).
- 24** : Mainly for motion pictures.

Total Movie Recording Time and File Size Per Minute (Approx.)

| Movie recording Size | | Total Recording Time on Card | | | File Size |
|----------------------|----|------------------------------|---------------|----------------|-------------|
| | | 4 GB | 16 GB | 64 GB | |
| [1920x1080] | 30 | 11 min. | 44 min. | 2 hr. 59 min. | 340 MB/min. |
| | 25 | | | | |
| | 24 | | | | |
| [1280x720] | 60 | 11 min. | 44 min. | 2 hr. 59 min. | 340 MB/min. |
| | 50 | | | | |
| [640x480] | 30 | 42 min. | 2 hr. 50 min. | 11 hr. 20 min. | 90 MB/min. |
| | 25 | | | | |

● Movie Files Exceeding 4 GB

Due to the file system, movie shooting will stop automatically if the file size of a single movie clip reaches 4 GB. You can start shooting a movie again by pressing the <📷> button. (The movie will be recorded as a new movie file.)

● Movie Shooting Time Limit

The maximum recording time of one movie clip is 29 min. 59 sec. If the movie shooting time reaches 29 min. 59 sec., the movie shooting will stop automatically. You can start shooting a movie again by pressing the <📷> button. (The movie will be recorded as a new movie file.)

 An increase of the camera's internal temperature may cause movie shooting to stop before the maximum recording time shown in the table above (p.181).

MENU Shooting Video Snapshots

You can shoot a series of short movie clips lasting approx. 2 sec., 4 sec., or 8 sec. called video snapshots. The video snapshots can be joined together into a single movie called a video snapshot album. You can thereby show quick highlights of a trip or event.

A video snapshot album can also be played back together with background music (p.174, 219).

Video Snapshot Album Concept

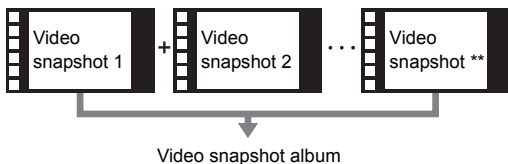

Setting the Video Snapshot Shooting Duration

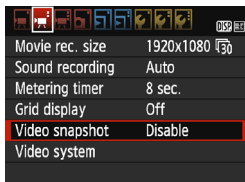

1 Select [Video snapshot].

- Under the [] tab, select [Video snapshot], then press <SET>.

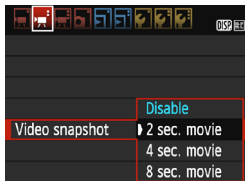

2 Select the [Video snapshot] shooting time.

- Select the shooting time for one video snapshot, then press <SET>.
- Press the <MENU> button to exit the menu, and return to the movie shooting screen.

Creating a Video Snapshot Album

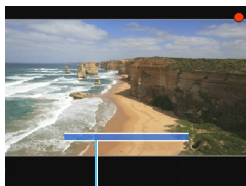

Shooting duration

3 Shoot the first video snapshot.

- Press the < [] > button, then shoot.
- ▶ The blue bar indicating the shooting duration will gradually decrease. After the set shooting duration elapses, the shooting stops automatically.
- ▶ The confirmation screen will appear (p.172).

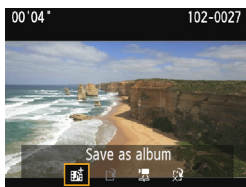

4 Save as a video snapshot album.

- Select [[] Save as album], then press < (SET) >.
- ▶ The movie clip will be saved as the video snapshot album's first video snapshot.

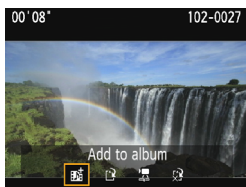

5 Continue to shoot more video snapshots.

- Repeat step 3 to shoot the next video snapshot.
- Select [[] Add to album], then press < (SET) >.
- To create another video snapshot album, select [[] Save as a new album].
- Repeat step 5 as necessary.



6 Exit the video snapshot shooting.

- Set [Video snapshot] to [Disable].
To return to normal movie shooting, be sure to set [Disable].
- Press the < MENU > button to exit the menu, and return to the normal movie shooting.

Options in Steps 4 and 5

| Function | Description |
|---|--|
| Save as album (Step 4) | The movie clip will be saved as the video snapshot album's first video snapshot. |
| Add to album (Step 5) | The video snapshot just recorded will be added to the album recorded immediately before. |
| Save as a new album (Step 5) | A new video snapshot album is created and the movie clip is saved as the first video snapshot. Select [OK] on the confirmation dialog. The new album will be a different file from the previously recorded album. |
| Playback video snapshot (Step 4 and 5) | The video snapshot just recorded will be played back. For playback operations, see the table below. |
| Do not save to album (Step 4) Delete without saving to album (Step 5) | The video snapshot just recorded will be erased instead of being saved to the album. Select [OK] on the confirmation dialog. |

[Playback video snapshot] Operations

| Function | Playback Description |
|-----------------------|--|
| Exit | The previous screen will reappear. |
| Play | By pressing $\langle \text{SET} \rangle$, you can play back or pause the video snapshot recorded immediately before. |
| First frame | Displays the first scene of the album's first video snapshot. |
| Skip backward* | Each time you press $\langle \text{SET} \rangle$, the video snapshot skips back by a few seconds. |
| Previous frame | Each time you press $\langle \text{SET} \rangle$, the previous frame is displayed. If you hold down $\langle \text{SET} \rangle$, it will rewind the movie. |
| Next frame | Each time you press $\langle \text{SET} \rangle$, the movie will play frame-by-frame. If you hold down $\langle \text{SET} \rangle$, it will fast forward the movie. |
| Skip forward* | Each time you press $\langle \text{SET} \rangle$, the video snapshot skips forward by a few seconds. |
| Last frame | Displays the last scene of the album's last video snapshot. |
| | Playback position |
| mm' ss" | Playback time (minutes:seconds) |
| Volume | Turn the $\langle \text{VOL} \rangle$ dial to adjust the volume of the built-in speaker (p.218). |

* With **[Skip backward]** and **[Skip forward]**, the skipping length corresponds to the number of seconds set under **[Video snapshot]** (approx. 2 sec., 4 sec., or 8 sec.).



Cautions for Shooting Video Snapshots

- You can add to an album only video snapshots with the same duration (approx. 2 sec., 4 sec., or 8 sec. each).
- Note that if you do any of the following while shooting video snapshots, a new album will be created for subsequent video snapshots.
 - Changing the [**Movie rec. size**] (p.168).
 - Changing the [**Video snapshot**]'s shooting time (p.170).
 - Changing the [**Sound rec.**] setting from [**Auto**]/[**Manual**] to [**Disable**] or from [**Disable**] to [**Auto**]/[**Manual**] (p.178).
 - Opening the card slot/battery compartment cover.
 - Updating the firmware.
- The sequence of snapshots in an album cannot be changed.
- Video snapshots taken afterward cannot be added to an existing album.
- The shooting duration of a video snapshot is only approximate. Depending on the frame rate, the shooting duration displayed during playback may not be exact.

Playing back an Album

You can play back a video snapshot album in the same way as a normal movie (p.218).



1 Play back the movie.

- Press the <▶> button to display an image.

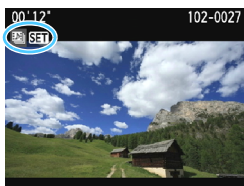

2 Select the album.

- In the single-image display, the [SET] icon displayed on the upper left of the screen indicates a video snapshot album.
- Press the <◀> <▶> keys to select a video snapshot album, then press <SET>.



3 Play back the album.

- On the movie playback panel displayed, select [▶] (Play), then press <SET>.



Background Music

- You can play background music when you play back albums, normal movies, and slide shows on the camera (p.174, 219). To play background music, you must first copy the background music to the card using EOS Utility (EOS software). For information on how to copy the background music, refer to the EOS Utility Instruction Manual.
- Music recorded on the memory card must be used only for private enjoyment. Do not violate the rights of the copyright holder.

MENU Menu Function Settings

Menu options under the [M/1], [M/2], and [M/3] tabs are explained below.

[M/1]

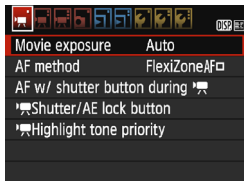

- **Movie exposure**

Normally, set this to [**Auto**].

Setting it to [**Manual**] will enable you to manually set the ISO speed, shutter speed, and aperture for movie shooting (p.162).

- **AF method**

The AF methods are the same as described on pages 148-155. You can select [**FlexiZone - Single**], [**Live mode**], or [**Quick mode**]. Note that continuous focusing of a moving subject is not possible.

- **AF with shutter button during [M/1]**

When [**Enable**] is set, AF is possible during movie shooting.

However, continuous autofocusing is not possible. If you autofocus during movie shooting, the focus may be momentarily thrown off or the exposure may be changed. The movie will also record the lens operation sound.

During movie shooting, if the AF method is set to [**Quick mode**], AF will be executed in [**FlexiZone - Single**].



- The settings under the [M/1], [M/2], and [M/3] menu tabs will take effect only in the <[M/]> mode. They will not be applied in shooting modes other than the <[M/]> mode.
- The [**AF method**] setting will also be applied to Live View shooting.

- **Shutter/AE lock button**

You can change the function assigned to the shutter button's halfway position and to the AE lock button.

- **AF/AE lock:**

Normal function. Press the shutter button halfway to execute AF. Press the <★> button for AE lock.

- **AE lock/AF:**

Press the shutter button halfway for AE lock. For AF, press the <★> button. This is convenient when you want to focus and meter separately.

- **AF/AF lock, no AE lock:**

Press the shutter button halfway to execute AF. While you autofocus by pressing the shutter button halfway, you can pause the autofocus by holding down the <★> button. You can resume the autofocus by letting go of the <★> button. AE lock is not possible.

- **AE/AF, no AE lock:**

Press the shutter button halfway for metering. For AF, press the <★> button. AE lock is not possible.

- **Highlight tone priority**

If [Enable] is set, highlight detail will be improved. The dynamic range is expanded from the standard 18% gray to bright highlights. The gradation between the grays and highlights becomes smoother. The settable ISO speed range will be ISO 200 - ISO 6400. The Auto Lighting Optimizer will also be set automatically to [Disable] and cannot be changed.

[2]

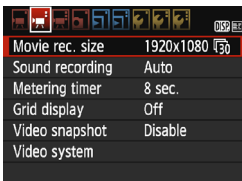

- **Movie recording size**

You can set the movie recording size (image size and frame rate).
For details, see page 168.

- **Sound recording**

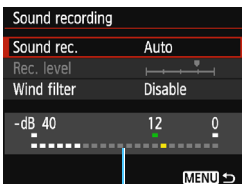

Level meter

Sound will be recorded by the built-in monaural microphone. An external microphone cannot be used.

[Sound rec.] and [Rec. level] options

[Auto] : The sound-recording level is adjusted automatically. Auto level control will operate automatically in response to the sound level.

[Manual] : For advanced users. You can adjust the sound-recording level to one of 64 levels. Select **[Rec. level]** and look at the level meter while pressing the <◀> <▶> keys to adjust the sound-recording level. Look at the peak hold indicator, and adjust so that the level meter sometimes lights up on the right of the “12” (-12 dB) mark for the loudest sounds. If it exceeds “0”, the sound will be distorted.

[Disable] : Sound will not be recorded.

[Wind filter]

When set to **[Enable]**, it reduces wind noise when there is wind outdoors.

Note that **[Enable]** will also reduce low bass sounds, so set this function to **[Disable]** when there is no wind. It will record a more natural sound than with **[Enable]**.



Sound is recorded at a sampling rate of 48 kHz/16-bit.

- **Metering timer**

You can change how long the exposure setting is displayed (AE lock time).

- **Grid display**

With **[Grid 1 \equiv]** or **[Grid 2 \equiv]**, you can display grid lines. You can check horizontal or vertical tilt when shooting.

- **Video snapshot**

You can shoot video snapshots. For details, see page 170.

- **Video system**

Select **[NTSC]** or **[PAL]** to suit your TV set's video system (p.168).



The Metering timer and Grid display settings will also be reflected in Live View shooting.

[3]

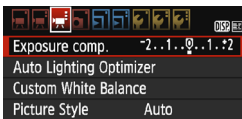

- **Exposure compensation**

The exposure compensation amount can be set up to ± 3 stops.

- **Auto Lighting Optimizer**

The Auto Lighting Optimizer can be set as explained on page 123. If the [1] menu tab's [**Highlight tone priority**] is set to **[Enable]**, the Auto Lighting Optimizer will be set automatically to **[Disable]** and cannot be changed.

- **Custom White Balance**

As explained on page 133, the image for custom white balance can be selected.

- **Picture Style**

The Picture Style can be set as explained on page 95.



General Movie Shooting Cautions

Red Internal Temperature Warning Icon

- If the camera's internal temperature increases due to prolonged movie shooting or under a high ambient temperature, a red icon will appear.
- The red icon indicates that movie shooting will soon be terminated automatically. If this happens, you will not be able to shoot again until the camera's internal temperature decreases. Turn off the power and let the camera rest for a while.
- Shooting a movie at a high temperature for a prolonged period will cause the icon to appear earlier. When you are not shooting, always turn off the camera.

Recording and Image Quality

- If the attached lens has an Image Stabilizer and you set the Image Stabilizer (IS) switch to <ON>, the Image Stabilizer will operate at all times even if you do not press the shutter button halfway. The Image Stabilizer consumes battery power and may shorten the total movie shooting time. If you use a tripod or if the Image Stabilizer is not necessary, it is recommended to set the IS switch to <OFF>.
- The camera's built-in microphone will also pick up camera operation sound.
- If the brightness changes during autoexposure movie shooting, the movie may freeze temporarily. In such cases, shoot movies with manual exposure.
- If there is a very bright light source in the image, the bright area may appear black on the LCD monitor. The movie will be recorded almost exactly as it appears on the LCD monitor.
- In low light, noise or irregular colors may appear in the image. The movie will be recorded almost exactly as it appears on the LCD monitor.

General Movie Shooting Cautions

Recording and Image Quality

- If you use a card with a slow writing speed, a five-level indicator may appear on the right of the screen during movie shooting. It indicates how much data has not yet been written to the card (remaining capacity of the internal buffer memory). The slower the card, the faster the indicator will climb upward. If the indicator becomes full, movie shooting will stop automatically.

If the card has a fast writing speed, the indicator will either not appear or the level (if displayed) will hardly go upward.

First, shoot a few test movies to see if the card can write fast enough.



Indicator

Playback and TV Connection

- If you connect the camera to a TV set with an HDMI cable (p.226) and shoot a movie at [1920x1080] or [1280x720], the movie being shot will be displayed in a small size on the TV set. The movie will still be recorded in the movie-recording size that was set.
- If you connect the camera to a TV set (p.226) and shoot a movie, the TV set will not output any sound during the shooting. However, the sound will be properly recorded.

7

Handy Features

- Disabling the Beeper (p.184)
- Card Reminder (p.184)
- Setting the Image Review Time (p.184)
- Setting the Auto Power-off Time (p.185)
- Adjusting the LCD Monitor Brightness (p.185)
- Creating and Selecting a Folder (p.186)
- File Numbering Methods (p.188)
- Setting Copyright Information (p.190)
- Auto Rotation of Vertical Images (p.192)
- Checking Camera Settings (p.193)
- Reverting the Camera to the Default Settings (p.194)
- Turning the LCD Monitor Off/On (p.197)
- Changing the Shooting Settings Screen Color (p.197)
- Setting the Flash (p.198)
- Appending Dust Delete Data (p.202)
- Manual Sensor Cleaning (p.204)

Handy Features

MENU Disabling the Beeper

You can prevent the beeper from sounding when focus is achieved or during self-timer operation.

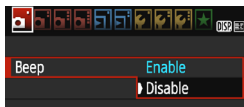

Under the [**1**] tab, select [**Beeper**], then press < (SET) >. Select [**Disable**], then press < (SET) >.

MENU Card Reminder

This setting prevents shooting if there is no card in the camera.



Under the [**1**] tab, select [**Release shutter without card**], then press < (SET) >. Select [**Disable**], then press < (SET) >.

If there is no card inserted in the camera and you press the shutter button, “**Card**” will be displayed in the viewfinder, and you cannot release the shutter.

MENU Setting the Image Review Time

You can set how long the image is displayed on the LCD monitor immediately after shooting. If [**Off**] is set, the image will not be displayed immediately after shooting. If [**Hold**] is set, the image review will be displayed up until the [**1: Auto power off**] time has elapsed. During image review, if you operate any camera controls such as pressing the shutter button halfway, the image review will end.



Under the [**1**] tab, select [**Image review**], then press < (SET) >. Select the desired setting, then press < (SET) >.

MENU Setting the Auto Power-off Time

To save battery power, the camera turns off automatically after the set time of idle operation elapses. You can set this auto power-off time. When the camera has turned off due to auto power off, you can turn it on again by pressing the shutter button halfway or pressing any of the following buttons: <MENU>, <DISP.>, <▶>, <📷>, etc.

If [Disable] is set, either turn off the camera or press the <DISP.> button to turn off the LCD monitor to save battery power.

Even when [Disable] is set, if the camera is not used for 30 min., the LCD monitor will turn off automatically. To turn on the LCD monitor again, press the <DISP.> button.



Under the [**1**] tab, select [**Auto power off**], then press <SET>. Select the desired setting, then press <SET>.

MENU Adjusting the LCD Monitor Brightness

You can adjust the brightness of the LCD monitor to make it easier to view.



Under the [**2**] tab, select [**LCD brightness**], then press <SET>. Press the <◀> <▶> keys to adjust the brightness on the adjustment screen, then press <SET>.



When checking the exposure of an image, set the LCD monitor brightness to 4 and prevent the ambient light from affecting the image.

MENU Creating and Selecting a Folder

You can freely create and select the folder where the captured images are to be saved.

This operation is optional since a folder will be created automatically for saving captured images.

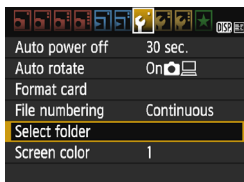
Creating a Folder**1 Select [Select folder].**

- Under the [**1**] tab, select [**Select folder**], then press <SET>.

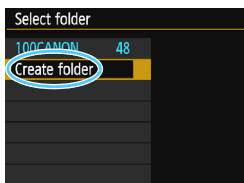
**2 Select [Create folder].**

- Select [**Create folder**], then press <SET>.

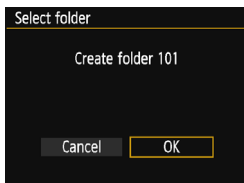
**3 Create a new folder.**

- Select [**OK**], then press <SET>.
- ▶ A new folder with the folder number increased by one is created.

Selecting a Folder



- With the folder selection screen displayed, select a folder and press \langle SET \rangle .
- ▶ The folder where the captured images will be saved is selected.
- Subsequent captured images will be recorded into the selected folder.

Folders

As with “100CANON” for example, the folder name starts with three digits (the folder number) followed by five alphanumeric characters. A folder can contain up to 9999 images (file number 0001 - 9999). When a folder becomes full, a new folder with the folder number increased by one is created automatically. Also, if manual reset (p.189) is executed, a new folder will be created automatically. Folders numbered from 100 to 999 can be created.

Creating Folders with a Computer

With the card open on the screen, create a new folder named “DCIM”. Open the DCIM folder and create as many folders as necessary to save and organize your images. The folder name must follow the format “100ABC_D”. The first three digits are the folder number, from 100 to 999. The last five characters can be any combination of upper- and lower-case letters from A to Z, numerals, and the underscore “_”. The space cannot be used. Also note that two folder names cannot share the same three-digit folder number (for example, “100ABC_D” and “100W_XYZ”), even if the last five characters in each name are different.

MENU File Numbering Methods

The image files will be numbered from 0001 to 9999 in the order the images are taken, then saved in a folder. You can change how the file number is assigned.

The file number will appear on your computer in this format:

IMG_0001.JPG

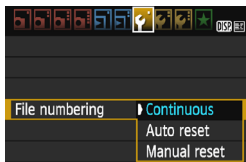

Under the [**F1**] tab, select [**File numbering**], then press <SET>. The available settings are described below. Select the option, then press <SET>.

- **[Continuous]: The file numbering continues in sequence even after you replace the card or create a folder.**

Even after you replace the card or create a new folder, the file numbering continues in sequence up to 9999. This is useful when you want to save images numbered anywhere between 0001 to 9999 on multiple cards or in multiple folders into one folder on a computer.

If the replacement card or existing folder already contains images recorded previously, the file numbering of the new images may continue from the file numbering of the existing images on the card or in the folder. If you want to use continuous file numbering, it is recommended that you use a newly-formatted card each time.

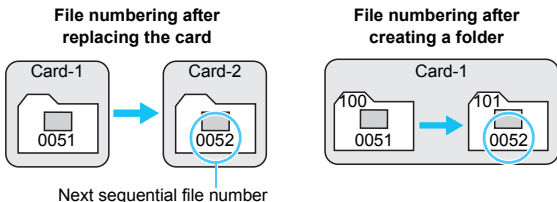

- **[Auto reset]: The file numbering restarts from 0001 each time the card is replaced or a new folder is created.**

When you replace the card or create a folder, the file numbering restarts from 0001 for the new images saved. This is useful if you want to organize images by cards or folders.

If the replacement card or existing folder already contains images recorded previously, the file numbering of the new images may continue from the file numbering of the existing images on the card or in the folder. If you want to save images with the file numbering starting from 0001, use a newly formatted card each time.

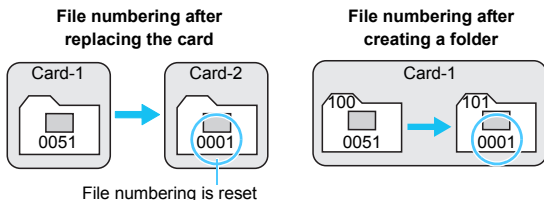

- **[Manual reset]: To reset the file numbering to 0001 manually or to start from file number 0001 in a new folder.**

When you reset the file numbering manually, a new folder is created automatically and the file numbering of images saved to that folder starts from 0001.

This is useful, for example, when you want to use different folders for the images taken yesterday and the ones taken today. After the manual reset, the file numbering returns to continuous or auto reset. (There will be no manual reset confirmation dialog.)



If the file number in folder 999 reaches 9999, shooting will not be possible even if the card still has storage capacity. The LCD monitor will display a message telling you to replace the card. Replace it with a new card.



For both JPEG and RAW images, the file name will start with "IMG_". Movie file names will start with "MVI_". The extension will be ".JPG" for JPEG images, ".CR2" for RAW images, and ".MOV" for movies.

MENU Setting Copyright Information ☆

When you set the copyright information, it will be appended to the image as Exif information.

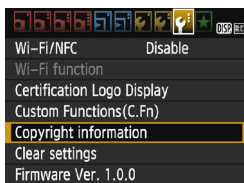

- 1 Select [Copyright information].**
- Under the [**3**] tab, select [**Copyright information**], then press <SET>.

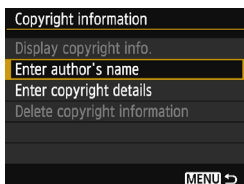

- 2 Select the option to be set.**
- Select [**Enter author's name**] or [**Enter copyright details**], then press <SET>.
 - The text entry screen will appear.
 - Select [**Display copyright info.**] to check the copyright information currently set.
 - Select [**Delete copyright information**] to delete the copyright information currently set.

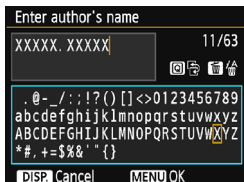

- 3 Enter text.**
- See "Text Entry Procedure" on the next page and enter the copyright information.
 - Enter up to 63 alphanumeric characters and symbols.

- 4 Exit the setting.**
- After entering the text, press the <MENU> button to exit.

Text Entry Procedure

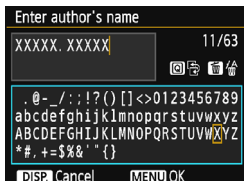

- **Changing the entry area**
Press the <Q> button to toggle between the top and bottom entry areas.
- **Moving the cursor**
Press the <◀> <▶> keys to move the cursor.
- **Entering text**
In the bottom area, press the <⬆> cross keys or turn the <⚙> dial to select a character, then press <SET> to enter it.
- **Deleting a character**
Press the <⏪> button to delete one character.
- **Finishing the text entry**
After entering the text, press the <MENU> button to finalize the text entry and return to the screen in step 2.
- **Canceling the text entry**
To cancel the text entry, press the <DISP.> button to cancel it and return to the screen in step 2.

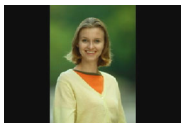

You can also set or check the copyright information with EOS Utility (EOS software, p.314).

MENU Auto Rotation of Vertical Images

Vertical images are rotated automatically so they are displayed vertically on the camera's LCD monitor and on the computer instead of horizontally. You can change the setting for this feature.

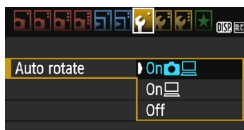

Under the [**1**] tab, select [**Auto rotate**], then press <[**SET**]>. The available settings are described below. Select the desired setting, then press <[**SET**]>.

- [**On**]: The vertical image is automatically rotated during playback on both the camera's LCD monitor and on the computer.
- [**On**] : The vertical image is automatically rotated only on the computer.
- [**Off**] : The vertical image is not automatically rotated.

? FAQ

- **The vertical image is not rotated during the image review immediately after shooting.**
Press the <[**▶**]> button and the image playback will display the rotated image.
- **[On] is set, but the image does not rotate during playback.**
Auto rotate will not work with vertical images captured while [**Auto rotate**] was set to [**Off**]. If the vertical image is taken while the camera is pointed up or down, the image may not be rotated automatically for playback. In such a case, see “Rotating the Image” on page 211.
- **On the camera's LCD monitor, I want to rotate an image captured when [On] had been set.**
Set [**On**], then play back the image. It will be rotated.
- **The vertical image does not rotate on the computer screen.**
The software used is not compatible with image rotation. Use EOS software instead.

DISP. Checking Camera Settings

While the menu is displayed, press the <DISP.> button to display the camera's major function settings.

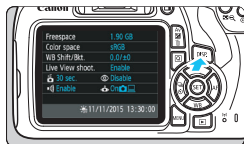

- While the menu is displayed, press the <DISP.> button to display the settings.
- Press the <DISP.> button again to return to the menu.

Settings display

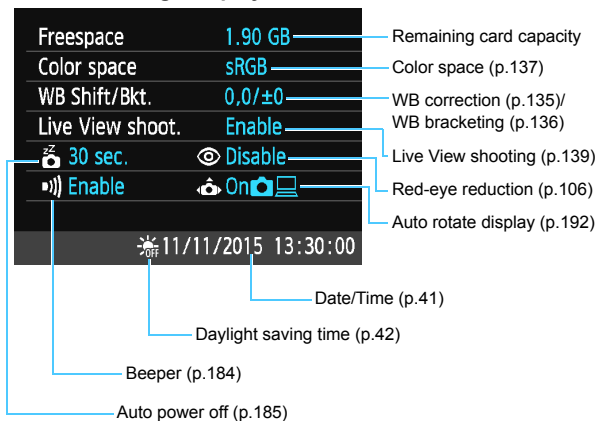

MENU Reverting the Camera to the Default Settings ☆

The camera's shooting function settings and menu settings can be reverted to their defaults. This option is available in Creative Zone modes.

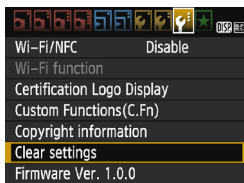

- 1 **Select [Clear settings].**
 - Under the [**3**] tab, select [**Clear settings**], then press <SET>.

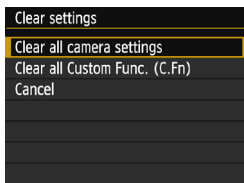

- 2 **Select [Clear all camera settings].**
 - Select [**Clear all camera settings**], then press <SET>.

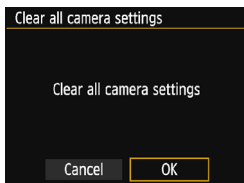

- 3 **Select [OK].**
 - Select [**OK**], then press <SET>.
 - ▶ Setting [**Clear all camera settings**] will reset the camera to the default settings as shown on the next pages.

? FAQ

● **Clearing all camera settings**

After the procedure above, select [**Clear all Custom Func. (C.Fn)**] in [**3: Clear settings**] to clear all the Custom Function settings (p.258).

Shooting Function Settings









| | |
|------------------------------------|---|
| AF operation | One-Shot AF |
| AF point selection | Automatic selection |
| Drive/self-timer | <input type="checkbox"/> (Single shooting) |
| Metering mode |  (Evaluative metering) |
| ISO speed | AUTO (Auto) |
| ISO Auto | Maximum 3200 |
| Exposure compensation/AEB | Canceled |
| Flash exposure compensation | 0 (Zero) |
| Custom Functions | Unchanged |

Image Recording Settings

| | |
|---|---|
| Image quality |  L |
| Picture Style | Auto |
| Auto Lighting Optimizer | Standard |
| Peripheral illumination correction | Enable / Correction data retained |
| Color space | sRGB |
| White balance |  (Ambience priority) |
| Custom White Balance | Canceled |
| White balance correction | Canceled |
| White balance bracketing | Canceled |
| File numbering | Continuous |
| Dust Delete Data | Erased |



Camera Settings

| | |
|---|--|
| Auto power off | 30 sec. |
| Beep | Enable |
| Release shutter without card | Enable |
| Image review | 2 sec. |
| Histogram display | Brightness |
| Image jump w/  |  (10 images) |
| Auto rotate | On   |
| LCD brightness |  |
| LCD off/on button | Shutter button |
| Date/Time/Zone | Unchanged |
| Language | Unchanged |
| Screen color | 1 |
| Feature guide | Enable |
| Copyright information | Unchanged |
| Eye-Fi transmission | Disable |
| Wi-Fi/NFC | Disable |
| Wi-Fi function | Unchanged |
| My Menu settings | Unchanged |
| Display from My Menu | Disable |

Live View Shooting Settings

| | |
|--------------------|--------------------|
| Live View shooting | Enable |
| AF method | FlexiZone - Single |
| Grid display | Hide |
| Aspect ratio | 3:2 |
| Metering timer | 8 sec. |

Movie Shooting Settings

| | |
|---|--------------------|
| Movie shooting mode | Auto |
| AF method | FlexiZone - Single |
| AF with shutter button during movie recording | Disable |
|  Shutter/AE lock button | AF/AE lock |
|  Highlight tone priority | Disable |
| Movie recording size | 1920x1080 |
| Sound recording | Auto |
| Metering timer | 8 sec. |
| Grid display | Hide |
| Video snapshot | Disable |
| Video system | Unchanged |
| Exposure compensation | Canceled |
| Auto Lighting Optimizer | Standard |
| Custom White Balance | Canceled |
| Picture Style | Auto |

 For Wi-Fi/NFC settings, refer to the Wireless Function Instruction Manual.

MENU Turning the LCD Monitor Off/On

You can set the camera so that the shooting function settings display (p.54) does not turn off and on as you press the shutter button halfway (or press the <★> button).

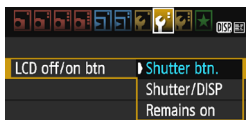

Under the [**2**] tab, select [**LCD off/on btn**], then press <SET>. The available settings are described below. Select the option, then press <SET>.

- [**Shutter btn.**]: When you press the shutter button halfway, the display will turn off. When you let go of the shutter button, the display will turn on.
- [**Shutter/DISP**]: When you press the shutter button halfway, the display will turn off. The display will remain off even after you let go of the shutter button. To turn on the display, press the <DISP.> button.
- [**Remains on**]: Display remains on even when you press the shutter button halfway. To turn off the display, press the <DISP.> button.

MENU Changing the Shooting Settings Screen Color

You can change the background color of the shooting settings screen.

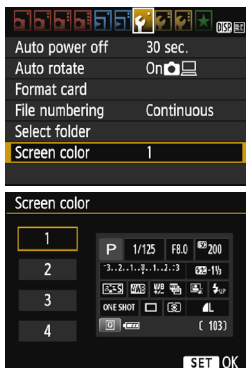

Under the [**1**] tab, select [**Screen color**], then press <SET>. Select the desired color, then press <SET>.

When you exit the menu, the shooting settings screen based in the selected color will be displayed.

MENU Setting the Flash ☆

The built-in flash and external Speedlite settings can be set with the camera's menu. You can use the camera's menu to set the external Speedlite function settings only if **an EX-series Speedlite compatible with this function is attached**.

The setting procedure is the same as when setting a camera menu function.

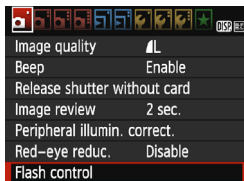

Select [Flash control].

- Under the [📷 1] tab, select [Flash control], then press <SET>.
- ▶ The flash control screen will appear.

[Flash firing]

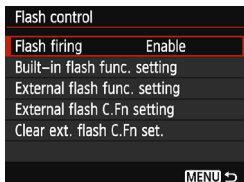

- Normally, set this to [Enable].
- If [Disable] is set, neither the built-in flash nor the external Speedlite will fire. This is useful when you want to use only the flash's AF-assist beam.

 Even if [Flash firing] is set to [Disable], if focus is difficult to achieve in low light, the built-in flash may still fire a series of flashes (AF-assist beam, p.100).

[Built-in flash func. setting] and [External flash func. setting]

With [Built-in flash func. setting] and [External flash func. setting], you can set the functions in the table below. The functions displayed under [External flash func. setting] vary depending on the Speedlite model.

| Built-in flash func. setting | |
|------------------------------|-----------------|
| Flash mode | E-TTL II |
| Shutter sync. | 1st curtain |
| Flash exp. comp | -2..1..@..1..*2 |
| E-TTL II meter. | Evaluative |
| MENU → | |

- Select [Built-in flash func. setting] or [External flash func. setting].
- ▶ The flash functions will be displayed. The highlighted functions can be selected and set.

[Built-in flash func. setting] and [External flash func. setting] Functions

| Function | [Built-in flash func. setting] | [External flash func. setting] | Page |
|-----------------------------|--------------------------------|--------------------------------|------|
| Flash mode | E-TTL II (Fixed) | ○ | 200 |
| Shutter synchronization | | ○ | 200 |
| FEB* | - | ○ | - |
| Flash exposure compensation | | ○ | 117 |
| E-TTL II flash metering | | ○ | 200 |
| Flash zoom* | - | ○ | - |
| Wireless functions* | - | ○ | - |

* Regarding [FEB] (Flash exposure bracketing), [Zoom], and [Wireless func.], refer to the Speedlite's instruction manual compatible with the function.



- Cautions for Radio Transmission Wireless Flash Shooting
 - Radio transmission wireless flash shooting cannot be set with the camera. Use the Speedlite to set the function.
 - Set flash sync speed to 1/100 or less.
 - High-speed synchronization is not possible.
 - Group flash is not possible.
- The camera may not be able to set some of the functions of [Flash mode], [Zoom], and [MULTI flash], depending on the Speedlite model used. In such a case, use the Speedlite to set the functions.

● Flash mode

When using an external Speedlite, you can select the flash mode to suit your desired flash shooting.

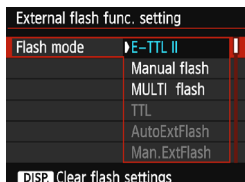

- **[E-TTL II]** is the standard mode of EX-series Speedlites for automatic flash shooting.
- **[Manual flash]** enables you to set the flash output yourself. This is for advanced users.
- Regarding other flash modes, refer to the instruction manual of a Speedlite compatible with the functions.

● Shutter synchronization

Normally, set this to **[1st curtain]** so that the flash fires immediately after the exposure starts.

If **[2nd curtain]** is set, the flash will fire right before the shutter closes. When this is combined with a slow shutter speed, you can create a trail of light such as from car headlights at night with a more natural feel. With E-TTL II (auto flash exposure), the flash will be fired twice in a row: once when you press the shutter button completely and once right before the end of the exposure. Also, if the shutter speed is 1/30 sec. or faster, first-curtain synchronization will be applied automatically.

If an external Speedlite is attached, you can also select **[High-speed synchronization]** (⚡_H). For details, refer to the Speedlite's instruction manual.

● Flash exposure compensation

See “Flash Exposure Compensation” on page 117.

● E-TTL II flash metering

For normal flash exposures, set it to **[Evaluative]**. **[Average]** is for advanced users. As with an external Speedlite, the metering is averaged for the entire area. Depending on the scene, flash exposure compensation may be necessary.

● Clear flash settings

On the [External flash func. setting] screen, press the <DISP.> button to display the screen to clear the flash settings. **When you select [OK], the settings for the built-in flash and external Speedlite will be cleared.**

Setting the External Speedlite Custom Functions

The Custom Functions displayed under [External flash C.Fn setting] vary depending on the Speedlite model.

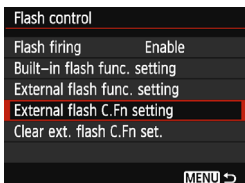

1 Display the Custom Function.

- Select [External flash C.Fn setting], then press <SET>.

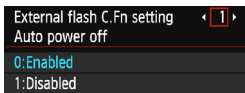

2 Set the Custom Function.

- Press the <◀> <▶> keys to select the function number, then set the function. The procedure is the same as setting the camera's Custom Functions (p.258).
- To clear all the Custom Function settings, select [Clear ext. flash C.Fn set.] in step 1.

MENU Appending Dust Delete Data ☆

Dust entering the camera can adhere to the image sensor and cause dust spots to be visible on the captured images. To erase these dust spots, you can append the Dust Delete Data to the images. The Dust Delete Data is used by Digital Photo Professional (EOS software, p.314) to erase the dust spots automatically.

Preparation

- Prepare a solid white object such as a sheet of paper.
- Set the lens focal length to 50 mm or longer.
- Set the lens's focus mode switch to <MF> and set the focus to infinity (∞). If the lens has no distance scale, rotate the camera to face toward you and turn the focusing ring clockwise all the way.

Obtaining the Dust Delete Data

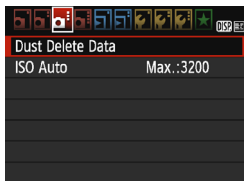

1 Select [Dust Delete Data].

- Under the [CAMERA] tab, select [Dust Delete Data], then press <SET>.

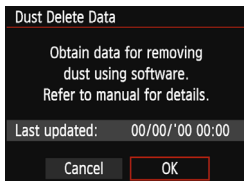

2 Select [OK].

- Select [OK], then press <SET>. Instructions will appear.

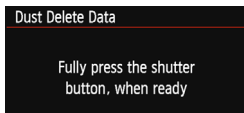

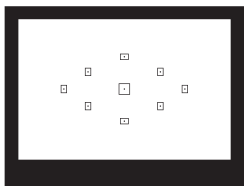

3 Shoot a solid-white object.

- At a distance of 20 cm - 30 cm (0.7 ft. - 1.0 ft.), fill the viewfinder with a patternless, solid-white object and take a picture.
- ▶ The picture will be taken in aperture-priority AE mode at an aperture of $f/22$.
- Since the image will not be saved, the data can still be obtained even if there is no card in the camera.
- ▶ When the picture is taken, the camera will start collecting the Dust Delete Data. When the Dust Delete Data is obtained, a message will appear. Select **[OK]** and the menu will reappear.
- If the data is not obtained successfully, an error message will appear. Follow the "Preparation" procedure on the preceding page, then select **[OK]**. Take the picture again.

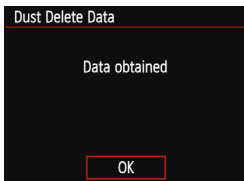

Dust Delete Data

After the Dust Delete Data is obtained, it is appended to all the JPEG and RAW images captured thereafter. Before an important shoot, it is recommended to update the Dust Delete Data by obtaining it again. For details about using Digital Photo Professional (EOS software, p.314) to erase dust spots, refer to the Digital Photo Professional Instruction Manual.

The Dust Delete Data appended to the image is so small that it hardly affects the image file size.

 Be sure to use a solid-white object such as a new sheet of white paper. If the object has any pattern or design, it may be recognized as dust data and affect the accuracy of the dust deletion with Digital Photo Professional (EOS software).

MENU Manual Sensor Cleaning ☆

If dust adheres to the image sensor and dust spots appear on the images, you can clean the image sensor yourself with a camera blower. Before cleaning the sensor, detach the lens from the camera.

The image sensor is extremely delicate. If the sensor needs to be cleaned directly, having it done by a Canon Service Center is recommended.

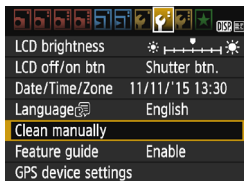

1 Select [Clean manually].

- Under the [**2**] tab, select [**Clean manually**], then press <SET>.



2 Select [OK].

- Select [**OK**], then press <SET>.
- ▶ In a moment, the reflex mirror will lock up and the shutter will open.

3 Clean the sensor.

4 End the cleaning.

- Set the power switch to <OFF>.

 If you use a battery, make sure it is fully charged.

 For the power source, using DC Coupler DR-E10 (sold separately) and Compact Power Adapter CA-PS700 (sold separately) is recommended.



- **While cleaning the sensor, never do any of the following. If the power is cut off, the shutter will close and the shutter curtains and image sensor may get damaged.**
 - **Setting the power switch to <OFF>.**
 - **Opening the card slot/battery compartment cover.**
- The surface of the image sensor is extremely delicate. Clean the sensor with care.
- Use a plain blower without any brush attached. A brush can scratch the sensor.
- Do not insert the blower tip inside the camera beyond the lens mount. If the power is turned off, the shutter will close and the shutter curtains or reflex mirror may get damaged.
- Never use pressurized air or gas to clean the sensor. Pressurized air may damage the sensor, and sprayed gas may freeze on the sensor and scratch it.
- If the battery level becomes low while cleaning the sensor, the beeper will sound as a warning. Stop cleaning the sensor.
- If a smudge that cannot be removed with a blower remains, having the sensor cleaned by a Canon Service Center is recommended.



8

Image Playback

This chapter explains functions related to viewing photos and movies, with more advanced uses than in Chapter 2 “Basic Shooting and Image Playback”. Here you will find explanations of how to play back and erase photos and movies with the camera and view them on a TV set.

Images shot and saved with another device

The camera may not be able to properly display images captured with a different camera, edited with a computer, or that have had their file names changed.

▶ Searching for Images Quickly

📷 Displaying Multiple Images on One Screen (Index Display)

Search for images quickly with the index display showing four or nine images on one screen.



1 Play back the image.

- When you press the <▶> button, the last image captured will be displayed.



2 Switch to the index display.

- Press the <🔍> button.
- ▶ The 4-image index display will appear. The selected image is highlighted with an orange frame.
- Press the <🔍> button again to switch to the 9-image display.
- Pressing the <🔍> button will switch the display between nine images, four images and one image displayed.



3 Select an image.

- Press the <⬆> cross keys to move the orange frame to select an image.
- Turning the <🔄> dial will display image(s) on the next or previous screen.
- Press <Ⓢ> in the index display to display the selected image in the single-image display.

Jumping through Images (Jump Display)

In the single-image display, you can turn the < > dial to jump through the images forward or backward according to the jump method set.



1 Select [Image jump w/].

- Under the [▶2] tab, select [Image jump w/ ], then press <ⓈET>.

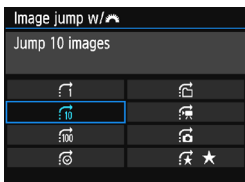

2 Select the jump method.

- Press the <⬥> cross keys to select the jump method, then press <ⓈET>.

: Display images one by one

: Jump 10 images

: Jump 100 images

: Display by date

: Display by folder

: Display movies only

: Display stills only

: Display by image rating (p.212)

Turn the < > dial to select.



Jump method

Playback position

3 Browse by jumping.

- Press the <▶> button to play back images.
- In the single-image display, turn the < > dial.
- ▶ You can browse images with the method that was set.





- To search images by shooting date, select [Date].
- To search images by folder, select [Folder].
- If the card contains both movies and still photos, select [Movies] or [Stills] to display only one or the other.
- If no images match the selected [Rating], you cannot browse through the images with the < > dial.

Magnified View

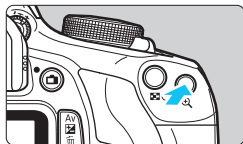
You can magnify a captured image by approx. 1.5x to 10x on the LCD monitor.





1 Magnify the image.

- Press the  button during image playback.
- ▶ The image will be magnified.
- If you hold down the  button, the image will be magnified until it reaches the maximum magnification.
- Press the  button to reduce the magnification. If you hold down the button, the magnification will be reduced to the single-image display.



Magnified area position

2 Scroll around the image.

- Use the  cross keys to scroll around the magnified image.
- To exit magnified view, press the  button and the single-image display will reappear.

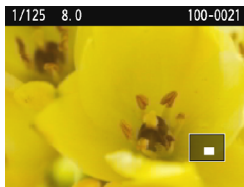



- In magnified view, you can turn the  dial to view another image at the same magnification.
- The image cannot be magnified during the image review immediately after shooting.
- A movie cannot be magnified.

Rotating the Image

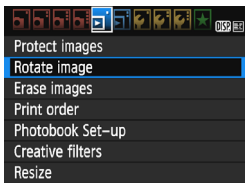
You can rotate the displayed image to the desired orientation.



1 Select [Rotate image].

- Under the [] tab, select [Rotate image], then press < >.



2 Select an image.







- Press the << >> >> keys to select the image to be rotated.
- You can also select an image in the index display (p.208).



3 Rotate the image.

- Each time you press < >, the image will rotate clockwise as follows:
90° → 270° → 0°.
- To rotate another image, repeat steps 2 and 3.
- To exit and return to the menu, press the <MENU> button.



- If you set [: Auto rotate] to [ ] (p.192) before taking vertical shots, you need not rotate the image as described above.
- If the rotated image is not displayed in the rotated orientation during image playback, set [: Auto rotate] to [ ].
- A movie cannot be rotated.

MENU Setting Ratings

You can rate images (still photos and movies) with one of five rating marks: [★]/[★]/[★]/[★]/[★]. This function is called rating.



1 Select [Rating].

- Under the [▶2] tab, select [Rating], then press <SET>.



2 Select an image.

- Press the <◀> <▶> keys to select a still photo or movie to be rated.
- By pressing the <[grid icon] Q> button, you can select images from a three-image display. To return to the single-image display, press the <Q> button.



3 Rate the image.

- Press the <▲> <▼> keys to select a rating.
- ▶ When you select a rating for the image, the number beside the set rating will increase by one.
- To rate another image, repeat steps 2 and 3.
- To return to the menu, press the <MENU> button.







A total of up to 999 images of a given rating can be displayed. If there are more than 999 images with a given rating, [###] will be displayed.

Taking Advantage of Ratings

- With [▶2: **Image jump w/** , you can display only images having the specified rating.
- With [▶2: **Slide show**], you can play back only images having the specified rating.
- With Digital Photo Professional (EOS software, p.314), you can select only images with a specific rating (still photos only).
- Depending on the computer OS, you can see each file's rating as part of the file information display or in the provided image viewer (JPEG images only).

Quick Control for Playback

During playback, you can press the <Q> button to set any of the following: [**On**: **Protect images**], [: Rotate image], [**★**: **Rating**], [: Creative filters], [: Resize (JPEG images only)], and [: **Image jump w/ **].

For movies, only the functions in bold above can be set.



1 Press the <Q> button.

- During image playback, press the <Q> button.
- ▶ The Quick Control options will appear.









2 Select a function and set it.

- Press the <▲> <▼> keys to select a function.
- ▶ The name and current setting of the selected function are displayed at the bottom of the screen.
- Set it by pressing the <◀> <▶> keys.
- For Creative filters and Resize, press <SET> and set the function. For details, see page 236 for Creative filters and page 239 for Resize. To cancel, press the <MENU> button.

3 Exit the setting.

- Press the <Q> button to exit the Quick Control.

 To rotate an image, set [**1: Auto rotate**] to [**On**  ]. If [**1: Auto rotate**] is set to [**On** ] or [**Off**], the [**Rotate image**] setting will be recorded to the image, but the camera will not rotate the image for display.

- 
- Pressing the <> button during the index display will switch to the single-image display and the Quick Control icons will appear. Pressing the <> button again will return to the index display.
 - For images taken with another camera, the options you can select may be restricted.

Enjoying Movies

You can play back movies in the following three ways:

Playback on a TV Set

(p.226)



An HDMI cable (sold separately) is necessary to connect the camera to a TV set. Also, an HDMI terminal on a TV set is required.

When the camera is connected to a TV set with an HDMI cable, you can play back movies and still photos on the TV set.

If you have a High-Definition TV set and connect your camera with an HDMI cable, you can watch Full High-Definition (Full HD: 1920x1080) and High-Definition (HD: 1280x720) movies with higher image quality.

-  The camera does not have an audio/video OUT terminal. Therefore, the camera cannot be connected to a TV set with an analog AV cable.
- Since hard disk recorders do not have an HDMI IN terminal, the camera cannot be connected to a hard disk recorder with an HDMI cable.
- Even if the camera is connected to a hard disk recorder with a USB cable, movies and still photos cannot be played back or saved.
- If the playback device is not compatible with MOV files, the movie cannot be played back.

Playback on the Camera's LCD Monitor

(p.218-225)

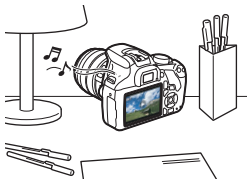

You can play back movies on the camera's LCD monitor. You can also edit out the movie's first and last scenes, and play back the still photos and movies on the card in an automatic slide show.



A movie edited with a computer cannot be rewritten to the card or played back with the camera.

Playback and Editing with a Computer



To play back or edit a movie, use pre-installed or general-purpose software, compatible with the movie's recording format.



If you want to use commercially-available software to play back or edit the movies, be sure it is compatible with MOV-format movies. For details on commercially-available software, contact the software manufacturer.

▶▶ Playing Back Movies



1 Play back the image.

- Press the <▶▶> button to display an image.

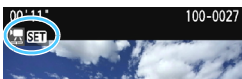

2 Select a movie.

- Press the <◀▶> keys to select a movie.
- In the single-image display, the <▶▶ SET > icon displayed on the upper left of the screen indicates a movie. If the movie is a video snapshot, [▶▶ SET] will be displayed.
- In the index display, perforations at the left edge of a thumbnail indicate a movie. **As movies cannot be played back from the index display, press <SET> to switch to the single-image display.**

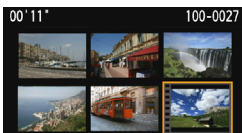

3 In the single-image display, press <SET>.

- ▶ The movie playback panel will appear at the bottom of the screen.







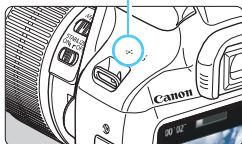



4 Play back the movie.

- Select [▶▶] (Play), then press <SET>.
- ▶ The movie will start playing back.
- You can pause the movie playback by pressing <SET>.
- You can adjust the built-in speaker's volume by turning the <◀⚙▶> dial even during movie playback.
- For more details on the playback procedure, see the next page.

Speaker



Movie Playback Panel

| Operation | Playback Description |
|---|---|
|  Exit | Returns to the single-image display. |
|  Play | Pressing <SET> toggles between play and stop. |
|  Slow motion | Adjust the slow motion speed by pressing the <◀> <▶> keys. The slow motion speed is indicated on the upper right of the screen. |
|  First frame | Displays the movie's first frame. |
|  Previous frame | Each time you press <SET>, the previous frame is displayed. If you hold down <SET>, it will rewind the movie. |
|  Next frame | Each time you press <SET>, the movie will play frame-by-frame. If you hold down <SET>, it will fast forward the movie. |
|  Last frame | Displays the movie's last frame. |
|  Edit | Displays the editing screen (p.220). |
|  Background music* | Plays back a movie with the selected background music (p.225). |
|  | Playback position |
| mm' ss" | Playback time (minutes:seconds) |
|  Volume | Turn the <🔊> dial to adjust the volume of the built-in speaker (p.218). |

* When background music is set, the movie sound will not be played back.

 The camera may not be able to play back movies shot with another camera.

- 
- With a fully-charged Battery Pack LP-E10, the continuous playback time at room temperature (23°C / 73°F) will be as follows: Approx. 2 hr. 20 min.
 - During the single-image display, you can press the <DISP.> button to change the display format (p.233).
 - If you connect the camera to a TV set (p.226) to play back a movie, adjust the sound volume with the TV set. (Turning the <🔊> dial will not change the sound volume.)

✂ Editing a Movie's First and Last Scenes

You can edit out the first and last scenes of a movie in approx. 1-sec. increments.



1 On the movie playback screen, select [✂].

- ▶ The editing screen will be displayed.



2 Specify the part to be edited out.

- Select either [⏪] (Cut beginning) or [⏩] (Cut end), then press <SET>.
- Press the <◀> <▶> keys to see the previous or next frames. Holding down the key will fast forward or fast rewind the frames.
- After deciding which part to edit out, press <SET>. The portion highlighted in white on the top is what will remain.

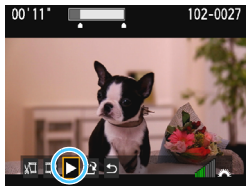

3 Check the edited movie.

- Select [▶] and press <SET> to play back the edited movie.
- To change the editing, go back to step 2.
- To cancel the editing, select [↶], then press <SET>. Select [OK] on the confirmation dialog, then press <SET>.

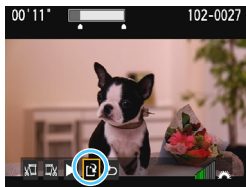

4 Save the edited movie.

- Select [**S**], then press <ⓈET>.
- ▶ The save screen will appear.
- To save it as a new movie, select [**New file**]. To save it and overwrite the original movie file, select [**Overwrite**], then press <ⓈET>.
- On the confirmation dialog, select [**OK**], then press <ⓈET> to save the edited movie and return to the movie playback screen.



- Since the editing is performed in approx. 1-sec. increments (position indicated by [**S**] on the top of the screen), the actual position where the movie is edited may differ from the position you specified.
- If the card does not have enough free space, [**New file**] will not be available.
- When the battery level is low, movie editing is not possible. Use a fully-charged battery.

MENU Slide Show (Auto Playback)

You can play back the images on the card as an automatic slide show.



Number of images to be played back

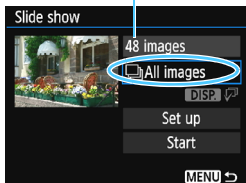

1 Select [Slide show].

- Under the [▶2] tab, select [Slide show], then press <SET>.

2 Select the images to be played back.

- Press the <▲> <▼> keys to select the desired option, then press <SET>.

All images/Movies/Stills

- Press the <▲> <▼> keys to select one of the following: [📁All images] [🎬Movies] [📷Stills]. Then press <SET>.

Date/Folder/Rating

- Press the <▲> <▼> keys to select one of the following: [📅Date] [📁Folder] [★Rating].
- When <DISP. ↗> is highlighted, press the <DISP.> button.
- Press the <▲> <▼> keys to select an option, then press <SET>.

[Date]

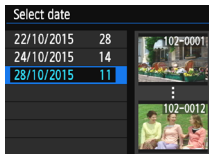

[Folder]

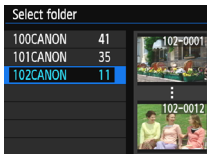

[Rating]

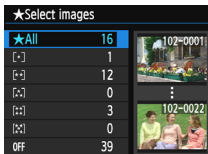

| Item | Playback Description |
|-------------------|--|
| All images | All the still photos and movies on the card will be played back. |
| Date | Still photos and movies taken on the selected shooting date will be played back. |
| Folder | Still photos and movies in the selected folder will be played back. |
| Movies | Only the movies on the card will be played back. |
| Stills | Only the still photos on the card will be played back. |
| Rating | Only the still photos and movies with the selected rating will be played back. |

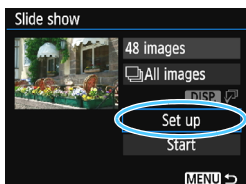

3 Configure [Set up] as desired.

- Press the <▲> <▼> keys to select [**Set up**], then press <ⓈET>.
- Set the [**Display time**], [**Repeat**] (repeated playback), [**Transition effect**] (effect when changing images), and [**Background music**] for the still photos.
- The background music selection procedure is explained on page 225.
- After selecting the settings, press the <MENU> button.

[Display time]



[Repeat]

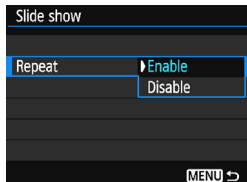

[Transition effect]

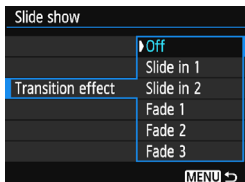

[Background music]

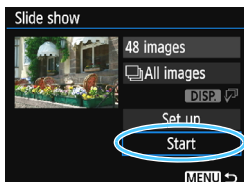
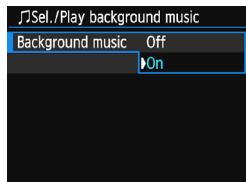

4 Start the slide show.

- Press the <▲><▼> keys to select [Start], then press <SET>.
- ▶ After [Loading image...] is displayed, the slide show will start.

5 Exit the slide show.

- To exit the slide show and return to the setting screen, press the <MENU> button.

- To pause the slide show, press <SET>. During pause, [||] will be displayed on the upper left of the image. Press <SET> again to resume the slide show.
- During auto playback, you can press the <DISP.> button to change the still photo display format (p.83).
- During movie playback, you can adjust the sound volume by turning the <VOLUME> dial.
- During auto playback or pause, you can press the <◀><▶> keys to view another image.
- During auto playback, auto power off will not take effect.
- The display time may vary depending on the image.
- To view the slide show on a TV set, see page 226.

Selecting the Background Music

After you use EOS Utility (EOS software) to copy background music to the card, you can play background music together with the slide show.

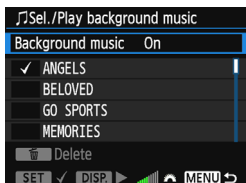

1 Select [Background music].

- Set [Background music] to [On], then press <SET>.
- If the card has no background music, you cannot perform step 2.

2 Select the background music.

- Press the <▲> <▼> keys to select the desired background music, then press <SET>. You can also select multiple background music tracks.

3 Play the background music.

- To listen to a sample of the background music, press the <DISP.> button.
- Press the <▲> <▼> keys to play another background music track. To stop listening to the background music, press the <DISP.> button again.
- Adjust the sound volume by turning the <VOL.> dial.
- To delete a background music track, press the <▲> <▼> keys and select the track, then press the <DELETE> button.



At the time of purchase, the camera does not have background music. The procedure to copy background music to a card is explained in the EOS Utility Instruction Manual.

Viewing Images on a TV Set

You can play back still photos and movies on a TV set. **An HDMI cable (sold separately) is necessary to connect the camera to a TV set. Also, an HDMI terminal on a TV set is required.**

If [**Y3: Wi-Fi/NFC**] is set to [**Enable**], the camera cannot be connected to a TV set. Set [**Wi-Fi/NFC**] to [**Disable**], then reconnect the camera to the TV set with an HDMI cable.

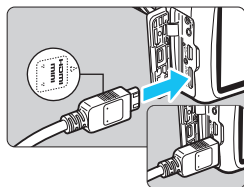

1 Connect the HDMI cable to the camera.

- With the plug's <▲HDMI MINI> logo facing the front of the camera, insert it into the <HDMI OUT> terminal.

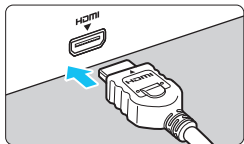

2 Connect the HDMI cable to the TV set.

- Connect the HDMI cable to the TV set's HDMI IN port.

3 Turn on the TV set and switch the TV set's video input to select the connected port.

4 Set the camera's power switch to <ON>.

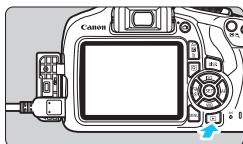

5 Press the <▶> button.

- ▶ The image will appear on the TV screen. (Nothing will be displayed on the camera's LCD monitor.)
- The images will automatically be displayed at the optimum resolution of the TV set.
- By pressing the <DISP.> button, you can change the display format.
- To play back movies, see page 218.



- Adjust movie sound volume with the TV set. The sound volume cannot be adjusted with the camera.
- Before connecting or disconnecting the cable between the camera and TV set, turn off the camera and TV set.
- Depending on the TV set, part of the image displayed may be cut off.
- Do not connect any other device's output to the camera's <HDMI OUT> terminal. Doing so may cause a malfunction.
- Certain TV sets may not be able to play back the captured images.

Protecting Images

You can set protections to prevent the precious images from being erased accidentally.

MENU Protecting a Single Image

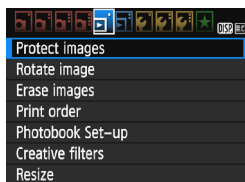

1 Select [Protect images].

- Under the [ 1] tab, select [Protect images], then press <SET>.
- ▶ The protect setting screen will appear.

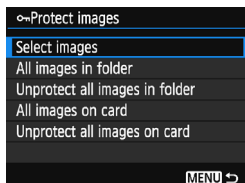



2 Select [Select images].

- Select [Select images], then press <SET>.
- ▶ An image will be displayed.

Image protect icon



3 Protect the image.

- Press the <◀> <▶> keys to select the image to be protected, then press <SET>.
- ▶ When an image is protected, the <> icon will appear on the top of the screen.
- To cancel the image protection, press <SET> again. The <> icon will disappear.
- To protect another image, repeat step 3.
- To return to the menu, press the <MENU> button.

MENU Protecting All Images in a Folder or on a Card

You can protect all the images in a folder or on a card at one time.

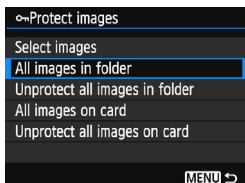

When you select [**All images in folder**] or [**All images on card**] in [**▶ 1: Protect images**], all the images in the folder or on the card will be protected.

To cancel the image protection, select [**Unprotect all images in folder**] or [**Unprotect all images on card**].

! If you format the card (p.52), the protected images will also be erased.



- Movies can also be protected.
- Once an image is protected, it cannot be erased by the camera's erase function. To erase a protected image, you must first cancel the protection.
- If you erase all the images (p.231), only the protected images will remain. This is convenient when you want to erase unnecessary images all at once.

Erasing Images

You can either select and erase unnecessary images one by one or erase them in one batch. Protected images (p.228) will not be erased.

! Once an image is erased, it cannot be recovered. Make sure you no longer need the image before erasing it. To prevent important images from being erased accidentally, protect them. Erasing a **RAW** + **L** image will erase both the RAW and JPEG images.

Erasing a Single Image

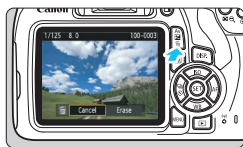

1 Play back the image to be erased.

2 Press the **<trash can>** button.

▶ The Erase menu will appear.



3 Erase the image.

• Select **[Erase]**, then press **<SET>**. The image displayed will be erased.

MENU Checkmarking [✓] Images to Be Erased in a Batch

By adding checkmarks [✓] to the images to be erased, you can erase multiple images at once.

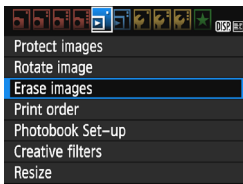

1 Select **[Erase images]**.

• Under the **[▶ 1]** tab, select **[Erase images]**, then press **<SET>**.

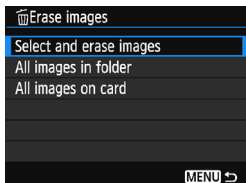

2 Select [Select and erase images].

- Select [**Select and erase images**], then press <SET>.
- ▶ An image will be displayed.
- To display the three-image display, press the <☒ Q> button. To return to the single-image display, press the <Q> button.



3 Select the images to be erased.

- Press the <◀> <▶> keys to select the image to be erased, then press the <▲> <▼> keys.
- ▶ A checkmark [✓] will be displayed on the upper left of the screen.
- To select another image to be erased, repeat step 3.

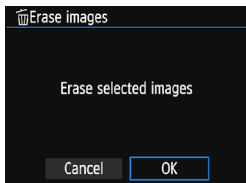

4 Erase the image.

- Press the <☒> button.
- Select [**OK**], then press <SET>.
- ▶ The selected images will be erased.

MENU Erasing All Images in a Folder or on a Card

You can erase all the images in a folder or on a card at one time. When [**▶ 1: Erase images**] is set to [**All images in folder**] or [**All images on card**], all the images in the folder or on the card will be erased.

 To erase all images including protected images, format the card (p.52).

DISP. Shooting Information Display

Sample Still Photo Taken in a Creative Zone Mode

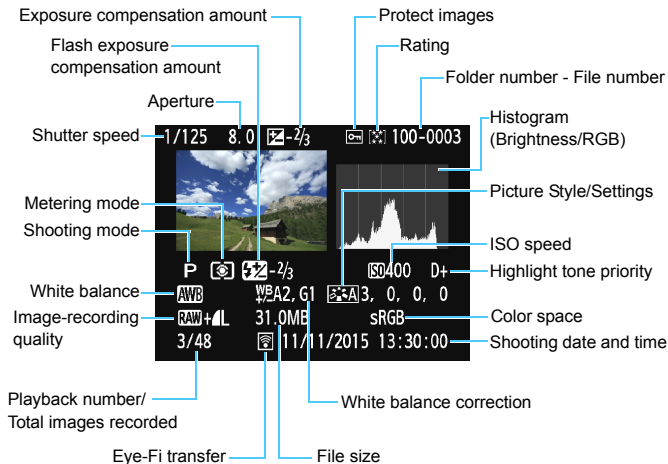

* With **RAW** + **L** images, the **RAW** file size is displayed.

* If a Creative filter or Resize has been applied to the image, the **<RAW+>** icon will change to **<[icon]>**.

* Images taken with flash without any flash exposure compensation are marked with the **<[icon]>** icon. Images taken with flash exposure compensation are marked with the **<[icon]>** icon.

- If the image was taken by another camera, certain shooting information may not be displayed.
- It may not be possible to play back images taken with this camera on other cameras.

Sample Still Photo Taken in a Basic Zone Mode

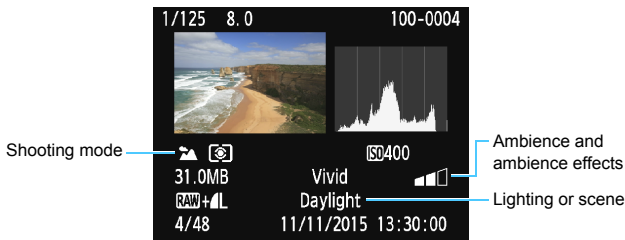

* With images taken in a Basic Zone mode, the information displayed will differ depending on the shooting mode.

Sample Movie Information Display

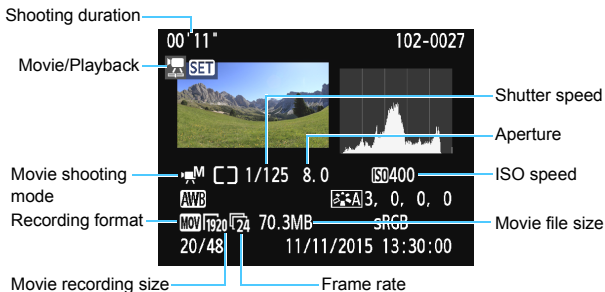

* If manual exposure is used, the shutter speed, aperture, and ISO speed (when set manually) will be displayed.

* The icon will be displayed for video snapshots.

● Highlight Alert

When the shooting information is displayed, any overexposed areas of the image will blink. To obtain more image detail in the overexposed, blinking areas, set the exposure compensation to a negative amount and shoot again.

● Histogram

The brightness histogram shows the exposure level distribution and overall brightness. The RGB histogram is for checking the color saturation and gradation. The display can be switched with [**▶**2: **Histogram disp**].

[Brightness] Display

This histogram is a graph showing the distribution of the image's brightness level. The horizontal axis indicates the brightness level (darker on the left and brighter on the right), while the vertical axis indicates how many pixels exist for each brightness level. The more pixels there are toward the left, the darker the image. The more pixels there are toward the right, the brighter the image. If there are too many pixels on the left, the shadow detail will be lost. If there are too many pixels on the right, the highlight detail will be lost. The gradation in-between will be reproduced. By checking the image and its brightness histogram, you can see the exposure level inclination and the overall gradation.

Sample Histograms



Dark image



Normal brightness



Bright image

[RGB] Display

This histogram is a graph showing the distribution of each primary color's brightness level in the image (RGB or red, green, and blue). The horizontal axis indicates the color's brightness level (darker on the left and brighter on the right), while the vertical axis indicates how many pixels exist for each color brightness level. The more pixels there are toward the left, the darker and less prominent the color. The more pixels there are toward the right, the brighter and denser the color. If there are too many pixels on the left, the respective color information will be lacking. If there are too many pixels on the right, the color will be too saturated with no gradation. By checking the image's RGB histogram, you can see the color's saturation and gradation condition, as well as white balance inclination.

9

Post-Processing Images

After taking a picture, you can apply a Creative filter or resize the JPEG image (reduce the number of pixels).



- The camera may not be able to process images taken with another camera.
- Post-processing images as described in this chapter is not possible while the camera is connected to a computer via the interface cable.

Applying Creative Filters

You can apply the following Creative filters to an image and save it as a new image: Grainy B/W, Soft focus, Fish-eye effect, Toy camera effect, and Miniature effect.

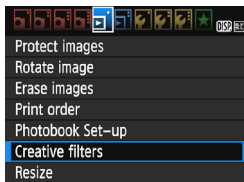

1 Select [Creative filters].

- Under the [▶1] tab, select [Creative filters], then press <SET>.
- ▶ An image will be displayed.

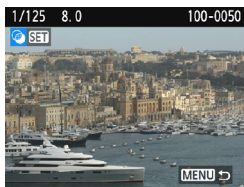

2 Select an image.

- Select the image you want to apply a filter to.
- By pressing the <Q> button, you can switch to the index display and select an image.

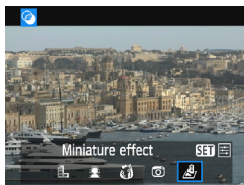

3 Select a filter.

- When you press <SET>, the types of Creative filters will be displayed (p.238).
- Press the <◀> <▶> keys to select a filter, then press <SET>.
- ▶ The image will be displayed with the effects of the filter applied.

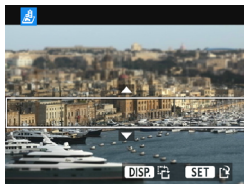

4 Adjust the filter effect.

- Press the <◀> <▶> keys to adjust the filter effect, then press <SET>.
- For the Miniature effect, press the <▲> <▼> keys to move the white frame to where you want the image to look sharp, then press <SET>.

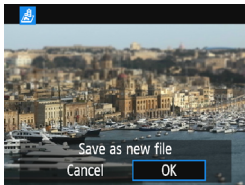





5 Save the image.

- Select **[OK]** to save the image.
- Check the destination folder and image file number, then select **[OK]**.
- To apply a filter to another image, repeat steps 2 to 5.
- To return to the menu, press the **<MENU>** button.



- When shooting **RAW + L** or **RAW** image, the filter effect will be applied to the **RAW** image and the image will be saved as a JPEG image.
- If an aspect ratio was set for a **RAW** image and the filter effect is applied to it, the image will be saved in the aspect ratio that is set.
- Dust Delete Data (p.202) will not be appended to images with Fish-eye effect applied.

Creative Filter Characteristics



-  **Grainy B/W**
Creates a grainy black-and-white photo. You can change the black-and-white effect by adjusting the contrast.
-  **Soft focus**
Gives the image a soft look. You can change the degree of softness by adjusting the blur.
-  **Fish-eye effect**
Gives the effect of a fish-eye lens. The image will have a barrel-type distortion.
Depending on the level of this filter effect, the area trimmed along the periphery of the image changes. Also, since this filter effect will magnify the image center, the apparent resolution at the center may degrade depending on the number of recorded pixels. Set the filter effect in step 4 while checking the resulting image.
-  **Toy camera effect**
Darkens the photo's corners and applies a color tone that makes it look as if it was shot by a toy camera. You can change the color cast by adjusting the color tone.
-  **Miniature effect**
Creates a diorama effect. You can change where the image looks sharp. In step 4 on page 236, if you press the <DISP.> button, you can switch between the white frame's vertical and horizontal orientations.

Resizing JPEG Images

You can resize a JPEG image to make the pixel count lower and save it as a new image. Resizing an image is possible only with JPEG **L/M/S1/S2** images. **JPEG S3 and RAW images cannot be resized.**





1 Select [Resize].

- Under the [] **1** tab, select [**Resize**], then press < >.
- ▶ An image will be displayed.





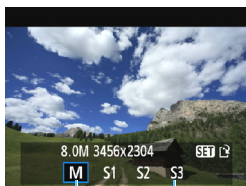

2 Select an image.

- Select the image you want to resize.
- By pressing the <  > button, you can switch to the index display and select an image.



3 Select the desired image size.

- Press < > to display the image sizes.
- Press the < > < > keys to select the desired image size, then press < >.

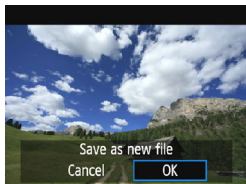

4 Save the image.

- Select [**OK**] to save the resized image.
- Check the destination folder and image file number, then select [**OK**].
- To resize another image, repeat steps 2 to 4.
- To return to the menu, press the <**MENU**> button.

Resize Options by Original Image Size

| Original Image Size | Available Resize Settings | | | |
|---------------------|---------------------------|-----------------------|-----------------------|-----------------------|
| | M | S1 | S2 | S3 |
| L | <input type="radio"/> | <input type="radio"/> | <input type="radio"/> | <input type="radio"/> |
| M | | <input type="radio"/> | <input type="radio"/> | <input type="radio"/> |
| S1 | | | <input type="radio"/> | <input type="radio"/> |
| S2 | | | | <input type="radio"/> |
| S3 | | | | |

Image Sizes

The image sizes displayed in step 3 on the preceding page, such as [***M ***x***], have a 3:2 aspect ratio. The image sizes by aspect ratios are shown in the table below.

The items marked with an asterisk do not exactly match the indicated aspect ratio. The image will be cropped slightly.

| Image Quality | Aspect Ratio and Pixel Count (Approx.) | | | |
|---------------|--|--------------------------------|--------------------------------|-------------------------------|
| | 3:2 | 4:3 | 16:9 | 1:1 |
| M | 3456x2304 (8.0 megapixels) | 3072x2304 (7.0 megapixels) | 3456x1944 (6.7 megapixels) | 2304x2304 (5.3 megapixels) |
| S1 | 2592x1728 (4.5 megapixels) | 2304x1728 (4.0 megapixels) | 2592x1456* (3.8 megapixels) | 1728x1728 (3.0 megapixels) |
| S2 | 1920x1280 (2.5 megapixels) | 1696x1280* (2.2 megapixels) | 1920x1080 (2.1 megapixels) | 1280x1280 (1.6 megapixels) |
| S3 | 720x480 (350,000 pixels) | 640x480 (310,000 pixels) | 720x400* (290,000 pixels) | 480x480 (230,000 pixels) |

10

Printing Images

- **Printing** (p.242)
You can connect the camera directly to a printer and print out the images on the card. The camera is compliant with “PictBridge”, which is the standard for direct printing.
- **Digital Print Order Format (DPOF)** (p.251)
DPOF (Digital Print Order Format) enables you to print images recorded on the card according to your printing instructions such as the image selection, quantity to print, etc. You can print multiple images in one batch or give the print order to a photofinisher.
- **Specifying Images for a Photobook** (p.255)
You can specify images on the card for printing in a photobook.

Preparing to Print

The direct printing procedure can be performed entirely with the camera while looking at the setting screens on camera's LCD monitor.

Connecting the Camera to a Printer

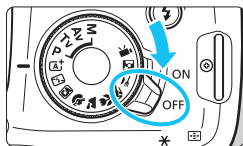

- 1 Set the camera's power switch to <OFF>.

- 2 Set up the printer.

- For details, refer to the printer's instruction manual.

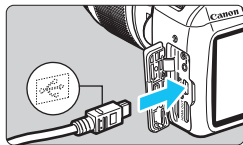

- 3 Connect the camera to the printer.

- Use the interface cable provided with the camera.
- Connect the cable to the camera's digital terminal with the cable plug's <↔> icon facing the front of the camera.
- To connect to the printer, refer to the printer's instruction manual.

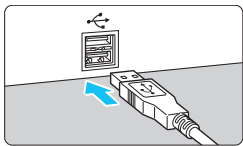

- 4 Turn on the printer.

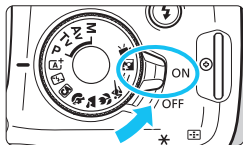

- 5 Set the camera's power switch to <ON>.

- ▶ Some printers may make a beeping sound.



6 Play back the image.

- Press the <▶> button.
- ▶ The image will appear with the <📷> icon on the upper left of the screen to indicate that the camera is connected to a printer.



- Before using the printer, make sure it has a PictBridge connection port.
- Movies cannot be printed.
- The camera cannot be used with printers compatible only with CP Direct or Bubble Jet Direct.
- Do not use any interface cable other than the one provided.
- If there is a long beeping sound in step 5, it indicates a problem with the printer. Resolve the problem displayed in the error message (p.250).
- If [🔌3: Wi-Fi/NFC] is set to [Enable], the camera cannot be connected to a printer. Set [Wi-Fi/NFC] to [Disable], then reconnect the camera to a printer with an interface cable.



- You can also print RAW images taken with this camera.
- When you use a battery to power the camera, make sure it is fully charged. With a fully-charged battery, you can print for approx. 2 hr. 40 min.
- Before disconnecting the cable, first turn off the camera and printer. Hold the plug (not the cord) to pull out the cable.
- For direct printing, using DC Coupler DR-E10 (sold separately) and Compact Power Adapter CA-PS700 (sold separately) to power the camera is recommended.

☞ Printing

The screen display and setting options will differ depending on the printer. Some settings may not be available. For details, refer to the printer's instruction manual.

Printer-connected icon



1 Select the image to be printed.

- Check that the <☞> icon is displayed on the upper left of the LCD monitor.
- Press the <◀> <▶> keys to select the image to be printed.

2 Press <SET>.

- ▶ The print setting screen will reappear.

Print setting screen

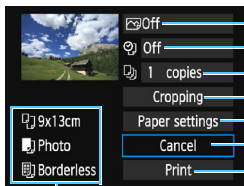

— Sets the printing effects (p.246).

— Sets the date or file number imprinting to on or off.

— Sets the quantity to be printed.

— Sets the print area (p.249).

— Sets the paper size, type, and layout.

— Returns to the screen in step 1.

— Starts the printing.

The paper size, type, and layout you have set are displayed.

* Depending on the printer, certain settings such as the date and file number imprinting and cropping may not be selectable.

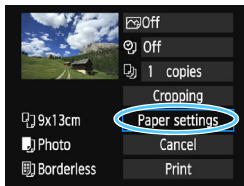

3 Select [Paper settings].

- Select [Paper settings], then press <SET>.
- ▶ The paper settings screen will appear.

Setting the Paper Size

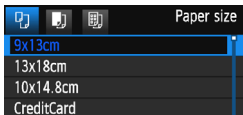

- Select the size of the paper loaded in the printer, then press **<SET>**.
- ▶ The paper type screen will appear.

Setting the Paper Type

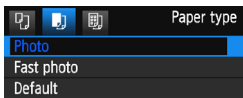

- Select the type of the paper loaded in the printer, then press **<SET>**.
- ▶ The page layout screen will appear.

Setting the Page Layout



- Select the page layout, then press **<SET>**.
- ▶ The print setting screen will reappear.

| | |
|--------------------------------------|---|
| Bordered | Prints with white borders along the edges. |
| Borderless | Prints with no borders. If your printer cannot print borderless prints, the print will have borders. |
| Bordered [i] | Imprints the shooting information*1 on the border on 9x13 cm or larger prints. |
| xx-up | Option to print 2, 4, 8, 9, 16, or 20 images on one sheet. |
| 20-up [i] 35-up [i] | Prints 20 or 35 images as thumbnails on A4 or Letter size paper*2. • Imprints the shooting information*1 with [20-up [i]] . |
| Default | The page layout varies depending on the printer model or its settings. |

*1: From the Exif data, the camera name, lens name, shooting mode, shutter speed, aperture, exposure compensation amount, ISO speed, white balance, etc., will be imprinted.

*2: After ordering the prints with “Digital Print Order Format (DPOF)” (p.251), printing by following “Direct Printing of Print-Ordered Images” (p.254) is recommended.



If the image's aspect ratio is different from the printing paper's aspect ratio, the image may be cropped significantly when you print it as a borderless print. If the image is cropped, the print may look grainier due to the fewer number of pixels.

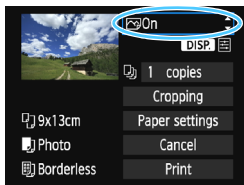

4 Set the printing effects (image optimization).

- Set them if necessary. If you do not need to set any printing effects, go to step 5.
- **Contents displayed on the screen vary depending on the printer.**
- Select the option, then press <SET>.
- Select the desired printing effect, then press <SET>.
- If the <DISP.> icon is displayed brightly next to <DISP.>, you can also adjust the printing effect (p.248).

| Printing Effect | Description |
|----------------------|---|
| On | Prints with the printer's standard colors. The image's Exif data is used to make automatic corrections. |
| Off | No automatic correction is applied. |
| Vivid | Prints with higher saturation to produce more vivid blues and greens. |
| NR | Image noise is reduced before printing. |
| B/W B/W | Prints in black-and-white with true blacks. |
| B/W Cool tone | Prints in black-and-white with cool, bluish blacks. |
| B/W Warm tone | Prints in black-and-white with warm, yellowish blacks. |
| Natural | Prints the image in the actual colors and contrast. No automatic color adjustments are applied. |
| Natural M | Printing characteristics are the same as the "Natural" setting. However, this setting enables finer printing adjustments than with "Natural". |
| Default | Printing differs depending on the printer. For details, refer to the printer's instruction manual. |

* When you change the printing effects, changes are reflected in the image displayed on the upper left of the screen. Note that the printed image may look slightly different from the displayed image, which is only an approximation. This also applies to [Brightness] and [Adjust levels] on page 248.

If you imprint shooting information on an image shot at an expanded ISO speed (H), the correct ISO speed may not be imprinted.



5 Set the date and file number imprinting.

- Set them if necessary.
- Select <Both>, then press <SET>.
- Set the print settings as desired, then press <SET>.



6 Set the number of copies.

- Set it if necessary.
- Select <1>, then press <SET>.
- Set the number of copies, then press <SET>.

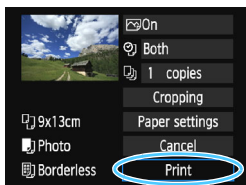

7 Start printing.

- Select [Print], then press <SET>.



- The **[Default]** setting for printing effects and other options are the printer's own default settings as set by the printer's manufacturer. Refer to the printer's instruction manual to find out what the **[Default]** settings are.
- Depending on the image's file size and image-recording quality, it may take some time for the printing to start after you select **[Print]**.
- If image tilt correction (p.249) is applied, it may take longer to print the image.
- To stop the printing, press <SET> while **[Stop]** is displayed, then select **[OK]**.
- If you execute **[Clear all camera settings]** (p.194), all the settings will revert to their defaults.

Adjusting Printing Effects

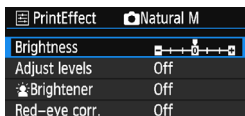
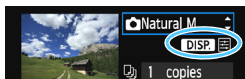

In step 4 on page 246, select the printing effect. When the  icon is displayed brightly next to **<DISP.>**, you can press the **<DISP.>** button to adjust the printing effect. What can be adjusted or what is displayed will depend on the selection made in step 4.

- **Brightness**

The image brightness can be adjusted.

- **Adjust levels**

When you select **[Manual]**, you can change the histogram's distribution and adjust the image's brightness and contrast.

With the Adjust levels screen displayed, press the **<DISP.>** button to change the position of the . Press the **<◀>** **<▶>** keys to freely adjust the shadow level (0-127) or highlight level (128-255).

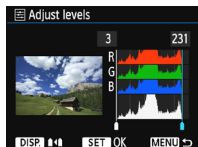

-  **Brightener**

Effective in backlit conditions where the subject's face looks dark. When **[On]** is set, the face will be brightened for printing.

- **Red-eye corr.**

Effective in flash images where the subject has red eyes. When **[On]** is set, the red eye will be corrected for printing.

- The  **[Brightener]** and **[Red-eye corr.]** effects will not be reflected on the screen.
- When **[Detail set.]** is selected, you can adjust the **[Contrast]**, **[Saturation]**, **[Color tone]**, and **[Color balance]**. To adjust the **[Color balance]**, use the **<⬆>** cross keys. B is for blue, A for amber, M for magenta, and G for green. The image's color balance will be adjusted toward the color in the direction of the move.
- If you select **[Clear all]**, all the printing effect settings will be reverted to their defaults.

Cropping the Image

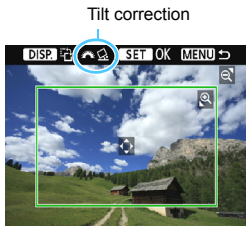

You can crop the image and print only an enlarged version of the cropped portion, as if the image is recomposed.

Set the cropping right before printing. If you change the print settings after setting the cropping, you may have to set the cropping again before printing.

1 On the print setting screen, select [Cropping].

2 Set the cropping frame size, position, and aspect ratio.

- The image area within the cropping frame will be printed. The cropping frame's aspect ratio can be changed with **[Paper settings]**.

Changing the Cropping Frame Size

Press the <Q> or <Q> button to change the cropping frame size. The smaller the cropping frame, the larger the image magnification will be for printing.

Moving the Cropping Frame

Press the <+> cross keys to move the frame over the image vertically or horizontally. Move the cropping frame until it covers the desired image area.

Rotate the Cropping Frame

Pressing the <DISP.> button will toggle the cropping frame between the vertical and horizontal orientations. This enables you to create a vertically oriented print from a horizontal image.

Image Tilt Correction

By turning the <DIAL> dial, you can adjust the image tilt angle up to ± 10 degrees in 0.5-degree increments. When you adjust the image tilt, the <Q> icon on the screen will turn blue.

3 Press <SET> to exit the cropping.

- ▶ The print setting screen will reappear.
- You can check the cropped image area on the upper left of the print setting screen.

- Depending on the printer, the cropped image area may not be printed as you specified.
- The smaller you make the cropping frame, the grainier the picture will look in the print.
- Check the camera's LCD monitor while cropping the image. If you look at the image on a TV screen, the cropping frame may not be displayed accurately.



Handling Printer Errors

If printing does not resume after you resolve a printer error (no ink, no paper, etc.) and select **[Continue]**, operate the buttons on the printer to resume printing. For details on resuming the printing, refer to the printer's instruction manual.

Error Messages

If a problem occurs during printing, an error message will appear on the camera's LCD monitor. Press <  > to stop printing. After fixing the problem, resume printing. For details on how to fix a printing problem, refer to the printer's instruction manual.

Paper Error

Check whether the paper is properly loaded in the printer.

Ink Error

Check the printer's ink level and the waste ink tank.

Hardware Error

Check for any printer problems other than paper and ink problems.

File Error

The selected image cannot be printed via PictBridge. Images taken with a different camera or images edited with a computer may not be printable.

Digital Print Order Format (DPOF)

You can set the print type, date imprinting, and file number imprinting. The print settings will be applied to all print-ordered images. (They cannot be set individually for each image.)

Setting the Printing Options

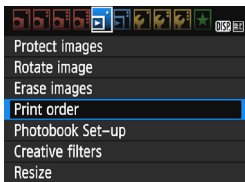

1 Select [Print order].

- Under the [**1**] tab, select [**Print order**], then press <SET>.

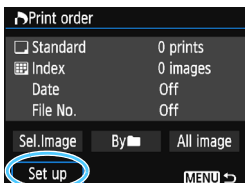

2 Select [Set up].

- Select [**Set up**], then press <SET>.

3 Set the option as desired.

- Set the [**Print type**], [**Date**], and [**File No.**].
- Select the option to be set, then press <SET>. Select the desired setting, then press <SET>.

[Print type]

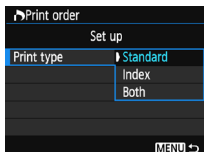

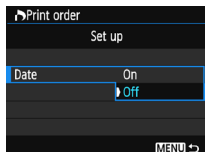

[Date]

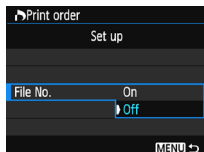

[File No.]



| | | | |
|-------------|---|---|---|
| Print type |  | Standard | Prints one image on one sheet. |
| |  | Index | Multiple thumbnail images are printed on one sheet. |
| |  | Both | Prints both the standard and index prints. |
| Date | On | [On] imprints the recorded date on the print. | |
| | Off | | |
| File number | On | [On] imprints the file number on the print. | |
| | Off | | |

4 Exit the setting.

- Press the <MENU> button.
- ▶ The print order screen will reappear.
- Next, select [**Sel. Image**], [**By** ], or [**All image**] to order the images to be printed.

- RAW images and movies cannot be print ordered. You can print RAW images with PictBridge (p.242).
- Even if [**Date**] and [**File No.**] are set to [**On**], the date or file number may not be imprinted depending on the print type setting and printer model.
- With [**Index**] prints, the [**Date**] and [**File No.**] cannot both be set to [**On**] at the same time.
- When printing with DPOF, use the card whose print order specifications have been set. It cannot be printed with the specified print order if you just extract images from the card and try to print them.
- Certain DPOF-compatible printers and photofinishers may not be able to print the images as you specified. Refer to the printer's instruction manual before printing, or check with your photofinisher about compatibility when ordering prints.
- Do not insert into the camera a card whose print order was set by a different camera and then try to specify a print order. The print order may be overwritten. Also, the print order may not be possible, depending on the image type.

Print Ordering

Sel.Image

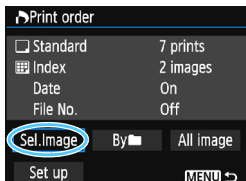

Select and order images one by one. To display the three-image display, press the <☑> button. To return to the single-image display, press the <☐> button.

Press the <MENU> button to save the print order to the card.



Quantity

Total images selected



Checkmark

Index icon

[Standard] [Both]

Press the <▲> <▼> keys to set the number of copies to be printed for the displayed image.

[Index]

Press the <▲> <▼> keys to add a checkmark to the box <☑>. The image will be included in the index print.

By

Select [**Mark all in folder**] and select the folder. A print order for one copy of all the images in the folder will be specified. If you select [**Clear all in folder**] and select the folder, the print order for that folder will all be canceled.

All image

If you select [**Mark all on card**], one copy of all the images on the card will be set for printing. If you select [**Clear all on card**], the print order will be cleared for all the images on the card.



- Note that RAW images and movies will not be included in the print order even if you set [**By **] or [**All image**].
- When using a PictBridge printer, print no more than 400 images for one print order. If you specify more than this, all the images may not be printed.

Direct Printing of Print-Ordered Images

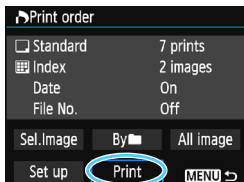

With a PictBridge printer, you can easily print images with DPOF.

1 Prepare to print.

- See page 242.

Follow the “Connecting the Camera to a Printer” procedure up to step 5.

2 Under the [▶ 1] tab, select [Print order].

3 Select [Print].

- [Print] will be displayed only if the camera is connected to a printer and printing is possible.

4 Set the [Paper settings] (p.244).

- Set the printing effects (p.246) if necessary.

5 Select [OK].

- Before printing, be sure to set the paper size.
- Certain printers cannot imprint the file number.
- If [Bordered] is set, certain printers may imprint the date on the border.
- Depending on the printer, the date may appear faint if it is imprinted on a bright background or on the border.

- Under [Adjust levels], [Manual] cannot be selected.
- If you stopped the printing and want to resume printing the remaining images, select [Resume]. Note that printing will not resume if any of the following occurs.
 - You changed the print order or deleted any of the print ordered images before resuming the printing.
 - When index is set, you changed the paper setting before resuming the printing.
 - The card's remaining capacity was low when you paused the printing.
- If a problem occurs during printing, see page 250.



Specifying Images for a Photobook

You can specify up to 998 images to be printed in a photobook. When you use EOS Utility (EOS software) to transfer images to a computer, the specified images will be copied into a dedicated folder. This function is useful for ordering photobooks online and for printing photobooks on a printer.

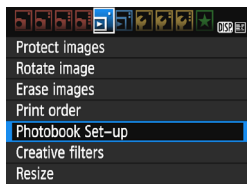
Specifying One Image at a Time



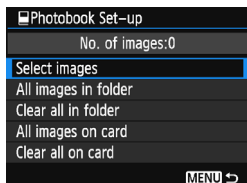

1 Select [Photobook Set-up].

- Under the [] 1 tab, select [Photobook Set-up], then press < >.









2 Select [Select images].

- Select [Select images], then press < >.
- ▶ An image will be displayed.
- To display the three-image display, press the < > button. To return to the single-image display, press the < > button.



3 Select the image to be specified.

- Press the << >> > keys to select the image to be specified, then press the < > > keys.
- Repeat this step to select another image. The number of images that have been specified will be displayed on the upper left of the screen.
- To cancel the image specification, press the < > > keys again.
- To return to the menu, press the <MENU> button.

Specifying All Images in a Folder or on a Card

You can specify all the images in a folder or on a card at once.

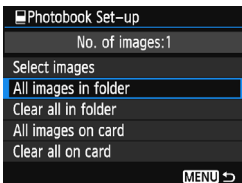

When [**▶ 1: Photobook Set-up**] is set to [**All images in folder**] or [**All images on card**], all the images in the folder or on the card will be specified.

To cancel the image specification, select [**Clear all in folder**] or [**Clear all on card**].

- ❗ RAW images and movies cannot be specified.
- Do not specify images already specified for a photobook in another camera for another photobook with this camera. The photobook settings may be overwritten.

11

Customizing the Camera

You can make fine adjustments to various camera functions to suit your picture-taking preferences with Custom Functions. Custom Functions can be set and used only in Creative Zone modes.

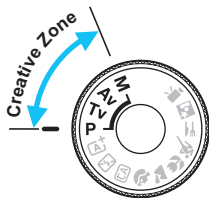

MENU Setting Custom Functions ☆

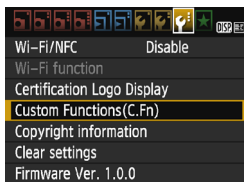

1 Select [Custom Functions (C.Fn)].

- Under the [**3**] tab, select [**Custom Functions (C.Fn)**], then press <SET>.

Custom Function number

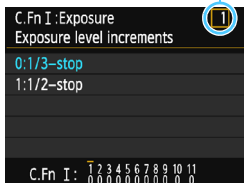

2 Select the Custom Function number.

- Press the <◀> <▶> keys to select the Custom Function number, then press <SET>.

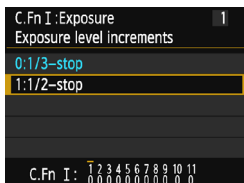

3 Change the setting as desired.

- Press the <▲> <▼> keys to select the desired setting (number), then press <SET>.
- Repeat steps 2 and 3 if you want to set other Custom Functions.
- At the bottom of the screen, the current Custom Function settings are indicated below the respective function numbers.

4 Exit the setting.

- Press the <MENU> button.
- ▶ The screen for step 1 will reappear.

Clearing All Custom Functions

Under [**3**: Clear settings], select [**Clear all Custom Func. (C.Fn)**] to clear all the Custom Function settings (p.194).

Custom Functions

C.Fn I: Exposure

| C.Fn I: Exposure | | | LV Shooting |
|------------------|--|-------|-----------------------|
| 1 | Exposure level increments | p.260 | <input type="radio"/> |
| 2 | ISO expansion | | <input type="radio"/> |
| 3 | Flash synchronization speed in Av mode | p.261 | <input type="radio"/> |

C.Fn II: Image

| | | | |
|---|--------------------------------|-------|-----------------------|
| 4 | Long exposure noise reduction | p.262 | <input type="radio"/> |
| 5 | High ISO speed noise reduction | p.263 | <input type="radio"/> |
| 6 | Highlight tone priority | | <input type="radio"/> |

C.Fn III: Autofocus/Drive

| | | | |
|---|-----------------------|-------|---------------------------------------|
| 7 | AF-assist beam firing | p.264 | <input type="radio"/> (With AFQuick*) |
|---|-----------------------|-------|---------------------------------------|

* If you use an EX-series Speedlite (sold separately) equipped with an LED light, the LED light will turn on for AF-assist even in the AF □ or AF ∞ mode.

C.Fn IV: Operation/Others

| | | | |
|----|---------------------------|-------|----------------------------------|
| 8 | Shutter/AE lock button | p.265 | <input type="radio"/> |
| 9 | Assign SET button | p.266 | <input type="radio"/> (Except 3) |
| 10 | Flash button function | | <input type="radio"/> |
| 11 | LCD display when power ON | | <input type="radio"/> |



- Custom Functions cannot be set during movie shooting. (Settings already set will be disabled.)
- Shaded Custom Function does not function during Live View (LV) shooting.

MENU Custom Function Settings ☆

Custom Functions are organized into four groups based on the function type: C.Fn I: Exposure, C.Fn II: Image, C.Fn III: Autofocus/Drive, C.Fn IV: Operation/Others.

C.Fn I: Exposure

C.Fn-1 Exposure level increments

0: 1/3-stop

1: 1/2-stop

Sets 1/2-stop increments for the shutter speed, aperture, exposure compensation, AEB, flash exposure compensation, etc. This is effective when you prefer to control the exposure in less fine increments than 1/3-stop increments.

 When 1 is set, the exposure level will be displayed in the viewfinder and on the LCD Monitor as shown below.



C.Fn-2 ISO expansion

0: Off

1: On

When you set the ISO speed, you will be able to set "H" (equivalent to ISO 12800). Note that if [C.Fn-6: Highlight tone priority] is set to [1: Enable], "H" cannot be set.

C.Fn-3 Flash Synchronization Speed in Av Mode

You can set the flash-sync speed for flash photography in the aperture-priority AE <Av> mode.

0: Auto

The flash sync speed is set automatically within a range of 1/200 sec. to 30 sec. to suit the scene's brightness. With an external Speedlite, high-speed sync will also be possible.

1: 1/200-1/60 sec. auto

Prevents a slow shutter speed from being set in low-light conditions. It is effective for preventing subject blur and camera shake. However, while the subject will be properly exposed with the flash, the background may come out dark.

2: 1/200 sec. (fixed)

The flash-sync speed is fixed at 1/200 sec. This more effectively prevents subject blur and camera shake than with [1: 1/200-1/60sec. auto]. However, in low light, the subject's background will come out darker than with [1: 1/200-1/60sec. auto].



When 1 or 2 is set, high-speed sync cannot be used with an external Speedlite.

C.Fn II: Image

C.Fn-4 Long Exposure Noise Reduction

0: Off

1: Auto

For exposures of 1 sec. or longer, noise reduction is performed automatically if noise typical of long exposures is detected. This [Auto] setting is effective in most cases.

2: On

Noise reduction is performed for all exposures of 1 sec. or longer. The [2: On] setting may reduce noise that cannot be detected with the [1: Auto] setting.

- With settings 1 and 2, after the picture is taken, the noise reduction process may take the same amount of time as the exposure. You cannot take another picture until the noise reduction process is completed.
- At ISO 1600 or higher, noise may be more pronounced with setting 2 than with setting 0 or 1.
- With setting 1 or 2, if a long exposure is shot with the Live View image displayed, "BUSY" will be displayed during the noise reduction process. The Live View display will not appear until the noise reduction is completed. (You cannot take another picture.)

C.Fn-5 High ISO speed noise reduction

This function reduces the noise generated in the image. Although noise reduction is applied at all ISO speeds, it is particularly effective at high ISO speeds. At low ISO speeds, the noise in the darker parts of the image (shadow areas) is further reduced. Change the setting to suit the noise level.

0: Standard

2: Strong

1: Low

3: Disable



- With setting 2, the maximum burst during continuous shooting will greatly decrease. Also, the continuous shooting speed may be slower.
- If you play back or directly print a **RAW** or **RAW** + **L** image with the camera, the high ISO speed noise reduction effect may become smaller. Check the noise reduction effect or print noise-reduced images with Digital Photo Professional (EOS software, p.314).
- If you send RAW images to a smartphone, the high ISO speed noise reduction effect of saved images on the smartphone may become smaller. Therefore, if you shoot RAW images, setting the image-recording quality to **RAW** + **L** is recommended.

C.Fn-6 Highlight tone priority

0: Disable

1: Enable

Improves the highlight detail. The dynamic range is expanded from the standard 18% gray to bright highlights. The gradation between the grays and highlights becomes smoother.



- With setting 1, the Auto Lighting Optimizer (p.123) is automatically set to **[Disable]** and the setting cannot be changed.
- With setting 1, noise (grainy image, banding, etc.) may become slightly more noticeable than with setting 0.



With setting 1, the ISO setting range will be ISO 200 - ISO 6400. Also, the **<D+>** icon will be displayed on the LCD monitor and in the viewfinder to indicate that highlight tone priority is enabled.

C.Fn III: Autofocus/Drive

C.Fn-7 AF-assist beam firing

Enables or disables the built-in flash's AF-assist beam or the EOS-dedicated external Speedlite's AF-assist beam.

0: Enable

The AF-assist beam will be emitted when necessary.

1: Disable

The AF-assist beam will not be emitted. This prevents the AF-assist beam from disturbing others.

2: Enable external flash only

If an external Speedlite is attached, it will emit the AF-assist beam when necessary. The camera's built-in flash will not fire the AF-assist beam.

3: IR AF assist beam only

When an external Speedlite is attached, only the infrared AF-assist beam will be emitted. This prevents any Speedlite which uses a series of intermittent flashes (like the built-in flash) from emitting the AF-assist beam.

With an EX-series Speedlite equipped with an LED light, the LED light will not automatically turn on for AF-assist.

 If an external Speedlite's [AF-assist beam firing] Custom Function is set to [Disabled], the Speedlite will not emit the AF-assist beam even if the camera's C.Fn-7 is set to 0, 2, or 3.

C.Fn IV: Operation/Others

C.Fn-8 Shutter/AE lock button

0: AF/AE lock

1: AE lock/AF

This is convenient when you want to focus and meter separately. Press the <★> button to autofocus, and press the shutter button halfway to apply AE lock.

2: AF/AF lock, no AE lock

During AI Servo AF, you can press the <★> button to pause the AF operation momentarily. This prevents the AF from being thrown off by any obstacle passing between the camera and subject. The exposure is set at the moment the picture is taken.

3: AE/AF, no AE lock

This is useful for subjects that keep moving and stopping repeatedly. During AI Servo AF, you can press the <★> button to start or stop the AI Servo AF operation. The exposure is set at the moment the picture is taken. Thus, you can set your camera, so that the optimum focusing and exposure can be achieved and wait for the decisive moment.



During Live View shooting

- With setting 1 or 3, press the <★> button for One-Shot AF.
- With setting 0 or 2, press the shutter button halfway for One-Shot AF.

C.Fn-9 Assign SET button

You can assign a frequently-used function to <SET>. When the camera is ready to shoot, pressing the <SET> button will display the respective function setting screen.

0: Normal (disabled)

1: Image quality

The image quality setting screen will appear. Select the desired image-recording quality, then press <SET>.

2: Flash exposure compensation

The flash exposure compensation setting screen will appear. Set the adjustment amount, then press <SET>.

3: LCD monitor On/Off

You can turn on or off the LCD monitor.

4: Depth-of-field preview

The lens will stop down to the aperture that was set, and you can see the depth of field (range of acceptable focus) in the viewfinder or in the Live View image.

C.Fn-10 Flash button function

0: Raise built-in flash

1: ISO speed

The ISO speed setting screen will appear. Press the <◀> <▶> keys or turn the <☀> dial to change the ISO speed. You can also refer to the viewfinder to set the ISO speed.

C.Fn-11 LCD display when power ON

0: Display on

When the power switch is turned on, the shooting settings will be displayed (p.54).

1: Previous display status

If you pressed the <DISP.> button and turned off the camera while the LCD monitor was off, the shooting function settings will not be displayed when you turn on the camera again. This helps to save battery power. The menu operations and image playback will be available as usual.

If you pressed the <DISP.> button to display the shooting function settings and then turned off the camera, the shooting settings will be displayed when you turn on the camera again.

MENU Registering My Menu ☆

Under the My Menu tab, you can register up to six menu options and Custom Functions whose settings you change frequently.



1 Select [My Menu settings].

- Under the [★] tab, select [My Menu settings], then press <SET>.

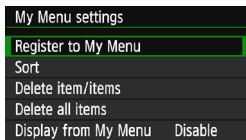

2 Select [Register to My Menu].

- Select [Register to My Menu], then press <SET>.

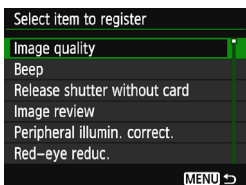

3 Register the desired items.

- Select the item, then press <SET>.
- On the confirmation dialog, select [OK] and press <SET> to register the item.
- You can register up to six items.
- To return to the screen in step 2, press the <MENU> button.

My Menu Settings

• Sort

You can change the order of the registered items in My Menu. Select [Sort] and select the item whose order you want to change. Then press <SET>. With [◆] displayed, press the <▲> <▼> keys to change the order, then press <SET>.

• Delete item/items and Delete all items

You can delete any of the registered items. [Delete item/items] deletes one item at a time, and [Delete all items] deletes all registered items.

• Display from My Menu

When [Enable] is set, the [★] tab will be displayed first when you display the menu screen.



12

Reference

This chapter provides reference information for camera features, system accessories, etc.



Certification Logo

Under the [**3**] tab, if you select [**Certification Logo Display**] and press <[**SET**]>, some of the logos of the camera's certifications will appear. Other certification logos can be found in this Instruction Manual, on the camera body, and on the camera's package.

Using a Household Power Outlet

You can power the camera with a household power outlet by using the DC Coupler DR-E10 and Compact Power Adapter CA-PS700 (both sold separately).

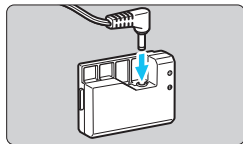

1 Connect the DC coupler.

- Connect the DC cord's plug to the DC coupler.

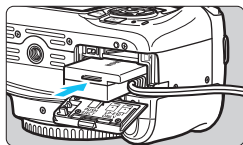

2 Insert the DC coupler.

- Open the cover and insert the DC coupler until it locks in place.

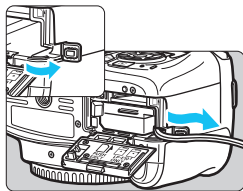

3 Push in the DC cord.

- Open the DC cord hole cover and install the cord as shown in the illustration.
- Close the cover.

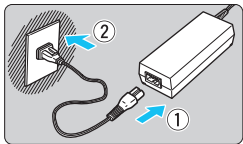

4 Connect the power cord.

- Connect the power cord as shown in the illustration.
- After using the camera, unplug the power plug from the power outlet.

 Do not connect or disconnect the power cord when the camera's power switch is set to <ON>.

 AC Adapter Kit ACK-E10 can also be used.

Using a Remote Switch

Remote Switch RS-60E3 (sold separately) comes with an approx. 60 cm/ 2.0 ft cord. When connected to the camera's remote control terminal, it can be pressed halfway and completely, just like the shutter button.

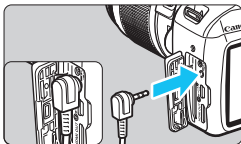

Remote Controller RC-6, RC-1, and RC-5 (all sold separately) cannot be used with this camera.

Using the Eyepiece Cover

When you use the self-timer, bulb, or a remote switch and do not look through the viewfinder, stray light entering the viewfinder can cause the picture to look dark. To prevent this, use the eyepiece cover (p.33) attached to the camera strap.

During Live View shooting and movie shooting, attaching the eyepiece cover is unnecessary.

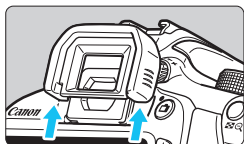

1 Detach the eyecup.

- Push the bottom of the eyecup to detach it.

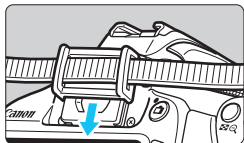

2 Attach the eyepiece cover.

- Slide the eyepiece cover down into the eyepiece groove to attach it.
- After you finish shooting, detach the eyepiece cover and attach the eyecup by sliding it down into the eyepiece groove.

External Speedlites

EOS-dedicated, EX-series Speedlites

Basically operates like a built-in flash for easy operation.

When an EX-series Speedlite (sold separately) is attached to the camera, almost all the autoflash control is done by the camera. In other words, it is like a high-output flash attached externally in place of the built-in flash.



For detailed instructions, refer to the EX-series Speedlite's instruction manual. This camera is a Type-A camera.



Shoe-mount Speedlites



Macro Lites

- With an EX-series Speedlite not compatible with flash function settings (p.199), only **[Flash exp. comp]** and **[E-TTL II meter.]** can be set for **[External flash func. setting]**. (**[Shutter sync.]** can also be set with certain EX-series Speedlites.)
- If flash exposure compensation is set with the external Speedlite, the flash exposure compensation icon displayed on the camera's LCD monitor will change from  to .
- If the external Speedlite's Custom Function has the flash metering mode set to TTL autoflash, the flash will fire at full output only.

Canon Speedlites Other Than the EX-series

- **With an EZ/E/EG/ML/TL-series Speedlite set in TTL or A-TTL autoflash mode, the flash will be fired at full output only.** Set the camera's shooting mode to <M> (manual exposure) or <Av> (aperture-priority AE) and adjust the aperture setting before shooting.
- When using a Speedlite that has manual flash mode, shoot in the manual flash mode.

Using Non-Canon Flash Units

Sync Speed

The camera can synchronize with compact, non-Canon flash units at 1/200 sec. or slower shutter speeds. Use a sync speed slower than 1/200 sec.

Be sure to test the flash unit beforehand to make sure it synchronizes properly with the camera.



- If the camera is used with a flash unit or flash accessory dedicated to another camera brand, the camera may not operate properly and malfunction may result.
- Do not attach a high-voltage flash unit on the camera's hot shoe. It may not fire.

Using Eye-Fi Cards

With a commercially-available Eye-Fi card already set up, you can automatically transfer captured images to a computer or upload them to an online service via a wireless LAN.

The image transfer is a function of the Eye-Fi card. For instructions on how to set up and use the Eye-Fi card or to troubleshoot any image transfer problems, refer to the Eye-Fi card's instruction manual or contact the card manufacturer.

⚠ The camera is not guaranteed to support Eye-Fi card functions (including wireless transfer). In case of a problem with an Eye-Fi card, please check with the card manufacturer. Also note that approval is required to use Eye-Fi cards in many countries or regions. Without approval, use of the card is not permitted. If it is unclear whether the card has been approved for use in your area, please check with the card manufacturer.

1 Insert an Eye-Fi card (p.36).

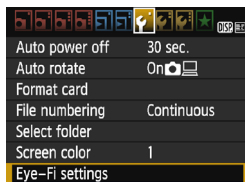

2 Select [Eye-Fi settings].

- Under the [**1**] tab, select [**Eye-Fi settings**], then press <SET>.
- This menu is displayed only when an Eye-Fi card is inserted into the camera.



3 Enable Eye-Fi transmission.

- Select [**Eye-Fi trans.**], then press <SET>.
- Select [**Enable**], then press <SET>.
- If you set [**Disable**], there will be no automatic transmission even with the Eye-Fi card inserted (transmission status icon ).

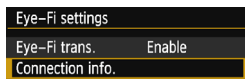

4 Display the connection information.

- Select [**Connection info.**], then press <SET>.



5 Check the [Access point SSID:].

- Check that an access point is displayed for [Access point SSID:].
- You can also check the Eye-Fi card's MAC address and firmware version.
- Press the <MENU> button three times to exit the menu.



6 Take the picture.

- ▶ The picture is transferred and the <Wi-Fi> icon switches from gray (not connected) to one of the icons below.
- For transferred images, [Image icon] is displayed in the shooting information display (p.232).

Transmission status icon

- (Gray) **Not connected** : No connection with access point.
- (Blinking) **Connecting...** : Connecting to access point.
- (Illuminated) **Connected**: Connection to access point established.
- (1) **Transferring...** : Image transfer to access point in progress.

Cautions for Using Eye-Fi Cards

- If [4:Wi-Fi/NFC] is set to [Enable], image transfer with an Eye-Fi card is not possible.
- If "" is displayed, an error occurred while retrieving the card information. Turn the camera's power switch off and on again.
- Even if [1: Eye-Fi trans.] is set to [Disable], it may still transmit a signal. In hospitals, airports, and other places where wireless transmissions are prohibited, remove the Eye-Fi card from the camera.
- If the image transfer does not function, check the Eye-Fi card and computer settings. For details, refer to the card's instruction manual.
- Depending on the wireless LAN's connection conditions, the image transfer may take longer or it may be interrupted.
- The Eye-Fi card may become hot as it transmits.
- The battery power will be consumed faster.
- During the image transfer, auto power off will not take effect.
- If you insert a wireless LAN card other than an Eye-Fi card, [1: Eye-Fi settings] will not appear. Also, the transmission status icon <Wi-Fi> will not appear.

Function Availability Table by Shooting Mode

●: Set automatically ○: User selectable □: Not selectable/Disabled

| Mode Dial | | Basic Zone | | | | | | | | Creative Zone | | | | ⓘ | |
|---------------------------------------|-------------------------|------------|-----|-----|-----|-----|-----|-----|-------|---------------|----|----|---|---|-----------------|
| | | A+ | Fn | CA | Ⓢ | Ⓜ | Ⓜ | Ⓜ | Ⓜ | P | Tv | Av | M | | |
| All image quality settings selectable | | ○ | ○ | ○ | ○ | ○ | ○ | ○ | ○ | ○ | ○ | ○ | ○ | ○ | |
| ISO speed | Automatically set/ Auto | ● | ● | ● | ● | ● | ● | ● | ● | ● | ○ | ○ | ○ | ○ | ○ |
| | Manually set | | | | | | | | | | ○ | ○ | ○ | ○ | ○ ^{*1} |
| | Maximum for Auto | | | | | | | | | | ○ | ○ | ○ | ○ | |
| Picture Style | Automatically set/ Auto | ● | ● | ● | ● | ● | ● | ● | ● | ○ | ○ | ○ | ○ | ○ | ○ |
| | Manual selection | | | | | | | | | ○ | ○ | ○ | ○ | ○ | ○ |
| Ambience-based shots | | | | ○ | ○ | ○ | ○ | ○ | ○ | | | | | | |
| Lighting/scene based shots | | | | | ○ | ○ | ○ | ○ | | | | | | | |
| Blurring/sharpening the background | | | | ○ | | | | | | | | | | | |
| Color tone | | | | | | | | | ○ | | | | | | |
| White balance | Auto | AWB | AWB | AWB | AWB | AWB | AWB | AWB | AWB w | AWB | ○ | ○ | ○ | ○ | ○ |
| | Preset | | | | | | | | | | ○ | ○ | ○ | ○ | ○ |
| | Custom | | | | | | | | | | ○ | ○ | ○ | ○ | ○ |
| | Correction/ Bracketing | | | | | | | | | | ○ | ○ | ○ | ○ | |
| Auto Lighting Optimizer | | ● | ● | ● | ● | ● | ● | ● | ● | ● | ○ | ○ | ○ | ○ | ○ |
| Peripheral illumination correction | | ○ | ○ | ○ | ○ | ○ | ○ | ○ | ○ | ○ | | | | | |
| Long exposure noise reduction | | | | | | | | | | | ○ | ○ | ○ | ○ | |
| High ISO speed noise reduction | | ● | ● | ● | ● | ● | ● | ● | ● | ● | ○ | ○ | ○ | ○ | |
| Highlight tone priority | | | | | | | | | | | ○ | ○ | ○ | ○ | ○ |
| Color space | sRGB | ● | ● | ● | ● | ● | ● | ● | ● | ● | ○ | ○ | ○ | ○ | |
| | Adobe RGB | | | | | | | | | | ○ | ○ | ○ | ○ | |
| AF operation (Viewfinder shooting) | One-Shot AF | | | | ● | ● | ● | | ● | ● | ○ | ○ | ○ | ○ | |
| | AI Servo AF | | | | | | | ● | | | ○ | ○ | ○ | ○ | |
| | AI Focus AF | ● | ● | ● | | | | | | | ○ | ○ | ○ | ○ | |
| AF operation (Live View shooting) | One-Shot AF | ● | ● | ● | ● | ● | ● | ● | ● | ● | ● | ● | ● | | |
| AF method (Live View shooting) | AF □ | ○ | ○ | ○ | ○ | ○ | ○ | ○ | ○ | ○ | ○ | ○ | ○ | ○ | ○ |
| | AF ㄣ | ○ | ○ | ○ | ○ | ○ | ○ | ○ | ○ | ○ | ○ | ○ | ○ | ○ | ○ |
| | AFQuick | ○ | ○ | ○ | ○ | ○ | ○ | ○ | ○ | ○ | ○ | ○ | ○ | ○ | ○ ^{*2} |

*1: Settable only for manual exposures.

*2: If used during movie shooting, it will switch to <AF □>.

| Mode Dial | | Basic Zone | | | | | | | | | Creative Zone | | | | AFQuick | |
|----------------------------|-------------------------------|------------|----|----|----|----|----|----|----|----|---------------|----|----|---|---------|---------|
| | | A+ | TV | CA | AF | AE | AF | AF | AF | AF | P | Tv | Av | M | | |
| AF | AF point selection | | | | | | | | | | | | | | | AFQuick |
| | AF-assist beam | ● | | ● | ● | *3 | ● | *4 | ● | ● | ○ | ○ | ○ | ○ | | |
| Metering mode | Evaluative metering | ● | ● | ● | ● | ● | ● | ● | ● | ○ | ○ | ○ | ○ | | | |
| | Metering mode selection | | | | | | | | | ○ | ○ | ○ | ○ | | | |
| Exposure | Program shift | | | | | | | | | ○ | | | | | | |
| | Exposure compensation | | | | | | | | | ○ | ○ | ○ | | ○ | *6 | |
| | AEB | | | | | | | | | ○ | ○ | ○ | ○ | | | |
| | AE lock | | | | | | | | | ○ | ○ | ○ | | ○ | *6 | |
| | Depth-of-field preview | | | | | | | | | ○ | (C.Fn-9-4) | | | | | |
| Drive/ self-timer | Single shooting | ○ | ○ | ○ | | ○ | ○ | | ○ | ○ | ○ | ○ | ○ | ○ | | |
| | Continuous shooting | | | ○ | ○ | | | ○ | | ○ | ○ | ○ | ○ | | | |
| | ⌚ (10 sec.) | ○ | ○ | ○ | ○ | ○ | ○ | ○ | ○ | ○ | ○ | ○ | ○ | | | |
| | ⌚ ₂ (2 sec.) | | | | | | | | | ○ | ○ | ○ | ○ | | | |
| | ⌚ _c (Continuous) | ○ | ○ | ○ | ○ | ○ | ○ | ○ | ○ | ○ | ○ | ○ | ○ | | | |
| Built-in flash | Automatic firing | ● | | ○ | ● | | ● | | ● | | | | | | | |
| | Flash on (Fires at all times) | | | ○ | | | | | ○ | | ○ | ○ | ○ | ○ | | |
| | Flash off | | ● | ○ | | ● | | ● | ○ | | ○ | ○ | ○ | ○ | ● | |
| | Red-eye reduction | ○ | | ○ | ○ | | ○ | | ○ | ○ | ○ | ○ | ○ | ○ | | |
| | FE lock | | | | | | | | | | ○ | ○ | ○ | ○ | | |
| | Flash exposure compensation | | | | | | | | | | ○ | ○ | ○ | ○ | | |
| External flash | Function settings | | | | | | | | | | ○ | ○ | ○ | ○ | | |
| | Custom Function settings | | | | | | | | | | ○ | ○ | ○ | ○ | | |
| Live View shooting | | ○ | ○ | ○ | ○ | ○ | ○ | ○ | ○ | ○ | ○ | ○ | ○ | ○ | | |
| Aspect ratio ^{*5} | | | | | | | | | | | ○ | ○ | ○ | ○ | | |
| Quick Control | | ○ | ○ | ○ | ○ | ○ | ○ | ○ | ○ | ○ | ○ | ○ | ○ | ○ | ○ | |
| Feature guide | | ○ | ○ | ○ | ○ | ○ | ○ | ○ | ○ | ○ | ○ | ○ | ○ | ○ | ○ | |

*3: When an external Speedlite is used, it will emit the AF-assist beam when necessary.

*4: If the AF method is <AFQuick> during Live View shooting, the external Speedlite will emit the AF-assist beam when necessary.

*5: Settable only during Live View shooting.

*6: Settable only for autoexposures.

System Map

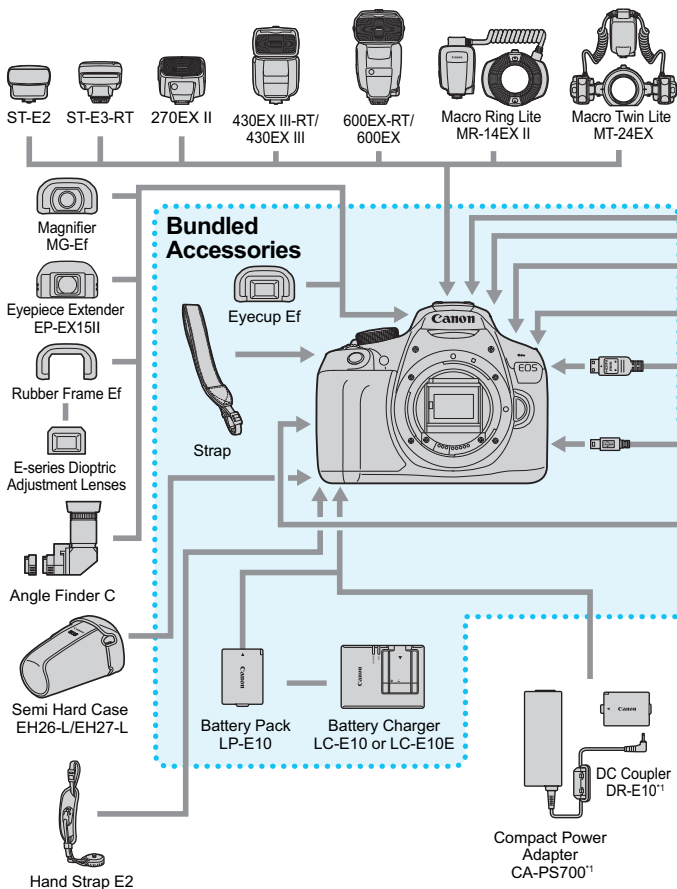

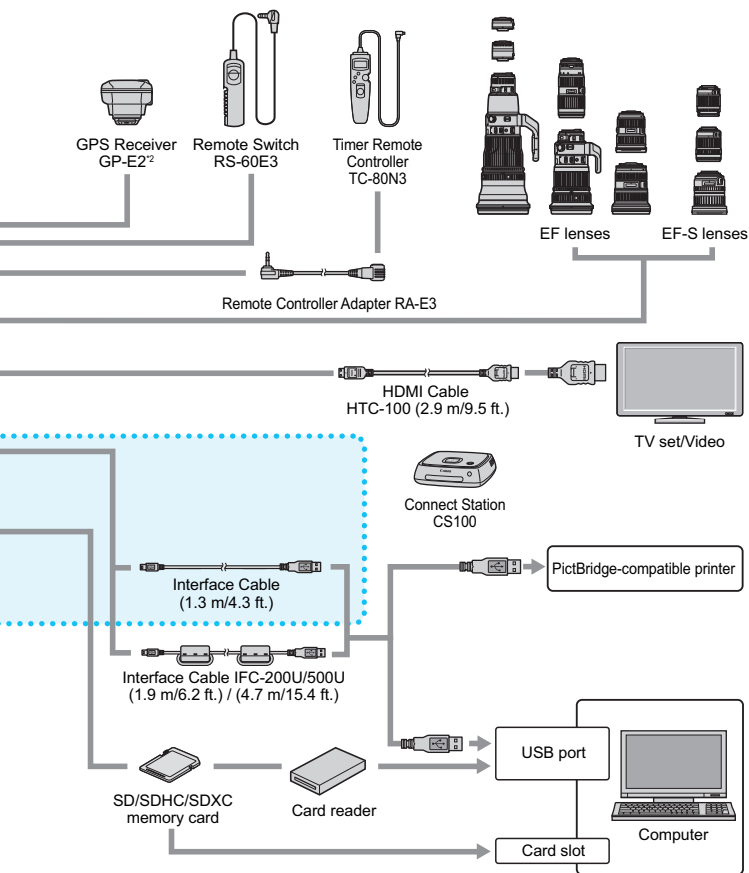

*1: AC Adapter Kit ACK-E10 can also be used.

*2: When using the GP-E2 with this camera, connect it to the camera with the cable provided with the GP-E2.

* All cable lengths given are approximate figures.

MENU Menu Settings

Viewfinder Shooting and Live View Shooting

📷 Shooting 1 (Red)

Page

| | | |
|------------------------------------|--|-----|
| Image quality | L / L / M / M / S1 / S1 / S2 / S3 / RAW + L / RAW | 88 |
| Beep | Enable / Disable | 184 |
| Release shutter without card | Enable / Disable | 184 |
| Image review | Off / 2 sec. / 4 sec. / 8 sec. / Hold | 184 |
| Peripheral illumination correction | Enable / Disable | 124 |
| Red-eye reduction | Disable / Enable | 106 |
| Flash control | Flash firing / Built-in flash function setting / External flash function setting / External flash C.Fn setting / Clear external flash C.Fn setting | 198 |

📷 Shooting 2 (Red)

| | | |
|--------------------------------|---|------------------|
| Exposure compensation/AEB | 1/3-stop or 1/2-stop increments, ±5 stops (AEB: ±2 stops) | 118 |
| Auto Lighting Optimizer | Disable / Low / Standard / High | 123 |
| Metering mode | Evaluative metering / Partial metering / Center-weighted average metering | 115 |
| Custom White Balance | Manual setting of white balance | 133 |
| White balance shift/bracketing | WB correction: White balance correction BKT setting: White balance bracketing | 135 136 |
| Color space | sRGB / Adobe RGB | 137 |
| Picture Style | Auto / Standard / Portrait / Landscape / Neutral / Faithful / Monochrome / User Def. 1-3 | 95 126 129 |



Shaded menu options are not displayed in Basic Zone modes.

📷 Shooting 3 (Red)

Page

| | | |
|-------------------------|---|-----|
| Dust Delete Data | Obtains data to be used to erase dust spots | 202 |
| ISO Auto | Max.:400 / Max.:800 / Max.:1600 / Max.:3200 / Max.:6400 | 94 |

📷 Shooting 4* (Red)

| | | |
|---------------------------|---|-----|
| Live View shooting | Enable / Disable | 141 |
| AF method | FlexiZone - Single /  Live mode / Quick mode | 148 |
| Grid display | Off / Grid 1  / Grid 2  | 145 |
| Aspect ratio | 3:2 / 4:3 / 16:9 / 1:1 | 146 |
| Metering timer | 4 sec. / 8 sec. / 16 sec. / 30 sec. / 1 min. / 10 min. / 30 min. | 147 |

* In Basic Zone modes, these menu options are displayed under the **[📷2]** tab.

▶ Playback 1 (Blue)



| | | |
|-------------------------|--|-----|
| Protect images | Protect images | 228 |
| Rotate image | Rotate images | 211 |
| Erase images | Erase images | 230 |
| Print order | Specify images to be printed (DPOF) | 251 |
| Photobook Set-up | Specify images for a photobook | 255 |
| Creative filters | Grainy B/W / Soft focus / Fish-eye effect / Toy camera effect / Miniature effect | 236 |
| Resize | Downsize JPEG image's pixel count | 239 |

▶ Playback 2 (Blue)

Page

| | | |
|--|---|-----|
| Histogram display | Brightness / RGB | 234 |
| Image jump w/  | 1 image / 10 images / 100 images / Date / Folder / Movies / Stills / Rating | 209 |
| Slide show | Playback description / Display time / Repeat / Transition effect / Background music | 222 |
| Rating | [OFF] / [•] / [••] / [•••] / [••••] / [•••••] | 212 |

🔧 Set-up 1 (Yellow)

| | | |
|------------------------|---|-----|
| Auto power off | 30 sec. / 1 min. / 2 min. / 4 min. / 8 min. / 15 min. / Disable | 185 |
| Auto rotate | On   / On  / Off | 192 |
| Format card | Initialize and erase data on the card | 52 |
| File number | Continuous / Auto reset / Manual reset | 188 |
| Select folder | Create and select a folder | 186 |
| Screen color | Select the shooting settings screen color | 197 |
| Eye-Fi settings | Displayed when a commercially-available Eye-Fi card is inserted | 274 |

🔧 Set-up 2 (Yellow)

| | | |
|---|--|-----|
| LCD brightness | Adjust the brightness (seven levels) | 185 |
| LCD off/on button | Shutter button / Shutter/DISP / Remains on | 197 |
| Date/Time/Zone | Date (year, month, day) / Time (hour, min., sec.) / Daylight saving time / Time zone | 41 |
| Language  | Select the interface language | 43 |
| Clean manually | Clean image sensor manually | 204 |
| Feature guide | Enable / Disable | 55 |
| GPS device settings | Settings available when the GPS Receiver GP-E2 (sold separately) is attached | 283 |

🔧 Set-up 3 (Yellow)

Page

| | | |
|-----------------------------------|--|-----|
| Wi-Fi/NFC | Disable / Enable | _* |
| | Allow NFC connections | |
| Wi-Fi function | Connect to smartphone / Upload to Web service | |
| Certification Logo Display | Displays some of the logos of the camera's certifications | 269 |
| Custom Functions (C.Fn) | Customize camera functions as desired | 258 |
| Copyright information | Display copyright information / Enter author's name / Enter copyright details / Delete copyright information | 190 |
| Clear settings | Clear all camera settings / Clear all Custom Func. (C.Fn) | 194 |
| Firmware Ver. | For updating the firmware | - |

* For details, refer to the Wireless Function Instruction Manual.

★ My Menu (Green)

| | | |
|-------------------------|---|-----|
| My Menu settings | Register frequently-used menu options and Custom Functions | 267 |
|-------------------------|---|-----|



- When using Wi-Fi function, be sure to check the countries and areas of use, and use the device in accordance with the laws and regulations of the country or region.
- **[Wi-Fi/NFC]** cannot be set if the camera is connected to a computer, printer, GPS receiver, TV set, or other device with a cable. When **[Wi-Fi/NFC]** is set to **[Enable]**, you cannot connect the camera to the above devices with a cable.



Cautions for Using GPS Receiver GP-E2 (sold separately)

- Check if your country or area allows the use of GPS and follow any legal regulations.
- When using the GP-E2 with the camera, connect it to the camera with the cable that came with the GP-E2. If you do not use the provided cable, the geotag information will not be appended to the image when you shoot.
- Certain functions of the GP-E2 will not work with this camera. Note the following:
 - The shooting direction is not recorded. (The electronic compass cannot be used.)
 - The geotag information can be appended to a movie when the shooting starts. However, the location will not be displayed on Map Utility (EOS software). Check the location with the camera.









Movie Shooting

Movie 1 (Red)

Page









| | | |
|--|---|-----|
| Movie exposure | Auto / Manual | 176 |
| AF method | FlexiZone - Single /  Live mode / Quick mode | 176 |
| AF with shutter button during movie recording | Disable / Enable | 176 |
| Shutter button/ AE lock button | AF/AE lock / AE lock/AF / AF/AF lock, no AE lock / AE/AF, no AE lock | 177 |
| Highlight tone priority | Disable / Enable | 177 |

Movie 2 (Red)











| | | |
|-----------------------------|--|-----|
| Movie recording size | 1920x1080 ( /  / ) / 1280x720 ( / ) / 640x480 ( / ) | 168 |
| Sound recording | Sound recording: Auto / Manual / Disable | 178 |
| | Recording level | |
| | Wind filter: Disable/ Enable | |
| Metering timer | 4 sec. / 8 sec. / 16 sec. / 30 sec. / 1 min. / 10 min. / 30 min. | 179 |
| Grid display | Off / Grid 1  / Grid 2  | 179 |
| Video snapshot | Disable / 2 sec. movie / 4 sec. movie / 8 sec. movie | 170 |
| Video system | NTSC / PAL | 179 |

 **Movie 3(Red)**

Page

| | | |
|--------------------------------|--|-----|
| Exposure compensation | 1/3-stop increments, ± 3 stops | 180 |
| Auto Lighting Optimizer | Disable / Low / Standard / High | 180 |
| Custom White Balance | Manual setting of white balance | 180 |
| Picture Style |  Auto /  Standard /  Portrait /  Landscape /  Neutral /  Faithful /  Monochrome /  User Def. 1-3 | 180 |

Menus for Movie Shooting Mode

- The [ 1], [ 2], and [ 3] tabs appear only in the movie shooting mode.
- The [ 2], [ 3], [ 4], and [ ★] tabs do not appear.
- The following menu items do not appear:
 - [ 1]: Red-eye reduction, Flash control
 - [ 1]: Screen color
 - [ 2]: LCD off/on button, Clean manually
 - [ 3]: Certification Logo Display, Custom Functions (C.Fn), Copyright information, Clear settings, Firmware Ver.

Troubleshooting Guide

If a problem occurs with the camera, first consult this Troubleshooting Guide. If this Troubleshooting Guide does not resolve the problem, contact your dealer or nearest Canon Service Center.

Power-Related Problems

The battery does not recharge.

- Do not use any battery other than a genuine Canon Battery Pack LP-E10.

The battery charger's lamp blinks.

- If the battery charger has a problem, the protection circuit will stop the charging and the charge lamp will blink in orange. If this happens, unplug the charger's power plug from the power outlet and detach the battery. Attach the battery to the charger again and wait a while before connecting the charger to a power outlet again. If the problem persists, contact your dealer or nearest Canon Service Center.

The camera does not operate even when the power switch is set to <ON>.

- Make sure the battery is properly installed in the camera (p.36).
- Make sure the card slot/battery compartment cover is closed (p.36).
- Recharge the battery (p.34).
- Press the <DISP.> button (p.54).

The access lamp still lights or blinks even when the power switch is <OFF>.

- If the power is turned off while an image is being recorded to the card, the access lamp will remain on/continue to blink for a few seconds. When the image recording is completed, the power will turn off automatically.

The battery becomes exhausted quickly.

- Use a fully-charged battery (p.34).
- The rechargeable battery performance will degrade over repeated use. Purchase a new one.
- The number of possible shots will decrease with any of the following operations:
 - Pressing the shutter button halfway for a prolonged period.
 - Activating the AF frequently without taking a picture.
 - Using the lens's Image Stabilizer.
 - Using the LCD monitor frequently.
 - Continuing Live View shooting or movie shooting for a prolonged period.
 - The Eye-Fi card's communication function is operating.

The camera turns off by itself.

- Auto power off is in effect. If you do not want auto power off to take effect, set [**1: Auto power off**] to [**Disable**] (p.185).
- Even if [**1: Auto power off**] is set to [**Disable**], the LCD monitor will still turn off after the camera is left idle for approx. 30 min. (The camera's power does not turn off.) Press the <DISP.> button to turn on the LCD monitor.

Shooting-Related Problems

The lens cannot be attached.

- The camera cannot be used with EF-M lenses (p.44).

No images can be shot or recorded.

- Make sure the card is properly inserted (p.36).
- Slide the card's write-protect switch to the write/erase position (p.36).
- If the card is full, replace the card or delete unnecessary images to make space (p.36, 230).
- If you try to focus in the One-Shot AF mode and the focus indicator <●> in the viewfinder blinks, a picture cannot be taken. Press the shutter button halfway again to refocus automatically, or focus manually (p.47, 101).

The card cannot be used.

- If a card error message is displayed, see page 38 or 298.

The image is out of focus.

- Set the lens's focus mode switch to <AF> (p.44).
- Press the shutter button gently to prevent camera shake (p.46-47).
- If the lens has an Image Stabilizer, set the IS switch to <ON>.
- In low light, the shutter speed may become slow. Use a faster shutter speed (p.108), set a higher ISO speed (p.92), use flash (p.104), or use a tripod.

I cannot lock the focus and recompose the shot.

- Set the AF operation to One-Shot AF. Focus lock is not possible in the AI Servo AF mode, or when servo takes effect in AI Focus AF mode (p.97).

Horizontal stripes appear, or the exposure or color tone look strange.

- Horizontal stripes (noise) or irregular exposures can be caused by fluorescent lighting, LED lighting, or other light sources during viewfinder or Live View shooting. Also, the exposure or color tone may not come out right. A slow shutter speed may solve the problem.

The standard exposure cannot be obtained or the exposure is irregular.

- During viewfinder shooting or Live View shooting, if you use a TS-E lens (except the TS-E17mm f/4L or TS-E24mm f/3.5L II) and shift or tilt the lens or use an Extension Tube, the standard exposure may not be obtained or the exposure may be irregular.

The continuous shooting speed is slow.

- Depending on the lens type, shutter speed, aperture, subject conditions, brightness, etc., the continuous shooting speed may become slower.

The maximum burst during continuous shooting is lower.

- Under [**43: Custom Functions (C.Fn)**], set [**5: High ISO speed noise reduct'n**] to [**0: Standard**], [**1: Low**], or [**3: Disable**]. If it is set to [**2: Strong**], the maximum burst during continuous shooting will greatly decrease (p.263).
- During WB bracketing, the maximum burst for continuous shooting will decrease (p.136).
- If you shoot something that has fine detail such as a field of grass, the file size will be larger, and the actual maximum burst may be lower than the number mentioned on page 89.

ISO 100 cannot be set.

- Under [**F3: Custom Functions (C.Fn)**], if [**6: Highlight tone priority**] is set to [**1: Enable**], ISO 100 cannot be set. If [**0: Disable**] is set, ISO 100 can be set (p.263). This also applies to movie shooting (p.177).

ISO speed [H] (equivalent to ISO 12800) cannot be set.

- Under [**F3: Custom Functions (C.Fn)**], if [**6: Highlight tone priority**] is set to [**1: Enable**], the [**H**] ISO speed (equivalent to ISO 12800) cannot be selected even when [**2: ISO expansion**] is set to [**1: On**]. If [**0: Disable**] is set for [**6: Highlight tone priority**], [**H**] can be set (p.263).

The Auto Lighting Optimizer cannot be set.

- Under [**F3: Custom Functions (C.Fn)**], if [**6: Highlight tone priority**] is set to [**1: Enable**], the Auto Lighting Optimizer cannot be set. If [**0: Disable**] is set, the Auto Lighting Optimizer can be set (p.263).

Even though I set a decreased exposure compensation, the image comes out bright.

- Set [**2: Auto Lighting Optimizer**] to [**Disable**]. When [**Low**], [**Standard**], or [**High**] is set, even if you set a decreased exposure compensation or flash exposure compensation, the image may come out bright (p.123).

When I use the <Av> mode with flash, the shutter speed becomes slow.

- If you shoot at night when the background is dark, the shutter speed automatically becomes slow (slow-sync shooting) so that both the subject and background are properly exposed. To prevent a slow shutter speed, under [**3: Custom Functions (C.Fn)**], set [**3: Flash sync. speed in Av mode**] to [**1: 1/200-1/60sec. auto**] or [**2: 1/200sec. (fixed)**] (p.261).

The built-in flash rises by itself.

- In shooting modes (<A> <CA> <P> <M> <S>) whose default setting is <A> (built-in flash auto firing), the built-in flash will be raised automatically when necessary.

The built-in flash does not fire.

- If you use the built-in flash too often in too short a period of time, the flash may stop firing for a while to protect the light-emitting unit.

The external flash always fires at full output.

- If you use a flash unit other than an EX-series Speedlite, the flash will always be fired at full output (p.273).
- Under [**1: Flash control**], if [**Flash metering mode**] in [**External flash C.Fn setting**] is set to [**TTL**], the flash will always fire at full output (p.201).

Flash exposure compensation cannot be set for the external Speedlite.

- If flash exposure compensation is set with the external Speedlite, flash exposure compensation cannot be set with the camera. When the external Speedlite's flash exposure compensation is canceled (set to 0), flash exposure compensation can be set with the camera.

High-speed sync cannot be set in the <Av> mode.

- Under [**F3: Custom Functions (C.Fn)**], set [**3: Flash sync. speed in Av mode**] to [**0: Auto**] (p.261).

The camera makes a noise when it is shaken.

- The built-in flash's pop-up mechanism moves slightly. This is normal and not a malfunction.

The shutter makes two shooting sounds during Live View shooting.

- If you use flash, the shutter will make two sounds each time you shoot (p.141).

During Live View shooting, a white <🔥> or red <🔥> icon is displayed.

- It indicates that the camera's internal temperature is high. If the white <🔥> icon is displayed, the still photo's image quality may deteriorate. If the red <🔥> icon is displayed, it indicates that the Live View shooting will soon stop automatically (p.157).

During movie shooting, a red 🔥 icon is displayed.

- It indicates that the camera's internal temperature is high. If the red <🔥> icon is displayed, it indicates that the movie shooting will soon stop automatically (p.181).

Movie shooting stops by itself.

- If the card's writing speed is slow, movie shooting may stop automatically. Use an SD Speed Class 6 "CLASS 6" or faster card. To find out the card's reading/writing speed, refer to the card manufacturer's website, etc.
- If a movie clip's file size reaches 4 GB or the shooting length reaches 29 min. 59 sec., the movie shooting will stop automatically.

The ISO speed cannot be set for movie shooting.

- If [**1: Movie exposure**] is set to [**Auto**], the ISO speed will be set automatically. If [**Manual**] is set, you can set the ISO speed manually (p.162).

The exposure changes during movie shooting.

- If you change the shutter speed or aperture during movie shooting, the changes in the exposure may be recorded.
- Zooming the lens during movie shooting can cause changes in the exposure regardless of whether the lens's maximum aperture changes or not. The changes in the exposure may be recorded as a result.

The subject looks distorted during movie shooting.

- If you move the camera to the left or right quickly (high-speed panning) or shoot a moving subject, the image may look distorted.

The image flickers or horizontal stripes appear during movie shooting.

- Flickering, horizontal stripes (noise), or irregular exposures can be caused by fluorescent lighting, LED lighting, or other light sources during movie shooting. Also, changes in the exposure (brightness) or color tone may be recorded. With manual exposure, a slow shutter speed may solve the problem.

Wireless Functions

Wi-Fi cannot be set.

- If the camera is connected to a computer, printer, GPS receiver, TV set, or other device with a cable, Wi-Fi cannot be set ([**3: Wi-Fi/NFC**] will be grayed out). Disconnect the cable before changing any settings.
- Refer to the Wireless Function Instruction Manual.

Display Problems

The menu screen shows fewer tabs and options.

- In Basic Zone modes and in movie shooting mode, certain tabs and menu options are not displayed. Set the shooting mode to a Creative Zone mode (p.50).

The file name's first character is an underscore (“_”).

- Set the color space to sRGB. If Adobe RGB is set, the first character will be an underscore (p.137).

The file name starts with “MVI_”.

- It is a movie file (p.189).

The file numbering does not start from 0001.

- If the card already contains recorded images, the image number may not start from 0001 (p.188).

The shooting date and time displayed is incorrect.

- Check that the correct date and time are set (p.41).
- Check the time zone and daylight saving time (p.41).

The date and time are not in the picture.

- The shooting date and time do not appear in the picture. The date and time are instead recorded in the image data as shooting information. When printing, you can imprint the date and time in the picture, using the date and time recorded in the shooting information (p.247).

[###] is displayed.

- If the number of images recorded on the card exceeds the number the camera can display, [###] will be displayed (p.213).

The LCD monitor does not display a clear image.

- If the LCD monitor is dirty, use a soft cloth to clean it.
- In low or high temperatures, the LCD monitor display may seem slow or may look black. It will return to normal at room temperature.

[Eye-Fi settings] does not appear.

- [Eye-Fi settings] will appear only when an Eye-Fi card is inserted in the camera. If the Eye-Fi card has a write-protect switch set to the LOCK position, you will not be able to check the card's connection status or disable Eye-Fi transmission (p.274).

Playback Problems

Part of the image blinks in black.

- It is the highlight alert (p.234). Overexposed areas with clipped highlight will blink.

The image cannot be erased.

- If the image is protected, it cannot be erased (p.228).

The movie cannot be played back.

- Movies edited with a computer cannot be played back with the camera.

Camera operation sound can be heard when the movie is played back.

- If you operate the camera's dials or lens during movie shooting, the operation sound will also be recorded.

The movie has still moments.

- During autoexposure movie shooting, if there is a drastic change in the exposure level, the recording will stop momentarily until the brightness stabilizes. In such cases, shoot movies with manual exposure (p.162).

I cannot connect the camera to my TV set.

- An HDMI cable (sold separately) is necessary to connect the camera to a TV set. Using the HDMI Cable HTC-100 (sold separately) is recommended (p.226).
- Also check that your TV set has an HDMI IN terminal. If the TV set does not have an HDMI IN terminal and has only an A/V IN jack, the camera cannot be connected.

No picture on the TV set.

- Check that the HDMI cable's plug is inserted all the way in (p.226).
- If [**43: Wi-Fi/NFC**] is set to [**Enable**], the camera cannot be connected to a TV set. Set [**Wi-Fi/NFC**] to [**Disable**], then reconnect the camera to the TV set with an HDMI cable.

My card reader does not recognize the card.

- Depending on the card reader and computer OS used, SDXC cards may not be correctly recognized. In such a case, connect your camera to the computer with the interface cable, then transfer the images to your computer using EOS Utility (EOS software, p.314).

I cannot resize the image.

- JPEG **S3** and RAW images cannot be resized with the camera (p.239).

Printing-Related Problems

I cannot connect the camera to my printer.

- If [**3: Wi-Fi/NFC**] is set to [**Enable**], the camera cannot be connected to a printer. Set [**Wi-Fi/NFC**] to [**Disable**], then reconnect the camera to a printer with an interface cable.

There are fewer printing effects than listed in the instruction manual.

- Contents displayed on the screen vary depending on the printer. This instruction manual lists all the printing effects available (p.246).

Computer Connection Problems

I cannot download images to a computer.

- Install the EOS software on the computer (p.315).
- If [**3: Wi-Fi/NFC**] is set to [**Enable**], the camera cannot be connected to a computer. Set [**Wi-Fi/NFC**] to [**Disable**], then reconnect the camera to a computer with an interface cable.

Error Codes

Error number If there is a problem with the camera, an error message will appear. Follow the on-screen instructions.

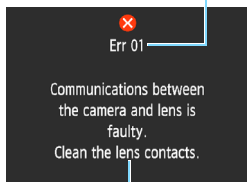

Cause and countermeasures

| Number | Error Message and Solution |
|--|---|
| 01 | Communications between the camera and lens is faulty. Clean the lens contacts. |
| | → Clean the electrical contacts on the camera and lens or use a Canon lens (p.25, 26). |
| 02 | Card cannot be accessed. Reinsert/change card or format card with camera. |
| | → Remove and insert the card again, replace the card, or format the card (p.36, 52). |
| 04 | Cannot save images because card is full. Replace card. |
| | → Replace the card, erase unnecessary images, or format the card (p.36, 52, 230). |
| 05 | The built-in flash could not be raised. Turn the camera off and on again. |
| | → Operate the power switch (p.39). |
| 10, 20 30, 40 50, 60 70, 80 99 | An error prevented shooting. Turn the camera off and on again or re-install the battery. |
| | → Operate the power switch, remove and install the battery again, or use a Canon lens (p.36, 39). |

*** If the error still persists, write down the error number and contact your nearest Canon Service Center.**

Specifications

• Type

| | |
|--------------------|---|
| Type: | Digital, single-lens reflex, AF/AE camera with built-in flash |
| Recording media: | SD memory card, SDHC memory card, SDXC memory card |
| Image sensor size: | Approx. 22.3 x 14.9 mm |
| Compatible lenses: | Canon EF lenses (including EF-S lenses) * Excluding EF-M lenses (35mm-equivalent angle of view is that of a lens with approx. 1.6x the focal length indicated.) |
| Lens mount: | Canon EF mount |

• Image Sensor

| | |
|----------------------|--|
| Type: | CMOS sensor |
| Effective pixels: | Approx. 18.0 megapixels |
| Aspect ratio: | 3:2 |
| Dust delete feature: | Dust Delete Data appending, Clean manually |

• Recording System

| | |
|-------------------------|--|
| Recording format: | Design rule for Camera File System (DCF) 2.0 |
| Image type: | JPEG, RAW (14-bit Canon original) RAW+JPEG Large simultaneous recording possible |
| Pixels recorded: | L (Large) : Approx. 17.9 megapixels (5184 x 3456) M (Medium) : Approx. 8.0 megapixels (3456 x 2304) S1 (Small 1) : Approx. 4.5 megapixels (2592 x 1728) S2 (Small 2) : Approx. 2.5 megapixels (1920 x 1280) S3 (Small 3) : Approx. 350,000 pixels (720 x 480) RAW : Approx. 17.9 megapixels (5184 x 3456) |
| Create/select a folder: | Possible |
| File numbering: | Continuous, Auto reset, Manual reset |

• Image Processing During Shooting

| | |
|----------------|--|
| Picture Style: | Auto, Standard, Portrait, Landscape, Neutral, Faithful, Monochrome, User Def. 1 - 3 |
| Basic+: | Ambience-based shots, Light/scene-based shots |
| White balance: | Auto (Ambience priority), Auto (White priority), Preset (Daylight, Shade, Cloudy, Tungsten light, White fluorescent light, Flash), Custom White balance correction, and White balance bracketing provided * Flash color temperature information transmission enabled |

Specifications

| | |
|--|---|
| Noise reduction: | Applicable to long exposures and high ISO speed shots |
| Automatic image brightness correction: | Auto Lighting Optimizer |
| Highlight tone priority: | Provided |
| Lens peripheral illumination correction: | Provided |

• **Viewfinder**

| | |
|----------------------------|---|
| Type: | Eye-level pentamirror |
| Coverage: | Vertical/Horizontal approx. 95% (with eyepoint approx. 21 mm) |
| Magnification: | Approx. 0.8x (-1 m^{-1} with 50mm lens at infinity) |
| Eye point: | Approx. 21 mm (from eyepiece lens center at -1 m^{-1}) |
| Dioptric adjustment range: | Approx. $-2.5 - +0.5 \text{ m}^{-1}$ (dpt) |
| Focusing screen: | Fixed, Precision Matte |
| Mirror: | Quick-return type |
| Depth-of-field preview: | Enabled with Custom Function setting |

• **Autofocus** (for viewfinder shooting)

| | |
|----------------------------|--|
| Type: | TTL secondary image-registration, phase-difference detection |
| AF points: | 9-point (Cross-type AF sensitive to f/5.6 with center AF point) |
| Focusing brightness range: | EV 0 - 18 (Center AF point) EV 1 - 18 (Other AF points) (With One-Shot AF, at room temperature, ISO 100) |
| AF operation: | One-Shot AF, AI Servo AF, AI Focus AF |
| AF-assist beam: | Small series of flashes fired by built-in flash |

• **Exposure Control**

| | |
|----------------------------|--|
| Metering modes: | 63-zone TTL open-aperture metering <ul style="list-style-type: none">• Evaluative metering (linked to all AF points)• Partial metering (approx. 10% of viewfinder at center)• Center-weighted average metering |
| Metering brightness range: | EV 1 - 20 (at room temperature, ISO 100) |
| Shooting mode: | Basic Zone modes: Scene Intelligent Auto, Flash Off, Creative Auto, Portrait, Landscape, Close-up, Sports, Food, Night Portrait Creative Zone modes: Program AE, Shutter-priority AE, Aperture-priority AE, Manual exposure |

| | |
|--|---|
| ISO speed (Recommended exposure index): | Basic Zone modes*: ISO 100 - ISO 3200 set automatically * Portrait: ISO 100 |
| Exposure compensation: | Creative Zone modes: ISO 100 - ISO 6400 set manually (whole-stop increments), ISO 100 - ISO 6400 set automatically, maximum ISO speed settable for ISO Auto, or ISO expansion to "H" (equivalent to ISO 12800) Manual: ± 5 stops in 1/3- or 1/2-stop increments AEB: ± 2 stops in 1/3- or 1/2-stop increments (can be combined with manual exposure compensation) |
| AE lock: | Auto: Applied in One-Shot AF with evaluative metering when focus is achieved Manual: With AE lock button |

• Shutter

| | |
|----------------|--|
| Type: | Electronically-controlled, focal-plane shutter |
| Shutter speed: | 1/4000 sec. to 30 sec. (Total shutter speed range. Available range varies by shooting mode.), Bulb, X-sync at 1/200 sec. |

• Flash

| | |
|------------------------------|--|
| Built-in flash: | Retractable, auto pop-up flash Guide No.: Approx. 9.2/30.2 (ISO 100, in meters/feet) or approx. 13/42.7 (ISO 200, in meters/feet) Flash coverage: Approx. 17mm lens angle of view Recharge time: Approx. 2 sec. |
| External flash: | EX-series Speedlite |
| Flash metering: | E-TTL II autoflash |
| Flash exposure compensation: | ± 2 stops in 1/3- or 1/2-stop increments |
| FE lock: | Provided |
| PC terminal: | None |

• Drive System

| | |
|----------------------------|--|
| Drive modes: | Single shooting, Continuous shooting, Self-timer with 10-sec. or 2-sec. delay and 10-sec. delay with continuous shooting |
| Continuous shooting speed: | Max. approx. 3.0 shots/sec. |
| Max. burst (Approx.): | JPEG Large/Fine: 1110 shots RAW: 6 shots RAW+JPEG Large/Fine: 5 shots |

* Figures are based on Canon's testing standards (ISO 100 and Standard Picture Style) using an 8 GB card.

• Live View Shooting

| | |
|----------------------------|--|
| Aspect ratio: | 3:2, 4:3, 16:9, 1:1 |
| Focus methods: | Contrast detection (FlexiZone-Single, Face detection Live mode), Phase-difference detection (Quick mode) Manual focus (approx. 5x / 10x magnification possible) |
| Focusing brightness range: | EV 1 - 18 (at room temperature, ISO 100) |
| Metering mode: | Real-time metering with image sensor |
| Metering brightness range: | EV 0 - 20 (at room temperature, ISO 100) |
| Grid display: | Two types |

• Movie Shooting

| | |
|---|--|
| Recording format: | MOV |
| Movie: | MPEG-4 AVC/H.264 Variable (average) bit rate |
| Audio: | Linear PCM |
| Recording size and frame rate: | 1920x1080 (Full HD): 30p/25p/24p 1280x720 (HD) : 60p/50p 640x480 (SD) : 30p/25p * 30p: 29.97 fps, 25p: 25.00 fps, 24p: 23.98 fps, 60p: 59.94 fps, 50p: 50.00 fps |
| Bit rate: | 1920x1080 (30p/25p/24p): Approx. 46 Mbps 1280x720 (60p/50p) : Approx. 46 Mbps 640x480 (30p/25p) : Approx. 11 Mbps |
| Focus method: | Same as focusing with Live View shooting |
| Focusing brightness range: | EV 1 - 18 (at room temperature, ISO 100) |
| Metering mode: | Center-weighted average and evaluative metering with the image sensor * Automatically set by the focus method. |
| Metering brightness range: | EV 0 - 20 (at room temperature, ISO 100) |
| Exposure control: | Autoexposure and manual exposure |
| Exposure compensation: | ±3 stops in 1/3-stop increments |
| ISO speed (Recommended exposure index): | With autoexposure shooting: ISO 100 - ISO 6400 set automatically With manual exposure: ISO 100 - ISO 6400 set automatically/manually |
| Video snapshots: | Settable to 2 sec./4 sec./8 sec. |
| Sound recording: | Built-in monaural microphone Sound-recording level adjustable, wind filter provided |
| Grid display: | Two types |
| Still photo shooting: | Not possible during movie shooting |

• LCD Monitor

| | |
|------------------------|--|
| Type: | TFT color liquid-crystal monitor |
| Monitor size and dots: | Approx. 7.5 cm (3.0 in.) (4:3) with approx. 920,000 dots |
| Brightness adjustment: | Manual (7 levels) |
| Interface languages: | 25 |
| Feature guide: | Displayable |

• Playback

| | |
|------------------------|--|
| Image display format: | Basic info, basic info + image quality/playback number, shooting info. display, histogram, index display (4/9) |
| Zoom magnification: | Approx. 1.5x - 10x |
| Highlight alert: | Overexposed highlights blink |
| Image browsing method: | Single image, jump by 10 or 100 images, by shooting date, by folder, by movies, by stills, by rating |
| Image rotation: | Possible |
| Ratings: | Provided |
| Movie playback: | Enabled (LCD monitor, HDMI) Built-in speaker |
| Image protect: | Possible |
| Slide show: | All images, by date, by folder, by movies, by stills, by rating Five transition effects selectable |
| Background music: | Selectable for slide shows and movie playback |

• Post-Processing of Images

| | |
|-------------------|--|
| Creative filters: | Grainy B/W, Soft focus, Fish-eye effect, Toy camera effect, Miniature effect |
| Resize: | Possible |

• Direct Printing

| | |
|----------------------|--------------------------------|
| Compatible printers: | PictBridge-compatible printers |
| Printable images: | JPEG and RAW images |
| Print ordering: | DPOF Version 1.1 compatible |

• Customization Features

| | |
|------------------------|------------------------------|
| Custom Functions: | 11 |
| My Menu registration: | Possible |
| Copyright information: | Entry and appending possible |

• Interface

| | |
|--------------------------|--|
| Digital terminal: | Hi-Speed USB equivalent: Computer communication, Direct printing, GPS Receiver GP-E2, Connect Station CS100 connection |
| HDMI mini OUT terminal: | Type C (Auto switching of resolution) |
| Remote control terminal: | For Remote Switch RS-60E3 |
| Eye-Fi card: | Compatible |

• Power

| | |
|--|---|
| Battery: | Battery Pack LP-E10 (Quantity 1) * AC power can be supplied via household power outlet accessories. |
| Number of possible shots: (Based on CIPA testing standards, with 50% flash use) | With viewfinder shooting: Approx. 500 shots at room temperature (23°C/73°F), approx. 410 shots at low temperatures (0°C/32°F) With Live View shooting: Approx. 180 shots at room temperature (23°C/73°F), approx. 170 shots at low temperatures (0°C/32°F) |
| Movie shooting time: | Approx. 1 hr. 15 min. at room temperature (23°C/73°F) Approx. 1 hr. 10 min. at low temperatures (0°C/32°F) (with a fully-charged Battery Pack LP-E10) |

• Dimensions and Weight

| | |
|-------------------------|---|
| Dimensions (W x H x D): | Approx. 129.0 x 101.3 x 77.6 mm / 5.08 x 3.99 x 3.06 in. |
| Weight: | Approx. 485 g / 17.11 oz. (CIPA Guidelines), Approx. 440 g / 15.52 oz. (Body only) |

• Operation Environment

| | |
|----------------------------|---------------------------|
| Working temperature range: | 0°C - 40°C / 32°F - 104°F |
| Working humidity: | 85% or less |

• Battery Pack LP-E10

| | |
|----------------------------|--|
| Type: | Rechargeable lithium-ion battery |
| Rated voltage: | 7.4 V DC |
| Battery capacity: | 860 mAh |
| Working temperature range: | During charging: 6°C - 40°C / 43°F - 104°F During shooting: 0°C - 40°C / 32°F - 104°F |
| Working humidity: | 85% or less |
| Dimensions (W x H x D): | Approx. 36.2 x 14.7 x 49.0 mm / 1.4 x 0.6 x 1.9 in. |
| Weight: | Approx. 45 g / 1.6 oz. |

• Battery Charger LC-E10

| | |
|----------------------------|---|
| Compatible battery: | Battery Pack LP-E10 |
| Recharging time: | Approx. 2 hours (at room temperature (23°C/73°F)) |
| Rated input: | 100 - 240 V AC (50/60 Hz) |
| Rated output: | 8.3 V DC / 580 mA |
| Working temperature range: | 6°C - 40°C / 43°F - 104°F |
| Working humidity: | 85% or less |
| Dimensions (W x H x D): | Approx. 67.0 x 30.5 x 87.5 mm / 2.6 x 1.2 x 3.4 in. |
| Weight: | Approx. 85 g / 3.0 oz. |

• Battery Charger LC-E10E

| | |
|----------------------------|---|
| Compatible battery: | Battery Pack LP-E10 |
| Power cord length: | Approx. 1 m / 3.3 ft. |
| Recharging time: | Approx. 2 hours (at room temperature (23°C/73°F)) |
| Rated input: | 100 - 240 V AC (50/60 Hz) |
| Rated output: | 8.3 V DC / 580 mA |
| Working temperature range: | 6°C - 40°C / 43°F - 104°F |
| Working humidity: | 85% or less |
| Dimensions (W x H x D): | Approx. 67.0 x 30.5 x 87.5 mm / 2.6 x 1.2 x 3.4 in. |
| Weight: | Approx. 82 g / 2.9 oz. (excluding power cord) |

- All the data above is based on Canon's testing standards and CIPA (Camera & Imaging Products Association) testing standards and guidelines.
- Dimensions and weight listed above are based on CIPA Guidelines (except weight for camera body only).
- Product specifications and the exterior are subject to change without notice.
- If a problem occurs with a non-Canon lens attached to the camera, consult the respective lens manufacturer.

Trademarks

- Adobe is a trademark of Adobe Systems Incorporated.
- Microsoft and Windows are trademarks or registered trademarks of Microsoft Corporation in the United States and/or other countries.
- Macintosh and Mac OS are trademarks of Apple Inc., registered in the U.S. and other countries.
- SDXC logo is a trademark of SD-3C, LLC.
- HDMI, HDMI logo, and High-Definition Multimedia Interface are trademarks or registered trademarks of HDMI Licensing LLC.
- All other trademarks are the property of their respective owners.

About MPEG-4 Licensing

"This product is licensed under AT&T patents for the MPEG-4 standard and may be used for encoding MPEG-4 compliant video and/or decoding MPEG-4 compliant video that was encoded only (1) for a personal and non-commercial purpose or (2) by a video provider licensed under the AT&T patents to provide MPEG-4 compliant video. No license is granted or implied for any other use for MPEG-4 standard."

* Notice displayed in English as required.

Use of genuine Canon accessories is recommended

This product is designed to achieve excellent performance when used with genuine Canon accessories.

Canon shall not be liable for any damage to this product and/or accidents such as fire, etc., caused by the malfunction of non-genuine Canon accessories (e.g., a leakage and/or explosion of a battery pack). Please note that this warranty does not apply to repairs arising out of the malfunction of non-genuine Canon accessories, although you may request such repairs on a chargeable basis.

Only for European Union and EEA (Norway, Iceland and Liechtenstein)



These symbols indicate that this product is not to be disposed of with your household waste, according to the WEEE Directive (2012/19/EU), the Battery Directive (2006/66/EC) and/or national legislation implementing those Directives.

■
If a chemical symbol is printed beneath the symbol shown above, in accordance with the Battery Directive, this indicates that a heavy metal (Hg = Mercury, Cd = Cadmium, Pb = Lead) is present in this battery or accumulator at a concentration above an applicable threshold specified in the Battery Directive.

This product should be handed over to a designated collection point, e.g., on an authorized one-for-one basis when you buy a new similar product or to an authorized collection site for recycling waste electrical and electronic equipment (EEE) and batteries and accumulators. Improper handling of this type of waste could have a possible impact on the environment and human health due to potentially hazardous substances that are generally associated with EEE. Your cooperation in the correct disposal of this product will contribute to the effective usage of natural resources.

For more information about the recycling of this product, please contact your local city office, waste authority, approved scheme or your household waste disposal service or visit www.canon-europe.com/weee, or www.canon-europe.com/battery.

CAUTION

RISK OF EXPLOSION IF BATTERY IS REPLACED BY AN INCORRECT TYPE.
DISPOSE OF USED BATTERIES ACCORDING TO LOCAL REGULATION.







13

Software Start Guide / Downloading Images to a Computer

This chapter explains the following:

- Overview of the software for EOS cameras
- How to download and install the software on a computer
- How to download and view the Software Instruction Manuals (PDF files)
- How to download images from the camera to a computer

Software Start Guide

Software Overview

This section explains an overview of various software applications for EOS cameras. Internet connection is required to download and install the software. Download and installation are not possible in environments with no Internet connection.

EOS Utility

With the camera connected to a computer, EOS Utility enables you to transfer still photos and movies shot with the camera to the computer. You can also use this software to set various camera settings and shoot remotely from the computer connected to the camera. Also, you can copy background music tracks, such as EOS Sample Music*, to the card.

* You can use the background music as the soundtrack for a video snapshot album, movie, or slide show played back with your camera.

Digital Photo Professional

This software is recommended for users who shoot RAW images. You can view, edit, and print RAW and JPEG images.

* Some functions differ between the version to be installed on a 64-bit computer and that to be installed on a 32-bit computer.

Picture Style Editor

You can edit Picture Styles, and create and save original Picture Style files. This software is aimed at advanced users who are experienced in processing images.

Downloading and Installing the Software



- **Do not connect the camera to your computer before you install the software. Otherwise, the software will not be installed properly.**
- Even if a previous version of the software is installed on your computer, follow the procedure below to install the latest version. (The previous version will be overwritten.)

1 Download the software.

- Connect to the Internet from a computer and access the following Canon website.

www.canon.com/icpd

- Select your country or region of residence and download the software.
- Decompress it on the computer.

For Windows: Click the displayed installer file to start the installer.

For Macintosh: A dmg file will be created and displayed. Follow the steps below to start the installer.

(1) Double-click the dmg file.

- ▶ A drive icon and installer file will appear on the desktop. If the installer file does not appear, double-click the drive icon to display it.

(2) Double-click the installer file.

- ▶ The installer starts.

2 Click **[Easy Installation]** and follow the on-screen instructions to install.

- For Macintosh, click **[Install]**.

Downloading and Viewing the Software Instruction Manuals (PDF Files)

Internet connection is required to download the Software Instruction Manuals (PDF files). Download is not possible in environments with no Internet connection.

1 Download the Software Instruction Manuals (PDF files).

- Connect to the Internet and access the following Canon website.

www.canon.com/icpd

- Select your country or region of residence and download the Instruction Manuals.

2 View the Software Instruction Manuals (PDF files).

- Double-click a downloaded Instruction Manual (PDF file) to open it.
- To view the Instruction Manuals (PDF files), Adobe Acrobat Reader DC or other Adobe PDF viewer (most recent version recommended) is required.
- Adobe Acrobat Reader DC can be downloaded free from the Internet.
- To learn how to use a PDF viewer, refer to its Help section.

Downloading Images to a Computer

You can use the EOS software to download the images in the camera to a computer. There are two ways to do this.

Downloading by Connecting the Camera to the Computer

1 Install the software (p.315).

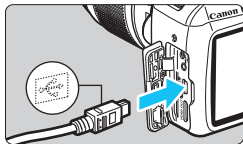

2 Use the provided interface cable to connect the camera to a computer.

- Use the interface cable provided with the camera.
- Connect the cable to the camera's digital terminal with the cable plug's <↔> icon facing the front of the camera.
- Connect the cord's plug to the computer's USB terminal.

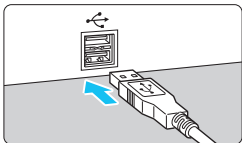

3 Use EOS Utility to download the images.

- Refer to the EOS Utility Instruction Manual.

⚠ If [**3: Wi-Fi/NFC**] is set to [**Enable**], the camera cannot be connected to a computer. Set [**Wi-Fi/NFC**] to [**Disable**], then reconnect the camera to a computer with an interface cable.

Downloading Images with a Card Reader

You can also use a card reader to download images to a computer.

1 Install the software (p.315).

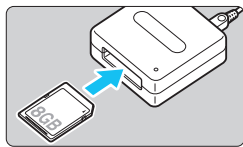

2 Insert the card into the card reader.

3 Use Digital Photo Professional to download the images.

- Refer to the Digital Photo Professional Instruction Manual.

 When downloading images from the camera to a computer with a card reader without using EOS software, copy the DCIM folder on the card to the computer.

Index

Numerics

| | |
|---------------------------------|-----|
| 10- or 2-sec. self-timer | 103 |
| 1280x720 (movie) | 168 |
| 1920x1080 (movie) | 168 |
| 640x480 (movie) | 168 |
| 9-point AF auto selection | 99 |

A

| | |
|---|----------|
|  (Scene Intelligent Auto) | 58 |
| Access lamp | 38 |
| Accessories | 3 |
| Adobe RGB | 137 |
| AE lock | 120 |
| AEB (Auto exposure bracketing) ... | 118, 260 |
| AF → Focusing | |
| AI FOCUS (AI Focus AF) | 98 |
| AI SERVO (AI Servo AF) | 98 |
| Ambience-based shots | 76 |
| Angle of view | 45 |
| Aperture-priority AE | 110 |
| Aspect ratio | 146 |
| Auto Lighting Optimizer | 57, 123 |
| Auto playback | 222 |
| Auto power off | 39, 185 |
| Auto reset | 189 |
| Auto rotate vertical images | 192 |
| Autofocus | 97, 99 |
| Automatic selection (AF point) | 99 |
| Av (Aperture-priority AE) | 110 |

B

| | |
|------------------------|------------|
| B/W (Monochrome) | 96, 128 |
| Background music | 225 |
| Basic Zone modes | 30 |
| Battery | 34, 36, 40 |
| Beep (Beeper) | 184 |

| | |
|---|-------------|
| Black-and-white images ... | 76, 96, 128 |
| Bracketing | 118, 136 |
| Brightness (exposure) | 116 |
| Auto exposure bracketing (AEB) | 118, 260 |
| Autoexposure lock (AE lock) | 120 |
| Exposure compensation | 116 |
| Measurement method (metering mode) | 115 |
| Built-in flash | 104 |
| Function settings | 199 |
| BULB (bulb exposure) | 114 |

C

| | |
|---|----------------------------|
|  (Creative Auto) | 64 |
| Cable | 3, 216, 226, 242, 278, 317 |
| Camera | |
| Clearing the camera settings ... | 194 |
| Holding the camera | 46 |
| Settings display | 193 |
| Camera shake | 46 |
| Cards | 25, 36, 52 |
| Card reminder | 184 |
| Formatting | 52 |
| Low-level formatting | 53 |
| SD speed class | 5 |
| Troubleshooting | 38, 53 |
| Write protection | 36 |
| Center-weighted average metering | 115 |
| Charger | 31, 34 |
| Checking depth of field | 112 |
| Cleaning (image sensor) | 204 |
| Clearing the camera settings | 194 |
| Clipped highlights | 234 |
| Close-ups | 69 |
| Color saturation | 127 |
| Color space (color reproduction range) | 137 |

| | |
|---------------------------------|---------|
| Color temperature..... | 131 |
| Color tone | 71, 127 |
| Continuous file numbering | 188 |
| Continuous shooting | 102 |
| Contrast | 127 |
| Copyright information..... | 190 |
| Creative Auto | 64 |
| Creative filters..... | 236 |
| ☆ (Creative Zone) icon..... | 8 |
| Creative Zone modes | 30 |
| Custom Functions..... | 258 |
| Custom white balance | 133 |

D

| | |
|--|------------------|
| Date/time | 41 |
| Daylight saving time..... | 42 |
| DC Coupler..... | 270 |
| Depth-of-field preview..... | 112 |
| Dial..... | 26, 107 |
| Digital terminal | 242, 317 |
| Dioptric adjustment..... | 46 |
| Direct printing..... | 242 |
| DPOF (Digital Print Order Format)..... | 251 |
| Drive/Self-timer | 28, 66, 102, 103 |
| Dust Delete Data | 202 |

E











| | |
|--------------------------------|---------|
| Erasing images | 230 |
| Error codes | 298 |
| Evaluative metering | 115 |
| Exposure compensation | 116 |
| Exposure level increments..... | 260 |
| External flash | 272 |
| Custom Functions | 201 |
| Eyecup..... | 271 |
| Eye-Fi cards..... | 274 |
| Eyepiece cover | 33, 271 |

F

| | |
|--------------------------------------|--------------|
| Faithful | 96 |
| FE lock | 121 |
| Feature guide..... | 55 |
| FEB | 199 |
| File extension | 189 |
| File name | 188 |
| File size | 89, 169, 232 |
| Filter effects..... | 128 |
| Final image simulation | 143, 166 |
| Fine (image-recording quality) | 28 |
| Firmware | 283 |
| First-curtain synchronization | 200 |
| Fish-eye effect..... | 238 |
| Flash (Speedlite) | |
| Built-in flash | 104 |
| Custom Functions..... | 201 |
| Effective range..... | 105 |
| External flash | 272 |
| FE lock..... | 121 |
| Flash control | 198 |
| Flash exposure compensation ... | 117 |
| Flash mode | 200 |
| Flash off..... | 63, 66, 75 |
| Flash sync contacts | 26 |
| Flash sync speed..... | 261, 273 |
| Manual flash | 200 |
| Red-eye reduction | 106 |
| Shutter synchronization | |
| (1st/2nd curtain)..... | 200 |
| Focus indicator | 58 |
| Focus lock | 61 |
| Focus mode | |
| switch | 44, 101, 156 |
| Focusing | |
| AF method | 148, 176 |
| AF operation | 97 |
| AF point selection | 99 |

- AF-assist beam..... 100, 264
- Beeper 184
- Difficult subjects for AF 101, 152
- Manual focusing 101, 156
- Out of focus 46, 101, 152
- Recomposing..... 61
- Focusing point (AF point)..... 99
- Folder creation/selection..... 186
- Food..... 71
- Formatting (card initialization)..... 52
- Frame rate 168
- Full High-Definition (Full HD)..... 168, 216
- Fully automatic shooting (Scene Intelligent Auto)..... 58
- Functions settable by shooting mode 276
- G**
- Grainy B/W..... 238
- Grid display..... 145, 179
- H**
- HDMI..... 216, 226
- High ISO speed noise reduction ... 263
- High-Definition (HD) movies ... 168, 216
- Highlight alert..... 234
- Highlight tone priority 177, 263
- Histogram (Brightness/RGB) 234
- Hot shoe..... 26, 272
- Household power 270
- I**
- ICC profile 137
- Image dust prevention 202, 204
- Image review time..... 184
- Image Zone..... 30
- Image-recording quality 88
- Images
 - Auto playback 222
 - Auto rotation..... 192
 - Erasing..... 230
 - Highlight alert..... 234
 - Histogram..... 234
 - Image characteristics (Picture Style)..... 95, 126, 129
 - Index display 208
 - Jump display (image browsing) 209
 - Magnification..... 210
 - Manual rotation 211
 - Numbering 188
 - Playback 83, 207
 - Protecting..... 228
 - Rating..... 212
 - Review time 184
 - Shooting information 232
 - Slide show..... 222
 - Viewing on a TV set..... 216, 226
- Index display 208
- ISO speed 92
 - Automatic setting (Auto)..... 93
 - ISO expansion 260
 - Maximum ISO speed for ISO Auto 94
- J**
- JPEG 89
- Jump display 209
- L**
- Landscape..... 68, 96
- Language selection 43
- Large (image-recording quality) 28
- LCD monitor 24
 - Brightness adjustment 185
 - Image playback..... 83, 207
 - Menu display..... 50, 280
 - Screen color..... 197
 - Shooting function settings.... 28, 54

- Lens 44
 - Lock release 45
 - Peripheral illumination correction 124
- Lighting/scene-based shots 80
- Live View shooting 62, 139
 - Aspect ratio 146
 - Face detection Live mode (AF) 149
 - FlexiZone - Single 148
 - Grid display 145
 - Information display 142
 - Manual focusing (MF) 101, 156
 - Metering timer 147
 - Possible shots 141
 - Quick Control 144
 - Quick mode 154
- Long exposure noise reduction 262
- Long exposures 114
- M**
- M (Manual exposure) 113
- Macro photography 69
- Magnification 156, 210
- Manual exposure 113, 162
- Manual focusing (MF) 101, 156
- Manual reset 189
- Manual selection (AF point) 99
- Maximum burst 89, 90
- Medium (image-recording quality) ... 28
- Memory cards → Cards
- Menu 50
 - My Menu 267
 - Setting procedure 51
 - Settings 280
- MENU** icon 8
- Metering mode 115
- Metering timer 147, 179
- MF (manual focusing) 101, 156
- Microphone 160
- Miniature effect 238
- Mode Dial 30
- Monochrome 76, 96, 128
- Movies 159
 - AF method 167, 176
 - Autoexposure 160
 - Editing out first and last scenes 220
 - Enjoying 216
 - File size 169
 - Frame rate 168
 - Grid display 179
 - Information display 164
 - Manual exposure shooting 162
 - Manual focus 160
 - Metering timer 179
 - Movie recording size 168
 - Playback 218
 - Quick Control 167
 - Recording time 169
 - Sound recording 178
 - Video snapshot album 170
 - Video snapshots 170
 - Viewing on a TV set 216, 226
 - Wind filter 179
- My Menu 267
- N**
- Neutral 96
- Night Portrait 72
- Night scenes 68, 72
- Noise reduction
 - High ISO speed 263
 - Long exposures 262
- Nomenclature 26
- Non-Canon flash units 273
- Normal (image-recording quality) ... 28
- NTSC 168, 284

- O**
- ONE SHOT (One-Shot AF).....97
- P**
- P (Program AE).....86
- PAL168, 284
- Paper settings (printing).....244
- Partial metering.....115
- Peripheral illumination correction ...124
- Photobook set-up.....255
- PictBridge.....241
- Picture Style.....95, 126, 129
- Pixel count88
- Playback83, 207
- Portrait67, 95
- Possible shots.....40, 88, 141
- Power
- Auto power off185
 - Battery level.....40
 - Household power.....270
 - Possible shots40, 88, 141
 - Recharge.....34
- Predictive (AI Servo).....98
- Pressing completely.....47
- Pressing halfway.....47
- Printing.....241
- Cropping.....249
 - Page layout.....245
 - Paper settings.....244
 - Photobook set-up255
 - Print order (DPOF)251
 - Printing effects.....246
 - Tilt correction249
- Program AE86
- Program shift.....87
- Protecting images228
- Q**
-  (Quick Control)...48, 74, 144, 167, 214
- Quick Control.....74
- Quick mode154
- R**
- Rating mark.....212
- RAW28, 89, 91
- RAW+JPEG.....28, 89, 91
- Recharging34
- Red-eye reduction106
- Release shutter without card.....184
- Remote switch.....271
- Resizing.....239
- Revert to default settings.....194
- Rotation (image).....192, 211, 249
- S**
- Safety precautions.....20
- SD, SDHC, SDXC cards → Cards
- Second-curtain synchronization ...200
- Self-timer103
- Sensitivity → ISO speed
- Sensor cleaning.....204
- Sepia (monochrome).....76, 128
- Sharpness127
- Shooting function settings28, 54
- Shooting information display232
- Shooting modes30
- Av (Aperture-priority AE).....110
 - M (Manual exposure).....113
 - P (Program AE).....86
 - Tv (Shutter-priority AE)108
 -  (Scene Intelligent Auto).....58
 -  (Flash Off).....63
 -  (Creative Auto).....64
 -  (Portrait).....67
 -  (Landscape).....68
 -  (Close-up).....69
 -  (Sports).....70
 -  (Food).....71
 -  (Night Portrait).....72

| | |
|--|---------|
| Shutter button | 47 |
| Shutter synchronization (1st/2nd curtain) | 200 |
| Shutter-priority AE | 108 |
| Single shooting | 66, 277 |
| Single-image display | 83 |
| Single-point AF | 99 |
| Slide show | 222 |
| Small (image-recording quality) | 28, 240 |
| Soft focus | 238 |
| Speaker | 218 |
| Sports | 70 |
| sRGB | 137 |
| Stop down aperture | 266 |
| Strap | 33 |
| System map | 278 |

T

| | |
|----------------------------------|----------|
| Temperature warning | 157, 181 |
| Time zone | 41 |
| Tone priority | 177, 263 |
| Toning effect (monochrome) | 128 |
| Toy camera effect | 238 |
| Tripod socket | 27 |
| Troubleshooting | 286 |
| Tv (Shutter-priority AE) | 108 |

U

| | |
|------------------------------|----------|
| USB (digital) terminal | 242, 317 |
|------------------------------|----------|

V

| | |
|-------------------------------|----------|
| Video snapshot album | 170 |
| Video snapshots | 170 |
| Video system | 168, 179 |
| Viewfinder | 29 |
| Dioptric adjustment | 46 |
| Viewing on a TV set | 216, 226 |
| Volume (movie playback) | 219 |

W

| | |
|-------------------------------|-----|
| White balance (WB) | 131 |
| Ambience priority (AWB) | 132 |
| Bracketing | 136 |
| Correction | 135 |
| Custom | 133 |
| Personal | 134 |
| White priority (AWB w) | 132 |
| Wi-Fi/NFC | 283 |
| Wind filter | 179 |





CANON INC.

30-2 Shimomaruko 3-chome, Ohta-ku, Tokyo 146-8501, Japan

Europe, Africa & Middle East

CANON EUROPA N.V.

PO Box 2262, 1180 EG Amstelveen, The Netherlands

For your local Canon office, please refer to your warranty card or to www.canon-europe.com/Support

The product and associated warranty are provided in European countries by Canon Europa N.V.

The descriptions in this Instruction Manual are current as of December 2015. For information on the compatibility with any products introduced after this date, contact any Canon Service Center. For the latest version Instruction Manual, refer to the Canon website.