

Read this guide first.

Please read this guide before operating this product.
After you finish reading this guide, store it in a safe place for future reference.

SPA **Lea esta guía primero.**

Por favor, lea esta guía antes de usar este producto.
Después de leer esta guía, guárdela en un lugar seguro para posteriores consultas.

Before installing the printer, read the cautions carefully which are described on the right side.

SPA Antes de instalar la impresora, lea atentamente las precauciones que se describen en el lado derecho.

English

WARNING

To avoid the risk of personal injury or damage to the printer, and for legal information, make sure to read the "Legal Notices" and "Important Safety Instructions" in the e-Manual included on the accompanying CD-ROM carefully before using the printer.

Español

ADVERTENCIA

Para evitar el riesgo de sufrir lesiones personales o de causar daños a la impresora (y para información legal), asegúrese de leer atentamente los "Avisos legales" y las "Instrucciones de seguridad importantes" del e-Manual incluido en el CD-ROM suministrado antes de utilizar la impresora.



! Important Safety Instructions

This manual describes only warnings and cautions for the installation and the power supply. Be sure to read "Important Safety Instructions" described in the e-Manual (HTML manual).

Installation

WARNING

- Do not install the printer in a location near alcohol, paint thinner, or other flammable substances. If flammable substances come into contact with electrical parts inside the printer, this may result in a fire or electrical shock.
- Do not place the following items on the printer.
 - Necklaces and other metal objects
 - Cups, vases, flowerpots, and other containers filled with water or liquids

If these items come into contact with a high-voltage area inside the printer, this may result in a fire or electrical shock.
If these items are dropped or spilled inside the printer, immediately turn OFF the power switch (1) and disconnect the interface cables if they are connected (2). Then, unplug the power plug from the AC power outlet (3) and contact your local authorized Canon dealer.

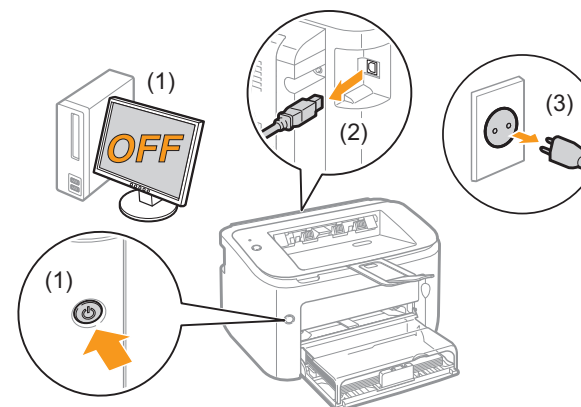

CAUTION

- Do not install the printer in unstable locations, such as on unsteady platforms or inclined floors, or in locations subject to excessive vibrations, as this may cause the printer to fall or tip over, resulting in personal injury.
- The ventilation slots are provided for proper ventilation of working parts inside the printer. Never place the printer on a soft surface, such as a bed, sofa, or rug. Blocking the slots can cause the printer to overheat, resulting in a fire.
- Do not install the printer in the following locations, as this may result in a fire or electrical shock.
 - A damp or dusty location
 - A location exposed to smoke and steam, such as near a cookery or humidifier
 - A location exposed to rain or snow
 - A location near a water faucet or water
 - A location exposed to direct sunlight
 - A location subject to high temperatures
 - A location near open flames
- When installing the printer, gently lower the printer to the installation site so as not to catch your hands between the printer and the floor or between the printer and other equipment, as this may result in personal injury.
- When connecting the interface cable, connect it properly by following the instructions in the e-Manual. If not connected properly, this may result in malfunction or electrical shock.
- When moving the printer, follow the instructions in the e-Manual to hold it correctly. Failure to do so may cause you to drop the printer, resulting in personal injury.

Symbols

WARNING

Indicates a warning concerning operations that may lead to death or injury to persons if not performed correctly. To use the machine safely, always pay attention to these warnings.

CAUTION

Indicates a caution concerning operations that may lead to injury to persons if not performed correctly. To use the machine safely, always pay attention to these cautions.

Power Supply

WARNING

- Do not damage or modify the power cord. Also, do not place heavy objects on the power cord or pull on or excessively bend it, as this can cause electrical damage, resulting in fire or electrical shock.
- Keep the power cord away from all heat sources. Failure to do so can cause the power cord insulation to melt, resulting in a fire or electrical shock.
- The power cord should not be taut, as this may lead to a loose connection and cause overheating, which could result in a fire.
- The power cord may become damaged if it is stepped on, fixed with staples, or if heavy objects are placed on it. Continued use of a damaged power cord can lead to an accident, such as a fire or electrical shock.
- Do not plug or unplug the power plug with wet hands, as this can result in electrical shock.
- Do not plug the power cord into a multi-plug power strip, as this can result in a fire or electrical shock.
- Do not bundle up or tie up the power cord in a knot, as this can result in a fire or electrical shock.
- Insert the power plug completely into the AC power outlet. Failure to do so can result in a fire or electrical shock.
- If excessive stress is applied to the connection part of the power cord, it may damage the power cord or the wires inside the machine may disconnect. This could result in a fire. Avoid the following situations:
 - Connecting and disconnecting the power cord frequently.
 - Tripping over the power cord.
 - The power cord is bent near the connection part, and continuous stress is being applied to the power outlet or the connection part.
 - Applying a shock to the power connector.
- Do not use power cords other than the one provided, as this can result in a fire or electrical shock.
- As a general rule, do not use extension cords. Using an extension cord may result in a fire or electrical shock.

CAUTION

- Do not use a power supply voltage other than that listed herein, as this may result in a fire or electrical shock.
- Always grasp the power plug when unplugging the power plug. Do not pull on the power cord, as this may expose the core wire of the power cord or damage the cord insulation, causing electricity to leak, resulting in a fire or electrical shock.
- Leave sufficient space around the power plug so that it can be unplugged easily. If objects are placed around the power plug, you may be unable to unplug it in an emergency.

1 Confirm the supplied accessories.

SPA Verifique los accesorios suministrados.

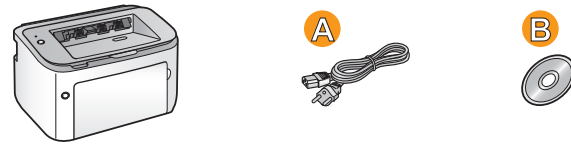

2 Remove the packing materials, and then load paper.

SPA Retire los materiales de embalaje y, a continuación, cargue papel.

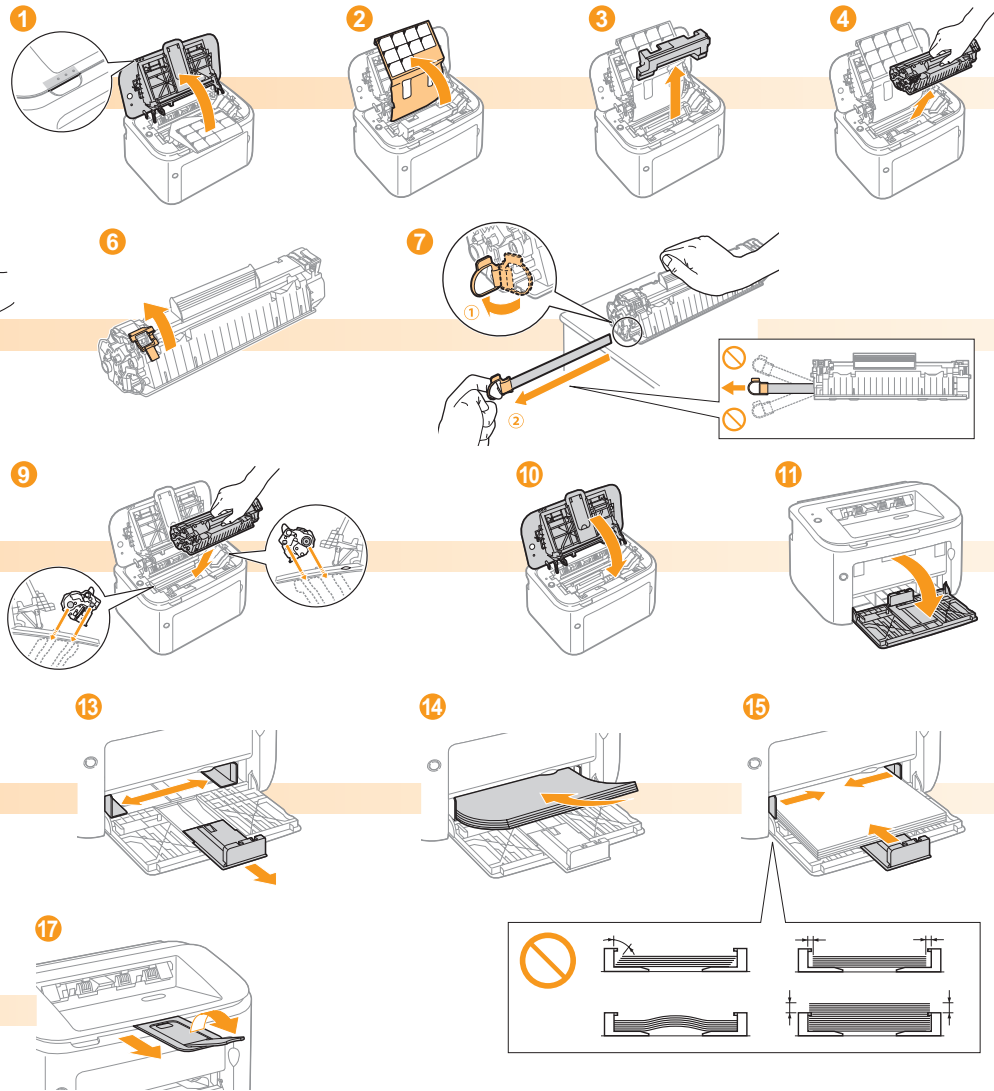

Check!

Did you remove all the packing materials?

SPA ¿Ha retirado todos los materiales de embalaje?

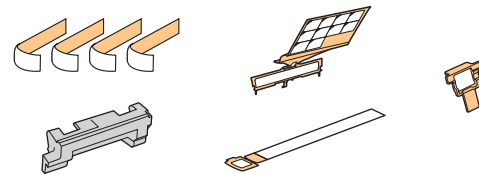

3 Connect the power cord.

SPA Conecte el cable de alimentación.

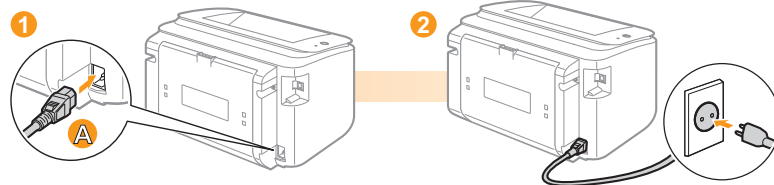

4 Connect the printer and computer.

SPA Conecte la impresora y el ordenador.

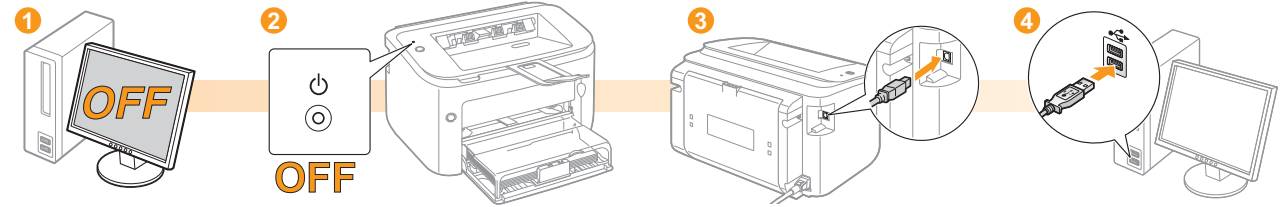

Download the manual and the printer driver that supports this printer from the Canon Web site (<http://www.usa.canon.com/>). See the following procedure.

1 Select [Support & Drivers].

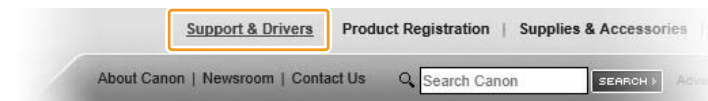

2 From [Product Type], select [Consumer & Home Office], and [Printers & Multifunction] → [imageCLASS Series] → the desired model name.

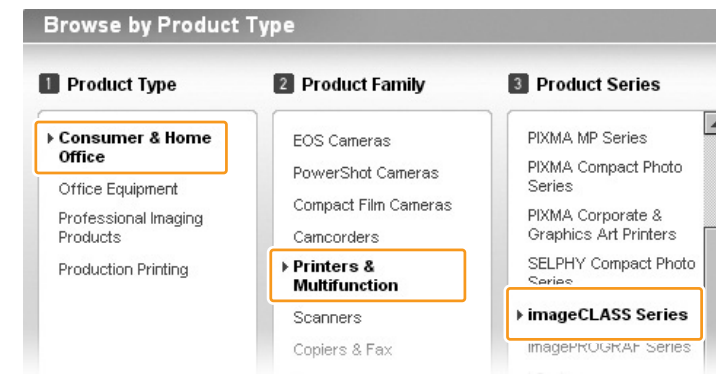

3 Select [Drivers & Software] and [Brochures & Manuals] from the product page. Download the files by following the instructions on the each screen.

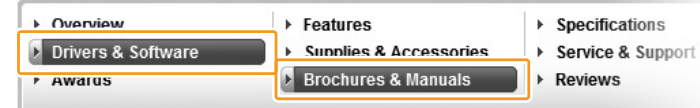

Setup finished. SPA Ha finalizado la configuración.