



MULTIMEDIA PROJECTOR LV-HD420 / LV-X420 User's Manual



BEFORE USING, BE SURE TO READ THIS USER'S MANUAL.
Read the "Safety Instructions" in this manual thoroughly and use correctly the projector.
Store this user's manual in a convenient location where you can refer to it easily.

Table of Contents

SAFETY INSTRUCTIONS.....	1
FOR SAFE USE	10
GETTING STARTED	13
PACKING CHECKLIST	13
VIEWS OF PROJECTOR PARTS.....	14
<i>Front-right View</i>	14
<i>Top view—On-screen Display (OSD) buttons and LEDs</i>	15
<i>Rear view</i>	16
<i>Bottom view</i>	18
REMOTE CONTROL PARTS	19
REMOTE CONTROL OPERATING RANGE	20
PROJECTOR AND REMOTE CONTROL BUTTONS.....	20
SETUP AND OPERATION	21
INSERTING THE REMOTE CONTROL BATTERIES	21
STARTING AND SHUTTING DOWN THE PROJECTOR	22
HOW TO STORE THE PROJECTOR IN THE SOFT CARRYING CASE (LV-SC02)	23
SETTING AN ACCESS PASSWORD (SECURITY LOCK).....	24
ADJUSTING THE PROJECTOR LEVEL	26
ADJUSTING THE ZOOM, FOCUS AND KEYSTONE.....	27
ADJUSTING THE VOLUME	28
ON-SCREEN DISPLAY (OSD) MENU SETTINGS	29
OSD MENU CONTROLS	29
<i>Navigating the OSD</i>	29
SETTING THE OSD LANGUAGE.....	30
OSD MENU OVERVIEW.....	31
IMAGE MENU	34
<i>Analog setting Menu</i>	35
<i>Advanced Feature</i>	36
<i>White Balance</i>	37
<i>Color Manager</i>	38
SETTINGS 1 MENU.....	39
<i>Keystone</i>	40
<i>Audio</i>	40
<i>Advanced 1 Feature</i>	41
<i>Advanced 2 Feature</i>	43
<i>4 Corner</i>	44
SETTINGS 2 MENU.....	45
<i>Status</i>	46
<i>Advanced 1 Feature</i>	47
<i>Advanced 2 Feature</i>	59
MAINTENANCE AND SECURITY	61
REPLACING THE PROJECTION LAMP	61
<i>Resetting the Lamp Hour</i>	64
CLEANING THE PROJECTOR	65
<i>Cleaning the Lens</i>	65
<i>Cleaning the Case</i>	65
USING THE KENSINGTON LOCK.....	66
<i>Using the Kensington Lock</i>	66
<i>Using the Security Bar</i>	66
TROUBLESHOOTING.....	67
COMMON PROBLEMS AND SOLUTIONS	67
TIPS FOR TROUBLESHOOTING	67
LED ERROR MESSAGES	68
PROBLEM AND COUNTERMEASURES	68
SPECIFICATIONS.....	71

SPECIFICATIONS	71
PROJECTION DISTANCE VS. PROJECTION SIZE	73
<i>Projection Distance and Size Table</i>	73
TIMING MODE TABLE	75
PROJECTOR DIMENSIONS	77
REGULATORY COMPLIANCE	78
FCC WARNING	78
CANADA	78
SAFETY CERTIFICATIONS	78
APPENDIX I	79
RS-232 PROTOCOL	79

SAFETY INSTRUCTIONS



Before installing and operating the projector, read this manual thoroughly.

This projector provides many convenient features and functions. Operating the projector properly enables you to manage those features and maintain it in good condition for many years to come.

Improper operation may result in not only shortening the product life, but also malfunctions, fire hazards, or other accidents.

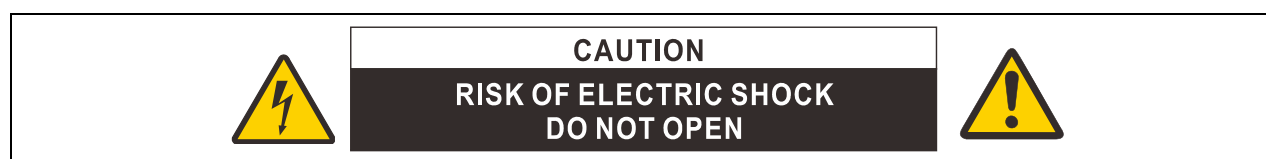
If your projector does not seem to be operating properly, read this manual again, check operations and cable connections, and try the solutions in the "Troubleshooting" section in the user's manual. If the problem still persists, contact the Canon Customer Support Center.



	THIS SYMBOL INDICATES THAT DANGEROUS VOLTAGE CONSTITUTING A RISK OF ELECTRIC SHOCK IS PRESENT WITHIN THIS UNIT.
	THIS SYMBOL INDICATES THAT THERE ARE IMPORTANT OPERATING AND MAINTENANCE INSTRUCTIONS FOR THIS UNIT IN THE USER'S MANUAL.

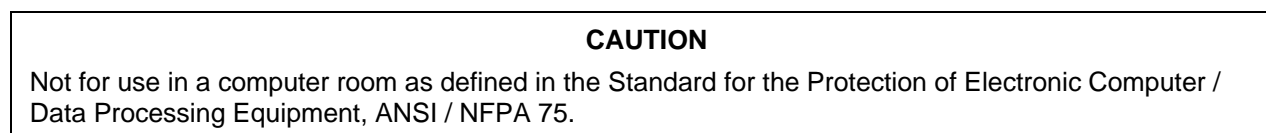



Safety Precautions

WARNING:

- **THIS APPARATUS MUST BE GROUNDED.**
- **TO REDUCE THE RISK OF FIRE OR ELECTRIC SHOCK, DO NOT EXPOSE THIS APPLIANCE TO RAIN OR MOISTURE.**
- This projector produces intense light from the projection lens. Do not stare directly into the lens, otherwise eye damage could result. Be especially careful that children do not stare directly into the beam.
- Install the projector in a proper position. Otherwise it may result in a fire hazard.
- Do not cover the ventilation slots on the projector. Heat build-up can reduce the service life of your projector, and can also be dangerous.
- If the projector is unused for an extended time, unplug the projector from the power outlet.
- Do not project the same image for a long time.

An afterimage may remain on the DMD panel due to the characteristics of the panel of the projector.



WARNING ON HANGING FROM THE CEILING

When hanging the projector from the ceiling, clean the air intake vents and top of the projector periodically with a vacuum cleaner. If you leave the projector unclean for a long time, the cooling fans can be clogged with dust, and it may cause a breakdown or a disaster.

Make sure to implement anti-fall measures such as an anti-fall wire when installing the projector in high places, for example, installing it on the ceiling.

DO NOT SET THE PROJECTOR IN GREASY, WET, OR SMOKY CONDITIONS SUCH AS IN A KITCHEN TO PREVENT A BREAKDOWN OR A DISASTER. IF THE PROJECTOR COMES IN CONTACT WITH OIL OR CHEMICALS, IT MAY BECOME DETERIORATED.

■ READ AND KEEP THIS MANUAL FOR LATER USE.

All the safety and operating instructions should be read before beginning to operate the product.

Read all of the instructions given here and retain them for later use. Unplug this projector from the AC power supply before cleaning. Do not use liquid or aerosol cleaners on the projector. Use a damp cloth for cleaning.

Follow all warnings and instructions marked on the projector.

For added protection of the projector during a lightning storm, or when it is left unattended or unused for long periods of time, unplug it from the wall outlet. This will prevent damage due to lightning and power surges.

Do not expose this unit to rain or use near water. For example, in a wet basement, near a swimming pool..., etc.

Do not use attachments not recommended by the manufacturer as they may result in hazards.

Do not place this projector on an unstable cart, stand, or table. The projector may fall, causing serious injury to a child or adult, and serious damage to the projector. Use only with a cart or stand recommended by the manufacturer, or sold with the projector. For wall or shelf mounting, use a tool such as a mounting kit to secure the projector.

An appliance and cart combination should be moved with care.

Sudden stops, excessive force, and uneven surfaces may cause the appliance and cart combination to overturn.

Slots and openings in the rear and front of the cabinet are provided for ventilation, to insure reliable operation of the equipment and to protect it from overheating.

The openings should never be covered with cloth or other materials, and the bottom opening should not be blocked by placing the projector on a bed, sofa, rug, or other similar surface. This projector should never be placed near or over a radiator or heat register.

This projector should not be placed in a built-in installation such as a book case unless proper ventilation is provided.

Never push objects of any kind into this projector through cabinet slots as they may touch dangerous voltage points or short out parts that could result in a fire or electric shock. Never spill liquid of any kind onto the projector.

Do not install the projector near the ventilation duct of air-conditioning equipment.

This projector should be operated using only the type of power source indicated on the marking label. If you are not sure of the type of power supplied, contact the Canon Customer Support Center or local power company.

Do not overload wall outlets and extension cords as this can result in fire or electric shock. Do not allow anything to rest on the power cord. Do not locate this projector where the cord may be damaged by people walking on it.

Do not attempt to service this projector yourself as opening or removing covers may expose you to dangerous voltages or other hazards. Refer all servicing to qualified service personnel.

Unplug this projector from the wall outlet and refer servicing to qualified service personnel under the following conditions:

- a. When the power cord or plug is damaged or frayed.
- b. If liquid has been spilled into the projector.
- c. If the projector has been exposed to rain or water.
- d. If the projector does not operate normally after following the operating instructions. Adjust only those controls that are covered in the operating instructions as improper adjustment of other controls may result in damage and will often require extensive work by a qualified technician to restore the projector to normal operating condition.
- e. If the projector has been dropped or the cabinet has been damaged.
- f. When the projector exhibits a distinct change in performance-this indicates a need for servicing.

When replacement parts are required, be sure the service technician uses replacement parts specified by the manufacturer that have the same characteristics as the original parts. Unauthorized substitutions may result in fire, electric shock, or injury.

Upon completion of any service or repairs to this projector, ask the service technician to perform routine safety checks to determine that the projector is in safe operating condition.



AC Power Cord Requirement

The AC Power Cord supplied with this projector meets the requirements for use in the country you purchased it.

AC Power Cord for the United States and Canada:

The AC Power Cord used in the United States and Canada is listed by the Underwriters Laboratories (UL) and certified by the Canadian Standard Association (CSA).

The AC Power Cord has a grounding-type AC line plug. This is a safety feature to ensure the plug fits into the power outlet. Do not try to tamper with this safety feature. Should you be unable to insert the plug into the outlet, contact your electrician.

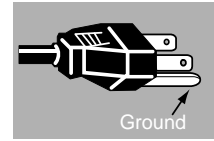

THE SOCKET-OUTLET SHOULD BE INSTALLED NEAR THE EQUIPMENT AND EASILY ACCESSIBLE.



For the U.S. and Canada, LAMP(S) INSIDE THIS PRODUCT CONTAIN MERCURY AND MUST BE RECYCLED OR DISPOSED OF ACCORDING TO LOCAL, MUNICIPAL, STATE, PROVINCIAL, OR FEDERAL LAWS.

For lamp recycling and disposal information please call 1-800-OK-CANON for the U.S. and Canada.



Only for European Union and EEA (Norway, Iceland and Liechtenstein)

These symbols indicate that this product is not to be disposed of with your household waste, according to the WEEE Directive (2012/19/EU), the Battery Directive (2006/66/EC) and/or national legislation implementing those Directives.



If a chemical symbol is printed beneath the symbol shown above, in accordance with the Battery Directive, this indicates that a heavy metal (Hg = Mercury, Cd = Cadmium, Pb = Lead) is present in this battery or accumulator at a concentration above an applicable threshold specified in the Battery Directive.



This product should be handed over to a designated collection point, e.g., on an authorized one-for-one basis when you buy a new similar product or to an authorized collection site for recycling waste electrical and electronic equipment (EEE) and batteries and accumulators. Improper handling of this type of waste could have a possible impact on the environment and human health due to potentially hazardous substances that are generally associated with EEE. Your cooperation in the correct disposal of this product will contribute to the effective usage of natural resources.

For more information about the recycling of this product, please contact your local city office, waste authority, approved scheme or your household waste disposal service or visit

www.canon-europe.com/weee, or www.canon-europe.com/battery.

For CA, USA only

Included lithium battery contains Perchlorate Material - special handling may apply.

See www.dtsc.ca.gov/hazardouswaste/perchlorate/ for details.

Federal Communication Commission Notice

Multimedia Projector, Model: LV-HD420 / LV-X420

This device complies with Part 15 of the FCC Rules. Operation is subject to the following two conditions:

- (1) This device may not cause harmful interference, and
- (2) this device must accept any interference received, including interference that may cause undesired operation.

Note: This equipment has been tested and found to comply with the limits for a Class B digital device, pursuant to Part 15 of the FCC Rules. These limits are designed to provide reasonable protection against harmful interference in a residential installation. This equipment generates, uses and can radiate radio frequency energy and, if not installed and used in accordance with the instructions, may cause harmful interference to radio communications. However, there is no guarantee that interference will not occur in a particular installation. If this equipment does cause harmful interference to radio or television reception, which can be determined by turning the equipment off and on, the user is encouraged to try to correct the interference by one or more of the following measures:

- Reorient or relocate the receiving antenna.
- Increase the separation between the equipment and receiver.
- Connect the equipment into an outlet on a circuit different from that to which the receiver is connected.
- Consult the dealer or an experienced radio / TV technician for help.

The cable with a ferrite core provided with the projector must be used with this equipment in order to comply with Class B limits in Subpart B of Part 15 of the FCC Rules.

Use of a shielded cable is required to comply with class B limits in Subpart B of Part 15 of FCC Rules.

Do not make any changes or modifications to the equipment unless otherwise specified in the instructions. If such changes or modifications should be made, you could be required to stop operation of the equipment.

Canon U.S.A. Inc.

One Canon Park, Melville, New York 11747, U.S.A.

Tel No. (1) 631-330-5000

Safety Symbols in this Manual

This section describes the safety symbols used in this manual. Important projector safety information is identified by the following symbols. Always observe the safety information by these symbols.



Warning

Denotes the risk of death or serious injury from improper handling if the information is not observed. To ensure safe use, always observe this information.



Caution

Denotes the risk of injury from improper handling if the information is not observed. To ensure safe use, always observe this information.

Precautions for Use

As this section contains important safety-related information, be sure to read the following carefully beforehand in order to use your projector correctly and safely.

Warning

During installation, keep the projector plug easily accessible so that the projector can be unplugged immediately if necessary, or keep a circuit breaker within reach.

If the following situations occur, turn the power off, remove the power plug from the power outlet and contact the Canon Customer Support Center. Failure to do so may result in fire or electric shock.

- If smoke is emitted
- If an unusual smell or noise is emitted
- If water or other liquid has entered the projector
- If metal or any other foreign material has entered the projector
- If the projector is knocked over or dropped and the cabinet is damaged
- If the projector is physically damaged through uses prohibited in this document, etc.

Take the following precautions when handling the power cord. Failure to do so may result in fire or electric shock.

- Do not place any objects on the power cord and do not allow it to become trapped under the projector.
- Do not cover the power cord with a carpet.
- Do not modify or excessively bend, twist, pull, wind, or bundle the power cord.
- Keep the power cord away from heaters and other sources of heat.
- Do not use a damaged power cord. If the power cord is damaged, purchase a replacement from your dealer.
- The power cord included with this projector is for use exclusively with this product. Do not use this cord for other products.

Warning

Take the following precautions regarding the power supply, power plug, and connector. Failure to do so may result in fire or electric shock.

- Do not use any power source with a voltage other than the voltage indicated (AC 100–240 V).
- Do not pull the power cord and be sure to hold the power plug or connector when removing. Incorrect handling may damage the power cord.
- Do not insert any metal objects into the contact parts of the power plug or connector.
- Do not remove the power plug or connector with wet hands.
- Insert the power plug and connector securely up to the base. Additionally, do not use a damaged power plug or an outlet that is loose.
- When using an extension cord, do not exceed the cord's rated capacity.
- Periodically inspect the power plug and outlet and remove any dust or dirt from between the plug and the outlet.

Installation and Handling Precautions

Take the following precautions regarding installation and handling of the projector. Failure to do so may result in a fire, electric shock or personal injury.

- Do not use the projector where it might get wet, such as outdoors or by bathtubs or showers.
- Do not place containers containing liquid on top of the projector.
- Do not touch the projector itself, the power cord, or the cable if there is lightning outside.
- Do not move the projector until you have switched off the power, removed the power plug from the power outlet and unplugged any other cables.
- Unplug the projector before cleaning or maintenance.
- Do not install the projector in a location that is damp or dusty, or where there is a lot of oily smoke or steam. Oil can degrade the plastic, which could result in a ceiling-mounted projector falling from its mounting.
- Do not remove the cabinet from the projector or disassemble it. The interior of the projector contains high-voltage components as well as parts that are hot. If inspection, maintenance or repair is required, contact the Canon Customer Support Center.
- Do not disassemble or modify the projector (including consumable parts) or the remote control.

Warning

Take the following precautions regarding installation and handling of the projector. Failure to do so may result in a fire, electric shock or personal injury.

- Do not look directly into the exhaust vents during use.
- Do not insert any object into vents in the projector, such as the air intake vent or exhaust vents.
- Do not place a pressurized can in front of the exhaust vents. The pressure of the contents of the can may increase due to heat from the exhaust vents and this could result in an explosion.
- When cleaning off dust or dirt from projector parts such as the lens, never use any spray that is flammable. Internal parts that become hot may ignite and cause a fire.
- Do not use adhesives, lubricants, oils, or alkaline detergents for maintenance of the projector. They could adhere to the cabinet and damage it, possibly resulting in the projector falling from its mounting and causing an accident or personal injury.
- As strong light beams are emitted while the projector is in use, do not look directly into the projector lens. Doing so could cause an eye injury. Pay particular attention to prevent small children from doing so.
- Light from the projector is classified as Risk Group 2 (RG2) according to IEC 62471-5:2015.
- If children may approach the projector or touch it, always ensure the projector is used under adult supervision.
- Do not hold or install optical instruments (such as magnifying glasses, reflectors, or glasses) in the path of light from the projector. If projected light is refracted or reflected and enters people's eyes, it may result in eye injury.
- When setting the projector on a high surface for projection, be sure the surface is flat and stable.
- Do not install the projector on a soft surface such as a carpet or foam mat. Doing so could cause heat to build up inside the projector and this could result in a fire.



Precautions on the lamp

Warning

This projector uses a high-pressure mercury lamp as a light source. The mercury lamp has the following characteristics.

- The lamp will gradually become darker over time.
- Impact, abrasion, or use of worn-out lamps may cause lamps to rupture (accompanied by a loud noise) or burn out.
- Lamps are more likely to rupture once the lamp replacement message has been displayed. Replace the lamp with a new one as soon as possible. For details, refer to the user's manual.
- Useful life of lamps varies widely from lamp to lamp and depending on the environment of use. Some lamps may fail or rupture soon after they are first used.

Take the following precautions during lamp replacement or when a lamp has ruptured. Failure to do so may result in electric shock, burns, or other injury.



- Before replacing the lamp, always unplug the projector and wait at least 45 minutes.
- Ruptured lamps may emit dust and gas (containing mercury vapor) out of the exhaust vents. If so, immediately open windows and doors to ventilate the room. Additionally, shards of glass may be scattered. Do not attempt lamp replacement yourself. Instead, contact an installer or Canon Customer Support Center for internal cleaning, inspection, and lamp replacement.
- If you accidentally inhale gas from the lamp or get any pieces in your eyes or mouth, consult a doctor immediately.

Take the following precautions when replacing lamps that stop working. Failure to do so may result in injury.

- If illumination suddenly stops, either when you turn the projector on or during use, the lamp may have ruptured. In this case, never attempt replacement yourself. Request replacement from an installer or Canon Customer Support Center.
- With ceiling-mounted projectors, the lamp may fall out when you open the lamp cover, or during replacement. During replacement, stand to the side of the lamp cover, not directly under it.

Precautions for the Batteries of the Remote Control

Warning

Take the following precautions regarding handling of batteries. Failure to do so may result in a fire or personal injury.

- Do not heat, short circuit or disassemble the batteries, or place them in a fire.
- Do not attempt to recharge the batteries that are included with the remote control.
- Remove the batteries when they are flat or when the remote control will not be used for a long period of time.
- Insert the batteries with the + and - terminals in the correct directions.
- If any liquid from inside the batteries leaks out and contacts your skin, be sure to wash the liquid off thoroughly.

Caution

Take the following precautions regarding installation and handling of the projector.

- If the projector will not be used for a long period of time, be sure to remove the power plug from the power outlet to ensure safety. Failure to do so presents a risk of fire if dust accumulates on the plug or outlet.
- Do not touch parts of the cabinet around and above the exhaust vents, which may become hot during projection or for a while after projection. Be especially careful to keep children away from these parts. Additionally, do not place any metal objects around or above the exhaust vents. Such objects may become hot from the projector, which may result in burns or other injury.
- Do not place any heavy objects on top of the projector or sit / stand on it. Pay particular attention to prevent small children from doing so. The projector may be knocked over and this could result in damage or a personal injury.
- Do not place the projector on an unstable or slanted surface. Doing so may cause the projector to fall or be knocked over and could result in a personal injury.
- Do not place any objects in front of the lens during projection. This may result in a fire.



When handling the lamp, take the following precautions.

- Lamps are more likely to rupture once the lamp replacement message has been displayed. Replace the lamp with a new one as soon as possible.
- Before removing the lamp, wait at least 45 minutes after turning off the projector and confirm that the lamp and projector have cooled down sufficiently. Failure to do so may result in burns or other injury.
- Be prepared by keeping a spare lamp.
- Dispose of used mercury lamps in accordance with local regulations.

Caution for viewing 3D content

Caution

Pay attention to the following points when viewing 3D content.

- Photosensitive patients, patients with heart disease, pregnant women, elderly people, and people with serious illness and/or with a history of epilepsy should not view 3D content.
- We advise that you should refrain from viewing 3D content if you are in bad physical condition, need sleep or have been drinking alcohol.
- Stop watching 3D content if you experience the following symptoms. If you experience such symptom, immediately stop viewing 3D content and take a break until the symptom has subsided.
 - You see doubly-blurred images or you cannot view the image stereoscopically.
 - You feel fatigue or discomfort.
- Take breaks when viewing 3D content for an extended period of time. As this may cause eye fatigue. Viewing 3D content for an extended period of time or viewing them from an oblique angle can cause eye strain.
- Parents should accompany and monitor their children as children cannot properly express discomfort with 3D content viewing. Children who are six year of age or younger should not view 3D content.
- The optimum 3D viewing distance from the screen is about 3 times of the vertical screen size or more and your eyes should be level with the screen.

 **Caution**

Take the following precautions when carrying or transporting the projector.

- This projector is a precision instrument. Do not knock it over or subject it to impacts. Doing so may cause a malfunction.
- Protection of the projector cannot be guaranteed if used packaging or shock-absorbent materials are reused. Fragments from shock-absorbent material may also enter the interior of the projector which could cause a malfunction.
- Disconnect the cables connected to the projector. Carrying the projector while the cables are attached may cause an accident.
- Retract the adjustable feet before moving the projector. Leaving the feet extended may cause damage.
- Do not touch the lens with bare hands. Doing so may result in deterioration of image quality.

Take the following precautions when installing or using the projector.

- Be careful of condensation.
If the projector is abruptly taken to a warmer location, or if the room temperature rises abruptly, moisture in the air may condense on the lens and mirror, causing the image to become blurred.
- Do not install the projector in a location where the temperature changes rapidly such as in front of a cooling and heating machine. Otherwise, it may damage the projector due to condensation or a rapid change in temperature.
- Do not install the projector in extremely hot or cold locations. This may damage the projector. Ranges for the environment of use and storage are as follows.
 - Environment of use: 5°C (41°F) to 40°C (104°F), up to 85% RH
 - Storage temperature: -10°C (14°F) to 60°C (140°F)
- When using the projector at an altitude of 1,500 m (4,921') or higher: Adjust projector menu settings accordingly (Page 47).
- Do not block the air intake or exhaust vents. Blocking the vents may trap heat inside the projector, which may shorten the useful life of optical components or other parts and damage the projector.
- Install the projector leaving at least 50 cm (1.6') between air intake/exhaust vents and walls. Failure to do so may trap heat inside the projector and damage it.
- Do not place any objects on top of the projector that may change shape or color due to heat.
- Do not install the projector in a location that is damp, or where there is a lot of dust, oily smoke or tobacco smoke. Doing so could cause contamination of optical components such as the lens and the mirror and may result in deterioration of image quality. And oil can degrade the plastic, which could result in a ceiling-mounted projector falling from its mounting.
- Do not install the projector near high-voltage electrical power lines or an electrical power source.

Projector Installation Notice

- Place the projector in a horizontal position
The tilt angle of the projector should not exceed 15 degrees, nor should the projector be installed in any way other than the desktop and ceiling mount, otherwise lamp life could decrease dramatically, and may lead to other **unpredictable damages**.

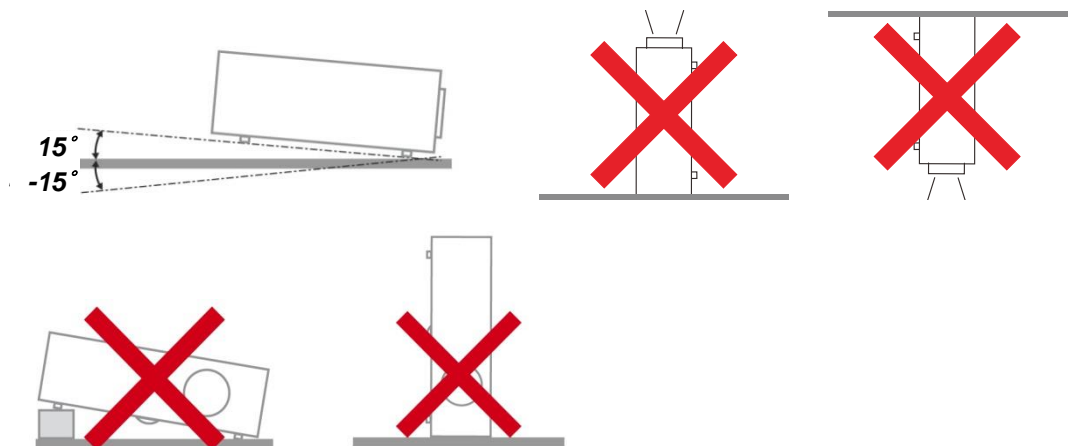

- Allow at least 50 cm clearance around the exhaust vent.

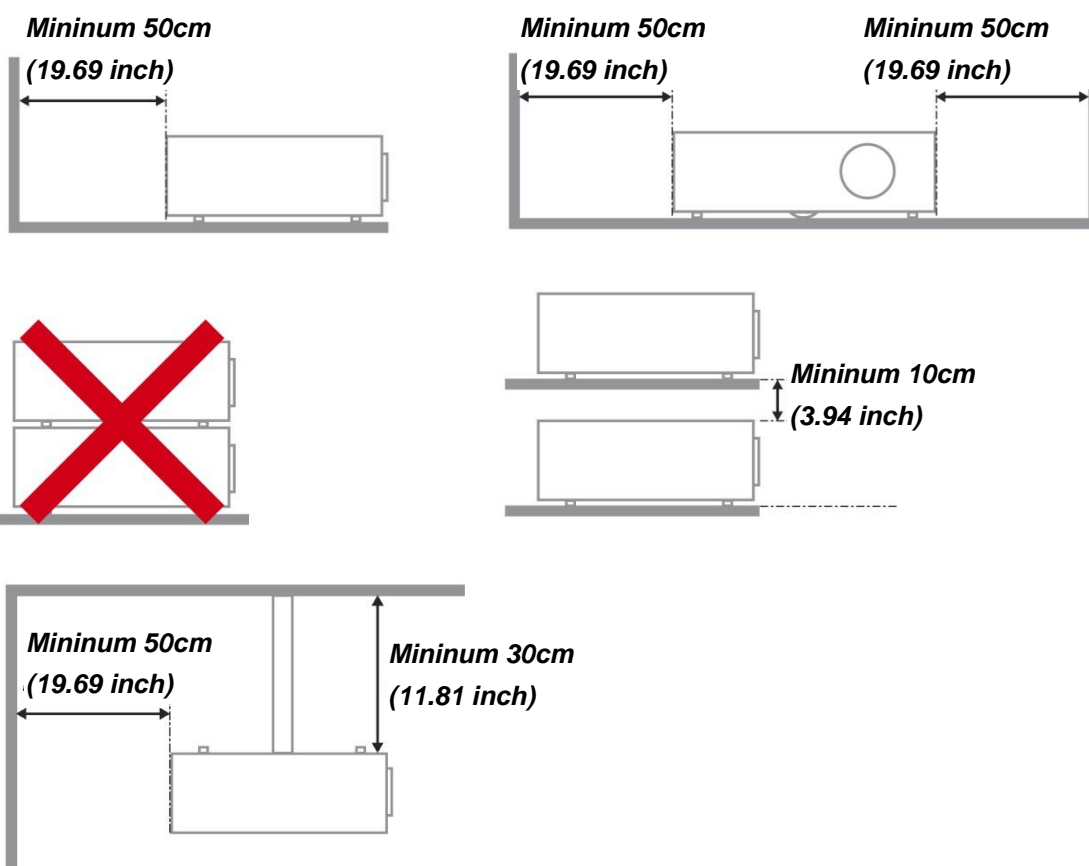

- Ensure that the intake vents do not recycle hot air from the exhaust vent.
- When operating the projector in an enclosed space, ensure that the surrounding air temperature within the enclosure does not exceed operation temperature while the projector is running, and the air intake and exhaust vents are unobstructed.
- All enclosures should pass a certified thermal evaluation to ensure that the projector does not recycle exhaust air, as this may cause the device to shutdown even if the enclosure temperature is within the acceptable operation temperature range.
- Make sure to implement anti-fall measures such as an anti-fall wire when installing the projector in high places, for example, installing it on the ceiling.

Copyright Notice

Please note that enlarging or reducing the size of an image for commercial purposes or public presentation may infringe on the legally protected copyright or the copyright holder of the original material.

Ensure Network Security

Take measures to ensure network security. Note that Canon is not liable in any way for direct or indirect loss from network security incidents, such as unauthorized access.

Before using the projector, configure the appropriate projector, computer, and network security settings. Install the projector in a network protected by a firewall or other security measures. Do not connect it directly to the Internet.

About Trademarks

- Ethernet is a registered trademark of Xerox Corporation.
- Microsoft, Windows, Windows Vista, Windows 7, Windows 8, Windows 8.1 and Windows 10 are registered trademarks or trademarks of Microsoft Corporation in the United States and / or other countries.
- Mac, Mac OS and Macintosh are trademarks of Apple Inc., registered in the United States and / or other countries.
- HDMI, the HDMI logo and High-Definition Multimedia Interface are trademarks or registered trademarks of HDMI Licensing, LLC.
- PJLink is a registered trademark of JBMIA and pending trademark in some countries.
- PJLink is a registered trademark, or an application has been submitted for trademark, in Japan, the United States and / or other countries or regions.
- AMX is a trademark of AMX Corporation.
- Crestron®, Crestron RoomView®, and Crestron Connected™ are registered trademarks of Crestron Electronics, Inc.
- MHL, the MHL logo, and Mobile High-Definition Link are trademarks or registered trademarks of MHL, LLC in the United States and other countries.
- All other trademarks are the property of their respective owners.

Packing Checklist

Carefully unpack the projector and check that the following items are included:

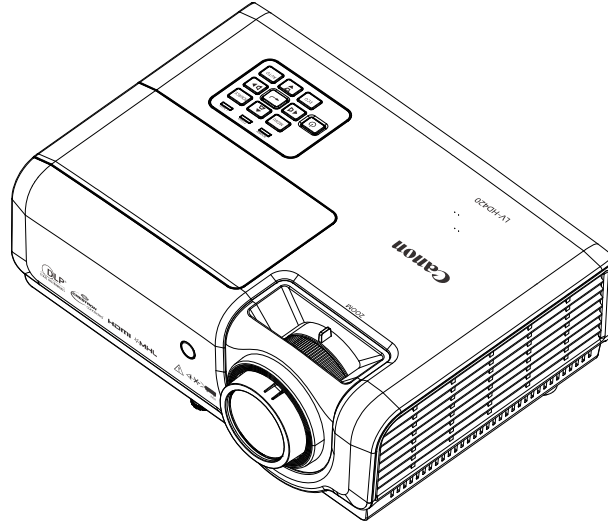

PROJECTOR

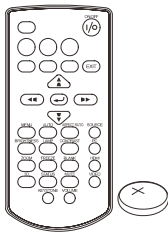

REMOTE CONTROL
(WITH ONE CR2025 BATTERY)

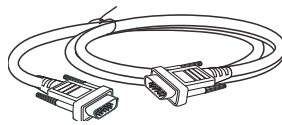

RGB CABLE (1.8 M / 5.9')
(MINI D-SUB 15-PIN / MINI D-SUB 15-PIN)
(P/N: 3081409201)

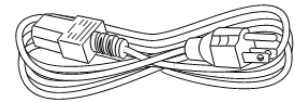

POWER CORD (1.8 M / 5.9')



CD-ROM
(THIS USER'S MANUAL)

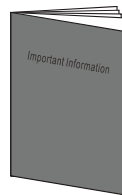

IMPORTANT INFORMATION

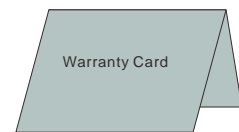

WARRANTY CARD

Views of Projector Parts

Front-right View

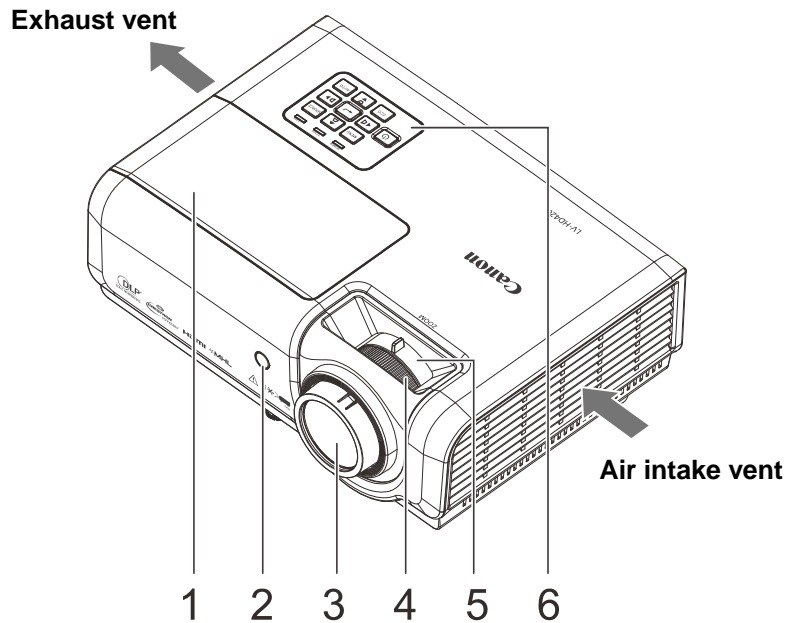

ITEM	LABEL	DESCRIPTION	SEE PAGE
1.	Lamp Cover	Remove to change the lamp.	61
2.	IR receiver	Receive IR signal from remote control.	
3.	Projection Lens		
4.	Focus ring	Focuses the projected image.	27
5.	Zoom ring	Enlarges the projected image.	
6.	Function keys	See Top view—On-screen Display (OSD) buttons and LEDs.	15

Install at a Sufficient Distance from Walls and Other Obstructions

If the air intake or exhaust vent is blocked, heat will accumulate inside the projector, possibly resulting in a shortened projector lifetime or a malfunction.

Top view—On-screen Display (OSD) buttons and LEDs

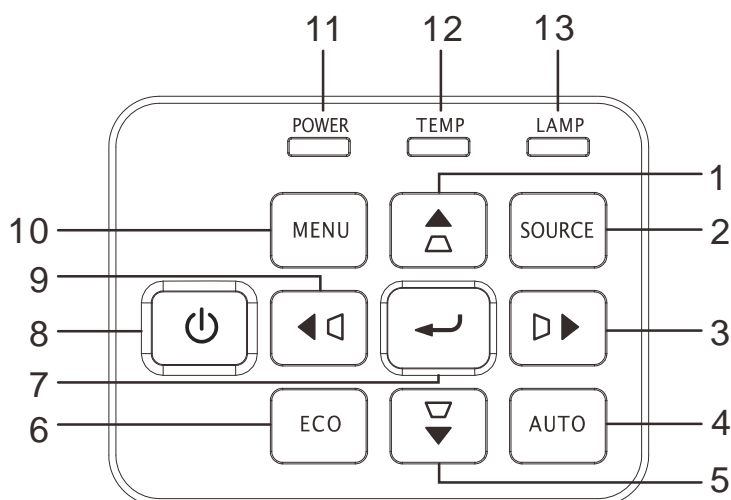

ITEM	LABEL	DESCRIPTION		SEE PAGE	
1.	▲ △	Navigates and changes settings in the OSD Quick Menu – For Keystone		29	
2.	SOURCE	Navigates and changes settings in the OSD Enter the Source menu			
3.	▶▶	Navigates and changes settings in the OSD Quick Menu – For Keystone			
4.	AUTO	Optimizes image size, position, and resolution			
5.	▽ ▼	Navigates and changes settings in the OSD Quick Menu – For Keystone			
6.	ECO	Enter the lamp mode menu			29
7.	↵	Enter or confirm highlighted OSD menu item			
8.	⏻	Turns the projector On or Off.			
9.	◀◀	Navigates and changes settings in the OSD Quick Menu – For Keystone			
10.	MENU	Opens and exits OSD menus		68	
11.	POWER LED	Solid	Standby, Lamp Lit, over temperature		
		Flashing	System Initialized, System Power On , Cooling , Error code		
12.	TEMP LED	Solid	Over temperature		
13.	LAMP LED	Solid	Lamp Fail.		
		Flashing	Error code		

Rear view

Before connecting the projector to other equipment, turn off both the projector and the other equipment.

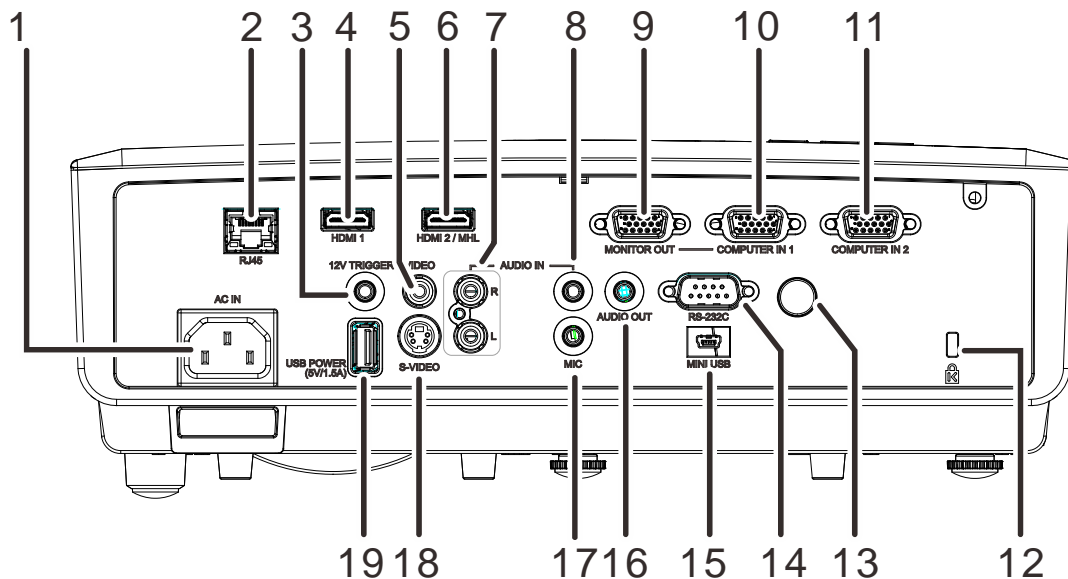

ITEM	LABEL	DESCRIPTION	SEE PAGE
1.	AC IN	Connect the POWER cable	22
2.	RJ45	Connect a LAN cable from Ethernet	
3.	12V TRIGGER	Connect the 12V OUT (Screen Trigger-- For screen controllers used)	
4.	HDMI 1	Connect the HDMI cable from a HDMI device(*)	
5.	VIDEO	Connect the COMPOSITE cable from a video device	
6.	HDMI 2 / MHL	Connect the HDMI cable from a HDMI device. (*) Connect the MHL cable from a MHL-compatible device. Note: <ul style="list-style-type: none"> • A dedicated adapter is required if your projector does not support the standard MHL cable. • Use a MHL cable (available on the market) and MHL-HDMI conversion adapter (available on the market) that certified with the MHL standard. When non-compliant items are used, image projection may not be possible, or the connected device may malfunction or generate heat. • Images may not be displayed correctly depending on the connected device type and the settings. • When images cannot be projected properly, disconnect and reconnect the MHL cable. • Operation is not guaranteed for all connected devices. 	
7.	AUDIO IN (R / L)	Connect an AUDIO cable from the audio device	
8.	AUDIO IN	Connect an AUDIO cable from the audio device	
9.	MONITOR OUT	Connect the RGB cable from a computer (Loop Thru only for COMPUTER IN-1)	
10.	COMPUTER IN 1	Connect the RGB cable from a computer or components device	

* When connecting to HDMI device, use an HDMI certified cable.

ITEM	LABEL	DESCRIPTION	SEE PAGE
11.	COMPUTER IN 2	Connect the RGB cable from a computer or components device	
12.	Kensington Lock	Secure to permanent object with a Kensington Lock system	66
13.	IR receiver	Receive IR signal from remote control.	
14.	RS-232	Connect RS-232 serial port cable to control the projector with control commands	
15.	MINI USB	Connect the USB cable from a computer (For service only)	
16.	AUDIO OUT	Connect an AUDIO cable to audio amplifier	
17.	MIC	Connect the Microphone for use	
18.	S-VIDEO	Connect the S-VIDEO cable from a video device	
19.	USB POWER (5V/1.5A)	Connect the USB cable for power supply.	

Bottom view

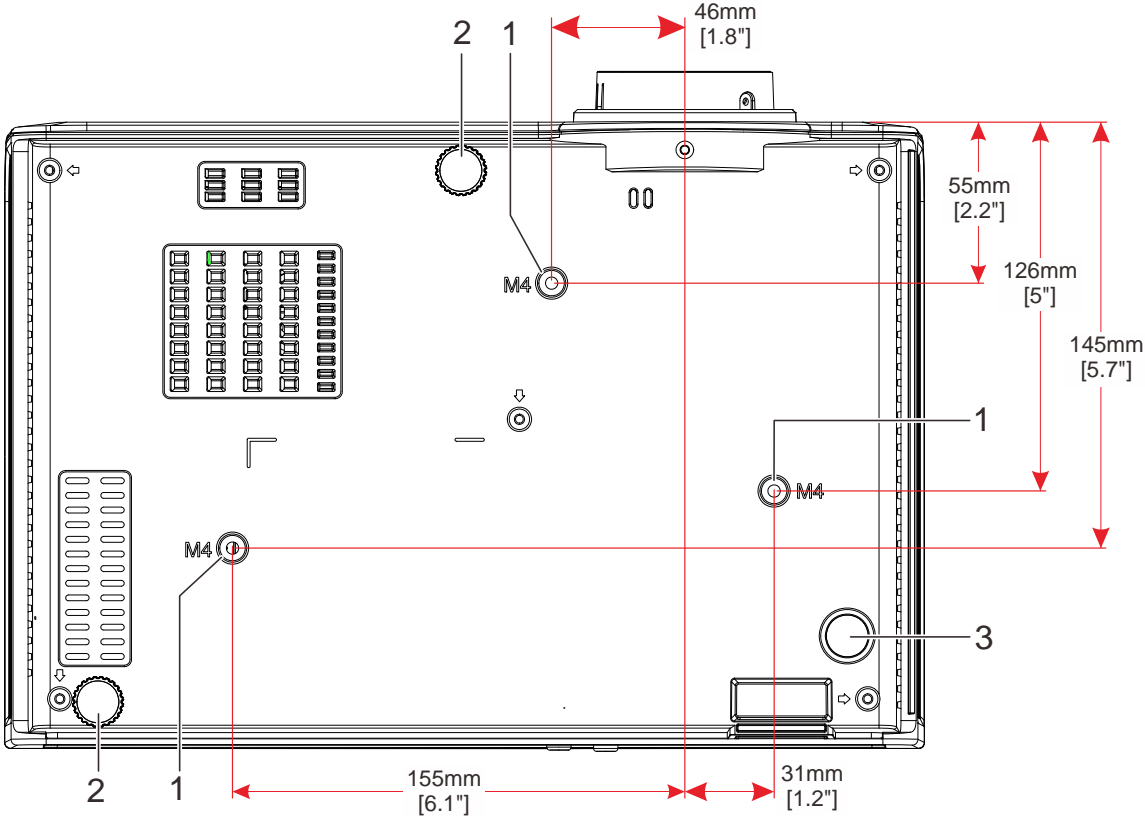

ITEM	LABEL	DESCRIPTION	SEE PAGE
1.	Ceiling support holes	Contact your dealer for information on mounting the projector on a ceiling	
2.	Adjustable feet	Rotate adjuster lever to adjust angle position.	26
3.	Fixed foot		

Remote Control Parts

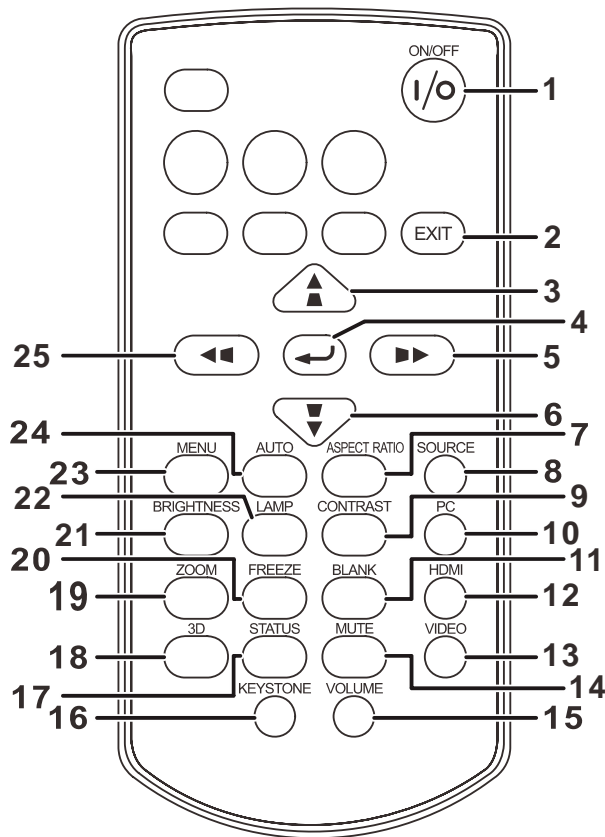

Note:

If buttons on the remote control are inoperative when you attempt to operate the projector, replace the batteries with new ones.

Do not drop the remote control or subject it to impact.

Do not spill any liquids on the remote control. Doing so may cause a malfunction.

ITEM	LABEL	DESCRIPTION	SEE PAGE
1.	ON/OFF	Turns the projector On or Off.	29
2.	EXIT	Goes back to previous OSD menu, exits and saves menu settings. Goes back to previous page.	
3.		Navigates and changes settings in the OSD. Keystone correction.	29
4.		Enters and confirms settings in the OSD.	
5.		Navigates and changes settings in the OSD. Keystone correction.	
6.		Navigates and changes settings in the OSD. Keystone correction.	
7.	ASPECT RATIO	Displays the ASPECT RATIO selections.	
8.	SOURCE	Displays the source selection bar.	29
9.	CONTRAST	Displays the contrast setting bar.	
10.	PC	Toggles the input sources for display between PC sources.	

ITEM	LABEL	DESCRIPTION	SEE PAGE
11.	BLANK	Toggles the screen between blank and normal. Also, toggles the built-in speaker between off and on.	
12.	HDMI	Toggles the input sources for display between HDMI sources.	
13.	VIDEO	Toggles the input sources for display between Video and S-Video.	
14.	MUTE	Toggles the built-in speaker between off and on.	
15.	VOLUME	Displays the volume setting bar.	28
16.	KEystone	Displays the keystone setting bar.	27
17.	STATUS	Opens the OSD Status menu. (the menu only opens when an input device is detected)	46
18.	3D	Opens the 3D function OSD.	
19.	ZOOM	Displays the zoom setting bar.	
20.	FREEZE	Freeze/unfreezes the on-screen picture.	
21.	BRIGHTNESS	Displays the brightness setting bar.	
22.	LAMP	Displays the lamp mode selection.	
23.	MENU	Opens and exits OSD menus.	29
24.	AUTO	Auto adjustment for frequency, phase, position.	
25.		Navigates and changes settings in the OSD. Keystone correction.	

Remote Control Operating Range

The remote control is an infrared type. Point it at the infrared remote receiver on the front or rear of the projector to operate it. Remote control range is up to approximately 5 m (16') . Use the remote control within an angle approximately 15° in any direction from directly in front of the infrared remote receiver. But the effective control range may be reduced.

Projector and Remote Control Buttons

The projector can be operated using the remote control or the buttons on the top of the projector. All operations can be carried out with the remote control; however, the buttons on the projector are limited in use.

Inserting the Remote Control Batteries

1. Remove the battery compartment cover by sliding the cover in the direction of the arrow (A). Pull out the cover (B)..

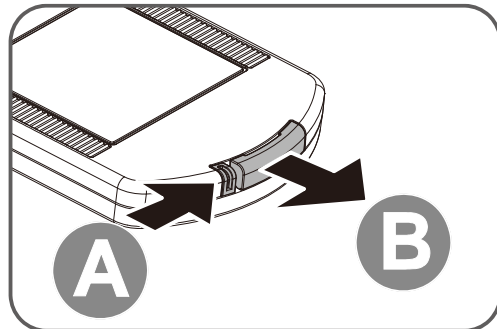

2. Insert the battery with the positive side facing up.

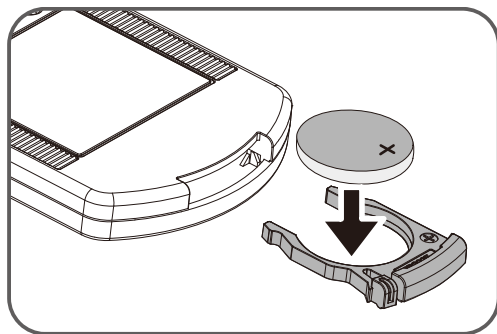

3. Replace the cover.

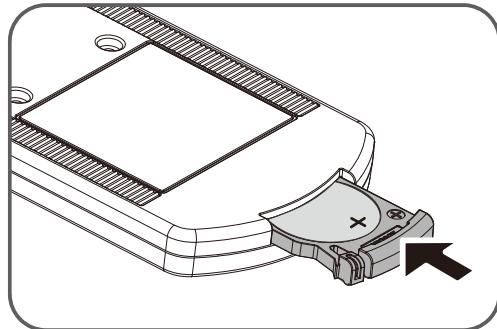

Warning:

Pay attention to the following points regarding handling of battery. Failing to do so could result in a fire or personal injury.

- Do not heat, short circuit or disassemble the battery, or place them in a fire.
- Do not attempt to recharge the battery that is included with the remote control.
- Remove the battery when they are flat or when the remote control will not be used for a long period of time.
- Insert the battery with the + and - terminals in the correct directions.
- If any liquid from inside the battery leaks out and contacts your skin, be sure to wash the liquid off thoroughly.



Caution:

- RISK OF EXPLOSION IF BATTERY IS REPLACED BY AN INCORRECT TYPE.
- DISPOSE OF USED BATTERIES IN ACCORDANCE WITH LOCAL REGULATIONS.

Starting and Shutting down the Projector

1. Connect the power cord to the projector. Connect the other end to a wall outlet.
The **POWER** LED on the projector light.

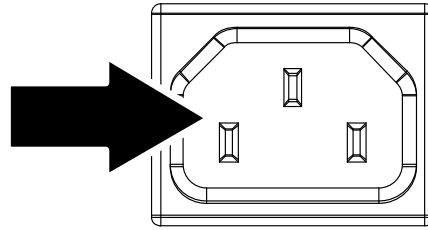

2. Turn on the connected devices.
3. Ensure the POWER LED not a flashing. Then press the **POWER** button to turn on the projector.

The projector splash screen displays and connected devices are detected.

See [Setting an Access Password \(Security Lock\)](#) on page 24 if security lock is enabled.



4. If more than one input device is connected, press the **SOURCE** button and use **▲▼** to scroll among devices.
(Component is supported through the RGB to COMPONENT ADAPTER.)

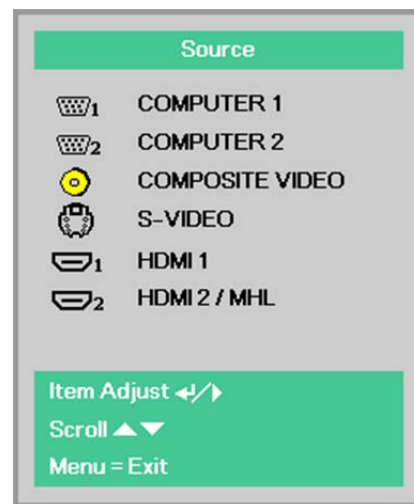

- COMPUTER1, COMPUTER2: Analog RGB
- COMPOSITE VIDEO: Traditional composite video
- S-VIDEO: Super video (Y/C separated)
- HDMI 1: HDMI
- HDMI 2/MHL: HDMI, MHL

5. Press the **POWER** button.
When the “Power Off? /Press Power again” message appears, press the **POWER** button. The projector turns off.

Note:

Do not unplug the power cord until the POWER LED stops flashing—indicating the projector has cooled down.

How to store the projector in the soft carrying case (LV-SC02)

The soft carrying case is not provided with the projector. Please contact with a store if you want to purchase it.

Note:

To protect lens of the projector, make sure to store the projector with its lens up as shown below.

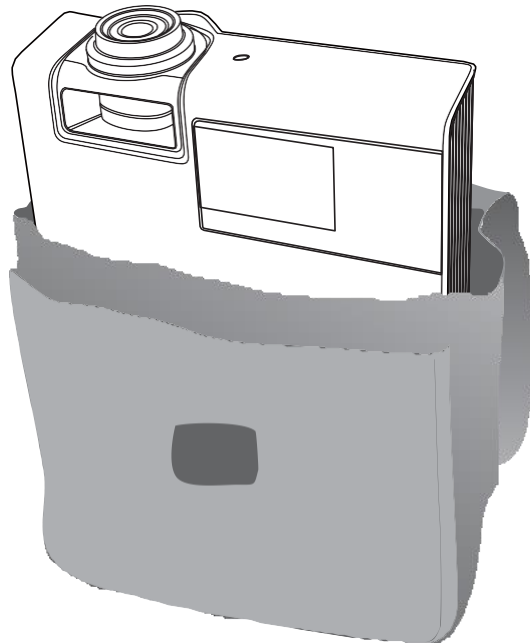

Setting an Access Password (Security Lock)

You can use the four (arrow) buttons to set a password and prevent unauthorized use of the projector. When enabled, the password must be entered after you power on the projector. (See [Navigating the OSD](#) on page 29 and [Setting the OSD Language](#) on page 30 for help on using OSD menus.)

Note:

Keep the password strictly. Without the password, you will not be able to use the projector. If you lose the password, contact Canon Customer Support Center for information on clearing the password.

1. Press the **MENU** button to open the OSD menu.

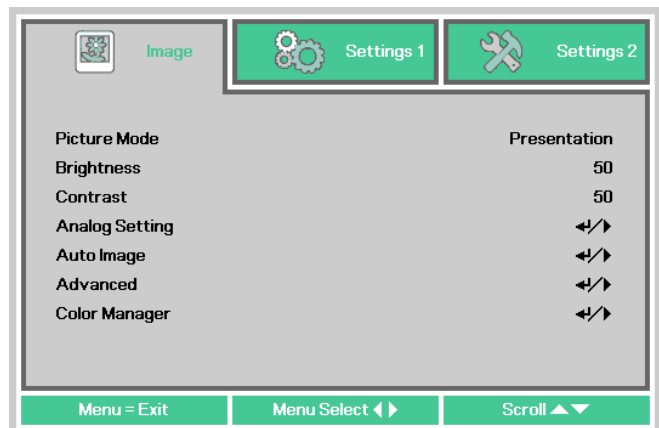

2. Press the cursor ◀▶ button to move to the **Settings 1** menu, press the cursor ▲▼ button to select **Advanced 1**.

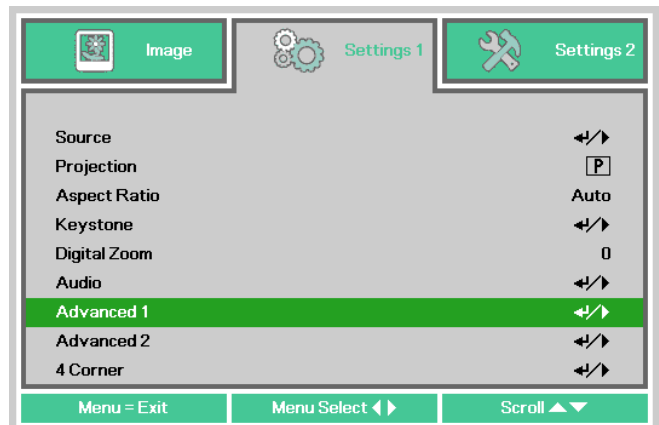

3. Press ◀ (Enter) / ▶ to enter the **Advanced 1** sub menu. Press the cursor ▲▼ button to select **Security Lock**.

4. Press the cursor ◀▶ button to enter and enable or disable security lock function.

A password dialog box automatically appears.

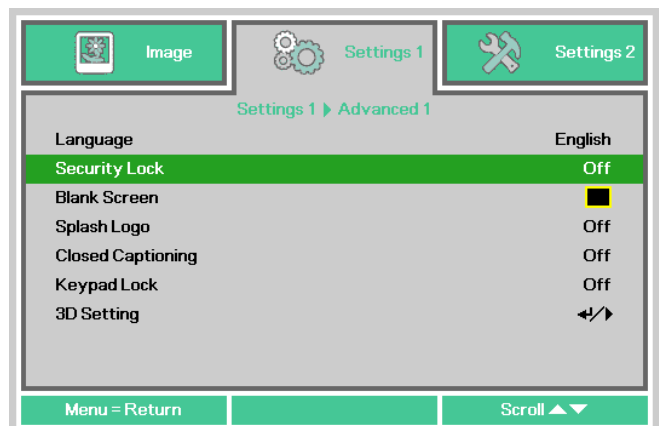

- 5.** You can use the cursor buttons ▲▼◀▶ either on keypad or IR remote control for password entry. You can use any combination including the same arrow five times, but not less than five.

Press the cursor buttons in any order to set the password. Push the **MENU** button to exit the dialog box.

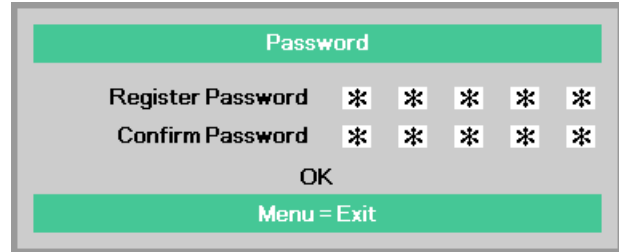
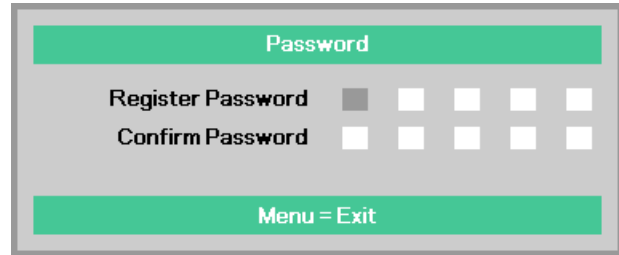

- 6.** The password confirm menu appears when user presses the power-on key in case the **Security Lock** is enabled. Enter the password in the order you set it at step 5. In case you forget the password, please contact the Canon Customer Support Center.

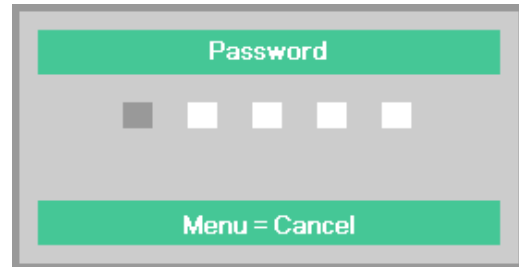

Adjusting the Projector Level

Take note of the following when setting up the projector:

- *The projector table or stand should be level and sturdy.*
- *Position the projector so that it is perpendicular to the screen.*

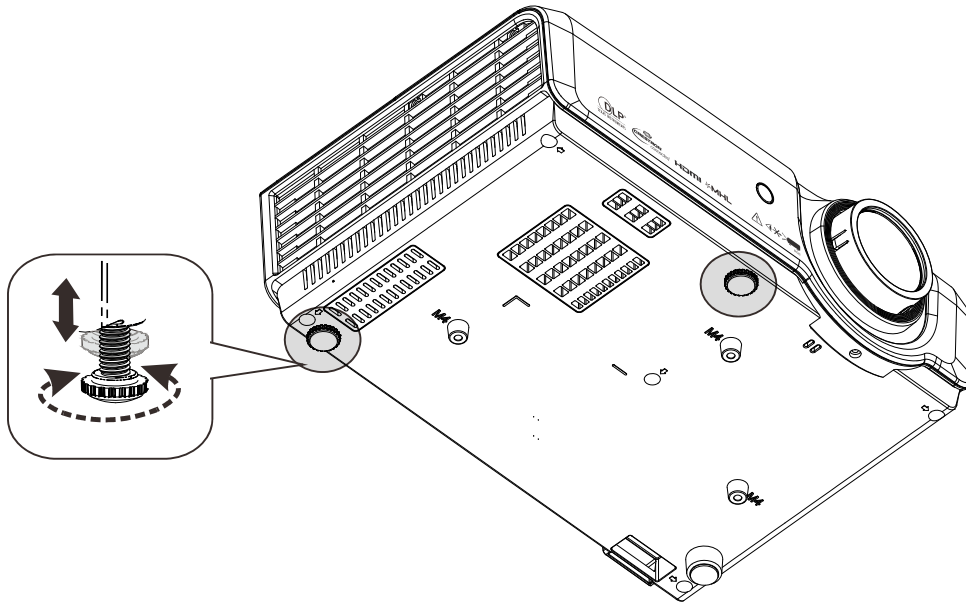

To adjust the angle of the picture, turn the Adjustable feet right or left until the desired angle has been achieved.

Adjusting the Zoom, Focus and Keystone

1. Use the **zoom ring** to resize the projected image **A**

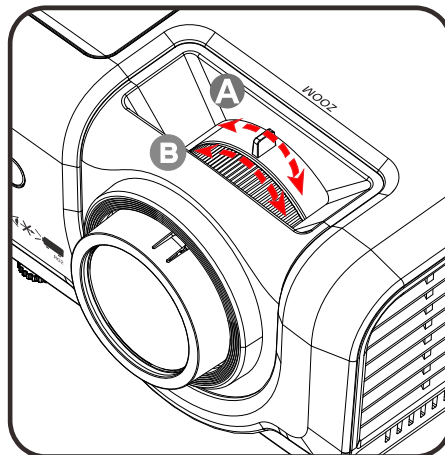

Use the **Focus ring** to sharpen the projected image. **B**

2. Use the **KEYSTONE** buttons to correct image-trapezoid (wider top, bottom, left side or right side).

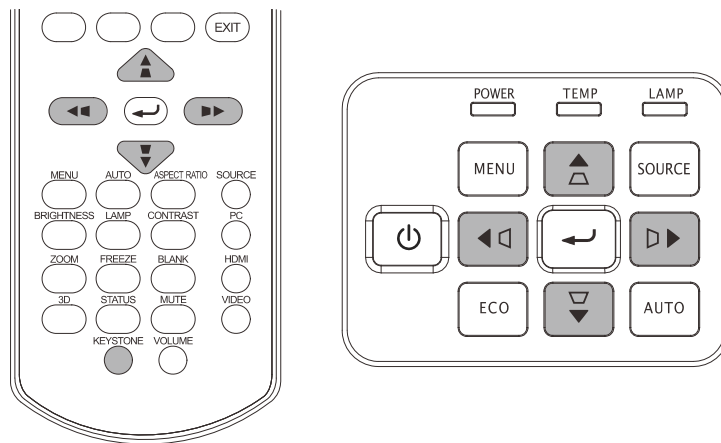

The keystone control appears on the display.

Press **▲** / **▼** for V Keystone correcting image.

Press **◀** / **▶** for H Keystone correcting image.

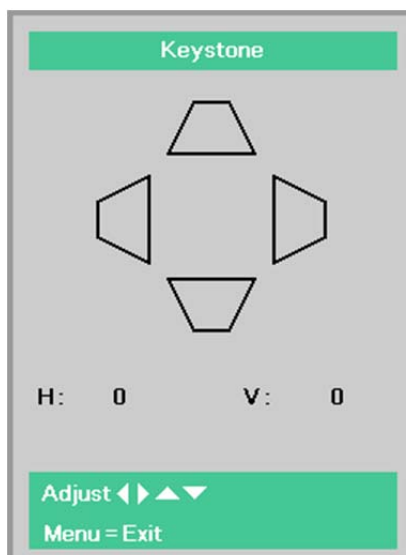

Adjusting the Volume

1. Press the **Volume** buttons on the remote control.
The volume control appears on the display.

Press the ◀/▶ buttons on the remote control to adjust volume.

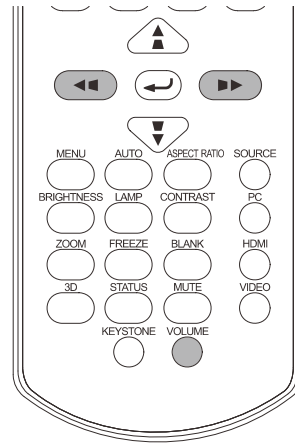

2. Press the **MUTE** button to turn off the volume.
(This feature is available only on the remote).



ON-SCREEN DISPLAY (OSD) MENU SETTINGS

OSD Menu Controls

The projector has an OSD that lets you make image adjustments and change various settings.

Navigating the OSD

You can use the remote control cursor buttons or the projector keypad to navigate and make changes to the OSD.

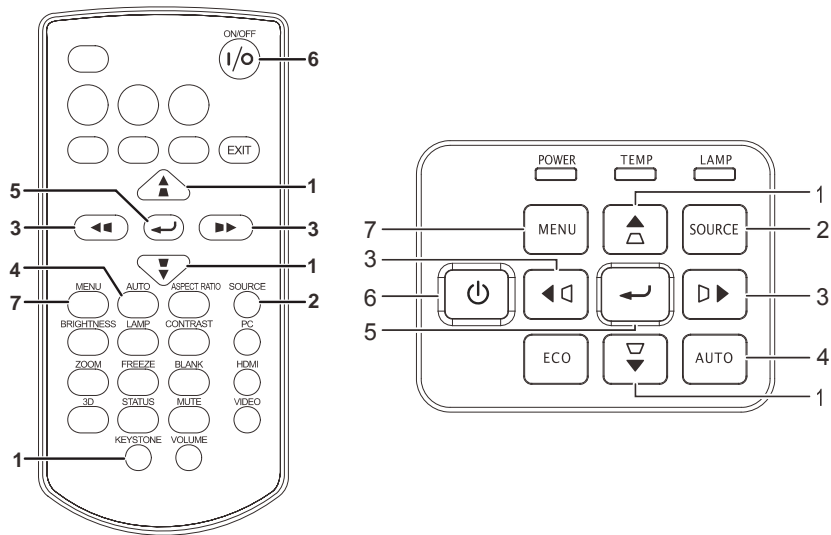

1. To enter the OSD, press the **MENU** button.
2. There are three menus. Press the cursor ◀▶ button to move through the menus.
3. Press the cursor ▲▼ button to move up and down in a menu.
4. Press ◀▶ to change values for settings.
5. Press **MENU** to close the OSD or leave a submenu.

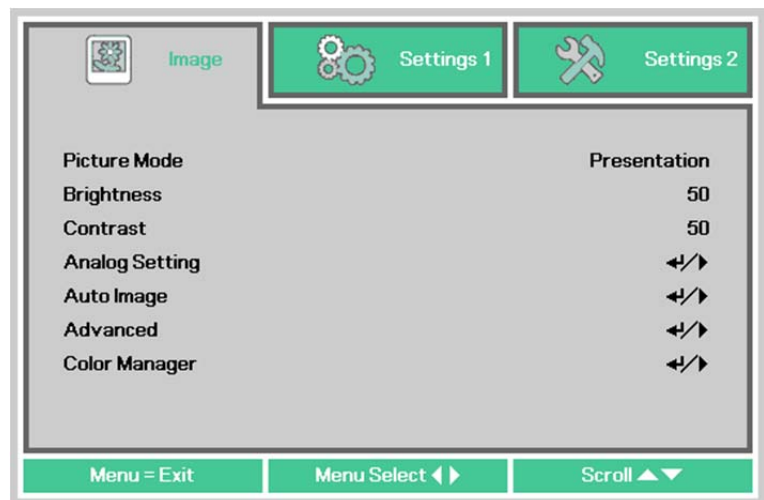

Note:

Depending on the video source, not all items in the OSD are available. For example, the **Horizontal/Vertical Position** items in the **Analog Setting** menu can only be modified when connected to a PC. Items that are not available cannot be accessed and are grayed out.

Setting the OSD Language

Set the OSD language to your preference before continuing.

1. Press the **MENU** button. Press the cursor ◀▶ button to navigate to **Settings 1**. Press the cursor ▲▼ button to move to the **Advanced 1** menu.

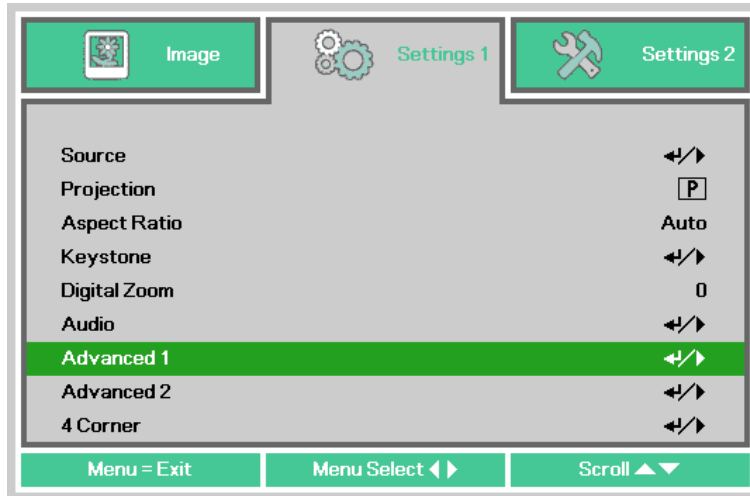

2. Press ◀ (Enter) / ▶ to enter the **Advanced 1** sub menu. Press the cursor ▲▼ button until **Language** is highlighted.

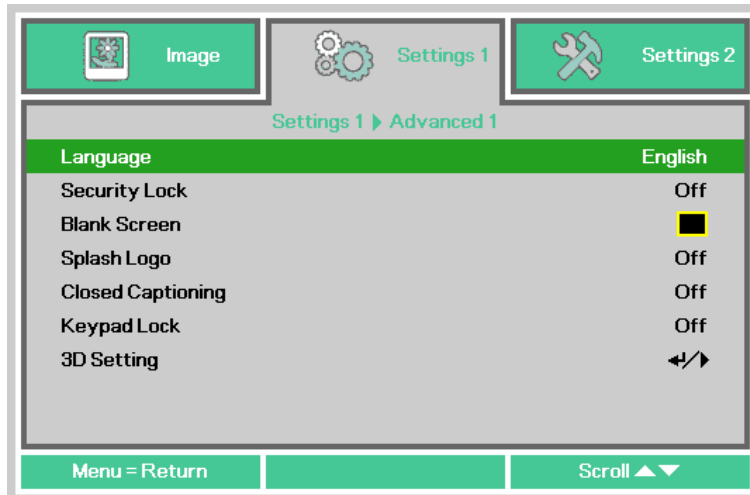

3. Press the cursor ▼▲◀▶ button until the language you want is highlighted.
4. Press the **MENU** button four times to close the OSD.

OSD Menu Overview

Use the following illustration to quickly find a setting or determine the range for a setting.

Main Menu	Sub Menu	Settings		
Image	Picture Mode	Standard (*1), Presentation, Movie (*2), sRGB, User *1:When computer signal input *2:When other signal input		
	Brightness	0~100		
	Contrast	0~100		
	Analog setting	Horizontal Position	-5~ 0 ~5 (depend on Autolock)	
		Vertical Position	-5~ 0 ~5 (depend on Autolock)	
		Frequency	0 ~31	
		Tracking	-5~ 0 ~5	
	Auto Image			
	Advanced	Brilliant Color	0~10	
		Sharpness	0~31	
		Gamma	1.8, 2.0, 2.2, 2.4, Linear	
		Color Temperature	6500K, 7500K, 8300K	
		Video AGC	On , Off	
		Video Saturation	0~ 50 ~100	
		Video Tint	0~ 50 ~100	
		White Balance	RGain	0~ 100 ~200
			GGain	0~ 100 ~200
			BGain	0~ 100 ~200
			ROffset	-256~ 0 ~255
	GOffset		-256~ 0 ~255	
	Color Manager	Red	Hue, Saturation, Gain 0~100	
		Green	Hue, Saturation, Gain 0~100	
		Blue	Hue, Saturation, Gain 0~100	
Cyan		Hue, Saturation, Gain 0~100		
Magenta		Hue, Saturation, Gain 0~100		
Yellow		Hue, Saturation, Gain 0~100		
White		Red, Green, Blue 0~100		

Main Menu	Sub Menu		Settings		
Settings 1	Source	Source	COMPUTER 1 , COMPUTER 2, COMPOSITE VIDEO, S-VIDEO, HDMI 1, HDMI 2 / MHL		
	Projection		Front , Rear, Ceiling, Rear+Ceiling		
	Aspect Ratio		Fill , 4:3, 16:9, Letter Box, Real, 2.35:1		
	Keystone	H		-30~ 0 ~30	
		V		-30~ 0 ~30	
	Digital Zoom		-10~ 0 ~10		
	Audio	Volume		0~ 5 ~10	
		Mute		Off , On	
		MIC		Off , On	
	Advanced 1	Language		English , Français, Deutsch, Español, 简体中文, 繁體中文, Italiano, Svenska, Nederlands, Русский, Polski, 한국어, Čeština, Türkçe, Việt, 日本語, ไทย	
		Security Lock		Off , On	
		Blank Screen		Blank , Red, Green, Blue, White	
		Splash Logo		On , Off	
		Closed Captioning		Off , On	
		KeypadLock		Off , On	
		3D Setting	3D		Off , DLP-Link
			3D Sync Invert		Off , On
			3D Format		Frame Sequential , Top/Bottom, Side-By-Side, Frame Packing
		Advanced 2	Test Pattern		None , Grid, White, Red, Green, Blue, Black
	H Image Shift			-50~ 0 ~50	
	V Image Shift			-50~ 0 ~50	
	4 Corner	Upper Left		H: 0 ~60, V: 0 ~60	
		Upper Right		H: 0 ~60, V: 0 ~60	
Lower Left			H: 0 ~60, V: 0 ~60		
Lower Right			H: 0 ~60, V: 0 ~60		

Main Menu	Sub Menu	Settings		
Settings 2	Auto Source	Off, On		
	Auto Power Off	0 (Off), 1~180		
	Direct Power On	Off , On		
	Lamp Mode	ECO, Normal , Smart Eco		
	Reset All			
	Status	Active Source		
		Video Information		
		Lamp Hours (ECO, Normal, Smart Eco)		
		Software Version		
	Advanced 1	Menu Position	Left, Right, Center , Down, Up	
		Translucent Menu	0% , 25%, 50%, 75%, 100%	
		Standby Power	Full Standby, RS-232 , Network	
		Fan Speed	Normal , High	
		Lamp Hour Reset		
		Projector ID	0-98	
		Network	DHCP	Off , On
			IP Address	0~ 10 ~255, 0~ 10 ~255, 0~ 10 ~255, 0~ 10 ~255
			Subnet Mask	0~ 255 , 0~ 255 , 0~ 255 , 0~ 255
			Gateway	0 ~255, 0 ~255, 0 ~255, 0 ~255
			DNS	0 ~255, 0 ~255, 0 ~255, 0 ~255
			Apply	
		Advanced 2	Sleep Timer	0 (Off), 1~600
	Source Filter		COMPUTER 1	Disable, Enable
			COMPUTER 2	Disable, Enable
COMPOSITE VIDEO			Disable, Enable	
S-VIDEO			Disable, Enable	
HDMI 1			Disable, Enable	
HDMI 2/MHL			Disable, Enable	
Screen Color	Off , Light Yellow, Pink, Light Green, Blue, Blackboard			
Color Space	Auto , RGB, YUV			
Input Level	Auto , Full, Limited			

Image Menu

Note:

All of picture mode parameters when changed will be saved to user mode.

Press the **MENU** button to open the **OSD** menu. Press the cursor ◀▶ button to move to the **Image Menu**. Press the cursor ▲▼ button to move up and down in the **Image** menu. Press ◀▶ to enter and change values for settings.

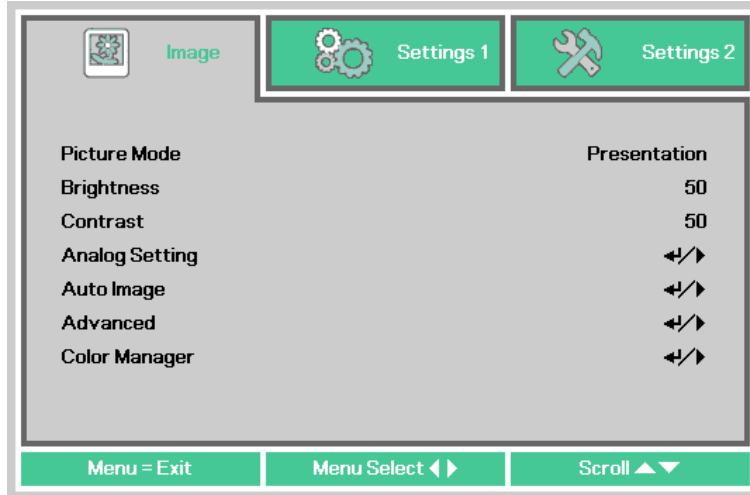

ITEM	DESCRIPTION
Picture Mode	<p>Press the cursor ◀▶ button to enter and set the Picture Mode.</p> <p>Note:</p> <ul style="list-style-type: none"> • Standard mode: Suitable for projecting computer screens or colorful images (movies), etc. • Presentation mode: Suitable for projecting images with a lot of text. It is recommended to use the Standard, Movie, or sRGB mode if you want to emphasize the color temperature since the Presentation mode prioritizes brightness. • Movie mode: Suitable for projecting movies. • sRGB mode: Suitable for projecting photos from a digital camera that supports sRGB.
Brightness	Press the cursor ◀▶ button to enter and adjust the display brightness.
Contrast	Press the cursor ◀▶ button to enter and adjust the display contrast.
Analog Setting	Press ◀ (Enter) / ▶ to enter the Analog Setting menu. See Analog setting Menu on page 35.
Auto Image	Press ◀ (Enter) / ▶ to automatically adjustment for phase, tracking, size and position.
Advanced	Press ◀ (Enter) / ▶ to enter the Advanced menu. See Advanced Feature on page 36.
Color Manager	Press ◀ (Enter) / ▶ to enter the color manager menu. See page 38 for more information on Color Manager .

Analog setting Menu

Press the **MENU** button to open the **OSD** menu. Press ◀▶ to move to the **Image** menu. Press ▲▼ to move to the **Analog setting** menu and then press **Enter** or ▶. Press ▲▼ to move up and down in the **Analog setting** menu.



ITEM	DESCRIPTION
Horizontal Position	Press the cursor ◀▶ button to enter and adjust the display position to left or right.
Vertical Position	Press the cursor ◀▶ button to enter and adjust the display position to up or down.
Frequency	Press the cursor ◀▶ button to adjust the total number of dots in the horizontal direction. Adjust this when stripes are displayed on the screen.
Tracking	Press the cursor ◀▶ button to adjust a timing to reproduce the projected image based on a video signal. Adjust this when the image is corrupted or flickers.

Advanced Feature

Press the **Menu** button to open the **OSD** menu. Press ◀▶ to move to the **Image** menu. Press ▼▲ to move to the **Advanced** menu and then press **Enter** or ▶. Press ▼▲ to move up and down in the **Advanced** menu.



ITEM	DESCRIPTION
Brilliant Color	Press the cursor ◀▶ button to enter and adjust the Brilliant Color value.
Sharpness	Press the cursor ◀▶ button to enter and adjust the display Sharpness.
Gamma	Press the cursor ◀▶ button to enter and adjust the gamma correction of the display.
Color Temperature	Press the cursor ◀▶ button to enter and adjust the color temperature.
Video AGC	Press the cursor ◀▶ button to enter and enable or disable the Automatic Gain Control for video source.
Video Saturation	Press the cursor ◀▶ button to enter and adjust the video saturation.
Video Tint	Press the cursor ◀▶ button to enter and adjust the video tint/hue.
White Balance	Press ◀ (Enter) / ▶ to enter the White Balance sub menu. See White Balance on page 37

White Balance

Press the **ENTER** button to enter the **White Balance** sub menu.

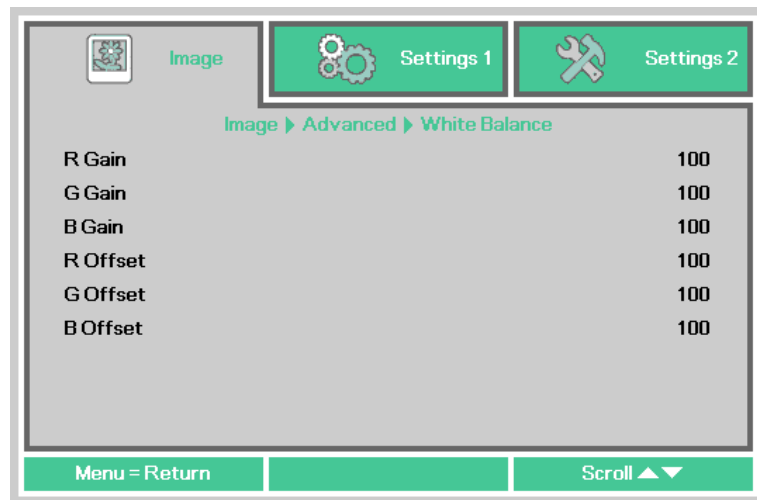

ITEM	DESCRIPTION
R Gain	Press the ◀▶ buttons to adjust the Red Gain.
G Gain	Press the ◀▶ buttons to adjust the Green Gain.
B Gain	Press the ◀▶ buttons to adjust the Blue Gain.
R Offset	Press the ◀▶ buttons to adjust the Red Offset.
G Offset	Press the ◀▶ buttons to adjust the Green Offset.
B Offset	Press the ◀▶ buttons to adjust the Blue Offset.

Color Manager

Press the **Menu** button to open the **OSD** menu. Press ◀▶ to move to the **Image** menu. Press ▼▲ to move to the **Color Manager** menu and then press **Enter** or ▶. Press ▼▲ to move up and down in the **Color Manager** menu.

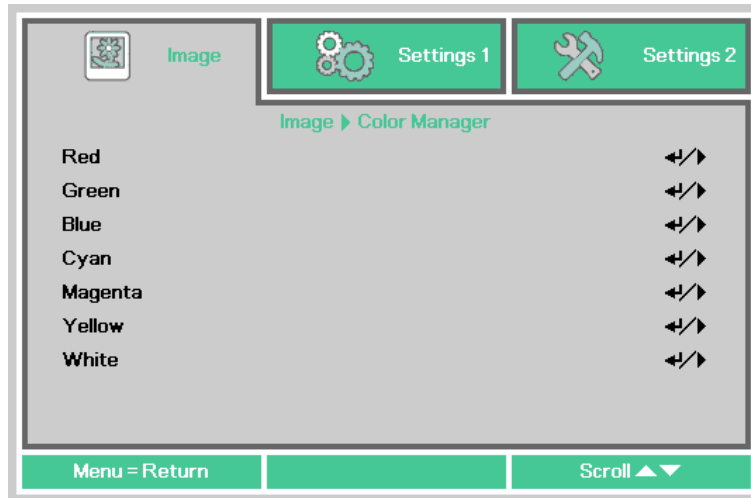

ITEM	DESCRIPTION
Red	Select to enter the Red Color Manager. Press the ◀▶ buttons to adjust the Hue, Saturation, and Gain.
Green	Select to enter the Green Color Manager. Press the ◀▶ buttons to adjust the Hue, Saturation, and Gain.
Blue	Select to enter the Blue Color Manager. Press the ◀▶ buttons to adjust the Hue, Saturation, and Gain.
Cyan	Select to enter the Cyan Color Manager. Press the ◀▶ buttons to adjust the Hue, Saturation, and Gain.
Magenta	Select to enter the Magenta Color Manager. Press the ◀▶ buttons to adjust the Hue, Saturation, and Gain.
Yellow	Select to enter the Yellow Color Manager. Press the ◀▶ buttons to adjust the Hue, Saturation, and Gain.
White	Select to enter the White Color Manager. Press the ◀▶ buttons to adjust the Red, Green, and Blue.

Settings 1 Menu

Press the **MENU** button to open the **OSD** menu. Press the cursor ◀▶ button to move to the **Settings 1** menu. Press the cursor ▲▼ button to move up and down in the **Settings 1** menu. Press ◀▶ to enter and change values for settings.



ITEM	DESCRIPTION
Source	Press the cursor ◀▶ button to enter the Source menu. Reference input Source select (IR / Keypad).
Projection	Press the cursor ◀▶ button to enter and choose from four projection methods.
Aspect Ratio	Press the cursor ◀▶ button to enter and adjust the video aspect ratio.
Keystone	Press ◀ (Enter) / ▶ to enter the keystone menu. See Keystone on page 40.
Digital Zoom	Press the cursor ◀▶ button to enter and adjust the Digital Zoom menu.
Audio	Press ◀ (Enter) / ▶ to enter the Audio menu. See Audio on page 40.
Advanced 1	Press ◀ (Enter) / ▶ to enter the Advanced 1 menu. See Advanced 1 Feature on page 41.
Advanced 2	Press ◀ (Enter) / ▶ to enter the Advanced 2 menu. See Advanced 2 Feature on page 43.
4 Corner	Press ◀ (Enter) / ▶ to enter the 4 Corner menu. See 4 Corner on page 44.

Keystone

Press the **Menu** button to open the **OSD** menu. Press ◀▶ to move to the **Settings 1** menu. Press ▼▲ to move to the **Keystone** menu and then press **Enter** or ▶. Press ▼▲ to adjust vertical values from -30 to 30. Press ◀▶ to adjust horizontal values from -30 to 30.

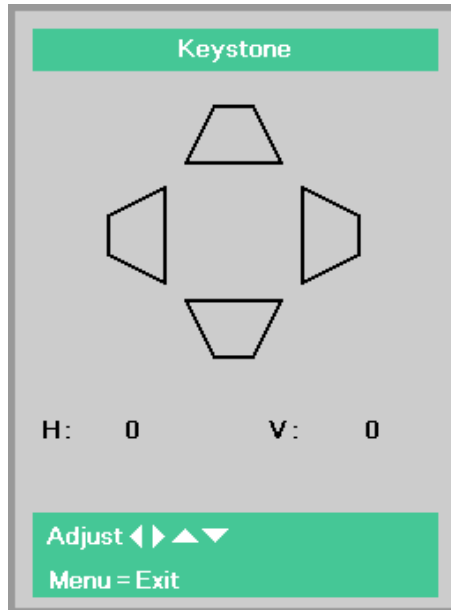

Audio

Press the **Menu** button to open the **OSD** menu. Press ◀▶ to move to the **Settings 1** menu. Press ▼▲ to move to the **Audio** menu and then press **Enter** or ▶. Press ▼▲ to move up and down in the **Audio** menu.

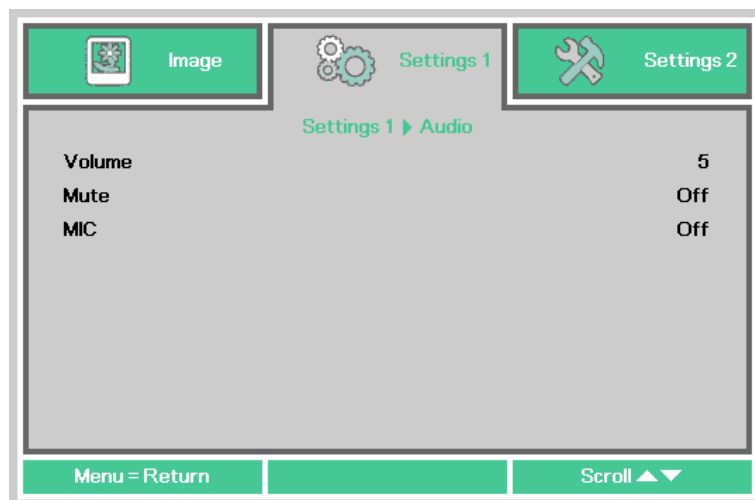

ITEM	DESCRIPTION
Volume	Press the ◀▶ buttons to enter and adjust the audio volume.
Mute	Press the ◀▶ buttons to enter and turn on or off the speaker.
MIC	Press the ◀▶ buttons to enter and turn MIC Mode Off or On. Note: When MIC plug in, OSD MIC item can be turn on.

Advanced 1 Feature

Press the **Menu** button to open the **OSD** menu. Press ◀▶ to move to the **Settings 1** menu. Press ▲▼ to move to the **Advanced 1** menu and then press **Enter** or ▶. Press ▲▼ to move up and down in the **Advanced 1** menu. Press ◀▶ to enter and change values for setting.



ITEM	DESCRIPTION
Language	Press the cursor ◀▶ button to enter and select a different localization Menu.
Security Lock	Press the cursor ◀▶ button to enter and enable or disable security lock function.
Blank Screen	Press the cursor ◀▶ button to enter and select different color to blank the screen.
Splash Logo	Press the cursor ◀▶ button to enter and select splash logo.
Closed Captioning	Press the cursor ◀▶ buttons to enter and enable or disable Closed Captioning.
Keypad Lock	Press the cursor ◀▶ button to enter and enable or disable keys can be work on keypad. When keypad locked, press ▼ button 5 sec can be unlock.
3D Setting	Press ◀ (Enter) / ▶ to enter the 3D menu. See page 42 for more information on 3D Setting .

Note:

To enjoy the 3D function, first enable the Play Movie in 3D setting found in your DVD device under the 3D Disc Menu.

3D Setting

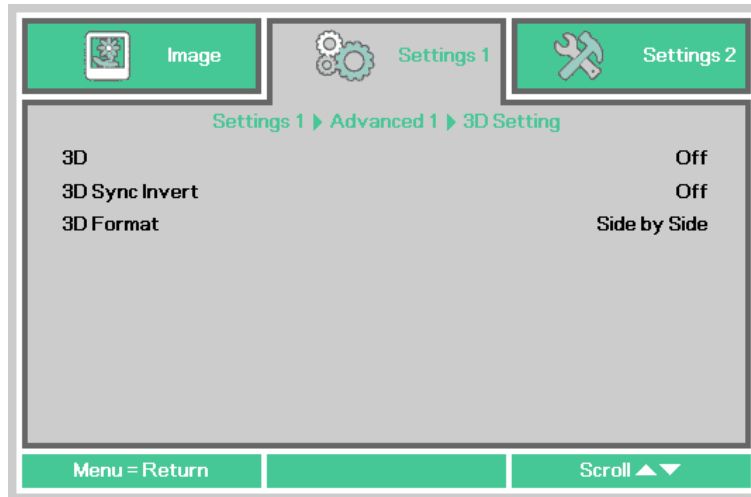

ITEM	DESCRIPTION
3D	Press the cursor ◀▶ button to enter and select different 3D mode.
3D Sync Invert	Press the cursor ◀▶ button to enter and enable or disable 3D Sync Invert.
3D Format	Press the cursor ◀▶ button to enter and enable or disable different 3D Format.

Note:

1. If an input signal is not a 3D image, the 3D menu items are grayed out in OSD. The default setting for the 3D is "Off."
2. If an input signal is a displayable 3D image, the 3D menu items are disabled in OSD.
3. Please use 3D glasses for DLP Link projectors when watching a 3D image.
4. A 3D content in 3D DVD or 3D media file format is required.
5. Some 3D DVD contents have a 3D on-off selection feature. If some case, turn on the 3D feature.
6. Turn on and set up the 3D glasses in accordance with the setup instructions in the document for the 3D glasses..

Note:

There are various types of 3D glasses (for DLP Link projectors). Please set up your 3D glasses in accordance with the corresponding setup instructions.

Advanced 2 Feature

Press the **Menu** button to open the **OSD** menu. Press ◀▶ to move to the **Settings 1** menu. Press ▲▼ to move to the **Advanced 2** menu and then press **Enter** or ▶. Press ▲▼ to move up and down in the **Advanced 2** menu. Press ◀▶ to enter and change values for setting.

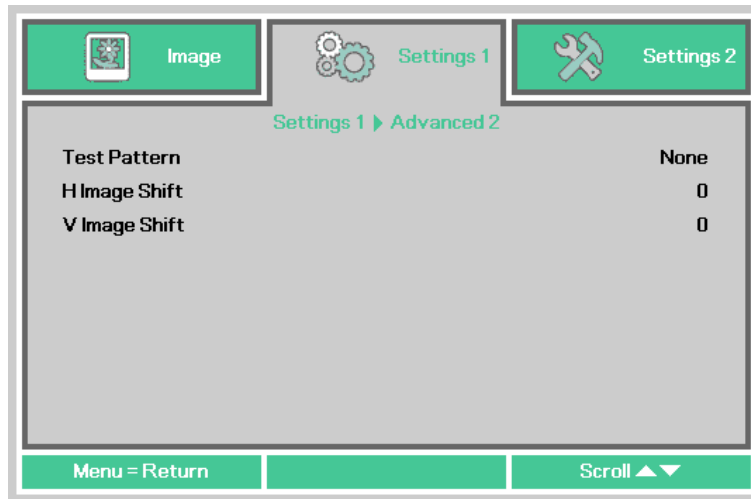

ITEM	DESCRIPTION
Test Pattern	Press the cursor ◀▶ button to enter and select internal test pattern.
H Image Shift	Press the cursor ◀▶ button to enter and select H Image Shift.
V Image Shift	Press the cursor ◀▶ button to enter and select V Image Shift.

4 Corner

Press **↵** (Enter) / **▶** to enter the **4 Corner** sub menu.

1. Press the cursor **▲** / **▼** buttons to select a corner and press **ENTER**.

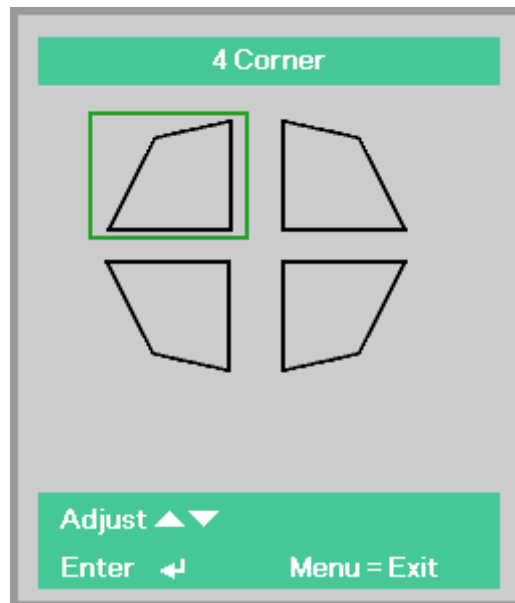

2. Press the cursor **▲** / **▼** buttons to adjust vertical and press the cursor **◀** / **▶** buttons to adjust horizontal.
3. Press **MENU** to save and Exit the settings.

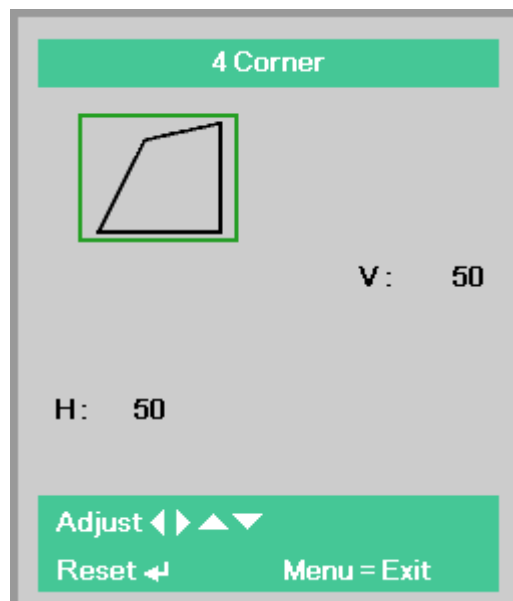

Settings 2 Menu

Press the **MENU** button to open the **OSD** menu. Press the cursor ◀▶ button to move to the **Settings 2** menu. Press the cursor ▲▼ button to move up and down in the **Settings 2** menu.

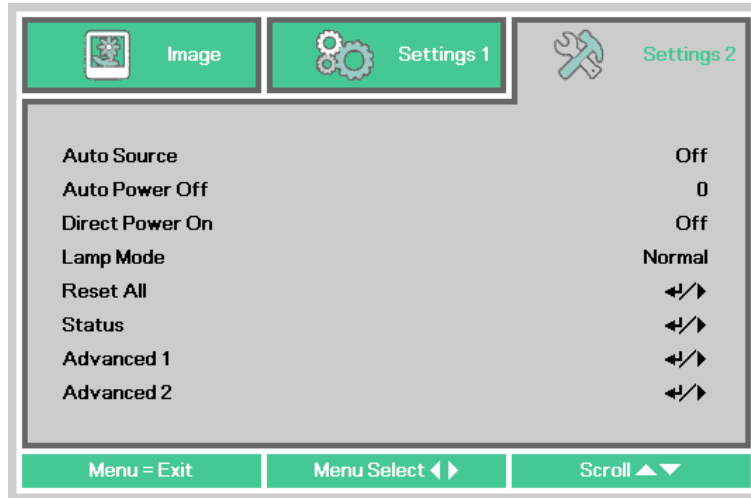

ITEM	DESCRIPTION
Auto Source	Press the cursor ◀▶ button to enter and enable or disable automatic source detection.
Auto Power Off	Press the cursor ◀▶ button to enter and enable or disable automatic shutdown of lamp when no signal. The standby mode is started if there is no input signal and the selected time period (minutes) has elapsed with no operation. This function is disabled if "0" is selected.
Direct Power On	Press the cursor ◀▶ button to enter and enable or disable a function to power on the projector only by connecting the AC power cable.
Lamp Mode	Press the cursor ◀▶ button to enter and select the lamp mode for higher brightness or lower brightness to save lamp life.
Reset All	Press ◀ (Enter) / ▶ to reset all settings to default values. Reset All will not reset the following settings. <ul style="list-style-type: none"> • Language • Network • Lamp Hour
Status	Press ◀ (Enter) / ▶ to enter the Status menu. See page 46 for more information on Status .
Advanced 1	Press ◀ (Enter) / ▶ to enter the Advanced 1 menu. See Advanced 1 Feature on page 47.
Advanced 2	Press ◀ (Enter) / ▶ to enter the Advanced 2 menu. See Advanced 2 Feature on page 59.

Note :

The lamp is automatically dimmed to 30% if the **BLANK** button is pressed or it is there is no input signal for 30 seconds.

Status

Press the cursor ▲▼ button to move up and down in the **Settings 2** menu. Select the **Status** menu and press **Enter** or ► to enter.

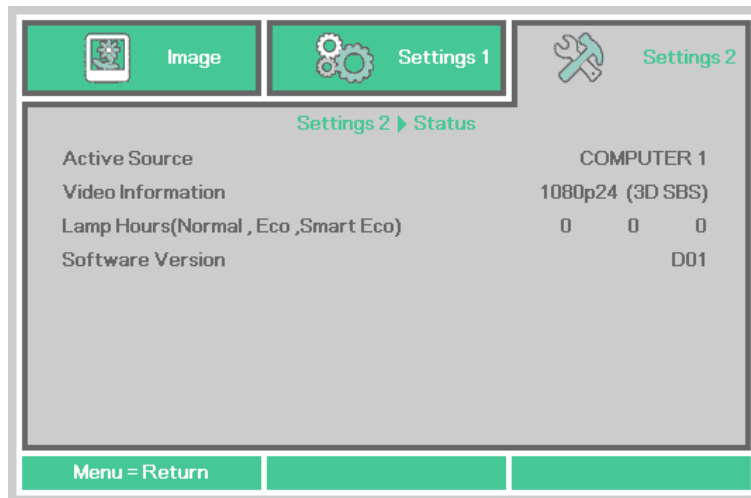

ITEM	DESCRIPTION
Active Source	Display the activated source.
Video Information	Displays resolution/video information for RGB source.
Lamp Hours (Eco, Normal, Smart Eco)	Lamp hour used information is displayed. (Eco, Normal, Smart Eco)
Software Version	Showing system software version.

Advanced 1 Feature

Press the **Menu** button to open the **OSD** menu. Press ◀▶ to move to the **Settings 2** menu. Press ▲▼ to move to the **Advanced 1** menu and then press **Enter** or ▶. Press ▲▼ to move up and down in the **Advanced 1** menu. Press ◀▶ to enter and change values for setting.

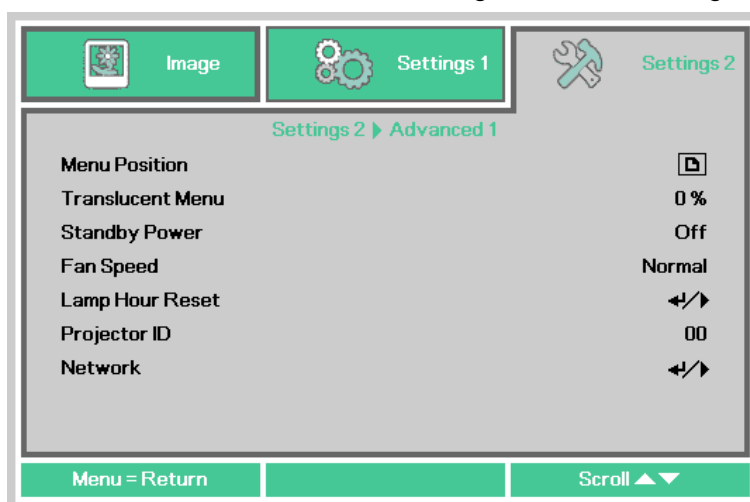

ITEM	DESCRIPTION
Menu Position	Press the cursor ◀▶ button to enter and select different OSD location.
Translucent Menu	Press the cursor ◀▶ button to enter and select OSD background translucent level.
Standby Power	Press the cursor ◀▶ button to select the operation state during the standby mode. Full standby: Both network and RS-232 functions are enabled. RS-232: The RS-232 function is enabled. The network function is disabled. Network: The network function is enabled. The RS-232 function is disabled.
Fan Speed	Press the cursor ◀▶ button to enter and toggle between Normal and High fan speeds. Note: We recommend selecting high speed in high altitude (1,500m/4,921' or higher) areas.
Lamp Hour Reset	After replacing the lamp, the Lamp Hour should be reset. See page 48 for more information on Lamp Hour Reset .
Projector ID	Press the cursor ◀▶ button to enter and adjust a two digit projector ID from 0 through 98.
Network	Press ◀ (Enter) / ▶ to enter the Network menu. See page 48 for more information on Network .

Note:

About "**Network**": Standby state that can use a network with under 2W.

Lamp Hour Reset

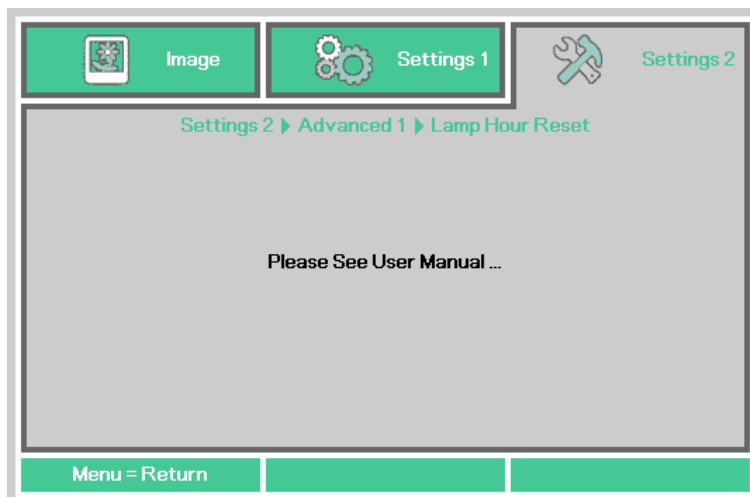

Please refer to [Resetting the Lamp Hour](#) on page 64 to reset the lamp hour counter.

Network

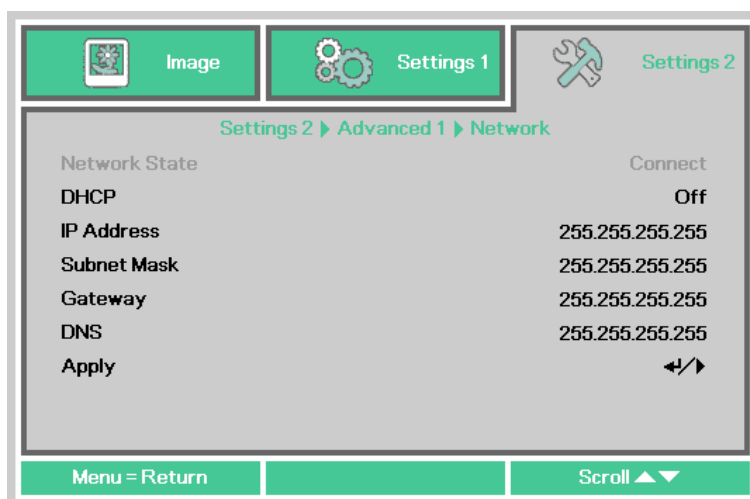

ITEM	DESCRIPTION
DHCP	Press the cursor ◀▶ button to turn DHCP On or Off. Note: If you select DHCP Off, complete the IP Address, Subnet Mask, Gateway, and DNS fields.
IP Address	Enter a valid IP address if DHCP is turned off.
Subnet Mask	Enter a valid Subnet Mask if DHCP is turned off.
Gateway	Enter a valid Gateway address if DHCP is turned off.
DNS	Enter a valid DNS name if DHCP is turned off.
Apply	Press ◀ (Enter) / ▶ to confirm settings.

LAN_RJ45

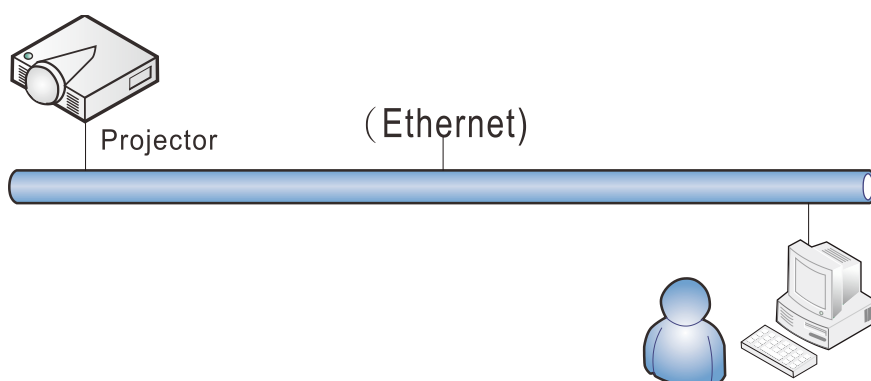

Wired LAN Terminal functionalities

Remote control and monitoring of a projector from a PC (or Laptop) via wired LAN is also possible. Compatibility with Crestron / AMX (Device Discovery) control boxes enables not only collective projector management on a network but also management from a control panel on a PC (or Laptop) browser screen.

- ★ Crestron is a registered trademark of Crestron Electronics, Inc. of the United States.
- ★ AMX is a registered trademark of AMX LLC of the United States.
- ★ PJLink applied for trademark and logo registration in Japan, the United States of America, and other countries by JBMIA.

Supported External Devices

This projector is supported by the specified commands of the Crestron Electronics controller and related software (ex, RoomView ®).

<http://www.crestron.com/>

This projector is supported by AMX (Device Discovery).

<http://www.amx.com/>

This projector supports all commands of PJLink Class1 (Version 1.00).

<http://pjlink.jbmia.or.jp/english/>

For more detail of information about the diverse types of external devices which can be connected to the LAN/RJ45 port and remote/control the projector, as well as the related control commands supporting for each external device, kindly please get contact with the Canon Customer Support Center directly.

LAN RJ45

1. Connect an RJ45 cable to RJ45 ports on the projector and the PC (Laptop).

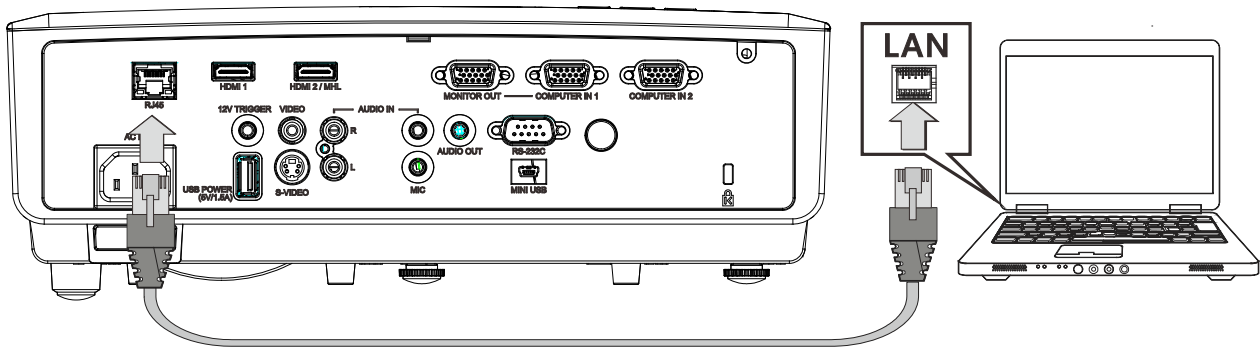

2. On the PC (Laptop), select **Start** → **Control Panel** → **Network and Internet**.

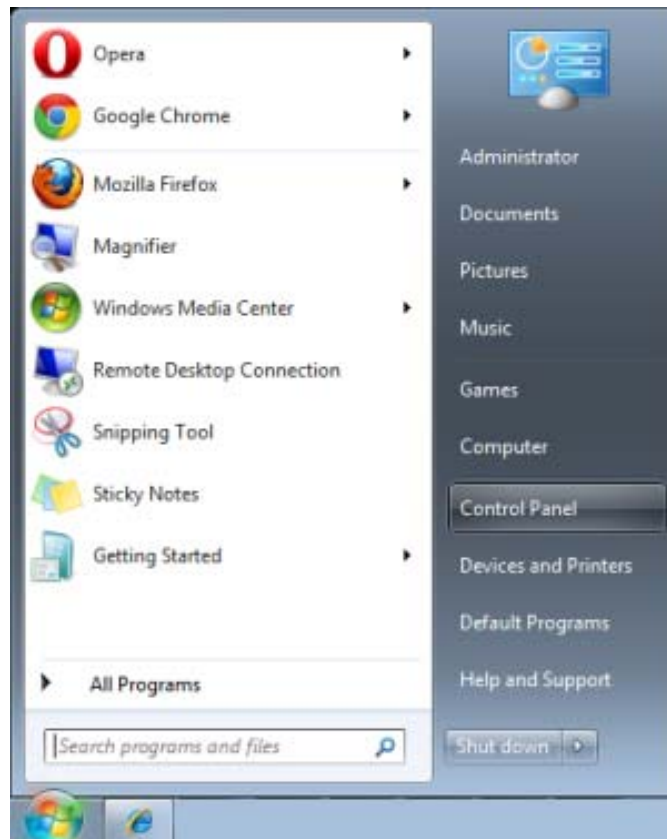

3. Right-click on **Local Area Connection**, and select **Properties**.

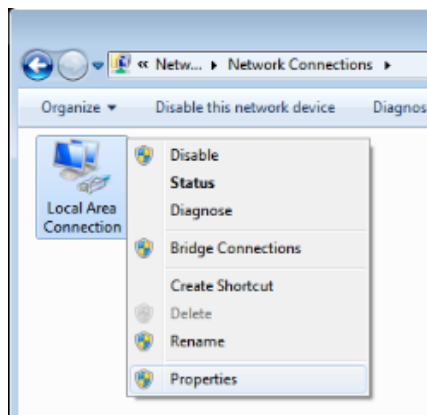

4. In the **Properties** window, select the **Networking** tab, and select **Internet Protocol (TCP/IP)**.
5. Click **Properties**.

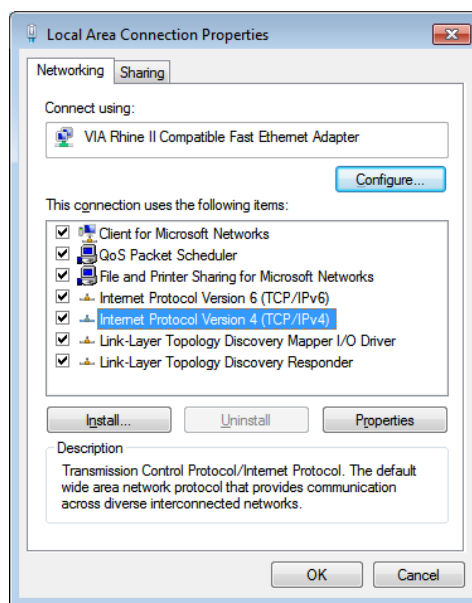

6. Click **Use the following IP address** and fill in the IP address and Subnet mask, then click **OK**.

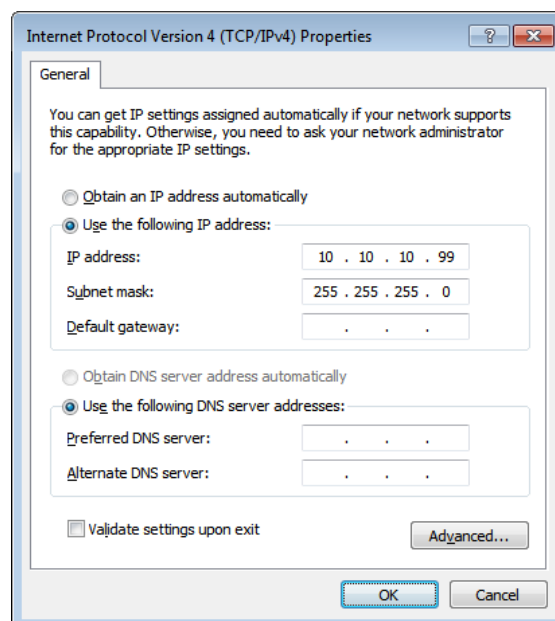

7. Press the **Menu** button on the projector.
8. Select **Settings2** → **Advanced1** → **Network**
9. After getting into **Network**, input the following:
 - ▶ DHCP: Off
 - ▶ IP Address: 10.10.10.10
 - ▶ Subnet Mask: 255.255.255.0
 - ▶ Gateway: 0.0.0.0
 - ▶ DNS Server: 0.0.0.0
10. Press **↵** (Enter) / **▶** to confirm settings.

Open a web browser
(for example, Microsoft Internet Explorer with Adobe Flash Player 9.0 or higher).

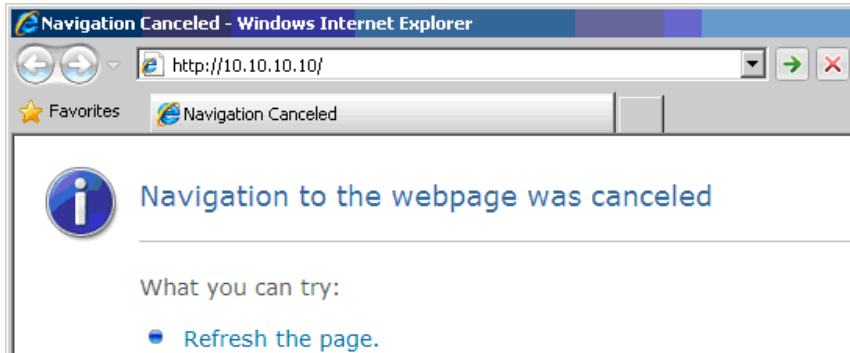

11. In the Address bar, input the IP address: 10.10.10.10.
12. Press **↵** (Enter) / **▶**.

The projector is setup for remote management. The LAN/RJ45 function displays as follows.

Canon

Projector Info	Model Name LV-HD420
Alert Mail Settings	System
PJLink Settings	System Status Power On
Crestron	Display Source COMPOSITE VIDEO
	Lamp Hours 93
	Picture Mode Movie
	Error Status No Error
	LAN Status
	IP address 10.10.10.10
	Subnet mask 255.255.255.0
	Default gateway 0.0.0.0
	DNS Server 0.0.0.0
	MAC address 00:18:23:2F:DA:12
	Version
	LAN Version MHD03
	F/W Version D04

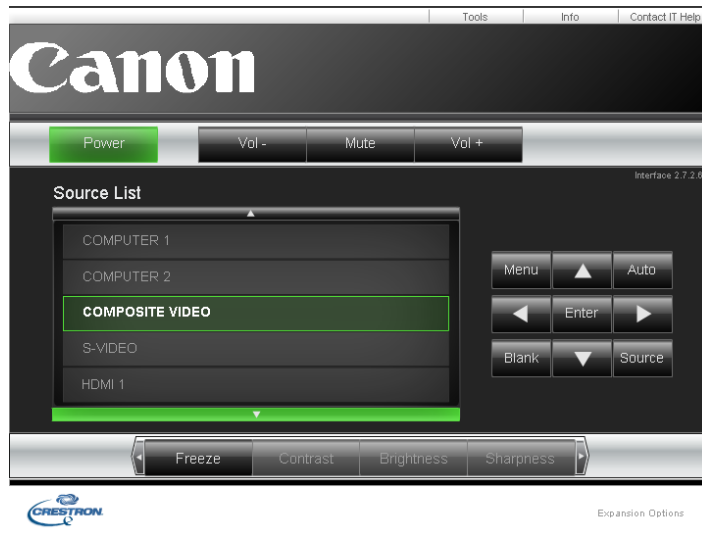

Crestron Control	Projector	User Password
IP Address <input type="text"/>	Projector Name <input type="text" value="PJ01"/>	<input type="checkbox"/> Usr Enabled
IP ID <input type="text"/>	Location <input type="text" value="RM01"/>	Password <input type="text"/>
Control Port <input type="text"/>	Assigned To <input type="text" value="Sir"/>	Confirmed <input type="text"/>
<input type="button" value="Control Set"/>	<input type="button" value="Set"/>	<input type="button" value="Usr Set"/>
	Network Config <input type="checkbox"/> DHCP Enabled	Admin Password
	IP Address <input type="text" value="10.10.10.10"/>	<input type="checkbox"/> Adm Enabled
	Subnet Mask <input type="text" value="255.255.255.0"/>	Password <input type="text"/>
	Default Gateway <input type="text" value="0.0.0.0"/>	Confirmed <input type="text"/>
	DNS Server <input type="text" value="0.0.0.0"/>	<input type="button" value="Adm Set"/>
	<input type="button" value="Net Set"/>	
	<input type="button" value="Tools Exit"/>	

CATEGORY	ITEM	INPUT-LENGTH
Crestron Control	IP Address	15
	IP ID	3
	Port	5
Projector	Projector Name	10
	Location	10
	Assigned To	10
Network Configuration	DHCP (Enabled)	(N/A)
	IP Address	15
	Subnet Mask	15
	Default Gateway	15
	DNS Server	15
User Password	Enabled	(N/A)
	New Password	10
	Confirm	10
Admin Password	Enabled	(N/A)
	New Password	10
	Confirm	10

For more information, please visit <http://www.crestron.com>.

Preparing Email Alerts

1. Make sure that user can access the homepage of LAN RJ45 function by web browser (for example, Microsoft Internet Explorer).
2. From the Homepage of LAN/RJ45, click **Alert Mail Settings**.



Projector Info	Model Name LV-HD420
Alert Mail Settings	System
PJLink Settings	System Status Power On
Crestron	Display Source COMPOSITE VIDEO
	Lamp Hours 93
	Picture Mode Movie
	Error Status No Error
	LAN Status
	IP address 10.10.10.10
	Subnet mask 255.255.255.0
	Default gateway 0.0.0.0
	DNS Server 0.0.0.0
	MAC address 00:18:23:2F:DA:12
	Version
	LAN Version MHD03
	F/W Version D04

3. By default, these input boxes in **Alert Mail Settings** are blank.



Projector Info	Send E-Mail
Alert Mail Settings	Enter the appropriate settings in the fields below: (Your SMTP server may not require a user name or password.)
PJLink Settings	SMTP Server: <input type="text"/> Port: <input type="text" value="25"/>
Crestron	User Name: <input type="text"/>
	Password: <input type="password"/>
	Password(re-type): <input type="password"/>
	<input type="button" value="Mail Server Apply"/>
	From: <input type="text"/>
	To: <input type="text"/>
	CC: <input type="text"/>
	<input type="button" value="Mail Address Apply"/>
	E-mail Alert Options:
	Fan lock : <input checked="" type="checkbox"/> Over_Heat: <input checked="" type="checkbox"/>
	Case Open: <input checked="" type="checkbox"/> Lamp Fail: <input checked="" type="checkbox"/>
	Lamp Hours Over: <input checked="" type="checkbox"/>
	<input type="button" value="Alert Option Apply"/>
	<input type="button" value="Send Test Mail"/>

4. For Sending alert mail, input the following:

The **SMTP** field is the mail server for sending out email (SMTP protocol). This is a required field.

The **To** field is the recipient's email address (for example, the projector administrator). This is a required field.

The **Cc** field sends a carbon copy of the alert to the specified email address. This is an optional field (for example, the projector administrator's assistant).

The From field is the sender's email address (for example, the projector administrator). This is a required field.

Select the alert conditions by checking the desired boxes.

Note: Fill in all fields as specified. User can click **Send Test Mail** to test what setting is correct. For sending an e-mail alert, you must select alert conditions and enter a correct e-mail address.

RS232 by Telnet Function

Besides projector connected to RS232 interface with “Hyper-Terminal” communication by dedicated RS232 command control, there is alternative RS232 command control way, so called “RS232 by TELNET” for LAN/RJ45 interface.

Quick Start-Guide for “RS232 by TELNET”

1. Check and get the IP-Address on OSD of the projector.
2. Make sure that laptop/PC can access the web-page of the projector.
3. Have the TELNET function enabled.

See [How to have TELNET enabled in Windows 7 / 8 / 10](#) on page 57.

4. Start => All Programs => Accessories => Command Prompt

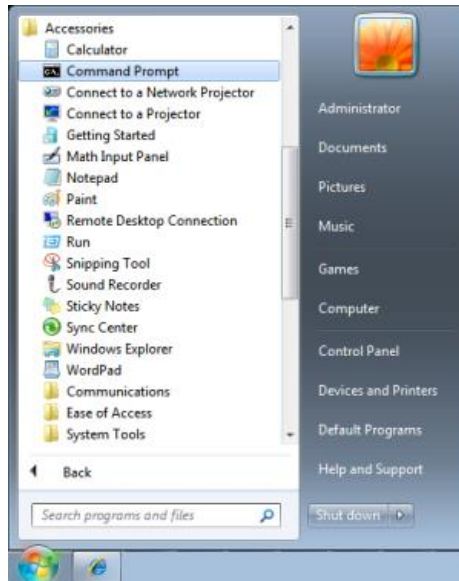

5. Input the command format like the below:

telnet tt.ttt.xxx.yyy.zzz 23 (“Enter” key pressed)

(tt.ttt.xxx.yyy.zzz: IP-Address of the projector)

If Telnet-Connection ready, and user can have RS232 command input, then “Enter” key pressed, the RS232 command will be workable.

How to have TELNET enabled in Windows 7 / 8 / 10

By default installation for Windows, “TELNET” function is not included. But end-user can have it by way of “Turn Windows features On or Off” to be enabled.

1. Open “Control Panel” in Windows

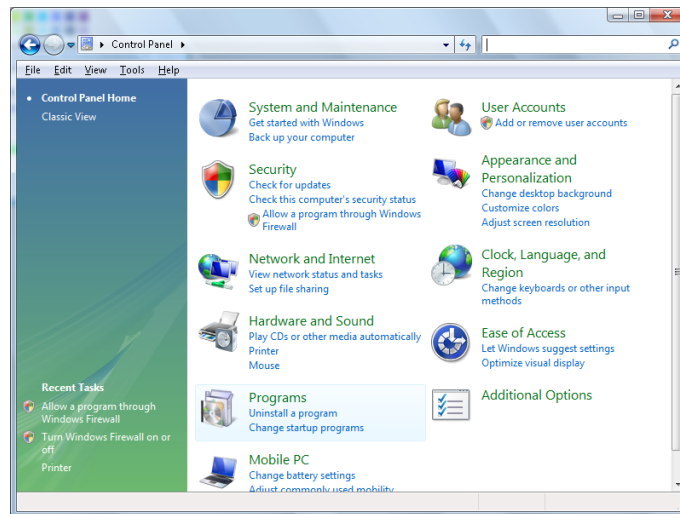

2. Open “Programs”

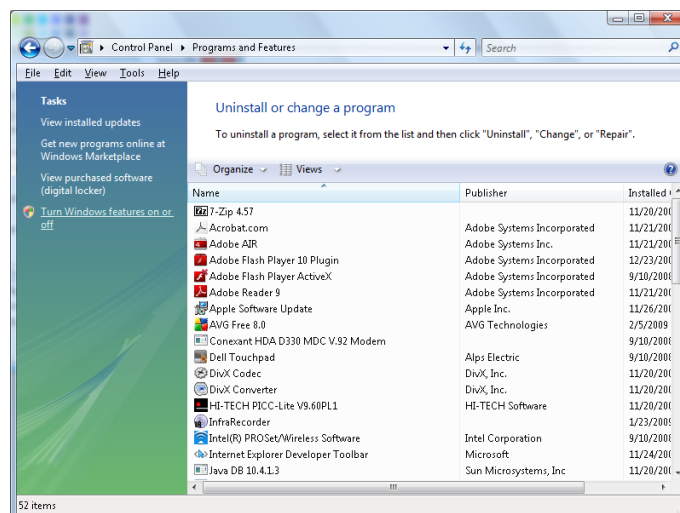

3. Select “Turn Windows features on or off” to open

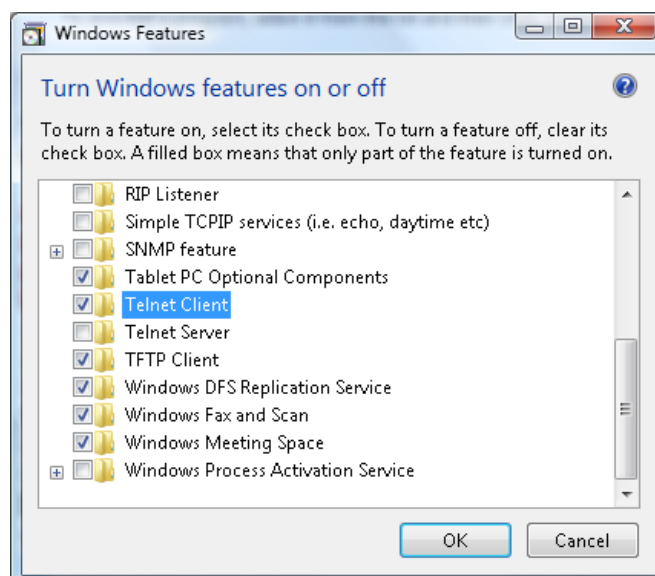

4. Have "Telnet Client" option checked, then press "OK" button.

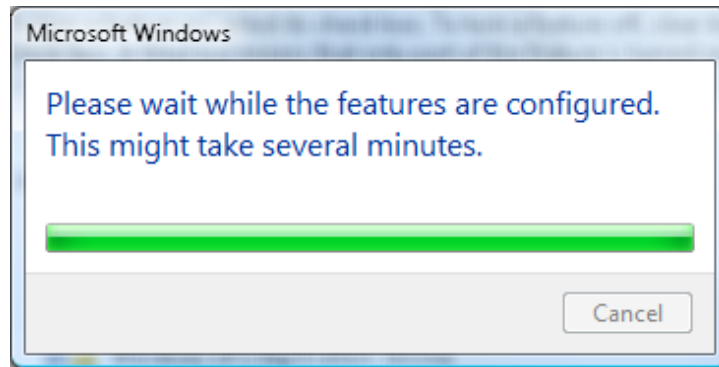

Specsheet for "RS232 by TELNET" :

1. Telnet: TCP
2. Telnet port: 23
(for more detail, kindly please get contact with the Canon Customer Support Center)
3. Telnet utility: Windows "TELNET.exe" (console mode)
4. Disconnection for RS232-by-Telnet control normally: Close Windows Telnet utility directly after TELNET connection ready
5. Limitation 1 for Telnet-Control: there is less than 50 bytes for successive network payload for Telnet-Control application.
Limitation 2 for Telnet-Control: there is less than 26 bytes for one complete RS232 command for Telnet-Control.
Limitation 3 for Telnet-Control: Minimum delay for next RS232 command must be more than 200 (ms).
(* , In Windows built-in "TELNET.exe" utility, "Enter" key pressed will have "Carriage-Return" and "New-Line" code.)

Advanced 2 Feature

Press the **Menu** button to open the **OSD** menu. Press ◀▶ to move to the **Settings 2** menu. Press ▲▼ to move to the **Advanced 2** menu and then press **Enter** or ▶. Press ▲▼ to move up and down in the **Advanced 2** menu. Press ◀▶ to enter and change values for setting.

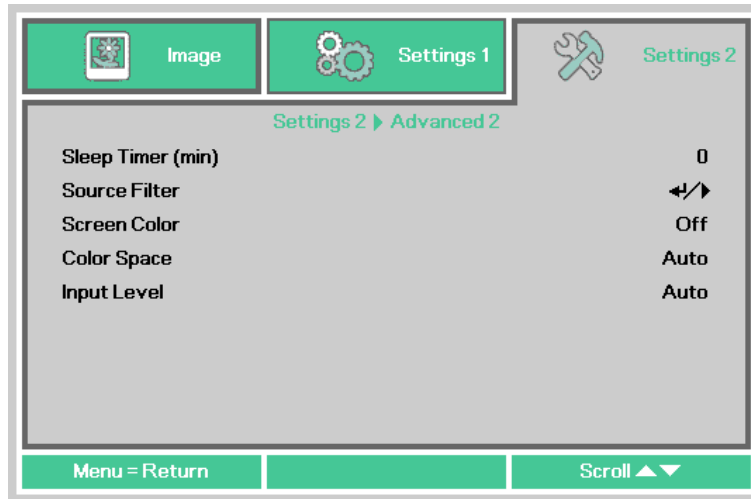

ITEM	DESCRIPTION
Sleep Timer	Press the cursor ◀▶ button to enter and set Sleep timer. The projector automatically turns off after the preset period of time.
Source Filter	Press ◀ (Enter) / ▶ to enter the Source Filter menu. See page 60 for more information on Source Filter .
Screen Color	Press the cursor ◀▶ button to enable or disable the Screen Color function.
Color Space	Press the cursor ◀▶ button to enter and adjust the Color Space.
Input Level	Press the cursor ◀▶ button to enter and adjust the Input Level

Source Filter

Press the **ENTER** button to enter the **Source Filter** sub menu.

If Enable is selected , the source becomes the object of Auto search.

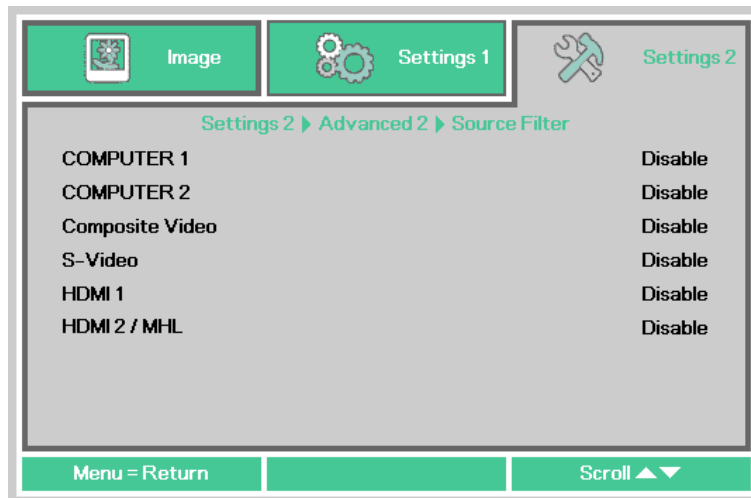

ITEM	DESCRIPTION
COMPUTER 1	Press the ◀▶ buttons to enter and enable or disable the COMPUTER 1 source.
COMPUTER 2	Press the ◀▶ buttons to enter and enable or disable the COMPUTER 2 source.
Composite Video	Press the ◀▶ buttons to enter and enable or disable the Composite Video source.
S-Video	Press the ◀▶ buttons to enter and enable or disable the S-Video source.
HDMI 1	Press the ◀▶ buttons to enter and enable or disable the HDM 1 source.
HDMI 2 / MHL	Press the ◀▶ buttons to enter and enable or disable the HDMI 2 / MHL-compatible source.

Replacing the Projection Lamp

This projector uses the following lamps.

■ Replacement Lamp LV-LP42

Contact the Canon Customer Support Center when purchasing a replacement lamp.



Warning:

Precautions when replacing lamps that stop working

If the illumination suddenly stops when the projector is in use or after you turn it on, the lamp may be broken. In this case, never attempt to replace the lamp by yourself. Always request service from the Canon Customer Support Center.

Additionally, with ceiling-mounted projectors, the lamp may fall out when you open the lamp cover or while you are attempting to replace it. During replacement, stand to the side of the lamp cover, not directly under it. If the lamp breaks and any glass shards or other pieces get in your eyes or mouth, consult a doctor immediately.



Caution:

Before replacing the lamp, always turn off the projector, unplug it after the cooling fan stops, and wait at least 45 minutes. Do not touch the lamp immediately after turning the projector off. It is very hot initially and poses a risk of burns.

- *Be sure to use the specified lamp.*
- *Contact the Canon Customer Support Center for further information. This can also be purchased from the Canon website.*
- *Do not touch the inner glass surface when you replace the lamp. Doing so may cause deterioration to the projector's performance.*
- *Handle lamps with care. Impact or abrasion may cause lamps to rupture while they are in use. If a lamp ruptures, contact the Canon Customer Support Center and follow the instructions in "Precautions when replacing lamps that stop working" (P8).*
- *When replacing the lamp, do not remove any screws other than those specified.*

- 1.** Remove two screws on the lamp cover.

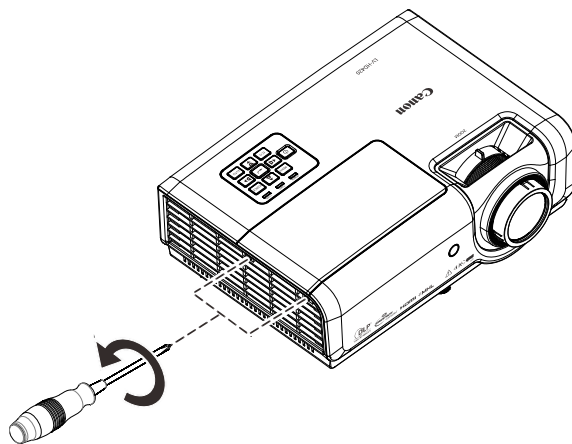

- 2.** Remove the lamp cover.

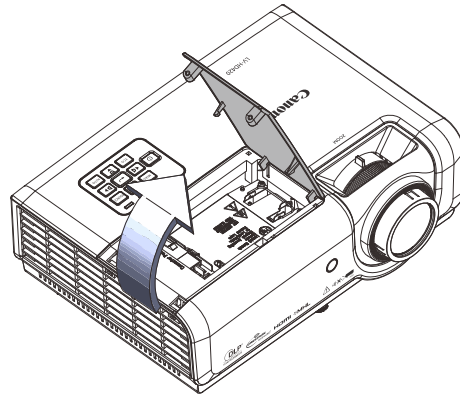

- 3.** Disconnect the lamp connector

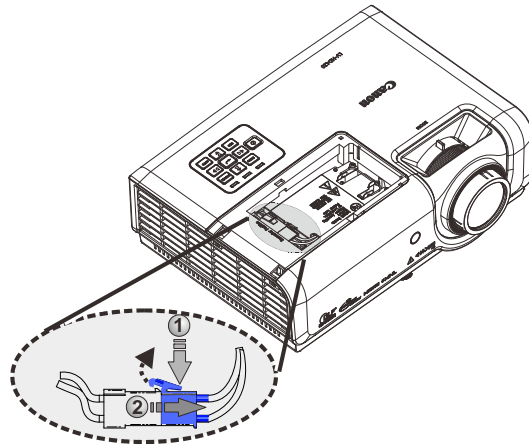

- 4.** Remove the two screws from the lamp module.

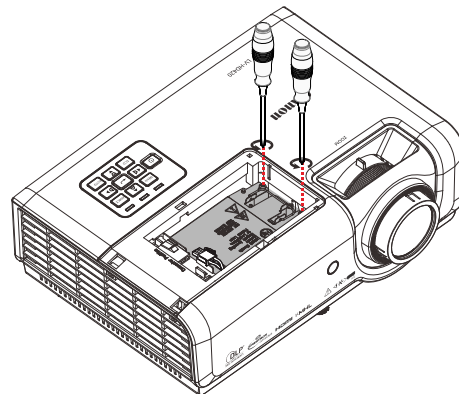

- 5.** Lift the module handle up.

- 6.** Pull firmly on the module handle to remove the lamp module.

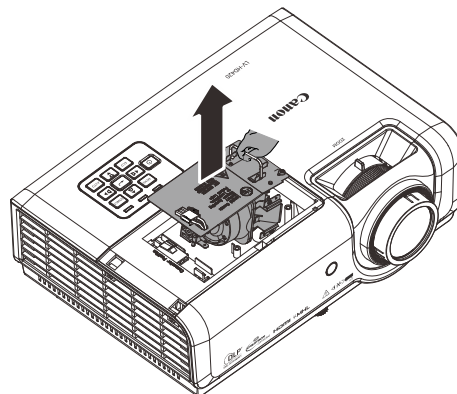

- 7.** Reverse steps 1 to 6 to install the new lamp module. While installing, align the lamp module and ensure it is level to avoid damage.

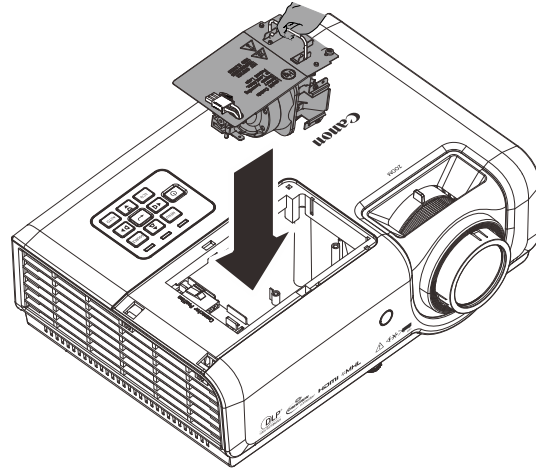

Note:

The lamp module must sit securely in place before tightening the screws.

The lamp connector must be connected properly and placed as drawing before Lamp cover installation back.

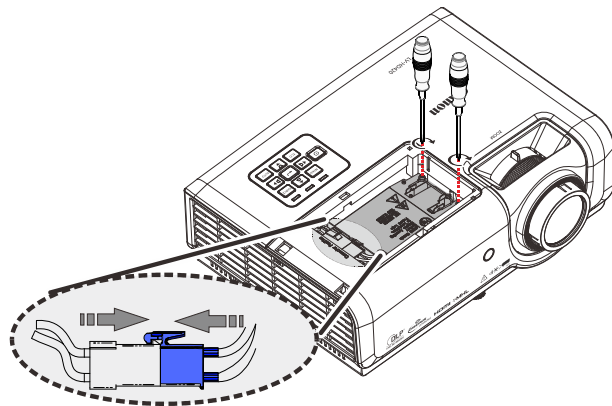

Note:

Lamp Connector must be installed flush with the connector base as shown in the image below. A gap between the Lamp Connector and the connector base will cause damage to the projector. The following images illustrate correct and incorrect Lamp Connector installations.

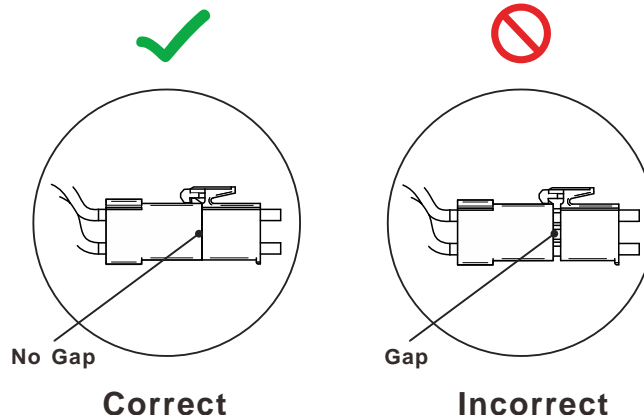

- 8.** Close the lamp cover and tighten the screws.

Resetting the Lamp Hour

After replacing the lamp, you should reset the lamp hour counter to zero. Refer to the following:

1. Press the **MENU** button to open the OSD menu.

2. Press the cursor ◀▶ button to move to the **Settings 2** menu. Press the cursor ▼▲ button to move down to **Advanced 1** and press enter.

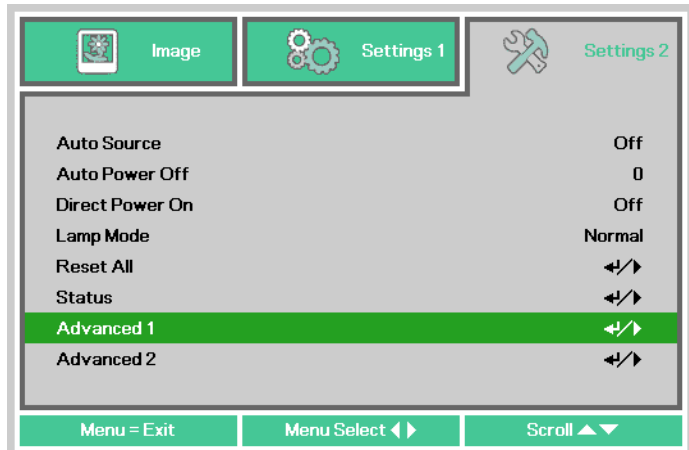

3. Press the cursor ▼▲ button to move down to **Lamp Hour Reset**.

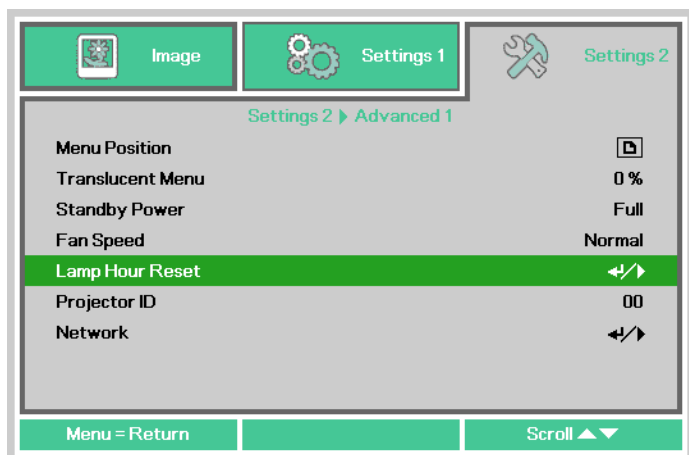

4. Press the cursor ▶ or Enter button.

A message screen appears.

5. Press the four buttons (▼▲◀▶) in order, to reset the lamp hour.

6. Press the **MENU** button to get back to **Settings 2**.

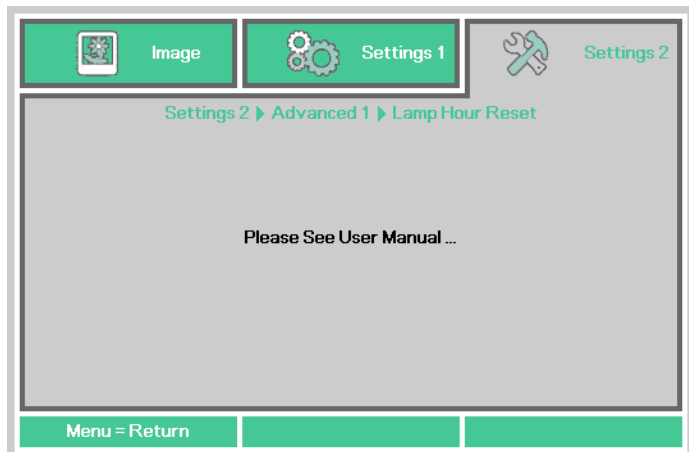

Cleaning the Projector

Clean the projector frequently to prevent dust from settling on the surface. A dirty lens may ruin the quality of the projected image.



Caution:

Before cleaning the projector, always turn it off, unplug it after the cooling fan stops, and wait at least 45 minutes. Otherwise, you may get burned because the main unit is very hot immediately after the projector is turned off.

Do not use adhesives, lubricants, oils, or alkaline detergents for maintenance of the projector. They could adhere to the cabinet and damage it, possibly resulting in the projector falling from its mounting and causing an accident or personal injury.

Wipe the projector's main unit softly with a soft cloth.

If the projector is heavily soiled, soak the cloth in water with a small amount of Neutral detergent in it, squeeze the cloth thoroughly, and then wipe the projector with it.

After cleaning, wipe the projector with a dry cloth.

Cleaning the Lens

When cleaning the projector's lens, use a commonly available air blower or lens cleaning paper. The lens surface is easily damaged, so do not use a hard cloth or tissues.

Cleaning the Case

Refer to the following to clean the projector case.

1. Wipe off dust with a clean dampened cloth.
2. Moisten the cloth with warm water and mild detergent (such as used to wash dishes), and then wipe the case.
3. Rinse all detergent from the cloth and wipe the projector again.

Note:

To prevent discoloration or fading of the case, do not use abrasive alcohol-based cleaners.

Using the Kensington Lock

Using the Kensington Lock

If you are concerned about security, attach the projector to a permanent object with the Kensington slot and a security cable.

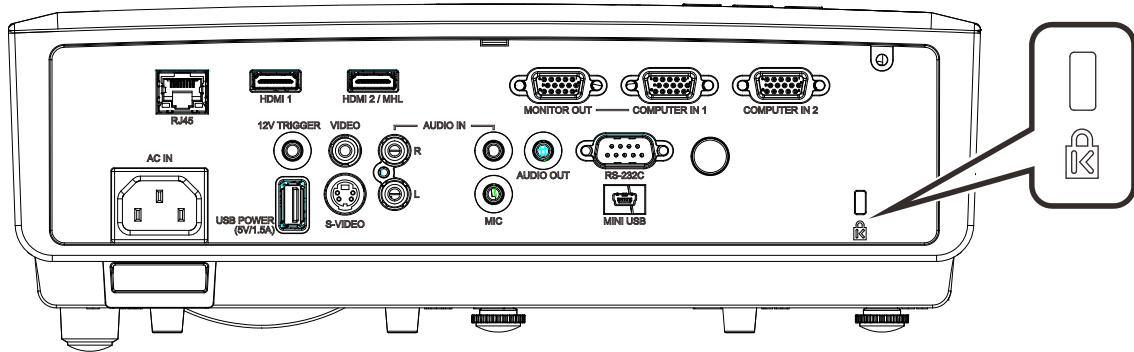

Note:

Contact your vendor for details on purchasing a suitable Kensington security cable. The security lock corresponds to Kensington's MicroSaver Security System. If you have any comment, contact: Kensington, 2853 Campus Drive, San Mateo, CA 94403, U.S.A. Tel: 800-535-4242, <http://www.Kensington.com>.

Using the Security Bar

In addition to the Kensington lock, the Security Bar helps protect the projector from unauthorized removal. See the following picture.

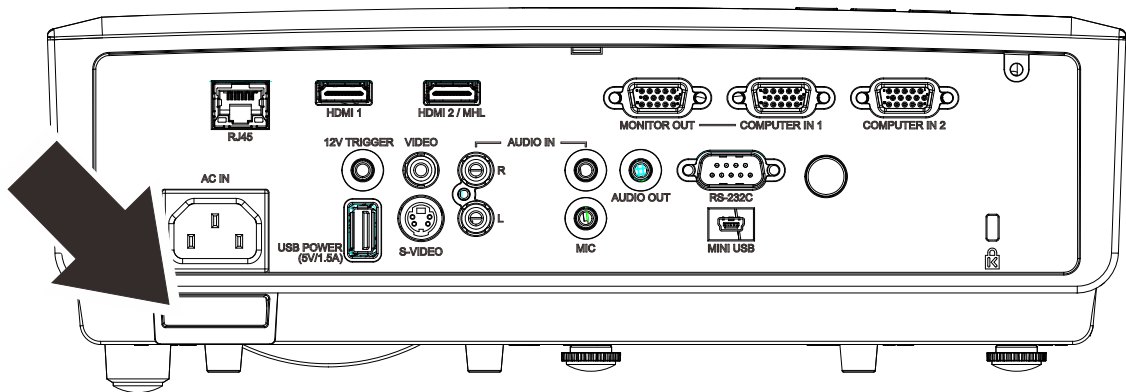

Common problems and solutions

These guidelines provide tips to deal with problems you may encounter while using the projector. If the problem remains unsolved, contact Canon Customer Support Center.

Often after time spent troubleshooting, the problem is traced to something as simple as a loose connection. Check the following before proceeding to the problem-specific solutions.

- *Use some other electrical device to confirm that the electrical outlet is working.*
- *Ensure the projector is turned on.*
- *Ensure all connections are securely attached.*
- *Ensure the attached device is turned on.*
- *Ensure a connected PC is not in suspending mode.*
- *Ensure a connected PC is configured for an external display.
(This is usually done by pressing an Fn-key combination on the PC.)*

Tips for Troubleshooting

In each problem-specific section, try the steps in the order suggested. This may help you to solve the problem more quickly.

Try to pin point the problem and thus avoid replacing non-defective parts.

For example, if you replace batteries and the problem remains, put the original batteries back and go to the next step.

Keep a record of the steps you take when troubleshooting: The information may be useful when calling for technical support or for passing on to service personnel.

LED Error Messages

ERROR CODE MESSAGES	POWER LED GREEN	LAMP LED RED	TEMP LED RED
System Initial	Flashing	OFF	OFF
Ready to Power on (Standby)	ON	OFF	OFF
System Power on	Flashing	OFF	OFF
Lamp Lit , System stable	ON	OFF	OFF
Cooling	Flashing	OFF	OFF
1W MCU detects scaler stops working (initial fail)	2 blinks	OFF	OFF
Over Temperature	OFF	OFF	ON
Thermal Break Sensor error	4 blinks	OFF	OFF
Lamp Fail	5 blinks	OFF	OFF
Lamp Temperature shut down	5 blinks	1 blinks	OFF
Lamp Short circuit in output detected	5 blinks	2 blinks	OFF
Lamp End of lamp life detected	5 blinks	3 blinks	OFF
Lamp did not ignite	5 blinks	4 blinks	OFF
Lamp extinguished normal	5 blinks	5 blinks	OFF
Lamp extinguished run-up	5 blinks	6 blinks	OFF
Lamp voltage too low	5 blinks	7 blinks	OFF
Lamp ballast Fail	5 blinks	8 blinks	OFF
Lamp ballast Communication error	5 blinks	10 blinks	OFF
Fan-1 error	6 blinks	1 blinks	OFF
Fan-2 error	6 blinks	2 blinks	OFF
Fan-3 error	6 blinks	3 blinks	OFF
Fan-4 error	6 blinks	4 blinks	OFF
Lamp Cover Open	7 blinks	OFF	OFF
DMD error	8 blinks	OFF	OFF
Color wheel error	9 blinks	OFF	OFF

In the event of an error, please disconnect the AC power cord and wait for one (1) minute before restarting the projector. If the Power or Lamp LEDs are still blinking or any other situation that isn't listed in the chart above, please contact Canon Customer Support Center.

Problem and Countermeasures

Image Problems

Problem: No image appears on the screen

1. Verify the settings on your notebook or desktop PC.
2. Turn off all equipment and power up again in the correct order.

Problem: The image is blurred

1. Adjust the **Focus** on the projector.
2. Press the **Auto** button on the remote control or the projector.
3. Ensure the projector-to-screen distance is within the specified range.
4. Check that the projection lens is clean.

Problem: The image is wider at the top or bottom (trapezoid effect)

1. Position the projector so it is as perpendicular to the screen as possible.
2. Use the **Keystone** button on the remote control or the projector to correct the problem.

Problem: The image is reversed

Check the **Projection** setting on the **Settings 1** menu of the OSD.

Problem: The image is streaked

1. Set the **Frequency** and **Tracking** settings on the **Image->Analog setting** menu of the OSD to the default settings.
2. To ensure the problem is not caused by a connected PC's video card, connect to another computer.

Problem: The image is flat with no contrast

Adjust the **Contrast** setting on the **Image** menu of the OSD.

Problem: The color of the projected image does not match the source image.

Adjust the **Color Temperature** and **Gamma** settings on the **Image->Advanced** menu of the OSD.

Lamp Problems

Problem: There is no light from the projector

1. Check that the power cable is securely connected.
2. Ensure the power source is good by testing with another electrical device.
3. Restart the projector in the correct order and check that the Power LED is on.
4. If you have replaced the lamp recently, try resetting the lamp connections.

Problem: The lamp goes off

Power surges can cause the lamp to turn off. Re-plug power cord. When the Power LED is on, press the power button.

Remote Control Problems

Problem: The projector does not respond to the remote control

1. Direct the remote control towards remote sensor on the projector.
2. Ensure the path between remote and sensor is not obstructed.
3. Turn off any fluorescent lights in the room.
4. Check the battery polarity.
5. Replace the battery.
6. Turn off other Infrared-enabled devices in the vicinity.
7. Have the remote control serviced.

Audio Problems

Problem: There is no sound

1. Adjust the volume on the remote control.
2. Adjust the volume of the audio source.
3. Check the audio cable connection.
4. Test the audio source output with other speakers.
5. Have the projector serviced.

Problem: The sound is distorted

1. Check the audio cable connection.
2. Test the audio source output with other speakers.
3. Have the projector serviced.

Having the Projector Serviced

If you are unable to solve the problem, you should have the projector serviced. Pack the projector in the original carton. Include a description of the problem and a checklist of the steps you took when trying to fix the problem: For servicing, return the projector to the place you purchased it or Canon Customer Support Center.

SPECIFICATIONS

Specifications

Model name		LV-HD420	LV-X420
Display system		1-chip DLP™	
Optical system		Time division color extraction, sequential display	
Display device	Effective display area size	0.65" / 16:9	0.55" / 4:3
	Number of pixels	2,073,600 (1920 X 1080) X 1 panel	786,432 (1024 X 768) X 1 panel
Projection lens	Zoom	Manual (X 1.5)	
	Focus	Manual	
	Lens shift	V:65%, Fixed	V:64%, Fixed
	Focal length	f=20.7 – 31.1mm	
	F number	F=2.42 – 2.97	
Light source (Lamp mode normal / eco)		High-pressure mercury lamp : 310/245W	
Image size / Projection distance		Minimum: 76 cm (30"); maximum: 813 cm (320") Projection distance: 1.2 m – 10.0 m (3.9 – 32.8')	Minimum: 76 cm (30"); maximum: 660 cm (260") Projection distance: 1.2 m – 10.0 m (3.9 – 32.8')
Number of colors		16,770,000 colors	
Brightness (*1) (*2)		4200lm	
Contrast ratio (Fully white: fully black) (*2)(*3)		8000:1	10000:1
Ratio of brightness at periphery to center (*2)		80%	
Speaker		10W, monaural	
Supported input signal types		See " Timing Mode Table " (page 75).	
Display resolution	Computer signal input	Maximum input resolution 1920x1200 dot (Re-sizing display) Panel display resolution 1920x1080	Maximum input resolution 1920x1200 dot (Re-sizing display) Panel display resolution 1024x768
Video signals	Analog PC input	WUXGA / WSXGA+ / UXGA / SXGA+ / WXGA+ / WXGA / SXGA / XGA / SVGA / VGA / MAC	
	Digital PC input	WUXGA / WSXGA+ / UXGA / SXGA+ / WXGA+ / WXGA / SXGA / XGA / SVGA / VGA	
	Digital video input	1080p / 1080i / 720p / 576p / 480p	
	MHL input	1080p / 1080i / 720p / 576p / 480p / 576i / 480i	
	Component video input	1080p / 1080i / 720p / 576p / 576i / 480p / 480i	
	Video input / S-video	NTSC / PAL / SECAM / NTSC4.43 / PAL-M / PAL-N	
Video signal input/output terminal	D-sub 15 x 2	Analog PC / component video input	
	D-sub 15	Analog PC / component video output	
	HDMI / MHL	Digital PC / digital video / MHL input	
	HDMI	Digital PC / digital video input	
	Mini DIN4	S-video input	
	RCa1	Video input	

Other terminals and connectors	RCA x 2	Audio-L / Audio-R input
	Mini jack x 3	Audio input x1, audio output x1, microphone input x1
	Mini jack	Trigger output (12 V)
	Dsub9	RS-232 connection
	RJ-45	Network connection (100BASE-TX / 10BASE-T)
	Mini USB	Service port
	USB A	Power feeding (1.5A)
Noise		40/36 dB (Lamp mode: Normal/Eco)
Operation temperature		5°C – 40°C
Power supply		AC100V – 240V 50 / 60Hz
Maximum power consumption (Lamp mode: Normal)		410W
Power consumption (Lamp mode: Eco)		320W
Power consumption in standby	RS-232	0.5W
	Network	2.0W
Standard dimensions		W: 314 mm (12.4"), H: 112 mm (4.4"), D: 231 mm (9.1")
Weight		3.4 kg
Accessories		Remote control, battery for remote control, power cord, computer cable, User's Manual(CD-ROM), Important Information and Warranty Card

*1: Picture mode: Presentation

*2: Compliance with ISO21118-2012

*3: Optimizes the contrast depending on the brightness of each scene by adjusting lamp output.

- Using the projector continuously for an extended period of time may accelerate the deterioration of optical parts.
- Product specifications and appearance are subject to change without notice.

Projection Distance vs. Projection Size

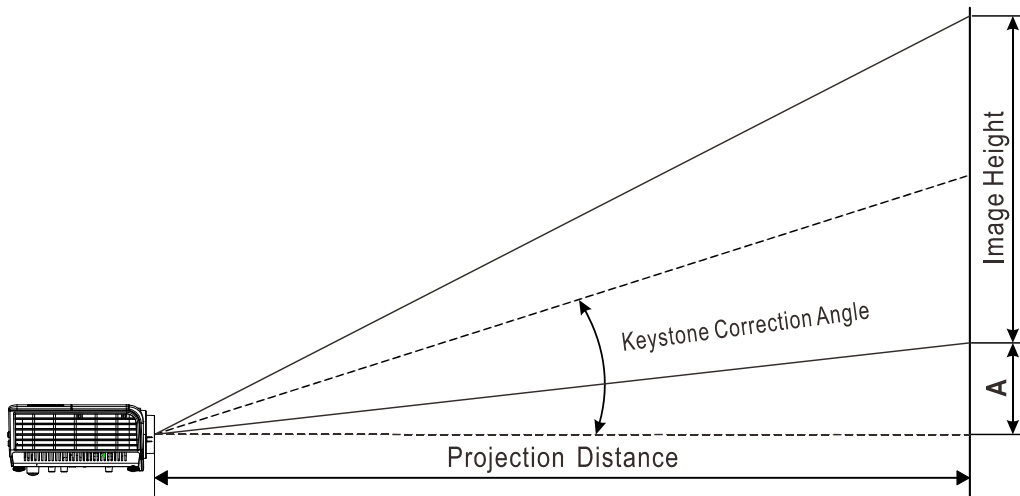

Projection Distance and Size Table

LV-HD420

Image size (16:9)			Projection Distance				Offset-A
Diagonal	Width	Height	Wide		Table		
inch	cm	cm	m	inch	m	inch	mm
30	66	37	—	—	1.39	55	56
40	89	50	1.23	48	1.85	73	75
60	133	75	1.85	73	2.78	109	113
80	177	100	2.46	97	3.7	146	150
100	221	125	3.08	121	4.63	182	188
120	266	149	3.69	145	5.55	219	224
140	310	174	4.31	170	6.48	255	261
160	354	199	4.92	194	7.4	291	299
180	398	224	5.54	218	8.33	328	336
200	443	249	6.15	242	9.25	364	374
210	465	262	6.46	254	9.72	383	393
220	487	274	6.77	267	—	—	411
240	531	299	7.39	291	—	—	449
260	576	324	8	315	—	—	486
280	620	349	8.62	339	—	—	524
300	664	374	9.23	363	—	—	561
320	708	398	9.85	388	—	—	597

LV-X420

Image size (16:9)			Projection Distance				Offset-A
Diagonal	Width	Height	Wide		Table		
inch	cm	cm	m	inch	m	inch	mm
30	61	46	—	—	1.68	66	64
40	81	61	1.49	59	2.24	88	85
60	122	91	2.23	88	3.35	132	126
80	163	122	2.97	117	4.47	176	170
100	203	152	3.72	146	5.59	220	211
120	244	183	4.46	176	6.71	264	254
140	284	213	5.21	205	7.82	308	296
160	325	244	5.95	234	8.94	352	339
170	346	249	6.32	249	9.5	374	346
180	366	274	6.69	263	—	—	381
200	406	305	7.44	293	—	—	424
220	447	335	8.18	322	—	—	466
230	467	351	8.55	337	—	—	488
240	488	366	8.92	351	—	—	509
260	528	396	9.67	381	—	—	550

Timing Mode Table

SIGNAL	RESOLUTION	H-SYNC (KHz)	V-SYNC (Hz)	COMPOSITE / S-VIDEO	COMPONENT	RGB	DVI/ HDMI
NTSC	—	15.734	60.0	O	—	—	—
PAL/SECAM	—	15.625	50.0	O	—	—	—
VESA	720 x 400	37.9	85.0	—	—	O	O
	640 x 480	31.5	60.0	—	—	O	O
	640 x 480	37.9	72.8	—	—	O	O
	640 x 480	37.5	75.0	—	—	O	O
	640 x 480	43.3	85.0	—	—	O	O
	800 x 600	35.2	56.3	—	—	O	O
	800 x 600	37.9	60.3	—	—	O	O
	800 x 600	46.9	75.0	—	—	O	O
	800 x 600	48.1	72.2	—	—	O	O
	800 x 600	53.7	85.1	—	—	O	O
	800 x 600	76.3	120.0	—	—	O	O
	1024 x 768	48.4	60.0	—	—	O	O
	1024 x 768	56.5	70.1	—	—	O	O
	1024 x 768	60.0	75.0	—	—	O	O
	1024 x 768	68.7	85.0	—	—	O	O
	1024 x 768	97.6	120.0	—	—	O	O
	1280 x 720	45.0	60.0	—	—	O	O
	1280 x 720	91.5	119.9	—	—	O	O
	1280 x 800	49.7	59.8	—	—	O	O
	1280 x 800	62.8	74.9	—	—	O	O
	1280 x 800	71.6	84.8	—	—	O	O
	1280 x 800	101.6	119.9	—	—	O	O
	1280 x 1024	64.0	60.0	—	—	O	O
	1280 x 1024	80.0	75.0	—	—	O	O
	1280 x 1024	91.1	85.0	—	—	O	O
	1280 x 960	60.0	60.0	—	—	O	O
1280 x 960	85.9	85.0	—	—	O	O	
1400 x 1050	65.3	60.0	—	—	O	O	

SIGNAL	RESOLUTION	H-SYNC (KHz)	V-SYNC (Hz)	COMPOSITE / S-VIDEO	COMPONENT	RGB	DVI/ HDMI
	1440 x 900	70.6	75.0	—	—	○	○
	1440 x 900	55.9	60.0	—	—	○	○
	1600 x1200	75.0	60.0	—	—	○	○
	1680 x1050	64.7	59.9	—	—	○	○
	1680 x1050	65.3	60.0	—	—	○	○
	1920 x1200	74.0	60.0	—	—	○	○
Apple Mac	640 x 480	35.0	66.7	—	—	○	○
	832 x 624	49.7	74.5	—	—	○	○
	1024 x 768	60.2	74.9	—	—	○	○
	1152 x 870	68.7	75.1	—	—	○	○
SDTV	480i	15.734	60.0	—	○	—	○
	576i	15.625	50.0	—	○	—	○
EDTV	576p	31.3	50.0	—	○	—	○
	480p	31.5	60.0	—	○	—	○
HDTV	720p	37.5	50.0	—	○	—	○
	720p	45.0	60.0	—	○	—	○
	1080i	33.8	60.0	—	○	—	○
	1080i	28.1	50.0	—	○	—	○
	1080p	67.5	60.0	—	○	—	○
	1080p	56.3	50.0	—	○	—	○
	1080p	27	24.0	—	○	—	○
	1080p	28	25.0	—	○	—	○
	1080p	33.7	30.0	—	○	—	○

○ : Frequency supported

— : Frequency not supported

* : LV-HD420 native resolution of the panel is 1920 x 1080

LV-X420 native resolution of the panel is 1024 x 768

The aspect ratio of an input signal may be changed if its resolution is different with the panel resolution.

* : The color of mean Displayable only. (4:3 only)

* : The color of mean may have a little noise

Projector Dimensions

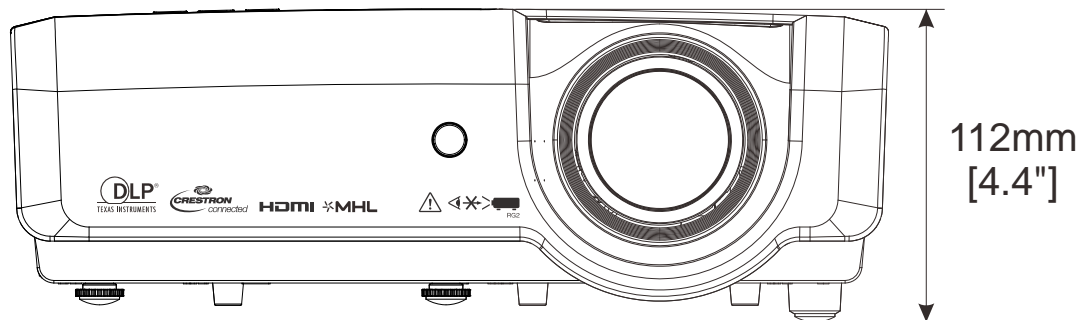
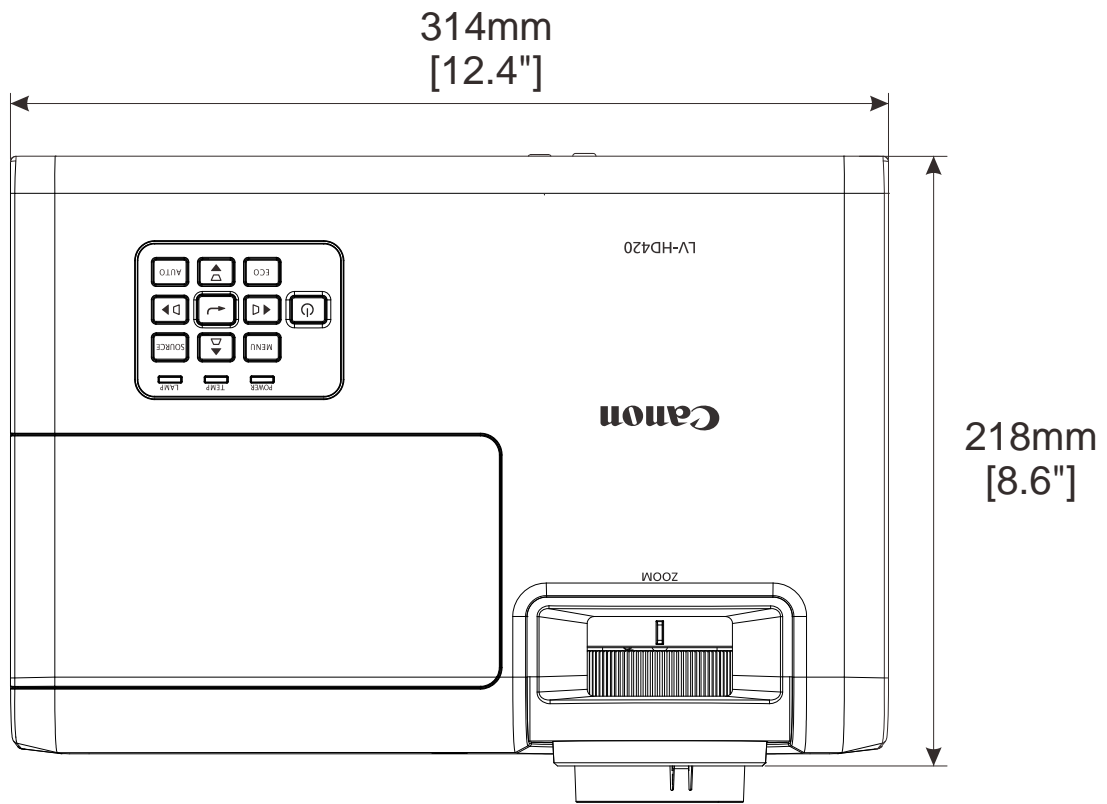

FCC Warning

This equipment has been tested and found to comply with the limits for a Class B digital device pursuant to Part 15 of the FCC Rules. These limits are designed to provide reasonable protection against harmful interference when the equipment is operated in a commercial environment.

This equipment generates, uses, and can radiate radio frequency energy and, if not installed and used in accordance with the instruction manual, may cause harmful interference to radio communications. Operation of this equipment in a residential area is likely to cause harmful interference in which case the user will be required to correct the interference at his/her own expense.

Changes or modifications not expressly approved by the parties responsible for compliance could void the user's authority to operate the equipment.

Canada

This class B digital apparatus complies with Canadian ICES-003.

Safety Certifications

FCC-B, cUL, UL, CCC, CECP, PSB, EAC, KC, CE, RCM

RS-232 Protocol

RS232 Setting

Baud rate:	9600
Parity check:	None
Data bit:	8
Stop bit:	1
Flow Control	None

Minimum delay for next command: **1ms**

Control Command Structure

	Header code	Command code	Data code	End code
HEX		Command	Data	0Dh
ASCII	'V'	Command	Data	CR

Operation Command

<p><i>Note:</i></p> <p>"CR" mean Carriage Return</p> <p>XX=00-98, projector's ID, XX=99 is for all projectors</p> <p>Return Result P=Pass / F=Fail</p> <p>n: 0:Disable/1: Enable/Value(0~9999)</p>
--

Command Group 00

ASCII	HEX	Function	Description	Return Result
VXXS0001	56h Xh Xh 53h 30h 30h 30h 31h 0Dh	Power On		P/F
VXXS0002	56h Xh Xh 53h 30h 30h 30h 32h 0Dh	Power Off		P/F
VXXS0003	56h Xh Xh 53h 30h 30h 30h 33h 0Dh	Resync		P/F
VXXG0004	56h Xh Xh 47h 30h 30h 30h 34h 0Dh	Get Lamp Hours		Pn/F
VXXS0006	56h Xh Xh 53h 30h 30h 30h 36h 0Dh	System Reset		P/F
VXXG0007	56h Xh Xh 47h 30h 30h 30h 37h 0Dh	Get System Status	0:Reset 1:Standby 2:Operation 3:Cooling	Pn/F
VXXG0008	56h Xh Xh 47h 30h 30h 30h 38h 0Dh	Get F/W Version		Pn/F

Command Group 01

ASCII	HEX	Function	Description	Return Value
VXXG0101	56h Xh Xh 47h 30h 31h 30h 31h 0Dh	Get Brightness	n=0~100	Pn/F
VXXS0101n	56h Xh Xh 53h 30h 31h 30h 31h nh 0Dh	Set Brightness	n=0~100	P/F
VXXG0102	56h Xh Xh 47h 30h 31h 30h 32h 0Dh	Get Contrast	n=0~100	Pn/F
VXXS0102n	56h Xh Xh 53h 30h 31h 30h 32h nh 0Dh	Set Contrast	n=0~100	P/F
VXXG0103	56h Xh Xh 47h 30h 31h 30h 33h 0Dh	Get Color	n=0~100	Pn/F
VXXS0103n	56h Xh Xh 53h 30h 31h 30h 33h nh 0Dh	Set Color	n=0~100	P/F
VXXG0104	56h Xh Xh 47h 30h 31h 30h 34h 0Dh	Get Tint	n=0~100	Pn/F
VXXS0104n	56h Xh Xh 53h 30h 31h 30h 34h nh 0Dh	Set Tint	n=0~100	P/F
VXXG0105	56h Xh Xh 47h 30h 31h 30h 35h 0Dh	Get Sharpness	0~31	Pn/F

Command Group 01				
ASCII	HEX	Function	Description	Return Value
VXXS0105n	56h Xh Xh 53h 30h 31h 30h 35h nh 0Dh	Set Sharpness	0~31	P/F
VXXG0106	56h Xh Xh 47h 30h 31h 30h 36h 0Dh	Get Color Temperature	0:6500K 1:7500K 2:8300K	Pn/F
VXXS0106n	56h Xh Xh 53h 30h 31h 30h 36h nh 0Dh	Set Color Temperature	0:6500K 1:7500K 2:8300K	P/F
VXXG0107	56h Xh Xh 47h 30h 31h 30h 37h 0Dh	Get Gamma	0:1.8 1:2.0 2:2.2 3:2.4 5:Linear	Pn/F
VXXS0107n	56h Xh Xh 53h 30h 31h 30h 37h nh 0Dh	Set Gamma	0:1.8 1:2.0 2:2.2 3:2.4 5:Linear	P/F
VXXG0108	56h Xh Xh 53h 30h 33h 31h 38h 0Dh	Adjust the Picture mode	0:Standard 1:Presentation 3:Movie 5:sRGB 7:User	Pn/F
VXXS0108n	56h Xh Xh 47h 30h 33h 31h 38h nh 0Dh	Adjust the Picture mode	0:Standard 1:Presentation 3:Movie 5:sRGB 7:User	P/F

Command Group 02				
ASCII	HEX	Function	Description	Return Value
VXXS0201	56h Xh Xh 53h 30h 32h 30h 31h 0Dh	Select COMPUTER1		P/F
VXXS0202	56h Xh Xh 53h 30h 32h 30h 32h 0Dh	Select COMPUTER2		P/F
VXXS0204	56h Xh Xh 53h 30h 32h 30h 34h 0Dh	Select Video		P/F
VXXS0205	56h Xh Xh 53h 30h 32h 30h 35h 0Dh	Select S-Video		P/F
VXXS0206	56h Xh Xh 53h 30h 32h 30h 36h 0Dh	Select HDMI		P/F
VXXS0208	56h Xh Xh 53h 30h 32h 30h 38h 0Dh	Select Component		P/F
VXXS0209	56h Xh Xh 53h 30h 32h 30h 39h 0Dh	Select HDMI 2/MHL		P/F
VXXG0220	56h Xh Xh 47h 30h 32h 32h 30h 0Dh	Get Current Source	Return 1:COMPUTER1 2:COMPUTER2 4:Video 5:S-Video 6:HDMI 8:Component 9:HDMI 2/MHL	Pn/F

Command Group 03				
ASCII	HEX	Function	Description	Return Value
VXXG0301	56h Xh Xh 47h 30h 33h 30h 31h 0Dh	Get Scaling	0:Fill 1:4:3 2:16:9 3:Letter Box 4:Real 5:2.35:1	Pn/F
VXXS0301n	56h Xh Xh 53h 30h 33h 30h 31h nh 0Dh	Set Scaling	0:Fill 1:4:3 2:16:9 3:Letter Box 4:Real 5:2.35:1	P/F
VXXG0302	56h Xh Xh 47h 30h 33h 30h 32h 0Dh	Get Blank		Pn/F
VXXS0302n	56h Xh Xh 53h 30h 33h 30h 32h nh 0Dh	Set Blank		P/F
VXXG0304	56h Xh Xh 47h 30h 33h 30h 34h 0Dh	Get Freeze On		Pn/F
VXXS0304n	56h Xh Xh 53h 30h 33h 30h 34h nh 0Dh	Set Freeze On		P/F
VXXG0305	56h Xh Xh 47h 30h 33h 30h 35h 0Dh	Get Volume	n=0~10	Pn/F
VXXS0305n	56h Xh Xh 53h 30h 33h 30h 35h nh 0Dh	Set Volume	n=0~10	P/F
VXXG0308	56h Xh Xh 47h 30h 33h 30h 38h 0Dh	Get Projection Mode	0:Front 1:Rear 2:Ceiling 3:Rear+Ceiling	Pn/F
VXXS0308n	56h Xh Xh 53h 30h 33h 30h 38h nh 0Dh	Set Projection Mode	0:Front 1:Rear 2:Ceiling 3:Rear+Ceiling	P/F
VXXG0309	56h Xh Xh 47h 30h 33h 30h 39h 0Dh	Get vertical keystone value	n=-30~+30	Pn/F
VXXS0309n	56h Xh Xh 53h 30h 33h 30h 39h nh 0Dh	Set vertical keystone value	n=-30~+30	P/F
VXXG0310	56h Xh Xh 47h 30h 33h 31h 30h 0Dh	Get horizontal keystone value	n=-30~+30	Pn/F
VXXS0310n	56h Xh Xh 53h 30h 33h 31h 30h nh 0Dh	Set horizontal keystone value	n=-30~+30	P/F
VXXG0315	56h Xh Xh 47h 30h 33h 31h 35h 0Dh	Get 3D Mode	n=0~1	Pn/F
VXXS0315n	56h Xh Xh 53h 30h 33h 31h 35h nh 0Dh	Set 3D Mode	0:Off 1:DLP	P/F
VXXG0316	56h Xh Xh 47h 30h 33h 31h 36h 0Dh	Get 3D sync inverter	n=0~1	Pn/F
VXXS0316n	56h Xh Xh 53h 30h 33h 31h 36h nh 0Dh	Set 3D sync inverter	0:Off 1:On	P/F
VXXG0317	56h Xh Xh 53h 30h 33h 31h 37h 0Dh	Get 3D format	n=0~3	Pn/F
VXXS0317n	56h Xh Xh 47h 30h 33h 31h 37h nh 0Dh	Set 3D format	0:FS 1:TB 2:SBS 3:FP	P/F
VXXG0319	56h Xh Xh 47h 30h 33h 31h 39h 0Dh	Get Lamp mode	n=0~2	Pn/F
VXXS0319n	56h Xh Xh 53h 30h 33h 31h 39h nh 0Dh	Set Lamp mode	0:Eco 1:Normal 2:Smart ECO	P/F
VXXG0322	56h Xh Xh 47h 30h 33h 32h 32h 0Dh	Get Fan Speed	n=0~1	Pn/F
VXXS0322n	56h Xh Xh 53h 30h 33h 32h 32h nh 0Dh	Set Fan Speed	0:Normal 1:High Speed	P/F

Command Group 03				
ASCII	HEX	Function	Description	Return Value
VXXG0331	56h Xh Xh 47h 30h 33h 33h 31h 0Dh	Get the R gain	n=0~200	Pn/F
VXXS0331n	56h Xh Xh 53h 30h 33h 33h 31h nh 0Dh	Set the R gain	n=0~200	P/F
VXXG0332	56h Xh Xh 47h 30h 33h 33h 32h 0Dh	Get the G gain	n=0~200	Pn/F
VXXS0332n	56h Xh Xh 53h 30h 33h 33h 32h nh 0Dh	Set the G gain	n=0~200	P/F
VXXG0333	56h Xh Xh 47h 30h 33h 33h 33h 0Dh	Get the B gain	n=0~200	Pn/F
VXXS0333n	56h Xh Xh 53h 30h 33h 33h 33h nh 0Dh	Set the B gain	n=0~200	P/F
VXXG0334	56h Xh Xh 53h 30h 33h 31h 37h 0Dh	Get the R offset	n=-100~100	Pn/F
VXXS0334n	56h Xh Xh 47h 30h 33h 31h 37h nh 0Dh	Set the R offset	n=-100~100	P/F
VXXG0335	56h Xh Xh 47h 30h 33h 31h 39h 0Dh	Get the G offset	n=-100~100	Pn/F
VXXS0335n	56h Xh Xh 53h 30h 33h 31h 39h nh 0Dh	Set the G offset	n=-100~100	P/F
VXXG0336	56h Xh Xh 47h 30h 33h 32h 32h 0Dh	Get the B offset	n=-100~100	Pn/F
VXXS0336n	56h Xh Xh 53h 30h 33h 32h 32h nh 0Dh	Set the B offset	n=-100~100	P/F
VXXG0337	56h Xh Xh 47h 30h 33h 33h 37h 0Dh	Get the white R gain	n=0~100	Pn/F
VXXS0337n	56h Xh Xh 53h 30h 33h 33h 37h nh 0Dh	Set the white R gain	n=0~100	P/F
VXXG0338	56h Xh Xh 47h 30h 33h 33h 38h 0Dh	Get the white G gain	n=0~200	Pn/F
VXXS0338n	56h Xh Xh 53h 30h 33h 33h 38h nh 0Dh	Set the white G gain	n=0~200	P/F
VXXG0339	56h Xh Xh 47h 30h 33h 33h 39h 0Dh	Get the white B gain	n=0~200	Pn/F
VXXS0339n	56h Xh Xh 53h 30h 33h 33h 39h nh 0Dh	Set the white B gain	n=0~200	P/F
VXXG0340	56h Xh Xh 53h 30h 33h 34h 30h 0Dh	Get the Red Hue	n=-100~100	Pn/F
VXXS0340n	56h Xh Xh 47h 30h 33h 34h 30h nh 0Dh	Set the Red Hue	n=-100~100	P/F
VXXG0341	56h Xh Xh 47h 30h 33h 34h 31h 0Dh	Get the Red Saturation	n=-100~100	Pn/F
VXXS0341n	56h Xh Xh 53h 30h 33h 34h 31h nh 0Dh	Set the Red Saturation	n=-100~100	P/F
VXXG0342	56h Xh Xh 47h 30h 33h 34h 32h 0Dh	Get the Red Gain	n=-100~100	Pn/F
VXXS0342n	56h Xh Xh 53h 30h 33h 34h 32h nh 0Dh	Set the Red Gain	n=-100~100	P/F
VXXG0343	56h Xh Xh 53h 30h 33h 34h 33h 0Dh	Get the Green Hue	n=-100~100	Pn/F
VXXS0343n	56h Xh Xh 47h 30h 33h 34h 33h nh 0Dh	Set the Green Hue	n=-100~100	P/F
VXXG0344	56h Xh Xh 47h 30h 33h 34h 34h 0Dh	Get the Green Saturation	n= -100~100	Pn/F
VXXS0344n	56h Xh Xh 53h 30h 33h 34h 34h nh 0Dh	Set the Green Saturation	n= -100~100	P/F
VXXG0345	56h Xh Xh 47h 30h 33h 34h 35h 0Dh	Get the Green Gain	n= -100~100	Pn/F
VXXS0345n	56h Xh Xh 53h 30h 33h 34h 35h nh 0Dh	Set the Green Gain	n= -100~100	P/F
VXXG0346	56h Xh Xh 53h 30h 33h 34h 36h 0Dh	Get the Blue Hue	n= -100~100	Pn/F
VXXS0346n	56h Xh Xh 47h 30h 33h 34h 36h nh 0Dh	Set the Blue Hue	n= -100~100	P/F
VXXG0347	56h Xh Xh 47h 30h 33h 34h 37h 0Dh	Get the Blue Saturation	n= -100~100	Pn/F
VXXS0347n	56h Xh Xh 53h 30h 33h 34h 37h nh 0Dh	Set the Blue Saturation	n= -100~100	P/F
VXXG0348	56h Xh Xh 47h 30h 33h 34h 38h 0Dh	Get the Blue Gain	n= -100~100	Pn/F
VXXS0348n	56h Xh Xh 53h 30h 33h 34h 38h nh 0Dh	Set the Blue Gain	n= -100~100	P/F
VXXG0349	56h Xh Xh 53h 30h 33h 34h 39h 0Dh	Get the Cyan Hue	n= -100~100	Pn/F
VXXS0349n	56h Xh Xh 47h 30h 33h 34h 39h nh 0Dh	Set the Cyan Hue	n= -100~100	P/F
VXXG0350	56h Xh Xh 47h 30h 33h 35h 30h 0Dh	Get the Cyan Saturation	n=-100~100	Pn/F
VXXS0350n	56h Xh Xh 53h 30h 33h 35h 30h nh 0Dh	Set the Cyan Saturation	n=-100~100	P/F

Command Group 03				
ASCII	HEX	Function	Description	Return Value
VXXG0351	56h Xh Xh 47h 30h 33h 35h 31h 0Dh	Get the Cyan Gain	n=-100~100	Pn/F
VXXS0351n	56h Xh Xh 53h 30h 33h 35h 31h nh 0Dh	Set the Cyan Gain	n=-100~100	P/F
VXXG0352	56h Xh Xh 53h 30h 33h 35h 32h 0Dh	Get the Magenta Hue	n=-100~100	Pn/F
VXXS0352n	56h Xh Xh 47h 30h 33h 35h 32h nh 0Dh	Set the Magenta Hue	n=-100~100	P/F
VXXG0353	56h Xh Xh 47h 30h 33h 35h 33h 0Dh	Get the Magenta Saturation	n=-100~100	Pn/F
VXXS0353n	56h Xh Xh 53h 30h 33h 35h 33h nh 0Dh	Set the Magenta Saturation	n=-100~100	P/F
VXXG0354	56h Xh Xh 47h 30h 33h 35h 34h 0Dh	Get the Magenta Gain	n=-100~100	Pn/F
VXXS0354n	56h Xh Xh 53h 30h 33h 35h 34h nh 0Dh	Set the Magenta Gain	n=-100~100	P/F
VXXG0355	56h Xh Xh 53h 30h 33h 35h 35h 0Dh	Get the Yellow Hue	n=-100~100	Pn/F
VXXS0355n	56h Xh Xh 47h 30h 33h 35h 35h nh 0Dh	Set the Yellow Hue	n=-100~100	P/F
VXXG0356	56h Xh Xh 47h 30h 33h 35h 36h 0Dh	Get the Yellow Saturation	n=-100~100	Pn/F
VXXS0356n	56h Xh Xh 53h 30h 33h 35h 36h nh 0Dh	Set the Yellow Saturation	n=-100~100	P/F
VXXG0357	56h Xh Xh 47h 30h 33h 35h 37h 0Dh	Get the Yellow Gain	n=-100~100	Pn/F
VXXS0357n	56h Xh Xh 53h 30h 33h 35h 37h nh 0Dh	Set the Yellow Gain	n=-100~100	P/F
VXXG0358	56h Xh Xh 47h 30h 33h 35h 38h 0Dh	Get IR On/Off Status	n= 0~3	Pn/F
VXXS0358n	56h Xh Xh 53h 30h 33h 35h 38h nh 0Dh	Set IR On/Off Status	0:Both on 1:Front on 2:Back on 3:Both off	P/F



CANON INC.

30-2, Shimomaruko 3-chome, Ohta-ku, Tokyo 146-8501, Japan

CANON U.S.A. INC.

One Canon Park, Melville, New York 11747, U.S.A.

For all inquires concerning this product, call toll free in the U.S. 1-800-OK-CANON

CANON EUROPE LTD.

3 The Square, Stockley Park, Uxbridge, Middlesex, UB11 1ET United Kingdom

CANON EUROPA N.V.

Bovenkerkerweg 59, 1185 XB Amstelveen, The Netherlands