

Canon

EOS R



- This manual is for the EOS R with firmware version 1.2.0 or later installed.



Advanced User Guide

Introduction

Before Starting to Shoot, Be Sure to Read the Following

To avoid shooting problems and accidents, first read the “Safety Instructions” (p.25–27) and “Handling Precautions” (p.28–30).

Also, read this manual carefully to ensure that you use the camera correctly.

Refer to This Manual while Using the Camera to Further Familiarize Yourself with the Camera

While reading this manual, take a few test shots and see how they come out. You can then better understand the camera. Be sure to store this manual safely, too, so that you can refer to it again when necessary.

Testing the Camera Before Use and Liability

After shooting, play images back and check whether they have been properly recorded. If the camera or memory card is faulty and the images cannot be recorded or imported to a computer, Canon cannot be held liable for any loss or inconvenience caused.

Copyrights

Copyright laws in your country may prohibit the use of your recorded images of people and certain subjects for anything but private enjoyment. Also be aware that certain public performances, exhibitions, etc. may prohibit photography even for private enjoyment.

Connecting Other Devices

Use the included interface cable or a genuine Canon cable when connecting the camera to a computer or other device. When connecting an interface cable, also use the included cable protector (p.37).

Item Check List

Before starting, check that all the following items are included with your camera. If anything is missing, contact your dealer.

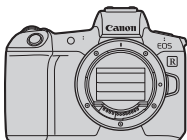

Camera

(with eyecup and body cap)



**Battery Pack
LP-E6N**

(with protective cover)



**Battery Charger
LC-E6/LC-E6E***

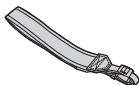

Strap



Interface Cable



Cable Protector

* Battery Charger LC-E6 or LC-E6E is provided. (The LC-E6E comes with a power cord.)

- The camera does not come with a memory card (p.10) or HDMI cable.
- For details on the Advanced User Guide and Instruction Manuals, see the next page.
- If you purchased a Lens Kit, check that the lenses are included.
- Be careful not to lose any of the above items.



When you need Lens Instruction Manuals, download them from the Canon website (p.4).

The Lens Instruction Manuals (PDF files) are for lenses sold individually. Note that when purchasing the Lens Kit, some of the accessories included with the lens may not match those listed in the Lens Instruction Manual.

Instruction Manuals



The Instruction Manual included with the camera provides **basic instructions for the camera and Wi-Fi functions.**

The Advanced User Guide (this PDF file), which provides complete instructions, can be downloaded from the Canon website to a computer or other device.

Downloading the Advanced User Guide/Instruction Manuals

The Advanced User Guide and instruction manuals for lenses and software (PDF files) can be downloaded from the Canon website to a computer or other device.

● Download site

- **Advanced User Guide**
- **Lens Instruction Manual**
- **Software Instruction Manual**

▶ www.canon.com/icpd



- **To view the PDF files, an Adobe PDF viewing software such as Adobe Acrobat Reader DC (most recent version recommended) is required.**
- Adobe Acrobat Reader DC can be downloaded for free from the Internet.
- Double-click the downloaded PDF file to open it.
- To learn how to use PDF viewing software, refer to the software's Help section or the like.

Downloading the Advanced User Guide/Instruction Manuals Using QR Code

The Advanced User Guide and instruction manuals for lenses and software (PDF files) can be downloaded to a smartphone or tablet using the QR code.



▶ www.canon.com/icpd



- A software application is required to read the QR code.
- Select your country or region of residence, then download the Advanced User Guide/Instruction Manuals.
- Select [**Manual/software URL**] under the [**46**] tab to display the QR code on the camera screen.

Quick Start Guide

1

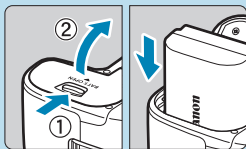

Insert the battery (p.43).

- Upon purchase, charge the battery to start using (p.40).

2

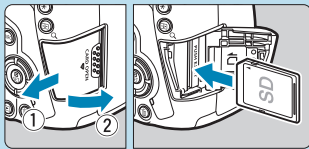

Insert the card (p.44).

- With the card's label facing toward the back of the camera, insert it into the card slot.

3

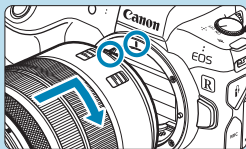

Attach the lens (p.50).

- Align the red mount index on the lens with the red mount index on the camera to attach the lens.
- Make sure the lens's focus mode switch is set to **<AF>** (p.50).

4

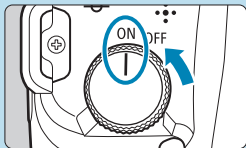

Set the power switch to **<ON>** (p.48).

5

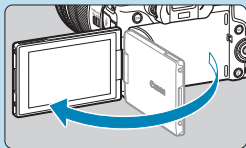

Flip out the screen (p.47).

- When the date/time/zone setting screen is displayed, see page 380.

6

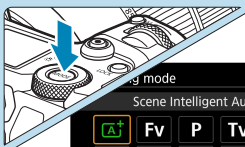

Set the shooting mode to [A+]
(p.123).

- Press the <MODE> button and turn the <[A+]> dial to select [A+], then press <SET>.
- All the necessary camera settings will be set automatically.

7



Focus on the subject (p.56).

- <[]> (an AF point) appears over any face detected.
- Press the shutter button halfway, and the camera will focus on the subject.

8



Take the picture (p.56).

- Press the shutter button completely to take the picture.

9



Review the picture.

- The image just captured will be displayed for approx. 2 sec. on the screen.
- To display the image again, press the <[]> button (p.304).







- To view the images captured so far, see “Image Playback” (p.304).
- To delete images, see “Erasing Images” (p.335).

About This Manual

Chapter Organization

Chapters 2–7 correspond to the functions in camera menus.

Icons in this Manual

- <MODE> : Indicates the Mode button.
- <> : Indicates the Main dial.
- <> : Indicates the Quick control dial.
- <▲><▼><◀><▶> : Indicates the corresponding direction on the <> cross keys.
- <> : Indicates the <M-Fn> Multi-function bar.
- <> : Indicates the lens control ring.
- <SET> : Indicates the Setting button.
- * : Indicates the duration (in seconds) of the operation for the button you pressed, as timed after you release the button.

- In addition to the above, the icons and symbols used on the camera's buttons and displayed on the screen are also used in this manual when discussing relevant operations and functionality.

☆ : A ☆ icon to the right of a page title indicates that the function is available only in **[Fv]**, **[P]**, **[Tv]**, **[Av]**, **[M]**, or **[BULB]** mode.

(p.***): Reference page numbers for more information.

 : Warning to prevent shooting problems.

 : Supplemental information.

 : Tips or advice for better shooting.

? : Troubleshooting advice.

Basic Assumptions for Operational Instructions, Sample Photos

- Before following any instructions, make sure the power switch is set to <ON> and no controls are locked with the Multi-function lock (p.48, 60).
- It is assumed that all the menu settings and Custom Functions are set to their defaults.
- The illustrations in this manual show the camera attached with the RF24-105mm F4 L IS USM lens as an example.
- The sample photos used in this manual are for instructional purposes only.
- In references to using EF or EF-S lenses, it is assumed that a mount adapter is used.

Compatible Cards

The following cards can be used with the camera regardless of capacity. **If the card is new or was previously formatted (initialized) by another camera or computer, format the card with this camera** (p.373).

- **SD/SDHC/SDXC memory cards**

* UHS-II and UHS-I cards supported.

Cards that Can Record Movies

When shooting movies, use a large-capacity card with good enough performances (fast enough writing and reading speeds) to handle the movie recording quality. For details, see page 611.



In this manual, “card” refers to SD memory cards, SDHC memory cards, and SDXC memory cards.

* **The camera does not come with a card for recording photos/movies.** Please purchase it separately.

Chapters

	Introduction	2
1	Preparation and Basic Operations	39
2	Shooting	69
3	AF	255
4	Playback	301
5	Set-up	361
6	Wi-Fi (Wireless Communication) Functions	423
7	Custom Functions / My Menu	539
8	Reference	571



Contents

Introduction 2

Item Check List.....	3
Instruction Manuals	4
Quick Start Guide	6
About This Manual	8
Compatible Cards.....	10
Chapters.....	11
Index to Features	21
Safety Instructions.....	25
Handling Precautions	28
Part Names	31

1 Preparation and Basic Operations 39









Charging the Battery	40
Inserting/Removing the Battery	43
Inserting and Removing the Card.....	44
Using the Screen.....	47
Turning on the Power	48
Attaching and Detaching a Lens	50
Attaching and Detaching EF/EF-S Lenses.....	52
Using the Viewfinder	54
Basic Operations	55
Menu Operations and Settings.....	63



 Touch-Screen Operation	67
 Quick Control	68

2 Shooting 69



2-1 Shooting Still Photos 70

Tab Menus: Still Photo Shooting	71
Index to Features: Still Photo Shooting	74
Setting Image Quality	75
Setting Up Dual Pixel RAW Shooting	78
Setting Cropping/Aspect Ratio	80
ISO : Setting the ISO Speed for Still Photos	83
Selecting a Picture Style	88
Customizing a Picture Style	92
Registering a Picture Style	95
WB : Setting the White Balance	97
 White Balance Correction	102
Auto Correction of Brightness and Contrast	104
Setting Noise Reduction	105
Highlight Tone Priority	109
Correction of Lens Aberrations due to Optical Characteristics	110
Reducing Flicker	115
Setting the Color Space	117

Card Reminder	118
Setting the Image Review Time.....	118
Setting the Metering Timer	119
Exposure Simulation	120
Appending Dust Delete Data.....	121
 Fully Automatic Shooting (Scene Intelligent Auto).....	123
 Full Auto Techniques (Scene Intelligent Auto)	126
 Shooting with the Touch Shutter.....	130
P : Program AE	132
Tv : Shutter-Priority AE.....	134
Av : Aperture-Priority AE	136
M : Manual Exposure	138
Fv : Flexible-Priority AE.....	140
 Selecting the Drive Mode	144
 Using the Self-Timer	147
Selecting the Display Speed for High-Speed Continuous Shooting	149
Silent Live View Shooting.....	150
Silent Shooting	151
 Selecting the Metering Mode.....	152
 Setting the Desired Exposure Compensation	154
 Auto Exposure Bracketing (AEB).....	155
 Locking the Exposure for Shooting (AE Lock).....	157

BULB : Long (Bulb) Exposures.....	158
HDR : HDR (High Dynamic Range) Shooting.....	161
 Multiple Exposures.....	166
Remote Control Shooting.....	174
Using a Remote Switch.....	176
 Flash Photography.....	177
Setting the Flash Function.....	179

2-2 Shooting Movies **188**









Tab Menus: Movie Shooting.....	189
Index to Features: Movie Shooting.....	191
Setting the Movie Recording Quality.....	192
Setting the Sound Recording.....	202
Setting the Time Code.....	205
 Shooting Movies.....	209
Movie Cropping.....	219
Movie Digital IS.....	220
Shooting HDR Movies.....	222
 Shooting Time-lapse Movies.....	224
Shooting Movies Set to Canon Log.....	236
Menu Function Settings.....	244











3 AF **255**

Tab Menus: AF (Still Photos).....	256
-----------------------------------	-----

Tab Menus: AF (Movies).....	259
Selecting the AF Operation	262
Selecting the AF Method	265
Setting the AF Point Size.....	276
Focusing on People's Eyes	277
Setting Continuous AF.....	278
Setting Touch & Drag AF	279
MF: Focusing Manually	281
Setting Movie Servo AF.....	286
Customizing AF Functions.....	288



4 Playback 301

Tab Menus: Playback.....	302
Index to Features: Playback and Related Operations.....	303
 Image Playback	304
Customizing Playback Information Display	307
 Index Display (Multiple-Image Display).....	310
 Jump Display (Jumping Through Images).....	311
 Filtering Images for Playback.....	313
 Magnifying Images.....	315
 Rotating Images	317
 Protecting Images.....	318
 Setting Ratings.....	321

 Enjoying Movies	324
 Playing Back Movies	325
 Editing a Movie's First and Last Scenes	327
 Grabbing a Frame from 4K Movies or 4K Time-Lapse Movies.....	329
Slide Show (Auto Playback).....	331
Viewing Images on a Television	333
 Erasing Images	335
 Processing RAW Images with the Camera.....	339
 Resizing JPEG Images.....	345
 Cropping JPEG Images	346
 Transferring Images to a Computer/FTP Server.....	348
 Digital Print Order Format (DPOF)	353
 Specifying Images for a Photobook.....	357

5 Set-up 361

Tab Menus: Set-up	362
Creating and Selecting a Folder.....	365
File Numbering Methods	367
Renaming Files	370
Setting the Auto Rotation of Vertical Images.....	372
Formatting the Card	373
Setting Eco Mode.....	376

Setting Power-Saving Features.....	377
Adjusting the Screen Brightness	378
Adjusting the Screen Color Tone.....	379
Setting the Date, Time, and Time Zone.....	380
Setting the Interface Language	383
Setting the Video System.....	384
Setting the Touch Control Response.....	385
Disabling Beeps for Camera Operations.....	386
Checking the Battery Information.....	387
 Sensor Cleaning.....	391
Setting the HDMI Output Resolution	395
RAW Playback on an HDR TV	396
Customizing Information Displayed When Shooting	397
Setting a Priority for Shooting Display Performance	402
Setting the Viewfinder Display Format	402
Setting the Display Mode	403
Customizing Shutter Button Functionality	404
 Help.....	405
Setting Wireless Features	407
Geotagging Images.....	411
LOCK Setting the Multi-Function Lock.....	416
 : Registering Custom Shooting Modes.....	417
Reverting the Camera to the Default Settings	419

Setting Copyright Information	420
Checking Other Information	422

6 Wi-Fi (Wireless Communication) Functions 423

What You Can Do via Wi-Fi (Wireless Communication) Functions.....	424
Connecting to a Smartphone via Wi-Fi.....	427
Connecting to a Computer via Wi-Fi	461
Connecting to a Printer via Wi-Fi.....	469
Sending Images to a Web Service	481
Wi-Fi Connection via Access Points.....	496
Reconnecting via Wi-Fi	509
Changing or Deleting Connection Settings	513
Clearing Wireless Communication Settings to Default.....	515
View Info Screen	516
Responding to Error Messages.....	517
Wireless Communication Function Notes	528
Security	530
Checking Network Settings	531
[Wireless communication settings] Screen	532
[Wi-Fi settings] Screen	533
Virtual Keyboard Operation	534
Setting the IP Address Manually	535

Wi-Fi/Bluetooth Status Display	537
--------------------------------------	-----

7 Custom Functions / My Menu 539

Tab Menus: Customization	540
Custom Function Settings	542
Customizing Operations	555
Tab Menus: My Menu	565
Registering My Menu	566

8 Reference 571

Software Overview	572
Importing Images to a Computer	574
Charging a Battery in the Camera	576
Using a Battery Grip	578
Troubleshooting Guide	588
Error Codes	607
Performance Data	608
Information Display	617
Index	633

Index to Features

Power

- Charging the battery → p.40
- Battery level → p.49
- Checking battery information → p.387
- Household power outlet → p.582
- Eco mode → p.376
- Power saving → p.377

Cards

- Formatting → p.373
- Releasing shutter without card → p.118
- Cards compatible with movie recording → p.611

Lens

- Attaching → p.50, 52
- Detaching → p.51, 53
- Releasing shutter without lens → p.551

Basic Settings

- Language → p.383
- Date/Time/Zone → p.380
- Beeper → p.386
- Copyright information → p.420
- Clear all camera settings → p.419

Viewfinder

- Dioptic adjustment → p.54
- Information display in viewfinder → p.397
- Viewfinder vertical display → p.399
- Viewfinder display format → p.402

Screen

- Vari-angle → p.47
- Touch control → p.67
- Color tone → p.379
- Brightness → p.378
- Display settings → p.403
- Electronic level → p.397
- Help → p.405

AF

- AF operation → p.262
- AF method → p.265
- AF point selection → p.271
- AF frame size → p.276
- Eye Detection AF → p.277
- Continuous AF → p.278
- Touch & drag AF → p.279
- MF peaking settings → p.283
- Focus guide → p.284
- Customizing AF functions → p.288
- Manual focusing → p.281
- Electronic manual focus → p.293

Metering

- Metering mode → p.152

Drive

- Drive mode → p.144
- Self-timer → p.147
- Silent LV shooting → p.150
- Silent shooting → p.151
- Maximum burst → p.77

Image Recording Settings

- Creating/Selecting a folder → p.365
- File numbering → p.367

Image Quality

- Image quality → p.75
- Dual Pixel RAW → p.78
- Cropping/aspect ratio → p.80
- ISO speed (still photos) → p.83
- Picture Style → p.88
- White balance → p.97
- Auto Lighting Optimizer → p.104
- Noise reduction for high ISO speeds → p.105
- Noise reduction for long exposures → p.107
- Highlight tone priority → p.109
- Lens aberration correction → p.110
- Reducing flicker → p.115
- Color space → p.117

Shooting

- Shooting mode → p.70
- HDR mode → p.161
- Multiple exposures → p.166
- Bulb timer → p.159
- Depth-of-field preview → p.137
- Remote switch → p.176
- Remote control → p.174
 - Pairing → p.408
- Quick Control → p.68
- Touch Shutter → p.130
- Magnified view → p.273
- Grid display → p.399
- Shooting information display → p.397
- Display settings → p.403
- Multi-function lock → p.60
- Error codes → p.607

Exposure

- Exposure compensation → p.154
- Exposure compensation with M+ISO Auto → p.139
- AEB → p.155
- AE lock → p.157
- Safety shift → p.545
- Exposure simulation → p.120

Flash

- External flash → p.177
- Flash exposure compensation → p.177
- FE lock → p.177
- Flash function settings → p.182
- Flash Custom Function settings → p.187

Movie Shooting

- Autoexposure shooting → p.209
- Shutter priority AE shooting → p.210
- Aperture priority AE shooting → p.211
- Manual exposure shooting → p.213
- ISO speed (movie) → p.246
- Movie Servo AF → p.286
- Movie Servo AF tracking sensitivity → p.291
- Movie Servo AF speed → p.292
- Movie recording quality → p.192
- 24.00p → p.198
- High Frame Rate → p.199
- Movie cropping shooting → p.219
- HDR movie → p.222
- Time-lapse movie → p.224
- Canon Log → p.236
- Sound recording → p.202
- Microphone → p.203
- Wind filter → p.202

- Attenuator → p.203
- Time code → p.205
- Auto slow shutter → p.248
- Av 1/8-stop increments → p.249
- HDMI output → p.251
- Remote control shooting → p.245

Playback

- Image review time → p.118
- Single-image display → p.304
- Shooting information display → p.305
- Grid display → p.305
- Touch playback → p.306
- Playback information display → p.307
- Index display → p.310
- Image browsing (Jump display) → p.311
- Setting image search conditions → p.313
- Magnified view → p.315
- Image rotation → p.317
- Protect → p.318
- Rating → p.321
- Movie playback → p.325
- Editing a movie's first and last scenes → p.327
- Frame Grab (4K) → p.329
- Slide show → p.331
- Viewing images on a television → p.333
- Erasing → p.335

Image Editing

- RAW image processing → p.339
- Resizing JPEGs → p.345
- Cropping JPEGs → p.346

Image Transfer/Print Order

- Image transfer to a computer/FTP server → p.348
- Print order (DPOF) → p.353
- Photobook Set-up → p.357

Customization

- Custom Functions (C.Fn) → p.542
- Customizing operations → p.555
- My Menu → p.566
- Custom shooting mode → p.417

Sensor Cleaning and Dust Reduction

- Sensor cleaning → p.391
- Appending Dust Delete Data → p.121
- Manual sensor cleaning → p.393

Software

- Downloading and Installing → p.572
- Software Instruction Manuals → p.573

Wireless Features

- Connect to smartphones → p.427
- Auto send images to smartphones → p.446
- Remote control (EOS Utility) → p.461
- Auto send images to computers → p.466
- Print from Wi-Fi printers → p.469
- Upload to Web services → p.481
- Clear wireless settings → p.515

Safety Instructions

Be sure to read these instructions in order to operate the product safely.

Follow these instructions to prevent injury or harm to the operator of the product or others.



WARNING: Denotes the risk of serious injury or death.

- Keep the product out of the reach of young children.

A strap wrapped around a person's neck may result in strangulation.

The parts or provided items of cameras or accessories are dangerous if swallowed. If swallowed, seek immediate medical assistance.

The battery is dangerous if swallowed. If swallowed, seek immediate medical assistance.

- Use only power sources specified in this instruction manual for use with the product.
- Do not disassemble or modify the product.
- Do not expose the product to strong shocks or vibration.
- Do not touch any exposed internal parts.
- Stop using the product in any case of unusual circumstances such as the presence of smoke or a strange smell.
- Do not use organic solvents such as alcohol, benzene or paint thinner to clean the product.
- Do not get the product wet. Do not insert foreign objects or liquids into the product.
- Do not use the product where flammable gases may be present.

This may cause electric shock, explosion or fire.

- Do not leave a lens or a camera with a lens attached, exposed without the lens cap attached.

The lens may concentrate the light and cause fire.

- Do not touch the product connected to a power outlet during lightning storms.

This may cause electric shock.

- Observe the following instructions when using commercially available batteries or provided battery packs.
 - Use batteries/battery packs only with their specified product.
 - Do not heat batteries/battery packs or expose them to fire.
 - Do not charge batteries/battery packs using non-authorized battery chargers.
 - Do not expose the terminals to dirt or let them come into contact with metallic pins or other metal objects.
 - Do not use leaking batteries/battery packs.
 - When disposing of batteries/battery packs, insulate the terminals with tape or other means.

This may cause electric shock, explosion or fire.

If a battery/battery pack leaks and the material contacts your skin or clothing, flush the exposed area thoroughly with running water. In case of eye contact, flush thoroughly with copious amounts of clean running water and seek immediate medical assistance.

- Observe the following instructions when using a battery charger or AC adapter.
 - Periodically remove any dust buildup from the power plug and power outlet using a dry cloth.
 - Do not plug in or unplug the product with wet hands.
 - Do not use the product if the power plug is not fully inserted into the power outlet.
 - Do not expose the power plug and terminals to dirt or let them come into contact with metallic pins or other metal objects.
- Do not touch the battery charger or AC adapter connected to a power outlet during lightning storms.
- Do not place heavy objects on the power cord. Do not damage, break or modify the power cord.
- Do not wrap the product in cloth or other materials when in use or shortly after use when the product is still warm in temperature.
- Do not unplug the product by pulling the power cord.
- Do not leave the product connected to a power source for long periods of time.
- Do not charge batteries/battery packs at temperatures outside the range of 5–40 °C (41–104 °F).

This may cause electric shock, explosion or fire.

- Do not allow the product to maintain contact with the same area of skin for extended periods of time during use.

This may result in low-temperature contact burns, including skin redness and blistering, even if the product does not feel hot. The use of a tripod or similar equipment is recommended when using the product in hot places and for people with circulation problems or less sensitive skin.

- Follow any indications to turn off the product in places where its use is forbidden.

Not doing so may cause other equipment to malfunction due to the effect of electromagnetic waves and even result in accidents.

- To prevent fire, excessive heat, chemical leakage, explosions, and electrical shock, follow the safeguards below:
 - Do not insert the battery's plus and minus ends incorrectly.
- Do not leave any cords near a heat source.

It can deform the cord or melt the insulation and cause a fire or electrical shock.

- Do not fire the flash at anyone driving a car or other vehicle.

It may cause an accident.

- Do not use or store the equipment in dusty or humid places. Likewise, keep the battery away from metallic items and store it with its protective cover attached to prevent short-circuit.

This is to prevent fire, excessive heat, electrical shock, and burns.

- To prevent a fire and electrical shock, follow the safeguards below:
 - Do not connect too many power plugs to the same power outlet.
 - Do not use a cord whose wire is broken or insulation is damaged.
- Do not connect the battery directly to an electrical outlet or a car's cigarette lighter outlet.

The battery may leak, generate excessive heat or explode, causing fire, burns, or injuries.

- A thorough explanation of how to use the product by an adult is required when the product is used by children. Supervise children while they are using the product.

Incorrect usage may result in electrical shock or injury.

 **CAUTION:** Denotes the risk of injury.

- Do not fire the flash near the eyes.

It may hurt the eyes.

- Strap is intended for use on the body only. Hanging the strap with any product attached on a hook or other object may damage the product. Also, do not shake the product or expose the product to strong impacts.

- Do not apply strong pressure on the lens or allow an object to hit it.

This may cause injury or damage to the product.

- Flash emits high temperatures when fired. Keep fingers, any other part of your body, and objects away from the flash unit while taking pictures.

This may cause burns or malfunction of the flash.

- Do not leave the product in places exposed to extremely high or low temperatures.

The product may become extremely hot/cold and cause burns or injury when touched.

- Only mount the product on a tripod that is sufficiently sturdy.

- Do not carry the product when it is mounted on a tripod.

This may cause injury or may result in an accident.

- Do not look at the screen or through the viewfinder for prolonged periods of time.

This may induce symptoms similar to motion sickness. In such a case, stop using the product immediately and rest for a while before resuming use.

- Do not touch any parts inside the product.

This may cause injury.

Handling Precautions

Camera Care

- This camera is a precision instrument. Do not drop it or subject it to physical shock.
- The camera is not waterproof and cannot be used underwater.
- To maximize the camera's dust- and drip- resistance, keep the terminal cover, battery compartment cover, card slot cover, and all other covers firmly closed.
- This camera is designed to be dust- and drip- resistant, in order to help prevent sand, dust, dirt, or water that falls on it unexpectedly from getting inside, but it is impossible to prevent dirt, dust, water, or salt from getting inside at all. As far as possible, do not allow dirt, dust, water, or salt to get on the camera.
- If water gets on the camera, wipe it off with a dry and clean cloth. If dirt, dust, or salt gets on the camera, wipe it off with a clean, well-wrung wet cloth.
- Using the camera in a location with large amounts of dirt or dust may cause a malfunction.
- Cleaning the camera after use is recommended. Allowing dirt, dust, water, or salt to remain on the camera may cause a malfunction.
- If you accidentally drop the camera into water or are concerned that moisture (water), dirt, dust, or salt may have gotten inside it, promptly consult the nearest Canon Service Center.
- Never leave the camera near anything having a strong magnetic field such as a magnet or electric motor. Also, avoid using or leaving the camera near anything emitting strong radio waves, such as a large antenna. Strong magnetic fields can cause camera malfunction or destroy image data.
- Do not leave the camera in excessive heat, such as in a car in direct sunlight. High temperatures can cause the camera to malfunction.
- The camera contains precision electronic circuitry. Never attempt to disassemble the camera yourself.

- Do not block shutter curtain operation with your finger or other objects. Doing so may cause a malfunction.
- Use only a commercially available blower to blow away dust when it adheres to the lens, viewfinder, etc. Do not use cleaners that contain organic solvents to clean the camera body or lens. For stubborn dirt, take the camera to the nearest Canon Service Center.
- Do not touch the camera's electrical contacts with your fingers. This is to prevent the contacts from corroding. Corroded contacts can cause camera malfunction.
- If the camera is suddenly brought in from the cold into a warm room, condensation may form on the camera and internal parts. To prevent condensation, first put the camera in a sealed plastic bag and let it adjust to the warmer temperature before taking it out of the bag.
- If condensation forms on the camera, do not use the camera. This is to avoid damaging the camera. If there is condensation, remove the lens, card and battery from the camera, and wait until condensation has evaporated before using the camera.
- If the camera will not be used for an extended period, remove the battery and store the camera in a cool, dry, well-ventilated location. Even while the camera is in storage, press the shutter button a few times once in a while to check that the camera is still working.
- Avoid storing the camera where there are chemicals that result in rust and corrosion such as in a chemical lab.
- If the camera has not been used for an extended period, test all its functions before using it. If you have not used the camera for some time or if there is an important shoot such as a foreign trip coming up, have the camera checked by your nearest Canon Service Center or check the camera yourself and make sure it is working properly.
- The camera may become hot after repeated continuous shooting or still photo/movie shooting over an extended period. This is not a malfunction.
- If there is a bright light source inside or outside the image area, ghosting may occur.

Screen, Viewfinder, and LCD Panel

- Although the screen and viewfinder are manufactured with very high precision technology with over 99.99% effective pixels, 0.01% or fewer of the pixels may be dead, and there may also be spots of black, red, or other colors. This is not a malfunction. They do not affect the images recorded.
- If the screen is left on for a prolonged period, screen burn-in may occur where you see remnants of what was displayed. However, this is only temporary and will disappear when the camera is left unused for a few days.
- The screen display may seem slightly slow in low temperatures or may look black in high temperatures. It will return to normal at room temperature.

Shutter

- Shutter blades may become scuffed from shutter operations, but this does not indicate damage.

Cards

To protect the card and its recorded data, note the following:

- Do not drop, bend, or wet the card. Do not subject it to excessive force, physical shock, or vibration.
- Do not touch the card's electronic contacts with your fingers or anything metallic.
- Do not affix any stickers, etc. on the card.
- Do not store or use the card near anything that has a strong magnetic field, such as a television, speakers, or magnets. Also avoid places prone to having static electricity.
- Do not leave the card in direct sunlight or near a heat source.
- Store the card in a case.
- Do not store the card in hot, dusty, or humid locations.

Lens

- After detaching the lens from the camera, put down the lens with the rear end up and attach the rear lens cap to avoid scratching the lens surface and electrical contacts (1).



Part Names

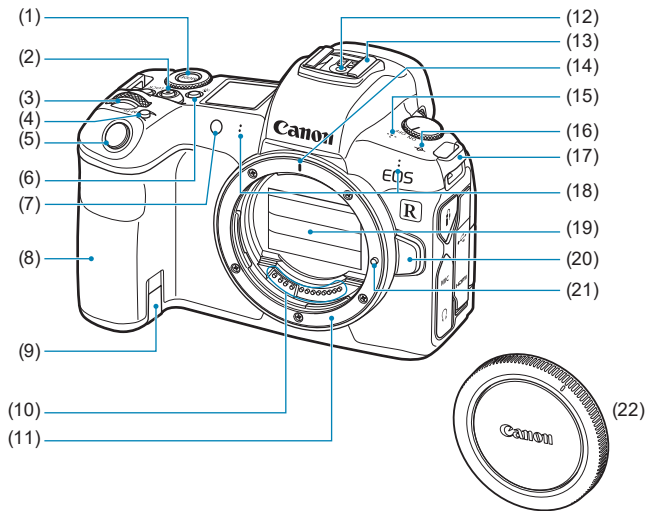

(1) <MODE> button

(2) Movie shooting button

(3) <  > Main dial

(4) <M-Fn> Multi-function button

(5) Shutter button

(6) <  > LCD panel info switching/
Illumination button

(7) AF-assist beam/Self-timer/
Remote control lamp

(8) Grip (Battery compartment)

(9) DC coupler cord hole

(10) Contacts

(11) Lens mount

(12) Flash sync contacts

(13) Hot shoe

(14) RF lens mount index

(15) Speaker

(16) <  > Focal plane mark

(17) Strap mount

(18) Microphone

(19) Shutter curtain/Image sensor

(20) Lens release button

(21) Lens lock pin

(22) Body cap

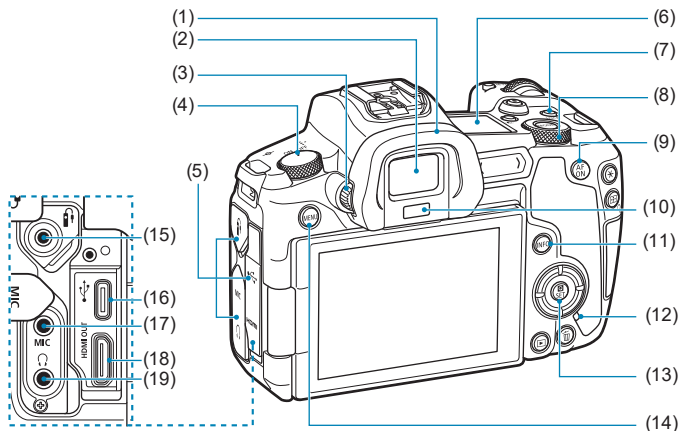

- (1) Eyecup
- (2) Viewfinder eyepiece
- (3) Dioptic adjustment knob
- (4) Power switch
- (5) Terminal cover
- (6) LCD panel
- (7) <LOCK> Multi-function lock button
- (8) <Q> Quick control dial
- (9) <AF ON> AF start button
- (10) Viewfinder sensor

- (11) <INFO> Info button
- (12) Access lamp
- (13) <Q/SET> Quick Control/Setting button
- (14) <MENU> Menu button
- (15) <f> Remote control terminal
- (16) <D> Digital terminal
- (17) <MIC> External microphone IN terminal
- (18) <HDMI OUT> HDMI mini OUT terminal
- (19) <H> Headphone terminal

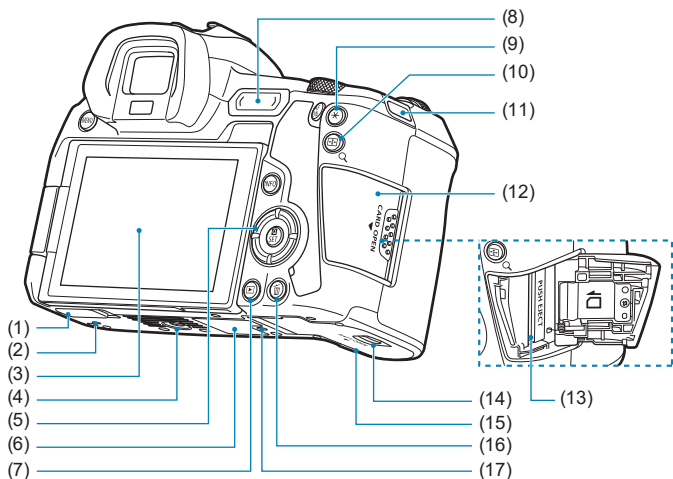

- | | |
|---|--|
| (1) Contact cover | (10) $\langle \text{AF} \rangle / \text{Q}$ AF point/Index/Magnify/Reduce button |
| (2) Accessory positioning hole | (11) Strap mount |
| (3) Screen | (12) Card slot cover |
| (4) Tripod socket | (13) Card slot |
| (5) $\langle \blacktriangle \rangle \langle \blacktriangledown \rangle \langle \blacktriangleleft \rangle \langle \blacktriangleright \rangle$: $\langle \blacklozenge \rangle$ cross keys | (14) Battery compartment cover lock |
| (6) Serial number | (15) Battery compartment cover |
| (7) $\langle \text{▶} \rangle$ Playback button | (16) $\langle \text{🗑} \rangle$ Erase button |
| (8) $\langle \text{M-Fn} \rangle$ Multi-function bar | (17) Accessory positioning hole |
| (9) $\langle \text{✳} \rangle$ AE lock/FE lock button | |

LCD Panel

Sample display

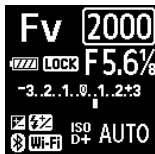

Information displayed varies depending on camera status. For icon details, see page 617.

Viewfinder Information Display

Sample display

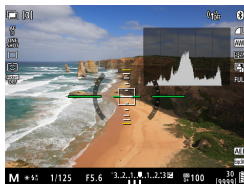

Information displayed varies depending on camera status.

Battery Charger LC-E6

Charger for Battery Pack LP-E6N/LP-E6 (p.40).

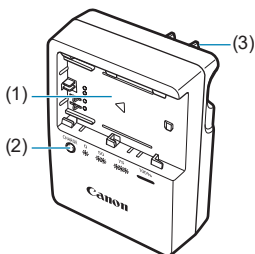

- (1) Battery pack slot
- (2) Charge lamp
- (3) Power plug

Battery Charger LC-E6E

Charger for Battery Pack LP-E6N/LP-E6 (p.40).

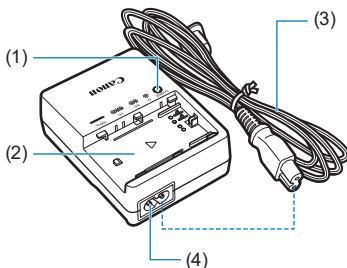

- (1) Charge lamp
- (2) Battery pack slot
- (3) Power cord
- (4) Power cord socket

Attaching the Strap

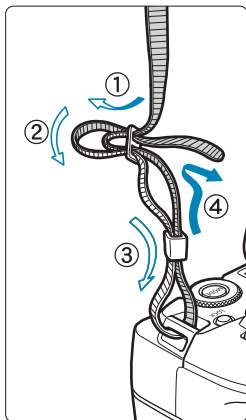

Pass the end of the strap through the camera's strap mount eyelet from the bottom. Then pass it through the strap's buckle as shown in the illustration. Pull the strap to take up any slack and make sure the strap will not loosen from the buckle.

Using the Cable Protector

When connecting the camera to a computer, use the included interface cable or a genuine Canon cable.

When connecting the interface cable, also **use the included cable protector**. Using the cable protector helps prevent accidental disconnection and terminal damage.

Using the Included Interface Cable and a Canon HDMI Cable (Sold Separately)

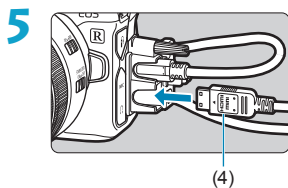
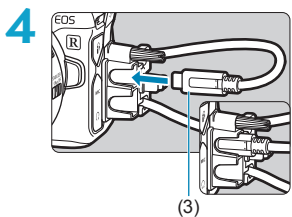
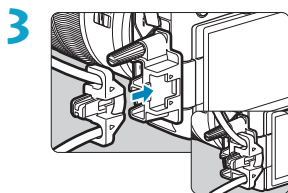
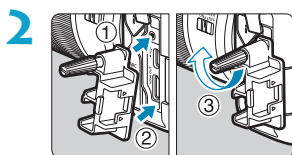
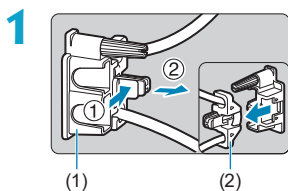

- (1) Cable protector
- (2) Clamp
- (3) Included interface cable
- (4) HDMI cable (sold separately)

Using an Optional Canon Interface Cable

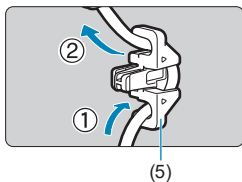

When using a genuine Canon interface cable (sold separately), run the cable through the clamp (5) as shown before attaching the clamp to the cable protector.

- The digital terminal may be damaged if the interface cable is connected without the cable protector.
- Make sure the interface cable is securely connected to the digital terminal.

 HDMI Cable HTC-100 (sold separately) is recommended when connecting the camera to a television. Also use the cable protector when connecting an HDMI cable.

1

Preparation and Basic Operations

This chapter describes preparatory steps before you start shooting and the basic camera operations.

Charging the Battery

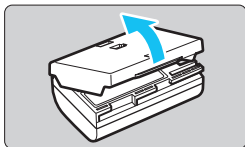

- 1 Detach the protective cover provided with the battery.**

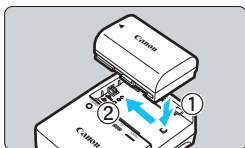

- 2 Fully insert the battery in the charger.**

- Do the opposite to remove the battery.

LC-E6

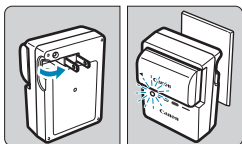

- 3 Recharge the battery.**

For LC-E6

- As shown by the arrow, flip out the battery charger's prongs and insert the prongs into a power outlet.

LC-E6E

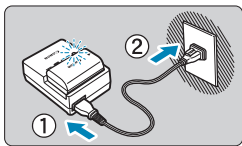

For LC-E6E

- Connect the power cord to the charger and insert the plug into a power outlet.
- ▶ Recharging starts automatically and the charge lamp blinks in orange.

Charge Level	Charge Lamp	
	Color	Display
0–49%	Orange	Blinks once per second
50–74%		Blinks twice per second
75% or higher		Blinks three times per second
Fully charged	Green	Turned on

- **It takes approx. 2 hr. and 30 min. to fully recharge a completely exhausted battery at room temperature (23°C / 73°F).** The time required to recharge the battery will vary greatly depending on the ambient temperature and the battery's remaining capacity.
- For safety reasons, recharging in low temperatures (5–10°C / 41–50°F) will take longer (up to approx. 4 hr.).

- **Upon purchase, the battery is not fully charged.**
Charge the battery before use.
- **Recharge the battery on the day before or on the day it is to be used.**
Even during storage, a charged battery will gradually drain and lose its capacity.
- **After recharging the battery, remove it and disconnect the charger from the power outlet.**

- **You can attach the protective cover in a different orientation to indicate whether the battery is recharged or not.**

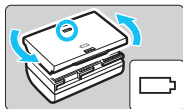

If the battery is recharged, attach the protective cover so that the battery-shaped hole is aligned over the blue sticker on the battery. If the battery is exhausted, attach the protective cover in the opposite orientation.

- **When not using the camera, remove the battery.**
If the battery is left in the camera for a prolonged period, a small amount of power current will keep being released, resulting in excess discharge and shorter battery life. Store the battery with the protective cover attached. Storing the battery when it is fully charged may lower the battery performance.
- **The battery charger can also be used in foreign countries.**
The battery charger is compatible with a 100 V AC to 240 V AC 50/60 Hz power source. If necessary, attach a commercially available plug adapter for the respective country or region. Do not attach any portable voltage transformer to the battery charger. Doing so may damage the battery charger.
- **If the battery becomes exhausted quickly even after having been fully charged, the battery has reached the end of its service life.**
Check the battery's recharge performance (p.387) and purchase a new battery.



- After disconnecting the charger's power plug, do not touch the prongs for approx. 10 sec.
- If the battery's remaining capacity (p.387) is 94% or higher, the battery will not be recharged.
- The provided charger cannot charge any battery other than Battery Pack LP-E6N/LP-E6.

Inserting/Removing the Battery

Load a fully-charged Battery Pack LP-E6N (or LP-E6) into the camera.

Insertion

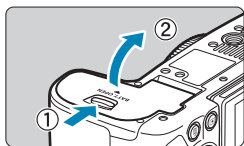

- 1 Slide the battery compartment cover lock and open the cover.**

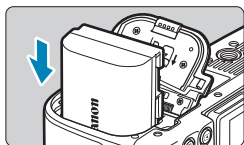

- 2 Insert the battery.**
 - Insert the end with the electrical contacts.
 - Insert the battery until it locks in place.

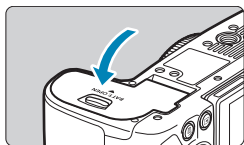

- 3 Close the cover.**
 - Press the cover until it snaps shut.



You cannot use batteries other than the Battery Pack LP-E6N or LP-E6.

Removal

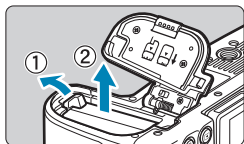

Open the cover and remove the battery.

- Press the battery lock lever as shown by the arrow and remove the battery.
- To prevent short circuiting, be sure to attach the provided protective cover (p.40) to the battery.

Inserting and Removing the Card

The captured images are recorded onto the card.

- ⓘ Make sure the card's write-protect switch (1) is set upward to enable writing and erasing.

Insertion

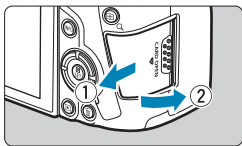

- 1 Slide the cover to open it.

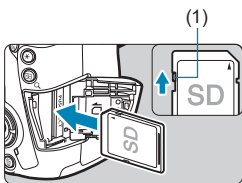

- 2 Insert the card.
 - As shown by the illustration, face the card's label side toward you and insert it until it clicks in place.

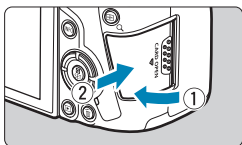

- 3 Close the cover.
 - Close the cover and slide it in the direction shown by the arrow until it snaps shut.

Removal

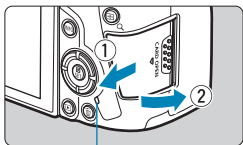

(1)

1 Open the cover.

- Set the power switch to <OFF>.
- **Check that the access lamp (1) is off, then open the cover.**
- If [Saving...] is displayed on the screen, close the cover.

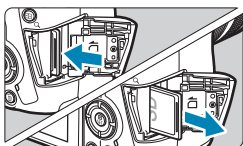

2 Remove the card.

- Gently push in the card, then let it go to eject.
- Pull the card straight out, then close the cover.

Formatting the Card

If the card is new or was previously formatted (initialized) by another camera or computer, format the card with this camera (p.373).



- The number of possible shots varies depending on the remaining capacity of the card, the settings of image quality, ISO speed, etc.
- Setting [📷1: Release shutter without card] to [Disable] will prevent you from forgetting to insert a card (p.118).

- **When the access lamp is lit or blinking, it indicates that images are being written to, read from, or erased from the card, or data is being transferred. Do not open the card slot cover during this time. Also, never do any of the following while the access lamp is lit or blinking. Otherwise, it can damage the image data, card, or camera.**
 - **Removing the card.**
 - **Removing the battery.**
 - **Shaking or striking the camera.**
 - **Unplugging and connecting a power cord** (when household power outlet accessories (sold separately) are used).
- If the card already contains recorded images, the image number may not start from 0001 (p.367).
- If a card-related error message is displayed on the screen, remove and reinsert the card. If the error persists, use a different card. If you can transfer images on the card to a computer, transfer all the images and then format the card with the camera (p.373). The card may then return to normal.
- Do not touch the card's contacts with your fingers or metal objects. Do not expose the contacts to dust or water. If smudges adhere to the contacts, contact failure may result.
- Multimedia cards (MMC) cannot be used. (Card error will be displayed.)
- Use of UHS-II microSDHC/SDXC cards with a microSD to SD adapter is not recommended. When using UHS-II cards, use SDHC/SDXC cards.

Using the Screen

You can change the direction and angle of the screen.

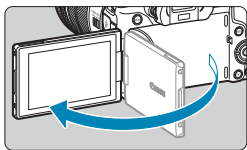

1 Flip out the screen.

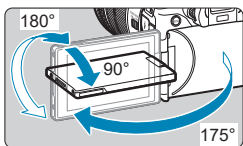

2 Rotate the screen.

- When the screen is swung out, you can rotate it up, down, or over 180° to face the subject.
- The indicated angle is only approximate.



3 Face it toward you.

- Normally, use the camera with the screen facing you.



- Be careful not to forcefully rotate the screen, putting much power on the rotating axis (hinge).
- When a cable is connected to a camera terminal, the rotation angle range of the flipped-out screen will be limited.



- When not using the camera, close the screen facing inward. You can protect the screen.
- A mirror image (right/left reversed) of subjects is displayed when the screen faces subjects in front of the camera.

Turning on the Power



- **<ON>**
Turns the camera on, accompanied by the sound of the shutter curtain opening. Also accompanied by the sound of the aperture opening, when an RF lens is attached.
- **<OFF>**
Stops camera operation, accompanied by the sound of the shutter curtain closing. Set the power switch to this position when not using the camera. Also accompanied by the sound of the aperture closing, when an RF lens is attached.

Setting the Date, Time, and Zone

If you turn on the power switch and the date/time/zone setting screen appears, see page 380 to set the date/time/zone.

Changing the Interface Language

To change the interface language, see page 383.

Automatic Sensor Cleaning

- Whenever you set the power switch to **<OFF>**, sensor cleaning will be performed automatically. (A small sound may be audible.) During the sensor cleaning, the screen will display **<[Sensor Cleaning Icon]>**. To enable automatic sensor cleaning when the power switch is set to **<ON>** as well, you can set this in **[4 3: Sensor cleaning]** (p.392).
- If you repeatedly turn the power switch **<ON>/<OFF>** at a short interval, the **<[Sensor Cleaning Icon]>** icon may not be displayed. This is normal and not a malfunction.







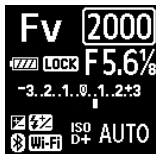

If you set the power switch to **<OFF>** while an image is being recorded to the card, **[Saving...]** will be displayed and the power will turn off after the recording finishes.

Battery Level Indicator

When the power switch is set to <ON>, the battery level will be indicated in one of six levels. A blinking battery icon < > indicates that the battery will soon be exhausted.



Display			
Level (%)	100–70	69–50	49–20

Display			
Level (%)	19–10	9–1	0



- Doing any of the following will exhaust the battery faster:
 - Pressing the shutter button halfway for a prolonged period.
 - Activating the AF frequently without taking a picture.
 - Using the lens's Image Stabilizer.
 - Using the Wi-Fi function or Bluetooth function.
- The number of possible shots may decrease depending on the actual shooting conditions.
- The lens operation is powered by the camera's battery. Certain lenses may exhaust the battery faster than others.
- In low ambient temperatures, shooting may not be possible even with a sufficient battery level.



See [**43: Battery info.**] to check the battery status (p.387).

Attaching and Detaching a Lens

Attaching a Lens

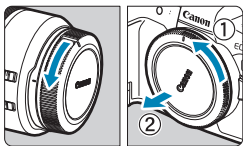

1 Remove the caps.

- Remove the rear lens cap and the body cap by turning them as shown by the arrows.

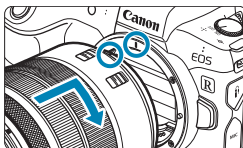

2 Attach the lens.

- Align the red mount index on the lens with the red mount index on the camera and turn the lens as shown by the arrow until it clicks in place.

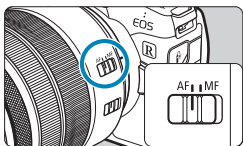

3 Set the lens's focus mode switch to <AF>.

- <AF> stands for autofocus.
- <MF> stands for manual focus. Autofocus will not operate.

4 Remove the front lens cap.

Detaching the Lens

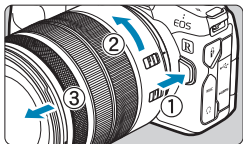

While pressing the lens release button, turn the lens as shown by the arrow.

- Turn the lens until it stops, then detach it.
- Attach the rear lens cap to the detached lens.



- Do not look at the sun directly through any lens. Doing so may cause loss of vision.
- When attaching or detaching a lens, set the camera's power switch to <OFF>.
- If the front part (focusing ring) of the lens rotates during autofocus, do not touch the rotating part.



For instructions on how to use the lens, refer to the Lens Instruction Manual (p.4).

Tips for Avoiding Smudges and Dust

- When changing lenses, do it quickly in a place with minimal dust.
- When storing the camera without a lens attached, be sure to attach the body cap to the camera.
- Remove dust on the body cap before attaching it.

Attaching and Detaching EF/EF-S Lenses

All EF and EF-S lenses can be used by attaching the optional Mount Adapter EF-EOS R. **The camera cannot be used with EF-M lenses.**

Attaching a Lens

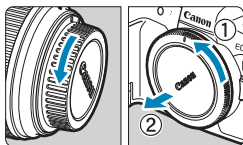

1 Remove the caps.

- Remove the rear lens cap and the body cap by turning them as shown by the arrows.

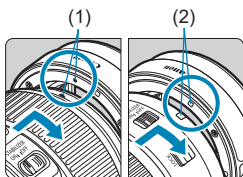

2 Attach the lens to the adapter.

- Align the red or white mount index on the lens with the corresponding mount index on the adapter and turn the lens as shown by the arrow until it clicks into place.

- (1) Red index
- (2) White index

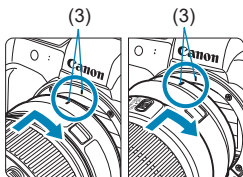

3 Attach the adapter to the camera.

- Align the red mount indexes (3) on the adapter and camera and turn the lens as shown by the arrow until it clicks into place.

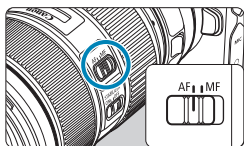

4 Set the lens's focus mode switch to <AF>.

- <AF> stands for autofocus.
- <MF> stands for manual focus. Autofocus will not operate.

5 Remove the front lens cap.

Detaching the Lens

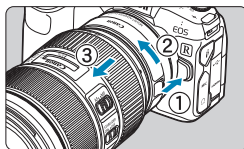

1 While pressing the lens release button, turn the adapter as shown by the arrow.

- Turn the adapter until it stops, then detach it.

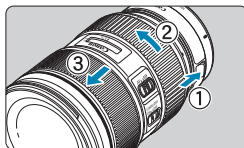

2 Detach the lens from the adapter.

- Hold down the lens release lever on the adapter and turn the lens counterclockwise.
- Turn the lens until it stops, then detach it.
- Attach the rear lens cap to the detached lens.



For lens precautions, see page 51.

Using the Viewfinder

Look through the viewfinder to activate it. You can also restrict display to either the screen or viewfinder (p.403).

Adjusting the Viewfinder Clarity

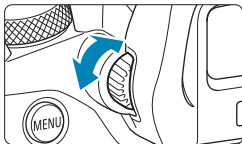

Turn the dioptic adjustment knob.

- Turn the knob left or right to make the viewfinder display look sharp.

- ⚠ ● The viewfinder display and camera screen cannot be activated at the same time.
- At some aspect ratios, black bars are displayed on the top and bottom or left and right edges of the screen. These areas are not recorded.

Basic Operations

Holding the Camera

● Viewing the Screen as You Shoot

As you shoot, you can tilt the screen to adjust it. For details, see page 47.



Normal angle



Low angle



High angle

● Shooting Through the Viewfinder

To obtain sharp images, hold the camera still to minimize camera shake.

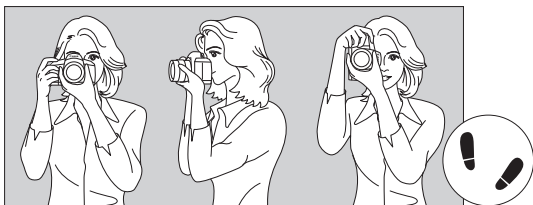

Horizontal shooting

Vertical shooting

1. Wrap your right hand around the camera grip firmly.
2. Hold the lens bottom with your left hand.
3. Rest your right index finger lightly on the shutter button.
4. Press your arms and elbows lightly against the front of your body.
5. To maintain a stable stance, place one foot slightly ahead of the other.
6. Press the camera against your face and look through the viewfinder.

Shutter Button

The shutter button has two steps. You can press the shutter button halfway. Then you can further press the shutter button completely.

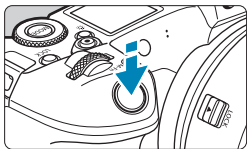

Pressing Halfway

This activates autofocus and the automatic exposure system that sets the shutter speed and aperture.

The exposure setting (shutter speed and aperture) is displayed on the screen, in the viewfinder, or on the LCD panel for approx. 8 sec. or as set for the metering timer.*

* By default, the metering timer is set to 8 sec.

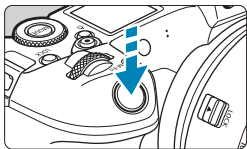

Pressing Completely

This action shoots.

● Preventing Camera Shake

Hand-held camera movement during the moment of exposure is called camera shake. It can cause blurred pictures. To prevent camera shake, note the following:

- Hold the camera steady.
- Press the shutter button halfway to autofocus, then slowly press the shutter button completely.



- If you press the shutter button completely without pressing it halfway first, or if you press the shutter button halfway and then press it completely immediately, the camera will take a moment before it takes the picture.
- Even during menu display or image playback, you can go back to shooting-ready state by pressing the shutter button halfway.

<MODE> Mode Button

You can set the shooting mode.

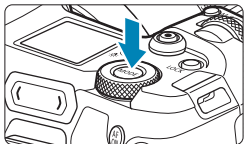

Press the <MODE> button, turn the <MODE> dial, then select the shooting mode.

To switch between shooting still photos and movies, press the <MODE> button and then the <INFO> button.

<AF ON> AF Start Button

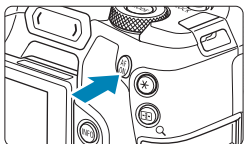

Has the same effect as pressing the shutter halfway in **[Fv]**, **[P]**, **[Tv]**, **[Av]**, **[M]**, or **[BULB]** shooting mode.

<M-Fn> Multi-Function Button

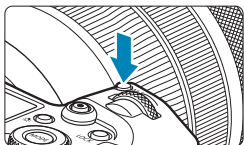

By pressing the <M-Fn> button and turning the <MODE> dial, you can set the ISO speed, drive mode, AF operation, white balance, and flash exposure compensation.

<  > Main Dial

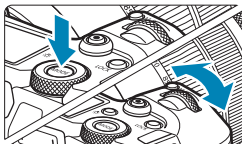

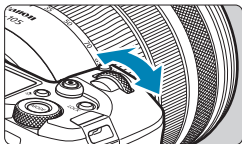

- (1) After pressing a button, turn the <  > dial.

Press a button such as <MODE> or <M-Fn>, then turn the <  > dial. If you press the shutter button halfway, the camera will go back to shooting-ready state.





- (2) Turn only the <  > dial.

While looking at the screen, viewfinder, or LCD panel, turn the <  > dial. Use this dial to set the shutter speed, aperture, etc.

 Step (1) can be performed even when controls are locked with the Multi-function lock (p.60).

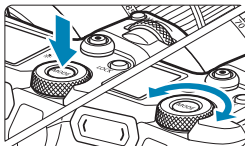
< > Quick Control Dial



- (1) After pressing a button, turn the <  > dial.**

Press a button such as <MODE> or <M-Fn>, then turn the <  > dial. If you press the shutter button halfway, the camera will go back to shooting-ready state.

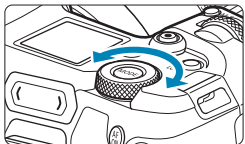

- (2) Turn only the <  > dial.**

While looking at the screen, viewfinder, or LCD panel, turn the <  > dial. Use this dial to set the exposure compensation amount, the aperture setting for manual exposures, etc.



Step (1) can be performed even when controls are locked with the Multi-function lock (p.60).

<LOCK> Multi-Function Lock Button

By setting [**6: Multi function lock**] and pressing the <LOCK> button, you can prevent settings from being changed by accidentally operating the Main dial, Quick control dial, M-Fn bar, or control ring or tapping the touch-screen panel. Press the <LOCK> button again to unlock the controls. For [**6: Multi function lock**] details, see page 416.

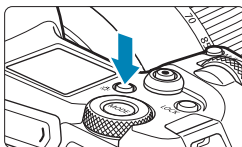
<☀> LCD Panel Info Switching/Illumination Button

- Each press of the <☀> button changes the information on the LCD panel.
- Illuminate the LCD panel by holding down the <☀> button (☀6).

 During a bulb exposure, pressing the shutter button completely will turn off the LCD panel illumination.

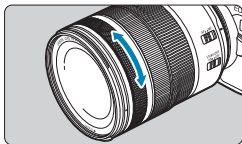
<C> Control Ring

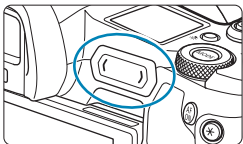

By default, the aperture value can be set by turning the control ring of RF lenses or mount adapters while pressing the shutter button halfway in [**Fv**], [**Av**], [**M**], or [**BULB**] mode. Otherwise, you can assign a different function to the control ring by customizing operations in [**4: Customize dials**] (p.555).

< > M-Fn (Multi-Function) Bar ☆



You can assign commonly used functions to swiping the <  > bar and tapping each end. By default, no function is assigned.



After purchase or when no function is assigned, you can access a shortcut screen for the [ **4: Customize M-Fn bar**] setting menu by tapping the left end on <  >. Select [**Yes**] to access the setting screen (p.561).

Basic Operations



Swipe

Slide your finger left or right immediately after touching <  >.



Tap (left end)

Touch the left end of <  >, then lift your finger immediately.



Tap (right end)

Touch the right end of <  >, then lift your finger immediately.



Operations are canceled unless you move your finger immediately after touching <  >.

INFO Button

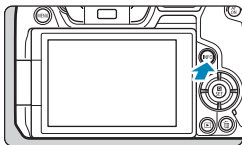

Each press of the <INFO> button changes the information shown. The following sample screens are for still photos.

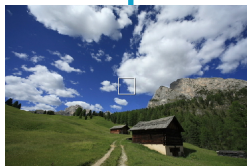

Menu Operations and Settings

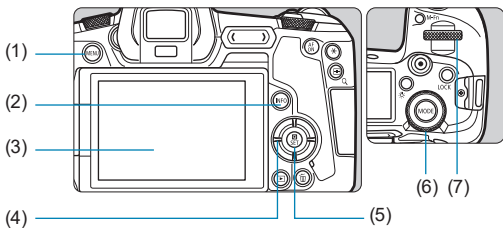

(1) <MENU> button

(2) <INFO> button

(3) Screen

(4) <⬆> cross keys

(5) <SET> button

(6) Quick control dial

(7) Main dial

[A+] Mode Menu Screen

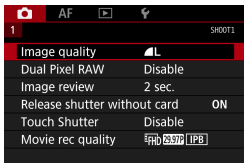

* In [A+] mode, some tabs and menu items do not appear.

Screen in [Fv], [P], [Tv], [Av], [M], and [BULB] Modes

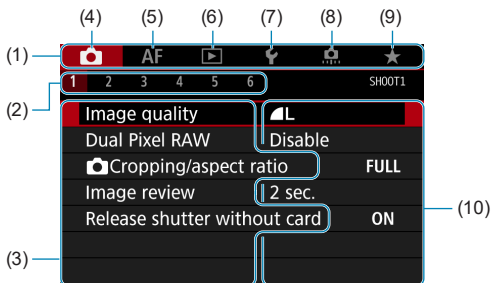

(1) Main tabs

(2) Secondary tabs

(3) Menu items

(4) : Shooting

(5) **AF**: Autofocus

(6) : Playback

(7) : Set-up

(8) : Custom Functions

(9) : My Menu

(10) Menu settings

Menu Setting Procedure

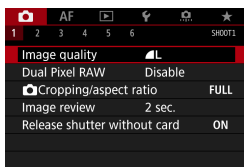
**1** Display the menu screen.

- Press the <MENU> button.

2 Select a tab.

- Press the <INFO> button to switch between main tabs.
- Turn the dial to select a secondary tab.
- For example, the [CAMERA 4] tab in this manual refers to the screen displayed when the (Shooting) tab's fourth box [4] from the left is selected.

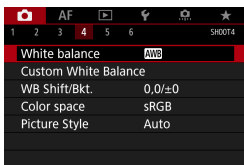

3 Select an item.

- Turn the <  > dial to select an item, then press <SET>.

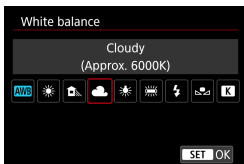

4 Select an option.

- Turn the <  > dial to select an option.
- The current setting is indicated in blue.

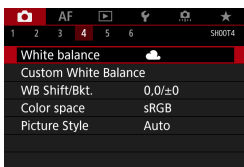

5 Confirm the option.

- Press <SET> to set it.

6 Exit the setting.

- Press the <MENU> button to finish and prepare for shooting.



- The description of menu functions hereafter assumes that you have pressed the <MENU> button to display the menu screen.
- You can also tap on the menu screen or press the <  > cross keys to operate the menu.
- To cancel the operation, press the <MENU> button.

Dimmed Menu Items

Example: Highlight tone priority

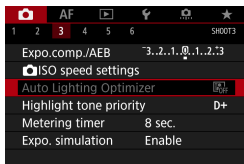

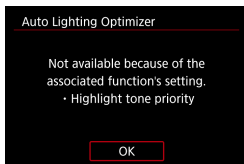

Dimmed menu items cannot be set. The menu item is dimmed if another function setting is overriding it.



You can see the overriding function by selecting the dimmed menu item and pressing <SET>.

If you cancel the overriding function's setting, the dimmed menu item will become settable.

 You may not be able to see the overriding function for certain dimmed menu items.

 With [**F6: Clear all camera settings**], you can reset the menu functions to the default settings (p.419).

Touch-Screen Operation

You can operate the camera by tapping or dragging on the screen (touch-screen panel) with your finger.

Tap

Sample screen (Quick Control)



- Use your finger to tap on (touch briefly and then remove your finger from) the screen.
- For example, when you tap on **[Q]**, the Quick Control screen appears. By tapping on **[↶]**, you can return to the preceding screen.

Drag

Sample screen (Menu screen)

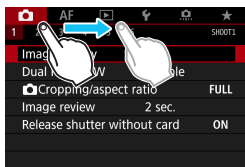

- Slide your finger while touching the screen.



- If **[43: Beep]** is set to **[Touch **, the beep will not sound for touch operations (p.386).
- Touch control responsiveness can be adjusted (p.385).

Q Quick Control

You can directly select and set the settings displayed on the screen. This is called Quick Control.

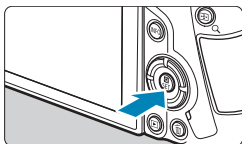

1 Press the **<Q>** button (C10).



2 Select a setting item.

- Press the **<▲>** **<▼>** keys to select an item.

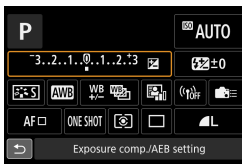

- When the screen at left is displayed, press the **<▲>** **<▼>** **<◀>** **<▶>** keys for selection.

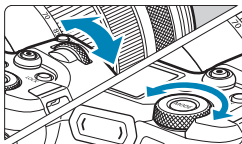

3 Select an option.

- Turn the **<DIAL>** or **<DIAL>** dial, or press the **<◀>** **<▶>** keys to change the setting. There are also functions that are set by pressing a button following these operations.
- Press **<SET>** to finalize the setting and return to the previous screen.

 You can also tap on the screen for Quick Control settings (p.67).

2

Shooting

This chapter describes shooting and introduces menu settings on the shooting ([📷]) tab.

- A ☆ icon to the right of a page title indicates that the function is available only in **[Fv]**, **[P]**, **[Tv]**, **[Av]**, **[M]**, or **[BULB]** mode.

2-1 Shooting Still Photos

[Shooting Mode] Settings for Still Photos

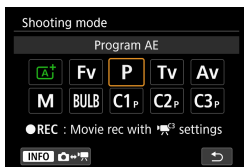

To prepare for still photo shooting, press the <MODE> button, then press the <INFO> button to access the **[Shooting mode]** screen at left.

- [\square]** : Scene Intelligent Auto (p.123)
- [Fv]** : Flexible-priority AE (p.140)
- [P]** : Program AE (p.132)
- [Tv]** : Shutter-priority AE (p.134)
- [Av]** : Aperture-priority AE (p.136)
- [M]** : Manual exposure (p.138)
- [BULB]** : Bulb (p.158)
- [\square]/**[\square]/**[\square]** : Custom shooting mode (p.417)****

Tab Menus: Still Photo Shooting

● Shooting 1

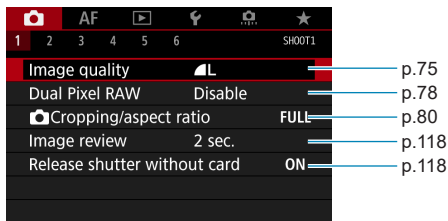

● Shooting 2

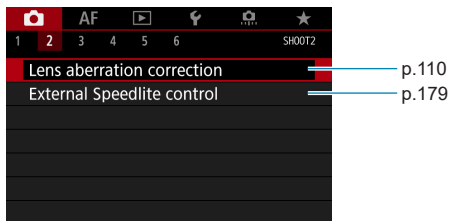

● Shooting 3

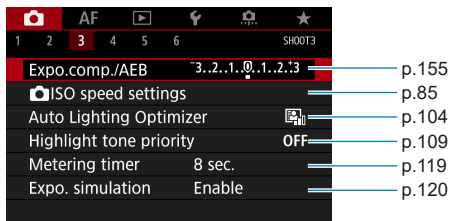

● Shooting 4

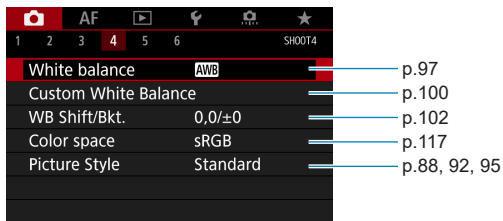

● Shooting 5

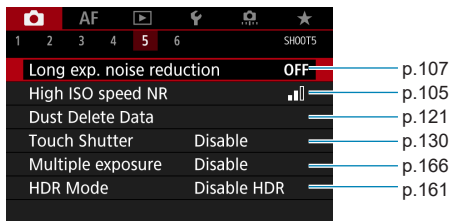

● Shooting 6

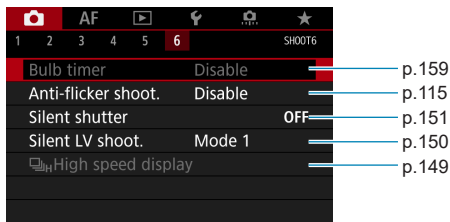

In **[A+]** mode, the following screen is displayed.

● Shooting 1

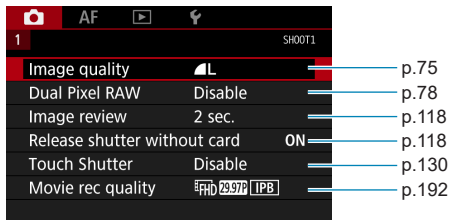

Index to Features: Still Photo Shooting

Shooting Modes

- [A+] mode → p.123
- [FV] mode → p.140
- [P] mode → p.132
- [Tv] mode → p.134
- [Av] mode → p.136
- [M] mode → p.138
- [BULB] mode → p.158

Menus/Shooting Features

- Image quality → p.75
- Dual Pixel RAW → p.78
- Cropping/aspect ratio → p.80
- ISO speed (still photos) → p.83
- Picture Style → p.88
- White balance → p.97
- Custom White Balance → p.100
- White balance shift/
bracketing → p.102
- Auto Lighting Optimizer → p.104
- Noise reduction for
high ISO speeds → p.105
- Noise reduction for long
exposures → p.107
- Highlight tone priority → p.109
- Lens aberration
correction → p.110
- Reducing flicker → p.115
- Color space → p.117
- Releasing shutter
without card → p.118
- Image review time → p.118
- Metering timer → p.119

- Exposure simulation → p.120
- Dust Delete Data → p.121
- Touch Shutter → p.130
- Drive mode → p.144
- Self-timer → p.147
- Silent LV shooting → p.150
- Silent shutter → p.151
- Metering mode → p.152
- Exposure
compensation → p.154
- AEB → p.155
- AE lock → p.157
- Bulb timer → p.159
- HDR mode → p.161
- Multiple exposures → p.166
- Remote control → p.174
- Remote switch → p.176
- External flash → p.177
- Flash function settings → p.179
- Flash Custom Function
settings → p.187

Setting Image Quality

You can select the pixel count and the image quality. JPEG image quality options include **L**, **L**, **M**, **M**, **S1**, **S1**, and **S2**. RAW image quality options include **RAW** and **CRAW**.

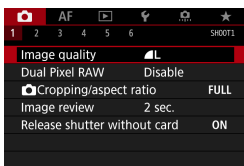

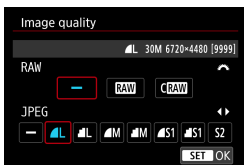

1 Select [**1**: Image quality].



2 Set the image quality.

- To select the RAW quality, turn the  dial, and to select the JPEG quality, press the <◀> <▶> keys.
- Press <SET> to set it.

 Number of shots available as indicated by [****] on the image quality setting screen always applies to a setting of **[Full-frame]**, regardless of the actual aspect ratio setting (p.80).

- 
- If [-] is set for both the RAW image and JPEG image, **L** will be set.
 - If you select both RAW and JPEG, each time you shoot, the image will be recorded simultaneously to the card in both RAW and JPEG at the image qualities that were set. The two images will be recorded with the same file numbers (file extension: .JPG for JPEG and .CR3 for RAW).
 - **S2** is in **L** (Fine) quality.
 - Meaning of image quality icons: **RAW** RAW, **CRAW** Compact RAW, JPEG, **L** Fine, **L** Normal, **L** Large, **M** Medium, **S** Small.

RAW Images

A RAW image is raw data output by the image sensor converted to digital data. It is recorded to the card as is, and you can select the quality as follows: **RAW** or **CRAW**. **CRAW** produces RAW images with smaller file sizes than **RAW**.

RAW images can be processed using [ **1: RAW image processing**] (p.339) and saved as JPEG images. (Just as for **RAW**, all JPEG size options are available for **CRAW**.) As the RAW image itself does not change, you can process the RAW image to create any number of JPEG images with various processing conditions.

You can use Digital Photo Professional (EOS software) to process RAW images. You can make various adjustments to images depending upon how they will be used and can generate JPEG or other types of images reflecting the effects of those adjustments.



RAW Image Processing Software

- To display RAW images on a computer, using Digital Photo Professional (hereafter DPP, EOS software) is recommended.
- Previous versions of DPP Ver.4.x cannot process RAW images taken with this camera. If a previous version of DPP Ver.4.x is installed on your computer, obtain and install the latest version of DPP from the Canon Web site to update it (p.572). (The previous version will be overwritten.) Note that DPP Ver.3.x or earlier cannot process RAW images taken with this camera.
- Commercially available software may not be able to display RAW images taken with this camera. For compatibility information, contact the software manufacturer.

Guidelines for Choosing Image Quality

For guidelines on file sizes, number of possible shots, and maximum burst shots, see page 609.

Maximum Burst for Continuous Shooting



The approximate maximum burst is displayed at the upper left of the shooting screen and lower right of the viewfinder.

If the maximum burst for continuous shooting is 99 or higher, “99” will be displayed.



If the maximum burst is displayed as “99”, it indicates that you can shoot 99 or more shots continuously. The value starts decreasing once it reaches 98 or less. **[BUSY]** on the screen and LCD panel indicates that the internal buffer memory is full and shooting will stop temporarily. If you stop continuous shooting, the maximum burst will increase. After all the captured images are written to the card, you can resume continuous shooting and shoot up to the maximum burst listed in the table on page 609.

Setting Up Dual Pixel RAW Shooting

Shooting **RAW** or **CRAW** images with this feature enabled produces special, Dual Pixel RAW images containing dual pixel information from the image sensor. This is called Dual Pixel RAW shooting.

When processing these images in Digital Photo Professional software for EOS cameras, you can take advantage of the Dual Pixel data to fine-tune sharpness (using depth information), shift the camera viewpoint slightly, and reduce ghosting.

Results will vary depending on shooting conditions, so before using this feature, refer to the Digital Photo Professional Instruction Manual for details on Dual Pixel RAW characteristics and image processing.

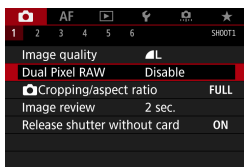

1 Select [**1**: Dual Pixel RAW].

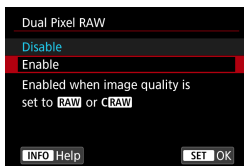

2 Select [**Enable**].

- Press the <INFO> button and read the Help screen (p.405) before proceeding.

3 Set the image quality to **RAW** or **CRAW**.

- Set the image quality to **RAW**, **RAW**+JPEG, **CRAW**, or **CRAW**+JPEG.

4 Take the picture.

- ▶ A RAW image containing Dual Pixel data (Dual Pixel RAW image) is captured.



- Startup takes longer when the power switch is set to <ON> or the camera resumes operation from auto power off.
- Continuous shooting speed is slower when you shoot with Dual Pixel RAW (p.144). Maximum burst also decreases.
- <H> drive mode is not available. Setting the mode to <H> has the effect of setting it to <>.
- Noise may be more noticeable in RAW or RAW+JPEG images.
- One-touch image quality setting is not available.



Amount and Effect of Dual Pixel RAW Correction

- Larger lens apertures increase the amount and effect of correction.
- The amount and effect of correction may not be sufficient with some lenses and in some shooting scenes.
- The amount and effect of correction varies depending on the camera orientation (vertical or horizontal).
- The amount and effect of correction may not be sufficient under some shooting conditions.

Setting Cropping/Aspect Ratio ☆

Normally with RF or EF lenses, images are captured at the sensor size of approx. 36.0 x 24.0 mm in full-frame shooting, but in cropped shooting, you can isolate and magnify the center of the image approx. 1.6x (APS-C size) as if using a telephoto lens, or you can set an aspect ratio to suit your shooting application before shooting.

For EF-S lenses, a 3:2 aspect ratio in the center is captured, magnified approx. 1.6x (APS-C size).

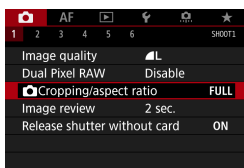

1 Select [1: Cropping/aspect ratio].

2 Select an item.

- Select [**Full-frame**], [**1.6x (crop)**], [**1:1 (aspect ratio)**], [**4:3 (aspect ratio)**], or [**16:9 (aspect ratio)**].
- With EF-S lenses, [**1.6x (crop)**] is set automatically, and no other option is available.
- To proceed without changing shooting area display, press <SET> and go to step 4.

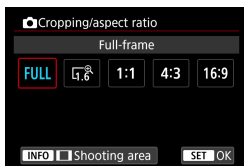

3 Select how the shooting area is displayed.

- On the screen in step 2, press the <INFO> button.
- Select the display method, then press <SET>.



- M / M / S1 / S1 image quality options are not available when [**1.6x (crop)**] is set, or with EF-S lenses.
- Cropped shooting with the image quality set to L / L / S2 / S2 images, respectively.
- Shooting with an EF-S lens when [**1:1 (aspect ratio)**], [**4:3 (aspect ratio)**], or [**16:9 (aspect ratio)**] is set automatically clears the setting and shoots with [**1.6x (crop)**] at a 3:2 aspect ratio.

Setting examples

FULL set



1.6x set or EF-S lens used



1:1 and [] set



4:3 and [] set



4 Take the picture.

- When [1.6x (crop)] is set or an EF-S lens is used, an image magnified approx. 1.6x is displayed.
- When [1:1 (aspect ratio)], [4:3 (aspect ratio)], or [16:9 (aspect ratio)] is set, the image within the black masked or outlined area is captured.

- **Areas outside the cropped area are not recorded in RAW shooting when [1.6x (crop)] is set, or with EF-S lenses.**
- **[Shooting area]** has no effect on display when **[1.6x (crop)]** is set, or with EF-S lenses.
- **[.5: Add cropping information]** is only available when **[Full-frame]** is set.
- The **[1: Cropping/aspect ratio]** setting is not used as the basis for auto flash zoom (auto flash coverage adjustment) by an external Speedlite.

- For details on pixel counts when cropping or an aspect ratio is set, see page 610.
- Nearly 100% field of view coverage is maintained vertically and horizontally when cropping or an aspect ratio is set.
- Aspect ratio information is added to RAW images when an aspect ratio is set, which are captured at full size. When the RAW images are played back, the image area used for shooting is indicated by lines. Note that only the shooting image area is shown in slideshows (p.331).

ISO: Setting the ISO Speed for Still Photos ☆

Set the ISO speed (image sensor's sensitivity to light) to suit the ambient light level. In **[A+]** mode, ISO speed is set automatically (p.608).

Regarding the ISO speed during movie shooting, see page 614.

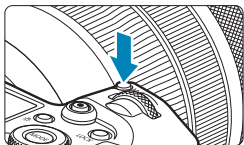

1 Press the <M-Fn> button (ⓘ6).

- With an image displayed on the screen, press the <M-Fn> button.

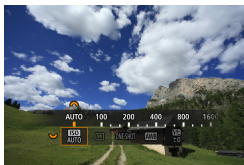

2 Select the ISO speed item.

- Turn the <ⓘ6> dial to select the ISO speed item.



3 Set the ISO speed.

- Turn the <ⓘ6> dial to set it.
- ISO speed can be set within ISO 100–40000 in 1/3-stop increments.
- Select **[AUTO]** to set the ISO speed automatically.
- For details on the ISO Auto range, see page 608.



To expand the available ISO speed range from L (equivalent to ISO 50) to H1 (equivalent to ISO 51200) or H2 (equivalent to ISO 102400), adjust **[ISO speed range]** under **[CAM3: ISO speed settings]** (p.85).

ISO Speed Guide

- Low ISO speeds reduce image noise but may increase the risk of camera/subject shake or reduce the area in focus (shallower depth of field), in some shooting conditions.
- High ISO speeds enable low-light shooting, a larger area in focus (deeper depth of field), and longer flash range but may increase image noise.



- As H1 (equivalent to ISO 51200) and H2 (equivalent to ISO 102400) are expanded ISO speed settings, noise (dots of light, banding, etc.) and irregular colors will be more noticeable, and the resolution lower compared with the standard setting.
- As L (equivalent to ISO 50) is an expanded ISO speed setting, the dynamic range will be somewhat narrower compared with the standard setting.
- If [ 3: Highlight tone priority] is set to **[Enable]** or **[Enhanced]** (p.109), L (equivalent to ISO 50), ISO 100/125/160, H1 (equivalent to ISO 51200), and H2 (equivalent to ISO 102400) cannot be selected.
- When shooting with a high ISO speed, high temperature, long exposure, or multiple exposure, image noise (rough grain, dots of light, banding, etc.), irregular colors, or color shift may become noticeable.
- When shooting in conditions that produce an extreme amount of noise, such as a combination of high ISO speed, high temperature, and long exposure, images may not be recorded properly.
- If you use a high ISO speed and flash to shoot a close subject, overexposure may result.

Setting the Manually-Settable ISO Speed Range

You can set the manually-settable ISO speed range (minimum and maximum limits). You can set the minimum limit within L (equivalent to ISO 50) to H1 (equivalent to ISO 51200), and the maximum limit within ISO 100 to H2 (equivalent to ISO 102400).

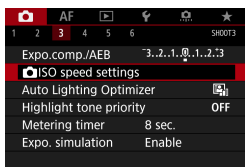

1 Select [**3**: **ISO speed settings**].

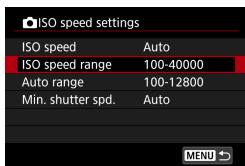

2 Select [**ISO speed range**].

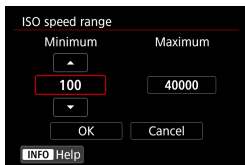

3 Set the minimum limit.

- Select the minimum limit box, then press <SET>.
- Select the ISO speed, then press <SET>.

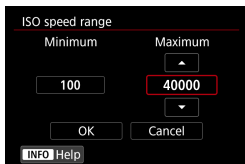

4 Set the maximum limit.

- Select the maximum limit box, then press <SET>.
- Select the ISO speed, then press <SET>.

5 Select [**OK**].

Setting the ISO Speed Range for ISO Auto

You can set the automatic ISO speed range for ISO Auto within ISO 100–40000. You can set the minimum limit within ISO 100–25600, and the maximum limit within ISO 200–40000.

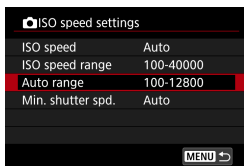

1 Select [Auto range].

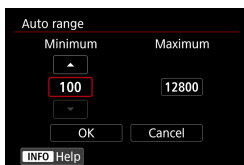

2 Set the minimum limit.

- Select the minimum limit box, then press <SET>.
- Select the ISO speed, then press <SET>.

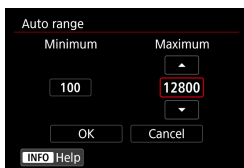

3 Set the maximum limit.

- Select the maximum limit box, then press <SET>.
- Select the ISO speed, then press <SET>.

4 Select [OK].

The **[Minimum]** and **[Maximum]** settings will also function as the minimum and maximum speeds for ISO speed safety shift (p.545).

Setting the Minimum Shutter Speed for ISO Auto

You can set the minimum shutter speed so that the shutter speed set automatically will not be too slow when ISO Auto is set.

This is effective in **[P]** and **[Av]** modes when shooting moving subjects with a wide-angle lens, or when using a telephoto lens. It helps to reduce camera shake and blurred subjects.

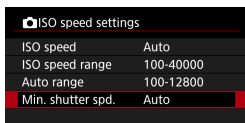

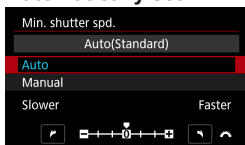

1 Select **[Min. shutter spd.]**.

Automatically set



2 Set the desired minimum shutter speed.

- Select **[Auto]** or **[Manual]**.
- If you select **[Auto]**, turn the  dial to set the desired speed, slower or faster compared to the standard speed, then press **<SET>**.
- If you select **[Manual]**, turn the  dial to select the shutter speed, then press **<SET>**.

Manually set

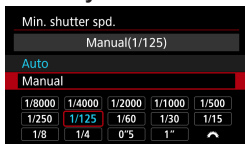

- If a correct exposure cannot be obtained with the maximum ISO speed limit set with **[Auto range]**, a shutter speed slower than the **[Min. shutter spd.]** will be set to obtain the standard exposure.
- This function will not be applied to flash photography and movie shooting.

When **[Auto(Standard)]** is set, the minimum shutter speed will be the reciprocal of the lens focal length. A single step from **[Slower]** to **[Faster]** is equivalent to a single stop of the shutter speed.

Selecting a Picture Style ☆

Just by selecting a preset Picture Style, you can obtain image characteristics effectively matching your photographic expression or the subject.

In [**A**] mode, [**Auto**] (Auto) is set automatically.

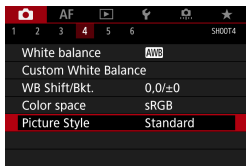

1 Select [**4**: Picture Style].



2 Select a Picture Style.

- Select a Picture Style, then press <SET>.

Picture Style Characteristics

-  **Auto**

The color tone will be adjusted automatically to suit the scene. The colors will look vivid for blue skies, greenery and sunsets, particularly in nature, outdoor and sunset scenes.



If the desired color tone is not obtained with **[Auto]**, use another Picture Style.

-  **Standard**

The image looks vivid, sharp, and crisp. This is a general-purpose Picture Style suitable for most scenes.

-  **Portrait**

For nice skin tones. The image looks softer. Suited for close-up portraits.

By changing the **[Color tone]** (p.93), you can adjust the skin tone.

-  **Landscape**

For vivid blues and greens, and very sharp and crisp images. Effective for impressive landscapes.

-  **Fine Detail**

Suited for detailed outline and fine texture description of the subject. The colors will be slightly vivid.

-  **Neutral**

Suited for processing the image with a computer. For natural colors and subdued images with modest brightness and color saturation.

-  **Faithful**

Suited for processing the image with a computer. The color of a subject that is captured in sunlight at a color temperature of 5200K will be adjusted to match the subject's colorimetric color. For subdued images with modest brightness and color saturation.

-  **Monochrome**

Creates black-and-white images.

 Color images cannot be recovered from JPEG images shot with the **[Monochrome]** Picture Style.

-  **User Defined 1–3**

You can register a basic style such as **[Portrait]**, **[Landscape]**, a Picture Style file, etc. and adjust it as desired (p.95). With any of the User Defined Picture Style that has not yet been set, pictures will be taken with the same characteristics settings as with the default settings of **[Standard]**.

Symbols

The Picture Style selection screen has icons for **[Strength]**, **[Fineness]**, or **[Threshold]** for **[Sharpness]** as well as **[Contrast]** and other settings. The numbers indicate the values for these settings specified for the respective Picture Style.

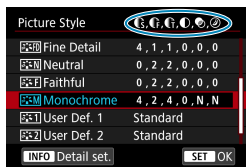
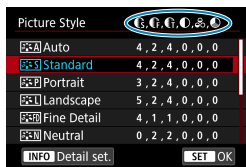

Symbols

	Sharpness	
		Strength
		Fineness
		Threshold
	Contrast	
	Saturation	
	Color tone	
	Filter effect (Monochrome)	
	Toning effect (Monochrome)	

During movie shooting, an asterisk "*" will be displayed for both **[Fineness]** and **[Threshold]** for **[Sharpness]**. **[Fineness]** and **[Threshold]** will not be applied to movies.

Customizing a Picture Style ☆

You can customize the Picture Styles. You can adjust Picture Style settings such as **[Contrast]** or **[Sharpness]** (**[Strength]**, **[Fineness]**, and **[Threshold]**). To see the resulting effects, take test shots. To customize **[Monochrome]**, see page 94.

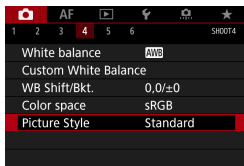

1 Select [📷4: Picture Style].



2 Select a Picture Style.

- Select the Picture Style to adjust, then press the <INFO> button.

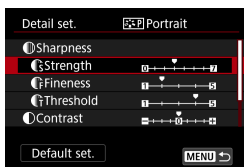

3 Select an item.

- Select an item (such as **[Strength]** in **[Sharpness]**), then press <SET>.
- See the next page for details on the settings and effects.



4 Adjust the item.

- Adjust the effect level, then press <SET>.
- Press the <MENU> button to save the adjusted setting and return to the Picture Style selection screen.
- ▶ Any settings you change from default values are displayed in blue.

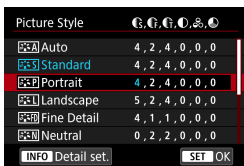

Settings and Effects

	Sharpness			
		Strength	0: Weak outline emphasis	7: Strong outline emphasis
		Fineness* ¹	1: Fine	5: Grainy
		Threshold* ²	1: Low	5: High
	Contrast			
	Saturation			
	Color tone			

*1: Indicates the fineness of the outlines to be emphasized. The smaller the number, the finer the outlines that can be emphasized.

*2: Sets how much the outline is emphasized based on the difference in contrast between the subject and the surrounding area. The smaller the number, the more the outline will be emphasized when the contrast difference is low. However, noise tends to be more noticeable when the number is smaller.



- For movie shooting, **[Fineness]** and **[Threshold]** for **[Sharpness]** cannot be set (not displayed).
- By selecting **[Default set.]** in step 3, you can revert the parameter settings of the respective Picture Style to their defaults.
- To shoot with the Picture Style you adjusted, first select the adjusted Picture Style, then shoot.

Monochrome Adjustment

Besides the effects described on the preceding page such as **[Contrast]**, or **[Strength]**, **[Fineness]** and **[Threshold]** for **[Sharpness]**, you can also set **[Filter effect]** and **[Toning effect]**.

Filter effect

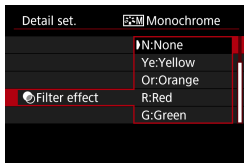

With a filter effect applied to a monochrome image, you can make white clouds or green trees stand out more.

Filter	Sample Effects
N: None	Normal black-and-white image with no filter effects.
Ye: Yellow	The blue sky will look more natural, and the white clouds will look crisper.
Or: Orange	The blue sky will look slightly darker. The sunset will look more brilliant.
R: Red	The blue sky will look quite dark. Fall leaves will look crisper and brighter.
G: Green	Skin tones and lips will appear muted. Green tree leaves will look crisper and brighter.

 Increasing the **[Contrast]** will make the filter effect more pronounced.

Toning effect

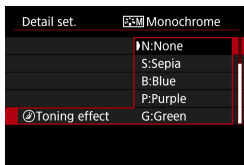

By applying a toning effect, you can create a monochrome image in the selected color. Effective when you want to create more impressive images.

Registering a Picture Style ☆

You can select a base Picture Style such as **[Portrait]** or **[Landscape]**, adjust it as desired, and register it under **[User Def. 1]**, **[User Def. 2]**, or **[User Def. 3]**. Useful when creating several Picture Styles with different settings.

Picture Styles that you have registered on the camera using EOS Utility (EOS software) can also be modified here.

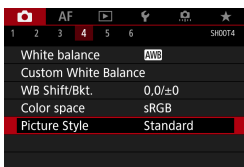

1 Select [CAMERA 4: Picture Style].

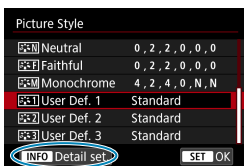

2 Select [User Def. *].

- Select **[User Def. *]**, then press the **<INFO>** button.

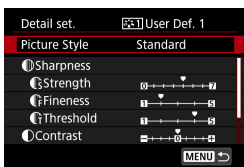

3 Press <SET>.

- With **[Picture Style]** selected, press **<SET>**.

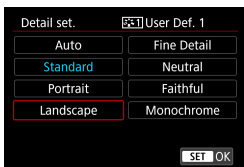

4 Select the base Picture Style.

- Select the base Picture Style, then press **<SET>**.
- Also select styles this way when adjusting styles registered to the camera with EOS Utility (EOS software).

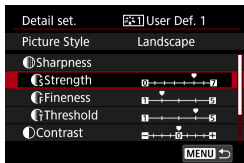

5 Select an item.

- Select an item (such as **[Strength]** in **[Sharpness]**), then press **<SET>**.



6 Adjust the item.

- Adjust the effect level, then press **<SET>**.
- For details, see “Customizing a Picture Style” (p.92).

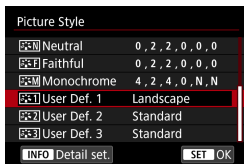

- Press the **<MENU>** button to save the adjusted setting and return to the Picture Style selection screen.
 - ▶ The base Picture Style will be indicated on the right of **[User Def. *]**.
 - ▶ Blue style names indicate that you have changed the settings from default values.

- If a Picture Style is already registered under **[User Def. *]**, changing the base Picture Style will clear the parameter settings of the previously registered User Defined Picture Style.
- If you perform **[46: Clear all camera settings]** (p.419), all the **[User Def. *]** settings will revert to their defaults.

- To shoot with a registered Picture Style, select the registered **[User Def. *]**, then shoot.
- Regarding the procedure to register a Picture Style file to the camera, refer to the EOS Utility Instruction Manual.

WB: Setting the White Balance ☆

White balance (WB) is for making the white areas look white. Normally, the Auto [AWB] (Ambience priority) or [AWB w] (White priority) setting will obtain the correct white balance. If natural-looking colors cannot be obtained with Auto, you can select the white balance to match the light source or set it manually by shooting a white object.

In [A+] mode, [AWB] (Ambience priority) is set automatically.

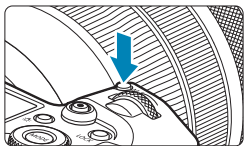

1 Press the <M-Fn> button (⊙6).

- With an image displayed on the screen, press the <M-Fn> button.



2 Select the white balance item.

- Turn the <☀> dial to select the white balance setting item.

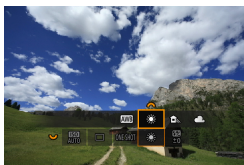











3 Select a white balance setting.

- Turn the <☀> dial to make a selection.



- For [AWB] and [AWB w] setting instructions, see page 99.
- To set your preferred color temperature, select [K] in [4: White balance], then turn the <☀> dial.

(Approx.)

Display	Mode	Color Temperature (K: Kelvin)
	Auto (Ambience priority, p.99)	3000–7000
	Auto (White priority, p.99)	
	Daylight	5200
	Shade	7000
	Cloudy, twilight, sunset	6000
	Tungsten light	3200
	White fluorescent light	4000
	Flash use	Automatically set*
	Custom (p.100)	2000–10000
	Color temperature (p.101)	2500–10000

* Applicable with Speedlites having a color temperature transmission function. Otherwise, it will be fixed to approx. 6000 K.

White Balance

To the human eye, a white object looks white regardless of the type of lighting. With a digital camera, the white for color correction basis is decided depending on the color temperature of the illumination, and then the color is adjusted with software to make the white areas look white. With this function, you can take the pictures with natural color tones.

[AWB] Auto White Balance

With [AWB] (Ambience priority), you can slightly increase the intensity of the image's warm color cast when shooting a tungsten-light scene. If you select [AWBw] (White priority), you can reduce the intensity of the image's warm color cast.

If you want to match the Auto white balance of previous EOS DIGITAL camera models, select [AWB] (Ambience priority).

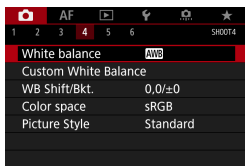

1 Select [AWB: White balance].

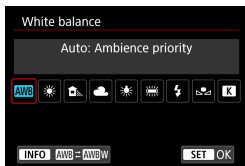

2 Select [AWB].

- With [AWB] selected, press the <INFO> button.

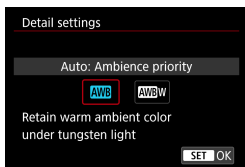

3 Select an item.

- Select an item, then press <SET>.

⚠ Cautions for Setting [AWBw] (White priority)

- The warm color cast of subjects may fade.
- When multiple light sources are included in the scene, the warm color cast of the picture may not be reduced.
- When using flash, the color tone will be the same as with [AWB] (Ambience priority).

[] Custom White Balance

With custom white balance, you can manually set the white balance for the specific light source of the shooting location. Make sure to perform this procedure under the light source at the actual location of the shoot.

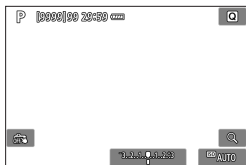

1 Shoot a white object.

- Aim the camera at a plain white subject, so that white fills the screen.
- Focus manually and shoot with the standard exposure set for the white object.
- You can use any of the white balance settings.

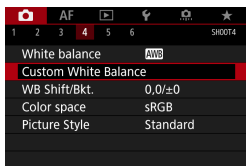

2 Select [4: Custom White Balance].



3 Import the white balance data.

- Press the <◀> <▶> keys to select the image captured in step 1, then press <SET>.
- ▶ Select [OK] to import the data.

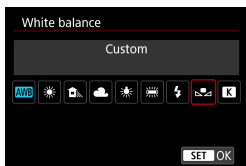

4 Select [4: White balance].

5 Select the custom white balance.

- Select [], then press <SET>.



- If the exposure obtained in step 1 differs greatly from the standard exposure, a correct white balance may not be obtained.
- The following images cannot be selected: Images captured with the Picture Style set to **[Monochrome]**, multiple-exposure images, cropped images, and images shot with another camera.



Instead of shooting a white object, you can also shoot a gray chart or standard 18% gray reflector (commercially available).

[K] Setting the Color Temperature

You can set the white balance's color temperature numerically. This is for advanced users.

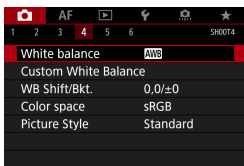

1 Select [☑4: White balance].

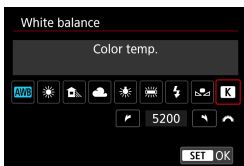

2 Set the color temperature.

- Select **[K]**.
- Turn the dial to set the desired color temperature, then press <SET>.
- The color temperature can be set from approx. 2500 K to 10000 K in 100 K increments.



- When setting the color temperature for an artificial light source, set the white balance correction (magenta or green bias) as necessary.
- If you set **[K]** to the reading taken with a commercially available color temperature meter, take test shots and adjust the setting to compensate for the difference between the color temperature meter's reading and the camera's color temperature reading.

WB \pm White Balance Correction ☆

You can correct the white balance that is set. This adjustment will have the same effect as using a commercially available color temperature conversion filter or color compensating filter. Each color can be corrected to one of nine levels.

This function is for advanced users who understand the use of color temperature conversion and color compensating filters and their effects.

White Balance Correction

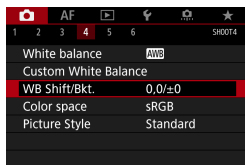

1 Select [**WB Shift/Bkt.**].

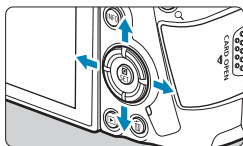

2 Set the white balance correction.

- Press the <⬆⬇⬅➤> cross keys to move the “■” mark to the appropriate position.
- B is for blue, A for amber, M for magenta, and G for green. The image’s color balance will be adjusted toward the color in the direction of the move.
- ▶ On the right of the screen, “**Shift**” indicates the direction and correction amount, respectively.
- Pressing the <⏏> button will cancel all the [**WB Shift/Bkt.**] settings.
- Press <SET> to exit the setting.

Sample setting: A2, G1

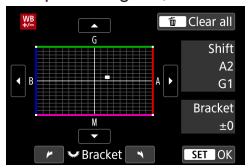

One level of the blue/amber correction is equivalent to approx. 5 mireds of a color temperature conversion filter. (Mired: Unit of measure for color temperature used to indicate values such as the density of a color temperature conversion filter.)



White Balance Auto Bracketing

With just one shot, three images with different color tones can be recorded simultaneously. Based on the color temperature of the current white balance setting, the image will be bracketed with a blue/amber bias and magenta/green bias. This function is called white balance bracketing (WB Bkt.). White balance bracketing is possible up to ± 3 levels in single-level increments.

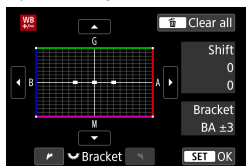
B/A bias ± 3 levels



Set the white balance bracketing amount.

- In step 2 for “White Balance Correction”, when you turn the  dial, the “■” mark on the screen will change to “...” (3 points).
- Turning the dial clockwise sets the B/A bracketing, and turning it counterclockwise sets the M/G bracketing.
 - ▶ On the right, “Bracket” indicates the bracketing direction and correction amount.
- Pressing the  button will cancel all the [WB Shift/Bkt.] settings.
- Press <SET> to exit the setting.



- During white balance bracketing, the maximum burst for continuous shooting will be lower.
- Since three images are recorded for one shot, it takes longer to record the image to the card.



- The images will be bracketed in the following sequence: 1. Standard white balance, 2. Blue (B) bias, and 3. Amber (A) bias, or 1. Standard white balance, 2. Magenta (M) bias, and 3. Green (G) bias.
- You can also set white balance correction and AEB together with white balance bracketing. If you set AEB in combination with white balance bracketing, a total of nine images will be recorded for a single shot.
- The white balance icon blinks when WB bracketing is set.
- “Bracket” stands for bracketing.

Auto Correction of Brightness and Contrast ☆

Brightness and contrast can be corrected automatically if shots look dark or contrast is too low or high. This function is called Auto Lighting Optimizer. The default setting is **[Standard]**.

In **[A+]** mode, **[Standard]** is set automatically.

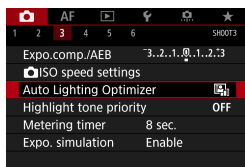

1 Select **[CAMERA 3: Auto Lighting Optimizer]**.

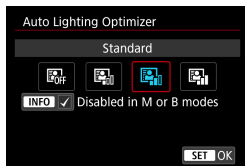

2 Set a correction option.

- Select an option, then press <SET>.

3 Take the picture.

- ▶ The image will be recorded with the brightness and contrast corrected as necessary.

- Noise may increase and sharpness may change, under some shooting conditions.
- If the effect of Auto Lighting Optimizer is too strong and results are not at your preferred brightness, set to **[Low]** or **[Disable]**.
- If a setting other than **[Disable]** is set and you use exposure compensation or flash exposure compensation to darken the exposure, the image may still come out bright. If you want a darker exposure, set this function to **[Disable]**.
- Maximum burst is lower with **[High]**. Image recording to the card also takes longer.

In step 2, if you press the <INFO> button and remove the checkmark **[✓]** for **[Disabled in M or B modes]** setting, the **[CAMERA 3: Auto Lighting Optimizer]** can also be set even in **[M]** and **[BULB]** modes.

Setting Noise Reduction ☆

High ISO Speed Noise Reduction

This function reduces the noise generated in the image. It is especially effective at high ISO speeds. When shooting at low ISO speeds, the noise in the darker parts of the image (shadow areas) can further be reduced.

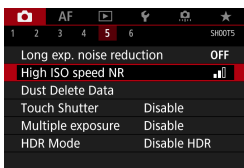

1 Select [📷 5: High ISO speed NR].



2 Set the level.

- Select the desired noise reduction level, then press <SET>.

● [NR] Multi Shot Noise Reduction

Applies the noise reduction with higher image quality than [High]. For a single photo, four shots are taken continuously and aligned and merged automatically into a single JPEG image.

If the image quality is set to RAW or RAW+JPEG, you cannot set [Multi Shot Noise Reduction].

3 Take the picture.

- ▶ The image will be recorded with noise reduction applied.



Cautions for Setting Multi Shot Noise Reduction

- If there is significant misalignment in the image due to camera shake, the noise reduction effect may become smaller.
- If you are handholding the camera, keep it steady to prevent camera shake. Using a tripod is recommended.
- If you shoot a moving subject, the moving subject may leave afterimages.
- Auto image alignment may not function properly with repetitive patterns (lattice, stripes, etc.) or flat, single-tone images.
- If the subject's brightness changes as the four consecutive shots are taken, irregular exposure in the image may result.
- After shooting, it may take some time to record an image to the card after performing noise reduction and merging the images. **[BUSY]** is displayed as images are processed, and shooting is not possible until processing is finished.
- AEB is not available.
- **[Multi Shot Noise Reduction]** is not available with bulb shooting, Servo AF, Silent shutter, shooting with AEB or WB bracketing, shooting RAW or RAW+JPEG images, or with features such as long exposure noise reduction, multiple exposures, or HDR mode.
- Flash photography is not possible. Note that the AF-assist beam of EOS-dedicated, external Speedlites will be emitted according to the **[AF4: AF-assist beam firing]** setting.
- **[Multi Shot Noise Reduction]** is not available (not displayed) when recording movies.
- **[Standard]** will be set automatically if you do any of the following: Setting the power switch to <OFF>, replacing card, or setting shooting mode to other than **[Fv]**, **[P]**, **[Tv]**, **[Av]**, or **[M]**.

Long Exposure Noise Reduction

For images exposed for 1 sec. or longer, noise (dots of light and banding) typical of long exposures can be reduced.

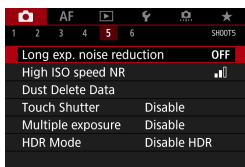

1 Select [**5**: Long exp. noise reduction].

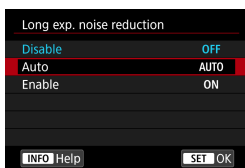

2 Set a reduction option.
 ● Select an option, then press <SET>.

● [AUTO] Auto

For exposures of 1 sec. or longer, noise reduction is performed automatically if noise typical of long exposures is detected. This [**Auto**] setting is effective enough in most cases.

● [ON] Enable

Noise reduction is performed for all exposures of 1 sec. or longer. The [**Enable**] setting may reduce noise that cannot be detected with the [**Auto**] setting.

3 Take the picture.

- ▶ The image will be recorded with noise reduction applied.

- With **[Auto]** or **[Enable]** set, the noise reduction process after the picture is taken may take the same amount of time as that for the exposure.
- Images may look grainier with the **[Enable]** setting than with the **[Disable]** or **[Auto]** setting.
- **[BUSY]** is displayed as noise is reduced, and the shooting screen is not displayed until processing is finished, when you can shoot again.

Highlight Tone Priority ☆

You can reduce overexposed, clipped highlights.

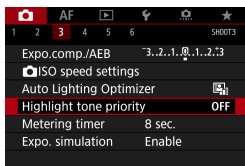

1 Select [CAMERA 3: Highlight tone priority].

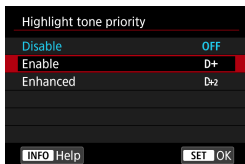

2 Set an option.

- **[Enable]**: Improves gradation in highlights. The dynamic range is expanded from the standard 18% gray to bright highlights. The gradation between the grays and highlights becomes smoother.
- **[Enhanced]**: Reduces overexposed highlights even more than **[Enable]**, under some shooting conditions.

3 Take the picture.

- ▶ The image will be recorded with highlight tone priority applied.



- Noise may increase slightly.
- The available ISO range starts at ISO 200. Expanded ISO speeds cannot be set.
- **[Enhanced]** is not available (not displayed) when shooting movies.
- With **[Enhanced]**, results in some scenes may not look as expected.

Correction of Lens Aberrations due to Optical Characteristics ☆

Peripheral light fall-off is a phenomenon that makes the image corners look darker due to the optical characteristics of the lens. Image distortion due to optical characteristics of the lens is called distortion. Color fringing along subject outlines is called chromatic aberration. And decreased image sharpness due to the aperture is called diffraction phenomenon. These lens aberrations can be corrected. You can also use Digital Lens Optimizer to correct lens aberration, diffraction, and a loss of sharpness from the low-pass filter.

By default, **[Peripheral illum corr]** and **[Digital Lens Optimizer]** (**[Chromatic aberr corr]** and **[Diffraction correction]**) are set to **[Enable]**, and **[Distortion correction]** is set to **[Disable]**.

Even in **[A+]** mode, peripheral illumination correction and Digital Lens Optimizer are applied when lens correction data is registered (saved) on the camera.

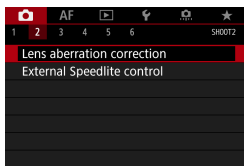

1 Select **[ 2: Lens aberration correction]**.

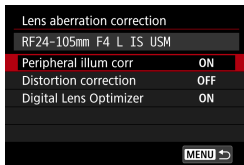

2 Select an item.

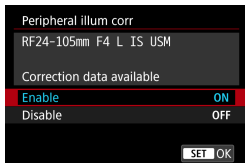

3 Select [Enable].

- Confirm that the name of the attached lens and (except for diffraction correction) **[Correction data available]** are displayed.
- Select **[Enable]**, then press <SET>.

4 Take the picture.

- The image captured will have lens aberration corrected.

Peripheral Illumination Correction



- Depending on shooting conditions, noise may appear on the image periphery.
- The higher the ISO speed, the lower the correction amount will be.



The correction amount applied will be lower than the maximum correction amount that applied with Digital Photo Professional (EOS software).

Distortion Correction



- To correct distortion, the camera captures a narrower image area than the area seen when shooting, which crops the image a little and slightly lowers the apparent resolution.
- Setting distortion correction may change the angle of view slightly.
- The amount of image cropped may vary between still photos and movies.
- When you magnify images, distortion correction is not applied to the images displayed.
- Images with distortion correction applied will not have the Dust Delete Data (p.121) appended.



With RF lenses, distortion correction during movie recording is supported.

Digital Lens Optimizer

- Depending on shooting conditions, noise may be intensified together with the effects of correction. Image edges may also be emphasized. Adjust Picture Style sharpness or set **[Digital Lens Optimizer]** to **[Disable]** as needed before shooting.
- The higher the ISO speed, the lower the correction amount will be.
- For movie shooting, **[Digital Lens Optimizer]** will not appear. (Correction is not possible.)

 Enabling **[Digital Lens Optimizer]** corrects both chromatic aberration and diffraction, although these options are not displayed.

Chromatic Aberration Correction



[Chromatic aberr corr] is not displayed when **[Digital Lens Optimizer]** is enabled.

Diffraction Correction



- Depending on shooting conditions, noise may be intensified together with the effects of correction.
- The higher the ISO speed, the lower the correction amount will be.
- For movie shooting, **[Diffraction correction]** will not appear. (Correction is not possible.)



- With “Diffraction correction”, degraded resolution due to the low-pass filter, etc. is corrected in addition to diffraction. Therefore, correction is effective even at an aperture close to the open aperture.
- **[Diffraction correction]** is not displayed when **[Digital Lens Optimizer]** is enabled.

Lens Correction Data

The lens correction data for lens aberration corrections is registered (stored) in the camera. With **[Enable]** selected, the peripheral illumination correction, distortion correction, Digital Lens Optimizer, chromatic aberration correction, and diffraction correction will be applied automatically.

For lenses incorporating the correction data, it is not necessary to register the correction data to the camera.



General Cautions for Lens Aberration Correction

- Peripheral illumination correction, chromatic aberration correction, distortion correction, and diffraction correction cannot be applied to JPEG images already taken.
- When using a non-Canon lens, setting the corrections to **[Disable]** is recommended even if **[Correction data available]** is displayed.
- Magnifying the periphery of the image may display parts of the image that will not be recorded.
- The correction amount will be less (except for diffraction correction) if the lens used does not have distance information.



General Notes for Lens Aberration Correction

- The effect of the lens aberration correction varies depending on the lens used and shooting conditions. Also, the effect may be difficult to discern depending on the lens used, shooting conditions, etc.
- If the correction is difficult to discern, magnifying and checking the image after shooting is recommended.
- Corrections can be applied even when an extender or life-size converter is attached.
- If the correction data for the attached lens is not registered to the camera, the result will be the same as when the correction is set to **[Disable]** (except for diffraction correction).
- If necessary, refer to the EOS Utility Instruction Manual as well.

Reducing Flicker ☆

If you shoot an image with a fast shutter speed under a light source such as fluorescent light, the blinking of the light source causes flicker and the image may be vertically unevenly exposed. If continuous shooting is used under these conditions, uneven exposures or colors across the images may result. This feature enables the camera to detect the flickering frequency and take pictures when exposure and colors are less affected by flickering.

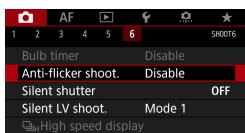

1 Select [**6**: Anti-flicker shoot.].

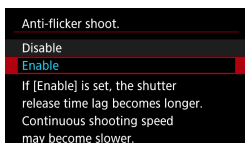

2 Select [**Enable**].

3 Take the picture.

- To detect flicker manually after setting to [**Enable**] or when the light source changes, before shooting, press the <**Q**> button, select [**Anti-flicker shoot.**], then press the <**INFO**> button.
- The picture will be taken with reduced unevenness of exposure or color tone caused by the flicker.



- With [**Enable**] set, the shutter-release time lag is longer when you shoot under a flickering light source. Also, the continuous shooting speed may become slower, and the shooting interval may become irregular.
- Flicker at a frequency other than 100 Hz or 120 Hz cannot be detected. Also, if the flickering frequency of the light source changes during continuous shooting, effects of the flicker cannot be reduced.

- In the **[Fv]**, **[P]**, or **[Av]** mode, if the shutter speed changes during continuous shooting or if you shoot multiple shots of the same scene at different shutter speeds, the color tone may become inconsistent. To avoid inconsistent color tones, use **[Fv]**, **[Tv]**, or **[M]** mode at a fixed shutter speed.
- Color tone of captured images may vary between **[Enable]** and **[Disable]**.
- Shutter speed, aperture, and ISO speed may change when you start shooting (even with AE lock).
- If the subject is against a dark background or if there is a bright light in the image, flicker may not be properly detected.
- Flicker reduction may not be possible under special lighting.
- Depending on the light source, flicker may not be detected properly.
- Depending on the light sources or shooting conditions, the expected result may not be obtained even if you use this function.

- Taking test shots in advance is recommended.
- Detect flicker manually if the screen flickers (as when the light source changes) by pressing the **<Q>** button, selecting **[Anti-flicker shoot.]**, then pressing the **<INFO>** button.
- Flicker is not reduced in **[A+]** mode.
- Flicker reduction also works with flash photography. However, the expected result may not be obtained for wireless flash photography.

Setting the Color Space ☆

The range of reproducible colors is called “color space”. With this camera, you can set the color space for captured images to sRGB or Adobe RGB. For normal shooting, sRGB is recommended.

In [A+] mode, [sRGB] is set automatically.

1 Select [CAMERA 4: Color space].

2 Set a color space option.

- Select an option, then press <SET>.

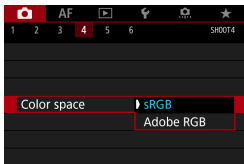

Adobe RGB

This color space is mainly used for commercial printing and other industrial uses. This setting is not recommended if you are not familiar with image processing, Adobe RGB, and Design rule for Camera File System 2.0 (Exif 2.21 or higher). The image will look very subdued in an sRGB computer environment and with printers not compliant to Design rule for Camera File System 2.0 (Exif 2.21 or higher). Post-processing of the image with computer software will therefore be required.



- If the still photo is shot in the Adobe RGB color space, the first character in the file name will be an underscore “_”.
- The ICC profile is not appended. For the descriptions about the ICC profile, refer to the Digital Photo Professional Instruction Manual (EOS software).

Card Reminder

You can set the camera not to shoot unless there is a card in the camera. The default setting is **[Enable]**.

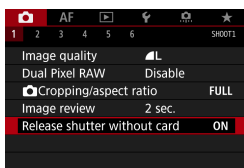

- 1 Select [**📷 1: Release shutter without card**].
- 2 Select [**Disable**].
 - Select [**Disable**], then press <SET>.

Setting the Image Review Time

You can set how long the image is displayed on the screen immediately after shooting. To keep the captured image displayed, set **[Hold]**. To not have the captured image displayed, set **[Off]**.

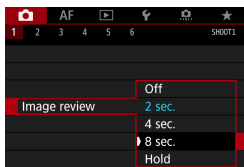

- 1 Select [**📷 1: Image review**].
- 2 Set a time option.
 - Select an option, then press <SET>.



When **[Hold]** is set, images are displayed as long as the time set in [**🔧 2: Power saving**].

Setting the Metering Timer ☆

You can set how long the metering timer runs (which determines the duration of exposure display/AE lock) after it is triggered by an action such as pressing the shutter button halfway.

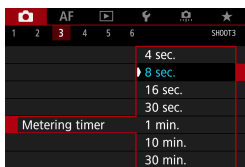

1 Select [3: Metering timer].

2 Set a time option.

- Select an option, then press <SET>.

Exposure Simulation ☆

Exposure simulation simulates and displays how the brightness (exposure) of the actual image will look.

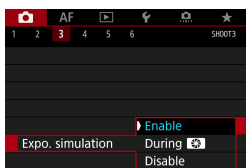

1 Select [**3**: Expo. simulation].

2 Set an option.

- Select an option, then press <SET>.

● Enable (Exp.SIM)

The displayed image brightness will be close to the actual brightness (exposure) of the resulting image. If you set exposure compensation, the image brightness will change accordingly.

● During

Normally, the image is displayed at standard brightness, so it is easy to see (**DISP**). Image brightness will only be close to the actual brightness (exposure) of the resulting image while you hold down the button you have assigned to [**Depth-of-field preview**] using [**4: Customize buttons**], (p.555) (**Exp.SIM**).

● Disable (**DISP**)

The image is displayed at standard brightness, so it is easy to see. Even if you set exposure compensation, the image is displayed at the standard brightness.

Appending Dust Delete Data ☆

Normally, the Self Cleaning Sensor Unit will eliminate most of the dust that may be visible on captured images. However, for the case where visible dust still remains, you can append the Dust Delete Data to the image for erasing the dust spots later. The Dust Delete Data is used by Digital Photo Professional (EOS software) to erase the dust spots automatically.

Preparation

- Use an RF or EF lens.
- Prepare a solid white object such as a sheet of paper.
- Set the lens focal length to 50 mm or longer.
- Set the lens's focus mode switch to <MF> and set the focus to infinity (∞). If the lens has no distance scale, rotate the camera to face toward you and turn the focusing ring clockwise all the way.

Obtaining the Dust Delete Data

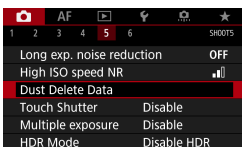

1 Select [**5**: Dust Delete Data].

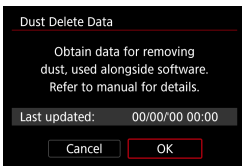

2 Select [OK].

- ▶ After the automatic self-cleaning of the sensor is performed, a message will appear. Although there will be a mechanical sound of the shutter during the cleaning, no picture is taken.

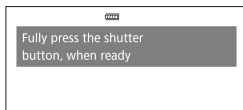
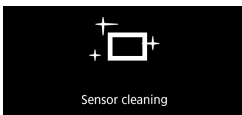

3 Shoot a solid-white object.

- At a distance of 20–30 cm (0.7–1.0 ft.), fill the screen with a patternless, solid-white object and take a picture.
- Since the image will not be saved, the data can still be obtained even if there is no card in the camera.
- ▶ When the picture is taken, the camera will start collecting the Dust Delete Data. When the Dust Delete Data is obtained, a message will appear.
- If the data is not obtained successfully, an error message will appear. Follow the “Preparation” procedure on the preceding page, then select **[OK]**. Take the picture again.

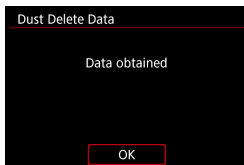

Dust Delete Data

After the Dust Delete Data is obtained, it is appended to all the JPEG and RAW images captured thereafter. Before an important shoot, it is recommended that you update the Dust Delete Data by obtaining it again. For details about using Digital Photo Professional (EOS software) to erase dust spots automatically, refer to the Digital Photo Professional Instruction Manual.

The Dust Delete Data appended to the image is so small that it hardly affects the image file size.

- ⓘ ● Dust Delete Data is not obtained when EF-S lenses are used, or when **[1: Cropping/aspect ratio]** is set to **[1.6x (crop)]**.
- Be sure to use a solid-white object such as a new sheet of white paper. If the object has any pattern or design, it may be recognized as dust data and affect the accuracy of the dust deletion with the Digital Photo Professional (EOS software).

[A+] Fully Automatic Shooting (Scene Intelligent Auto)

[A+] is a fully automatic mode. The camera analyzes the scene and sets the optimum settings automatically. It can also adjust focus automatically on either the still or moving subject by detecting the motion of the subject (p.126).

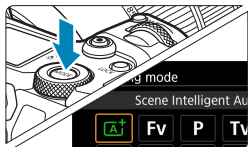

1 Set the shooting mode to [A+].

- Press the <MODE> button.
- Turn the <mode> dial to select [A+], then press <SET>.



2 Aim the camera at what you will shoot (the subject).

- A frame may be displayed around the subject, under some shooting conditions.
- When an AF point is displayed on the screen, aim it over the subject.

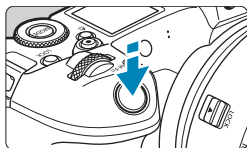

3 Focus on the subject.

- Press the shutter button halfway to focus.
- You can also focus by touching a person's face or other subject on the screen (Touch AF).
- Under low light, the AF-assist beam (p.264) is automatically activated if needed.
- ▶ For stationary subjects, the AF point is displayed in green when the subject is in focus, and the camera beeps (One-Shot AF).



- ▶ For moving subjects, the AF point is displayed in blue and tracks subject movement. The camera does not beep. (Servo AF)



4 Take the picture.

- Press the shutter button completely to take the picture.
- ▶ The image just captured will be displayed for approx. 2 sec. on the screen.

 Subject movement (whether subjects are still or moving) may not be detected correctly for some subject or shooting conditions.

- If you normally prefer to shoot with One-Shot AF, set **[AF1:  Auto servo]** to **[Disable]**.
- AF operation (One-Shot AF or Servo AF) is set automatically when you press the shutter button halfway. Note that AF operation cannot be switched during shooting.
- The **[]** mode makes the colors look more impressive in nature, outdoor, and sunset scenes. If you prefer other color tones, set the shooting mode to **[Fv]**, **[P]**, **[Tv]**, **[Av]**, or **[M]** and select a Picture Style other than **<A>** before shooting (p.88).

Minimizing Blurred Photos

- Use a sturdy tripod that can bear the weight of the shooting equipment. Mount the camera securely on the tripod.
- Using a remote switch (sold separately, p.176) or a wireless remote control (sold separately, p.174) is recommended.

? FAQ**● Focusing is not possible (indicated by an orange AF point).**

Aim the AF point over an area with good contrast, then press the shutter button halfway (p.56). If you are too close to the subject, move away and shoot again.

● Multiple AF points are displayed simultaneously.

If multiple AF points are displayed simultaneously, all of these positions are in focus. As long as one AF point is displayed on the subject, you can take the picture.

● Pressing the shutter button halfway does not focus the subject.

If the focus mode switch on the lens is set to <MF> (manual focus), set it to <AF> (autofocus).

● The shutter speed display is blinking.

Since it is too dark, taking the picture may result in a blurred subject due to camera shake. Using a tripod or a Canon EL/EX series Speedlite (sold separately, p.177) is recommended.

● When the external flash was used, the bottom part of the picture came out unnaturally dark.

If a hood is attached to the lens, it may obstruct the flash light. If the subject is close, detach the hood before taking the picture with flash.

[A+] Full Auto Techniques (Scene Intelligent Auto)

Recomposing the Shot



Depending on the scene, positioning the subject toward the left or right to include a balanced background will result in a picture with better perspective.

In the **[A+]** mode, pressing the shutter button halfway to focus on a still subject will lock the focus on that subject. Recompose the shot while keeping the shutter button pressed halfway, and then press the shutter button completely to take the picture. This is called “focus lock”.

Shooting a Moving Subject



With **[AF1: A+ Auto servo]** set to **[Enable]**, moving subjects are kept in focus using Servo AF when you compose a shot with a moving subject and press the shutter button halfway. As long as you keep the AF point over the subject while pressing the shutter button halfway, the camera will continue to focus on it, as shown by a blue AF point that tracks subject movement. At the decisive moment, press the shutter button completely to take the picture.

Scene Icons



In the **[A⁺]** shooting mode, the camera detects the scene type and sets everything automatically to suit the scene. The detected scene type is indicated on the upper left of the screen. For icon details, see page 623.

Information Display (Still Photo Shooting)

For details on the icons displayed for still photo shooting, see page 619.



- When <Exp.SIM> is displayed in white, it indicates that the image is displayed at the brightness level closely matching that of the actual image to be captured.
- If <Exp.SIM> is blinking, it indicates that the image is displayed at a brightness that differs from the actual shooting result because of low- or bright-light conditions. However, the actual image recorded will reflect the exposure setting. Note that the noise may be more noticeable than the actual image recorded.
- Exposure simulation may not be performed under some shooting settings. The <Exp.SIM> icon and histogram will be displayed in gray. The image will be displayed on the screen at the standard brightness. The histogram may not be properly displayed in low- or bright-light conditions.
- The histogram can be displayed when [**3: Expo. simulation**] is set to **[Enable]** (p.120).



Cautions for Still Photo Shooting

- Do not point the camera toward an intense light source, such as the sun or an intense artificial light source. Doing so may damage the image sensor or the camera's internal components.
- “**General Still Photo Shooting Cautions**” are on pages 142–143.



Notes for Still Photo Shooting





- The image's field of view coverage is approx. 100% (with image quality set to JPEG **L**).
- If the camera is idle over an extended period, the screen will turn off automatically after the time set in **[Display off]** or **[Viewfinder off]** under **[P2: Power saving]**. The camera then turns off automatically after the time set in **[Auto power off]** (p.377).
- With the HDMI Cable HTC-100 (sold separately), you can display the image on a television (p.333). Note that no sound will be output.
- You can also shoot with a remote switch (sold separately, p.176) or wireless remote control (sold separately, p.174).

Shooting with the Touch Shutter

Just by tapping on the screen, you can focus and take the picture automatically.



1 Enable the Touch Shutter.

- Tap  on the screen's bottom left. Each time you tap on the icon, it will toggle between  and .
-  (Touch Shutter: Enable)
The camera will focus on the spot you tap on, then the picture will be taken.
-  (Touch Shutter: Disable)
You can tap on a spot to perform focusing on the spot. Press the shutter button completely to take the picture.



2 Tap on the screen to shoot.

- Tap on the face or subject on the screen.
 - ▶ On the point you tap, the camera will focus (Touch AF) with the AF method that was set (p.265).
 - ▶ When  is set, the AF point turns green when focus is achieved, then the picture is taken automatically.
 - ▶ If focus is not achieved, the AF point turns orange and the picture cannot be taken. Tap on the face or subject on the screen again.



- Even if you set the drive mode to H> or , the camera will still shoot in the single shooting mode.
- Even if **[AF operation]** is set to **[Servo AF]**, tapping on the screen will focus on the image with **[One-Shot AF]**.
- Tapping on the screen in magnified view will not focus or take the picture.
- If you shoot by tapping on the screen with **[CAMERA 1: Image review]** set to **[Hold]**, you can press the shutter button halfway to take the next shot.



To shoot with bulb exposure, tap on the screen twice. The first tap on the screen will start the bulb exposure. Tapping it again will stop the bulb exposure. Be careful not to shake the camera when tapping on the screen.

P: Program AE

The camera automatically sets the shutter speed and aperture to suit the subject's brightness. This is called Program AE.

* [P] stands for Program.

* AE stands for Auto Exposure.

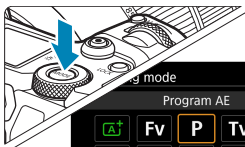

1 Set the shooting mode to [P].



2 Focus on the subject.

- Aim the AF point over the subject and press the shutter button halfway.
- ▶ Once the subject is in focus, the AF point turns green (with One-Shot AF).
- ▶ The shutter speed and aperture are set automatically.



3 Check the display.

- As long as the exposure value is not blinking, standard exposure will be obtained.

4 Take the picture.

- Compose the shot and press the shutter button completely.



- If the “30” shutter speed and the lowest f/number blink, it indicates underexposure. Increase the ISO speed or use flash.



- If the “1/8000” shutter speed and the highest f/number blink, it indicates overexposure. Lower the ISO speed or use an ND filter (sold separately) to reduce the amount of light entering the lens.



Differences Between [P] and [A+] Modes

- In [A+] mode, many functions, such as the AF operation and metering mode, are set automatically to prevent spoiled shots. The functions you can set are limited. On the other hand, with [P] mode, only the shutter speed and aperture are set automatically. You can freely set the AF operation, metering mode, and other functions.

Program Shift

- In [P] mode, you can freely change the shutter speed and aperture combination (Program) set automatically by the camera while maintaining the same exposure. This is called Program shift.
- To shift the program, press the shutter button halfway, then turn the  dial until the desired shutter speed or aperture is displayed.
- Program shift will be canceled automatically when the metering timer ends (exposure setting display turns off).
- Program shift cannot be used with flash.

Tv: Shutter-Priority AE

In this mode, you set the shutter speed and the camera automatically sets the aperture to obtain the standard exposure matching the brightness of the subject. This is called shutter-priority AE. A faster shutter speed can freeze the action of a moving subject. A slower shutter speed can create a blurred effect, giving the impression of motion.

* [Tv] stands for Time value.



Blurred motion
(Slow speed: 1/30 sec.)



Frozen motion
(Fast speed: 1/2000 sec.)

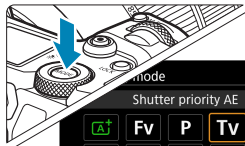

1 Set the shooting mode to [Tv].



2 Set the desired shutter speed.

- Turn the <  > dial to set it.

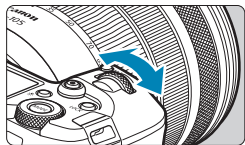

3 Focus on the subject.

- Press the shutter button halfway.
- ▶ The aperture is set automatically.



4 Check the display and shoot.

- As long as the aperture is not blinking, the standard exposure will be obtained.



- If the lowest f/number blinks, it indicates underexposure.

Turn the <  > dial to set a slower shutter speed until the aperture stops blinking or set a higher ISO speed.



- If the highest f/number blinks, it indicates overexposure.

Turn the <  > dial to set a faster shutter speed until the aperture stops blinking or set a lower ISO speed.



Shutter Speed Display

- For example, “1/125” or “125” indicates 1/125 sec. Additionally, “0”5” indicates 0.5 sec. and “15””, 15 sec.
- Shutter speeds from “8000” to “4” on the LCD panel indicate the denominator of the fractional shutter speed.

Av: Aperture-Priority AE

In this mode, you set the desired aperture and the camera sets the shutter speed automatically to obtain the standard exposure matching the subject brightness. This is called aperture-priority AE. A higher f/number (smaller aperture hole) will make more of the foreground and background fall within acceptable focus. On the other hand, a lower f/number (larger aperture hole) will make less of the foreground and background fall within acceptable focus.

* **[Av]** stands for Aperture value (aperture opening).



Blurred background
(With a low aperture f/number: f/5.6)



Sharp foreground and background
(With a high aperture f/number: f/32)

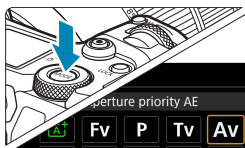

1 Set the shooting mode to **[Av]**.



2 Set the desired aperture.

- Turn the <  > dial to set it.

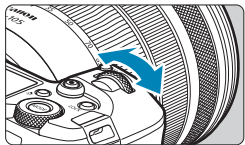

3 Focus on the subject.

- Press the shutter button halfway.
- ▶ The shutter speed is set automatically.

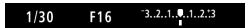

4 Check the display and shoot.

- As long as the shutter speed is not blinking, the standard exposure will be obtained.



- If the “30” shutter speed blinks, it indicates underexposure. Turn the dial to set a larger aperture (lower f/number) until the shutter speed blinking stops or set a higher ISO speed.



- If the “1/8000” shutter speed blinks, it indicates overexposure. Turn the dial to set a smaller aperture (higher f/number) until the shutter speed blinking stops or set a lower ISO speed.



Aperture Value Display

The higher the f/number, the smaller the aperture opening will be. The f/number displayed varies depending on the lens. If no lens is attached to the camera, “F00” will be displayed for the aperture.

Depth-of-Field Preview ☆

Press the button you have assigned to depth-of-field preview (using [**4: Customize buttons**], (p.555)) to stop down the lens to the current aperture setting and check the area in focus (depth of field).



- The larger the aperture value, the wider the area in focus, from the foreground to the background.
- The depth-of-field effect can be clearly seen on images as you change the aperture and press the depth-of-field preview button.
- Exposure is locked (AE lock) as you hold down the button assigned to depth-of-field preview.

M: Manual Exposure

In this mode, you set both the shutter speed and aperture as desired. To determine the exposure, refer to the exposure level indicator or use a commercially available exposure meter. This method is called manual exposure.

* **[M]** stands for Manual.

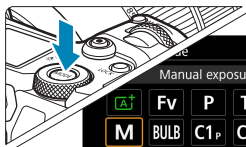

1 Set the shooting mode to **[M]**.

2 Set the ISO speed (p.83).

- With ISO Auto, you can set exposure compensation (p.139).



3 Set the shutter speed and aperture.

- To set the shutter speed, turn the dial. To set the aperture, turn the dial.

4 Focus on the subject.

- Press the shutter button halfway.
 - ▶ The exposure setting will be displayed.
- Check the exposure level mark to see how far the current exposure level is from the standard exposure level.

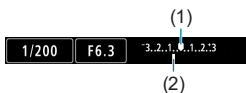

(1) Standard exposure index

(2) Exposure level mark



5 Set the exposure and take the picture.

- Check the exposure level indicator and set the desired shutter speed and aperture.

Exposure Compensation with ISO Auto

If the ISO speed is set to **[AUTO]** for manual exposure shooting, you can set exposure compensation (p.154) as follows:

- Touch the exposure level indicator
- **[CAMERA: Expo.comp./AEB]**
- Quick Control screen



If ISO Auto is set, the ISO speed setting will change to obtain the standard exposure with the set shutter speed and aperture. Therefore, you may not obtain the desired exposure effect. In such a case, set the exposure compensation.



- With the camera set to the **[M]** mode + ISO Auto + **<[METERING]>** (Evaluative metering) and **[CAMERA: Meter. mode, AE locked after focus]** set to the default setting (p.548), holding down the shutter button halfway will lock the ISO speed after focus is achieved with One-Shot AF.
- When ISO Auto is set, you can press the **<[ISO LOCK]>** button to lock the ISO speed.
- To compare the current exposure to the exposure when you pressed the **<[ISO LOCK]>** button initially with a manually set ISO speed, press the **<[ISO LOCK]>** button, recompose the shot, and check the exposure level indicator.
- With ISO Auto set and **[CAMERA: Exposure level increments]** set to **[1/2-stop]**, any 1/2-stop exposure compensation will be implemented with the ISO speed (1/3 stop) and shutter speed. However, the shutter speed displayed will not change.

Fv: Flexible-Priority AE

In this mode, you can set shutter speed, aperture, and ISO speed manually or automatically and combine these settings with your choice of exposure compensation. Shooting in **[Fv]** mode, with control over each of these parameters, is equivalent to shooting in **[P]**, **[Tv]**, **[Av]**, or **[M]** mode.

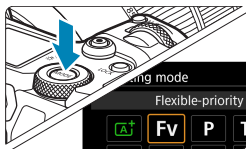

* **[Fv]** stands for Flexible value.



1 Set the shooting mode to **[Fv]**.





2 Set the shutter speed, aperture, and ISO speed.

- Turn the  dial to select an item to set. A  icon appears to the left of the selected item.
- Turn the  dial to set the option.
- To reset the setting to **[AUTO]**, press the **<▲>** or **<◀>** key.



3 Set the amount of exposure compensation.

- Turn the  dial and select the exposure level indicator. A  icon appears to the left of the exposure level indicator.
- Turn the  dial to set the option.
- To reset the setting to **[±0]**, press the **<▲>** or **<◀>** key.

Combinations of Functions in [Fv] Mode

Shutter Speed	Aperture	ISO Speed	Exposure Compensation	Shooting Mode
[AUTO]	[AUTO]	[AUTO]	Available	Similar to [P]
		Manual selection		
Manual selection	[AUTO]	[AUTO]	Available	Similar to [Tv]
		Manual selection		
[AUTO]	Manual selection	[AUTO]	Available	Similar to [Av]
		Manual selection		
Manual selection	Manual selection	[AUTO]	Available	Similar to [M]
		Manual selection	-	



- Blinking values indicate that the values set will cause underexposure or overexposure. Adjust the exposure until the value stops blinking.
- Slow synchro is not used under low light when you have set up [Fv] mode to resemble [Av] or [P] mode, even when [Slow synchro] in [Q2: External Speedlite control] is set to [1/200-30sec. auto].









- Values for shutter speed, aperture, and ISO speed that are set to [AUTO] are underlined.
- You can set shutter speed, aperture, and ISO speed to [AUTO] and exposure compensation to [±0] in steps 2 or 3 by pressing the <▼> or <▶> key.

General Still Photo Shooting Cautions

Image Quality

- When you shoot at high ISO speeds, noise (such as dots of light and banding) may become noticeable.
- Shooting in high temperatures may cause noise and irregular colors in the image.
- Continuous shooting over an extended period may cause the camera's internal temperature to rise and affect image quality. Stop shooting occasionally.
- If you shoot a long exposure while the camera's internal temperature is high, image quality may decline. Stop shooting and wait a few minutes before shooting again.

White and Red Internal Temperature Warning Icons

- If the camera's internal temperature rises from extended shooting or use in hot environments, a white  or red  icon will appear.
- The white  icon indicates that the image quality of still photos will decline. Stop shooting for a while and allow the camera to cool down.
- The red  icon indicates that shooting will soon end automatically. Shooting will not be possible again until the camera cools down internally, so stop shooting temporarily or turn off the camera and let it cool down a while.
- Shooting in hot environments over extended periods will cause the white  or red  icon to appear sooner. When you are not shooting, always turn off the camera.
- If the camera's internal temperature is high, the quality of images shot with a high ISO speed or long exposure may decline even before the white  icon is displayed.

Shooting Results

- If you take the picture in magnified view, the exposure may not come out as desired. Return to the normal view before taking the picture.
- Even if you take the picture in magnified view, the image will be captured with the image area of the normal view.



General Still Photo Shooting Cautions

Images and Display

- Under low- or bright-light conditions, the displayed image may not reflect the brightness of the captured image.
- Under low light, noise may be noticeable in image display even at low ISO speeds, but there will be less noise in your shots, because image quality varies between display and captured images.
- The screen or exposure value may flicker if the light source (lighting) changes. In this case, stop shooting temporarily and resume under the light source you will use.
- Pointing the camera a different direction may momentarily prevent correct display of brightness. Wait until the brightness level stabilizes before shooting.
- If there is a very bright light source in the image, the bright area may appear black on the screen. However, the actual captured image will correctly show the bright area.
- In low light, if you set the [**2: Disp. brightness**] to a bright setting, noise or irregular colors may appear in the image. However, the noise or irregular colors will not be recorded in the captured image.
- When you magnify the image, the image sharpness may look more pronounced than in the actual image.

Lens

- If the attached lens has an Image Stabilizer and you set the Image Stabilizer (IS) switch to <ON>, the Image Stabilizer will operate at all times even if you do not press the shutter button halfway. The Image Stabilizer consumes battery power and may decrease the number of possible shots depending on the shooting conditions. When the Image Stabilizer is not necessary, such as when using a tripod, it is recommended that you set the IS switch to <OFF>.
- With EF lenses, focus preset during shooting is only available when using (super) telephoto lenses equipped with this function released in and after the second half of 2011.

Selecting the Drive Mode

Single and continuous drive modes are provided. You can select the drive mode suiting the scene or subject.

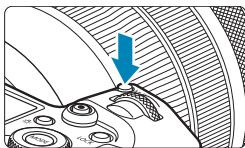

1 Press the <M-Fn> button ()

- With an image displayed on the screen, press the <M-Fn> button.



2 Select the drive mode item.

- Turn the < > dial to select the drive mode item.



3 Select the drive mode.

- Turn the < > dial to make a selection.

• Single shooting

When you press the shutter button completely, only one shot will be taken.

• High-speed continuous shooting

When you hold down the shutter button completely, you can shoot continuously at **max. approx. 8.0 shots/sec.** while you keep holding it down. However, the maximum continuous shooting speed may become slower under the following conditions:

• When set to reduce flicker:

The continuous shooting speed will be **max. approx. 5.4 shots/sec.**

• When set for Dual Pixel RAW:

Automatically switches to low-speed continuous shooting.

- **With Servo AF shooting:**

When **[AF operation]** is set to **[Servo AF]**, the continuous shooting speed of **max. approx. 5.0 shots/sec.** will be given priority.

- **With silent shooting:**

When **[📷6: Silent shutter]** is set to **[Enable]**, the continuous shooting speed will be **max. approx. 5.0 shots/sec.**

- **In flash photography:**

With EL or EX series Speedlites, the continuous shooting speed will be **max. approx. 3.0 shots/sec.**

- **[📷] Low-speed continuous shooting**

When you hold down the shutter button completely, you can shoot continuously at **max. approx. 3.0 shots/sec.** while you keep holding it down.

When **[AF operation]** is set to **[Servo AF]**, subject tracking with a continuous shooting speed of **max. approx. 3.0 shots/sec.** is given priority.

When set to Dual Pixel RAW, this is **max. approx. 2.2 shots/sec.**



- **[🕒10] Self-timer: 10 sec./remote control**

- **[🕒2] Self-timer: 2 sec./remote control**

For self-timer shooting, see page 147. For remote control shooting, see page 174.



During **<📷H>** high-speed continuous shooting, the maximum continuous shooting speed varies depending on the shooting conditions. For details, see the next page.

-  Approx. 8.0 shots/sec. is the maximum high-speed continuous shooting speed (p.144) under these conditions: shooting with a fully charged battery in One-Shot AF mode at a 1/1000 sec. or faster shutter speed and maximum aperture (depending on the lens*), at room temperature (23°C / 73°F), with flicker reduction, Dual Pixel RAW shooting, and Silent shutter disabled.
 - * In One-Shot AF mode with Image Stabilizer off when using these lenses: EF300mm f/4L IS USM, EF28-135mm f/3.5-5.6 IS USM, EF75-300mm f/4-5.6 IS USM, EF100-400mm f/4.5-5.6L IS USM.
- The continuous shooting speed for high-speed continuous shooting may be lower, depending on conditions such as these: battery level, temperature, flicker reduction, Dual Pixel RAW shooting, silent LV shooting, silent shooting, shutter speed, aperture, subject conditions, brightness, AF operation, type of lens, use of flash, and shooting settings.
- With Servo AF, the maximum continuous shooting speed may become slower depending on subject conditions or the lens used. Setting [ 6: Silent LV shoot.] to [Disable] when Servo AF is set also lowers the maximum continuous shooting speed.
- With [ 6: Anti-flicker shoot.] set to [Enable] (p.115), shooting under flickering light will decrease the maximum continuous shooting speed. Also, the continuous shooting interval may become irregular and the release time lag may become longer.
- The maximum continuous shooting speed may drop to approx. 6.0 shots/sec. when a cold battery is used in cold environments, or when the battery level is low.
- Even with low-speed continuous shooting, the continuous shooting speed may become slower depending on the shooting conditions.
- When internal memory becomes full during continuous shooting, the continuous shooting speed may drop off because shooting will be temporarily disabled (p.77).

🕒 Using the Self-Timer

Use the self-timer when you want to be in the picture such as a commemorative photograph.

1 Press the <M-Fn> button (🕒6).

- With an image displayed on the screen, press the <M-Fn> button.



2 Select the drive mode item.

- Turn the <🕒> dial to select the drive mode item.



3 Select the self-timer.

- Turn the <🕒> dial to select the self-timer.

🕒10: Shoot in 10 sec.

🕒2: Shoot in 2 sec.

- <🕒10> <🕒2> are displayed when the camera is paired with a wireless remote control (sold separately, p.174).

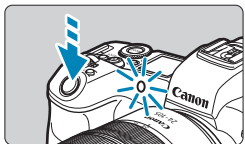

4 Take the picture.

- Focus on the subject, then press the shutter button completely.
- ▶ You can check the self-timer operation with the self-timer lamp, beeper, and countdown display (in seconds) on the LCD panel.
- ▶ Self-timer lamp blinking accelerates and the camera beeps quickly approx. 2 sec. before the picture is taken.



- <  > enables you to shoot without touching the camera mounted on a tripod. This prevents camera shake if you shoot still lifes or long exposures.
- After taking self-timer shots, playing back the image (p.304) to check focus and exposure is recommended.
- When using the self-timer to shoot yourself, use focus lock (p.126) on an object at the same distance as where you will stand.
- To cancel the self-timer after it starts, press <SET>.
- Auto power off time may be extended when the camera is set for remote shooting.

Selecting the Display Speed for High-Speed Continuous Shooting ☆

High-speed display that switches between your shot and the live image is available when shooting with an RF lens, with **[AF1: AF operation]** set to **[Servo AF]**, and with the drive mode set to <[H]> **[High speed continuous]**. Display is more responsive, making it easier to follow fast-moving subjects.

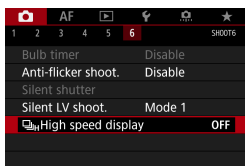

1 Select [**6**]: **[High speed display]**.

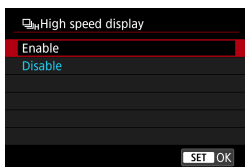

2 Select an item.

- Select **[Enable]** for display that switches between each continuous shot and the live image.

- Images may waver or flicker during high-speed display. This occurs more often at high shutter speeds. However, this does not affect shooting results.
- High-speed display is not performed under the following conditions. It may also stop as you are shooting.
 - Shutter speed slower than 1/30 sec., aperture value larger than f/11, conditions that make autofocus difficult, flash photography, and ISO expansion

 **[Enable]** is available when all of these conditions apply.

- With an RF lens, **[AF operation]** set to **[Servo AF]** (p.262), drive mode set to **[High speed continuous]** (p.144), **[Anti-flicker shoot.]** set to **[Disable]** (p.115), **[Expo. simulation]** set to **[Enable]** (p.120), **[Silent shutter]** set to **[Disable]** (p.151)

Silent Live View Shooting ☆

You can adjust the camera's drive and shutter operating characteristics to suit shooting conditions or the lens used.

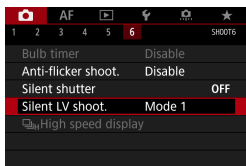

1 Select [**6**: Silent LV shoot.].

2 Set an option.

- Select an option, then press <SET>.

- **Mode 1** (Default setting)

- **Mode 2**

When the shutter button is pressed completely, only one shot will be taken. While you keep holding down the shutter button, the camera operation will be suspended. This enables quieter shooting, and operation will resume once you return the shutter button to the halfway position. Even if continuous shooting is set, only a single shot will be taken.

- **Disable**

Be sure to set it to [**Disable**] if you use a TS-E lens **for shifting or tilting the lens** or if you use an extension tube. If [**Mode 1**] or [**Mode 2**] is set, the standard exposure may not be obtained, or an irregular exposure may result.

- Defocused image areas may be incomplete when shooting near maximum aperture at high shutter speeds. If you dislike the appearance of defocused image areas, shooting as follows may give better results.
 - Shoot with [**6**: Silent LV shoot.] set to [**Disable**].
 - Shoot using Silent shutter.
 - Lower the shutter speed.
 - Increase the aperture value.
- If [**Mode 2**] is set and you use a wireless remote control (sold separately, p.174), the operation will be the same as with [**Mode 1**].

Silent Shooting ☆

You can shoot silently, using the sensor's electronic shutter feature, instead of with the mechanical shutter normally used in still photo shooting. Continuous shooting is also possible. This is useful when shooting where the camera must be quiet.

Available in <□>, <□H>, <⊙₁₀>, or <⊙₂> drive mode.

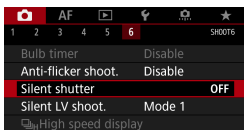

1 Select [6: Silent shutter].

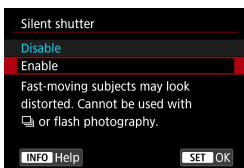

2 Select [Enable].

3 Select the drive mode (p.144).

- Select <□>, <□H>, <⊙₁₀>, or <⊙₂>.

4 Take the picture.

- ▶ As you shoot, a white frame is displayed around the screen.



- Be responsible when using silent shooting, and respect subject privacy and portrait rights.
- With fast-moving subjects, shots of the subject may be distorted, or, in continuous shooting with Servo AF (p.263), shots may be out of focus.
- With some lenses and under some shooting conditions, lens focusing and aperture adjustment may be audible.
- When using silent shooting, if the flash of another camera is fired or silent shooting is performed under flickering light source such as a fluorescent light, stripes of light or banding due to the brightness difference may be recorded in the image.
- AEB shooting and flash photography are not available.
- High-speed display (p.149) is not used in silent shooting, even when the drive mode is set to <□H>.



Setting [6: Silent shutter] to [Disable] restores the original setting for [6: Silent LV shoot.].

Selecting the Metering Mode ☆

You can select one of four methods to measure the subject brightness. In **[A+]** mode, evaluative metering is set automatically.

1 Press the **<Q>** button ()

- With an image displayed, press the **<Q>** button.

2 Select the metering mode.

- Press the **<▲>** **<▼>** keys to select the item.
- Press the **<◀>** **<▶>** keys to select the metering mode.



[]: Evaluative metering

[]: Partial metering

[]: Spot metering

[]: Center-weighted average metering

[] Evaluative metering

General-purpose metering mode suited even for backlit subjects. The camera adjusts the exposure automatically to suit the scene.

[] Partial metering

Effective where there are much brighter lights around the subject due to backlight, etc. Covers approx. 6.1% of the area at the center of the screen. The partial metering area is indicated on the screen.

[] Spot metering

Effective when metering a specific part of the subject or scene. Covers approx. 2.7% of the area at the center of the screen. The spot metering area is indicated on the screen.

[] Center-weighted average metering

The metering across the screen is averaged, with the center of the screen weighted more heavily.



- By default, the camera will set the exposure as follows.
With [M] (Evaluative metering), holding down the shutter button halfway will lock the exposure setting (AE lock) after focus is achieved with One-Shot AF. In the [P] (Partial metering), [S] (Spot metering), and [C] (Center-weighted average metering) modes, the exposure is set at the moment the picture is taken. (Pressing the shutter button halfway does not lock the exposure.)
- With [M: 2: Meter. mode, AE locked after focus], you can set whether or not to lock the exposure (AE lock) when focus is achieved with One-Shot AF (p.548).

Setting the Desired Exposure Compensation ☆

Exposure compensation can brighten (increased exposure) or darken (decreased exposure) the standard exposure set by the camera.

Exposure compensation can be set in the [Fv], [P], [Tv], [Av], and [M] shooting modes. You can set exposure compensation up to ± 3 stops in 1/3-stop increments.

For details on exposure compensation when [M] mode and ISO Auto are both set, see page 139, and see page 140 for [Fv] mode.



1 Check the exposure.

- Press the shutter button halfway and check the exposure level indicator.

Increased exposure for a brighter image





2 Set the compensation amount.



- Set it by looking at the screen as you turn the  dial.
- ▶ A  icon is displayed to indicate exposure compensation.

Decreased exposure for a darker image



3 Take the picture.

- To cancel exposure compensation, set the exposure level indicator  to the standard exposure index (.

 If [ 3: Auto Lighting Optimizer] (p.104) is set to any setting other than [Disable], the image may still look bright even if a decreased exposure compensation for a darker image is set.

 The exposure compensation amount will remain in effect even after you set the power switch to <OFF>.

Auto Exposure Bracketing (AEB) [★]

By changing the shutter speed, aperture, or ISO speed automatically, you can bracket the exposure up to ± 3 stops in $1/3$ -stop increments for three consecutive shots. This is called AEB.

* AEB stands for Auto Exposure Bracketing.

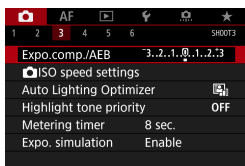

1 Select [3: Expo.comp./AEB].

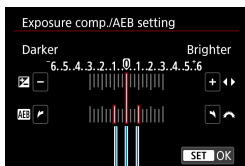

2 Set the AEB range.

- Turn the dial to set the AEB range (1). By pressing the $\langle \blacktriangleleft \rangle$ $\langle \blacktriangleright \rangle$ keys, you can set the exposure compensation amount.
- Press $\langle \text{SET} \rangle$ to set it.
- ▶ When you exit the menu, the AEB range will be displayed on the screen.

Standard exposure

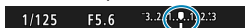

Decreased exposure

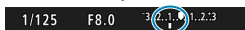

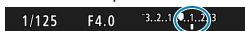

Increased exposure



3 Take the picture.

- Three bracketed shots will be taken according to the drive mode set in this sequence: Standard exposure, decreased exposure, and increased exposure.
- AEB will not be automatically canceled. To cancel AEB, follow step 2 to turn off the AEB range display.

 If [**3: Auto Lighting Optimizer**] (p.104) is set to any setting other than [**Disable**], the effect of AEB may be reduced.

- 
- <✳> blinks in the lower left of the screen during AEB shooting.
 - If the drive mode is set to <□>, press the shutter button three times for each shot. When <□H> or <□> is set and you hold down the shutter button completely, the three bracketed shots will be taken consecutively and the camera will automatically stop shooting. When <⊙10> or <⊙2> is set, the three bracketed shots will be taken consecutively after a 10-sec. or 2-sec. delay.
 - You can set AEB in combination with exposure compensation.
 - The shooting mode cannot be changed during AEB shooting.
 - AEB cannot be used with flash, Multi Shot Noise Reduction, or in HDR mode.
 - AEB will be canceled automatically if you do any of the following: Setting the power switch to <OFF> or when the flash is fully charged.

✳ Locking the Exposure for Shooting (AE Lock) ☆

You can lock the exposure when you want to set the focus and exposure separately or when you are to take multiple shots at the same exposure setting. Press the <✳> button to lock the exposure, then recompose and take the picture. This is called AE lock. It is effective for shooting backlit subjects, etc.

1 Focus on the subject.

- Press the shutter button halfway.
- ▶ The exposure setting will be displayed.

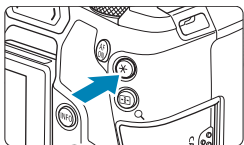

2 Press the <✳> button (⊗8).

- ▶ A <✳> icon is displayed in the lower left of the screen to indicate that exposure is locked (AE lock).
- Each time you press the <✳> button, the current exposure setting is locked.



3 Recompose and take the picture.

- When you are to take more pictures while maintaining the AE lock, keep holding down the <✳> button and press the shutter button to take another picture.

AE Lock Effects

Metering Mode	AF Point Selection Method	
	Automatic Selection	Manual Selection
	Exposure centered on the AF point in focus is locked.	Exposure centered on the selected AF point is locked.
	Exposure at the center of the screen is locked.	

* In mode with the lens's focus mode switch set to <MF>, the exposure at the center of the screen is locked.

BULB: Long (Bulb) Exposures

In this mode, the shutter stays open as long as you hold down the shutter button completely, and closes when you let go of the shutter button. This photographic technique is called “bulb exposure”. Use bulb exposures for night scenes, fireworks, the heavens, and other subjects requiring long exposures.

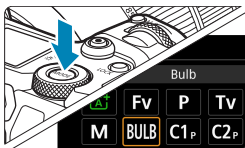

1 Set the shooting mode to [BULB].



2 Set the desired aperture.

- Turn the dial to set it.

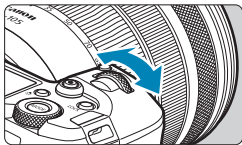

3 Take the picture.

- The exposure will continue for as long as you keep the shutter button pressed completely.
- ▶ The elapsed exposure time will be displayed on the LCD panel.

- ⚠ Do not point the camera toward an intense light source, such as the sun or an intense artificial light source. Doing so may damage the image sensor or the camera's internal components.
- Long bulb exposures produce more noise in the image than usual.
- If ISO Auto is set, ISO 400 will be set (p.608).
- When shooting bulb exposures with the self-timer instead of the bulb timer, keep pressing the shutter button completely (for the self-timer time and bulb exposure time).



- With [**5: Long exp. noise reduction**], you can reduce the noise generated during long exposures (p.107).
- For bulb exposures, using a tripod and bulb timer is recommended.
- You can also shoot bulb exposures by using Remote Switch RS-60E3 (sold separately, p.176).
- You can also use Wireless Remote Control BR-E1 (sold separately, p.174) for bulb exposures. When you press the remote control's transmit button, the bulb exposure will start immediately or 2 sec. later. Press the button again to stop the bulb exposure.

Bulb Timer ☆

You can preset the bulb exposure's exposure time. The bulb timer eliminates the need to keep holding down the shutter button during the bulb exposure. This reduces camera shake.

The bulb timer can be set only in the [**BULB**] (bulb exposure). It cannot be set (or will not function) in any other mode.

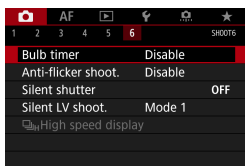

1 Select [**6: Bulb timer**].

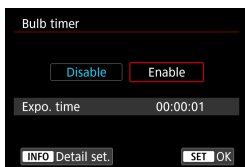

2 Select [**Enable**].

- Select [**Enable**], then press the <INFO> button.

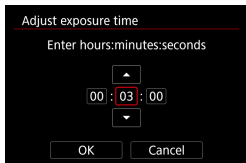

3 Set the desired exposure time.

- Select the hour, minute, or second.
- Press <SET> to display <⏱>.
- Set the desired number, then press <SET>. (Returns to <□>.)

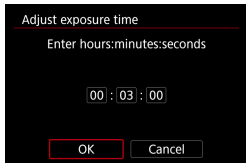

4 Select [OK].

5 Take the picture.

- ▶ Press the shutter button completely, and the bulb exposure will start and continue until the set time elapses.
- **[TIMER]** and the exposure time are displayed on the LCD panel during bulb timer shooting.
- To cancel the timer setting, set **[Disable]** in step 2.

- ❗ While the bulb timer is operating, if you press the shutter button completely and let go of it, the bulb exposure will stop.
- If you keep pressing the shutter button completely after the exposure starts, the bulb exposure will continue even after the set exposure time elapses. (The bulb exposure will not stop automatically when the set exposure time elapses.)
- Changing shooting modes cancels the bulb timer and restores the setting to **[Disable]**.

HDR : HDR (High Dynamic Range) Shooting ☆

You can shoot still photos with clipped highlights and shadows reduced for a high dynamic range of tones even in high-contrast scenes. HDR shooting is effective for landscape and still-life shots.

With HDR shooting, three images of different exposures (standard exposure, underexposure, and overexposure) are captured consecutively for each shot and then merged together automatically. The HDR image is recorded as a JPEG image.

* HDR stands for High Dynamic Range.

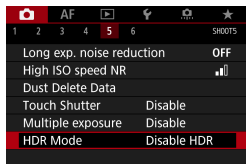

1 Select [CAMERA 5: HDR Mode].

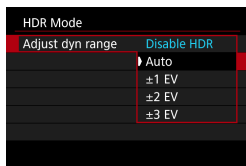

2 Set [Adjust dyn range].

- Select the range, then press <SET>.
- Selecting [Auto] will have the dynamic range set automatically depending on the image's overall tonal range.
- The higher the number, the wider the dynamic range will be.
- To exit HDR shooting, select [Disable HDR].



3 Set [Effect].

- Select the effect, then press <SET>.

Effects

-  **Natural**

For images preserving a wide tonal range where the highlight and shadow details would otherwise be lost. Clipped highlights and shadows will be reduced.

-  **Art standard**

While the clipped highlights and shadows will be reduced more than with **[Natural]**, the contrast will be lower, and the gradation flatter to have the picture look like a painting. The subject outlines will have bright (or dark) edges.

-  **Art vivid**

The colors are more saturated than with **[Art standard]**, and the low contrast and flat gradation create a graphic art effect.

-  **Art bold**

The colors are the most saturated, making the subject pop out, and the picture looks like an oil painting.

-  **Art embossed**

The color saturation, brightness, contrast and gradation are decreased to make the picture look flat. The picture looks faded and old. The subject outlines will have bright (or dark) edges.

	Art standard	Art vivid	Art bold	Art embossed
Saturation	Standard	High	Higher	Low
Outline emphasis	Standard	Weak	Strong	Stronger
Brightness	Standard	Standard	Standard	Dark
Tone	Flat	Flat	Flat	Flatter

 Each effect will be applied based on the characteristics of the Picture Style currently set (p.88).

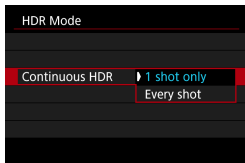

4 Set a [Continuous HDR] option.

- Select an option, then press <SET>.
- With **[1 shot only]**, HDR shooting will be canceled automatically after the shooting ends.
- With **[Every shot]**, HDR shooting continues until the setting in step 2 is set to **[Disable HDR]**.

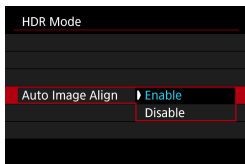

5 Set [Auto Image Align].

- For handheld shooting, select **[Enable]**. When using a tripod, select **[Disable]**, then press <SET>.

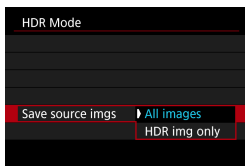

6 Specify the images to save.

- To save the three images captured and the resulting HDR image, select **[All images]** and press <SET>.
- To save only the HDR image, select **[HDR img only]** and press <SET>.

7 Take the picture.

- When you press the shutter button completely, three consecutive images will be captured, and the HDR image will be recorded to the card.

- RAW HDR images are captured in JPEG **L** image quality. RAW+JPEG HDR images are captured in the specified JPEG image quality. The three images captured to create an HDR image are also in the specified image quality.
- HDR shooting is not possible with expanded ISO speeds (L, H1, H2). HDR shooting is possible within ISO 100–40000 (varies depending on the settings of **[Minimum]** and **[Maximum]** for **[ISO speed range]**).
- The flash will not fire during HDR shooting.
- AEB is not available.
- If you shoot a moving subject, the moving subject may leave afterimages.
- In HDR shooting, three images are captured with different shutter speeds set automatically. Therefore, even in the **[Fv]**, **[Tv]**, and **[M]** shooting modes, the shutter speed will be shifted based on the shutter speed you set.
- To prevent camera shake, a high ISO speed may be set.



- When shooting HDR images with **[Auto Image Align]** set to **[Enable]**, AF point display information (p.309) and Dust Delete Data (p.121) will not be appended to the image.
- If you perform handheld HDR shooting with **[Auto Image Align]** set to **[Enable]**, image periphery will be slightly trimmed and resolution will be slightly lowered. Also, if the images cannot be aligned properly due to camera shake, etc., auto image alignment may not take effect. Note that when shooting with excessively bright (or dark) exposure settings, auto image alignment may not work properly.
- If you perform handheld HDR shooting with **[Auto Image Align]** set to **[Disable]**, the three images may not be properly aligned and the HDR effect may be reduced. Using a tripod is recommended.
- Auto image alignment may not function properly with repetitive patterns (lattice, stripes, etc.) or flat, single-tone images.
- The color gradation of the sky or white walls may not be reproduced correctly. Irregular colors, irregular exposure or noise may appear.
- HDR shooting under fluorescent or LED lighting may result in unnatural color reproduction of the illuminated areas.
- With HDR shooting, the images will be merged, then saved to the card, so it may take some time. **[BUSY]** is displayed on the screen and LCD panel as images are processed, and shooting is not possible until processing is finished.

Multiple Exposures ☆

As you shoot multiple exposures (2–9), you can see how the images will be merged into a single image.

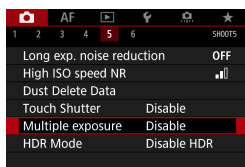

1 Select [**5: Multiple exposure**].

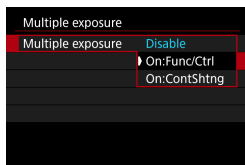

2 Set a [**Multiple exposure**] option.

- Select an option, then press <SET>.
- To exit shooting multiple exposures, select [**Disable**].

● On: Func/Ctrl (Function and control priority)

Convenient when shooting multiple exposures gradually as you check the results. During continuous shooting, the continuous shooting speed will decrease greatly.

● On: ContShtng (Continuous shooting priority)

Used for continuous multiple exposures of moving subjects. Continuous shooting is possible without the following operations: menu viewing, image review after capture, image playback, and undo last image (p.172). Captured images are not displayed merged.

Note that only the multiple-exposure image will be saved. (Single exposures used for the multiple-exposure image are discarded.)

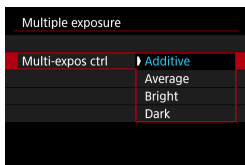

3 Set [Multi-expos ctrl].

- Select the desired multiple-exposure control method, then press <SET>.

● Additive

The exposure of each single image captured is added cumulatively. Based on the **[No. of exposures]**, set a negative exposure compensation. Follow the basic guide below to set the exposure compensation amount.

Exposure Compensation Setting Guide by Number of Exposures

Two exposures: -1 stop, three exposures: -1.5 stop, four exposures: -2 stops

● Average

Based on the **[No. of exposures]**, negative exposure compensation is set automatically as you shoot multiple exposures. If you shoot multiple exposures of the same scene, the exposure of the subject's background will be automatically controlled to obtain the standard exposure.

● Bright/Dark

Brightness (or darkness) of the base image and added images is compared at the same position, and bright (or dark) portions are retained. Some overlapping colors may be mixed, depending on the relative brightness (or darkness) of the images.



4 Set the [No. of exposures].

- Select the number of exposures, then press <SET>.
- You can set it from 2 to 9 exposures.

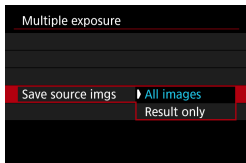

5 Specify the images to save.

- To save all single exposures and the multiple-exposure image, select **[All images]** and press <SET>.
- To save only the multiple-exposure image, select **[Result only]** and press <SET>.

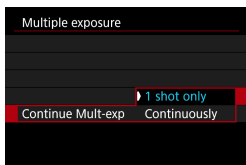

6 Set a [Continue Mult-exp] option.

- Select an option, then press <SET>.
- With **[1 shot only]**, multiple-exposure shooting will be canceled automatically after the shooting ends.
- With **[Continuously]**, multiple-exposure shooting continues until the setting in step 2 is set to **[Disable]**.



7 Shoot the first exposure.



- ▶ When **[On:Func/Ctrl]** is set, the image is displayed after capture.
- You can check the remaining exposures, which is indicated on the screen (1).
- Pressing the <▶> button enables you to view the captured image (p.172).

8 Shoot the next exposures.

- When **[On:Func/Ctrl]** is set, images captured so far are displayed merged. To display only the current image, press the <INFO> button repeatedly.
- Multiple-exposure shooting will end when the set number of exposures are taken.



- With **[On:Func/Ctrl]**, you can press the <▶> button to view the multiple-exposure images so far or delete the previous single exposure (p.172).
- The shooting information for the last shot will be recorded and appended to the multiple-exposure image.

- The image quality, ISO speed, Picture Style, high ISO speed noise reduction, color space, etc. set for the first single exposure will also be set for the subsequent exposures.
- If [ 4: **Picture Style**] is set to [**Auto**], [**Standard**] will be applied for shooting.
- With [**On:Func/Ctrl**] and [**Additive**] set, any noise, irregular colors, banding, or similar issues affecting images displayed as you shoot may look different in the final multiple-exposure image.
- With multiple exposures, the more exposures there are, the more noticeable the noise, irregular colors, and banding will be.
- If [**Additive**] is set, the image processing after taking the multiple exposures will take time. (The access lamp will light up longer.)
- In step 8, the brightness and noise of the multiple-exposure image displayed during shooting will be different from those of the final multiple-exposure image recorded.
- Multiple-exposure shooting is canceled if you set the power switch to <OFF> or switch batteries or cards.
- Switching to [] shooting mode ends multiple-exposure shooting.

Merging Multiple Exposures with an Image Recorded on the Card

You can select a RAW image recorded on the card as the first single exposure. The image data of the selected RAW image will remain intact. **Only RAW or CRAW images can be used.** JPEG images cannot be selected. Images you can specify also vary depending on the lens attached. For details, see the table below.

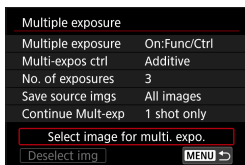

1 Select [Select image for multi. expo.].

2 Select the first image.

- Press the <◀> <▶> keys to select the image to be used as the first single exposure, then press <SET>.
- Select [OK].
- ▶ The file number of the selected image will be displayed at the bottom of the screen.

3 Take the picture.

- When you select the first image, the number of remaining exposures as set with [No. of exposures] will decrease by 1.

● Images You Can Select

Lens Attached	Cropped Shooting	Selectable Images
RF/ EF lens	Off	RAW images captured at full size
	On	RAW images from cropped shooting or taken with an EF-S lens
EF-S lens	—	



- These images cannot be selected as the first single exposure: Images captured with [📷3: Highlight tone priority] set to [Enable] or [Enhanced], or images captured with [📷1: Cropping/aspect ratio] not set to [Full-frame] or [1.6x (crop)].
- [Disable] is applied for [📷2: Lens aberration correction] and [📷3: Auto Lighting Optimizer] regardless of the settings of the image selected as the first single exposure.

- The ISO speed, Picture Style, high ISO speed noise reduction, color space, etc. set for the first image will also be applied for the subsequent images.
- If Picture Style is **[Auto]** for the image selected as the first image, **[Standard]** will be applied for shooting.
- You cannot select an image taken with another camera.
- **[Select image for multi. expo.]** is not available unless a lens is attached.

- You can also select a RAW image used in multiple-exposure shooting.
- Select **[Deselect img]** to cancel image selection.

Checking and Deleting Multiple Exposures During Shooting

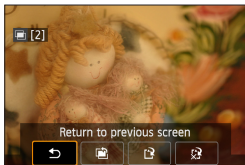

Before you finish shooting your specified number of exposures using **[On:Func/Ctrl]** (not with **[On:ContShtg]**), you can press the **<▶>** button to view the multiple-exposure image so far, check exposure, and see how the images are layered. Pressing the **<🗑>** button will display the operations possible during multiple-exposure shooting.

Operation	Description
Return to previous screen	The screen before you pressed the <🗑> button will reappear.
Undo last image	Deletes the last image you shot (shoot another image). The number of remaining exposures will increase by 1.
Save and exit	With [Save source imgs: All images] , all single exposures and the multiple-exposure image created so far are saved before exiting. With [Save source imgs: Result only] , only the multiple-exposure image created so far is saved before exiting.
Exit without saving	The multiple-exposure shooting will end without saving the image.

- During multiple-exposure shooting, you can only play back multiple-exposure images.

? FAQ

● Are there any restrictions on the image quality?

All single exposures and the multiple-exposure image are captured at your specified image quality. All JPEG image quality settings can be selected.

● Can I merge images recorded on the card?

With [**Select image for multi. expo.**], you can select the first single exposure from the images recorded on the card (p.171). Note that you cannot merge multiple images already recorded on the card.

● How are multiple-exposure files numbered?

With the camera set to save all images, multiple-exposure image files are named with the number after the last single exposure used to create them.

● Will auto power off take effect during multiple-exposure shooting?

As long as [**Auto power off**] under [**⚡2: Power saving**] is not set to [**Disable**], the camera automatically turns off after approx. 30 min., which ends multiple-exposure shooting and cancels multiple-exposure settings.

Remote Control Shooting

Wireless Remote Control BR-E1 (sold separately) compatible with Bluetooth® low energy technology enables remote control shooting up to approx. 5 meters/16.4 feet from the camera.

Pairing

To use BR-E1, you must first pair (connect and register) the camera and remote control. For pairing instructions, see page 408.

Do the following after the devices are paired.

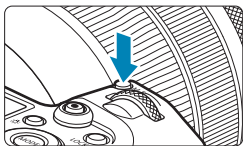

- 1 Press the <M-Fn> button ().**
 - With an image displayed on the screen, press the <M-Fn> button.



- 2 Select the drive mode item.**
 - Turn the <  > dial to select the drive mode item.



- 3 Select the self-timer/remote control.**
 - Turn the <  > dial to select <  > or <  >.

4 Take the picture.

- By pressing the <AF> button on the remote control, you can also autofocus.
- To shoot, press the release button on the remote control.
- **For detailed shooting instructions, refer to the BR-E1 instruction manual.**



You cannot use infrared remote control units such as Remote Controller RC-6.



- If focusing is not possible with AF, focus manually before shooting (p.281).
- Auto power off time may be extended when the camera is set for remote shooting.
- The remote control can also be used for movie shooting (p.245).

Using a Remote Switch



You can shoot by connecting Remote Switch RS-60E3 (sold separately). For operating instructions, refer to the remote switch instruction manual.

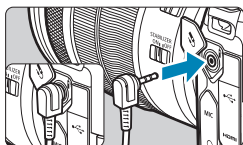

- 1** Open the terminal cover.
- 2** Connect the plug to the remote control terminal.

⚡ Flash Photography



EL/EX Series Speedlites for EOS Cameras

Using an EL/EX series Speedlite (sold separately) makes flash photography easy.

For operation procedures, refer to the EL/EX series Speedlite's Instruction Manual. This camera is a Type-A camera that can use all the features of EL/EX series Speedlites.



To set the flash functions and flash Custom Functions on the camera's menu screen, see page 179.



● Flash exposure compensation

You can adjust flash output (flash exposure compensation). With an image displayed on the screen, press the <M-Fn> button, turn the < > dial to select the flash exposure compensation item, then turn the < > dial to set the flash exposure compensation. You can set flash exposure compensation up to ±3 stops in 1/3-stop increments.

● FE lock

This enables you to attain an appropriate flash exposure for a specific part of the subject. Aim the viewfinder center over the subject, press the camera's <✳> button, then compose the shot and take the picture.

 Even if you set negative flash exposure compensation (to keep images darker), bright images may still be captured unless [ **3: Auto Lighting Optimizer**] (p.104) is set to [**Disable**].

- 
- The Speedlite will automatically fire an AF-assist beam as needed, if autofocusing is difficult under low light.
 - You can adjust the flash exposure compensation with Quick Control (p.68) or with [**Flash function settings**] under [ **2: External Speedlite control**] (p.182).
 - The camera can turn on a Speedlite automatically when the camera is turned on. For details, refer to the instruction manual of Speedlites that support this feature.

Canon Speedlites Other Than the EL/EX Series

- **With an EZ/E/EG/ML/TL-series Speedlite set to A-TTL or TTL autoflash mode, the flash can be fired at full output only.**
Set the camera's shooting mode to **[M]** manual exposure or **[Av]** aperture-priority AE and adjust the aperture setting before shooting.
- When using a Speedlite that has manual flash mode, shoot in the manual flash mode.

Non-Canon Flash Units

● Sync Speed

The camera can synchronize with non-Canon compact flash units at 1/200 sec. and slower speeds. With large studio flash units, the flash duration is longer than that of a compact flash unit and varies depending on the model. Be sure to check before shooting if flash sync is properly performed by test shooting at a sync speed of approx. 1/60 sec. to 1/30 sec.



- If the camera is used with a flash unit or flash accessory dedicated to another camera brand, the camera not only may not operate properly, but malfunction may result.
- Do not attach a high-voltage flash unit to the camera's hot shoe. It may not be fired.



Flash photography using the PC terminal is possible with Battery Grip BG-E22 (sold separately).

Setting the Flash Function ☆

With an EL/EX series Speedlite having compatible flash function settings, you can use the camera's menu screen to set the Speedlite's functions and Custom Functions. **Attach the Speedlite to the camera and turn on the Speedlite before setting the flash functions.** For details on the Speedlite's functions, refer to the Speedlite's Instruction Manual.

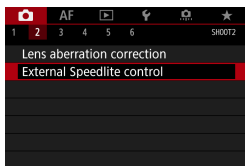

1 Select [2: External Speedlite control].

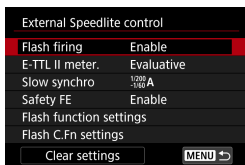

2 Select an item.

- Select an item, then press <SET>.

Flash Firing

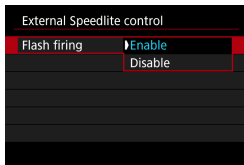

To enable flash photography, set to **[Enable]**. To disable flash firing or enable only the AF-assist beam, set to **[Disable]**.

When a Speedlite is attached that supports auto flash firing, you can also configure the following settings to enable automatic firing as needed for shooting conditions.

- Set **[Flash firing]** to **[Enable]**.
- Set the Speedlite to automatic flash mode.
- Set the camera shooting mode to **[A⁺]** or **[P]**.

For detailed shooting instructions, refer to the instruction manual of Speedlites supporting auto flash firing.

E-TTL II Flash Metering

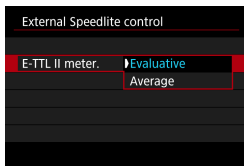

For normal flash exposures, set it to **[Evaluative]**. If **[Average]** is set, the flash exposure will be averaged for the entire metered scene. Depending on the scene, flash exposure compensation may be necessary. This setting is for advanced users.

Slow Synchro

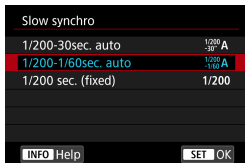

You can set the flash-sync speed for flash photography in **[Av]** aperture-priority AE mode or **[P]** Program AE mode.

- **[1/200 -30] 1/200-30sec. auto**

The flash sync speed is set automatically within a range of 1/200 sec. to 30 sec. to suit the scene's brightness. Slow-sync shooting is used under some shooting conditions, in low-light locations, and shutter speed is automatically lowered.

- **[1/200 -1/60] 1/200-1/60sec. auto**

Prevents a slow shutter speed from being set in low-light conditions. It is effective for preventing subject blur and camera shake. However, while the subject will be properly exposed with the flash, the background may come out dark.

- **[1/200] 1/200 sec. (fixed)**

The flash sync speed is fixed at 1/200 sec. This more effectively prevents subject blur and camera shake than with **[1/200-1/60sec. auto]**. However, in low light, the subject's background will come out darker than with **[1/200-1/60sec. auto]**.



- By default, it is set to **[1/200-1/60sec. auto]**. To use Slow synchro in **[Av]** or **[P]** mode, set to **[1/200-30sec. auto]**.
- High-speed sync is not available in **[Av]** or **[P]** mode when set to **[1/200 sec. (fixed)]**.

Safety FE

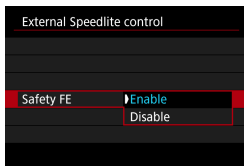

To avoid overexposure from the flash firing during the day or at close range, the camera can automatically lower the ISO speed and shoot with standard subject exposure when set to ISO Auto.

Flash Function Settings

The information displayed, position of display, and available options vary depending on the Speedlite model, its Custom Function settings, the flash mode, and other factors. For details on the Speedlite's functions, refer to the Speedlite's Instruction Manual.

Sample display

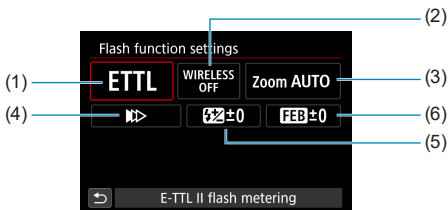

(1) Flash mode

(2) Wireless functions/Flash ratio control

(3) Flash zoom (Flash coverage)

(4) Shutter synchronization

(5) Flash exposure compensation

(6) Flash exposure bracketing

! Functions are limited when using EX series Speedlites that are not compatible with flash function settings.

● Flash mode

You can select the flash mode to suit your desired flash photography.

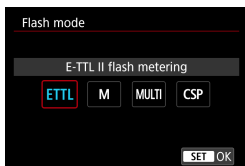

[E-TTL II flash metering] is the standard mode of EL/EX series Speedlites for automatic flash photography.

[Manual flash] is for setting the Speedlite's **[Flash output level]** yourself.

[CSP] (continuous shooting priority mode) automatically decreases flash output by one stop and increases ISO speed by one stop. Useful in continuous shooting, and helps conserve flash battery power. Regarding other flash modes, refer to the Instruction Manual of a Speedlite compatible with the respective flash mode.

 Adjust exposure compensation (p.154) as needed in case of overexposure from flash photography with **[CSP]** in **[Fv]**, **[Tv]**, or **[M]** mode.

 With **[CSP]**, ISO speed is automatically set to **[Auto]**. **[Safety FE]** is also set to **[Enable]** automatically. After canceling **[CSP]**, check the ISO speed and **[Safety FE]** setting.

● Wireless functions / Flash ratio control

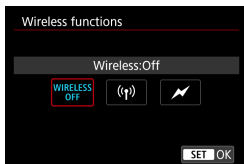

Wireless (multiple) flash photography is possible with radio or optical transmission.

For details on wireless flash, refer to the Instruction Manual of a Speedlite compatible with wireless flash photography.



With a macro flash (MR-14EX II, etc.) compatible with flash function settings, you can set the flash ratio between flash tubes or flash heads A and B, or use wireless flash with additional receiver units.

For details on flash ratio control, refer to the macro flash's Instruction Manual.

● Flash zoom (Flash coverage)

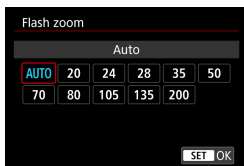

With Speedlites having a zooming flash head, you can set the flash coverage. Normally, set this to **[AUTO]** so that the camera will automatically set the flash coverage to match the lens focal length.

● Shutter synchronization

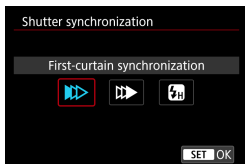

Normally, set this to **[First-curtain synchronization]** so that the flash fires immediately after the exposure starts.

If **[Second-curtain synchronization]** is set, the flash will be fired right before the shutter closes. When this is combined with a slow shutter speed, you can create a trail of light such as from car headlights at night with a more natural feel. When second-curtain synchronization is set together with **[E-TTL II flash metering]**, the flash will be fired twice in a row: once when you press the shutter button completely and once right before the end of the exposure.

If **[High-speed synchronization]** is set, the flash can be used at all shutter speeds. This is effective when you want to shoot with background blur (open aperture) in locations such as outdoors in daylight.

 When using second-curtain synchronization, set the shutter speed to 1/80 sec. or slower. If the shutter speed is 1/90 sec. or faster, first-curtain synchronization will be applied automatically even if **[Second-curtain synchronization]** is set.

● Flash exposure compensation

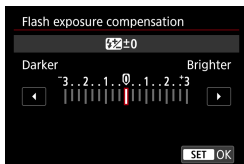

You can set flash exposure compensation up to ± 3 stops in 1/3-stop increments.

For details, refer to the Speedlite's Instruction Manual.

! If flash exposure compensation is set with the Speedlite, you cannot set the flash exposure compensation with the camera. If it is set with both the camera and Speedlite, the Speedlite's setting overrides the camera's.

● Flash exposure bracketing

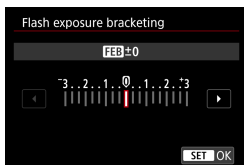

While changing the flash output automatically, three shots will be taken. For details, refer to the Instruction Manual of a Speedlite equipped with flash exposure bracketing.

Flash Custom Function Settings

For details on the Speedlite's Custom Functions, refer to the Speedlite's (sold separately) Instruction Manual.

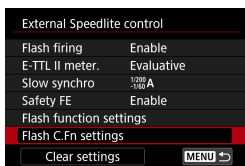

1 Select **[Flash C.Fn settings]**.

2 Set the desired functions.

- Select the number, then press <SET>.
- Select an option, then press <SET>.

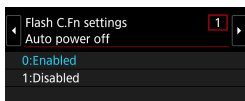

- With an EL/EX series Speedlite, the Speedlite will always fire at full output if the **[Flash metering mode]** Custom Function is set to **[TTL]** (autoflash).
- The Speedlite's Personal Function (P.Fn) cannot be set or canceled on the camera's **[☞2: External Speedlite control]** screen. Set it directly on the Speedlite.

Clearing Flash Function Settings / Flash C.Fn Settings

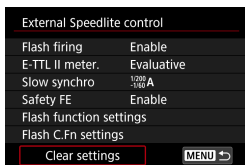

1 Select **[Clear settings]**.

2 Select the settings to be cleared.

- Select **[Clear flash settings]** or **[Clear all Speedlite C.Fn's]**, then press <SET>.
- On the confirmation dialog, select **[OK]**. Then the flash settings or Custom Function settings will all be cleared.

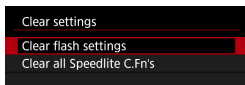

2 -2 Shooting Movies

[Shooting Mode] Settings for Movies

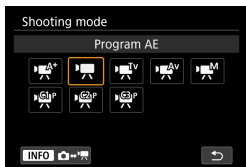

To prepare for movie shooting, press the <MODE> button, then press the <INFO> button to access the **[Shooting mode]** screen at left.

[AiAf] : Scene Intelligent Auto (p.209)

[Program AE] : Program AE (p.209)

[Tv] : Shutter-priority AE (p.210)

[Av] : Aperture-priority AE (p.211)

[M] : Manual exposure (p.213)

[P/P/P]: Custom shooting mode
(p.417)

 You can also shoot movies by pressing the movie shooting button during still photo shooting. Doing this in **[AiAf]** mode records movies in **[AiAf]** mode with the settings specified in **[CAM 1: Movie rec quality]**. In other shooting modes, movies are recorded using **[P/P]** (movie C3) mode settings.

Tab Menus: Movie Shooting

● Shooting 1

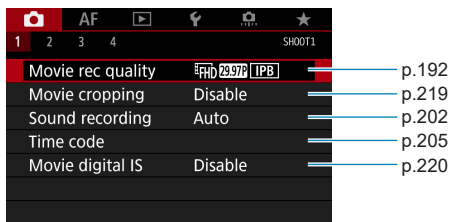

● Shooting 2

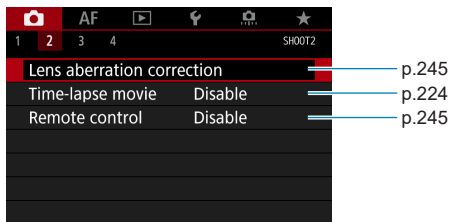

● Shooting 3

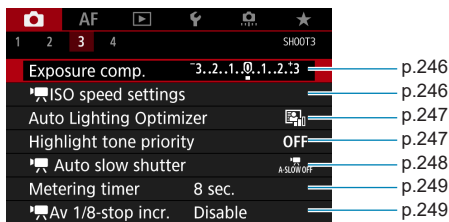

● Shooting 4



In [A*] mode, the following screens are displayed.

● Shooting 1

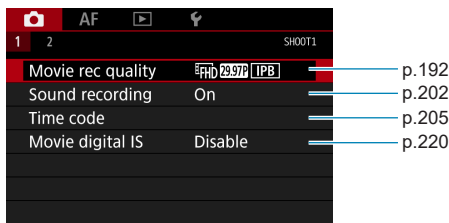

● Shooting 2

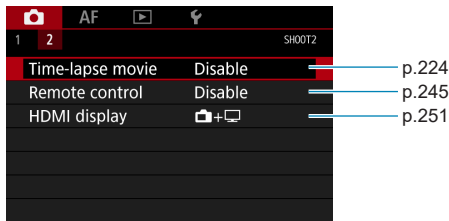

Index to Features: Movie Shooting

Shooting Mode

- [M] [M] modes → p.209
- [M] mode → p.210
- [M] mode → p.211
- [M] mode → p.213

Menus/Shooting Features

- Movie recording quality → p.192
- 24.00p → p.198
- High Frame Rate → p.199
- Sound recording → p.202
- Time code → p.205
- Movie cropping → p.219
- Movie digital IS → p.220
- HDR movie → p.222
- Time-lapse movie → p.224
- Canon Log → p.236
- Lens aberration correction → p.245
- Remote control shooting → p.245
- Exposure compensation → p.246
- ISO speed (movie) → p.246
- Auto Lighting Optimizer → p.247
- Highlight tone priority → p.247
- Auto slow shutter → p.248
- Metering timer → p.249
- Av 1/8-stop increments → p.249
- White balance → p.250
- Custom White Balance → p.250

- White balance correction → p.250
- Picture Style → p.250
- Noise reduction for high ISO speeds → p.250
- HDMI display → p.251

Setting the Movie Recording Quality

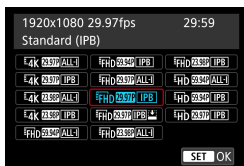

Under the **[📷 1: Movie rec quality]** tab, select **[Movie rec. size]** to set the image size, frame rate, and compression method. The movie will be recorded as an MP4 file.

The frame rate displayed on the **[Movie rec. size]** screen switches automatically depending on the **[🔧 3: Video system]** setting (p.384).

⚠ The card's writing and reading speeds required for recording movies (card performance requirements) vary depending on the movie recording quality. Before shooting movies, see page 611 to check the performance requirements of the card.

Movie Recording Size

● Image size

● **[4K] 3840x2160**

The movie is recorded in 4K quality. The aspect ratio is 16:9.

When shooting 4K [ALL-I] movies, use a UHS-II SD card (p.611).

● **[FHD] 1920x1080**

The movie is recorded in Full High-Definition (Full HD) quality. The aspect ratio is 16:9.

● **[HD] 1280x720**

The movie is recorded in High-Definition (HD) quality. The aspect ratio is 16:9.



- If you change the [**43: Video system**] setting, also set [**1: Movie rec quality**] again.
- Normal playback of 4K, **FHD 59.94P / 50.00P**, and High Frame Rate movies, for example, may not be possible on other devices, because playback is processing-intensive.
- Sharpness and noise vary slightly depending on movie recording quality, cropped shooting settings, and the lens used.



- To obtain better performance with the card, formatting the card with the camera before shooting movies is recommended (p.373).
- Frame rate options on the screen for movie recording size vary depending on whether [**43: Video system**] is set to [**For NTSC**] or [**For PAL**].
- Movies cannot be recorded in VGA quality.

4K Movie Shooting

- Shooting 4K movies requires a high-performance card. For details, see “Cards that Can Record Movies” on page 611.
- Shooting 4K movies or High Frame Rate movies greatly increases the processing load, which may cause the camera’s internal temperature to increase faster or become higher than for regular movies. If a red  icon appears during movie shooting, the card may be hot, so stop shooting the movie and let the camera cool down before removing the card. (Do not remove the card immediately.)
- From a 4K movie, you can select any frame to save as an approx. 8.3-megapixel (3840×2160) JPEG still image to the card (p.329).

Movie-Recording Coverage

Image sensor coverage for movies varies depending on movie recording quality and cropped shooting settings and the lens used. With EF-S lenses, movies are cropped around the center of the image.

● RF or EF lenses: With [CAMERA 1: Movie cropping] set to [Disable]

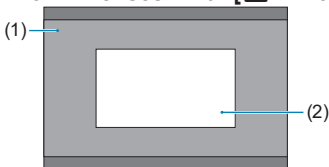

- | | |
|-----|--|
| (1) | Full HD
HD
4K time-lapse
Full HD time-lapse |
| (2) | 4K |

● RF or EF lenses: With [CAMERA 1: Movie cropping] set to [Enable]

● EF-S lenses

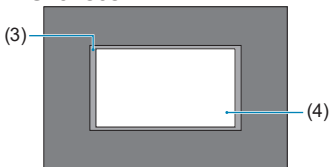

- | | |
|-----|-------------------------------------|
| (3) | 4K time-lapse
Full HD time-lapse |
| (4) | 4K
Full HD
HD |

- [FHD 59.94P ALL-I], [FHD 59.94P IPB], [FHD 50.00P ALL-I], [FHD 50.00P IPB] and High Frame Rate movies cannot be shot with EF-S lenses or when [CAMERA 1: Movie cropping] set to [Enable].
- Recording with Movie digital IS (p.220) further crops the image around the center of the screen.

- **Frame rate** (fps: frame per second)

- **[119.9P] 119.9fps/[59.94P] 59.94fps/[29.97P] 29.97fps**

For areas where the TV system is NTSC (North America, Japan, South Korea, Mexico, etc.). For **119.9P**, see page 199.

- **[100.0P] 100.0fps/[50.00P] 50.00fps/[25.00P] 25.00fps**

For areas where the TV system is PAL (Europe, Russia, China, Australia, etc.). For **100.0P**, see page 199.

- **[23.98P] 23.98fps/[24.00P] 24.00fps**

Mainly for motion pictures. **23.98P** (23.98fps) is available when **[4:3: Video system]** is set to **[For NTSC]**. For **24.00P**, see page 198.

- **Compression method**

- **[ALL-I] ALL-I** (For editing/I-only)

Compresses each frame, one at a time, for recording. Although file sizes are larger than with IPB (Standard), movies are more suitable for editing.

- **[IPB] IPB** (Standard)

Compresses multiple frames at a time efficiently for recording. File sizes are smaller than with ALL-I (For editing), which enables movie shooting over longer periods (with a card of the same capacity).

- **[IPB] IPB** (Light)

Since the movie is recorded at a bit rate lower than with IPB (Standard), the file size will be smaller than with IPB (Standard) and the playback compatibility will be higher. This will make the possible shooting time longer than with IPB (Standard) (with a card having the same capacity).

- **Movie recording format**

- **[MP4] MP4**

All movies you shoot with the camera are recorded as movie files in MP4 format (file extension “.MP4”). This file format provides higher compatibility for playback than with MOV.

Cards that Can Record Movies

For details on cards that can record at each level of movie recording quality, see page 611.

When shooting movies, use a high-capacity card with a writing/reading speed (as specified in card performance requirements) shown in the table on page 611 or higher than the standard specification. Test the card by taking a few movies in the desired quality (p.192) and make sure the card can properly record the movie.



- Format cards before shooting 4K movies (p.373).
- If you use a slow-writing card when shooting movies, the movie may not be recorded properly. Also, if you play back a movie on a card with a slow reading speed, the movie may not be played back properly.
- When shooting movies, use high-performance cards with a writing speed sufficiently higher than the bit rate.
- When movies cannot be recorded normally, format the card and try again. If formatting the card does not resolve the problem, refer to the card manufacturer's Web site, etc.



- To obtain better performance with the card, formatting the card with the camera before shooting movies is recommended (p.373).
- To check the card's writing/reading speed, refer to the card manufacturer's Web site, etc.

24.00p

Records movies at a frame rate of 24.00 fps.

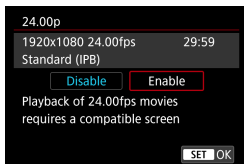

When **[Enable]** is set, you can select the movie recording quality as follows:

[4K 24.00P ALL-I], **[4K 24.00P IPB]**, **[FHD 24.00P ALL-I]**,
or **[FHD 24.00P IPB]**.

If you set **[Movie rec. size]** before setting **[24.00p]** to **[Enable]**, set **[Movie rec. size]** again.



Precautions on [24.00p: Enable]

- HDMI video output is 2160/24.00p or 1080/24.00p, depending on your specified movie recording quality. Movies may not be displayed unless the camera is connected via HDMI to a television or other device compatible with 1080/24.00p signals.
- Check the **[Movie rec. size]** setting if you return this setting to **[Disable]**.

High Frame Rate

You can shoot HD movies at a high frame rate of 119.9 fps or 100.0 fps. This is ideal for shooting movies that will be played back in slow motion. The maximum recording time per movie is 7 min. 29 sec.

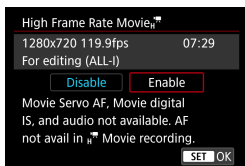

Movies are recorded as **HD 119.9P ALL-I** or **HD 100.0P ALL-I**.

Movie Servo AF and Movie digital IS have no effect when you shoot High Frame Rate movies. Also during High Frame Rate movie shooting, AF is not used in focusing.

Sound is not recorded in High Frame Rate movies.

Movie time code display during recording advances 4 sec. per second. Because High Frame Rate movies are recorded as 29.97 fps/25.00 fps movie files, they are played back in slow motion at 1/4 speed.



Precautions on [High Frame Rate: Enable]

- Time codes are not recorded when **[Count up]** is set to **[Free run]** under **[1: Time code]** (p.205).
- Check the **[Movie rec. size]** setting if you return this setting to **[Disable]**.
- The screen may flicker if you shoot High Frame Rate movies under fluorescent or LED lighting.
- For a moment when you start or stop shooting High Frame Rate movies, the movie is not updated, and the frame stops momentarily. Be aware of this when recording movies to external devices via HDMI.
- Movie frame rates shown on the screen as you shoot High Frame Rate movies do not correspond to the frame rate of the movie recorded.
- Headphones cannot be used, because no sound is audible.

Movie Files Exceeding 4 GB

Even if you shoot a movie exceeding 4 GB, you can keep shooting without interruption.

● **Using SD/SDHC cards formatted with the camera**

If you use the camera to format an SD/SDHC card, the camera will format it in FAT32.

With a FAT32-formatted card, if you shoot a movie and the file size exceeds 4 GB, a new movie file will be created automatically.

When you play back the movie, you will have to play back each movie file individually. Movie files cannot be played back automatically in consecutive order. After the movie playback ends, select the next movie and play it back.

● **Using SDXC cards formatted with the camera**

If you use the camera to format an SDXC card, the camera will format it in exFAT.

When using an exFAT-formatted card, even if the file size exceeds 4 GB during movie shooting, the movie will be saved as a single file (rather than being split into multiple files).

 When importing movie files exceeding 4 GB to a computer, use either EOS Utility or a card reader (p.575). It may not be possible to save movie files exceeding 4 GB if you attempt this using standard features of the computer's operating system.

Total Movie Recording Time and File Size Per Minute

For details on file sizes and the recording time available at each level of recording quality, see page 612.

Movie Shooting Time Limit

- **When shooting non-High Frame Rate movies**

The maximum recording time per movie is 29 min. 59 sec. Once 29 min. 59 sec. is reached, recording automatically stops. You can start shooting a movie again by pressing the movie shooting button (which records the movie as a new file).

- **When shooting High Frame Rate movies**

The maximum recording time per movie is 7 min. 29 sec. Once 7 min. 29 sec is reached, recording automatically stops. You can start shooting a High Frame Rate movie again by pressing the movie shooting button (which records the movie as a new file).

Setting the Sound Recording



You can shoot movies while recording sound with the built-in stereo microphone or an external stereo microphone. You can also freely adjust the sound-recording level.

Use [**1**: Sound recording] to set sound recording functions.

Audio is recorded in LPCM format for movies with ALL-I compression and AAC for movies with IPB compression.

Sound Recording/Sound-Recording Level

● Auto

The sound-recording level is adjusted automatically. Auto level control will take effect automatically in response to the sound level.

● Manual

For advanced users. You can adjust the sound-recording level as needed.

Select [**Rec. level**] and press the <◀> <▶> keys while looking at the level meter to adjust the sound-recording level. Look at the peak hold indicator, and adjust so that the level meter sometimes lights up on the right of the “12” (-12 dB) mark for the loudest sounds. If it exceeds “0”, the sound will be distorted.

● Disable

Sound will not be recorded.

Wind Filter

Set to [**Auto**] to reduce wind noise when there is wind outdoors. Only activated when the camera's built-in microphone is used. When the wind filter function takes effect, part of the low bass sounds will also be reduced.

Attenuator

Automatically suppresses sound distortion caused by loud noises. Even if **[Sound rec.]** is set to **[Auto]** or **[Manual]** for shooting, sound distortion may still result if there is a very loud sound. In such a case, setting it to **[Enable]** is recommended.

● Using a microphone

Normally, the camera's built-in microphone records in stereo.

If an external stereo microphone equipped with a miniature stereo plug (3.5 mm diameter) is connected to the camera's external microphone IN terminal, the external microphone will be given the priority. Using the Directional Stereo Microphone DM-E1 (sold separately) is recommended.

● Using headphones

By connecting commercially available headphones with a 3.5 mm mini plug to the headphone terminal, you can listen to the sound as movies are recorded. You can listen in stereo when using the built-in microphone or an external stereo microphone. To adjust headphone volume, press the **<Q>** button, select **[Q]**, then turn the **<VOLUME>** dial for adjustment.

You can also use headphones during movie playback.



- Sounds from Wi-Fi operations may be captured with built-in or external microphones. During sound recording, using the wireless communication function is not recommended.
- When connecting an external microphone or headphones to the camera, be sure to insert the plug all the way in.
- The camera's built-in microphone will also record the operation sound and mechanical sound of the camera during shooting. Using Directional Stereo Microphone DM-E1 (sold separately) may reduce such sounds in the movie.
- Do not connect anything other than an external microphone to the camera's external microphone IN terminal.
- Noise reduction is not applied to the audio played through headphones. Thus, the audio recorded with the movie will be different.
- Do not change the **[Sound recording]** settings when listening with headphones. This may cause sudden loud output that may hurt your ears.



- In **[A+]** mode, the settings available for **[Sound recording]** are **[On]** or **[Off]**. Set to **[On]** for automatic adjustment of the recording level.
- Audio is also output when the camera is connected to televisions via HDMI, except when **[Sound rec.]** is set to **[Disable]**.
- The sound volume balance between L (left) and R (right) cannot be adjusted.
- Sound is recorded at a 48 kHz/16-bit sampling rate.

Setting the Time Code

Time code	
Count up	Rec run
Start time setting	
Movie rec count	Rec time
Movie play count	Rec time
HDMI	
Drop frame	Enable
MENU 	

As movies are recorded, a time code is also recorded automatically to keep track of the time for synchronization. Time codes are constantly recorded in hours, minutes, seconds, and frames. They are mainly used when movies are edited. To set up the time code, use [**📷 1: Time code**].

Count Up

● Rec run

The time code advances only while you are shooting movies. The initial time code value in each movie file captured continues from the value in the previous file.

● Free run

The time code advances even when you are not shooting movies.

Start Time Setting

You can set the initial start time of the time code.

● Manual input setting

Enables you to set any starting hour, minute, second, and frame.

● Reset

Resets the time set with [**Manual input setting**] or [**Set to camera time**] to “00:00:00.” or “00:00:00:” (p.208).

● Set to camera time

Matches the hour, minute, and second set as the time on the camera. Sets the frame value to “00”.



- When set to [**Free run**], time codes are not added to High Frame Rate movies that you shoot.
- When set to [**Free run**], time codes will be affected by any changes to settings for time, zone, or daylight saving time (p.380).
- Time codes may not be displayed correctly if your movies are played back on devices other than the camera.

Movie Recording Count

You can select how time is displayed on the movie shooting screen.

- **Rec time**

Displays the time that has elapsed since you started shooting the movie.

- **Time code**

Displays the time code during movie recording.

Movie Playback Count

You can select how time is displayed on the movie playback screen.

- **Rec time**

Displays the recording or playback time during movie playback.

- **Time code**

Displays the time code during movie playback.

With [Time code] set



During movie shooting



During movie playback



- Time codes are always recorded to movie files (except for High Frame Rate movies with set to **[Free run]**), regardless of the **[Movie rec count]** setting.
- The **[Movie play count]** setting under **[CAMERA 1: Time code]** is linked to the **[PLAYBACK 3: Movie play count]** setting, so that these settings always match.
- The “frame” count is not displayed during movie shooting or playback.

HDMI

● Time code

Time codes can be added to movies as you record them to an external device via HDMI.

● Off

No time code is added to HDMI video output.

● On

Adds a time code to HDMI video output. When **[On]** is set, **[Rec Command]** is displayed.

● Record Command

For HDMI video output recorded by an external device, you can synchronize recording to when you start and stop shooting the movie on the camera.

● Off

Recording is started and stopped by the external device.

● On

Recording by an external device is synchronized to when you start and stop shooting a movie.



- Time codes are not added to HDMI video output when you shoot High Frame Rate movies with **[Count up]** in **[Time code]** set to **[Free run]**.
- To determine whether your external recording device is compatible with **[Time code]** and **[Rec Command]** functions, check with the device manufacturer.
- Even with **[Time code]** set to **[Off]**, external recording devices may add time codes to movies, depending on their specifications. For details on device specifications relevant to adding time code to HDMI input, check with the device manufacturer.
- Depending on support by external recording devices, **[Rec Command]** may not work correctly if you start recording movies by pressing the movie shooting button during still photo shooting.

Drop Frame

The time code will not match the actual time when frames are counted in the time code if the frame rate is set to **119.9P** (119.9 fps), **59.94P** (59.94 fps), or **29.97P** (29.97 fps). The discrepancy is corrected automatically when **[Enable]** is set. This correction function is called “drop frame”. It is intended for use in movie editing or other applications by advanced users.

- **Enable**

Corrects the discrepancy automatically by skipping time code numbers (DF: drop frame).

- **Disable**

The discrepancy is not corrected (NDF: non-drop frame).

Time codes are displayed as follows.

- **Enable (DF)**

00:00:00. (Playback: 00:00:00.00)

- **Disable (NDF)**

00:00:00: (Playback: 00:00:00.00)



Drop frame is not used when the frame rate is **100.0P** (100.0 fps), **50.00P** (50.00 fps), **25.00P** (25.00 fps), **24.00P** (24.00 fps), or **23.98P** (23.98 fps). (The **[Drop frame]** item is not displayed when **100.0P / 50.00P / 25.00P / 24.00P / 23.98P** is set, or when **[Video system]** is set to **[For PAL]**.)

Shooting Movies

Autoexposure Shooting

When the shooting mode is set to [A+] or [i], autoexposure control will take effect to suit the scene's current brightness.

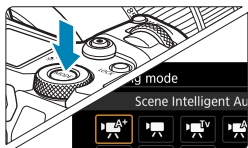

1 Set the shooting mode to [A+] or [i].

- Press the <MODE> button.
- Turn the < &img alt="gear icon" data-bbox="615 275 655 295" > dial to select [A+] or [i].



2 Focus on the subject.

- Before shooting a movie, focus with AF or manual focus (p.268–275, 281).
- By default, [AF1: Movie Servo AF] is set to [Enable] so that the camera always keeps focusing (p.286).
- When you press the shutter button halfway, the camera will focus with the current AF method.

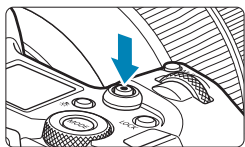

3 Shoot the movie.

- Press the movie shooting button to start shooting a movie.
- ▶ While the movie is being shot, the “● REC” mark (1) will be displayed on the upper right of the screen.
- ▶ Sound is recorded by the microphones at the positions indicated (2).
- To stop shooting the movie, press the movie shooting button again.

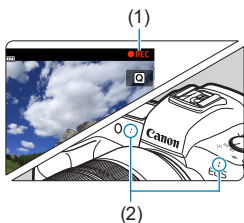

Shutter-Priority AE

 mode enables you to set your preferred shutter speed for movies. ISO speed and aperture are set automatically to suit the brightness and obtain standard exposure.

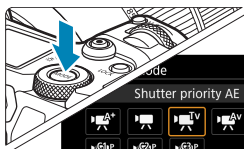

1 Set the shooting mode to .



(1)

2 Set the desired shutter speed (1).

- Turn the  dial as you watch the screen.
- The settable shutter speeds vary depending on the frame rate.



3 Focus and shoot the movie.

- The procedure is the same as steps 2 and 3 for “Autoexposure Shooting” (p.209).

- Avoid adjusting shutter speed while a movie is being recorded, which may record changes in exposure.
- When shooting a movie of a moving subject, a shutter speed of approx. 1/25 sec. to 1/125 sec. is recommended. The faster the shutter speed, the less smooth the subject’s movement will look.
- If you change the shutter speed while shooting under fluorescent or LED lighting, image flicker may be recorded.

Aperture-Priority AE

[] mode enables you to set your preferred aperture for movies. ISO speed and shutter speed are set automatically to suit the brightness and obtain standard exposure.

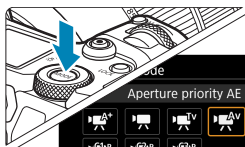

1 Set the shooting mode to [].

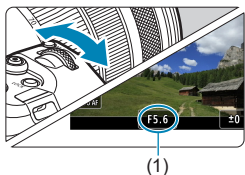

2 Set the desired aperture (1).

- Turn the < > dial as you watch the screen.



3 Focus and shoot the movie.

- The procedure is the same as steps 2 and 3 for “Autoexposure Shooting” (p.209).



Avoid adjusting aperture while a movie is being recorded, which may record changes in exposure caused by aperture adjustment.



Notes for [A+], [P], [Tv], and [Av] Modes

- In the [A+] mode, the scene icon for the scene detected by the camera is displayed on the upper left of the screen (p.623).
- You can lock the exposure (AE lock) by pressing the < * > button (except in the [A+] mode, p.157). After applying AE lock during movie shooting, you can cancel it by pressing the < [AE-L/AF-ON] > button. (AE lock setting is retained until you press the < [AE-L/AF-ON] > button.)
- Exposure compensation can be set in a range of up to ±3 stops (except in the [A+] mode).
- ISO speed, shutter speed, and aperture are not recorded in movie Exif information in [A+] or [P] mode.
- The camera is compatible with Speedlite functionality to turn on the LED light automatically under low light when shooting movies in [A+], [P], [Tv], or [Av] mode. For details, refer to the Instruction Manual of the Speedlite equipped with an LED light.

ISO Speed in [A+], [P], [Tv], and [Av] Modes

ISO speed is set automatically in [A+], [P], [Tv], and [Av] modes. For details on the ISO speed, see page 614.

Scene Icons



In the [A+] shooting mode, the camera detects the scene type and sets everything automatically to suit the scene. The detected scene type is indicated on the upper left of the screen. For icon details, see page 623.

Manual Exposure Shooting

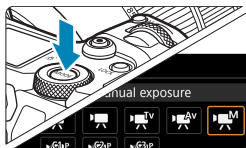

You can manually set the shutter speed, aperture, and ISO speed for movie shooting. Using manual exposure to shoot movies is for advanced users.

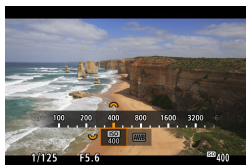

1 Set the shooting mode to [].



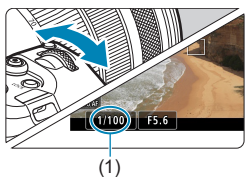

2 Set the ISO speed.

- Press the <M-Fn> button.
- Turn the < > dial to select the ISO speed item.
- Turn the < > dial to set it.



3 Set the shutter speed (1) and aperture (2).

- Press the shutter button halfway and check the exposure level indicator.
- To set the shutter speed, turn the < > dial. To set the aperture, turn the < > dial.
- The settable shutter speeds vary depending on the frame rate.

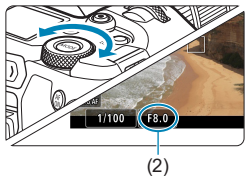

4 Focus and shoot the movie.

- The procedure is the same as steps 2 and 3 for “Autoexposure Shooting” (p.209).

- For movie shooting, the ISO speed cannot be expanded to L (equivalent to ISO 50).
- When switching from still photo shooting to movie shooting, check the camera settings again before shooting movies.
- During movie shooting, avoid changing the shutter speed or aperture. Doing so may record the changes in the exposure or create more noise at high ISO speeds.
- When shooting a movie of a moving subject, a shutter speed of approx. 1/25 sec. to 1/125 sec. is recommended. The faster the shutter speed, the less smooth the subject's movement will look.
- If you change the shutter speed while shooting under fluorescent or LED lighting, image flicker may be recorded.

- With ISO Auto, exposure compensation can be set in a range of ± 3 stops.
- When ISO Auto is set, you can press the **< * >** button to lock the ISO speed. After locking the ISO speed during movie shooting, you can cancel it by pressing the **< [] >** button. (ISO speed lock is maintained until you press the **< [] >** button.)
- If you press the **< * >** button and recompose the shot, you can see the exposure level difference on the exposure level indicator compared to when the **< * >** button was pressed.
- With the camera ready to shoot in the **[M]** mode, you can display the histogram by pressing the **< INFO >** button.
- You can adjust ISO speed while recording a movie by pressing the **< M-Fn >** button and using the **< [] >** dial.

ISO Speed in [M] Mode

In [M] mode, you can set the ISO speed manually or select [AUTO] to set it automatically. For details on the ISO speed, see page 614.

Shutter Speed

Available shutter speeds in [Tv] (shutter-priority AE) and [M] (manual exposure) modes vary depending on the frame rate of your specified movie recording quality.

Frame Rate	Shutter Speed (sec.)		
	Normal Movie Shooting	High Frame Rate Movie Shooting	HDR Movie Shooting
119.9P	-	1/4000–1/125	-
100.0P		1/4000–1/100	
59.94P	1/4000–1/8	-	-
50.00P			[Tv] 1/4000–1/60 [M] 1/1000–1/60
29.97P			[Tv] 1/4000–1/50 [M] 1/1000–1/50
25.00P			-
24.00P			-
23.98P			-

Still Photo Shooting

Still photos cannot be taken during movie shooting. To take still photos, stop recording and change the **[Shooting mode]** setting to still photos (p.70) first.

Information Display (Movie Shooting)

For details on the icons displayed for movie shooting, see page 621.



Cautions for Movie Shooting

- Do not point the camera toward an intense light source, such as the sun or an intense artificial light source. Doing so may damage the image sensor or the camera's internal components.
- If you shoot something that has fine detail, moire or false colors may result.
- If <AWB> or <AWB w> is set and the ISO speed or aperture changes during movie shooting, the white balance may also change.
- If you shoot a movie under fluorescent or LED lighting, the movie image may flicker.
- If you perform AF with a USM lens during movie shooting in low light, horizontal banding noise may be recorded in the movie. The same type of noise may occur if you focus manually with certain lenses equipped with an electronic focusing ring.
- Shooting a few test movies is recommended if you intend to perform zooming during movie shooting. Zooming as you shoot movies may cause exposure changes or lens sounds to be recorded, an uneven audio level, or loss of focus.
- Large aperture values may delay or prevent accurate focusing.
- During movie shooting, if you perform AF, any of the following may occur: The focus is temporarily greatly thrown off, changes in movie brightness is recorded, the movie recording stops momentarily, and the mechanical sound of the lens is recorded.
- Avoid covering the built-in microphones (p.209) with your fingers or other objects.
- **“General Movie Shooting Cautions” are on page 253.**
- **If necessary, also read “General Still Photo Shooting Cautions” on page 142.**



Notes for Movie Shooting

- Each time you shoot a movie, a new movie file is created on the card.
- The movie's field of view coverage for shooting 4K, Full HD, and HD movies is approx. 100%.
- You can also focus by pressing the $\langle \overset{AF}{ON} \rangle$ button.
- To enable starting or stopping movie shooting by pressing the shutter button completely, set **[Fully-press]** for **[4:  btn function]** to **[Start/stop mov rec]**.
- Stereo sound is recorded by the camera's built-in microphone (p.209).
- Any external microphones such as Directional Stereo Microphone DM-E1 (sold separately) connected to the camera's external microphone IN terminal are used instead of the built-in microphones (p.203).
- Most external microphones equipped with a 3.5 mm diameter mini plug can be used.
- With EF lenses, focus preset during movie shooting is available when using (super) telephoto lenses equipped with this function released in and after the second half of 2011.
- YCbCr 4:2:0 (8-bit) color sampling and the Rec. ITU-R BT.709 color space are used for 4K, Full HD, and HD movies.

Movie Cropping ☆

With RF or EF lenses, movies can be cropped around the center of the image, as if using a telephoto lens.

Shooting movies with EF-S lenses has the same effect as this movie cropping feature.

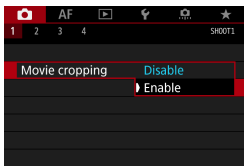

1 Select [**1**: Movie cropping].

2 Select [**Enable**].

▶ The center area is magnified.



- [FHD 59.94P ALL-I], [FHD 59.94P IPB], [FHD 50.00P ALL-I], [FHD 50.00P IPB] and High Frame Rate movies cannot be shot with movie cropping.
- The center of the screen is further cropped, reducing the shooting area, when [**1**: Movie digital IS] is set to [**Enable**] or [**Enhanced**].



- The shooting area available with movie cropping is the same as when shooting movies with EF-S lenses.
- 4K movies are always shot with the center of the shooting screen cropped, and enabling [**1**: Movie cropping] does not change the shooting angle of view.
- For details on the shooting area, see page 194.

Movie Digital IS

In-camera image stabilization electronically corrects camera shake during movie shooting. This function is called “Movie digital IS”. With Movie digital IS, images can be stabilized even when using a lens without Image Stabilizer. When using a lens with built-in optical Image Stabilizer, set the lens’s Image Stabilizer switch to <ON>.

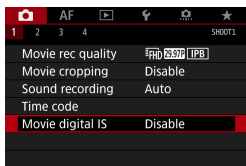

1 Select [1: Movie digital IS].

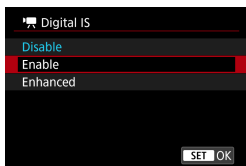

2 Select an item.

- **Disable** ()

Image stabilization with Movie digital IS is disabled.

- **Enable** ()

Camera shake will be corrected. The image will be slightly magnified.

- **Enhanced** ()

Compared to when **[Enable]** is set, stronger camera shake can be corrected. The image will be more magnified.

Combination IS

Even more effective correction is possible by shooting movies with Movie digital IS and a Combination IS-compatible lens, which will combine optical and digital image stabilization by the lens and camera.



- Movie digital IS will not function when the lens's optical Imager Stabilizer switch is set to <OFF>.
- Although movies can also be recorded with Movie digital IS when using EF-S lenses or movie cropping, the shooting area is further reduced.
- With a lens whose focal length is longer than 800 mm, Movie digital IS will not function.
- Stabilization by Movie digital IS may be less effective under some settings for movie recording quality.
- The wider the angle of view (wide angle), the more effective the image stabilization will be. The narrower the angle of view (telephoto), the less effective the image stabilization will be.
- When using a tripod, setting Movie digital IS to **[Disable]** is recommended.
- Depending on the subject and shooting conditions, the subject may blur noticeably (the subject momentarily looks out of focus) due to the effects of the Movie digital IS.
- When using a TS-E lens, fish-eye lens, or non-Canon lens, setting Movie digital IS to **[Disable]** is recommended.
- Since Movie digital IS magnifies the image, the image looks more grainy. Noise, dots of light, etc. may also become noticeable.



- For details on lenses compatible with Combination IS, visit the Canon website.
- "+" is added to the Movie digital IS icon (see p.220) when a lens compatible with Combination IS is used.

Shooting HDR Movies

You can shoot high dynamic range movies that retain detail in highlights of high-contrast scenes.

You can specify to shoot HDR movies from the Quick Control screen when using RF or EF lenses with **[Movie rec. size]** under **[CAMERA 1: Movie rec. quality]** set to **FHD 29.97P IPB** (NTSC) or **FHD 25.00P IPB** (PAL), or when using EF-S lenses or movie cropping with this setting set to **HD 29.97P IPB** (NTSC) or **HD 25.00P IPB** (PAL).

- 1 Check [Movie rec. size].**
 - Check that **[Movie rec. size]** under **[CAMERA 1: Movie rec quality]** is set to a size mentioned above.
- 2 Press the <Q> button (10).**



- 3 Select [HDR Off].**
 - Press the <▲> <▼> keys to select **[HDR Off]** (HDR Movie Shooting) in the lower right of the screen.

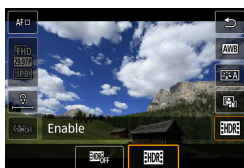

- 4 Select [HDR On] (Enable).**
 - Press the <◀> <▶> keys to select **[HDR On]** (Enable).

5 Shoot an HDR movie.

- Shoot the movie in the same way as normal movie shooting.
- For details on file sizes and the recording time available, see the table on page 612.



- Movies are recorded in HD (Full HD is not available) when EF-S lenses or movie cropping is used.
- ISO speed for HDR movies has a setting range of ISO 100–25600, whether set automatically or manually. ISO expansion is not available.
- For details on shutter speeds, see page 215.
- Minimum ISO speed in [TV] mode is ISO 400.
- HDR movie shooting is not available with [1: Movie digital IS], [2: Time-lapse movie], [3: Highlight tone priority], or [Canon Log].
- Images may still flicker in HDR movie shooting even when a suitable shutter speed is set.
- Since multiple frames are merged to create an HDR movie, certain parts of the movie may look distorted. During handheld shooting, camera shake may make the distortion look more noticeable. Using a tripod is recommended. Note that even if a tripod is used for shooting, afterimages or noise may become more noticeable when the HDR movie is played back frame-by-frame or in slow-motion compared to normal playback.
- Image color and brightness may change significantly for a moment if you change settings for HDR movie shooting. Also, the movie will not be updated for a moment, and the frame stops momentarily. Be aware of this when recording movies to external devices via HDMI.

Shooting Time-lapse Movies

Still photos shot at a set interval can be stitched together automatically to create a 4K or Full HD time-lapse movie. A time-lapse movie shows how a subject changes in a much shorter period of time than the actual time it took. It is effective for a fixed-point observation of changing scenery, growing plants, celestial motion, etc.

Time-lapse movies will be recorded in MP4 format at the following quality: **4K 29.97P ALL-I** (NTSC)/**4K 25.00P ALL-I** (PAL) for 4K shooting, and **FHD 29.97P ALL-I** (NTSC)/**FHD 25.00P ALL-I** (PAL) for Full HD shooting.

Note that the frame rate will be switched automatically according to the [**4.3: Video system**] setting (p.384).

1 Select a shooting mode.

2 Select [**2: Time-lapse movie**].

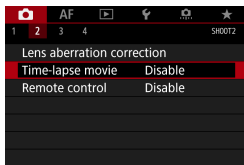

3 Select [**Time-lapse**].

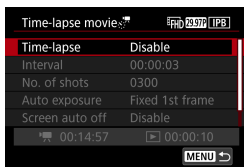

4 Select the desired movie recording size.

- Select the size, then press <SET>.



● Enable **4K (3840x2160)**

The movie is recorded in 4K quality. The aspect ratio is 16:9. The frame rate is 29.97 fps (**29.97P**) for NTSC and 25.00 fps (**25.00P**) for PAL, and movies are recorded in MP4 (**MP4**) format with ALL-I (**ALL-I**) compression.

● Enable **FHD (1920x1080)**

The movie will be recorded in Full High-Definition (Full HD) quality. The aspect ratio is 16:9. The frame rate is 29.97 fps (**29.97P**) for NTSC and 25.00 fps (**25.00P**) for PAL, and movies are recorded in MP4 (**MP4**) format with ALL-I (**ALL-I**) compression.

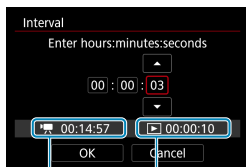

(1)

(2)

5 Set the shooting interval.

- Select **[Interval]**.
- Refer to **[: Time required]** (1) and **[: Playback time]** (2) to set the number.
- Select the hour, minute, or second.
- Press **<SET>** to display **<>**.
- Set the desired number, then press **<SET>**. (Returns to **<>**.)
- Can be set in a range of **[00:00:02]–[99:59:59]**. (An interval of once per second is not available.)
- Select **[OK]** to register the setting.

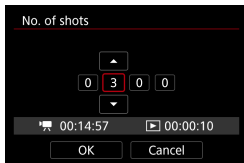

6 Set the number of shots.

- Select **[No. of shots]**.
- Refer to the **[: Time required]** and **[: Playback time]** to set the number.
- Select the digit.
- Press **<SET>** to display **<>**.
- Set the desired number, then press **<SET>**. (Returns to **<>**.)
- Can be set in a range of **[0002]–[3600]**.
- Check that **[: Playback time]** is not displayed in red.
- Select **[OK]** to register the setting.



- For cards that can record time-lapse movies (card performance requirements), see page 611.
- If the number of shots is set to 3600, the time-lapse movie will be approx. 2 min. in NTSC and approx. 2 min. 24 sec. in PAL.

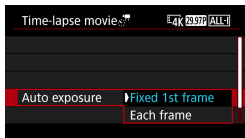

7 Select the exposure's setting method.

- Select [**Auto exposure**].
- Select an option, then press <SET>.

● Fixed 1st frame

When taking the first shot, metering is performed to set the exposure automatically to match the brightness. The exposure setting for the first shot will be applied to subsequent shots. Other shooting-related settings for the first shot will also be applied for subsequent shots.

● Each frame

Metering is also performed for each subsequent shot to set the exposure automatically to match the brightness. Note that if functions such as Picture Style and white balance are set to [**Auto**], they will be set automatically for each subsequent shot.

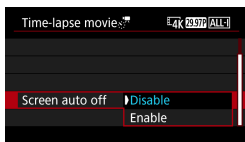

8 Set whether the image is to be displayed.

- Select [**Screen auto off**].
- Select an option, then press <SET>.

● Disable

Even during time-lapse movie shooting, the image will be displayed. (The screen turns off only at the time of shooting.) Note that the screen will turn off when approx. 30 min. elapse after the shooting started.

● Enable

Note that the screen will turn off when approx. 10 sec. elapse after the shooting started.



During time-lapse movie shooting, you can press the <INFO> button to turn on/off the screen.

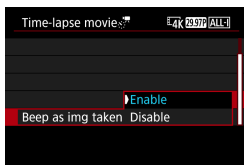

9 Set the beeper.

- Select [**Beep as img taken**].
- If [**Disable**] is set, the beeper will not sound for shooting.



10 Check the settings.

(1) Time required

Indicates the time required to shoot the set number of shots with the set interval. If it exceeds 24 hours, “*** days” will be displayed.

(2) Playback time

Indicates the movie recording time (time required to play back the movie) when creating the time-lapse movie in 4K movie or Full HD movie from the still photos taken with the set intervals.

11 Exit the menu.

- Press the <MENU> button to turn off the menu screen.

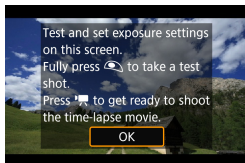

12 Read the message.

- Read the message and select **[OK]**.

13 Take test shots.

- As with still photo shooting, set the exposure and shooting functions, then press the shutter button halfway to focus.
- Press the shutter button completely to take test shots. The still photos will be recorded to the card.
- If there are no problems with the test shots, go to the next step.
- To take test shots again, repeat this step.



- Test shots are captured in JPEG quality.
- In the **[Tv]** or **[M]** mode, you can set the shutter speed within a range of 1/4000 sec. to 30 sec.
- You can set the maximum limit for ISO Auto in **[Tv]**, **[Tv]**, or **[Av]** mode or in **[M]** mode with ISO Auto, in **[ISO Auto]** under **[3: ISO speed settings]** (p.246).
- When shooting with manual exposure, setting **[Maximum]** for **[ISO speed range]** or **[Range for 4K]** under **[3: ISO speed settings]** to **[H2(102400)]** expands the maximum limit of the manual setting range to H2 (equivalent to ISO 102400).
- If you have set **[Half-press]** under **[4: btn function]** to **[Meter.+ISO Servo AF]**, it is automatically changed to **[Meter.+One-Shot AF]** when you set up time-lapse movie shooting.

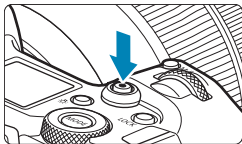

14 Press the movie shooting button.

- ▶ The camera will be ready to start shooting a time-lapse movie.
- To return to step 13, press the movie shooting button again.



(1)

(2)

15 Shoot the time-lapse movie.

- Press the <INFO> button and check again the “Time required (1)” and “Interval (2)” displayed on the screen.
- **Press the shutter button completely to start shooting the time-lapse movie.**
- AF will not work during time-lapse movie shooting.
- While the time-lapse movie is recorded, “● REC” is displayed in the upper right of the screen.
- Since the electronic shutter is used for shooting, the shutter make no mechanical sound during time-lapse movie shooting.
- ▶ When the set number of shots are taken, the time-lapse movie shooting ends.
- To cancel shooting time-lapse movies, set **[Time-lapse]** to **[Disable]**.

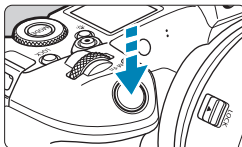



- Using a tripod is recommended.
- Taking test shots as in step 13 and shooting test movies for time-lapse movies beforehand is recommended.
- Regardless of the **[Movie rec. size]** setting under **[CAMERA 1: Movie rec quality]**, 4K time-lapse movies are recorded in **[4K 29.97P ALL-I]** (NTSC)/**[4K 25.00P ALL-I]** (PAL), and Full HD time-lapse movies are recorded in **[FHD 29.97P ALL-I]** (NTSC)/**[FHD 25.00P ALL-I]** (PAL).
- The movie's field of view coverage for both the 4K and Full HD time-lapse movie shooting is approx. 100%.
- To cancel the time-lapse movie shooting in progress, either press the shutter button completely or press the movie shooting button. The time-lapse movie shot so far will be recorded on the card.
- If the time required for shooting is more than 24 hours but not more than 48 hours, "2 days" will be indicated. If three or more days are required, the number of days will be indicated in 24-hour increments.
- Even if the time-lapse movie's playback time is less than 1 sec., a movie file will still be created. For **[Playback time]**, "00:00:00" will be displayed.
- If the shooting time is long, using the household power outlet accessories (sold separately) is recommended.
- YCbCr 4:2:0 (8-bit) color sampling and the Rec. ITU-R BT.709 color space are used for 4K/Full HD time-lapse movies.





- If the card does not have enough free space to record the set number of shots, **[Playback time]** will be displayed in red. Although the camera can continue shooting, the shooting will stop when the card becomes full.
- If the movie file size exceeds 4 GB with the **[No. of shots]** settings and the card is not formatted in exFAT (p.374), **[Playback time]** will be displayed in red. If you keep shooting in this condition and the movie file size reaches 4 GB, the time-lapse movie shooting will stop.



- Do not point the camera toward an intense light source, such as the sun or an intense artificial light source. Doing so may damage the image sensor or the camera's internal components.
- If the camera is connected to a computer with the interface cable, or if an HDMI cable is connected to the camera, you cannot select **[Enable]**.
- Movie Servo AF will not function.
- For time-lapse movies in **[Tv]** (Shutter priority AE) mode, aperture is fixed and exposure is controlled using ISO speed.
- If the shutter speed is 1/30 sec. or slower, the exposure of the movie may not be displayed properly (may differ from that of the resulting movie).
- Do not zoom the lens during time-lapse movie shooting. Zooming the lens may cause the image to be out of focus, the exposure to change, or the lens aberration correction not to function properly.
- When shooting a time-lapse movie under a flickering light, noticeable image flickering, horizontal stripes (noise), or irregular exposures may be recorded.
- Images displayed as time-lapse movies are recorded may look different from the resulting movie (in details such as inconsistent brightness from flickering light sources, or noise from a high ISO speed).
- When shooting a time-lapse movie under low light, the image displayed during shooting may look different from what is actually recorded in the movie. In such cases, the **<Exp.SIM>** icon will blink.
- If you move the camera from left to right (panning) or shoot a moving subject during time-lapse movie shooting, the image may look extremely distorted.
- During time-lapse movie shooting, auto power off will not take effect. Also, you cannot adjust the shooting function and menu function settings, play back images, etc.
- No sound or time codes are recorded for time-lapse movies.
- With time-lapse movie shooting, you can press the shutter button completely to start or stop the movie shooting regardless of the **[4: Eye btn function]** setting.
- With **[Interval]** set to less than 3 sec. and **[Auto exposure]** set to **[Each frame]**, if the brightness differs greatly from the preceding shot, the camera may not shoot at the set interval.



- If the shutter speed exceeds the shooting interval (such as for long exposures), or if a slow shutter speed is set automatically, the camera may not be able to shoot at the set interval. Shooting may also be prevented by shooting intervals nearly the same as the shutter speed.
- If the next scheduled shot is not possible, it will be skipped. This may shorten the recording time of the created time-lapse movie.
- If the time it takes to record to the card exceeds the shooting interval due to the shooting functions set or card performance, some of the shots may not be taken with the set intervals.
- Even if **[Screen auto off]** is set to **[Disable]**, the screen will turn off during the exposure.
- Even if **[Screen auto off]** is set to **[Disable]**, the image may not be displayed for the short interval before the next shot.
- If the time it takes to record to the card exceeds the shooting interval due to the shooting functions set or card performance, some of the shots may not be taken with the set intervals.
- The captured images are not recorded as still photos. Even if you cancel the time-lapse movie shooting after only one shot is taken, it will be recorded as a movie file.
- If you connect the camera to a computer with the interface cable and use EOS Utility (EOS software), set **[CAM2: Time-lapse movie]** to **[Disable]**. If it is set to **[Enable]**, the camera cannot communicate with the computer.
- During time-lapse movie shooting, the lens's Image Stabilizer will not operate.
- Time-lapse movie shooting ends if the power switch is set to <OFF>, for example, and the setting is changed to **[Disable]**.
- Even if a flash is used, it will not fire.
- The following operations cancel standby for time-lapse movie shooting and switch the setting to **[Disable]**.
 - Selecting either **[Clean now]**  or **[Clean manually]** under **[43: Sensor cleaning]** or selecting **[46: Clear all camera settings]**.

- If you start time-lapse movie shooting while the white <  > temperature warning (p.253) is displayed, the image quality of the time-lapse movie may decline. It is recommended that you start time-lapse movie shooting after the white <  > disappears (camera's internal temperature decreases).
- With **[Auto exposure]** set to **[Each frame]**, ISO speed, shutter speed, and aperture may not be recorded in the time-lapse movie Exif information in some modes.



You can use Wireless Remote Control BR-E1 (sold separately, p.174) to start and stop the time-lapse movie shooting.

● **With Wireless Remote Control BR-E1**

- First pair the Wireless Remote Control BR-E1 with the camera (p.408).
- Set [**2: Remote control**] to [**Enable**].
- Take test shots, then when the camera is ready to shoot (as in step 14 on page 230), set the BR-E1's release mode/movie shooting switch to <●> (immediate release) or <2> (release after 2-sec. delay).
- If the remote control's switch has been set to [**Movie**], the time-lapse movie shooting cannot start.

Camera status/remote control setting	<2> 2-sec. delay <●> Immediate release	[Movie] Movie shooting
Test-shooting screen	Test-shooting	To shooting-ready
Shooting-ready	Starts shooting	To test-shooting screen
During time-lapse movie shooting	Ends shooting	Ends shooting

Approx. Time Available for Shooting Time-lapse Movies

For guidelines on how long you can shoot time-lapse movies (until the battery runs out), see page 613.

Shooting Movies Set to Canon Log[☆]

Canon Log gamma curve leverages image sensor characteristics to capture a wide dynamic range for movies that will be processed later in postproduction. With minimal loss of detail in shadows and highlights, movies retain more visual information across the dynamic range. To work with Canon Log movies in postproduction, you can apply look-up tables (LUTs). LUT data can be downloaded from the Canon website.

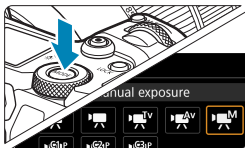

- 1 Set the shooting mode to [M].**
 - Settings after step 3 are only available in [M] shooting mode.

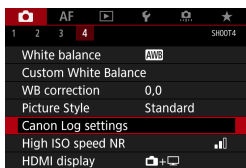

- 2 Select [4: Canon Log settings].**

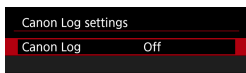

- 3 Select [Canon Log].**
 - Press <SET>.

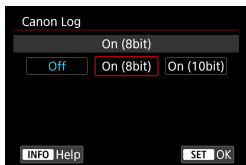

- 4 Select [On (8bit)] or [On (10bit)] (p.238).**
 - Select [On (8bit)] when recording movies to the card.
 - Select either [On (8bit)] or [On (10bit)] when recording to an external device via HDMI.

Canon Log settings	
Canon Log	On (8bit)
View Assist.	Off
Color Matrix	EOS Original
Characteristics	0, 0, 0

MENU ↗

5 Set the options as desired.

- Set **[View Assist.]**, **[Color Matrix]** **[Characteristics]**, and **[HDMI color space]**. For details, see pages 239–241.

6 Set up shooting.

- Set the ISO speed manually (p.242).
- Set the shutter speed and aperture.

7 Shoot the movie.

- Before recording movies to a card, see page 611.
- When recording movies to an external device via HDMI, connect the devices with an HDMI cable.
- For instructions on external recording via HDMI, refer to the instruction manual of the external device.

● Canon Log

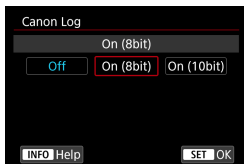

● On (8bit)

Select when recording movies with Canon Log to the card. Also enables you to record to an external device via HDMI. Recording quality via HDMI switches automatically based on the [CAMERA 1: Movie rec quality] setting.

● On (10bit)

Select for 10-bit 4K (3840×2160) recording via HDMI to an external device that supports 10-bit recording in 4K. Movies cannot be recorded to the card. [CAMERA 4: HDMI display] is automatically set to [CAMERA + MONITOR].

- ⚠ ● No HDMI output is produced by the camera when set to [On (10bit)] if the external recording device does not support 10-bit recording in 4K. If there is no video output, confirm that the external recording device supports the signals.
- Full HD and HD output is not available when set to [On (10bit)].
- Pressing the movie shooting button (p.209) will not start movie recording if you are shooting still photos in a mode other than [CAMERA+] and [On (10bit)] is set for [CAMERA+] (movie C3) mode.

📄 YCbCr 4:2:0 (8-bit) color sampling and the Rec. ITU-R BT.709 color space are used when recording with Canon Log to the card, just as in regular movie shooting.

● View Assist.

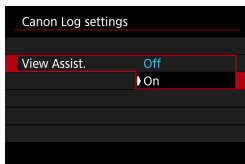

When played on the camera, these movies may look darker and have lower contrast than movies shot with a Picture Style applied, due to Canon Log image characteristics, which are intended to ensure a wide dynamic range.

For clearer display that makes it easier to check details, set **[View Assist.]** to **[On]**.

- Setting this feature to **[On]** does not affect movies recorded to the card, which are recorded using Canon Log. Similarly, HDMI video output has Canon Log characteristics, and View Assist is not used for it.



- **[V.Assist]** is displayed on the information display screen when View Assist is used.
- When set to **[On]**, View Assist is also used with magnified display.

● Color Matrix

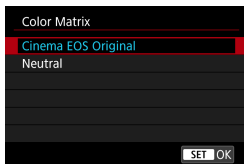

Using a color matrix, you can specify how colors are reproduced, to plan for postproduction processing.

● Cinema EOS Original

Reproduces [**Cinema EOS Original**] colors as used on professional Cinema EOS cameras.

● Neutral

Reproduces [**Neutral**] colors as used on professional Cinema EOS cameras. Similar to actual subject colors.

● Characteristics

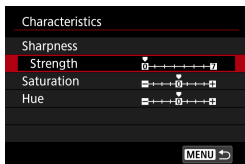

Adjust as needed. Select an item ([**Sharpness: Strength**], [**Saturation**], or [**Hue**]), adjust the effect level, then press <SET>.

Sharpness: Strength		0: Weak outline emphasis	7: Strong outline emphasis
Saturation		-4: Low	+4: High
Hue*	Reds	-4: Toward magenta	+4: Toward yellow
	Greens	-4: Toward yellow	+4: Toward cyan
	Blues	-4: Toward cyan	+4: Toward magenta

* Reds, greens, and blues cannot be adjusted separately.

● HDMI color space

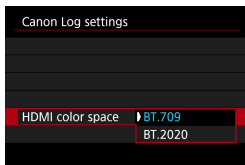

[**HDMI color space**] can be set when [**Canon Log**] is set to [**On (10bit)**] and [**Color Matrix**] to [**Neutral**]. Choose [**BT.709**] or [**BT.2020**] as the color space for HDMI output.

Shooting Settings

- Shooting with ISO Auto is not possible, and if set to ISO Auto when Canon Log is specified, the setting is changed to ISO 400. Set the ISO speed manually.
- Manually setting the ISO speed to 100–320 will make the dynamic range narrower.
- Canon Log offers a dynamic range of approx. 800% at ISO 400 or higher.
- With Canon Log, autofocus may be more difficult for subjects under low light, or for low-contrast subjects.



Expanded ISO speeds when shooting with Canon Log are ISO 100, 125, 160, 200, 250, and 320. **[L]** is displayed when an ISO speed is set.

Canon Log Image Quality

- With Canon Log, movies may be affected by horizontal banding, depending on the subject or shooting conditions. Shoot a few test movies and check the results in advance. In particular, noise may become more noticeable if you enhance the contrast when color-grading your movies.
- With Canon Log, skies, white walls, and similar subjects may be affected by noise or uneven gradation, exposure, or colors.
- Horizontal banding is more likely to occur when you shoot somewhat dark, flat subjects. This image noise may even occur at relatively low ISO speeds around ISO 400.
- If noise is noticeable, try shooting under brighter conditions and adjusting brightness in color grading. Noise can also be reduced by shooting at ISO speeds lower than ISO 400, although dynamic range is narrower.



General Canon Log Shooting Precautions

- HDR movies are not available when Canon Log is set.
- Specifying Canon Log will set **[Peripheral illum corr]** under **[CAMERA 2: Lens aberration correction]** to **[Disable]**.
- Canon Log 2 and Canon Log 3 are not supported.



Playing Movies Recorded with Canon Log

View Assist is not used during movie playback.

Menu Function Settings

This section describes menus used for shooting movies.

[CAMERA 1]

- **Movie recording quality**

For details on movie recording quality, see page 192.

- **Movie cropping** ☆

For details on movie cropping, see page 219.

- **Sound recording**

For details on sound recording, see page 202.

- **Time code**

For details on time codes, see page 205.

- **Movie digital IS**

For details on Movie digital IS, see page 220.

[📷2]**● Lens aberration correction ☆**

Peripheral illumination, distortion, and chromatic aberration can be corrected as you shoot movies. For details on lens aberration correction, see page 110.

● Time-lapse movie

For details on shooting time-lapse movies, see page 224.

● Remote control shooting

When **[Enable]** is set, you can start or stop movie shooting using Wireless Remote Control BR-E1 (sold separately, p.174). First, pair the BR-E1 with the camera (p.408).

With Wireless Remote Control BR-E1

Set the release mode/movie shooting switch to the <📷> position, then press the release button.

For details on Time-lapse movie shooting, see page 235.

[📷3] ☆

● **Exposure compensation** ☆

Exposure compensation is available in a range of ± 3 stops, in 1/3-stop increments. For details on exposure compensation, see page 154.

● **ISO speed settings** ☆● **ISO speed**

In [M] mode, you can set the ISO speed manually. You can also select ISO Auto.

● **ISO speed range**

When recording HD/Full HD movies or Full HD time-lapse movies, you can set the ISO speed setting range (minimum and maximum). By default, it is set to ISO 100–25600. You can set the minimum limit within ISO 100 to H1 (equivalent to ISO 51200), and the maximum limit within ISO 200 to H2 (equivalent to ISO 102400).





● **Range for 4K**

When recording 4K or 4K time-lapse movies, you can set the ISO speed setting range (minimum and maximum). By default, it is set to ISO 100–12800. You can set the minimum limit within ISO 100 to H1 (equivalent to ISO 51200), and the maximum limit within ISO 200 to H2 (equivalent to ISO 102400).





● **ISO Auto**

You can set the maximum limit for ISO Auto in HD or Full HD movie shooting in [P], [Tv], and [Av] modes or in [M] mode with ISO Auto. By default, it is set to [Max.:25600]. You can set the maximum limit within [Max.:6400] to [Max.:H2(102400)].

-  **ISO Auto**

You can set the maximum limit for ISO Auto in 4K movie shooting in [, [, or [ mode or in [ mode with ISO Auto. By default, it is set to **[Max.:12800]**. You can set the maximum limit within **[Max.:6400]** to **[Max.:H2(102400)]**.

-  **ISO Auto**

You can set the maximum limit for ISO Auto in 4K/Full HD time-lapse movie shooting in [, [, or [ mode or in [ mode with ISO Auto. By default, it is set to **[Max.:12800]**. You can set the maximum limit within **[Max.:400]** to **[Max.:25600]**.



Expanded ISO speeds (indicated by **[H]**) are ISO 32000/40000 for HD/Full HD movies and ISO 16000/20000/25600/32000/40000 for 4K movies.

- **Auto Lighting Optimizer** ☆

Brightness and contrast can be corrected automatically. For details on Auto Lighting Optimizer, see page 104.

- **Highlight tone priority** ☆

You can reduce overexposed, clipped highlights as you shoot movies. For details on Highlight tone priority, see page 109.





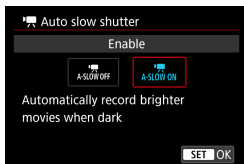

[Enhanced] is not available (not displayed) when shooting movies with [3: **Highlight tone priority**] set.

● Auto slow shutter ☆



You can choose whether to shoot movies that are brighter and less noisy than when set to **[Disable]** by automatically slowing the shutter speed under low light.

Available in [, ] and [, ] shooting modes. Applies to movies recorded with a frame rate of **50.00P** or **59.94P**.

● Disable

Enables you to shoot movies with smoother, more natural movement, less affected by subject shake than when set to **[Enable]**. Note that under low light, movies may be darker than when set to **[Enable]**.

● Enable

Enables you to shoot brighter, less noisy movies than when set to **[Disable]** by automatically reducing the shutter speed to a maximum of 1/30 sec. (NTSC) or 1/25 sec. (PAL) under low light.



Setting to **[Disable]** is recommended when shooting moving subjects under low light, or when afterimages such as trails may occur.



● Metering timer ☆

For details on the metering timer, see page 119.

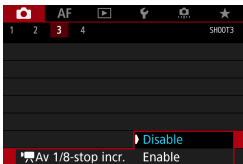

● Av 1/8-stop increments ☆



You can set aperture values on a finer scale when shooting movies with an RF lens.

Select **[Enable]** to change the aperture increment from 1/3 stop (or 1/2 stop) to 1/8 stop in [Av] or [M] mode.



- [ Av 1/8-stop incr.] is not available (not displayed) when EF or EF-S lenses are used.
- Even when set to **[Enable]**, aperture cannot be set in 1/8-stop increments with EF or EF-S lenses.
- When set to **[Enable]**, setting options in [ 1: Exposure level increments] are disabled and have no effect.

[📷4] ☆

● **White balance ☆**

For details on white balance, see page 97.

● **Custom White Balance ☆**

For details on custom white balance, see page 100.

● **White balance correction ☆**

For details on white balance correction, see page 102.

● **Picture Style ☆**

For details on Picture Styles, see page 88.

● **Canon Log settings ☆**

For details on Canon Log, see page 236.

● **High ISO speed noise reduction ☆**

For details on High ISO speed noise reduction, see page 105.

● HDMI display

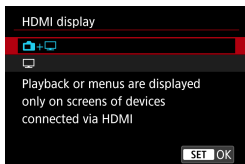

You can specify how movies are displayed as they are recorded via HDMI to an external device. Movie output itself is either 4K (3840×2160) or Full HD (1920×1080), depending on the **[Movie rec. size]** setting.

The default setting for HDMI display is **[📷+🖥️]**.



● 📷+🖥️

- Enables movie display both on the camera screen and on the other device, via HDMI output.
- Camera operations such as image playback or menu display are shown on the other device via HDMI, not on the camera.

● 🖥️

- Deactivates the camera screen during output via HDMI, so that the screen is blank.
- Shooting information, AF points, and other information is shown on the other device via HDMI, but as you watch an external monitor or other device connected to the recorder, you can stop output of this information by pressing the <INFO> button.
- Before recording movies to an external device, confirm that no information is being sent by the camera, so that no shooting information, AF points, and so on is displayed on the external monitor or other device.

? For Longer HDMI Output

To continue HDMI output for longer than 30 min., select [+>], then set [**Auto power off**] under [**2: Power saving**] to [**Disable**] (p.377). HDMI output will continue after the screen turns off when the time set in [**Display off**] elapses.



- HDMI output without information prevents display of warnings about the card space, battery level, or high internal temperature (p.253) via HDMI.
- During HDMI output, display of the next image may take some time if you switch between movies of different recording qualities or frame rates.
- Avoid operating the camera when recording movies to external devices, which may cause information to be displayed in the HDMI video output.
- Brightness and color of movies shot with the camera may look different from that of HDMI video output recorded by external recording devices, depending on the viewing environment.



- You can change the information displayed by pressing the <INFO> button.
- Time codes can be added to HDMI video output (p.207).
- Audio is also output via HDMI, except when [**Sound rec.**] is set to [**Disable**].



General Movie Shooting Cautions

Red <🔥> Internal Temperature Warning Icon

- If the camera's internal temperature increases due to prolonged movie shooting or under a high ambient temperature, a red <🔥> icon will appear.
- The red <🔥> icon indicates that movie shooting will soon be terminated automatically. If this happens, you will not be able to shoot again until the camera's internal temperature decreases. Turn off the power and let the camera rest for a while.
- Shooting a movie at a high temperature for a prolonged period will cause the red <🔥> icon to appear earlier. When you are not shooting, always turn off the camera.

Recording and Image Quality

- If the attached lens has an Image Stabilizer and you set the Image Stabilizer (IS) switch to <ON>, the Image Stabilizer will operate at all times even if you do not press the shutter button halfway. The Image Stabilizer consumes battery power and may shorten the total movie shooting time depending on the shooting conditions. When the Image Stabilizer is not necessary, such as when using a tripod, it is recommended that you set the IS switch to <OFF>.
- If the brightness changes as you shoot a movie with auto exposure or shutter priority AE, the movie may appear to stop momentarily. In such a case, shoot movies with manual exposure.
- If there is a very bright light source in the image, the bright area may appear black on the screen. The movie will be recorded almost exactly as it appears on the screen.
- In low light, noise or irregular colors may appear in the image. Movies are recorded almost exactly as they appear on the screen, except in time-lapse movie shooting or with Canon Log View Assist.
- If you play back a movie with other devices, image or sound quality may decline or playback may not be possible (even if the devices support MP4 format).

General Movie Shooting Cautions

Recording and Image Quality

- If you use a card with a slow writing speed, an indicator may appear on the right of the screen during movie shooting. It indicates how much data has not yet been written to the card (remaining capacity of the internal buffer memory). The slower the card, the faster the indicator will climb upward. If the indicator (1) becomes full, movie shooting will stop automatically.
- If the card has a fast writing speed, the indicator will either not appear or the level (if displayed) will hardly go upward. First, shoot a few test movies to see if the card can write fast enough.
- If the indicator indicates that the card is full and movie shooting stops automatically, the sound near the end of the movie may not be recorded properly.
- If the card's writing speed is slow (due to fragmentation) and the indicator appears, formatting the card may make the writing speed faster.



Restrictions in IPB Recording

Note that the following restrictions apply when the compression method for movie recording quality is **IPB** or **IPB** (audio: AAC).

- Sound will not be recorded for approx. the last two frames.
- When you play back movies on Windows, movie images and sound may become slightly out of synchronization.

3

AF

This chapter describes autofocus operation and introduces menu settings on the AF (**[AF]**) tab.

- A ☆ icon to the right of a page title indicates that the function is available only in **[Fv]**, **[P]**, **[Tv]**, **[Av]**, **[M]**, or **[BULB]** mode.



<AF> stands for autofocus. <MF> stands for manual focus.

Tab Menus: AF (Still Photos)

● AF1

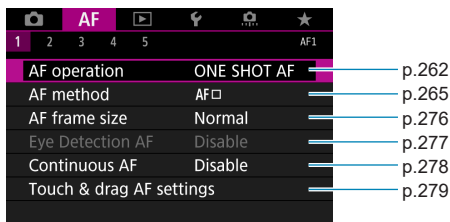

● AF2

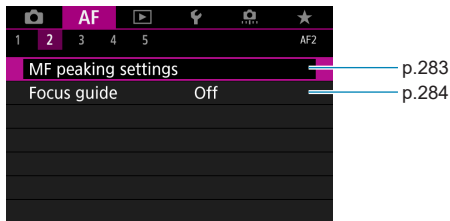

● AF3

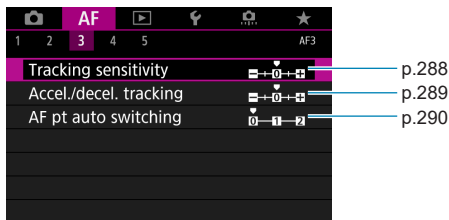

● AF4

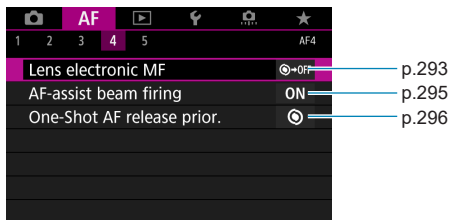

● AF5

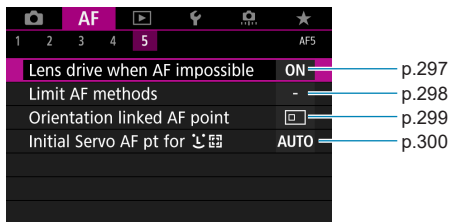

 Features in [AF3], [AF4], and [AF5] menus are described in the camera's Help system (p.405).

In [**A⁺**] mode, the following screen is displayed.

● AF1

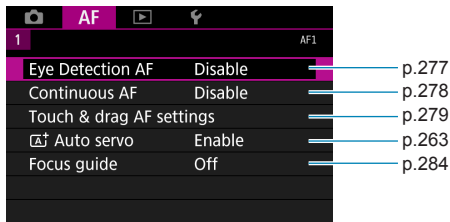

Tab Menus: AF (Movies)

● AF1

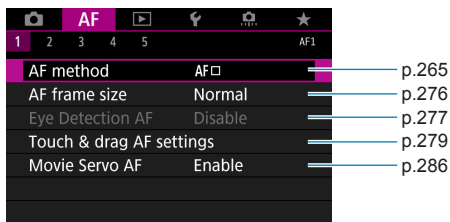

● AF2

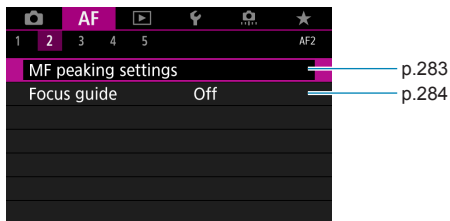

● AF3

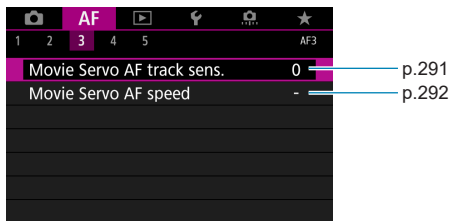

● AF4

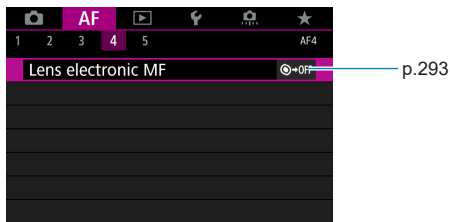

● AF5

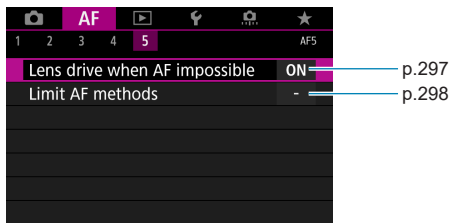

 Features in **[AF3]**, **[AF4]**, and **[AF5]** menus are described in the camera's Help system (p.405).

In [AF] mode, the following screen is displayed.

● AF1

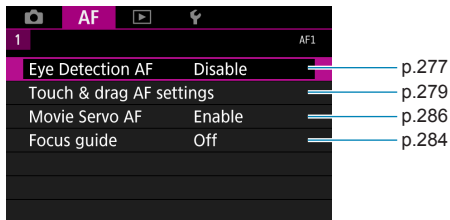

Selecting the AF Operation ☆

You can select the AF operation characteristics to suit the shooting conditions or subject.

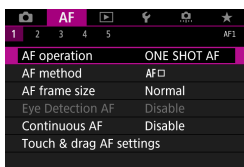

1 Select [AF1: AF operation].



2 Select an item.



If focus cannot be achieved, the AF point will turn orange. If this occurs, the picture cannot be taken even if the shutter button is pressed completely. Recompose the shot and try to focus again. Or, see “Shooting Conditions that Make Focusing Difficult” (p.275).

One-Shot AF for Still Subjects (ONE SHOT)

Suited for still subjects. When you press the shutter button halfway, the camera will focus only once.

- When focus is achieved, the AF point will turn green and the beeper will sound.
- The focus remains locked while you hold down the shutter button halfway, allowing you to recompose the image before taking the picture.
- For details on the continuous shooting speed for continuous shooting, see p.144.



If [**3: Beep**] is set to [**Disable**], the beeper will not sound when focus is achieved.

Servo AF for Moving Subjects (SERVO)

This AF operation is suited for moving subjects. While you hold down the shutter button halfway, the camera will keep focusing on the subject continuously.

- When focus is achieved, the AF point will turn blue.
- The exposure is set at the moment the picture is taken.
- For details on the continuous shooting speed for continuous shooting, see p.144.



- Depending on the lens used, the distance to the subject and the subject's speed, the camera may not be able to achieve correct focus.
- Zooming during continuous shooting may throw off the focus. Zoom first, then recompose and shoot.
- When [**Servo AF**] is set and [**Multi Shot Noise Reduction**] is set (p.105), [**5: High ISO speed NR**] will automatically switch to [**Standard**].



- With Servo AF, the beeper will not sound even when focus is achieved.
- In [**A+**] mode, by default, the camera automatically switches to Servo AF in response to subject movement. If you normally prefer to shoot with One-Shot AF, set [**AF1: A+ Auto servo**] to [**Disable**].

AF-Assist Beam

Under low light, the AF-assist beam may be lit continuously when you press the shutter button halfway. This makes it easier to focus with AF.

- The AF-assist beam does not fire when **[AF1: AF operation]** is set to **[Servo AF]**.
- The AF-assist beam does not fire when Touch AF is used (when **[CAMERA 5: Touch Shutter]** is set to **[Disable]**).
- A small series of flashes is fired by external flash units equipped with an IR AF-assist beam. However, the beam does not fire when you are using a Speedlite 90EX, Macro Ring Lite, or Macro Twin Lite, or in wireless flash shooting using radio or optical transmission.
- A small series of flashes is fired even if you set the external flash's AF-assist beam emission method in the Personal Functions to infrared AF-assist beam firing. To disable AF-assist beam firing, set **[AF4: AF-assist beam firing]** to **[Disable]** (p.295).

- Focus range with the AF-assist beam is generally no more than 4 meters / 13.1 feet.
- The AF-assist beam firing in **[Fv]**, **[P]**, **[Tv]**, **[Av]**, **[M]**, and **[BULB]** modes depends on the setting in **[AF4: AF-assist beam firing]** (p.295).

Selecting the AF Method

You can select the AF method to suit the shooting conditions or subject. The camera attempts to focus on faces of any people in an AF point or Zone AF frame. In **[AF+]** mode, **[AF+Tracking]** is set automatically. For instructions on selecting an AF method, see page 268.

AF Method



Face+Tracking

The camera detects and focuses on human faces. The AF point **<[]>** appears over a detected face, which is then tracked.

If no face is detected, the entire AF area is used for auto selection AF. With Servo AF, you can set the initial position for Servo AF (p.270). As long as the Area AF frame can track the subject during shooting, focusing will continue.



1-point AF

The camera focuses using a single AF point **<[]>**.

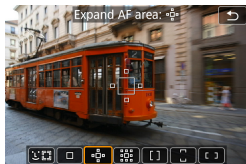

☐ : Expand AF area (☐)

Focusing uses one AF point <☐> and points above, below, and to the left and right <☐>. Effective for moving subjects, which are difficult to track with 1-point AF.

Although Servo AF requires you to focus on a subject initially with an AF point <☐>, focusing is easier with this AF method than with Zone AF.

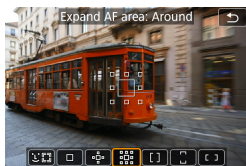

☐☐☐☐ : Expand AF area: Around

Focusing uses one AF point <☐> and surrounding points <☐>.

Enables focusing over a wider area than ☐☐☐☐ AF point expansion. Effective for moving subjects, which are difficult to track with 1-point AF.

Servo AF operation is the same as for ☐☐☐☐ AF point expansion.



[] : Zone AF

Uses auto selection AF in Zone AF frames to cover a larger area than AF point expansion, which makes focusing easier than with 1-point AF/AF point expansion and also effective for moving subjects.

Generally focuses on the nearest subject. Note the camera attempts to focus on faces of any people in the Zone AF frame.

AF points in focus are displayed with <☐>.

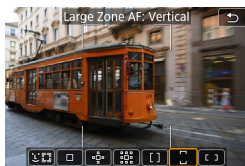

: **Large Zone AF: Vertical**

Uses auto selection AF in a vertical Large Zone AF frame to cover a larger area than Zone AF, which makes focusing easier than with 1-point AF/AF point expansion and also effective for moving subjects.

Generally focuses on the nearest subject. Note the camera attempts to focus on faces of any people in the Zone AF frame.

AF points in focus are displayed with .

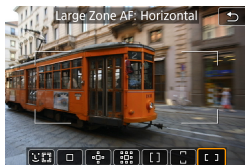

: **Large Zone AF: Horizontal**

Uses auto selection AF in a horizontal Large Zone AF frame to cover a larger area than Zone AF, which makes focusing easier than with 1-point AF/AF point expansion and also effective for moving subjects.

Generally focuses on the nearest subject. Note the camera attempts to focus on faces of any people in the Zone AF frame.

AF points in focus are displayed with .

Selecting the AF Method ☆

You can select the AF method to suit the shooting conditions or subject. If you prefer to focus manually, see page 281.

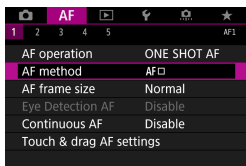

1 Select [AF1: AF method].

2 Select an item.











- To set the AF method, you can also access the AF method screen by pressing the <[AF]> button and then the <M-Fn> button.
- The descriptions on pages 269–272 assume that [AF1: AF operation] is set to [One-Shot AF] (p.263). With [Servo AF] (p.263) set, the AF point will turn blue when focus is achieved.
- Regarding the Touch Shutter (AF and shutter release by touch operation), see page 130.

● **☺ (face)+Tracking:**

The camera detects and focuses on human faces. If a face moves, the AF point  also moves to track the face.



1 Check the AF point.

- ▶  (an AF point) appears over any face detected.
- To choose a different face, first press the  button, after which  appears when multiple faces are detected. Use the   keys to move  over the face you want to focus on.
- To switch **[Eye Detection AF]** between **[Enable]** and **[Disable]**, press the  button repeatedly after pressing the  button (p.277).
- You can also tap on the screen to select the face or subject. Tapping the screen changes the AF point to .



2 Focus on the subject.

- Press the shutter button halfway to focus.
- ▶ When focus is achieved, the AF point will turn green and the beeper will sound.
- ▶ An orange AF point is displayed if the camera cannot focus.

3 Take the picture.

Specifying a Subject for Focus

On the screen, tap where you want to focus, whether on a subject or at a certain position.

Once the AF point achieves focus, the AF point will also move to track the subject if you change the composition or if the subject moves.

- If the subject's face is significantly out of focus, face detection will not be possible. Adjust the focus manually (p.281) so that the face can be detected, then perform AF.
- An object other than a human face may be detected as a face.
- Face detection will not work if the face is very small or large in the picture, too bright or too dark, or partially hidden.
- The may cover only a part of the face, not the whole face.

- AF cannot detect subjects or people's faces at the edges of the screen. Recompose the shot to center the subject or bring the subject closer to the center.
- The size of the AF point changes depending on the subject.

Setting the Initial Servo AF Position

1. Set [**AF5: Initial Servo AF pt for**] to an option other than **[Automatic]**.
2. An Area AF frame (1) and AF point (2) are displayed.

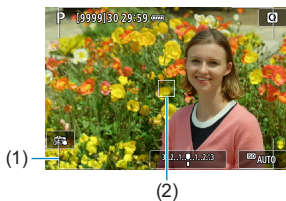

3. Press the button, then turn the or dial to move the AF point to the position to focus on. You can also move the AF point by touching the screen or pressing the cross keys. Pressing the button will return the AF point to the screen center.
4. Press to set the current position as the starting position for Servo AF.

● **1-point AF / Expand AF area () / Expand AF area: Around / Zone AF / Large Zone AF: Vertical / Large Zone AF: Horizontal ☆**

You can manually set the AF point or Zone AF frame. Here, 1-point AF screens are used as an example.









(1)

1 Check the AF point.

- ▶ The AF point (1) will appear.
- With Expand AF area () or Expand AF area: Around, adjacent AF points are also displayed.
- With Zone AF, Large Zone AF (Vertical), or Large Zone AF (Horizontal), the specified Zone AF frame is displayed.



2 Move the AF point.

- Press the  button.
- Move the AF point to where you want to focus by turning the  dial to move horizontally or  dial to move vertically. (With some lenses, it may not go to the edge of the screen.)
- You can also move the AF point by touching the screen or pressing the  cross keys.
- To center the AF point or Zone AF frame, press the  button.
- To magnify display, press the  button. Each press of the  button changes the magnification ratio.

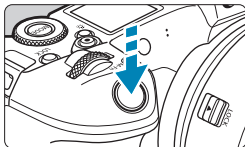

3 Focus on the subject.

- Aim the AF point over the subject and press the shutter button halfway.
- ▶ When focus is achieved, the AF point will turn green and the beeper will sound.
- ▶ If focus is not achieved, the AF point will turn orange.





4 Take the picture.

- The camera will keep moving the active AF point <□> to track subjects for Zone AF, Large Zone AF: Vertical, or Large Zone AF: Horizontal when Servo AF operation is used, but under some shooting conditions (such as when subjects are small), it may not be possible to track the subject.
- Focusing with an AF-assist beam may be difficult when using a peripheral AF point. In this case, select an AF point in the center.

With **[AF5: Orientation linked AF point]**, you can set separate AF points for vertical and horizontal shooting (p.299).

Magnified View

You can check the focus by magnifying display by approx. 5x or 10x. Magnified view is not possible with [+Tracking].

- Magnification is centered on the AF point for [**1-point AF**], [**Expand AF area** ()], and [**Expand AF area: Around**] and is centered on the Zone AF frame for [**Zone AF**], [**Large Zone AF: Vertical**], and [**Large Zone AF: Horizontal**].
- Autofocusing is performed with magnified display if you press the shutter button halfway when set to [**1-point AF**]. When set to other AF methods, autofocusing is performed after restoring normal display.
- With Servo AF, if you press the shutter button halfway in the magnified view, the camera will return to the normal view for focusing.



- If focusing is difficult in the magnified view, return to the normal view and perform AF.
- If you perform AF in the normal view and then use the magnified view, accurate focus may not be achieved.
- AF speed differs between normal view and magnified view.
- Continuous AF and Movie Servo AF are not available when display is magnified.
- With the magnified view, achieving focus becomes more difficult due to camera shake. Using a tripod is recommended.

Notes for AF

AF Operation

- Even when focus is achieved, pressing the shutter button halfway will focus again.
- Image brightness may change during autofocusing.
- Depending on the subject and shooting conditions, it may take longer to focus, or the continuous shooting speed may decrease.
- If the light source changes as you shoot, the screen may flicker, and focusing may be difficult. In this case, restart the camera and resume shooting with AF under the light source you will use.



- If focusing is not possible with AF, focus manually (p.281).
- For subjects at the edge of the screen that are slightly out of focus, try centering the subject (or AF point, or Zone AF frame) to bring them into focus, then recompose the shot before shooting.
- With certain lenses, it may take more time to achieve focus with autofocus, or accurate focusing may not be achieved.

Shooting Conditions that Make Focusing Difficult

- Subject with low-contrast such as the blue sky, solid-color flat surfaces or when highlight or shadow details are clipped.
- Subjects in low light.
- Stripes and other patterns where there is contrast only in the horizontal direction.
- Subjects with repetitive patterns (Example: Skyscraper windows, computer keyboards, etc.).
- Fine lines and subject outlines.
- Under a light source whose brightness, color, or pattern keeps changing.
- Night scenes or points of light.
- The image flickers under fluorescent or LED lighting.
- Extremely small subjects.
- Subjects at the edge of the screen.
- Strongly backlit or reflective subjects (Example: Car with a highly reflective body, etc.).
- Near and distant subjects covered by an AF point (Example: Animal in a cage, etc.).
- Subjects that keep moving within the AF point and will not stay still due to camera shake or subject blur.
- Performing AF when the subject is very far out of focus.
- Soft focus effect is applied with a soft focus lens.
- A special effect filter is used.
- Noise (dots of light, banding, etc.) appears on the screen during AF.

AF Range

The available autofocus range varies depending on the lens and aspect ratio used and whether you are shooting 4K movies or using features such as Movie cropping or Movie digital IS.

Setting the AF Point Size ☆

For pinpoint focusing, you can set [AF frame size] to [Small].

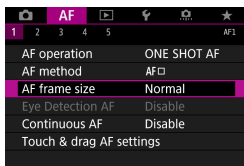

1 Select [AF1: AF frame size].

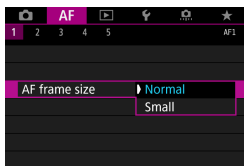

2 Select an item.



Only available when [AF1: AF method] is set to [1-point AF].

Focusing on People's Eyes

With the AF method set to [**L**+Tracking], you can shoot with the subject's eyes in focus.

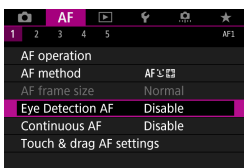

1 Select [**AF 1: Eye Detection AF**].

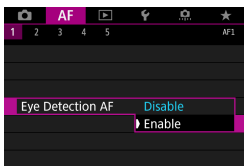

2 Select [**Enable**].



3 Aim the camera at the subject.

- ▶ An AF point is displayed around their eye.
- You can also touch the screen to select an eye. Eyes to focus on are selected automatically.
- Depending on the [**Eye Detection AF**] setting, you can choose an eye or face for focus with the <◀> <▶> keys when <👁> appears after you press the <👁> button.

4 Take the picture.



Subject eyes may not be detected correctly, depending on the subject and shooting conditions.



To disable Eye Detection AF without using menu operations, press these buttons, one after another: <👁>, <M-Fn>, and <INFO>. To resume Eye Detection AF, press the <INFO> button again.

Setting Continuous AF

This function keeps subjects generally in focus. The camera is ready to focus immediately when you press the shutter button halfway.

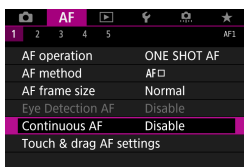

1 Select [AF1: Continuous AF].

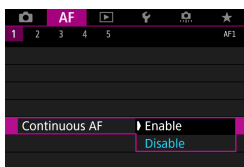

2 Select [Enable].

- Enabling this function reduces the number of shots available, because the lens is driven continuously and battery power is consumed.
- Before setting the lens focus mode switch to <MF> during Continuous AF, set the camera's power switch to <OFF>.

Setting Touch & Drag AF

You can move the AF point or Zone AF frame by touching or dragging on the screen as you look through the viewfinder.

Enabling Touch & Drag AF

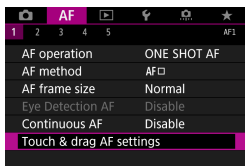

1 Select [AF1: Touch & drag AF settings].

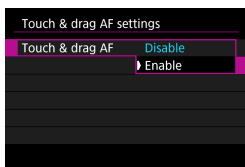

2 Select [Touch & drag AF].
● Select [Enable].

Positioning Method

You can set how positions are specified by touching or dragging.

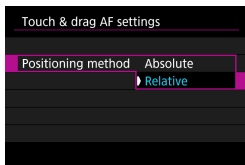

1 Set the positioning method.
● Select an item.

● **[Absolute]**

The AF point moves to the touched or dragged position on the screen.

● **[Relative]**

The AF point moves in the direction you drag, by an amount corresponding to the amount you drag, no matter where you touch the screen.

Active Touch Area

You can specify the area of the screen used for touch and drag operations.

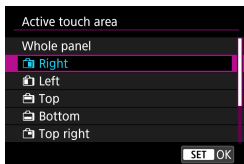

1 Set the active touch area.

- Select an item.



Touching the screen when [**☺+Tracking**] is set displays a round orange frame <⊙>. After you lift your finger at the position to move the AF point to, <⊙> is displayed and that subject is tracked. To cancel subject selection, press the <🗑> button.

MF: Focusing Manually

If focusing is not possible with autofocus, you can magnify the image and focus manually.

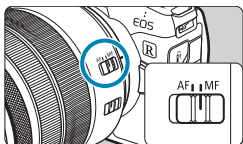

1 Set the lens's focus mode switch to <MF>.

- Turn the lens focusing ring to focus roughly.

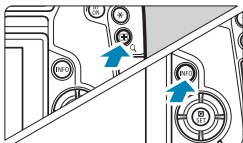

2 Magnify the image.

- Press the <Q> button, then the <INFO> button.

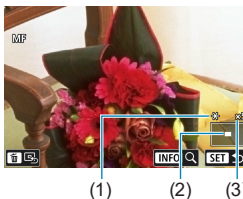

3 Move the magnified area.

- Move the area horizontally by turning the <gear> dial or vertically by turning the <gear> dial. You can also move the area by pressing the <cross keys>.
- To center the magnified area again, press the <trash> button.

(1) AE lock

(2) Magnified area position

(3) Magnification (Approx.)

4 Adjust magnification.

- Each press of the <INFO> button changes the magnification ratio, as follows.

→ 1x → 5x → 10x →

5 Focus manually.

- While looking at the magnified image, turn the lens focusing ring to focus.
- After focusing, press <SET> to return to the normal view.

6 Take the picture.



- In magnified view, the exposure is locked.
- Even with manual focusing, you can use the Touch Shutter to take a picture.

Setting MF Peaking (Outline Emphasis) ☆

Edges of subjects in focus can be displayed in color to make focusing easier. You can set the outline color and adjust the sensitivity (level) of edge detection.

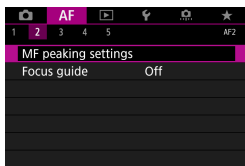

1 Select **[AF2: MF peaking settings]**.

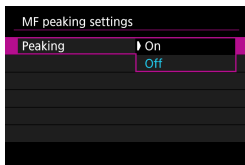

2 Select **[Peaking]**.
● Select **[On]**.

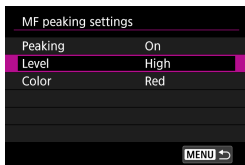

3 Set the level and color.
● Set it as necessary.



- Peaking display is not shown during magnified display.
- MF peaking may be hard to discern at high ISO speeds, especially when ISO expansion is set. If necessary, lower the ISO speed or set **[Peaking]** to **[Off]**.



- Peaking display shown on the screen is not recorded in images.
- MF peaking may be hard to discern when Canon Log is set. If necessary, set **[View Assist.]** to **[On]**.

Focus Guide

Setting **[Focus guide]** to **[On]** provides a visual guide that shows which direction to adjust focus and the extent of adjustment needed. The guide frame is displayed near any eyes that are detected for the main subject when **[AF1: AF method]** is set to **[L +Tracking]** and **[AF1: Eye Detection AF]** is set to **[Enable]**.

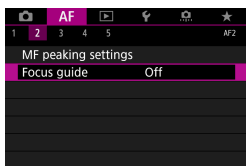

1 Select [AF2: Focus guide].

- In [A] mode, it is shown on the [AF1] tab.

2 Select [On].

- To move the guide frame, press the $\langle \text{Grid} \rangle$ button, then press the $\langle \text{Cross} \rangle$ cross keys.
- You can also touch the screen to move the guide frame.
- To center the guide frame, press the $\langle \text{Trash} \rangle$ button.

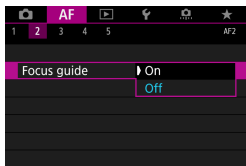

The guide frame indicates the direction and extent of adjustment as follows.

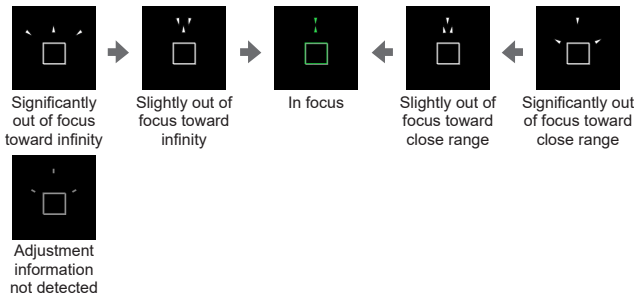



- Under difficult shooting conditions for AF (p.275), the guide frame may not be displayed correctly.
- No AF points are displayed while the guide frame is displayed.
- No adjustment information is detected for apertures darker than $f/8$ when MP-E 65mm $f/2.8$ 1-5x Macro Photo is used or darker than $f/11$ for other lenses, as indicated by the Focus Guide appearance.
- The guide frame is not displayed in these situations.
 - When the lens's focus mode switch is set to $<AF>$
 - When display is magnified
 - When you are shooting High Frame Rate movies
- The guide frame is not displayed correctly after you shift or tilt a TS-E lens.



The camera's auto power off counter does not count time spent adjusting the focus with a lens's electronic focusing ring.

Setting Movie Servo AF

With this function enabled, the camera focuses on the subject continuously during movie shooting.

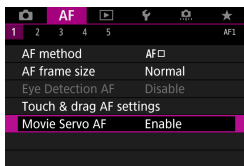

1 Select [AF1: Movie Servo AF].

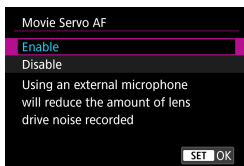

2 Select [Enable].

● When [Enable] is set:

- The camera focuses on the subject continuously even when you are not pressing the shutter button halfway.
- To keep the focus at a specific position, or if you prefer not to record mechanical sounds from the lens, you can temporarily stop Movie Servo AF by touching [] in the lower left of the screen.
- When Movie Servo AF is paused, if you return to movie shooting after operations such as pressing the <MENU> or <▶> button or changing the AF method, Movie Servo AF will resume.

● When [Disable] is set:

- Press the shutter button halfway or press the <> button to focus.



Cautions When [Movie Servo AF] is Set to [Enable]

● Shooting Conditions that Make Focusing Difficult

- A fast-moving subject approaching or moving away from the camera.
 - A subject moving at a close distance to the camera.
 - When shooting with a higher f/number.
 - Also see “Shooting Conditions that Make Focusing Difficult” on page 275.
- Since the lens is driven continuously and the battery power is consumed, the possible movie shooting time (p.612) will be shortened.
 - With certain lenses, the mechanical sound for focusing may be recorded. In such a case, using Directional Stereo Microphone DM-E1 (sold separately) may reduce such sounds in the movie.
 - Movie Servo AF will pause during zooming or magnified view.
 - During movie shooting, if a subject approaches or moves away or if the camera is moved vertically or horizontally (panning), the recorded movie image may momentarily expand or contract (change in image magnification).
 - Before setting the lens focus mode switch to <MF> during Movie Servo AF, set the camera's power switch to <OFF>.

Customizing AF Functions ☆

[AF3]

● Tracking sensitivity

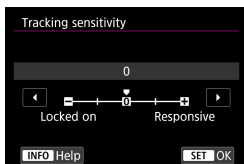

You can set the subject-tracking sensitivity, which affects responsiveness to interfering objects that move across AF points or subjects that stray from AF points during Servo AF.

● 0

Standard setting. Suitable for moving subjects in general.

● Locked on: -2 / Locked on: -1

The camera will try to continue focusing on the subject even if an obstacle cuts across the AF points or if the subject strays from the AF points. The -2 setting makes the camera keep tracking the target subject longer than the -1 setting.

However, if the camera focuses on a wrong subject, it may take slightly longer to switch and focus on the target subject.

● Responsive: +2 / Responsive: +1

The camera can focus consecutively on subjects at different distances that are covered by the AF points. Also effective when you want to always focus on the closest subject. The +2 setting is more responsive than the +1 setting when focusing on the next subject.

However, the camera will be more prone to focus on an unintended subject.

● Acceleration/deceleration tracking

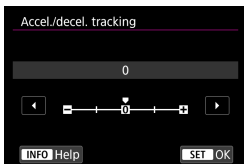

Sets the Servo AF tracking sensitivity for subjects that change speed suddenly, as by suddenly moving or stopping.

● 0

Suited for subjects that move at a steady speed (minor changes in moving speed).

● -2 / -1

Suited for subjects that move at a steady speed (minor changes in moving speed). Effective when a setting of 0 makes focus unstable, due to slight subject movement or an obstruction in front of the subject.

● +2 / +1

Effective for subjects having sudden movements, sudden acceleration/deceleration, or sudden stops. Even if the moving subject's speed suddenly changes dramatically, the camera continues to focus on the target subject. For example, the camera is less likely to focus behind a subject that suddenly starts approaching you, or in front of an approaching subject that suddenly stops moving. Setting +2 can track dramatic changes in the moving subject's speed better than with +1.

However, since the camera will be sensitive to even slight movements of the subject, focusing may become unstable for short periods.

● AF point auto switching

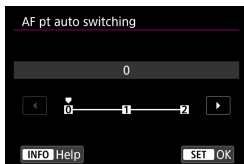

This sets the switching sensitivity of the AF points as they track the subject moving dramatically up, down, left, or right.

Takes effect when [**AF1: AF method**] is set to [**Face+Tracking**], [**Expand AF area: \square**], [**Expand AF area: Around**], [**Zone AF**], [**Large Zone AF: Vertical**], or [**Large Zone AF: Horizontal**].

● 0

Standard setting for gradual AF point switching.

● +2 / +1

Even if the target subject moves dramatically up, down, left, or right and moves away from the AF point, the camera switches its focus to neighboring AF points to continue focusing on the subject. The camera switches to the AF point deemed most likely to focus on the subject based on the subject's continual movement, contrast, etc. Setting +2 makes the camera more prone to switch the AF point than with +1.

However, with a wide-angle lens having a wide depth of field or if the subject is too small in the frame, the camera may focus with an unintended AF point.

● Movie Servo AF track sensitivity

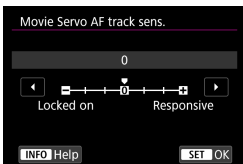

You can adjust the tracking sensitivity (to one of seven levels), which affects responsiveness if the subject strays from the AF point during Movie Servo AF, as when interfering objects move across AF points or when you pan.

This function is settable when **[AF1: Movie Servo AF]** is set to **[Enable]** and **[AF1: AF method]** is set to **[1-point AF]**.

● Locked on: -3/-2/-1

With this setting, the camera is less likely to track a different subject if the main subject strays from the AF point. The closer the setting is to the minus (-) symbol, the less the camera is inclined to track a different subject. It is effective when you want to prevent the AF points from rapidly tracking something that is not the intended subject during panning or when an obstacle cuts across the AF points.

● Responsive: +1/+2/+3

This makes the camera more responsive when tracking a subject that covers the AF point. The closer the setting is to the plus (+) symbol, the more responsive the camera is. It is effective when you want to keep tracking a moving subject as its distance from the camera changes or to rapidly focus on another subject.



Operation when **[AF1: AF method]** is set to an option other than **[1-point AF]** is equivalent to a setting of **[0]**.

● Movie Servo AF speed

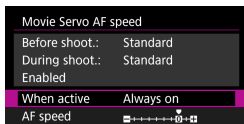

You can set the Movie Servo AF's AF speed and its operation conditions.

This function is settable when **[AF1: Movie Servo AF]** is set to **[Enable]** and **[AF1: AF method]** is set to **[1-point AF]**.

Additionally, the function is enabled when using a lens supporting slow focus transition during movie shooting*.

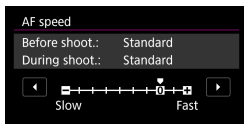

● When active:

You can set **[Always on]** to have the AF speed take effect at all times for movie shooting (before and during movie shooting) or set **[During shooting]** to have the AF speed take effect only during movie shooting.

● AF speed:

You can adjust the AF speed (focus transition speed) from the standard speed (0) to slow (one of seven levels) or fast (one of two levels) to obtain the desired effect for the movie creation.

* Lenses supporting slow focus transition during movie shooting

USM and STM lenses released in and after 2009 are compatible. For details, refer to the Canon Web site.

 With certain lenses, even if you adjust the AF speed, the speed may not change.

- Operation when **[AF1: AF method]** is set to an option other than **[1-point AF]** is equivalent to setting **[AF speed]** to **[Standard (0)]**.
- An asterisk to the right of **[AF3: Movie Servo AF Speed]** indicates that the default setting has been modified.

[AF4]

● **Lens electronic MF**

With the USM and STM lenses equipped with electronic manual focusing, you can set whether to use electronic manual focusing after autofocusing in One-Shot AF mode.



1 Select [AF4: Lens electronic MF].

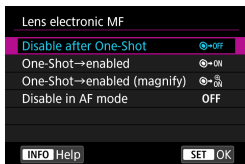

2 Select an item.

● **[C]→OFF] Disable after One-Shot**

Manual focus adjustment after the AF operation is disabled.

● **[C]→ON] One-Shot→enabled**

You can manually adjust the focus after the AF operation if you keep holding down the shutter button halfway.

● **[C]→^MON] One-Shot→enabled (magnify)**

You can manually adjust the focus after the AF operation if you keep holding down the shutter button halfway, and you can magnify the area in focus by turning the lens focusing ring while the button is pressed halfway.

- **[OFF] Disable in AF mode**

Manual focus adjustment is disabled when the lens's focus mode switch is set to <AF>.

 With **[One-Shot → enabled (magnify)]**, display may not be magnified even if you turn the lens focusing ring while pressing the shutter button halfway immediately after shooting. If so, you can magnify display by releasing the shutter button, waiting for <Q > display, then pressing the shutter button halfway as you turn the lens focusing ring.

 For details on whether your lens supports electronic manual focus, refer to the lens instruction manual.

● AF-assist beam firing

Enables or disables the AF-assist beam of the camera or an external Speedlite for EOS cameras.

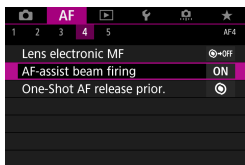

1 Select [AF4: AF-assist beam firing].

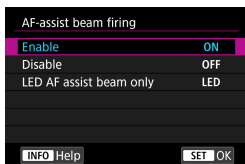

2 Select an item.

● [ON] Enable

Enables firing of the AF-assist beam, when needed.

● [OFF] Disable

Disables firing of the AF-assist beam. Set if you prefer not to fire AF-assist beams from the camera and external flash units.

● [LED] LED AF assist beam only

An LED AF-assist beam is fired by LED-equipped external flash units. If your external flash unit is not LED-equipped, the camera's AF-assist beam is fired instead.



If an external Speedlite's **[AF-assist beam firing]** Custom Function is set to **[Disable]**, this function's setting will be overridden and the AF-assist beam will not be emitted.

● One-Shot AF release priority

You can specify whether to prioritize focus or release timing for One-Shot AF (except when shooting with Touch Shutter).

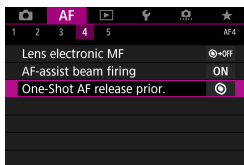

1 Select [AF4: One-Shot AF release prior.].

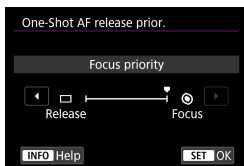

2 Select an item.

● [◎] Focus priority

The picture will not be taken until focus is achieved. Useful when you want to achieve focus before capturing the image.

● [□] Release priority

Shutter release timing is prioritized over focusing. Useful when capturing the decisive moment is most important.

Note that pictures are taken whether or not the subject is in focus.

[AF5]

- **Lens drive when AF impossible**

If focus cannot be achieved with autofocus, you can have the camera keep searching for the precise focus or have it stop searching.

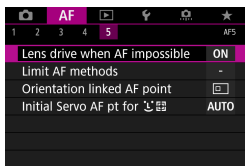

1 Select [AF5: Lens drive when AF impossible].

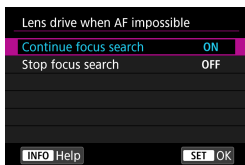

2 Select an item.

- **[ON] Continue focus search**

If focus cannot be achieved with autofocus, the lens is driven to search for the precise focus.

- **[OFF] Stop focus search**

If autofocus starts and the focus is far off or if focus cannot be achieved, the lens drive will not be performed. This prevents the lens from becoming grossly out of focus due to the focus search drive.



When focus search drive is performed using a super telephoto lens or a lens with a wide focusing drive range, the lens can become grossly out of focus, and it may take more time to achieve focus next time. Setting **[Stop focus search]** is recommended.

● Limit AF methods

You can limit the AF methods available to those that you will use. For details on AF methods, see page 265.

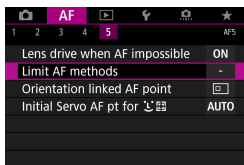

1 Select [**AF5: Limit AF methods**].

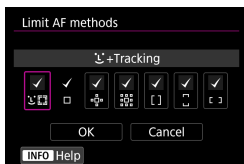

2 To limit the available AF methods, add a checkmark [✓] to the ones to display.

! The [✓] mark cannot be removed from [**1-point AF**].

i An asterisk to the right of [**AF5: Limit AF methods**] indicates that the default setting has been modified.

● Orientation linked AF point

You can assign AF points or Zone AF frames to different positions based on whether you are shooting vertically or horizontally.

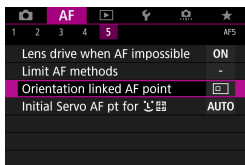

1 Select [AF5: Orientation linked AF point].

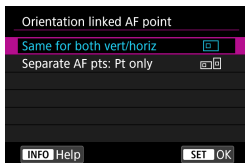

2 Select an item.

-  **Same for both vert/horiz**

AF points or Zone AF frames in the same position are used for both vertical and horizontal shooting.

-  **Separate AF pts: Pt only**

Separate AF point or Zone AF frame positions can be assigned for each camera orientation (1. Horizontal, 2. Vertical with the camera grip above, 3. Vertical with the camera grip below). Useful when switching to AF points or Zone AF frames in other positions automatically based on camera orientation. AF points or Zone AF frames assigned to each of the three camera orientations are retained.



Clearing all camera settings (p.419) restores this setting to **[Same for both vert/horiz]**. Settings for orientations 1–3 are cleared, and the camera is set to use the center AF point in 1-point AF.

● Initial Servo AF pt for

You can set the initial AF point for Servo AF when the AF method is set to **[Face+Tracking]**.

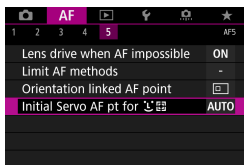

1 Select **[AF5: Initial Servo AF pt for **].

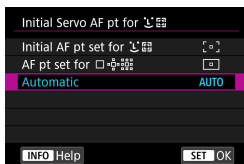



2 Select an item.

● Initial AF pt set for

Servo AF starts from the manually set AF point when AF operation is set to **[Servo AF]** and the AF method is set to **[+Tracking]**.

● AF pt set for

If you switch from 1-point AF, Expand AF area () , or Expand AF area: Around to **[+Tracking]**, Servo AF starts from the manually set AF point. Useful for starting Servo AF from the specified AF point before switching to **[+Tracking]**.

● **[AUTO] Automatic**

The initial AF point of Servo AF for **[+Tracking]** is set automatically to suit the shooting conditions.

4

Playback

This chapter covers topics related to playback—playing back captured still photos and movies—and introduces menu settings on the Playback ([▶]) tab.

Images shot and saved with another device

Normal display or selection on this camera may not be possible for images captured on other cameras, or images from this camera that have been edited or renamed on a computer.

Tab Menus: Playback

● Playback 1

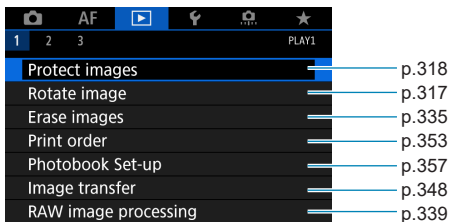

● Playback 2

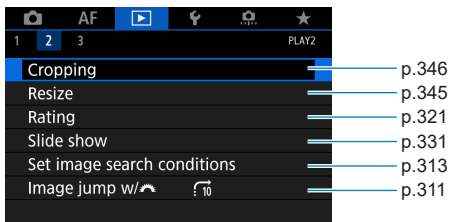

● Playback 3

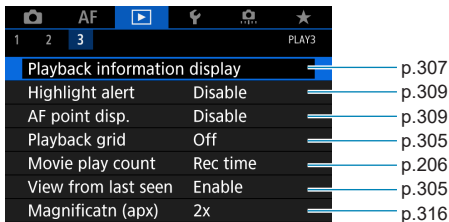

! [▶] 1: RAW image processing is not shown in [A+] or [A*] mode.

Index to Features: Playback and Related Operations

Playback

- Single-image display → p.304
- Shooting information display → p.305
- Grid display → p.305
- Touch playback → p.306
- Playback information display → p.307
- Index display → p.310
- Image browsing (Jump display) → p.311
- Setting image search conditions → p.313
- Magnified view → p.315
- Image rotation → p.317
- Protect → p.318
- Rating → p.321
- Movie playback → p.325
- Editing a movie's first and last scenes → p.327
- Frame Grab (4K) → p.329
- Slide show → p.331
- Viewing images on a television → p.333
- Erasing → p.335

Image Editing

- RAW image processing → p.339
- Resizing JPEGs → p.345
- Cropping JPEGs → p.346

Image Transfer

- Image transfer to a computer/FTP server → p.348
- Print order (DPOF) → p.353
- Photobook Set-up → p.357

▶ Image Playback

Single-Image Display



- 1 Play back the image.**
 - Press the <▶> button.

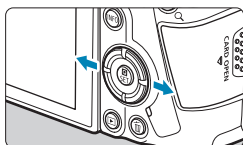

- 2 Select an image.**
 - To play back newer images, press the <▶> button, and to play back older images, press the <◀> button.
 - Each time you press the <INFO> button, the display will change.

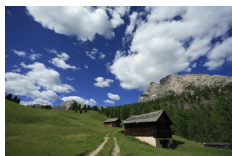

No information



Basic information display

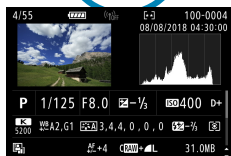

Shooting information display

- 3 Exit the image playback.**
 - Press the <▶> button to exit the image playback.

Shooting Information Display

With the shooting information screen displayed, you can press the <▲> <▼> keys to change the information displayed. You can also customize the information displayed, in [▶3: Playback information display] (p.307).

Specifying Initial Image Display When Playback Begins

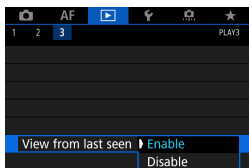

You can specify which image is displayed first when you start image playback.

Playback resumes from the last image played (except when you have just finished shooting) when [▶3: View from last seen] is set to [Enable]. To resume playback from your most recent shot, set to [Disable] and restart the camera.

Grid Display

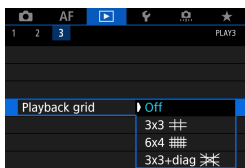

In single-image display, you can display a grid over the images you view. You can choose the type of grid in [▶3: Playback grid].

This function is convenient for checking the image's vertical or horizontal tilt as well as composition.



The grid is not displayed during movie playback.

Touch Playback

The camera features a touch-screen panel that you can touch to control playback. Supported touch operations are like those used with smartphones and similar devices. First, press the <▶> button to prepare for touch playback.

Browsing images



Jump display



Index display

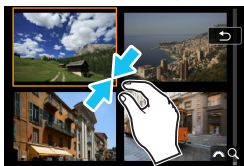

Magnified view



You can also magnify display by double-tapping with one finger.

Customizing Playback Information Display

You can specify screens and accompanying information displayed during image playback.

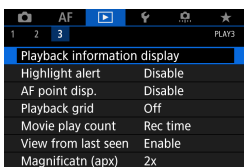

1 Select [**▶**3: Playback information display].

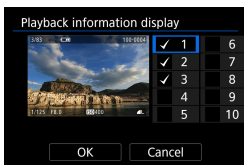

2 Add a checkmark [**✓**] next to the number of screens to display.

- Press the <▲> <▼> keys to select a number.
 - Press <SET> to add a checkmark [**✓**].
 - Repeat these steps to add a checkmark [**✓**] to the number of each screen to display, then select [**OK**].
- ▶ Your selected information can be accessed by pressing the <INFO> button during playback, or by pressing the <▲> <▼> keys when shooting information is displayed.

Histogram

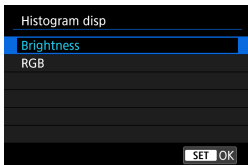

The brightness histogram shows the exposure level distribution and overall brightness. The RGB histogram is for checking the color saturation and gradation. You can switch the histogram displayed by pressing the <INFO> button when <INFO> is displayed in the lower left of the [**▶**3: Playback information display] screen.

● [Brightness] display

This histogram is a graph showing the distribution of the image's brightness level. The horizontal axis indicates the brightness level (darker on the left and brighter on the right) while the vertical axis indicates how many pixels exist for each brightness level. The more pixels there are toward the left, the darker the image. The more pixels there are toward the right, the brighter the image. If there are too many pixels on the left, the shadow detail will be lost. If there are too many pixels on the right, the highlight detail will be lost. The gradation in-between will be reproduced. By checking the image and its brightness histogram, you can see the exposure level inclination and the overall gradation.

Sample Histograms



Dark image



Normal brightness



Bright image

● [RGB] display

This histogram is a graph showing the distribution of each primary color's brightness level in the image (RGB or red, green, and blue). The horizontal axis indicates the color's brightness level (darker on the left and brighter on the right), while the vertical axis indicates how many pixels exist for each color brightness level. The more pixels there are toward the left, the darker and less prominent the color. The more pixels there are toward the right, the brighter and denser the color. If there are too many pixels on the left, the respective color information will be lacking. If there are too many pixels on the right, the color will be too saturated with no gradation. By checking the image's RGB histogram, you can see the color's saturation and gradation condition, as well as white balance inclination.

Highlight Alert

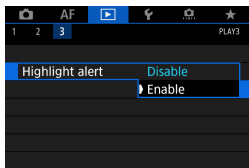

When [**▶ 3: Highlight alert**] is set to **[Enable]**, overexposed, clipped highlights will blink. To obtain more detailed gradation in the blinking areas where you want the gradation to be faithfully reproduced, set the exposure compensation to a negative amount and shoot again for a better result.

AF Point Display

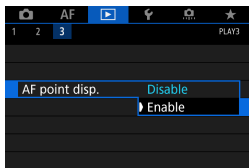

When [**▶ 3: AF point disp.**] is set to **[Enable]**, the AF point that achieved focus will be displayed in red. Note that multiple AF points may be displayed when AF points are automatically selected.

Index Display (Multiple-Image Display)

Search for images quickly with the index display showing 4, 9, 36, or 100 images on one screen.

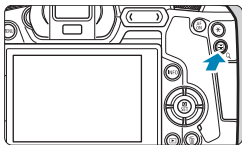

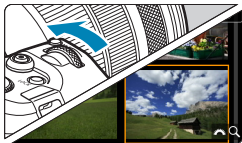

1 Press the <Q> button.

- During image playback, press the <Q> button.
- ▶ [ Q] will be displayed on the lower right of the screen.



2 Switch to the index display.

- Turn the < > dial counterclockwise.
- ▶ The 4-image index display will appear. The selected image is highlighted with an orange frame.
- Turning the < > dial further counterclockwise will switch the display from 9 images, 36 images, and to 100 images. If you turn the dial clockwise, it will rotate through 100, 36, 9, 4, and single-image display.



3 Select an image.

- Press the < > cross keys to move the orange frame and select the image.
- Press <SET> in the index display to display the selected image in the single-image display.

Jump Display (Jumping Through Images)

In the single-image display, you can turn the  dial to jump through the images forward or backward according to the jump method set.

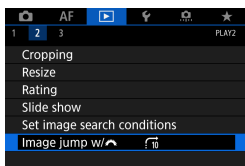

1 Select [2: Image jump w/ ].

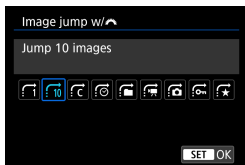

2 Select the jump method.

 Display images one by one

 Jump by 10 images

 Jump images by the specified number

 Display by date

 Display by folder



 Display movies only

 Display stills only

 Display protected images only

 Display by image rating (p.321)



- With [**Jump images by the specified number**], you can turn the  dial to select the number of images to jump by.
- When you select [**Display by image rating**], turn the  dial to specify the rating. If you browse images with ★ selected, all the rated images will be displayed.

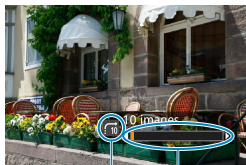

(1)

(2)

3 Browse by jumping.

- Press the <▶> button.
- In the single-image display, turn the <◀▶> dial.
- ▶ You can browse by the set method.

(1) Jump method

(2) Playback position



- To search images by shooting date, select [📅 : **Date**].
- To search images by folder, select [📁 : **Folder**].
- If the card contains both movies and still photos, select [🎞️ : **Movies**] or [📷 : **Stills**] to display one or the other.

Filtering Images for Playback

You can filter image display according to your search conditions. After setting the image search conditions, you can play back and display only the found images.

You can also protect, rate, erase, play a slide show, and apply other operations to filtered images. This feature enables you to quickly do a specific task to the found images in one batch.

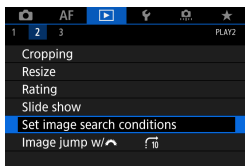



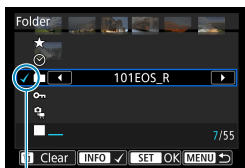







1 Select []2: Set image search conditions].



(1)

2 Set the search conditions.

- Press the <▲> <▼> keys to select an item.
- Press the <◀> <▶> keys to set an option.
- ▶ A checkmark [] (1) is appended to the left of the item. (Specified as the search condition.)
- If you select the item and press the <INFO> button, the checkmark [] will be removed. (The search condition is canceled.)

Item	Description
★ Rating	Displays images with the selected (rating) condition.
<input checked="" type="checkbox"/> Date	Displays images taken on the selected shooting date.
 Folder	Displays images in the selected folder.
 Protect	Displays images with the selected (protect) condition.
 Type of file	Displays images in the selected file type. [ Stills], [ (RAW)], [ (RAW, RAW+JPEG)], [ (RAW+JPEG)], [ (RAW+JPEG, JPEG)], [ (JPEG)], and [ Movies]

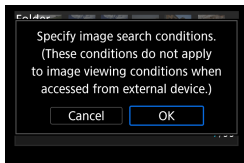

3 Apply the search conditions.

- Press <SET> and read the message displayed.
- Select [OK].
- ▶ The search condition is specified.

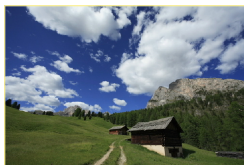

(2)

4 Display the found images.

- Press the <▶> button.
- ▶ Only the images that match the set conditions (filtered) will be played back.
- ▶ When the images are filtered for display, the screen will have an outer yellow frame (2).

Clearing the Search Conditions

Access the screen in step 2, then press the <⏮> button to remove all the checkmarks [✓]. Press <SET> to clear the search conditions.

⚠ If no images match the search conditions, [OK] is not available on the screen in step 2.

- Search conditions may be cleared if you perform power, card, or image editing operations.
- Auto power off time may be extended while the [▶2: Set image search conditions] screen is displayed.

Q Magnifying Images

You can magnify your captured images.

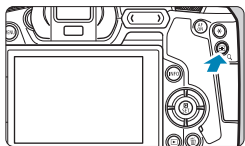

1 Magnify the image.

- During image playback, press the <Q> button.
- ▶ The magnified view will appear. The magnified area position (1) and [🔍 Q] will be displayed on the lower right of the screen.
- To magnify images, turn the <🔍> dial clockwise.
- To reduce magnification, turn the <🔍> dial counterclockwise. For index display (p.310), keep turning the dial.



(1)

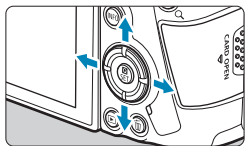

2 Scroll the image.

- Press the <🔍> cross keys to scroll the image vertically and horizontally.
- To cancel the magnified view, press the <Q> button.



Setting the Initial Magnification Ratio and Position

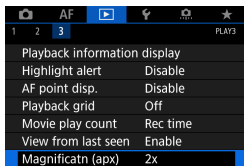

If you select [**▶**3: **Magnificatn (apx)**], you can set the initial magnification ratio and position for the magnified view.

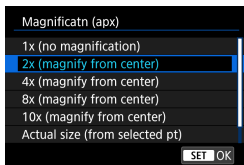

● 1x (no magnification)

The image is not magnified. The magnified view will start with the single-image display.

● 2x, 4x, 8x, 10x (magnify from center)

The magnified view starts at the image center at the selected magnification.

● Actual size (from selected point)

The recorded image's pixels will be displayed at approx. 100%. The magnified view starts at the AF point that achieved focus. If the photo is taken with manual focus, the magnified view starts at the image center.

● Same as last magnification (from center)

The magnification will be the same as the last time you exited the magnified view with the <Q> button. The magnified view starts at the image center.

 Under some AF method settings, the magnified view extends from the center of images even if [**Actual size (from selected pt)**] is set.

Rotating Images

You can use this feature to rotate the displayed image to the desired orientation.

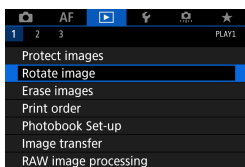

1 Select [1: Rotate image].

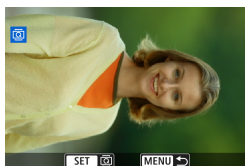

2 Select an image.



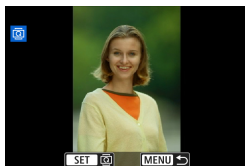



- Press the <◀> <▶> keys to select the image to be rotated.



3 Rotate the image.

- Each time you press <SET>, the image will rotate clockwise as follows: 90° → 270° → 0°.
- To rotate another image, repeat steps 2 and 3.



- If you set [ 1: Auto rotate] to [On  ] (p.372) before taking vertical shots, you need not rotate the image with this function.
- If the rotated image is not displayed in the rotated orientation during image playback, set [ 1: Auto rotate] to [On  ].

Protecting Images

You can protect important images from being accidentally erased.

Protecting a Single Image

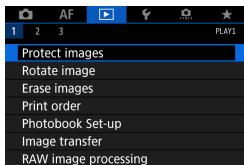

1 Select [ 1: Protect images].

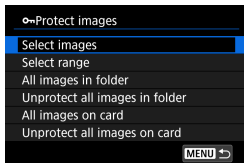



2 Select [Select images].

3 Select an image.

- Press the <◀> <▶> keys to select the image to be protected.

4 Protect the image.

- Press <SET> to protect the selected image. The <> icon (1) will appear at the top of the screen.
- To cancel the image protection, press <SET> again. The <> icon will disappear.
- To protect another image, repeat steps 3 and 4.



Specifying the Range of Images to be Protected

While looking at the images in the index display, you can specify the first and last images for a range to protect all the specified images at once.

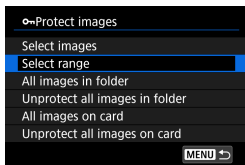

1 Select [Select range].

- Select **[Select range]** in [**▶**1: **Protect images**].

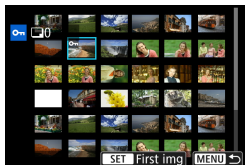

2 Specify the range of images.

- Select the first image (start point), then press <SET>.
- Next, select the last image (end point), then press <SET>.
- ▶ The images in the specified range will be protected and the <On> icon will appear.
- To select another image to be protected, repeat step 2.

Protecting All Images in a Folder or on a Card

You can protect all the images in a folder or on a card at once.

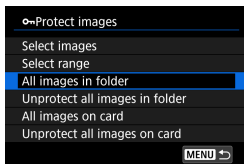

When you select **[All images in folder]** or **[All images on card]** in **[▶ 1: Protect images]**, all the images in the folder or on the card will be protected. To cancel the selection, select **[Unprotect all images in folder]** or **[Unprotect all images on card]**.

If the search conditions are set with **[▶ 2: Set image search conditions]** (p.313), the display will change to **[All found images]** and **[Unprotect all found]**.

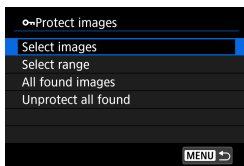

If you select **[All found images]**, all the images filtered by the search conditions will be protected.

If you select **[Unprotect all found]**, the protection of all the filtered images will be canceled.

! If you format the card (p.373), the protected images will also be erased.

-  ● Once an image is protected, it cannot be erased by the camera's erase function. To erase a protected image, you must first cancel the protection.
- If you erase all the images (p.338), only the protected images will remain. This is convenient when you want to erase all unnecessary images at once.

☆☆☆ Setting Ratings

You can rate images on a scale of 1–5 ([★]/[★]/[★★]/[★★]/[★★]). This function is called rating.

Rating a Single Image

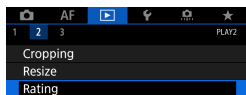

1 Select [▶] 2: Rating].

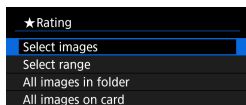

2 Select [Select images].

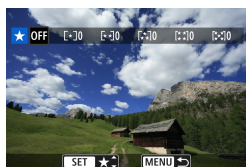

3 Select the image to be rated.

- Press the <◀> <▶> keys to select the image to be rated.



4 Rate the image.

- Press <SET>, and a blue highlight frame will appear as shown in the screen shown on the left.
- Press the <▲> <▼> keys to select a rating mark, then press <SET>.
- ▶ When you append a rating mark to the image, the number beside the set rating will increase by one.
- To rate another image, repeat steps 3 and 4.

Rating by Specifying the Range

While looking at the images in the index display, you can specify the first and last images for a range to rate all the specified images at once.

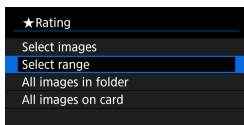

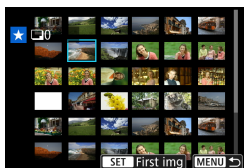

- 1 **Select [Select range].**
 - Select [**Select range**] in [**▶ 2: Rating**].

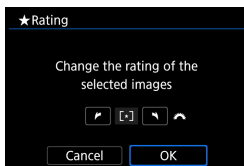

- 2 **Specify the range.**
 - Select the first image (start point), then press <SET>.
 - Next, select the last image (end point), then press <SET>.
 - A checkmark [✓] will be appended to all the images within the range between first and last images.

- 3 **Press the <MENU> button.**



- 4 **Rate the image.**
 - Turn the <  > dial to select a rating mark, then select [**OK**].
 - ▶ All the images in the specified range will be rated (same rating) at once.

Rating All Images in a Folder or on a Card

You can rate all the images in a folder or on a card at once.

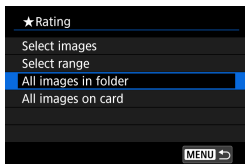

Under **[▶2: Rating]**, when you select **[All images in folder]** or **[All images on card]**, all the images in the folder or on the card will be rated.

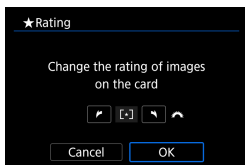

Turn the  dial to select a rating, then select **[OK]**.

When you are not rating images or cancelling the rating, select **[OFF]**.

If the search conditions are set with **[▶2: Set image search conditions]** (p.313), the display will change to **[All found images]**.

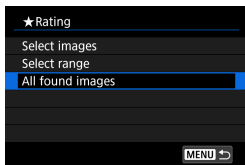

If you select **[All found images]**, all the images filtered by the search conditions will be rated as specified.



- Values next to ratings are displayed as **[###]** if more than 1,000 images have that rating.
- With **[▶2: Set image search conditions]** and **[▶2: Image jump w/ **, you can display only the images given a specific rating.

Enjoying Movies

You can play back and enjoy the captured movies mainly in the following three ways.

Playback on a Television (p.333)



By connecting the camera to a television with an HDMI cable, you can play back the captured still photos and movies on the television. Using the HDMI Cable HTC-100 (sold separately) is recommended.

❗ Even if the camera is connected to a hard disk recorder with a interface cable, movies and still photos cannot be played back or saved.

Playback on the Camera Screen (p.325)



You can play back movies on the camera screen. You can also edit out the movie's first and last scenes and can play back the still photos or movies on the card in an automatic slide show.

Playback and Editing with a Computer



The movie files recorded on the card can be imported to a computer and played back or edited with pre-installed or general-purpose software.

📄 To play back or edit movies with commercially available software, use software compatible with the file format of your movies. For details on commercially available software, contact the software manufacturer.

▶▶ Playing Back Movies

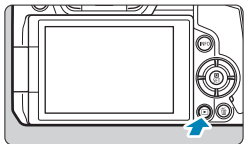

- 1 Play back the image.**
- Press the <▶> button.



- 2 Select a movie.**

- Press the <◀> <▶> keys to select the movie to be played back.
- In the single-image display, the <SET ▶> icon displayed on the upper left indicates a movie.
- In the index display, perforations at the left edge of a thumbnail indicate a movie. **As movies cannot be played back from the index display, press <SET> to switch to the single-image display.**

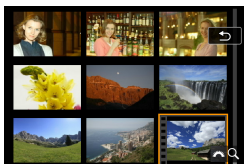

- 3 In the single-image display, press <SET>.**

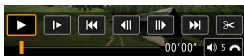





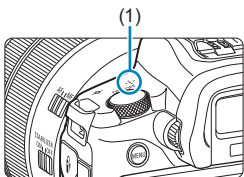







- 4 Press <SET> to play back the movie.**

- ▶ The movie will start playing back.
- You can pause playback and display the movie playback panel by pressing <SET>. Press it again to resume the playback.
- You can adjust the sound volume even during movie playback by turning the <◀▶> dial.



- (1) Speaker

Movie Playback Panel

Item	Playback Operations
 Play	Pressing <SET> toggles between playback and stop.
 Slow motion	Adjusts the slow motion speed by turning the <  > dial. The slow motion speed is indicated on the upper right of the screen.
 First frame	Displays the movie's first frame.
 Previous frame	Displays the previous frame each time you press <SET>. Holding <SET> down will rewind the movie.
 Next frame	Plays the movie frame-by-frame each time you press <SET>. Holding <SET> down will fast forward the movie.
 Last frame	Displays the movie's last frame.
 Edit	Displays the editing screen (p.327).
 Frame Grab	Available when you play 4K or 4K time-lapse movies. Enables you to extract the current frame and save it as a JPEG still image (p.329).
	Playback position
mm' ss"	Playback time (minutes:seconds)
 Volume	Turn the <  > dial to adjust the volume of the speaker (p.325).



- The camera may not be able to play back movies shot with another camera.
- If you connect the camera to a television to play back a movie (p.333), adjust the sound volume with the television. (Turning the <  > dial will not change the sound volume.)
- Movie playback may stop if the card's read speed is too slow or movie files have corrupted frames.

✂ Editing a Movie's First and Last Scenes

You can edit out the first and last scenes of a movie in approx. 1-sec. increments.



1 Pause movie playback.

- ▶ The movie playback panel will appear.



2 On the movie playback panel, select [✂].



3 Specify the part to be edited out.

- Select either [✂] (Cut beginning) or [✂] (Cut end), then press <SET>.
- Press the <◀> <▶> keys to see the previous or next frames. Keep holding down the key to fast forward or fast rewind the frames. Turn the <☺> dial for frame-by-frame playback.
- After deciding which part to edit out, press <SET>. The portion indicated by a line at the bottom of the screen will remain.

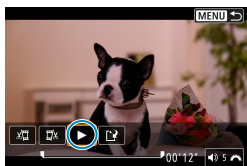

4 Check the edited movie.

- Select [▶] and press <SET> to play back the edited movie.
- To change the edited part, go back to step 3.
- To cancel the editing, press the <MENU> button.

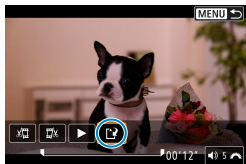

5 Save the edited movie.

- Select [**EDIT**], then press <SET>.
- The save screen will appear.
- To save it as a new movie, select [**New file**]. To save it and overwrite the original movie file, select [**Overwrite**], then press <SET>.
- On the confirmation dialog, select [**OK**] to save the edited movie and return to the movie playback screen.

- ! ● Because editing is performed in approx. 1-sec. increments (at the position indicated by [**X**] at the bottom of the screen), the actual position where movies are trimmed may differ from your specified position.
- Movies shot with another camera cannot be edited with this camera.
- You cannot edit a movie when the camera is connected to a computer.

Grabbing a Frame from 4K Movies or 4K Time-Lapse Movies

From 4K movies or 4K time-lapse movies, you can select individual frames to save as approx. 8.3-megapixel (3840×2160) JPEG still images. This function is called “Frame Grab (4K frame capture)”.

1 Play back the image.

- Press the <▶> button.

2 Select a 4K movie.

- Press the <◀> <▶> keys to select a 4K movie or 4K time-lapse movie.
- On the shooting information screen, 4K movies and 4K time-lapse movies are indicated by an [4K] icon.
- In index display, press <SET> to switch to single-image display.

3 In the single-image display, press <SET>.

4 Play and pause the movie.

- ▶ The movie playback panel will appear.

5 Select a frame to grab.

- Use the movie playback panel to select the frame to grab as a still photo.
- For movie playback panel instructions, see page 326.

6 Select [].

- Press the <◀> <▶> keys to select [], then press <SET>.

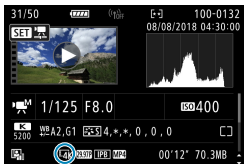



7 Save the frame.

- Select **[OK]** to save the current frame as a JPEG still image.

8 Select the image to display.

- Check the destination folder and image file number.
- Select **[View original movie]** or **[View extracted still image]**.
 - ▶ The selected image will be displayed.

❗ Frame grabbing is not possible with Full HD movies, Full HD time-lapse movies, or with 4K movies or 4K time-lapse movies shot with a different camera.

Slide Show (Auto Playback)

You can play back the images on the card as an automatic slide show.

1 Specify the images to be played back.

- To play back all the images on the card, go to step 2.
- If you want to specify the images to be played back in the slide show, filter the images with [**▶ 2: Set image search conditions**] (p.313).

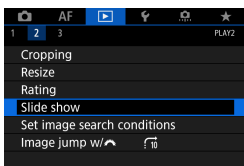

2 Select [**▶ 2: Slide show**].

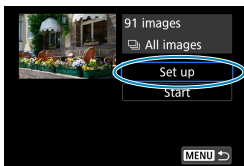

3 Set the playback as desired.

- Select [**Set up**], then press <SET>.
- Set the [**Display time**], [**Repeat**] (repeated playback), and [**Transition effect**] (effect when changing images) for the still photos.
- After completing the settings, press the <MENU> button.

Display time

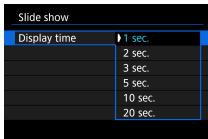

Repeat

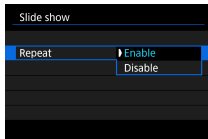

Transition effect

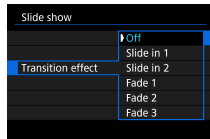

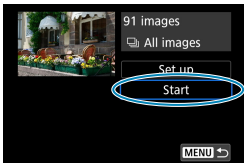

4 Start the slide show.

- Select **[Start]**, then press <SET>.
- ▶ After **[Loading image...]** is displayed, the slide show will start.

5 Exit the slide show.

- To exit the slide show and return to the setting screen, press the <MENU> button.



- To pause the slide show, press <SET>. During pause, **[III]** will be displayed on the upper left of the image. Press <SET> again to resume the slide show.
- During the automatic playback of still photos, you can press the <INFO> button to switch the display format (p.304).
- During movie playback, you can adjust the sound volume by turning the <SOUND> dial.
- During auto playback or pause, you can press the <◀> <▶> keys to view another image.
- During auto playback, auto power off will not take effect.
- The display time may differ depending on the image.

Viewing Images on a Television

By connecting the camera to a television with an HDMI cable, you can play back the captured still photos and movies on the television. Using the HDMI Cable HTC-100 (sold separately) is recommended.

If the image does not appear on the TV screen, check if the [**F3: Video system**] is correctly set to [**For NTSC**] or [**For PAL**] (depending on the video system of your television).

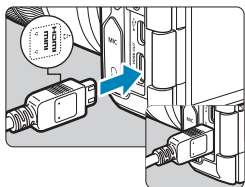

1 Connect the HDMI cable to the camera.

- With the plug's <▲HDMI MINI> logo facing the front of the camera, insert it into the <HDMI OUT> terminal.

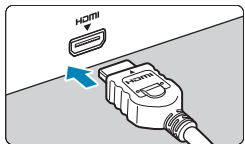

2 Connect the HDMI cable to the television.

- Connect the HDMI cable to the television's HDMI IN port.

3 Turn on the television and switch the television's video input to select the connected port.

4 Set the camera's power switch to <ON>.

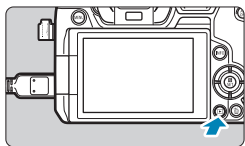

5 Press the <▶> button.

- ▶ The image will appear on the TV screen. (Nothing will be displayed on the camera screen.)
- The images will automatically be displayed at the optimum resolution matching the connected television.



- Adjust movie sound volume with the television. The sound volume cannot be adjusted with the camera.
- Before connecting or disconnecting the cable between the camera and television, turn off the camera and television.
- Depending on the television, part of the image displayed may be cut off.
- Do not connect any other device's output to the camera's <HDMI OUT> terminal. Doing so may cause a malfunction.
- Certain televisions may not display the images due to incompatibility.
- It may take some time before images are displayed. To avoid delay, set [**3: HDMI resolution**] to [**1080p**] (p.395).
- Touch-screen operations are not supported while the camera is connected to a television.

Erasing Images

You can either select and erase unnecessary images one by one or erase them in one batch. Protected images (p.318) will not be erased.

 **Once an image is erased, it cannot be recovered. Make sure you no longer need the image before erasing it. To prevent important images from being erased accidentally, protect them.**

Erasing a Single Image

1 Select the image to be erased.

- Press the <▶> button.
- Press the <◀> <▶> keys to select the image to be erased.



2 Press the <🗑️> button.

3 Erase the image.

JPEG or RAW Images or Movies

- Select [Erase], then press <SET>.



RAW+JPEG Images

- Select an item, then press <SET>.



Checkmarking [✓] Images to Be Erased in a Batch

By adding checkmarks to the images to be erased, you can erase all those images at once.

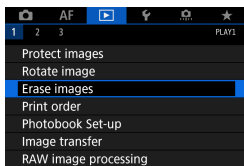

1 Select [1: Erase images].

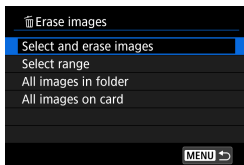

2 Select [Select and erase images].



3 Select an image.

- Press the <◀> <▶> keys to select the image to be erased, then press <SET>.
- ▶ A checkmark [✓] will be displayed on the upper left of the screen.
- To select another image to be erased, repeat step 3.

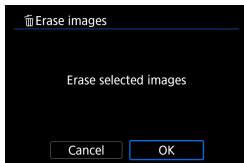

4 Erase the images.

- Press the <MENU> button, then press [OK].
- ▶ The selected images will be erased at once.

Specifying the Range of Images to Be Erased

While looking at the images in the index display, you can specify the first and last images for a range to erase all the specified images at once.

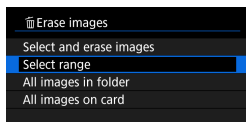

1 Select [Select range].

- Select [Select range] in [1: Erase images].

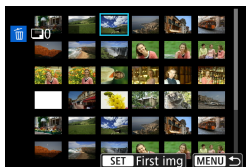

2 Specify the range of images.

- Select the first image (start point), then press <SET>.
- Next, select the last image (end point), then press <SET>.
- ▶ A checkmark [>] will be appended to all the images within the range between first and last images.

3 Press the <MENU> button.

4 Erase the images.

- Select [OK].
- ▶ The images in the specified range will be erased.

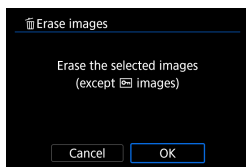

Erasing All Images in a Folder or on a Card

You can erase all the images in a folder or on a card at once.

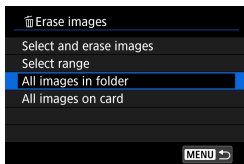

When [▶ 1: Erase images] is set to [All images in folder] or [All images on card], all the images in the folder or on the card will be erased.

If the search conditions are set with [▶ 2: Set image search conditions] (p.313), the display will change to [All found images].

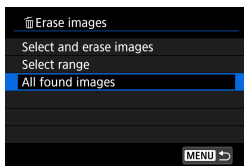

If you select [All found images], all the images filtered by the search conditions will be erased.

 To erase all the images including protected images, format the card (p.373).

RAW/JPEG ↓ Processing RAW Images with the Camera ☆

You can process **RAW** or **CRAW** images with the camera and save them as JPEG images. As the RAW image itself does not change, you can apply different processing conditions to create any number of JPEG images from it.

You can also use Digital Photo Professional (EOS software) to process RAW images.

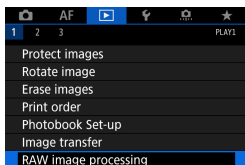

1 Select [▶] 1: RAW image processing.

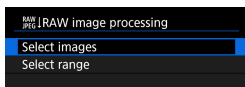

2 Select an item, then select images.

- You can select multiple images to process at once.

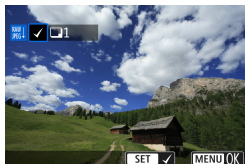

[Select images]

- Press the <◀> <▶> keys to select images to process, then press <SET>.
- ▶ A checkmark [✓] will be displayed on the upper left of the screen.
- Press the <MENU> button.

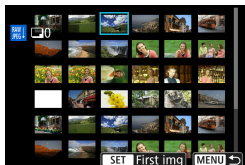

[Select range]

- Select the first image (start point), then press <SET>.
- Next, select the last image (end point), then press <SET>.
- ▶ A checkmark [✓] will be appended to all the images within the range between first and last images.
- Press the <MENU> button.

3 Set the desired processing conditions.

[Use shot settings]

- Images are processed using image settings at the time of capture.

[Customize RAW processing]

- Press the <▲> <▼> <◀> <▶> keys to select an item.
- Turn the <☀> or <☾> dial to switch the setting.
- Press <SET> to access the function setting screen.
- To return to the image settings at the time of shooting, press the <🗑> button.



Comparison Screen

- You can switch between the [After change] and [Shot settings] screens by pressing the <INFO> button and turning the <☀> dial.
- Items in orange on the [After change] screen have been modified since the time of capture.
- Press the <MENU> button.

4 Save the image.

- When using [Customize RAW processing], select [📁] (Save).
- Read the message and select [OK].
- To process other images, select [Yes] and repeat steps 2–4.

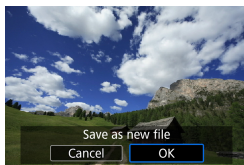



5 Select the image to display.

- Select [**Original image**] or [**Processed img.**].
- ▶ The selected image will be displayed.

Magnified View

You can magnify images displayed for [**Customize RAW processing**] by pressing the <Q> button. Magnification varies depending on the [**Image quality**] setting. Using <⬅➡> cross keys, you can scroll the magnified image vertically and horizontally.

To cancel the magnified view, press the <Q> button again.

Images with Aspect Ratio Setting

The area of the image inside the aspect-ratio lines is processed for images captured with [**1: 1: Cropping/aspect ratio**] (p.80) set to [**1:1 (aspect ratio)**], [**4:3 (aspect ratio)**], or [**16:9 (aspect ratio)**]. JPEG images generated from RAW images are saved with your specified aspect ratio.

Dual Pixel RAW Images

Although you can also use the camera to process RAW images shot with [**1: Dual Pixel RAW**] set to [**Enable**] (p.78), the camera cannot take advantage of the Dual Pixel data in processing.



ⓘ When you process multiple-exposure **RAW** or **CRRAW** images, certain settings cannot be changed.

RAW Image Processing Options

-  **Brightness adjustment**

You can adjust the image brightness up to ± 1 stop in 1/3-stop increments.

-  **White balance** (p.97)

You can select the white balance. If you select , you can select **[Auto: Ambience priority]** or **[Auto: White priority]**. If you select , you can set the color temperature.

-  **Picture Style** (p.88)

You can select the Picture Style. You can adjust the sharpness, contrast, and other parameters.



-  **Auto Lighting Optimizer** (p.104)

You can set the Auto Lighting Optimizer.

-  **High ISO speed noise reduction** (p.105)

You can set the noise reduction processing for high ISO speeds. If the effect is difficult to discern, magnify the image (p.341).

-  **Image quality** (p.75)

You can set the image quality when creating a JPEG image. Note that only  **L** /  **L/S2** are available for RAW images captured in cropped shooting or with EF-S lenses.

- **[sRGB] Color space** (p.117)

You can select either sRGB or Adobe RGB. Since the camera screen is not compatible with Adobe RGB, the difference in the image will hardly be perceptible when either color space is set.

- **[] Lens aberration correction**

- **[ OFF] Peripheral illumination correction** (p.111)

A phenomenon that makes the image corners look darker due to the lens characteristics can be corrected. If **[Enable]** is set, the corrected image will be displayed. If the effect is difficult to discern, magnify the image (p.341) and check the four corners. The peripheral illumination correction applied with the camera will be less pronounced than that applied with the Digital Photo Professional (EOS software) at maximum correction amount. If the effects of correction are not apparent, use Digital Photo Professional to apply the peripheral illumination correction.

- **[ OFF] Distortion correction** (p.111)

Image distortion due to lens characteristics can be corrected. If **[Enable]** is set, the corrected image will be displayed. The image periphery will be trimmed in the corrected image. Since the image resolution may look slightly lower, adjust the sharpness with the Picture Style's **[Sharpness]** parameter setting as necessary.

- **[ OFF] Digital Lens Optimizer** (p.112)

Correct lens aberration, diffraction, and low-pass filter-induced loss of sharpness by applying optical design values. Magnify images (p.341) to check the effects of setting this option to **[Enable]**. Without magnification, the effect of Digital Lens Optimizer is not displayed. Selecting **[Enable]** corrects both chromatic aberration and diffraction, although these options are not displayed.

-  **Chromatic aberration correction** (p.113)

Chromatic aberrations (color fringing along the subject's outline) due to the lens characteristics can be corrected. If **[Enable]** is set, the corrected image will be displayed. If the effect is difficult to discern, magnify the image (p.341).

-  **Diffraction correction** (p.113)

The diffraction by the lens aperture degrading the image sharpness can be corrected. If **[Enable]** is set, the corrected image will be displayed. If the effect is difficult to discern, magnify the image (p.341).



- Processing RAW images in the camera will not produce exactly the same results as processing RAW images with Digital Photo Professional (EOS software).
- If you perform **[Brightness adjustment]**, noise, banding, etc. may be intensified with the effects of adjustment.
- When **[Digital Lens Optimizer]** is set, noise may be intensified together with the effects of correction. Image edges may also be emphasized. Adjust Picture Style sharpness or set **[Digital Lens Optimizer]** to **[Disable]**, as needed.



- The lens correction data for lens aberration corrections is registered (stored) in the camera.
- The effect of the lens aberration correction varies depending on the lens used and shooting conditions. Also, the effect may be difficult to discern depending on the lens used, shooting conditions, etc.
- For details on the correction data used with Digital Lens Optimizer, see page 112.

Resizing JPEG Images

You can resize a JPEG image to make the pixel count lower and save it as a new image. Resizing an image is possible only with JPEG **L**, **M**, and **S1** images. **JPEG S2** and **RAW** images cannot be resized.



1 Select []2: Resize].

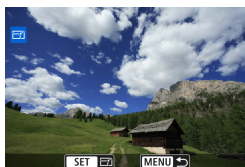

2 Select an image.

- Press the <◀> <▶> keys to select the image you want to resize.



3 Select the desired image size.

- Press <SET> to display the image sizes.
- Select the desired image size (1), then press <SET>.
- Only resizing to **S2** is available for JPEG images captured in cropped shooting or with EF-S lenses.

(1)

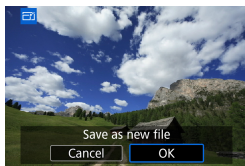

4 Save the image.

- Select [**OK**] to save the resized image.
- Check the destination folder and image file number, then select [**OK**].
- To resize another image, repeat steps 2 to 4.



For details on image sizes of resized images, see page 616.

☒ Cropping JPEG Images

You can crop a captured JPEG image and save it as another image. Cropping an image is possible only with JPEG images. **Images shot in RAW cannot be cropped.**

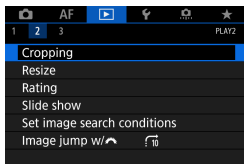

1 Select [▶] 2: Cropping].

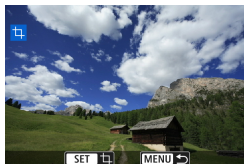

2 Select an image.

- Press the <◀> <▶> keys to select the image you want to crop.

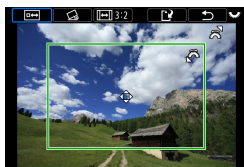

3 Set the cropping frame.

- Press <SET> to display the cropping frame.
- The image area within the cropping frame will be cropped.

● Changing the Cropping Frame Size

Turn the <☺> dial to change the cropping frame size. The smaller the cropping frame, the more magnified the cropped image will look.

● Changing the Aspect Ratio and Orientation

Turn the <☺> dial to select <☒>. Press <SET> to change the cropping frame's aspect ratio. You can select the aspect ratio as follows: [3:2], [16:9], [4:3], [1:1], [2:3], [9:16], or [3:4].

● Moving the Cropping Frame

Press the <⬅➡> cross keys to move the frame vertically or horizontally. Move the cropping frame until it covers the desired image area.

● Correcting the Tilt

You can correct image tilt by $\pm 10^\circ$. Turn the <⚙> dial to select <⏏>, then press <SET>. While checking the tilt against the grid, turn the <⚙> dial (in 0.1° increments) or tap the left or right wedge (in 0.5° increments) on the upper left of the screen to correct the tilt. After completing the tilt correction, press <SET>.



4 Check the image area to be cropped.

- Turn the <⚙> dial to select <⏏>.
- ▶ The image area to be cropped will be displayed.

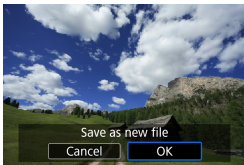

5 Save the image.

- Turn the <⚙> dial to select <⏏>.
- Select **[OK]** to save the cropped image.
- Check the destination folder and image file number, then select **[OK]**.
- To crop another image, repeat steps 2 to 5.



- The position and size of the cropping frame may change depending on the angle set for tilt correction.
- Once a cropped image is saved, it cannot be cropped again or resized.
- AF point display information (p.309) and Dust Delete Data (p.121) will not be appended to the cropped images.

Transferring Images to a Computer/FTP Server

You can connect the camera to a computer and use the camera to transfer images from the card to the computer. You can also connect the camera to a wireless file transmitter (sold separately) and transfer images to an FTP server. This function is called direct image transfer.

Direct image transfer is performed from the camera, as you look at the camera screen.

This section describes how to transfer images by connecting the camera to a computer with an interface cable. For details on image transfer to FTP servers, refer to the instruction manual of the wireless file transmitter.

Images transferred to a computer are saved in folders by shooting date, within the **[Pictures]** or **[My Pictures]** folder.

 Before connecting the camera to the computer, install EOS Utility (EOS software) on the computer (p.572).

Preparing for Image Transfer

1 Set the camera's power switch to <OFF>.

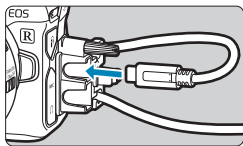

2 Connect the camera to the computer.

- Use the interface cable included with the camera.
- When connecting the cable to the camera, use the cable protector (p.37) and insert the plug in the digital terminal.
- Insert the other end of the cable into the computer's USB terminal (Type-C).

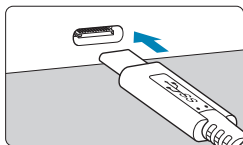

 As an interface cable, use either the included cable or a genuine Canon cable.

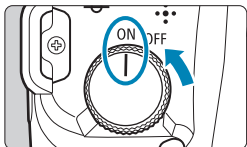

3 Set the power switch to <ON>.

- When a message to select a program is displayed on the computer, select **[EOS Utility]**.
- ▶ The EOS Utility screen is displayed on the computer.



After the EOS Utility screen appears, do not operate EOS Utility. **[Direct transfer]** in step 6 on page 351 is not displayed unless the main EOS Utility screen is displayed, which will prevent image transfer to the computer.



- If the EOS Utility screen does not appear, refer to the EOS Utility Instruction Manual.
- Turn off the camera before disconnecting the cable, and hold the cable by the plug when disconnecting it.

Transferring RAW+JPEG Images

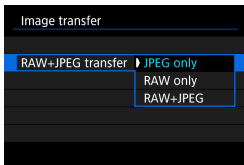

For RAW+JPEG images, you can specify which image to transfer.

In step 2 on the next page, select **[RAW+JPEG transfer]**, then specify the type of image to transfer.

Selecting Images to Transfer

Selecting Images

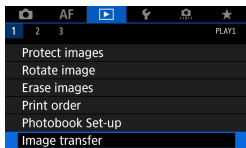

1 Select [**▶** 1: Image transfer].

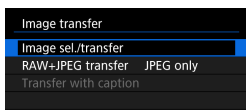

2 Select [Image sel./transfer].

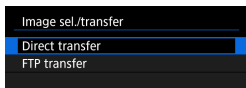

3 Select a transfer method.

- Select [**Direct transfer**] for image transfer to a computer.



4 Select [Sel.Image].

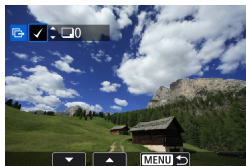

5 Select the images to transfer.

- Press the <◀> <▶> keys to select images to transfer, then press <SET>.
- Press the <▲> <▼> keys to add a [✓] in the upper left of the screen, then press <SET>.
- To select other images to transfer, repeat step 5.
- After you finish choosing images, press <MENU>.



6 Transfer the image.

- Confirm that the main EOS Utility screen is displayed on the computer.
- Select **[Direct transfer]**, then press **<SET>**.
- Select **[OK]** on the confirmation dialog to transfer the images to the computer.
- You can also transfer images selected with **[Multiple]** this way.



- When **[Sel.Image]** is selected, you can check image transfer status in the upper left of the screen: No mark: Not selected. ✓: Selected for transfer. ×: Transfer failed. ○: Transfer successful.
- You can also follow the instructions for **[RAW+JPEG transfer]** (p.349) and steps 1–5 on the previous page when the camera is not connected to a computer.

● Selecting Multiple Images

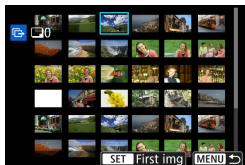

- **Select Range**
Under **[Multiple]**, select **[Select range]**. Selecting the first and last images of the range marks all the images in the range with a checkmark **[✓]**, and one copy of each image will be sent.

- **In a Folder**

Selecting [**Folder images not transfer'd**] selects all unsent images in the folder.

Selecting [**Folder images failed transf.**] selects all images in the folder for which transfer failed.

Selecting [**Clear folder transf. history**] clears the transfer history of images in the folder. After clearing the transfer history, you can select [**Folder images not transfer'd**] and transfer all images in the folder again.

- **On a Card**

For a description of [**Card images not transferred**], [**Card images failed transfer**], and [**Clear card's transf. history**], see “● In a Folder”.



- [**Direct transfer**] is not displayed unless the main EOS Utility screen is displayed on the computer.
- Some menu items are not available during image transfer.



- You can also transfer movies.
- Shooting is also possible during image transfer.
- For details on [**Transfer with caption**] under [**▶ 1: Image transfer**], refer to the instruction manual of Wireless File Transmitter WFT-E7 (Ver. 2) (sold separately).

Digital Print Order Format (DPOF)

DPOF (Digital Print Order Format) enables you to print images recorded on the card according to your printing instructions such as the image selection, quantity to print, etc. You can print multiple images in one batch or create a print order for a photofinisher.

You can set the print settings such as print type, date imprinting, file number imprinting, etc. The print settings will be applied to all the images specified for printing. (They cannot be set individually for each image.)

Setting the Printing Options

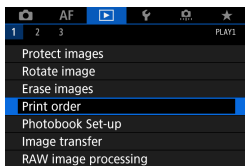

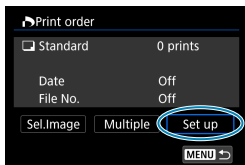

1 Select [▶▶ 1: Print order].



2 Select [Set up].

3 Set the options as desired.

- Set the [Print type], [Date], and [File No.].

Print type	 Standard	Prints one image on one sheet.
	 Index	Multiple thumbnail images are printed on one sheet.
	 Both	Prints both the standard and index prints.
Date	On	[On] imprints the recorded date of the captured image.
	Off	
File number	On	[On] imprints the file number.
	Off	

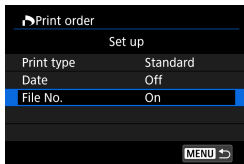

4 Exit the setting.

- Press the <MENU> button.
- Next, select [**Sel.Image**] or [**Multiple**] to specify the images to be printed.

- RAW images or movies cannot be specified for printing.
- If you print an image with a large image size using the [**Index**] or [**Both**] setting (p.353), the index print may not be printed with certain printers. In such a case, resize the image (p.345), then print the index print.
- Even if [**Date**] and [**File No.**] are set to [**On**], the date or file number may not be imprinted, depending on the print type setting and printer.
- With [**Index**] prints, the [**Date**] and [**File No.**] cannot both be set to [**On**] at the same time.
- When printing with DPOF, use the card for which print order specifications are set. You cannot print in the specified print order if you extract just the images from the card for printing.
- Certain DPOF-compliant printers and photofinishers may not be able to print the images as you specified. Refer to the printer's instruction manual before printing, or check with your photofinisher about compatibility when ordering prints.
- Do not use this camera to configure print settings for images with DPOF settings set up on another camera. All the print orders may be overwritten inadvertently. Also, the print order may not be possible, depending on the image type.

 You can send images from the camera via Wi-Fi to a PictBridge-compatible (Wireless LAN) printer and print the images (direct printing) (p.469).

Specifying Images for Printing

Selecting Images

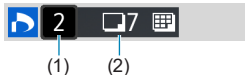
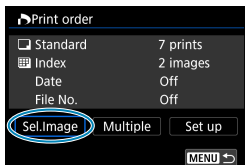

Select and specify the images one by one.

Press the **<MENU>** button to save the print order to the card.

Standard / Both

Press **<SET>** to print a copy of the displayed image. By pressing the **<▲>** **<▼>** keys, you can set the number of copies to be printed up to 99.

- (1) Quantity
- (2) Total images selected

Index

Press **<SET>** to add a checkmark to the box **[✓]**. The image will be included in the index print.

- (3) Checkmark
- (4) Index icon

Selecting Multiple Images

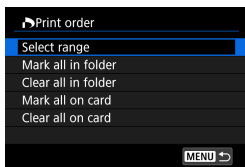

Select Range

Under **[Multiple]**, select **[Select range]**. Selecting the first and last images of the range marks all the images in the range with a checkmark **[✓]**, and one copy of each image will be printed.

- **All Images in a Folder**

Select **[Mark all in folder]** and select the folder. A print order for one copy of all the images in the folder will be specified.

If you select **[Clear all in folder]** and select the folder, the print order for all the images in the folder will be canceled.

- **All Images on a Card**

If you select **[Mark all on card]**, one copy of all the images on the card will be specified for printing.

If you select **[Clear all on card]**, the print order will be cleared for all the images on the card.

If the search conditions are set with **[▶ 2: Set image search conditions]** (p.313) and you select **[Multiple]**, the display will change to **[Mark all found images]** and **[Clear all found images]**.

- **All Found Images**

If you select **[Mark all found images]**, one copy of all the images filtered by the search conditions will be specified for printing.

If you select **[Clear all found images]**, all the print order of the filtered images will be cleared.

- RAW images or movies cannot be specified for printing. Note that RAW images or movies will not be specified for printing even if you specify all images with **[Multiple]**.
- When using a PictBridge-compatible printer, do not specify more than 400 images for one print order. If you specify more than this, the images may not all be printed.

Specifying Images for a Photobook

You can specify up to 998 images to be printed in a photobook. When you use EOS Utility (EOS software) to import images to a computer, the specified images for a photobook will be copied to a dedicated folder. This function is useful for ordering photobooks online.

Specifying One Image at a Time

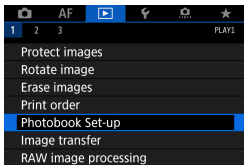

1 Select [ 1: Photobook Set-up].

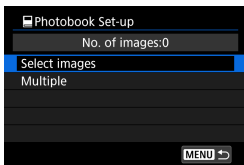

2 Select [Select images].

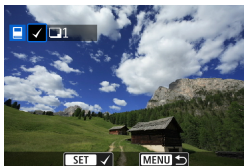

3 Select the image to be specified.

- Press the <◀> <▶> keys to select the image to be specified, then press <SET>.
- To select other images to be specified for a photobook, repeat step 3.

Specifying the Image Range for a Photobook

While looking at the images in the index display, you can specify the range (start point to end point) of images to be specified for a photobook at once.

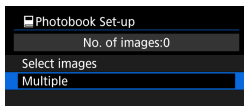

- 1 **Select [Multiple].**
 - Under [**▶** 1: Photobook Set-up], select [**Multiple**].

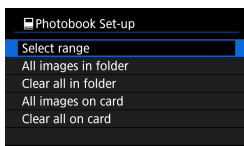

- 2 **Select [Select range].**

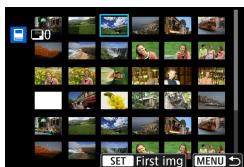

- 3 **Specify the range of images.**
 - Select the first image (start point), then press <SET>.
 - Next, select the last image (end point), then press <SET>.
 - ▶ A checkmark [**✓**] will be appended to all the images within the range between first and last images.

Specifying All Images in a Folder or on a Card

You can specify all the images in a folder or on a card at once for a photobook.

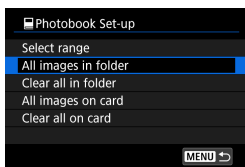

Under [▶1: **Photobook Set-up**], you can set [**Multiple**] to [**All images in folder**] or [**All images on card**] to specify all the images in the folder or on the card for a photobook.

To cancel the selection, select [**Clear all in folder**] or [**Clear all on card**].

If the search conditions are set with [▶2: **Set image search conditions**] (p.313) and you select [**Multiple**], the display will change to [**All found images**] and [**Clear all found images**].

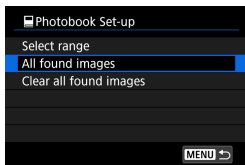

If you select [**All found images**], all the images filtered by the search conditions will be specified for the photobook.

If you select [**Clear all found images**], all the photobook order of the filtered images will be cleared.



- RAW images or movies cannot be specified for the photobook. Note that RAW images or movies will not be specified for the photobook even if you specify all images with [**Multiple**].
- Do not use this camera to configure photobook settings for images with photobook settings set up on another camera. All the photobook settings may be overwritten inadvertently.

5

Set-up

This chapter describes menu settings on the set-up ([F4]) tab.

- A ☆ icon to the right of a page title indicates that the function is available only in **[Fv]**, **[P]**, **[Tv]**, **[Av]**, **[M]**, or **[BULB]** mode.

Tab Menus: Set-up

● Set-up 1

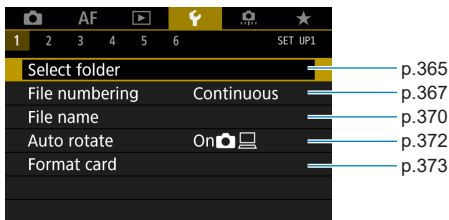

● Set-up 2

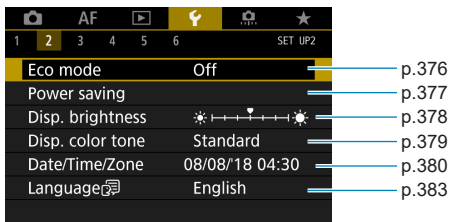

● Set-up 3

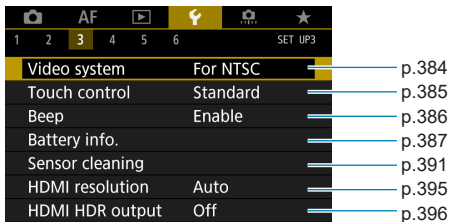

● Set-up 4

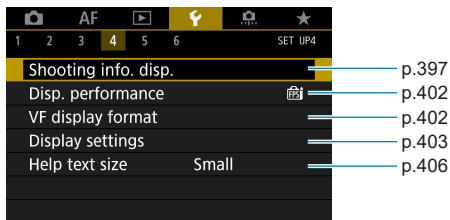

● Set-up 5

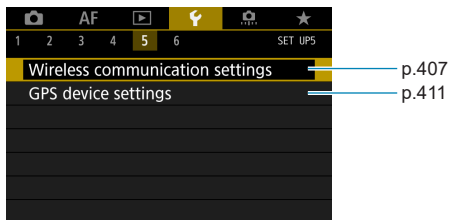

● Set-up 6

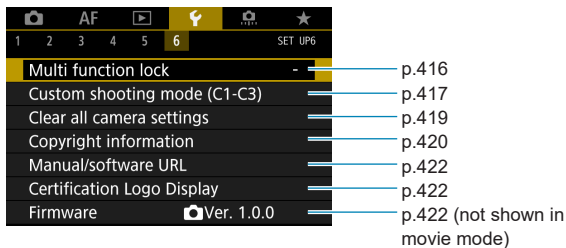

When you are shooting movies, the following screen is displayed for [F4].

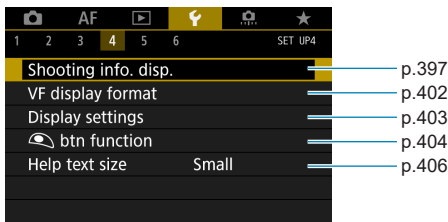

In [A+] and [A+] modes, the following screen is displayed for [F6].

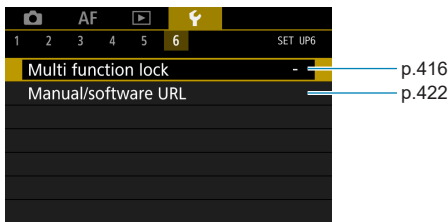

Creating and Selecting a Folder

You can freely create and select the folder where the captured images are to be saved.

Creating a Folder

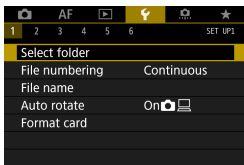

1 Select [**F** 1: Select folder].



2 Select [Create folder].

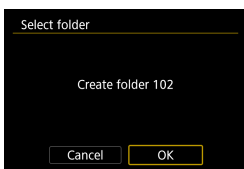

3 Select [OK].

Selecting a Folder

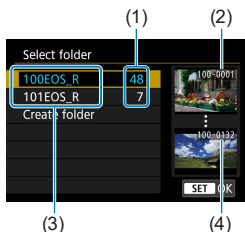

- Select a folder on the folder selection screen.
- Captured images are stored in your selected folder.

- (1) Number of images in folder
- (2) Lowest file number
- (3) Folder name
- (4) Highest file number



Folders

A folder can contain up to 9999 images (file number 0001–9999). When a folder becomes full, a new folder with the folder number increased by one is created automatically. Also, if manual reset (p.369) is executed, a new folder will be created automatically. Folders numbered from 100 to 999 can be created.

Creating Folders with a Computer

With the card open on the screen, create a new folder named “**DCIM**”. Open the DCIM folder and create as many folders as necessary to save and organize your images. The folder name must follow the format “**100ABC_D**”. The first three digits are always the folder number from 100 to 999. The last five characters can be any combination of upper- and lower-case letters from A to Z, numerals, and the underscore “_”. The space cannot be used. Also note that two folder names cannot share the same three-digit folder number (for example, “100ABC_D” and “100W_XYZ”) even if the remaining five characters in each name are different.

File Numbering Methods

The captured images saved in a folder are assigned a file number from 0001 to 9999. (Example) **BE3B0001.JPG**
You can change how the image files are numbered.

File number

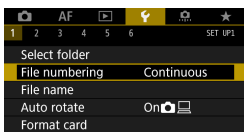

1 Select [**F1**: File numbering].

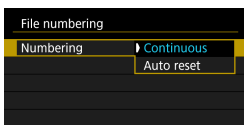

2 Set the item.

- Select [**Numbering**].
- Select [**Continuous**] or [**Auto reset**].

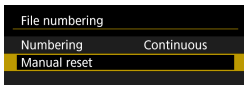

- If you want to reset the file numbering, select [**Manual reset**] (p.369).
- Select [**OK**] to create a new folder, and the file number will start with 0001.

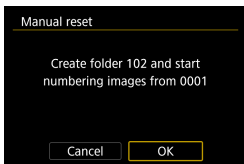

If the file number in folder 999 reaches 9999, shooting will not be possible even if the card still has storage capacity. The screen will display a message telling you to replace the card. Replace it with a new card.

Continuous

When you wish to continue the file numbering sequence even after the card is replaced or a new folder is created.

Even after you replace the card or create a new folder, the file numbering continues in sequence up to 9999. This is useful when you want to save images numbered anywhere between 0001 to 9999 on multiple cards or in multiple folders into one folder on a computer. If the replacement card or existing folder already contains images recorded previously, the file numbering of the new images may continue from the file numbering of the existing images on the card or in the folder. If you want to use continuous file numbering, it is recommended that you use a newly-formatted card each time.

File numbering after replacing the card

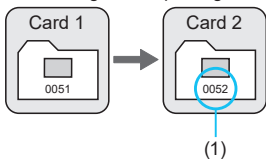

File numbering after creating a folder

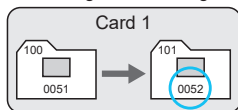

(1) Next sequential file number

Auto Reset

When you wish to restart the file numbering from 0001 each time the card is replaced or a new folder is created.

When you replace the card or create a folder, the file numbering restarts from 0001 for the new images saved. This is useful if you want to organize images by cards or folders.

If the replacement card or existing folder already contains images recorded previously, the file numbering of the new images may continue from the file numbering of the existing images on the card or in the folder. If you want to save images with the file numbering starting from 0001, use a newly formatted card each time.

File numbering after replacing the card

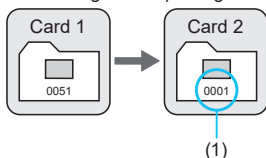

File numbering after creating a folder

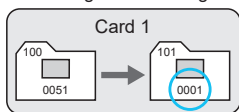

(1) File numbering is reset

Manual Reset

When you wish to reset the file numbering to 0001 or to start from file number 0001 in a new folder.

When you reset the file numbering manually, a new folder is created automatically and the file numbering of images saved to that folder starts from 0001.

This is useful, for example, if you want to use different folders for the images taken yesterday and the ones taken today.

Renaming Files

File names consist of four alphanumeric characters followed by a four-digit image number (p.367) and the file extension. (Example) BE3B0001.JPG

You can change the first four characters.

Registering/Changing File Names

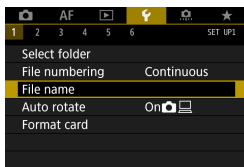

1 Select [**1**: File name].

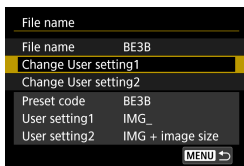

2 Select [**Change User setting***].

- **[User setting1]**
You can register four characters of your choice.
- **[User setting2]**
You can register three characters of your choice. The fourth character, for the image quality (p.371), is assigned automatically.

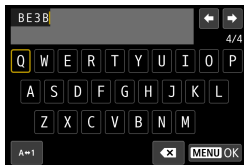

3 Enter the letters and numbers of your preferred file name.

- Use [**X**] or the <  > button to delete any unneeded characters.



- Use the <⬅➡> cross keys or <🔧> dial to select a character, then press <SET> to enter it.
- By selecting [A↔1], you can change the input mode.

4 Exit the setting.

- Press the <MENU> button, then press [OK].

5 Select a registered file name.

- Select [File name].
- Select a registered file name.

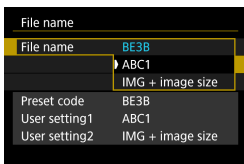

An underscore cannot be used as the first character.



- When you select “*** + image size” as registered to User setting2 and take pictures, a character representing the current image quality is automatically added as fourth character in the file name.

“***L” = 📷 L / 📷 L / RAW

“***M” = 📷 M / 📷 M

“***S” = 📷 S1 / 📷 S1

“***T” = S2

“***C” = 📷 RAW

This fourth character enables you to determine the image size (quality) if you import the images to a computer or other device. Using the file extension, you can also distinguish RAW and JPEG images.

- The extension will be “.JPG” for JPEG images, “.CR3” for RAW images, and “.MP4” for movies.

Setting the Auto Rotation of Vertical Images

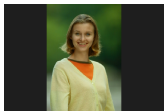



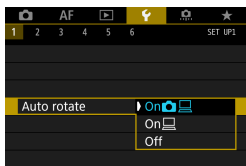

You can change the auto rotation setting that straightens images shot in vertical orientation when they are displayed.



1 Select [**1**: Auto rotate].

2 Select an item.

- **On**  
Automatically rotates images for display on both the camera and computers.
- **On** 
Automatically rotates images only for display on computers.
- **Off**

 Images captured with auto rotation set to **[Off]** will not rotate during playback even if you later set auto rotation to **[On]**.

-  ● If a picture is taken while the camera is pointing up or down, automatic rotation to the proper orientation for viewing may not be performed correctly.
- If images are not rotated automatically on a computer, try using EOS software.

Formatting the Card

If the card is new or was previously formatted (initialized) by another camera or computer, format the card with this camera.



When the card is formatted, all images and data on the card will be erased. Even protected images will be erased, so make sure there is nothing you need to keep. If necessary, transfer the images and data to a computer, etc. before formatting the card.

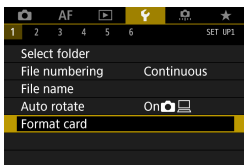

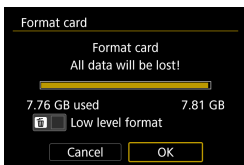

1 Select [**1**: Format card].

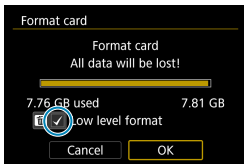

2 Format the card.

- Select [**OK**].



- For low-level formatting, press the  button to add a checkmark  to [**Low level format**], then select [**OK**].



- The card capacity displayed on the card format screen may be smaller than the capacity indicated on the card.
- This device incorporates exFAT technology licensed from Microsoft.



Format the card in the following cases:

- The card is new.
- The card was formatted by a different camera or a computer.
- The card is full of images or data.
- A card-related error is displayed (p.607).

Low-Level Formatting

- Perform low-level formatting if the card's writing or reading speed seems slow or if you want to totally erase the data on the card.
- Since low-level formatting will format all recordable sectors on the card, the formatting will take longer than normal formatting.
- During low-level formatting, you can cancel formatting by selecting **[Cancel]**. Even in this case, normal formatting will already be complete and you can use the card as usual.

Card's File Formats

- SD/SDHC cards will be formatted in FAT32. SDXC cards will be formatted in exFAT.
- When shooting a movie with a card formatted in exFAT, the movie will be recorded in a single file (instead of being split into multiple files) even if it exceeds 4 GB. (The movie file will exceed 4 GB.)



- It may not be possible to use SDXC cards formatted with this camera in other cameras. Also note that exFAT-formatted cards may not be recognized by some computer operating systems or card readers.
- Formatting or erasing data on a card does not completely erase the data. Be aware of this when selling or discarding the card. When disposing of cards, take steps to protect personal information if necessary, as by physically destroying cards.

Setting Eco Mode

Enables you to conserve battery power in shooting mode. When the camera is not in use, the screen darkens to reduce battery consumption.

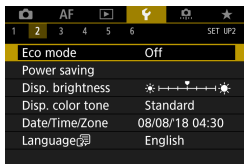

1 Select [**⚡**2: Eco mode].

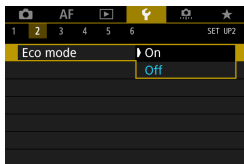

2 Select [On].

- The screen darkens when the camera is not used for approximately two seconds. Approx. ten seconds after darkening, the screen turns off.
- To activate the screen and prepare for shooting when the screen is off, press the shutter button halfway.

Setting Power-Saving Features

You can adjust the timing of when the screen, camera, and viewfinder turn off automatically (Display off, Auto power off, and Viewfinder off).

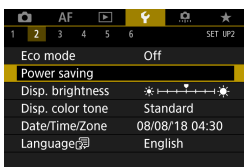

1 Select [**⚡**: Power saving].

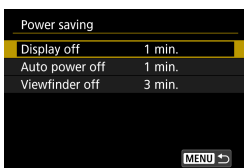

2 Select an item.

- Even when [**Auto power off**] is set to [**Disable**], the screen will turn off after the time set in [**Display off**].



[**Display off**] and [**Auto power off**] settings do not apply when Eco mode is set to [**On**].

Adjusting the Screen Brightness

Screen and viewfinder brightness can be adjusted separately.

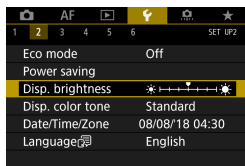

1 Select [**2: Disp. brightness**].

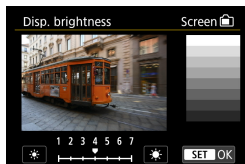

2 Make the adjustment.

- Referring to the gray chart, press the <◀> <▶> keys to adjust the brightness, then press <SET>.
- When adjusting viewfinder brightness, look through the viewfinder as you set it.



To check the image's exposure, referring to the histogram (p.307) is recommended.

Adjusting the Screen Color Tone

Screen and viewfinder color tone can be adjusted separately.

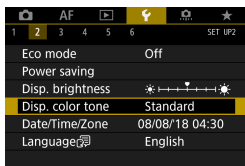

1 Select [**2**: Disp. color tone].

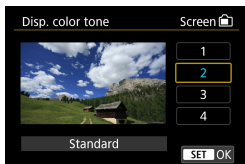

2 Make the adjustment.

- Press the <▲> <▼> keys or turn the <⚙> dial to select an item, then press <SET>.
- When adjusting viewfinder color tone, look through the viewfinder as you set it.

Setting the Date, Time, and Time Zone

When you turn on the power for the first time or if the date/time/zone have been reset, follow the steps below to set the time zone first.

By setting the time zone first, you can simply adjust this setting as needed in the future and the date/time will be updated to match it.

Since the captured images will be appended with the shooting date and time information, be sure to set your date/time.

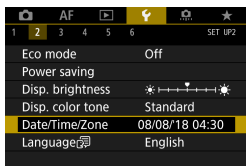

1 Select [**4**: Date/Time/Zone].

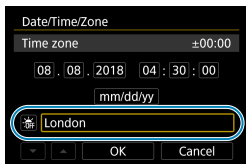

2 Set the time zone.

- Press the <◀> <▶> keys to select [Time zone].

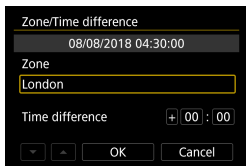

- Press <SET>.

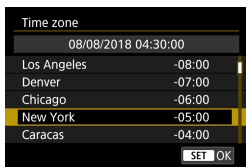

- Press the <▲> <▼> keys to select the time zone, then press <SET>.
- If your time zone is not listed, press the <MENU> button, then set the difference from UTC in [Time difference].

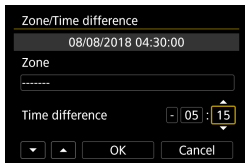

- Press the <◀> <▶> keys to select a **[Time difference]** item (+/-/hour/minute), then press <SET>.
- Press the <▲> <▼> keys to set it, then press <SET>.
- After entering the time zone or time difference, press the <◀> <▶> keys to select **[OK]**, then press <SET>.

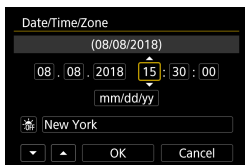

3 Set the date and time.

- Press the <◀> <▶> keys to select an item, then press <SET>.
- Press the <▲> <▼> keys to set it, then press <SET>.

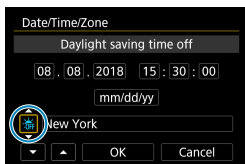

4 Set the daylight saving time.

- Set it as necessary.
- Press the <◀> <▶> keys to select **[☀️]**, then press <SET>.
- Press the <▲> <▼> keys to select **[☀️]**, then press <SET>.
- When the daylight saving time is set to **[☀️]**, the time set in step 3 will advance by 1 hr. If **[☀️]** is set, the daylight saving time will be canceled and the time will go back by 1 hour.

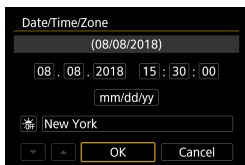

5 Exit the setting.

- Press the <◀> <▶> keys to select **[OK]**.

-  ● The date, time, and time zone settings may be reset when the camera is stored without the battery, when its battery becomes exhausted, or when it is exposed to below freezing temperatures for a prolonged period. If this happens, set them once again.
- After changing **[Zone/Time difference]**, check that the correct date/time are set.

 Auto power off time may be extended while the **[⚡2: Date/Time/Zone]** screen is displayed.

Setting the Interface Language

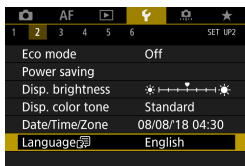

1 Select [F2: Language] icon.



2 Set the desired language.

Setting the Video System

Set the video system of any television used for display. This setting determines the frame rates available when you shoot movies.

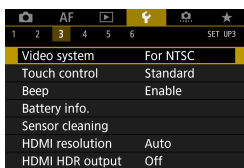

1 Select [**3**: Video system].

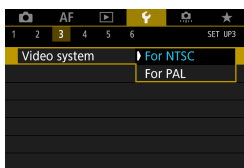

2 Select an item.

- **NTSC**

For areas where the TV system is NTSC (North America, Japan, South Korea, Mexico, etc.).

- **PAL**

For areas where the TV system is PAL (Europe, Russia, China, Australia, etc.).

Setting the Touch Control Response

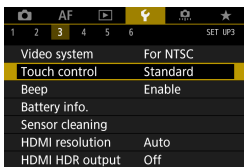

1 Select [F3: Touch control].

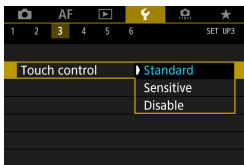

2 Select an item.

- [Standard] is the normal setting.
- [Sensitive] provides a more reactive touch-screen panel response than [Standard].
- To disable touch operations, select [Disable].



Cautions for Touch Control Operations

- Since the screen is not pressure sensitive, do not use any sharp objects, such as your fingernail or a ballpoint pen, for touch operations.
- Do not use wet fingers for touch operations.
- If the screen has any moisture or if your fingers are wet, the touch-screen panel may not respond or malfunction may occur. In such a case, turn off the power and wipe off the moisture with a cloth.
- Attaching any commercially available protective sheet or sticker on the screen may degrade the touch operation response.
- If you quickly perform touch operation when [Sensitive] is set, the touch operation response may be poor.

Disabling Beeps for Camera Operations

You can disable beeping when subjects are in focus or for other operations.

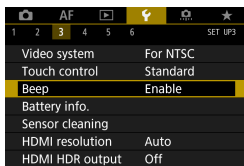

1 Select [**⚡**3: Beep].

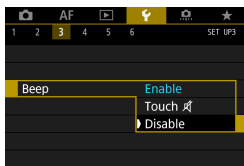

2 Select an item.

- **Touch** 

The beeper will be silent only for touch operations.

- **Disable**

Disables beeping when subjects are in focus, when you shoot with the self-timer, and when you use touch operations.

Checking the Battery Information

You can check the conditions of the battery you are using. By registering multiple batteries to the camera, you can check their approximate remaining capacity and usage history.

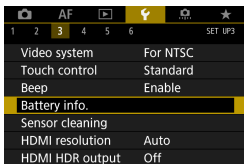

Select [P3: Battery info.].

- (1) Battery position
- (2) Battery model or household power source being used.
- (3) The battery level indicator (p.49) is displayed together with the remaining battery level shown in 1% increments.
- (4) The number of shots taken with the current battery. The number is reset when the battery is recharged.
- (5) Battery's recharge performance level is displayed in three levels.

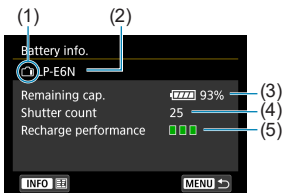

■■■ (Green) :

Battery's recharge performance is good.

■■■ (Green) :

Battery's recharge performance is slightly degraded.

■■■ (Red) :

Purchasing a new battery is recommended.



Using a genuine Canon Battery Pack LP-E6N/LP-E6 is recommended. If you use batteries that are not genuine Canon products, the camera's full performance may not be attained or malfunction may result.



- The shutter count is the number of still photos taken. (Movie shooting is not counted.)
- The battery information will also be displayed when using Battery Grip BG-E22 (sold separately).
- If a battery communication error message is displayed, follow the instructions in the message.

Registering Batteries to the Camera

You can register up to six LP-E6N/LP-E6 batteries to the camera. To register multiple batteries to the camera, follow the procedure below for each battery.

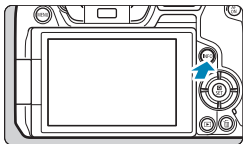

1 Press the <INFO> button.

- With the battery info. screen displayed, press the <INFO> button.
- ▶ If the battery is not registered, it will be grayed out.

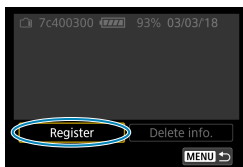

2 Select [Register].

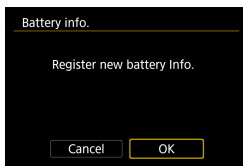

3 Select [OK].

- ▶ The battery is now displayed in white.

 The battery cannot be registered if the household power outlet accessories (sold separately, p.582) are used.

Labeling Batteries with Serial Numbers

It is convenient to label registered LP-E6N/LP-E6 battery packs with their serial numbers, using commercially available labels.

(1)

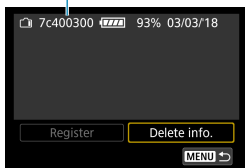

1 On a label approx. 25×15 mm, write the serial number (1).

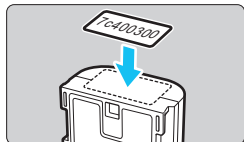

2 Apply the label.

- Set the power switch to <OFF>.
- Remove the battery from the camera.
- Apply the label as shown in the illustration (on the side with no electrical contacts).



- Do not apply the label on any part other than as shown in the illustration in step 2. Otherwise, the misplaced label may make it difficult to insert the battery or impossible to turn on the power.
- When you use Battery Grip BG-E22 (sold separately), the label may peel off as you repeatedly insert and remove the battery into the battery magazine. If it peels off, apply a new label.

Checking the Remaining Capacity of a Registered Battery

You can check the remaining capacity of batteries not currently in use, as well as their last date of use.

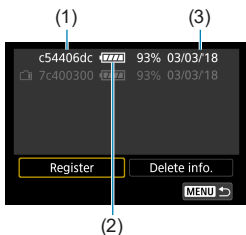

Look for the serial number.

- Refer to the battery's serial number label and look for the battery's serial number (1) on the battery history screen.
- ▶ You can check the respective battery's approximate remaining capacity (2) and the date when it was last used (3).

Deleting the Registered Battery Information

- 1 Select [Delete info.]**
 - Follow step 2 on page 387 to select [Delete info.]
- 2 Select the battery information to delete.**
 - ▶ [✓] will appear.
- 3 Press the < [trash] > button.**
 - Select [OK] on the confirmation dialog.

Sensor Cleaning

Self-cleaning of the front of the sensor is performed whenever you set the power switch to <OFF>.

You can also activate sensor cleaning manually.

Activating Immediate Cleaning

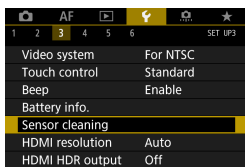

1 Select [**3**: Sensor cleaning].

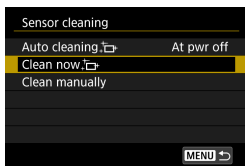

2 Select [**Clean now**].

- Select [**OK**] on the confirmation dialog.

Setting Auto Cleaning

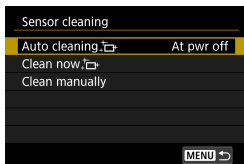

1 Select [Auto cleaning].

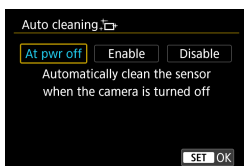

2 Select an item.

- Press the <◀> <▶> keys to select an item, then press <SET>.



- For best results, clean with the camera in a stable position on a desk or other flat surface.
- Even if you repeat the sensor cleaning, the result will not improve much. Note that [Clean now] may not be available immediately after cleaning.
- Dots of light may appear in captured images or on the shooting screen if the sensor is affected by cosmic rays or similar factors. By selecting [Clean now], their appearance may be suppressed (p.391).

Manual Sensor Cleaning ☆

Dust that could not be removed by automatic cleaning can be removed manually with a commercially available blower or similar tool.

The image sensor is extremely delicate. If the sensor needs to be cleaned directly, having it done by a Canon Service Center is recommended.

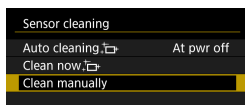

1 Select [Clean manually].

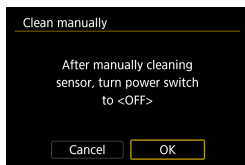

2 Select [OK].

3 Remove the lens and clean the sensor.

4 End the cleaning.

- Set the power switch to <OFF>.



If you will clean the sensor manually, make sure to use a fully-charged battery.



Using the household power outlet accessories (sold separately) is recommended.

- **While cleaning the sensor, never do any of the following. If the power is cut off, the shutter will close. These may result in damaging the image sensor and shutter curtains.**
 - **Setting the power switch to <OFF>.**
 - **Removing or inserting the battery.**
- The surface of the image sensor is extremely delicate. Clean the sensor with care.
- Use a plain blower without any brush attached. A brush can scratch the sensor.
- Do not insert the blower tip inside the camera beyond the lens mount. If the power is turned off, the shutter will close and the shutter curtains may get damaged.
- Never use pressurized air or gas to clean the sensor. Pressurized air may damage the sensor, and sprayed gas may freeze on the sensor and scratch it.
- If the battery level becomes low while cleaning the sensor, the beeper will sound as a warning. Stop cleaning the sensor.
- If a smudge that cannot be removed with a blower remains, having the sensor cleaned by a Canon Service Center is recommended.

Setting the HDMI Output Resolution

Set the image output resolution used when the camera is connected to a television or external recording device with an HDMI cable.

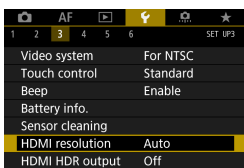

1 Select [**3**: HDMI resolution].

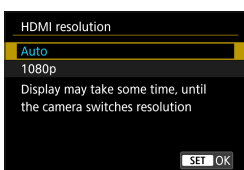

2 Select an item.

- **Auto**

The images will automatically be displayed at the optimum resolution matching the connected television.

- **1080p**

Output at 1080p resolution. Select if you prefer to avoid display or delay issues when the camera switches resolution.

RAW Playback on an HDR TV

You can view RAW images in HDR by connecting the camera to an HDR TV.

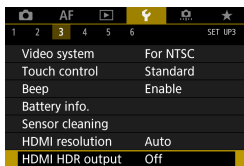

1 Select [**3**: HDMI HDR output].

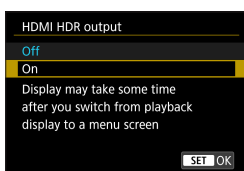

2 Select [On].

- Image operations such as RAW processing are not available during HDR display.
- JPEG images are used for HDR display in the case of L (ISO 50-equivalent) images or multiple-exposure RAW images.

- Make sure the HDR TV is set up for HDR input. For details on how to switch inputs on the TV, refer to the TV manual.
- Depending on the TV used, images may not look as expected.
- Some image effects and information may not be displayed on an HDR TV.

Customizing Information Displayed When Shooting

You can customize the details and screens of information shown on the camera or in viewfinder when you shoot.

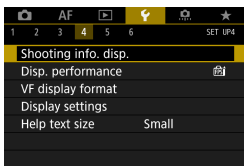

Select [**4**: Shooting info. disp.].

Customizing Information on the Screen

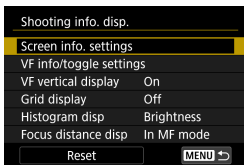

1 Select [**S**creen info. settings].

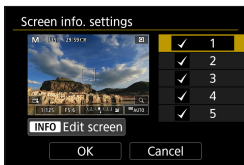

2 Select screens.

- Press the <▲> <▼> keys to select screens of information to show on the camera.
- For screens you prefer not to display, press <SET> to clear the checkmark [✓].
- To edit the screen, press the <INFO> button.

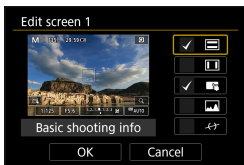

3 Edit the screen.

- Press the <▲> <▼> keys to select items to show on the screen.
- For items you prefer not to display, press <SET> to clear the checkmark [✓].
- Select [**OK**] to register the setting.

Customizing Information in the Viewfinder

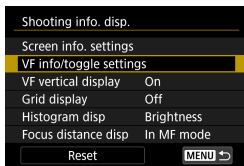

1 Select [VF info/toggle settings].

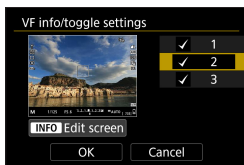

2 Select screens.

- Press the <▲> <▼> keys to select screens of information to show in the viewfinder.
- For screens you prefer not to display, press <SET> to clear the checkmark [✓].
- To edit the screen, press the <INFO> button.

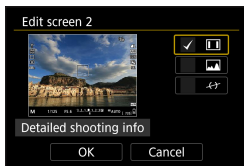

3 Edit the screen.

- Press the <▲> <▼> keys to select items to show in the viewfinder.
- For items you prefer not to display, press <SET> to clear the checkmark [✓].
- Select [OK] to register the setting.

Vertical Viewfinder Display

You can select how viewfinder information is displayed when you are shooting still photos vertically.

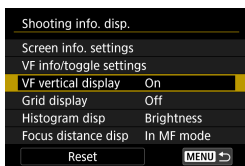

1 Select [VF vertical display].

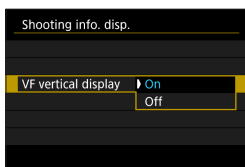

2 Select an item.

- **On**
Information is automatically rotated, making it easier to read.
- **Off**
Information is not automatically rotated.

Grid Display

A grid can be displayed on the screen and viewfinder.

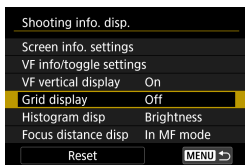

1 Select [Grid display].

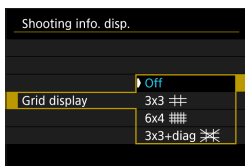

2 Select an item.

Setting the Histogram

You can select the content and display size of the histogram.

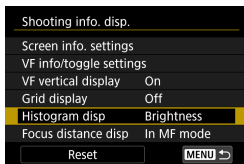

1 Select **[Histogram disp]**.

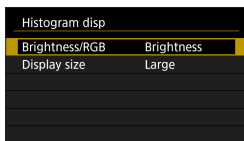

2 Select an item.

- Select the content (**[Brightness]** or **[RGB]**) and display size (**[Large]** or **[Small]**).
- Press the **<MENU>** button to confirm the setting.

Setting Focus Distance Display

You can display focus distance when using RF lenses. In focus distance display, you can select the timing and unit of measurement.

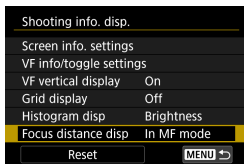

1 Select **[Focus distance disp]**.



2 Select the timing of display.



3 Select the unit of measurement.

- Press the **<MENU>** button to confirm the setting.

Clearing Settings

You can restore **[Shooting info. disp.]** defaults.

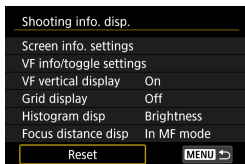

1 Select **[Reset]**.

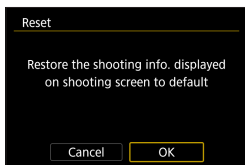

2 Select **[OK]**.

Setting a Priority for Shooting Display Performance

You can select the performance parameter to prioritize in shooting screen display for still photos.

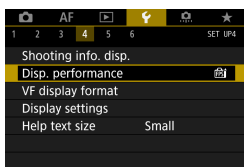

1 Select [**4**: Disp. performance].

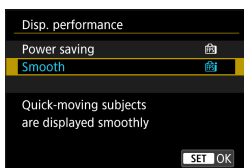

2 Select an item.

Setting the Viewfinder Display Format

You can select the viewfinder display format.

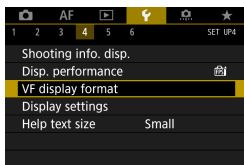

1 Select [**4**: VF display format].

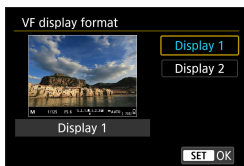

2 Select an item.

- Press the <▲> <▼> keys for selection.
- Press <SET> to set it.

Setting the Display Mode

You can select the display mode for shooting screens.

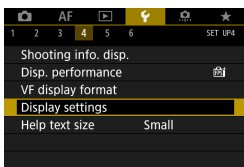

1 Select [**4**: Display settings].

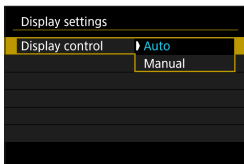

2 Select an item.

- **Auto**

Normally use the screen for display, but switch to the viewfinder when you look through it.

- **Manual**

You can restrict display to the screen or viewfinder.

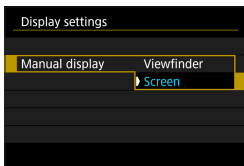

3 Select screen or viewfinder display.

- Press <SET> to confirm the setting.

Customizing Shutter Button Functionality

You can set the functions performed by pressing the shutter button halfway or completely during movie shooting.

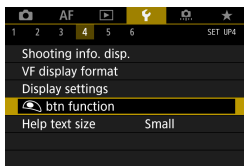

1 Select [**4**: btn function].

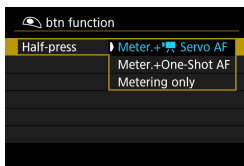

2 Select an item.

- **Half-press**

Specify whether pressing the shutter button halfway starts metering, metering and Movie Servo AF, or metering and One-Shot AF.

- **Fully-press**

Specify whether pressing the shutter button completely is disregarded or starts/stops movie shooting.



With [**Fully-press**] set to [**Start/stop mov rec**], you can start/stop shooting movies not only with the movie shooting button but also by pressing the shutter button completely or using Remote Switch RS-60E3 (sold separately, p.176).



Even if you set [**Fully-press**] to [**No function**], the camera will start or stop shooting time-lapse movies if the shutter button is pressed completely when the camera is set up for time-lapse movies.

? Help

When [INFO Help] is displayed below a menu, you can display a description about the feature by pressing the <INFO> button. Press it again to exit Help display. To scroll the screen when a scrollbar (1) appears on the right, press the <▲> <▼> keys or turn the <◀☺▶> dial.

● Example: [CAM 5: High ISO speed NR]



INFO
→

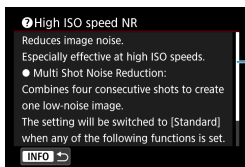

(1)

● Example: [CAM 6: Multi function lock]

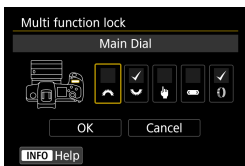

INFO
→

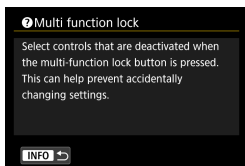

● Example: [AF3: Tracking sensitivity]

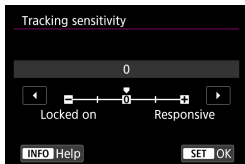

INFO
→

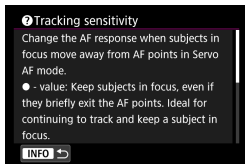

Help Display Text Size

You can change the text size for the Help display.

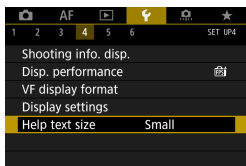

1 Select [**4**: Help text size].



2 Select an item.

● Example: [**5**: High ISO speed NR]

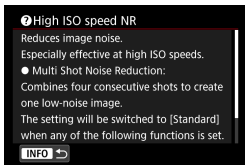

Text size: Small

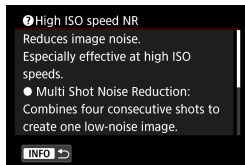

Text size: Standard

Setting Wireless Features

You can connect the camera to a smartphone or computer wirelessly and send your shots or control the camera remotely.

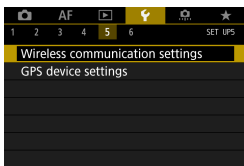

- 1 Select [**5**: Wireless communication settings].

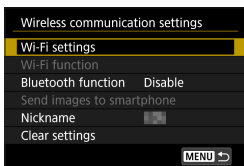

- 2 Set the item.
 - For details, see Chapter 6, “Wi-Fi (Wireless Communication) Functions”.

Shooting with a Remote Control

By pairing the camera via Bluetooth with Wireless Remote Control BR-E1 (sold separately, supporting Bluetooth low energy technology), you can shoot remotely up to approx. 5 m/16.4 ft. from the camera.

Pairing

To use BR-E1, you must first pair (connect and register) the camera and remote control.

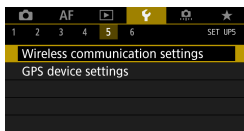

1 Select [**5: Wireless communication settings**].

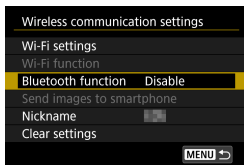

2 Select [**Bluetooth function**].

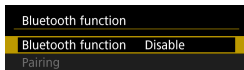

3 Select [**Bluetooth function**].

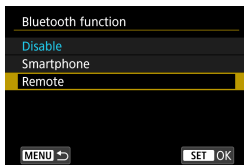

4 Select [**Remote**].

- If the message “Register a nickname to identify the camera.” appears, register a nickname as described on page 430.

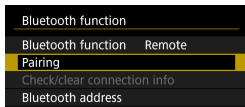

5 Select [Pairing].

- Select **[Pairing]**.
- Press and hold the **<W>** button and **<T>** button on the BR-E1 simultaneously for 3 sec. or more.
- ▶ Pairing now begins. When pairing is complete, BR-E1 is registered on the camera.

When shooting still photos

6 Set up the camera for remote shooting.

- Select **[]** or **[]** as the drive mode (p.144).
- In **[CAMERA 2: Remote control]**, select **[Enable]**.

When shooting movies

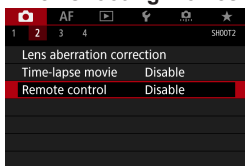

- For instructions after the pairing is complete, refer to the BR-E1's Instruction Manual.



Bluetooth connections consume battery power even after the camera's auto power off is activated.



- When you do not use the Bluetooth function, setting it to **[Disable]** in step 4 is recommended. To use the remote control again, select **[Remote]** again.
- Auto power off time may be extended when the camera is set for remote shooting.

Canceling the Pairing

Before pairing with a different BR-E1, clear the information about the connected remote control.

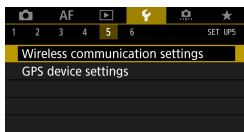

- 1 Select [**5: Wireless communication settings**].

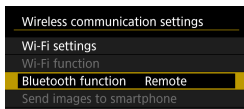

- 2 Select [**Bluetooth function**].

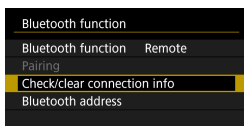

- 3 Select [**Check/clear connection info**].

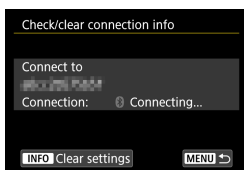

- 4 Press the <INFO> button.

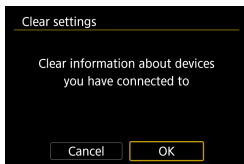

- 5 Clear the connection information.
 - Select [**OK**].

Geotagging Images

You can geotag images with GPS Receiver GP-E2 (sold separately) or a Bluetooth enabled smartphone.

Using GP-E2

- 1 Attach GP-E2 to the camera.**
 - Attach GP-E2 to the camera's hot shoe and turn it on. For details, refer to the GP-E2 Instruction Manual.
- 2 Select [F5: GPS device settings].**

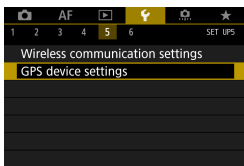

- 3 Select [GPS receiver].**

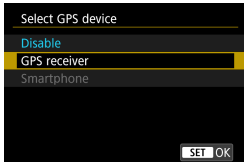

- 4 Take the picture.**
 - For details on **[Set up]**, refer to the GP-E2 Instruction Manual.

Precautions When Using GP-E2

- Be sure to check the countries and regions where its use is allowed, and use the function in accordance with the laws and regulations of the country or region.
- Make sure the GP-E2 firmware is updated to Ver. 2.0.0 or later. Firmware updating requires an interface cable. For updating instructions, visit the Canon website.
- The cable cannot be used to connect the camera to the GP-E2.
- The digital compass cannot be used with the camera, and the shooting direction is not recorded.

Using a Smartphone

The dedicated application Camera Connect (free of charge) must be installed on the smartphone. For details on installing Camera Connect, see page 427.

Specifying the smartphone as the GPS device

- 1 On the smartphone, activate location services.**
- 2 Establish a Bluetooth connection.**
 - Connect the camera to a smartphone via Bluetooth. For details, see page 429.

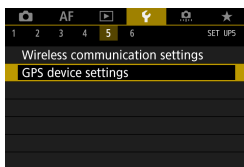

- 3 Select [5: GPS device settings].**

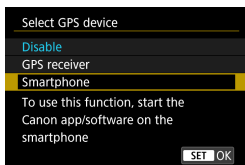

4 Select [Smartphone].

- Select **[Smartphone]** in **[Select GPS device]**.
- ▶ Location information can now be acquired from the smartphone.
- To check acquired geotag information (latitude, longitude, elevation, and Coordinated Universal Time (UTC)), select **[GPS information display]** on the **[GPS device settings]** screen.

5 Take the picture.

- Images are geotagged with the information from the smartphone.

GPS connection display

You can check the status of smartphone location information acquisition on the screens for still photo or movie shooting (p.619 and p.621, respectively).

- Gray: Location services are off
- Blinking: Location information cannot be acquired
- On: Location information acquired

For details on how GPS connection status is indicated when the GP-E2 is used, refer to the GP-E2 Instruction Manual.

Geotagging images as you shoot

Images you shoot while the GPS icon is on are geotagged.

Geotagging information

You can check the location information added to your shots on the shooting information screen (p.304, 307).

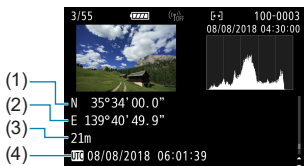

- (1) Latitude
- (2) Longitude
- (3) Elevation
- (4) UTC (Coordinated Universal Time)



- The smartphone can acquire location information only while it is paired with the camera via Bluetooth.
- Direction information is not acquired.
- Acquired location information may not be accurate, depending on traveling conditions or smartphone status.
- It may take some time to acquire location information from the smartphone after you turn the camera on.
- Location information is no longer acquired after any of the following operations.
 - Setting [**Bluetooth function**] to an option other than [**Smartphone**]
 - Turning the camera off
 - Quitting Camera Connect
 - Deactivating location services on the smartphone
- Location information is no longer acquired in any of the following situations.
 - The camera power turns off
 - The Bluetooth connection is ended
 - The smartphone's remaining battery level is low



- Coordinated Universal Time, abbreviated as UTC, is essentially the same as Greenwich Mean Time.
- For movies, the GPS information initially acquired is added.

LOCK Setting the Multi-Function Lock

Specify camera controls to lock when the Multi-function lock is enabled. This can help prevent accidentally changing settings.

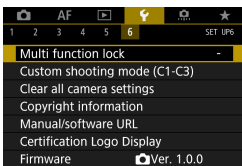

1 Select [**6**: Multi function lock].



2 Select camera controls to lock.

- Press <SET> to add a checkmark [**✓**].
- Select [**OK**].
- ▶ Pressing the <LOCK> button locks the selected [**✓**] camera controls.

- In [**A+**] mode, only [**Touch control**] can be set.
- If it is changed from the default setting, an asterisk "*" will be displayed on the right edge of [**6: Multi function lock**].

C1: Registering Custom Shooting Modes ☆

You can register current camera settings, such as shooting, menu, and Custom Function settings, as Custom shooting modes assigned to <C1> to <C3> modes. You can register different functions to use when shooting still photos or movies.

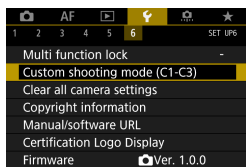

1 Select [**F6**: Custom shooting mode (C1-C3)].

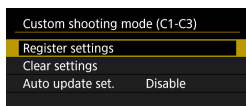

2 Select [**Register settings**].

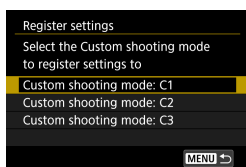

3 Register the desired items.

- Select the Custom shooting mode to register, then select [**OK**] on the registration screen.
- ▶ The current camera settings are registered to Custom shooting mode C*.

Automatic Update of Registered Settings

If you change a setting while shooting in Custom shooting mode, the mode can be automatically updated with the new setting (Auto update). To enable this automatic update, set [**Auto update set.**] to [**Enable**] in step 2.

Canceling Registered Custom Shooting Modes

If you select [**Clear settings**] in step 2, the settings of respective modes can be reverted to the default settings with no Custom shooting modes registered.

 My Menu settings will not be registered under Custom shooting modes.

 You can also change shooting and menu settings in Custom shooting modes.

Reverting the Camera to the Default Settings ☆ ■

The camera's settings for shooting functions and menu functions can be reverted to their defaults.

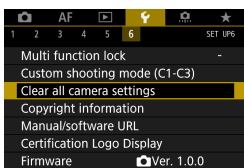

1 Select [**⚡6**: Clear all camera settings].

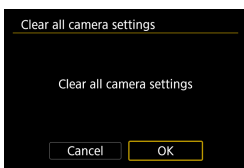

2 Select [OK].



For how to clear all the Custom Function settings, see page 554.

Setting Copyright Information ☆

When you set the copyright information, it will be recorded to the image as Exif information.

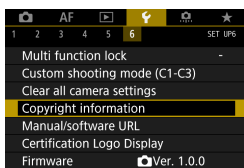

1 Select [**6**: Copyright information].

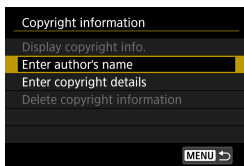

2 Select an item.

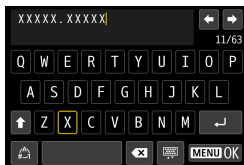

3 Enter text.

- Use the <⬅️➡️> cross keys or <🔄> dial to select a character, then press <SET> to enter it.
- By selecting [**🔄**], you can change the input mode.
- You can enter up to 63 characters.
- Select [**⌫**] or press the <🗑️> button to delete any unneeded characters.

4 Exit the setting.

- Press the <MENU> button, then press [OK].

Checking the Copyright Information

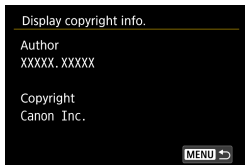

When you select **[Display copyright info.]** in step 2, you can check the **[Author]** and **[Copyright]** information that you entered.

Deleting the Copyright Information

When you select **[Delete copyright information]** in step 2, you can delete the **[Author]** and **[Copyright]** information.

 If the entry for "Author" or "Copyright" is long, it may not be displayed entirely when you select **[Display copyright info.]**.

 You can also set or check the copyright information with EOS Utility (EOS software).

Checking Other Information

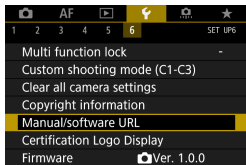

● Downloading instruction manuals

To download instruction manuals, select [**⚡6: Manual/software URL**] and scan the displayed QR code with a smartphone. Note that scanning QR codes requires an app.

● Displaying certification logos ☆

Select [**⚡6: Certification Logo Display**] to display some of the logos of the camera's certifications. Other certification logos can be found in this Instruction Manual, on the camera body, and on the camera's package.

● Firmware version ☆

Select [**⚡6: Firmware**] to update the firmware of the camera or current lens.

6

Wi-Fi (Wireless Communication) Functions

This chapter describes how to send images via Wi-Fi[®] from the camera to a variety of compatible devices, and how to use Web services.



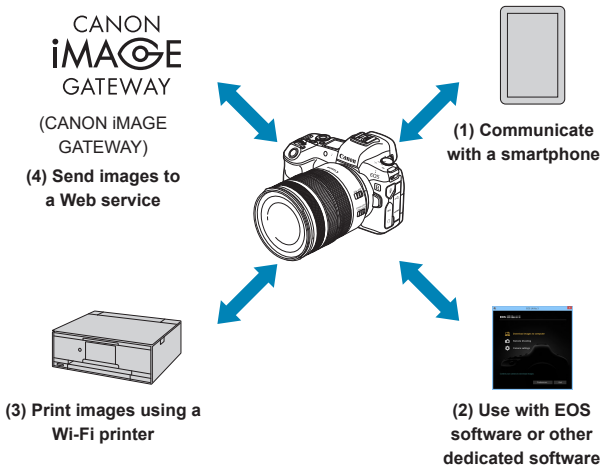

What You Can Do via Wi-Fi (Wireless Communication) Functions



Important

Note that Canon cannot be held liable for any loss or damage from erroneous wireless communication settings when using the camera. In addition, Canon cannot be held liable for any other loss or damage caused by use of the camera.

When using wireless communication functions, establish appropriate security at your own risk and discretion. Canon cannot be held liable for any loss or damage caused by unauthorized access or other security breaches.

- (1)  **Communicate with a smartphone** (p.427)
Control the camera remotely and browse images on the camera over a Wi-Fi connection by using the dedicated Camera Connect app on smartphones or tablets (collectively referred to as “smartphones” in this manual).
- (2)  **Use with EOS software or other dedicated software** (p.461)
Connect the camera to a computer via Wi-Fi and operate the camera remotely using EOS Utility (EOS software). With the dedicated application Image Transfer Utility 2, images on the camera can also be sent to a computer automatically.
- (3)  **Print images using a Wi-Fi printer** (p.469)
Connect the camera to a printer supporting PictBridge (Wireless LAN) via Wi-Fi to print images.
- (4)  **Send images to a Web service** (p.481)
Share images with friends or family on social media or the CANON iIMAGE GATEWAY online photo service for Canon customers after you complete member registration (free of charge).

Bluetooth® Features

By pairing the camera with a smartphone compatible with Bluetooth low energy technology (hereafter, “Bluetooth”), you can:

- Establish a Wi-Fi connection from either the camera or smartphone, by itself (p.448, 511)
- Establish a Wi-Fi connection with the camera even when it is off (p.437)
- Geotag images with GPS information acquired by the smartphone (p.412)

This camera can also be connected to Wireless Remote Control BR-E1 (sold separately) via Bluetooth for remote control shooting (p.174).

Wi-Fi Connection via Access Points

To establish a Wi-Fi connection with smartphones or computers already on a Wi-Fi network, see “Wi-Fi Connection via Access Points” (p.496).



Interface Cable Connection Cautions

- Other devices, such as computers, cannot be used with the camera by connecting them with an interface cable while the camera is connected to devices via Wi-Fi. Terminate the connection before connecting the interface cable.
- When the camera is connected to a computer or another device with an interface cable, you cannot select [**5: Wireless communication settings**]. Disconnect the interface cable before changing any settings.

Cards

- The camera cannot be connected via Wi-Fi if there is no card in the camera (except for [**□**]). Also, for [**△**] and Web services, the camera cannot be connected via Wi-Fi if there are no images saved on the card.

Using the Camera with a Wi-Fi Connection Established

- When you want to prioritize the Wi-Fi connection, do not operate the power switch, card slot cover, battery compartment cover or other parts. Otherwise, the Wi-Fi connection will be terminated.

Connecting to a Smartphone via Wi-Fi

This section describes how to directly connect the camera to a smartphone via Wi-Fi.

- Connecting to a smartphone via Wi-Fi enables you to perform the following:
 - View images stored in the camera on a smartphone or save viewed images to a smartphone.
 - Operate the camera to take a picture or change camera settings using a smartphone.
 - Send images to a smartphone from the camera.
 - To establish a Wi-Fi connection via an access point, see “Wi-Fi Connection via Access Points” (p.496).
-

Selecting the Wi-Fi Connection Method

Connecting to a Bluetooth-compatible Smartphone via Wi-Fi (p.429)

By connecting to a Bluetooth-compatible smartphone via Bluetooth in advance, you can connect via Wi-Fi simply by performing an operation on the camera or smartphone.

Connecting to a Smartphone via Wi-Fi from the [Wi-Fi function] Menu (p.440)

You can use Wi-Fi to connect to a smartphone that is not compatible with Bluetooth or a smartphone that cannot use its Bluetooth function.

Installing Camera Connect on a Smartphone

To connect the camera to a smartphone, a smartphone on which Android or iOS is installed is necessary. In addition, the dedicated application Camera Connect (free of charge) must be installed on the smartphone.

- Use the latest version of the smartphone OS.
- Camera Connect can be installed from Google Play or App Store. Google Play or App Store can also be accessed using the QR codes that appear when the camera is paired or connected via Wi-Fi to a smartphone.



- For the operating system versions supported by Camera Connect, refer to the download site of Camera Connect.
- Interface or functions of the camera and Camera Connect are subject to change for firmware update of the camera or application update of Camera Connect, Android, iOS, etc. In such a case, features of the camera or Camera Connect may differ from sample screens or operation instructions in this manual.
- An application is required to read the QR codes.

Connecting to a Bluetooth-compatible Smartphone via Wi-Fi

Steps on the Camera (1)

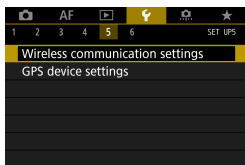

1 Select [**Y5: Wireless communication settings**].

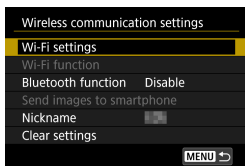

2 Select [**Wi-Fi settings**].

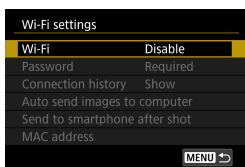

3 Select [**Wi-Fi**].

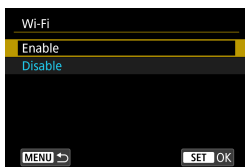

4 Select [**Enable**].

- After the [**Wi-Fi settings**] screen appears, press the <MENU> button to return to the [**Wireless communication settings**] screen.

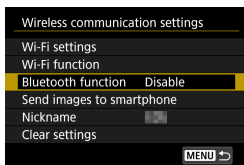

5 Select [Bluetooth function].

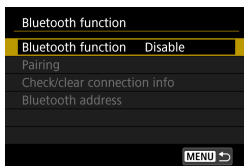

6 Select [Bluetooth function].

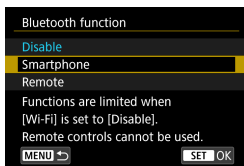

7 Select [Smartphone].

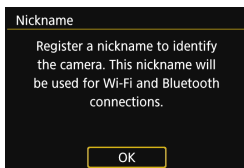

8 Register [Nickname].

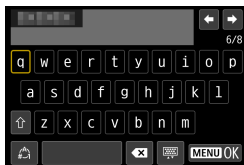

- When using the displayed nickname, press the <MENU> button.
- You can change the nickname as needed (p.514).

9 Select [OK].

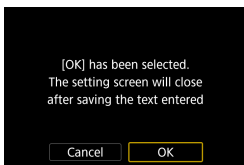

10 Select [Pairing].

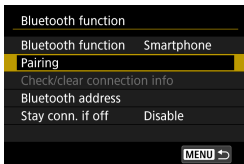

11 Select an item.

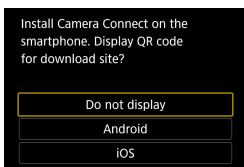

- If Camera Connect is already installed, select **[Do not display]**.
 - If Camera Connect is not installed, select **[Android]** or **[iOS]**, scan the displayed QR code with the smartphone to access Google Play or App Store and install Camera Connect.
- ▶ Pairing now begins.



Steps on the Smartphone (1)

12 Enable the Bluetooth function.

13 Start Camera Connect.



14 Select the camera to pair with.

▶ If you are using an Android smartphone, go to step 16.

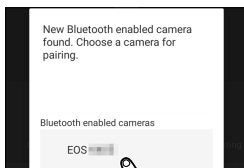

15 Tap on [Pair] (iOS only).

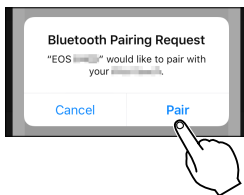

Steps on the Camera (2)

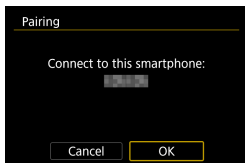

16 Select [OK].



17 Press <SET>.

- Pairing is now complete, and the camera is connected to the smartphone via Bluetooth.
- ▶ A Bluetooth icon appears on the main Camera Connect screen.

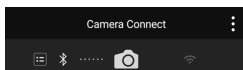

- Pairing or Bluetooth connection is not possible if the camera is connected to a computer or another device with an interface cable.
- The camera cannot be connected to two or more devices at the same time via Bluetooth.
- Bluetooth connection consumes battery power even after the camera's auto power off is activated. Therefore, the battery level may be low when you use the camera.



With a Bluetooth connection established, you can operate the camera to send images to the smartphone. For details, see page 448.

Steps on the Smartphone (2)

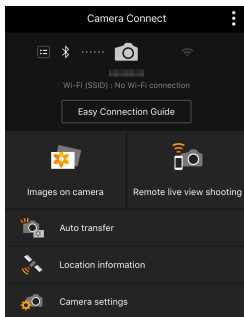

18 Select a Camera Connect function.

- In iOS, select **[Join]** when a message is displayed to confirm camera connection.
 - For the Camera Connect functions, see page 444.
 - ▶ When a Wi-Fi connection is established, the screen for the selected function will appear.
-
- ▶ **[Wi-Fi on]** is displayed on the camera.
 - ▶ The Bluetooth and Wi-Fi icons are lit on the main Camera Connect screen.

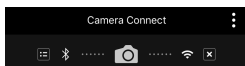

The Wi-Fi connection to a Bluetooth-compatible smartphone is now complete.

- For how to terminate the Wi-Fi connection, see “Terminating the Wi-Fi Connection” (p.457).
- Terminating the Wi-Fi connection will switch the camera to the Bluetooth connection.
- To reconnect via Wi-Fi, see “Reconnecting via Wi-Fi” (p.509).

[Wi-Fi on] Screen

Disconnect,exit

- Terminates the Wi-Fi connection.

Confirm set.

- You can check the settings.

Error details

- When a Wi-Fi connection error occurs, you can check the details of the error.

[Bluetooth function] Screen

On the **[Bluetooth function]** screen, you can change or check the Bluetooth function settings.

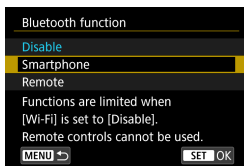

Bluetooth function

- Select the device to pair with the camera.
- If you will not use the Bluetooth function, select **[Disable]**.

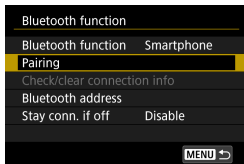

Pairing

- Pair the camera with the device selected in **[Bluetooth function]**.

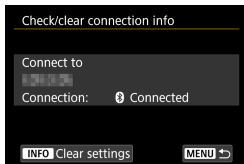

Check/clear connection info

- You can check the name and communication status of the paired device.
- To remove registration of the paired device, press the <INFO> button. For details, see “Removing a Paired Device’s Registration” (p.439).



Bluetooth address

- You can check the camera’s Bluetooth address.

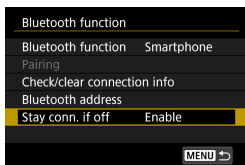

Stay conn. if off

- Selecting **[Enable]** lets you view images on the camera and control it in other ways by connecting via Wi-Fi even if the camera is off. For details, see “Establishing a Wi-Fi Connection When the Camera Is Off”.

Establishing a Wi-Fi Connection When the Camera Is Off

Once the devices are paired, you can use a smartphone to connect via Wi-Fi and transfer images from the camera even when it is off.

Setting [Stay conn. if off]

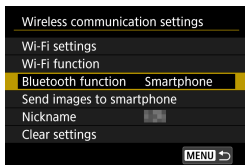

1 Select [Bluetooth function].

- Select **[Bluetooth function]** on the **[Wireless communication settings]** screen.

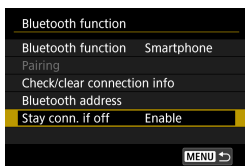

2 Set [Stay conn. if off] to [Enable].

- On the **[Bluetooth function]** screen, set **[Stay conn. if off]** to **[Enable]**. Even when the camera is off, it will remain paired with the smartphone via Bluetooth.

Establishing a Wi-Fi Connection When the Camera Is Off



1 Start Camera Connect.

- Start Camera Connect on a smartphone paired with the camera via Bluetooth.

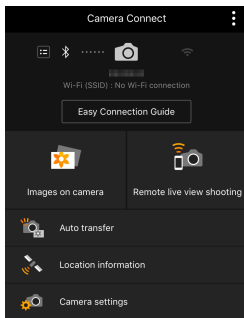

2 Select [Images on camera].

- In the Camera Connect menu, tap on **[Images on camera]**. In iOS, select **[Join]** when a message is displayed to confirm camera connection. Images on the camera are listed when the Wi-Fi connection is established.

Using Camera Connect

- You can use Camera Connect to transfer images to the smartphone, and you can delete or rate images from the camera.
- To end the Wi-Fi connection, tap on **[x]** on the main Camera Connect screen (p.457).

- **This feature is not available unless the camera and smartphone are paired via Bluetooth.**
- This function can no longer be used if the wireless settings are reset or the smartphone connection information is erased.

Removing a Paired Device's Registration

To pair the camera with a different smartphone, clear the paired device's registration on the **[Bluetooth function]** screen (p.436).

Steps on the Camera

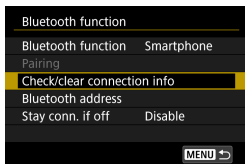

- 1 Select **[Check/clear connection info]**.

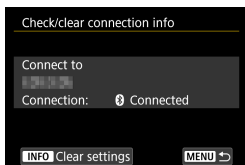

- 2 Press the **<INFO>** button.

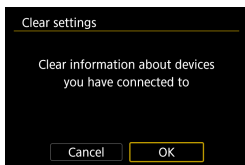

- 3 Clear the connection information.
 - Select **[OK]**.

Steps on the Smartphone

- 4 Remove the camera registration.
 - In the Bluetooth settings of the smartphone, select the nickname of the camera to remove registration for.

Connecting to a Smartphone via Wi-Fi from the [Wi-Fi function] Menu

Steps on the Camera (1)

1 Set Wi-Fi settings to [Enable].

- See steps 1–4 on page 429.

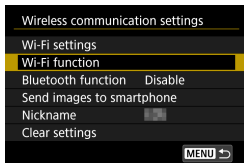

2 Select [Wi-Fi function].

- Select [Wi-Fi function] on the [Wireless communication settings] screen.

3 Register a nickname.

- If the [Nickname] screen is displayed, register a nickname (p.430).

4 Select [☐] (Connect to smartphone).

- If the history (p.509) is displayed, switch the screen with the <◀> <▶> keys.

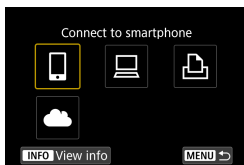

5 Select [Register a device for connection].

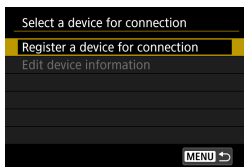

Install Camera Connect on the smartphone. Display QR code for download site?

Do not display

Android

iOS

6 Select an item.

- If Camera Connect is already installed, select **[Do not display]**.
- If Camera Connect is not installed, select **[Android]** or **[iOS]** on the screen on the left, scan the displayed QR code with the smartphone, then access Google Play or App Store and install Camera Connect.

7 Check the SSID (network name) and password.

- Check the SSID (1) and password (2) displayed on the camera screen. “_ Canon0A” is displayed at the end of the SSID.
- In **[Wi-Fi settings]**, if you set **[Password]** to **[None]**, the password will not be displayed or required. For details, see page 533.

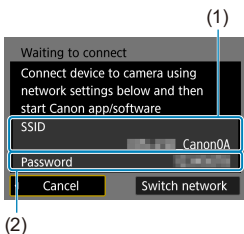

 By selecting **[Switch network]** in step 7, you can establish a Wi-Fi connection via an access point (p.496).

Steps on the Smartphone

Smartphone's screen (sample)



8 Operate the smartphone to establish a Wi-Fi connection.

- Activate the smartphone's Wi-Fi function, then select the SSID (network name) checked in step 7.
- For the password, enter the password checked in step 7.

9 Start Camera Connect.

- When the **[Waiting to connect]** screen is displayed on the camera, start Camera Connect on the smartphone.

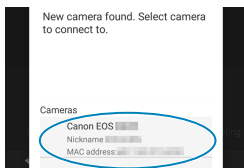

10 Select the camera to connect to via Wi-Fi.

- Select and tap on the camera to connect to via Wi-Fi from **[Cameras]** on Camera Connect.

Steps on the Camera (2)

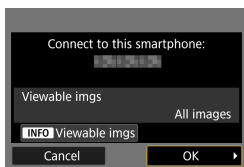

11 Establish a Wi-Fi connection.

- Select **[OK]**.
- To specify viewable images, press the **<INFO>** button. See step 5 on page 459 to set them.

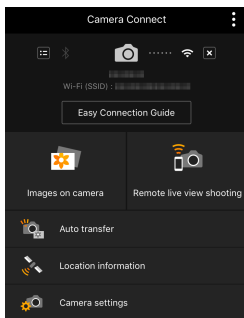

▶ The main window of Camera Connect will be displayed on the smartphone.
The Wi-Fi connection to a smartphone is now complete.

- Operate the camera using Camera Connect. See page 444.

- For how to terminate the Wi-Fi connection, see “Terminating the Wi-Fi Connection” (p.457).
- To reconnect via Wi-Fi, see “Reconnecting via Wi-Fi” (p.509).

[Wi-Fi on] Screen

Disconnect,exit

- Terminates the Wi-Fi connection.

Confirm set.

- You can check the settings.

Error details

- When a Wi-Fi connection error occurs, you can check the details of the error.



With a Wi-Fi connection established, you can send images to a smartphone from the camera menu (**[Send images to smartphone]**) or from the Quick Control screen during playback. For details, see page 448.

Operating the Camera Using a Smartphone

The main functions of Camera Connect are described below.

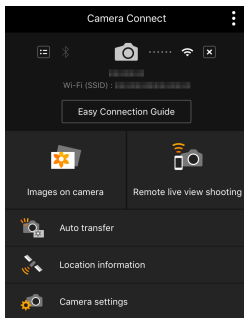

Images on camera

- Images stored in the camera can be viewed.
- Images stored in the camera can be saved on a smartphone.
- Operations such as deletion can be performed on images stored in the camera.

Remote live view shooting

- The camera's Live View image can be viewed on a smartphone.
- You can shoot with remote operation.

Auto transfer

- Enables camera and app setting adjustment to send shots to a smartphone automatically as they are captured (p.446).

Location information

- Not supported on this camera.

Camera settings

- Camera settings can be changed.



- If the Wi-Fi connection is terminated while recording a movie with remote shooting, the following will occur.
 - Any movie recording in progress in movie shooting mode will continue.
 - Any movie recording in progress in still photo shooting mode will end.
- You cannot use the camera to shoot after using Camera Connect to switch from still photo shooting mode to movie shooting mode.
- With a Wi-Fi connection to a smartphone established, certain functions are unavailable.
- In remote shooting, the AF speed may become slower.
- Depending on the communication status, image display or shutter release timing may be delayed.
- When saving images to a smartphone, you cannot take a picture even if you press the camera's shutter button. Also, the camera screen may turn off.
- The Wi-Fi connection will be terminated if you set the camera's power switch to <OFF>, or open the card slot cover or battery compartment cover.
- RAW images cannot be saved to a smartphone. When a RAW image is selected, it will be saved as a JPEG image.
- With a Wi-Fi connection established, the camera's auto power off does not function.



With a Wi-Fi connection established, disabling the smartphone's power saving function is recommended.

Sending Images to a Smartphone Automatically as You Shoot

Your shots can be sent automatically. Before following these steps, make sure the camera and smartphone are connected via Wi-Fi.

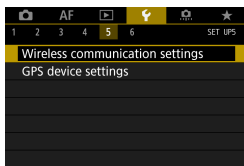

1 Select [**5: Wireless communication settings**].

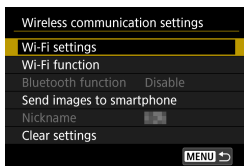

2 Select [**Wi-Fi settings**].

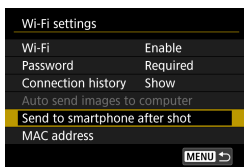

3 Select [**Send to smartphone after shot**].

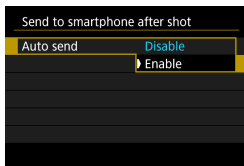

4 Set [**Auto send**] to [**Enable**].

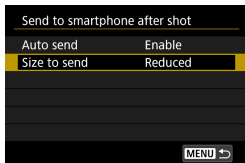

5 Set [Size to send].

- Select the image size, then press <SET>.

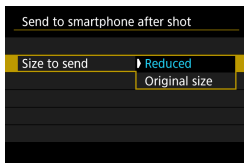

6 Take the picture.

Sending Images to a Smartphone from the Camera

You can use the camera to send images to a smartphone paired via Bluetooth (Android devices only) or connected via Wi-Fi.

(1) Selecting [Send images to smartphone] to Send Images

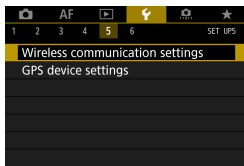

1 Select [**5: Wireless communication settings**].

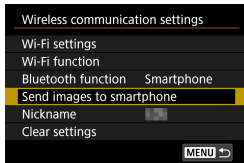

2 Select [**Send images to smartphone**].

- ▶ If you perform this step while connected via Bluetooth, a message is displayed, and the connection switches to a Wi-Fi connection.

3 Select sending options and send the images.

(2) Sending Images from the Quick Control Screen During Playback

1 Play back the image.



2 Press the **<Q>** button.

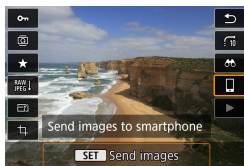

3 Select [☎].

- ▶ If you perform this step while connected via Bluetooth, a message is displayed, and the connection switches to a Wi-Fi connection.

4 Select sending options and send the images.

(3) Selecting Sending Options and Sending the Images

Sending Images Individually



1 Select an image to send.

- Press the <◀> <▶> keys or turn the <⚙> dial to select an image to send, then press <SET>.
- You can press the <Q> button and turn the <⚙> dial counterclockwise to select the image using the index display.



2 Select [Send img shown].

- In [Size to send], you can select the image sending size.

Sending Multiple Selected Images



1 Press <SET>.

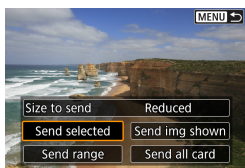

2 Select [Send selected].



3 Select images to send.

- Press the <◀> <▶> keys or turn the <⌚> dial to select an image to send, then press <SET>.
- You can press the <Q> button and turn the <⌚> dial counterclockwise to switch to the three-image display to select the images. To return to the single image display, also press the <Q> button and operate the <⌚> dial.
- After selecting the images to send, press the <MENU> button.



4 Exit image selection.

- Select [OK].

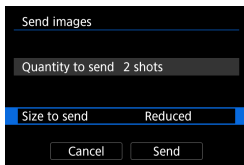

5 Select [Size to send].

- Set it as necessary.
- On the displayed screen, select an image size.

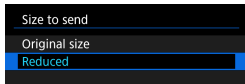

6 Select [Send].

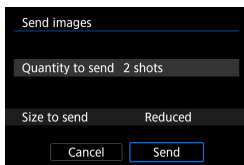

Sending a Specified Range of Images

1 Press <SET>.



2 Select [Send range].

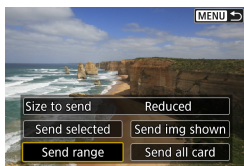

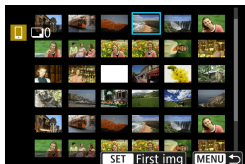

3 Specify the range of images.

- Select the first image (start point), then press <SET>.
- Select the last image (end point), then press <SET>.
- To cancel the selection, repeat this step.
- You can press the <Q> button and turn the <Q> dial to change the number of images shown in the index display.



4 Confirm the range.

- Press the <MENU> button.

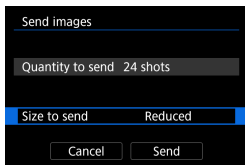

5 Select [Size to send].

- Set it as necessary.
- On the displayed screen, select an image size.

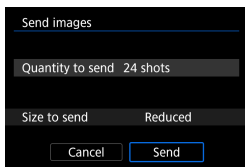
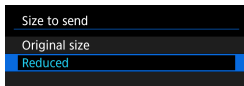

6 Select [Send].

Sending All Images on the Card



1 Press <SET>.

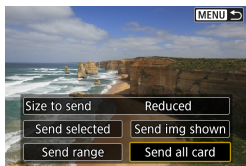

2 Select [Send all card].

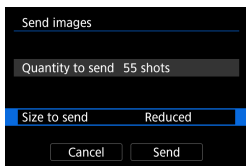

3 Select [Size to send].

- On the displayed screen, select an image size.

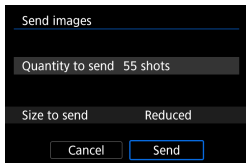
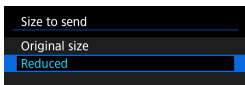

4 Select [Send].

Sending Images that Match the Search Conditions

Send all the images that match the search conditions set in **[Set image search conditions]** at once.

For details on **[Set image search conditions]**, see “Filtering Images for Playback” (p.313).



1 Press <SET>.



2 Select **[Send all found]**.

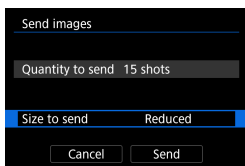

3 Select **[Size to send]**.

- On the displayed screen, select an image size.

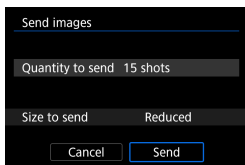
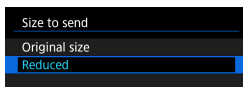

4 Select **[Send]**.

Ending Image Transfer

Sending Images from the Camera When Paired via Bluetooth (Android)



- Press the <MENU> button on the image transfer screen.

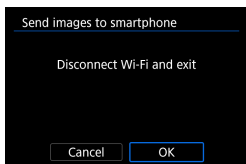

- Select [OK] on the screen at left to end image transfer and the Wi-Fi connection.

Sending Images from the Camera over a Wi-Fi Connection



- Press the <MENU> button on the image transfer screen.
- To terminate the Wi-Fi connection, see "Terminating the Wi-Fi Connection" (p.457).



- During the image transfer operation, a picture cannot be taken even if the camera's shutter button is pressed.
- The camera cannot be connected to multiple smartphones via Wi-Fi when it is connected to another device via Wi-Fi.



- You can cancel the image transfer by selecting [**Cancel**] during the transfer.
- You can select up to 999 files at a time.
- With a Wi-Fi connection established, disabling the smartphone's power saving function is recommended.
- When you reduce the image size, all images to be sent at the same time are resized. Note that movies or **S2** size still photos are not reduced.
- When you use a battery to power the camera, make sure it is fully charged.
- With a Wi-Fi connection established, the camera's auto power off does not function.

Terminating the Wi-Fi Connection

To terminate the Wi-Fi connection, perform either of the following operations.

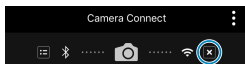

On the Camera Connect screen, tap on [**X**].

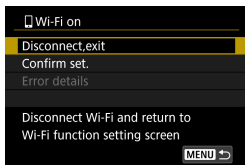

On the [**Wi-Fi on**] screen, select [**Disconnect,exit**].

- If the [**Wi-Fi on**] screen is not displayed, select [**Wi-Fi function**] on the [**F5: Wireless communication settings**] screen.
- Select [**Disconnect,exit**], then select [**OK**] on the confirmation dialog.

Specifying Viewable Images

You can specify images viewable on a smartphone by operating the camera. **Images can be specified after the Wi-Fi connection is terminated.**

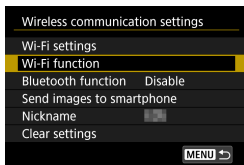

- 1 Select [Wi-Fi function].**
 - Select **[Wi-Fi function]** on the **[Wireless communication settings]** screen.

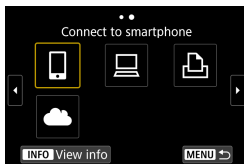

- 2 Select [☐].**
 - If the history (p.509) is displayed, switch the screen with the <◀> <▶> keys.

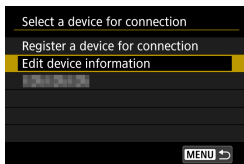

- 3 Select [Edit device information].**

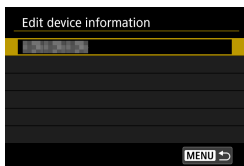

- 4 Select a smartphone.**
 - Select the name of the smartphone on which you want to make the images viewable.

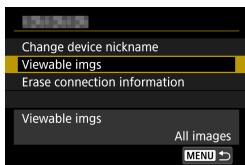

5 Select [Viewable imgs].

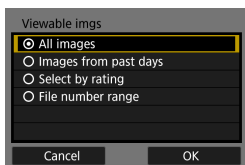

6 Select an item.

- Select [OK] to access the setting screen.

[All images]

All images stored on the card become viewable.

[Images from past days]

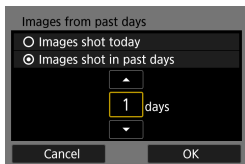

Specify viewable images on the shooting-date basis. Images shot up to nine days ago can be specified.

- Select an item.
- When [Images shot in past days] is selected, images shot up to the specified number of days before the current date become viewable. Press the <▲> <▼> keys to specify the number of days, then press <SET> to confirm the selection.
- Once you select [OK], the viewable images are set.

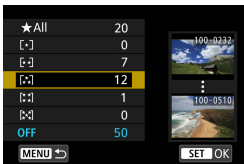

If [Viewable imgs] is set to any setting other than [All images], remote shooting is not possible.

[Select by rating]

Specify viewable images depending on whether a rating is appended (or not appended) or by the type of rating.

- Once you select the type of rating, the viewable images are set.

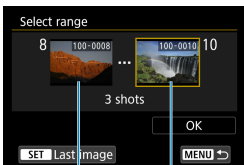
[File number range] (Select range)

(1)

(2)

Select the first and last images from images arranged by the file number to specify the viewable images.

- (1) Press <SET> to display the image selection screen.
Select an image using the <◀> <▶> keys or <⚙> dial.
- You can press the <Q> button and turn the <⚙> dial counterclockwise to select the image using the index display.
- (2) Select the first image (1), then press <SET>.
- (3) Press the <▶> key to select the last image (2), then press <SET>.
- (4) Select **[OK]**.

Connecting to a Computer via Wi-Fi

This section describes how to connect the camera to a computer via Wi-Fi and perform camera operations using EOS software or other dedicated software. Install the latest version of EOS software or other dedicated software on the computer before setting up a Wi-Fi connection.

For computer operating instructions, refer to the computer user manual.

Operating the Camera Using EOS Utility

Using EOS Utility (EOS software), you can perform a variety of camera operations.

Steps on the Camera (1)

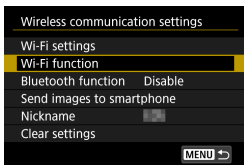

- 1 Set Wi-Fi settings to [Enable].**
 - See steps 1–4 on page 429.
- 2 Select [Wi-Fi function].**
 - Select **[Wi-Fi function]** on the **[Wireless communication settings]** screen.

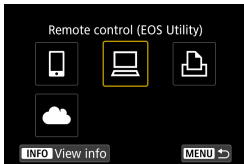

- 3 Register a nickname.**
 - If the **[Nickname]** screen is displayed, register a nickname (p.430).
- 4 Select [🖥️] (Remote control (EOS Utility)).**
 - If the history (p.509) is displayed, switch the screen with the <◀> <▶> keys.

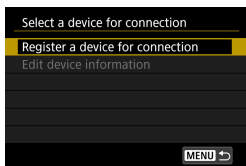

5 Select [Register a device for connection].

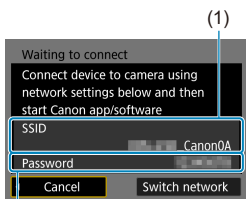

6 Check the SSID (network name) and password.

- Check the SSID (1) and password (2) displayed on the camera screen.
- In **[Wi-Fi settings]**, if you set **[Password]** to **[None]**, the password will not be displayed or required. For details, see page 533.

Steps on the Computer (1)

Computer's screen (sample)

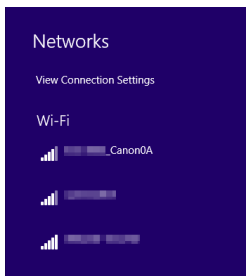

7 Select the SSID, then enter the password.

- On the computer's network setting screen, select the SSID checked in step 6. "**_Canon0A**" is displayed at the end of the SSID.
- For the password, enter the password checked in step 6.

Steps on the Camera (2)

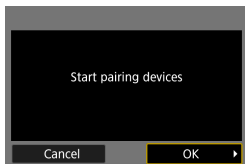

8 Select [OK].

- ▶ The following message is displayed. "*****" represents the last six digits of the MAC address of the camera to be connected.

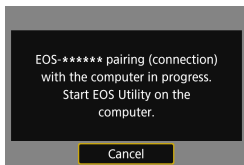

Steps on the Computer (2)

9 Start EOS Utility.

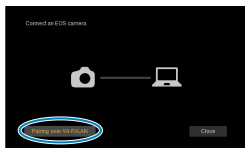

10 In EOS Utility, click [Pairing over Wi-Fi/LAN].

- If a firewall-related message is displayed, select [Yes].

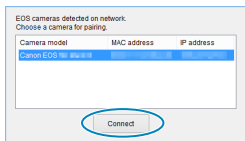

11 Click [Connect].

- Select the camera to connect to, then click [Connect].

Steps on the Camera (2)

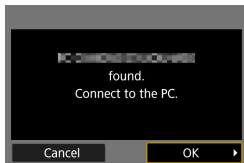

12 Establish a Wi-Fi connection.

- Select [OK].

[Wi-Fi on] Screen

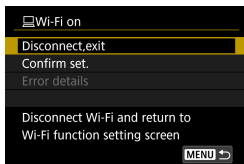

Disconnect,exit

- Terminates the Wi-Fi connection.

Confirm set.

- You can check the settings.

Error details

- When a Wi-Fi connection error occurs, you can check the details of the error.

The Wi-Fi connection to a computer is now complete.

- Operate the camera using EOS Utility on the computer.
- To reconnect via Wi-Fi, see “Reconnecting via Wi-Fi” (p.509).



- If the Wi-Fi connection is terminated while recording a movie with remote shooting, the following will occur.
 - Any movie recording in progress in movie shooting mode will continue.
 - Any movie recording in progress in still photo shooting mode will end.
- Operations using the camera are not possible after you use EOS Utility to switch from still photo shooting mode to movie shooting mode.
- With a Wi-Fi connection to EOS Utility established, certain functions are unavailable.
- In remote shooting, the AF speed may become slower.
- Depending on the communication status, image display or shutter release timing may be delayed.
- In Remote Live View shooting, the rate of image transmission is slower compared to a connection via an interface cable. Therefore, moving subjects cannot be displayed smoothly.
- The Wi-Fi connection will be terminated if you set the camera's power switch to <OFF>, or open the card slot cover or battery compartment cover.

Sending Images to a Computer Automatically

With the dedicated software Image Transfer Utility 2, you can send images on the camera to a computer automatically.

Steps on the Computer (1)

1 Connect the computer and access point and start Image Transfer Utility 2.

- In Image Transfer Utility 2, access the pairing settings screen.
- The screen to set up pairing is shown when you follow the instructions displayed the first time Image Transfer Utility 2 starts up.

Steps on the Camera

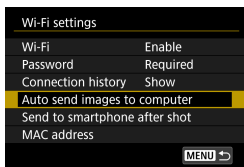

2 Select [Auto send images to computer].

- Select [Wi-Fi settings] on the [Wireless communication settings] screen.
- On the [Wi-Fi settings] screen, select [Auto send images to computer].

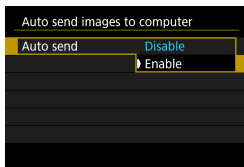

3 In [Auto send], select [Enable].

- If the [Nickname] screen is displayed, register a nickname (p.430).

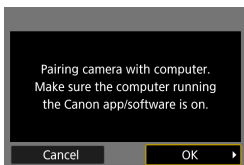

4 Select [OK].

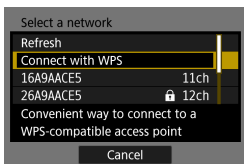

5 Connect to an access point via Wi-Fi.

- Establish a Wi-Fi connection between the camera and the access point connected to the computer. For connection instructions, see “Wi-Fi Connection via Access Points” (p.496).

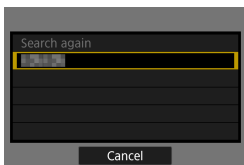

6 Select the computer to pair the camera with.

Steps on the Computer (2)

7 Pair the camera and computer.

- Select the camera, then click [Pairing].

Sending Images on the Camera to a Computer Automatically

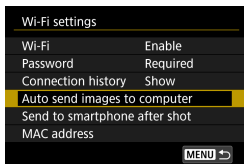

- 1 On the [Wi-Fi settings] screen, select [Auto send images to computer].

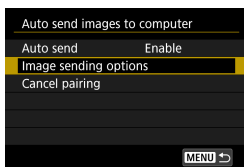

- 2 Select [Image sending options].

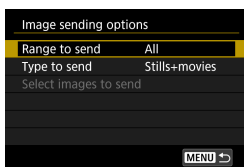

- 3 Select what to send.

- If you select [Selected imgs] in [Range to send], specify the images to send on the [Select images to send] screen.

- 4 Connect the computer and access point via Wi-Fi and start Image Transfer Utility 2.

- Images are sent automatically to the computer when you turn the camera on within range of the access point.

- ! Auto power off is disabled.
- Any images captured after automatic transfer are sent automatically when the camera is restarted.
- If automatic transfer does not begin automatically, try restarting the camera.

 Any images captured during automatic transfer are also sent automatically.

Connecting to a Printer via Wi-Fi

This section describes how to print images by directly connecting the camera to a printer via Wi-Fi. For printer operating instructions, refer to the printer user manual.

Establishing a Wi-Fi Connection

- 1 Set Wi-Fi settings to [Enable].**
 - See steps 1–4 on page 429.
- 2 Select [Wi-Fi function].**
 - Select **[Wi-Fi function]** on the **[Wireless communication settings]** screen.
- 3 Register a nickname.**
 - If the **[Nickname]** screen is displayed, register a nickname (p.430).
- 4 Select [🖨️] (Print from Wi-Fi printer).**
 - If the history (p.509) is displayed, switch the screen with the <◀> <▶> keys.
- 5 Select [Register a device for connection].**

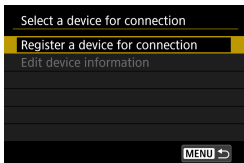
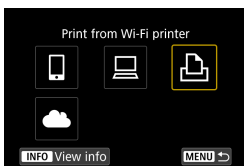
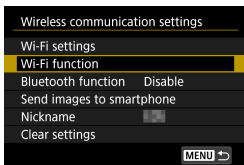

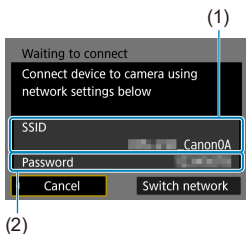

6 Check the SSID (network name) and password.

- Check the SSID (1) and password (2) displayed on the camera screen.
- In **[Wi-Fi settings]**, if you set **[Password]** to **[None]**, the password will not be displayed or required. For details, see page 533.

7 Set up the printer.

- On the Wi-Fi settings menu of the printer to be used, select the SSID you have checked.
“_Canon0A” is displayed at the end of the SSID.
- For the password, enter the password checked in step 6.

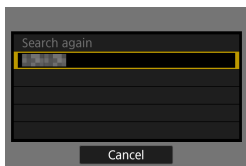

8 Select the printer.

- In the list of detected printers, select the printer to connect to via Wi-Fi.
- When 16 or more printers are detected or the search takes over 3 minutes, you can select **[Search again]**.

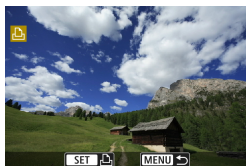

9 Print images (p.472).



Wi-Fi connection is possible with Wi-Fi printers supporting PictBridge (Wireless LAN).



To establish a Wi-Fi connection via an access point, see “Wi-Fi Connection via Access Points” (p.496).

Printing Images

Printing Images Individually

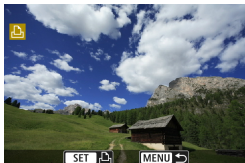

1 Select the image to be printed.

- Press the <◀> <▶> keys or turn the <☺> dial to select an image to print, then press <SET>.
- You can press the <Q> button and turn the <☺> dial counterclockwise to select the image using the index display.



2 Select [Print image].

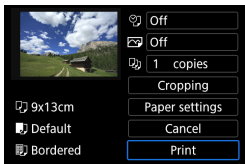

3 Print the image.

- For the print setting procedures, see page 475.
- Select [**Print**], then [**OK**] to start printing.

Printing by Specifying the Options

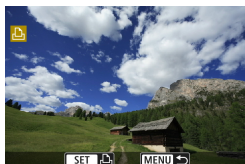

1 Press <SET>.



2 Select [Print order].

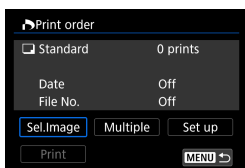

3 Set the printing options.

- For the setting procedures, refer to “Digital Print Order Format (DPOF)” (p.353).
- If the print order is complete before establishing a Wi-Fi connection, go to step 4.

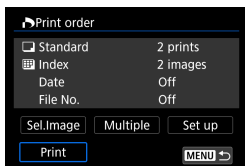

4 Select [Print].

- [Print] can be selected only when an image is selected and the printer is ready to print.

5 Set the [Paper settings] (p.475).

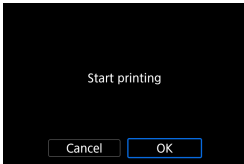

6 Print the image.

- When **[OK]** is selected, printing starts.

- ❗ ● With a Wi-Fi connection to a printer established, a picture cannot be taken even if the camera's shutter button is pressed.
- Movies cannot be printed.
- Before printing, be sure to set the paper size.
- Certain printers may not be able to imprint the file number.
- If **[Bordered]** is set, certain printers may imprint the date on the border.
- Depending on the printer, the date may appear faint if it is imprinted on a bright background or on the border.
- RAW images cannot be printed by selecting **[Print order]**. When printing, select **[Print image]** and print.

- 📄 ● When you use a battery to power the camera, make sure it is fully charged.
- Depending on the image's file size and image quality, it may take some time to start printing after you select **[Print]**.
- To stop printing, press **<SET>** while **[Stop]** is displayed, then select **[OK]**.
- When printing with **[Print order]**, if you stopped printing and want to resume printing of the remaining images, select **[Resume]**. Note that printing will not resume if any of the following occurs.
 - You change the print order or delete any of the print ordered images before resuming printing.
 - When index is set, you change the paper setting before resuming printing.
 - The card's remaining capacity is low when you pause printing.
- If a problem occurs during printing, see page 480.

Print Settings

The screen display and setting options vary depending on the printer. Also, certain settings may not be available. For details, refer to the printer's instruction manual.

Print setting screen

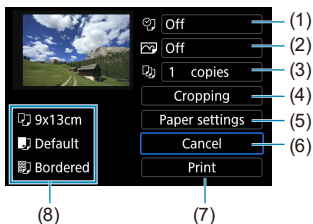

- (1) Sets the date or file number imprinting to on or off (p.477).
- (2) Sets the printing effects (p.477).
- (3) Sets the quantity to be printed (p.478).
- (4) Sets the print area (p.479).
- (5) Sets the paper size, type, and layout (p.476).
- (6) Returns to the image selection screen.
- (7) Starts the printing.
- (8) The paper size, type, and layout you have set are displayed.

* Depending on the printer, certain settings such as the date and file number imprinting or the cropping may not be selectable.

Paper Settings

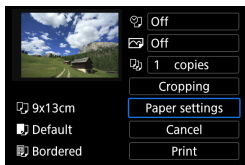

- Select **[Paper settings]**.

Setting the Paper Size

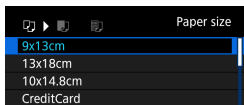

- Select the size of the paper in the printer.

Setting the Paper Type

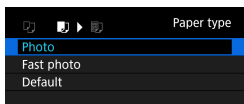

- Select the type of the paper in the printer.

Setting the Page Layout

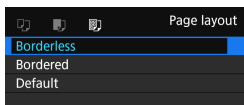

- Select the page layout.

Borderless	Prints with no borders. If your printer cannot print borderless prints, the print will have borders.
Bordered	Prints with white borders along the edges.
xx-up	Option to print 2, 4, 8, 9, 16, 20 or 35 images on one sheet.
Default	The page layout varies depending on the printer model or its settings.

 If the image's aspect ratio is different from the printing paper's aspect ratio, the image may be cropped significantly when you print it as a borderless print. If the image is cropped, the print may look grainier due to the fewer number of pixels.

Setting the Date/File Number Imprinting

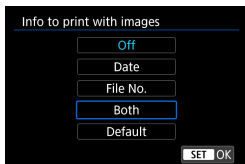

- Select [].
- Select what to print.

Setting the Printing Effects (Image Optimization)

Contents displayed on the screen vary depending on the printer.

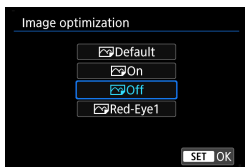

- Select [].
- Select printing effects.

Option	Printing Effect
Default	Printing effects differ depending on the printer. For details, refer to the printer's instruction manual.
On	Prints in the printer's standard colors. The image's Exif information is used to make automatic corrections.
Off	No automatic correction is applied.
Red-Eye1	Effective in flash images where the subject has red eye. The red eye is reduced for printing.



If you imprint shooting information on an image shot at an expanded ISO speed (**H**), the correct ISO speed may not be imprinted.

Setting the Number of Copies

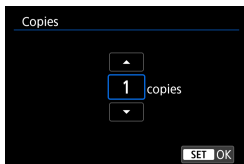

- Select [].
- Select the number of copies to print.

 The **[Default]** setting for printing effects and other options are the printer's own default settings as set by the printer's manufacturer. Refer to the printer's instruction manual to find out what the **[Default]** settings are.

Cropping the Image

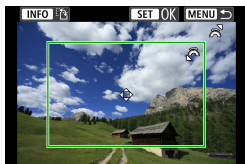

Set cropping immediately before printing. Changing other print settings after you crop images may require you to crop the images again.

- 1 On the print setting screen, select [Cropping].**
- 2 Set the cropping frame size, position, and aspect ratio.**
 - The image area within the cropping frame will be printed. The shape of the frame (aspect ratio) can be changed with **[Paper settings]**.

Changing the Cropping Frame Size

Turn the  dial to change the cropping frame size.

Moving the Cropping Frame

Press the **<▲>** **<▼>** or **<◀>** **<▶>** keys to move the frame over the image vertically or horizontally.

Switching the Orientation of the Cropping Frame

Pressing the **<INFO>** button will toggle the cropping frame between the vertical and horizontal orientations.

- 3 Press <SET> to exit the cropping.**
 - You can check the cropped image area on the upper left of the print setting screen.

- Depending on the printer, the cropped image area may not be printed as you specified.
- The smaller you make the cropping frame, the grainier the picture will look in the print.



Handling Printer Errors

If printing does not resume after you resolve a printer error (no ink, no paper, etc.) and select **[Continue]**, operate the buttons on the printer. For details on resuming printing, refer to the printer's instruction manual.

Error Messages

If a problem occurs during printing, an error message will appear on the camera screen. After fixing the problem, resume printing. For details on how to fix a printing problem, refer to the printer's instruction manual.

Paper Error

Check whether the paper is properly loaded in the printer.

Ink Error

Check the printer's ink level and the waste ink tank.

Hardware Error

Check for any printer problems other than paper and ink problems.

File Error

The selected image cannot be printed. Images taken with a different camera or images edited with a computer may not be printable.

Sending Images to a Web Service

This section describes how to use Web services to send images.

Registering Web Services

Use a smartphone or computer to add your Web services to the camera.

- A smartphone or computer with a browser and Internet connection is required to complete camera settings for CANON iIMAGE GATEWAY and other Web services.
- Visit the CANON iIMAGE GATEWAY website for details on versions of browsers (such as Microsoft Internet Explorer) and settings required for CANON iIMAGE GATEWAY access.
- For information on countries and regions where CANON iIMAGE GATEWAY is available, visit the Canon website (<http://www.canon.com/cig/>).
- For CANON iIMAGE GATEWAY instructions and setting details, refer to the help information for CANON iIMAGE GATEWAY.
- If you also intend to use Web services other than CANON iIMAGE GATEWAY, you must have an account with the services you intend to use. For further details, check the websites for each Web service you will register.
- Fees to connect to your provider and communication fees to access your provider's access point are charged separately.

Registering CANON iIMAGE GATEWAY

Link the camera and CANON iIMAGE GATEWAY by adding CANON iIMAGE GATEWAY as a destination Web service on the camera. You will need to enter an email address used on your computer or smartphone.

Steps on the Camera (1)

1 Set Wi-Fi settings to [Enable].

- See steps 1–4 on page 429.

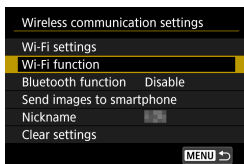

2 Select [Wi-Fi function].

- Select [Wi-Fi function] on the [Wireless communication settings] screen.

3 Register a nickname.

- If the [Nickname] screen is displayed, register a nickname (p.430).

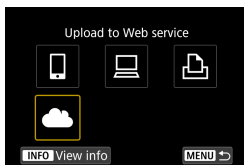

4 Select [☁].

5 Select [I Agree].

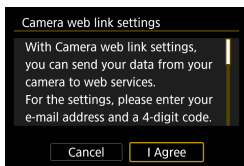

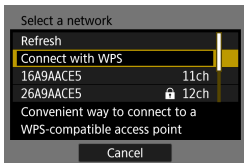

6 Establish a Wi-Fi connection.

- Go to step 7 on page 498 (PBC mode), step 7 on page 502 (PIN mode), or step 7 on page 505 (manually).

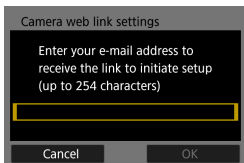

7 Enter your email address.

- Enter your email address, then select **[OK]**.

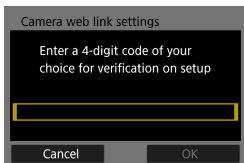

8 Enter a four-digit number.

- Enter a four-digit number of your choice, then select **[OK]**.

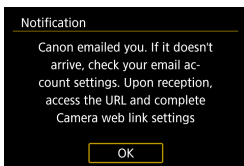

9 Select **[OK]**.

- The **[☁]** icon changes to **[☁+]**.

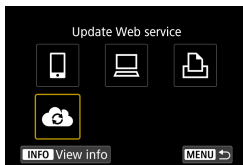

Steps on the Computer or Smartphone

10 Set up camera web link.

- Access the page in the notification message.
- Follow the instructions to complete the settings on the camera web link settings page.

Steps on the Camera (2)

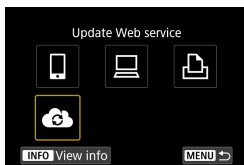

11 Add CANON iMAGE GATEWAY as a destination.

- Select [☁️].
- ▶ CANON iMAGE GATEWAY is now added.

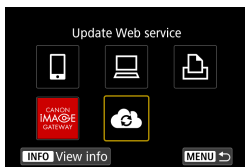

Registering Other Web Services

Steps on the Computer or Smartphone

1 Configure the Web service you want to use.

- Visit the CANON IMAGE GATEWAY website and access the camera web link settings page.
- Follow the on-screen instructions to complete settings for Web services you want to use.

Steps on the Camera

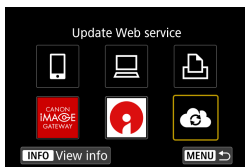

2 Add the Web service you configured as a destination.

- On the [Wi-Fi function] screen, select [📷].

Establishing a Wi-Fi Connection

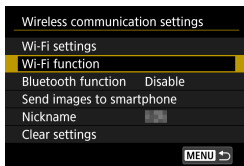

- 1 Select [Wi-Fi function].**
 - Select **[Wi-Fi function]** on the **[Wireless communication settings]** screen.

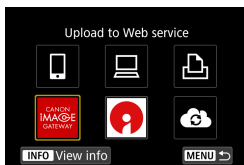

- 2 Select a Web service.**
 - If the history (p.509) is displayed, switch the screen with the <◀> <▶> keys.
 - A screen to select a destination may be displayed, depending on the type and settings of the Web service (p.508).

Sending Images to a Web Service

You can share images with your family and friends by sending images from the camera to a Web service registered on the camera or by sending Web links of the online albums.

Sending Images Individually



1 Select an image to send.

- Press the <◀> <▶> keys or turn the <🌀> dial to select an image to send, then press <SET>.
- You can press the <Q> button and turn the <🌀> dial counterclockwise to select the image using the index display.



2 Select [Send img shown].

- In [**Size to send**], you can select the image sending size.
- On the screen after images are sent, select [**OK**] to end the Wi-Fi connection.
- When the [**Terms of use**] screen is displayed, thoroughly read the message, then select [**I Agree**].
- To scroll the screen, use the <▲> <▼> keys.

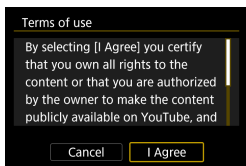

Sending Multiple Selected Images

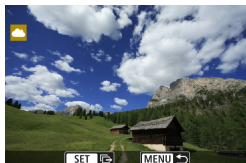

1 Press <SET>.



2 Select [Send selected].

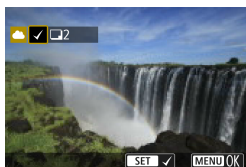

3 Select the images to send.

- Press the <◀> <▶> keys or turn the <⚙> dial to select an image to send, then press <SET>.
- You can press the <Q> button and turn the <⚙> dial counterclockwise to switch to the three-image display to select the images. To return to the single image display, also press the <Q> button and operate the <⚙> dial.
- After selecting the images to send, press the <MENU> button.

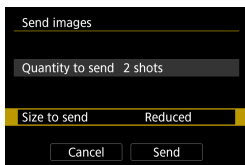

4 Select [Size to send].

- When YouTube is selected as the destination, **[Size to send]** is not displayed.
- On the displayed screen, select an image size.

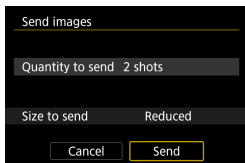
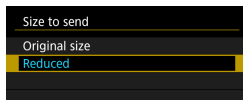

5 Select [Send].

- On the screen after images are sent, select **[OK]** to end the Wi-Fi connection.

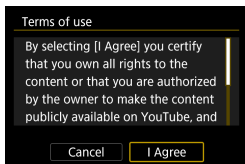

- When the **[Terms of use]** screen is displayed, thoroughly read the message, then select **[I Agree]**.
- To scroll the screen, use the <▲> <▼> keys.

Sending a Specified Range of Images

Specify the range of images to send all the images in the range at once.

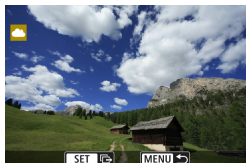

1 Press <SET>.



2 Select [Send range].

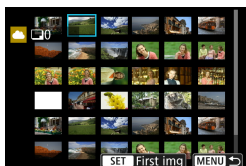

3 Specify the range of images.

- Select the first image (start point).
- Select the last image (end point).
- ▶ Images will be selected and [✓] will appear.
- To cancel the selection, repeat this step.
- You can press the <Q> button and turn the <DISP/OK> dial to change the number of images shown in the index display.

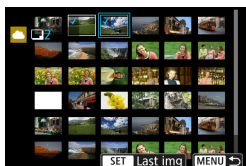

4 Confirm the range.

- Press the <MENU> button.

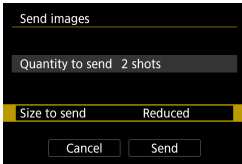

5 Select [Size to send].

- On the displayed screen, select an image size.

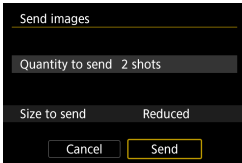
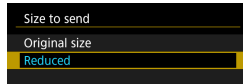

6 Select [Send].

- On the screen after images are sent, select **[OK]** to end the Wi-Fi connection.

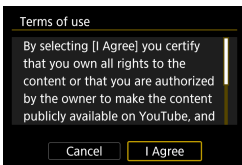

- When the **[Terms of use]** screen is displayed, thoroughly read the message, then select **[I Agree]**.
- To scroll the screen, use the <▲> <▼> keys.

Sending All Images on the Card



1 Press <SET>.



2 Select [Send all card].

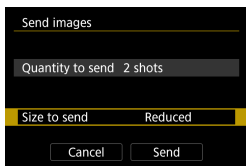

3 Select [Size to send].

- Set it as necessary.
- On the displayed screen, select an image size.

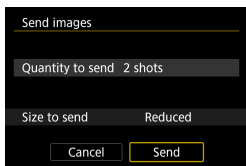
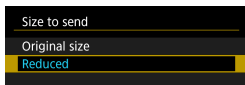

4 Select [Send].

- On the screen after images are sent, select **[OK]** to end the Wi-Fi connection.

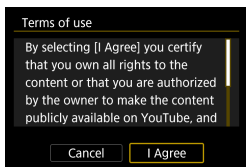

- When the **[Terms of use]** screen is displayed, thoroughly read the message, then select **[I Agree]**.
- To scroll the screen, use the <▲> <▼> keys.

Sending Images that Match the Search Conditions

Send all the images that match the search conditions set in **[Set image search conditions]** at once.

For **[Set image search conditions]**, refer to “Filtering Images for Playback” (p.313).



1 Press <SET>.



2 Select **[Send all found]**.

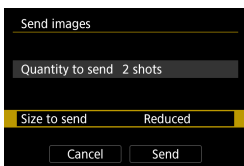

3 Select **[Size to send]**.

- Set it as necessary.
- On the displayed screen, select an image size.

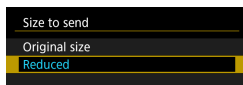

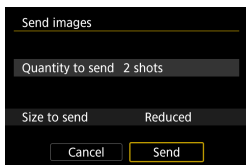

4 Select [Send].

- On the screen after images are sent, select **[OK]** to end the Wi-Fi connection.
- When the **[Terms of use]** screen is displayed, thoroughly read the message, then select **[I Agree]**.
- To scroll the screen, use the <▲> <▼> keys.

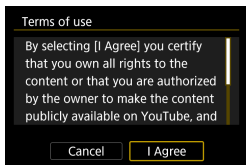



- With a Wi-Fi connection to a Web service established, a picture cannot be taken even if the camera's shutter button is pressed.
- When sending an image to a Web service other than CANON iIMAGE GATEWAY, a send error message may not be displayed even if the image has not been sent to the Web service successfully. Since such send errors can be checked on the CANON iIMAGE GATEWAY site, check the error content, then try sending the image again.



- Depending on the Web service, the type or number of images that can be sent and the length of movies will be limited.
- Certain images may not be able to be sent with **[Send range]**, **[Send all card]**, or **[Send all found]**.
- When you reduce the image size, all images to be sent at the same time are resized. Note that movies or **S2** size still photos are not reduced.
- **[Reduced]** is enabled only for still photos shot with cameras of the same model as this camera. Still photos shot with other models are sent without resizing.
- When accessing CANON iIMAGE GATEWAY from a computer or other device, you can check the send history for the Web services that the images were sent to.
- To terminate the Wi-Fi connection without sending an image, press the **<MENU>** button on the screen for step 1.
- When you use a battery to power the camera, make sure it is fully charged.

Wi-Fi Connection via Access Points

This section describes how to join a Wi-Fi network via an access point.

Checking the Type of Access Point

Determine whether the access point for the Wi-Fi connection is compatible with WPS (Wi-Fi Protected Setup), as described in the access point instruction manual or other documentation.

● When WPS is supported

The following two Wi-Fi connection methods are available. Connection can be established easier with WPS (PBC mode).

● WPS (PBC mode):

Follow the steps beginning on page 497.

● WPS (PIN mode):

Follow the steps beginning on page 501.

● When WPS is not supported

Follow the steps beginning on page 504. In this case, access point encryption must be set to one of the following.

● [Authentication]:

Open system, Shared key, or WPA/WPA2-PSK

● [Encryption settings]:

WEP, TKIP, or AES



● If stealth functions of the access point are active, Wi-Fi connection may be disabled. Deactivate stealth functions.

● When connecting to a network that has a network administrator, ask the administrator about the detailed setting procedures.



If the network you use filters by MAC address, register the MAC address of the camera at the access point. The MAC address can be checked on the [View info] screen (p.516).

Establishing a Wi-Fi Connection with WPS (PBC Mode)

First, check the position of the WPS button and how long to press it. It may take approx. one minute to establish a Wi-Fi connection. If multiple access points are active nearby and you cannot establish a Wi-Fi connection, try to establish the connection in **[WPS (PIN mode)]**.

1 Set Wi-Fi settings to [Enable].

- See steps 1–4 on page 429.

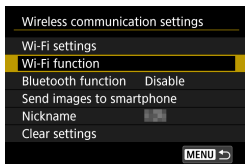

2 Select [Wi-Fi function].

- Select **[Wi-Fi function]** on the **[Wireless communication settings]** screen.

3 Register a nickname.

- If the **[Nickname]** screen is displayed, register a nickname (p.430).

4 Select an item.

- If the history (p.509) is displayed, switch the screen with the <◀> <▶> keys.
- Press the <▲> <▼> or <◀> <▶> keys to select an item.

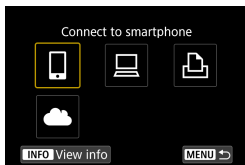

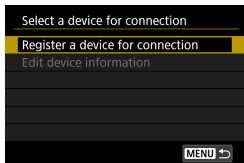

5 Select [Register a device for connection].

- When [☐] (Connect to smartphone) is selected, the screen on the left is displayed. If Camera Connect is already installed, select [Do not display].

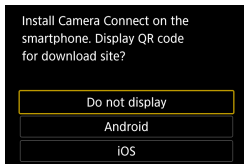

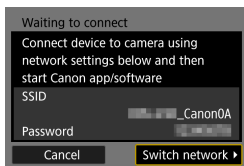

6 Select [Switch network].

- Displayed when [☐], [☐], or [☐] is selected.

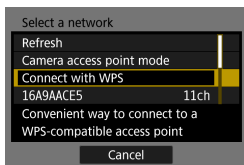

7 Select [Connect with WPS].



 For [Camera access point mode] displayed on the screen in step 7, see page 508.

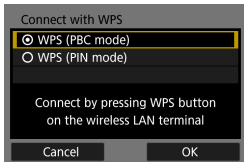

8 Select [WPS (PBC mode)].

- Select [OK].

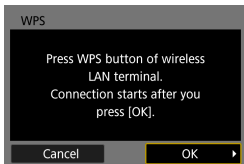

9 Connect to the access point via Wi-Fi.

- Press the access point's WPS button.
- Select [OK].

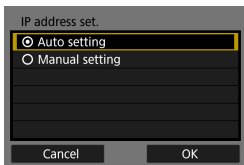

10 Select [Auto setting].

- Select [OK] to access the setting screen for the Wi-Fi function.
- If [Auto setting] results in an error or if you want to specify the settings manually, see page 535.

11 Specify the settings for the Wi-Fi function.



The IP address can only be set automatically in environments using DHCP servers, or access points or routers with DHCP server functionality, and IP addresses, etc. are set to be assigned automatically.

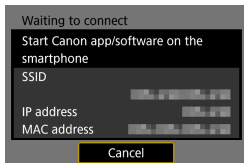

[📱 **Connect to smartphone**]

Go to step 9 on page 442.

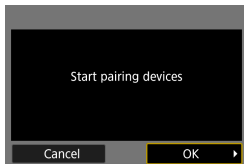

[💻 **Remote control (EOS Utility)**]

Go to step 8 on page 463.

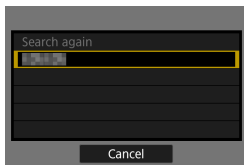

[🖨️ **Print from Wi-Fi printer**]

Go to step 8 on page 470.

Registering CANON iMAGE GATEWAY

Go to step 7 on page 483.

Establishing a Wi-Fi Connection with WPS (PIN Mode)

First, check how to enter a PIN code on the access point.
It may take approx. one minute to establish a Wi-Fi connection.

1 Set Wi-Fi settings to [Enable].

- See steps 1–4 on page 429.

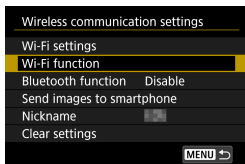

2 Select [Wi-Fi function].

- Select **[Wi-Fi function]** on the **[Wireless communication settings]** screen.

3 Register a nickname.

- If the **[Nickname]** screen is displayed, register a nickname (p.430).

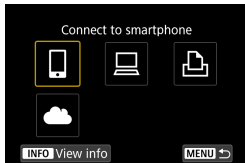

4 Select an item.

- If the history (p.509) is displayed, switch the screen with the <◀> <▶> keys.
- Press the <▲> <▼> or <◀> <▶> keys to select an item.

5 Select [Register a device for connection].



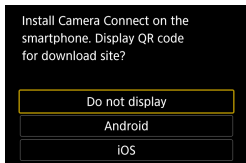

- When [📱] (Connect to smartphone) is selected, the screen on the left is displayed. If Camera Connect is already installed, select [Do not display].

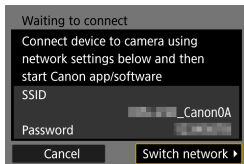

6 Select [Switch network].

- Displayed when [📱], [💻], or [🖨️] is selected.

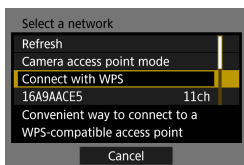

7 Select [Connect with WPS].

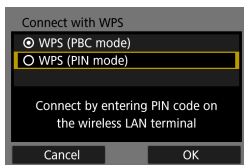

8 Select [WPS (PIN mode)].

- Select [OK].

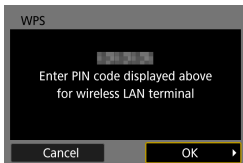

9 Specify the PIN code at the access point.

- At the access point, specify the PIN code displayed on the camera screen.
- Once you have entered the PIN code, select **[OK]**.

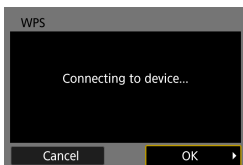

10 Connect to the access point via Wi-Fi.

- Select **[OK]**.

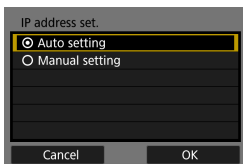

11 Select **[Auto setting]**.

- Select **[OK]** to access the setting screen for the Wi-Fi function.
- If **[Auto setting]** results in an error or if you want to specify the settings manually, see page 535.

12 Specify the settings for the Wi-Fi function (p.500).



For **[Camera access point mode]** displayed in step 7, see page 508.



The IP address can only be set automatically in environments using DHCP servers, or access points or routers with DHCP server functionality, and IP addresses, etc. are set to be assigned automatically.

Establishing a Wi-Fi Connection Manually

Establish a Wi-Fi connection by selecting the SSID (or ESS-ID) of the access point for a Wi-Fi connection from a list of active access points nearby.

Selecting the Access Point

1 Set Wi-Fi settings to [Enable].

- See steps 1–4 on page 429.

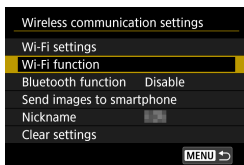

2 Select [Wi-Fi function].

- Select [Wi-Fi function] on the [Wireless communication settings] screen.

3 Register a nickname.

- If the [Nickname] screen is displayed, register a nickname (p.430).

4 Select an item.

- If the history (p.509) is displayed, switch the screen with the <◀> <▶> keys.
- Press the <▲> <▼> or <◀> <▶> keys to select an item.

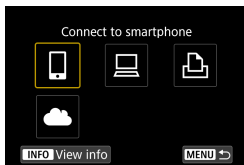

5 Select [Register a device for connection].

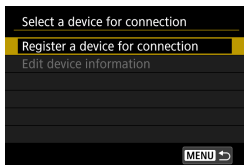

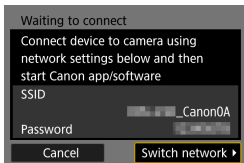

6 Select [Switch network].

- Displayed when [☐], [☒], or [☑] is selected.

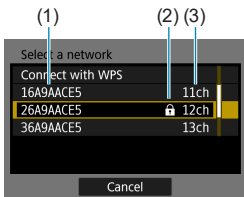

7 Select the access point.

- Press the <▲> <▼> keys to select the access point to connect to via Wi-Fi from the list of access points.

- (1) SSID
 (2) An icon is displayed if the access point is encrypted
 (3) Channel used

Refreshing and Manual Settings

- Scroll down the screen in step 7 to display [Manual settings].
- To search for access points again, select [Refresh].
- To specify the settings for the access point manually, select [Manual settings]. Enter the SSID using the virtual keyboard and then specify the settings following the instructions displayed.

Entering the Access Point Password

- Enter the password specified for the access point. For details on the specified password, refer to the access point's instruction manual.
- The screens displayed in steps 8 to 9 below vary depending on the authentication and encryption specified for the access point.
- Go to step 10 when the **[IP address set.]** screen is displayed instead of the screens for steps 8 to 9.

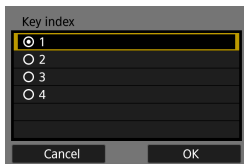

8 Select a key index.

- The **[Key index]** screen is displayed only if WEP encryption is used by the access point.
- Select the key index number specified for the access point.
- Select **[OK]**.

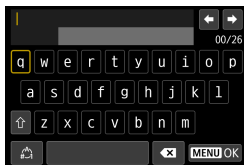

9 Enter the password.

- Enter the password using the virtual keyboard (p.534).

Setting the IP Address

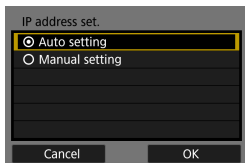

10 Select [Auto setting].

- Select **[OK]** to access the setting screen for the Wi-Fi function.
- If **[Auto setting]** results in an error or if you want to specify the settings manually, see page 535.

11 Specify the settings for the Wi-Fi function (p.500).



The IP address can only be set automatically in environments using DHCP servers, or access points or routers with DHCP server functionality, and IP addresses, etc. are set to be assigned automatically.

Send To Screen

A screen to select a destination may be displayed depending on the Web service.

To register destinations or to specify the settings, you must use a computer. For more information, refer to the EOS Utility Instruction Manual.

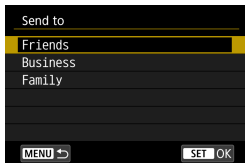

- When [✉] (Email) or other service is selected on the [Upload to Web service] screen, the [Send to] screen may be displayed.
- Select the destination from the list of registered destinations.
- The procedures for setting up a connection and sending images are the same as those for other Web services.

Camera Access Point Mode

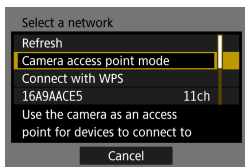

Camera access point mode is a connection mode for connecting the camera directly to each device via Wi-Fi. Displayed when [📶], [🖨️], or [📷] is selected in [Wi-Fi function].

Reconnecting via Wi-Fi

Follow these steps to reconnect to devices or Web services with registered connection settings.

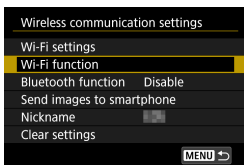

1 Select [Wi-Fi function].

- Select **[Wi-Fi function]** on the **[Wireless communication settings]** screen.

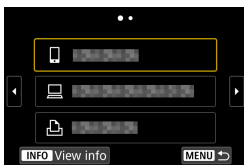

2 Select an item.

- Select the item to connect to via Wi-Fi from the displayed history. If the item is not displayed, press the <◀> <▶> keys to switch the screen.
- If **[Connection history]** is set to **[Hide]**, the history will not be displayed (p.533).

3 Operate the connected device.

[☐] Smartphone

- Activate the smartphone's Wi-Fi function, then start Camera Connect.
- If the smartphone's connection destination has been changed, restore the setting to connect via Wi-Fi to the camera or the same access point as the camera.

When directly connecting the camera to a smartphone via Wi-Fi, “_Canon0A” is displayed at the end of the SSID.

Computer

- On the computer, start the EOS software.
- If the computer's connection destination has been changed, restore the setting to connect via Wi-Fi to the camera or the same access point as the camera.

When directly connecting the camera to a computer via Wi-Fi, “_Canon0A” is displayed at the end of the SSID.

Printer

- If the printer's connection destination has been changed, restore the setting to connect via Wi-Fi to the camera or the same access point as the camera.

When directly connecting the camera to a printer via Wi-Fi, “_Canon0A” is displayed at the end of the SSID.

 For the connection history, up to three items appear in the order of registration. When a connection setting is added, the oldest item will be deleted from the history.

Connecting to a Bluetooth-connected Smartphone via Wi-Fi



1 Start Camera Connect.

- Tap on the Camera Connect icon on the smartphone to start the application.

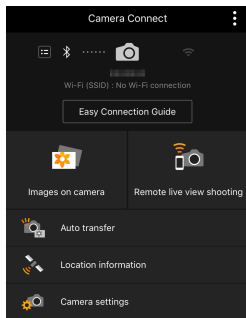

2 Select a Camera Connect function.

- Select the Camera Connect function you want to use.
- A Wi-Fi connection will be automatically established.
- In iOS, select **[Join]** when a message is displayed to confirm camera connection.

When a Wi-Fi connection is established, the screen for the selected function will appear.

- For the Camera Connect functions, see page 444.

Registering Multiple Connection Settings

You can register up to 20 connection settings for the Wi-Fi function.

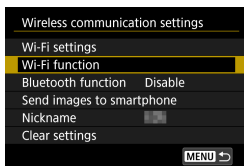

1 Select [Wi-Fi function].

- Select **[Wi-Fi function]** on the **[Wireless communication settings]** screen.

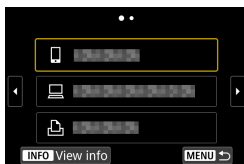

2 Select an item.

- When the screen on the left appears, press the <◀> <▶> keys to switch the screen.
- Select the item to newly connect to via Wi-Fi from the screen on the left.
- For details on [📱] (Connect to smartphone), see “Connecting to a Smartphone via Wi-Fi from the **[Wi-Fi function]** Menu” (p.427).
- For [💻] (Remote control (EOS Utility)), see “Connecting to a Computer via Wi-Fi” (p.461).
- For details on [🖨️] (Print from Wi-Fi printer), see “Connecting to a Printer via Wi-Fi” (p.469).
- When sending images to a Web service, see “Sending Images to a Web Service” (p.481).

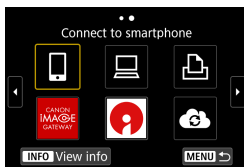

 To delete connection settings, see page 513.

Changing or Deleting Connection Settings

Change or delete connection settings saved on the camera. To change or delete the connection settings, terminate the Wi-Fi connection first.

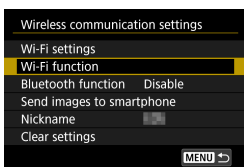

1 Select [Wi-Fi function].

- Select **[Wi-Fi function]** on the **[Wireless communication settings]** screen.

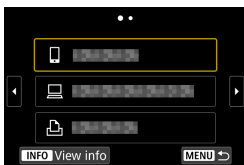

2 Select an item.

- When the screen on the left appears, press the <◀> <▶> keys to switch the screen.

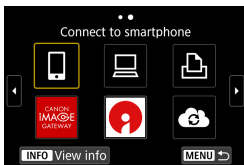

- From the screen on the left, select the item for which to change or delete the connection settings.

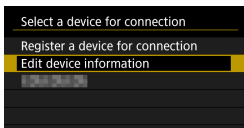

3 Select [Edit device information].

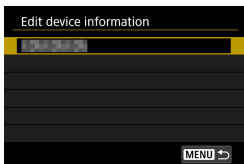

4 Select a device.

- Select the device for which to change or delete the connection settings.

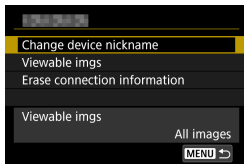

5 Check or change the connection settings.

- Select an item, then change or delete the connection settings on the displayed screen.

● **Change device nickname**

You can change the nickname using the virtual keyboard (p.534).

● **Viewable imgs** (p.458)

Displayed when [] (Connect to smartphone) is selected. Settings will appear at the bottom of the screen.

● **Erase connection information**

You can delete connection settings saved on the camera.

For Web services, visit the [CANON IMAGE GATEWAY](#) website to delete the connection settings.

Clearing Wireless Communication Settings to Default

All wireless communication settings can be deleted. By deleting the wireless communication settings, you can prevent their information from being exposed when you lend or give your camera to other people.

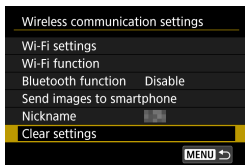

1 Select [Clear settings].

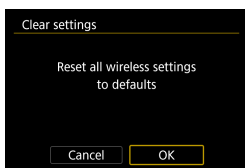

2 Select [OK].

- ▶ Wireless communication settings are cleared to default, and the **[Wireless communication settings]** screen will reappear.

 Performing [**46: Clear all camera settings**] does not delete the wireless communication setting information.

View Info Screen

On the **[View info]** screen, you can check error details and the camera's MAC address.

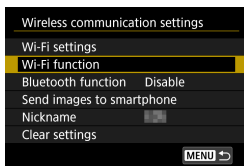

- 1 **Select [Wi-Fi function].**
 - Select **[Wi-Fi function]** on the **[Wireless communication settings]** screen.

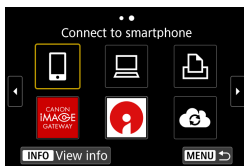

- 2 **Select an item, then press the <INFO> button.**
 - ▶ The **[View info]** screen will appear.

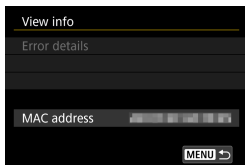

- When an error has occurred, press **<SET>** to display the error content.

Responding to Error Messages

When an error occurs, display the details of the error by following one of the procedures below. Then, eliminate the cause of the error by referring to the examples shown in this chapter.

- On the **[View info]** screen, press <SET> (p.516).
- Select **[Error details]** on the **[Wi-Fi on]** screen.

Click the error code number's page in the following chart to jump to the corresponding page.

11 (p.518)	12 (p.518)			
21 (p.519)	22 (p.520)	23 (p.521)		
61 (p.522)	63 (p.523)	64 (p.523)	65 (p.524)	66 (p.524)
67 (p.524)	68 (p.525)	69 (p.525)		
91 (p.525)	121 (p.525)			
125 (p.526)				
126 (p.526)	127 (p.526)			
141 (p.526)	142 (p.526)			
151 (p.527)	152 (p.527)			



When an error occurs, **[Err**]** is displayed on the upper right of the **[Wi-Fi function]** screen. It disappears when the camera's power is set to <OFF>.

11: Connection target not found

- **In the case of [□], is Camera Connect running?**
 - ▶ Establish a connection using Camera Connect (p.442).
- **In the case of [▢], is the power of the printer on?**
 - ▶ Turn on the printer.
- **In the case of [▣], is the EOS software running?**
 - ▶ Start the EOS software and reestablish the connection (p.463).
- **Are the camera and the access point set to use the same password for authentication?**
 - ▶ This error occurs if the passwords do not match when the authentication method for encryption is set to **[Open system]**. The setting is case-sensitive, so check upper- and lower-case characters. Make sure that the correct password for authentication is set on the camera (p.506).

12: Connection target not found

- **Is the power of the target device and access point on?**
 - ▶ Turn on the target device and access point, then wait a while. If a connection still cannot be established, perform the procedures to establish the connection again.

21: No address assigned by DHCP server

What to check on the camera

- **On the camera, IP address is set to [Auto setting]. Is this the correct setting?**
 - ▶ If no DHCP server is used, specify the settings after setting the IP address to **[Manual setting]** on the camera (p.535).

What to check on the DHCP server

- **Is the power of the DHCP server on?**
 - ▶ Turn on the DHCP server.
- **Are there enough addresses for assignment by the DHCP server?**
 - ▶ Increase the number of addresses assigned by the DHCP server.
 - ▶ Remove devices assigned addresses by the DHCP server from the network to reduce the number of addresses in use.
- **Is the DHCP server working correctly?**
 - ▶ Check the DHCP server settings to make sure it is working correctly as a DHCP server.
 - ▶ If applicable, ask your network administrator to ensure the DHCP server is available.

22: No response from DNS server

What to check on the camera

- **On the camera, does the DNS server's IP address setting match the server's actual address?**
 - ▶ Set the IP address to **[Manual setting]**. Then, on the camera, set the IP address that matches the address of the DNS server used (p.531, 535).

What to check on the DNS server

- **Is the power of the DNS server on?**
 - ▶ Turn on the DNS server.
- **Are the DNS server settings for IP addresses and the corresponding names correct?**
 - ▶ On the DNS server, make sure IP addresses and the corresponding names are entered correctly.
- **Is the DNS server working correctly?**
 - ▶ Check the DNS server settings to make sure it is working correctly as a DNS server.
 - ▶ If applicable, ask your network administrator to ensure the DNS server is available.

What to check on the network as a whole

- **Does the network that you are trying to connect to via Wi-Fi include a router or similar device that serves as a gateway?**
 - ▶ If applicable, ask your network administrator for the network gateway address and enter it on the camera (p.531, 535).
 - ▶ Make sure that the gateway address setting is correctly entered on all network devices including the camera.

23: Device with same IP address exists on selected network

What to check on the camera

- **Do the camera and another device connected via Wi-Fi to the same network have the same IP address?**
 - ▶ Change the camera's IP address to avoid using the same address as another device on the network. Otherwise, change the IP address of the device that has a duplicate address.
 - ▶ If the camera's IP address is set to **[Manual setting]** in network environments using a DHCP server, change the setting to **[Auto setting]** (p.507).



Responding to Error Messages 21–23

Also check the following points when responding to errors numbered 21–23.

Are the camera and the access point set to use the same password for authentication?

- ▶ This error occurs if the passwords do not match when the authentication method for encryption is set to **[Open system]**. The setting is case-sensitive, so check upper- and lower-case characters. Make sure that the correct password for authentication is set on the camera (p.506).

61: Selected SSID wireless LAN network not found

- **Are any obstacles blocking the line of sight between the camera and the antenna of the access point?**
 - ▶ Move the antenna of the access point to a position clearly visible from the point of view of the camera (p.528).

What to check on the camera

- **Does the SSID set on the camera match that of the access point?**
 - ▶ Check the SSID at the access point, then set the same SSID on the camera (p.505).

What to check at the access point

- **Is the access point turned on?**
 - ▶ Turn on the power of the access point.
- **If filtering by MAC address is active, is the MAC address of the camera in use registered at the access point?**
 - ▶ Register the MAC address of the camera used to the access point. The MAC address can be checked on the **[View info]** screen (p.516).

63: Wireless LAN authentication failed

- **Are the camera and the access point set to use the same authentication method?**
 - ▶ The camera supports the following authentication methods: **[Open system]**, **[Shared key]**, and **[WPA/WPA2-PSK]** (p.496).
- **Are the camera and the access point set to use the same password for authentication?**
 - ▶ The setting is case-sensitive, so check upper- and lower-case characters. Make sure that the correct password for authentication is set on the camera (p.506).
- **If filtering by MAC address is active, is the MAC address of the camera in use registered at the access point?**
 - ▶ Register the MAC address of the camera used to the access point. The MAC address can be checked on the **[View info]** screen (p.516).

64: Cannot connect to wireless LAN terminal

- **Are the camera and the access point set to use the same encryption method?**
 - ▶ The camera supports the following encryption methods: WEP, TKIP, and AES (p.496).
- **If filtering by MAC address is active, is the MAC address of the camera in use registered at the access point?**
 - ▶ Register the MAC address of the camera used to the access point. The MAC address can be checked on the **[View info]** screen (p.516).

65: Wireless LAN connection lost

- **Are any obstacles blocking the line of sight between the camera and the antenna of the access point?**
 - ▶ Move the antenna of the access point to a position clearly visible from the point of view of the camera (p.528).
- **The Wi-Fi connection was lost for some reason, and the connection cannot be restored.**
 - ▶ The following are possible reasons: excessive access to the access point from another device, a microwave oven or similar appliance in use nearby (interfering with IEEE 802.11b/g/n (2.4 GHz band)), or influence of rain or high humidity (p.528).

66: Incorrect wireless LAN password

- **Are the camera and the access point set to use the same password for authentication?**
 - ▶ The setting is case-sensitive, so check upper- and lower-case characters. Make sure that the correct password for authentication is set on the camera (p.506).

67: Incorrect wireless LAN encryption method

- **Are the camera and the access point set to use the same encryption method?**
 - ▶ The camera supports the following encryption methods: WEP, TKIP, and AES (p.496).
- **If filtering by MAC address is active, is the MAC address of the camera in use registered at the access point?**
 - ▶ Register the MAC address of the camera used to the access point. The MAC address can be checked on the **[View info]** screen (p.516).

68: Cannot connect to wireless LAN terminal. Retry from the beginning.

- **Did you hold down the access point's WPS (Wi-Fi Protected Setup) button for the specified period of time?**
 - ▶ Hold down the WPS button for the period of time specified in the access point's instruction manual.
- **Are you trying to establish a connection near the access point?**
 - ▶ Try establishing the connection when both devices are within reach of each other.

69: Multiple wireless LAN terminals have been found. Cannot connect. Retry from the beginning.

- **Connection is in progress by other access points in Pushbutton Connection mode (PBC mode) of WPS (Wi-Fi Protected Setup).**
 - ▶ Wait a while before trying to establish the connection, or try to establish a connection in PIN code connection mode (PIN mode) (p.501).

91: Other error

- **A problem other than error code number 11 to 69 occurred.**
 - ▶ Turn the camera's power switch off and on.

121: Not enough free space on server

- **The target Web server does not have enough free space.**
 - ▶ Delete unnecessary images on the Web server, check the free space on the Web server, then try sending the data again.

125: Check the network settings

- **Is the network connected?**
 - ▶ Check the connection status of the network.

126: Could not connect to server

- **CANON iIMAGE GATEWAY is under maintenance or load is concentrated temporarily.**
 - ▶ Try connecting to the Web service again later.

127: An error has occurred

- **A problem other than error code number 121 to 126 occurred while the camera is connected to the Web service.**
 - ▶ Try again to establish the Wi-Fi connection to the Web service.

141: Printer is busy. Try connecting again.

- **Is the printer performing a printing process?**
 - ▶ Try again to establish the Wi-Fi connection to the printer after the printing process is finished.
- **Is another camera connected to the printer via Wi-Fi?**
 - ▶ Try again to establish the Wi-Fi connection to the printer after the Wi-Fi connection to the other camera has been terminated.

142: Could not acquire printer information. Reconnect to try again.

- **Is the power of the printer on?**
 - ▶ Try again to establish the Wi-Fi connection after turning on the printer.

151: Transmission canceled

- **Automatic image transfer to the computer was somehow interrupted.**
- ▶ To resume automatic image transfer, set the camera's power switch to <OFF>, and then set it to <ON>.

152: Card's write protect switch is set to lock

- **Is the card's write-protect switch set to the locked position?**
- ▶ Slide the card's write-protect switch to the writing position.

Wireless Communication Function Notes

If the transmission rate drops, the connection is lost, or other problems occur when using the wireless communication functions, try the following corrective actions.

Distance Between the Camera and the Smartphone

If the camera is too far from the smartphone, a Wi-Fi connection may not be established even when Bluetooth connection is possible. In such a case, bring the camera and the smartphone closer together, then establish a Wi-Fi connection.

Installation Location of Access Point Antenna

- When using indoors, install the device in the room where you are using the camera.
- Install the device where people or objects do not come between the device and the camera.

Nearby Electronic Devices

If the Wi-Fi transmission rate drops because of the influence of the following electronic devices, stop using them or move further away from the devices to transmit communication.

- The camera communicates over Wi-Fi via IEEE 802.11b/g/n using radio waves in the 2.4 GHz band. For this reason, the Wi-Fi transmission rate will drop if there are Bluetooth devices, microwave ovens, cordless telephones, microphones, smartphones, other cameras, or similar devices operating on the same frequency band nearby.

Cautions for Using Multiple Cameras

- When connecting multiple cameras to one access point via Wi-Fi, make sure the cameras' IP addresses are different.
- When multiple cameras are connected to one access point via Wi-Fi, the transmission rate drops.
- When there are multiple IEEE 802.11b/g/n (2.4 GHz band) access points, leave a gap of five channels between each Wi-Fi channel to reduce radio wave interference. For example, use channels 1, 6, and 11, channels 2 and 7, or channels 3 and 8.

Using the Wireless Remote Control BR-E1

- When **[Bluetooth function]** is set to **[Remote]** to use the Wireless Remote Control BR-E1, the camera cannot be connected to a smartphone via Bluetooth.

Security

If security settings have not been properly set, the following problems may occur.

- **Transmission monitoring**

Third parties with malicious intent may monitor the Wi-Fi transmissions and attempt to acquire the data you are sending.

- **Unauthorized network access**

Third parties with malicious intent may gain unauthorized access to the network you are using to steal, modify, or destroy information. Additionally, you could fall victim to other types of unauthorized access such as impersonation (where someone assumes an identity to gain access to unauthorized information) or springboard attacks (where someone gains unauthorized access to your network as a springboard to cover their tracks when infiltrating other systems).

It is recommended to make use of the systems and functions to thoroughly secure your network, preventing these types of problems from occurring.

Checking Network Settings

● Windows

Open the Windows **[Command Prompt]**, then type `ipconfig/all` and press the **<Enter>** key.

In addition to the IP address assigned to the computer, the subnet mask, gateway, and DNS server information are also displayed.

● Mac OS

In Mac OS X, open the **[Terminal]** application, enter `ifconfig -a`, and press the **<Return>** key. The IP address assigned to the computer is indicated in the **[en0]** item next to **[inet]**, in the format `****.***.***.***`.

- * For information about the **[Terminal]** application, refer to the Mac OS X help.

To avoid using the same IP address for the computer and other devices on the network, change the rightmost number when setting up the IP address assigned to the camera in the processes described on page 535.

Example: 192.168.1.10

[Wireless communication settings] Screen ■

On the [Wireless communication settings] screen, you can change the wireless communication function settings.

Select [**5: Wireless communication settings**].

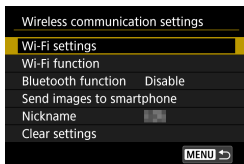

Wi-Fi settings

- See the next page.

Wi-Fi function

The following Wi-Fi functions are available:

- Communicate with smartphone
- Remote control (EOS Utility)
- Print from Wi-Fi printer
- Send images to Web service

Bluetooth function (p.436)

Displays the [Bluetooth function] screen on which you can set or check the Bluetooth functions.

Send images to smartphone (p.448)

While the camera is connected to a smartphone, use this function to send images stored in the camera to the smartphone.

Nickname

You can change the nickname using the virtual keyboard (p.534).

Clear settings (p.515)

Clear all wireless communication settings.

[Wi-Fi settings] Screen

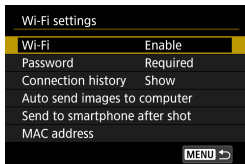

Wi-Fi

- You can set whether to **[Enable]** or **[Disable]** the wireless communication function.
- When the use of electronic devices and wireless devices is prohibited, such as on board airplanes or in hospitals, set it to **[Disable]**.

Password

Set to **[None]** to allow a Wi-Fi connection to be established without a password (except when connecting to an access point via Wi-Fi).

Connection history

You can set whether to **[Show]** or **[Hide]** the history of the Wi-Fi connected devices.

Auto send images to computer

With the dedicated software Image Transfer Utility 2, you can send images on the camera to a computer automatically (p.466).

Send to smartphone after shot

Your shots can be sent to a smartphone automatically (p.446).

MAC address

You can check the MAC address of the camera.

Virtual Keyboard Operation

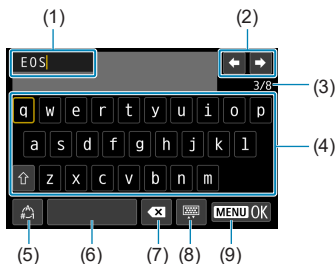

(1) Input area, for entering text

(2) Cursor keys, for moving in the input area

(3) Current no. of characters/no. available

(4) Keyboard

(5) Switch input modes

(6) Space

(7) Delete a character in the input area

(8) Change the type of keyboard

(9) Finish the text entry

- Press the <▲> <▼> <◀> <▶> keys to move within 2 and 4–8.
- Press <SET> to confirm input or when switching input modes.

Setting the IP Address Manually

Set up the IP address settings manually. The items displayed vary depending on the Wi-Fi function.

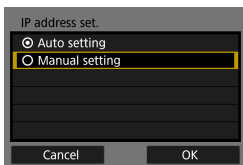

1 Select [Manual setting].

- Select [OK].

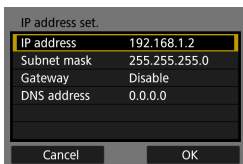

2 Select an item.

- Select an item to access the screen for numerical input.
- To use a gateway, select [Enable], then select [Address].

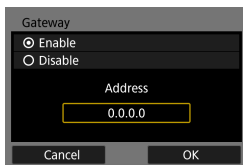

3 Enter the desired values.

- Turn the <gear> dial to move the input position in the upper area and turn the <wheel> dial to select the number. Press <SET> to enter the selected number.
- To set the entered values and return to the screen for step 2, press the <MENU> button.

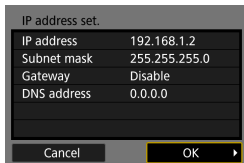

4 Select [OK].

- When you have completed setting the necessary items, select **[OK]**.
- If you are not sure what to enter, see “Checking Network Settings” (p.531), or ask the network administrator or another person knowledgeable about the network.

Wi-Fi/Bluetooth Status Display

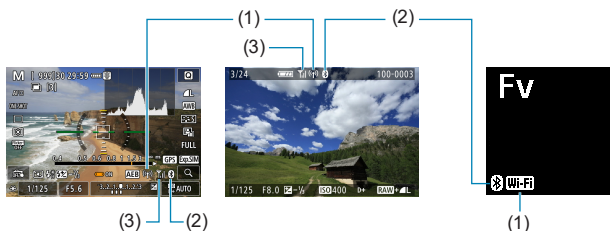

Wireless communication status can be checked on the camera screen and LCD panel.



- (1) Wi-Fi function
- (2) Bluetooth function
- (3) Wireless signal strength

Communication status		Wi-Fi function	Wireless signal strength	LCD Panel
				Wi-Fi function
Not connected	Wi-Fi: Disable	(OFF)	Off	Not displayed
	Wi-Fi: Enable	(OFF)		Wi-Fi
Connecting		() (Blinking)	⌵	
Connected		()	⌵⌵⌵	
Sending data		() (←→)	⌵⌵⌵	
Connection error		() (Blinking)	⌵	

Bluetooth Function Indicator

Bluetooth function	Connection status	Screen	LCD Panel
Other than [Disable]	Bluetooth connected		
	Bluetooth not connected		
[Disable]	Bluetooth not connected	Not displayed	Not displayed

7

Custom Functions / My Menu

You can fine-tune camera functions and change the functionality of buttons and dials to suit your shooting preferences with Custom Functions and control customization. You can also add menu items and Custom Functions that you adjust frequently to My Menu tabs.

Tab Menus: Customization

● C.Fn1

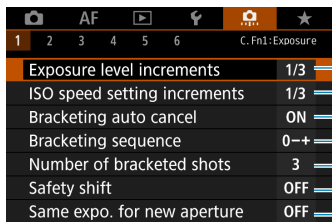

1	2	3	4	5	6	C. Fn1:Exposure
						Exposure level increments 1/3 p.542
						ISO speed setting increments 1/3 p.542
						Bracketing auto cancel ON p.543
						Bracketing sequence 0→+ p.543
						Number of bracketed shots 3 p.544
						Safety shift OFF p.545
						Same expo. for new aperture OFF p.546

● C.Fn2

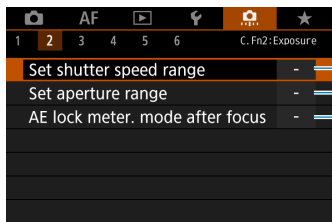

1	2	3	4	5	6	C. Fn2:Exposure
						Set shutter speed range - p.547
						Set aperture range - p.547
						AE lock meter. mode after focus - p.548

● C.Fn3

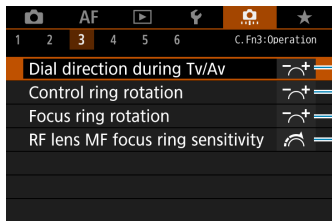

1	2	3	4	5	6	C. Fn3:Operation
						Dial direction during Tv/Av ↺+ p.548
						Control ring rotation ↺+ p.548
						Focus ring rotation ↺+ p.549
						RF lens MF focus ring sensitivity ↻ p.549

● C.Fn4

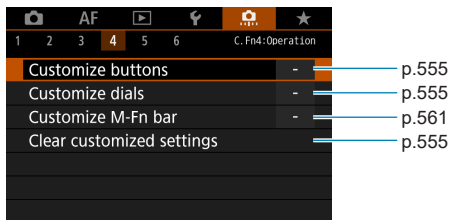

● C.Fn5

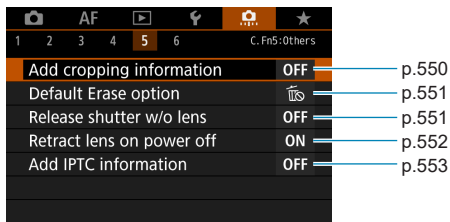

● C.Fn6

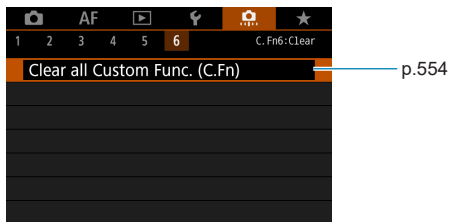

Custom Function Settings ☆

You can customize camera features on the [**Fn**] tab to suit your shooting preferences. Any settings you change from default values are displayed in blue.

C.Fn1

Exposure level increments

Sets 1/2-stop increments for the shutter speed, aperture, exposure compensation, AEB, flash exposure compensation, etc.

[1/3] 1/3-stop

[1/2] 1/2-stop



When [1/2-stop] is set, the display will be as shown below.



ISO speed setting increments

You can change the manual ISO speed setting increments to a whole-stop.

[1/3] 1/3-stop

[1/1] 1-stop



- Even if [1-stop] is set, ISO speed will be automatically set in 1/3-stop increments when ISO Auto is set.
- Even when [1-stop] is set, you can set ISO 40000 (for still photo shooting).

Bracketing auto cancel

Specify whether AEB and white balance bracketing settings are canceled when you set the power switch to <OFF> or switch to movie recording.

[ON] Enable

[OFF] Disable

Bracketing sequence

The AEB shooting sequence and white balance bracketing sequence can be changed.

[0→+] 0 → - → +

[-0+] - → 0 → +

[+0-] + → 0 → -

AEB	White Balance Bracketing	
	B/A Direction	M/G Direction
0 : Standard exposure	0 : Standard white balance	0 : Standard white balance
- : Decreased exposure	- : Blue bias	- : Magenta bias
+ : Increased exposure	+ : Amber bias	+ : Green bias

Number of bracketed shots

The number of shots taken with AEB and white balance bracketing can be changed from the default of 3 shots, to 2, 5, or 7 shots.

When [**1: Bracketing sequence**] is set to [0, -, +], the bracketed shots will be taken as shown in the table below.

[3] 3 shots

[2] 2 shots

[5] 5 shots

[7] 7 shots

(1-stop/step increments)

	1st Shot	2nd Shot	3rd Shot	4th Shot	5th Shot	6th Shot	7th Shot
3:3 shots	Standard (0)	-1	+1				
2:2 shots	Standard (0)	±1					
5:5 shots	Standard (0)	-2	-1	+1	+2		
7:7 shots	Standard (0)	-3	-2	-1	+1	+2	+3



If [**2 shots**] is set, you can select the + or - side when setting the AEB range. With WB bracketing, the 2nd shot will be adjusted toward either the B/A or M/G direction.

Safety shift

If the subject brightness changes and the standard exposure cannot be obtained within the autoexposure range, the camera will automatically change the manually selected setting to obtain the standard exposure. When set to **[Shutter speed/Aperture]**, applies to **[Tv]** and **[Av]** mode. When set to **[ISO speed]**, applies to **[P]**, **[Tv]**, and **[Av]** mode.

[OFF] Disable

[Tv/Av] Shutter speed/Aperture

[ISO] ISO speed



- Under **[📷3: 📷 ISO speed settings]**, even if **[ISO speed range]** or **[Min. shutter spd.]** is changed from the default setting, safety shift will override it if the standard exposure cannot be obtained.
- The minimum and maximum limits for the safety shift with the ISO speed are determined by **[Auto range]** (p.86). However, if the manually set ISO speed exceeds the **[Auto range]**, the safety shift will take effect up or down to the manually set ISO speed.
- Safety shift will take effect as necessary even when flash is used.

Same exposure for new aperture

Maximum aperture may decrease (the lowest f/number may increase) in **[M]** mode (manual exposure shooting) with ISO speed set manually (except when set to ISO Auto) if you 1. Change lenses, 2. Attach an extender, or 3. Use a zoom lens with a variable maximum aperture. This function prevents the corresponding underexposure by adjusting ISO speed or shutter speed (Tv) automatically to maintain the same exposure as before 1, 2, or 3.

[OFF] Disable

[ISO] ISO speed

[ISO/Tv] ISO speed/Shutter speed

[Tv] Shutter speed



- Does not respond to changes in effective aperture from changes in magnification when macro lenses are used.
- Cannot provide the same exposure as before 1, 2, or 3 if **[ISO speed]** is set and the exposure cannot be maintained at speeds in **[ISO speed range]**.
- Cannot provide the same exposure as before 1, 2, or 3 if **[Shutter speed]** is set and the exposure cannot be maintained at speeds in **[0.2: Set shutter speed range]**.
- Standard exposure is updated to the exposure at the moment the camera turns off if the camera turns off (as by setting the power switch to <OFF>) while maintaining exposure after you have performed 1, 2, or 3.



- Also responds to changes in the highest f/number (minimum aperture).
- The original exposure setting is restored if you perform 1, 2, or 3 with **[ISO speed]** or **[Shutter speed]** set and do not adjust ISO speed, shutter speed, or aperture before returning the camera to the original state, before 1, 2, or 3.
- Shutter speed may change to maintain exposure if the ISO speed increases to an expanded ISO speed when **[ISO speed]** is set.

C.Fn2

Set shutter speed range

You can set the shutter speed range. In **[Fv]**, **[Tv]** and **[M]** mode, you can set the shutter speed manually within your specified range. In **[P]** and **[Av]** mode, or in **[Fv]** mode with shutter speed set to **[AUTO]**, the shutter speed is set automatically within your specified range (except for movie shooting). Select **[OK]** to register the setting.

[Lowest speed]

Can be set in a range of 30 sec.–1/4000 sec.

[Highest speed]

Can be set in a range of 1/8000 sec.–15 sec.

Set aperture range

You can set the aperture range. In **[Fv]**, **[Av]**, **[M]**, and **[BULB]** mode, you can set the aperture manually within your specified range. In **[P]** and **[Tv]** mode, or in **[Fv]** mode with aperture set to **[AUTO]**, the aperture is set automatically within your specified range. Select **[OK]** to register the setting.

[Max. aperture (Min. f/)]

Can be set in a range of f/1.0–f/64.

[Min. aperture (Max. f/)]

Can be set in a range of f/91–f/1.4.



The available aperture range varies depending on the lens's minimum and maximum aperture.

AE lock metering mode after focus

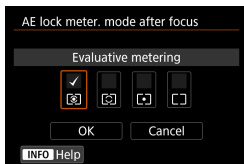

For each metering mode, you can set whether to lock the exposure (AE lock) after achieving focus with One-Shot AF by pressing the shutter button halfway. The exposure will be locked while you keep pressing the shutter button halfway. Checkmark [✓] the metering modes for when AE lock is to be applied. Select a metering mode [Matrix/Spot/Spot with center-weighted/Multi], then press <SET> to append a checkmark [✓]. Select [OK] to register the setting.

C.Fn3

Dial direction during Tv/Av

Dial turning direction when setting the shutter speed and aperture can be reversed.

In the [M] shooting mode, the turning direction of the <gear> and <arc> dials will be reversed. In other shooting modes, the turning direction of only the <gear> dial will be reversed. The <arc> dial's turning direction in the [M] mode and the turning direction to set the exposure compensation in the [P], [Tv], and [Av] modes will be the same.

[arc+] Normal

[+arc] Reverse direction

Control ring rotation

RF lens and mount adapter control ring turning direction when setting the shutter speed and aperture can be reversed.

[arc+] Normal

[+arc] Reverse direction

Focus ring rotation

RF lens focusing ring turning direction can be reversed.

 **Normal**

 **Reverse direction**

RF lens MF focus ring sensitivity

RF lens focusing ring sensitivity can be set.

 **Varies with rotation speed**

 **Linked to rotation degree**

C.Fn4

For details on the  **4** tab, see “Customizing Operations” (p.555).

C.Fn5**Add cropping information**

Adding cropping information displays vertical lines for your specified aspect ratio, so that you can compose shots as if shooting with a medium- or large-format camera (6×6 cm, 4×5 inch, and so on).

When you shoot, instead of cropping images recorded to the card, the camera adds aspect ratio information to images for cropping in Digital Photo Professional (EOS software).

You can import images to a computer and, in Digital Photo Professional, easily crop images to the aspect ratio set at the time of shooting.

[OFF] Off

[6:7] Aspect ratio 6:7

[6:6] Aspect ratio 6:6

[5:6] Aspect ratio 10:12

[3:4] Aspect ratio 3:4

[5:7] Aspect ratio 5:7

[4:5] Aspect ratio 4:5

- Cropping information is only added when **[CAMERA 1: CROPPING/ASPECT RATIO]** is set to **[Full-frame]**.
- JPEGs are not saved at the cropped size if you process RAW images with cropping information on the camera (p.346). In this case, RAW processing produces JPEGs with cropping information.

Default Erase option

You can set the default option in the erase menu (p.335) accessed by pressing the  button during image playback or review after shooting. You can simply press <SET> to erase the image immediately.

 **[Cancel] selected**

 **[Erase]/[Erase RAW +JPEG] selected**

 **[Erase RAW] selected**

 **[EraseJPEG] selected**



Be careful not to erase images accidentally when an option other than **[Cancel]** is set.

Release shutter without lens

You can specify whether shooting still photos or movies is possible without a lens attached.

[OFF] Disable

[ON] Enable

Retract lens on power off

This is to set the lens retraction mechanism for when a gear-driven STM lens (such as EF40mm f/2.8 STM) is attached to the camera. You can set whether to retract the extended lens automatically when the camera's power switch is set to <OFF>.

[ON] Enable

[OFF] Disable



- With auto power off, the lens will not retract regardless of the setting.
- Before detaching the lens, make sure that it is retracted.



When **[Enable]** is set, this function takes effect regardless of the lens's focus mode switch setting (AF or MF).

Add IPTC information

Registering IPTC (International Press Telecommunications Council) information to the camera from EOS Utility (EOS software) enables you to record (add) this information to JPEG/RAW still photos at the time of shooting. **This is helpful in file management and other tasks using the IPTC information.**

For instructions on registering IPTC information to the camera and details on the information you can register, refer to the EOS Utility Instruction Manual.

[OFF] Disable

[ON] Enable



IPTC information is not added when you shoot movies.





- During playback, you can check whether IPTC information was added.
- You can use Digital Photo Professional (EOS software) to check IPTC information in images.
- IPTC information registered to the camera is not erased if you select [6: Clear all Custom Func. (C.Fn)] (p.554), but the setting changes to [Disable].

C.Fn6

Clear all Custom Functions (C.Fn)

Selecting [ **6: Clear all Custom Func. (C.Fn)**] clears all Custom Function settings.



Customized operations for [ **4**] are not cleared if you perform [ **6: Clear all Custom Func. (C.Fn)**]. Note that although information added using [ **5: Add IPTC information**] is retained, the setting changes to [**Disable**].

Customizing Operations ☆

You can assign frequently used functions to camera buttons or dials according to your preferences for easy operations.

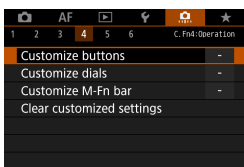

1 Select an item on the [C.Fn4] tab.

- **[Customize buttons]:**
Assign functions to buttons, such as <AF-ON> or <AF ON>.
- **[Customize dials]:**
Assign functions to the <DIAL 1> <DIAL 2> dials or control ring (<DIAL 1/2>).
- **[Customize M-Fn bar] (p.561):**
Assign functions to the <M-FN BAR> bar.

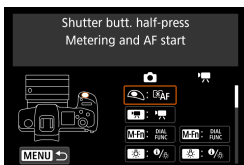

2 Select a camera control.

- With **[Customize buttons]**, a button can be assigned to activate one function when you are shooting still photos and a different function for movies.



























3 Specify a function to assign.

- Press <SET> to return to the screen in step 2.
- Press the <MENU> button to exit.

















Customized operations are not cleared if you select [C.Fn6: Clear all Custom Func. (C.Fn)]. To clear the settings, select [C.Fn4: Clear customized settings].

Functions Available for Buttons

	Function			M-Fn	
AF	 AF Metering and AF start	<input type="radio"/>	<input type="radio"/>	<input type="radio"/>	<input type="radio"/>
	AF-OFF AF stop	<input type="checkbox"/>	<input type="radio"/>	<input type="radio"/>	<input type="radio"/>
	*AF-OFF AE lock, AF stop	<input type="checkbox"/>	<input type="radio"/>	<input type="radio"/>	<input type="radio"/>
	 AF point selection	<input type="checkbox"/>	<input type="radio"/>	<input type="radio"/>	<input type="radio"/>
	 Direct AF point selection	<input type="checkbox"/>	<input type="checkbox"/>	<input type="checkbox"/>	<input type="checkbox"/>
	 Set AF point to center	<input type="checkbox"/>	<input type="radio"/>	<input type="radio"/>	<input type="radio"/>
	 Direct AF method selection* ¹	<input type="checkbox"/>	<input type="radio"/>	<input type="radio"/>	<input type="radio"/>
	 ONE SHOT SERVO → One-Shot AF ↔ Servo AF* ¹	<input type="checkbox"/>	<input type="radio"/>	<input type="radio"/>	<input type="radio"/>
	 Touch & drag AF	<input type="checkbox"/>	<input type="radio"/>	<input type="radio"/>	<input type="radio"/>
 Eye Detection AF* ¹	<input type="checkbox"/>	<input type="radio"/>	<input type="radio"/>	<input type="radio"/>	
 Focus guide	<input type="checkbox"/>	<input type="radio"/>	<input type="radio"/>	<input type="radio"/>	
Exposure	 Metering start	<input type="radio"/>	<input type="checkbox"/>	<input type="checkbox"/>	<input type="checkbox"/>
	 AE lock	<input type="checkbox"/>	<input type="radio"/>	<input type="radio"/>	<input type="radio"/>
	 AE lock (hold)	<input type="checkbox"/>	<input type="radio"/>	<input type="radio"/>	<input type="radio"/>
	 AE lock (while button pressed)	<input type="radio"/>	<input type="checkbox"/>	<input type="checkbox"/>	<input type="checkbox"/>
	 AEL FEL AE lock/FE lock* ¹	<input type="checkbox"/>	<input type="radio"/>	<input type="radio"/>	<input type="radio"/>
	 Exposure compensation (hold button, turn )	<input type="checkbox"/>	<input type="checkbox"/>	<input type="checkbox"/>	<input type="checkbox"/>
	 ISO Set ISO speed (hold button, turn )	<input type="checkbox"/>	<input type="checkbox"/>	<input type="checkbox"/>	<input type="checkbox"/>
	 Flash function settings* ¹	<input type="checkbox"/>	<input type="radio"/>	<input type="radio"/>	<input type="radio"/>
FEL FE lock* ¹	<input type="checkbox"/>	<input type="radio"/>	<input type="radio"/>	<input type="radio"/>	
Movies	 Movies	<input type="checkbox"/>	<input type="radio"/>	<input type="radio"/>	<input type="radio"/>
	 SERVO AF Pause Movie Servo AF* ²	<input type="checkbox"/>	<input type="checkbox"/>	<input type="radio"/>	<input type="radio"/>

MODE	AF-ON	* []	[]	LENS	[]	[]	[]	[]	SET
○	○	○		○					
○	○	○		○					
○	○	○		○					
○	○	○	○	○	○	○	○	○	○
					○	○	○	○	
○	○	○	○	○	○	○	○	○	○
○	○	○	○	○	○	○	○	○	○
○	○	○	○	○	○	○	○	○	○
○	○	○	○	○	○	○	○	○	○
○	○	○	○	○	○	○	○	○	○
○	○	○	○	○	○	○	○	○	○
○	○	○		○					
○	○	○		○					
○	○	○		○					
	○	○		○					○
	○	○		○					○
○	○	○	○	○	○	○	○	○	○
○	○	○		○					
○	○	○		○					
○	○	○	○	○	○	○	○	○	○

		Function			M-Fn	
Press buttons directly	DIAL FUNC	Dial function settings		<input type="radio"/>	<input type="radio"/>	<input type="radio"/>
	 /i	Short press: LCD illumination Long press: LCD information switching				<input type="radio"/>
	i/ 	Short press: LCD information switching Long press: LCD illumination				<input type="radio"/>
		LCD panel illumination		<input type="radio"/>	<input type="radio"/>	<input type="radio"/>
	i	LCD panel information switching		<input type="radio"/>	<input type="radio"/>	<input type="radio"/>
	MODE	Shooting mode settings		<input type="radio"/>	<input type="radio"/>	<input type="radio"/>
	C	Switch to Custom shooting mode			<input type="radio"/>	
		Depth-of-field preview* ¹		<input type="radio"/>	<input type="radio"/>	<input type="radio"/>
	AUTO	Reset selected item in Fv mode* ¹		<input type="radio"/>	<input type="radio"/>	<input type="radio"/>
	ALL AUTO	Reset Tv/Av/ISO in Fv mode* ¹		<input type="radio"/>	<input type="radio"/>	<input type="radio"/>
	Q	Quick Control screen		<input type="radio"/>	<input type="radio"/>	<input type="radio"/>
	Q	Magnify/Reduce		<input type="radio"/>	<input type="radio"/>	<input type="radio"/>
Menu	MENU	Menu display		<input type="radio"/>	<input type="radio"/>	<input type="radio"/>
		Image quality* ¹		<input type="radio"/>	<input type="radio"/>	<input type="radio"/>
	RAW JPEG	One-touch image quality setting* ¹		<input type="radio"/>	<input type="radio"/>	<input type="radio"/>
	RAW JPEG H	One-touch image quality (hold)* ¹		<input type="radio"/>	<input type="radio"/>	<input type="radio"/>
		Picture Style		<input type="radio"/>	<input type="radio"/>	<input type="radio"/>
		Protect		<input type="radio"/>	<input type="radio"/>	<input type="radio"/>
	★	Rating		<input type="radio"/>	<input type="radio"/>	<input type="radio"/>
		Select folder		<input type="radio"/>	<input type="radio"/>	<input type="radio"/>
		Maximize screen brightness (temporary)		<input type="radio"/>	<input type="radio"/>	<input type="radio"/>
		Display off		<input type="radio"/>	<input type="radio"/>	<input type="radio"/>
		Switch between viewfinder/screen		<input type="radio"/>	<input type="radio"/>	<input type="radio"/>
	ECO	Eco mode		<input type="radio"/>	<input type="radio"/>	<input type="radio"/>
	(Wi-Fi)	Wi-Fi function		<input type="radio"/>	<input type="radio"/>	<input type="radio"/>
	OFF	No function (disabled)		<input type="radio"/>	<input type="radio"/>	<input type="radio"/>

*1: Cannot be assigned as a function available when shooting movies.











*2: Cannot be assigned as a function available when shooting still photos.

MODE	AF-ON	*	☰	LENS	▲	◀	▶	▼	SET
<input type="radio"/>	<input type="radio"/>	<input type="radio"/>	<input type="radio"/>	<input type="radio"/>	<input type="radio"/>	<input type="radio"/>	<input type="radio"/>	<input type="radio"/>	<input type="radio"/>
<input type="radio"/>	<input type="radio"/>	<input type="radio"/>		<input type="radio"/>					
<input type="radio"/>	<input type="radio"/>	<input type="radio"/>		<input type="radio"/>					
<input type="radio"/>	<input type="radio"/>	<input type="radio"/>		<input type="radio"/>					
<input type="radio"/>	<input type="radio"/>	<input type="radio"/>		<input type="radio"/>					<input type="radio"/>
<input type="radio"/>	<input type="radio"/>	<input type="radio"/>	<input type="radio"/>	<input type="radio"/>	<input type="radio"/>	<input type="radio"/>	<input type="radio"/>	<input type="radio"/>	<input type="radio"/>
<input type="radio"/>	<input type="radio"/>	<input type="radio"/>	<input type="radio"/>	<input type="radio"/>	<input type="radio"/>	<input type="radio"/>	<input type="radio"/>	<input type="radio"/>	<input type="radio"/>
<input type="radio"/>	<input type="radio"/>	<input type="radio"/>	<input type="radio"/>	<input type="radio"/>	<input type="radio"/>	<input type="radio"/>	<input type="radio"/>	<input type="radio"/>	<input type="radio"/>
<input type="radio"/>	<input type="radio"/>	<input type="radio"/>	<input type="radio"/>	<input type="radio"/>	<input type="radio"/>	<input type="radio"/>	<input type="radio"/>	<input type="radio"/>	<input type="radio"/>
<input type="radio"/>	<input type="radio"/>	<input type="radio"/>	<input type="radio"/>	<input type="radio"/>	<input type="radio"/>	<input type="radio"/>	<input type="radio"/>	<input type="radio"/>	<input type="radio"/>
<input type="radio"/>	<input type="radio"/>	<input type="radio"/>	<input type="radio"/>	<input type="radio"/>	<input type="radio"/>	<input type="radio"/>	<input type="radio"/>	<input type="radio"/>	<input type="radio"/>
<input type="radio"/>	<input type="radio"/>	<input type="radio"/>	<input type="radio"/>	<input type="radio"/>	<input type="radio"/>	<input type="radio"/>	<input type="radio"/>	<input type="radio"/>	<input type="radio"/>
<input type="radio"/>	<input type="radio"/>	<input type="radio"/>	<input type="radio"/>	<input type="radio"/>	<input type="radio"/>	<input type="radio"/>	<input type="radio"/>	<input type="radio"/>	<input type="radio"/>
<input type="radio"/>	<input type="radio"/>	<input type="radio"/>	<input type="radio"/>	<input type="radio"/>	<input type="radio"/>	<input type="radio"/>	<input type="radio"/>	<input type="radio"/>	<input type="radio"/>
<input type="radio"/>	<input type="radio"/>	<input type="radio"/>		<input type="radio"/>					
<input type="radio"/>	<input type="radio"/>	<input type="radio"/>		<input type="radio"/>					
<input type="radio"/>	<input type="radio"/>	<input type="radio"/>	<input type="radio"/>	<input type="radio"/>	<input type="radio"/>	<input type="radio"/>	<input type="radio"/>	<input type="radio"/>	<input type="radio"/>
<input type="radio"/>	<input type="radio"/>	<input type="radio"/>	<input type="radio"/>	<input type="radio"/>	<input type="radio"/>	<input type="radio"/>	<input type="radio"/>	<input type="radio"/>	<input type="radio"/>
<input type="radio"/>	<input type="radio"/>	<input type="radio"/>	<input type="radio"/>	<input type="radio"/>	<input type="radio"/>	<input type="radio"/>	<input type="radio"/>	<input type="radio"/>	<input type="radio"/>
<input type="radio"/>	<input type="radio"/>	<input type="radio"/>	<input type="radio"/>	<input type="radio"/>	<input type="radio"/>	<input type="radio"/>	<input type="radio"/>	<input type="radio"/>	<input type="radio"/>
<input type="radio"/>	<input type="radio"/>	<input type="radio"/>	<input type="radio"/>	<input type="radio"/>	<input type="radio"/>	<input type="radio"/>	<input type="radio"/>	<input type="radio"/>	<input type="radio"/>
<input type="radio"/>	<input type="radio"/>	<input type="radio"/>	<input type="radio"/>	<input type="radio"/>	<input type="radio"/>	<input type="radio"/>	<input type="radio"/>	<input type="radio"/>	<input type="radio"/>
<input type="radio"/>	<input type="radio"/>	<input type="radio"/>	<input type="radio"/>	<input type="radio"/>	<input type="radio"/>	<input type="radio"/>	<input type="radio"/>	<input type="radio"/>	<input type="radio"/>
<input type="radio"/>	<input type="radio"/>	<input type="radio"/>	<input type="radio"/>	<input type="radio"/>	<input type="radio"/>	<input type="radio"/>	<input type="radio"/>	<input type="radio"/>	<input type="radio"/>
<input type="radio"/>	<input type="radio"/>	<input type="radio"/>	<input type="radio"/>	<input type="radio"/>	<input type="radio"/>	<input type="radio"/>	<input type="radio"/>	<input type="radio"/>	<input type="radio"/>
<input type="radio"/>	<input type="radio"/>	<input type="radio"/>	<input type="radio"/>	<input type="radio"/>	<input type="radio"/>	<input type="radio"/>	<input type="radio"/>	<input type="radio"/>	<input type="radio"/>
<input type="radio"/>	<input type="radio"/>	<input type="radio"/>	<input type="radio"/>	<input type="radio"/>	<input type="radio"/>	<input type="radio"/>	<input type="radio"/>	<input type="radio"/>	<input type="radio"/>
<input type="radio"/>	<input type="radio"/>	<input type="radio"/>	<input type="radio"/>	<input type="radio"/>	<input type="radio"/>	<input type="radio"/>	<input type="radio"/>	<input type="radio"/>	<input type="radio"/>
<input type="radio"/>	<input type="radio"/>	<input type="radio"/>	<input type="radio"/>	<input type="radio"/>	<input type="radio"/>	<input type="radio"/>	<input type="radio"/>	<input type="radio"/>	<input type="radio"/>



<LENS> stands for "AF stop button" provided on super telephoto lenses equipped with Image Stabilizer.

Functions Available for Dials

	Function			0
Tv	Shutter speed setting in M mode	<input type="radio"/>	<input type="radio"/>	
Av	Aperture setting in M mode	<input type="radio"/>	<input type="radio"/>	
ISO 	Set ISO speed ( during metering)		<input type="radio"/>	
Av 	Change aperture (hold metering button)			<input type="radio"/>
Tv 	Change shutter speed (hold metering button)			<input type="radio"/>
ISO 	Set ISO speed (hold metering button)			<input type="radio"/>
 	Exposure compensation (hold metering button)			<input type="radio"/>
Av	Change aperture value			<input type="radio"/>
Tv	Change shutter speed			<input type="radio"/>
ISO	Set ISO speed			<input type="radio"/>
	Exposure compensation			<input type="radio"/>
OFF	No function (disabled)	<input type="radio"/>	<input type="radio"/>	<input type="radio"/>



<  >: Control ring on RF lenses and mount adapters

Customizing the M-Fn (Multi-Function) Bar

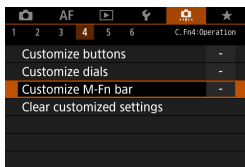

1 Select [4: Customize M-Fn bar].



2 Select [] (for use when shooting) or [] (for use during playback).

- You can assign different functions to each.

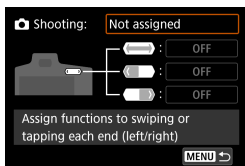

3 Select a function to assign.

- Selecting [] (for shooting) or [] (for playback) displays a screen of available functions. From the list, select functions to assign.
- Depending on your selected function, different functions can be assigned to swiping < > or tapping each end.

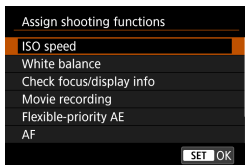

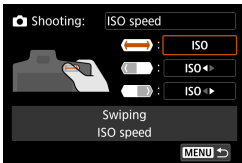

4 Assign functions to swiping <[Multi-selector]> or tapping each end.

- Selecting [Left arrow] (swipe), [Left arrow] (tap left end), or [Right arrow] (tap right end) displays a screen to assign functions.
- Select options to assign to each operation.



• M-Fn bar safety lock

To prevent unintended <[Multi-selector]> operations during shooting, safety lock is set by default. Note that operations are always possible during playback.

- To activate <[Multi-selector]> during shooting, press the left end of <[Multi-selector]> until [ON] is displayed in white.
- To deactivate <[Multi-selector]>, press the left end of <[Multi-selector]> until [OFF] is displayed in white.
- <[Multi-selector]> is deactivated automatically if not used within about 10 seconds.



Disabling Safety Lock

Disable safety lock if you prefer to keep <[Multi-selector]> activated during shooting.

- To change the setting, select [Disable (always available)] and press <SET> to select the radio button.

● Full Cover Setting





When **[Full cover setting]** is enabled, you can access the M-Fn bar customization screen by fully covering <[M-Fn bar]>.



- To configure this setting, press the <INFO> button on the screen in step 2.



- If you prefer not to use <[M-Fn bar]> at all, select **[Not assigned]** in step 3.
- Your current action is indicated on the screen when you use <[M-Fn bar]>.
- To assign your preferred function to bar operations, select **[User customization]** when assigning functions. When selecting **[User customization]**, you can also select the function to use as the basis of user customization by pressing the <INFO> button on the screen in step 4.

Functions Available for the M-Fn Bar

Function			
	ISO speed	ISO speed	Change value/selected item Auto ISO speed Custom ISO speed (***)
	White balance	White balance selection Color temperature setting	Change value/selected item Auto: Ambience ← → White Custom white balance: (***) White balance shift/bracketing
	Check focus/ display info	Magnify/reduce by swiping	Change value/selected item Magnify / reduce Focus guide MF peaking Electronic level Histogram
	Movie recording	Sound-recording level Volume Aperture setting	Change value/selected item MF peaking Focus guide Pause Movie Servo AF Electronic level Histogram
	Flexible- priority AE	Select by swiping [Fv]	Change value/selected item Reset all items [Fv] Reset selected item [Fv] Select *** [Fv]
	AF	Set autofocus method	Change value/selected item Eye Detection AF AF frame size Touch & drag AF settings Focus guide
	User customization	Manual Selection	Manual Selection
	Function shortcut	Swipe to browse images	Rating Protect
	Image browsing	Swipe to browse images	Previous image Next image

* **[Not assigned]** is also available as a function. For , , and , **[OFFNo function (disabled)]** is also available.

Tab Menus: My Menu

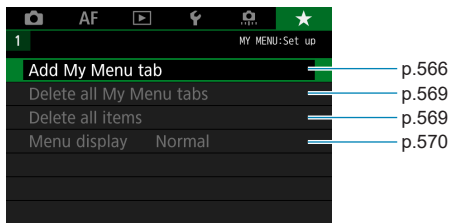

Registering My Menu ☆

Under My Menu tab, you can register menu items and Custom Functions whose settings you change frequently.

Creating and Adding My Menu Tab

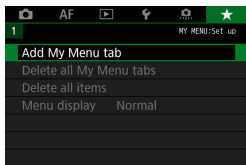

1 Select [Add My Menu tab].

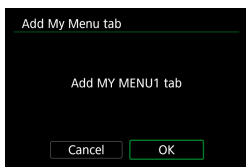

2 Select [OK].

- You can create up to five My Menu tabs by repeating steps 1 and 2.

Registering Menu Items under the My Menu Tab(s)



1 Select [MY MENU*: Configure].

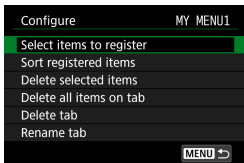

2 Select [Select items to register].

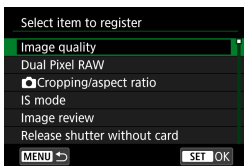

3 Register the desired items.

- Select the item to be set, then press <SET>.
- Select [OK] on the confirmation dialog.
- You can register up to six items.
- To return to the screen in step 2, press the <MENU> button.

My Menu Tab Settings

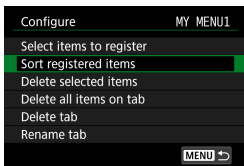

You can sort and delete items under the menu tab, and rename or delete the menu tab.

● Sort registered items

You can change the order of the registered items in My Menu. Select [Sort registered items] and select the item whose order you want to change. Then press <SET>. With [◆] displayed, press the <▲> <▼> keys to change the order, then press <SET>.

● Delete selected items / Delete all items on tab

You can delete any of the registered items. [Delete selected items] deletes one item at a time, and [Delete all items on tab] deletes all the registered items under the tab.

● Delete tab

You can delete the current My Menu tab. Select **[Delete tab]** to delete the **[MY MENU*]** tab.

● Rename tab

You can rename the My Menu tab from **[MY MENU*]**.

1 Select **[Rename tab]**.

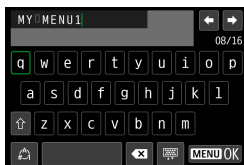

2 Enter text.

- Press the **<🗑️>** button to delete any unnecessary characters.
- Use the **<⬆️>** cross keys or **<🔍>** dial to select a character, then press **<SET>**.
- By selecting **[🔍]**, you can change the input mode.
- You can enter up to 16 characters.

3 Confirm input.

- Press the **<MENU>** button, then press **[OK]**.

Deleting all My Menu tabs / Deleting all items

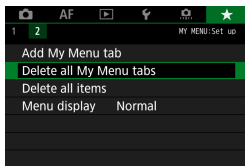

You can delete all the created My Menu tabs or My Menu items registered under them.

● Delete all My Menu tabs

You can delete all My Menu tabs you created. When you select **[Delete all My Menu tabs]**, all the tabs from **[MY MENU1]** to **[MY MENU5]** will be deleted and the **[★]** tab will revert to its default.

● Delete all items

You can delete all the items registered under the **[MY MENU1]** to **[MY MENU5]** tabs. The tab(s) will remain. When **[Delete all items]** is selected, all the items registered under all the created tabs will be deleted.



If you perform **[Delete tab]** or **[Delete all My Menu tabs]**, tab names renamed with **[Rename tab]** will also be deleted.

Menu Display Settings

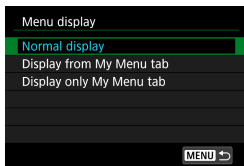

You can select **[Menu display]** to set the menu screen that is to appear first when you press the <MENU> button.

- **Normal display**

Displays the last displayed menu screen.

- **Display from My Menu tab**

Displays with the [**★**] tab selected.

- **Display only My Menu tab**

Only the [**★**] tab is displayed. (The [**📷**], [**AF**], [**▶**], [**🔍**], and [**⋮**] tabs will not be displayed.)

8

Reference

This chapter provides reference information on camera features.

Software Overview

You can download the latest version of EOS software or other dedicated software from the Canon website.

Downloading and Installing the Software

When using EOS software or other dedicated software, use the latest version available. To download it, you will need to enter the serial number on the bottom of the camera.

- **Do not connect the camera to a computer before you install the software. The software will not be installed correctly.**
- **You cannot install the EOS software to a computer without an Internet connection.**
- Even if a previous version of the software is installed on your computer, follow the procedure below to install the latest version. (The previous version will be overwritten.)

1 Download the software.

- Connect to the Internet from a computer and access the following Canon Web site.
 - ▶ www.canon.com/icpd
- Select your country or region of residence and download the software.
- Decompress it on the computer.
 - **For Windows :**
Click the displayed installer file to start the installer.
 - **For Macintosh :**
A dmg file will be created and displayed. Follow the steps below to startup the installer.

- (1) Double-click the dmg file.
 - ▶ A drive icon and installer file will appear on the desktop.
If the installer file does not appear, double-click the drive icon to display it.
- (2) Double-click the installer file.
 - ▶ The installer starts.

2 Follow the on-screen instructions to install the software.

Downloading the Software Instruction Manuals

Software Instruction Manuals (PDF files) can be downloaded from the Canon Web site to your computer.

● Software Instruction Manual Download Site

▶ www.canon.com/icpd



- **To view the Instruction Manuals (PDF files), an Adobe PDF viewing software such as Adobe Acrobat Reader DC (most recent version recommended) is required.**
- Adobe Acrobat Reader DC can be downloaded for free from the Internet.
- Double-click the downloaded Instruction Manual (PDF file) to open it.
- To learn how to use PDF viewing software, refer to the software's Help section.

Importing Images to a Computer

You can use EOS software to import images from the camera to a computer. There are two ways to do this.

Importing by Connecting the Camera to the Computer

1 Install the software (p.572).

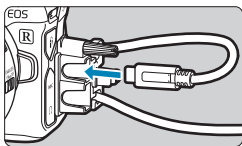

2 Connect the camera to the computer.

- When connecting the cable to the camera, use the cable protector (p.37) and insert the plug in the digital terminal.
- Insert the other end of the cable into the computer's USB terminal (Type-C).

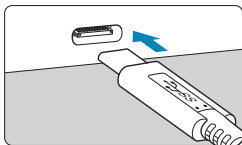

3 Use EOS Utility to import the images.

- Refer to the EOS Utility Instruction Manual.

! With Wi-Fi connection established, the camera cannot communicate with the computer even if they are connected with an interface cable.

Importing Images with a Card Reader

You can use a card reader to import images to a computer.

1 Install the software (p.572).

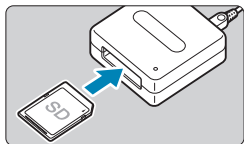

2 Insert the card into the card reader.

3 Use Digital Photo Professional to import the images.

- Refer to the Digital Photo Professional Instruction Manual.



When importing images from the camera to a computer with a card reader without using EOS software, copy the DCIM folder on the card to the computer.

Charging a Battery in the Camera

Using USB Power Adapter PD-E1 (sold separately), you can charge Battery Pack LP-E6N without removing it from the camera. **Note that Battery Pack LP-E6 cannot be charged this way. Also, charging will stop if you operate the camera.**

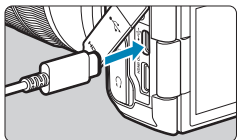

1 Connect the USB power adapter.

- With the camera's power switch to <OFF>, insert the USB power adapter fully into the digital terminal.

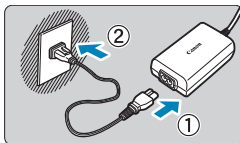

2 Connect the power cord.

- Connect the power cord to the USB power adapter and plug the other end into a power outlet.
 - ▶ Charging begins, and the access lamp (1) is lit in green. The LCD panel indicates that charging is in progress.
- When charging is finished, the access lamp turns off and **[FULL]** is indicated on the LCD panel. Unplug the power cord and disconnect the USB power adapter from the camera.

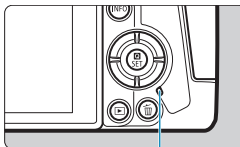

(1)

- To protect batteries and keep them in optimal condition, do not charge continuously for more than 24 hours.
- In case of charging problems, the access lamp blinks in green, **[Err]** is displayed on the LCD panel, and a protective circuit stops charging. In this case, unplug the power cord, reattach the battery, and wait a few minutes before plugging it in again. If the problem persists, contact your dealer or nearest Canon Service Center.



- If the access lamp does not light up, try unplugging the USB power adapter and plugging it in again.
- The charging time required and the amount charged vary depending on ambient temperature and remaining capacity.
- If the battery's remaining capacity (p.387) is approx. 90% or higher, the battery will not be recharged.
- For safety reasons, recharging in low temperatures (5–10°C / 41–50°F) will take longer.
- Batteries are not charged when the camera is connected via Wi-Fi or when the card slot cover is open.

Using a Battery Grip

Featuring buttons and dials for vertical shooting, Battery Grip BG-E22 (sold separately) is an EOS R accessory that can power the camera with two batteries and charge LP-E6N via a USB power adapter (sold separately).

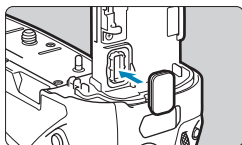
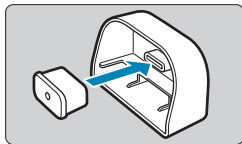
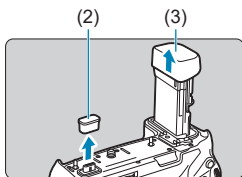
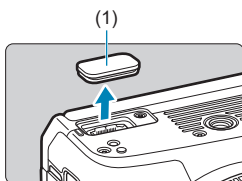

1 Remove the contact covers.

- Remove the contact covers on the bottom of the camera (1) and on the battery grip (2), (3).
- Attach the battery grip contact cover (2) to (3) to store it.
- Attach the camera contact cover (1) to the battery grip as shown at left.

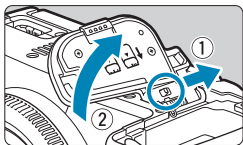

2 Remove the battery compartment cover.

- Turn the camera off and remove the cover.
- With the cover off, remove the battery (p.43).
- Attach the cover to the battery grip.

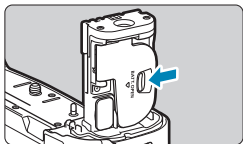
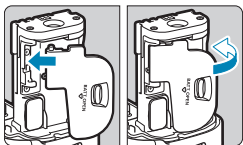

- To remove the cover, slide the lever to release it, following the attachment procedure in reverse.

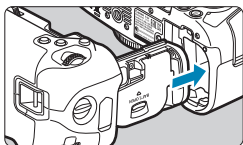

3 Attach and lock the battery grip.

- Insert the battery grip contacts into the camera and turn the attach/detach dial to lock the battery grip in place.

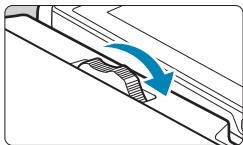

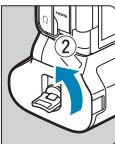
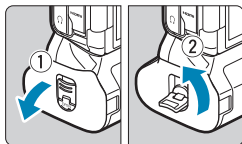

4 Remove the battery magazine.

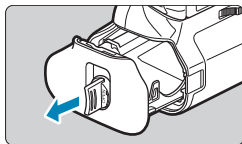

- ⚠ When reattaching the battery compartment cover to the camera, attach it opened to at least 90°.
- Do not touch the camera or battery grip contacts.

Attaching Batteries

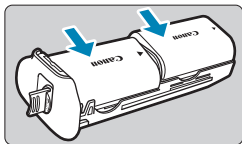

1 Attach the batteries.

- Insert the batteries as shown.
- When only one battery is used, it can be inserted in either position.

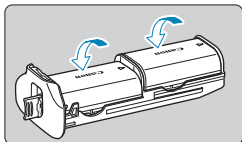

- To secure the batteries, push in the direction of the arrows until they click into place.

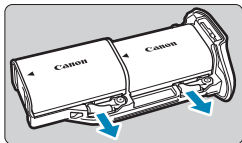

- To remove the batteries, press the battery magazine lever in the direction of the arrow.

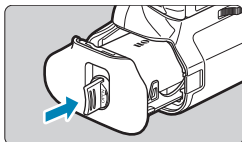

2 Attach the battery magazine.

- Insert the battery magazine all the way in to secure it.

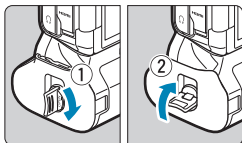

- When attaching batteries, make sure the electrical contacts are clean. Wipe off any dirt on the contacts with a soft cloth.
- Attach batteries after attaching the battery grip to the camera. If the battery grip is attached to the camera with batteries already attached, it may prevent correct display of battery check results.
- Before removing the battery grip, turn the camera off and remove the batteries.
- Reattach the protective covers for the camera and battery grip contacts after removing the battery grip. If the battery grip will not be used for some time, remove the batteries.
- If a battery communication error message is displayed when a battery grip is attached, follow the instructions in the message. If the camera loses power, reinstall the battery magazine and restart the camera.

Using a Household Power Outlet

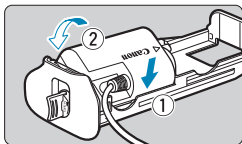

1 Attach the DC coupler.

- Attach DC Coupler DR-E6 (sold separately) the same way as the batteries.
- Pass the DC coupler cord through the battery magazine cord groove.
- Insert the battery magazine all the way in to secure it.

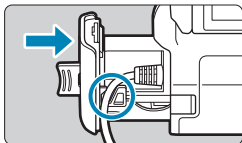

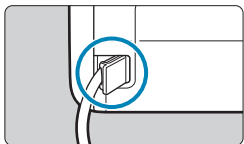

2 Attach the battery magazine.

- Guide the end of the cord out of the cord hole.

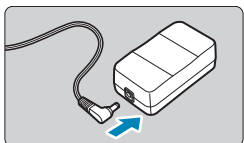

3 Connect the DC coupler to the AC adapter.

- Securely connect the DC coupler's plug to the connector of AC Adapter AC-E6 (sold separately).

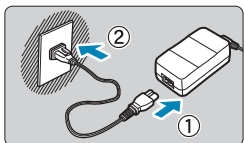

4 Connect the power cord.

- Connect the power cord to the AC adapter and insert the power plug into a power outlet.



- While the camera is on, do not connect or disconnect the power cord or connector, and do not remove the battery magazine.
- Avoid getting the DC coupler cord caught between the battery grip and battery magazine.

Button and Dial Operations

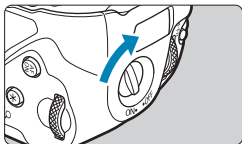

- To use the buttons and dials, turn the vertical-grip operation switch (4) to ON.
- The buttons and dials are used the same way as corresponding buttons and dials on the camera.

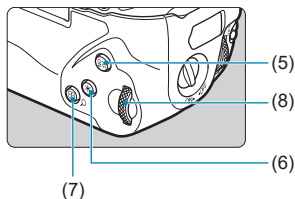
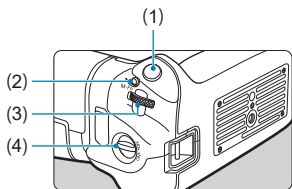

-
- (1) Shutter button
-
- (2) <M-Fn> Multi-function button
-
- (3) <Main dial> Main dial
-
- (4) Vertical-grip operation switch
-
- (5) <AF ON> AF start button
-

-
- (6) <AE lock/FE lock button> AE lock/FE lock button
-
- (7) <AF point/Index/Magnify/Reduce button> AF point/Index/Magnify/Reduce button
-
- (8) <Quick control dial> Quick control dial
-

Using a Flash with a PC Sync Cord

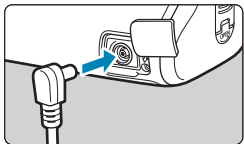

- The PC terminal enables you to use flash units with a PC sync cord.
- The PC sync cord can be used regardless of polarity.
- When configuring settings, use approx. 1/60–1/30 sec. as a guideline for sync speed. Confirm in advance that the flash unit is synced correctly.



Do not connect flash units with an output voltage of 250 V or more to the PC terminal.



You can use one flash unit attached to the camera's hot shoe and another connected to the PC terminal at the same time.

Charging Batteries in the Battery Grip

Using USB Power Adapter PD-E1, you can charge LP-E6N batteries without removing them from the battery grip.

- You can also charge a single LP-E6N battery at one time. Or, you can charge the battery grip by itself.
- LP-E6 cannot be charged this way. If LP-E6N and LP-E6 batteries are both attached, neither will be charged.
- Charging stops if you operate the camera.

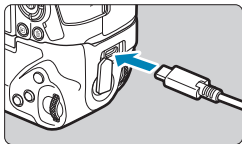

1 Connect the USB power adapter.

- With the camera's power switch to <OFF>, insert the USB power adapter plug fully into the battery grip terminal.

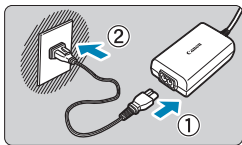

2 Charge the batteries.

- Connect the power cord to the USB power adapter and plug the other end into a power outlet.
- ▶ Charging begins, and the charge lamp lights up.
- When charging is finished, the charge lamp turns off. Unplug the power cord and disconnect the USB power adapter from the battery grip.

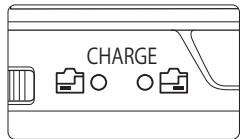



- To protect batteries and keep them in optimal condition, do not charge continuously for more than 24 hours.
- In case of charging problems, the charge lamp blinks and a protective circuit stops charging. In this case, unplug the power cord, reattach the battery, and wait a few minutes before plugging it in again. If the problem persists, contact your dealer or nearest Canon Service Center.



- If the charge lamp does not light up, try unplugging the USB power adapter and plugging it in again.
- The charging time required and the amount charged vary depending on ambient temperature and remaining capacity.
- If the battery's remaining capacity (p.387) is approx. 90% or higher, the battery will not be recharged.
- For safety reasons, recharging in low temperatures (5–10°C / 41–50°F) will take longer.
- Batteries are charged one after another when two are loaded.

Troubleshooting Guide

If a problem occurs with the camera, first refer to this Troubleshooting Guide. If this Troubleshooting Guide does not resolve the problem, contact your dealer or nearest Canon Service Center.

Power-Related Problems

Batteries cannot be charged with the charger.

- If the battery's remaining capacity (p.387) is 94% or higher, the battery will not be recharged.
- Do not use any battery other than genuine Canon Battery Pack LP-E6N/LP-E6.

The charger's lamp blinks at high speed.

- If (1) the battery charger or battery has a problem or (2) communication with the battery failed (with a non-Canon battery pack), the protection circuit will stop charging, and the charge lamp will blink in orange at a constant high speed. In the case of (1), unplug the charger's power plug from the power outlet. Detach and reattach the battery to the charger. Wait a few minutes, then reconnect the power plug to the power outlet. If the problem persists, contact your dealer or nearest Canon Service Center.

The charger's lamp does not blink.

- If the internal temperature of the battery attached to the charger is high, the charger will not charge the battery for safety reasons (lamp off). During charging, if the battery's temperature becomes high for any reason, charging will stop automatically (lamp blinks). When the battery temperature goes down, charging will resume automatically.

Batteries cannot be charged with the USB power adapter (sold separately).

- Batteries are not charged while the camera's power switch is set to <ON>.
- Note that Battery Pack LP-E6 cannot be charged this way.
- If the battery's remaining capacity is approx. 90% or higher, the battery will not be recharged.
- Operating the camera will stop charging in progress.
- When using a battery grip, insert the USB power adapter plug fully into the battery grip terminal to charge the batteries.

The access lamp blinks during charging with the USB power adapter.

- In case of charging problems, the access lamp blinks in green and a protective circuit stops charging. In this case, unplug the power cord, reattach the battery, and wait a few minutes before plugging it in again. If the problem persists, contact your dealer or nearest Canon Service Center.

The access lamp is not lit during charging with the USB power adapter.

- Try unplugging the USB power adapter and plugging it in again.

The camera is not activated even when the power switch is set to <ON>.

- Make sure the battery compartment cover is closed (p.43).
- Make sure the battery is installed properly in the camera (p.43).
- Recharge the battery (p.40).
- Make sure the card slot cover is closed (p.44).

The access lamp still lights or blinks even when the power switch is <OFF>.

- If the power is turned off while an image is being recorded to the card, the access lamp will remain on or continue to blink for a few seconds. When the image recording is complete, the power will turn off automatically.

[Does this battery/do these batteries display the Canon logo?] is displayed.

- Do not use any battery other than genuine Canon Battery Pack LP-E6N/LP-E6.
- Remove and install the battery again (p.43).
- If the electrical contacts are dirty, use a soft cloth to clean them.

The battery becomes exhausted quickly.

- Use a fully-charged battery (p.40).
- The battery performance may have degraded. See [**⚙3: Battery info.**] to check the battery's recharge performance level (p.387). If the battery performance is poor, replace the battery with a new one.
- The number of possible shots will decrease with any of the following operations:
 - Pressing the shutter button halfway for a prolonged period.
 - Activating the AF frequently without taking a picture.
 - Using the lens's Image Stabilizer.
 - Using the Wi-Fi/Bluetooth (wireless communication) function.

The camera turns off by itself.

- Auto power off is in effect. To deactivate auto power off, set [**Auto power off**] under [**⚙2: Power saving**] to [**Disable**] (p.377).
- Even if [**Auto power off**] is set to [**Disable**], the screen and viewfinder will still turn off after the camera is left idle for the time set in [**Display off**] and [**Viewfinder off**], but the camera will remain on.
- Set [**⚙2: Eco mode**] to [**Off**].

Shooting-Related Problems

The lens cannot be attached.

- To attach EF or EF-S lenses, you will need a mount adapter. The camera cannot be used with EF-M lenses.

No images can be shot or recorded.

- Make sure the card is properly inserted (p.44).
- Slide the card's write-protect switch to the Write/Erase setting (p.44).
- If the card is full, replace the card or delete unnecessary images to make space (p.44, 335).
- Shooting is not possible if the AF point turns orange when you attempt to focus. Press the shutter button halfway again to refocus automatically, or focus manually (p.56, 281).

The card cannot be used.

- If a card error message is displayed, see page 46 or 607.

An error message is displayed when the card is inserted in another camera.

- Since SDXC cards are formatted in exFAT, if you format a card with this camera and then insert it into another camera, an error may be displayed and it may not be possible to use the card.

The image is out of focus or blurred.

- Set the lens's focus mode switch to **<AF>** (p.50, 53).
- Press the shutter button gently to prevent camera shake (p.56).
- With a lens equipped with an Image Stabilizer, set the IS switch to **<ON>**.
- In low light, the shutter speed may become slow. Use a faster shutter speed (p.134), set a higher ISO speed (p.83), use flash (p.177), or use a tripod.
- See “Minimizing Blurred Photos” on page 124.

I cannot lock the focus and recompose the shot.

- Set the AF operation to One-Shot AF. Shooting with the focus locked is not possible with Servo AF (p.126, 262).

The continuous shooting speed is slow.

- The continuous shooting speed for high-speed continuous shooting may be lower, depending on conditions such as these: battery level, temperature, flicker reduction, Dual Pixel RAW shooting, Silent LV shooting, shutter speed, aperture, subject conditions, brightness, AF operation, type of lens, use of flash, and shooting settings (p.144).

The maximum burst during continuous shooting is lower.

- If you shoot a subject that has fine detail such as a field of grass, the file size will be larger, and the actual maximum burst may be lower than the number listed on page 609.



Even after I change the card, the maximum burst displayed for continuous shooting does not change.

- The maximum burst displayed does not change when you switch cards, even if you switch to a high-speed card. The maximum burst shown in the table on page 609 is based on Canon's testing card. (The faster the card's writing speed, the higher the actual maximum burst will be.) For this reason, the maximum burst displayed may differ from the actual maximum burst.

High-speed display is not available during high-speed continuous shooting.

- Refer to the high-speed display requirements on page 149.

Some image quality options are not available with cropped shooting.

-  M /  M /  S1 /  S1 image quality options are not available when **[1.6x (crop)]** is set, or with EF-S lenses.

The aspect ratio cannot be set.

- With EF-S lenses, **[1.6x (crop)]** is set automatically, and no other aspect ratios are available.
- Aspect ratios cannot be set when **[ 5: Add cropping information]** is set to an option other than **[Off]**.

ISO 100 cannot be set. ISO speed expansion cannot be selected.

- Check the **[ISO speed range]** setting under **[CAMERA 3: CAMERA ISO speed settings]**.
- When **[CAMERA 3: Highlight tone priority]** is set to **[Enable]** or **[Enhanced]**, the available ISO speed range is ISO 200–40000 for still photo shooting. Even if you set **[ISO speed range]** under **[CAMERA ISO speed settings]** to expand the setting range, you cannot select L (equivalent to ISO 50), H1 (equivalent to ISO 51200), or H2 (equivalent to ISO 102400). When **[CAMERA 3: Highlight tone priority]** is set to **[Disable]** (p.109), you can set ISO 100/125/160, L, or H1/H2.

Even if I set a decreased exposure compensation, the image comes out bright.

- Set **[CAMERA 3: Auto Lighting Optimizer]** to **[Disable]** (p.104). When **[Low]**, **[Standard]**, or **[High]** is set, even if you set a decreased exposure compensation or flash exposure compensation, the image may come out bright.

I cannot set the exposure compensation when both manual exposure and ISO Auto are set.

- See page 139 to set the exposure compensation.

Not all the lens aberration correction options are displayed.

- Enabling **[Digital Lens Optimizer]** corrects both chromatic aberration and diffraction, although these options are not displayed.
- During movie shooting, **[Digital Lens Optimizer]** or **[Diffraction correction]** will not be displayed.

Using flash in [Av] or [P] mode lowers the shutter speed.

- Under [**2: External Speedlite control**], set [**Slow synchro**] to [**1/200-1/60sec. auto**] or [**1/200 sec. (fixed)**] (p.181).

The flash does not fire.

- Make sure the flash is securely attached to the camera.

The flash always fires at full output.

- Flash units other than EL/EX series Speedlites used in autoflash mode always fire at full output (p.178).
- When the flash Custom Function setting for [**Flash metering mode**] is set to [**TTL**] (autoflash), the flash will always fire at full output (p.187).

Flash exposure compensation cannot be set.

- If flash exposure compensation is already set with the Speedlite, flash exposure compensation cannot be set with the camera. When the external Speedlite's flash exposure compensation is canceled (set to 0), flash exposure compensation can be set with the camera.

High-speed sync is not available in [Av] or [P] mode.

- Under [**2: External Speedlite control**], set [**Slow synchro**] to [**1/200-30sec. auto**] or [**1/200-1/60sec. auto**] (p.181).

Remote control shooting is not possible.

- When taking still photos, set the drive mode to <[> or <[> (p.147). When shooting movies, set [**2: Remote control**] to [**Enable**] (p.245).
- Check the position of the remote control's release timing switch.
- If you are using Wireless Remote Control BR-E1, see pages 174 and 408.
- To use a remote control for time-lapse movie shooting, see page 235.

A white or red icon is displayed during shooting.

- It indicates that the camera's internal temperature is high. Image quality of still photos may be worse when a white < > icon is displayed. If a red < > icon is displayed, it indicates that shooting will soon stop automatically (p.253).

During movie shooting, the red icon is displayed.

- It indicates that the camera's internal temperature is high. If the red < > icon is displayed, it indicates that the movie shooting will soon stop automatically (p.253).

Movie shooting stops by itself.

- If the card's writing speed is slow, movie shooting may stop automatically. For cards that can record movies, see page 611. To find out the card's writing speed, refer to the card manufacturer's website, etc.
- Recording stops automatically once your movie reaches 29 min. 59 sec. (or 7 min. 29 sec. for a High Frame Rate movie).

The ISO speed cannot be set for movie shooting.

- In shooting modes other than **[M]**, the ISO speed is set automatically. In **[M]** mode, you can manually set the ISO speed (p.615).

ISO 100 cannot be set or ISO speed expansion cannot be selected during movie shooting.

- When **[CAM3: Highlight tone priority]** is set to **[Enable]**, the available ISO speed range starts at ISO 200. Expanded ISO speed cannot be selected even if you set an expanded range for **[ISO speed range]** or **[Range for 4K]** under **[CAM3: ISO speed settings]**. When **[CAM3: Highlight tone priority]** is set to **[Disable]** (p.109), you can set ISO 100/125/160 or an expanded ISO speed.
- Check the **[ISO speed range]** and **[Range for 4K]** setting under **[CAM3: ISO speed settings]**.

The exposure changes during movie shooting.

- If you change the shutter speed or aperture during movie shooting, the changes in the exposure may be recorded.
- Shooting a few test movies is recommended if you intend to perform zooming during movie shooting. Zooming as you shoot movies may cause exposure changes or lens sounds to be recorded, an uneven audio level, or loss of focus.

The image flickers or horizontal stripes appear during movie shooting.

- Flickering, horizontal stripes (noise), or irregular exposures can be caused by fluorescent lighting, LED lighting, or other light sources during movie shooting. Also, changes in the exposure (brightness) or color tone may be recorded. In **[M]** mode, a slow shutter speed may reduce the problem. The problem may be more noticeable in time-lapse movie shooting.

The subject looks distorted during movie shooting.

- If you move the camera to the left or right (panning) or shoot a moving subject, the image may look distorted. The problem may be more noticeable in time-lapse movie shooting.

I cannot take still photos during movie shooting.

- Still photos cannot be taken during movie shooting. Before taking still photos, stop shooting the movie, then select a shooting mode for still photos.

10-bit HDMI output is not available with Canon Log.

- No HDMI output is produced by the camera when set to **[On (10bit)]** if the external recording device does not support 10-bit recording in 4K.

Problems with Wireless Features

Wi-Fi function cannot be set.

- If the camera is connected to a computer or another device with an interface cable, Wi-Fi functions cannot be set. Disconnect the interface cable before setting any functions (p.426).

A device connected with an interface cable cannot be used.

- Other devices, such as computers, cannot be used with the camera by connecting them with an interface cable while the camera is connected to devices via Wi-Fi. Terminate the Wi-Fi connection before connecting the interface cable.

Operations such as shooting and playback are not possible.

- With a Wi-Fi connection established, operations such as shooting and playback may not be possible.
Terminate the Wi-Fi connection, then perform the operation.

Cannot reconnect to a smartphone.

- Even with a combination of the same camera and smartphone, if you have changed the settings or selected a different setting, reconnection may not be established even after selecting the same SSID. In such a case, delete the camera connection settings from the Wi-Fi settings on the smartphone and set up a connection again.
- If Camera Connect is left running while setting up a connection again, the connection may not be established. In such a case, restart Camera Connect.

Cannot pair with a smartphone.

- A previously paired smartphone cannot be paired with the camera again if the camera's registration is retained on the smartphone. In such a case, remove the camera's registration retained in the Bluetooth settings on the smartphone and try pairing again (p.439).

Operation Problems

I cannot change the setting with <>, <>, <>, <>, or <>.</h3>

- Press the <LOCK> button to unlock the controls (p.60).
- Check the [**F6: Multi function lock**] setting (p.416).

Touch operation is not possible.

- Make sure [**F3: Touch control**] is set to [**Standard**] or [**Sensitive**] (p.385).

A camera button or dial does not work as expected.

- For movie shooting, check the [**F4:  btn function**] setting (p.404).
- Check [**C.Fn4**] tab settings (p.555).

Display Problems

The menu screen shows fewer tabs and items.

- In [**A**⁺] mode, some tabs and items are not displayed. Tabs and items on the menu screen also vary for still photos and movies.

The display starts with [**★**] My Menu or the [**★**] tab alone is displayed.

- [**★ Set up: Menu display**] is set to [**Display from My Menu tab**] or [**Display only My Menu tab**]. Set [**Normal display**] (p.570).

The file name's first character is an underscore (“_”).

- Set [**📷4: Color space**] to [**sRGB**]. If [**Adobe RGB**] is set, the first character will be an underscore (p.117).

The fourth character in the file name changes.

- [**📷1: File name**] is set to [***** + image size**]. Select the camera's unique file name (preset code) or the file name registered under User setting 1 (p.370).

The file numbering does not start from 0001.

- If the card already contains recorded images, the image number may not start from 0001 (p.367).

The shooting date and time displayed are incorrect.

- Make sure the correct date and time are set (p.380).
- Check the time zone and daylight saving time (p.380).

The date and time are not in the image.

- The shooting date and time do not appear in the image. The date and time are recorded in the image data as shooting information. When printing, you can imprint the date and time in the picture, using the date and time recorded in the shooting information (p.353).

[###] is displayed.

- If the number of images recorded on the card exceeds the number the camera can display, [###] will be displayed.

The screen does not display a clear image.

- If the screen is dirty, use a soft cloth to clean it.
- The screen display may seem slightly slow in low temperatures or may look black in high temperatures. It will return to normal at room temperature.

Playback Problems

Part of the image blinks in black.

- [▶ 3: Highlight alert] is set to [Enable] (p.309).

A red box is displayed on the image.

- [▶ 3: AF point disp.] is set to [Enable] (p.309).

During image playback, the AF points are not displayed.

- The AF points are not displayed when the following types of images are played back:
 - Images taken with Multi Shot Noise Reduction applied.
 - Cropped images.
 - Images captured with [Auto Image Align] set to [Enable] in HDR shooting.

The image cannot be erased.

- If the image is protected, it cannot be erased (p.318).

Still photos and movies cannot be played back.

- The camera may not be able to play back images taken with another camera.
- Movies edited with a computer cannot be played back with the camera.

Only few images can be played back.

- The images have been filtered for playback with [▶ 2: Set image search conditions] (p.313). Clear the image search conditions.

Operation sound and mechanical sound can be heard during movie playback.

- If you operate the camera's dials or lens during movie shooting, the operation sound will also be recorded. Using the Directional Stereo Microphone DM-E1 (sold separately) is recommended (p.202).

The movie appears to freeze momentarily.

- If there is a drastic change in the exposure level during autoexposure movie shooting, the recording will stop momentarily until the brightness stabilizes. In such a case, shoot in the [M] mode (p.213).

No picture appears on the television.

- Make sure [4:3: Video system] is set to [For NTSC] or [For PAL] correctly for the video system of your television (p.384).
- Make sure the HDMI cable's plug is inserted all the way in (p.333).

There are multiple movie files for a single movie shoot.

- If the movie file size reaches 4 GB, another movie file will be created automatically (p.200). However, if you use an SDXC card formatted with the camera, you can record a movie in a single file even if it exceeds 4 GB.

My card reader does not recognize the card.

- Depending on the card reader used and the computer's operating system, SDXC cards may not be correctly recognized. In such a case, connect your camera to the computer with the interface cable, then import the images to the computer using EOS Utility (EOS software).



The image cannot be resized.

- With this camera, you cannot resize JPEG **S2** and RAW images (p.345).

The image cannot be cropped.

- With this camera, you cannot crop RAW images (p.346).

Dots of light appear on the image.

- White, red, or blue dots of light may appear in captured images or on the shooting screen if the sensor is affected by cosmic rays or similar factors. Their appearance may be reduced by performing **[Clean now ]** under **[ 3: Sensor cleaning]** (p.391).

Sensor Cleaning Problems

The shutter makes a sound during sensor cleaning.

- Under [**3: Sensor cleaning**], when you select [**Clean now** ], the shutter will make a mechanical sound during the cleaning, but no picture will be recorded to the card (p.391).

Automatic sensor cleaning does not work.

- If you repeatedly turn the power switch <ON> and <OFF> within a short time period, the < > icon may not be displayed (p.48).

Computer Connection Problems

I cannot import images to a computer.

- Install EOS Utility (EOS software) in the computer (p.572).
- If the camera is already connected via Wi-Fi, it cannot communicate with any computer connected with an interface cable.

Communication between the connected camera and computer does not work.

- When using EOS Utility (EOS software), set [**2: Time-lapse movie**] to [**Disable**] (p.224).

Error Codes

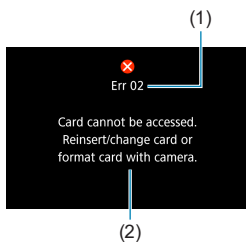

If there is a problem with the camera, an error message will appear. Follow the on-screen instructions. If the problem persists, write down the error code (Errxx) and contact a Customer Support Help Desk.

- (1) Error number
- (2) Cause and countermeasures

Performance Data

Still Photo Shooting

● Number of Possible Shots

(Approx. number of shots)

Temperature	Room Temperature (23°C / 73°F)	Low Temperature (0°C / 32°F)
Possible shots	370	350

- Based on using the screen and a fully charged battery pack (LP-E6N), with [**4: Disp. performance**] set to [**Smooth**], and following CIPA (Camera & Imaging Products Association) testing standards.
- With Battery Grip BG-E22 (sold separately) loaded with two LP-E6N battery packs, the number of possible shots will be approximately doubled.
- With [**4: Disp. performance**] set to [**Power saving**], approx. 450 shots are possible at room temperature and approx. 430 at low temperatures.

● ISO Auto Range

Shooting Mode	ISO Speed	
	No Flash	With Flash
A+	ISO 100–12800	ISO 100–1600
Fv/P/Tv/Av/M	ISO 100–40000*	ISO 100–1600*
BULB	ISO 400*	ISO 400*

* The actual ISO speed range depends on the [**Minimum**] and [**Maximum**] set with [**Auto range**].

● Guide to Image Quality Settings

(Approx.)

Image Quality	Pixels Recorded	File Size (MB)	Possible Shots	Maximum Burst	
				Standard	High Speed
JPEG					
L	30M	8.4	3570	100	100
L		4.4	6770	100	100
M	13M	4.7	6460	100	100
M		2.6	11510	100	100
S1	7.5M	3.1	9700	100	110
S1		1.8	16040	100	110
S2	3.8M	1.6	18830	100	110
RAW					
RAW	30M	31.3	970	34	47
RAW : DPR	30M	55.2	520	17	Full
CRAW	30M	17.3	1770	61	78
CRAW : DPR	30M	27.8	1000	150	Full
RAW+JPEG					
RAW	30M	31.3	760	34	39
L	30M	8.4			
CRAW	30M	17.3	1180	55	56
L	30M	8.4			

- The number of possible shots is based on Canon's testing standards and an 32 GB card.
- The maximum burst during continuous shooting is based on Canon's standard testing SD card (Standard: 32 GB, High-speed: UHS-II 32 GB) and testing standards (High-speed continuous shooting, still photo cropping/aspect ratio: Full-frame, ISO 100, without Dual Pixel RAW, Standard Picture Style).
- **The file size, number of possible shots, and maximum burst will vary depending on the subject, card brand, still photo cropping/aspect ratio, ISO speed, Picture Style, Custom Functions, and other settings.**
- Automatically set to Low-speed continuous shooting when shooting with Dual Pixel RAW.
- "Full" indicates that shooting is possible until the card becomes full with the listed conditions.



Even if you use a high-speed SD card, maximum burst indicator will not change. The maximum burst in the table will apply instead.

● Pixel Count When Still Photo Cropping/Aspect Ratio is Set

(Approx. pixels)

Image Quality	Full-frame (3:2)	1.6x (crop)
L / RAW / CRAW	6720x4480 (30.1 megapixels)	4176x2784 (11.6 megapixels)
M	4464x2976 (13.3 megapixels)	—
S1	3360x2240 (7.5 megapixels)	—
S2	2400x1600 (3.8 megapixels)	2400x1600 (3.8 megapixels)

Image Quality	1:1 (aspect ratio)	4:3 (aspect ratio)	16:9 (aspect ratio)
L / RAW / CRAW	4480x4480 (20.1 megapixels)	5952x4480 (26.7 megapixels)*	6720x3776 (25.4 megapixels)*
M	2976x2976 (8.9 megapixels)	3968x2976 (11.8 megapixels)	4464x2512 (11.2 megapixels)*
S1	2240x2240 (5.0 megapixels)	2976x2240 (6.7 megapixels)*	3360x1888 (6.3 megapixels)*
S2	1600x1600 (2.6 megapixels)	2112x1600 (3.4 megapixels)*	2400x1344 (3.2 megapixels)*



- The actual aspect ratio of images in the sizes marked with an asterisk “*” will differ from the aspect ratio indicated.
- For details on JPEG file sizes, see the values for full-frame recording on page 609. Under equivalent shooting conditions, file sizes will be smaller than when [📷 1: 📷 Cropping/aspect ratio] is set to [Full-frame].

Movie Shooting

• Cards that Can Record Movies

Movie Recording Quality			SD Card
4K	29.97P 25.00P 24.00P 23.98P	[ALL-I]	UHS-II, Video Speed Class 60 or higher
		[IPB]	UHS-I, UHS Speed Class 3 or higher
FHD	59.94P 50.00P	[ALL-I]	UHS-I, UHS Speed Class 3 or higher
		[IPB]	SD Speed Class 10 or higher
	29.97P 25.00P 24.00P 23.98P	[ALL-I]	UHS-I, UHS Speed Class 3 or higher
		[IPB]	SD Speed Class 4 or higher
	HDR movie		
	29.97P 25.00P	[IPB]	SD Speed Class 4 or higher
HD	59.94P 50.00P	[ALL-I]	SD Speed Class 10 or higher
		[IPB]	SD Speed Class 4 or higher
	29.97P 25.00P	[IPB]	SD Speed Class 4 or higher
	HDR movie		
	119.9P 100.0P	[ALL-I]	UHS-I, UHS Speed Class 3 or higher

- When movie cropping and Movie digital IS are disabled.
- This table indicates the card's writing and reading speeds required for recording movies (card performance requirements). However, card performance requirements for 4K/Full HD time-lapse movies apply to reading speed.

● Total Movie Recording Time and File Size Per Minute (Approx.)

Movie Recording Quality			Total Possible Recording Time on Card			File size
			8 GB	32 GB	128 GB	
4K	29.97P 25.00P	ALL-I	2 min.	8 min.	35 min.	3444 MB/min.
	24.00P 23.98P	IPB	8 min.	35 min.	2 hr. 21 min.	860 MB/min.
FHD	59.94P 50.00P	ALL-I	5 min.	23 min.	1 hr. 34 min.	1298 MB/min.
		IPB	17 min.	1 hr. 10 min.	4 hr. 43 min.	431 MB/min.
	29.97P 25.00P	ALL-I	11 min.	46 min.	3 hr. 06 min.	654 MB/min.
	24.00P 23.98P					
	29.97P 25.00P	IPB	35 min.	2 hr. 20 min.	9 hr. 23 min.	216 MB/min.
	24.00P 23.98P					
HDR movie						
29.97P 25.00P	IPB		1 hr. 26 min.	5 hr. 47 min.	23 hr. 11 min.	87 MB/min.
HD	59.94P 50.00P	ALL-I	13 min.	52 min.	3 hr. 29 min.	583 MB/min.
		IPB	40 min.	2 hr. 42 min.	10 hr. 49 min.	187 MB/min.
	29.97P 25.00P	IPB	1 hr. 20 min.	5 hr. 21 min.	21 hr. 26 min.	94 MB/min.
	HDR movie					
	119.9P 100.0P	ALL-I	6 min.	26 min.	1 hr. 46 min.	1144 MB/min.

- When movie cropping and Movie digital IS are disabled.

! An increase of the camera's internal temperature may cause movie shooting to stop before the total recording time shown in the table (p.253).

● Total Possible Time for Movie Shooting (Approx.)

Temperature	Room Temperature (23°C / 73°F)	Low Temperature (0°C / 32°F)
Possible recording time	2 hr. 20 min.	2 hr. 10 min.

- With a fully-charged Battery Pack LP-E6N.
- With **[Movie rec. size]** under **[CAM:1: Movie rec quality]** set to 4K FHD and **[AF1: Movie Servo AF]** set to **[Enable]**.

● Total Possible Time for Time-lapse Movie Shooting (Approx.)

Time-lapse Movie Shooting		Room Temperature (23°C / 73°F)	Low Temperature (0°C / 32°F)
Interval	Screen Auto Off		
2 sec.	Disable	4 hr. 30 min.	4 hr.
	Enable	7 hr. 10 min.	6 hr. 30 min.
10 sec.	Disable	4 hr. 20 min.	3 hr. 50 min.
	Enable	7 hr. 30 min.	6 hr. 50 min.

- With a fully-charged Battery Pack LP-E6N.
- The possible movie shooting time varies depending on the shooting conditions.

ISO Speed in Movie Shooting

In [M^A] Mode

- For HD/Full HD and High Frame Rate movies, ISO speed is automatically set in a range of ISO 100–25600.
- For 4K movies, ISO speed is automatically set in a range of ISO 100–12800.

In [M], [M^V], and [M^{Av}] Modes

- For HD/Full HD and High Frame Rate movies, ISO speed is automatically set in a range of ISO 100–25600.
- For 4K movies, ISO speed is automatically set in a range of ISO 100–12800.
- Under [CAM 3: ISO speed settings], if you set [ISO Auto] or [4K ISO Auto] to [Max.:H2(102400)] (p.246), the maximum limit of the automatic ISO speed setting range will be expanded to H2 (equivalent to ISO 102400). You can lower the maximum value to narrow the automatic ISO speed setting range.
- With [CAM 3: Highlight tone priority] set to [Enable] (p.109), the automatic ISO speed setting range is ISO 200–25600 for HD/Full HD and High Frame Rate movies and ISO 200–12800 for 4K movies.

In [M] Mode

- For HD/Full HD and High Frame Rate movies with ISO speed set to **[AUTO]**, it is automatically set in a range of ISO 100–25600.
- For 4K movies with ISO speed set to **[AUTO]**, ISO speed is automatically set in a range of ISO 100–12800.
- When setting ISO Auto, setting **[ISO Auto]** or **[4K ISO Auto]** under **[CAMERA 3: ISO speed settings]** to **[Max.:H2(102400)]** (p.246) expands the maximum speed in the automatic ISO speed setting range to H2 (equivalent to ISO 102400). You can lower the maximum value to narrow the automatic ISO speed setting range.
- You can set the ISO speed manually in a range of ISO 100–25600 for HD/Full HD and High Frame Rate movies and ISO 100–12800 for 4K movies. Note that under **[CAMERA 3: ISO speed settings]**, setting **[Maximum]** for **[ISO speed range]** or **[4K range]** to **[H2 (102400)]** (p.246) expands the maximum speed in the manual ISO speed setting range to H2 (equivalent to ISO 102400). Note that you can also set the **[Maximum]** and **[Minimum]** to a range narrower than the default range.
- If **[CAMERA 3: Highlight tone priority]** is set to **[Enable]** (p.109), the automatic and manual ISO speed setting range's minimum limit will be ISO 200. Even when ISO speed expansion is set, the maximum limit will not be expanded.

Image Playback

● Resize Options by Original Image Quality

Original Image Quality	Available Resize Settings		
	M	S1	S2
L*	<input type="radio"/>	<input type="radio"/>	<input type="radio"/>
M		<input type="radio"/>	<input type="radio"/>
S1			<input type="radio"/>

* Only S2 is available for images shot with [CAMERA 1: CROPPING/ASPECT RATIO] set to [1.6x (crop)].

● Size for Resized Images

(Approx. pixels)

Image Quality	Full-frame (3:2)	1.6x (crop)
M	4464x2976 (13.3 megapixels)	–
S1	3360x2240 (7.5 megapixels)	–
S2	2400x1600 (3.8 megapixels)	2400x1600 (3.8 megapixels)

Image Quality	1:1 (aspect ratio)	4:3 (aspect ratio)	16:9 (aspect ratio)
M	2976x2976 (8.9 megapixels)	3968x2976 (11.8 megapixels)	4464x2512 (11.2 megapixels)*
S1	2240x2240 (5.0 megapixels)	2976x2240 (6.7 megapixels)*	3360x1888 (6.3 megapixels)*
S2	1600x1600 (2.6 megapixels)	2112x1600 (3.4 megapixels)*	2400x1344 (3.2 megapixels)*



- The actual aspect ratio of images in the sizes marked with an asterisk “*” will differ from the aspect ratio indicated.
- The image may be cropped slightly depending on the resizing conditions.

Information Display

LCD Panel

Still photo/movie standby screen 1

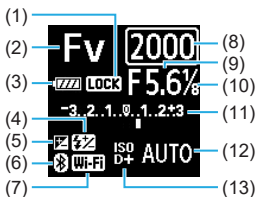

- (1) Multi-function lock
- (2) Shooting mode
- (3) Battery level
- (4) Flash exposure compensation
- (5) Exposure compensation
- (6) Bluetooth function
- (7) Wi-Fi function
- (8) Shutter speed
- (9) Aperture
- (10) Movie Av 1/8-stop increments
- (11) Exposure level indicator/Exposure compensation amount/AEB range
- (12) ISO speed
- (13) Highlight tone priority/ISO speed expansion

Still photo standby screen 2

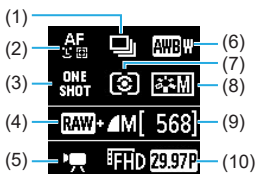

- (1) Drive mode
- (2) AF method
- (3) AF operation
- (4) Still photo image quality
- (5) Movie shooting mode
- (6) White balance
- (7) Metering mode
- (8) Picture Style
- (9) Possible shots
- (10) Movie recording quality

Movie standby screen 2

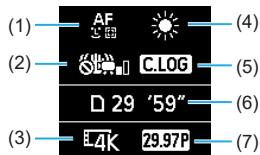

- (1) AF method
- (2) Movie digital IS
- (3) Image size
- (4) White balance
- (5) Canon Log
- (6) Movie recording time available
- (7) Frame rate

Movie recording in progress



- (1) Elapsed recording time
- (2) Recording in progress/External recording in progress (HDMI, 10-bit)

Still Photo Shooting Screen

Each time you press the <INFO> button, the information display will change.

- Viewfinder display positions vary for some items.
- The display will show only the settings currently applied.

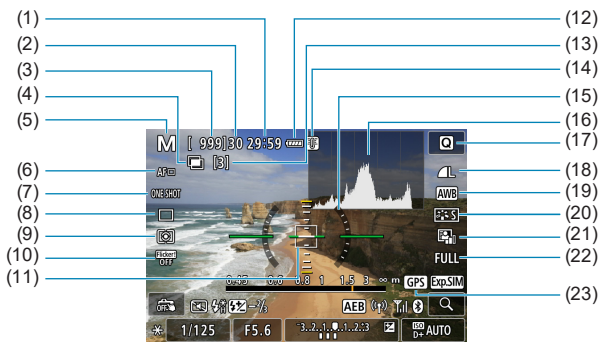

(1) Movie recording time available

(2) Maximum burst

(3) Possible shots/Sec. until self-timer shoots

(4) HDR/Multiple exposures/Dual Pixel RAW/Multi Shot Noise Reduction

(5) Shooting mode/Scene icon

(6) AF method

(7) AF operation

(8) Drive mode

(9) Metering mode

(10) Anti-flicker shooting

(11) AF point (1-point AF)

(12) Battery level

(13) Number of remaining multiple exposures

(14) Temperature warning

(15) Electronic level

(16) Histogram

(17) Quick Control button

(18) Image quality

(19) White balance/White balance correction

(20) Picture Style

(21) Auto Lighting Optimizer

(22) Still photo cropping/aspect ratio

(23) GPS acquisition status

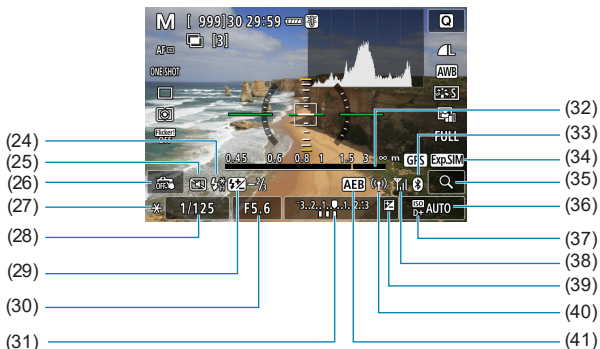

- (24) Flash ready/Flash off/FE lock/
High-speed sync
- (25) Silent shutter
- (26) Touch shutter
- (27) AE lock
- (28) Shutter speed/Multi-function lock
warning
- (29) Flash exposure compensation
- (30) Aperture
- (31) Exposure level indicator

- (32) Focus distance display
- (33) Bluetooth function
- (34) Exposure simulation
- (35) Magnify button
- (36) ISO speed
- (37) Highlight tone priority
- (38) Wi-Fi signal strength
- (39) Exposure compensation
- (40) Wi-Fi function
- (41) AEB/FEB

- You can set what is displayed when you press the <INFO> button (p.397).
- The electronic level is not displayed when the AF method is set to **[L+Tracking]** or the camera is connected via HDMI to a television.
- Other icons may be displayed temporarily after setting adjustments.

Movie Shooting Screen

Each time you press the <INFO> button, the information display will change.

- Viewfinder display positions vary for some items.
- The display will show only the settings currently applied.

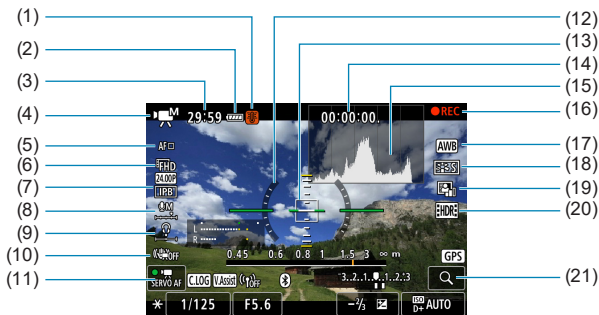

(1) Temperature warning	(12) Electronic level
(2) Battery level	(13) AF point (1-point AF)
(3) Movie recording time available/ Elapsed recording time	(14) Time code
(4) Movie shooting mode/Time-lapse movie/Scene icon	(15) Histogram (in M mode)
(5) AF method	(16) Recording in progress/ External recording in progress (HDMI, 10-bit)
(6) Movie recording size/Frame rate	(17) White balance/White balance correction
(7) Compression rate	(18) Picture Style
(8) Sound-recording level (manual)	(19) Auto Lighting Optimizer
(9) Headphone volume	(20) HDR movie
(10) Movie digital IS	(21) Magnify button
(11) Movie servo AF	

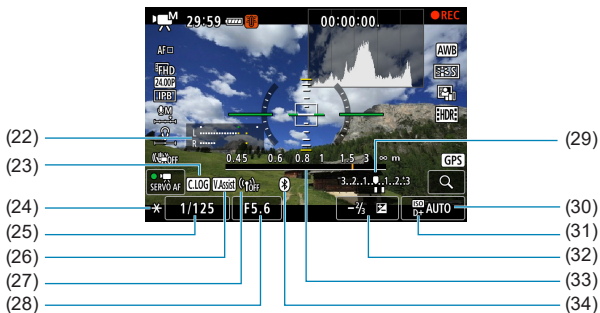

(22) Sound-recording level indicator (manual)

(23) Canon Log

(24) AE lock

(25) Shutter speed

(26) View Assist

(27) Wi-Fi function

(28) Aperture

(29) Exposure level indicator

(30) ISO speed

(31) Highlight tone priority

(32) Exposure compensation

(33) Focus distance display

(34) Bluetooth function

- You can set what is displayed for when you press the <INFO> button (p.397).
- The electronic level is not displayed when the AF method is set to **[L+Tracking]** or the camera is connected via HDMI to a television.
- The electronic level, grid lines, or histogram cannot be displayed during movie shooting. (The display will disappear when you start shooting a movie.)
- When movie shooting starts, the movie shooting remaining time will change to the elapsed time.

Other icons may be displayed temporarily after setting adjustments.

Scene Icons

In [A+] or [A+] shooting mode, the camera detects the type of scene, and all settings are configured accordingly. The detected scene type is indicated on the upper left of the screen.

Subject Background	Portrait* ¹		Non-Portrait			Background Color
		Movement** ²	Nature and Outdoor Scene	Movement** ²	Close** ³	
Bright						Gray
Backlit						
Blue Sky Included						Light blue
Backlit						
Sunset	* ⁴			* ⁴		Orange
Spotlight						Dark blue
Dark						
With Tripod** ²	* ⁵ * ⁶	* ⁴	* ⁵ * ⁶	* ⁴		

*1: During time-lapse movie shooting, the “Non-portrait” icon will be displayed even if a person is detected.

*2: Not displayed for movie recording.

*3: Displayed when the attached lens has distance information. With an extension tube or close-up lens, the icon displayed may not match the actual scene.



For certain scenes or shooting conditions, the icon displayed may not match the actual scene.

- *4: The icon of the scene selected from the detectable scenes will be displayed.
- *5: Displayed when all the following conditions apply:
The shooting scene is dark, it is a night scene, and the camera is mounted on a tripod.
- *6: Displayed with any of the lenses below:
 - EF300mm f/2.8L IS II USM
 - EF400mm f/2.8L IS II USM
 - EF500mm f/4L IS II USM
 - EF600mm f/4L IS II USM
 - Image Stabilizer lenses released in and after 2012.
- *5+*6: If the conditions in both *5 and *6 are met, the shutter speed will slow down.

Playback Screen

● Basic information display for still photos

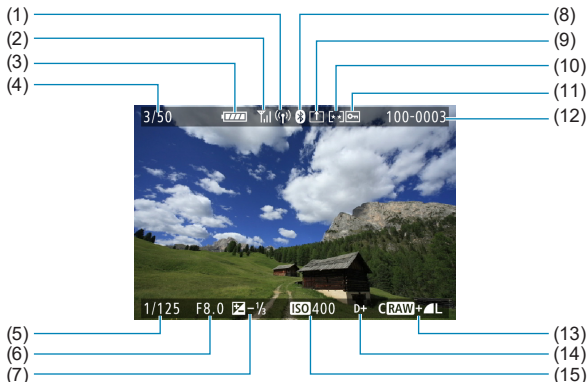

(1) Wi-Fi function

(2) Wi-Fi signal strength

(3) Battery level

(4) Playback No./Total images/
Number of found images

(5) Shutter speed

(6) Aperture

(7) Exposure compensation amount

(8) Bluetooth function

(9) Already sent to a computer/
smartphone

(10) Rating

(11) Image protection

(12) Folder number-File number

(13) Image quality/Edited image/
Cropping

(14) Highlight tone priority

(15) ISO speed



- If the image was taken by another camera, certain shooting information may not be displayed.
- It may not be possible to play back images taken with this camera on other cameras.

● Detailed information display for still photos

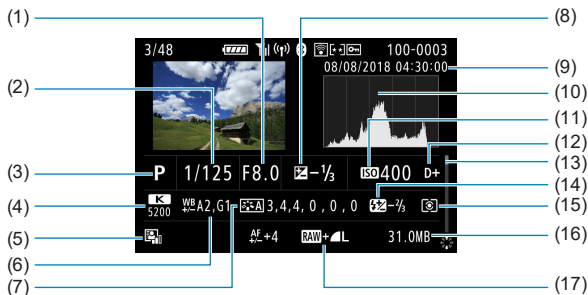

(1)	Aperture
(2)	Shutter speed
(3)	Shooting mode/Multiple exposure/Time-lapse movie
(4)	White balance
(5)	Auto Lighting Optimizer
(6)	White balance correction
(7)	Picture Style/Settings
(8)	Exposure compensation amount
(9)	Shooting date and time

(10)	Histogram (Brightness/RGB)
(11)	ISO speed
(12)	Highlight tone priority
(13)	Scroll bar
(14)	Flash exposure compensation/Bounce/HDR shooting/Multi Shot Noise Reduction
(15)	Metering mode
(16)	File size
(17)	Image quality/Edited image/Cropping

- * When you shoot in RAW+JPEG image quality, the RAW image file size will be displayed.
- * Lines indicating the image area will be displayed for images taken with the aspect ratio set (p.80) and with RAW or RAW+JPEG set for image quality.
- * During flash photography without flash exposure compensation, <f> will be displayed.
- * <f> will be displayed for images shot with bounce flash photography.
- * An icon for the effect (p.162) and the dynamic range adjustment amount will be displayed for images shot with HDR shooting.
- * <M> will be displayed for images shot with multiple-exposure shooting.
- * <NR> will be displayed for images shot with Multi Shot Noise Reduction.
- * <T> will be displayed for still photos taken as test shots for time-lapse movies.
- * <C> will be displayed for images created and saved after performing RAW image processing, resizing, or cropping.
- * <C> will be displayed for images cropped and then saved.

● Detailed information display for movies

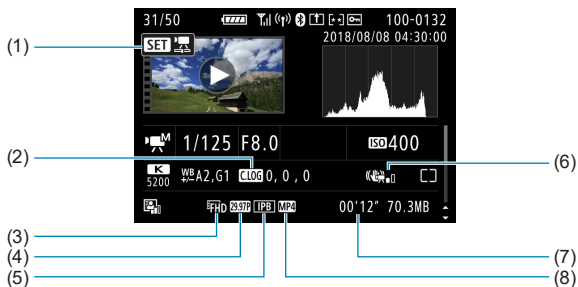

(1) Movie playback

(2) Picture Style: Settings
Canon Log: Characteristics

(3) Movie recording size

(4) Frame Rate

(5) Compression rate

(6) HDR movie/Movie digital IS

(7) Recording time

(8) Movie recording format



During movie playback, “* ,*” will be displayed for **[Fineness]** and **[Threshold]** of **[Picture Style]**'s **[Sharpness]**.

Trademarks

- Adobe is a trademark of Adobe Systems Incorporated.
- Microsoft and Windows are trademarks or registered trademarks of Microsoft Corporation in the United States and/or other countries.
- Macintosh and Mac OS are trademarks of Apple Inc., registered in the U.S. and other countries.
- SDXC logo is a trademark of SD-3C, LLC.
- HDMI, HDMI logo, and High-Definition Multimedia Interface are trademarks or registered trademarks of HDMI Licensing LLC.
- The Wi-Fi CERTIFIED logo and the Wi-Fi Protected Setup mark are trademarks of the Wi-Fi Alliance.
- WPS used on camera settings screens and in this manual stands for Wi-Fi Protected Setup.
- The Bluetooth® word mark and logos are registered trademarks owned by Bluetooth SIG, Inc. and any use of such marks by Canon Inc. is under license. Other trademarks and trade names are those of their respective owners.
- All other trademarks are the property of their respective owners.

About MPEG-4 Licensing

THIS PRODUCT IS LICENSED UNDER THE AVC PATENT PORTFOLIO LICENSE FOR THE PERSONAL USE OF A CONSUMER OR OTHER USES IN WHICH IT DOES NOT RECEIVE REMUNERATION TO (i) ENCODE VIDEO IN COMPLIANCE WITH THE AVC STANDARD ("AVC VIDEO") AND/OR (ii) DECODE AVC VIDEO THAT WAS ENCODED BY A CONSUMER ENGAGED IN A PERSONAL ACTIVITY AND/OR WAS OBTAINED FROM A VIDEO PROVIDER LICENSED TO PROVIDE AVC VIDEO. NO LICENSE IS GRANTED OR SHALL BE IMPLIED FOR ANY OTHER USE.

ADDITIONAL INFORMATION MAY BE OBTAINED FROM MPEG LA, L.L.C. SEE [HTTP://WWW.MPEGLA.COM](http://www.mpegla.com)

* Notice displayed in English as required.

Third party software

This product includes third party software.

- AES-128 Library
Copyright (c) 1998-2008, Brian Gladman, Worcester, UK. All rights reserved.

LICENSE TERMS

The redistribution and use of this software (with or without changes) is allowed without the payment of fees or royalties provided that:

1. source code distributions include the above copyright notice, this list of conditions and the following disclaimer;
2. binary distributions include the above copyright notice, this list of conditions and the following disclaimer in their documentation;
3. the name of the copyright holder is not used to endorse products built using this software without specific written permission.

DISCLAIMER

This software is provided 'as is' with no explicit or implied warranties in respect of its properties, including, but not limited to, correctness and/or fitness for purpose.

Use of Genuine Canon Accessories Is Recommended

This product is designed to achieve optimum performance when used with genuine Canon accessories. Therefore, using this product with genuine accessories is highly recommended.

Canon shall not be liable for any damage to this product and/or accidents such as malfunction, fire, etc. caused by the failure of non-genuine Canon accessories (e.g., a leakage and/or explosion of a battery). Please note that repairs arising out of the malfunction of non-genuine accessories will not be covered by the warranty for repairs, although you may request such repairs on a chargeable basis.

 Battery Pack LP-E6N/LP-E6 is dedicated to Canon products only. Using it with an incompatible battery charger or product may result in malfunction or accidents for which Canon cannot be held liable.



Index

Numeric

- [4K]** 3840x2160 (Movie)..... 192
 - [4K]** 3840x2160
(Time-lapse movie)..... 225
 - [A+]** (Scene Intelligent Auto) 123
 - [C1]/[C2]** (Custom shooting) 417
 - [FHD]** 1920x1080 (HDR shooting) 222
 - [FHD]** 1920x1080 (Movie)..... 192
 - [FHD]** 1920x1080
(Time-lapse movie)..... 225
 - [HD]** 1280x720 (HDR shooting) 222
 - [HD]** 1280x720 (Movie) 192
 - [Q]** (Quick Control)..... 68
 - 4, 9, 36, or 100 images..... 310
 - 4K frame capture..... 329
 - 8bit (Canon Log)..... 238
 - 10bit (Canon Log)..... 238
 - 10- or 2-sec. self-timer..... 147
- ## A
- AC adapter 583
 - Acceleration/deceleration tracking..... 289
 - Access lamp 45
 - Accessories 3
 - Adobe RGB 117
 - AEB (Auto Exposure Bracketing) 155
 - AE lock 157
 - AF 255
 - AF assist beam..... 264, 295
 - AF function customization 288
 - AF method..... 265
 - AF operation..... 262, 274
 - AF point selection..... 271
 - AF point size..... 276
 - AF speed 292
 - Area AF frame 265, 270
 - Beeper..... 386
 - Continuous AF..... 278
 - Eye Detection AF..... 277
 - Lens drive when AF impossible..... 297
 - Lens electronic MF 293
 - Limit AF methods..... 298
 - Manual focusing 281
 - One-Shot AF release priority 296
 - Orientation linked AF point 299
 - Out of focus 54
 - Recomposing 126
 - Touch & drag AF..... 279
 - AF point auto switching 290
 - AF point expansion..... 266, 271
 - AF start button 57
 - ALL-I (For editing/I-only)..... 195
 - Ambience priority (AWB) 99
 - Anti-flicker shooting 115
 - Aperture-priority AE 136
 - Area AF frame 265, 270
 - Aspect ratio →
 - Still photo cropping/aspect ratio
 - Attenuator 203
 - Auto 89

- Autofocus → AF
- Auto Lighting Optimizer 104
- Auto power off 377
- Auto reset 369
- Av (Aperture-priority AE)..... 136
- B**
- Basic information display..... 625
- Battery → Power
- Battery Grip 578
- Beep (Beeper) 386
- Black-and-white images 90, 94
- Bluetooth function..... 408, 426
- Address 436
- Connecting 429
- Bracketing
- AEB (Auto Exposure Bracketing) ... 155
- FEB
- (Flash Exposure Bracketing)..... 186
- White balance bracketing 103
- BULB (Bulb)..... 158
- Bulb exposures..... 158
- Bulb timer 159
- BUSY..... 77
- B/W..... 90, 94
- C**
- Cable protector 37
- Camera
- Camera vibration blur 125
- Default settings..... 419
- Holding the camera 55
- Camera shake 125
- Canon Log 236
- Card requirements..... 197, 611
- Cards..... 10, 30, 44, 373, 611
- Card reminder 118
- Formatting 373
- Low-level formatting 373
- Troubleshooting..... 46, 591
- Write-protect switch..... 44
- Center-weighted average metering ... 152
- Certification Logo..... 422
- Charger..... 35, 40
- Chromatic aberration
- correction..... 113, 344
- Cleaning (image sensor) 391
- Clipped highlights 309
- Color space 117, 343
- Color temperature..... 101
- Color tone 93
- Combination IS..... 221
- Continuous (file numbering) 368
- Continuous shooting..... 144
- Contrast..... 93, 104
- Control ring..... 60
- Copyright information 420
- Cropping (images)..... 346
- Cropping information 550
- Custom Functions..... 539
- Customizing operations 555

Custom shooting mode..... 417
 Custom white balance 100

D

D+ 109
 Date/time 380
 Daylight saving time 381
 DC Coupler 582
 Default settings..... 419
 Camera settings 419
 Custom Functions 554
 Customizing operations..... 555
 Custom shooting mode 417
 Flash function settings..... 187
 My Menu..... 569
 Depth-of-field preview..... 137
 Dials
 Main Dial 58
 Quick Control Dial 59
 Diffraction correction..... 113, 344
 Digital Lens Optimizer 112, 343
 Digital terminal..... 32, 348, 574
 Dioptric adjustment..... 54
 Display off..... 377
 Display settings 403
 Distortion correction..... 111, 343
 Double-tap..... 306
 DPOF (Digital Print Order Format) 353
 Dragging 67
 Drive mode 144
 Dual Pixel RAW 78

Dust Delete Data 121

E

Eco mode 376
 Electronic level 397
 Erasing images..... 335
 Err (error codes) 607
 Evaluative metering..... 152
 exFAT 200, 374
 Expanded ISO speed 83, 85, 246, 614
 Exposure compensation..... 155
 Exposure compensation in M mode with
 ISO Auto 139
 Exposure level increments 542
 Exposure level indicator 138, 617, 620
 Exposure maintained for
 new aperture..... 546
 Exposure simulation 120
 External microphone..... 203
 External Speedlite → Flash

F

Face+Tracking..... 265, 269
 Faithful..... 90
 FAT32 200, 374
 FEB (Flash Exposure Bracketing) 186
 FE lock..... 177
 File extension 371
 File name..... 370
 Underscore “_” 117

- File size 200, 609, 612
- Filter effect (Monochrome) 94
- Fine Detail 89
- Fine (Image-recording quality)..... 75
- Fineness (Sharpness) 93
- Firmware..... 422
- First-curtain synchronization..... 185
- Flash exposure compensation... 177, 186
- Flash mode..... 183
- Flash (Speedlite) 177
- Custom Functions 187
 - FEB
 - (Flash Exposure Bracketing)..... 186
 - FE lock 177
 - Flash control (function settings) 179
 - Flash exposure compensation 177, 186
 - Flash sync speed 178
 - Manual flash 183
 - Safety FE..... 182
 - Shutter synchronization (1st/2nd curtain) 185
 - Slow synchro 181
 - Wireless..... 184
- Flash sync contacts 31
- Flexible-priority AE..... 140
- Focus guide 284
- Focusing → AF
- Focus lock 126
- Focus mode switch..... 50, 53
- Folder creation/selection 365
- For editing (ALL-I)..... 195
- Formatting (card initialization) 373
- Frame Grab 329
- Frame rate 195, 384
- Free run..... 205
- Full Auto mode..... 123
- Full High-Definition (Full HD) (movie)..... 192, 225
- Full High-Definition (Full HD) (Time-lapse movie)..... 224
- Fv (Flexible-priority AE) 140

G

- GPS 411
- Grid display..... 305, 399

H

- H1/H2 (Expanded ISO speed)..... 85
- HD (High Frame Rate movie)..... 199
- HDMI 207, 251, 333, 395
- Connection indicator..... 252
 - Output..... 252
 - Record command 207
 - Time code..... 207
- HDMI HDR..... 396
- HDR movie shooting..... 222
- HDR shooting 161
- Headphones 203
- Help 405
- Text size 406
- High-Definition 192

- High dynamic range → HDR
- High Frame Rate 199
- High ISO speed noise reduction..... 105
- Highlight alert..... 309
- Highlight tone priority..... 109
- High-speed continuous shooting 144
- High-speed display..... 149
- Histogram 307, 400
- Hot shoe 31
- Household power..... 582
- I**
- ICC profile..... 117
- Icons 8
- Illumination (LCD panel)..... 60
- Image browsing (Jump display)..... 311
- Image-recording quality 75, 609
- Image review time 118
- Images
- AF point display 309
 - Auto reset 369
 - Auto rotation 372
 - Continuous (file numbering) 368
 - Erasing 335
 - File numbering..... 367
 - Highlight alert 309
 - Histogram 307
 - Image quality 75, 609
 - Image search..... 313
 - Importing (to computer)..... 574
 - Index display 310
 - Jump display (image browsing)..... 311
 - Magnifying images 315
 - Manual reset..... 369
 - Manual rotation..... 317
 - Playback..... 301
 - Protecting 318
 - Rating 321
 - Shooting information 305, 307, 625
 - Slide show 331
 - Transfer 348
 - Viewing on a television..... 324, 333
- Importing images to a computer..... 574
- Index display..... 310
- INFO button 62
- Initial AF Point..... 300
- Initial magnification ratio/position..... 316
- IPB..... 195
- IPTC information..... 553
- ISO speed..... 83, 246
- Auto range (Still photos)..... 86
 - ISO Auto (movie)..... 246
 - ISO Auto range..... 86, 246, 608
 - ISO expansion..... 85
 - ISO speed range 85, 246
 - Manual setting range..... 85
 - Minimum shutter speed for ISO Auto (Still photos) 87
 - Setting increments..... 542
 - Time-lapse ISO Auto 247
- J**
- JPEG 75, 609

Jump display.....311

L

Landscape..... 89

Language..... 383

Large (image-recording quality)..... 75

Large Zone AF..... 267, 271

LCD Panel..... 617

 Illumination..... 60

Lens..... 50, 52

 Chromatic aberration

 correction..... 113, 344

 Diffraction correction..... 113, 344

 Digital Lens Optimizer..... 112, 343

 Distortion correction..... 111, 343

 Focus mode switch..... 50, 53

 Lock release..... 51, 53

 Optical aberration correction... 110, 343

 Peripheral illumination

 correction..... 111, 343

Lens electronic MF..... 293

Light (IPB)..... 195

Location information..... 411

LOCK..... 60, 416

Long (bulb) exposures..... 158

Long Exposure Noise Reduction..... 107

Low-speed continuous shooting..... 145

M

Magnifying images..... 273, 281, 315

Main dial..... 58

Malfunction..... 588

Manual exposure..... 138

Manual focus..... 255

Manual focusing..... 281

Manual reset..... 369

Maximum burst..... 77

Medium (image-recording quality)..... 75

Memory cards → Cards

Menu..... 63

 Dimmed menu items..... 66

 My Menu..... 566

 Setting procedure..... 64

Metering mode..... 152

Metering timer..... 119

MF (Manual focusing)..... 281

M-Fn bar..... 59, 61

M-Fn button..... 57

MF peaking..... 283

Microphone..... 203

M (Manual exposure)..... 138

Mode Button..... 57

Monochrome..... 90, 94

Movies..... 188

 24.00p..... 198

 AE lock..... 212

 AF speed during Movie Servo AF... 292

 Aperture-priority AE..... 211

 Attenuator..... 203

 Autoexposure shooting..... 209

 Auto slow shutter..... 248

 Av 1/8-stop increments..... 249

- Canon Log..... 236
 - Cards suited for movie shooting.....611
 - Compression method 195
 - Cropped shooting 219
 - Drop frame 208
 - Editing 327
 - Editing out first and last scenes..... 327
 - Enjoying movies 324
 - External microphone 203
 - File size 200, 612
 - Frame Grab 329
 - Frame rate..... 195
 - Free run..... 205
 - HDMI output 251, 395
 - HDR movie shooting 222
 - Headphones 203
 - High Frame Rate 199
 - Information display 621
 - Manual exposure shooting 213
 - Metering timer 249
 - Microphone..... 203
 - Movie digital IS 220
 - Movie Servo AF 286, 291, 292
 - Movie Servo AF tracking sensitivity..... 291
 - Movie shooting button 209
 - Playback..... 324, 325
 - Playback count..... 206
 - Recording count 206
 - Recording coverage 194
 - Recording quality (size)..... 192
 - Recording time 201, 612
 - Rec run..... 205
 - Shutter-priority AE 210
 - Shutter speed 215
 - Sound recording/
Sound-recording level 202
 - Time code..... 205
 - Time-lapse movie 224, 613
 - Viewing on a television 324, 333
 - Wind filter 202
 - MP4 196
 - Multi function 57
 - Multi-function bar 61
Customization..... 561
 - Multi function lock..... 60, 416
 - Multiple exposure 166
 - Multi Shot Noise Reduction 105
 - My Menu..... 566
- N**
- Neutral 89
 - Noise reduction
High ISO speed 105
Long exposures..... 107
 - Non-Canon flash units..... 178
 - Normal (Image-recording quality)..... 75
 - NTSC..... 195, 384
- O**
- One-Shot AF..... 263
 - ONE SHOT (One-Shot AF)..... 263
 - Orientation linked AF point 299

- P**
- PAL 195, 384
 - Partial metering 152
 - Part names 31
 - PC terminal 585
 - Peripheral illumination
 - correction 111, 343
 - Photobook set-up 357
 - Picture Style 88, 92, 95
 - Pixel count 75, 609
 - Playback 301
 - Portrait 89
 - Positioning hole 33
 - Possible recording time (movie) 612
 - Possible shots 608
 - Power 48
 - Auto power off 377
 - Battery information 387
 - Battery level 49, 387
 - Charging 40, 576
 - Household power 582
 - Possible shots 608
 - Recharge performance 387
 - Power saving 377
 - P (Program AE) 132
 - Pressing completely 56, 404
 - Pressing halfway 56, 404
 - Printing
 - Photobook set-up 357
 - Print order (DPOF) 353
 - Program AE 132
 - Program shift 133
 - Protecting images 318
- Q**
- Quick Control 68
 - Quick control dial 59
- R**
- Rating 321
 - Rating mark 321
 - RAW 75, 76
 - RAW image processing 339
 - RAW+JPEG 75, 609
 - Recharging 40, 576
 - Rec run 205
 - Reduced display 310
 - Release shutter without card 118
 - Remote control 174
 - Remote control terminal 32, 176
 - Remote switch 176
 - Repeat (slide show) 331
 - Resizing 345
 - Rotation (image) 317, 372
- S**
- Safety instructions 25
 - Safety shift 545
 - Saturation 93
 - Scene icons 127, 623

- Scene Intelligent Auto..... 123
- Screen 30, 47
- Adjusting angle..... 47, 55
 - Brightness 378
 - Color tone..... 379
 - Electronic level 397
 - Image Playback..... 304
 - Menu display 63
 - Quick Control..... 68
- SD, SDHC, SDXC cards → Cards
- Search conditions 313
- Second-curtain synchronization 185
- Self-timer 147
- Sensitivity → ISO speed
- Sensor cleaning..... 391
- Serial number 33, 389
- SERVO 263
- Servo AF
- Movie Servo AF 286, 291, 292
 - SERVO 263
- Sharpness 93
- Shooting information display 397, 619
- Shooting modes..... 70, 188
- [A+]** (Scene Intelligent Auto) 123
 - Av (Aperture-priority AE) 136
 - BULB (Bulb) 158
 - [C1]/[C2]** (Custom shooting) 417
 - Fv (Flexible-priority AE) 140
 - M (Manual exposure) 138
 - P (Program AE) 132
 - Tv (Shutter-priority AE)..... 134
- Shooting range 400
- Shutter button 56
- Shutter button functions..... 404
- Shutter-priority AE 134
- Shutter synchronization 185
- Silent LV shooting..... 150
- Silent shooting..... 151
- Single-image display 304
- Single-point AF 265
- Single shooting 144
- Slide show 331
- Small (image-recording quality)..... 75
- Software 572
- Instruction Manual 573
- Sound recording/
- Sound-recording level..... 202
- Speaker 31, 325
- Spot metering 152
- sRGB 117
- Standard 89
- Standard (IPB)..... 195
- ☆ icon 8
- Still photo cropping/
- aspect ratio 80, 610
- Strap 36
- Strength (Sharpness) 93

T

- Temperature warning..... 142, 253
- Threshold (Sharpness)..... 93

Tilt correction	347
Time code	205
Time-lapse movie	224
Time zone	380
Tone priority	109
Toning effect (Monochrome).....	94
Touch beeping	386
Touch operation.....	67, 306, 385
Touch Shutter	130
Tracking sensitivity	288
Transition effect (slide show).....	331
Tripod socket.....	33
Troubleshooting.....	588
Tv (Shutter-priority AE).....	134

U

UHS.....	10
Underscore “_”.....	117
USB (digital) terminal.....	32, 348, 574
User Def.	90
UTC (Coordinated Universal Time) ...	415

V

Vari-angle screen.....	47, 55
Vertical image auto rotation.....	372
Video system	384
Viewfinder	
Dioptic adjustment.....	54
Display format	402
Grid display	399

Information display	398
Vertical display	399
Viewfinder off.....	377
Viewing on a television.....	324, 333
Volume (movie playback)	326

W

White balance (WB).....	97
Auto	99
Bracketing	103
Color temperature setting.....	101
Correction.....	102
Custom	100
White priority (AWB).....	99
Wi-Fi function.....	423
Access points	496
Encryption	496
Android	427
Authentication.....	496
Camera access point mode.....	508
Camera Connect	427, 444
CANON IMAGE GATEWAY	481
Clearing wireless communication	
settings	515
Communicating with a	
smartphone	427
Connection history.....	509, 533
Edit device information	458, 513
Erase connection information.....	514
Interface cable.....	426
iOS	427
IP address	499, 503, 507

- Manual setting 535
 - MAC address 496, 516
 - Network 441, 462, 470
 - Network settings 531
 - Nickname 514
 - Notes on wireless communications 528
 - Pairing 431
 - Password 506, 533
 - PictBridge 471
 - Printer/Printing 472
 - Print image 472
 - Print order 475
 - Print settings
 - Cropping 479
 - Date/file number 477
 - Image optimization 477
 - Number of copies 478
 - Paper settings 475
 - Quick Control 449
 - Reconnecting 509
 - Remote operation 444
 - Resize image 447, 453, 489
 - Send image shown 450, 487
 - Send images to smartphone 448
 - Sending all images on the card 454, 491
 - Sending images that match search conditions 455, 493
 - Sending images to a Web service 481
 - Send selected 451, 488
 - SSID 441, 462, 470
 - Switch network 498, 502, 505
 - Use with EOS software 461
 - Auto send 466
 - EOS Utility 461
 - Image Transfer Utility 2 466
 - Viewable images 458
 - View info screen 516
 - Viewing images 444
 - Virtual keyboard 534
 - Wi-Fi printer 469
 - Wi-Fi settings 429, 533
 - WPS (Wi-Fi Protected Setup) 496
 - PBC mode 497
 - PIN mode 501
 - Wind filter 202
 - Wireless communication settings 407, 423
- ## Z
- Zone AF 266, 271



The descriptions in this Instruction Manual are current as of May 2019. For information on the compatibility with any products introduced after this date, contact any Canon Service Center. For the latest version Instruction Manual, refer to the Canon Web site.