

Canon

EOS RP



Advanced User Guide

Introduction

Before Starting to Shoot, Be Sure to Read the Following

To avoid shooting problems and accidents, first read the “Safety Instructions” (📖 25–📖 27) and “Handling Precautions” (📖 28–📖 30). Also, read this manual carefully to ensure that you use the camera correctly.

Refer to This Manual while Using the Camera to Further Familiarize Yourself with the Camera

While reading this manual, take a few test shots and see how they come out. You can then better understand the camera. Be sure to store this manual safely, too, so that you can refer to it again when necessary.

Testing the Camera Before Use and Liability

After shooting, play images back and check whether they have been properly recorded. If the camera or memory card is faulty and the images cannot be recorded or downloaded to a computer, Canon cannot be held liable for any loss or inconvenience caused.

Copyrights

Copyright laws in some countries prohibit the unauthorized use of images recorded with the camera (or music/images with music transferred to the memory card) for purposes other than personal enjoyment. Also be aware that certain public performances, exhibitions, etc. may prohibit photography even for private enjoyment.

Item Check List

Before starting, check that all the following items are included with your camera. If anything is missing, contact your dealer.

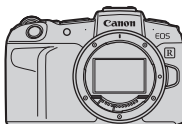

Camera
(with body cap)



Battery Pack LP-E17
(with protective cover)



Battery Charger
LC-E17/LC-E17E*

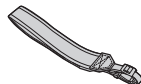

Strap

* Battery Charger LC-E17 or LC-E17E is provided. (The LC-E17E comes with a power cord.)

- The camera does not come with a memory card (📖 10), interface cable, or HDMI cable.
- For details on the Advanced User Guide and Instruction Manuals, see the next page.
- If you purchased a Lens Kit, check that the lenses are included.
- Be careful not to lose any of the above items.



- When you need Lens Instruction Manuals, download them from the Canon website (📖 4).
- The Lens Instruction Manuals (PDF files) are for lenses sold individually. Note that when purchasing the Lens Kit, some of the accessories included with the lens may not match those listed in the Lens Instruction Manual.

Instruction Manuals



The Instruction Manual included with the camera provides basic instructions for the camera and Wi-Fi functions. The Advanced User Guide (this PDF file), which provides complete instructions, can be downloaded from the Canon website to a computer or other device.

Downloading the Advanced User Guide/Instruction Manuals

The Advanced User Guide and Instruction Manuals for lenses and software (PDF files) can be downloaded from the Canon website to a computer or other device.

● Download site

www.canon.com/icpd

- **Advanced User Guide**
- **Lens Instruction Manual**
- **Software Instruction Manual**



- **To view the PDF files, an Adobe PDF viewing software such as Adobe Acrobat Reader DC (most recent version recommended) is required.**
- Adobe Acrobat Reader DC can be downloaded for free from the Internet.
- Double-click the downloaded PDF file to open it.
- To learn how to use PDF viewing software, refer to the software's Help section or the like.

Downloading the Advanced User Guide/Instruction Manuals Using QR Code

The Advanced User Guide and Instruction Manuals for lenses and software (PDF files) can be downloaded to a smartphone or tablet using the QR code.

www.canon.com/icpd



- A software app is required to read the QR code.
- Select your country or region of residence, then download the Advanced User Guide/Instruction Manuals.
- Select [**📄**: **Manual/software URL**] to display the QR code on the camera screen.

Quick Start Guide

1

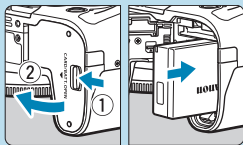

Insert the battery (📖 42).

- Upon purchase, charge the battery to start using (📖 40).

2

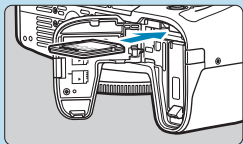

Insert the card (📖 42).

- With the card's label facing toward the back of the camera, insert it into the card slot.

3

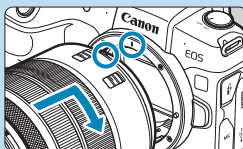

Attach the lens (📖 48).

- Align the red mount index on the lens with the red mount index on the camera to attach the lens.
- Make sure the lens's focus mode switch is set to <AF> (📖 48).

4

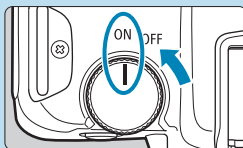

Set the power switch to <ON> (📖 46).

5

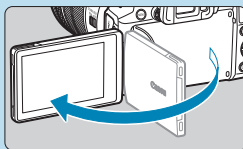

Flip out the screen (📖 45).

- When the date/time/zone setting screen is displayed, see 📖 374.

6

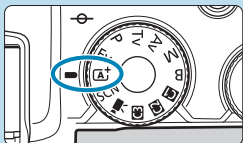

Set the Mode dial to **<A+>** (📖 68).

- All the necessary camera settings will be set automatically.

7



Focus on the subject (📖 54).

- **<[]>** (an AF point) appears over any face detected.
- Press the shutter button halfway, and the camera will focus on the subject.

8



Take the picture (📖 54).

- Press the shutter button completely to take the picture.

9

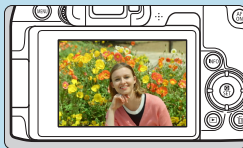







Review the picture.

- The image just captured will be displayed for approx. 2 sec. on the screen.
- To display the image again, press the **<▶>** button (📖 296).

- To view the images captured so far, see "Image Playback" (📖 296).
- To delete images, see "Erasing Images" (📖 314).





About This Manual

Icons in this Manual

-  : Indicates the Main dial.
-  : Indicates the Quick control dial.
-  : Indicates the corresponding direction on the cross keys.
-  : Indicates the lens control ring.
-  : Indicates the Setting button.
- * : Indicates the duration (in * seconds) of the operation for the button you pressed, as timed after you release the button.

* In addition to the above, the icons and symbols used on the camera's buttons and displayed on the screen are also used in this manual when discussing relevant operations and functionality.

☆ (in page titles) : Functions only available in Creative Zone modes (<Fv>, <P>, <Tv>, <Av>, <M>, or mode) or for movies recorded with manual exposure.

- *** : Reference page numbers for more information.
-  : Warning to prevent shooting problems.
-  : Supplemental information.
-  : Tips or advice for better shooting.
-  : Troubleshooting advice.

Basic Assumptions for Operational Instructions, Sample Photos

- Before following any instructions, make sure the power switch is set to <ON> and the Multi-function lock feature is off (📖 46, 📖 58).
- It is assumed that all the menu settings and Custom Functions are set to their defaults.
- The illustrations in this manual show the camera attached with the RF24-105mm F4 L IS USM lens as an example.
- The sample photos displayed on the camera and used in this manual are for instructional purposes only.
- In references to using EF or EF-S lenses, it is assumed that a mount adapter is used.

Compatible Cards

The following cards can be used with the camera regardless of capacity. **If the card is new or was previously formatted (initialized) by another camera or computer, format the card with this camera** (📖 367).

- **SD/SDHC/SDXC memory cards**

UHS-II and UHS-I cards supported.

Cards that Can Record Movies

When recording movies, use a high-capacity card with ample performance (fast enough writing and reading speeds) for the movie recording size. For details, see 📖 586.



In this manual, “card” refers to SD memory cards, SDHC memory cards, and SDXC memory cards.

* **The camera does not come with a card for recording photos/movies.** Please purchase it separately.

Chapters

Introduction	2
<hr/>	
Preparation and Basic Operations	39
<hr/>	
Basic Shooting	67
<hr/>	
Creative Zone	95
<hr/>	
Shooting	109
<hr/>	
Playback	293
<hr/>	
Set-up	357
<hr/>	
Wi-Fi (Wireless Communication) Functions	415
<hr/>	
Custom Functions / My Menu	523
<hr/>	
Reference	553
<hr/>	

Contents

Introduction	2
Item Check List	3
Instruction Manuals	4
Quick Start Guide	6
About This Manual	8
Compatible Cards	10
Chapters	11
Contents	12
Index to Features	21
Safety Instructions	25
Handling Precautions	28
Part Names	31
Preparation and Basic Operations	39
Charging the Battery	40
Inserting/Removing the Battery and Card	42
Using the Screen	45
Turning on the Power	46
Attaching and Detaching a Lens	48
Attaching and Detaching EF/EF-S Lenses	50
Using the Viewfinder	52
Basic Operations	53
Menu Operations and Settings	60
Touch-Screen Operation	64
Quick Control	65

Basic Shooting 67

Fully Automatic Shooting (Scene Intelligent Auto)	68
Full Auto Techniques (Scene Intelligent Auto).....	71
Special Scene Mode	75
Shooting Portraits	77
Shooting Group Photos.....	78
Shooting Landscapes	79
Shooting Moving Subjects	80
Photographing Children	81
Panning.....	82
Shooting Close-ups.....	84
Shooting Food.....	85
Shooting Night Portraits (With a Tripod)	86
Shooting Night Scenes (Handheld).....	87
Shooting Backlit Scenes	88
Shooting Quiet Scenes	89
Cautions for the <SCN> Modes	90

Creative Zone 95

Program AE.....	96
Shutter-Priority AE.....	98
Aperture-Priority AE	100
Manual Exposure	102
Flexible-Priority AE.....	104
Long (Bulb) Exposures	106

Shooting 109**Shooting Still Photos 110**

Tab Menus: Still Photo Shooting	111
Setting Image Quality	116
Setting Cropping/Aspect Ratio	119
Setting the Image Review Time	122
Correction of Lens Aberrations due to Optical Characteristics	123
Setting the Desired Exposure Compensation	128
Auto Exposure Bracketing (AEB)	129
Setting the ISO Speed for Still Photos	131
Auto Correction of Brightness and Contrast	136
Highlight Tone Priority	137
Setting the Metering Timer	138
Exposure Simulation	139
Setting the White Balance	140
White Balance Correction	145
Setting the Color Space	147
Selecting a Picture Style	148
Customizing a Picture Style	152
Registering a Picture Style	155
Setting Noise Reduction	157
Appending Dust Delete Data	161
Shooting with the Touch Shutter	163
Multiple Exposures	165

HDR (High Dynamic Range) Shooting.....	171
Interval Timer Shooting	176
Reducing Flicker	179
Selecting the Display Speed for High-Speed Continuous Shooting ..	181
Card Reminder.....	182
Setting Touch & Drag AF.....	183
Selecting the AF Operation	185
Selecting the AF Method	188
Focusing on People's Eyes.....	198
Setting Continuous AF	199
Setting Lens Electronic MF	200
Setting AF-Assist Beam Firing	201
Focus Bracketing	202
Selecting the Drive Mode.....	206
Using the Self-Timer	209
Selecting the Metering Mode	211
Locking the Exposure for Shooting (AE Lock)	213
Focusing Manually	214
Remote Control Shooting.....	217
Using a Remote Switch.....	219
Flash Photography.....	220
Setting the Flash Function	222
General Notes on Still Photo Shooting	231

Recording Movies 235

Tab Menu: Movie Recording	236
Recording Movies	239
Recording HDR Movies.....	247
Setting the Movie Recording Size.....	249
Movie Cropping.....	256
Setting the Sound Recording	257
Movie Digital IS	260
Recording Time-lapse Movies.....	262
Recording Video Snapshots.....	274
Setting Movie Servo AF	280
Other Menu Functions	285
General Movie Recording Cautions	291

Playback 293

Tab Menu: Playback	294
Image Playback	296
Magnifying Images	299
Index Display (Multiple-Image Display).....	300
Playing Back Movies	301
Editing a Movie's First and Last Scenes	304
Grabbing a Frame from 4K Movies or 4K Time-Lapse Movies	306
Playback on a TV	308
Protecting Images	310
Rotating Images.....	313

Erasing Images	314
Digital Print Order Format (DPOF).....	318
Specifying Images for a Photobook	322
Processing RAW Images with the Camera	325
Applying Your Favorite Effects (Creative Assist).....	331
Selecting the Type of RAW Image Processing	333
Editing Video Snapshot Albums	334
Cropping JPEG Images	337
Resizing JPEG Images	339
Setting Ratings.....	340
Slide Show (Auto Playback).....	343
Filtering Images for Playback.....	345
Jump Display (Jumping Through Images)	347
Customizing Playback Information Display	349
Displaying the Highlight Alert	351
Displaying AF Points	352
Displaying a Grid.....	353
Specifying Initial Image Display When Playback Begins	354
Setting the Initial Magnification Ratio and Position	355

Set-up

357

Tab Menus: Set-up	358
Creating and Selecting a Folder	361
File Numbering Methods	363
Setting the Auto Rotation of Vertical Images.....	366

Formatting Memory Cards	367
Displaying the Shooting Mode Guide.....	369
Displaying the Feature Guide	370
Setting Eco Mode.....	371
Setting Power-Saving Features	372
Adjusting the Screen Brightness.....	373
Setting the Date, Time, and Time Zone	374
Setting the Interface Language.....	377
Setting the Video System.....	378
Setting the Touch Control Response.....	379
Disabling Beeps for Camera Operations	380
Checking the Battery Information.....	381
Sensor Cleaning	382
Setting the HDMI Output Resolution.....	386
RAW Playback on an HDR TV	387
Customizing Information Displayed When Shooting.....	388
Setting a Priority for Shooting Display Performance.....	393
Setting the Viewfinder Display Format.....	393
Setting the Display Mode	394
Customizing Shutter Button Functionality for Movie Recording.....	395
Help.....	396
Setting Wireless Features.....	398
Geotagging Images.....	402
Setting the Multi-Function Lock.....	407

Registering Custom Shooting Modes	408
Reverting the Camera to the Default Settings	410
Setting Copyright Information	411
Checking Other Information	413

Wi-Fi (Wireless Communication) Functions 415

What You Can Do via Wi-Fi (Wireless Communication) Functions....	416
Connecting to a Smartphone via Wi-Fi	419
Connecting to a Computer via Wi-Fi	453
Connecting to a Printer via Wi-Fi	461
Sending Images to a Web Service.....	473
Wi-Fi Connection via Access Points	488
Reconnecting via Wi-Fi	493
Changing or Deleting Connection Settings	496
Clearing Wireless Communication Settings to Default	498
View Info Screen.....	499
Responding to Error Messages	500
Wireless Communication Function Notes	511
Security	513
Checking Network Settings.....	514
[Wireless communication settings] Screen	515
[Wi-Fi settings] Screen.....	516
Virtual Keyboard Operation.....	517
Setting the IP Address Manually	518
Wi-Fi/Bluetooth Status Display	520

Custom Functions / My Menu	523
Tab Menus: Customization.....	524
Setting Custom Functions.....	525
Custom Function Settings.....	526
Clearing Custom Function Settings	546
Tab Menus: My Menu.....	547
Registering My Menu	548
Reference	553
Software Overview.....	554
Importing Images to a Computer	556
Charging a Battery in the Camera	558
Using an Extension Grip	560
Troubleshooting	562
Error Codes.....	581
Performance Data.....	582
Information Display	591
Index	603

Index to Features

Power

- Charging the battery (📖 40)
- Battery level (📖 47)
- Checking battery information (📖 381)
- Eco mode (📖 371)
- Power saving (📖 372)

Cards

- Formatting (📖 367)
- Releasing shutter without card (📖 182)
- Cards compatible with movie recording (📖 585)

Lens

- Attaching (📖 48, 📖 50)
- Detaching (📖 49, 📖 51)
- Releasing shutter without lens (📖 544)

Basic Settings

- Language (📖 377)
- Date/Time/Zone (📖 374)
- Beeper (📖 380)
- Copyright information (📖 411)
- Clear all camera settings (📖 410)

Viewfinder

- Dioptic adjustment (📖 52)
- Information display in viewfinder (📖 389)
- Viewfinder vertical display (📖 390)
- Viewfinder display format (📖 393)

Screen

- Vari-angle (📖 45)
- Touch control (📖 64)
- Brightness (📖 373)
- Display settings (📖 394)
- Electronic level (📖 388)
- Help (📖 396)

AF

- AF operation (📖 185)
- AF method (📖 188)
- AF point selection (📖 193)
- Eye Detection AF (📖 198)
- Continuous AF (📖 199)
- Touch & drag AF (📖 183)
- MF peaking settings (📖 216)
- Manual focusing (📖 214)
- Electronic manual focus (📖 200)

Metering

- Metering mode (📖 211)

Drive

- Drive mode (📖 206)
- Self-timer (📖 209)
- Maximum burst (📖 118)

Image Recording Settings

- Creating/Selecting a folder (📖 361)
- File numbering (📖 363)

Image Quality

- Image quality (📖 116)
- Still photo cropping/aspect ratio (📖 119)
- ISO speed (still photos) (📖 131)
- Picture Style (📖 148)
- White balance (📖 140)
- Auto Lighting Optimizer (📖 136)
- Noise reduction for high ISO speeds (📖 157)
- Noise reduction for long exposures (📖 159)
- Highlight tone priority (📖 137)
- Lens aberration correction (📖 123)
- Reducing flicker (📖 179)
- Color space (📖 147)

Shooting

- Shooting mode (📖 34)
- HDR mode (📖 171)
- Multiple exposures (📖 165)
- Bulb timer (📖 107)
- Depth-of-field preview (📖 101)
- Remote switch (📖 219)
- Remote control (📖 217)
- Quick Control (📖 65)
- Touch Shutter (📖 163)
- Magnified view (📖 195)
- Grid display (📖 390)
- Shooting information display (📖 388)
- Display settings (📖 394)
- Multi-function lock (📖 58)
- Error codes (📖 581)

Exposure

- Exposure compensation (📖 128)
- Exposure compensation with M+ISO Auto (📖 103)
- AEB (📖 129)
- AE lock (📖 213)
- Safety shift (📖 529)
- Exposure simulation (📖 139)

Flash

- External flash (📖 220)
- Flash exposure compensation (📖 220)
- FE lock (📖 220)
- Flash function settings (📖 225)
- Flash Custom Function settings (📖 230)

Movie Recording

- Autoexposure recording (📖 239)
- Manual exposure recording (📖 241)
- ISO speed (movie) (📖 286)
- Movie Servo AF (📖 280)
- Movie Servo AF tracking sensitivity (📖 282)
- Movie Servo AF speed (📖 283)
- Movie recording size (📖 249)
- Movie cropping (📖 256)
- HDR movie (📖 247)
- Time-lapse movie (📖 262)
- Video snapshot (📖 274)
- Sound recording (📖 257)
- Microphone (📖 258)
- Wind filter (📖 257)
- Attenuator (📖 258)
- Auto slow shutter (📖 288)
- Av 1/8-stop increments (📖 289)
- HDMI output (📖 290)
- Remote control shooting (📖 285)

Playback

- Image review time (📖 122)
- Single-image display (📖 296)
- Shooting information display (📖 597)
- Grid display (📖 353)
- Touch playback (📖 298)
- Playback information display (📖 349)
- Index display (📖 300)
- Image browsing (Jump display) (📖 347)
- Setting image search conditions (📖 345)
- Magnified view (📖 299)
- Image rotation (📖 313)
- Protect (📖 310)
- Rating (📖 340)
- Movie playback (📖 301)
- Editing a movie's first and last scenes (📖 304)
- Frame Grab (4K) (📖 306)
- Slide show (📖 343)
- Viewing images on a television (📖 308)
- Erasing (📖 314)

Image Editing

- RAW image processing (📖 325)
- Resizing JPEGs (📖 339)
- Cropping JPEGs (📖 337)

Print Order

- Print order (DPOF) (📖 318)
- Photobook Set-up (📖 322)

Customization

- Custom Functions (C.Fn) (📖 524)
- Customizing operations (📖 537)
- My Menu (📖 548)
- Custom shooting mode (📖 408)

Sensor Cleaning and Dust Reduction

- Sensor cleaning (📖 382)
- Appending Dust Delete Data (📖 161)
- Manual sensor cleaning (📖 384)

Software

- Downloading and Installing (📖 554)
- Software Instruction Manuals (📖 555)

Wireless Features

- Connect to smartphones (📖 419)
- Auto send images to smartphones (📖 439)
- Remote control (EOS Utility) (📖 453)
- Auto send images to computers (📖 458)
- Print from Wi-Fi printers (📖 461)
- Upload to Web services (📖 473)
- Clear wireless settings (📖 498)

Safety Instructions

Be sure to read these instructions in order to operate the product safely. Follow these instructions to prevent injury or harm to the operator of the product or others.



WARNING: Denotes the risk of serious injury or death.

- Keep the product out of the reach of young children.

A strap wrapped around a person's neck may result in strangulation.

The parts or provided items of cameras or accessories are dangerous if swallowed. If swallowed, seek immediate medical assistance.

The battery is dangerous if swallowed. If swallowed, seek immediate medical assistance.

- Use only power sources specified in this instruction manual for use with the product.
- Do not disassemble or modify the product.
- Do not expose the product to strong shocks or vibration.
- Do not touch any exposed internal parts.
- Stop using the product in any case of unusual circumstances such as the presence of smoke or a strange smell.
- Do not use organic solvents such as alcohol, benzene or paint thinner to clean the product.
- Do not get the product wet. Do not insert foreign objects or liquids into the product.
- Do not use the product where flammable gases may be present.

This may cause electric shock, explosion or fire.

- Do not leave a lens or a camera with a lens attached, exposed without the lens cap attached.

The lens may concentrate the light and cause fire.

- Do not touch the product connected to a power outlet during lightning storms.

This may cause electric shock.

- Observe the following instructions when using commercially available batteries or provided battery packs.
 - Use batteries/battery packs only with their specified product.
 - Do not heat batteries/battery packs or expose them to fire.
 - Do not charge batteries/battery packs using non-authorized battery chargers.
 - Do not expose the terminals to dirt or let them come into contact with metallic pins or other metal objects.
 - Do not use leaking batteries/battery packs.
 - When disposing of batteries/battery packs, insulate the terminals with tape or other means.

This may cause electric shock, explosion or fire.

If a battery/battery pack leaks and the material contacts your skin or clothing, flush the exposed area thoroughly with running water. In case of eye contact, flush thoroughly with copious amounts of clean running water and seek immediate medical assistance.

- Observe the following instructions when using a battery charger or AC adapter.
 - Periodically remove any dust buildup from the power plug and power outlet using a dry cloth.
 - Do not plug in or unplug the product with wet hands.
 - Do not use the product if the power plug is not fully inserted into the power outlet.
 - Do not expose the power plug and terminals to dirt or let them come into contact with metallic pins or other metal objects.
- Do not touch the battery charger or AC adapter connected to a power outlet during lightning storms.
- Do not place heavy objects on the power cord. Do not damage, break or modify the power cord.
- Do not wrap the product in cloth or other materials when in use or shortly after use when the product is still warm in temperature.
- Do not unplug the product by pulling the power cord.
- Do not leave the product connected to a power source for long periods of time.
- Do not charge batteries/battery packs at temperatures outside the range of 5–40 °C (41–104 °F).

This may cause electric shock, explosion or fire.

- Do not allow the product to maintain contact with the same area of skin for extended periods of time during use.

This may result in low-temperature contact burns, including skin redness and blistering, even if the product does not feel hot. The use of a tripod or similar equipment is recommended when using the product in hot places and for people with circulation problems or less sensitive skin.

- Follow any indications to turn off the product in places where its use is forbidden.

Not doing so may cause other equipment to malfunction due to the effect of electromagnetic waves and even result in accidents.

 **CAUTION:** Denotes the risk of injury.

- Do not fire the flash near the eyes.

It may hurt the eyes.

- Do not look at the screen or through the viewfinder for prolonged periods of time.

This may induce symptoms similar to motion sickness. In such a case, stop using the product immediately and rest for a while before resuming use.

- Flash emits high temperatures when fired. Keep fingers, any other part of your body, and objects away from the flash unit while taking pictures.

This may cause burns or malfunction of the flash.

- Do not leave the product in places exposed to extremely high or low temperatures.

The product may become extremely hot/cold and cause burns or injury when touched.

- Strap is intended for use on the body only. Hanging the strap with any product attached on a hook or other object may damage the product. Also, do not shake the product or expose the product to strong impacts.

- Do not apply strong pressure on the lens or allow an object to hit it.

This may cause injury or damage to the product.

- Only mount the product on a tripod that is sufficiently sturdy.

- Do not carry the product when it is mounted on a tripod.

This may cause injury or may result in an accident.

- Do not touch any parts inside the product.

This may cause injury.

Handling Precautions

Camera Care

- This camera is a precision instrument. Do not drop it or subject it to physical shock.
- The camera is not waterproof and cannot be used underwater.
- To maximize the camera's dust- and drip- resistance, keep the terminal cover, battery compartment cover, card slot cover, and all other covers firmly closed.
- This camera is designed to be dust- and drip- resistant, in order to help prevent sand, dust, dirt, or water that falls on it unexpectedly from getting inside, but it is impossible to prevent dirt, dust, water, or salt from getting inside at all. As far as possible, do not allow dirt, dust, water, or salt to get on the camera.
- If water gets on the camera, wipe it off with a dry and clean cloth. If dirt, dust, or salt gets on the camera, wipe it off with a clean, well-wrung wet cloth.
- Using the camera in a location with large amounts of dirt or dust may cause a malfunction.
- Cleaning the camera after use is recommended. Allowing dirt, dust, water, or salt to remain on the camera may cause a malfunction.
- If you accidentally drop the camera into water or are concerned that moisture (water), dirt, dust, or salt may have gotten inside it, promptly consult the nearest Canon Service Center.
- Never leave the camera near anything having a strong magnetic field such as a magnet or electric motor. Also, avoid using or leaving the camera near anything emitting strong radio waves, such as a large antenna. Strong magnetic fields can cause camera malfunction or destroy image data.
- Do not leave the camera in excessive heat, such as in a car in direct sunlight. High temperatures can cause the camera to malfunction.
- The camera contains precision electronic circuitry. Never attempt to disassemble the camera yourself.

- Do not block shutter curtain operation with your finger or other objects. Doing so may cause a malfunction.
- Use only a commercially available blower to blow away dust when it adheres to the lens, viewfinder, etc. Do not use cleaners that contain organic solvents to clean the camera body or lens. For stubborn dirt, take the camera to the nearest Canon Service Center.
- Do not touch the camera's electrical contacts with your fingers. This is to prevent the contacts from corroding. Corroded contacts can cause camera malfunction.
- If the camera is suddenly brought in from the cold into a warm room, condensation may form on the camera and internal parts. To prevent condensation, first put the camera in a sealed plastic bag and let it adjust to the warmer temperature before taking it out of the bag.
- If condensation forms on the camera, to avoid damage, do not use the camera or remove the lens, card, or battery. Turn the camera off and wait until the moisture has fully evaporated before resuming use. Even after the camera is completely dry, if it is still internally cold, do not remove the lens, card, or battery until the camera has adjusted to the ambient temperature.
- If the camera will not be used for an extended period, remove the battery and store the camera in a cool, dry, well-ventilated location. Even while the camera is in storage, press the shutter button a few times once in a while to check that the camera is still working.
- Avoid storing the camera where there are chemicals that result in rust and corrosion such as in a chemical lab.
- If the camera has not been used for an extended period, test all its functions before using it. If you have not used the camera for some time or if there is an important shoot such as a foreign trip coming up, have the camera checked by your nearest Canon Service Center or check the camera yourself and make sure it is working properly.
- The camera may become hot after repeated continuous shooting or still photo/movie shooting over an extended period. This is not a malfunction.
- If there is a bright light source inside or outside the image area, ghosting may occur.

Screen and Viewfinder

- Although the screen and viewfinder are manufactured with very high precision technology with over 99.99% effective pixels, 0.01% or fewer of the pixels may be dead, and there may also be spots of black, red, or other colors. This is not a malfunction. They do not affect the images recorded.
- If the screen is left on for a prolonged period, screen burn-in may occur where you see remnants of what was displayed. However, this is only temporary and will disappear when the camera is left unused for a few days.
- The screen display may seem slightly slow in low temperatures or may look black in high temperatures. It will return to normal at room temperature.

Cards

To protect the card and its recorded data, note the following:

- Do not drop, bend, or wet the card. Do not subject it to excessive force, physical shock, or vibration.
- Do not touch the card's electronic contacts with your fingers or anything metallic.
- Do not affix any stickers, etc. on the card.
- Do not store or use the card near anything that has a strong magnetic field, such as a television, speakers, or magnets. Also avoid places prone to having static electricity.
- Do not leave the card in direct sunlight or near a heat source.
- Store the card in a case.
- Do not store the card in hot, dusty, or humid locations.

Lens

- After detaching the lens from the camera, put down the lens with the rear end up and attach the rear lens cap to avoid scratching the lens surface and electrical contacts (1).





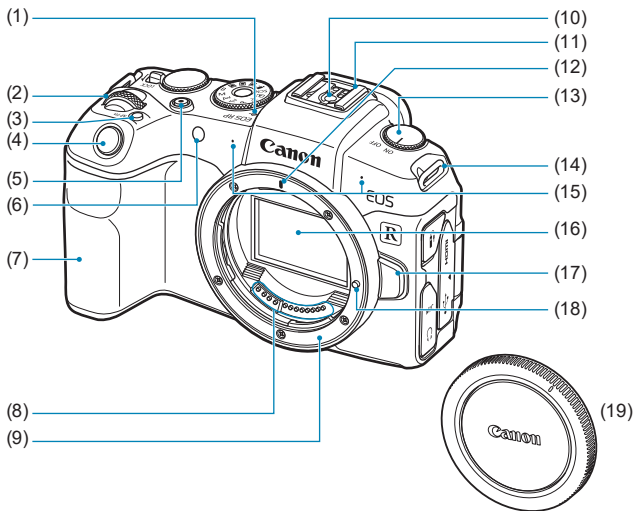

Part Names



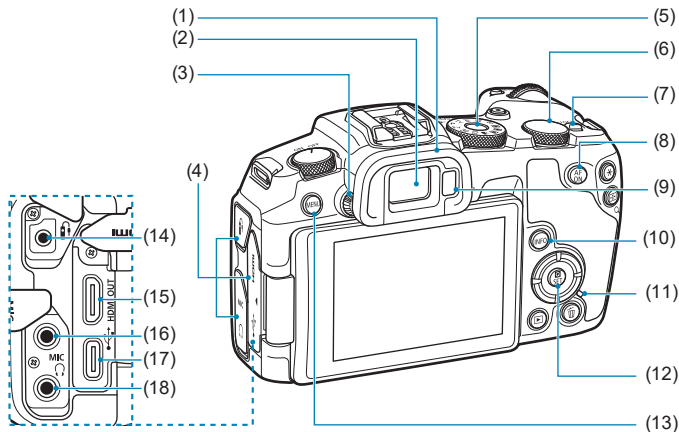





- | | |
|-----|---|
| (1) | <⊖> Focal plane mark |
| (2) | <MAIN DIAL> Main dial |
| (3) | <M-Fn> Multi-function button |
| (4) | Shutter button |
| (5) | Movie shooting button |
| (6) | AF-assist beam/Self-timer/
Remote control lamp |
| (7) | Grip (Battery compartment) |
| (8) | Contacts |
| (9) | Lens mount |

- | | |
|------|---------------------|
| (10) | Flash sync contacts |
| (11) | Hot shoe |
| (12) | RF lens mount index |
| (13) | Power switch |
| (14) | Strap mount |
| (15) | Microphone |
| (16) | Image sensor |
| (17) | Lens release button |
| (18) | Lens lock pin |
| (19) | Body cap |



- (1) Eyecup
- (2) Viewfinder eyepiece
- (3) Dioptic adjustment knob
- (4) Terminal cover
- (5) Mode dial
- (6)  Quick control dial
- (7)  Multi-function lock switch
- (8)  AF start button
- (9) Viewfinder sensor
- (10)  Info button

- (11) Access lamp
- (12)  Quick Control/Setting button
- (13)  Menu button
- (14)  Remote control terminal
- (15)  HDMI mini OUT terminal
- (16)  External microphone IN terminal
- (17)  Digital terminal
- (18)  Headphone terminal

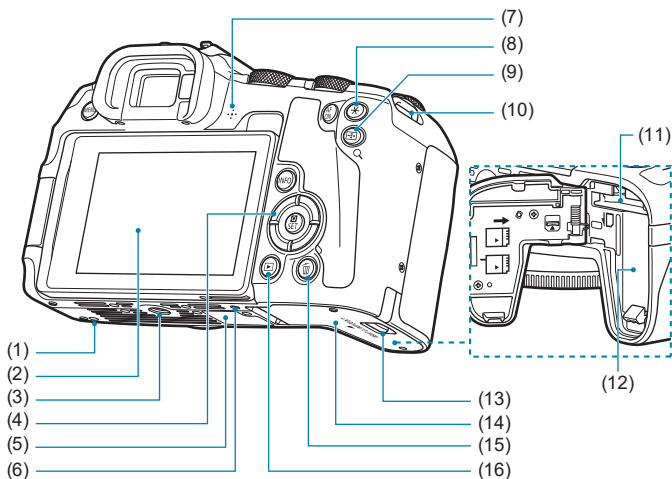

(1) Accessory positioning hole

(2) Screen

(3) Tripod socket

(4) <▲><▼><◀><▶>: <⬄> cross keys

(5) Serial number

(6) Accessory positioning hole

(7) Speaker

(8) <✳> AE lock/FE lock button

(9) <☒/Q> AF point/Index/Magnify/Reduce button

(10) Strap mount

(11) Card slot

(12) Battery compartment

(13) Card slot/Battery compartment cover lock

(14) Card slot/Battery compartment cover

(15) <🗑️> Erase button

(16) <▶️> Playback button

Mode Dial

The Mode dial includes Basic Zone modes, Creative Zone modes, and movie recording mode.

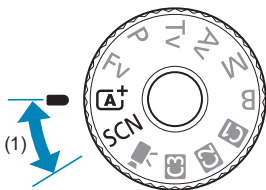













(1) Basic Zone

All you do is press the shutter button. The camera sets everything to suit the subject or scene for shooting.

A+ : Scene Intelligent Auto (📖 68)

SCN : Special scene (📖 75)

	Portrait (📖 77)		Close-up (📖 84)
	Group Photo (📖 78)		Food (📖 85)
	Landscape (📖 79)		Night Portrait (📖 86)
	Sports (📖 80)		Handheld Night Scene (📖 87)
	Kids (📖 81)		HDR Backlight Control (📖 88)
	Panning (📖 82)		Silent Mode (📖 89)

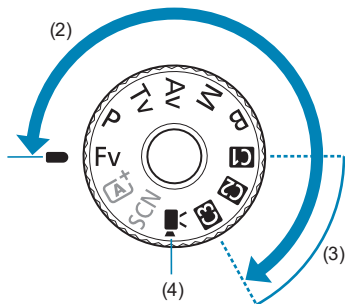

(2) Creative Zone

These modes give you more control for shooting various subjects as desired.

Fv	Flexible-priority AE (📖 104)
P	Program AE (📖 96)
Tv	Shutter-priority AE (📖 98)
Av	Aperture-priority AE (📖 100)
M	Manual exposure (📖 102)
B	Bulb (📖 106)

(3) Custom shooting modes

You can assign <Fv>, <P>, <Tv>, <Av>, <M>, , AF operation, menu functions, and more to <C1>, <C2>, or <C3> (📖 408).

(4) 🎥: Movie recording (📖 239)

Viewfinder Information Display

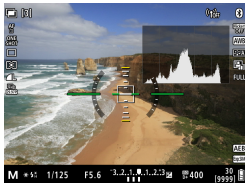

Information displayed varies depending on camera status.

Battery Charger LC-E17

Charger for Battery Pack LP-E17 (📖 40).

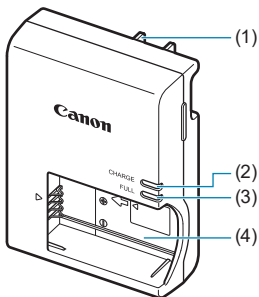

- (1) Power plug
- (2) Charge lamp
- (3) Full-charge lamp
- (4) Battery pack slot

Battery Charger LC-E17E

Charger for Battery Pack LP-E17 (📖 40).

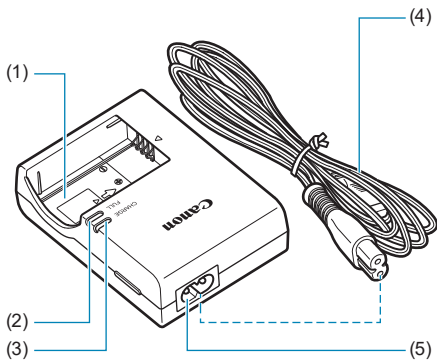

- (1) Battery pack slot
- (2) Full-charge lamp
- (3) Charge lamp
- (4) Power cord
- (5) Power cord socket

Attaching the Strap

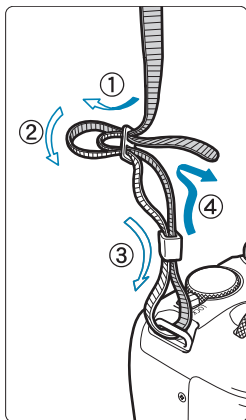

Pass the end of the strap through the camera's strap mount eyelet from the bottom. Then pass it through the strap's buckle as shown in the illustration. Pull the strap to take up any slack and make sure the strap will not loosen from the buckle.

Preparation and Basic Operations

This chapter describes preparatory steps before you start shooting and the basic camera operations.

Charging the Battery

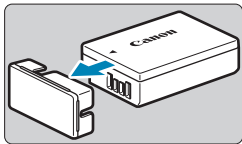

- 1** Detach the protective cover provided with the battery.

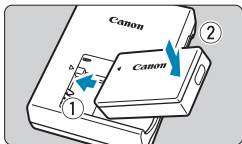

- 2** Fully insert the battery in the charger.

- Do the opposite to remove the battery.

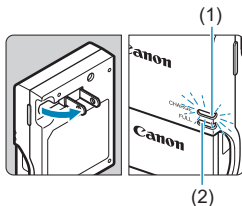

- 3** Recharge the battery.

For LC-E17

- As shown by the arrow, flip out the battery charger's prongs and insert the prongs into a power outlet.

For LC-E17E

- Connect the power cord to the charger and insert the plug into a power outlet.
- ▶ Recharging starts automatically and the charge lamp (1) lights up in orange.
- ▶ When the battery is fully recharged, the full-charge lamp (2) will light up in green.
- **It takes approx. 2 hr. to fully charge a completely exhausted battery at room temperature (23°C / 73°F).** The time required to charge the battery will vary greatly depending on the ambient temperature and the battery's remaining capacity.
- For safety reasons, charging in low temperatures (5–10°C / 41–50°F) will take longer (up to approx. 4 hr.).

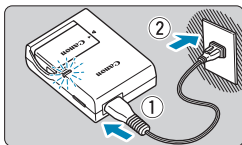

- **Upon purchase, the battery is not fully charged.**

Charge the battery before use.

- **Charge the battery on the day before or on the day it is to be used.**

Even during storage, a charged battery will gradually drain and lose its capacity.

- **After charging the battery, remove it and disconnect the charger from the power outlet.**

- **When not using the camera, remove the battery.**

If the battery is left in the camera for a prolonged period, a small amount of power current will keep being released, resulting in excess discharge and shorter battery life. Store the battery with the protective cover attached. Storing the battery when it is fully charged may lower the battery performance.

- **The battery charger can also be used in foreign countries.**

The battery charger is compatible with a 100 V AC to 240 V AC 50/60 Hz power source. If necessary, attach a commercially available plug adapter for the respective country or region. Do not attach any portable voltage transformer to the battery charger. Doing so may damage the battery charger.

- **If the battery becomes exhausted quickly even after having been fully charged, the battery has reached the end of its service life.**

Check the battery's recharge performance (📖 381) and purchase a new battery.



- After disconnecting the charger's power plug, do not touch the prongs for approx. 5 sec.
- The provided charger cannot charge any battery other than Battery Pack LP-E17.

Inserting/Removing the Battery and Card

Insert a fully charged Battery Pack LP-E17 into the camera. The camera can use SD, SDHC, or SDXC memory cards (sold separately). UHS-II/ UHS-I SDHC and SDXC cards are also supported. The captured images are recorded onto the card.

- Make sure the card's write-protect switch (1) is set upward to enable writing and erasing.

Insertion

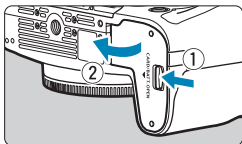

- 1 Slide the card slot/battery compartment cover lock and open the cover.**

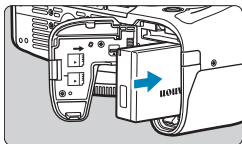

- 2 Insert the battery.**
 - Insert the end with the electrical contacts.
 - Insert the battery until it locks in place.

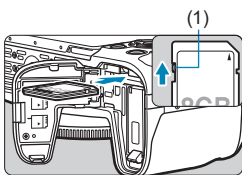

- 3 Insert the card.**
 - Insert the card with the label facing the back of the camera as shown until it clicks in place.

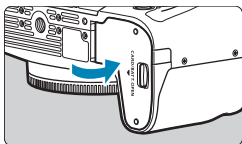

- 4 Close the cover.**
 - Press the cover until it snaps shut.



- You cannot use batteries other than the Battery Pack LP-E17.
- After opening the card slot/battery compartment cover, be careful not to swing it back any further. Otherwise, the hinge may break.

Removal

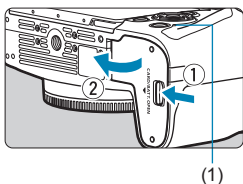

1 Open the card slot/battery compartment cover.

- Set the power switch to <OFF>.
- **Check that the access lamp (1) is off, then open the cover.**
- If [**Saving...**] is displayed on the screen, close the cover.

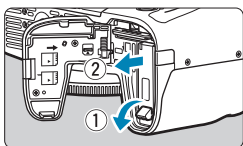

2 Remove the battery.

- Press the battery lock lever as shown by the arrow and remove the battery.
- To prevent short-circuits, always attach the included protective cover (📖 40) to the battery.

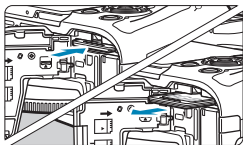

3 Remove the card.

- Gently push in the card, then let it go to eject.
- Pull the card straight out.

4 Close the cover.

- Press the cover until it snaps shut.

Formatting the Card

If the card is new or was previously formatted (initialized) by another camera or computer, format the card with this camera (📖 367).



- The number of possible shots varies depending on the remaining capacity of the card, the settings of image quality, ISO speed, etc.
- Setting [📷: Release shutter without card] to [Disable] will prevent you from forgetting to insert a card (📖 182).



- **When the access lamp is lit or blinking, it indicates that images are being written to, read from, or erased from the card, or data is being transferred. Do not open the card slot/battery cover compartment. Also, never do any of the following while the access lamp is lit or blinking. Otherwise, it can damage the image data, card, or camera.**
 - **Removing the card.**
 - **Removing the battery.**
 - **Shaking or striking the camera.**
 - **Unplugging and connecting a power cord** (when household power outlet accessories (sold separately) are used).
- If the card already contains recorded images, the image number may not start from 0001 (📖 363).
- If a card-related error message is displayed on the screen, remove and reinsert the card. If the error persists, use a different card. If you can transfer images on the card to a computer, transfer all the images and then format the card with the camera (📖 367). The card may then return to normal.
- Do not touch the card's contacts with your fingers or metal objects. Do not expose the contacts to dust or water. If smudges adhere to the contacts, contact failure may result.
- Multimedia cards (MMC) cannot be used. (Card error will be displayed.)
- Use of UHS-II microSDHC/SDXC cards with a microSD to SD adapter is not recommended. When using UHS-II cards, use SDHC/SDXC cards.

Using the Screen

You can change the direction and angle of the screen.

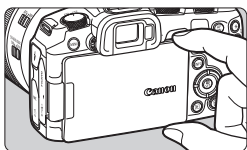

1 Flip out the screen.

- Hold at the top and bottom and pull out as shown.

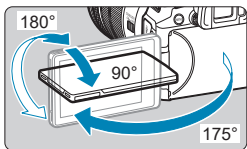

2 Rotate the screen.

- When the screen is swung out, you can rotate it up, down, or over 180° to face the subject.
- The indicated angle is only approximate.

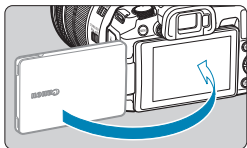

3 Face it toward you.

- Normally, use the camera with the screen facing you.



- Be careful not to forcefully rotate the screen, putting much power on the rotating axis (hinge).
- When a cable is connected to a camera terminal, the rotation angle range of the flipped-out screen will be limited.



- When not using the camera, close the screen facing inward. You can protect the screen.
- A mirror image (right/left reversed) of subjects is displayed when the screen faces subjects in front of the camera.

Turning on the Power

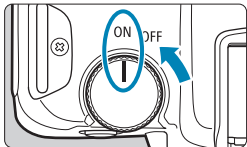

- <ON>
The camera turns on.
- <OFF>
The camera is turned off and does not function. Set the power switch to this position when not using the camera.

Setting the Date, Time, and Time Zone

If you turn on the power switch and the date/time/zone setting screen appears, see 374 to set the date/time/zone.

Changing the Interface Language

To change the interface language, see 377.

Automatic Sensor Cleaning





- Sensor cleaning, which may make a small noise, is performed automatically whenever you set the power switch to <OFF> or attach or detach lenses. To enable automatic sensor cleaning when the power switch is set to <ON> as well, you can set this in [: **Sensor cleaning**] (383).



- If you set the power switch to <OFF> while an image is being recorded to the card, [**Saving...**] will be displayed and the power will turn off after the recording finishes.

Battery Level Indicator





- : Battery level is sufficient.
- : Battery level is low, but the camera can still be used.
- : Battery will be exhausted soon. (Blinks)
- : Charge the battery.



- Doing any of the following will exhaust the battery faster:
 - Pressing the shutter button halfway for a prolonged period.
 - Activating the AF frequently without taking a picture.
 - Using the lens's Image Stabilizer.
 - Using the Wi-Fi function or Bluetooth function.
- The number of possible shots may decrease depending on the actual shooting conditions.
- The lens operation is powered by the camera's battery. Certain lenses may exhaust the battery faster than others.
- In low ambient temperatures, shooting may not be possible even with a sufficient battery level.



- See [: **Battery info.**] to check the battery status ( 381).

Attaching and Detaching a Lens

Attaching a Lens

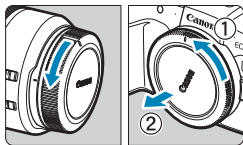

1 Remove the caps.

- Remove the rear lens cap and the body cap by turning them as shown by the arrows.

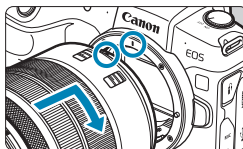

2 Attach the lens.

- Align the red mount index on the lens with the red mount index on the camera and turn the lens as shown by the arrow until it clicks in place.

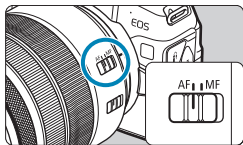

3 Set the lens's focus mode switch to <AF>.

- <AF> stands for autofocus.
- <MF> stands for manual focus. Autofocus will not operate.

4 Remove the front lens cap.

Detaching the Lens

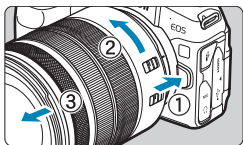

While pressing the lens release button, turn the lens as shown by the arrow.

- Turn the adapter until it stops, then detach it.
- Attach the rear lens cap to the detached lens.



- Do not look at the sun directly through any lens. Doing so may cause loss of vision.
- When attaching or detaching a lens, set the camera's power switch to <OFF>.
- If the front part (focusing ring) of the lens rotates during autofocus, do not touch the rotating part.



- For instructions on how to use the lens, refer to the Lens Instruction Manual (4).

Tips for Avoiding Smudges and Dust

When changing lenses, do it quickly in a place with minimal dust.

When storing the camera without a lens attached, be sure to attach the body cap to the camera.

Remove dust on the body cap before attaching it.

Attaching and Detaching EF/EF-S Lenses

All EF and EF-S lenses can be used by attaching the optional Mount Adapter EF-EOS R. **The camera cannot be used with EF-M lenses.**

Attaching a Lens

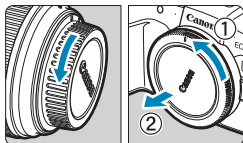

1 Remove the caps.

- Remove the rear lens cap and the body cap by turning them as shown by the arrows.

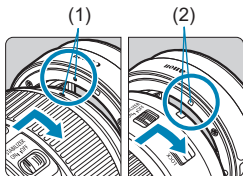

2 Attach the lens to the adapter.

- Align the red or white mount index on the lens with the corresponding mount index on the adapter and turn the lens as shown by the arrow until it clicks into place.

(1) Red index

(2) White index

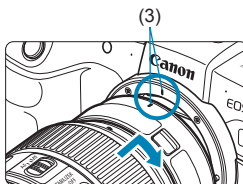

3 Attach the adapter to the camera.

- Align the red mount indexes (3) on the adapter and camera and turn the lens as shown by the arrow until it clicks into place.

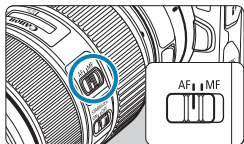

4 Set the lens's focus mode switch to <AF>.

- <AF> stands for autofocus.
- <MF> stands for manual focus. Autofocus will not operate.

5 Remove the front lens cap.

Detaching the Lens

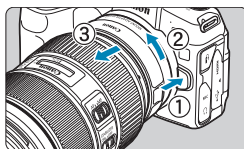

1 While pressing the lens release button, turn the adapter as shown by the arrow.

- Turn the adapter until it stops, then detach it.

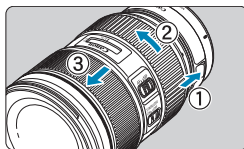

2 Detach the lens from the adapter.

- Hold down the lens release lever on the adapter and turn the lens counterclockwise.
- Turn the lens until it stops, then detach it.
- Attach the rear lens cap to the detached lens.



- For lens precautions, see 49.

Using the Viewfinder

Look through the viewfinder to activate it. You can also restrict display to either the screen or viewfinder (📖 394).

Adjusting the Viewfinder Clarity

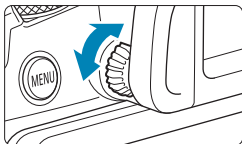

Turn the dioptic adjustment knob.

- Turn the knob left or right to make the viewfinder display look sharp.



- The viewfinder and screen cannot be activated at the same time.

Basic Operations

Holding the Camera

● Viewing the Screen as You Shoot

As you shoot, you can tilt the screen to adjust it. For details, see  45.



Normal angle



Low angle



High angle

● Shooting Through the Viewfinder

To obtain sharp images, hold the camera still to minimize camera shake.

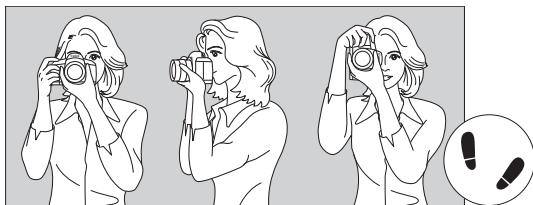

Horizontal shooting

Vertical shooting

1. Wrap your right hand around the camera grip firmly.
2. Hold the lens bottom with your left hand.
3. Rest your right index finger lightly on the shutter button.
4. Press your arms and elbows lightly against the front of your body.
5. To maintain a stable stance, place one foot slightly ahead of the other.
6. Press the camera against your face and look through the viewfinder.

Shutter Button

The shutter button has two steps. You can press the shutter button halfway. Then you can further press the shutter button completely.



Pressing Halfway

This activates autofocus and the automatic exposure system that sets the shutter speed and aperture.

The exposure setting (shutter speed and aperture) is displayed on the screen or in the viewfinder for approx. 8 sec. or as set for the metering timer.*

* By default, the metering timer is set to 8 sec.

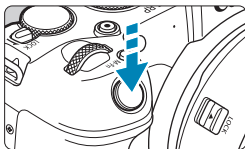

Pressing Completely

This action shoots.

● Preventing Camera Shake

Hand-held camera movement during the moment of exposure is called camera shake. It can cause blurred pictures. To prevent camera shake, note the following:

- Hold the camera steady.
- Press the shutter button halfway to autofocus, then slowly press the shutter button completely.

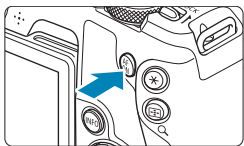

- If you press the shutter button completely without pressing it halfway first, or if you press the shutter button halfway and then press it completely immediately, the camera will take a moment before it takes the picture.
- Even during menu display or image playback, you can go back to shooting-ready state by pressing the shutter button halfway.

<AF ON> AF Start Button

In Creative Zone modes, has the same effect as pressing the shutter button halfway.

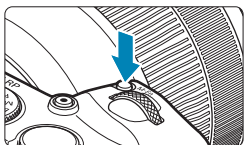
<M-Fn> Multi-Function Button

By pressing the <M-Fn> button and turning the <Mode> dial, you can set the ISO speed, drive mode, AF operation, white balance, and flash exposure compensation.

<  > Main Dial

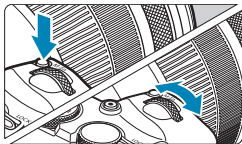

- (1) **After pressing a button, turn the <  > dial.**

Press a button such as <M-Fn>, then turn the <  > dial.

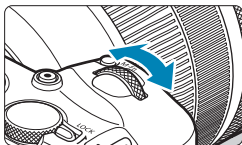

If you press the shutter button halfway, the camera will go back to shooting-ready state.





- (2) **Turn only the <  > dial.**

While looking at the screen or viewfinder, turn the <  > dial.

Use this dial to set the shutter speed, aperture, etc.

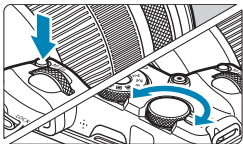
-  Step (1) can be performed even when controls are locked with the Multi-function lock ( 58).

 **Quick Control Dial**



- (1) After pressing a button, turn the  dial.**

Press a button such as <M-Fn>, then turn the  dial.

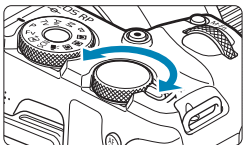
If you press the shutter button halfway, the camera will go back to shooting-ready state.



- (2) Turn only the  dial.**

While looking at the screen or viewfinder, turn the  dial.

Use this dial to set the exposure compensation amount, the aperture setting for manual exposures, etc.



- Step (1) can be performed even when controls are locked with the Multi-function lock ( 58).

<LOCK> Multi-Function Lock Switch

To avoid accidentally changing settings from the Main dial, Quick control dial, control ring, or touch-screen panel, configure [**🔒: Multi function lock**] and set the <LOCK> switch to <LOCK>.

For [**🔒: Multi function lock**] details, see 📖 407.

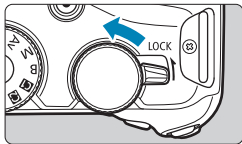

<🔒> Control Ring

You can assign a commonly used function to the control ring of RF lenses or mount adapters (📖 542).

INFO Button

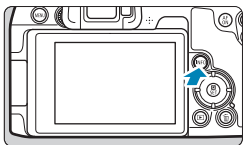

Each press of the <INFO> button changes the information shown.

The following sample screens are for still photos.

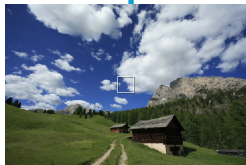

Menu Operations and Settings

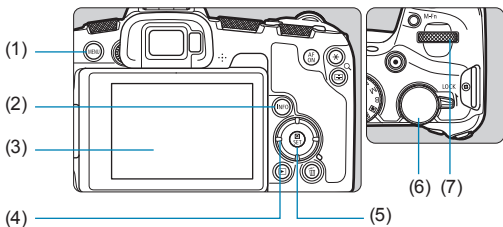

(1) <MENU> button

(2) <INFO> button

(3) Screen

(4) <↔> cross keys

(5) <SET> button

(6) Quick control dial

(7) Main dial

Basic Zone Modes Menu Screen

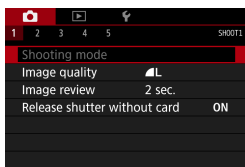

* In Basic Zone modes, some tabs and menu items do not appear.

Creative Zone Modes Menu Screen

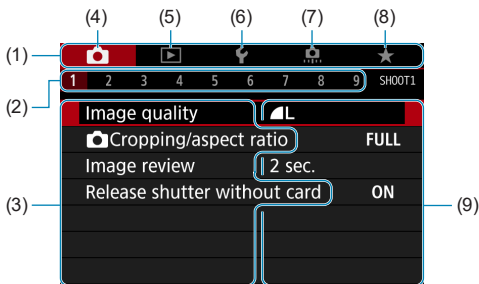

(1) Main tabs

(2) Secondary tabs

(3) Menu items

(4) : Shooting

(5) : Playback

(6) : Set-up

(7) : Custom Functions

(8) : My Menu

(9) Menu settings

Menu Setting Procedure

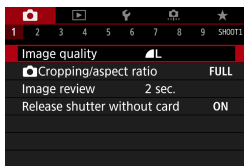

1 Display the menu screen.

- Press the <MENU> button.

2 Select a tab.

- Press the <INFO> button to switch between main tabs.
- Turn the <INFO> dial to select a secondary tab.

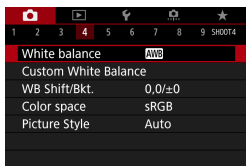

3 Select an item.

- Turn the <  > dial to select an item, then press <SET>.

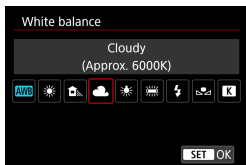

4 Select an option.

- Turn the <  > dial to select an option.
- The current setting is indicated in blue.

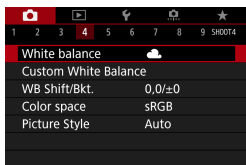

5 Set an option.

- Press <SET> to set it.

6 Exit the setting.

- Press the <MENU> button to finish and prepare for shooting.



- The description of menu functions hereafter assumes that you have pressed the <MENU> button to display the menu screen.
- You can also tap on the menu screen or press the <  > cross keys to operate the menu.
- To cancel the operation, press the <MENU> button.

Dimmed Menu Items

Example: Highlight tone priority

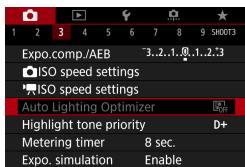

Dimmed menu items cannot be set. The menu item is dimmed if another function setting is overriding it.

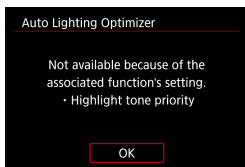

You can see the overriding function by selecting the dimmed menu item and pressing <SET>.

If you cancel the overriding function's setting, the dimmed menu item will become settable.



- You may not be able to see the overriding function for certain dimmed menu items.



- With [**W**: **Clear all camera settings**], you can reset the menu functions to the default settings (410).

Touch-Screen Operation

You can operate the camera by tapping or dragging on the screen (touch-screen panel) with your finger.

Tap

Sample screen (Quick Control)



- Use your finger to tap on (touch briefly and then remove your finger from) the screen.
- For example, when you tap on **[Q]**, the Quick Control screen appears. By tapping on **[↶]**, you can return to the preceding screen.

Drag

Sample screen (Menu screen)

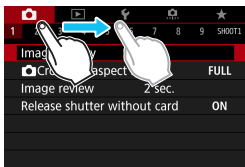

- Slide your finger while touching the screen.



- If **[🔊: Beep]** is set to **[Touch 🔊]**, the beep will not sound for touch operations (📖 380).
- Touch control responsiveness can be adjusted (📖 379).

Quick Control

You can directly select and set the settings displayed on the screen. This is called Quick Control (except in $\langle \text{A}^+ \rangle$ mode).

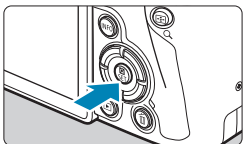

1 Press the $\langle \text{Q} \rangle$ button (⌚10).



2 Select a setting item.

- Press the $\langle \blacktriangle \rangle$ $\langle \blacktriangledown \rangle$ keys for selection.



- When the screen at left is displayed, press the $\langle \blacktriangle \rangle$ $\langle \blacktriangledown \rangle$ $\langle \blacktriangleleft \rangle$ $\langle \blacktriangleright \rangle$ keys for selection.

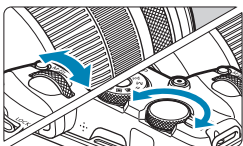

3 Select an option.

- Turn the $\langle \text{DIAL} \rangle$ or $\langle \text{DIAL} \rangle$ dial, or press the $\langle \blacktriangleleft \rangle$ $\langle \blacktriangleright \rangle$ keys to change the setting. There are also functions that are set by pressing a button following these operations.
- Press $\langle \text{SET} \rangle$ to finalize the setting and return to the previous screen.



- You can also tap ON the screen for Quick Control settings (📖64).



Basic Shooting

This chapter describes how to use the Basic Zone modes on the Mode dial for best results.

With Basic Zone modes, all you do is point and shoot, and the camera sets everything automatically.

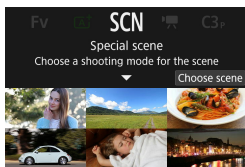
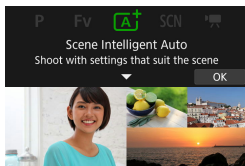

Fully Automatic Shooting (Scene Intelligent Auto)

<A⁺> is a fully automatic mode. The camera analyzes the scene and sets the optimum settings automatically. It can also adjust focus automatically on either the still or moving subject by detecting the motion of the subject (📖 71).



1 Set the Mode dial to <A⁺>.

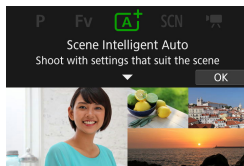

2 Press <SET>.

- Read the message and select [OK].



3 Aim the camera at what you will shoot (the subject).

- A frame may be displayed around the subject, under some shooting conditions.
- When an AF point is displayed on the screen, aim it over the subject.



4 Focus on the subject.

- Press the shutter button halfway to focus.
- You can also focus by touching a person's face or another subject on the screen (Touch AF) when [📷: **Continuous AF**] is set to [Disable].
- Under low light, the AF-assist beam (📖 201) is automatically activated if needed.
 - ▶ For stationary subjects, the AF point is displayed in green when the subject is in focus, and the camera beeps (One-Shot AF).
 - ▶ For moving subjects, the AF point is displayed in blue and tracks subject movement. The camera does not beep (Servo AF).



5 Take the picture.

- Press the shutter button completely to take the picture.
- ▶ The image just captured will be displayed for approx. 2 sec. on the screen.



- Subject movement (whether subjects are still or moving) may not be detected correctly for some subject or shooting conditions.



- If you normally prefer to shoot with One-Shot AF, set [📷: **AF+ Auto servo**] to [Disable].
- AF operation (One-Shot AF or Servo AF) is set automatically when you press the shutter button halfway. Note that AF operation cannot be switched during shooting.
- The <AF+> mode makes the colors look more impressive in nature, outdoor, and sunset scenes. If you do not obtain the desired color tones, change the mode to a Creative Zone mode (📖 35) and select a Picture Style other than <P-A>, then shoot again (📖 148).



Minimizing Blurred Photos

- Use a sturdy tripod that can bear the weight of the shooting equipment. Mount the camera securely on the tripod.
- Using a remote switch (sold separately, 219) or a wireless remote control (sold separately, 217) is recommended.

? FAQ

- **Focusing is not possible (indicated by an orange AF point).**

Aim the AF point over an area with good contrast, then press the shutter button halfway (54). If you are too close to the subject, move away and shoot again.

- **Multiple AF points are displayed simultaneously.**

If multiple AF points are displayed simultaneously, all of these positions are in focus. As long as one AF point is displayed on the subject, you can take the picture.

- **Pressing the shutter button halfway does not focus the subject.**

If the focus mode switch on the lens is set to <MF> (manual focus), set it to <AF> (autofocus).

- **The shutter speed display is blinking.**

Since it is too dark, taking the picture may result in a blurred subject due to camera shake. Using a tripod or a Canon EL/EX series Speedlite (sold separately, 220) is recommended.

- **When the external flash was used, the bottom part of the picture came out unnaturally dark.**

If a hood is attached to the lens, it may obstruct the flash light. If the subject is close, detach the hood before taking the picture with flash.

Full Auto Techniques (Scene Intelligent Auto)

Recomposing the Shot



Depending on the scene, positioning the subject toward the left or right to include a balanced background will result in a picture with better perspective.

Pressing the shutter button halfway to focus on a still subject will lock the focus on that subject. Recompose the shot while keeping the shutter button pressed halfway, and then press the shutter button completely to take the picture. This is called “focus lock”.

Shooting a Moving Subject



After you press the shutter button halfway and a blue AF point appears, the camera detects subject movement and focuses using Servo AF. Keep the subject on the screen as you hold down the shutter button halfway, and at the decisive moment, press the shutter button completely.

If you prefer to shoot with One-Shot AF, set [📷: ⏸️+ Auto servo] to [Disable].

Scene Icons



The camera detects the scene type and sets everything automatically to suit the scene. The detected scene type is indicated on the upper left of the screen. For icon details, see [📖 595](#).

Adjusting Settings by Touching the Screen



By touching icons, you can adjust settings for drive mode, image quality, Touch Shutter, and Creative Assist.

Shooting with Effects Applied (Creative Assist)

You can shoot with your selected effects applied.

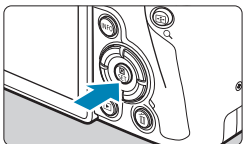

- 1 Press the **<Q>** button.
 - Read the message and select **[OK]**.

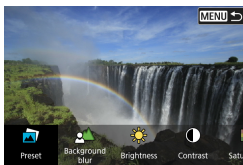

- 2 Select an effect.
 - Use the **<◀>** **<▶>** keys to select an effect, then press **<SET>**.

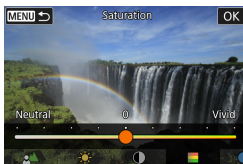

- 3 Select the effect level and other details.
 - Use the **<◀>** **<▶>** keys to set it, then press **<SET>**.
 - To reset the setting, press the **<✱>** button, then select **[OK]**.

Creative Assist Effects







- **[📷] Preset**

Select one of the preset effects.

Note that **[Saturation]**, **[Color tone 1]**, and **[Color tone 2]** are not available with **[B&W]**.

- **[🌫️] Background blur**

Adjust background blur. Choose higher values to make backgrounds sharper, or lower values to make them blurrier. **[Auto]** adjusts background blurring to match the brightness. Depending on lens brightness (f/number), some positions may not be available.

-  **Brightness**
Adjust image brightness.
-  **Contrast**
Adjust contrast.
-  **Saturation**
Adjust the vividness of colors.
-  **Color tone 1**
Adjust amber/blue color tone.
-  **Color tone 2**
Adjust green/magenta color tone.
-  **Monochrome**
Set the toning effect for monochrome shooting. Set to **[Off]** to shoot in color. **[Saturation]**, **[Color tone 1]**, and **[Color tone 2]** are not available with options other than **[Off]**.



- **[Background blur]** is not available when the flash is used.
- These settings are reset when you switch shooting modes or set the power switch to <OFF>. To save the settings, set **[📷: Retain Creative Assist data]** to **[Enable]**.

Saving Favorite Settings

To save the current setting to the camera, press the <INFO> button on the Creative Assist setting screen, then select **[OK]**. Up to three presets can be saved as **[USER*]**. After three have been saved, an existing **[USER*]** preset must be overwritten to save a new one.

Special Scene Mode

The camera will automatically choose the appropriate settings when you select a shooting mode for your subject or scene.

* <SCN> stands for Special Scene.



1 Set the Mode dial to <SCN>.

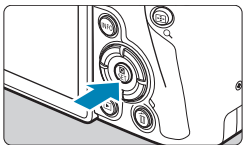

2 Press the <SET> button.

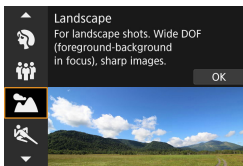

3 Select a shooting mode.

- Press the <▲> <▼> keys to select the shooting mode, then press <SET>.
- You can also select the shooting mode by turning the <☀> or <🌅> dial.



























- Cautions on each shooting mode are listed together (📖 90). Read the cautions before shooting.





- The Quick Control screen appears after step 2 when [**📷: Mode guide**] is set to [**Disable**]. Press the <◀> <▶> keys to select the shooting mode.

Available Shooting Modes in the SCN Mode

Shooting mode	Page
 Portrait	 77
 Group Photo	 78
 Landscape	 79
 Sports	 80
 Kids	 81
 Panning	 82

Shooting mode	Page
 Close-up	 84
 Food	 85
 Night Portrait	 86
 Handheld Night Scene	 87
 HDR Backlight Control	 88
 Silent Mode	 89

-  You can also set the shooting mode from [: Shooting mode] after setting the Mode dial to <SCN>.

Shooting Portraits

The (Portrait) mode blurs the background to make the human subject stand out. It also makes skin tones and hair look softer.

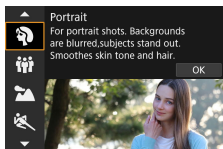

Shooting Tips

- **Select the location where the distance between the subject and the background is the farthest.**

The further the distance between the subject and background, the more blurred the background will look. The subject will also stand out better against an uncluttered dark background.

- **Use a telephoto lens.**

If you have a zoom lens, use the telephoto end to fill the frame with the subject from the waist up.

- **Focus on the face.**

As you focus, make sure the AF point on the face is lit in green before you shoot. When shooting close-ups of the face, you can set [: **Eye Detection AF**] to [**Enable**] to shoot with the subject's eyes in focus.



- The default setting is (Low-speed continuous shooting). If you keep holding down the shutter button, you can shoot continuously to capture changes in the subject's facial expression and pose.

Shooting Group Photos

Use the (Group Photo) mode to shoot group photos. You can take a picture in which both the people in the front and people in the back are all in focus.

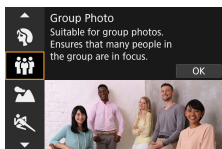

Shooting Tips

● Use a wide-angle lens.

When using a zoom lens, use the wide-angle end to make it easy to get all the people in the group in focus at once, from the front row to the back. Also, if you place a little distance between the camera and the subjects (so that the subjects' entire bodies are in the shot), the focus range increases in depth.

● Take multiple shots of the group.

It is recommended to shoot multiple photos in case some people close their eyes.

-  ● When shooting indoors or in low-light, hold the camera steady or use a tripod to prevent camera shake.

Shooting Landscapes

Use the < 🏔️ > (Landscape) mode for expansive scenery or to have everything in focus from near to far. For vivid blues and greens, and very sharp and crisp images.

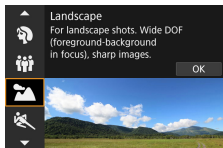

Shooting Tips

- **With a zoom lens, use the wide-angle end.**

When using a zoom lens, set the lens to the wide-angle end to make the objects near and far in focus. It also adds breadth to landscapes.

- **Shooting night scenes.**

Shooting with < 🏔️ > while handholding the camera may cause camera shake. Using a tripod is recommended.

Shooting Moving Subjects

Use the <  > (Sports) mode to shoot a moving subject, such as a running person or a moving vehicle.

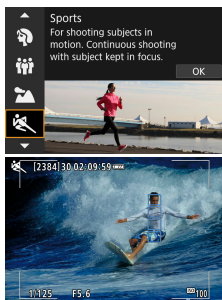

(1)





Shooting Tips

● Use a telephoto lens.

Use of a telephoto lens is recommended to enable shooting from a distance.

● Track the subject with the Area AF frame.

By default, [: AF method] is set to [ +Tracking]. An Area AF frame (1) appears when you press the shutter button halfway. Once the subject is in focus, the AF point turns blue.

● Shoot continuously.

The default setting is [H] (High-speed continuous shooting). At the decisive moment, press the shutter button completely to take the shot. To track the subject and capture changes as it moves, keep holding down the shutter button to shoot continuously.

Photographing Children

To photograph the children running around, use (Kids). Skin tones will look healthy.

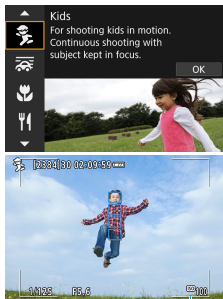



(1)



Shooting Tips

● Track the subject with the Area AF frame.

By default, [: AF method] is set to [+Tracking]. An Area AF frame (1) appears when you press the shutter button halfway. Once the subject is in focus, the AF point turns blue.

● Shoot continuously.

The default setting is [H] (High-speed continuous shooting). At the decisive moment, press the shutter button completely to take the shot. To track the subject and capture changes in facial expression and movement, keep holding down the shutter button to shoot continuously.

Panning

If you want to take a picture with the feel of speed and a blurred motion effect on the subject's background, use (Panning). If you use a lens supporting the mode, subject blur is detected, corrected, and reduced.

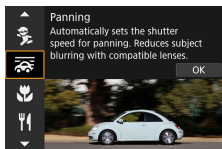

Shooting Tips

● Turn the camera to follow the moving subject.

When shooting, turn the camera smoothly as you track the moving subject. Aim the AF point over the part of the moving subject where you want to focus, then press the shutter button halfway and keep holding it down as you turn the camera to match the subject's speed and movement. Press the shutter button completely while moving the camera to take the picture. Keep tracking the subject with the camera.

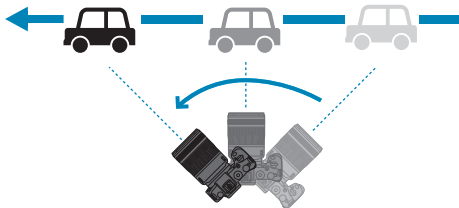

● Set the level of background motion blur.

With **[Effect]**, you can set the level of background motion blur. The **[Max]** setting will set a slower shutter speed to increase the background motion blur around the subject. If the subject blur is noticeable, set **[Effect]** to **[Med]** or **[Min]** to reduce the blur.



- For details on lenses compatible with mode, visit the Canon website.
- With lenses that support mode, the camera automatically corrects subject blur and (based on the **[Effect]** setting) adjusts shutter speed, regardless of the lens IS setting.
- The AF method can only be set to **[1-point AF]** or **[Zone AF]**. By default, it is set to **[Zone AF]**, with the zone in the center of the screen selected.
- To prevent camera shake, it is recommended that you hold the camera with both hands, tighten your arms close to your body, and track the subject's movement smoothly to take pictures.
- This effect is most effective with trains, cars, etc. that move at a constant speed in one direction.
- Taking test shots or checking the image by playing it back immediately after shooting is recommended.
- By default, (Low-speed continuous shooting) is set. At the decisive moment, press the shutter button completely to take the picture. You can track moving subjects by panning the camera as you keep holding down the shutter button to shoot continuously.

Shooting Close-ups

When you want to shoot flowers or small things up close, use the <🌸> (Close-up) mode. To make small things appear much larger, use a macro lens (sold separately).

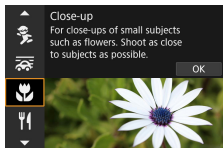

Shooting Tips

● Use a simple background.

A simple background makes small objects such as flowers stand out better.

● Move in as close as possible to the subject.

Check the lens for its minimum focusing distance. The lens minimum focusing distance is measured from the <∞> (focal plane) mark on the top of the camera to the subject. Focusing is not possible if you are too close.

● With a zoom lens, use the telephoto end.

If you have a zoom lens, using the telephoto end will make the subject look larger.

Shooting Food

When you want to take pictures of food, use <¶¶> (Food). The photo will look bright and appetizing. Also, depending on the light source, the reddish tinge will be suppressed in the pictures taken under tungsten lights, etc.

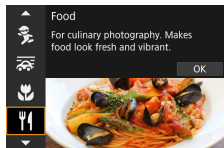

Shooting Tips

- **Change the color tone.**

You can change **[Color tone]**. To increase the food's reddish tinge, set it toward **[Warm]**. Set it toward **[Cool]** if it looks too red.

Shooting Night Portraits (With a Tripod)

When you want to photograph people at night and obtain a natural-looking night scene in the background, use the <Fn> (Night Portrait) mode. **Note that an external Speedlite is required for shooting.** Using a tripod is recommended.

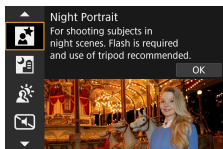

Shooting Tips

- **Use a wide-angle lens and a tripod.**

When using a zoom lens, use the wide-angle end to obtain a wide night view. Also, since camera shake is prone to occur with handheld shooting, use a tripod.

- **Check the image brightness.**

Note that it is recommended to play back the captured image on location to check the image brightness. If the subject looks dark, move nearer and shoot again.

- **Also shoot in other shooting modes.**

Since camera shake is prone to occur with night shots, shooting also with <A+> and <P> is recommended.

-  If you use the self-timer together with an external Speedlite, the self-timer lamp will light up briefly after the picture is taken.

Shooting Night Scenes (Handheld)

Using a tripod when shooting a night scene gives the best results. However, the  (Handheld Night Scene) mode enables you to shoot night scenes even while handholding the camera. In this shooting mode, four shots are taken consecutively for each picture, and the resulting one image with reduced camera shake is recorded.

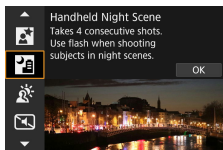

Shooting Tips

- **Hold the camera firmly.**

During shooting, hold the camera firmly and steadily. In this mode, four shots are aligned and merged into a single image. However, if there is significant misalignment in any of the four shots due to camera shake, they may not align properly in the final image.

- **For portraits, use an external Speedlite.**

If you are to include people in the picture, use an external Speedlite. To take a nice portrait, the first shot will use flash. Tell the subject not to move until all four consecutive shots are taken.

Shooting Backlit Scenes

When shooting a scene having both the bright and dark areas, use the <  > (HDR Backlight Control) mode. When you take one picture in this mode, three consecutive shots are taken at different exposures. This results in one image, with a wide tonal range, that has minimized the clipped shadows caused by backlighting.

* HDR stands for High Dynamic Range.

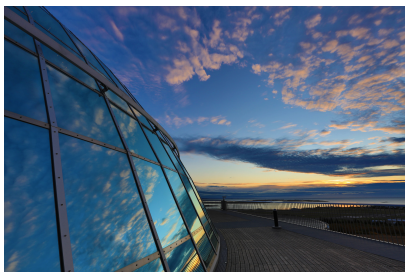
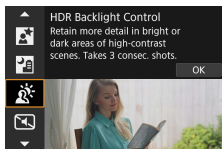

Shooting Tips

● Hold the camera firmly.

During shooting, hold the camera firmly and steadily. In this mode, three shots are aligned and merged into a single image. However, if there is significant misalignment in any of the three shots due to camera shake, they may not align properly in the final image.

Shooting Quiet Scenes

Where silence is needed, you can shoot without beeps such as shutter release sounds.

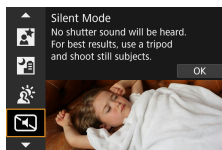

Shooting Tips

● Take some test shots.

It is recommended to take a few test shots in advance, because under some shooting conditions, lens aperture adjustment may be audible.



- As you shoot, a white frame is momentarily displayed around the screen.
- The drive mode can only be set to <□>, <📷10>, or <📷2>.

Cautions for the <SCN> Modes



: Group Photo

- The angle of view changes slightly, due to distortion correction.
- Depending on the shooting conditions, focus may not be attained for everyone from the front to the back of the image.

: Sports

- Under low light where camera shake tends to occur, the shutter speed value in the lower left will blink. Hold the camera steady and shoot.
- Using an external Speedlite will decrease the continuous shooting speed.

: Kids

- Using an external Speedlite will decrease the continuous shooting speed.

: Panning

- The shutter speed will become slower. Therefore, this mode is not suitable for any shooting except for panning.
- By default, <□□> is set. Note that <□□H> cannot be selected.
- External Speedlites cannot be used. (It will not fire.)
- Although lens IS is applied to images captured with lenses supporting <☰> mode, the effect is not shown on the screen as you shoot. (IS and subject blur correction are activated when you shoot, regardless of the lens IS setting.)
- If the lens does not support the <☰> mode, subject blur will not be corrected. However, the automatic shutter speed adjustment alone will take effect according to the setting of [Effect].
- When shooting under bright light such as a sunny summer day or when shooting a slow subject, the set degree of panning effect may not be obtained.



: Panning (continued)

- With a lens supporting the <P> mode, subject blur may not be corrected properly when shooting the following subjects or under the following shooting conditions.
 - Subjects with very low contrast.
 - Subjects in low light.
 - Strongly backlit or reflective subjects.
 - Subjects with repetitive patterns.
 - Subjects with less patterns or monotonous patterns.
 - Subjects with reflections (images reflected in glass, etc.).
 - Subjects smaller than the Zone AF frame.
 - When there are multiple subjects moving within the Zone AF frame.
 - Subjects moving in irregular directions or at irregular speeds.
 - Subjects whose movements are partly irregular. (For example, the vertical movement of a runner.)
 - Subjects whose speed changes dramatically. (For example, right after the start of movement or while turning along a curve.)
 - When you move the camera too fast or too slow.
 - When the camera's movement does not match the subject's movement.

: Food

- The warm color cast of subjects may fade.
- When multiple light sources are included in the scene, the warm color cast of the picture may not be reduced.
- If you use an external Speedlite, **[Color tone]** will be set to Standard.
- If there are people in the picture, the skin tone may not be reproduced properly.



: Night Portrait

- Tell subjects to remain still for a moment after the flash fires.
- Focusing may be difficult when subject faces look dark. In this case, set the lens's focus mode switch to <MF> and focus manually.
- Autofocusing at night or in dark scenes may be difficult when points of light lie within the AF point. In this case, set the lens's focus mode switch to <MF> and focus manually.
- Shots will look slightly different from the image as displayed on the screen.

: Handheld Night Scene

- Compared to other shooting modes, the image area will be smaller.
- RAW image quality cannot be set.
- Autofocusing at night or in dark scenes may be difficult when points of light lie within the AF point. In this case, set the lens's focus mode switch to <MF> and focus manually (📖 48, 📖 51).
- Shots will look slightly different from the image as displayed on the screen.
- If you use an external Speedlite and the subject is close, overexposure may result.
- If you use an external Speedlite for a night scene with limited lighting, the shots may not align correctly. This may result in a blurry picture.
- If you use an external Speedlite with a human subject close to the background that is also illuminated by the flash, the shots may not align correctly. This may result in a blurry picture. Unnatural shadows and unsuitable colors may also appear.
- Flash coverage angle with an external Speedlite:
 - When using a Speedlite with automatic flash coverage setting, the zoom position will be fixed to the wide (wide-angle) end regardless of the lens's zoom position.
 - When using a Speedlite requiring manual flash coverage setting, set the flash head to the normal position.

**📷: Handheld Night Scene (continued)**

- If you shoot a moving subject, the subject's movement may leave afterimages or the surrounding area of the subject may become dark.
- The image alignment may not function properly with repetitive patterns (lattice, stripes, etc.), flat or single-tone images, or images significantly misaligned due to camera shake.
- It takes some time to record images to the card since they are merged after shooting. **[BUSY]** is displayed as images are processed, and shooting is not possible until processing is finished.

📷: HDR Backlight Control

- Compared to other shooting modes, the image area will be smaller.
- RAW image quality cannot be set.
- External Speedlites cannot be used. (It will not fire.)
- Note that the image may not be rendered with a smooth gradation and may look irregular or have significant noise.
- HDR Backlight Control may not be effective for excessively backlit scenes or extremely high-contrast scenes.
- When shooting subjects that are sufficiently bright as they are, for example for normally lit scenes, the image may look unnatural due to the HDR effect.
- If you shoot a moving subject, the subject's movement may leave afterimages or the surrounding area of the subject may become dark.
- The image alignment may not function properly with repetitive patterns (lattice, stripes, etc.), flat or single-tone images, or images significantly misaligned due to camera shake.
- It takes some time to record images to the card since they are merged after shooting. **[BUSY]** is displayed as images are processed, and shooting is not possible until processing is finished.

📷: Silent Mode

- Be responsible when using silent shooting, and respect subject privacy and portrait rights.
- Images of fast-moving subjects may look distorted.
- Continuous shooting and flash photography are not available.

Creative Zone

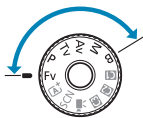

Creative Zone modes give you the freedom to shoot in a variety of ways by setting your preferred shutter speed, aperture value, exposure, and more.

- To clear the shooting mode description displayed when you turn the Mode dial, press <SET> (📖 369).



- Make sure the Multi-function lock feature is off.

Program AE

The camera automatically sets the shutter speed and aperture to suit the subject's brightness. This is called Program AE.

* <P> stands for Program.

* AE stands for Auto Exposure.



1 Set the Mode dial to <P>.



2 Focus on the subject.

- Aim the AF point over the subject and press the shutter button halfway.
- ▶ Once the subject is in focus, the AF point turns green (with One-Shot AF).
- ▶ The shutter speed and aperture are set automatically.



3 Check the display.

- As long as the exposure value is not blinking, standard exposure will be obtained.

4 Take the picture.

- Compose the shot and press the shutter button completely.



- If the “30” shutter speed and the lowest f/number blink, it indicates underexposure. Increase the ISO speed or use flash.



- If the “1/4000” shutter speed and the highest f/number blink, it indicates overexposure. Lower the ISO speed or use an ND filter (sold separately) to reduce the amount of light entering the lens.



Differences Between <P> and <A+> Modes

- In <A+> mode, many functions, such as the AF method and metering mode, are set automatically to prevent spoiled shots. The functions you can set are limited. On the other hand, with <P> mode, only the shutter speed and aperture are set automatically. You can freely set the AF method, metering mode, and other functions.

Program Shift

- In <P> mode, you can freely change the shutter speed and aperture combination (Program) set automatically by the camera while maintaining the same exposure. This is called Program shift.
- To shift the program, press the shutter button halfway, then turn the <A+> dial until the desired shutter speed or aperture is displayed.
- Program shift will be canceled automatically when the metering timer ends (exposure setting display turns off).
- Program shift cannot be used with flash.

Shutter-Priority AE

In this mode, you set the shutter speed and the camera automatically sets the aperture to obtain the standard exposure matching the brightness of the subject. This is called shutter-priority AE. A faster shutter speed can freeze the action of a moving subject. A slower shutter speed can create a blurred effect, giving the impression of motion.

* <Tv> stands for Time value.



Blurred motion
(Slow speed: 1/30 sec.)



Frozen motion
(Fast speed: 1/2000 sec.)



1 Set the Mode dial to <Tv>.



2 Set the desired shutter speed.

- Turn the  dial to set it.

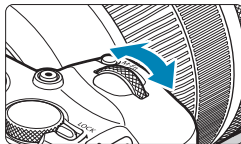

3 Focus on the subject.

- Press the shutter button halfway.
- ▶ The aperture is set automatically.

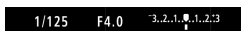

4 Check the display and shoot.

- As long as the aperture is not blinking, the standard exposure will be obtained.



- If the lowest f/number blinks, it indicates underexposure. Turn the dial to set a slower shutter speed until the aperture stops blinking or set a higher ISO speed.



- If the highest f/number blinks, it indicates overexposure. Turn the dial to set a faster shutter speed until the aperture stops blinking or set a lower ISO speed.



Shutter Speed Display

- For example, "0"5" indicates 0.5 sec. and "15"", 15 sec.

Aperture-Priority AE

In this mode, you set the desired aperture and the camera sets the shutter speed automatically to obtain the standard exposure matching the subject brightness. This is called aperture-priority AE. A higher f/number (smaller aperture hole) will make more of the foreground and background fall within acceptable focus. On the other hand, a lower f/number (larger aperture hole) will make less of the foreground and background fall within acceptable focus.

* <Av> stands for Aperture value (aperture opening).



Blurred background

(With a low aperture f/number: f/5.6)



Sharp foreground and background

(With a high aperture f/number: f/32)

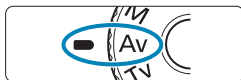

1 Set the Mode dial to <Av>.



2 Set the desired aperture.

- Turn the <⚙> dial to set it.

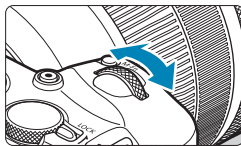

3 Focus on the subject.

- Press the shutter button halfway.
- ▶ The shutter speed is set automatically.

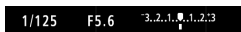

4 Check the display and shoot.

- As long as the shutter speed is not blinking, the standard exposure will be obtained.



- If the “1/30” shutter speed blinks, it indicates underexposure. Turn the dial to set a larger aperture (lower f/number) until the shutter speed blinking stops or set a higher ISO speed.





- If the “1/4000” shutter speed blinks, it indicates overexposure. Turn the dial to set a smaller aperture (higher f/number) until the shutter speed blinking stops or set a lower ISO speed.



Aperture Value Display

- The higher the f/number, the smaller the aperture opening will be. The f/number displayed varies depending on the lens. If no lens is attached to the camera, “F00” will be displayed for the aperture.

Depth-of-Field Preview ☆

Press the button you have assigned to depth-of-field preview (using [].C.Fn III-5: Customize buttons], ( 537)) to stop down the lens to the current aperture setting and check the area in focus (depth of field).



- The larger the aperture value, the wider the area in focus, from the foreground to the background.
- Exposure is locked (AE lock) as you hold down the button assigned to depth-of-field preview.

Manual Exposure

In this mode, you set both the shutter speed and aperture as desired. To determine the exposure, refer to the exposure level indicator or use a commercially available exposure meter. This method is called manual exposure.

* <M> stands for Manual.



1 Set the Mode dial to <M>.

2 Set the ISO speed (131).

- With ISO Auto, you can set exposure compensation (103).



3 Set the shutter speed and aperture.

- To set the shutter speed, turn the <Shutter Speed> dial. To set the aperture, turn the <Aperture> dial.



4 Focus on the subject.

- Press the shutter button halfway.
 - ▶ The exposure setting will be displayed.
- Check the exposure level mark <I> to see how far the current exposure level is from the standard exposure level.

- (1) Standard exposure index
(2) Exposure level mark



5 Set the exposure and take the picture.

- Check the exposure level indicator and set the desired shutter speed and aperture.

Exposure Compensation with ISO Auto

If the ISO speed is set to **[AUTO]** for manual exposure shooting, you can set exposure compensation (📖 128) as follows:

- Touch the exposure level indicator
- **[📷: Expo.comp./AEB]**
- Quick Control screen



- If ISO Auto is set, the ISO speed setting will change to obtain the standard exposure with the set shutter speed and aperture. Therefore, you may not obtain the desired exposure effect. In this case, set the exposure compensation.



- With the camera set to the **<M>** mode + ISO Auto + **<📷>** (Evaluative metering) and **[📷.C.Fn I-7: AE lock meter. mode after focus]** set to the default setting (📖 529), holding down the shutter button halfway will lock the ISO speed after focus is achieved with One-Shot AF.
- When ISO Auto is set, you can press the **<✳>** button to lock the ISO speed.
- To compare the current exposure to the exposure when you pressed the **<✳>** button initially with a manually set ISO speed, press the **<✳>** button, recompose the shot, and check the exposure level indicator.
- With ISO Auto set and **[📷.C.Fn I-1: Exposure level increments]** set to **[1/2-stop]**, any 1/2-stop exposure compensation will be implemented with the ISO speed (1/3 stop) and shutter speed. However, the shutter speed displayed will not change.

Flexible-Priority AE

In this mode, you can set shutter speed, aperture, and ISO speed manually or automatically and combine these settings with your choice of exposure compensation. Shooting in **<Fv>** mode, with control over each of these parameters, is equivalent to shooting in **<P>**, **<Tv>**, **<Av>**, or **<M>** mode.



* **<Fv>** stands for Flexible value.



1 Set the Mode dial to **<Fv>**.





2 Set the shutter speed, aperture, and ISO speed.

- Turn the  dial to select an item to set. A  icon appears to the left of the selected item.
- Turn the  dial to set the option.
- To reset the setting to **[AUTO]**, press the **<▲>** or **<▶>** key.



3 Set the amount of exposure compensation.

- Turn the  dial and select the exposure level indicator. A  icon appears to the left of the exposure level indicator.
- Turn the  dial to set the option.
- To reset the setting to **[±0]**, press the **<▲>** or **<▶>** key.

Combinations of Functions in <Fv> Mode

Shutter Speed	Aperture	ISO Speed	Exposure Compensation	Shooting Mode
[AUTO]	[AUTO]	<u>[AUTO]</u> Manual selection	Available	Similar to <P>
Manual selection	[AUTO]	<u>[AUTO]</u> Manual selection	Available	Similar to <Tv>
[AUTO]	Manual selection	<u>[AUTO]</u> Manual selection	Available	Similar to <Av>
Manual selection	Manual selection	<u>[AUTO]</u> Manual selection	Available –	Similar to <M>



- Blinking values indicate that the values set will cause underexposure or overexposure. Adjust the exposure until the value stops blinking.
- Slow-sync shooting is not used under low light when you have set up <Fv> mode to resemble <Av> or <P> mode, even when [Slow synchro] in [ⓘ: External Speedlite control] is set to [1/180-30sec. auto].



- Values for shutter speed, aperture, and ISO speed that are set to [AUTO] are underlined.
- You can set shutter speed, aperture, and ISO speed to [AUTO] and exposure compensation to [±0] in steps 2 or 3 by pressing the <▼> or <◀> key.

Long (Bulb) Exposures

In this mode, the shutter stays open as long as you hold down the shutter button completely, and closes when you let go of the shutter button. This photographic technique is called “bulb exposure”. Use bulb exposures for night scenes, fireworks, the heavens, and other subjects requiring long exposures.



1 Set the Mode dial to .



2 Set the desired aperture.

- Turn the <  > dial to set it.

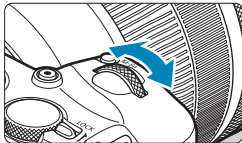

3 Take the picture.

- The exposure will continue for as long as you keep the shutter button pressed completely.
- ▶ The elapsed exposure time will be displayed on the screen.

- ❗ Do not point the camera toward an intense light source, such as the sun or an intense artificial light source. Doing so may damage the image sensor or the camera's internal components.
- Long bulb exposures produce more noise in the image than usual.
- If ISO Auto is set, ISO 400 will be set ( 582).
- When shooting bulb exposures with the self-timer instead of the bulb timer, keep pressing the shutter button completely (for the self-timer time and bulb exposure time).



- With [**📷 Long exp. noise reduction**], you can reduce the noise generated during long exposures (📖 159).
- For bulb exposures, using a tripod and bulb timer is recommended.
- You can also shoot bulb exposures by using Remote Switch RS-60E3 (sold separately, 📖 219).
- You can also use Wireless Remote Control BR-E1 (sold separately) for bulb exposures. When you press the remote control's transmit button, the bulb exposure will start immediately or 2 sec. later. Press the button again to stop the bulb exposure.

Bulb Timer ☆

You can preset the bulb exposure's exposure time. The bulb timer eliminates the need to keep holding down the shutter button during the bulb exposure. This reduces camera shake.

The bulb timer can be set only in the (bulb exposure). It cannot be set (or will not function) in any other mode.

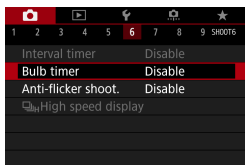

1 Select [**📷: Bulb timer**].

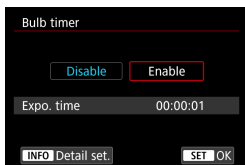

2 Select [**Enable**].

- Select [**Enable**], then press the <INFO> button.

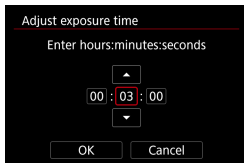

- 3 Set the desired exposure time.**
- Select the hour, minute, or second.
 - Press <SET> to display <⏏>.
 - Set the desired number, then press <SET>. (Returns to <□>.)

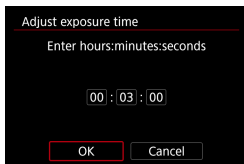

- 4 Select [OK].**

- 5 Take the picture.**
- ▶ Press the shutter button completely, and the bulb exposure will start and continue until the set time elapses.
 - **[TIMER]** and the exposure time are displayed on the screen during bulb timer shooting.
 - To cancel the timer setting, set **[Disable]** in step 2.

- !**
- While the bulb timer is operating, if you press the shutter button completely and let go of it, the bulb exposure will stop.
 - If you keep pressing the shutter button completely after the exposure starts, the bulb exposure will continue even after the set exposure time elapses. (The bulb exposure will not stop automatically when the set exposure time elapses.)
 - Changing shooting modes cancels the bulb timer and restores the setting to **[Disable]**.

Shooting

This chapter describes shooting and introduces menu settings on the shooting ([📷]) tab.

Shooting Still Photos

- A ☆ icon to the right of a page title indicates that the function is available only in Creative Zone <Fv>, <P>, <Tv>, <Av>, <M>, or mode.

Tab Menus: Still Photo Shooting

● Shooting 1

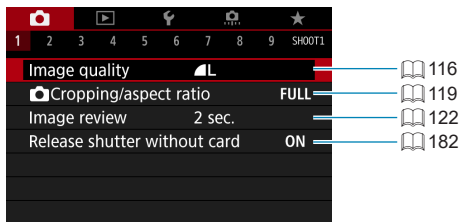

● Shooting 2

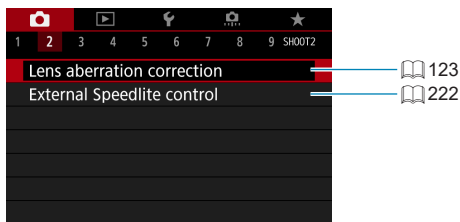

● Shooting 3

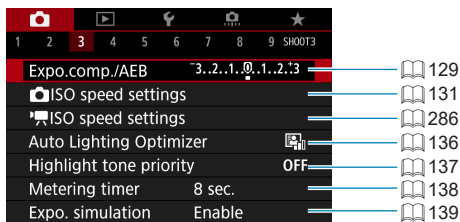

● Shooting 4

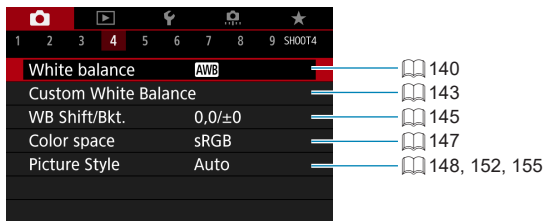

● Shooting 5

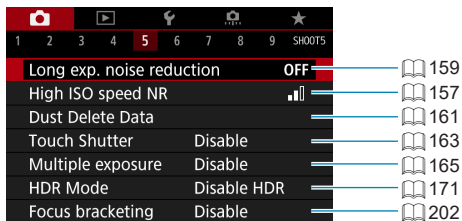

● Shooting 6

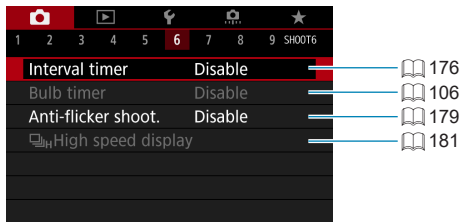

● Shooting 7

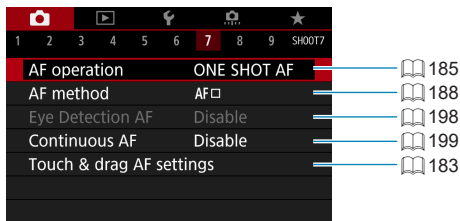

● Shooting 8

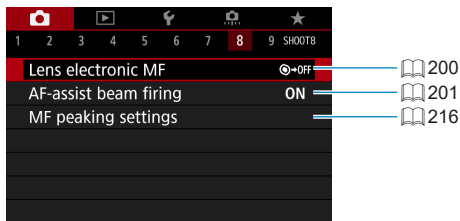

● Shooting 9

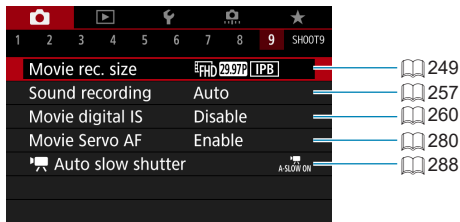

In **Basic Zone** modes, the following screens are displayed.

● Shooting 1

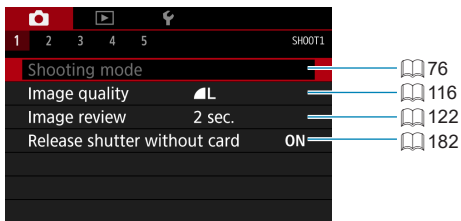

● Shooting 2

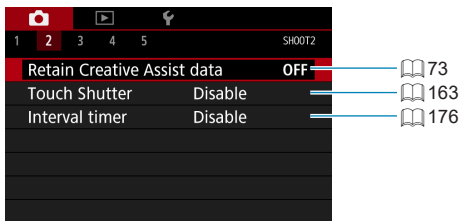

● Shooting 3

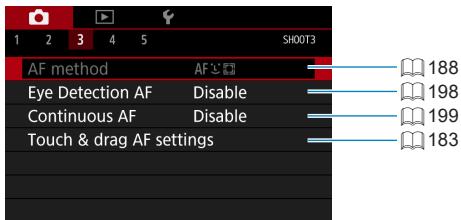

- **[Shooting mode]** and **[AF method]** are available in <SCN> mode.
- **[Retain Creative Assist data]** is available in <A+> mode.

● Shooting 4

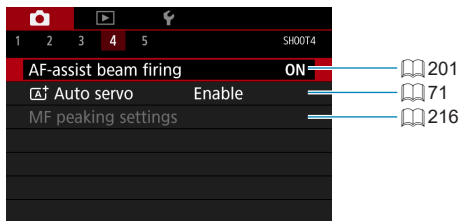

● Shooting 5

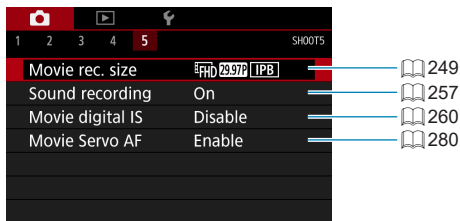

- [MF peaking settings] is available in <SCN> mode.
- [Auto servo] is available in <Auto servo> mode.

Setting Image Quality

You can select the pixel count and the image quality. JPEG image quality options include **L**, **L**, **M**, **M**, **S1**, **S1**, and **S2**. RAW image quality options include **RAW** and **CRAW**.

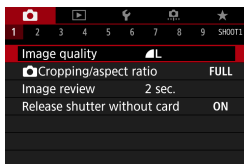

1 Select [: Image quality].

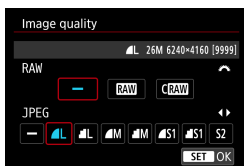

2 Set the image quality.

- To select the RAW quality, turn the dial, and to select the JPEG quality, press the <◀> <▶> keys.
- Press <SET> to set it.

Number of shots available as indicated by [****] on the image quality setting screen always applies to a setting of [Full-frame], regardless of the actual aspect ratio setting (119).

- If [-] is set for both the RAW image and JPEG image, **L** will be set.
- If you select both RAW and JPEG, each time you shoot, the image will be recorded simultaneously to the card in both RAW and JPEG at the image-recording qualities that were set. The two images will be recorded with the same file numbers (file extension: .JPG for JPEG and .CR3 for RAW).
- **S2** is in **L** (Fine) quality.
- Meaning of image quality icons: **RAW** RAW, **CRAW** Compact RAW, JPEG, **L** Fine, **L** Normal, **L** Large, **M** Medium, **S** Small.

RAW Images

A RAW image is raw data output by the image sensor converted to digital data. It is recorded to the card as is, and you can select the quality as follows: **RAW** or **CRAW**. **CRAW** produces RAW images with smaller file sizes than **RAW**.

RAW images can be processed using [▶]: **RAW image processing** (📖 325) and saved as JPEG images. (Just as for **RAW**, all JPEG size options are available for **CRAW**.) As the RAW image itself does not change, you can process the RAW image to create any number of JPEG images with various processing conditions.

You can use Digital Photo Professional (EOS software) to process RAW images. You can make various adjustments to images depending upon how they will be used and can generate JPEG or other types of images reflecting the effects of those adjustments.



RAW Image Processing Software

- To display RAW images on a computer, using Digital Photo Professional (hereafter DPP, EOS software) is recommended.
- Previous versions of DPP Ver.4.x cannot process RAW images taken with this camera. If a previous version of DPP Ver.4.x is installed on your computer, obtain and install the latest version of DPP from the Canon website to update it (📖 554). (The previous version will be overwritten.) Note that DPP Ver.3.x or earlier cannot process RAW images taken with this camera.
- Commercially available software may not be able to display RAW images taken with this camera. For compatibility information, contact the software manufacturer.

Guidelines for Choosing Image Quality

For guidelines on file sizes, number of possible shots, and maximum burst shots, see 📖 583.

Maximum Burst for Continuous Shooting



The approximate maximum burst is shown on the shooting screen and in the lower right of the viewfinder.



- If the maximum burst is displayed as “99”, it indicates that you can shoot 99 or more shots continuously. The value starts decreasing once it reaches 98 or less. **[BUSY]** display indicates that internal memory is full and shooting will stop temporarily. If you stop continuous shooting, the maximum burst will increase. After all the captured images are written to the card, you can resume continuous shooting and shoot up to the maximum burst listed in the table on 583.

Setting Cropping/Aspect Ratio

Normally with RF or EF lenses, images are captured at the sensor size of approx. 36.0×24.0 mm in full-frame shooting, but in cropped shooting, you can isolate and magnify the center of the image approx. 1.6x (APS-C size) as if using a telephoto lens, or you can set an aspect ratio to suit your shooting application before shooting.

For EF-S lenses, a 3:2 aspect ratio in the center is captured, magnified approx. 1.6x (APS-C size).

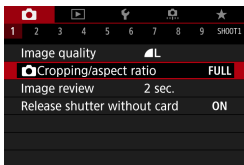

1 Select [: Cropping/aspect ratio].

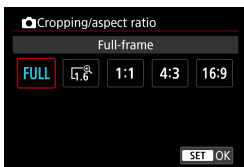

2 Select an item.

- Select [**Full-frame**], [**1.6x (crop)**], [**1:1 (aspect ratio)**], [**4:3 (aspect ratio)**], or [**16:9 (aspect ratio)**].
- With EF-S lenses, [**1.6x (crop)**] is set automatically, and no other option is available.



- image quality options are not available when [**1.6x (crop)**] is set, or with EF-S lenses.
- Cropped shooting with the image quality set to produces images, respectively.
- Shooting with an EF-S lens when [**1:1 (aspect ratio)**], [**4:3 (aspect ratio)**], or [**16:9 (aspect ratio)**] is set automatically clears the setting and shoots with [**1.6x (crop)**] at a 3:2 aspect ratio.

Setting examples

FULL set



1.6x set or EF-S lens used





4:3 set





3 Take the picture.

- When **[1.6x (crop)]** is set or an EF-S lens is used, an image magnified approx. 1.6x is displayed.
- When **[1:1 (aspect ratio)]**, **[4:3 (aspect ratio)]**, or **[16:9 (aspect ratio)]** is set, the image within the black masked is captured.



- **Areas outside the cropped area are not recorded in RAW shooting when [1.6x (crop)] is set, or with EF-S lenses.**
- The [:  **Cropping/aspect ratio**] setting is not used as the basis for auto flash zoom (auto flash coverage adjustment) by an external Speedlite.



- For details on pixel counts when cropping or an aspect ratio is set, see  584.
- Nearly 100% field of view coverage is maintained vertically and horizontally when cropping or an aspect ratio is set.
- Aspect ratio information is added to RAW images when an aspect ratio is set, which are captured at full size. When the RAW images are played back, the image area used for shooting is indicated by lines. Note that only the shooting image area is shown in slideshows ( 343).

Setting the Image Review Time

You can set how long the image is displayed on the screen immediately after shooting. To keep the captured image displayed, set **[Hold]**. To not have the captured image displayed, set **[Off]**.

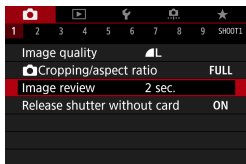

1 Select [: Image review].

2 Set a time option.

- When **[Hold]** is set, images are displayed as long as the time set in [: Power saving].

Correction of Lens Aberrations due to Optical Characteristics

Vignetting, image distortion, and other issues may be caused by lens optical characteristics. The camera can compensate for these phenomena by using **[Lens aberration correction]**.

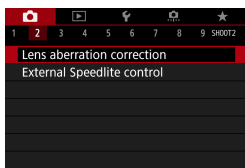

1 Select **[📷: Lens aberration correction]**.

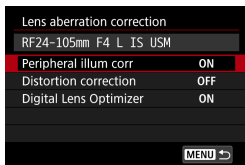

2 Select an item.

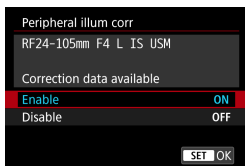

3 Select **[Enable]**.

- Confirm that the name of the attached lens and (except for diffraction correction) **[Correction data available]** are displayed.
- If **[Correction data not available]** or **[📷]** is displayed, see “Digital Lens Optimizer” (📖 125).

4 Take the picture.

- The image captured will have lens aberration corrected.

Peripheral Illumination Correction

Vignetting (dark image corners) can be corrected.

- Depending on shooting conditions, noise may appear on the image periphery.
- The higher the ISO speed, the lower the correction amount will be.

- The correction amount applied will be lower than the maximum correction amount that applied with Digital Photo Professional (EOS software).
- Peripheral illumination is corrected automatically in Basic Zone modes when correction data is registered on the camera.

Distortion Correction

Distortion (image warping) can be corrected.

- To correct distortion, the camera captures a narrower image area than the area seen when shooting, which crops the image a little and slightly lowers the apparent resolution.
- Setting distortion correction may change the angle of view slightly.
- The amount of image cropped may vary between still photos and movies.
- When you magnify images, distortion correction is not applied to the images displayed.
- Images with distortion correction applied will not have the Dust Delete Data (📖 161) appended.

- For details on lenses you can use to record movies with distortion correction, visit the Canon website.
- Distortion is corrected automatically when <SCN> mode is set to <👤> and correction data is registered on the camera.

Digital Lens Optimizer

Various aberrations from lens optical characteristics can be corrected, along with diffraction and low-pass filter-induced loss of clarity.

If **[Correction data not available]** or  is displayed by **[Digital Lens Optimizer]**, you can use EOS Utility to add the lens correction data to the camera. For details, refer to the EOS Utility Instruction Manual.



- Depending on shooting conditions, noise may be intensified together with the effects of correction. Image edges may also be emphasized. Adjust Picture Style sharpness or set **[Digital Lens Optimizer]** to **[Disable]** as needed before shooting.
- The higher the ISO speed, the lower the correction amount will be.
- For movie recording, **[Digital Lens Optimizer]** will not appear. (Correction is not possible.)



- Enabling **[Digital Lens Optimizer]** corrects both chromatic aberration and diffraction, although these options are not displayed.
- Digital Lens Optimizer is applied automatically in Basic Zone modes when correction data is registered on the camera.



Chromatic Aberration Correction

Chromatic aberration (color fringing around subjects) can be corrected.

-  [Chromatic aberr corr] is not displayed when [Digital Lens Optimizer] is enabled.

Diffraction Correction

Diffraction (loss of sharpness caused by the aperture) can be corrected.

-  Depending on shooting conditions, noise may be intensified together with the effects of correction.
 - The higher the ISO speed, the lower the correction amount will be.
 - For movie recording, [Diffraction correction] will not appear. (Correction is not possible.)
-  With “Diffraction correction”, degraded resolution due to the low-pass filter, etc. is corrected in addition to diffraction. Therefore, correction is effective even at an aperture close to the open aperture.
 - [Diffraction correction] is not displayed when [Digital Lens Optimizer] is enabled.



General Cautions for Lens Aberration Correction

- Peripheral illumination correction, chromatic aberration correction, distortion correction, and diffraction correction cannot be applied to JPEG images already taken.
- When using a non-Canon lens, setting the corrections to **[Disable]** is recommended even if **[Correction data available]** is displayed.
- Magnifying the periphery of the image may display parts of the image that will not be recorded.
- The correction amount will be less (except for diffraction correction) if the lens used does not have distance information.



General Notes for Lens Aberration Correction

- The effect of the lens aberration correction varies depending on the lens used and shooting conditions. Also, the effect may be difficult to discern depending on the lens used, shooting conditions, etc.
- If the correction is difficult to discern, magnifying and checking the image after shooting is recommended.
- Corrections can be applied even when an extender or life-size converter is attached.
- If the correction data for the attached lens is not registered to the camera, the result will be the same as when the correction is set to **[Disable]** (except for diffraction correction).
- If necessary, refer to the EOS Utility Instruction Manual as well.

Setting the Desired Exposure Compensation



Exposure compensation can brighten (increased exposure) or darken (decreased exposure) the standard exposure set by the camera.

Exposure compensation can be set in the <Fv>, <P>, <Tv>, <Av>, and <M> shooting modes. You can set exposure compensation up to ± 3 stops in 1/3-stop increments.

For details on exposure compensation when <M> mode and ISO Auto are both set, see 103, and see 104 for <Fv> mode.

Increased exposure for a brighter image



Decreased exposure for a darker image



1 Check the exposure.

- Press the shutter button halfway and check the exposure level indicator.

2 Set the compensation amount.

- Set it by looking at the screen as you turn the <Q> dial.
- ▶ A <Q> icon is displayed to indicate exposure compensation.

3 Take the picture.

- To cancel exposure compensation, set the exposure level indicator <I> to the standard exposure index (<0>).

● If [: Auto Lighting Optimizer] (136) is set to any setting other than [Disable], the image may still look bright even if a decreased exposure compensation for a darker image is set.

● The exposure compensation amount will remain in effect even after you set the power switch to <OFF>.

Auto Exposure Bracketing (AEB)

By changing the shutter speed, aperture, or ISO speed automatically, you can bracket the exposure up to ± 3 stops in 1/3-stop increments for three consecutive shots. This is called AEB.

* AEB stands for Auto Exposure Bracketing.

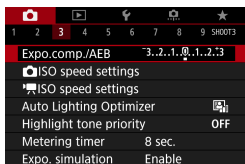

1 Select [: Expo.comp./AEB].

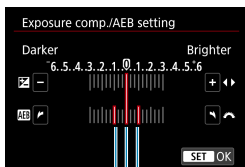

2 Set the AEB range.

- Turn the < > dial to set the AEB range (1). Press the <<> <>> keys to set the exposure compensation level.
- Press <SET> to set it.
- ▶ When you close the menu, the AEB range will be displayed on the screen.

(1)

Standard exposure

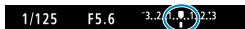

Decreased exposure

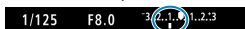

Increased exposure

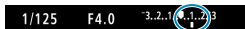

3 Take the picture.

- Three bracketed shots will be taken according to the drive mode set in this sequence: Standard exposure, decreased exposure, and increased exposure.
- AEB will not be automatically canceled. To cancel AEB, follow step 2 to turn off the AEB range display.



- If [: **Auto Lighting Optimizer**] (136) is set to any setting other than **[Disable]**, the effect of AEB may be reduced.



- <✳> blinks in the lower left of the screen during AEB shooting.
- If the drive mode is set to <□>, press the shutter button three times for each shot. When <□H> or <□> is set and you hold down the shutter button completely, the three bracketed shots will be taken consecutively and the camera will automatically stop shooting. When <Ⓜ10> or <Ⓜ2> is set, the three bracketed shots will be taken consecutively after a 10-sec. or 2-sec. delay. When set to <Ⓜc>, three times the specified number of shots are taken in continuous shooting.
- You can set AEB in combination with exposure compensation.
- AEB cannot be used with flash, Multi Shot Noise Reduction, focusing bracketing, or in HDR mode.
- AEB will be canceled automatically if you do any of the following: Setting the power switch to <OFF> or when the flash is fully charged.

Setting the ISO Speed for Still Photos



Set the ISO speed (image sensor's sensitivity to light) to suit the ambient light level. In Basic Zone modes, ISO speed is set automatically. Regarding the ISO speed during movie recording, see 588.

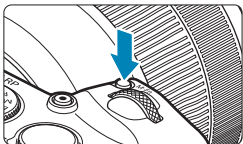

1 Press the <M-Fn> button ().

- With an image displayed on the screen, press the <M-Fn> button.



2 Select the ISO speed item.

- Turn the dial to select the ISO speed item.



3 Set the ISO speed.

- Turn the dial to set it.
- ISO speed can be set within ISO 100–40000 in 1/3-stop increments.
- Select **[AUTO]** to set the ISO speed automatically.
- For details on the ISO Auto range, see 582.



- To expand the available ISO speed range from L (equivalent to ISO 50) to H1 (equivalent to ISO 51200) or H2 (equivalent to ISO 102400), adjust **[ISO speed range]** under **[: ISO speed settings]** (133).

ISO Speed Guide

- Low ISO speeds reduce image noise but may increase the risk of camera/subject shake or reduce the area in focus (shallower depth of field), in some shooting conditions.
- High ISO speeds enable low-light shooting, a larger area in focus (deeper depth of field), and longer flash range but may increase image noise.



- As H1 (equivalent to ISO 51200) and H2 (equivalent to ISO 102400) are expanded ISO speed settings, noise (dots of light, banding, etc.) and irregular colors will be more noticeable, and the resolution lower compared with the standard setting.
- As L (equivalent to ISO 50) is an expanded ISO speed setting, the dynamic range will be somewhat narrower compared with the standard setting.
- If [: **Highlight tone priority**] is set to [**Enable**] or [**Enhanced**] (137), L (equivalent to ISO 50), ISO 100/125/160, H1 (equivalent to ISO 51200), and H2 (equivalent to ISO 102400) cannot be selected.
- When shooting with a high ISO speed, high temperature, long exposure, or multiple exposure, image noise (rough grain, dots of light, banding, etc.), irregular colors, or color shift may become noticeable.
- When shooting in conditions that produce an extreme amount of noise, such as a combination of high ISO speed, high temperature, and long exposure, images may not be recorded properly.
- If you use a high ISO speed and flash to shoot a close subject, overexposure may result.

Setting the Manually-Settable ISO Speed Range

You can set the manually-settable ISO speed range (minimum and maximum limits). You can set the minimum limit within L (equivalent to ISO 50) to H1 (equivalent to ISO 51200), and the maximum limit within ISO 100 to H2 (equivalent to ISO 102400).

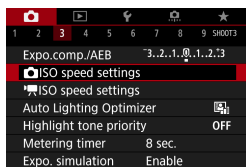

1 Select [: ISO speed settings].

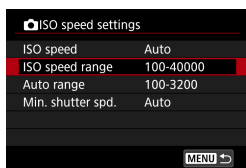

2 Select [ISO speed range].

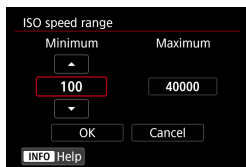

3 Set the minimum limit.

- Select the minimum limit box, then press <SET>.
- Select the ISO speed, then press <SET>.



4 Set the maximum limit.

- Select the maximum limit box, then press <SET>.
- Select the ISO speed, then press <SET>.

5 Select [OK].

Setting the ISO Speed Range for ISO Auto

You can set the automatic ISO speed range for ISO Auto within ISO 100–40000.

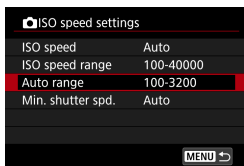

1 Select [Auto range].

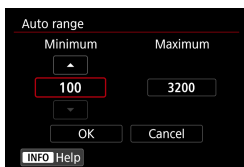

2 Set the minimum limit.

- Select the minimum limit box, then press <SET>.
- Select the ISO speed, then press <SET>.



3 Set the maximum limit.

- Select the maximum limit box, then press <SET>.
- Select the ISO speed, then press <SET>.

4 Select [OK].

- The [Minimum] and [Maximum] settings will also function as the minimum and maximum speeds for ISO speed safety shift (📖 529).

Setting the Minimum Shutter Speed for ISO Auto

You can set the minimum shutter speed for ISO Auto.

This can help reduce camera shake and subject blur in **<P>** or **<Av>** mode when shooting moving subjects with a wide-angle lens, or when using a telephoto lens.

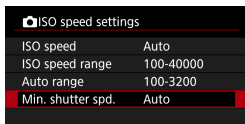

1 Select [Min. shutter spd.].

Automatically set

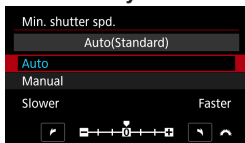

2 Set the desired minimum shutter speed.

- If you select **[Auto]**, turn the dial to set a slower or faster speed, then press **<SET>**.
- If you select **[Manual]**, turn the dial to select the shutter speed, then press **<SET>**.

Manually set

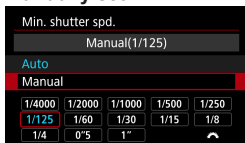

- If a correct exposure cannot be obtained with the maximum ISO speed limit set with **[Auto range]**, a shutter speed slower than the **[Min. shutter spd.]** will be set to obtain the standard exposure.
- This function will not be applied to flash photography and movie recording.



- When **[Auto(Standard)]** is set, the minimum shutter speed will be the reciprocal of the lens focal length. A single step from **[Slower]** to **[Faster]** is equivalent to a single stop of the shutter speed.

Auto Correction of Brightness and Contrast



Brightness and contrast can be corrected automatically if shots look dark or contrast is too low or high. This function is called Auto Lighting Optimizer. In Basic Zone modes, **[Standard]** is set automatically.

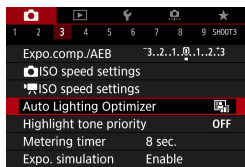

1 Select [: Auto Lighting Optimizer].

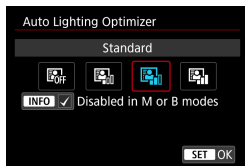

2 Set a correction option.

3 Take the picture.

- ▶ The image will be recorded with the brightness and contrast corrected as necessary.

- Noise may increase and clarity may change, under some shooting conditions.
- If the effect of Auto Lighting Optimizer is too strong and results are not at your preferred brightness, set to **[Low]** or **[Disable]**.
- If a setting other than **[Disable]** is set and you use exposure compensation or flash exposure compensation to darken the exposure, the image may still come out bright. If you want a darker exposure, set this function to **[Disable]**.
- Maximum burst is lower with **[High]**. Image recording to the card also takes longer.

- In step 2, if you press the <INFO> button and remove the checkmark [✓] for **[Disabled in M or B modes]** setting, the [: Auto Lighting Optimizer] can also be set even in <M> and modes.

Highlight Tone Priority



You can reduce overexposed, clipped highlights.

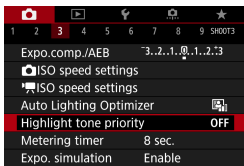

1 Select [📷: Highlight tone priority].

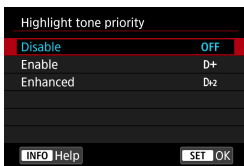

2 Set an option.

- **[Enable]**: Improves gradation in highlights. The dynamic range is expanded from the standard 18% gray to bright highlights. The gradation between the grays and highlights becomes smoother.
- **[Enhanced]**: Reduces overexposed highlights even more than **[Enable]**, under some shooting conditions.

3 Take the picture.

- ▶ The image will be recorded with highlight tone priority applied.



- Noise may increase slightly.
- The available ISO range starts at ISO 200. Expanded ISO speeds cannot be set.
- **[Enhanced]** is not available (not displayed) when recording movies.
- With **[Enhanced]**, results in some scenes may not look as expected.

Setting the Metering Timer



You can set how long the metering timer runs (which determines the duration of exposure display/AE lock) after it is triggered by an action such as pressing the shutter button halfway.

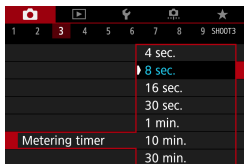

1 Select [: Metering timer].

2 Set a time option.

Exposure Simulation

Exposure simulation simulates and displays how the brightness (exposure) of the actual image will look.

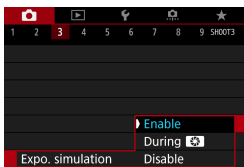

1 Select [: Expo. simulation].

2 Set an option.

- **Enable** ()

The displayed image brightness will be close to the actual brightness (exposure) of the resulting image. If you set exposure compensation, the image brightness will change accordingly.

- **During** (

Normally, the image is displayed at standard brightness, so it is easy to see (). Image brightness will only be close to the actual brightness (exposure) of the resulting image while you hold down the button you have assigned to [**Depth-of-field preview**] (using [: **C.Fn III-5: Customize buttons**], (537)) ().

- **Disable** (

The image is displayed at standard brightness, so it is easy to see. Even if you set exposure compensation, the image is displayed at the standard brightness.

Setting the White Balance



White balance (WB) is for making the white areas look white. Normally, the Auto [AWB] (Ambience priority) or [AWB w] (White priority) setting will obtain the correct white balance. If natural-looking colors cannot be obtained with Auto, you can select the white balance to match the light source or set it manually by shooting a white object.

In Basic Zone modes, [AWB] (Ambience priority) is set automatically. (In <P> mode, [AWB w] (White priority) is set.)

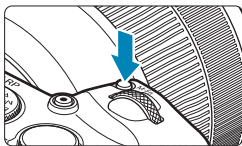

1 Press the <M-Fn> button (6).

- With an image displayed on the screen, press the <M-Fn> button.



2 Select the white balance item.

- Turn the <W> dial to select the white balance setting item.

















3 Select a white balance setting.

- Turn the <W> dial to make a selection.



- For [AWB] and [AWB w] setting instructions, see 142.

(Approx.)

Display	Mode	Color Temperature (K: Kelvin)
	Auto (Ambience priority,  142)	3000–7000
	Auto (White priority,  142)	
	Daylight	5200
	Shade	7000
	Cloudy, twilight, sunset	6000
	Tungsten light	3200
	White fluorescent light	4000
	Flash	Automatically set*
	Custom ( 143)	2000–10000
	Color temperature ( 144)	2500–10000

* Applicable with Speedlites having a color temperature transmission function. Otherwise, it will be fixed to approx. 6000K.

White Balance

To the human eye, a white object looks white regardless of the type of lighting. With a digital camera, the white for color correction basis is decided depending on the color temperature of the illumination, and then the color is adjusted with software to make the white areas look white. With this function, you can take the pictures with natural color tones.

[AWB] Auto White Balance

With [AWB] (Ambience priority), you can slightly increase the intensity of the image's warm color cast when shooting a tungsten-light scene. If you select [AWB w] (White priority), you can reduce the intensity of the image's warm color cast.

If you want to match the Auto white balance of previous EOS DIGITAL camera models, select [AWB] (Ambience priority).

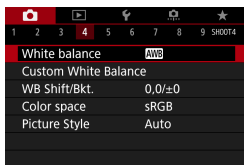

1 Select [📷: White balance].

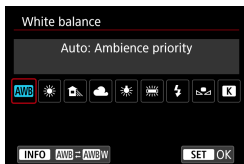

2 Select [AWB].
 ● With [AWB] selected, press the <INFO> button.

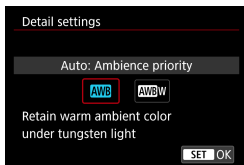

3 Select an item.

! Cautions for Setting [AWB w] (White priority)

- The warm color cast of subjects may fade.
- When multiple light sources are included in the scene, the warm color cast of the picture may not be reduced.
- When using flash, the color tone will be the same as with [AWB] (Ambience priority).

[] Custom White Balance

With custom white balance, you can manually set the white balance for the specific light source of the shooting location. Make sure to perform this procedure under the light source at the actual location of the shoot.



1 Shoot a white object.

- Aim the camera at a plain white subject, so that white fills the screen.
- Focus manually and shoot with the standard exposure set for the white object.
- You can use any of the white balance settings.

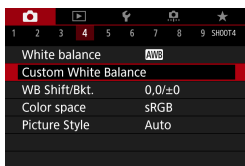

2 Select [: Custom White Balance].



3 Import the white balance data.

- Press the <◀> <▶> keys to select the image captured in step 1, then press <SET>.
- ▶ Select [OK] to import the data.

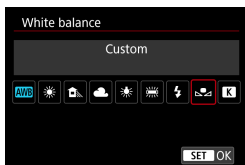

4 Select [: White balance].

5 Select the custom white balance.

- Select [].

- If the exposure obtained in step 1 differs greatly from the standard exposure, a correct white balance may not be obtained.
- The following images cannot be selected: Images captured with the Picture Style set to **[Monochrome]**, multiple-exposure images, cropped images, and images shot with another camera.

- Instead of shooting a white object, you can also shoot a gray chart or standard 18% gray reflector (commercially available).

[K] Setting the Color Temperature

A value can be set representing the white balance color temperature.

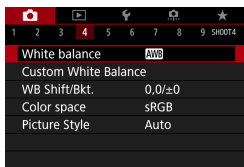

1 Select [: White balance].

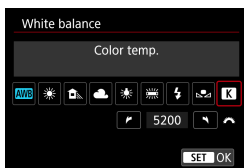

2 Set the color temperature.

- Select [**K**].
- Turn the dial to set the desired color temperature, then press <SET>.
- The color temperature can be set from approx. 2500K to 10000K in 100K increments.

- When setting the color temperature for an artificial light source, set the white balance correction (magenta or green bias) as necessary.
- If you set [**K**] to the reading taken with a commercially available color temperature meter, take test shots and adjust the setting to compensate for the difference between the color temperature meter's reading and the camera's color temperature reading.

White Balance Correction

You can correct the white balance that is set. This adjustment will have the same effect as using a commercially available color temperature conversion filter or color compensating filter. Each color can be corrected to one of nine levels.

White Balance Correction

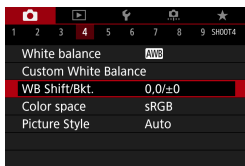

1 Select [: WB Shift/Bkt.].

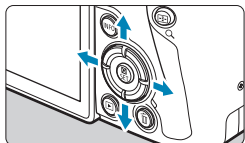

Sample setting: A2, G1

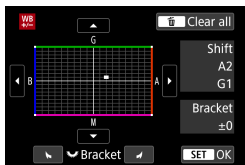

2 Set the white balance correction.

- Press the <⬅➡> cross keys to move the “+” mark to the appropriate position.
- B is for blue, A for amber, M for magenta, and G for green. The image's color balance will be adjusted toward the color in the direction of the move.
- ▶ On the right of the screen, “Shift” indicates the direction and correction amount, respectively.
- Pressing the <🗑> button will cancel all the [WB Shift/Bkt.] settings.
- Press <SET> to exit the setting.



- One level of the blue/amber correction is equivalent to approx. 5 mireds of a color temperature conversion filter. (Mired: Unit of measure for color temperature used to indicate values such as the density of a color temperature conversion filter.)



White Balance Auto Bracketing

White balance bracketing (WB Bkt.) enables you to capture three images at once with different color tones. Based on the color temperature of the current white balance setting, the image will be bracketed with a blue/amber bias and magenta/green bias. White balance bracketing is possible up to ± 3 levels in single-level increments.

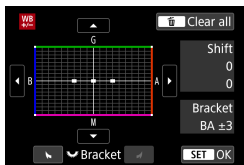
B/A bias ± 3 levels



Set the white balance bracketing amount.

- In step 2 for “White Balance Correction”, when you turn the <  > dial, the “.” mark on the screen will change to “...” (3 points).
- Turning the dial clockwise sets the B/A bracketing, and turning it counterclockwise sets the M/G bracketing.
- ▶ On the right, “**Bracket**” indicates the bracketing direction and correction amount.
- Pressing the <  > button will cancel all the [WB Shift/Bkt.] settings.
- Press <SET> to exit the setting.

- During white balance bracketing, the maximum burst for continuous shooting will be lower.
- Since three images are recorded for one shot, it takes longer to record the image to the card.

- The images will be bracketed in the following sequence: 1. Standard white balance, 2. Blue (B) bias, and 3. Amber (A) bias, or 1. Standard white balance, 2. Magenta (M) bias, and 3. Green (G) bias.
- You can also set white balance correction and AEB together with white balance bracketing. If you set AEB in combination with white balance bracketing, a total of nine images will be recorded for a single shot.
- The white balance icon blinks when white balance bracketing is set.
- “**Bracket**” stands for bracketing.

Setting the Color Space

The range of reproducible colors is called “color space”. With this camera, you can set the color space for captured images to sRGB or Adobe RGB. For normal shooting, sRGB is recommended.

1 Select [CAMERA]: Color space].

2 Set a color space option.

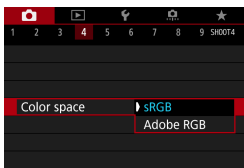

Adobe RGB

This color space is mainly used for commercial printing and other industrial uses. Recommended when using equipment such as Adobe RGB-compatible monitors or DCF 2.0 (Exif 2.21 or later) compatible printers.



- If the still photo is shot in the Adobe RGB color space, the first character in the file name will be an underscore “_”.
- The ICC profile is not appended. For the descriptions about the ICC profile, refer to the Digital Photo Professional Instruction Manual (EOS software).
- In Basic Zone modes, [sRGB] is set automatically.

Selecting a Picture Style



Just by selecting a preset Picture Style, you can obtain image characteristics effectively matching your photographic expression or the subject. In Basic Zone modes, [**Auto**] (Auto) is set automatically.

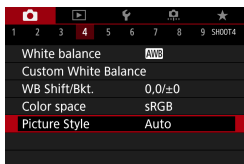

1 Select [**Auto**: Picture Style].



2 Select a Picture Style.

Picture Style Characteristics

- **[A]** **Auto**

The color tone will be adjusted automatically to suit the scene. The colors will look vivid for blue skies, greenery and sunsets, particularly in nature, outdoor and sunset scenes.



● If the desired color tone is not obtained with **[Auto]**, use another Picture Style.

- **[S]** **Standard**

The image looks vivid, sharp, and crisp. This is a general-purpose Picture Style suitable for most scenes.

- **[P]** **Portrait**

For nice skin tones. The image looks softer. Suited for close-up portraits. By changing the **[Color tone]** (153), you can adjust the skin tone.

- **[L]** **Landscape**

For vivid blues and greens, and very sharp and crisp images. Effective for impressive landscapes.

- **[FD]** **Fine Detail**

Suited for detailed outline and fine texture description of the subject. The colors will be slightly vivid.

- **[N]** **Neutral**

Suited for processing the image with a computer. For natural colors and subdued images with modest brightness and color saturation.

-  **Faithful**

Suited for processing the image with a computer. The color of a subject that is captured in sunlight at a color temperature of 5200K will be adjusted to match the subject's colorimetric color. For subdued images with modest brightness and color saturation.

-  **Monochrome**

Creates black-and-white images.



- Color images cannot be recovered from JPEG images shot with the **[Monochrome]** Picture Style.

-  **User Defined 1–3**

You can register a basic style such as **[Portrait]**, **[Landscape]**, a Picture Style file, etc. and adjust it as desired ( 155). With any of the User Defined Picture Style that has not yet been set, pictures will be taken with the same characteristics settings as with the default settings of **[Auto]**.

Symbols

The Picture Style selection screen has icons for **[Strength]**, **[Fineness]**, or **[Threshold]** for **[Sharpness]** as well as **[Contrast]** and other settings. The numbers indicate the values for these settings specified for the respective Picture Style.

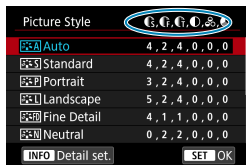

Symbols

●	Sharpness	
	●	Strength
	●	Fineness
●	●	Threshold
●	Contrast	
●	Saturation	
●	Color tone	
●	Filter effect (Monochrome)	
●	Toning effect (Monochrome)	



- During movie recording, an asterisk "*" will be displayed for both **[Fineness]** and **[Threshold]** for **[Sharpness]**. **[Fineness]** and **[Threshold]** will not be applied to movies.

Customizing a Picture Style



You can customize the Picture Styles. You can adjust Picture Style settings such as **[Contrast]** or **[Sharpness]** (**[Strength]**, **[Fineness]**, and **[Threshold]**). To customize **[Monochrome]**, see 154.

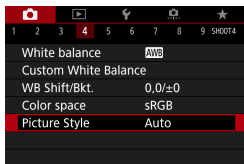

1 Select [: Picture Style].



2 Select a Picture Style.

- Select the Picture Style to adjust, then press the <INFO> button.

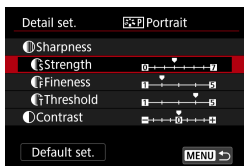

3 Select an item.

- See the next page for details on the settings and effects.

4 Set the effect level.



- Press the <MENU> button to save the adjusted setting and return to the Picture Style selection screen.
- ▶ Any settings you change from default values are displayed in blue.

Settings and Effects

①	Sharpness		
	🔍 Strength	0: Weak outline emphasis	7: Strong outline emphasis
	🔍 Fineness* ¹	1: Fine	5: Grainy
	🔍 Threshold* ²	1: Low	5: High
🌑	Contrast	-4: Low contrast	+4: High contrast
🌈	Saturation	-4: Low saturation	+4: High saturation
🌈	Color tone	-4: Reddish skin tone	+4: Yellowish skin tone

- *1: Indicates the fineness of the outlines to be emphasized. The smaller the number, the finer the outlines that can be emphasized.
- *2: Sets how much the outline is emphasized based on the difference in contrast between the subject and the surrounding area. The smaller the number, the more the outline will be emphasized when the contrast difference is low. However, noise tends to be more noticeable when the number is smaller.



- For movie recording, [Fineness] and [Threshold] for [Sharpness] cannot be set (not displayed).
- By selecting [Default set.] in step 3, you can revert the parameter settings of the respective Picture Style to their defaults.
- To shoot with the Picture Style you adjusted, first select the adjusted Picture Style, then shoot.

Monochrome Adjustment

Besides the effects described on the preceding page such as **[Contrast]**, or **[Strength]**, **[Fineness]** and **[Threshold]** for **[Sharpness]**, you can also set **[Filter effect]** and **[Toning effect]**.

Filter effect

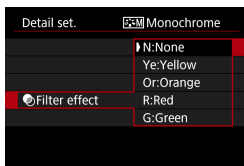

With a filter effect applied to a monochrome image, you can make white clouds or green trees stand out more.

Filter	Sample Effects
N: None	Normal black-and-white image with no filter effects.
Ye: Yellow	The blue sky will look more natural, and the white clouds will look crisper.
Or: Orange	The blue sky will look slightly darker. The sunset will look more brilliant.
R: Red	The blue sky will look quite dark. Fall leaves will look crisper and brighter.
G: Green	Skin tones and lips will appear muted. Green tree leaves will look crisper and brighter.

- Increasing the **[Contrast]** will make the filter effect more pronounced.

Toning effect

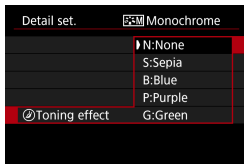

By applying a toning effect, you can create a monochrome image in the selected color. Effective when you want to create more impressive images.

Registering a Picture Style

You can select a base Picture Style such as **[Portrait]** or **[Landscape]**, adjust it as desired, and register it under **[User Def. 1]**, **[User Def. 2]**, or **[User Def. 3]**. Useful when creating several Picture Styles with different settings.

Picture Styles that you have registered on the camera using EOS Utility (EOS software) can also be modified here.

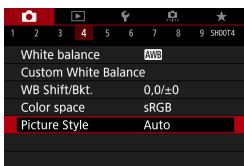

1 Select [📷: Picture Style].

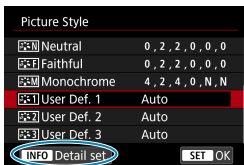

2 Select [User Def.].

- Select **[User Def. *]**, then press the **<INFO>** button.

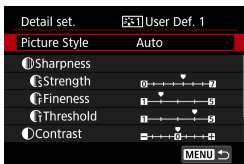

3 Press <SET>.

- With **[Picture Style]** selected, press **<SET>**.

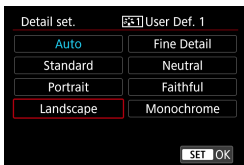

4 Select the base Picture Style.

- Select the base Picture Style.
- Also select styles this way when adjusting styles registered to the camera with EOS Utility (EOS software).

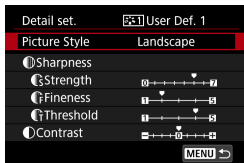

5 Select an item.



6 Set the effect level.

- For details, see “Customizing a Picture Style” (📖 152).

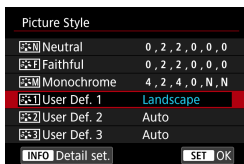

- Press the <MENU> button to save the adjusted setting and return to the Picture Style selection screen.
- ▶ The base Picture Style will be indicated on the right of **[User Def. *]**.
- ▶ Blue style names indicate that you have changed the settings from default values.

- ❗ If a Picture Style is already registered under **[User Def. *]**, changing the base Picture Style will clear the parameter settings of the previously registered User Defined Picture Style.
- If you perform [**🔧: Clear all camera settings**] (📖 410), all the **[User Def. *]** settings will revert to their defaults.

- 📄 To shoot with a registered Picture Style, select the registered **[User Def. *]**, then shoot.
- Regarding the procedure to register a Picture Style file to the camera, refer to the EOS Utility Instruction Manual.

Setting Noise Reduction



High ISO Speed Noise Reduction

This function reduces the noise generated in the image. This function is especially effective when shooting at high ISO speeds. When shooting at low ISO speeds, the noise in the darker parts of the image (shadow areas) can further be reduced.

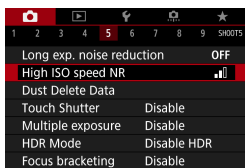

1 Select [: High ISO speed NR].

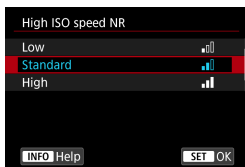

2 Set the level.

● [] Multi Shot Noise Reduction

Applies the noise reduction with higher image quality than [**High**]. For a single photo, four shots are taken continuously and aligned and merged automatically into a single JPEG image.

If the image quality is set to RAW or RAW+JPEG, you cannot set [**Multi Shot Noise Reduction**].

3 Take the picture.

- ▶ The image will be recorded with noise reduction applied.



Cautions for Setting Multi Shot Noise Reduction

- If there is significant misalignment in the image due to camera shake, the noise reduction effect may become smaller.
- If you are handholding the camera, keep it steady to prevent camera shake. Using a tripod is recommended.
- If you shoot a moving subject, the moving subject may leave afterimages.
- Auto image alignment may not function properly with repetitive patterns (lattice, stripes, etc.) or flat, single-tone images.
- If the subject's brightness changes as the four consecutive shots are taken, irregular exposure in the image may result.
- After shooting, it may take some time to record an image to the card after performing noise reduction and merging the images. **[BUSY]** is displayed as images are processed, and shooting is not possible until processing is finished.
- **[Multi Shot Noise Reduction]** is not available with bulb shooting, shooting with AEB or WB bracketing, shooting RAW or RAW+JPEG images, or with features such as long exposure noise reduction, multiple exposures, or HDR mode.
- Flash photography is not possible. Note that the AF-assist beam of EOS-dedicated, external Speedlites will be emitted according to the **[📷: AF-assist beam firing]** setting.
- **[Multi Shot Noise Reduction]** is not available (not displayed) when recording movies.
- Automatically switches to **[Standard]** if you set the power switch to <OFF>, replace the battery or card, switch to a Basic Zone or shooting mode, or switch to movie recording.

Long Exposure Noise Reduction

For images exposed for 1 sec. or longer, noise (dots of light and banding) typical of long exposures can be reduced.

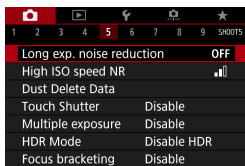

1 Select [: Long exp. noise reduction].

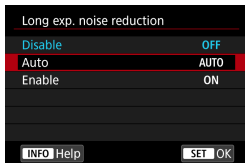

2 Set a reduction option.

- **[AUTO] Automatic**

For exposures of 1 sec. or longer, noise reduction is performed automatically if noise typical of long exposures is detected. This **[Auto]** setting is effective enough in most cases.

- **[ON] Enable**

Noise reduction is performed for all exposures of 1 sec. or longer. The **[Enable]** setting may reduce noise that cannot be detected with the **[Auto]** setting.

3 **Take the picture.**

- ▶ The image will be recorded with noise reduction applied.

- With **[Auto]** or **[Enable]** set, the noise reduction process after the picture is taken may take the same amount of time as that for the exposure.
- Images may look grainier with the **[Enable]** setting than with the **[Disable]** or **[Auto]** setting.
- **[BUSY]** is displayed as noise is reduced, and the shooting screen is not displayed until processing is finished, when you can shoot again.

Appending Dust Delete Data

Dust Delete Data used to erase dust spots can be appended to images in case sensor cleaning leaves dust on the sensor. The Dust Delete Data is used by Digital Photo Professional (EOS software) to erase the dust spots automatically.

Preparation

- Use an RF or EF lens.
- Prepare a solid white object such as a sheet of paper.
- Set the lens focal length to 50 mm or longer.
- Set the lens's focus mode switch to <MF> and set the focus to infinity (∞).
If the lens has no distance scale, rotate the camera to face toward you and turn the focusing ring clockwise all the way.

Obtaining the Dust Delete Data

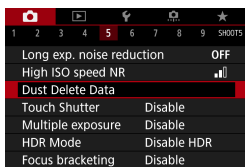

1 Select [: Dust Delete Data].

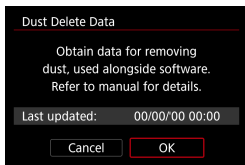

2 Select [OK].

- ▶ After the automatic self-cleaning of the sensor is performed, a message will appear. Although there will be a mechanical sound of the shutter during the cleaning, no picture is taken.

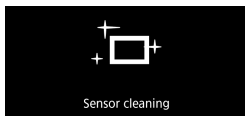
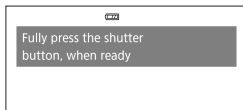

3 Shoot a plain white object.

- Shoot with a plain white object (such as a new sheet of white paper) filling the screen, at a distance of 20–30 cm (0.7–1.0 ft.).
- Since the image will not be saved, the data can still be obtained even if there is no card in the camera.
- ▶ When the picture is taken, the camera will start collecting the Dust Delete Data. When the Dust Delete Data is obtained, a message will appear.
- If the data is not obtained successfully, an error message will appear. Follow the “Preparation” procedure on the preceding page, then select **[OK]**. Take the picture again.

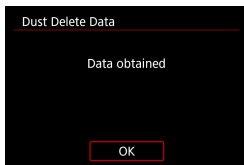

Dust Delete Data

The camera will append the Dust Delete Data obtained to all shots from now on. Acquiring Dust Delete Data before shooting is recommended. For details about using Digital Photo Professional (EOS software) to erase dust spots automatically, refer to the Digital Photo Professional Instruction Manual.

File size is essentially unaffected by Dust Delete Data appended to images.

- Dust Delete Data is not obtained when EF-S lenses are used, or when **[📷: Cropping/aspect ratio]** is set to **[1.6x (crop)]**.
- If the object has any pattern or design, it may be recognized as dust data and affect the accuracy of the dust deletion with the Digital Photo Professional (EOS software).

Shooting with the Touch Shutter

Just by tapping on the screen, you can focus and take the picture automatically.



1 Enable the Touch Shutter.

- Tap [OFF] on the screen's bottom left.
- Each time you tap on the icon, it will toggle between [OFF] and [ON].
- [ON] (Touch Shutter: Enable)
The camera will focus on the spot you tap on, then the picture will be taken.
- [OFF] (Touch Shutter: Disable)
You can tap on a spot to perform focusing on the spot. Press the shutter button completely to take the picture.



2 Tap on the screen to shoot.

- Tap on the face or subject on the screen.
- ▶ On the point you tap, the camera will focus (Touch AF) with the AF method that was set (188).
- ▶ When [ON] is set, the AF point turns green when focus is achieved, then the picture is taken automatically.
- ▶ If focus is not achieved, the AF point turns orange and the picture cannot be taken. Tap on the face or subject on the screen again.

- Even if you set the drive mode to H> or , the camera will still shoot in the single shooting mode.
- Even if **[AF operation]** is set to **[Servo AF]**, tapping on the screen will focus on the image with **[One-Shot AF]**.
- Tapping on the screen in magnified view will not focus or take the picture.
- If you shoot by tapping on the screen with **[📷: Image review]** set to **[Hold]**, you can press the shutter button halfway to take the next shot.

- To shoot with bulb exposure, tap on the screen twice. The first tap on the screen will start the bulb exposure. Tapping it again will stop the bulb exposure. Be careful not to shake the camera when tapping on the screen.

Multiple Exposures

As you shoot multiple exposures (2–9), you can see how the images will be merged into a single image.

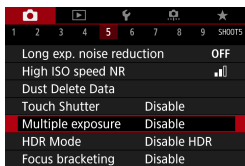

1 Select [**📷**: Multiple exposure].

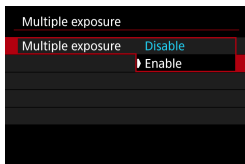

2 Set a [**Multiple exposure**] option.

- Select [**Enable**].
- To exit shooting multiple exposures, select [**Disable**].

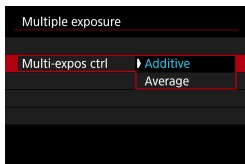

3 Set [**Multi-expos ctrl**].

● Additive

The exposure of each single image captured is added cumulatively. Based on the [**No. of exposures**], set a negative exposure compensation. Follow the basic guide below to set the exposure compensation amount.

Exposure Compensation Setting Guide by Number of Exposures

Two exposures: -1 stop, three exposures: -1.5 stop, four exposures: -2 stops

● Average

Based on the [**No. of exposures**], negative exposure compensation is set automatically as you shoot multiple exposures. If you shoot multiple exposures of the same scene, the exposure of the subject's background will be automatically controlled to obtain the standard exposure.



4 Set the [No. of exposures].

- Select the number of exposures, then press <SET>.
- You can set it from 2 to 9 exposures.

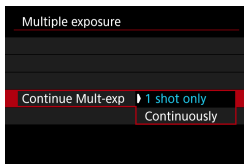

5 Set a [Continue Mult-exp] option.

- With [1 shot only], multiple-exposure shooting will be canceled automatically after the shooting ends.
- With [Continuously], multiple-exposure shooting continues until the setting in step 2 is set to [Disable].



6 Shoot the first exposure.

- ▶ The captured image will be displayed.
- In (1) on the screen, you can check the number of exposures left.
- Pressing the <▶> button enables you to view the captured image (169).

7 Shoot the next exposures.

- Images captured so far are displayed merged. For image-only display, press the <INFO> button repeatedly.
- Multiple-exposure shooting will end when the set number of exposures are taken.



- The shooting information for the last shot will be recorded and appended to the multiple-exposure image.



- The image quality, ISO speed, Picture Style, high ISO speed noise reduction, color space, etc. set for the first single exposure will also be set for the subsequent exposures.
- If [**📷: Picture Style**] is set to [**Auto**], [**Standard**] will be applied for shooting.
- With multiple exposures, the more exposures there are, the more noticeable the noise, irregular colors, and banding will be.
- If [**Additive**] is set, the image processing after taking the multiple exposures will take time. (The access lamp will light up longer.)
- In step 7, the brightness and noise of the multiple-exposure image displayed during shooting will be different from those of the final multiple-exposure image recorded.
- Multiple-exposure shooting is canceled if you set the power switch to <OFF> or switch batteries or cards.
- Multiple-exposure shooting ends if you switch to a Basic Zone mode or to <**📷**/**📷**/**📷**>.

Merging Multiple Exposures with an Image Recorded on the Card

You can select a RAW image recorded on the card as the first single exposure. The image data of the selected RAW image will remain intact. **Only RAW or CRAW images can be used.** JPEG images cannot be selected. Images you can specify also vary depending on the lens attached. For details, see the table below.

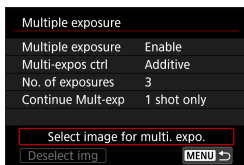

1 Select [Select image for multi. expo.].

2 Select the first image.

- Use the <<> <>> keys to select the first image, then press <SET>.
- Select [OK].
- ▶ The file number of the selected image will be displayed at the bottom of the screen.

3 Take the picture.

- When you select the first image, the number of remaining exposures as set with [No. of exposures] will decrease by 1.

● Images You Can Select

Lens Attached	Cropped Shooting	Selectable Images
RF/ EF lens	Off	RAW images captured at full size
	On	RAW images from cropped shooting or taken with an EF-S lens
EF-S lens	—	

- These images cannot be selected as the first single exposure: Images captured with [📷: Highlight tone priority] set to [Enable] or [Enhanced], or images captured with [📷: Cropping/aspect ratio] not set to [Full-frame] or [1.6x (crop)].
- [Disable] is applied for [📷: Lens aberration correction] and [📷: Auto Lighting Optimizer] regardless of the settings of the image selected as the first single exposure.



- The ISO speed, Picture Style, high ISO speed noise reduction, color space, etc. set for the first image will also be applied for the subsequent images.
- If Picture Style is **[Auto]** for the image selected as the first image, **[Standard]** will be applied for shooting.
- You cannot select an image taken with another camera.
- **[Select image for multi. expo.]** is not available unless a lens is attached.



- You can also select a RAW image used in multiple-exposure shooting.
- Select **[Deselect img]** to cancel image selection.

Checking and Deleting Multiple Exposures During Shooting

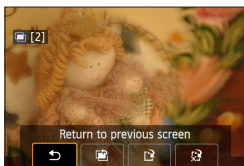

Before you finish shooting your specified number of exposures, you can press the button to view the multiple-exposure image so far, check exposure, and see how the images will be merged.

Pressing the button will display the operations possible during multiple-exposure shooting.

Operation	Description
Return to previous screen	The screen before you pressed the button will reappear.
Undo last image	Deletes the last image you shot (shoot another image). The number of remaining exposures will increase by 1.
Save and exit	Saves shots up to that point as a multiple-exposure image and exits multiple-exposure shooting.
Exit without saving	The multiple-exposure shooting will end without saving the image.



- During multiple-exposure shooting, you can only play back multiple-exposure images.

? FAQ

- **Are there any restrictions on the image quality?**

All single exposures and the multiple-exposure image are captured at your specified image quality.

- **Can I merge images recorded on the card?**

With [**Select image for multi. expo.**], you can select the first single exposure from the images recorded on the card (📖 168). Note that you cannot merge multiple images already recorded on the card.

- **Will auto power off take effect during multiple-exposure shooting?**

As long as [**Auto power off**] under [**⚡: Power saving**] is not set to [**Disable**], the camera automatically turns off after approx. 30 min., which ends multiple-exposure shooting and cancels multiple-exposure settings.

HDR (High Dynamic Range) Shooting

You can shoot still photos with clipped highlights and shadows reduced for a high dynamic range of tones even in high-contrast scenes. HDR shooting is effective for landscape and still-life shots.

With HDR shooting, three images of different exposures (standard exposure, underexposure, and overexposure) are captured consecutively for each shot and then merged together automatically. The HDR image is recorded as a JPEG image.

* HDR stands for High Dynamic Range.

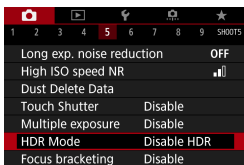

1 Select [📷: HDR Mode].

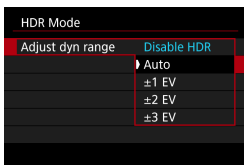

2 Set [Adjust dyn range].

- Selecting **[Auto]** will have the dynamic range set automatically depending on the image's overall tonal range.
- The higher the number, the wider the dynamic range will be.
- To exit HDR shooting, select **[Disable HDR]**.

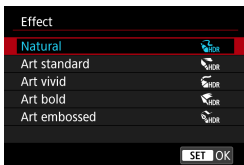

3 Set [Effect].

Effects

-  **Natural**

For images preserving a wide tonal range where the highlight and shadow details would otherwise be lost. Clipped highlights and shadows will be reduced.

-  **Art standard**

While the clipped highlights and shadows will be reduced more than with **[Natural]**, the contrast will be lower, and the gradation flatter to have the picture look like a painting. The subject outlines will have bright (or dark) edges.

-  **Art vivid**

The colors are more saturated than with **[Art standard]**, and the low contrast and flat gradation create a graphic art effect.

-  **Art bold**

The colors are the most saturated, making the subject pop out, and the picture looks like an oil painting.

-  **Art embossed**

The color saturation, brightness, contrast and gradation are decreased to make the picture look flat. The picture looks faded and old. The subject outlines will have bright (or dark) edges.

	Art standard	Art vivid	Art bold	Art embossed
Saturation	Standard	High	Higher	Low
Outline emphasis	Standard	Weak	Strong	Stronger
Brightness	Standard	Standard	Standard	Dark
Tone	Flat	Flat	Flat	Flatter

-  Each effect will be applied based on the characteristics of the Picture Style currently set (📖 148).

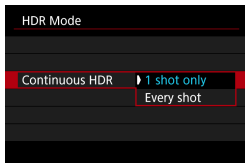

4 Set a [Continuous HDR] option.

- With [1 shot only], HDR shooting will be canceled automatically after the shooting ends.
- With [Every shot], HDR shooting continues until the setting in step 2 is set to [Disable HDR].

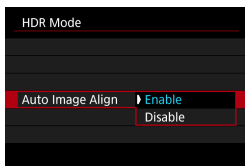

5 Set [Auto Image Align].

- For handheld shooting, select [Enable]. When using a tripod, select [Disable].

6 Take the picture.

- When you press the shutter button completely, three consecutive images will be captured, and the HDR image will be recorded to the card.

- RAW HDR images are captured in JPEG **L** image quality. RAW+JPEG HDR images are captured in the specified JPEG image quality.
- HDR shooting is not possible with expanded ISO speeds (L, H1, H2). HDR shooting is possible within ISO 100–40000 (varies depending on the settings of **[Minimum]** and **[Maximum]** for **[ISO speed range]**).
- The flash will not fire during HDR shooting.
- AEB is not available.
- If you shoot a moving subject, the moving subject may leave afterimages.
- In HDR shooting, three images are captured with different shutter speeds set automatically. For this reason, even in **<Fv>**, **<Tv>**, and **<M>** modes, the shutter speed will change, relative to your specified speed.
- To prevent camera shake, a high ISO speed may be set.



- When shooting HDR images with **[Auto Image Align]** set to **[Enable]**, AF point display information (📖 352) and Dust Delete Data (📖 161) will not be appended to the image.
- If you perform handheld HDR shooting with **[Auto Image Align]** set to **[Enable]**, image periphery will be slightly trimmed and resolution will be slightly lowered. Also, if the images cannot be aligned properly due to camera shake, etc., auto image alignment may not take effect. Note that when shooting with excessively bright (or dark) exposure settings, auto image alignment may not work properly.
- If you perform handheld HDR shooting with **[Auto Image Align]** set to **[Disable]**, the three images may not be properly aligned and the HDR effect may be reduced. Using a tripod is recommended.
- Auto image alignment may not function properly with repetitive patterns (lattice, stripes, etc.) or flat, single-tone images.
- The color gradation of the sky or white walls may not be reproduced correctly. Irregular colors, irregular exposure or noise may appear.
- HDR shooting under fluorescent or LED lighting may result in unnatural color reproduction of the illuminated areas.
- With HDR shooting, the images will be merged, then saved to the card, so it may take some time. **[BUSY]** appears on the screen as images are processed, and shooting is not possible until processing is finished.

Interval Timer Shooting

With the interval timer, you can set the shooting interval and number of shots, so that the camera takes individual shots repeatedly according to your interval until your specified number of shots are taken.

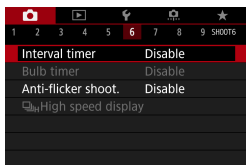

1 Select [: Interval timer].

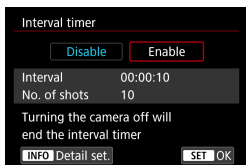

2 Select [Enable].

- Select [Enable], then press the <INFO> button.

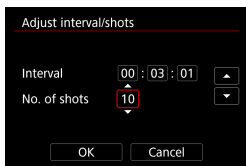

3 Set the shooting interval and number of shots.

- Select an item to set (hours : minutes : seconds / number of shots).
- Press <SET> to display <⏏>.
- Set the desired number, then press <SET>. (Returns to <□>.)

● Interval

Can be set in a range of [00:00:01]–[99:59:59].

● Number of shots

Can be set in a range of [01]–[99]. To keep the interval timer on indefinitely until you stop it, set [00].

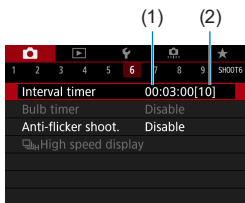

4 Select [OK].

- ▶ The interval timer settings will be displayed on the menu screen.

- (1) Interval
- (2) Number of shots

5 Take the picture.

- ▶ First shot is taken and shooting continues according to the interval timer settings.
- During interval timer shooting, < **TIMER** > will blink.
- After the set number of shots are taken, the interval timer shooting will stop and be automatically canceled.



- Using a tripod is recommended.
- Taking test shots in advance is recommended.
- Even during interval timer shooting, you can still shoot as usual by pressing the shutter button completely. Note that the camera will prepare for the next interval timer shot approx. 5 sec. in advance, which will temporarily prevent operations such as adjusting shooting settings, accessing menus, and playing back images.
- If the next scheduled interval timer shot is not possible because the camera is shooting or processing images, it will be skipped. For this reason, fewer shots than specified will be taken.
- Even during interval timer operation, auto power off is triggered after approx. 8 sec. of inactivity, as long as [**Auto power off**] under [**⚡: Power saving**] is not set to [**Disable**]. The camera will automatically turn on again approx. 1 min. before the next shot.
- Can also be combined with AEB, white balance bracketing, multiple exposures, and HDR mode.
- To stop interval timer shooting, select [**Disable**] or set the power switch to <OFF>.



- Do not point the camera toward an intense light source, such as the sun or an intense artificial light source. Doing so may damage the image sensor or the camera's internal components.
- Setting the lens focus mode switch to <AF> prevents the camera from shooting unless subjects are in focus. Setting it to <MF> and focusing manually before shooting is recommended.
- When shooting over an extended period, consider using an optional household power outlet accessory.
- Shooting long exposures or using shutter speeds longer than the shooting interval will prevent shooting at the specified interval. For this reason, fewer shots than specified will be taken. Using shutter speeds nearly the same as the shooting interval may also reduce the number of shots.
- If the time it takes to record to the card exceeds the shooting interval due to the shooting functions set or card performance, some of the shots may not be taken with the set intervals.
- When using flash with interval timer shooting, set an interval longer than the flash charge time. Intervals that are too short may prevent the flash from firing.
- Intervals that are too short may prevent shooting or autofocusing.
- Interval timer shooting will be canceled and reset to **[Disable]** if you set the power switch to <OFF>, set the shooting mode to <Q1/Q2/Q3>, or use EOS Utility (EOS software).
- During interval timer shooting, you cannot use remote control shooting (📖 217) or remote-release shooting with a Speedlite.

Reducing Flicker

If you shoot an image with a fast shutter speed under a light source such as fluorescent light, the blinking of the light source causes flicker and the image may be vertically unevenly exposed. If continuous shooting is used under these conditions, uneven exposures or colors across the images may result. Anti-flicker shooting enables you to take pictures when exposure and colors are less affected by flickering.

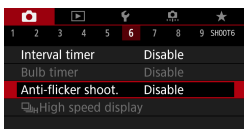

1 Select [: Anti-flicker shoot.].

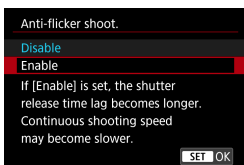

2 Select [Enable].

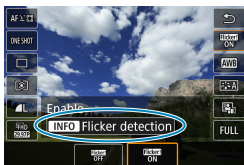

3 Take the picture.

- After setting to **[Enable]**, or when the light source changes, detect flicker before shooting by pressing the **<Q>** button, selecting **[Anti-flicker shoot.]**, then pressing the **<INFO>** button.
- The picture will be taken with reduced unevenness of exposure or color tone caused by the flicker.



- With **[Enable]** set, the shutter-release time lag is longer when you shoot under a flickering light source. Also, the continuous shooting speed may become slower, and the shooting interval may become irregular.
- Flicker at a frequency other than 100 Hz or 120 Hz cannot be detected. Also, if the flickering frequency of the light source changes during continuous shooting, effects of the flicker cannot be reduced.

- In the <Fv>, <P>, or <Av> mode, if the shutter speed changes during continuous shooting or if you shoot multiple shots of the same scene at different shutter speeds, the color tone may become inconsistent. To avoid inconsistent color tones, use <Fv>, <P>, or <Av> mode at a fixed shutter speed.
- Color tone of captured images may vary between **[Enable]** and **[Disable]**.
- Shutter speed, aperture, and ISO speed may change when you start shooting (even with AE lock).
- If the subject is against a dark background or if there is a bright light in the image, flicker may not be properly detected.
- Flicker reduction may not be possible under special lighting.
- Depending on the light source, flicker may not be detected properly.
- Depending on the light sources or shooting conditions, the expected result may not be obtained even if you use this function.

- Taking test shots in advance is recommended.
- Detect flicker manually if the screen flickers (as when the light source changes) by pressing the <Q> button, selecting **[Anti-flicker shoot.]**, then pressing the <INFO> button.
- Flicker is not reduced in Basic Zone modes.
- Flicker reduction also works with flash photography. However, the expected result may not be obtained for wireless flash photography.

Selecting the Display Speed for High-Speed Continuous Shooting

High-speed display that switches between your shot and the live image is available when shooting with an RF lens, with [**AF operation**] set to [**Servo AF**], and with the drive mode set to <[**H**]> [**High speed continuous**]. Display is more responsive, making it easier to follow fast-moving subjects.

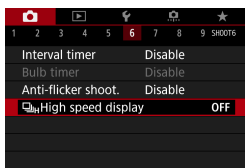

1 Select [**AF** : **H**] High speed display).

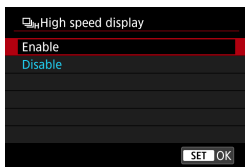

2 Select an item.

- Select [**Enable**] for display that switches between each shot and the live image.



- Images may waver or flicker during high-speed display. This occurs more often at high shutter speeds. However, this does not affect shooting results.
- High-speed display is not performed under the following conditions. It may also stop as you are shooting.
 - Shutter speed slower than 1/30 sec., aperture larger than f/11, conditions that make autofocusing difficult, and flash photography, and ISO expansion



- [**Enable**] is available when all of these conditions apply.
 - With an RF lens, [**AF operation**] set to [**Servo AF**] (📖 185), drive mode set to [**High speed continuous**] (📖 206), [**Anti-flicker shoot.**] set to [**Disable**] (📖 179), [**Expo. simulation**] set to [**Enable**] (📖 139)

Card Reminder

You can set the camera not to shoot unless there is a card in the camera. The default setting is **[Enable]**.

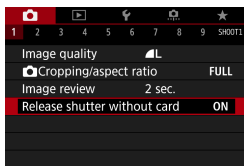

1 Select [: Release shutter without card].

2 Select [Disable].

Setting Touch & Drag AF

You can move the AF point or Zone AF frame by touching or dragging on the screen as you look through the viewfinder.

Enabling Touch & Drag AF

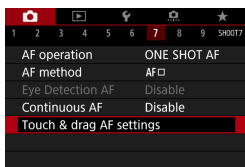

1 Select [: Touch & drag AF settings].

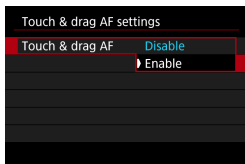

2 Select [Touch & drag AF].
● Select [Enable].

Positioning Method

You can set how positions are specified by touching or dragging.

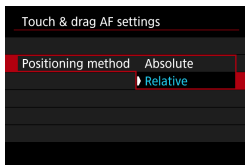

1 Set the positioning method.

● [Absolute]

The AF point moves to the touched or dragged position on the screen.

● [Relative]

The AF point moves in the direction you drag, by an amount corresponding to the amount you drag, no matter where you touch the screen.

Active Touch Area

You can specify the area of the screen used for touch and drag operations.

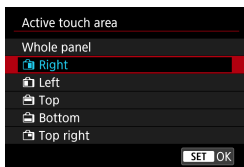

1 Set the active touch area.



- Touching the screen when [**☺+Tracking**] is set displays a round orange frame <C>. After you lift your finger at the position to move the AF point to, <P D> is displayed and that subject is tracked. To cancel subject selection, press the <🗑> button.

Selecting the AF Operation

You can select the AF operation characteristics to suit the shooting conditions or subject.

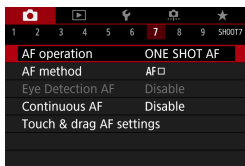

1 Select [: AF operation].



2 Select an item.





- If focus cannot be achieved, the AF point will turn orange. If this occurs, the picture cannot be taken even if the shutter button is pressed completely. Recompose the shot and try to focus again. Or, see “Shooting Conditions that Make Focusing Difficult” (197).

One-Shot AF for Still Subjects (ONE SHOT)

Suited for still subjects. When you press the shutter button halfway, the camera will focus only once.

- When focus is achieved, the AF point will turn green and the beeper will sound.
- The focus remains locked while you hold down the shutter button halfway, allowing you to recompose the image before taking the picture.
- For details on the continuous shooting speed for continuous shooting, see  206.





-  ● If [: **Beep**] is set to [**Disable**], the beeper will not sound when focus is achieved.

Servo AF for Moving Subjects (SERVO)

This AF operation is suited for moving subjects. While you hold down the shutter button halfway, the camera will keep focusing on the subject continuously.

- When focus is achieved, the AF point will turn blue.
- The exposure is set at the moment the picture is taken.
- For details on the continuous shooting speed for continuous shooting, see  206.

-  ● Depending on the lens used, the distance to the subject and the subject's speed, the camera may not be able to achieve correct focus.
- Zooming during continuous shooting may throw off the focus. Zoom first, then recompose and shoot.

-  ● With Servo AF, the beeper will not sound even when focus is achieved.
- In <+> mode, by default, the camera automatically switches to Servo AF in response to subject movement. If you normally prefer to shoot with One-Shot AF, set [:  **Auto servo**] to [**Disable**].

AF-Assist Beam

The AF-assist beam may fire repeatedly when you press the shutter button halfway under low light or in similar conditions, to make autofocus easier.



- The AF-assist beam does not fire when [: **AF operation**] is set to [**Servo AF**].
- The AF-assist beam does not fire when Touch AF is used (when [: **Touch Shutter**] is set to [**Disable**]).
- When you are using an external flash unit, either the camera or the flash unit fires an AF-assist beam as needed. However, only the camera's AF-assist beam fires when you are using a Speedlite 90EX, Macro Ring Lite, or Macro Twin Lite.
- A small series of flashes is fired even if you set the external flash's AF-assist beam emission method in the Personal Functions to infrared AF-assist beam firing. To disable AF-assist beam firing, set [: **AF-assist beam firing**] to [**Disable**] (201).



- Focus range with the AF-assist beam is generally no more than 3.5 m/11.5 ft.

Selecting the AF Method

You can select the AF method to suit the shooting conditions or subject. The camera attempts to focus on faces of any people in an AF point or Zone AF frame. In <[A+]> mode, [Face+Tracking] is set automatically. For instructions on selecting an AF method, see [190].

AF Method



[Face+Tracking]: Face+Tracking

The camera detects and focuses on people's faces. <[]> (an AF point) appears over any face detected, which is then tracked.

If no face is detected, the entire AF area is used for auto selection AF. With Servo AF, you can set the initial position for Servo AF ([192]). As long as the Area AF frame can track the subject during shooting, focusing will continue.

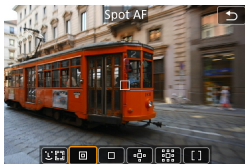

[Spot AF]: Spot AF

The camera focuses in a narrower area than 1-point AF.



[1-point AF]: 1-point AF

The camera focuses using a single AF point <[]>.

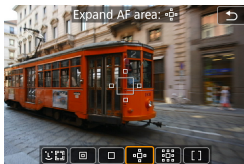

☐ : Expand AF area (☐)

Focusing uses one AF point <☐> and points above, below, and to the left and right <☐>. Effective for moving subjects, which are difficult to track with 1-point AF.

Focusing on your preferred subject is easier than with Zone AF. When Servo AF is used, first you will focus using an AF point <☐>.

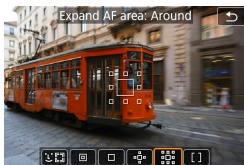

☐☐☐ : Expand AF area: Around

Focusing uses one AF point <☐> and surrounding points <☐>, which makes it easier to focus on moving subjects than with ☐ AF point expansion.

Servo AF operation is the same as for ☐ AF point expansion.

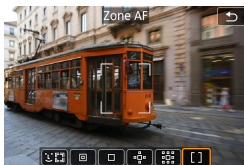

[] : Zone AF

Uses auto selection AF in Zone AF frames to cover a larger area than AF point expansion, which makes focusing easier than with AF point expansion.

Prioritizes focusing on the nearest subject. Faces of any people in the Zone AF frame are also given priority in focusing. AF points in focus are displayed with <☐>.

Selecting the AF Method

You can select the AF method to suit the shooting conditions or subject. If you prefer to focus manually, see 214.

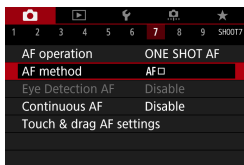

1 Select [: AF method].

2 Select an item.







- In $\langle \text{A}^+ \rangle$ mode, [+Tracking] is set automatically.
- In $\langle \text{AF} \rangle$ mode, only [1-point AF] or [Zone AF] can be set.
- Only [+Tracking] and [1-point AF] are available when 4K movie recording is set.
- To set the AF method, you can also access the AF method screen by pressing the $\langle \text{AF} \rangle$ button and then the $\langle \text{M-Fn} \rangle$ button.
- The descriptions on 191– 194 assume that [: AF operation] is set to [One-Shot AF] (186). With [Servo AF] (186) set, the AF point will turn blue when focus is achieved.
- Regarding the Touch Shutter (AF and shutter release by touch operation), see 163.

● (face)+Tracking:

The camera detects and focuses on human faces. If a face moves, the AF point  also moves to track the face.



1 Check the AF point.

- ▶  (an AF point) appears over any face detected.
- You can choose a face with the   keys when  appears after you press the .

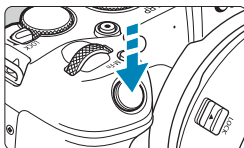

2 Focus on the subject.

- Once you press the shutter button halfway and the subject is in focus, the AF point turns green and the camera beeps twice.
- ▶ An orange AF point indicates that the camera could not focus on subjects.







3 Take the picture.

Tapping a Face for Focus



Tapping a face or subject to focus on changes the AF point to  and focuses where you tap.

Even if the face or subject moves on the screen, the AF point  moves to track it.





-  ● If the subject's face is significantly out of focus, face detection will not be possible. Adjust the focus manually ( 214) so that the face can be detected, then perform AF.
- An object other than a human face may be detected as a face.
- Face detection will not work if the face is very small or large in the picture, too bright or too dark, or partially hidden.
- AF cannot detect subjects or people's faces at the edges of the screen. Recompose the shot to center the subject or bring the subject closer to the center.

-  ● The  may cover only a part of the face, not the whole face.
- The size of the AF point changes depending on the subject.

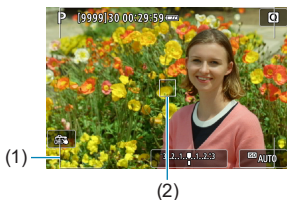
Setting the Initial Servo AF Position

1. Set [ **C.Fn II-7: Initial Servo AF pt for **] to an option other than **[Automatic]**.
2. An Area AF frame (1) and AF point (2) are displayed.



3. Press the  button, then turn the  or  dial to move the AF point to the position to focus on. You can also move the AF point by touching the screen or pressing the  cross keys. Pressing the  button will return the AF point to the screen center.
4. Press **<SET>** to set the current position as the starting position for Servo AF.

● Spot AF / 1-point AF / Expand AF area () / Expand AF area: Around / Zone AF

You can manually set the AF point or Zone AF frame. Here, 1-point AF screens are used as an example.









(1)

1 Check the AF point.

- ▶ The AF point (1) will appear.
- With Expand AF area () or Expand AF area: Around, adjacent AF points are also displayed.
- With Zone AF, the Zone AF frame is displayed.



2 Move the AF point.

- Press the  button.
- Move the AF point to where you want to focus by turning the  dial to move horizontally or  dial to move vertically. (With some lenses, it may not go to the edge of the screen.)
- You can also move the AF point by touching the screen or pressing the  cross keys.
- To center the AF point or Zone AF frame, press the  button.
- To magnify display, press the  button. Each press of the  button changes the magnification ratio.

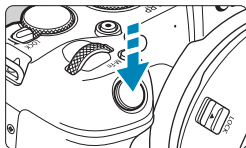

3 Focus on the subject.

- Aim the AF point over the subject and press the shutter button halfway.
- ▶ When focus is achieved, the AF point will turn green and the beeper will sound.
- ▶ If focus is not achieved, the AF point will turn orange.



4 Take the picture.

- ! The camera will keep moving the active AF point <□> to track subjects for Zone AF when Servo AF operation is used, but under some shooting conditions (such as when subjects are small), it may not be possible to track the subject.
- Focusing may be difficult when using a peripheral AF point. In this case, select an AF point in the center.

- ☰ With [**C.Fn II-6: Orientation linked AF point**], you can set separate AF points for vertical and horizontal shooting (📖 534).

Magnified View

You can check the focus by magnifying display by approx. 5× or 10×.

Magnified view is not possible with [Fn]+Tracking].

- Magnification is centered on the AF point for **[Spot AF]**, **[1-point AF]**, **[Expand AF area (•••)]**, and **[Expand AF area: Around]** and is centered on the Zone AF frame for **[Zone AF]**.
- Autofocusing is performed with magnified display if you press the shutter button halfway when set to **[1-point AF]**, and **[Spot AF]**. When set to other AF methods, autofocusing is performed after restoring normal display.
- With Servo AF, if you press the shutter button halfway in the magnified view, the camera will return to the normal view for focusing.



- If focusing is difficult in the magnified view, return to the normal view and perform AF.
- If you perform AF in the normal view and then use the magnified view, accurate focus may not be achieved.
- AF speed differs between normal view and magnified view.
- Continuous AF and Movie Servo AF are not available when display is magnified.
- With the magnified view, achieving focus becomes more difficult due to camera shake. Using a tripod is recommended.

Notes for AF

AF Operation

- Even when focus is achieved, pressing the shutter button halfway will focus again.
- Image brightness may change during autofocusing.
- Depending on the subject and shooting conditions, it may take longer to focus, or the continuous shooting speed may decrease.
- If the light source changes as you shoot, the screen may flicker, and focusing may be difficult. In this case, restart the camera and resume shooting with AF under the light source you will use.



- If focusing is not possible with AF, focus manually (📖 214).
- For subjects at the edge of the screen that are slightly out of focus, try centering the subject (or AF point, or Zone AF frame) to bring them into focus, then recompose the shot before shooting.
- With certain lenses, it may take more time to achieve focus with autofocus, or accurate focusing may not be achieved.

Shooting Conditions that Make Focusing Difficult

- Subject with low-contrast such as the blue sky, solid-color flat surfaces or when highlight or shadow details are clipped.
- Subjects in low light.
- Stripes and other patterns where there is contrast only in the horizontal direction.
- Subjects with repetitive patterns (Example: Skyscraper windows, computer keyboards, etc.).
- Fine lines and subject outlines.
- Under a light source whose brightness, color, or pattern keeps changing.
- Night scenes or points of light.
- The image flickers under fluorescent or LED lighting.
- Extremely small subjects.
- Subjects at the edge of the screen.
- Strongly backlit or reflective subjects (Example: Car with a highly reflective body, etc.).
- Near and distant subjects covered by an AF point (Example: Animal in a cage, etc.).
- Subjects that keep moving within the AF point and will not stay still due to camera shake or subject blur.
- Performing AF when the subject is very far out of focus.
- Soft focus effect is applied with a soft focus lens.
- A special effect filter is used.
- Noise (dots of light, banding, etc.) appears on the screen during AF.

AF Range

The available autofocus range varies depending on the lens and aspect ratio used and whether you are recording 4K movies or using features such as Movie cropping or Movie digital IS.

Focusing on People's Eyes

With the AF method set to [**AF+Tracking**], you can shoot with the subject's eyes in focus.

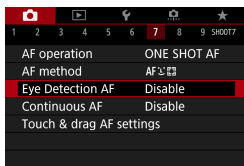

1 Select [**📷: Eye Detection AF**].

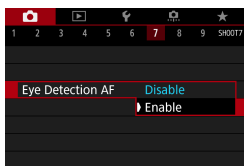

2 Select [**Enable**].



3 Aim the camera at the subject.

- ▶ An AF point is displayed around their eye.
- You can tap the screen to select an eye for focus.

The entire face is selected when you tap other facial features, such as their nose or mouth. Eyes to focus on are selected automatically.

- Depending on the [**Eye Detection AF**] setting, you can choose an eye or face for focus with the <◀> <▶> keys when <📷> appears after you press the <📷> button.

4 Take the picture.

- ! Subject eyes may not be detected correctly, depending on the subject and shooting conditions.

- 📄 To disable Eye Detection AF without using menu operations, press these buttons, one after another: <📷>, <M-Fn>, and <INFO>. To resume Eye Detection AF, press the <INFO> button again.

Setting Continuous AF

This function keeps subjects generally in focus. The camera is ready to focus immediately when you press the shutter button halfway.

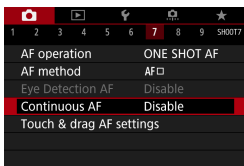

1 Select [: Continuous AF].

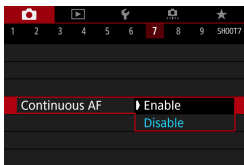

2 Select [Enable].



- Enabling this function reduces the number of shots available, because the lens is driven continuously and battery power is consumed.

Setting Lens Electronic MF



For RF, EF, or EF-S lenses equipped with electronic manual focusing, you can specify how manual focus adjustment is used with One-Shot AF.

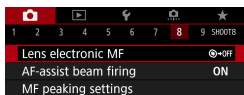

1 Select [: Lens electronic MF].

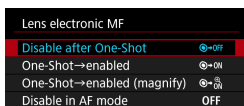

2 Select an item.

● [→OFF] Disable after One-Shot

Manual focus adjustment after the AF operation is disabled.

● [→ON] One-Shot→enabled

You can manually adjust the focus after the AF operation if you keep holding down the shutter button halfway.

● [→ ON] One-Shot→enabled (magnify)

After the AF operation, you can keep holding down the shutter button halfway as you turn the lens focusing ring to magnify the area in focus and manually adjust the focus.

● [OFF] Disable in AF mode

Manual focus adjustment is disabled when the lens's focus mode switch is set to <AF>.

- With [**One-Shot→enabled (magnify)**], display may not be magnified even if you turn the lens focusing ring while pressing the shutter button halfway immediately after shooting. If so, you can magnify display by releasing the shutter button, waiting for <Q> display, then pressing the shutter button halfway as you turn the lens focusing ring.

- For details on your lens's manual focus specifications, refer to the lens instruction manual.

Setting AF-Assist Beam Firing

You can specify how the AF-assist beam is used on the camera or a Speedlite.

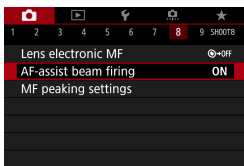

1 Select [: AF-assist beam firing].

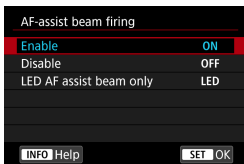

2 Select an item.

- **[ON] Enable**

Enables firing of the AF-assist beam, when needed.

- **[OFF] Disable**

Disables firing of the AF-assist beam. Set if you prefer not to fire AF-assist beams from the camera and external flash units.

- **[LED] LED AF assist beam only ☆**

An LED AF-assist beam is fired by LED-equipped external flash units. If your external flash unit is not LED-equipped, the camera's AF-assist beam is fired instead.



- If an external Speedlite's **[AF-assist beam firing]** Custom Function is set to **[Disable]**, this function's setting will be overridden and the AF-assist beam will not be emitted.

Focus Bracketing



Focus bracketing* enables continuous shooting with the focal distance changed automatically after a single shot. From these images, you can create a single image in focus over a wide area by using an application that supports depth compositing, such as Digital Photo Professional (EOS software).

* "Bkt." stands for bracketing.

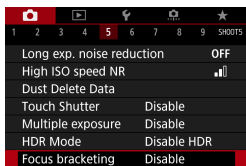

1 Select [: Focus bracketing].

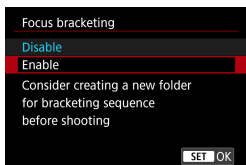

2 Specify [Focus bracketing].

- Select [Enable].



3 Set the number of images.

- Specify the number of images captured per shot.
- Can be set in a range of [2]–[999].

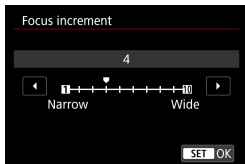

4 Set [Focus increment].

- Specify how much to shift the focus. This amount is automatically adjusted to suit the aperture value at the time of shooting. Because larger aperture values increase the focus shift, focus bracketing covers a wider range under the same **[Focus increment]** and **[Number of shots]** settings in that case.
- After completing the settings, press the <MENU> button.
- To save your shots in a new folder, tap **[]** and select **[OK]**.

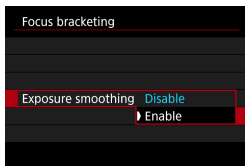

5 Set [Exposure smoothing].

- You can suppress changes in image brightness during focus bracketing by setting **[Exposure smoothing]** to **[Enable]**, which compensates for changes in the actual aperture value (effective f/number) at each focus position.

6 Take the picture.

- Focus at the nearer end of your preferred focal range, then press the shutter button completely.
- Once shooting begins, release the shutter button.
- The camera shoots continuously, shifting the focal position toward infinity.
- Shooting ends after your specified number of images, or at the far end of the focal range.



- Focus bracketing is intended for still photo shooting on a tripod.
- Shooting with a wider angle of view is recommended. After depth compositing, you can crop the image if necessary.
- The following lenses can be used (as of October 2018).
 - RF35mm F1.8 MACRO IS STM
 - RF50mm F1.2 L USM
 - RF28-70mm F2 L USM
 - RF24-105mm F4 L IS USM
 - EF16-35mm f/4L IS USM
 - EF24-70mm f/4L IS USM
 - EF100mm f/2.8L MACRO IS USM
 - EF180mm f/3.5L MACRO USM
 - EF-S35mm f/2.8 MACRO IS STM
 - EF-S60mm f/2.8 MACRO USM
- Set **[Exposure smoothing]** to **[Disable]** with the following lenses, because they may cause changes in image brightness.
 - EF100mm f/2.8L MACRO IS USM
 - EF180mm f/3.5L MACRO USM
 - EF-S60mm f/2.8 MACRO USM
- Suitable **[Focus increment]** settings vary by subject. An unsuitable **[Focus increment]** setting may cause unevenness in composite images, or shooting may take more time because more shots are taken. Take some test shots to decide a suitable **[Focus increment]** setting.
- Combining images may take some time when the **[Number of shots]** setting is high.
- Flash photography is not possible.
- Shooting under flickering light may cause uneven images. In this case, lowering the shutter speed may give better results.
- Focus bracketing is not available when the lens's focus mode switch is set to **<MF>**.
- Canceling shooting in progress may cause exposure problems in the last image. Avoid using the last image when combining the images in Digital Photo Professional.



- Use of a tripod, remote switch (sold separately, 219), or wireless remote control (sold separately, 217) is recommended.
- For best results, set the aperture value in a range of f/5.6–11 before shooting.
- Details such as shutter speed, aperture value, and ISO speed are determined by conditions for the first shot.
- If [: **Picture Style**] is set to [**Auto**], [**Standard**] will be applied for shooting.
- To cancel shooting, press the shutter button completely again.
- [**Focus bracketing**] switches to [**Disable**] when the power switch is set to <OFF>.

Selecting the Drive Mode

Single and continuous drive modes are provided. You can select the drive mode suiting the scene or subject.

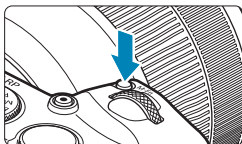

1 Press the <M-Fn> button (⚙️).

- With an image displayed on the screen, press the <M-Fn> button.



2 Select the drive mode item.

- Turn the <⚙️> dial to select the drive mode item.



3 Select the drive mode.

- Turn the <⚙️> dial to make a selection.

● [□] Single shooting

When you press the shutter button completely, only one shot will be taken.

● [□H] High-speed continuous shooting

When you hold down the shutter button completely, you can shoot continuously at **max. approx. 5.0 shots/sec.** while you keep holding it down.

However, the maximum continuous shooting speed may become slower under the following conditions:

● When set to reduce flicker:

The continuous shooting speed will be **max. approx. 4.0 shots/sec.**

- **With Servo AF shooting:**

When **[AF operation]** is set to **[Servo AF]**, the continuous shooting speed of **max. approx. 4.0 shots/sec.** will be given priority.

- **In flash photography:**

With EL or EX series Speedlites, the continuous shooting speed will be **max. approx. 2.3 shots/sec.**

- **[] Low-speed continuous shooting**



When you hold down the shutter button completely, you can shoot continuously at **max. approx. 2.6 shots/sec.** while you keep holding it down.

When **[AF operation]** is set to **[Servo AF]**, subject tracking with a continuous shooting speed of **max. approx. 2.6 shots/sec.** is given priority.

- **[] Self-timer: 10 sec./remote control**

- **[] Self-timer: 2 sec./remote control**

- **[] Self-timer: Continuous shooting**

For self-timer shooting, see  209. For remote control shooting, see  217.



- During **<H>** high-speed continuous shooting, the maximum continuous shooting speed varies depending on the shooting conditions. For details, see the next page.



- Approx. 5.0 shots/sec. is the maximum high-speed continuous shooting speed (📖 206) under these conditions: shooting with a fully charged battery in One-Shot AF mode at a 1/500 sec. or faster shutter speed and maximum aperture (depending on the lens), Image Stabilizer off (depending on the lens), at room temperature (23°C / 73°F), with flicker reduction, and Digital Lens Optimizer disabled.
- The continuous shooting speed for high-speed continuous shooting may be lower, depending on conditions such as these: battery level, temperature, flicker reduction, shutter speed, aperture, subject conditions, brightness, AF operation, type of lens, use of flash, and shooting settings.
- With Servo AF, the maximum continuous shooting speed may become slower depending on subject conditions or the lens used.
- With : **Anti-flicker shoot.** set to **[Enable]** (📖 179), shooting under flickering light will decrease the maximum continuous shooting speed. Also, the continuous shooting interval may become irregular and the release time lag may become longer.
- Even with low-speed continuous shooting, the continuous shooting speed may become slower depending on the shooting conditions.
- When internal memory becomes full during continuous shooting, the continuous shooting speed may drop off because shooting will be temporarily disabled (📖 118).

Using the Self-Timer

Use the self-timer when you want to be in the picture such as a commemorative photograph.

1 Press the <M-Fn> button (Ⓜ/6).

- With an image displayed on the screen, press the <M-Fn> button.



2 Select the drive mode item.

- Turn the <Ⓜ/6> dial to select the drive mode item.

3 Select the self-timer.

- Turn the <Ⓜ/6> dial to select the self-timer.

Ⓜ/6 (☀️): Shoot in 10 sec.

Ⓜ/6 (☀️): Shoot in 2 sec.

Ⓜ/6 (☀️): Shoot continuously in 10 sec. for the specified number of shots*

* To set the number of shots taken continuously (2–10), select the [Drive mode] item on the Quick Control screen, press the <INFO> button, then turn the <Ⓜ/6> dial.

- ☀️ and ☀️ icons are displayed when the camera is paired with a wireless remote control (sold separately,

☰ 217).



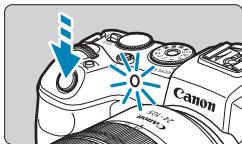

4 Take the picture.

- Focus on the subject, then press the shutter button completely.
- ▶ To check operation, look at the self-timer lamp, listen for beeps, or watch the countdown in seconds on the screen.
- ▶ Self-timer lamp blinking accelerates and the camera beeps quickly approx. 2 sec. before the picture is taken.

- With <S/C>, the shooting interval may become longer under some shooting conditions, depending on image quality, use of external flash, and other factors.

- <S₂> enables you to shoot without touching the camera mounted on a tripod. This prevents camera shake if you shoot still-life or long exposures.
- After taking self-timer shots, playing back the image (📖 296) to check focus and exposure is recommended.
- When using the self-timer to shoot yourself, use focus lock (📖 71) on an object at the same distance as where you will stand.
- To cancel the self-timer after it starts, either tap the screen or press <SET>.
- Auto power off time may be extended when the camera is set for remote shooting.

Selecting the Metering Mode

You can select one of four methods to measure the subject brightness. In Basic Zone modes, evaluative metering is set automatically.

1 Press the <Q> button (10).

- With an image displayed, press the <Q> button.

2 Select the metering mode.

- Use the <▲> <▼> keys to select the item shown.
- Use the <◀> <▶> keys to select the metering mode.

[☉]: Evaluative metering

[☉]: Partial metering

[◼]: Spot metering

[◻]: Center-weighted average metering



● [☉] Evaluative metering

General-purpose metering mode suited even for backlit subjects. The camera adjusts the exposure automatically to suit the scene.

● [☉] Partial metering

Effective where there are much brighter lights around the subject due to backlight, etc. Covers approx. 5.5% of the area at the center of the screen. The partial metering area is indicated on the screen.

● [◼] Spot metering

Effective when metering a specific part of the subject or scene. Covers approx. 2.7% of the area at the center of the screen. The spot metering area is indicated on the screen.

● [◻] Center-weighted average metering

The metering across the screen is averaged, with the center of the screen weighted more heavily.



- By default, the camera will set the exposure as follows.
With [M] (Evaluative metering), holding down the shutter button halfway will lock the exposure setting (AE lock) after focus is achieved with One-Shot AF. In the [P] (Partial metering), [S] (Spot metering), and [Av] (Center-weighted average metering) modes, the exposure is set at the moment the picture is taken. (Pressing the shutter button halfway does not lock the exposure.)
- With [C.Fn I-7: AE lock meter. mode after focus], you can set whether or not to lock the exposure (AE lock) when focus is achieved with One-Shot AF (p. 529).

Locking the Exposure for Shooting (AE Lock)

You can lock the exposure when you want to set the focus and exposure separately or when you are to take multiple shots at the same exposure setting. Press the **< * >** button to lock the exposure, then recompose and take the picture. This is called AE lock. It is effective for shooting backlit subjects, etc.

1 Focus on the subject.

- Press the shutter button halfway.
- ▶ The exposure setting will be displayed.

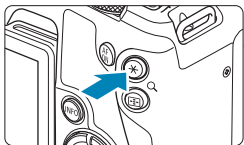

2 Press the **< * >** button (⊛8).

- ▶ A **< * >** icon is displayed in the lower left of the screen to indicate that exposure is locked (AE lock).
- Each time you press the **< * >** button, the current exposure setting is locked.

3 Recompose and take the picture.

- When you are to take more pictures while maintaining the AE lock, keep holding down the **< * >** button and press the shutter button to take another picture.



AE Lock Effects

Metering Mode	AF Point Selection Method	
	Automatic Selection	Manual Selection
	Exposure centered on the AF point in focus is locked.	Exposure centered on the selected AF point is locked.
	Exposure at the center of the screen is locked.	

* In [] mode with the lens's focus mode switch set to **<MF>**, the exposure at the center of the screen is locked.

Focusing Manually

If focusing is not possible with autofocus, you can magnify the image and focus manually.

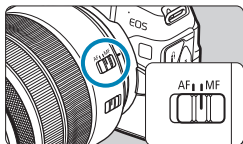

1 Set the lens's focus mode switch to <MF>.

- Turn the lens focusing ring to focus roughly.



2 Determine an area to magnify.

- Press the <[Grid Icon]> button to activate magnified display, then move it to where you want to focus by using the <[Gear Icon]> or <[Crosshair Icon]> dial or the <[Crosshair Icon]> cross keys.
- To center the magnified area, press the <[Trash Icon]> button.



(1) (2) (3)

3 Magnify the image.

- Each press of the <INFO> button changes the magnification ratio, as follows.

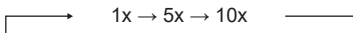

- (1) AE lock
- (2) Magnified area position
- (3) Magnification (Approx.)

4 Focus manually.

- While looking at the magnified image, turn the lens focusing ring to focus.
- After focusing, press the <INFO> button or <SET> to return to the normal view.

5 Take the picture.



- Even with manual focusing, you can use the Touch Shutter to take a picture.

Setting MF Peaking (Outline Emphasis)

Edges of subjects in focus can be displayed in color to make focusing easier. You can set the outline color and adjust the sensitivity (level) of edge detection (except in <A+> mode).

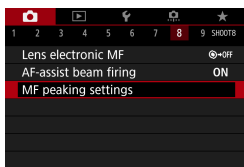

1 Select [: MF peaking settings].

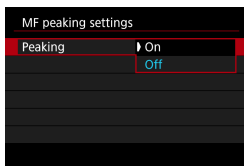

2 Select [Peaking].

- Select [On].

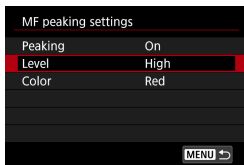

3 Set the level and color.

- Set it as necessary.

- Peaking display is not shown during magnified display.
- MF peaking may be hard to discern at high ISO speeds, especially when ISO expansion is set. If necessary, lower the ISO speed or set [Peaking] to [Off].

- Peaking display shown on the screen is not recorded in images.

Remote Control Shooting

Wireless Remote Control BR-E1 (sold separately) compatible with Bluetooth® low energy technology enables remote control shooting.

Pairing

To use BR-E1, you must first pair (connect and register) the camera and remote control. For pairing instructions, see  399.

Do the following after the devices are paired.

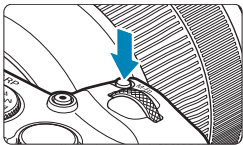

1 Press the <M-Fn> button ().

- With an image displayed on the screen, press the <M-Fn> button.





2 Select the drive mode item.

- Turn the <  > dial to select the drive mode item.



3 Select the self-timer/remote control.

- Turn the <  > dial to select <  > or <  2 >.

4 Take the picture.

- By pressing the <AF> button on the remote control, you can also autofocus.
- To shoot, press the release button on the remote control.
- **For detailed shooting instructions, refer to the BR-E1 instruction manual.**

 ● You cannot use infrared remote control units such as Remote Controller RC-6.

- 
- If focusing is not possible with AF, focus manually before shooting (📖 214).
 - Auto power off time may be extended when the camera is set for remote shooting.
 - The remote control can also be used for movie recording (📖 285).

Using a Remote Switch



You can shoot by connecting Remote Switch RS-60E3 (sold separately). For operating instructions, refer to the remote switch instruction manual.

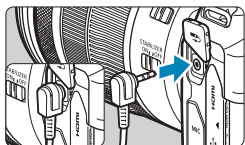

- 1** Open the terminal cover.
- 2** Connect the plug to the remote control terminal.

Flash Photography



EL/EX Series Speedlites for EOS Cameras

Using an EL/EX series Speedlite (sold separately) makes flash photography easy.

For operation procedures, refer to the EL/EX series Speedlite's Instruction Manual. This camera is a Type-A camera that can use all the features of EL/EX series Speedlites.

To set the flash functions and flash Custom Functions on the camera's menu screen, see  222.



● Flash exposure compensation

You can adjust flash output (flash exposure compensation). With an image displayed on the screen, press the <M-Fn> button, turn the < > dial to select the flash exposure compensation item, then turn the < > dial to set the flash exposure compensation. You can set flash exposure compensation up to ± 3 stops in 1/3-stop increments.



● FE lock

This enables you to attain an appropriate flash exposure for a specific part of the subject. Aim the viewfinder center over the subject, press the camera's < > button, then compose the shot and take the picture.



- Even if you set negative flash exposure compensation (to keep images darker), bright images may still be captured unless [: **Auto Lighting Optimizer**] ( 136) is set to [**Disable**].



- You can adjust the flash exposure compensation with Quick Control ( 65) or with [**Flash function settings**] under [: **External Speedlite control**] ( 225).
- The camera can turn on certain Speedlites automatically when the camera is turned on. For details, refer to the instruction manual of Speedlites that support this feature.

Canon Speedlites Other Than the EL/EX-Series

- **With an EZ/E/EG/ML/TL-series Speedlite set to A-TTL or TTL autoflash mode, the flash can be fired at full output only.**
Set the camera's shooting mode to <M> manual exposure or <Av> aperture-priority AE and adjust the aperture setting before shooting.
- When using a Speedlite that has manual flash mode, shoot in the manual flash mode.

Non-Canon Flash Units

● Sync Speed

The camera can synchronize with non-Canon compact flash units at up to 1/180 sec. With large studio flash units, the flash duration is longer than that of a compact flash unit and varies depending on the model. Before shooting, confirm that flash is synced correctly at approx. 1/60–1/30 sec.



- If the camera is used with a flash unit or flash accessory dedicated to another camera brand, the camera not only may not operate properly, but malfunction may result.
- Do not attach a high-voltage flash unit to the camera's hot shoe. It may not be fired.

Setting the Flash Function



With an EL/EX series Speedlite having compatible flash function settings, you can use the camera's menu screen to set the Speedlite's functions and Custom Functions. **Attach the Speedlite to the camera and turn on the Speedlite before setting the flash functions.**

For details on the Speedlite's functions, refer to the Speedlite's Instruction Manual.

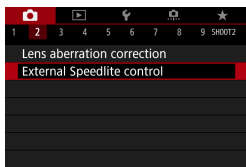

1 Select [: External Speedlite control].

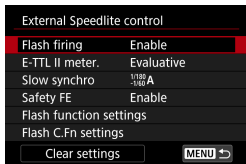

2 Select an item.

Flash Firing

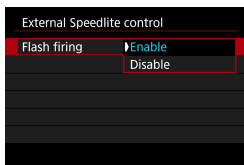

To enable flash photography, set to **[Enable]**. To disable flash firing or enable only the AF-assist beam, set to **[Disable]**.

Otherwise, when a Speedlite that supports auto flash firing is attached, the automatic firing is performed according to the shooting conditions. For detailed shooting instructions, refer to the instruction manual of Speedlites supporting auto flash firing.

E-TTL II Flash Metering

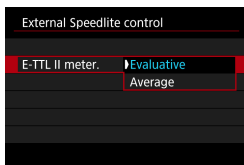

For normal flash exposures, set it to **[Evaluative]**. If **[Average]** is set, the flash exposure will be averaged for the entire metered scene.

Slow Synchro

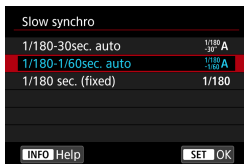

You can set the flash-sync speed for flash photography in <Av> aperture-priority AE mode or <P> Program AE mode.

- **[^{1/180}/₋₃₀ A] 1/180-30sec. auto**

The flash sync speed is set automatically within a range of 1/180 sec. to 30 sec. to suit the scene's brightness. Slow-sync shooting is used under some shooting conditions, in low-light locations, and shutter speed is automatically lowered.

- **[^{1/180}/_{-1/60} A] 1/180-1/60sec. auto**

Prevents a slow shutter speed from being set automatically in low-light conditions. It is effective for preventing subject blur and camera shake. However, while the subject will be properly exposed with the flash, the background may come out dark.

- **[1/180] 1/180 sec. (fixed)**

The flash sync speed is fixed at 1/180 sec. This more effectively prevents subject blur and camera shake than with **[1/180-1/60sec. auto]**. However, in low light, the subject's background will come out darker than with **[1/180-1/60sec. auto]**.

- By default, it is set to **[1/180-1/60sec. auto]**. To use slow-sync shooting in <Av> or <P> mode, set to **[1/180-30sec. auto]**.
- High-speed sync is not available in <Av> or <P> mode when set to **[1/180 sec. (fixed)]**.

Safety FE

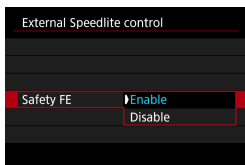

To avoid overexposure from the flash firing during the day or at close range, the camera can automatically lower the ISO speed and shoot with standard subject exposure when set to ISO Auto.

Flash Function Settings

The information displayed, position of display, and available options vary depending on the Speedlite model, its Custom Function settings, the flash mode, and other factors. For details on the Speedlite's functions, refer to the Speedlite's Instruction Manual.

Sample display

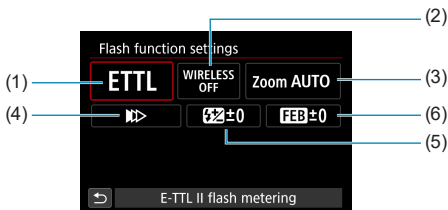

(1) Flash mode

(2) Wireless functions /
Firing ratio control

(3) Flash zoom (Flash coverage)

(4) Shutter synchronization

(5) Flash exposure compensation

(6) Flash exposure bracketing



- Functions are limited when using EX series Speedlites that are not compatible with flash function settings.

● Flash mode

You can select the flash mode to suit your desired flash photography.

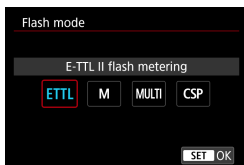

[E-TTL II flash metering] is the standard mode of EL/EX series Speedlites for automatic flash photography.

[Manual flash] is for setting the Speedlite's **[Flash output level]** yourself.

[CSP] (continuous shooting priority mode) automatically decreases flash output by one stop and increases ISO speed by one stop. Useful in continuous shooting, and helps conserve flash battery power.

Regarding other flash modes, refer to the Instruction Manual of a Speedlite compatible with the respective flash mode.



- Adjust exposure compensation (📖 128) as needed in case of overexposure from flash photography with **[CSP]** in **[Fv]**, **[Tv]**, or **[M]** mode.



- With **[CSP]**, ISO speed is automatically set to **[Auto]**. **[Safety FE]** is also set to **[Enable]** automatically. After canceling **[CSP]**, check the ISO speed and **[Safety FE]** setting.

● Wireless functions / Firing ratio control



Wireless (multiple) flash photography is possible with radio or optical transmission. For details on wireless flash, refer to the Instruction Manual of a Speedlite compatible with wireless flash photography.

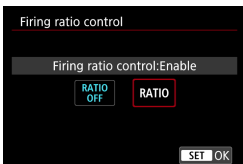

With a macro flash (MR-14EX II, etc.) compatible with flash function settings, you can set the firing ratio between flash tubes or flash heads A and B, or use wireless flash with additional receiver units. For details on firing ratio control, refer to the macro flash's Instruction Manual.

● Flash zoom (Flash coverage)

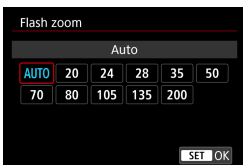

With Speedlites having a zooming flash head, you can set the flash coverage. Normally, set this to **[AUTO]** so that the camera will automatically set the flash coverage to match the lens focal length.

● Shutter synchronization

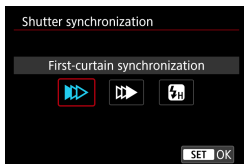

Normally, set this to **[First-curtain synchronization]** so that the flash fires immediately after the exposure starts.

If **[Second-curtain synchronization]** is set, the flash will be fired right before the shutter closes. When this is combined with a slow shutter speed, you can create a trail of light such as from car headlights at night with a more natural feel. When second-curtain synchronization is set together with **[E-TTL II flash metering]**, the flash will be fired twice in a row: once when you press the shutter button completely and once right before the end of the exposure.

If **[High-speed synchronization]** is set, the flash can be used at all shutter speeds. This is effective when you want to shoot with background blur (open aperture) in locations such as outdoors in daylight.

- When using second-curtain synchronization, set the shutter speed to 1/80 sec. or slower. If the shutter speed is 1/90 sec. or faster, first-curtain synchronization will be applied automatically even if **[Second-curtain synchronization]** is set.

● Flash exposure compensation

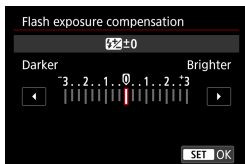

You can set flash exposure compensation up to ± 3 stops in $1/3$ -stop increments. For details, refer to the Speedlite's Instruction Manual.



- If flash exposure compensation is set with the Speedlite, you cannot set the flash exposure compensation with the camera. If it is set with both the camera and Speedlite, the Speedlite's setting overrides the camera's.

● Flash exposure bracketing

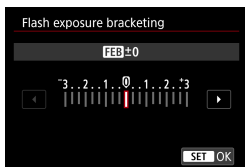

While changing the flash output automatically, three shots will be taken. For details, refer to the Instruction Manual of a Speedlite equipped with flash exposure bracketing.

Flash Custom Function Settings

For details on the Speedlite's Custom Functions, refer to the Speedlite's (sold separately) Instruction Manual.

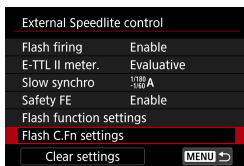

1 Select **[Flash C.Fn settings]**.

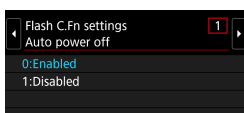

2 Set the desired functions.

- Select the number.
- Select an item.

- !**
- With an EL/EX series Speedlite, the Speedlite will always fire at full output if the **[Flash metering mode]** Custom Function is set to **[TTL]** (autoflash).
 - The Speedlite's Personal Function (P.Fn) cannot be set or canceled on the camera's **[📷: External Speedlite control]** screen. Set it directly on the Speedlite.

Clearing Flash Function Settings / Flash C.Fn Settings

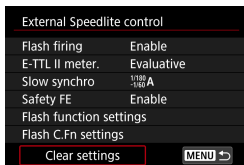

1 Select **[Clear settings]**.

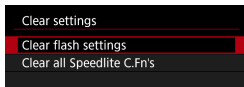

2 Select the settings to be cleared.



- Select **[Clear flash settings]** or **[Clear all Speedlite C.Fn's]**.
- On the confirmation dialog, select **[OK]**. Then the flash settings or Custom Function settings will all be cleared.

General Notes on Still Photo Shooting

Information Display

For details on the icons displayed for still photo shooting, see  591.



- When <Exp.SIM> is displayed in white, it indicates that the image is displayed at the brightness level closely matching that of the actual image to be captured.
- If <Exp.SIM> is blinking, it indicates that the image is displayed at a brightness that differs from the actual shooting result because of low- or bright-light conditions. However, the actual image recorded will reflect the exposure setting. Note that the noise may be more noticeable than the actual image recorded.
- Exposure simulation may not be performed under some shooting settings. The <Exp.SIM> icon and histogram will be displayed in gray. The image will be displayed on the screen at the standard brightness. The histogram may not be properly displayed in low- or bright-light conditions.
- The histogram can be displayed when [: Expo. simulation] is set to [Enable] ( 139).

- ❗ Do not point the camera toward an intense light source, such as the sun or an intense artificial light source. Doing so may damage the image sensor or the camera's internal components.
- Defocused image areas may be incomplete when shooting near maximum aperture at high shutter speeds. If you dislike the appearance of defocused image areas, shooting as follows may give better results.
 - Lower the shutter speed.
 - Increase the aperture value.

Image Quality

- When you shoot at high ISO speeds, noise (such as dots of light and banding) may become noticeable.
- Shooting in high temperatures may cause noise and irregular colors in the image.
- Frequent shooting over an extended period may cause the camera's internal temperature to rise and affect image quality. When you are not shooting, always turn off the camera.
- If you shoot a long exposure while the camera's internal temperature is high, image quality may decline. Stop shooting and wait a few minutes before shooting again.

White <🔥> and Red <🔥> Internal Temperature Warning Icons

- If the camera's internal temperature rises from extended shooting or use in hot environments, a white <🔥> or red <🔥> icon will appear.
- The white <🔥> icon indicates that the image quality of still photos will decline. Stop shooting for a while and allow the camera to cool down.
- The red <🔥> icon indicates that shooting will soon end automatically. Shooting will not be possible again until the camera cools down internally, so stop shooting temporarily or turn off the camera and let it cool down a while.
- Shooting in hot environments over extended periods will cause the white <🔥> or red <🔥> icon to appear sooner. When you are not shooting, always turn off the camera.
- If the camera's internal temperature is high, the quality of images shot with a high ISO speed or long exposure may decline even before the white <🔥> icon is displayed.

Shooting Results

- If you take the picture in magnified view, the exposure may not come out as desired. Return to the normal view before taking the picture.
- Even if you take the picture in magnified view, the image will be captured with the image area of the normal view.



Images and Display

- Under low- or bright-light conditions, the displayed image may not reflect the brightness of the captured image.
- Under low light, noise may be noticeable in image display even at low ISO speeds, but there will be less noise in your shots, because image quality varies between display and captured images.
- The screen or exposure value may flicker if the light source (lighting) changes. In this case, stop shooting temporarily and resume under the light source you will use.
- Pointing the camera at different direction may momentarily prevent correct display of brightness. Wait until the brightness level stabilizes before shooting.
- If there is a very bright light source in the image, the bright area may appear black on the screen. However, the actual captured image will correctly show the bright area.
- In low light, if you set the [**☛**: **Disp. brightness**] to a bright setting, noise or irregular colors may appear in the image. However, the noise or irregular colors will not be recorded in the captured image.
- When you magnify the image, the image sharpness may look more pronounced than in the actual image.

Lens

- If the attached lens has an Image Stabilizer and you set the Image Stabilizer (IS) switch to <ON>, the Image Stabilizer will operate at all times even if you do not press the shutter button halfway. The Image Stabilizer consumes battery power and may decrease the number of possible shots depending on the shooting conditions. When the Image Stabilizer is not necessary, such as when using a tripod, it is recommended that you set the IS switch to <OFF>.
- With EF lenses, focus preset during shooting is only available when using (super) telephoto lenses equipped with this function released in and after the second half of 2011.



- The image's field of view coverage is approx. 100% (with image quality set to JPEG **L**).
- If the camera is idle over an extended period, the screen will turn off automatically after the time set in **[Display off]** or **[Viewfinder off]** under **[P: Power saving]**. The camera then turns off automatically after the time set in **[Auto power off]** (📖 372).
- With the HDMI Cable HTC-100 (sold separately), you can display the image on a television (📖 308). Note that no sound will be output.

Recording Movies

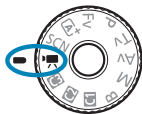

For movie recording, set the Mode dial to <[Movie camera icon]>.

- A ☆ icon to the right of a page title indicates that the function is available only for manual exposure recording (📖 241).



- You can record movies by pressing the movie shooting button during still photo shooting.
- You can also specify movie recording mode from [**📷: Shooting mode**] after setting the Mode dial to <[Movie camera icon]>.

Tab Menus: Movie Recording

● Shooting 1

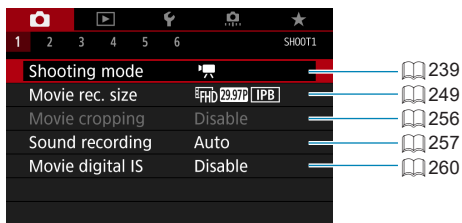

● Shooting 2

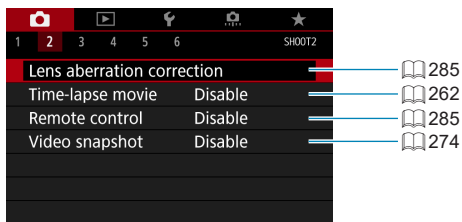

● Shooting 3

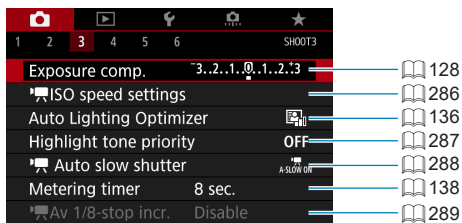

● Shooting 4

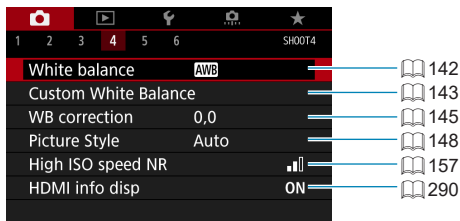

● Shooting 5

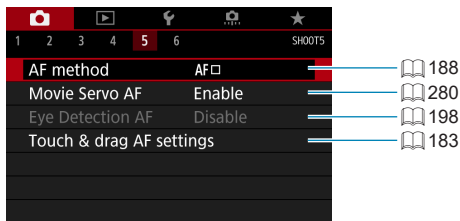

● Shooting 6

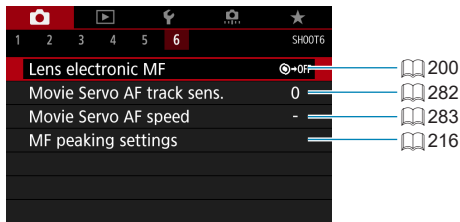

In **[HDR]** mode, the following screens are displayed.

● Shooting 1

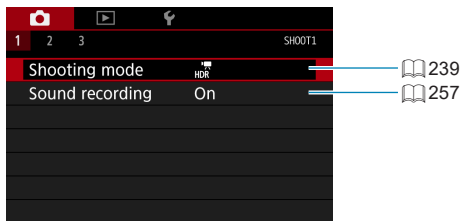

● Shooting 2

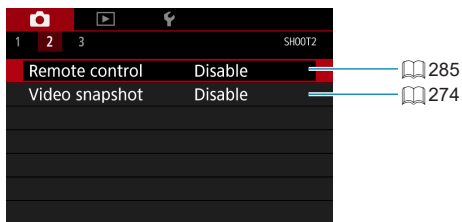

● Shooting 3

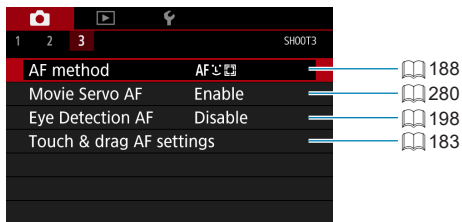

Recording Movies

Autoexposure Recording

Autoexposure control will take effect to suit the scene's current brightness.



1 Set the Mode dial to <Movie>.

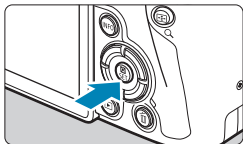

2 Press <SET>.

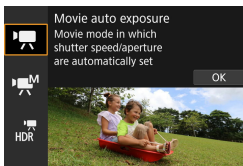

3 Select [Movie].

- Use the <▲> <▼> keys to select [Movie (Movie auto exposure)], then press <SET>.
- Selection is also possible by turning the <Sun> or <Gear> dial.



4 Focus on the subject.

- Before recording a movie, focus with AF or manual focus (📖 190–📖 197, 📖 214).
- By default, [📷: Movie Servo AF] is set to [Enable] so that the camera always keeps focusing (📖 280).
- When you press the shutter button halfway, the camera will focus with the current AF method.

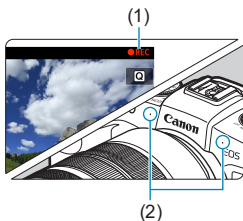
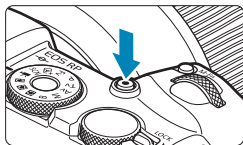

5 Record the movie.

- Press the movie shooting button to start recording a movie.
- ▶ While the movie is being recorded, the “● REC” mark (1) will be displayed on the upper right of the screen.
- ▶ Sound is recorded by the microphones at the positions indicated (2).
- To stop recording the movie, press the movie shooting button again.



- The Quick Control screen appears after step 2 when [**Mode guide**] is set to [**Disable**]. Use the <◀> <▶> keys to select [**REC**].
- You can lock the exposure (AE lock) by pressing the <∗> button. After applying AE lock during movie recording, you can cancel it by pressing the <☒> button. (AE lock setting is retained until you press the <☒> button.)
- Exposure compensation can be set in a range of up to ±3 stops.
- ISO speed, shutter speed, and aperture are not recorded in movie Exif information.
- The camera is compatible with Speedlite functionality to activate the LED light automatically under low light when recording movies with auto exposure. For details, refer to the Instruction Manual of the Speedlite equipped with an LED light.

ISO Speed in [**REC**] Mode

ISO speed is set automatically. For details on the ISO speed, see 588.

Manual Exposure Recording

You can manually set the shutter speed, aperture, and ISO speed for movie recording.



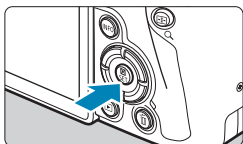

1 Set the Mode dial to .

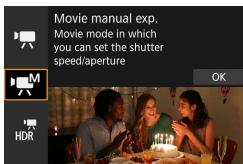

2 Press **<SET>**.



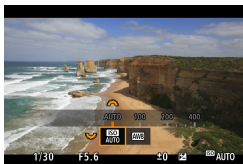

3 Select .

- Use the **<▲>** **<▼>** keys to select  (**Movie manual exposure**), then press **<SET>**.
- Selection is also possible by turning the  or  dial.



4 Set the ISO speed.

- Press the **<M-Fn>** button.
- Turn the  dial to select the ISO speed item.
- Turn the  dial to set it.

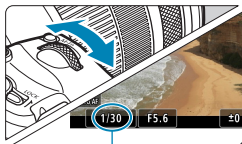

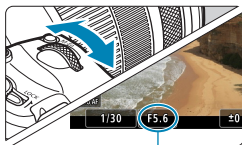

(1)







(2)

5 Set the shutter speed (1) and aperture (2).

- Press the shutter button halfway and check the exposure level indicator.
- To set the shutter speed, turn the <  > dial. To set the aperture, turn the <  > dial.
- Shutter speed can be set in a range of 1/4000–1/8 sec.

6 Focus and record the movie.

- The procedure is the same as steps 4 and 5 for “Autoexposure Recording” ( 239– 240).

- The Quick Control screen appears after step 2 when [: Mode guide] is set to [Disable]. Use the < ◀ > < ▶ > keys to select [M].



- For movie recording, the ISO speed cannot be expanded to L (equivalent to ISO 50).
- When switching from still photo shooting to movie recording, check the camera settings again before recording movies.
- During movie recording, avoid changing the shutter speed or aperture. Doing so may record the changes in the exposure or create more noise at high ISO speeds.
- When recording a movie of a moving subject, a shutter speed of approx. 1/25 sec. to 1/125 sec. is recommended. The faster the shutter speed, the less smooth the subject's movement will look.
- If you change the shutter speed while recording under fluorescent or LED lighting, image flicker may be recorded.



- With ISO Auto, exposure compensation can be set in a range of ± 3 stops.
- When ISO Auto is set, you can press the $\langle \star \rangle$ button to lock the ISO speed. After locking the ISO speed during movie recording, you can cancel it by pressing the $\langle \text{INFO} \rangle$ button. (ISO speed lock is maintained until you press the $\langle \text{INFO} \rangle$ button.)
- If you press the $\langle \star \rangle$ button and recompose the shot, you can see the exposure level difference on the exposure level indicator compared to when the $\langle \star \rangle$ button was pressed.
- With the camera ready to shoot in the $[\text{M}]$ mode, you can display the histogram by pressing the $\langle \text{INFO} \rangle$ button.

ISO Speed in $[\text{M}]$ Mode

You can set the ISO speed manually or select **[AUTO]** to set it automatically. For details on the ISO speed, see  589.

Still Photo Shooting

Still photos cannot be taken in movie recording mode. To shoot still photos, turn the Mode dial to switch to another shooting mode.

Information Display (Movie Recording)

For details on the icons displayed for movie recording, see  593.



Cautions for Movie Recording

- Do not point the camera toward an intense light source, such as the sun or an intense artificial light source. Doing so may damage the image sensor or the camera's internal components.
- If you shoot something that has fine detail, moire or false colors may result.
- If <AWB> or <AWB w> is set and the ISO speed or aperture changes during movie recording, the white balance may also change.
- If you record a movie under fluorescent or LED lighting, the movie image may flicker.
- If you perform AF with a USM lens during movie recording in low light, horizontal banding noise may be recorded in the movie. The same type of noise may occur if you focus manually with certain lenses equipped with an electronic focusing ring.
- Shooting a few test movies is recommended if you intend to perform zooming during movie recording. Zooming as you record movies may cause exposure changes or lens sounds to be recorded, an uneven audio level, or loss of focus.
- Large aperture values may delay or prevent accurate focusing.
- During movie recording, if you perform AF, any of the following may occur: The focus is temporarily greatly thrown off, changes in movie brightness is recorded, the movie recording stops momentarily, and the mechanical sound of the lens is recorded.
- Avoid covering the built-in microphones (📖 240) with your fingers or other objects.
- “General Movie Recording Cautions” are on 📖 291–📖 292.
- If necessary, also read “General Notes on Still Photo Shooting” on 📖 231–📖 234.



Notes for Movie Recording

- Each time you record a movie, a new movie file is created on the card.
- The movie's field of view coverage for recording 4K, Full HD, and HD movies is approx. 100%.
- You can also focus by pressing the $\langle \overset{AF}{ON} \rangle$ button.
- To enable starting or stopping movie recording by pressing the shutter button completely, set **[Fully-press]** for **[Ψ : Shutter btn function for movies]** to **[Start/stop mov rec]**.
- Stereo sound is recorded by the camera's built-in microphone (📖 240).
- Any external microphones such as Directional Stereo Microphone DM-E1 (sold separately) connected to the camera's external microphone IN terminal are used instead of the built-in microphones (📖 258).
- Most external microphones equipped with a 3.5 mm diameter mini plug can be used.
- With EF lenses, focus preset during movie recording is available when using (super) telephoto lenses equipped with this function released in and after the second half of 2011.
- YCbCr 4:2:0 (8-bit) color sampling and the Rec. ITU-R BT.709 color space are used for 4K, Full HD, and HD movies.

Recording HDR Movies

You can record high dynamic range movies that retain detail in highlights of high-contrast scenes.



1 Set the Mode dial to <M>.

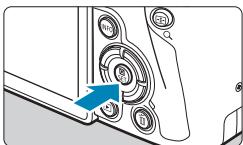

2 Press <SET>.

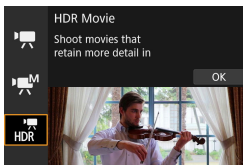

3 Select [].

- Use the <▲> <▼> keys to select [] (**HDR Movie**), then press <SET>.
- Selection is also possible by turning the <☀> or <⚙> dial.

4 Record an HDR movie.

- Record the movie in the same way as normal movie recording.
- For details on file sizes and the recording time available, see the table on  586.



- [📷: **Movie cropping**] is not available.
- Since multiple frames are merged to create an HDR movie, certain parts of the movie may look distorted. During handheld recording, camera shake may make the distortion look more noticeable. Using a tripod is recommended. Note that even if a tripod is used for recording, afterimages or noise may become more noticeable when the HDR movie is played back frame-by-frame or in slow-motion compared to normal playback.
- Image color and brightness may change significantly for a moment if you change settings for HDR movie recording. Also, the movie will not be updated for a moment, and the frame stops momentarily. Be aware of this when recording movies to external devices via HDMI.



- The recording size is $\frac{8}{3}$ FHD 29.97P IPB (NTSC) or $\frac{8}{3}$ FHD 25.00P IPB (PAL). Note that movies are recorded in HD when EF-S lenses are used.
- ISO speed is set automatically when you record HDR movies.

Setting the Movie Recording Size

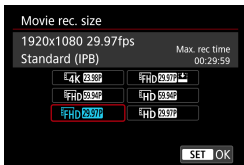

Under the [**📷**: **Movie rec. size**] tab, set the image size, frame rate, and compression method. The movie will be recorded as an MP4 file.

The frame rate displayed on the [**📷**: **Movie rec. size**] screen switches automatically depending on the [**🔧**: **Video system**] setting (📖 378).



- The card's writing and reading speeds required for recording movies (card performance requirements) vary depending on the movie recording size. Before recording movies, see 📖 585 to check the performance requirements of the card.

Image Size

- [**4K**] **3840×2160**



The movie is recorded in 4K quality. The aspect ratio is 16:9.
Not available unless the Mode dial is set to <📷>.

- [**FHD**] **1920×1080**

The movie will be recorded in Full High-Definition (Full HD) quality. The aspect ratio is 16:9.





- [**HD**] **1280×720**

The movie is recorded in High-Definition (HD) quality. The aspect ratio is 16:9.

- If you change the [: **Video system**] setting, also set [: **Movie rec. size**] again.
- Normal playback of 4K and $\overline{\text{FHD}}$ 59.94P / 50.00P movies may not be possible on other devices, because playback is processing-intensive.
- Clarity and noise vary slightly depending on movie recording size, cropped shooting settings, and the lens used.

-  Movies cannot be recorded in VGA quality.

4K Movie Recording

- Recording 4K movies requires a high-performance card. For details, see “Cards that Can Record Movies” on  585.
 - Recording 4K movies greatly increases the processing load, which may cause the camera’s internal temperature to increase faster or become higher than for regular movies. **If a red  icon appears during movie recording, the card may be hot, so stop recording the movie and let the camera cool down before removing the card. (Do not remove the card immediately.)**
 - From a 4K movie, you can select any frame to save as an approx. 8.3-megapixel (3840×2160) JPEG still image to the card ( 306).
-  Contrast detection is used to focus when recording 4K movies. Focusing may take longer than when recording HD or Full HD movies.

Movie-Recording Coverage

Image sensor coverage for movies varies depending on movie recording size, cropped shooting settings, and the lens used.

With EF-S lenses, movies are cropped around the center of the image.

● RF or EF lenses: With [📷: Movie cropping] set to [Disable]

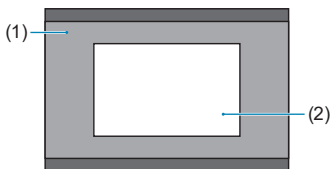

- | | |
|-----|--|
| (1) | Full HD
HD
4K time-lapse
Full HD time-lapse |
| (2) | 4K |

● RF or EF lenses: With [📷: Movie cropping] set to [Enable]

● EF-S lenses

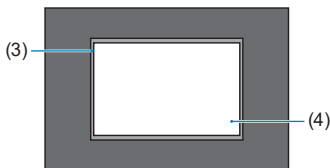

- | | |
|-----|---|
| (3) | HD
4K time-lapse
Full HD time-lapse |
| (4) | 4K |



- Full HD movies cannot be recorded with EF-S lenses, or with [📷: Movie cropping] set to [Enable].
- Recording with Movie digital IS (📖 260) further crops the image around the center of the screen.

● Frame rate (fps: frame per second)

- **[59.94P] 59.94fps / [29.97P] 29.97fps**

For areas where the TV system is NTSC (North America, Japan, South Korea, Mexico, etc.).

- **[50.00P] 50.00fps / [25.00P] 25.00fps**

For areas where the TV system is PAL (Europe, Russia, China, Australia, etc.).

- **[23.98P] 23.98fps**

Mainly for motion pictures. **[23.98P]** (23.98fps) is available when [**☑**: **Video system**] is set to [**For NTSC**].

● Compression method

- **[IPB] IPB (Standard)**

Compresses multiple frames at a time efficiently for recording.

- **[IPB] IPB (Light)**

Since the movie is recorded at a bit rate lower than with IPB (Standard), the file size will be smaller than with IPB (Standard) and the playback compatibility will be higher. This will make the possible recording time longer than with IPB (Standard) (with a card having the same capacity).



● Movie recording format

- **[MP4] MP4**

All movies you shoot with the camera are recorded as movie files in MP4 format (file extension “.MP4”).

Cards that Can Record Movies

For details on cards you can use for various movie recording sizes, see  585.

When recording movies, use a high-capacity card with a writing/reading speed (as specified in card performance requirements) shown in the table on  585 or higher than the standard specification. **Test cards by recording a few movies to make sure they can record correctly at your specified size ( 249).**



- Format cards before recording 4K movies ( 367).
- If you use a slow-writing card when recording movies, the movie may not be recorded properly. Also, if you play back a movie on a card with a slow reading speed, the movie may not be played back properly.
- When recording movies, use high-performance cards with a writing speed sufficiently higher than the bit rate.
- When movies cannot be recorded normally, format the card and try again. If formatting the card does not resolve the problem, refer to the card manufacturer's website, etc.



- To obtain better performance with the card, formatting the card with the camera before recording movies is recommended ( 367).
- To check the card's writing/reading speed, refer to the card manufacturer's website, etc.

Movie Files Exceeding 4 GB

Even if you record a movie exceeding 4 GB, you can keep recording without interruption.

● Using SD/SDHC cards formatted with the camera

If you use the camera to format an SD/SDHC card, the camera will format it in FAT32.

With a FAT32-formatted card, if you record a movie and the file size exceeds 4 GB, a new movie file will be created automatically.

When you play back the movie, you will have to play back each movie file individually. Movie files cannot be played back automatically in consecutive order. After the movie playback ends, select the next movie and play it back.

● Using SDXC cards formatted with the camera

If you use the camera to format an SDXC card, the camera will format it in exFAT.

When using an exFAT-formatted card, even if the file size exceeds 4 GB during movie recording, the movie will be saved as a single file (rather than being split into multiple files).



- When importing movie files exceeding 4 GB to a computer, use either EOS Utility or a card reader (📖 557). It may not be possible to save movie files exceeding 4 GB if you attempt this using standard features of the computer's operating system.

Total Movie Recording Time and File Size Per Minute

For details on file sizes and the recording time available at each movie recording size, see  586.

Movie Recording Time Limit

The maximum recording time per movie is 29 min. 59 sec. Once 29 min. 59 sec. is reached, recording automatically stops. You can start recording a movie again by pressing the movie shooting button (which records the movie as a new file).

Movie Cropping

With RF or EF lenses, movies can be cropped around the center of the image, as if using a telephoto lens.

Recording movies with EF-S lenses has the same effect as this movie cropping feature.

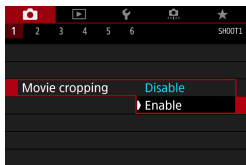

1 Select [: **Movie cropping**].

2 Select [**Enable**].

▶ The center area is magnified.

- Full HD movies cannot be recorded with movie cropping.
- The center of the screen is further cropped, reducing the shooting area, when [: **Movie digital IS**] is set to [**Enable**] or [**Enhanced**].

- The shooting area available with movie cropping is the same as when recording movies with EF-S lenses.
- 4K movies are always recorded with the center of the recording screen cropped, and enabling [: **Movie cropping**] does not change the recording angle of view.
- For details on the shooting area, see 251.

Setting the Sound Recording

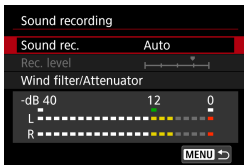

You can record movies while recording sound with the built-in stereo microphone or an external stereo microphone. You can also freely adjust the sound-recording level. Use **[CAMERA]: Sound recording]** to set sound recording functions.

Sound Recording/Sound-Recording Level

● Auto

The sound-recording level is adjusted automatically. Auto level control will take effect automatically in response to the sound level.

● Manual

You can adjust the sound-recording level as needed.

Select **[Rec. level]** and press the **<<>** **>>** keys while looking at the level meter to adjust the sound-recording level. Look at the peak hold indicator, and adjust so that the level meter sometimes lights up on the right of the “12” (–12 dB) mark for the loudest sounds. If it exceeds “0”, the sound will be distorted.

● Disable

Sound will not be recorded.

Wind Filter

Set to **[Auto]** to reduce wind noise automatically when there is wind outdoors. Only activated when the camera's built-in microphone is used. When the wind filter function takes effect, part of the low bass sounds will also be reduced.

Attenuator

Automatically suppresses sound distortion caused by loud noises. Even if **[Sound rec.]** is set to **[Auto]** or **[Manual]** for recording, sound distortion may still result if there is a very loud sound. In this case, setting it to **[Enable]** is recommended.

● Using a microphone

Normally, the camera's built-in microphone records in stereo.

If an external microphone equipped with a miniature stereo plug (3.5 mm diameter) is connected to the camera's external microphone IN terminal, the external microphone will be given the priority. Using the Directional Stereo Microphone DM-E1 (sold separately) is recommended.

● Using headphones

By connecting commercially available headphones with a 3.5 mm mini plug to the headphone terminal, you can listen to the sound as movies are recorded. To adjust headphone volume, press the **<Q>** button, select **[H]**, then turn the  dial for adjustment.

You can also use headphones during movie playback.



- Sounds from Wi-Fi operations may be captured with built-in or external microphones. During sound recording, using the wireless communication function is not recommended.
- When connecting an external microphone or headphones to the camera, be sure to insert the plug all the way in.
- The camera's built-in microphone will also record the operation sound and mechanical sound of the camera during shooting. Using Directional Stereo Microphone DM-E1 (sold separately) may reduce such sounds in the movie.
- Do not connect anything other than an external microphone to the camera's external microphone IN terminal.
- Noise reduction is not applied to the audio played through headphones. Thus, the audio recorded with the movie will be different.
- Do not change the **[Sound recording]** settings when listening with headphones. This may cause sudden loud output that may hurt your ears.



- In **[HDR]** mode, the settings available for **[Sound recording]** are **[On]** or **[Off]**. Set to **[On]** for automatic adjustment of the recording level.
- Audio is also output when the camera is connected to televisions via HDMI, except when **[Sound rec.]** is set to **[Disable]**.
- The sound volume balance between L (left) and R (right) cannot be adjusted.
- Sound is recorded at a 48 kHz/16-bit sampling rate.

Movie Digital IS

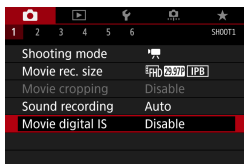

In-camera image stabilization electronically corrects camera shake during movie recording. This function is called “Movie digital IS”. With Movie digital IS, images can be stabilized even when using a lens without Image Stabilizer. When using a lens with built-in optical Image Stabilizer, set the lens’s Image Stabilizer switch to <ON>.

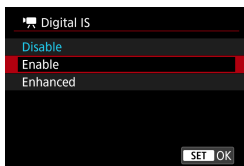

1 Select [: Movie digital IS].



2 Select an item.

- **Disable** ()
Image stabilization with Movie digital IS is disabled.
- **Enable** ()
Camera shake will be corrected. The image will be slightly magnified.
- **Enhanced** () (**Not displayed for still photos shooting**)
Compared to when [**Enable**] is set, stronger camera shake can be corrected. The image will be more magnified.

Combination IS

Even more effective correction is possible by recording movies with Movie digital IS and a Combination IS-compatible lens, which will combine optical and digital image stabilization by the lens and camera.



- Movie digital IS will not function when the lens's optical Image Stabilizer switch is set to <OFF>.
- Although movies can also be recorded with Movie digital IS when using EF-S lenses or movie cropping, the shooting area is further reduced.
- With a lens whose focal length is longer than 800 mm, Movie digital IS will not function.
- Stabilization by Movie digital IS may be less effective at some movie recording sizes.
- The wider the angle of view (wide angle), the more effective the image stabilization will be. The narrower the angle of view (telephoto), the less effective the image stabilization will be.
- When using a tripod, setting Movie digital IS to **[Disable]** is recommended.
- Depending on the subject and shooting conditions, the subject may blur noticeably (the subject momentarily looks out of focus) due to the effects of the Movie digital IS.
- When using a TS-E lens, fish-eye lens, or non-Canon lens, setting Movie digital IS to **[Disable]** is recommended.
- Since Movie digital IS magnifies the image, the image looks more grainy. Noise, dots of light, etc. may also become noticeable.
- Certain lenses do not support Movie digital IS. For details, refer to the Canon website.



- For details on lenses compatible with Combination IS, visit the Canon website.
- "+" is added to the Movie digital IS icon (📖 260) when a lens compatible with Combination IS is used.

Recording Time-lapse Movies

Still photos shot at a set interval can be stitched together automatically to create a 4K or Full HD time-lapse movie. A time-lapse movie shows how a subject changes in a much shorter period of time than the actual time it took. It is effective for a fixed-point observation of changing scenery, growing plants, celestial motion, etc.

Time-lapse movies will be recorded in MP4 format at the following quality: 4K 29.97P [ALL-I] (NTSC)/4K 25.00P [ALL-I] (PAL) for 4K shooting, and FHD 29.97P [ALL-I] (NTSC)/FHD 25.00P [ALL-I] (PAL) for Full HD shooting.

Note that the frame rate will be switched automatically according to the [Video system] setting (378).

- 1 Select a shooting mode.
 - Select [P] (239) or [M] (241).

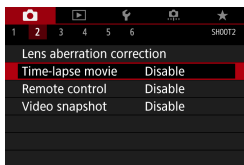

- 2 Select [Camera icon: Time-lapse movie].

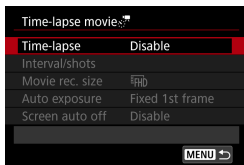

- 3 Select [Time-lapse].

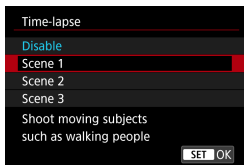

- 4 Select a scene.
 - Select a scene to suit the shooting situation.
 - For greater freedom when setting the shooting interval and number of shots manually, select [Custom].

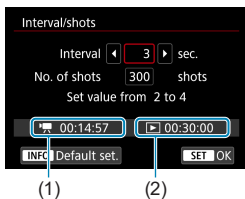

5 Set the shooting interval.

- Select **[Interval]** (sec.). Use the <◀> <▶> keys to set a value, then press <SET>.
- Refer to **[: Time required]** (1) and **[: Playback time]** (2) to set the number.

When [Custom] is set

- Select **[Interval]** (min.:sec.). (An interval of once per second is not available.)
- Press <SET> to display <⏱>.
- Set the desired number, then press <SET>. (Returns to <□>.)
- Select **[OK]** to register the setting.

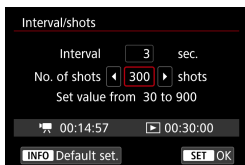

6 Set the number of shots.

- Select **[No. of shots]**. Use the <◀> <▶> keys to set a value, then press <SET>.
- Refer to the **[: Time required]** and **[: Playback time]** to set the number.

When [Custom] is set

- Select the digit.
- Press <SET> to display <⏱>.
- Set the desired number, then press <SET>. (Returns to <□>.)
- Check that **[: Playback time]** is not displayed in red.
- Select **[OK]** to register the setting.



- With **[Scene**]**, available intervals and numbers of shots are restricted, to suit the type of scene.
- For cards that can record time-lapse movies (card performance requirements), see 585.
- If the number of shots is set to 3600, the time-lapse movie will be approx. 2 min. in NTSC and approx. 2 min. 24 sec. in PAL.

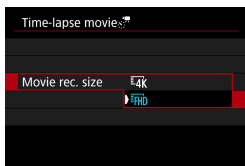

7 Select the desired movie recording size.

- **4K (3840×2160)**

The movie is recorded in 4K quality. The aspect ratio is 16:9. The frame rate is 29.97 fps (**29.97P**) for NTSC and 25.00 fps (**25.00P**) for PAL, and movies are recorded in MP4 (**MP4**) format with ALL-I (**ALL-I**) compression.

- **FHD (1920×1080)**

The movie will be recorded in Full High-Definition (Full HD) quality. The aspect ratio is 16:9. The frame rate is 29.97 fps (**29.97P**) for NTSC and 25.00 fps (**25.00P**) for PAL, and movies are recorded in MP4 (**MP4**) format with ALL-I (**ALL-I**) compression.

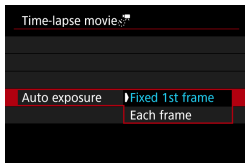

8 Configure [Auto exposure].

● Fixed 1st frame

When taking the first shot, metering is performed to set the exposure automatically to match the brightness. The exposure setting for the first shot will be applied to subsequent shots. Other shooting-related settings for the first shot will also be applied for subsequent shots.

● Each frame

Metering is also performed for each subsequent shot to set the exposure automatically to match the brightness. Note that if functions such as Picture Style and white balance are set to **[Auto]**, they will be set automatically for each subsequent shot.

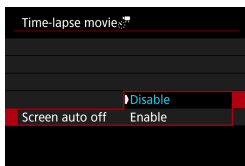

9 Configure [Screen auto off].

● Disable

Even during time-lapse movie recording, the image will be displayed. (The screen turns off only at the time of shooting.) Note that the screen will turn off when approx. 30 min. elapse after the shooting started.

● Enable

Note that the screen will turn off when approx. 10 sec. elapse after the shooting started.



- During time-lapse movie recording, you can press the <INFO> button to turn on/off the screen.

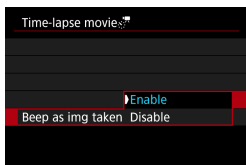

10 Set the beeper.

- Select [**Beep as img taken**].
- If [**Disable**] is set, the beeper will not sound for shooting.

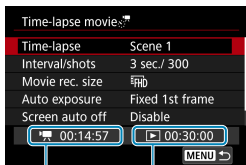

11 Check the settings.

(1) Time required

Indicates the time required to shoot the set number of shots with the set interval. If it exceeds 24 hours, “*** days” will be displayed.

(2) Playback time

Indicates the movie recording time (time required to play back the movie) when creating the time-lapse movie in 4K movie or Full HD movie from the still photos taken with the set intervals.

12 Close the menu.

- Press the <MENU> button to turn off the menu screen.

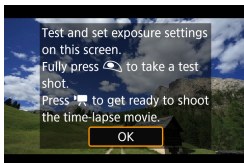

13 Read the message.

- Read the message and select **[OK]**.

14 Take test shots.

- As with still photo shooting, set the exposure and shooting functions, then press the shutter button halfway to focus.
- Press the shutter button completely to take test shots. The still photos will be recorded to the card.
- If there are no problems with the test shots, go to the next step.
- To take test shots again, repeat this step.



- Test shots are captured in JPEG quality.
- You can set the maximum limit for ISO Auto in [**ISO**] mode or in [**M**] mode with ISO Auto, in [**Max for Auto**] under [**ISO speed settings**] (286).
- If you have set [**Half-press**] under [**Shutter btn function for movies**] to [**Meter.+ Servo AF**], it is automatically changed to [**Meter.+One-Shot AF**] when you set up time-lapse movie recording.

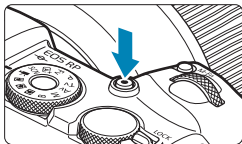

15 Press the movie shooting button.

- ▶ The camera will be ready to start recording a time-lapse movie.
- To return to step 14, press the movie shooting button again.



(1)

(2)

16 Record the time-lapse movie.

- Press the <INFO> button and check again the “Time required (1)” and “Interval (2)” displayed on the screen.
- **Press the shutter button completely to start recording the time-lapse movie.**
- AF will not work during time-lapse movie recording.
- While the time-lapse movie is recorded, “● REC” is displayed.
- ▶ When the set number of shots are taken, the time-lapse movie recording ends.
- **To cancel recording time-lapse movies, set [Time-lapse] to [Disable].**

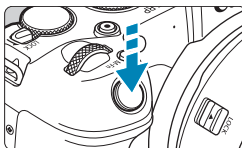



- Using a tripod is recommended.
- Taking test shots as in step 14 and recording test movies for time-lapse movies beforehand is recommended.
- The movie's field of view coverage for both the 4K and Full HD time-lapse movie recording is approx. 100%.
- To cancel the time-lapse movie recording in progress, either press the shutter button completely or press the movie shooting button. The time-lapse movie shot so far will be recorded on the card.
- If the time required for shooting is more than 24 hours but not more than 48 hours, "2 days" will be indicated. If three or more days are required, the number of days will be indicated in 24-hour increments.
- Even if the time-lapse movie's playback time is less than 1 sec., a movie file will still be created. For **[Playback time]**, "00'00"" will be displayed.
- If the shooting time is long, using the household power outlet accessories (sold separately) is recommended.
- YCbCr 4:2:0 (8-bit) color sampling and the Rec. ITU-R BT.709 color space are used for 4K/Full HD time-lapse movies.



- If the card does not have enough free space to record the set number of shots, **[Playback time]** will be displayed in red. Although the camera can continue shooting, the shooting will stop when the card becomes full.
- If the movie file size exceeds 4 GB with the **[No. of shots]** settings and the card is not formatted in exFAT (📖 368), **[Play back time]** will be displayed in red. If you keep shooting in this condition and the movie file size reaches 4 GB, the time-lapse movie recording will stop.



- Do not point the camera toward an intense light source, such as the sun or an intense artificial light source. Doing so may damage the image sensor or the camera's internal components.
- Time-lapse movies cannot be recorded when the camera is connected to a computer with the interface cable, or when an HDMI cable is connected.
- Movie Servo AF will not function.
- If the shutter speed is 1/30 sec. or slower, the exposure of the movie may not be displayed properly (may differ from that of the resulting movie).
- Do not zoom the lens during time-lapse movie recording. Zooming the lens may cause the image to be out of focus, the exposure to change, or the lens aberration correction not to function properly.
- When recording a time-lapse movie under a flickering light, noticeable image flickering, horizontal stripes (noise), or irregular exposures may be recorded.
- Images that are displayed while time-lapse movies are being recorded may look different from the resulting movie. (For example, there may be inconsistent brightness from flickering light sources, or noise from a high ISO speed.)
- When recording a time-lapse movie under low light, the image displayed during shooting may look different from what is actually recorded in the movie. In such cases, the <Exp.SIM> icon will blink.
- If you move the camera from left to right (panning) or shoot a moving subject during time-lapse movie recording, the image may look extremely distorted.
- During time-lapse movie recording, auto power off will not take effect. Also, you cannot adjust the shooting function and menu function settings, play back images, etc.
- Sound is not recorded for time-lapse movies.
- With time-lapse movie recording, you can press the shutter button completely to start or stop the movie recording regardless of the [**☑: Shutter btn function for movies**] setting.
- With [**Interval**] set to less than 3 sec. and [**Auto exposure**] set to [**Each frame**], if the brightness differs greatly from the preceding shot, the camera may not shoot at the set interval.



- If the shutter speed exceeds the shooting interval (such as for long exposures), or if a slow shutter speed is set automatically, the camera may not be able to shoot at the set interval. Shooting may also be prevented by shooting intervals nearly the same as the shutter speed.
- If the next scheduled shot is not possible, it will be skipped. This may shorten the recording time of the created time-lapse movie.
- If the time it takes to record to the card exceeds the shooting interval due to the shooting functions set or card performance, some of the shots may not be taken with the set intervals.
- Even if **[Screen auto off]** is set to **[Disable]**, the screen will turn off during the exposure. Also note that images may not be displayed if the interval between shots is too brief.
- The captured images are not recorded as still photos. Even if you cancel the time-lapse movie recording after only one shot is taken, it will be recorded as a movie file.
- If you connect the camera to a computer with the interface cable and use EOS Utility (EOS software), set **[📷: Time-lapse movie]** to **[Disable]**. If an option other than **[Disable]** is selected, the camera cannot communicate with the computer.
- During time-lapse movie recording, the lens's Image Stabilizer will not operate.
- Time-lapse movie recording ends if the power switch is set to <OFF>, for example, and the setting is changed to **[Disable]**.
- Even if a flash is used, it will not fire.
- The following operations cancel standby for time-lapse movie recording and switch the setting to **[Disable]**.
 - Selecting either **[Clean now 🧽]** under **[🔧: Sensor cleaning]** or selecting **[🔧: Clear all camera settings]**.
 - Turning the Mode dial.

- If you start time-lapse movie recording while the white temperature warning (📖 291) is displayed, the image quality of the time-lapse movie may decline. It is recommended that you start time-lapse movie recording after the white disappears (camera's internal temperature decreases).
- With **[Auto exposure]** set to **[Each frame]**, ISO speed, shutter speed, and aperture may not be recorded in the time-lapse movie Exif information in some modes.



- You can use Wireless Remote Control BR-E1 (sold separately) to start and stop the time-lapse movie recording.

With Wireless Remote Control BR-E1

- First pair the Wireless Remote Control BR-E1 with the camera (📖 399).
- Set [: Remote control] to [Enable].
- Take test shots, then when the camera is ready to shoot (as in step 15 on 📖 268), set the BR-E1's release mode/movie shooting switch to <●> (immediate release) or <2> (release after 2-sec. delay).
- If the remote control's switch has been set to <📽>, the time-lapse movie recording cannot start.

Camera status/remote control setting	<●> Immediate release <2> 2-sec. delay	<📽> Movie recording
Test-shooting screen	Test-shooting	To shooting-ready
Shooting-ready	Starts shooting	To test-shooting screen
During time-lapse movie recording	Ends recording	Ends recording

Approx. Time Available for Recording Time-lapse Movies

For guidelines on how long you can record time-lapse movies (until the battery runs out), see 📖 587.

Recording Video Snapshots

Record a series of short video snapshots, each a few seconds long, and the camera will combine them to create a video snapshot album that shows these highlights of your trip or event.

Video snapshots are available when the movie recording size is set to **FHD 29.97P IPB** (NTSC) or **FHD 25.00P IPB** (PAL).

Video snapshot albums can also be played back with background music (📖 336).

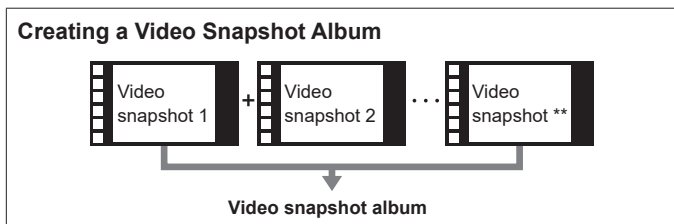

Setting Recording Time Per Video Snapshot

- 1 Select a shooting mode.
 - Select [**📷**] (📖 239) or [**📷M**] (📖 241).

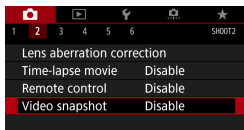

- 2 Select [**📷**: Video snapshot].

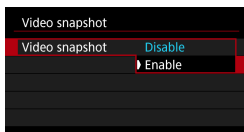

- 3 Select [**Enable**].

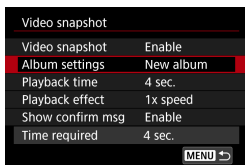

4 Select [Album settings].

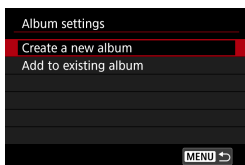

5 Select [Create a new album].

- Read the message and select [OK].

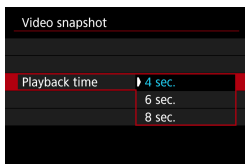

6 Specify the playback time.

- Specify playback time per video snapshot.

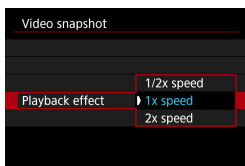

7 Specify the playback effect.

- This setting determines how fast albums are played back.

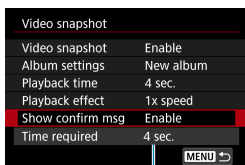

8 Check the required recording time.

- The time required to record each video snapshot is indicated (1), based on the playback time and effect.

(1)

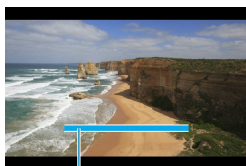

(2)

9 Close the menu.

- Press the <MENU> button to close the menu.
- ▶ A blue bar is displayed to indicate the recording time (2).
- Go to “Creating Video Snapshot Albums”.

Creating Video Snapshot Albums

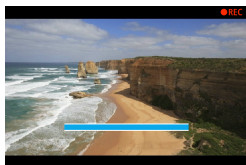

10 Record the first video snapshot.

- Press the movie shooting button to start recording.
- ▶ The blue bar indicating recording time gradually decreases, and after the specified time elapses, recording stops automatically.
- ▶ A confirmation message is displayed (📖 277).



11 Save as a video snapshot album.

- Select [📖 Save as album].
- The clip is saved as the first video snapshot in the album.



12 Record your next video snapshots.

- Repeat step 10 to record the next video snapshot.
- Select [📖 Add to album].
- To create another album, select [📖 Save as a new album].
- Repeat step 12 as needed.

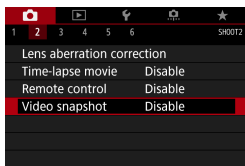

- 13 Stop recording video snapshots.**
- Set **[Video snapshot]** to **[Disable]**. To return to normal movie recording, be sure to specify **[Disable]**.
 - Press the **<MENU>** button to close the menu and return to normal movie recording.

Options in Steps 11 and 12

Function	Description
Save as album (step 11)	Saves the clip as the first video snapshot in an album.
Add to album (step 12)	Adds the current video snapshot to the album recorded most recently.
Save as a new album (step 12)	Creates a new album and saves the clip as the first video snapshot. This album file is different from the one recorded most recently.
Playback video snapshot (steps 11, 12)	Plays the video snapshot just recorded.
Do not save to album (step 11) Delete without saving to album (step 12)	Deletes the recently recorded video snapshot without saving it to an album. Select [OK] on the confirmation dialog.

- If you prefer to record the next video snapshot immediately, set **[Show confirm msg]** under **[📷: Video snapshot]** to **[Disable]**. This setting enables you to record the next video snapshot immediately, without a confirmation message.

Adding to an Existing Album

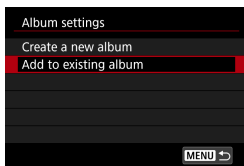

- 1 **Select [Add to existing album].**
 - Follow step 5 on [\(275\)](#) to select **[Add to existing album]**.



- 2 **Select an existing album.**
 - Turn the  dial to select an existing album, then press **<SET>**.
 - Select **[OK]**.
 - ▶ Some video snapshot settings will be updated to match settings of the existing album.

- 3 **Close the menu.**
 - Press the **<MENU>** button to close the menu.
 - ▶ The video snapshot recording screen is displayed.

- 4 **Record a video snapshot.**
 - Record the video snapshot, referring to "Creating Video Snapshot Albums" ([\(276\)](#)).



- You cannot select an album taken with another camera.



General Video Snapshot Precautions

- No sound is recorded when you set **[Playback effect]** to **[1/2x speed]** or **[2x speed]**.
- Recording time per video snapshot is only approximate. It may differ slightly from the actual recording time indicated during playback, due to the frame rate and other factors.

Setting Movie Servo AF

With this function enabled, the camera focuses on the subject continuously during movie recording.

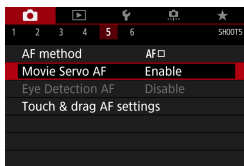

1 Select [: Movie Servo AF].

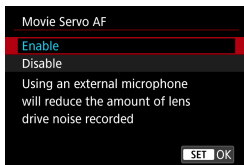

2 Select [Enable].

● When [Enable] is set:



- The camera focuses on the subject continuously even when you are not pressing the shutter button halfway.
- To keep the focus at a specific position, or if you prefer not to record mechanical sounds from the lens, you can temporarily stop Movie Servo AF by touching [] in the lower left of the screen.
- When Movie Servo AF is paused, if you return to movie recording after operations such as pressing the <MENU> or <▶> button or changing the AF method, Movie Servo AF will resume.

● When [Disable] is set:

- Press the shutter button halfway or press the <> button to focus.



Cautions When [Movie Servo AF] is Set to [Enable]

- **Recording Conditions that Make Focusing Difficult**
 - A fast-moving subject approaching or moving away from the camera.
 - A subject moving at a close distance to the camera.
 - When shooting with a higher f/number.
 - Also see “Shooting Conditions that Make Focusing Difficult” on  197.
- Since the lens is driven continuously and the battery power is consumed, the possible movie recording time ( 586) will be shortened.
- With certain lenses, the mechanical sound for focusing may be recorded. In this case, using Directional Stereo Microphone DM-E1 (sold separately) may reduce such sounds in the movie.
- Movie Servo AF will pause during zooming or magnified view.
- During movie recording, if a subject approaches or moves away or if the camera is moved vertically or horizontally (panning), the recorded movie image may momentarily expand or contract (change in image magnification).

Movie Servo AF Track Sensitivity

You can adjust the tracking sensitivity (to one of seven levels), which affects responsiveness if the subject strays from the AF point during Movie Servo AF, as when interfering objects move across AF points or when you pan.

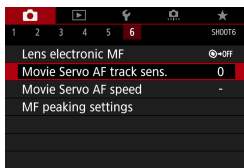

1 Select [CAMERA]: Movie Servo AF track sens.].

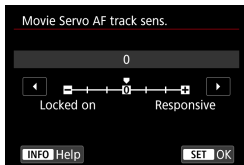

● Locked on: -3/-2/-1

With this setting, the camera is less likely to track a different subject if the main subject strays from the AF point. The closer the setting is to the minus (-) symbol, the less the camera is inclined to track a different subject. It is effective when you want to prevent the AF points from rapidly tracking something that is not the intended subject during panning or when an obstacle cuts across the AF points.

● Responsive: +1/+2/+3

This makes the camera more responsive when tracking a subject that covers the AF point. The closer the setting is to the plus (+) symbol, the more responsive the camera is. It is effective when you want to keep tracking a moving subject as its distance from the camera changes or to rapidly focus on another subject.



- Has no effect (setting is disabled) when 4K movie recording is set.



- Available when [CAMERA]: Movie Servo AF] is set to [Enable] and [CAMERA]: AF method] is set to [1-point AF].
- Operation when [CAMERA]: AF method] is set to an option other than [1-point AF] is equivalent to a setting of [0].

Movie Servo AF Speed

You can set the Movie Servo AF's AF speed and its operation conditions. The function is enabled when using a lens supporting slow focus transition during movie recording*.

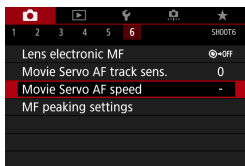

1 Select [CAMERA: Movie Servo AF speed].

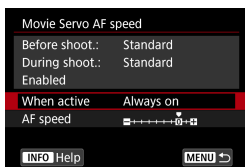

- **When active:**

You can set **[Always on]** to have the AF speed take effect at all times for movie recording (before and during movie recording) or set **[During shooting]** to have the AF speed take effect only during movie recording.

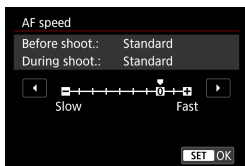

- **AF speed:**

You can adjust the AF speed (focus transition speed) from the standard speed (0) to slow (one of seven levels) or fast (one of two levels) to obtain the desired effect for the movie creation.

* Lenses supporting slow focus transition during movie recording

USM and STM lenses released in and after 2009 are compatible. For details, refer to the Canon website.



- With certain lenses, even if you adjust the AF speed, the speed may not change.
- Has no effect (setting is disabled) when 4K movie recording is set.



- Available when [**📷**: **Movie Servo AF**] is set to [**Enable**] and [**📷**: **AF method**] is set to [**1-point AF**].
- Operation when [**📷**: **AF method**] is set to an option other than [**1-point AF**] is equivalent to setting [**AF speed**] to [**Standard (0)**].
- An asterisk to the right of [**📷**: **Movie Servo AF speed**] indicates that the default setting has been modified.

Other Menu Functions



- **Lens aberration correction**

Peripheral illumination, distortion, and chromatic aberration can be corrected as you record movies. For details on lens aberration correction, see 123.

- **Remote control shooting**

When **[Enable]** is set, you can start or stop movie recording using Wireless Remote Control BR-E1 (sold separately). First, pair the BR-E1 with the camera (399).

With Wireless Remote Control BR-E1

Set the release mode/movie shooting switch to the < > position, then press the release button.

For details on Time-lapse movie recording, see 273.

[📷3]

● 🗨️ ISO speed settings

● ISO speed ☆

In [🗨️] mode, you can set the ISO speed manually. You can also select ISO Auto.

● ISO speed range

When recording Full HD/HD movies or Full HD time-lapse movies, you can set the manual ISO speed setting range (minimum and maximum).

● Range for 4K

When recording 4K or 4K time-lapse movies, you can set the manual ISO speed setting range (minimum and maximum).

● Max for Auto

You can set the maximum limit for ISO Auto in Full HD/HD movie recording in [🗨️] mode or in [🗨️] mode with ISO Auto.

● 4K Max for Auto

You can set the maximum limit for ISO Auto in 4K movie recording in [🗨️] mode or in [🗨️] mode with ISO Auto.

● 🗨️ Max for Auto

You can set the maximum limit for ISO Auto in 4K time-lapse/Full HD time-lapse movie recording in [🗨️] mode or in [🗨️] mode with ISO Auto.



- Expanded ISO speeds (indicated by [H]) are ISO 32000/40000 for Full HD/HD movies and ISO 16000/20000/25600/32000/40000 for 4K movies.

- **Highlight tone priority**

You can reduce overexposed, clipped highlights as you record movies. For details on Highlight tone priority, see  137.



- **[Enhanced]** is not available (not displayed) when recording movies with [: **Highlight tone priority**] set.

● Auto slow shutter

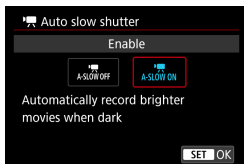

You can choose whether to shoot movies that are brighter and less affected by image noise than when set to **[Disable]** by automatically slowing the shutter speed under low light.

Available in [] shooting mode. Applies when the frame rate of the movie recording size is **59.94P** or **50.00P**.

● **Disable**

Enables you to record movies with smoother, more natural movement, less affected by subject shake than when set to **[Enable]**. Note that under low light, movies may be darker than when set to **[Enable]**.

● **Enable**

Enables you to shoot brighter movies, less affected by image noise, than when set to **[Disable]** by automatically reducing the shutter speed to 1/30 sec. (NTSC) or 1/25 sec. (PAL) under low light.



- Setting to **[Disable]** is recommended when recording moving subjects under low light, or when afterimages such as trails may occur.

● Av 1/8-stop increments ☆

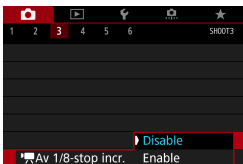



You can set aperture values on a finer scale when recording movies with an RF lens.

Available in [M] shooting mode.

Select [**Enable**] to change the aperture increment from 1/3 stop (or 1/2 stop) to 1/8 stop.



- [ Av 1/8-stop incr.] is not available (not displayed) when EF or EF-S lenses are used.
- When set to [**Enable**], setting options in [ C.Fn I-1: Exposure level increments] are disabled and have no effect.

[📷4]

● **HDMI info disp**

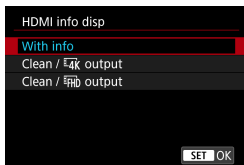

You can configure information display for image output via an HDMI cable.

● **With info**

The image, shooting information, AF points, and other information is shown on the other device via HDMI. Note that the camera screen goes off.

Recorded movies are saved to the card.

● **Clean / 4K output**

HDMI output consists solely of 4K movies. Shooting information and AF points are also displayed on the camera, but no image is recorded to the card. Note that Wi-Fi communication is not available.

● **Clean / FHD output**

HDMI output consists solely of Full HD movies. Shooting information and AF points are also displayed on the camera, but no image is recorded to the card. Note that Wi-Fi communication is not available.

General Movie Recording Cautions



Red <[Red Icon]> Internal Temperature Warning Icon

- If the camera's internal temperature increases due to prolonged movie recording or under a high ambient temperature, a red <[Red Icon]> icon will appear.
- The red <[Red Icon]> icon indicates that movie recording will soon be terminated automatically. If this happens, you will not be able to shoot again until the camera's internal temperature decreases. Turn off the power and let the camera rest for a while.
- Recording a movie at a high temperature for a prolonged period will cause the red <[Red Icon]> icon to appear earlier. When you are not shooting, always turn off the camera.

Recording and Image Quality

- If the attached lens has an Image Stabilizer and you set the Image Stabilizer (IS) switch to <ON>, the Image Stabilizer will operate at all times even if you do not press the shutter button halfway. The Image Stabilizer consumes battery power and may shorten the total movie recording time depending on the shooting conditions. When the Image Stabilizer is not necessary, such as when using a tripod, it is recommended that you set the IS switch to <OFF>.
- If the brightness changes as you record a movie with auto exposure, the movie may appear to stop momentarily. In this case, record movies with manual exposure.
- If there is a very bright light source in the image, the bright area may appear black on the screen. Movies are recorded almost exactly as they appear on the screen.
- Image noise or irregular colors may occur when shooting at high ISO speeds, high temperatures, low shutter speeds, or under low light. Movies are recorded almost exactly as they appear on the screen, except in time-lapse movie recording.
- If you play back a movie with other devices, image or sound quality may decline or playback may not be possible (even if the devices support MP4 format).

Recording and Image Quality

- If you use a card with a slow writing speed, an indicator may appear on the right of the screen during movie recording. It indicates how much data has not yet been written to the card (remaining capacity of the internal buffer memory). The slower the card, the faster the indicator will climb upward. If the indicator (1) becomes full, movie recording will stop automatically.
- If the card has a fast writing speed, the indicator will either not appear or the level (if displayed) will hardly go upward. First, shoot a few test movies to see if the card can write fast enough.
- If the indicator indicates that the card is full and movie recording stops automatically, the sound near the end of the movie may not be recorded properly.
- If the card's writing speed is slow (due to fragmentation) and the indicator appears, formatting the card may make the writing speed faster.



Audio Restrictions

- Note that the following restrictions apply when **[Movie rec. size]** is set to **FHD 29.97P 1PB** (NTSC) or **FHD 25.00P 1PB** (PAL), when **[C.Fn III-9: Audio compression]** is set to **[Enable]**, and for HDR movies.
 - Sound will not be recorded for approx. the last two frames.
 - When you play back movies on Windows, movie images and sound may become slightly out of synchronization.

Playback

This chapter covers topics related to playback—playing back captured still photos and movies—and introduces menu settings on the Playback ([▶]) tab.

Images shot and saved with another device

Normal display or selection on this camera may not be possible for images captured on other cameras, or images from this camera that have been edited or renamed on a computer.

Tab Menus: Playback

● Playback 1

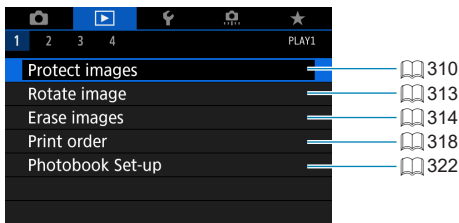

● Playback 2

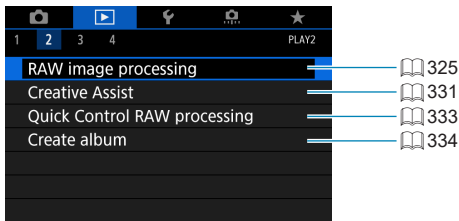

● Playback 3

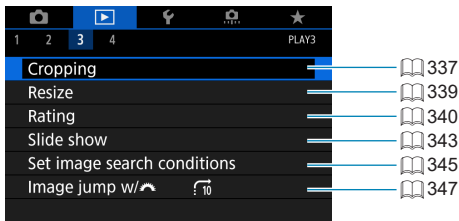

! ● [▶]: RAW image processing] and [▶]: Quick Control RAW processing] are not displayed in Basic Zone modes.

● Playback 4

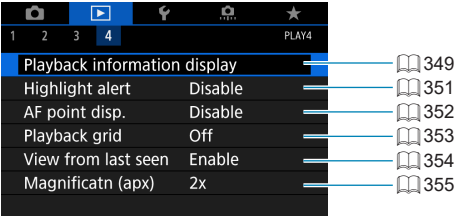

1	2	3
4		PLAY4
Playback information display		349
Highlight alert	Disable	351
AF point disp.	Disable	352
Playback grid	Off	353
View from last seen	Enable	354
Magnificatn (apx)	2x	355

Image Playback

Single-Image Display



- 1 Play back the image.**
 - Press the <▶> button.

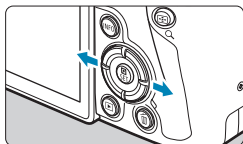

- 2 Select an image.**
 - To play back newer images, press the <▶> button, and to play back older images, press the <◀> button.
 - Each time you press the <INFO> button, the display will change.



No information



Basic information display

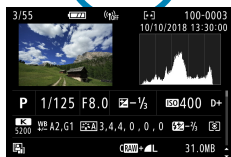

Shooting information display

- 3 Exit the image playback.**
 - Press the <▶> button to exit the image playback.

Shooting Information Display

With the shooting information screen displayed, you can press the <▲> <▼> keys to change the information displayed. You can also customize the information displayed, in [▶: **Playback information display**] (📖 349).

Touch Playback

The camera features a touch-screen panel that you can touch to control playback. Supported touch operations are like those used with smartphones and similar devices. First, press the <▶> button to prepare for touch playback.

Image browsing



Jump display



Index display



Magnified view



- You can also magnify display by double-tapping with one finger.

Magnifying Images

You can magnify your captured images.

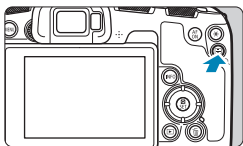

1 Magnify the image.

- During image playback, press the <Q> button.
- ▶ The magnified view will appear. The magnified area position (1) and [Q] will be displayed on the lower right of the screen.
- To magnify images, turn the <Q> dial clockwise.
- To reduce magnification, turn the <Q> dial counterclockwise. For index display (300), keep turning the dial.



(1)

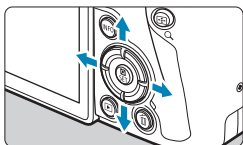

2 Scroll the image.

- Press the <⬆> cross keys to scroll the image vertically and horizontally.
- To cancel the magnified view, press the <Q> button.

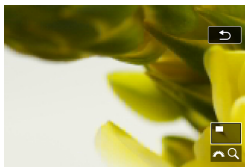

Index Display (Multiple-Image Display)

Search for images quickly with the index display showing 4, 9, 36, or 100 images on one screen.

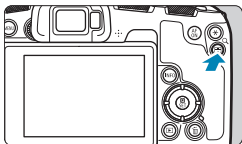

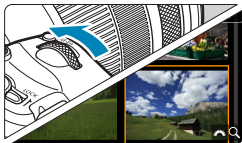

1 Press the <Q> button.

- During image playback, press the <Q> button.
- ▶ [ Q] will be displayed on the lower right of the screen.



2 Switch to the index display.

- Turn the <  > dial counterclockwise.
- ▶ The 4-image index display will appear. The selected image is highlighted with an orange frame.
- Turning the <  > dial further counterclockwise will switch the display from 9 images, 36 images, and to 100 images. If you turn the dial clockwise, it will rotate through 100, 36, 9, 4, and single-image display.



3 Select an image.

- Press the <  > cross keys to move the orange frame and select the image.
- Press <SET> in the index display to display the selected image in the single-image display.

Playing Back Movies

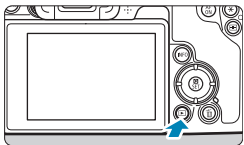

1 Play back the image.

- Press the <▶> button.



2 Select a movie.

- Use the <◀> <▶> keys to select the movie to play back.
- In the single-image display, the <SET [movie icon]> icon displayed on the upper left indicates a movie.
- In the index display, perforations at the left edge of a thumbnail indicate a movie. **As movies cannot be played back from the index display, press <SET> to switch to the single-image display.**

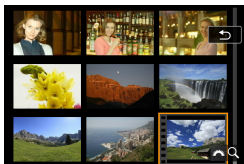

3 In the single-image display, press <SET>.

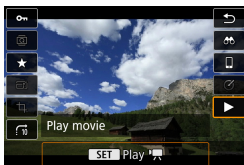

4 Press <SET> to play back the movie.



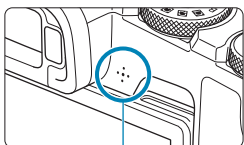











- ▶ The movie will start playing back.
- You can pause playback and display the movie playback panel by pressing <SET>. Press it again to resume the playback.
- You can also adjust the volume during movie playback by using the <▲> <▼> keys.













(1)

(1) Speaker

Movie Playback Panel

Item	Playback Operations
 Play	Pressing <SET> toggles between playback and stop.
 Slow motion	Adjust the slow motion speed with the <◀> <▶> keys. The slow motion speed is indicated on the upper right of the screen.
 Skip backward	Skips backward 4 sec. each time you press <SET>.
 Previous frame	Displays the previous frame each time you press <SET>. Holding <SET> down will rewind the movie.
 Next frame	Plays the movie frame-by-frame each time you press <SET>. Holding <SET> down will fast forward the movie.
 Skip forward	Skips forward 4 sec. each time you press <SET>.
 Edit	Displays the editing screen ( 304).
 Background music	Plays back a movie with the selected background music ( 336).
 Frame Grab	Available when you play 4K or 4K time-lapse movies. Enables you to extract the current frame and save it as a JPEG still image ( 306).
	Playback position
mm' ss"	Playback time (minutes:seconds)
 Volume	Use the <▲> <▼> keys to adjust the speaker volume ( 301).

Movie Playback Panel (Video Snapshot Albums)

Item	Playback Operations
 Play	Pressing <SET> toggles between playback and stop.
 Slow motion	Adjust the slow motion speed with the <◀> <▶> keys. The slow motion speed is indicated on the upper right of the screen.
 Previous clip	Displays the first frame of the previous video snapshot.
 Previous frame	Displays the previous frame each time you press <SET>. Holding <SET> down will rewind the movie.
 Next frame	Plays the movie frame-by-frame each time you press <SET>. Holding <SET> down will fast forward the movie.
 Next clip	Displays the first frame of the next video snapshot.
 Erase clip	Erases the current video snapshot.
 Edit	Displays the editing screen (📖 304).
 Background music	Plays back an album with the selected background music (📖 336).
	Playback position
mm' ss"	Playback time (minutes:seconds)
 Volume	Use the <▲> <▼> keys to adjust the speaker volume (📖 301).



- Adjust the volume using television controls when the camera is connected to a television for movie playback (📖 308). (Volume cannot be adjusted with the <▲> <▼> keys.)
- Movie playback may stop if the card's read speed is too slow or movie files have corrupted frames.



- For details on the movie recording time available, see 📖 586.

Editing a Movie's First and Last Scenes

You can edit out the first and last scenes of a movie in approx. 1-sec. increments.



- 1 Pause movie playback.**
 - ▶ The movie playback panel will appear.



- 2 On the movie playback panel, select [⏏].**



- 3 Specify the part to be edited out.**
 - Select either [⏏] (Cut beginning) or [⏏] (Cut end).
 - Press the <◀> <▶> keys for frame-by-frame playback.
 - After deciding which part to edit out, press <SET>. The portion indicated by a line at the bottom of the screen will remain.

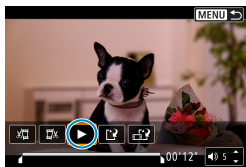

- 4 Check the edited movie.**
 - Select [▶] to play the edited movie.
 - To change the edited part, go back to step 3.
 - To cancel the editing, press the <MENU> button.

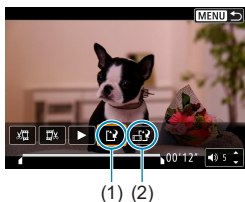

5 Save the image.

- Select [**⏏**] (1).
- The save screen will appear.
- To save it as a new movie, select [**New file**]. To save it and overwrite the original movie file, select [**Overwrite**].
- Select [**⏏**] (2) to save a compressed version of the file. 4K movies are converted to Full HD movies before compression.
- On the confirmation dialog, select [**OK**] to save the edited movie and return to the movie playback screen.



- Because editing is performed in approx. 1-sec. increments (at the position indicated by [**⏏**] at the bottom of the screen), the actual position where movies are trimmed may differ from your specified position.
- Movies shot with another camera cannot be edited with this camera.
- You cannot edit a movie when the camera is connected to a computer.
- Compress and save is not available for movie recording sizes of **FHD 29.97P 1PB** (NTSC) or **FHD 25.00P 1PB** (PAL).



- For instructions on editing video snapshot albums, see "Editing Video Snapshot Albums" (📖 334).

Grabbing a Frame from 4K Movies or 4K Time-Lapse Movies

From 4K movies or 4K time-lapse movies, you can select individual frames to save as approx. 8.3-megapixel (3840×2160) JPEG still images. This function is called “Frame Grab (4K frame capture)”.

1 Play back the image.

- Press the <▶> button.

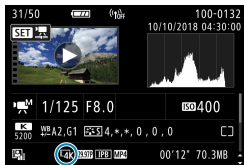

2 Select a 4K movie.

- Use the <◀> <▶> keys to select a 4K movie or 4K time-lapse movie.
- On the shooting information screen (📖 599), 4K movies and 4K time-lapse movies are indicated by an [4K] icon.
- In index display, press <SET> to switch to single-image display.

3 In the single-image display, press <SET>.

4 Pause movie playback.

- ▶ The movie playback panel will appear.



5 Select a frame to grab.

- Use the movie playback panel to select the frame to grab as a still photo.
- For movie playback panel instructions, see 📖 302.

6 Select [📷].

- Use the <◀> <▶> keys to select [📷].





7 Save the image.

- Select **[OK]** to save the current frame as a JPEG still image.

8 Select the image to display.

- Check the destination folder and image file number.
- Select **[View original movie]** or **[View extracted still image]**.



- Frame grabbing is not possible with Full HD movies, Full HD time-lapse movies, or with 4K movies or 4K time-lapse movies from a different camera.

Playback on a TV

By connecting the camera to a television with an HDMI cable, you can play back the captured still photos and movies on the television. Using the HDMI Cable HTC-100 (sold separately) is recommended.

If the image does not appear on the TV screen, check if the [Video system] is correctly set to [For NTSC] or [For PAL] (depending on the video system of your television).

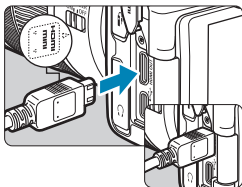

1 Connect the HDMI cable to the camera.

- With the plug's <▲HDMI MINI> logo facing the front of the camera, insert it into the <HDMI OUT> terminal.

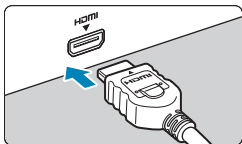

2 Connect the HDMI cable to the television.

- Connect the HDMI cable to the television's HDMI IN port.

3 Turn on the television and switch the television's video input to select the connected port.

4 Set the camera's power switch to <ON>.

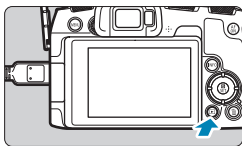

5 Press the <▶> button.

- ▶ The image will appear on the TV screen. (Nothing will be displayed on the camera screen.)
- The images will automatically be displayed at the optimum resolution matching the connected television.



- Adjust movie sound volume with the television. The sound volume cannot be adjusted with the camera.
- Before connecting or disconnecting the cable between the camera and television, turn off the camera and television.
- Depending on the television, part of the image displayed may be cut off.
- Do not connect any other device's output to the camera's <HDMI OUT> terminal. Doing so may cause a malfunction.
- Certain televisions may not display the images due to incompatibility.
- It may take some time before images are displayed. To avoid delay, set [: **HDMI resolution**] to [**1080p**] (386).
- Touch-screen operations are not supported while the camera is connected to a television.

Protecting Images

You can protect important images from being accidentally erased.

Protecting a Single Image

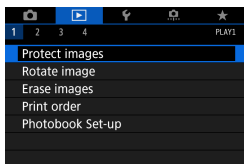

1 Select [: Protect images].

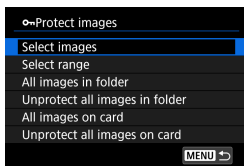



2 Select [Select images].

3 Select an image.

- Use the <◀> <▶> keys to select the image to protect.



4 Protect the image.

- Press <SET> to protect the selected image. The <> icon (1) will appear at the top of the screen.
- To cancel the image protection, press <SET> again. The <> icon will disappear.
- To protect another image, repeat steps 3 and 4.

Specifying the Range of Images to be Protected

While looking at the images in the index display, you can specify the first and last images for a range to protect all the specified images at once.

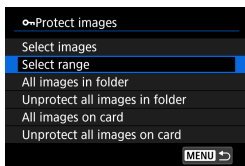

1 Select [Select range].

- Select [Select range] in [▶]: Protect images].

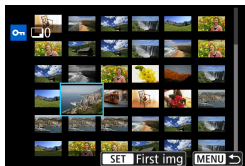

2 Specify the range of images.

- Select the first image (start point).
- Next, select the last image (end point).
- ▶ The images in the specified range will be protected and the <On> icon will appear.
- To select another image to be protected, repeat step 2.

Protecting All Images in a Folder or on a Card

You can protect all the images in a folder or on a card at once.

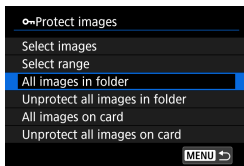

When you select **[All images in folder]** or **[All images on card]** in **[▶]: Protect images**, all the images in the folder or on the card will be protected.

To cancel the selection, select **[Unprotect all images in folder]** or **[Unprotect all images on card]**.

If the search conditions are set with **[▶]: Set image search conditions** (📖 345), the display will change to **[All found images]** and **[Unprotect all found]**.

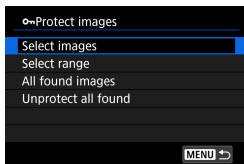

If you select **[All found images]**, all the images filtered by the search conditions will be protected.

If you select **[Unprotect all found]**, the protection of all the filtered images will be canceled.

! If you format the card (📖 367), the protected images will also be erased.

- 📄**
- Once an image is protected, it cannot be erased by the camera's erase function. To erase a protected image, you must first cancel the protection.
 - If you erase all the images (📖 317), only the protected images will remain. This is convenient when you want to erase all unnecessary images at once.

Rotating Images

You can use this feature to rotate the displayed image to the desired orientation.

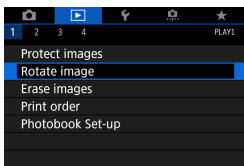

1 Select [▶]: Rotate image.

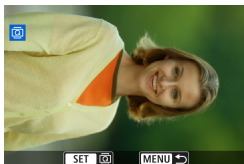

2 Select an image.

- Use the <◀> <▶> keys to select the image to rotate.

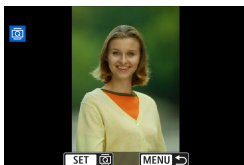

3 Rotate the image.

- Each time you press <SET>, the image will rotate clockwise as follows: 90° → 270° → 0°.
- To rotate another image, repeat steps 2 and 3.



- If you set [⚙: Auto rotate] to [On📷📺] (📖 366) before taking vertical shots, you need not rotate the image with this function.
- If the rotated image is not displayed in the rotated orientation during image playback, set [⚙: Auto rotate] to [On📷📺].

Erasing Images

You can either select and erase unnecessary images one by one or erase them in one batch. Protected images (📖 310) will not be erased.

- Once an image is erased, it cannot be recovered. Make sure you no longer need the image before erasing it. To prevent important images from being erased accidentally, protect them.

Erasing a Single Image

- Select the image to be erased.**
 - Press the <▶> button.
 - Use the <◀> <▶> keys to select the image to erase.



- Press the <🗑> button.**



- Erase the images.**

JPEG or RAW Images or Movies

- Select [Erase].



RAW+JPEG images

- Select an item.

Checkmarking [✓] Images to Be Erased in a Batch

By adding checkmarks to the images to be erased, you can erase all those images at once.

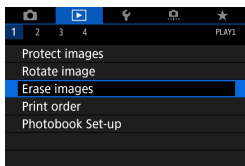

1 Select [▶]: Erase images].

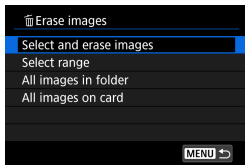

2 Select [Select and erase images].



3 Select an image.

- Use the <◀> <▶> keys to select the image to erase, then press <SET>.
- To select another image to be erased, repeat step 3.

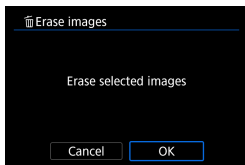

4 Erase the images.

- Press the <MENU> button, then press [OK].

Specifying the Range of Images to Be Erased

While looking at the images in the index display, you can specify the first and last images for a range to erase all the specified images at once.

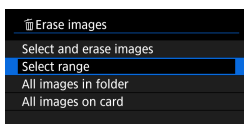

- 1 **Select [Select range].**
 - Select [Select range] in [▶]: Erase images].

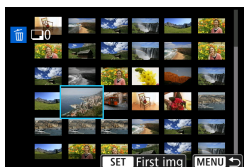

- 2 **Specify the range of images.**
 - Select the first image (start point).
 - Next, select the last image (end point).

- 3 **Press the <MENU> button.**

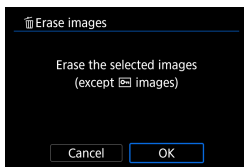

- 4 **Erase the images.**
 - Select [OK].

Erasing All Images in a Folder or on a Card

You can erase all the images in a folder or on a card at once.

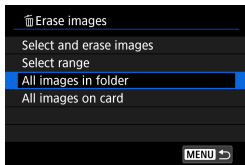

When [**▶**: **Erase images**] is set to [**All images in folder**] or [**All images on card**], all the images in the folder or on the card will be erased.

If the search conditions are set with [**▶**: **Set image search conditions**] (📖 345), the display will change to [**All found images**].

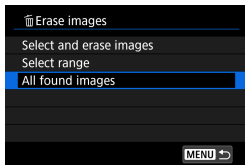

If you select [**All found images**], all the images filtered by the search conditions will be erased.



- To erase all the images including protected images, format the card (📖 367).

Digital Print Order Format (DPOF)

DPOF (Digital Print Order Format) enables you to print images recorded on the card according to your printing instructions such as the image selection, quantity to print, etc. You can print multiple images in one batch or create a print order for a photofinisher.

You can set the print settings such as print type, date imprinting, file number imprinting, etc. The print settings will be applied to all the images specified for printing. (They cannot be set individually for each image.)

Setting the Printing Option

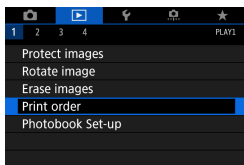

1 Select []: Print order].

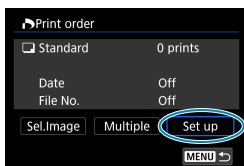

2 Select [Set up].

3 Set the options as desired.

- Set the [Print type], [Date], and [File No.].

Print type	Standard	Prints one image on one sheet.
	Index	Multiple thumbnail images are printed on one sheet.
	Both	Prints both the standard and index prints.
Date	On	[On] imprints the recorded date of the captured image.
	Off	
File number	On	[On] imprints the file number.
	Off	

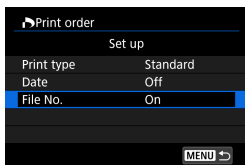

4 Exit the setting.

- Press the <MENU> button.
- Next, select **[Sel.Image]** or **[Multiple]** to specify the images to be printed.



- If you print an image with a large image size using the **[Index]** or **[Both]** setting (📖 318), the index print may not be printed with certain printers. In this case, resize the image (📖 339), then print the index print.
- Even if **[Date]** and **[File No.]** are set to **[On]**, the date or file number may not be imprinted, depending on the print type setting and printer.
- With **[Index]** prints, the **[Date]** and **[File No.]** cannot both be set to **[On]** at the same time.
- When printing with DPOF, use the card for which print order specifications are set. You cannot print in the specified print order if you extract just the images from the card for printing.
- Certain DPOF-compliant printers and photofinishers may not be able to print the images as you specified. Refer to the printer's instruction manual before printing, or check with your photofinisher about compatibility when ordering prints.
- Do not use this camera to configure print settings for images with DPOF settings set up on another camera. All the print orders may be overwritten inadvertently. Also, the print order may not be possible, depending on the image type.

Specifying Images for Printing

Selecting Images

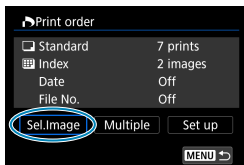

Select and specify the images one by one. Press the **<MENU>** button to save the print order to the card.



Standard / Both

Press **<SET>** to print a copy of the displayed image. By pressing the **<▲>** **<▼>** keys, you can set the number of copies to be printed up to 99.

- (1) Quantity
- (2) Total images selected

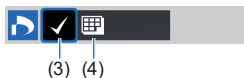

Index

Press **<SET>** to add a checkmark to the box **[✓]**. The image will be included in the index print.

- (3) Checkmark
- (4) Index icon

Selecting Multiple Images

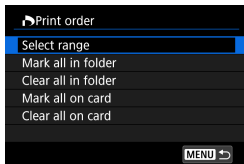

Select Range

Under **[Multiple]**, select **[Select range]**. Selecting the first and last images of the range marks all the images in the range with a checkmark **[✓]**, and one copy of each image will be printed.

- **All Images in a Folder**



Select [**Mark all in folder**] and select the folder. A print order for one copy of all the images in the folder will be specified.

If you select [**Clear all in folder**] and select the folder, the print order for all the images in the folder will be canceled.

- **All Images on a Card**

If you select [**Mark all on card**], one copy of all the images on the card will be specified for printing.

If you select [**Clear all on card**], the print order will be cleared for all the images on the card.

If the search conditions are set with []: **Set image search conditions**] ( 345) and you select [**Multiple**], the display will change to [**Mark all found images**] and [**Clear all found images**].

- **All Found Images**

If you select [**Mark all found images**], one copy of all the images filtered by the search conditions will be specified for printing.

If you select [**Clear all found images**], all the print order of the filtered images will be cleared.



- RAW images or movies cannot be specified for printing. Note that RAW images or movies will not be specified for printing even if you specify all images with [**Multiple**].
- When using a PictBridge-compatible printer, do not specify more than 400 images for one print order. If you specify more than this, the images may not all be printed.

Specifying Images for a Photobook

You can specify up to 998 images to be printed in a photobook. When you use EOS Utility (EOS software) to import images to a computer, the specified images for a photobook will be copied to a dedicated folder. This function is useful for ordering photobooks online.

Specifying One Image at a Time

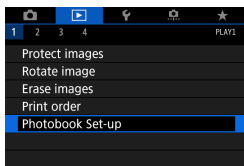

1 Select [: Photobook Set-up].

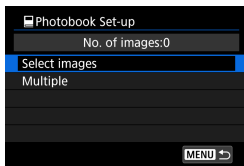

2 Select [Select images].

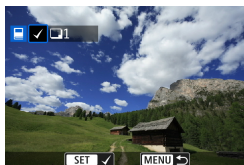

3 Select the image to be specified.

- Use the <◀> <▶> keys to select an image, then press <SET>.
- To select other images to be specified for a photobook, repeat step 3.

Specifying the Image Range for a Photobook

While looking at the images in the index display, you can specify the range (start point to end point) of images to be specified for a photobook at once.

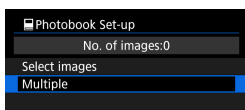

1 Select [Multiple].

- Under [**▶** : Photobook Set-up], select [Multiple].

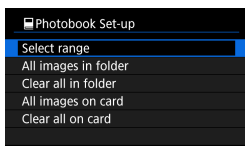

2 Select [Select range].

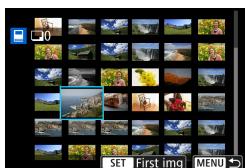

3 Specify the range of images.

- Select the first image (start point).
- Next, select the last image (end point).
- ▶ A checkmark [**✓**] will be appended to all the images within the range between first and last images.

Specifying All Images in a Folder or on a Card

You can specify all the images in a folder or on a card at once for a photobook.

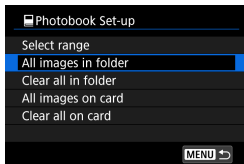

Under [▶]: **Photobook Set-up**], you can set [Multiple] to [All images in folder] or [All images on card] to specify all the images in the folder or on the card for a photobook.

To cancel the selection, select [Clear all in folder] or [Clear all on card].

If the search conditions are set with [▶]: **Set image search conditions** (📖 345) and you select [Multiple], the display will change to [All found images] and [Clear all found images].

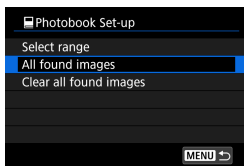

If you select [All found images], all the images filtered by the search conditions will be specified for the photobook.

If you select [Clear all found images], all the photobook order of the filtered images will be cleared.



- RAW images or movies cannot be specified for the photobook. Note that RAW images or movies will not be specified for the photobook even if you specify all images with [Multiple].
- Do not use this camera to configure photobook settings for images with photobook settings set up on another camera. All the photobook settings may be overwritten inadvertently.

Processing RAW Images with the Camera ☆

You can process **RAW** or **CRAW** images with the camera to create JPEG images. RAW images are not affected, so different conditions can be applied to create JPEGs.

You can also use Digital Photo Professional (EOS software) to process RAW images.

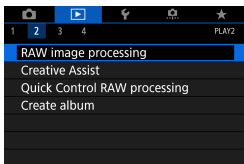

1 Select [▶]: RAW image processing].

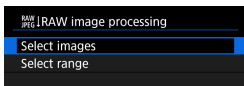

2 Select an item, then select images.

- You can select multiple images to process at once.

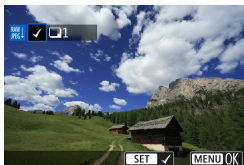

Select images

- Use the <◀> <▶> keys to select images to process, then press <SET>.
- Press the <MENU> button.

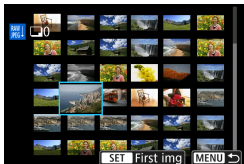

Select range

- Select the first image (start point).
- Next, select the last image (end point).
- Press the <MENU> button.

3 Set the desired processing conditions.

Use shot settings

- Images are processed using image settings at the time of capture.

Customize RAW processing

- Use the <▲> <▼> <◀> <▶> keys to select an item.
- Turn the <☀> or <☾> dial to switch the setting.
- Press <SET> to access the function setting screen.
- To return to the image settings at the time of shooting, press the <☰> button.



Comparison Screen

- You can switch between the [After change] and [Shot settings] screens by pressing the <INFO> button and turning the <☾> dial.
- Items in orange on the [After change] screen have been modified since the time of capture.
- Press the <MENU> button.

4 Save the image.

- When using [Customize RAW processing], select [☑] (Save).
- Read the message and select [OK].
- To process other images, select [Yes] and repeat steps 2–4.

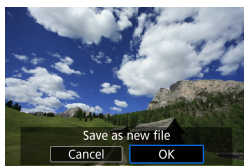



- 5 Select the image to display.**
- Select **[Original image]** or **[Processed img.]**.

Magnified View

You can magnify images displayed for **[Customize RAW processing]** by pressing the **<Q>** button. Magnification varies depending on the **[Image quality]** setting. Using **<⬆>** cross keys, you can scroll the magnified image vertically and horizontally.

To cancel the magnified view, press the **<Q>** button again.

Images with Aspect Ratio Setting

JPEG images at the specified aspect ratio are created when you process RAW images with **[📷: 📷Cropping/aspect ratio]** (📖 119) set to **[1:1 (aspect ratio)]**, **[4:3 (aspect ratio)]**, or **[16:9 (aspect ratio)]**.



- Some settings cannot be changed when multiple-exposure **RAW** or **CRRAW** images are processed.

RAW Image Processing Options

-  **Brightness adjustment**

You can adjust the image brightness up to ± 1 stop in 1/3-stop increments.

-  **White balance** (📖 140)

You can select the white balance. If you select **[AWB]**, you can select **[Auto: Ambience priority]** or **[Auto: White priority]**. If you select **[K]**, you can set the color temperature.

-  **Picture Style** (📖 148)

You can select the Picture Style. You can adjust the sharpness, contrast, and other parameters.



-  **Auto Lighting Optimizer** (📖 136)

You can set the Auto Lighting Optimizer.

-  **High ISO speed noise reduction** (📖 157)

You can set the noise reduction processing for high ISO speeds. If the effect is difficult to discern, magnify the image (📖 299).

-  **Image quality** (📖 116)

You can set the image quality when creating a JPEG image. Note that only  **L** /  **L/S2** are available for RAW images captured in cropped shooting or with EF-S lenses.

- **[sRGB] Color space** (📖 147)

You can select either sRGB or Adobe RGB. Since the camera screen is not compatible with Adobe RGB, the difference in the image will hardly be perceptible when either color space is set.

- **[📐] Lens aberration correction**

- **[🔍 OFF] Peripheral illumination correction** (📖 124)

A phenomenon that makes the image corners look darker due to the lens characteristics can be corrected. If **[Enable]** is set, the corrected image will be displayed. If the effect is difficult to discern, magnify the image (📖 299) and check the four corners. The peripheral illumination correction applied with the camera will be less pronounced than that applied with the Digital Photo Professional (EOS software) at maximum correction amount. If the effects of correction are not apparent, use Digital Photo Professional to apply the peripheral illumination correction.

- **[🔍 OFF] Distortion correction** (📖 124)

Image distortion due to lens characteristics can be corrected. If **[Enable]** is set, the corrected image will be displayed. The image periphery will be trimmed in the corrected image. Since the image resolution may look slightly lower, adjust the sharpness with the Picture Style's **[Sharpness]** parameter setting as necessary.

- **[🔍 OFF] Digital Lens Optimizer** (📖 125)

Correct lens aberration, diffraction, and low-pass filter-induced loss of sharpness by applying optical design values. Magnify images (📖 299) to check the effects of setting this option to **[Enable]**. Without magnification, the effect of Digital Lens Optimizer is not displayed. Selecting **[Enable]** corrects both chromatic aberration and diffraction, although these options are not displayed.

-  **Chromatic aberration correction** (📖 126)

Chromatic aberrations (color fringing along the subject's outline) due to the lens characteristics can be corrected. If **[Enable]** is set, the corrected image will be displayed. If the effect is difficult to discern, magnify the image (📖 299).

-  **Diffraction correction** (📖 126)

The diffraction by the lens aperture degrading the image sharpness can be corrected. If **[Enable]** is set, the corrected image will be displayed. If the effect is difficult to discern, magnify the image (📖 299).



- Processing RAW images in the camera will not produce exactly the same results as processing RAW images with Digital Photo Professional (EOS software).
- If you perform **[Brightness adjustment]**, noise, banding, etc. may be intensified with the effects of adjustment.
- When **[Digital Lens Optimizer]** is set, noise may be intensified together with the effects of correction. Image edges may also be emphasized. Adjust Picture Style sharpness or set **[Digital Lens Optimizer]** to **[Disable]**, as needed.



- The effect of the lens aberration correction varies depending on the lens used and shooting conditions. Also, the effect may be difficult to discern depending on the lens used, shooting conditions, etc.

Applying Your Favorite Effects (Creative Assist)

You can process RAW images by applying your preferred effects and saving as JPEGs.

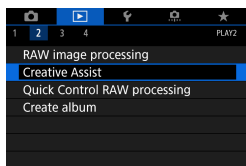

1 Select [▶]: Creative Assist.

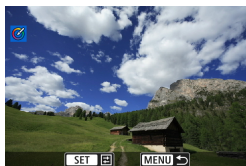

2 Select an image.

- Use the <<◀> <▶> keys to select images to process, then press <SET>.



3 Select an effect level.

- Use the <<◀> <▶> keys to select the effect.



- By selecting [**Preset**] and pressing <SET>, you can choose [**Vivid**], [**Soft**], or other preset effects. [**Auto 1**], [**Auto 2**], and [**Auto 3**] are effects recommended by the camera based on image conditions.

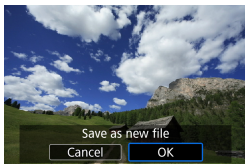

- You can adjust effects such as **[Brightness]** or **[Contrast]** by pressing <SET> and then using the <◀> <▶> keys.
- Press <SET> when adjustment is finished.
- To reset the effect, press the <🗑️> button.
- To confirm the effect, press the <📄> button.

4 Select [OK] to save the image.

Selecting the Type of RAW Image Processing

You can select the type of RAW image processing performed from the Quick Control screen.

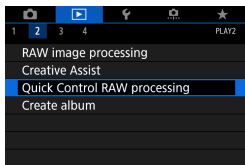

1 Select [▶]: **Quick Control RAW processing**.

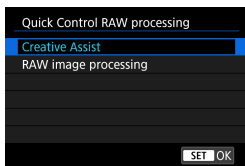

2 Select an item.

- **Creative Assist**
RAW processing that applies your preferred effect (📖 331).
- **RAW image processing**
RAW processing according to conditions you specify (📖 325).

Editing Video Snapshot Albums

You can rearrange, delete, or play back the video snapshots in an album.

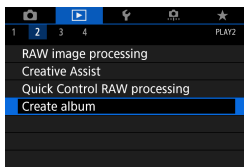

1 Select []: Create album].



2 Select an album to edit.

- Press <SET> to add a checkmark [].
- After selection, press the <MENU> button.



3 Select [OK].



4 Select an editing option.

Option	Description
↔ Rearrange video snapshots	Use the <◀> <▶> keys to select a video snapshot to move, then press <SET>. Use the <◀> <▶> keys to move it, then press <SET>.
🗑️ Remove video snapshot	Use the <◀> <▶> keys to select a video snapshot to delete, then press <SET>. Selected video snapshots are labeled [🗑️]. To clear the selection and remove [🗑️], press <SET> again.
▶ Play video snapshot	Use the <◀> <▶> keys to select a video snapshot to play, then press <SET>. Use the <▲> <▼> keys to adjust the volume.



5 Finish editing.

- Press the <MENU> button when you are finished editing.
- Select [🗑️] (Finish editing).

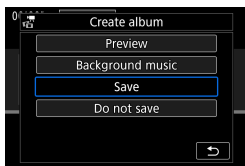

6 Save the image.

- To play an album with background music, use [Background music] to select the music (📖 336).
- To check your editing, select [Preview].
- Selecting [Save] saves the edited album as a new album.



- Video snapshot albums can only be edited once.

Selecting Background Music

Albums and slideshows can be played with background music once you copy the music to the card, using EOS Utility (EOS software).

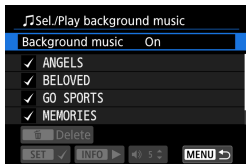

- 1 **Select [Background music].**
 - Set [Background music] to [On].

- 2 **Select the background music.**
 - Use the <▲> <▼> keys to select the music, then press <SET>. For [Slide show], you can select multiple tracks.

- 3 **Listen to a sample.**
 - To listen to a sample, press the <INFO> button.
 - Use the <▲> <▼> keys to adjust the volume. Press the <INFO> again to stop playback.
 - To delete the music, use the <▲> <▼> keys to select it, then press the <🗑️> button.



- For instructions on copying background music to cards, refer to the EOS Utility Instruction Manual.

Cropping JPEG Images

You can crop a captured JPEG image and save it as another image. Cropping an image is possible only with JPEG images. **Images shot in RAW cannot be cropped.**

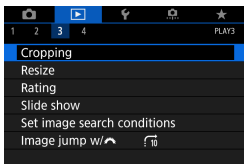

1 Select []: Cropping].

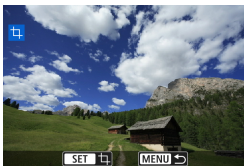

2 Select an image.

- Use the <◀> <▶> keys to select the image to crop.





3 Set the cropping frame.

- Press <SET> to display the cropping frame.
- The image area within the cropping frame will be cropped.

● Changing the Cropping Frame Size

Turn the < > dial to change the cropping frame size. The smaller the cropping frame, the more magnified the cropped image will look.

● Changing the Aspect Ratio and Orientation

Turn the < > dial to select < >. Press <SET> to change the cropping frame's aspect ratio.

● Moving the Cropping Frame

Press the <⬆> cross keys to move the frame vertically or horizontally. Move the cropping frame until it covers the desired image area.

● Correcting the Tilt

You can correct image tilt by $\pm 10^\circ$. Turn the <⚙> dial to select <📐>, then press <SET>. While checking the tilt against the grid, turn the <⚙> dial (in 0.1° increments) or tap the left or right wedge (in 0.5° increments) on the upper left of the screen to correct the tilt. After completing the tilt correction, press <SET>.



4 Check the image area to be cropped.

- Turn the <⚙> dial to select <📐>.
- ▶ The image area to be cropped will be displayed.

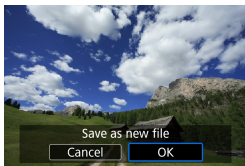

5 Save the image.

- Turn the <⚙> dial to select <[?]>.
- Select **[OK]** to save the cropped image.
- Check the destination folder and image file number, then select **[OK]**.
- To crop another image, repeat steps 2 to 5.

- ⚠
- The position and size of the cropping frame may change depending on the angle set for tilt correction.
 - Once a cropped image is saved, it cannot be cropped again or resized.
 - AF point display information (📖 352) and Dust Delete Data (📖 161) will not be appended to the cropped images.

Resizing JPEG Images

You can resize a JPEG image to make the pixel count lower and save it as a new image. Resizing an image is possible only with JPEG **L**, **M**, and **S1** images. JPEG **S2** and **RAW** images cannot be resized.

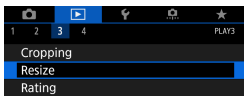

1 Select []: Resize.

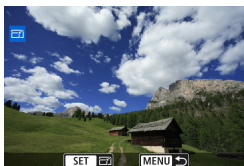

2 Select an image.

- Use the << >> <> >> keys to select the image to resize.



3 Select the desired image size.

- Press <SET> to display the image sizes.
- Select the desired image size (1).
- Only resizing to **S2** is available for JPEG images captured in cropped shooting or with EF-S lenses.

(1)

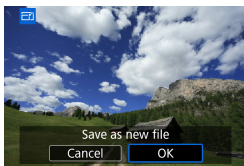

4 Save the image.

- Select [OK] to save the resized image.
- Check the destination folder and image file number, then select [OK].
- To resize another image, repeat steps 2 to 4.



● For details on image sizes of resized images, see  590.

Setting Ratings

You can rate images on a scale of 1–5 ([★]/[★]/[★]/[★]/[★]). This function is called rating.

Rating a Single Image

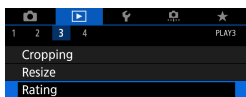

1 Select [▶]: Rating].

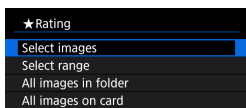

2 Select [Select images].



3 Select the image to be rated.

- Use the <◀> <▶> keys to select the image to rate.



4 Rate the image.

- Press <SET>, and a blue highlight frame will appear as shown in the screen shown on the left.
- Use the <▲> <▼> keys to select a rating mark, then press <SET>.
- ▶ When you append a rating mark to the image, the number beside the set rating will increase by one.
- To rate another image, repeat steps 3 and 4.

Rating by Specifying the Range

While looking at the images in the index display, you can specify the first and last images for a range to rate all the specified images at once.

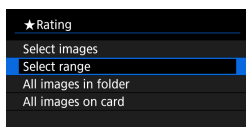

1 Select [Select range].

- Select [Select range] in [▶: Rating].

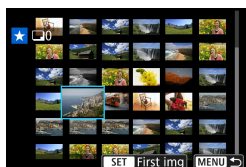

2 Specify the range of images.

- Select the first image (start point).
- Next, select the last image (end point).
- ▶ A checkmark [✓] will be appended to all the images within the range between first and last images.

3 Press the <MENU> button.

4 Rate the image.

- Turn the <◀▶> dial to select a rating mark, then select [OK].
- ▶ All the images in the specified range will be rated (same rating) at once.



Rating All Images in a Folder or on a Card

You can rate all the images in a folder or on a card at once.

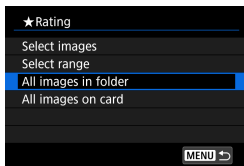

Under []: **Rating**], when you select [**All images in folder**] or [**All images on card**], all the images in the folder or on the card will be rated.



Turn the < > dial to select a rating, then select [**OK**].

When you are not rating images or cancelling the rating, select [**OFF**].

If the search conditions are set with []: **Set image search conditions**] (345), the display will change to [**All found images**].

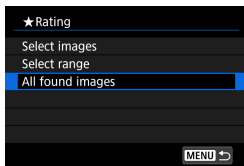

If you select [**All found images**], all the images filtered by the search conditions will be rated as specified.



- Values next to ratings are displayed as [###] if more than 1,000 images have that rating.
- With []: **Set image search conditions**] and []: **Image jump w/**, you can display only the images given a specific rating.

Slide Show (Auto Playback)

You can play back the images on the card as an automatic slide show.

1 Specify the images to be played back.

- To play back all the images on the card, go to step 2.
- If you want to specify the images to be played back in the slide show, filter the images with [**▶** : **Set image search conditions**] (📖 345).

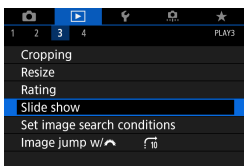

2 Select [**▶** : Slide show].

3 Set the playback as desired.

- Select [**Set up**].
- Set the [**Display time**], [**Repeat**] (repeated playback), and [**Transition effect**] (effect when changing images) for the still photos.
- To play background music, use [**Background music**] to select the music (📖 336).
- After completing the settings, press the <MENU> button.

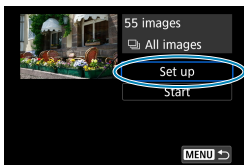

Display time

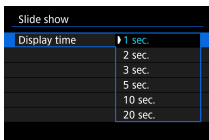

Repeat

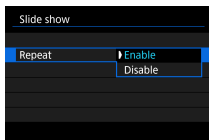

Transition effect

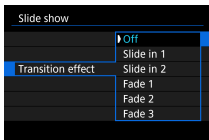

Background music

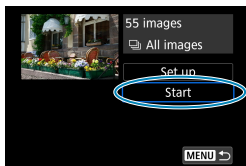
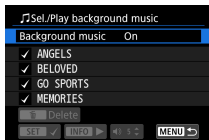

4 Start the slide show.

- Select **[Start]**.
- ▶ After **[Loading image...]** is displayed, the slide show will start.

5 Exit the slide show.

- To exit the slide show and return to the setting screen, press the **<MENU>** button.

- To pause the slide show, press **<SET>**. During pause, **[III]** will be displayed on the upper left of the image. Press **<SET>** again to resume the slide show.
- During the automatic playback of still photos, you can press the **<INFO>** button to switch the display format (📖 296).
- Volume during movie playback can be adjusted by pressing the **<▲>** **<▼>** keys.
- During auto playback or pause, you can press the **<◀>** **<▶>** keys to view another image.
- During auto playback, auto power off will not take effect.
- The display time may differ depending on the image.

Filtering Images for Playback

You can filter image display according to your search conditions. After setting the image search conditions, you can play back and display only the found images.

You can also protect, rate, erase, play a slide show, and apply other operations to filtered images.

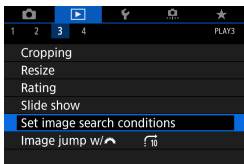



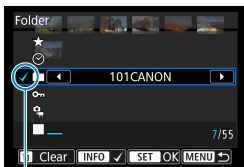



1 Select []: Set image search conditions].



(1)

2 Set the search conditions.

- Use the <▲> <▼> keys to select an item.
- Use the <◀> <▶> keys to set the setting.
- ▶ A checkmark [] (1) is appended to the left of the item. (Specified as the search condition.)
- If you select the item and press the <|INFO|> button, the checkmark [] will be removed. (The search condition is canceled.)

Item	Description
 Rating	Displays images with the selected (rating) condition.
 Date	Displays images taken on the selected shooting date.
 Folder	Displays images in the selected folder.
 Protect	Displays images with the selected (protect) condition.
 Type of file	Displays images in the selected file type.

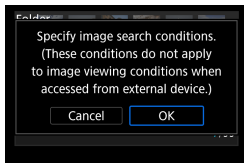

3 Apply the search conditions.

- Press <SET> and read the message displayed.
- Select [OK].
- ▶ The search condition is specified.



4 Display the found images.

- Press the <▶> button.
- ▶ Only the images that match the set conditions (filtered) will be played back.
- ▶ When the images are filtered for display, the screen will have an outer yellow frame (2).

Clearing the Search Conditions

Access the screen in step 2, then press the <⏏> button to remove all the checkmarks [✓]. Press <SET> to clear the search conditions.

- If no images match the search conditions, [OK] is not available on the screen in step 2.

- Search conditions may be cleared if you perform power, card, or image editing operations.
- Auto power off time may be extended while the [▶]: **Set image search conditions** screen is displayed.

Jump Display (Jumping Through Images)

In the single-image display, you can turn the <⚙️> dial to jump through the images forward or backward according to the jump method set.

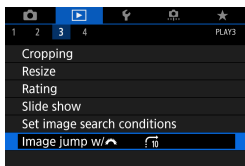

1 Select [: Image jump w/⚙️].

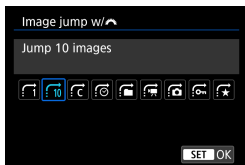

2 Select the jump method.



- With [**Jump images by the specified number**], you can turn the <⚙️> dial to select the number of images to jump by.
- When you select [**Display by image rating**], turn the <⚙️> dial to specify the rating (📖 340). If you browse images with ★ selected, all the rated images will be displayed.

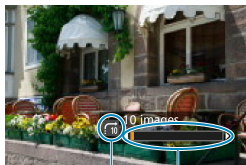

(1)

(2)

3 Browse by jumping.

- Press the <▶> button.
- In the single-image display, turn the <◀▶> dial.
- ▶ You can browse by the set method.

- (1) Jump method
- (2) Playback position



- To search images by shooting date, select [📅: **Date**].
- To search images by folder, select [📁: **Folder**].
- If the card contains both movies and still photos, select [🎞️: **Movies**] or [📷: **Stills**] to display one or the other.

Customizing Playback Information Display

You can specify screens and accompanying information displayed during image playback.

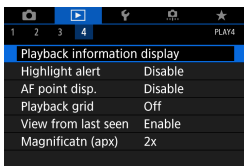

1 Select []: Playback information display].

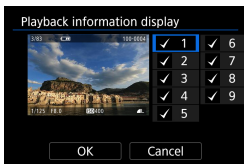

2 Add a checkmark [] next to the number of screens to display.

- Use the <▲> <▼> keys to select a number.
- Press <SET> to add a checkmark [].
- Repeat these steps to add a checkmark [] to the number of each screen to display, then select [**OK**].
- ▶ Your selected information can be accessed by pressing the <INFO> button during playback, or by pressing the <▲> <▼> keys when shooting information is displayed.

Histogram

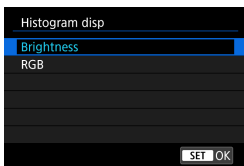

The brightness histogram shows the exposure level distribution and overall brightness. The RGB histogram is for checking the color saturation and gradation. You can switch the histogram displayed by pressing the <INFO> button when <INFO> is displayed in the lower left of the []: Playback information display] screen.

● [Brightness] display

This histogram is a graph showing the distribution of the image's brightness level. The horizontal axis indicates the brightness level (darker on the left and brighter on the right) while the vertical axis indicates how many pixels exist for each brightness level. The more pixels there are toward the left, the darker the image. The more pixels there are toward the right, the brighter the image. If there are too many pixels on the left, the shadow detail will be lost. If there are too many pixels on the right, the highlight detail will be lost. The gradation in-between will be reproduced. By checking the image and its brightness histogram, you can see the exposure level inclination and the overall gradation.

Sample Histograms



Dark image



Normal brightness



Bright image

● [RGB] display

This histogram is a graph showing the distribution of each primary color's brightness level in the image (RGB or red, green, and blue). The horizontal axis indicates the color's brightness level (darker on the left and brighter on the right), while the vertical axis indicates how many pixels exist for each color brightness level. The more pixels there are toward the left, the darker and less prominent the color. The more pixels there are toward the right, the brighter and denser the color. If there are too many pixels on the left, the respective color information will be lacking. If there are too many pixels on the right, the color will be too saturated with no gradation. By checking the image's RGB histogram, you can see the color's saturation and gradation condition, as well as white balance inclination.

Displaying the Highlight Alert

You can specify blinking display of overexposed highlights on the playback screen. To obtain more detailed gradation in the blinking areas where you want the gradation to be faithfully reproduced, set the exposure compensation to a negative amount and shoot again for a better result.

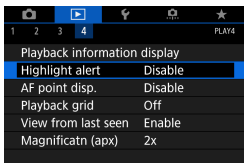

1 Select [▶]: Highlight alert].

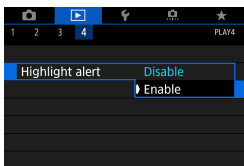

2 Select [Enable].

Displaying AF Points

You can display the AF points that were used to focus, which will be outlined in red on the playback screen. If automatic AF point selection is set, multiple AF points may be displayed.

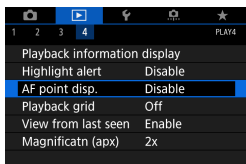

1 Select [: AF point disp.].

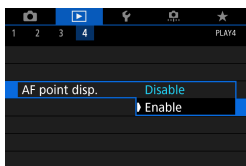

2 Select [Enable].

Displaying a Grid

You can display a grid over still photos shown in single-image display on the playback screen. This function is convenient for checking the image's vertical or horizontal tilt as well as composition.

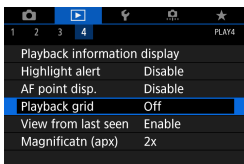

1 Select [▶]: Playback grid].

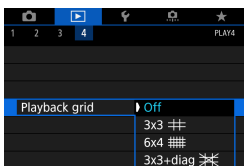

2 Select an item.

Specifying Initial Image Display When Playback Begins

You can specify which image is displayed first when you start image playback.

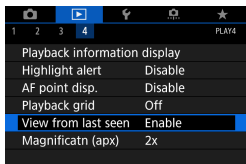

1 Select [▶]: View from last seen].

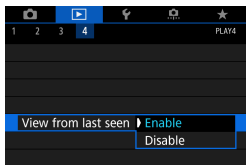

2 Select an item.

- **[Enable]**: Playback resumes from the last image displayed (except when you have just finished shooting).
- **[Disable]**: Playback resumes from your most recent shot whenever the camera is restarted.

Setting the Initial Magnification Ratio and Position

You can set the initial magnification ratio and position for the magnified view.

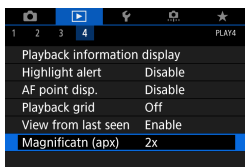

1 Select []: Magnificatn (apx)].

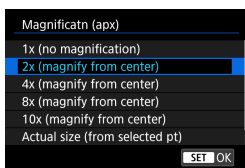

2 Select an item.

● 1x (no magnification)

The image is not magnified. The magnified view will start with the single-image display.

● 2x, 4x, 8x, 10x (magnify from center)

The magnified view starts at the image center at the selected magnification.

● Actual size (from selected point)

The recorded image's pixels will be displayed at approx. 100%. The magnified view starts at the AF point that achieved focus. If the photo is taken with manual focus, the magnified view starts at the image center.

● Same as last magnification (from center)

The magnification will be the same as the last time you exited the magnified view with the <Q> button. The magnified view starts at the image center.



- Under some AF method settings, the magnified view extends from the center of images even if **[Actual size (from selected pt)]** is set.







Set-up

This chapter describes menu settings on the set-up ([F4]) tab.





- A ☆ icon to the right of a page title indicates that the function is available only in <Fv>, <P>, <Tv>, <Av>, <M>, or mode.

Tab Menus: Set-up







● Set-up 1

1	2	3	4	5	6	SET UP1
						Select folder  361
						File numbering Continuous  363
						Auto rotate On  366
						Format card  367
						Mode guide Enable  369
						Feature guide Enable  370

● Set-up 2

1	2	3	4	5	6	SET UP2
						Eco mode Off  371
						Power saving  372
						Disp. brightness  373
						Date/Time/Zone 10/10/18 13:30  374
						Language English  377

● Set-up 3

1	2	3	4	5	6	SET UP3
						Video system For NTSC  378
						Touch control Standard  379
						Beep Enable  380
						Battery info.  381
						Sensor cleaning  382
						HDMI resolution Auto  386
						HDMI HDR output Off  387

● Set-up 4

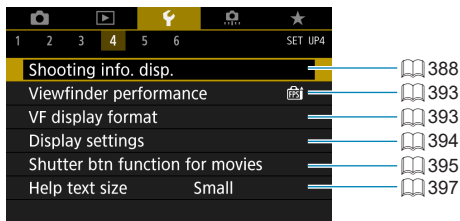

● Set-up 5

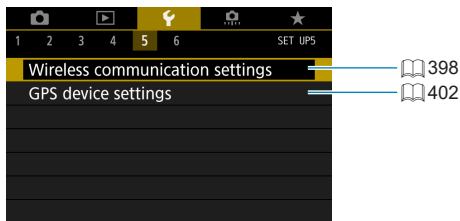

● Set-up 6

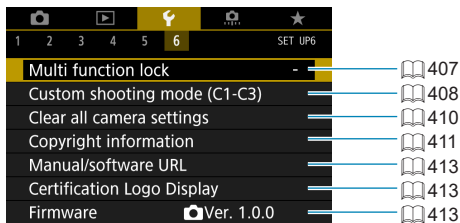

When you are recording movies, the following screen is displayed for [F4] and [F6].

● Set-up 4

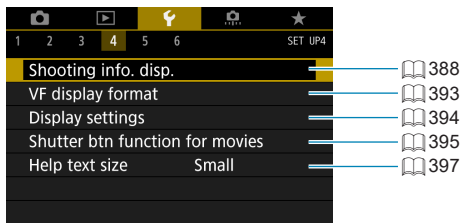

● Set-up 6

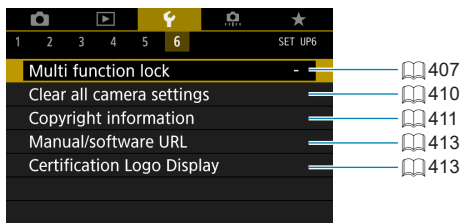

In Basic Zone and [HDR Movie] modes, the following screen is displayed for [F6].

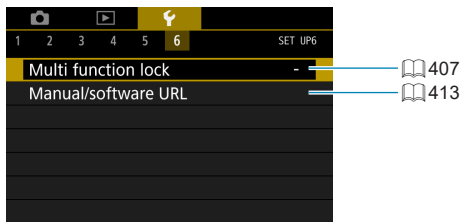

Creating and Selecting a Folder

You can freely create and select the folder where the captured images are to be saved.

Creating a Folder

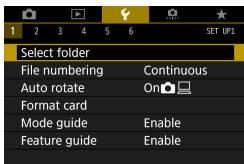

1 Select [**↗**: Select folder].

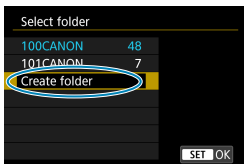

2 Select [**CREATE** folder].

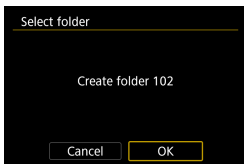

3 Select [**OK**].

Selecting a Folder

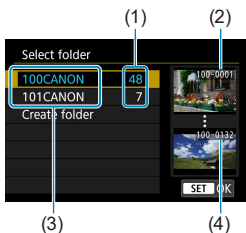

- Select a folder on the folder selection screen.
- Captured images are stored in your selected folder.

- (1) Number of images in folder
- (2) Lowest file number
- (3) Folder name
- (4) Highest file number



Folders

- A folder can contain up to 9999 images (file number 0001–9999). When a folder becomes full, a new folder with the folder number increased by one is created automatically. Also, if manual reset (📖 365) is executed, a new folder will be created automatically. Folders numbered from 100 to 999 can be created.

Creating Folders with a Computer

- With the card open on the screen, create a new folder named “**DCIM**”. Open the DCIM folder and create as many folders as necessary to save and organize your images. The folder name must follow the format “**100ABC_D**”. The first three digits are always the folder number from 100 to 999. The last five characters can be any combination of upper- and lower-case letters from A to Z, numerals, and the underscore “_”. The space cannot be used. Also note that two folder names cannot share the same three-digit folder number (for example, “100ABC_D” and “100W_XYZ”) even if the remaining five characters in each name are different.

File Numbering Methods

The captured images saved in a folder are assigned a file number from 0001 to 9999. You can change how the image files are numbered.

(Example) **IMG_0001.JPG**

File number

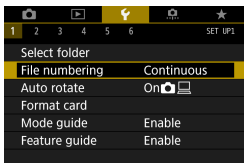

1 Select [**⚡**: File numbering].

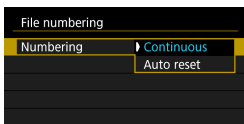

2 Set the item.

- Select [**N**umbering].
- Select [**C**ontinuous] or [**A**uto reset].
- If you want to reset the file numbering, select [**M**anual reset] (📖 365).
- Select [**O**K] to create a new folder, and the file number will start with 0001.

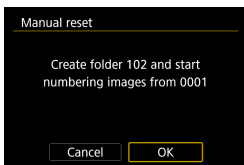
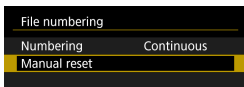

- If the file number in folder 999 reaches 9999, shooting will not be possible even if the card still has storage capacity. The screen will display a message telling you to replace the card. Replace it with a new card.

Continuous

When you wish to continue the file numbering sequence even after the card is replaced or a new folder is created.

Even after you replace the card or create a new folder, the file numbering continues in sequence up to 9999. This is useful when you want to save images numbered anywhere between 0001 to 9999 on multiple cards or in multiple folders into one folder on a computer.

If the replacement card or existing folder already contains images recorded previously, the file numbering of the new images may continue from the file numbering of the existing images on the card or in the folder. If you want to use continuous file numbering, it is recommended that you use a newly-formatted card each time.

File numbering after replacing the card

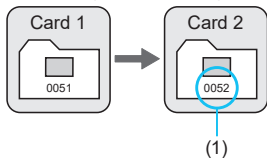

File numbering after creating a folder

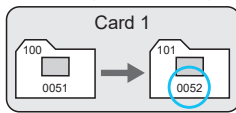

(1) Next sequential file number

Auto Reset

When you wish to restart the file numbering from 0001 each time the card is replaced or a new folder is created.

When you replace the card or create a folder, the file numbering restarts from 0001 for the new images saved. This is useful if you want to organize images by cards or folders.

If the replacement card or existing folder already contains images recorded previously, the file numbering of the new images may continue from the file numbering of the existing images on the card or in the folder. If you want to save images with the file numbering starting from 0001, use a newly formatted card each time.

File numbering after replacing the card File numbering after creating a folder

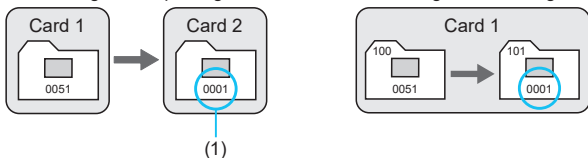

(1) File numbering is reset

Manual Reset

When you wish to reset the file numbering to 0001 or to start from file number 0001 in a new folder.

When you reset the file numbering manually, a new folder is created automatically and the file numbering of images saved to that folder starts from 0001.

This is useful, for example, if you want to use different folders for the images taken yesterday and the ones taken today.

Setting the Auto Rotation of Vertical Images

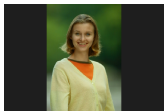



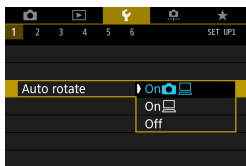

You can change the auto rotation setting that straightens images shot in vertical orientation when they are displayed.



1 Select [**📷**: Auto rotate].

2 Select an item.

- **On**  
Automatically rotates images for display on both the camera and computers.
- **On** 
Automatically rotates images only for display on computers.
- **Off**

 ● Images captured with auto rotation set to **[Off]** will not rotate during playback even if you later set auto rotation to **[On]**.

- 
- If a picture is taken while the camera is pointing up or down, automatic rotation to the proper orientation for viewing may not be performed correctly.
 - If images are not rotated automatically on a computer, try using EOS software.

Formatting Memory Cards

If the card is new or was previously formatted (initialized) by another camera or computer, format the card with this camera.



- When the card is formatted, all images and data on the card will be erased. Even protected images will be erased, so make sure there is nothing you need to keep. If necessary, transfer the images and data to a computer, etc. before formatting the card.

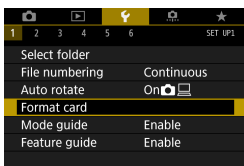

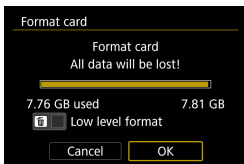

1 Select [: Format card].

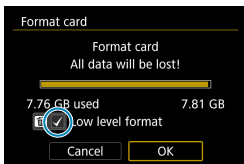

2 Format the card.

- Select [**OK**].



- For low-level formatting, press the  button to add a checkmark  to [**Low level format**], then select [**OK**].



- The card capacity displayed on the card format screen may be smaller than the capacity indicated on the card.
- This device incorporates exFAT technology licensed from Microsoft.



Format the Card in the Following Cases:

- The card is new.
- The card was formatted by a different camera or a computer.
- The card is full of images or data.
- A card-related error is displayed (📖 581).

Low-Level Formatting

- Perform low-level formatting if the card's writing or reading speed seems slow or if you want to totally erase the data on the card.
- Since low-level formatting will format all recordable sectors on the card, the formatting will take longer than normal formatting.
- During low-level formatting, you can cancel formatting by selecting **[Cancel]**. Even in this case, normal formatting will already be complete and you can use the card as usual.

Card's File Formats

- **SD/SDHC cards will be formatted in FAT32. SDXC cards will be formatted in exFAT.**
- When recording a movie with a card formatted in exFAT, the movie will be recorded in a single file (instead of being split into multiple files) even if it exceeds 4 GB. (The movie file will exceed 4 GB.)



- It may not be possible to use SDXC cards formatted with this camera in other cameras. Also note that exFAT-formatted cards may not be recognized by some computer operating systems or card readers.
- Formatting or erasing data on a card does not completely erase the data. Be aware of this when selling or discarding the card. When disposing of cards, take steps to protect personal information if necessary, as by physically destroying cards.

Displaying the Shooting Mode Guide

A brief description of the shooting mode can be displayed when you switch shooting modes.

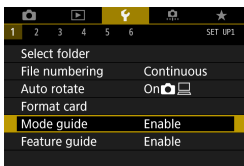

1 Select [**Y**: Mode guide].

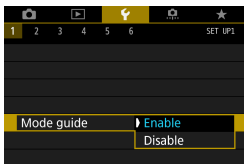

2 Select [Enable].

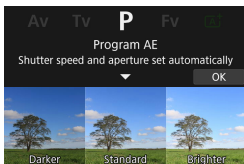

3 Turn the Mode dial.

- ▶ A brief description of the selected shooting mode is displayed.
- To display more details, press the <▼> key.
- To clear the mode guide, press <SET>. In <SCN> or <Pict.> mode, the shooting mode selection screen is displayed.

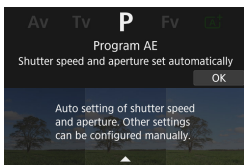

Displaying the Feature Guide

A brief description of functions and items can be displayed when you use Quick Control setting.

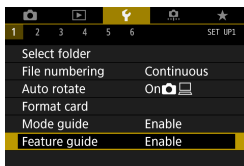

1 Select [**🔧**: Feature guide].

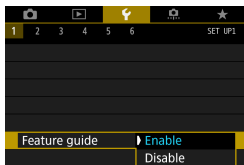

2 Select [**Enable**].



● To clear a description, either tap it or continue performing operations.

Setting Eco Mode

Enables you to conserve battery power in shooting mode. When the camera is not in use, the screen darkens to reduce battery consumption.

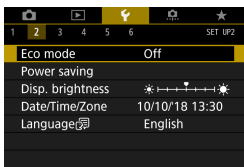

1 Select [**⚡**: Eco mode].

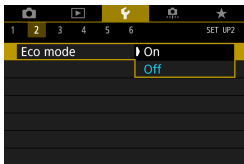

2 Select [**On**].

- The screen darkens when the camera is not used for approx. two seconds. Approx. ten seconds after darkening, the screen turns off.
- To activate the screen and prepare for shooting when the screen is off, press the shutter button halfway.

Setting Power-Saving Features

You can adjust the timing of when the screen, camera, and viewfinder turn off automatically (Display off, Auto power off, and Viewfinder off).

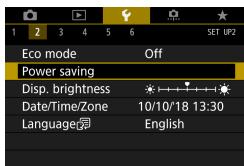

1 Select [P: Power saving].

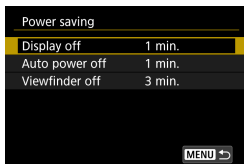

2 Select an item.

- Even when [Auto power off] is set to [Disable], the screen will turn off after the time set in [Display off].

- 
- [Display off] and [Auto power off] settings do not apply when Eco mode is set to [On].

Adjusting the Screen Brightness

Screen and viewfinder brightness can be adjusted separately.

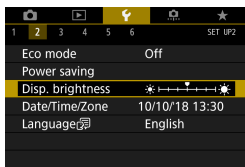

1 Select [**☀**: Disp. brightness].

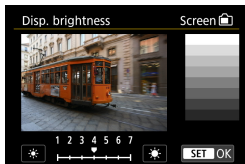

2 Make the adjustment.

- Referring to the gray chart, use the <◀> <▶> keys to adjust the brightness, then press <SET>.
- When adjusting viewfinder brightness, look through the viewfinder as you set it.



- To check the image's exposure, referring to the histogram (📖 349) is recommended.

Setting the Date, Time, and Time Zone

When you turn on the power for the first time or if the date/time/zone have been reset, follow the steps below to set the time zone first.

By setting the time zone first, you can simply adjust this setting as needed in the future and the date/time will be updated to match it.

Since the captured images will be appended with the shooting date and time information, be sure to set your date/time.

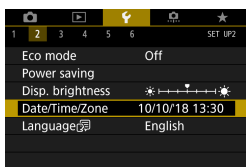

1 Select [**👉**: Date/Time/Zone].

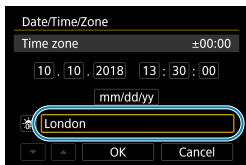

2 Set the time zone.

- Use the <◀> <▶> keys to select [Time zone].

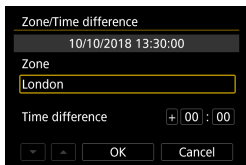

- Press <SET>.



- Use the <▲> <▼> keys to select the time zone, then press <SET>.
- If your time zone is not listed, press the <MENU> button, then set the difference from UTC in [Time difference].

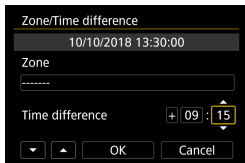

- Use the <◀> <▶> keys to select a **[Time difference]** item (+/-/hour/minute), then press <SET>.
- Use the <▲> <▼> keys to set it, then press <SET>.
- After entering the time zone or time difference, use the <◀> <▶> keys to select **[OK]**, then press <SET>.

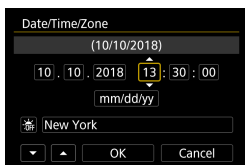



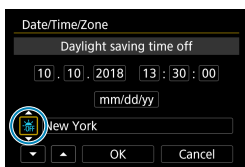

3 Set the date and time.

- Use the <◀> <▶> keys to select an item, then press <SET>.
- Use the <▲> <▼> keys to set it, then press <SET>.



4 Set the daylight saving time.

- Set it as necessary.
- Use the <◀> <▶> keys to select [>], then press <SET>.
- Use the <▲> <▼> keys to select [>], then press <SET>.
- When the daylight saving time is set to [>], the time set in step 3 will advance by 1 hour. If [>] is set, the daylight saving time will be canceled and the time will go back by 1 hour.

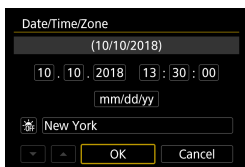

5 Exit the setting.

- Use the <◀> <▶> keys to select **[OK]**.



- The date, time, and time zone settings may be reset when the camera is stored without the battery, when its battery becomes exhausted, or when it is exposed to below freezing temperatures for a prolonged period. If this happens, set them once again.
- After changing **[Zone/Time difference]**, check that the correct date/time are set.



- Auto power off time may be extended while the **[📄 : Date/Time/Zone]** screen is displayed.

Setting the Interface Language

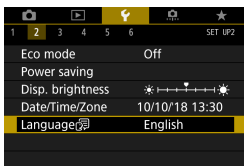

1 Select [: Language ].



2 Set the desired language.

Setting the Video System

Set the video system of any television used for display. This setting determines the frame rates available when you record movies.

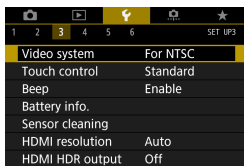

1 Select [**⚙**: Video system].

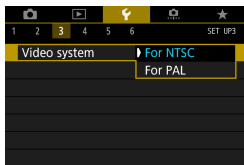

2 Select an item.

- **NTSC**
For areas where the TV system is NTSC (North America, Japan, South Korea, Mexico, etc.).
- **PAL**
For areas where the TV system is PAL (Europe, Russia, China, Australia, etc.).

Setting the Touch Control Response

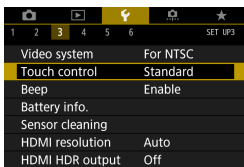

1 Select [**Touch control**].



2 Select an item.

- [**Standard**] is the normal setting.
- [**Sensitive**] provides a more reactive touch-screen panel response than [**Standard**].
- To disable touch operations, select [**Disable**].



Cautions for Touch Control Operations

- Do not use sharp objects such as fingernails or ballpoint pens for touch operations.
- Do not use wet fingers for touch operations. If the screen has any moisture or if your fingers are wet, the touch-screen panel may not respond or malfunction may occur. In this case, turn off the power and wipe off the moisture with a cloth.
- Attaching any commercially available protective sheet or sticker on the screen may degrade the touch operation response.
- If you quickly perform touch operation when [**Sensitive**] is set, the touch operation response may be poor.

Disabling Beeps for Camera Operations

You can disable beeping when subjects are in focus or for other operations.

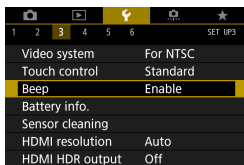

1 Select [🔊: Beep].

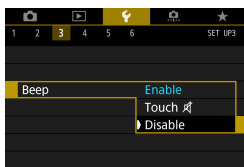

2 Select an item.

- **Touch** 🔊
The beeper will be silent only for touch operations.
- **Disable**
Disables beeping when subjects are in focus, when you shoot with the self-timer, and when you use touch operations.

Checking the Battery Information

You can check the conditions of the battery you are using.

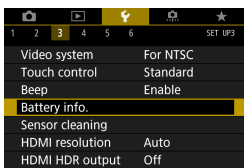

1 Select [: Battery info.].

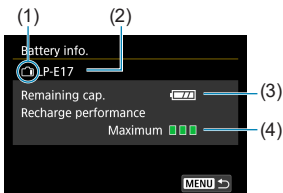

- (1) Battery position
- (2) Model of battery or household power outlet accessory used.
- (3) Battery level (47).
- (4) Battery's recharge performance level is displayed.
 - (Green) : Battery's recharge performance is good.
 - (Green) : Battery's recharge performance is slightly degraded.
 - (Red) : Purchasing a new battery is recommended.



- Using a genuine Canon Battery Pack LP-E17 is recommended. If you use batteries that are not genuine Canon products, the camera's full performance may not be attained or malfunction may result.



- If a battery communication error message is displayed, follow the instructions in the message.

Sensor Cleaning

The camera's sensor cleaning feature cleans the front of the image sensor.

Activating Immediate Cleaning

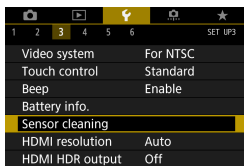

1 Select [**W**: Sensor cleaning].

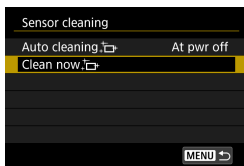

2 Select [**Clean now** ].
● Select [**OK**] on the confirmation dialog.

Setting Auto Cleaning

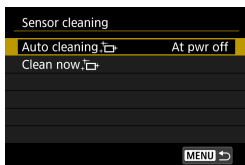

1 Select [Auto cleaning].

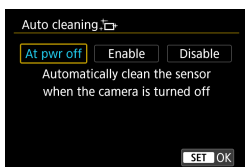

2 Select an item.

- Use the <<> <>> keys to select an item, then press <SET>.



- For best results, clean with the camera in a stable position on a desk or other flat surface.
- Even if you repeat the sensor cleaning, the result will not improve much. Note that [Clean now] may not be available immediately after cleaning.
- Dots of light may appear in captured images or on the shooting screen if the sensor is affected by cosmic rays or similar factors. By selecting [Clean now], their appearance may be suppressed (📖382).

Manual Sensor Cleaning

Dust that could not be removed by automatic cleaning can be removed manually with a commercially available blower or similar tool.

The image sensor is extremely delicate. If the sensor needs to be cleaned directly, having it done by a Canon Service Center is recommended.

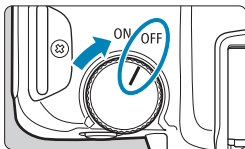

1 Setting the power switch to <OFF>.

2 Remove the lens and clean the sensor.

3 End the cleaning.

- Attach the lens or body cap.



- **During sensor cleaning, never set the power switch to <ON>. This will cause the shutter to move, which may damage the image sensor or shutter curtains.**
- The surface of the image sensor is extremely delicate. Clean the sensor with care.
- Use a plain blower without any brush attached. A brush can scratch the sensor.
- Do not insert the blower tip inside the camera beyond the lens mount. This may damage the shutter curtains.
- Never use pressurized air or gas to clean the sensor. Pressurized air may damage the sensor, and sprayed gas may freeze on the sensor and scratch it.
- If a smudge that cannot be removed with a blower remains, having the sensor cleaned by a Canon Service Center is recommended.

Setting the HDMI Output Resolution

Set the image output resolution used when the camera is connected to a television or external recording device with an HDMI cable.

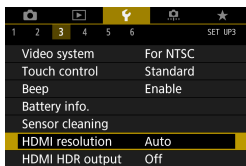

1 Select [**⚙**: HDMI resolution].

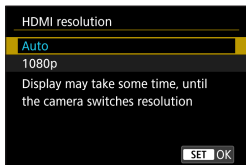

2 Select an item.

- **Auto**

The images will automatically be displayed at the optimum resolution matching the connected television.

- **1080p**

Output at 1080p resolution. Select if you prefer to avoid display or delay issues when the camera switches resolution.

RAW Playback on an HDR TV

You can view RAW images in HDR by connecting the camera to an HDR TV.

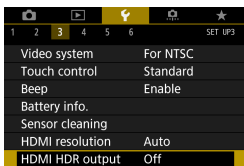

1 Select [**⚡**: HDMI HDR output].

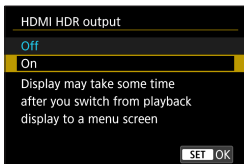

2 Select [**On**].



- Image operations such as RAW processing are not available during HDR display.
- JPEG images are used for HDR display in the case of L (ISO 50-equivalent) images or multiple-exposure RAW images.



- Make sure the HDR TV is set up for HDR input. For details on how to switch inputs on the TV, refer to the TV manual.
- Depending on the TV used, images may not look as expected.
- Some image effects and information may not be displayed on an HDR TV.

Customizing Information Displayed When Shooting

You can customize the details and screens of information shown on the camera or in the viewfinder when you shoot.

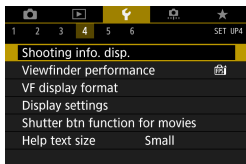

Select [**4**: Shooting info. disp.].

Customizing Information on the Screen

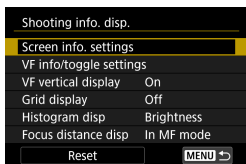

1 Select [Screen info. settings].

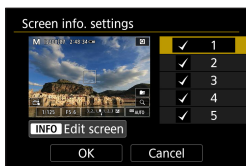

2 Select screens.

- Use the <▲> <▼> keys to select screens of information to show on the camera.
- For information you prefer not to display, press <SET> to clear the checkmark [✓].
- To edit the screen, press the <INFO> button.

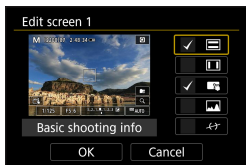

3 Edit the screen.

- Use the <▲> <▼> keys to select items to show on the screen.
- For items you prefer not to display, press <SET> to clear the checkmark [✓].
- Select [OK] to register the setting.

Customizing Information in the Viewfinder

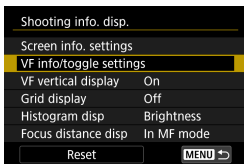

1 Select [VF info/toggle settings].

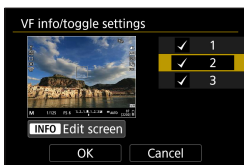

2 Select screens.

- Use the <▲> <▼> keys to select screens of information to show in the viewfinder.
- For information you prefer not to display, press <SET> to clear the checkmark [✓].
- To edit the screen, press the <INFO> button.

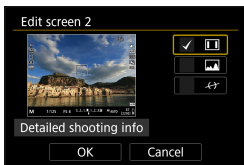

3 Edit the screen.

- Use the <▲> <▼> keys to select items to show in the viewfinder.
- For items you prefer not to display, press <SET> to clear the checkmark [✓].
- Select [OK] to register the setting.

Vertical Viewfinder Display

You can select how viewfinder information is displayed when you are shooting still photos vertically.

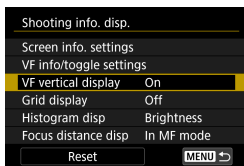

1 Select [VF vertical display].

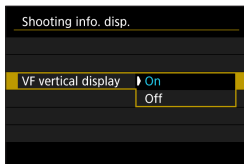

2 Select an item.

- **On**
Information is automatically rotated, making it easier to read.
- **Off**
Information is not automatically rotated.

Grid Display

A grid can be displayed on the screen and viewfinder.

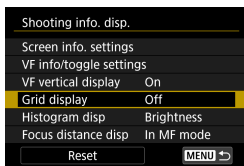

1 Select [Grid display].

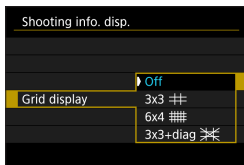

2 Select an item.

Setting the Histogram

You can select the content and display size of the histogram.

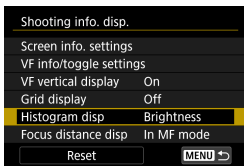

1 Select [Histogram disp].

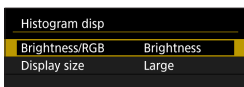

2 Select an item.

- Select the content ([**Brightness**] or [**RGB**]) and display size ([**Large**] or [**Small**]).
- Press <MENU> button to confirm the setting.

Setting Focus Distance Display

You can display focus distance when using RF lenses. In focus distance display, you can select the timing and unit of measurement.

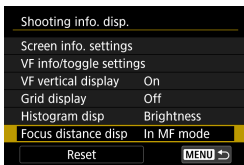

1 Select [Focus distance disp].



2 Select the timing of display.



3 Select the unit of measurement.

- Press <MENU> button to confirm the setting.

Clearing Settings

You can restore [Shooting info. disp.] to the default settings.

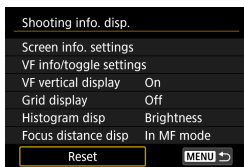

1 Select [Reset].

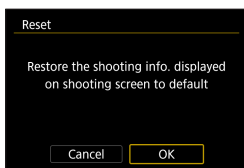

2 Select [OK].

Setting a Priority for Shooting Display Performance

You can select the performance option to prioritize in viewfinder display for still photos.

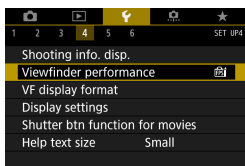

1 Select [**F**: Viewfinder performance].

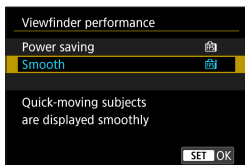

2 Select an item.

Setting the Viewfinder Display Format

You can select the viewfinder display format.

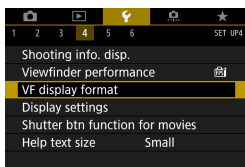

1 Select [**F**: VF display format].

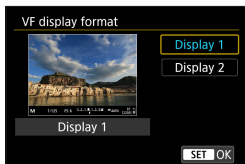

2 Select an item.

- Use the <▲> <▼> keys to select an item.
- Press <SET> to set it.

Setting the Display Mode

You can select the display mode for shooting screens.

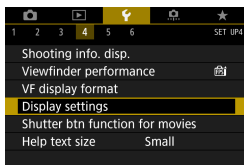

1 Select [**F**: Display settings].

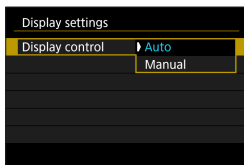

2 Select an item.

- **Auto**

Normally use the screen for display, but switch to the viewfinder when you look through it.

- **Manual**

You can restrict display to the screen or viewfinder.

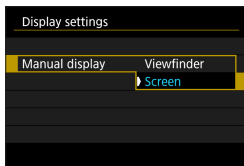

3 Select screen or viewfinder display.

- Press <SET> to set it.

Customizing Shutter Button Functionality for Movie Recording

You can set the functions performed by pressing the shutter button halfway or completely during movie recording.

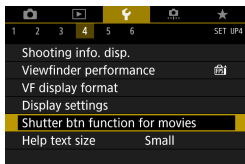

1 Select []: Shutter btn function for movies].

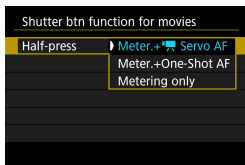

2 Select an item.

- **Half-press**
Specify the function performed by pressing the shutter button halfway.
- **Fully-press (shown in mode)**
Specify the function performed by pressing the shutter button completely.

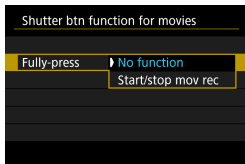

With **[Fully-press]** set to **[Start/stop mov rec]**, you can start/stop movie recording not only by pressing the movie shooting button but also by pressing the shutter button completely or by using Remote Switch RS-60E3 (sold separately, 219).



- **[Half-press]** switches from **[Meter.+One-Shot AF]** to **[Meter.+ Servo AF]** when **[Movie rec. size]** is set to **[4K]**.
- Even if you set **[Fully-press]** to **[No function]**, the camera will start or stop recording time-lapse movies if the shutter button is pressed completely when the camera is set up for time-lapse movies.

Help

When [INFO Help] is displayed below a menu, you can display a description about the feature by pressing the <INFO> button. Press it again to exit Help display. To scroll the screen when a scrollbar (1) appears on the right, press the <▲> <▼> keys or turn the <🌀> dial.

● Example: [📷: High ISO speed NR]

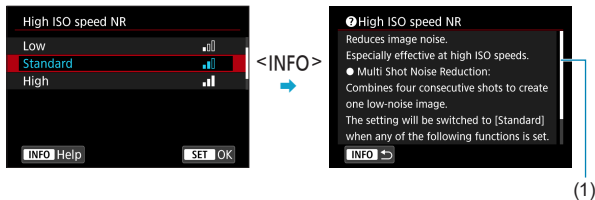

● Example: [🔒: Multi function lock]

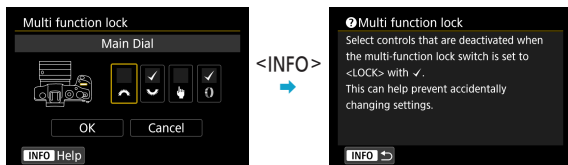

Help Display Text Size

You can change the text size for the Help display.

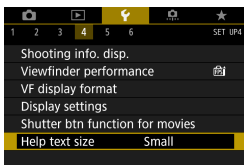

1 Select [**Y**: Help text size].

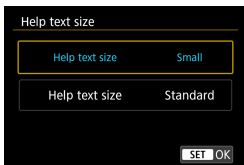

2 Select an item.

Setting Wireless Features

You can connect the camera to a smartphone or computer wirelessly and send your shots or control the camera remotely.

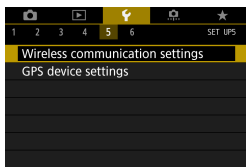

1 Select [**5**: Wireless communication settings].

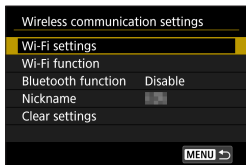

2 Set the item.

- For details, see “Wi-Fi (Wireless Communication) Functions”.

Shooting with a Remote Control

You can shoot remotely by pairing the camera via Bluetooth with Wireless Remote Control BR-E1 (sold separately), which supports Bluetooth low energy technology.

Pairing

To use BR-E1, you must first pair (connect and register) the camera and remote control.

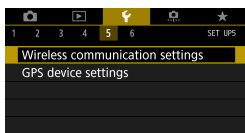

- 1 Select [**W**: Wireless communication settings].

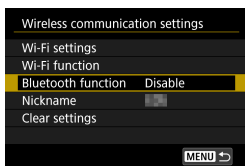

- 2 Select [**B**: Bluetooth function].

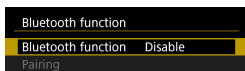

- 3 Select [**B**: Bluetooth function].

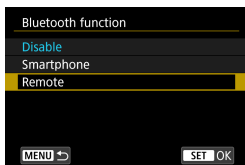

- 4 Select [**R**: Remote].
 - If the message “Register a nickname to identify the camera.” appears, register a nickname as described on [p. 497](#).

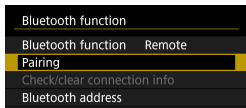

5 Select [Pairing].

- Select **[Pairing]**.
- Press and hold the **<W>** button and **<T>** button on the BR-E1 simultaneously for 3 sec. or more.
- ▶ Pairing now begins. When pairing is complete, BR-E1 is registered on the camera.

6 Set up the camera for remote shooting.

- Select **[]** or **[]** as the drive mode (209).

- In **[: Remote control]**, select **[Enable]**.

- For instructions after the pairing is complete, refer to the BR-E1's Instruction Manual.

When shooting still photos

When recording movies

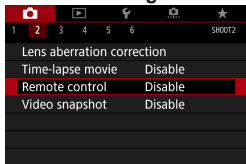

- Bluetooth connections consume battery power even after the camera's auto power off is activated.

- When you do not use the Bluetooth function, setting it to **[Disable]** in step 4 is recommended. To use the remote control again, select **[Remote]** again.
- Auto power off time may be extended when the camera is set for remote shooting.

Canceling the Pairing

Before pairing with a different BR-E1, clear the information about the connected remote control.

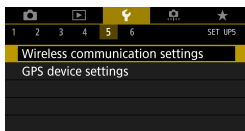

- 1 Select [**W**: Wireless communication settings].

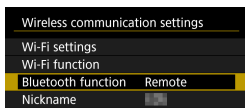

- 2 Select [**B**: Bluetooth function].

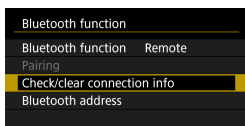

- 3 Select [**C**: Check/clear connection info].

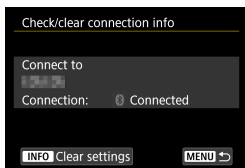

- 4 Press the <INFO> button.

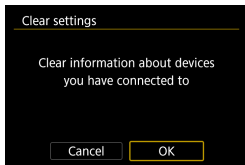

- 5 Clear the connection information.
 - Select [**OK**].

Geotagging Images

You can geotag images with GPS Receiver GP-E2 (sold separately) or a Bluetooth enabled smartphone.

Using GP-E2

- 1 Attach GP-E2 to the camera.**
 - Attach GP-E2 to the camera's hot shoe and turn it on. For details, refer to the GP-E2 Instruction Manual.

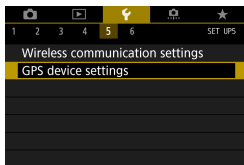

- 2 Select [f: GPS device settings].**

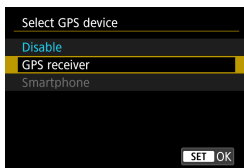

- 3 Select [GPS receiver].**

- 4 Take the picture.**
 - For details on [Set up], refer to the GP-E2 Instruction Manual.



Precautions When Using GP-E2

- Be sure to check the countries and regions where its use is allowed, and use the function in accordance with the laws and regulations of the country or region.
- Make sure the GP-E2 firmware is updated to Ver. 2.0.0 or later. Firmware updating requires an interface cable. For updating instructions, visit the Canon website.
- The cable cannot be used to connect the camera to the GP-E2.
- The digital compass cannot be used with the camera, and the shooting direction is not recorded.

Using a Smartphone

The dedicated app Camera Connect (free of charge) must be installed on the smartphone. For details on installing Camera Connect, see  420.

Specifying the smartphone as the GPS device

- 1 On the smartphone, activate location services.**
- 2 Establish a Bluetooth connection.**
 - Connect the camera to a smartphone via Bluetooth. For details, see  421.
- 3 Select [ : GPS device settings].**

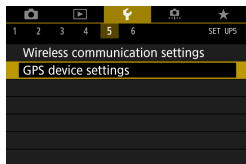

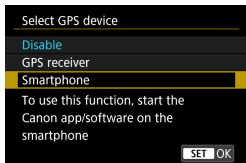

4 Select [Smartphone].

- Select **[Smartphone]** in **[Select GPS device]**.
- ▶ Location information can now be acquired from the smartphone.
- To check acquired geotag information (latitude, longitude, elevation, and Coordinated Universal Time (UTC)), select **[GPS information display]** on the **[GPS device settings]** screen.

5 Take the picture.

- Images are geotagged with the information from the smartphone.

GPS connection display

You can check the status of smartphone location information acquisition in the GPS connection icon on the screens for still photo or movie shooting (📖 591 and 📖 593, respectively).

- Gray: Location services are off
- Blinking: Location information cannot be acquired
- On: Location information acquired

For details on how GPS connection status is indicated when the GP-E2 is used, refer to the GP-E2 Instruction Manual.

Geotagging images as you shoot

Images you shoot while the GPS icon is on are geotagged.

Geotagging information

You can check the location information added to your shots on the shooting information screen (📖 296, 📖 349).

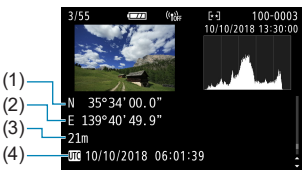

- (1) Latitude
- (2) Longitude
- (3) Elevation
- (4) UTC (Coordinated Universal Time)



- The smartphone can acquire location information only while it is paired with the camera via Bluetooth.
- Direction information is not acquired.
- Acquired location information may not be accurate, depending on traveling conditions or smartphone status.
- It may take some time to acquire location information from the smartphone after you turn the camera on.
- Location information is no longer acquired after any of the following operations.
 - Setting **[Bluetooth function]** to an option other than **[Smartphone]**
 - Turning the camera off
 - Quitting Camera Connect
 - Deactivating location services on the smartphone
- Location information is no longer acquired in any of the following situations.
 - The camera power turns off
 - The Bluetooth connection is ended
 - The smartphone's remaining battery level is low



- Coordinated Universal Time, abbreviated as UTC, is essentially the same as Greenwich Mean Time.
- For movies, the GPS information initially acquired is added.

Setting the Multi-Function Lock

Specify camera controls to lock when the Multi-function lock is enabled. This can help prevent accidentally changing settings.

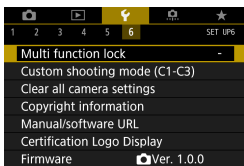

1 Select [**☛**: Multi function lock].



2 Select camera controls to lock.

- Press <SET> to add a checkmark [✓].
- Select [OK].
- ▶ Setting the <LOCK> switch to <LOCK> locks the selected [✓] camera controls.



- In Basic Zone modes, only [**Touch control**] can be set.
- If it is changed from the default setting, an asterisk "*" will be displayed on the right edge of [**☛**: Multi function lock].

Registering Custom Shooting Modes



You can register current camera settings, such as shooting, menu, and Custom Function settings, as Custom shooting modes assigned to <C1> to <C3> modes.

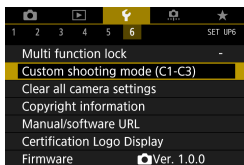

1 Select [**C**: Custom shooting mode (C1-C3)].

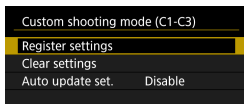

2 Select [**Register settings**].

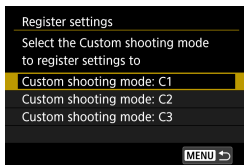

3 Register the desired items.

- Select the Custom shooting mode to register, then select [**OK**] on the registration screen.
- ▶ The current camera settings are registered to Custom shooting mode C*.

Automatic Update of Registered Settings

If you change a setting while shooting in Custom shooting mode, the mode can be automatically updated with the new setting (Auto update). To enable this automatic update, set [**Auto update set.**] to [**Enable**] in step 2.

Canceling Registered Custom Shooting Modes

If you select [**Clear settings**] in step 2, the settings of respective modes can be reverted to the default settings with no Custom shooting modes registered.



- You can also change shooting and menu settings in Custom shooting modes.

Reverting the Camera to the Default Settings



The camera's settings for shooting functions and menu functions can be reverted to their defaults.

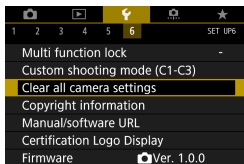

1 Select [**↶**]: Clear all camera settings].

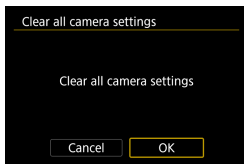

2 Select [OK].



- For details on clearing all Custom Function and customized control settings, see 546.

Setting Copyright Information



When you set the copyright information, it will be recorded to the image as Exif information.

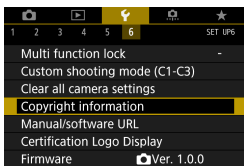

1 Select [**Y**: Copyright information].

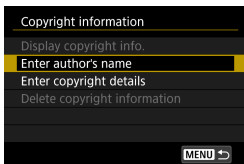

2 Select an item.

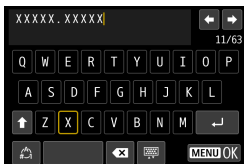

3 Enter text.

- Use the <⬅➡> cross keys or <🔄> dial to select a character, then press <SET> to enter it.
- By selecting [**Y**], you can change the input mode.
- To delete single characters, select [**X**] or press the <🗑> button.

4 Exit the setting.

- Press the <MENU> button, then press [OK].

Checking the Copyright Information

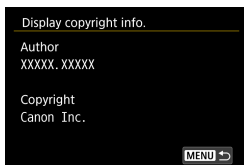

When you select **[Display copyright info.]** in step 2, you can check the **[Author]** and **[Copyright]** information that you entered.

Deleting the Copyright Information

When you select **[Delete copyright information]** in step 2, you can delete the **[Author]** and **[Copyright]** information.

- If the entry for "Author" or "Copyright" is long, it may not be displayed entirely when you select **[Display copyright info.]**.

- You can also set or check the copyright information with EOS Utility (EOS software).

Checking Other Information

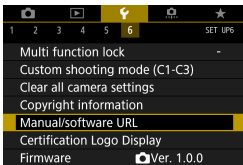

- **Downloading instruction manuals**

To download instruction manuals, select [**☛: Manual/software URL**] and scan the displayed QR code with a smartphone. Note that scanning QR codes requires an app.

- **Displaying certification logos ☆**

Select [**☛: Certification Logo Display**] to display some of the logos of the camera's certifications. Other certification logos can be found in this Instruction Manual, on the camera body, and on the camera's package.

- **Firmware version ☆**

Select [**☛: Firmware**] to update the firmware of the camera or current lens.



Wi-Fi (Wireless Communication) Functions

This chapter describes how to send images via Wi-Fi® from the camera to a variety of compatible devices, and how to use Web services.

What You Can Do via Wi-Fi (Wireless Communication) Functions

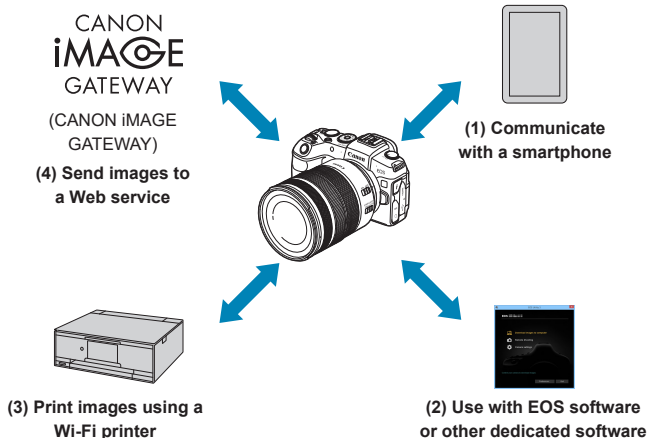



Important

Note that Canon cannot be held liable for any loss or damage from erroneous wireless communication settings when using the camera. In addition, Canon cannot be held liable for any other loss or damage caused by use of the camera.

When using wireless communication functions, establish appropriate security at your own risk and discretion. Canon cannot be held liable for any loss or damage caused by unauthorized access or other security breaches.

(1)  Communicate with a smartphone  419)

Control the camera remotely and browse images on the camera over a Wi-Fi connection by using the dedicated Camera Connect app on smartphones or tablets (collectively referred to as “smartphones” in this manual).

(2)  Use with EOS software or other dedicated software  453)

Connect the camera to a computer via Wi-Fi and operate the camera remotely using EOS Utility (EOS software). With the dedicated application Image Transfer Utility 2, images on the camera can also be sent to a computer automatically.

(3)  Print images using a Wi-Fi printer  461)

Connect the camera to a printer supporting PictBridge (Wireless LAN) via Wi-Fi to print images.

(4)  Send images to a Web service  473)

Share images with friends or family on social media or the CANON iIMAGE GATEWAY online photo service for Canon customers after you complete member registration (free of charge).

Bluetooth® Features

By pairing the camera with a smartphone compatible with Bluetooth low energy technology (hereafter, “Bluetooth”), you can:

- Control the camera remotely from a smartphone (📖 433)
- Establish a Wi-Fi connection from either the smartphone or the camera, by itself (📖 428, 📖 441)
- Establish a Wi-Fi connection with the camera even when it is off (📖 430)
- Geotag images with GPS information acquired by the smartphone (📖 403)

This camera can also be connected to Wireless Remote Control BR-E1 (sold separately) via Bluetooth for remote control shooting (📖 399).

Wi-Fi Connection via Access Points

To establish a Wi-Fi connection with smartphones or computers already on a Wi-Fi network, see “Wi-Fi Connection via Access Points” (📖 488).



Interface Cable Connection Cautions

- Other devices, such as computers, cannot be used with the camera by connecting them with an interface cable while the camera is connected to devices via Wi-Fi. Terminate the connection before connecting the interface cable.
- When the camera is connected to a computer or another device with an interface cable, you cannot select [**📶: Wireless communication settings**]. Disconnect the interface cable before changing any settings.

Cards

- The camera cannot be connected via Wi-Fi if there is no card in the camera (except for [📄]). Also, for [📷] and Web services, the camera cannot be connected via Wi-Fi if there are no images saved on the card.

Using the Camera with a Wi-Fi Connection Established

- When the Wi-Fi connection is most important, do not operate the power switch, card slot/battery compartment cover, or other parts. Otherwise, the Wi-Fi connection will be terminated.

Connecting to a Smartphone via Wi-Fi

This section describes how to directly connect the camera to a smartphone via Wi-Fi.

Connecting to a smartphone via Wi-Fi enables you to perform the following:

- View images stored in the camera on a smartphone or save viewed images to a smartphone.
- Operate the camera to take a picture or change camera settings using a smartphone.
- Send images to a smartphone from the camera.

To establish a Wi-Fi connection via an access point, see “Wi-Fi Connection via Access Points” (📖 488).

Selecting the Wi-Fi Connection Method

Connecting to a Bluetooth-compatible Smartphone via Wi-Fi (📖 421)

By connecting to a Bluetooth-compatible smartphone via Bluetooth in advance, you can connect via Wi-Fi simply by performing an operation on the camera or smartphone.

Connecting to a Smartphone via Wi-Fi from the [Wi-Fi function] Menu (📖 433)

You can use Wi-Fi to connect to a smartphone that is not compatible with Bluetooth or a smartphone that cannot use its Bluetooth function.

Turning on Bluetooth and Wi-Fi on a Smartphone

Turn on Bluetooth and Wi-Fi from the smartphone settings screen. Note that pairing with the camera is not possible from the smartphone’s Bluetooth settings screen.

Installing Camera Connect on a Smartphone

To connect the camera to a smartphone, a smartphone on which Android or iOS is installed is necessary. In addition, the dedicated app Camera Connect (free of charge) must be installed on the smartphone.

- Use the latest version of the smartphone OS.
- Camera Connect can be installed from Google Play or App Store. Google Play or App Store can also be accessed using the QR codes that appear when the camera is paired or connected via Wi-Fi to a smartphone.

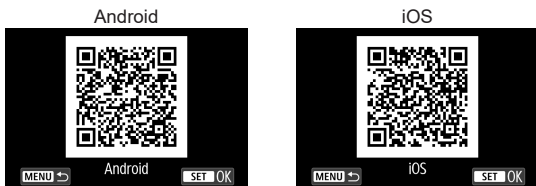

- For the operating system versions supported by Camera Connect, refer to the download site of Camera Connect.
- Interface or functions of the camera and Camera Connect are subject to change for firmware update of the camera or application update of Camera Connect, Android, iOS, etc. In this case, features of the camera or Camera Connect may differ from sample screens or operation instructions in this manual.
- An application is required to read the QR codes.

Connecting to a Bluetooth-compatible Smartphone via Wi-Fi

Make sure Camera Connect is installed on the smartphone, and that Bluetooth and Wi-Fi are on.

Steps on the Camera (1)

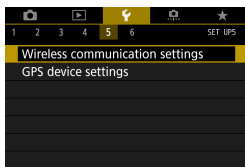

1 Select [**5**: Wireless communication settings].

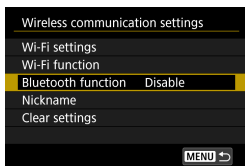

2 Select [Bluetooth function].

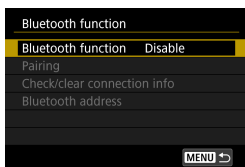

3 Select [Bluetooth function].

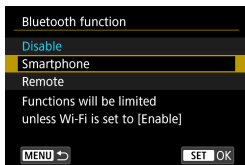

4 Select [Smartphone].

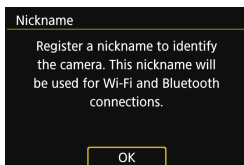

5 Register [Nickname].

- When using the displayed nickname, press the <MENU> button.
- You can change the nickname (📖 497).

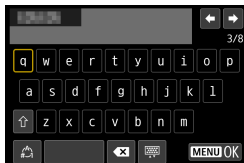

6 Select [OK].

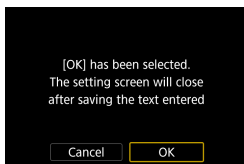

7 Select [Pairing].

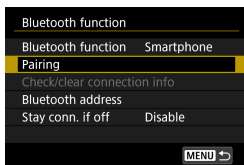

Install Camera Connect on the smartphone. Display QR code for download site?

Do not display

Android

iOS

Pairing

Pairing in progress.
Use Canon app/software on the smartphone to finish pairing.

Cancel

8 Select an item.

- If Camera Connect is already installed, select **[Do not display]**.
 - If Camera Connect is not installed, select **[Android]** or **[iOS]**, scan the displayed QR code with the smartphone to access Google Play or App Store and install Camera Connect.
- ▶ Pairing now begins.

Steps on the Smartphone (1)



9 Start Camera Connect.

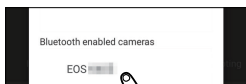

10 Select the camera to pair with.
▶ If you are using an Android smartphone, go to step 12.

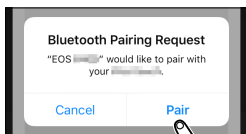

11 Tap on [Pair] (iOS only).

Steps on the Camera (2)

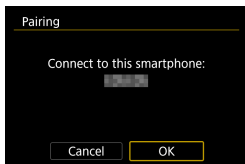

12 Select [OK].



13 Press <SET>.

- Pairing is now complete, and the camera is connected to the smartphone via Bluetooth.
- ▶ A Bluetooth icon appears on the main Camera Connect screen.

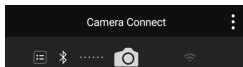

- Pairing or Bluetooth connection is not possible if the camera is connected to a computer or another device with an interface cable.
- The camera cannot be connected to two or more devices at the same time via Bluetooth.
- Bluetooth connection consumes battery power even after the camera's auto power off is activated. Therefore, the battery level may be low when you use the camera.

Troubleshooting Pairing

- Keeping pairing records for previously paired cameras on your smartphone will prevent it from pairing with this camera. Before you try pairing again, remove pairing records for previously paired cameras from your smartphone's Bluetooth settings screen (📖 432).



- With a Bluetooth connection established, you can operate the camera to send images to the smartphone. For details, see 📖 441.

Steps on the Smartphone (2)

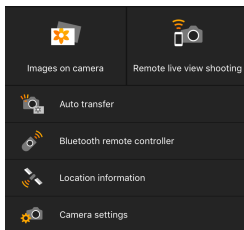

14 Select a Camera Connect function.

- In iOS, select **[Join]** when a message is displayed to confirm camera connection.
- For the Camera Connect functions, see  437.
- ▶ When a Wi-Fi connection is established, the screen for the selected function will appear.

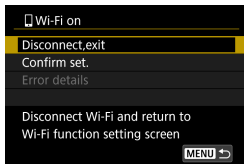

- ▶ **[Wi-Fi on]** is displayed on the camera.
- ▶ The Bluetooth and Wi-Fi icons are lit on the main Camera Connect screen.

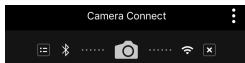

The Wi-Fi connection to a Bluetooth-compatible smartphone is now complete.

- For how to terminate the Wi-Fi connection, see “Terminating the Wi-Fi Connection” (📖 449).
- Terminating the Wi-Fi connection will switch the camera to the Bluetooth connection.

[📱Wi-Fi on] Screen

Disconnect,exit

- Terminates the Wi-Fi connection.

Confirm set.

- You can check the settings.

Error details

- When a Wi-Fi connection error occurs, you can check the details of the error.

Connecting to a Bluetooth-connected Smartphone via Wi-Fi



1 Start Camera Connect.

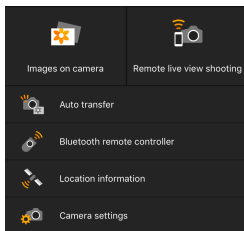

2 Select a Camera Connect function.

- Select the Camera Connect function you want to use.
- In iOS, select **[Join]** when a message is displayed to confirm camera connection. When a Wi-Fi connection is established, the screen for the selected function will appear.
- For the Camera Connect functions, see  437.

[Bluetooth function] Screen

On the **[Bluetooth function]** screen, you can change or check the Bluetooth function settings.

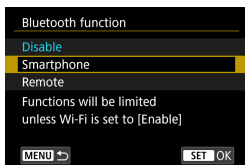

Bluetooth function

- Select the device to pair with the camera.
- If you will not use the Bluetooth function, select **[Disable]**.

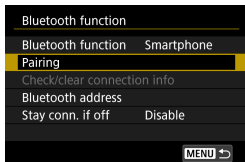

Pairing

- Pair the camera with the device selected in **[Bluetooth function]**.

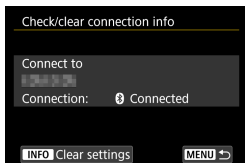

Check/clear connection info

- You can check the name and communication status of the paired device.
- To remove registration of the paired device, press the <INFO> button. For details, see “Removing a Paired Device’s Registration” (📖 432).

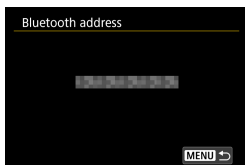

Bluetooth address

- You can check the camera’s Bluetooth address.

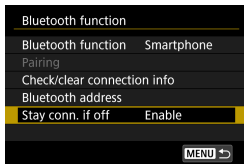

Stay conn. if off

- Selecting **[Enable]** lets you view images on the camera and control it in other ways by connecting via Wi-Fi even if the camera is off.

Establishing a Wi-Fi Connection When the Camera Is Off

Once the devices are paired, you can use a smartphone to connect via Wi-Fi and transfer images from the camera even when it is off.

Configure **[Stay conn. if off]**.

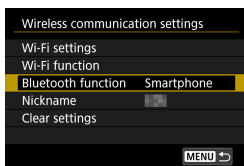

1 Select **[Bluetooth function]**.

- Select **[Bluetooth function]** on the **[Wireless communication settings]** screen.

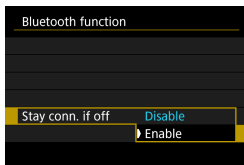

2 Set **[Stay conn. if off]** to **[Enable]**.

- On the **[Bluetooth function]** screen, set **[Stay conn. if off]** to **[Enable]**. Even when the camera is off, it will remain paired with the smartphone via Bluetooth.

Establishing a Wi-Fi Connection



1 Start Camera Connect.

- Start Camera Connect on a smartphone paired with the camera via Bluetooth.

2 Select [Images on camera].

- In the Camera Connect menu, tap on **[Images on camera]**.
- In iOS, select **[Join]** when a message is displayed to confirm camera connection. Images on the camera are listed when the Wi-Fi connection is established.

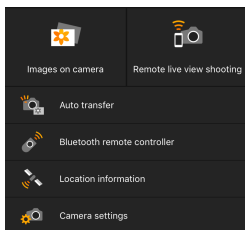

Using Camera Connect

- You can use Camera Connect to transfer images to the smartphone, and you can delete or rate images from the camera.
- To terminate the Wi-Fi connection, tap on **[x]** on the main Camera Connect screen (📖 449).



- **This feature is not available unless the camera and smartphone are paired via Bluetooth.**
- This function can no longer be used if the wireless settings are reset or the smartphone connection information is erased.

Removing a Paired Device's Registration

To pair the camera with a different smartphone, clear the paired device's registration on the **[Bluetooth function]** screen (📖 429).

Steps on the Camera

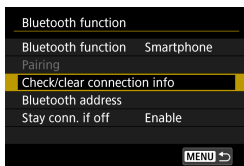

- 1 Select **[Check/clear connection info]**.

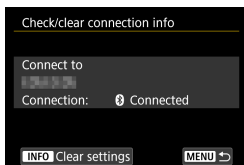

- 2 Press the **<INFO>** button.

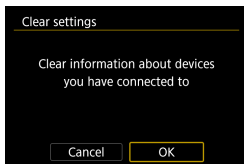

- 3 Clear the connection information.
 - Select **[OK]**.

Steps on the Smartphone

- 4 Remove the camera registration.
 - In the Bluetooth settings of the smartphone, select the nickname of the camera to remove registration for.

Connecting to a Smartphone via Wi-Fi from the [Wi-Fi function] Menu

Steps on the Camera (1)

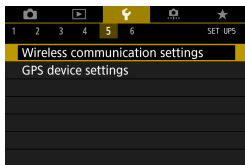

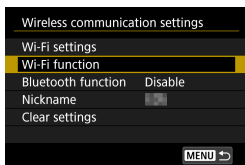

- 1 Select [: Wireless communication settings].

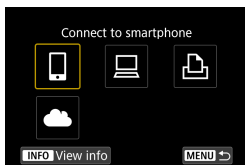

- 2 Select [Wi-Fi function].
- If the [Nickname] screen is displayed, register a nickname ( 422).



- 3 Select [] (Connect to smartphone).
- If the history ( 493) is displayed, switch the screen with the <<> <>> keys.

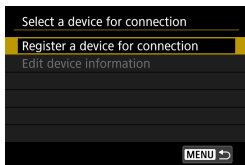

- 4 Select [Register a device for connection].

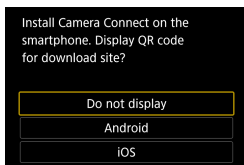

5 Select an item.

- If Camera Connect is already installed, select **[Do not display]**.
- If Camera Connect is not installed, select **[Android]** or **[iOS]** on the screen on the left, scan the displayed QR code with the smartphone, then access Google Play or App Store and install Camera Connect.

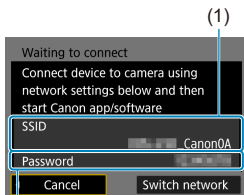

6 Check the SSID (network name) and password.

- Check the SSID (1) and password (2) displayed on the camera screen.
- In **[Wi-Fi settings]**, if you set **[Password]** to **[None]**, the password will not be displayed or required. For details, see [516](#).



- By selecting **[Switch network]** in step 6, you can establish a Wi-Fi connection via an access point ([488](#)).

Steps on the Smartphone

Smartphone's screen (sample)

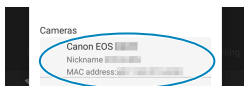

7 Operate the smartphone to establish a Wi-Fi connection.

- Activate the smartphone's Wi-Fi function, then select the SSID (network name) checked in step 6.
- For the password, enter the password checked in step 6.

8 Start Camera Connect.

- When the **[Waiting to connect]** screen is displayed on the camera, start Camera Connect on the smartphone.

9 Select the camera to connect to via Wi-Fi.

- Select and tap on the camera to connect to via Wi-Fi from **[Cameras]** on Camera Connect.

Steps on the Camera (2)

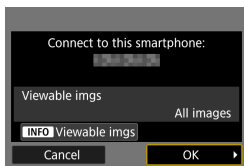

10 Establish a Wi-Fi connection.

- Select **[OK]**.
- To specify viewable images, press the **<INFO>** button. See step 5 on 451 to set them.

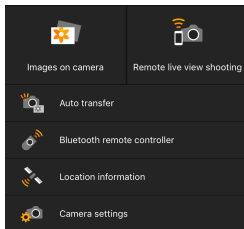

- ▶ The main window of Camera Connect will be displayed on the smartphone.

The Wi-Fi connection to a smartphone is now complete.

- Operate the camera using Camera Connect. See [📖 437](#).

- For how to terminate the Wi-Fi connection, see “Terminating the Wi-Fi Connection” ([📖 449](#)).
- To reconnect via Wi-Fi, see “Reconnecting via Wi-Fi” ([📖 493](#)).

[📱 Wi-Fi on] Screen

Disconnect,exit

- Terminates the Wi-Fi connection.

Confirm set.

- You can check the settings.

Error details

- When a Wi-Fi connection error occurs, you can check the details of the error.

- When connected via Wi-Fi, you can send images to a smartphone from the Quick Control screen during playback. For details, see [📖 441](#).

Operating the Camera Using a Smartphone

The main functions of Camera Connect are described below.

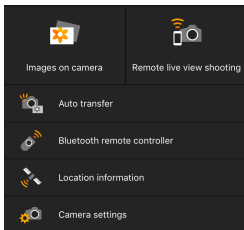

Images on camera

- Images stored in the camera can be viewed.
- Images stored in the camera can be saved on a smartphone.
- Operations such as deletion can be performed on images stored in the camera.

Remote live view shooting

- The camera's Live View image can be viewed on a smartphone.
- You can shoot with remote operation.

Auto transfer

- Enables camera and app setting adjustment to send shots to a smartphone automatically as they are captured (📖 439).

Bluetooth remote controller

- You can control the camera by using a smartphone paired via Bluetooth as a remote control. (Not available when connected via Wi-Fi.)

Location information

- Not supported on this camera.

Camera settings

- Camera settings can be changed.



- If the Wi-Fi connection is terminated while recording a movie with remote shooting, the following will occur.
 - Any movie recording in progress in movie recording mode will continue.
 - Any movie recording in progress in still photo shooting mode will end.
- You cannot use the camera to shoot after using Camera Connect to switch from still photo shooting mode to movie recording mode.
- With a Wi-Fi connection to a smartphone established, certain functions are unavailable.
- In remote shooting, the AF speed may become slower.
- Depending on the communication status, image display or shutter release timing may be delayed.
- When saving images to a smartphone, you cannot take a picture even if you press the camera's shutter button. Also, the camera screen may turn off.
- The Wi-Fi connection will be terminated if you set the camera's power switch to <OFF> or open the card slot/battery compartment cover.
- RAW images cannot be saved to a smartphone. When a RAW image is selected, it will be saved as a JPEG image.
- With a Wi-Fi connection established, the camera's auto power off does not function.



- With a Wi-Fi connection established, disabling the smartphone's power saving function is recommended.

Sending Images to a Smartphone Automatically as You Shoot

Your shots can be sent automatically. Before following these steps, make sure the camera and smartphone are connected via Wi-Fi.

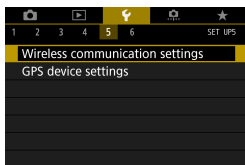

- 1** Select [**Wi-Fi**: Wireless communication settings].

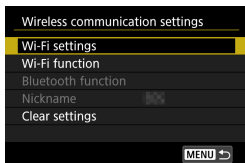

- 2** Select [**Wi-Fi settings**].

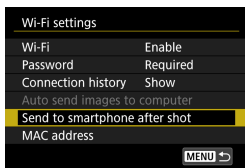

- 3** Select [**Send to smartphone after shot**].

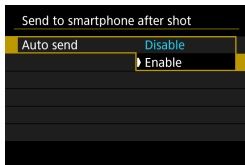

- 4** Set [**Auto send**] to [**Enable**].

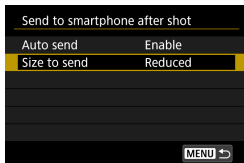

5 Set [Size to send].

- Select the image size, then press <SET>.

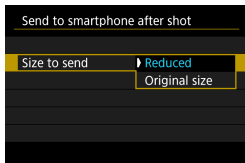

6 Take the picture.

Sending Images to a Smartphone from the Camera

You can use the camera to send images to a smartphone paired via Bluetooth (Android devices only) or connected via Wi-Fi.



1 Play back the image.



2 Press the <Q> button.



3 Select [☐].

- ▶ If you perform this step while connected via Bluetooth, a message is displayed, and the connection switches to a Wi-Fi connection.

4 Select sending options and send the images.

(1) Sending Images Individually



1 Select an image to send.

- Press the <◀> <▶> keys or turn the <⚙️> dial to select an image to send, then press <SET>.
- You can press the <Q> button and turn the <⚙️> dial counterclockwise to select the image using the index display.

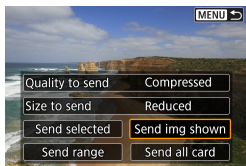

2 Select [Send img shown].

- In [Size to send], you can select the image sending size.
- When sending movies, you can select the image quality of movies to send in [Quality to send].

(2) Sending Multiple Selected Images

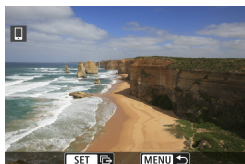

1 Press <SET>.

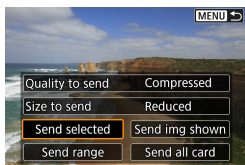

2 Select [Send selected].



3 Select images to send.

- Press the <◀> <▶> keys or turn the <⚙> dial to select an image to send, then press <SET>.
- You can press the <Q> button and turn the <⚙> dial counterclockwise to switch to the three-image display to select the images. To return to the single image display, also press the <Q> button and operate the <⚙> dial.
- After selecting the images to send, press the <MENU> button.



4 Exit image selection.

- Select [OK].

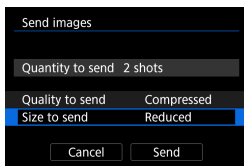

5 Select [Size to send].

- On the displayed screen, select an image size.

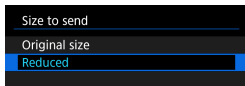

- When sending movies, select the image quality in [Quality to send].

6 Select [Send].

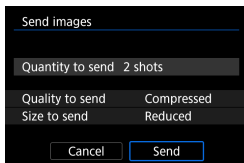

(3) Sending a Specified Range of Images

1 Press <SET>.



2 Select [Send range].

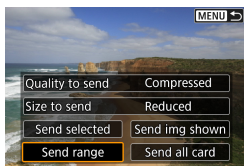

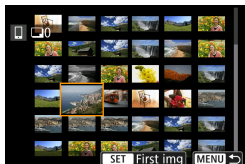

3 Specify the range of images.

- Select the first image (start point).
- Select the last image (end point).
- To cancel the selection, repeat this step.
- You can press the <Q> button and turn the <⚙> dial to change the number of images shown in the index display.

4 Confirm the range.

- Press the <MENU> button.

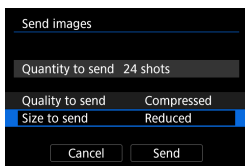

5 Select [Size to send].

- On the displayed screen, select an image size.

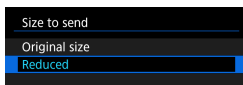

- When sending movies, select the image quality in [Quality to send].

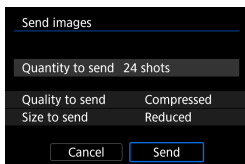

6 Select [Send].

(4) Sending All Images on the Card



1 Press <SET>.

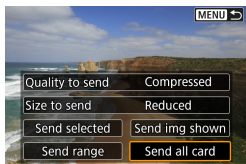

2 Select [Send all card].

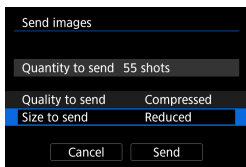

3 Select [Size to send].

- On the displayed screen, select an image size.

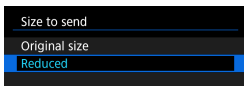

- When sending movies, select the image quality in [Quality to send].

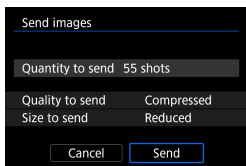

4 Select [Send].

(5) Sending Images that Match the Search Conditions

Send all the images that match the search conditions set in **[Set image search conditions]** at once.

For **[Set image search conditions]**, refer to “Filtering Images for Playback” (📖 345).



1 Press <SET>.

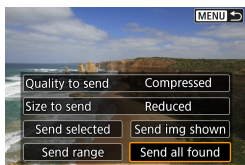

2 Select **[Send all found]**.

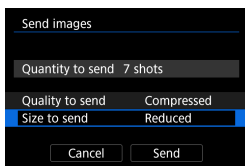

3 Select **[Size to send]**.

- On the displayed screen, select an image size.

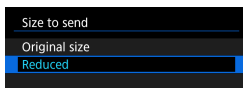

- When sending movies, select the image quality in **[Quality to send]**.

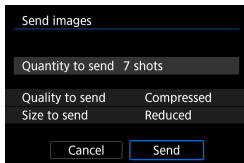

4 Select [Send].

Ending Image Transfer

Sending Images from the Camera When Paired via Bluetooth (Android)



- Press the <MENU> button on the image transfer screen.

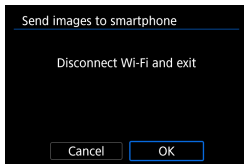

- Select [OK] on the screen on the left to end image transfer and the Wi-Fi connection.

Sending Images from the Camera over a Wi-Fi Connection



- Press the <MENU> button on the image transfer screen.
- To terminate the Wi-Fi connection, see "Terminating the Wi-Fi Connection" (449).



- During the image transfer operation, a picture cannot be taken even if the camera's shutter button is pressed.
- The camera cannot be connected to multiple smartphones via Wi-Fi when it is connected to another device via Wi-Fi.



- You can cancel the image transfer by selecting **[Cancel]** during the transfer.
- You can select up to 999 files at a time.
- With a Wi-Fi connection established, disabling the smartphone's power saving function is recommended.
- Selecting the reduced size for still photos applies to all still photos sent at that time. Note that **S2** size still photos are not reduced.
- Selecting compression for movies applies to all movies sent at that time.
- When you use a battery to power the camera, make sure it is fully charged.
- With a Wi-Fi connection established, the camera's auto power off does not function.

Terminating the Wi-Fi Connection

To terminate the Wi-Fi connection, perform either of the following operations.

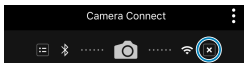

On the Camera Connect screen, tap on **[X]**.



On the **[Wi-Fi on]** screen, select **[Disconnect,exit]**.

- If the **[Wi-Fi on]** screen is not displayed, select **[Wi-Fi function]** on the **[Wireless communication settings]** screen.
- Select **[Disconnect,exit]**, then select **[OK]** on the confirmation dialog.

Specifying Viewable Images

You can specify images viewable on a smartphone by operating the camera. **Images can be specified after the Wi-Fi connection is terminated.**

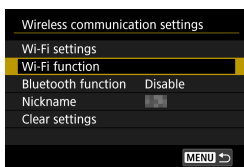

1 Select [Wi-Fi function].

- Select **[Wi-Fi function]** on the **[Wireless communication settings]** screen.

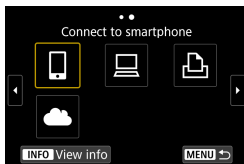

2 Select [☎].

- If the history (📖 493) is displayed, switch the screen with the <◀> <▶> keys.

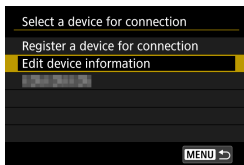

3 Select [Edit device information].

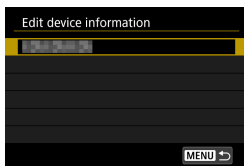

4 Select a smartphone.

- Select the name of the smartphone on which you want to make the images viewable.

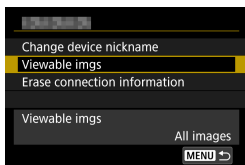

5 Select [Viewable imgs].

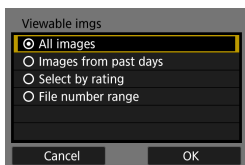

6 Select an item.

- Select [OK] to access the setting screen.

[All images]

All images stored on the card become viewable.

[Images from past days]

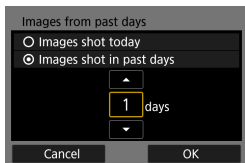

Specify viewable images on the shooting-date basis. Images shot up to nine days ago can be specified.

- When [Images shot in past days] is selected, images shot up to the specified number of days before the current date become viewable. Use the <▲> <▼> keys to specify the number of days, then press <SET> to confirm the selection.
- Once you select [OK], the viewable images are set.



- If [Viewable imgs] is set to any setting other than [All images], remote shooting is not possible.

[Select by rating]

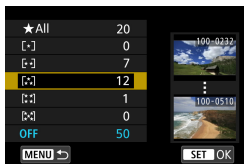

Specify viewable images depending on whether a rating is appended (or not appended) or by the type of rating.

- Once you select the type of rating, the viewable images are set.

[File number range] (Select range)

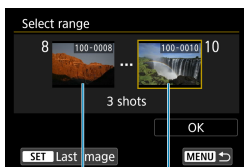

(1)

(2)

Select the first and last images from images arranged by the file number to specify the viewable images.

1. Press <SET> to display the image selection screen.
Select an image using the <◀> <▶> keys or <⚙> dial.
You can press the <Q> button and turn the <⚙> dial counterclockwise to select the image using the index display.
2. Select an image as the starting point (1).
3. Use <▶> to select an image as the ending point (2).
4. Select **[OK]**.

Connecting to a Computer via Wi-Fi

This section describes how to connect the camera to a computer via Wi-Fi and perform camera operations using EOS software or other dedicated software. Install the latest version of software on the computer before setting up a Wi-Fi connection.

For computer operating instructions, refer to the computer user manual.

Operating the Camera Using EOS Utility

Using EOS Utility (EOS software), you can perform a variety of camera operations.

Steps on the Camera (1)

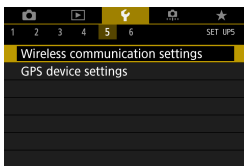

- 1 Select [: Wireless communication settings].

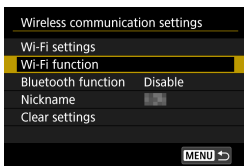

- 2 Select [Wi-Fi function].
 - If the [Nickname] screen is displayed, register a nickname (422).

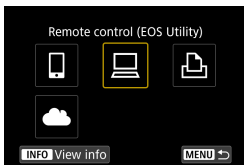

- 3 Select [] (Remote control (EOS Utility)).
 - If the history (493) is displayed, switch the screen with the <<> <>> keys.

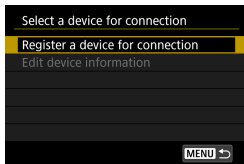

4 Select [Register a device for connection].

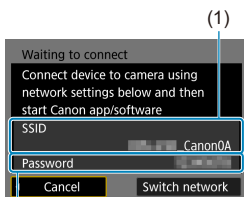

5 Check the SSID (network name) and password.

- Check the SSID (1) and password (2) displayed on the camera screen.
- In **[Wi-Fi settings]**, if you set **[Password]** to **[None]**, the password will not be displayed or required. For details, see 516.

(2)

Steps on the Computer (1)

Computer's screen (sample)

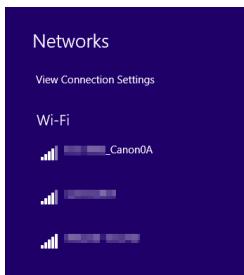

6 Select the SSID, then enter the password.

- On the computer's network setting screen, select the SSID checked in step 5.
- For the password, enter the password checked in step 5.

Steps on the Camera (2)

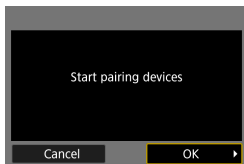

7 Select [OK].

- ▶ The following message is displayed. "*****" represents the last six digits of the MAC address of the camera to be connected.

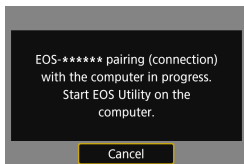

Steps on the Computer (2)

8 Start EOS Utility.

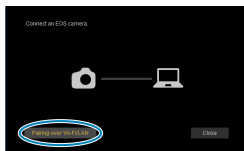

9 In EOS Utility, click [Pairing over Wi-Fi/LAN].

- If a firewall-related message is displayed, select [Yes].

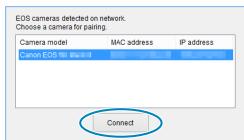

10 Click [Connect].

- Select the camera to connect to, then click [Connect].

Steps on the Camera (2)

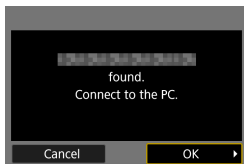

- 11 Establish a Wi-Fi connection.**
- Select [OK].

[Wi-Fi on] Screen

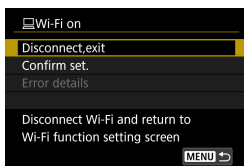

Disconnect,exit

- Terminates the Wi-Fi connection.

Confirm set.

- You can check the settings.

Error details

- When a Wi-Fi connection error occurs, you can check the details of the error.

The Wi-Fi connection to a computer is now complete.

- Operate the camera using EOS Utility on the computer.
- To reconnect via Wi-Fi, see “Reconnecting via Wi-Fi” (493).



- If the Wi-Fi connection is terminated while recording a movie with remote shooting, the following will occur.
 - Any movie recording in progress in movie recording mode will continue.
 - Any movie recording in progress in still photo shooting mode will end.
- Operations using the camera are not possible after you use EOS Utility to switch from still photo shooting mode to movie recording mode.
- With a Wi-Fi connection to EOS Utility established, certain functions are unavailable.
- In remote shooting, the AF speed may become slower.
- Depending on the communication status, image display or shutter release timing may be delayed.
- In Remote Live View shooting, the rate of image transmission is slower compared to a connection via an interface cable. Therefore, moving subjects cannot be displayed smoothly.
- The Wi-Fi connection will be terminated if you set the camera's power switch to <OFF> or open the card slot/battery compartment cover.

Sending Images to a Computer Automatically

With the dedicated software Image Transfer Utility 2, you can send images on the camera to a computer automatically.

Steps on the Computer (1)

1 Connect the computer and access point and start Image Transfer Utility 2.

- In Image Transfer Utility 2, access the pairing settings screen.
- The screen to set up pairing is shown when you follow the instructions displayed the first time Image Transfer Utility 2 starts up.

Steps on the Camera

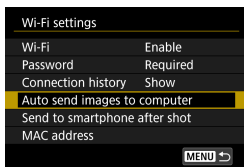

2 Select [Auto send images to computer].

- Select [Wi-Fi settings] on the [📶: Wireless communication settings] screen.
- On the [Wi-Fi settings] screen, select [Auto send images to computer].

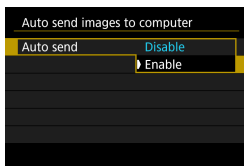

3 In [Auto send], select [Enable].

- If the [Nickname] screen is displayed, register a nickname (📖 422).

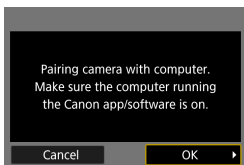

4 Select [OK].

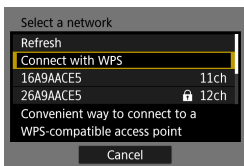

5 Connect to an access point via Wi-Fi.

- Establish a Wi-Fi connection between the camera and the access point connected to the computer. For connection instructions, see “Wi-Fi Connection via Access Points” (488).

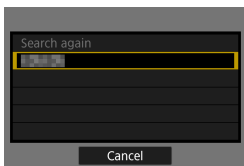

6 Select the computer to pair the camera with.

Steps on the Computer (2)

7 Pair the camera and computer.

- Select the camera, then click [Pairing].

Sending Images on the Camera to a Computer Automatically

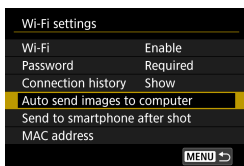

- 1 On the [Wi-Fi settings] screen, select [Auto send images to computer].

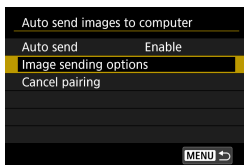

- 2 Select [Image sending options].

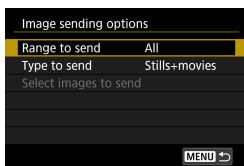

- 3 Select what to send.
 - If you select [Selected imgs] in [Range to send], specify the images to send on the [Select images to send] screen.

- 4 Connect the computer and access point via Wi-Fi and start Image Transfer Utility 2.

- Images are sent automatically to the computer when you turn the camera on within range of the access point.

- !
 - Auto power off is disabled.
 - Any images captured after automatic transfer are sent automatically when the camera is restarted.
 - If images are not sent automatically, try restarting the camera.

- Any images captured during automatic transfer are also sent automatically.

Connecting to a Printer via Wi-Fi

This section describes how to print images by directly connecting the camera to a printer via Wi-Fi. For printer operating instructions, refer to the printer user manual.

Establishing a Wi-Fi Connection

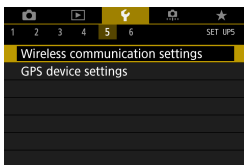

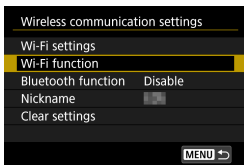

- 1** Select [: Wireless communication settings].



- 2** Select [**Wi-Fi function**].
- If the [**Nickname**] screen is displayed, register a nickname ( 422).



- 3** Select [] (**Print from Wi-Fi printer**).
- If the history ( 493) is displayed, switch the screen with the <<> <>> keys.

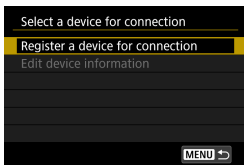

- 4** Select [**Register a device for connection**].

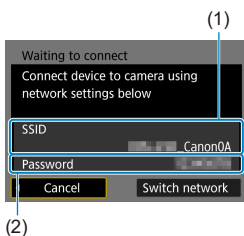

5 Check the SSID (network name) and password.

- Check the SSID (1) and password (2) displayed on the camera screen.
- In **[Wi-Fi settings]**, if you set **[Password]** to **[None]**, the password will not be displayed or required. For details, see 516.

6 Set up the printer.

- On the Wi-Fi settings menu of the printer to be used, select the SSID you have checked.
- For the password, enter the password checked in step 5.

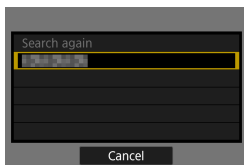

7 Select the printer.

- In the list of detected printers, select the printer to connect to via Wi-Fi.
- If your preferred printer is not listed, selecting **[Search again]** may enable the camera to find and display it.

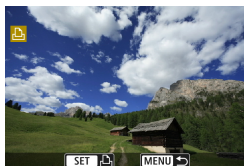

8 Print the image (464).



- Wi-Fi connection is possible with Wi-Fi printers supporting PictBridge (Wireless LAN).



- To establish a Wi-Fi connection via an access point, see "Wi-Fi Connection via Access Points" (📖 488).

Printing Images

Printing Images Individually



1 Select the image to be printed.

- Press the <◀> <▶> keys or turn the dial to select an image to print, then press <SET>.
- You can press the <Q> button and turn the dial counterclockwise to select the image using the index display.



2 Select [Print image].

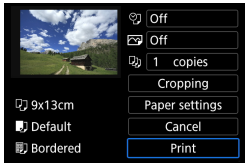

3 Print the image.

- For the print setting procedures, see 467.
- Select [Print], then [OK] to start printing.

Printing by Specifying the Options

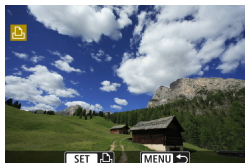

1 Press <SET>.



2 Select [Print order].

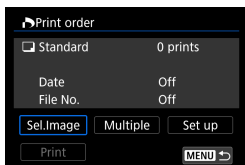

3 Set the printing options.

- For the setting procedures, refer to “Digital Print Order Format (DPOF)” (318).
- If the print order is complete before establishing a Wi-Fi connection, go to step 4.

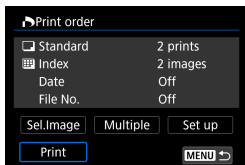

4 Select [Print].

- [Print] can be selected only when an image is selected and the printer is ready to print.

5 Set the [Paper settings] (467).

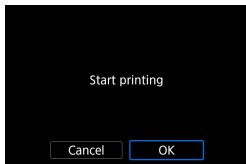

6 Print the image.

- When **[OK]** is selected, printing starts.



- Shooting is not possible while connected to a printer via Wi-Fi.
- Movies cannot be printed.
- Before printing, be sure to set the paper size.
- Certain printers may not be able to imprint the file number.
- If **[Bordered]** is set, certain printers may imprint the date on the border.
- Depending on the printer, the date may appear faint if it is imprinted on a bright background or on the border.
- RAW images cannot be printed by selecting **[Print order]**. When printing, select **[Print image]** and print.



- When you use a battery to power the camera, make sure it is fully charged.
- Depending on the image's file size and image quality, it may take some time to start printing after you select **[Print]**.
- To stop printing, press **<SET>** while **[Stop]** is displayed, then select **[OK]**.
- When printing with **[Print order]**, if you stopped printing and want to resume printing of the remaining images, select **[Resume]**. Note that printing will not resume if any of the following occurs.
 - You change the print order or delete any of the print ordered images before resuming printing.
 - When index is set, you change the paper setting before resuming printing.
 - The card's remaining capacity is low when you pause printing.
- If a problem occurs during printing, see [472](#).

Print Settings

The screen display and setting options vary depending on the printer. Also, certain settings may not be available. For details, refer to the printer's instruction manual.

Print setting screen

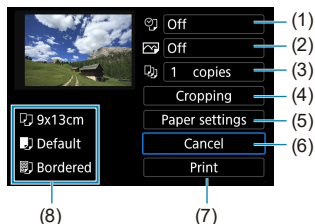

- (1) Sets date or file number printing (📖 469).
- (2) Sets the printing effects (📖 469).
- (3) Sets the number of copies to print (📖 470).
- (4) Sets the print area (📖 471).
- (5) Sets the paper size, type, and layout (📖 468).
- (6) Returns to the image selection screen.
- (7) Starts the printing.
- (8) The paper size, type, and layout you have set are displayed.

* Depending on the printer, certain settings may not be selectable.

Paper Settings

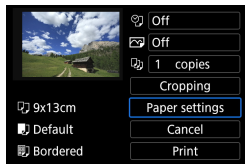

- Select [Paper settings].

Setting the Paper Size

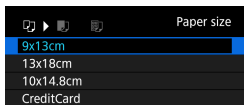

- Select the size of the paper in the printer.

Setting the Paper Type

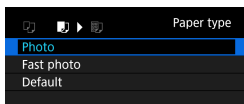

- Select the type of the paper in the printer.

Setting the Page Layout

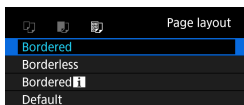

- Select the page layout.

Borderless	Prints with no borders. If your printer cannot print borderless prints, the print will have borders.
Bordered	Prints with white borders along the edges.
xx-up	Option to print 2, 4, 8, 9, 16, 20 or 35 images on one sheet.
Default	The page layout varies depending on the printer model or its settings.

-  ● Borderless printing may result in significant cropping if the aspect ratio of the paper and image do not match. Images may also be printed at lower resolution.

Setting the Date/File Number Imprinting

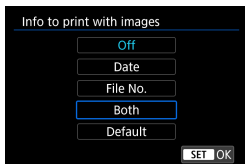

- Select [📷].
- Select what to print.

Setting the Printing Effects (Image Optimization)

Contents displayed on the screen vary depending on the printer.

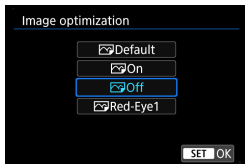

- Select [📷].
- Select printing effects.

Option	Printing Effect
[📷] Default	Printing effects differ depending on the printer. For details, refer to the printer's instruction manual.
[📷] On	Prints in the printer's standard colors. The image's Exif information is used to make automatic corrections.
[📷] Off	No automatic correction is applied.
[📷] Red-Eye1	Effective in flash images where the subject has red eye. The red eye is reduced for printing.



- If you imprint shooting information on an image shot at an expanded ISO speed (**H**), the correct ISO speed may not be imprinted.

Setting the Number of Copies

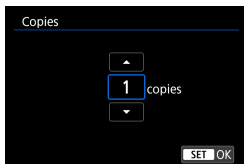

- Select [].
- Select the number of copies to print.



- The **[Default]** setting for printing effects and other options are the printer's own default settings as set by the printer's manufacturer. Refer to the printer's instruction manual to find out what the **[Default]** settings are.

Cropping the Image

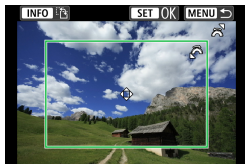

Set cropping immediately before printing. Changing other print settings after you crop images may require you to crop the images again.

1 On the print setting screen, select **[Cropping]**.

2 Set the cropping frame size, position, and aspect ratio.

- The image area within the cropping frame will be printed. The shape of the frame (aspect ratio) can be changed with **[Paper settings]**.

Changing the Cropping Frame Size

Turn the  dial to change the cropping frame size.

Moving the Cropping Frame

Press the **<▲>** **<▼>** or **<◀>** **<▶>** keys to move the frame over the image vertically or horizontally.

Switching the Orientation of the Cropping Frame

Pressing the **<INFO>** button will toggle the cropping frame between the vertical and horizontal orientations.

3 Press **<SET>** to exit the cropping.

- You can check the cropped image area on the upper left of the print setting screen.



- Depending on the printer, the cropped image area may not be printed as you specified.
- The smaller the cropping frame, the lower the resolution at which images are printed.



Handling Printer Errors

- If printing does not resume after you resolve a printer error (no ink, no paper, etc.) and select **[Continue]**, operate the buttons on the printer. For details on resuming printing, refer to the printer's instruction manual.

Error Messages

- If a problem occurs during printing, an error message will appear on the camera screen. After fixing the problem, resume printing. For details on how to fix a printing problem, refer to the printer's instruction manual.

Paper Error

- Confirm that paper is loaded correctly.

Ink Error

- Check the printer's ink level and the waste ink tank.

Hardware Error

- Check for any printer problems other than paper and ink problems.

File Error

- The selected image cannot be printed. Images taken with a different camera or images edited with a computer may not be printable.

Sending Images to a Web Service

This section describes how to use Web services to send images.

Registering Web Services

Use a smartphone or computer to add your Web services to the camera.

- A smartphone or computer with a browser and Internet connection is required to complete camera settings for CANON iIMAGE GATEWAY and other Web services.
- Visit the CANON iIMAGE GATEWAY website for details on versions of browsers (such as Microsoft Internet Explorer) and settings required for CANON iIMAGE GATEWAY access.
- For information on countries and regions where CANON iIMAGE GATEWAY is available, visit the Canon website (<http://www.canon.com/cig/>).
- For CANON iIMAGE GATEWAY instructions and setting details, refer to the help information for CANON iIMAGE GATEWAY.
- If you also intend to use Web services other than CANON iIMAGE GATEWAY, you must have an account with the services you intend to use. For further details, check the websites for each Web service you will register.
- Fees to connect to your provider and communication fees to access your provider's access point are charged separately.

Registering CANON iMAGE GATEWAY

Link the camera and CANON iMAGE GATEWAY by adding CANON iMAGE GATEWAY as a destination Web service on the camera.

You will need to enter an email address used on your computer or smartphone.

Steps on the Camera (1)

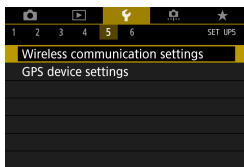

1 Select [**W** : Wireless communication settings].

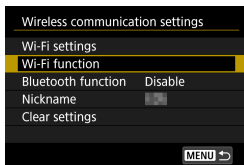

2 Select [**Wi-Fi function**].
• If the [**Nickname**] screen is displayed, register a nickname (📖422).

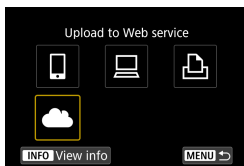

3 Select [**☁**].

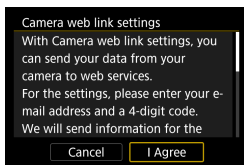

4 Select [**I Agree**].

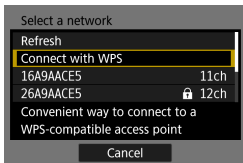

5 Establishing a Wi-Fi Connection

- Connect to an access point via Wi-Fi. Go to step 7 on 490.

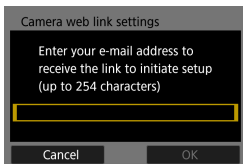

6 Enter your email address.

- Enter your email address, then select [OK].

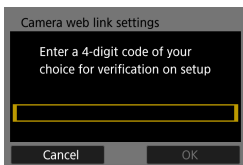

7 Enter a four-digit number.

- Enter a four-digit number of your choice, then select [OK].

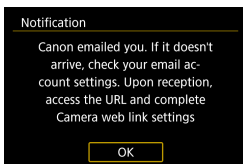

8 Select [OK].

- ▶ The [] icon changes to [].

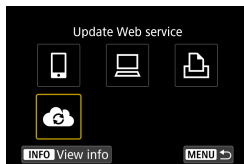

Steps on the Computer or Smartphone

9 Set up camera web link.

- Access the page in the notification message.
- Follow the instructions to complete the settings on the camera web link settings page.

Steps on the Camera (2)

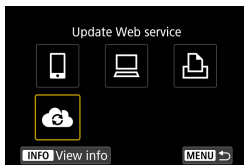

10 Add CANON iMAGE GATEWAY as a destination.

- Select [C].
- ▶ CANON iMAGE GATEWAY is now added.

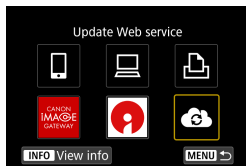

Registering Other Web Services

Steps on the Computer or Smartphone

1 Configure the Web service you want to use.

- Visit the CANON IMAGE GATEWAY website and access the camera web link settings page.
- Follow the on-screen instructions to complete settings for Web services you want to use.

Steps on the Camera

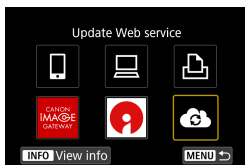

2 Add the Web service you configured as a destination.

- On the [Wi-Fi function] screen, select [📷].

Establishing a Wi-Fi Connection

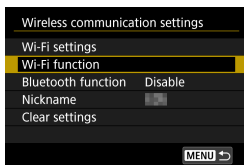

1 Select [Wi-Fi function].

- Select **[Wi-Fi function]** on the **[Wireless communication settings]** screen.

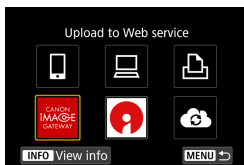

2 Select a Web service.

- If the history (📖 493) is displayed, switch the screen with the <◀> <▶> keys.
- A screen to select a destination may be displayed, depending on the type and settings of the Web service (📖 492).

Sending Images to a Web Service

You can share images with your family and friends by sending images from the camera to a Web service registered on the camera or by sending Web links of the online albums.

Sending Images Individually



1 Select an image to send.

- Press the <◀> <▶> keys or turn the <☺> dial to select an image to send, then press <SET>.
- You can press the <Q> button and turn the <☺> dial counterclockwise to select the image using the index display.



2 Select [Send img shown].

- In [Size to send], you can select the image sending size.
- On the screen after images are sent, select [OK] to end the Wi-Fi connection.
- When the [Terms of use] screen is displayed, thoroughly read the message, then select [I Agree].
- To scroll the screen, use the <▲> <▼> keys.

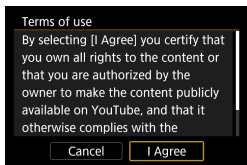

Sending Multiple Selected Images

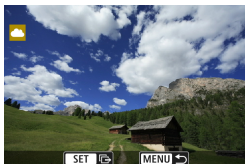

1 Press <SET>.



2 Select [Send selected].

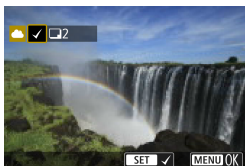

3 Select images to send.

- Press the <◀> <▶> keys or turn the <⚙> dial to select an image to send, then press <SET>.
- You can press the <Q> button and turn the <⚙> dial counterclockwise to switch to the three-image display to select the images. To return to the single image display, also press the <Q> button and operate the <⚙> dial.
- After selecting the images to send, press the <MENU> button.

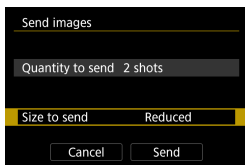

4 Select [Size to send].

- When YouTube is selected as the destination, **[Size to send]** is not displayed.
- On the displayed screen, select an image size.

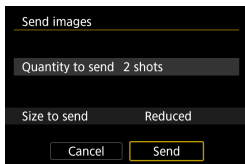
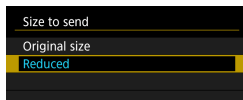

5 Select [Send].

- On the screen after images are sent, select **[OK]** to end the Wi-Fi connection.

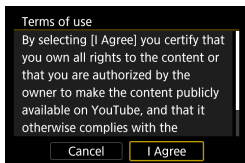

- When the **[Terms of use]** screen is displayed, thoroughly read the message, then select **[I Agree]**.
- To scroll the screen, use the <▲> <▼> keys.

Sending a Specified Range of Images

Specify the range of images to send all the images in the range at once.

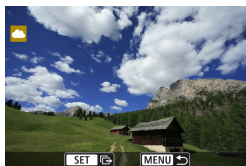

1 Press <SET>.



2 Select [Send range].

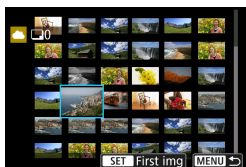

3 Specify the range of images.

- Select the first image (start point).
- Select the last image (end point).
- ▶ Images will be selected and [✓] will appear.
- To cancel the selection, repeat this step.
- You can press the <Q> button and turn the <Q> dial to change the number of images shown in the index display.

4 Confirm the range.

- Press the <MENU> button.

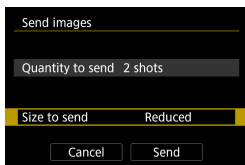

5 Select [Size to send].

- On the displayed screen, select an image size.

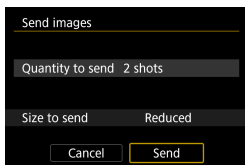
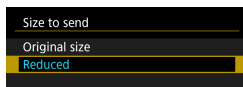

6 Select [Send].

- On the screen after images are sent, select [OK] to end the Wi-Fi connection.

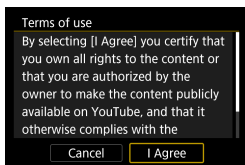

- When the [Terms of use] screen is displayed, thoroughly read the message, then select [I Agree].
- To scroll the screen, use the <▲> <▼> keys.

Sending All Images on the Card

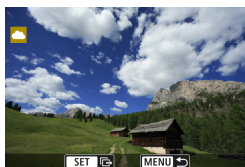

1 Press <SET>.



2 Select [Send all card].

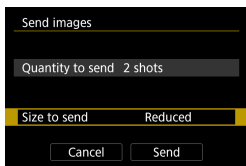

3 Select [Size to send].

- On the displayed screen, select an image size.

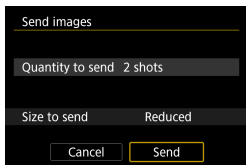
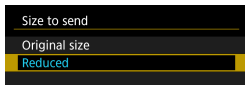

4 Select [Send].

- On the screen after images are sent, select [OK] to end the Wi-Fi connection.

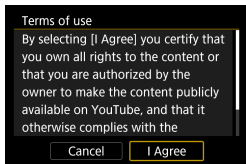

- When the [Terms of use] screen is displayed, thoroughly read the message, then select [I Agree].
- To scroll the screen, use the <▲> <▼> keys.

Sending Images that Match the Search Conditions

Send all the images that match the search conditions set in **[Set image search conditions]** at once.

For **[Set image search conditions]**, refer to “Filtering Images for Playback” (📖 345).



1 Press <SET>.



2 Select **[Send all found]**.

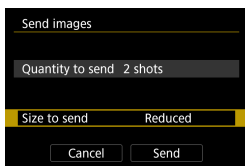

3 Select **[Size to send]**.

- On the displayed screen, select an image size.

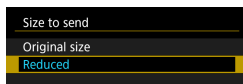

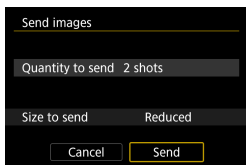

4 Select [Send].

- On the screen after images are sent, select **[OK]** to end the Wi-Fi connection.

- When the **[Terms of use]** screen is displayed, thoroughly read the message, then select **[I Agree]**.
- To scroll the screen, use the <▲> <▼> keys.

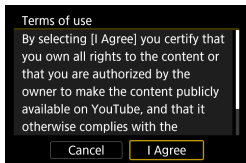



- With a Wi-Fi connection to a Web service established, a picture cannot be taken even if the camera's shutter button is pressed.
- When sending an image to a Web service other than CANON iMAGE GATEWAY, a send error message may not be displayed even if the image has not been sent to the Web service successfully. Since such send errors can be checked on the CANON iMAGE GATEWAY site, check the error content, then try sending the image again.



- Depending on the Web service, the type or number of images that can be sent and the length of movies will be limited.
- Certain images may not be able to be sent with **[Send range]**, **[Send all card]**, or **[Send all found]**.
- When you reduce the image size, all images to be sent at the same time are resized. Note that movies or **S2** size still photos are not reduced.
- **[Reduced]** is enabled only for still photos shot with cameras of the same model as this camera. Still photos shot with other models are sent without resizing.
- When accessing CANON iMAGE GATEWAY from a computer or other device, you can check the send history for the Web services that the images were sent to.
- To terminate the Wi-Fi connection without sending an image, press the **<MENU>** button on the screen for step 1.
- When you use a battery to power the camera, make sure it is fully charged.

Wi-Fi Connection via Access Points

This section describes how to join a Wi-Fi network via an access point compatible with WPS (PCB mode).

First, check the position of the WPS button and how long to press it. It may take approx. one minute to establish a Wi-Fi connection.

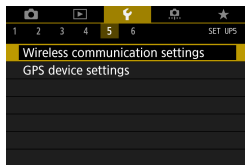

- 1 Select [**WPS**: Wireless communication settings].

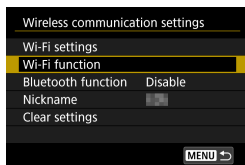

- 2 Select [**Wi-Fi function**].
 - If the [**Nickname**] screen is displayed, register a nickname (📖422).

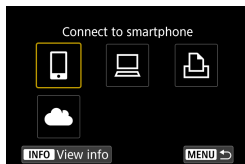

- 3 Select an item.
 - If the history (📖493) is displayed, switch the screen with the <◀> <▶> keys.
 - Press the <▲> <▼> or <◀> <▶> keys to select an item.



4 Select [Register a device for connection].

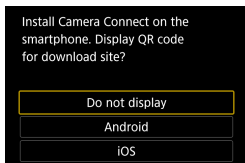

- When [📱] (Connect to smartphone) is selected, the screen on the left is displayed. If Camera Connect is already installed, select **[Do not display]**.

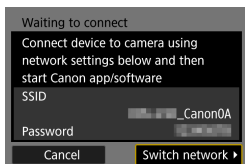

5 Select [Switch network].

- Displayed when [📱], [💻], or [🖨️] is selected.

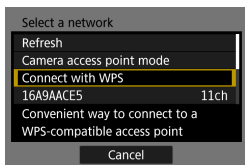

6 Select [Connect with WPS].



- For [Camera access point mode] displayed in step 6, see [📖492](#).

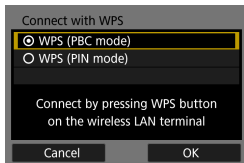

- 7** Select **[WPS (PBC mode)]**.
- Select **[OK]**.

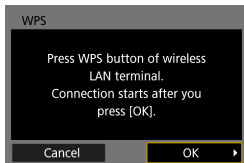

- 8** Connect to the access point via **Wi-Fi**.
- Press the access point's WPS button.
 - Select **[OK]**.

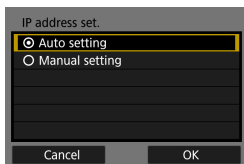

- 9** Select **[Auto setting]**.
- Select **[OK]** to access the setting screen for the Wi-Fi function.
 - If an error occurs with **[Auto setting]**, see 518.

10 Specify the settings for the Wi-Fi function.

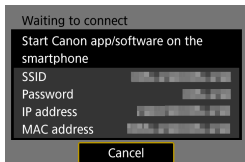

[📱 Connect to smartphone]

Go to step 7 on 435.

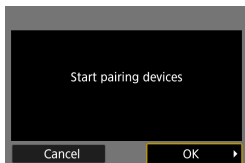

[🖨️ Remote control (EOS Utility)]

Go to step 8 or 9 on 455.

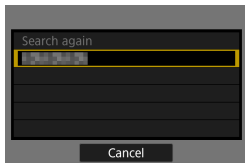

[📄 Print from Wi-Fi printer]

Go to step 7 on 462.

Registering CANON iIMAGE GATEWAY

Go to step 6 on 475.

Send To Screen

A screen to select a destination may be displayed depending on the Web service.

To register destinations or to specify the settings, you must use a computer. For more information, refer to the EOS Utility Instruction Manual.

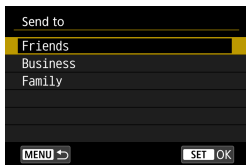

- The **[Send to]** screen may be displayed.
- Select the destination from the list of registered destinations.
- The procedures for setting up a connection and sending images are the same as those for other Web services.

Camera Access Point Mode

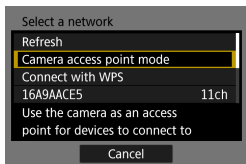

Camera access point mode is a connection mode for connecting the camera directly to each device via Wi-Fi.

Displayed when [📱], [💻], or [🖨️] is selected in **[Wi-Fi function]**.

Reconnecting via Wi-Fi

Follow these steps to reconnect to devices or Web services with registered connection settings.

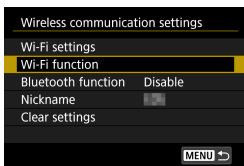

1 Select [Wi-Fi function].

- Select [Wi-Fi function] on the [Wireless communication settings] screen.

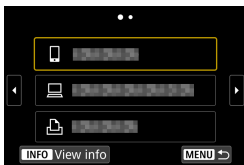

2 Select an item.

- Select the item to connect to via Wi-Fi from the displayed history. If the item is not displayed, use the <◀> <▶> keys to switch screens.
- If [Connection history] is set to [Hide], the history will not be displayed (📖 516).

3 Operate the connected device.

[📱] Smartphone

- Activate the smartphone's Wi-Fi function, then start Camera Connect.
- If the smartphone's connection destination has been changed, restore the setting to connect via Wi-Fi to the camera or the same access point as the camera.

When directly connecting the camera to a smartphone via Wi-Fi, “_Canon0A” is displayed at the end of the SSID.

Computer

- On the computer, start the EOS software.
- If the computer's connection destination has been changed, restore the setting to connect via Wi-Fi to the camera or the same access point as the camera.

When directly connecting the camera to a computer via Wi-Fi, “_Canon0A” is displayed at the end of the SSID.

Printer

- If the printer's connection destination has been changed, restore the setting to connect via Wi-Fi to the camera or the same access point as the camera.

When directly connecting the camera to a printer via Wi-Fi, “_Canon0A” is displayed at the end of the SSID.

Registering Multiple Connection Settings

You can register up to 20 connection settings for the Wi-Fi function.

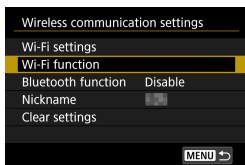

1 Select [Wi-Fi function].

- Select **[Wi-Fi function]** on the **[Wireless communication settings]** screen.

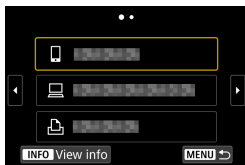

2 Select an item.

- When the screen on the left appears, use the <◀> <▶> keys to switch screens.

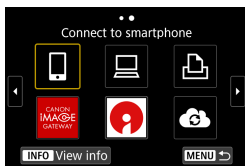

- Select the item to newly connect to via Wi-Fi from the screen on the left.
- For details on **[📱]** (Connect to smartphone), see “Connecting to a Smartphone via Wi-Fi from the **[Wi-Fi function] Menu**” (📖 419).
- For **[💻]** (Remote control (EOS Utility)), see “Connecting to a Computer via Wi-Fi” (📖 453).
- For details on **[🖨️]** (Print from Wi-Fi printer), see “Connecting to a Printer via Wi-Fi” (📖 461).
- When sending images to a Web service, see “Sending Images to a Web Service” (📖 473).



- To delete connection settings, see 📖 496.

Changing or Deleting Connection Settings

Change or delete connection settings saved on the camera. To change or delete the connection settings, terminate the Wi-Fi connection first.

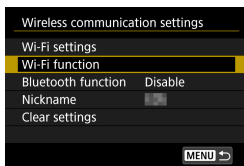

1 Select [Wi-Fi function].

- Select **[Wi-Fi function]** on the **[Wireless communication settings]** screen.

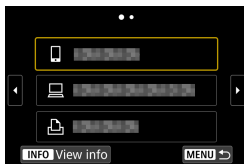

2 Select an item.

- When the screen on the left appears, use the <<> <>> keys to switch screens.

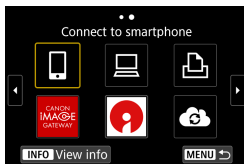

- From the screen on the left, select the item for which to change or delete the connection settings.

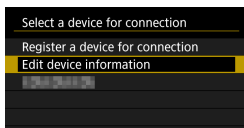

3 Select [Edit device information].

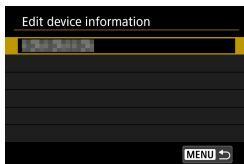

4 Select a device.

- Select the device for which to change or delete the connection settings.

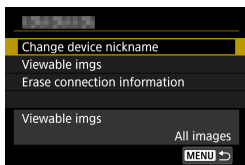

5 Check or change the connection settings.

- Select an item, then change or delete the connection settings on the displayed screen.

● Change device nickname

You can change the nickname using the virtual keyboard (📖 517).

● Viewable imgs (📖 450)

Displayed when [📱] (Connect to smartphone) is selected. Settings will appear at the bottom of the screen.

● Erase connection information

You can delete connection settings saved on the camera.

For Web services, visit the CANON IMAGE GATEWAY website to delete the connection settings.

Clearing Wireless Communication Settings to Default

All wireless communication settings can be deleted. By deleting the wireless communication settings, you can prevent their information from being exposed when you lend or give your camera to other people.

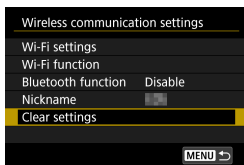

1 Select [Clear settings].

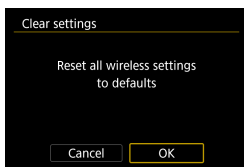

2 Select [OK].

- ▶ Wireless communication settings are cleared to default, and the **[Wireless communication settings]** screen will reappear.



- Performing [**⏏**: **Clear all camera settings**] does not delete the wireless communication setting information.

View Info Screen

On the **[View info]** screen, you can check error details and the camera's MAC address.

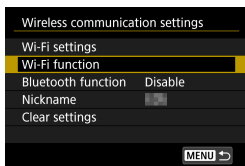

1 Select **[Wi-Fi function]**.

- Select **[Wi-Fi function]** on the **[Wireless communication settings]** screen.

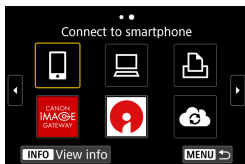

2 Press the **<INFO>** button.

- ▶ The **[View info]** screen will appear.

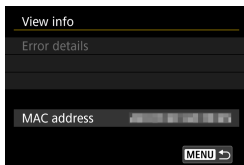

- When an error has occurred, press **<SET>** to display the error content.

Responding to Error Messages

When an error occurs, display the details of the error by following one of the procedures below. Then, eliminate the cause of the error by referring to the examples shown in this chapter.

- On the **[View info]** screen, press <SET> (📖 499).
- Select **[Error details]** on the **[Wi-Fi on]** screen.

Click the error code number's page in the following chart to jump to the corresponding page.

11 (📖 501)	12 (📖 501)	21 (📖 502)	22 (📖 503)
23 (📖 504)	61 (📖 505)	63 (📖 506)	64 (📖 506)
65 (📖 507)	66 (📖 507)	67 (📖 507)	68 (📖 508)
69 (📖 508)	91 (📖 508)	121 (📖 508)	125 (📖 509)
126 (📖 509)	127 (📖 509)	141 (📖 509)	142 (📖 509)
151 (📖 510)	152 (📖 510)		



- When an error occurs, **[Err**]** is displayed on the upper right of the **[Wi-Fi function]** screen. It disappears when the camera's power is set to <OFF>.

11: Connection target not found

- In the case of [📷], is Camera Connect running?
 - ▶ Establish a connection using Camera Connect (📖 435).
- In the case of [🖨️], is the power of the printer on?
 - ▶ Turn on the printer.
- In the case of [💻], is the EOS software running?
 - ▶ Start the EOS software and reestablish the connection (📖 455).
- Are the camera and the access point set to use the same password for authentication?
 - ▶ This error occurs if the passwords do not match when the authentication method for encryption is set to **[Open system]**. The setting is case-sensitive, so check upper- and lower-case characters. Make sure that the correct password for authentication is set on the camera (📖 517).

12: Connection target not found

- Is the power of the target device and access point on?
 - ▶ Turn on the target device and access point, then wait a while. If a connection still cannot be established, perform the procedures to establish the connection again.

21: No address assigned by DHCP server

What to check on the camera

- On the camera, IP address is set to **[Auto setting]**. Is this the correct setting?
 - ▶ If no DHCP server is used, specify the settings after setting the IP address to **[Manual setting]** on the camera (📖 518).

What to check on the DHCP server

- Is the power of the DHCP server on?
 - ▶ Turn on the DHCP server.
- Are there enough addresses for assignment by the DHCP server?
 - ▶ Increase the number of addresses assigned by the DHCP server.
 - ▶ Remove devices assigned addresses by the DHCP server from the network to reduce the number of addresses in use.
- Is the DHCP server working correctly?
 - ▶ Check the DHCP server settings to make sure it is working correctly as a DHCP server.
 - ▶ If applicable, ask your network administrator to ensure the DHCP server is available.

22: No response from DNS server

What to check on the camera

- On the camera, does the DNS server's IP address setting match the server's actual address?
 - ▶ Set the IP address to **[Manual setting]**. Then, on the camera, set the IP address that matches the address of the DNS server used (📖 514, 📖 518).

What to check on the DNS server

- Is the power of the DNS server on?
 - ▶ Turn on the DNS server.
- Are the DNS server settings for IP addresses and the corresponding names correct?
 - ▶ On the DNS server, make sure IP addresses and the corresponding names are entered correctly.
- Is the DNS server working correctly?
 - ▶ Check the DNS server settings to make sure it is working correctly as a DNS server.
 - ▶ If applicable, ask your network administrator to ensure the DNS server is available.

What to check on the network as a whole

- Does the network that you are trying to connect to via Wi-Fi include a router or similar device that serves as a gateway?
 - ▶ If applicable, ask your network administrator for the network gateway address and enter it on the camera (📖 514, 📖 518).
 - ▶ Make sure that the gateway address setting is correctly entered on all network devices including the camera.

23: Device with same IP address exists on selected network

What to check on the camera

- Do the camera and another device connected via Wi-Fi to the same network have the same IP address?
 - ▶ Change the camera's IP address to avoid using the same address as another device on the network. Otherwise, change the IP address of the device that has a duplicate address.
 - ▶ If the camera's IP address is set to **[Manual setting]** in network environments using a DHCP server, change the setting to **[Auto setting]** (📖 490).



Responding to Error Messages 21–23

- Also check the following points when responding to errors numbered 21–23.
- **Are the camera and the access point set to use the same password for authentication?**
 - This error occurs if the passwords do not match when the authentication method for encryption is set to **[Open system]**. The setting is case-sensitive, so check upper- and lower-case characters. Make sure that the correct password for authentication is set on the camera (📖 517).

61: Selected SSID wireless LAN network not found

- Are any obstacles blocking the line of sight between the camera and the antenna of the access point?
 - ▶ Move the antenna of the access point to a position clearly visible from the point of view of the camera (📖 511).

What to check on the camera

- Does the SSID set on the camera match that of the access point?
 - ▶ Check the SSID at the access point, then set the same SSID on the camera.

What to check at the access point

- Is the access point turned on?
 - ▶ Turn on the power of the access point.
- If filtering by MAC address is active, is the MAC address of the camera in use registered at the access point?
 - ▶ Register the MAC address of the camera used to the access point. The MAC address can be checked on the **[View info]** screen (📖 499).

63: Wireless LAN authentication failed

- Are the camera and the access point set to use the same authentication method?
 - ▶ The camera supports the following authentication methods: **[Open system]**, **[Shared key]**, and **[WPA/WPA2-PSK]**.
- Are the camera and the access point set to use the same password for authentication?
 - ▶ The setting is case-sensitive, so check upper- and lower-case characters. Make sure that the correct password for authentication is set on the camera.
- If filtering by MAC address is active, is the MAC address of the camera in use registered at the access point?
 - ▶ Register the MAC address of the camera used to the access point. The MAC address can be checked on the **[View info]** screen (📖499).

64: Cannot connect to wireless LAN terminal

- Are the camera and the access point set to use the same encryption method?
 - ▶ The camera supports the following encryption methods: WEP, TKIP, and AES.
- If filtering by MAC address is active, is the MAC address of the camera in use registered at the access point?
 - ▶ Register the MAC address of the camera used to the access point. The MAC address can be checked on the **[View info]** screen (📖499).

65: Wireless LAN connection lost

- Are any obstacles blocking the line of sight between the camera and the antenna of the access point?
 - ▶ Move the antenna of the access point to a position clearly visible from the point of view of the camera (📖 511).
- The Wi-Fi connection was lost for some reason, and the connection cannot be restored.
 - ▶ The following are possible reasons: excessive access to the access point from another device, a microwave oven or similar appliance in use nearby (interfering with IEEE 802.11b/g/n (2.4 GHz band)), or influence of rain or high humidity (📖 511).

66: Incorrect wireless LAN password

- Are the camera and the access point set to use the same password for authentication?
 - ▶ The setting is case-sensitive, so check upper- and lower-case characters. Make sure that the correct password for authentication is set on the camera.

67: Incorrect wireless LAN encryption method

- Are the camera and the access point set to use the same encryption method?
 - ▶ The camera supports the following encryption methods: WEP, TKIP, and AES.
- If filtering by MAC address is active, is the MAC address of the camera in use registered at the access point?
 - ▶ Register the MAC address of the camera used to the access point. The MAC address can be checked on the **[View info]** screen (📖 499).

68: Cannot connect to wireless LAN terminal. Retry from the beginning.

- Did you hold down the access point's WPS (Wi-Fi Protected Setup) button for the specified period of time?
 - ▶ Hold down the WPS button for the period of time specified in the access point's instruction manual.
- Are you trying to establish a connection near the access point?
 - ▶ Try establishing the connection when both devices are within reach of each other.

69: Multiple wireless LAN terminals have been found. Cannot connect. Retry from the beginning.

- Connection is in progress by other access points in Pushbutton Connection mode (PBC mode) of WPS (Wi-Fi Protected Setup).
 - ▶ Wait a while before trying to establish the connection.

91: Other error

- A problem other than error code number 11 to 69 occurred.
 - ▶ Turn the camera's power switch off and on.

121: Not enough free space on server

- The target Web server does not have enough free space.
 - ▶ Delete unnecessary images on the Web server, check the free space on the Web server, then try sending the data again.

125: Check the network settings

- Is the network connected?
 - ▶ Check the connection status of the network.

126: Could not connect to server

- CANON iIMAGE GATEWAY is under maintenance or load is concentrated temporarily.
 - ▶ Try connecting to the Web service again later.

127: An error has occurred

- A problem other than error code number 121 to 126 occurred while the camera is connected to the Web service.
 - ▶ Try again to establish the Wi-Fi connection to the Web service.

141: Printer is busy. Reconnect to try again.

- Is the printer performing a printing process?
 - ▶ Try again to establish the Wi-Fi connection to the printer after the printing process is finished.
- Is another camera connected to the printer via Wi-Fi?
 - ▶ Try again to establish the Wi-Fi connection to the printer after the Wi-Fi connection to the other camera has been terminated.

142: Could not acquire printer information. Reconnect to try again.

- Is the power of the printer on?
 - ▶ Try again to establish the Wi-Fi connection after turning on the printer.

151: Transmission canceled

- Automatic image transfer to the computer was somehow interrupted.
 - ▶ To resume automatic image transfer, set the camera's power switch to <OFF>, and then set it to <ON>.

152: Card's write protect switch is set to lock

- Is the card's write protect switch set to the locked position?
 - ▶ Slide the card's write protect switch to the writing position.

Wireless Communication Function Notes

If the transmission rate drops, the connection is lost, or other problems occur when using the wireless communication functions, try the following corrective actions.

Distance Between the Camera and the Smartphone

If the camera is too far from the smartphone, a Wi-Fi connection may not be established even when Bluetooth connection is possible. In this case, bring the camera and the smartphone closer together, then establish a Wi-Fi connection.

Installation Location of Access Point Antenna

- When using indoors, install the device in the room where you are using the camera.
- Install the device where people or objects do not come between the device and the camera.

Nearby Electronic Devices

If the Wi-Fi transmission rate drops because of the influence of the following electronic devices, stop using them or move further away from the devices to transmit communication.

- The camera communicates over Wi-Fi via IEEE 802.11b/g/n using radio waves in the 2.4 GHz band. For this reason, the Wi-Fi transmission rate will drop if there are Bluetooth devices, microwave ovens, cordless telephones, microphones, smartphones, other cameras, or similar devices operating on the same frequency band nearby.

Cautions for Using Multiple Cameras

- When connecting multiple cameras to one access point via Wi-Fi, make sure the cameras' IP addresses are different.
- When multiple cameras are connected to one access point via Wi-Fi, the transmission rate drops.
- When there are multiple IEEE 802.11b/g/n (2.4 GHz band) access points, leave a gap of five channels between each Wi-Fi channel to reduce radio wave interference. For example, use channels 1, 6, and 11, channels 2 and 7, or channels 3 and 8.

Using the Wireless Remote Control BR-E1

- When **[Bluetooth function]** is set to **[Remote]** to use the Wireless Remote Control BR-E1, the camera cannot be connected to a smartphone via Bluetooth.

Security

If security settings have not been properly set, the following problems may occur.

- **Transmission monitoring**

Third parties with malicious intent may monitor the Wi-Fi transmissions and attempt to acquire the data you are sending.

- **Unauthorized network access**

Third parties with malicious intent may gain unauthorized access to the network you are using to steal, modify, or destroy information. Additionally, you could fall victim to other types of unauthorized access such as impersonation (where someone assumes an identity to gain access to unauthorized information) or springboard attacks (where someone gains unauthorized access to your network as a springboard to cover their tracks when infiltrating other systems).

It is recommended to make use of the systems and functions to thoroughly secure your network, preventing these types of problems from occurring.

Checking Network Settings

● Windows

Open the Windows **[Command Prompt]**, then type `ipconfig/all` and press the **<Enter>** key.

In addition to the IP address assigned to the computer, the subnet mask, gateway, and DNS server information are also displayed.

● Mac OS

In Mac OS X, open the **[Terminal]** application, enter `ifconfig -a`, and press the **<Return>** key. The IP address assigned to the computer is indicated in the **[en0]** item next to **[inet]**, in the format `****.***.***.****`.

* For information about the **[Terminal]** application, refer to the Mac OS X help.

To avoid using the same IP address for the computer and other devices on the network, change the rightmost number when setting up the IP address assigned to the camera in the processes described on  518.

Example: 192.168.1(10)

[Wireless communication settings] Screen

On the [Wireless communication settings] screen, you can change the wireless communication function settings.

Select [: Wireless communication settings].

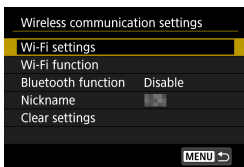

Wi-Fi settings

- See the next page.

Wi-Fi function

The following Wi-Fi functions are available:

- Communicate with smartphone
- Remote control (EOS Utility)
- Print from Wi-Fi printer
- Send images to Web service

Bluetooth function (429)

Displays the [Bluetooth function] screen on which you can set or check the Bluetooth functions.

Nickname

You can change the nickname using the virtual keyboard ( 517).

Clear settings (498)

Clear all wireless communication settings.

[Wi-Fi settings] Screen

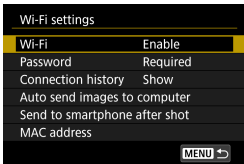

Wi-Fi

When the use of electronic devices and wireless devices is prohibited, such as on board airplanes or in hospitals, set it to **[Disable]**.

Password

Set to **[None]** to allow a Wi-Fi connection to be established without a password (except when connecting to an access point via Wi-Fi).

Connection history

You can set whether to **[Show]** or **[Hide]** the history of the Wi-Fi connected devices.

Auto send images to computer

With the dedicated software Image Transfer Utility 2, you can send images on the camera to a computer automatically (📖458).

Send to smartphone after shot

Your shots can be sent to a smartphone automatically (📖439).

MAC address

You can check the MAC address of the camera.

Virtual Keyboard Operation

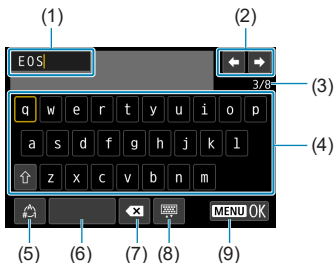

(1) Input area, for entering text

(2) Cursor keys, for moving in the input area

(3) Current no. of characters/no. available

(4) Keyboard

(5) Switch input modes

(6) Space

(7) Delete a character in the input area

(8) Change the type of keyboard

(9) Finish the text entry

- Use the <▲> <▼> <◀> <▶> keys to move within 2 and 4–8.
- Press <SET> to confirm input or when switching input modes.

Setting the IP Address Manually

Set up the IP address settings manually. The items displayed vary depending on the Wi-Fi function.

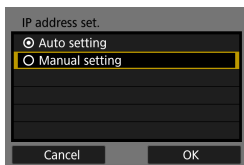

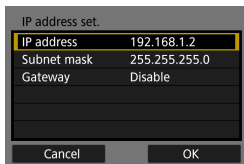

- 1 Select [Manual setting].**
- Select **[OK]**.

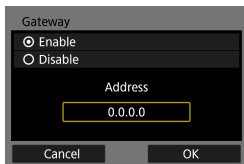

- 2 Select an item.**
- Select an item to access the screen for numerical input.
 - To use a gateway, select **[Enable]**, then select **[Address]**.



- 3 Enter the desired values.**
- Turn the  dial to move the input position in the upper area and turn the  dial to select the number. Press **<SET>** to enter the selected number.
 - To set the entered values and return to the screen for step 2, press the **<MENU>** button.

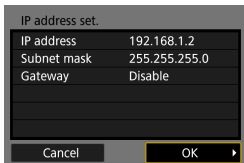

IP address set.	
IP address	192.168.1.2
Subnet mask	255.255.255.0
Gateway	Disable
Cancel	OK

4 Select [OK].

- When you have completed setting the necessary items, select **[OK]**.
- If you are not sure what to enter, see “Checking Network Settings” (📖 514), or ask the network administrator or another person knowledgeable about the network.

Wi-Fi/Bluetooth Status Display

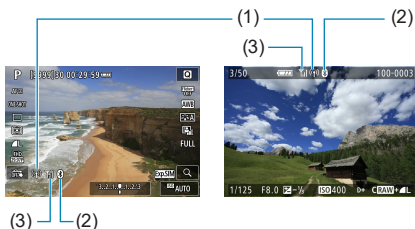

Wireless communication status can be checked on the camera screen.



- (1) Wi-Fi function
- (2) Bluetooth function
- (3) Wireless signal strength

Communication status		Wi-Fi function	Wireless signal strength
Not connected	Wi-Fi: Disable	(OFF)	Off
	Wi-Fi: Enable	(OFF)	
Connecting		() (Blinking)	⏸
Connected		()	⏸
Sending data		() (↔)	⏸
Connection error		() (Blinking)	⏸

Bluetooth Function Indicator

Bluetooth function	Connection status	Screen
Other than [Disable]	Bluetooth connected	
	Bluetooth not connected	
[Disable]	Bluetooth not connected	Not displayed



Custom Functions / My Menu

You can fine-tune camera functions and change the functionality of buttons and dials to suit your shooting preferences. You can also add menu items and Custom Functions that you adjust frequently to My Menu tabs.

Tab Menus: Customization

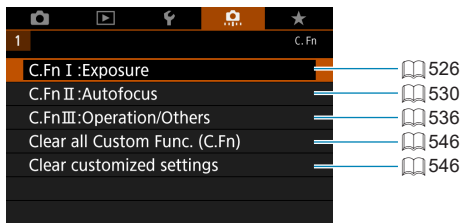

Setting Custom Functions

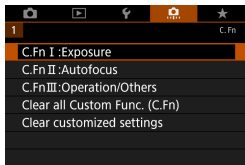

- 1** Select [C.Fn I: Exposure], [C.Fn II: Autofocus], or [C.Fn III: Operation/Others].

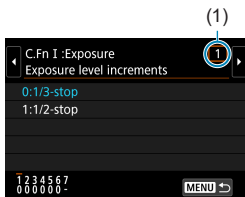

- 2** Select a Custom Function number.
- Use the <<> <>> keys to select the Custom Function number (1) to set up.

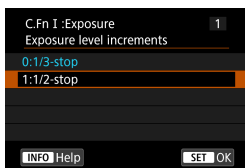

- 3** Change the setting as desired.
- Use the <▲> <▼> keys to select a setting (number).
 - To set up another Custom Function, repeat steps 2–3.

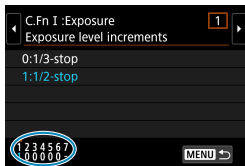

- At the bottom of the screen, the current Custom Function settings are indicated below the respective function numbers.
- Any options changed from defaults are displayed in blue.

- 4** Exit the setting.

- Press the <MENU> button.
- The screen in step 1 is displayed again.

Custom Function Settings



You can customize camera features on the [] tab to suit your shooting preferences.

C.Fn I: Exposure

C.Fn I-1: Exposure level increments

Sets 1/2-stop increments for the shutter speed, aperture, exposure compensation, AEB, flash exposure compensation, etc.

- 0: 1/3-stop
- 1: 1/2-stop



- When [**1/2-stop**] is set, the display will be as shown below.



C.Fn I-2: ISO speed setting increments

You can change the manual ISO speed setting increments to a whole-stop.

- 0: 1/3-stop
- 1: 1-stop



- Even if [**1-stop**] is set, ISO speed will be automatically set in 1/3-stop increments when ISO Auto is set.
- Even when [**1-stop**] is set, you can set ISO 40000 (for still photo shooting).

C.Fn I-3: Bracketing auto cancel

You can specify to cancel AEB and white balance bracketing when the power switch is set to <OFF>.

- 0: Enable
- 1: Disable

C.Fn I-4: Bracketing sequence

The AEB shooting sequence and white balance bracketing sequence can be changed.

- 0: 0 → - → +
- 1: - → 0 → +
- 2: + → 0 → -

AEB	White Balance Bracketing	
	B/A Direction	M/G Direction
0 : Standard exposure	0 : Standard white balance	0 : Standard white balance
- : Decreased exposure	- : Blue bias	- : Magenta bias
+ : Increased exposure	+ : Amber bias	+ : Green bias

C.Fn I-5: Number of bracketed shots

The number of shots taken with AEB and white balance bracketing can be changed.

When **[Bracketing sequence]** is set to **[0, -, +]**, the bracketed shots will be taken as shown in the table below.

- 0: 3 shots
- 1: 2 shots
- 2: 5 shots
- 3: 7 shots

(1-stop/step increments)

	1st Shot	2nd Shot	3rd Shot	4th Shot	5th Shot	6th Shot	7th Shot
3: 3 shots	Standard (0)	-1	+1				
2: 2 shots	Standard (0)	±1					
5: 5 shots	Standard (0)	-2	-1	+1	+2		
7: 7 shots	Standard (0)	-3	-2	-1	+1	+2	+3



- If **[2 shots]** is set, you can select the + or - side when setting the AEB range. With WB bracketing, the 2nd shot will be adjusted toward either the B/A or M/G direction.

C.Fn I-6: Safety shift

If the subject brightness changes and the standard exposure cannot be obtained within the autoexposure range, the camera will automatically change the manually selected setting to obtain the standard exposure. When set to **[Shutter speed/Aperture]**, this setting applies to <Tv> and <Av> mode. When set to **[ISO speed]**, this setting applies to <P>, <Tv>, and <Av> mode.

- 0: Disable
- 1: Shutter speed/Aperture
- 2: ISO speed



- Under **[📷: ISO speed settings]**, even if **[ISO speed range]** or **[Min. shutter spd.]** is changed from the default setting, safety shift will override it if the standard exposure cannot be obtained.
- The minimum and maximum limits for the safety shift with the ISO speed are determined by **[Auto range]** (📖 134). However, if the manually set ISO speed exceeds the **[Auto range]**, the safety shift will take effect up or down to the manually set ISO speed.
- Safety shift will take effect as necessary even when flash is used.

C.Fn I-7: AE lock metering mode after focus

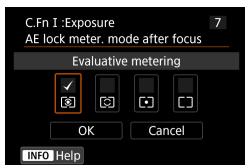

For each metering mode, you can specify whether to lock the exposure (AE lock) once subjects are in focus with One-Shot AF. The exposure will be locked while you keep pressing the shutter button halfway. Select metering modes for AE lock and add a checkmark [✓]. Select **[OK]** to register the setting.

C.Fn II: Autofocus

C.Fn II-1: Tracking sensitivity

You can set the subject-tracking sensitivity, which affects responsiveness to interfering objects that move across AF points or subjects that stray from AF points during Servo AF.

- 0
Standard setting. Suitable for moving subjects in general.
- Locked on: -2 / Locked on: -1
The camera will try to continue focusing on the subject even if an obstacle cuts across the AF points or if the subject strays from the AF points. The -2 setting makes the camera keep tracking the target subject longer than the -1 setting.
However, if the camera focuses on a wrong subject, it may take slightly longer to switch and focus on the target subject.
- Responsive: +2 / Responsive: +1
The camera can focus consecutively on subjects at different distances that are covered by the AF points. Also effective when you want to always focus on the closest subject. The +2 setting is more responsive than the +1 setting when focusing on the next subject.
However, the camera will be more prone to focus on an unintended subject.

C.Fn II-2: Acceleration/deceleration tracking

Sets the Servo AF tracking sensitivity for subjects that change speed suddenly, as by suddenly moving or stopping.

- 0

Suited for subjects that move at a steady speed (minor changes in moving speed).

- -2 / -1



Suited for subjects that move at a steady speed (minor changes in moving speed). Effective when a setting of 0 makes focus unstable, due to slight subject movement or an obstruction in front of the subject.

- +2 / +1

Effective for subjects having sudden movements, sudden acceleration/deceleration, or sudden stops. Even if the moving subject's speed suddenly changes dramatically, the camera continues to focus on the target subject. For example, the camera is less likely to focus behind a subject that suddenly starts approaching you, or in front of an approaching subject that suddenly stops moving. Setting +2 can track dramatic changes in the moving subject's speed better than with +1. However, since the camera will be sensitive to even slight movements of the subject, focusing may become unstable for short periods.

C.Fn II-3: AF point auto switching

This sets the switching sensitivity of the AF points as they track the subject moving dramatically up, down, left, or right.

Takes effect when [: **AF method**] is set to [ **+Tracking**], [**Expand AF area: **], [**Expand AF area: Around**], or [**Zone AF**].

- 0

Standard setting for gradual AF point switching.

- +2 / +1

Even if the target subject moves dramatically up, down, left, or right and moves away from the AF point, the camera switches its focus to neighboring AF points to continue focusing on the subject. The camera switches to the AF point deemed most likely to focus on the subject based on the subject's continual movement, contrast, etc. Setting +2 makes the camera more prone to switch the AF point than with +1. However, with a wide-angle lens having a wide depth of field or if the subject is too small in the frame, the camera may focus with an unintended AF point.

C.Fn II-4: Lens drive when AF impossible

You can specify lens operation in cases when the camera cannot autofocus on a subject.

- 0: Continue focus search

If focus cannot be achieved with autofocus, the lens is driven to search for the precise focus.

- 1: Stop focus search

If autofocus starts and the focus is far off or if focus cannot be achieved, the lens drive will not be performed. This prevents the lens from becoming grossly out of focus due to the focus search drive.



- **[1: Stop focus search]** is recommended for super telephoto lenses or other lens that cover a large area, to avoid significant delay from focus search drive if the lens becomes greatly out of focus.

C.Fn II-5: Limit AF methods

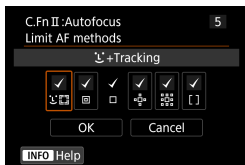

You can limit the AF methods available to those that you will use.

For details on AF methods, see 188–
 190.

Add a checkmark **[✓]** to the AF methods to make available. Select **[OK]** to register the setting.



- The **[✓]** mark cannot be removed from **[1-point AF]**.

C.Fn II-6: Orientation linked AF point

You can assign AF points or Zone AF frames to different positions based on whether you are shooting vertically or horizontally.

- 0: Same for both vertic./horiz.

AF points or Zone AF frames in the same position are used for both vertical and horizontal shooting.

- 1: Separate AF pts: pt only

Separate AF point or Zone AF frame positions can be assigned for each camera orientation (1. Horizontal, 2. Vertical with the camera grip above, 3. Vertical with the camera grip below). Useful when switching to AF points or Zone AF frames in other positions automatically based on camera orientation.

AF points or Zone AF frames assigned to each of the three camera orientations are retained.

C.Fn II-7: Initial Servo AF pt for

You can set the initial AF point for Servo AF when the AF method is set to **[+Tracking]**.



- 0: Automatic

The initial AF point of Servo AF for **[+Tracking]** is set automatically to suit the shooting conditions.

- 1: Initial AF pt set for 

Servo AF starts from the manually set AF point when AF operation is set to **[Servo AF]** and the AF method is set to **[+Tracking]**.





- 2: AF pt set for   

If you switch from Spot AF, 1-point AF, Expand AF area : , or Expand AF area: Around to **[+Tracking]**, Servo AF starts from the manually set AF point. Useful for starting Servo AF from the AF point set before switching to **[+Tracking]**.

C.Fn III: Operation/Others

C.Fn III-1: Dial direction during Tv/Av

Dial turning direction when setting the shutter speed and aperture can be reversed.

In the <M> shooting mode, the turning direction of the < > and < > dials will be reversed. In other shooting modes, the turning direction of only the < > dial will be reversed. The direction of the < > dial in <M> mode matches the direction to set exposure compensation in <P>, <Tv>, and <Av> modes.

- 0: Normal
- 1: Reverse direction

C.Fn III-2: Control ring rotation

RF lens and mount adapter control ring turning direction when setting the shutter speed and aperture can be reversed.

- 0: Normal
- 1: Reverse direction

C.Fn III-3: Focus ring rotation

RF lens focusing ring turning direction can be reversed.

- 0: Normal
- 1: Reverse direction

C.Fn III-4: RF lens MF focus ring sensitivity

RF lens focusing ring sensitivity can be set.

- 0: Varies with rotation speed
- 1: Linked to rotation degree

C.Fn III-5: Customize buttons

You can assign frequently used functions to buttons, such as $\langle \text{AF} \rangle$ or $\langle \text{AF ON} \rangle$. Different functions, for use when shooting still photos or movies, can be assigned to the same button.

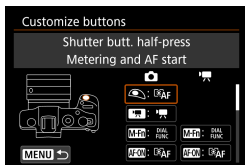























1 Select a part of the bar.

















2 Select a function to assign.

- Press $\langle \text{SET} \rangle$ to set it.

Functions Available for Buttons



		Function			M-Fn
AF	 AF	Metering and AF start	<input type="radio"/>	<input type="radio"/>	<input type="radio"/>
	AF-OFF	AF stop	<input type="checkbox"/>	<input type="radio"/>	<input type="radio"/>
		AF point selection	<input type="checkbox"/>	<input type="radio"/>	<input type="radio"/>
		Direct AF point selection	<input type="checkbox"/>	<input type="checkbox"/>	<input type="checkbox"/>
		Set AF point to center	<input type="checkbox"/>	<input type="radio"/>	<input type="radio"/>
	 ONE SHOT SERVO	One-Shot AF ↔ Servo AF* ¹	<input type="checkbox"/>	<input type="radio"/>	<input type="radio"/>
		Touch & drag AF	<input type="checkbox"/>	<input type="radio"/>	<input type="radio"/>
	Eye Detection AF* ¹	<input type="checkbox"/>	<input type="radio"/>	<input type="radio"/>	
Exposure		Metering start	<input type="radio"/>	<input type="checkbox"/>	<input type="checkbox"/>
		AE lock	<input type="checkbox"/>	<input type="radio"/>	<input type="radio"/>
		AE lock (hold)	<input type="checkbox"/>	<input type="radio"/>	<input type="radio"/>
		AE lock (while button pressed)	<input type="radio"/>	<input type="checkbox"/>	<input type="checkbox"/>
	 AEL FEL	AE Lock/FE Lock* ¹	<input type="checkbox"/>	<input type="radio"/>	<input type="radio"/>
		Exposure compensation (hold button, turn )	<input type="checkbox"/>	<input type="checkbox"/>	<input type="checkbox"/>
	 ISO	Set ISO speed (hold button, turn )	<input type="checkbox"/>	<input type="checkbox"/>	<input type="checkbox"/>
	Flash function settings* ¹	<input type="checkbox"/>	<input type="radio"/>	<input type="radio"/>	
 FEL	FE lock* ¹	<input type="checkbox"/>	<input type="radio"/>	<input type="radio"/>	
Movie		Movies	<input type="checkbox"/>	<input type="radio"/>	<input type="radio"/>
	 SERVO AF	Pause Movie Servo AF	<input type="checkbox"/>	<input type="checkbox"/>	<input type="radio"/>

AF-ON	✖	☰	LENS	▲	◀	▶	▼	SET
○	○		○					
○	○		○					
○	○	○	○	○	○	○	○	○
				○	○	○	○	
○	○	○	○	○	○	○	○	○
○	○	○	○	○	○	○	○	○
○	○	○	○	○	○	○	○	○
○	○	○	○	○	○	○	○	○
○	○		○					
○	○		○					
○	○		○					
○	○		○					○
○	○		○					○
○	○	○	○	○	○	○	○	○
○	○		○					
○	○		○					
○	○	○	○	○	○	○	○	○

		Function			M-Fn
Press buttons directly	 DIAL FUNC	Dial function settings		<input type="radio"/>	<input type="radio"/>
		Depth-of-field preview* ¹		<input type="radio"/>	<input type="radio"/>
	AUTO	Reset selected item in Fv mode* ¹		<input type="radio"/>	<input type="radio"/>
	 ALL AUTO	Reset Tv/Av/[Z]/ISO in Fv mode* ¹		<input type="radio"/>	<input type="radio"/>
		Quick Control screen		<input type="radio"/>	<input type="radio"/>
		Magnify/Reduce		<input type="radio"/>	<input type="radio"/>
Menu	MENU	Menu display		<input type="radio"/>	<input type="radio"/>
		Image quality* ¹		<input type="radio"/>	<input type="radio"/>
		Picture Style		<input type="radio"/>	<input type="radio"/>
		Select folder		<input type="radio"/>	<input type="radio"/>
		Create folder		<input type="radio"/>	<input type="radio"/>
		Maximize screen brightness (temporary)		<input type="radio"/>	<input type="radio"/>
		Display off		<input type="radio"/>	<input type="radio"/>
		Switch between viewfinder/screen		<input type="radio"/>	<input type="radio"/>
	ECO	Eco mode		<input type="radio"/>	<input type="radio"/>
		Wi-Fi function		<input type="radio"/>	<input type="radio"/>
	OFF	No function (disabled)		<input type="radio"/>	<input type="radio"/>

*1: Cannot be assigned as a function available when recording movies.

C.Fn III-6: Customize dials

You can assign frequently used functions to dials, such as , , or .

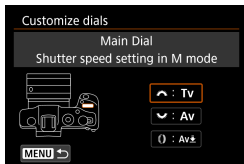



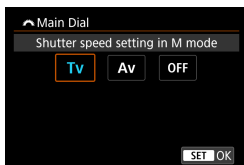





1 Select a part of the bar.



2 Select a function to assign.
● Press <SET> to set it.

Functions Available for Dials

	Function			0
Tv	Shutter speed setting in M mode	<input type="radio"/>	<input type="radio"/>	
Av	Aperture setting in M mode	<input type="radio"/>	<input type="radio"/>	
Av 	Change aperture (hold metering button)			<input type="radio"/>
Tv 	Change shutter speed (hold metering button)			<input type="radio"/>
ISO 	Set ISO speed (hold metering button)			<input type="radio"/>
 	Exposure compensation (hold metering button)			<input type="radio"/>
Av	Change aperture value			<input type="radio"/>
Tv	Change shutter speed			<input type="radio"/>
ISO	Set ISO Speed			<input type="radio"/>
	Exposure compensation			<input type="radio"/>
OFF	No function (disabled)	<input type="radio"/>	<input type="radio"/>	<input type="radio"/>



● <0>: Control ring on RF lenses and mount adapters

C.Fn III-7: Release shutter without lens

You can specify whether shooting still photos or movies is possible without a lens attached to the camera.

- 0: Disable
- 1: Enable

C.Fn III-8: Retract lens on power off

You can set whether to retract gear-type STM lenses (such as EF40mm f/2.8 STM) automatically when the camera's power switch is set to <OFF>.

- 0: Enable
- 1: Disable



- With auto power off, the lens will not retract regardless of the setting.
- Before detaching the lens, make sure that it is retracted.



- When [**0: Enable**] is set, this function takes effect regardless of the lens's focus mode switch setting (AF or MF).

C.Fn III-9: Audio compression

Sets audio compression for movie recording. **[1: Disable]** allows higher audio quality than when audio is compressed, but file sizes are larger.

- 0: Enable
- 1: Disable



- Editing movie files recorded with **[1: Disable]** and then saving them with compression will also compress the audio.
- Audio is compressed even if **[1: Disable]** is selected when **[Movie rec. size]** is set to $\overline{\text{FHD}} \overline{29.97\text{P}} \overline{\text{IPB}} \overline{\text{+}}$ (NTSC) or $\overline{\text{FHD}} \overline{25.00\text{P}} \overline{\text{IPB}} \overline{\text{+}}$ (PAL).
- Audio for video snapshots is compressed even when **[1: Disable]** is selected.

Clearing Custom Function Settings

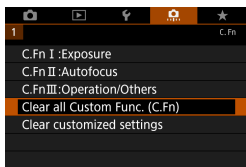

● Clearing all Custom Function settings

By selecting [**⚙️** : **Clear all Custom Func. (C.Fn)**], you can clear all Custom Function settings other than [**Customize buttons**] and [**Customize dials**] settings.

● Clearing [**Customize buttons**] and [**Customize dials**] settings

By selecting [**⚙️** : **Clear customized settings**], you can clear [**Customize buttons**] and [**Customize dials**] settings.

Tab Menu: My Menu

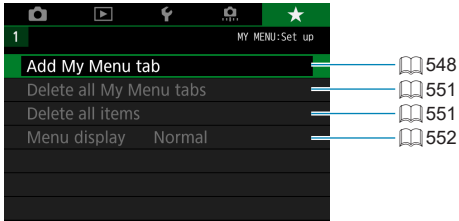

Registering My Menu



Under My Menu tab, you can register menu items and Custom Functions whose settings you change frequently.

Creating and Adding My Menu Tab

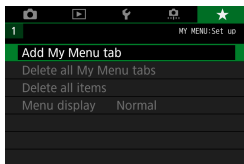

1 Select [Add My Menu tab].

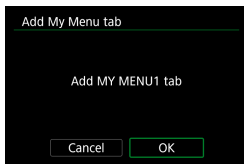

2 Select [OK].

- You can create up to five My Menu tabs by repeating steps 1 and 2.

Registering Menu Items under the My Menu Tab(s)

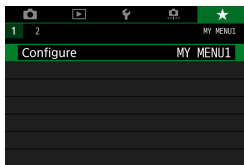

1 Select [MY MENU*: Configure].

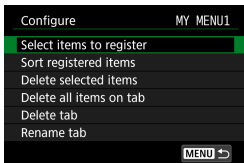

2 Select [Select items to register].

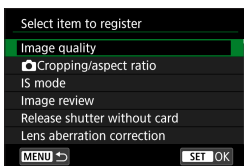

3 Register the desired items.

- Select the item to be set, then press <SET>.
- Select [OK] on the confirmation dialog.
- You can register up to six items.
- To return to the screen in step 2, press the <MENU> button.

My Menu Tab Settings

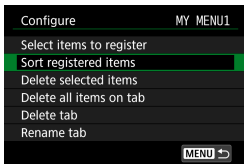

You can sort and delete items under the menu tab, and rename or delete the menu tab.

● Sort registered items

You can change the order of the registered items in My Menu. Select **[Sort registered items]**, select an item to rearrange, then press <SET>. With [\blacktriangle] displayed, use the <▲> <▼> keys to move the item, then press <SET>.

● Delete selected items / Delete all items on tab

You can delete any of the registered items. **[Delete selected items]** deletes one item at a time, and **[Delete all items on tab]** deletes all the registered items under the tab.

● Delete tab

You can delete the current My Menu tab. Select **[Delete tab]** to delete the **[MY MENU*]** tab.

● Rename tab

You can rename the My Menu tab from **[MY MENU*]**.

1 Select **[Rename tab]**.

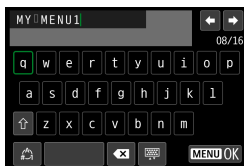

2 Enter text.

- Select **[X]** or press the **<[trash]>** button to delete any unneeded characters.
- Use the **<[cross keys]>** or **<[dial]>** to select a character, then press **<SET>**.
- By selecting **[input mode]**, you can change the input mode.

3 Confirm input.

- Press the **<MENU>** button, then press **[OK]**.

Deleting all My Menu tabs / Deleting all items

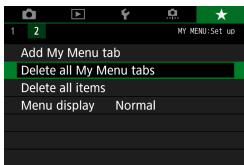

You can delete all the created My Menu tabs or My Menu items registered under them.

● Delete all My Menu tabs

You can delete all My Menu tabs you created. When you select **[Delete all My Menu tabs]**, all the tabs from **[MY MENU1]** to **[MY MENU5]** will be deleted and the **[★]** tab will revert to its default.

● Delete all items

You can delete all the items registered under the **[MY MENU1]** to **[MY MENU5]** tabs. The tab(s) will remain. When **[Delete all items]** is selected, all the items registered under all the created tabs will be deleted.



- If you perform **[Delete tab]** or **[Delete all My Menu tabs]**, tab names renamed with **[Rename tab]** will also be deleted.

Menu Display Settings

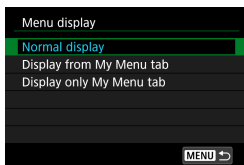

You can select **[Menu display]** to set the menu screen that is to appear first when you press the **<MENU>** button.

- **Normal display**

Displays the last displayed menu screen.

- **Display from My Menu tab**

Displays with the **[★]** tab selected.

- **Display only My Menu tab**

Only the **[★]** tab is displayed. (The **[📷]**, **[▶]**, **[🔍]**, and **[⋮]** tabs will not be displayed.)

Reference

This chapter provides reference information on camera features.

Software Overview

Downloading and Installing the Software

When using EOS software or other dedicated software, use the latest version available. To download it, you will need to enter the serial number on the bottom of the camera.

- Do not connect the camera to a computer before you install the software. The software will not be installed correctly.
- You cannot install the EOS software to a computer without an Internet connection.
- Previous versions cannot display images from this camera correctly. Also, processing RAW images from this camera is not possible.
- Always update any previous version of the software that is installed (by overwriting it with the latest version).

1 Download the software.

- Connect to the Internet from a computer and access the following Canon website.

www.canon.com/icpd

- Select your country or region of residence and download the software.
- Decompress it on the computer.

- **For Windows**

Click the displayed installer file to start the installer.

- **For Macintosh**

A dmg file will be created and displayed. Follow the steps below to startup the installer.

- (1) Double-click the dmg file.
 - ▶ A drive icon and installer file will appear on the desktop.
If the installer file does not appear, double-click the drive icon to display it.
- (2) Double-click the installer file.
 - ▶ The installer starts.

2 Follow the on-screen instructions to install the software.

Downloading the Software Instruction Manuals

Software Instruction Manuals (PDF files) can be downloaded from the Canon website to your computer.

● Software Instruction Manual Download Site

www.canon.com/icpd



- To view the Instruction Manuals (PDF files), an Adobe PDF viewing software such as Adobe Acrobat Reader DC (most recent version recommended) is required.
- Adobe Acrobat Reader DC can be downloaded for free from the Internet.
- Double-click the downloaded Instruction Manual (PDF file) to open it.
- To learn how to use PDF viewing software, refer to the software's Help section.

Importing Images to a Computer

You can use EOS software to import images from the camera to a computer. There are two ways to do this.

Importing by Connecting the Camera to the Computer

1 Install the software (📖 554).

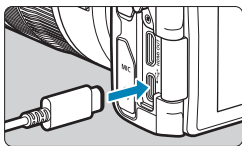

2 Connect the camera to the computer with an interface cable (sold separately).

- Insert the plug into the camera's digital terminal.
- Insert the other end of the cable into the computer's USB terminal.

3 Use EOS Utility to import the images.

- Refer to the EOS Utility Instruction Manual.

! ● With Wi-Fi connection established, the camera cannot communicate with the computer even if they are connected with an interface cable.

Importing Images with a Card Reader

You can use a card reader to import images to a computer.

1 Install the software (📖 554).

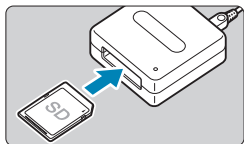

2 Insert the card into the card reader.

3 Use Digital Photo Professional to import the images.

- Refer to the Digital Photo Professional Instruction Manual.



- When importing images from the camera to a computer with a card reader without using EOS software, copy the DCIM folder on the card to the computer.

Charging a Battery in the Camera

Using USB Power Adapter PD-E1 (sold separately), you can charge Battery Pack LP-E17 without removing it from the camera. **Charging stops if you operate the camera.**

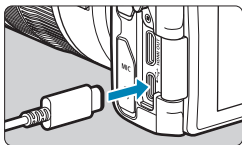

1 Connect the USB power adapter.

- With the camera's power switch set to <OFF>, insert the USB power adapter plug fully into the digital terminal.

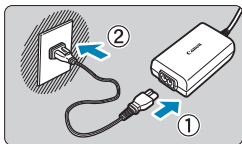

2 Connect the power cord.

- Connect the power cord to the USB power adapter and plug the other end into a power outlet.
- ▶ Charging begins, and the access lamp (1) is lit in green.
- When charging is finished, the access lamp turns off. Unplug the power cord and disconnect the USB power adapter from the camera.

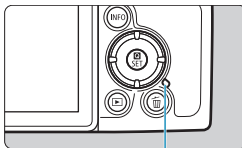

(1)

- ⚠ To protect batteries and keep them in optimal condition, do not charge continuously for more than 24 hours.
- In case of charging problems, the access lamp blinks in green and a protective circuit stops charging. In this case, unplug the power cord, reattach the battery, and wait a few minutes before plugging it in again. If the problem persists, contact your dealer or nearest Canon Service Center.



- If the access lamp does not light up, try unplugging the USB power adapter and plugging it in again.
- The charging time required and the amount charged vary depending on ambient temperature and remaining capacity.
- For safety reasons, recharging in low temperatures (5–10°C / 41–50°F) will take longer.
- Batteries are not charged when the camera is connected via Wi-Fi or when the card slot/battery compartment cover is open.

Using an Extension Grip

Extension Grip EG-E1 (sold separately) is a dedicated accessory that makes EOS RP cameras even easier to hold. The battery and card can be inserted or removed while the extension grip is attached to the camera.

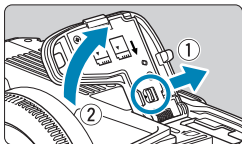

1 Remove the card slot/battery compartment cover.

- Turn the camera off and remove the cover. Be careful not to lose the cover after removal.

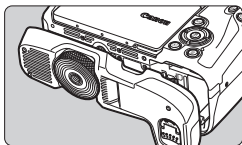

2 Attach the extension grip.

- Attach as shown at left and turn the attach/detach dial to lock in place.

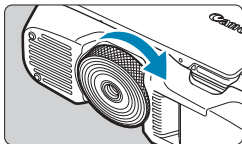

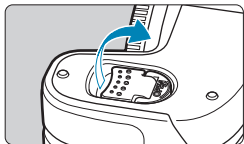

3 Open the extension grip cover.

- For instructions on inserting or removing the battery and card, see “Inserting/Removing the Battery and Card” (📖 42).

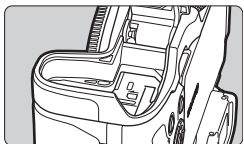
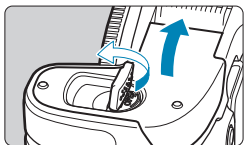

- When reattaching the card slot/battery compartment cover to the camera, attach it opened to at least 90°.

Troubleshooting

If a problem occurs with the camera, first refer to this Troubleshooting Guide. If this Troubleshooting Guide does not resolve the problem, contact your dealer or nearest Canon Service Center.

Power-Related Problems

Batteries cannot be charged with the charger.

- Do not use any battery packs other than a genuine Canon Battery Pack LP-E17.

The charger's lamp blinks at high speed.

- If (1) the battery charger or battery has a problem or (2) communication with the battery failed (with a non-Canon battery pack), the protection circuit will stop charging, and the charge lamp will blink in orange. In the case of (1), unplug the charger's power plug from the power outlet. Detach and reattach the battery to the charger. Wait a few minutes, then reconnect the power plug to the power outlet. If the problem persists, contact your dealer or nearest Canon Service Center.

The charger's lamp does not blink.

- If the internal temperature of the battery attached to the charger is high, the charger will not charge the battery for safety reasons (lamp off). During charging, if the battery's temperature becomes high for any reason, charging will stop automatically (lamp blinks). When the battery temperature goes down, charging will resume automatically.

Batteries cannot be charged with the USB power adapter (sold separately).

- Batteries are not charged while the camera's power switch is set to <ON>.
- Operating the camera will stop charging in progress.

The access lamp blinks during charging with the USB power adapter.

- In case of charging problems, the access lamp blinks in green and a protective circuit stops charging. In this case, unplug the power cord, reattach the battery, and wait a few minutes before plugging it in again. If the problem persists, contact your dealer or nearest Canon Service Center.

The access lamp is not lit during charging with the USB power adapter.

- Try unplugging the USB power adapter and plugging it in again.

The camera is not activated even when the power switch is set to <ON>.

- Make sure the card slot/battery compartment cover is closed (📖 42).
- Make sure the battery is installed properly in the camera (📖 42).
- Charge the battery (📖 40).

The access lamp still lights or blinks even when the power switch is set to <OFF>.

- If the power is turned off while an image is being recorded to the card, the access lamp will remain on or continue to blink for a few seconds. When the image recording is complete, the power will turn off automatically.

[Does this battery/do these batteries display the Canon logo?] is displayed.

- Do not use any battery packs other than a genuine Canon Battery Pack LP-E17.
- Remove and install the battery again (📖 42).
- If the electrical contacts are dirty, use a soft cloth to clean them.

The battery becomes exhausted quickly.

- Use a fully charged battery (📖 40).
- The battery performance may have degraded. See [🔧: Battery info.] to check the battery's recharge performance level (📖 381). If the battery performance is poor, replace the battery with a new one.
- The number of possible shots will decrease with any of the following operations:
 - Pressing the shutter button halfway for a prolonged period.
 - Activating the AF frequently without taking a picture.
 - Using the lens's Image Stabilizer.
 - Using the Wi-Fi/Bluetooth (wireless communication) function.

The camera turns off by itself.

- Auto power off is in effect. To deactivate auto power off, set [Auto power off] under [🔧: Power saving] to [Disable] (📖 372).
- Even if [Auto power off] is set to [Disable], the screen and viewfinder will still turn off after the camera is left idle for the time set in [Display off] and [Viewfinder off], but the camera will remain on.
- Set [🔧: Eco mode] to [Off].

Shooting-Related Problems

The lens cannot be attached.

- To attach EF or EF-S lenses, you will need a mount adapter. The camera cannot be used with EF-M lenses.

No images can be shot or recorded.

- Make sure the card is properly inserted (📖 42).
- Slide the card's write-protect switch to the Write/Erase setting (📖 42).
- If the card is full, replace the card or delete unnecessary images to make space (📖 42, 📖 314).
- Shooting is not possible if the AF point turns orange when you attempt to focus. Press the shutter button halfway again to refocus automatically, or focus manually (📖 54, 📖 214).

The card cannot be used.

- If a card error message is displayed, see 📖 44 or 📖 581.

An error message is displayed when the card is inserted in another camera.

- Since SDXC cards are formatted in exFAT, if you format a card with this camera and then insert it into another camera, an error may be displayed and it may not be possible to use the card.

The image is out of focus or blurred.

- Set the lens's focus mode switch to <AF> (📖 48, 📖 51).
- Press the shutter button gently to prevent camera shake (📖 54).
- With a lens equipped with an Image Stabilizer, set the IS switch to <ON>.
- In low light, the shutter speed may become slow. Use a faster shutter speed (📖 98), set a higher ISO speed (📖 131), use flash (📖 222), or use a tripod.
- See "Minimizing Blurred Photos" on 📖 70.

I cannot lock the focus and recompose the shot.

- Set the AF operation to One-Shot AF. Shooting with the focus locked is not possible with Servo AF (📖 71, 📖 185).

The continuous shooting speed is slow.

- The continuous shooting speed for high-speed continuous shooting may be lower, depending on conditions such as these: battery level, temperature, flicker reduction, shutter speed, aperture, subject conditions, brightness, AF operation, type of lens, use of flash, and shooting settings (📖 208).

The maximum burst during continuous shooting is lower.

- If you shoot a subject that has fine detail such as a field of grass, the file size will be larger, and the actual maximum burst may be lower than the number listed on  583.





Even after I change the card, the maximum burst displayed for continuous shooting does not change.

- The maximum burst displayed does not change when you switch cards, even if you switch to a high-speed card. The maximum burst shown in the table on  583 is based on Canon's testing card. (The faster the card's writing speed, the higher the actual maximum burst will be.) For this reason, the maximum burst displayed may differ from the actual maximum burst.

High-speed display is not available during high-speed continuous shooting.

- Refer to the high-speed display requirements on  181.

Some image quality options are not available with cropped shooting.

-  M/ M/ S1/ S1 image quality options are not available when **[1.6x (crop)]** is set, or with EF-S lenses.

The aspect ratio cannot be set.

- With EF-S lenses, **[1.6x (crop)]** is set automatically, and no other aspect ratios are available.

ISO 100 cannot be set. ISO speed expansion cannot be selected.

- Check the **[ISO speed range]** setting under **[📷: 📷 ISO speed settings]**.
- When **[📷: Highlight tone priority]** is set to **[Enable]** or **[Enhanced]**, the available ISO speed range is ISO 200–40000 for still photo shooting. Even if you set **[ISO speed range]** under **[📷: ISO speed settings]** to expand the setting range, you cannot select L (equivalent to ISO 50), H1 (equivalent to ISO 51200), or H2 (equivalent to ISO 102400). When **[📷: Highlight tone priority]** is set to **[Disable]** (📖 137), you can set ISO 100/125/160, L, or H1/H2.

Even if I set a decreased exposure compensation, the image comes out bright.

- Set **[📷: Auto Lighting Optimizer]** to **[Disable]** (📖 136). When **[Low]**, **[Standard]**, or **[High]** is set, even if you set a decreased exposure compensation or flash exposure compensation, the image may come out bright.

I cannot set the exposure compensation when both manual exposure and ISO Auto are set.

- See 📖 103 to set the exposure compensation.

Not all the lens aberration correction options are displayed.

- Although **[Chromatic aberr corr]** and **[Diffraction correction]** are not displayed when **[Digital Lens Optimizer]** is set to **[Enable]**, both functions are applied in shooting, as when set to **[Enable]**.
- During movie recording, **[Digital Lens Optimizer]** or **[Diffraction correction]** will not be displayed.



Using flash in <Av> or <P> mode lowers the shutter speed.

- Under [: External Speedlite control], set [Slow synchro] to [1/180-1/60sec. auto] or [1/180 sec. (fixed)] ( 224).

The flash does not fire.

- Make sure the flash is securely attached to the camera.

The flash always fires at full output.

- Flash units other than EL/EX series Speedlites used in autoflash mode always fire at full output ( 221).
- When the flash Custom Function setting for [Flash metering mode] is set to [TTL] (autoflash), the flash will always fire at full output ( 230).

Flash exposure compensation cannot be set.

- If flash exposure compensation is already set with the Speedlite, flash exposure compensation cannot be set with the camera. When the external Speedlite's flash exposure compensation is canceled (set to 0), flash exposure compensation can be set with the camera.

High-speed sync cannot be set in <Av> or <P> mode.

- Under [: External Speedlite control], set [Slow synchro] to [1/180-30sec. auto] or [1/180-1/60sec. auto] (📖 224).

Remote control shooting is not possible.

- When taking still photos, set the drive mode to <📷> or <📷📷> (📖 209). When recording movies, set [: Remote control] to [Enable] (📖 285).
- Check the position of the remote control's release timing switch.
- If you are using Wireless Remote Control BR-E1, see 📖 217 or 📖 399.
- To use a remote control for time-lapse movie recording, see 📖 273.

A white or red icon is displayed during shooting.

- It indicates that the camera's internal temperature is high. Image quality of still photos may be worse when a white <🌡️> icon is displayed. If a red <🌡️> icon is displayed, it indicates that shooting will soon stop automatically (📖 291).



During movie recording, the red icon is displayed.

- It indicates that the camera's internal temperature is high. If the red <🌡️> icon is displayed, it indicates that the movie recording will soon stop automatically (📖 291).







Movie recording stops by itself.

- If the card's writing speed is slow, movie recording may stop automatically. For cards that can record movies, see  585. To find out the card's writing speed, refer to the card manufacturer's website, etc.
- If you shoot a movie for 29 min. 59 sec., the movie recording will stop automatically.

The ISO speed cannot be set for movie recording.

- In shooting modes other than [M], the ISO speed is set automatically. In [M] mode, you can manually set the ISO speed ( 589).

ISO 100 cannot be set or ISO speed expansion cannot be selected during movie recording.

- Check the [**ISO speed range**] and [**Range for 4K**] setting under [: ISO speed settings].
- When [: **Highlight tone priority**] is set to [**Enable**], the available ISO speed range starts at ISO 200. Expanded ISO speed cannot be selected even if you set an expanded range for [**ISO speed range**] or [**Range for 4K**] under [: ISO speed settings]. When [: **Highlight tone priority**] is set to [**Disable**] ( 137), you can set ISO 100/125/160 or an expanded ISO speed.

The exposure changes during movie recording.

- If you change the shutter speed or aperture during movie recording, the changes in the exposure may be recorded.
- Shooting a few test movies is recommended if you intend to perform zooming during movie recording. Zooming as you record movies may cause exposure changes or lens sounds to be recorded, an uneven audio level, or loss of focus.

The image flickers or horizontal stripes appear during movie recording.

- Flickering, horizontal stripes (noise), or irregular exposures can be caused by fluorescent lighting, LED lighting, or other light sources during movie recording. Also, changes in the exposure (brightness) or color tone may be recorded. In [M] mode, a slow shutter speed may reduce the problem. The problem may be more noticeable in time-lapse movie recording.

The subject looks distorted during movie recording.

- If you move the camera to the left or right (panning) or shoot a moving subject, the image may look distorted. The problem may be more noticeable in time-lapse movie recording.

I cannot take still photos during movie recording.

- Still photos cannot be taken during movie recording. Before taking still photos, stop recording the movie, then select a shooting mode for still photos.

Problems with Wireless Features

Cannot pair with a smartphone.

- Use a smartphone compliant with Bluetooth Specification Version 4.1 or later.
- Turn on Bluetooth from the smartphone settings screen.
- Pairing with the camera is not possible from the smartphone's Bluetooth settings screen. Install the dedicated app Camera Connect (free of charge) on the smartphone (📖 420).
- A previously paired smartphone cannot be paired with the camera again if the camera's registration is retained on the smartphone. In this case, remove the camera's registration retained in the Bluetooth settings on the smartphone and try pairing again (📖 432).

Wi-Fi function cannot be set.

- If the camera is connected to a computer or another device with an interface cable, Wi-Fi functions cannot be set. Disconnect the interface cable before setting any functions (📖 418).

A device connected with an interface cable cannot be used.

- Other devices, such as computers, cannot be used with the camera by connecting them with an interface cable while the camera is connected to devices via Wi-Fi. Terminate the Wi-Fi connection before connecting the interface cable.

Operations such as shooting and playback are not possible.

- With a Wi-Fi connection established, operations such as shooting and playback may not be possible. Terminate the Wi-Fi connection, then perform the operation.

Cannot reconnect to a smartphone.

- Even with a combination of the same camera and smartphone, if you have changed the settings or selected a different setting, reconnection may not be established even after selecting the same SSID. In this case, delete the camera connection settings from the Wi-Fi settings on the smartphone and set up a connection again.
- A connection may not be established if Camera Connect is running when you reconfigure connection settings. In this case, quit Camera Connect for a moment and then restart it.

Operation Problems



I cannot change the setting with < >, < >, < >, or < >.

- Use the <LOCK> switch to unlock the controls (📖 58).
- Check the [: Multi function lock] setting (📖 407).

Touch operation is not possible.

- Make sure [: Touch control] is set to [Standard] or [Sensitive] (📖 379).

A camera button or dial does not work as expected.

- For movie recording, check the [: Shutter btn function for movies] setting (📖 395).
- Check [: C.Fn III-5: Customize buttons] and [: C.Fn III-6: Customize dials] settings (📖 537, 📖 542).

Display Problems

The menu screen shows fewer tabs and items.

- In Basic Zone modes, some tabs and items are not displayed. Tabs and items on the menu screen also vary for still photos and movies.

The display starts with [★] My Menu, or the [★] tab alone is displayed.

- [Menu display] on the [★] tab is set to [Display from My Menu tab] or [Display only My Menu tab]. Set [Normal display] (📖 552).

The file name's first character is an underscore (“_”).

- Set [📷: Color space] to [sRGB]. If [Adobe RGB] is set, the first character will be an underscore (📖 147).

The file name starts with “MVI_”.

- It is a movie file.

The file numbering does not start from 0001.

- If the card already contains recorded images, the image number may not start from 0001 (📖 363).

The shooting date and time displayed are incorrect.

- Make sure the correct date and time are set (📖 374).
- Check the time zone and daylight saving time (📖 374).

The date and time are not in the image.

- The shooting date and time do not appear in the image. The date and time are recorded in the image data as shooting information. When printing, you can imprint the date and time in the picture, using the date and time recorded in the shooting information (📖 318).

[###] is displayed.

- If the number of images recorded on the card exceeds the number the camera can display, [###] will be displayed.

The screen does not display a clear image.

- If the screen is dirty, use a soft cloth to clean it.
- The screen display may seem slightly slow in low temperatures or may look black in high temperatures. It will return to normal at room temperature.

Playback Problems

Part of the image blinks in black.

- [▶]: **Highlight alert** is set to **[Enable]** (📖 351).

A red box is displayed on the image.

- [▶]: **AF point disp.** is set to **[Enable]** (📖 352).

During image playback, the AF points are not displayed.

- The AF points are not displayed when the following types of images are played back:
 - Images captured in <SCN: 📷> or <SCN: 📷> mode.
 - Images taken with Multi Shot Noise Reduction applied.
 - Cropped images.
 - Images captured with **[Auto Image Align]** set to **[Enable]** in HDR shooting.

The image cannot be erased.

- If the image is protected, it cannot be erased (📖 310).

Still photos and movies cannot be played back.

- The camera may not be able to play back images taken with another camera.
- Movies edited with a computer cannot be played back with the camera.

Only few images can be played back.

- The images have been filtered for playback with [▶]: **Set image search conditions** (📖 345). Clear the image search conditions.

Operation sound and mechanical sound can be heard during movie playback.

- If you operate the camera's dials or lens during movie recording, the operation sound will also be recorded. Using the Directional Stereo Microphone DM-E1 (sold separately) is recommended (📖 258).

The movie appears to freeze momentarily.

- If there is a drastic change in the exposure level during autoexposure movie recording, the recording will stop momentarily until the brightness stabilizes. In this case, shoot in the [M] mode (📖 241).

No picture appears on the television.

- Make sure [📺: Video system] is set to [For NTSC] or [For PAL] correctly for the video system of your television (📖 378).
- Make sure the HDMI cable's plug is inserted all the way in (📖 308).

There are multiple movie files for a single movie recording.

- If the movie file size reaches 4 GB, another movie file will be created automatically (📖 254). However, if you use an SDXC card formatted with the camera, you can record a movie in a single file even if it exceeds 4 GB.

My card reader does not recognize the card.

- Depending on the card reader used and the computer's operating system, SDXC cards may not be correctly recognized. In this case, connect your camera to the computer with the interface cable, then import the images to the computer using EOS Utility (EOS software).

The image cannot be resized.

- With this camera, you cannot resize JPEG **S2** and RAW images (📖 339).

The image cannot be cropped.



- With this camera, you cannot crop RAW images (📖 337).

Dots of light appear on the image.



- White, red, or blue dots of light may appear in captured images or on the shooting screen if the sensor is affected by cosmic rays or similar factors. Their appearance may be reduced by performing [**Clean now** ] under [**☛: Sensor cleaning**] (📖 382).

Sensor Cleaning Problems

The shutter makes a sound during sensor cleaning.

- Under [**☛ : Sensor cleaning**], when you select [**Clean now** ], the shutter will make a mechanical sound during the cleaning, but no picture will be recorded to the card ( 382).

Automatic sensor cleaning does not work.

- If you repeatedly turn the power switch <ON> and <OFF> within a short time period, the < > icon may not be displayed ( 46).

Computer Connection Problems

I cannot import images to a computer.

- Install EOS Utility (EOS software) in the computer ( 554).
- If the camera is already connected via Wi-Fi, it cannot communicate with any computer connected with an interface cable.

Communication between the connected camera and computer does not work.

- When using EOS Utility (EOS software), set [**📷 : Time-lapse movie**] to [**Disable**] ( 262).

Error Codes

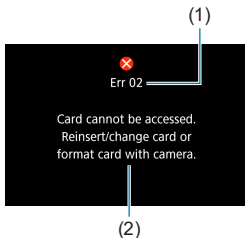

If there is a problem with the camera, an error message will appear. Follow the on-screen instructions.

- (1) Error number
- (2) Cause and countermeasures

Number	Error Message and Solution
01	Communication between the devices is faulty. Check the camera, lens, or mount adapter contacts.
	Clean the electrical contacts on the camera, lens, and mount adapter, use a genuine Canon lens, or reinsert the battery (📖 30, 📖 42).
02	Card cannot be accessed. Reinsert/change card or format card with camera.
	Remove and insert the card again, replace the card, or format the card (📖 42, 📖 367).
04	Cannot save images because card is full. Replace card.
	Replace the card, erase unnecessary images, or format the card (📖 42, 📖 314, 📖 367).
06	Sensor cleaning could not be performed. Turn the camera off and on again.
	Operate the power switch (📖 46).
07, 10 20, 30 40, 50 60, 70 80	An error prevented shooting. Turn the camera off and on again or re-install the battery.
	Operate the power switch, remove and install the battery again, or use a Canon lens (📖 46, 📖 42).

* If the error message still persists after following the above instructions, write down the error code number and contact your nearest Canon Service Center.

Performance Data

Still Photo Shooting

● Number of Possible Shots

(Approx. number of shots)

Temperature	Room Temperature (23°C / 73°F)	Low Temperature (0°C / 32°F)
Possible shots	250	240

- Based on using the screen and a fully charged Battery Pack LP-E17, and following CIPA (Camera & Imaging Products Association) testing standards.

● ISO Auto Range

Shooting Mode	ISO Speed	
	No Flash	With Flash
Fv/P/Tv/Av/M	ISO 100–40000*	ISO 100–1600*
B	ISO 400*	ISO 400*

* The actual ISO speed range depends on the **[Minimum]** and **[Maximum]** set with **[Auto range]**.

- In Basic Zone modes, ISO speed is set automatically.

● Guide to Image Quality Settings

(Approx.)

Image Quality	Pixels Recorded	File Size (MB)	Possible Shots	Maximum Burst	
				Standard	High Speed
JPEG					
L	26M	9.1	3320	Full	Full
L		4.9	6060	Full	Full
M	12M	5.1	5820	Full	Full
M		2.9	10280	Full	Full
S1	6.5M	3.4	8750	Full	Full
S1		2.0	14620	Full	Full
S2	3.8M	1.9	15760	Full	Full
RAW					
RAW	26M	29.1	1040	50	Full
RAW	26M	17.1	1780	130	Full
RAW+JPEG					
RAW L	26M 26M	29.1+9.1	790	42	98
RAW L	26M 26M	17.1+9.1	1160	66	170

- The number of possible shots is based on Canon's testing standards and an 32 GB card.
- Maximum burst measured under conditions and with an SD card conforming to Canon testing standards (32 GB standard/UHS-II card, High-speed continuous shooting, Full-frame still photo cropping/aspect ratio, ISO 100, Standard Picture Style).
- **The file size, number of possible shots, and maximum burst will vary depending on the subject, card brand, still photo cropping/aspect ratio, ISO speed, Picture Style, Custom Functions, and other settings.**
- "Full" indicates that shooting is possible until the card becomes full with the listed conditions.



- Even if you use a high-speed SD card, maximum burst indicator will not change. The maximum burst in the table will apply instead.

● Pixel Count When Still Photo Cropping/Aspect Ratio is Set

(Approx. pixels)

Image Quality	Full-frame (3:2)	1.6x (crop)
L / RAW / CRAW	6240×4160 (Approx. 26.0 megapixels)	3888×2592 (Approx. 10.1 megapixels)
M	4160×2768* (Approx. 11.5 megapixels)	—
S1	3120×2080 (Approx. 6.5 megapixels)	—
S2	2400×1600 (Approx. 3.8 megapixels)	2400×1600 (Approx. 3.8 megapixels)

Image Quality	1:1 (aspect ratio)	4:3 (aspect ratio)	16:9 (aspect ratio)
L / RAW / CRAW	4160×4160 (Approx. 17.3 megapixels)	5536×4160* (Approx. 23.0 megapixels)	6240×3504* (Approx. 21.9 megapixels)
M	2768×2768 (Approx. 7.7 megapixels)	3680×2768* (Approx. 10.2 megapixels)	4160×2336* (Approx. 9.7 megapixels)
S1	2080×2080 (Approx. 4.3 megapixels)	2768×2080* (Approx. 5.8 megapixels)	3120×1752* (Approx. 5.5 megapixels)
S2	1600×1600 (Approx. 2.6 megapixels)	2112×1600* (Approx. 3.4 megapixels)	2400×1344* (Approx. 3.2 megapixels)



- The actual aspect ratio of images in the sizes marked with an asterisk "*" will differ from the aspect ratio indicated.
- For details on JPEG file sizes, see the values for full-frame recording on 583. Under equivalent shooting conditions, file sizes will be smaller than when **Cropping/aspect ratio** is set to **[Full-frame]**.

Movie Recording

● Cards that Can Record Movies

Movie Recording Size			SD Card
4K	23.98P 25.00P	IPB	UHS-I, UHS Speed Class 3 or higher
FHD	59.94P 50.00P	IPB	SD Speed Class 10 or higher
	29.97P 25.00P	IPB	
	HDR movie		SD Speed Class 4 or higher
	29.97P 25.00P	IPB	
HD	59.94P 50.00P	IPB	
	29.97P 25.00P		

- When movie cropping and Movie digital IS are disabled.
- This table indicates the card's writing and reading speeds required for recording movies (card performance requirements). However, card performance requirements for 4K/Full HD time-lapse movies apply to reading speed.

● Total Movie Recording Time and File Size Per Minute

(Approx.)

Movie Recording Size				Total Possible Recording Time on Card			File Size
				8 GB	32 GB	128 GB	
4K	23.98P	25.00P	IPB	8 min.	35 min.	2 hr. 20 min.	869 MB/min.
	59.94P	50.00P	IPB	17 min.	1 hr. 09 min.	4 hr. 37 min.	440 MB/min.
FHD	29.97P	25.00P	IPB	33 min.	2 hr. 15 min.	9 hr. 01 min.	225 MB/min.
	HDR movie						
	29.97P	25.00P	IPB	1 hr. 26 min.	5 hr. 47 min.	23 hr. 11 min.	87 MB/min.
HD	59.94P	50.00P	IPB	38 min.	2 hr. 34 min.	10 hr. 19 min.	196 MB/min.
	29.97P	25.00P	IPB	1 hr. 13 min.	4 hr. 53 min.	19 hr. 34 min.	103 MB/min.

- When movie cropping and Movie digital IS are disabled.



- An increase of the camera's internal temperature may cause movie recording to stop before the total recording time shown in the table (📖 291).

● Total Possible Time for Movie Recording

(Approx.)

Temperature	Room Temperature (23°C / 73°F)	Low Temperature (0°C / 32°F)
Possible recording time	1 hr. 40 min.	1 hr. 30 min.

- With a fully charged Battery Pack LP-E17.
- With [📷: Movie rec. size] set to FHD 29.97P IPB (NTSC)/FHD 25.00P IPB (PAL) and [📷: Movie Servo AF] set to [Enable].

● Total Possible Time for Time-lapse Movie Recording

(Approx.)

Time-lapse Movie Recording		Room Temperature (23°C / 73°F)	Low Temperature (0°C / 32°F)
Interval	Screen Auto Off		
2 sec.	Disable	Approx. 2 hr. 40 min.	Approx. 2 hr. 30 min.
	Enable	Approx. 2 hr. 50 min.	Approx. 2 hr. 40 min.
10 sec.	Disable	Approx. 2 hr. 20 min.	Approx. 2 hr. 10 min.
	Enable	Approx. 4 hr. 40 min.	Approx. 4 hr. 30 min.

- With a fully charged Battery Pack LP-E17.
- The possible movie recording time varies depending on the shooting conditions.

ISO Speed in Movie Recording

In [📷] Mode

- For Full HD/HD movies, ISO speed is automatically set in a range of ISO 100–25600.
- For 4K movies, ISO speed is automatically set in a range of ISO 100–12800.
- Under [📷: 📷 ISO speed settings], setting [Max for Auto] or [4K Max for Auto] to [H2(102400)] (📖 286) expands the maximum limit of the automatic ISO speed setting range to H2 (equivalent to ISO 102400). You can lower the maximum value to narrow the automatic ISO speed setting range.
- With [📷: Highlight tone priority] set to [Enable] (📖 137), the automatic ISO speed setting range is ISO 200–25600 for Full HD/HD movies and ISO 200–12800 for 4K movies.

In [M] Mode

- For Full HD/HD movies with ISO speed set to **[AUTO]**, ISO speed is automatically set in a range of ISO 100–25600.
- For 4K movies with ISO speed set to **[AUTO]**, ISO speed is automatically set in a range of ISO 100–12800.
- When setting ISO Auto, setting **[Max for Auto]** or **[4K Max for Auto]** under **[CAMERA: ISO speed settings]** to **[H2(102400)]** (📖 286) expands the maximum limit of the automatic ISO speed setting range to H2 (equivalent to ISO 102400). You can lower the maximum value to narrow the automatic ISO speed setting range.
- You can set the ISO speed manually in a range of ISO 100–25600 for Full HD/HD movies and ISO 100–12800 for 4K movies. Note that under **[CAMERA: ISO speed settings]**, setting **[ISO speed range]** or **[Range for 4K]** to **[H2(102400)]** (📖 286) expands the maximum limit of the manual ISO speed setting range to H2 (equivalent to ISO 102400). Note that you can also set the **[Maximum]** and **[Minimum]** to a range narrower than the default range.
- If **[CAMERA: Highlight tone priority]** is set to **[Enable]** (📖 137), the automatic and manual ISO speed setting range's minimum limit will be ISO 200. Even when ISO speed expansion is set, the maximum limit will not be expanded.

Image Playback

● Resize Options by Original Image Quality

Original Image Quality	Available Resize Settings		
	M	S1	S2
L*	○	○	○
M		○	○
S1			○

* Only S2 is available for images shot with [📷: 📷 Cropping/aspect ratio] set to [1.6x (crop)].

● Size for Resized Images

(Approx. pixels)

Image Quality	Full-frame (3:2)	1.6x (crop)
M	4160×2768* (Approx. 11.5 megapixels)	–
S1	3120×2080 (Approx. 6.5 megapixels)	–
S2	2400×1600 (Approx. 3.8 megapixels)	2400×1600 (Approx. 3.8 megapixels)

Image Quality	1:1 (aspect ratio)	4:3 (aspect ratio)	16:9 (aspect ratio)
M	2768×2768 (Approx. 7.7 megapixels)	3680×2768* (Approx. 10.2 megapixels)	4160×2336* (Approx. 9.7 megapixels)
S1	2080×2080 (Approx. 4.3 megapixels)	2768×2080* (Approx. 5.8 megapixels)	3120×1752* (Approx. 5.5 megapixels)
S2	1600×1600 (Approx. 2.6 megapixels)	2112×1600* (Approx. 3.4 megapixels)	2400×1344* (Approx. 3.2 megapixels)



- The actual aspect ratio of images in the sizes marked with an asterisk "*" will differ from the aspect ratio indicated.
- The image may be cropped slightly depending on the resizing conditions.

Information Display

Still Photo Shooting Screen

Each time you press the <INFO> button, the information display will change.

- Viewfinder display positions vary for some items.
- The display will show only the settings currently applied.

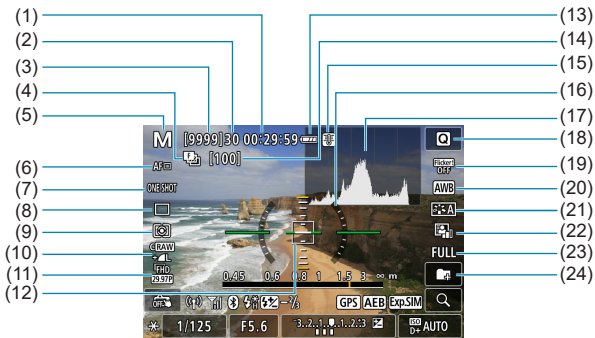

- (1) Movie recording mode available
- (2) Maximum burst
- (3) Possible shots/Sec. until self-timer shoots
- (4) Focus bracketing/HDR/Multiple exposures/Multi Shot Noise Reduction/Bulb timer/Interval timer
- (5) Shooting mode/Scene icon
- (6) AF method
- (7) AF operation
- (8) Drive mode
- (9) Metering mode
- (10) Image quality
- (11) Movie recording size
- (12) AF point (1-point AF)

- (13) Battery level
- (14) No. of shots left for focus bracketing/multiple exposures/interval timer
- (15) Temperature warning
- (16) Electronic level
- (17) Histogram
- (18) Quick Control button
- (19) Anti-flicker shooting
- (20) White balance/White balance correction
- (21) Picture Style
- (22) Auto Lighting Optimizer
- (23) Still photo cropping/aspect ratio
- (24) Create folder

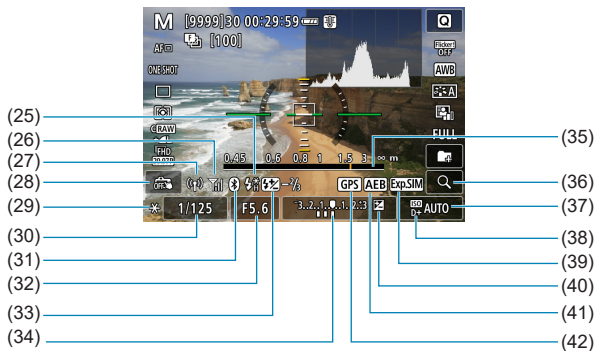

(25) Flash ready/FE Lock/High-speed sync

(26) Wi-Fi signal strength

(27) Wi-Fi function

(28) Touch Shutter

(29) AE lock

(30) Shutter speed/Multi-function lock warning

(31) Bluetooth function

(32) Aperture

(33) Flash exposure compensation

(34) Exposure level indicator

(35) Focus distance display

(36) Magnify button

(37) ISO speed

(38) Highlight tone priority

(39) Exposure simulation

(40) Exposure compensation

(41) AEB/FEB

(42) GPS acquisition status

- You can set what is displayed for when you press the <INFO> button (📖 388).
- The electronic level is not displayed when the AF method is set to **[L+Tracking]** or the camera is connected via HDMI to a television.
- Other icons may be displayed temporarily after setting adjustments.

Movie Recording Screen

Each time you press the <INFO> button, the information display will change.

- Viewfinder display positions vary for some items.
- The display will show only the settings currently applied.

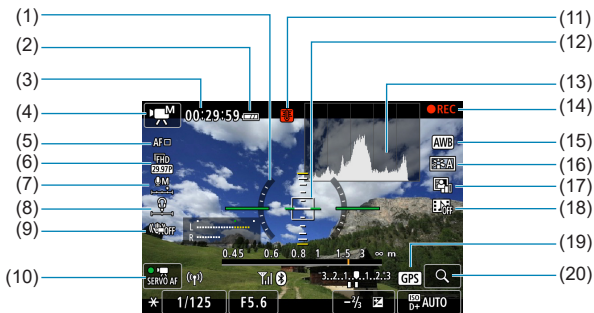

- | | |
|---|--|
| (1) Electronic level | (11) Temperature warning |
| (2) Battery level | (12) AF point (1-point AF) |
| (3) Movie recording time available/
Elapsed recording time | (13) Histogram (for manual exposure) |
| (4) Movie recording mode/Time-lapse
movie/Scene icon | (14) Movie recording in progress |
| (5) AF method | (15) White balance/White balance
correction |
| (6) Movie recording size | (16) Picture Style |
| (7) Sound-recording level (manual) | (17) Auto Lighting Optimizer |
| (8) Headphone volume | (18) Video snapshot |
| (9) Movie digital IS | (19) GPS acquisition status |
| (10) Movie Servo AF | (20) Magnify button |

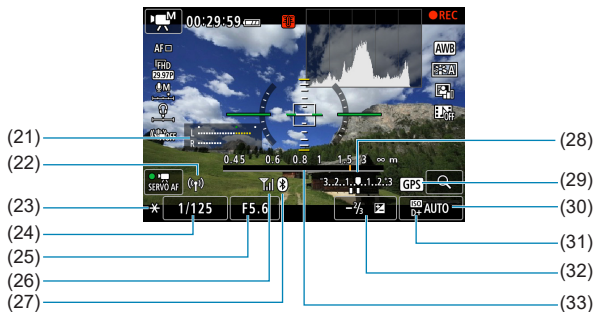

(21) Sound-recording level indicator (manual)

(22) Wi-Fi function

(23) AE lock

(24) Shutter speed

(25) Aperture

(26) Wi-Fi signal strength

(27) Bluetooth function

(28) Exposure level indicator

(29) GPS acquisition status

(30) ISO speed

(31) Highlight tone priority

(32) Exposure compensation

(33) Focus distance display

- You can set what is displayed when you press the <INFO> button (388).
- The electronic level is not displayed when the AF method is set to **[Tracking]** or the camera is connected via HDMI to a television.
- The electronic level, grid lines, or histogram cannot be displayed during movie recording. (The display will disappear when you start recording a movie.)
- When movie recording starts, the movie recording remaining time will change to the elapsed time.

- Other icons may be displayed temporarily after setting adjustments.

Scene Icons

In the <A+> shooting mode, the camera detects the scene type and sets everything automatically to suit the scene. The detected scene type is indicated on the upper left of the screen.

Background \ Subject	Portrait		Non-Portrait			Background Color
		In Motion* ¹	Nature and Outdoor Scene	In Motion* ¹	Close* ²	
Bright						Gray
	Backlit					
Blue Sky Included						Light blue
	Backlit					
Sunset	*3			*3		Orange
Spotlight						Dark blue
Dark						
With Tripod* ¹	*4*5	*3	*4*5	*3		

*1: Not displayed during movie recording.

*2: Displayed when the attached lens has distance information. With an extension tube or close-up lens, the icon displayed may not match the actual scene.

*3: The icon of the scene selected from the detectable scenes will be displayed.



- For certain scenes or shooting conditions, the icon displayed may not match the actual scene.

- *4: Displayed when all the following conditions apply:
The shooting scene is dark, it is a night scene, and the camera is mounted on a tripod.
- *5: Displayed with any of the lenses below:
 - EF300mm f/2.8L IS II USM
 - EF400mm f/2.8L IS II USM
 - EF500mm f/4L IS II USM
 - EF600mm f/4L IS II USM
 - Image Stabilizer lenses released in and after 2012.
- *4+*5: If the conditions in both *4 and *5 are met, the shutter speed will slow down.

Playback Screen

● Basic information display for still photos

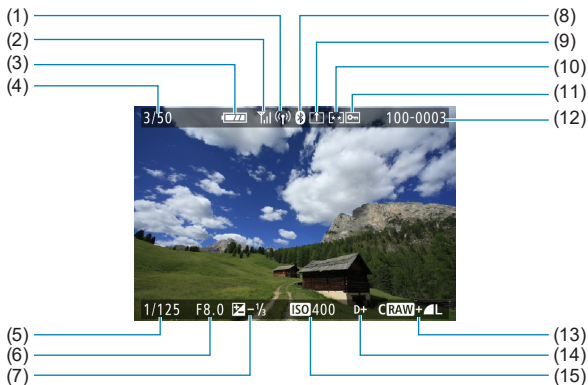

(1)	Wi-Fi function
(2)	Wi-Fi signal strength
(3)	Battery level
(4)	Playback No./Total images/ Number of found images
(5)	Shutter speed
(6)	Aperture
(7)	Exposure compensation amount
(8)	Bluetooth function

(9)	Already sent to a computer/ smartphone
(10)	Rating
(11)	Image protection
(12)	Folder number-File number
(13)	Image quality/Edited image/ Cropping
(14)	Highlight tone priority
(15)	ISO speed



- If the image was taken by another camera, certain shooting information may not be displayed.
- It may not be possible to play back images taken with this camera on other cameras.

● Detailed information display for still photos

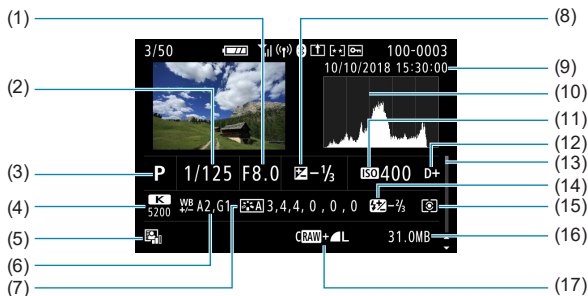

- (1) Aperture
- (2) Shutter speed
- (3) Shooting mode/Multiple exposure
- (4) White balance
- (5) Auto Lighting Optimizer
- (6) White balance correction
- (7) Picture Style/Settings
- (8) Exposure compensation amount
- (9) Shooting date and time
- (10) Histogram (Brightness/RGB)

- (11) ISO speed
- (12) Highlight tone priority
- (13) Scroll bar
- (14) Flash exposure compensation/
Bounce/HDR shooting/Multi Shot
Noise Reduction
- (15) Metering mode
- (16) File size
- (17) Image quality/Edited image/
Cropping

- * When you shoot in RAW+JPEG image quality, the RAW image file size will be displayed.
- * Lines indicating the image area will be displayed for images taken with the aspect ratio set (119) and with RAW or RAW+JPEG set for image quality.
- * During flash photography without flash exposure compensation, <f> will be displayed.
- * <f> will be displayed for images shot with bounce flash photography.
- * An icon for the effect (172) and the dynamic range adjustment amount will be displayed for images shot with HDR shooting.
- * <M> will be displayed for images shot with multiple-exposure shooting.
- * <NR> will be displayed for images shot with Multi Shot Noise Reduction.
- * <[> will be displayed for images created and saved after performing RAW image processing, resizing, cropping, or Creative Assist.
- * <L> will be displayed for images cropped and then saved.

● Detailed information display for movies

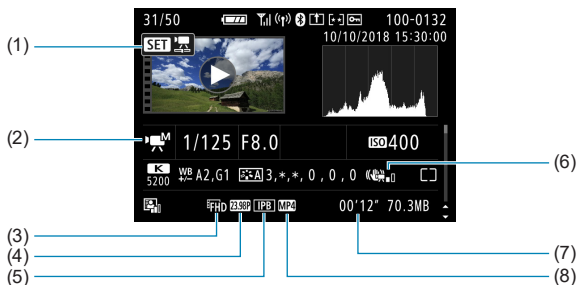

(1) Movie playback

(2) Movie recording mode/Time-lapse movie/Video snapshot

(3) Image size

(4) Frame rate

(5) Compression method

(6) Movie digital IS

(7) Recording time

(8) Movie recording format

* < [] > will be displayed for still photos taken as test shots for time-lapse movies.



- During movie playback, “*,” “*” will be displayed for **[Fineness]** and **[Threshold]** of **[Picture Style]**'s **[Sharpness]**.

Trademarks

- Adobe is a trademark of Adobe Systems Incorporated.
- Microsoft and Windows are trademarks or registered trademarks of Microsoft Corporation in the United States and/or other countries.
- Macintosh and Mac OS are trademarks of Apple Inc., registered in the U.S. and other countries.
- SDXC logo is a trademark of SD-3C, LLC.
- HDMI, HDMI logo, and High-Definition Multimedia Interface are trademarks or registered trademarks of HDMI Licensing LLC.
- The Wi-Fi CERTIFIED logo and the Wi-Fi Protected Setup mark are trademarks of the Wi-Fi Alliance.
- WPS used on camera settings screens and in this manual stands for Wi-Fi Protected Setup.
- The Bluetooth® word mark and logos are registered trademarks owned by Bluetooth SIG, Inc. and any use of such marks by Canon Inc. is under license. Other trademarks and trade names are those of their respective owners.
- All other trademarks are the property of their respective owners.

About MPEG-4 Licensing

"This product is licensed under AT&T patents for the MPEG-4 standard and may be used for encoding MPEG-4 compliant video and/or decoding MPEG-4 compliant video that was encoded only (1) for a personal and non-commercial purpose or (2) by a video provider licensed under the AT&T patents to provide MPEG-4 compliant video. No license is granted or implied for any other use for MPEG-4 standard."

* Notice displayed in English as required.

Third party software

This product includes third party software.

- AES-128 Library

Copyright (c) 1998-2008, Brian Gladman, Worcester, UK. All rights reserved.

LICENSE TERMS

The redistribution and use of this software (with or without changes) is allowed without the payment of fees or royalties provided that:

1. source code distributions include the above copyright notice, this list of conditions and the following disclaimer;
2. binary distributions include the above copyright notice, this list of conditions and the following disclaimer in their documentation;
3. the name of the copyright holder is not used to endorse products built using this software without specific written permission.

DISCLAIMER

This software is provided 'as is' with no explicit or implied warranties in respect of its properties, including, but not limited to, correctness and/or fitness for purpose.

Use of Genuine Canon Accessories Is Recommended

This product is designed to achieve optimum performance when used with genuine Canon accessories. Therefore, using this product with genuine accessories is highly recommended.

Canon shall not be liable for any damage to this product and/or accidents such as malfunction, fire, etc. caused by the failure of non-genuine Canon accessories (e.g., a leakage and/or explosion of a battery). Please note that repairs arising out of the malfunction of non-genuine accessories will not be covered by the warranty for repairs, although you may request such repairs on a chargeable basis.

-  ● Battery Pack LP-E17 is dedicated to Canon products only. Using it with an incompatible battery charger or product may result in malfunction or accidents for which Canon cannot be held liable.

Index

Numbers

- 1-point AF : 188, 193
- [4K] 3840×2160 (Movie) : 249
- 4K frame capture : 306

A

- Acceleration/deceleration tracking : 531
- Access lamp : 43
- Accessories : 3
- Adobe RGB : 147
- AEB (Auto Exposure Bracketing) : 129
- AE lock : 213
- AF
 - AF-assist beam : 187, 201
 - AF method : 188
 - AF operation : 185, 196
 - AF point selection : 193
 - AF speed : 283
 - Area AF frame : 80, 81, 192
 - Beep (Beeper) : 380
 - Continuous AF : 199
 - Eye detection AF : 198
 - Lens drive when AF impossible : 533
 - Lens electronic MF : 200
 - Limit AF methods : 533
 - Manual focusing : 214
 - Orientation linked AF point : 534
 - Recomposing : 71
 - Touch & drag AF : 183
- AF point auto switching : 532
- AF point expansion : 189, 193
- AF start button : 55
- Album (video snapshot) : 274, 334

- ALL-I : 265
- Ambience priority (AWB) : 142
- Anti-flicker shooting : 179
- Aperture-priority AE : 100
- Area AF frame : 80, 81, 192
- <A+> (Scene Intelligent Auto) : 68
- Aspect ratio → Still photo cropping/
aspect ratio
- Attenuator : 258
- Autofocus → AF
- Auto Lighting Optimizer : 136
- Auto power off : 372
- Auto reset : 365
- Auto rotate : 366
- Av (Aperture-priority AE) : 100

B

- Background music : 336
- Basic information display : 597
- Basic Zone : 34
- Battery → Power
- B (Bulb) : 106
- Beep (Beeper) : 380
- Bluetooth function : 399, 418
 - Address : 429
 - Connecting : 421
- Bracketing
 - AEB (Auto Exposure Bracketing) : 129
 - FEB (Flash Exposure Bracketing) :
229
 - Focus bracketing : 202
 - White balance bracketing : 146
- Bulb exposures : 106

Bulb timer : 107

BUSY : 118

C

<C1>/<C2>/<C3> (Custom shooting) : 408

Camera

 Camera vibration blur : 107, 210

 Default settings : 410

 Holding the camera : 53

Camera shake : 54, 70

Card requirements : 253, 585

Cards : 10, 30, 42

 Card reminder : 182

 Formatting : 367

 Low-level formatting : 367

 Troubleshooting : 44, 565

 Write protection : 42

Center-weighted average metering : 211

Certification logo : 413

Charger : 37, 40

Charging : 40, 558

Chromatic aberration correction : 126, 330

Cleaning (image sensor) : 382

Clipped highlights : 351

Close-up : 84

Color space : 147, 329

Color temperature : 144

Color tone : 153

Combination IS : 261

Continuous (file numbering) : 364

Continuous shooting : 206

Contrast : 136, 153

Control ring : 58

Copyright information : 411

Creative Assist : 73, 331

Creative Zone : 35

Cropping (images) : 337

Custom Functions : 523

Customize buttons : 538

Custom shooting mode : 408

Custom white balance : 143

D

Date/time : 374

Daylight saving time : 375

Default settings : 410

 Custom Functions : 546

 Customizing operations : 546

 Custom shooting mode : 408

 Flash function settings : 230

 My Menu : 551

Depth-of-field preview : 101

Diffraction correction : 126, 330

Digital Lens Optimizer : 125, 329

Digital terminal : 32, 556

Dioptric adjustment : 52

Display off : 372

Display settings : 394

Distortion correction : 124, 329

Double-tap : 298

DPOF (Digital Print Order Format) : 318

Dragging : 64

Drive mode : 206

Dust Delete Data : 161

E

Eco mode : 371

Electronic level : 388

Erasing (images) : 314

Err (error codes) : 581

Evaluative metering : 211

exFAT : 254, 368

Expanded ISO speed : 131, 133, 286, 588

Exposure compensation : 129

Exposure compensation in M mode with ISO Auto : 103

Exposure level increments : 526

Exposure level indicator : 102, 592

Exposure simulation : 139

Extension grip : 560

External microphone : 258

External Speedlite → Flash

F

Face+Tracking : 188, 191

FAT32 : 254, 368

Feature guide : 370

FEB (Flash Exposure Bracketing) : 229

FE lock : 220

File extension : 116, 252

File size : 254, 583, 586

Filter effect (Monochrome) : 154

Fine (Image quality) : 116

Firmware : 413

First-curtain synchronization : 228

Flash exposure compensation : 220, 229

Flash mode : 226

Flash (Speedlite) : 220

Custom Functions : 230

FEB (Flash Exposure Bracketing) : 229

FE lock : 220

Flash control (function settings) : 222

Flash exposure compensation : 220, 229

Flash sync speed : 221

Manual flash : 226

Safety FE : 225

Shutter synchronization (1st/2nd curtain) : 228

Slow synchro : 224

Wireless : 227

Flash sync contacts : 31

Flexible-priority AE : 104

Focus bracketing : 202

Focusing → AF

Focus lock : 71

Focus mode switch : 48, 51

Folder creation/selection : 361

Food : 85

Formatting (card initialization) : 367

Frame Grab : 306

Frame rate : 252, 378

Full High-Definition (Full HD) (movie) : 249

Fv (Flexible-priority AE) : 104

G

GPS : 402

Grid display : 353, 390

Group Photo : 78

H

H1/H2 (Expanded ISO speed) : 133

Handheld night scene : 87

[HD] 1280×720 (Movie) : 249

HDMI : 290, 308, 386

HDMI HDR : 387

HDMI output : 290

HDR Backlight Control : 88

HDR movie recording : 247

HDR shooting : 171

Headphones : 258

Help : 396

Text size : 397

High dynamic range → HDR

High ISO speed noise reduction : 157

Highlight alert : 351

Highlight tone priority : 137

High-speed continuous shooting : 206

High-speed display : 181

Histogram : 349, 391

Hot shoe : 31

I

ICC profile : 147

Icons : 8

Image browsing (jump display) : 347

Image quality : 116, 583

Image review time : 122

Images

AF point display : 352

Auto reset : 365

Auto rotation : 366

Continuous (file numbering) : 364

Erasing : 314

File numbering : 363

Highlight alert : 351

Histogram : 349

Importing (to computer) : 556

Index display : 300

Jump display (image browsing) : 347

Magnifying images : 299

Manual reset : 365

Manual rotation : 313

Playback : 293

Protecting images : 310

Rating : 340

Search conditions : 345

Shooting information : 297, 598

Image search : 345

Importing images to a computer : 556

Index display : 300

INFO button : 59

Initial magnification ratio/position : 355

Interval timer : 176

IPB : 252

ISO speed : 131, 286

Auto range (Still photos) : 134

ISO Auto range : 134, 582

ISO speed range : 133, 286

Minimum shutter speed for ISO Auto
(Still photos) : 135

J

JPEG : 116, 583

Jump display : 347

K

Kids : 81

L

Landscape : 79

Language : 377

Large (image quality) : 116

Lens : 48, 50

Chromatic aberration correction : 126, 330

Diffraction correction : 126, 330

Digital Lens Optimizer : 125, 329

Distortion correction : 124, 329

Focus mode switch : 48, 51

Lock release : 49, 51

Optical aberration correction : 123, 329

Peripheral illumination correction : 124, 329

Lens electronic MF : 200

Location information : 402

LOCK : 58, 407

Long (bulb) exposures : 106

Long Exposure Noise Reduction : 159

Low-speed continuous shooting : 207

M

Magnifying images : 195, 214, 299

Main dial : 56

Malfunction : 562

Manual exposure : 102

Manual focus : 214

Manual focusing : 214

Manual reset : 365

Maximum burst : 118, 583

Medium (image quality) : 116

Memory cards → Cards

Menu : 60

Custom Functions : 524

Dimmed menu items : 63

Function settings : 358

Movie shooting : 236

My Menu : 548

Playback : 294

Setting procedure : 61

Still photo shooting : 111

Metering mode : 211

Metering timer : 138

MF (Manual focusing) : 214

M-Fn button : 55

MF peaking : 216

Microphone : 258

M (Manual exposure) : 102

Mode dial : 34

Mode guide : 369

Monochrome : 150

Movies : 235

AE lock : 240

AF speed during Movie Servo AF : 283

Attenuator : 258

Autoexposure shooting : 239

Auto slow shutter : 288

Av 1/8-stop increments : 289

Cards that can record movies : 585

Compression method : 252

Cropped shooting : 256

Editing : 304
 Editing out first and last scenes : 304
 External microphone : 258
 File size : 254, 586
 Frame Grab : 306
 Frame rate : 252
 HDMI output : 290, 386
 HDR movie recording : 247
 Headphones : 258
 Information display : 593
 Manual exposure shooting : 241
 Microphone : 258
 Movie digital IS : 260
 Movie recording size : 249
 Movie Servo AF : 280, 282, 283
 Movie Servo AF tracking sensitivity : 282
 Movie shooting button : 31
 Playback : 301
 Recording time : 255, 586
 Shooting area : 251
 Sound recording/Sound-recording level : 257
 Time-lapse movie : 262
 Video snapshots : 274
 Wind filter : 257
 MP4 : 252
 Multi function : 55
 Multi-function lock : 58, 407
 Multiple exposure : 165
 Multi Shot Noise Reduction : 157
 My Menu : 548

N

Night Portrait : 86
 Noise reduction
 High ISO speed : 157
 Long exposures : 159
 Non-Canon flash units : 221
 Normal (Image quality) : 116
 NTSC : 252, 378

O

One-Shot AF : 186
 Orientation linked AF point : 534

P

PAL : 252, 378
 Panning : 82
 Partial metering : 211
 Part names : 31
 Peripheral illumination correction : 124, 329
 Photobook set-up : 322
 Picture Style : 148, 152, 155
 Pixel count : 116, 583
 Playback : 293
 Portrait : 77
 Positioning hole : 33
 Possible recording time (movie) : 586
 Possible shots : 582
 Power : 46
 Auto power off : 372
 Battery information : 381
 Battery level : 47
 Charging : 40, 558
 Possible shots : 582

Power saving : 372

P (Program AE) : 96

Pressing completely : 54, 395

Pressing halfway : 54, 395

Printing

Photobook set-up : 322

Print order (DPOF) : 318

Program AE : 96

Program shift : 97

Protecting images : 310

Q

[Q] (Quick Control) : 65

Quick Control : 65

Quick control dial : 57

R

Rating : 340

Rating mark : 340

RAW : 116, 117

RAW image processing : 325

RAW+JPEG : 116, 583

Reduced display : 300

Release shutter without card : 182

Remote control : 217

Remote control terminal : 32, 219

Remote switch : 219

Resizing : 339

Rotating (images) : 313, 366

S

Safety instructions : 25

Safety shift : 529

Saturation : 153

Scene icons : 72, 595

Scene Intelligent Auto : 68

<SCN> (Special scene) : 34, 75

Screen : 30, 45

Angle adjustment : 45

Brightness : 373

SD/SDHC/SDXC cards → Cards

Second-curtain synchronization : 228

Self-timer : 209

Sensitivity → ISO speed

Sensor cleaning : 382

Serial number : 33

Servo AF

Initial AF Point : 535

Movie Servo AF : 280, 282, 283

SERVO : 186

SERVO (Servo AF) : 186

Sharpness : 153

Shooting information display : 388, 591

Shooting mode

<A+> (Scene Intelligent Auto) : 68

Av (Aperture-priority AE) : 100

B (Bulb) : 106

<C1>/<C2>/<C3> (Custom shooting) :

408

Fv (Flexible-priority AE) : 104

M (Manual exposure) : 102

P (Program AE) : 96

SCN (Special scene mode) : 75

Tv (Shutter-priority AE) : 98

Shooting range : 391

Shutter button : 54

Shutter button functions : 395

Shutter-priority AE : 98

Shutter synchronization : 228

Silent mode : 89

Single-image display : 296

Single shooting : 206

Slide show : 343

Small (image quality) : 116

Software : 554

 Instruction Manual : 555

Sound recording/Sound-recording level : 257

Speaker : 33

Special scene mode (SCN) : 75

Sports : 80

Spot AF : 188, 193

Spot metering : 211

sRGB : 147

Still photo cropping/aspect ratio : 119, 584

Strap : 38

T

Temperature warning : 232, 291

Tilt correction : 338

Time-lapse movie : 262

Time zone : 374

Tone priority : 137

Toning effect (Monochrome) : 154

Touch beeping : 380

Touch operation : 64, 298, 379

Touch Shutter : 163

Tracking sensitivity : 530

Tripod socket : 33

Troubleshooting : 562

TV display : 308

Tv (Shutter-priority AE) : 98

U

UHS-II/UHS-I : 10

USB (digital) terminal : 32, 556

UTC (Coordinated Universal Time) : 406

V

Video snapshots : 274

Video system : 378

Viewfinder

 Dioptic adjustment : 52

 Display format : 393

 Grid display : 390

 Information display : 389

 Vertical display : 390

Viewfinder off : 372

Volume (movie playback) : 302, 303

W

White balance : 140

 Auto : 142

 Bracketing : 146

 Color temperature setting : 144

 Correction : 145

 Custom : 143

White priority (AWB) : 142

Wi-Fi function : 415

 Android : 420

 Camera access point mode : 492

 Camera Connect : 420, 437

 CANON iIMAGE GATEWAY : 473

Clearing wireless communication settings : 498

Connection history : 493, 516

Edit device information : 450, 496

EOS Utility : 453

Erase connection information : 497

Image Transfer Utility 2 : 458

iOS : 420

IP address : 518

MAC address : 499

Network : 434, 454, 462

Network settings : 514

Nickname : 497

Notes : 511

Pairing : 422

Password : 516

PictBridge : 463

Printer : 461

Printing : 464

Print order : 467

Reconnecting : 493

Remote operation : 437

Resize image : 440, 445, 481

Sending all images on the card : 446, 483

Sending images that match search conditions : 447, 485

Send selected : 443, 480

SSID : 434, 454, 462

Switch network : 489

Viewable images : 450

View info screen : 499

Viewing images : 437

Virtual keyboard : 517

Wi-Fi settings : 516

WPS (Wi-Fi Protected Setup) : 488

Wind filter : 257

Wireless communication settings : 398, 415

Z

Zone AF : 189, 193



The descriptions in this Instruction Manual are current as of October 2018. For information on the compatibility with any products introduced after this date, contact any Canon Service Center. For the latest version Instruction Manual, refer to the Canon Web site.