

# Canon PowerShot S110

CDP-E491-010

© CANON INC. 2012

## English Getting Started

- Before use, be sure to read this guide.
- Reading this guide will help you learn to use the camera properly.
- Store this guide safely so that you can use it in the future.

## Package Contents

Before use, make sure the following items are included in the package. If anything is missing, contact your camera dealer.

- ① Camera
  - ② Battery Pack NB-5L (with terminal cover)
  - ③ Battery Charger CB-2LX/CB-2LXE\*
  - ④ Wrist Strap WS-DC11
  - ⑤ Interface Cable IFC-400PCU
  - ⑥ DIGITAL CAMERA Solution Disk
  - ⑦ Getting Started (this guide)
- \* Power cord also included.

## PDF Manuals and Camera Software

Install PDF manuals and software from the included DIGITAL CAMERA Solution Disk. Note that Adobe Reader is required to view the PDF manuals.

- Insert the included DIGITAL CAMERA Solution Disk in the computer's CD-ROM drive and follow the installation instructions.
- After installation, you can access the Camera User Guide by double-clicking the desktop shortcut icon.
- For instructions on using the wireless LAN function, refer to the *Camera User Guide*.
- For software instructions, refer to the *Camera User Guide* or the *ImageBrowser EX Help*.

## Compatible Memory Cards

The following memory cards (sold separately) can be used, regardless of capacity.

- SD memory cards\* • SDXC memory cards\* 
- SDHC memory cards\* • Eye-Fi cards

\* Conforms to SD specifications. However, not all memory cards have been verified to work with the camera.

## About Eye-Fi Cards

This product is not guaranteed to support Eye-Fi card functions (including wireless transfer). In case of an issue with an Eye-Fi card, please check with the card manufacturer. Also note that an approval is required to use Eye-Fi cards in many countries or regions. Without approval, use of the card is not permitted. If it is unclear whether the card has been approved for use in the area, please check with the card manufacturer.

## Charging the Battery

### Remove the battery cover and insert the battery in the charger.

- After aligning the ▲ marks on the battery and charger, insert the battery by pushing it in (1) and down (2).

### Charge the battery.

- Battery chargers with a plug:  
Flip out the plug and plug the charger into a power outlet. The lamp turns orange.
- Battery chargers with a power cord:  
Connect the power cord to the battery charger, and then plug the other end into a power outlet.
- When charging is finished, the lamp turns green. Remove the battery.

## Inserting the Battery and Memory Card

### Open the cover.

- Slide the cover (1) and open it (2).

### Insert the battery.

- Holding the battery with the terminals (1) facing as shown, move the battery lock in the direction of the arrow, insert the battery, and push it in all the way until the lock clicks shut.
- To remove the battery, press the battery lock in the direction of the arrow.

### Check the card's write-protect tab and insert the memory card.

- Shooting is not possible with cards that have a write-protect tab (1) in the locked position. Slide the tab up until it clicks into the unlocked position.
- Insert the memory card with the terminals (2) facing as shown until the lock clicks shut.
- To remove the memory card, push it in until you feel a click, and then slowly release it.

### Close the cover.

- Lower the cover (1) and hold it down as you slide it, until it clicks into the closed position (2).

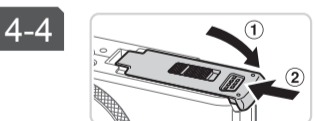
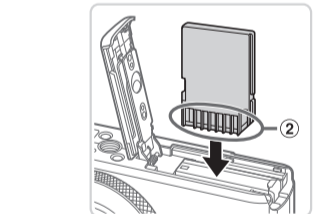
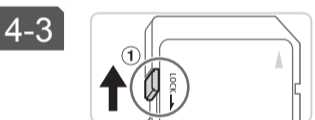
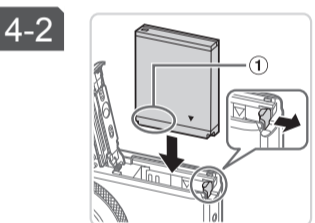
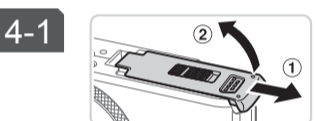
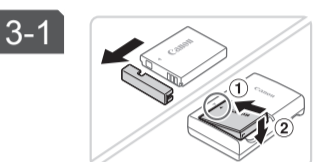
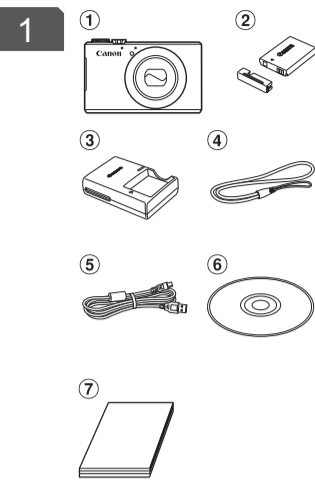

## Setting the Date and Time

### Turn the camera on.

- Press the power button to turn the camera on. The [Date/Time] screen is displayed.

### Set the date and time.

- Press the <◀><▶> buttons to choose an option, and then adjust the setting, either by pressing the <▲><▼> buttons or turning the <⦿> dial.
- When finished, press the <MENU> button.

### Specify your home time zone.

- Press the <◀><▶> buttons or turn the <⦿> dial to choose your home time zone.
- Press the <MENU> button when finished. After a confirmation message, the setting screen is no longer displayed.

### Change the date and time.

- 1 Press the <MENU> button.
- 2 Move the zoom lever to choose the [F/T] tab.
- 3 Press the <▲><▼> buttons or turn the <⦿> dial to choose [Date/Time], and then press the <MENU> button.
- 4 Follow step 5-2 to configure the setting, and then press the <MENU> button.

## Display Language

### Enter Playback mode.

- Press the <▶> button.

### Access the setting screen.

- Press and hold the <MENU> button, and then immediately press the <MENU> button.
- Press the <▲><▼><◀><▶> buttons or turn the <⦿> dial to choose a language, and then press the <MENU> button.

## Shooting

### Turn the camera on and enter <AUTO> mode.

- Press the power button and set the mode dial to <AUTO>.

### Compose the shot.

- To zoom in and enlarge the subject, move the zoom lever toward <☐> (telephoto) as you watch the screen, and to zoom away from the subject, move it toward <☐> (wide angle).

### Shoot still images.

- Press the shutter button lightly (1).
- The camera beeps twice after focusing, and AF frames are displayed to indicate image areas in focus. Press the shutter button all the way down (2).

### Shoot movies.

- Press the movie button to start shooting, and press it again to stop.

## Viewing

### Enter Playback mode.

- Press the <▶> button.

### Browse through your images.

- To view the previous or next image, press the <◀><▶> buttons or turn the <⦿> dial.
- Movies are identified by a [MOV] icon. To play movies, go to step 8-3.

### Play movies.

- Press the <MENU> button to access the movie control panel, choose [▶] (either press the <◀><▶> buttons or turn the <⦿> dial), and then press the <MENU> button again.
- Movie playback begins, and you can adjust the volume as needed by pressing the <▲><▼> buttons.
- After the movie is finished, [MOV] is displayed.

## Touch-Screen Operations

- The camera's touch-screen panel enables intuitive operation simply by touching or tapping the screen.
- Touch ..... Touch the screen briefly with your finger.  
Ex: Touch [▶] to start movie playback.
- Drag ..... Touch the screen and move your finger across it.  
Ex: In playback mode, drag right to left (or left to right) to choose an image to view.  
To adjust the volume during movie playback, quickly drag up or down across the screen.

### Erase the images.

- 1 Press the <MENU> button.
- 2 After [Erase?] is displayed, press the <◀><▶> buttons or turn the <⦿> dial to choose [Erase], and then press the <MENU> button.

## Using wireless LAN function

- For instructions on using the wireless LAN function, refer to the *Camera User Guide* in the CD-ROM.

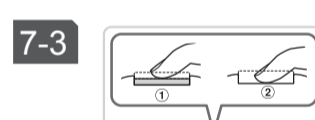
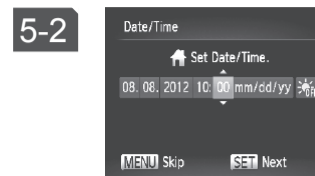

## Safety Precautions

- Before using the product, please ensure that you read the safety precautions described below. Always ensure that the product is used correctly.
- The safety precautions noted on the following pages are intended to prevent injuries to yourself and other persons, or damage to the equipment.

### Warning

Denotes the possibility of serious injury or death.

- **Do not trigger the flash in close proximity to people's eyes.**  
Exposure to the intense light produced by the flash could damage eyesight. In particular, remain at least 1 meter (39 inches) away from infants when using the flash.
- **Store this equipment out of the reach of children and infants.**  
Strap: Putting the strap around a child's neck could result in asphyxiation.  
Date/time battery (if removable): Dangerous if swallowed. If this occurs, contact a doctor immediately.
- **Use only recommended power sources.**
- **Do not attempt to disassemble, alter or apply heat to the product.**
- **Avoid dropping or subjecting the product to severe impacts.**
- **To avoid the risk of injury, do not touch the interior of the product if it has been dropped or otherwise damaged.**
- **Stop using the product immediately if it emits smoke, a strange smell, or otherwise behaves abnormally.**
- **Do not use organic solvents such as alcohol, benzene, or thinner to clean the product.**
- **Do not let the product come into contact with water (e.g. sea water) or other liquids.**
- **Do not allow liquids or foreign objects to enter the camera.**

This could result in electrical shock or fire.

If liquids or foreign objects come into contact with the camera interior, immediately turn the camera off and remove the battery/batteries.

If the battery charger (for cameras that use one) becomes wet, unplug it from the outlet and consult your camera distributor or a Canon Customer Support Help Desk.

- **Do not look through the viewfinder (if your model has one) at bright light sources, such as the sun on a clear day.**

This could damage your eyesight.

- **Use only the recommended battery/batteries.**
- **Do not place the battery/batteries near or in direct flame.**
- **If your camera uses a battery charger, note the following precautions.**
  - Unplug the power cord periodically, and using a dry cloth, wipe away any dust and dirt that has collected on the plug, the exterior of the power outlet, and the surrounding area.
  - Do not handle the power cord with wet hands.
  - Do not use the equipment in a manner that exceeds the rated capacity of the electrical outlet or wiring accessories. Do not use if the power cord or plug are damaged, or not fully plugged into the outlet.
  - Do not allow dirt or metal objects (such as pins or keys) to contact the terminals or plug.

The battery/batteries may explode or leak, resulting in electrical shock or fire. This could cause injury and damage the surroundings. In the event that a battery leaks and the battery electrolyte contacts eyes, mouth, skin or clothing, immediately flush with water.

- **Turn the camera off in places where camera use is prohibited.**

The electromagnetic waves emitted by the camera may interfere with the operation of electronic instruments and other devices. Exercise adequate caution when using the camera in places where use of electronic devices is restricted, such as inside airplanes and medical facilities.

- **Do not play any included CD-ROMs in a CD player that does not support data CD-ROMs.**

It is possible to suffer hearing loss from listening with headphones to the loud sounds of a CD-ROM played on an audio CD player (music player). Additionally, this could damage the speakers.

### Caution

Denotes the possibility of injury.

- **When holding the camera by the strap, be careful not to bang it, subject it to strong impacts or shocks, or let it get caught on other objects.**
- **Be careful not to bump or push strongly on the lens.**

This could lead to injury or damage the camera.

- **Be careful not to subject the screen to strong impacts.**

If the screen cracks, injury may result from the broken fragments.

- **When using the flash, be careful not to cover it with your fingers or clothing.**

This could result in burns or damage to the flash.

- **Avoid using, placing or storing the product in the following places:**

- Places subject to strong sunlight
- Places subject to temperatures above 40 °C (104 °F)
- Humid or dusty areas

These could cause leakage, overheating or an explosion of the battery/batteries, resulting in electrical shock, fire, burns or other injuries.

High temperatures may deform the product.

- **The slideshow transition effects may cause discomfort when viewed for prolonged periods.**
- **When using optional lenses, lens filters, or filter adapters (if applicable), be sure to attach these accessories firmly.**

If the lens becomes loose and falls off, it may crack, and the shards of glass may lead to cuts.

- **On cameras that raise and lower the flash automatically, make sure your finger is out of the way when the flash is lowered, to avoid pinching it.**

This could result in injury.

### Caution

Denotes the possibility of damage to the equipment.

- **Do not aim the camera at bright light sources (such as the sun on a clear day).**

Doing so may damage the image sensor.

- **When using the camera on a beach or at a windy location, be careful not to allow dust or sand to enter the camera.**
- **On cameras that raise and lower the flash automatically, do not push the flash down or pry it open.**

This may cause the product to malfunction.

- **In regular use, small amounts of smoke may be emitted from the flash.**

This is due to the high intensity of the flash burning dust and foreign materials stuck to the front of the unit. Please use a cotton swab to remove dirt, dust or other foreign matter from the flash to prevent heat build-up and damage to the unit.

- **Remove and store the battery/batteries when you are not using the camera.**

If the battery/batteries is/are left inside the camera, damage caused by leakage may occur.

- **Before you discard the battery/batteries, cover the terminals with tape or other insulators.**

Contacting other metal materials may lead to fire or explosions.

- **If your camera uses a battery and battery charger, note the following precautions.**

- Unplug the battery charger from the power outlet after charging is complete, or when you are not using it.

- Do not place anything, such as cloth, on top of the battery charger while it is charging.

Leaving the unit plugged in for a long period of time may cause it to overheat and distort, resulting in fire.

- **Do not place the battery near pets.**

Pets biting the battery could cause leakage, overheating or explosion, resulting in fire or damage.

- **If your camera uses multiple batteries, note the following precautions.**

- Do not charge batteries of different types at the same time, or use older batteries together with newer batteries.

- Do not insert the batteries with the + and - terminals reversed.

This may cause the product to malfunction.

- **Do not sit down with the camera in your pocket.**

Doing so may cause malfunctions or damage the screen.

- **When putting the camera in your bag, ensure that hard objects do not come into contact with the screen. Also close the screen (so that it faces the camera body), if your camera has a screen that closes.**

- **Do not attach any hard objects to the camera.**

Doing so may cause malfunctions or damage the screen.

## Preliminary Notes and Legal Information

- Take and review some test shots initially to make sure the images were recorded correctly. Please note that Canon Inc., its subsidiaries and affiliates, and its distributors are not liable for any consequential damages arising from any malfunction of a camera or accessory, including memory cards, that results in the failure of an image to be recorded or to be recorded in a way that is machine readable.
- Images recorded by the camera are intended for personal use. Refrain from unauthorized recording that infringes on copyright law, and note that even for personal use, photography may contravene copyright or other legal rights at some performances or exhibitions, or in some commercial settings.
- The camera warranty is valid only in the area of purchase. In case of camera problems while abroad, return to the area of purchase before contacting a Canon Customer Support Help Desk.
- Although the LCD monitor is produced under extremely high-precision manufacturing conditions and more than 99.99% of the pixels meet design specifications, in rare cases some pixels may be defective or may appear as red or black dots. This does not indicate camera damage or affect recorded images. This also applies to viewfinders, on applicable cameras.
- The LCD monitor may be covered with a thin plastic film for protection against scratches during shipment. If covered, remove the film before using the camera.
- When the camera is used over an extended period, it may become warm. This does not indicate damage.

Complies with  
IDA Standards  
DB00671

This product is installed with the WLAN Module which is certified to standards set by IDA Singapore.

### CAUTION

RISK OF EXPLOSION IF BATTERY IS REPLACED BY AN INCORRECT TYPE.  
DISPOSE OF USED BATTERIES ACCORDING TO LOCAL REGULATION.

### Use of genuine Canon accessories is recommended.

This product is designed to achieve excellent performance when used with genuine Canon accessories.

Canon shall not be liable for any damage to this product and/or accidents such as fire, etc., caused by the malfunction of non-genuine Canon accessories (e.g., a leakage and/or explosion of a battery pack). Please note that this warranty does not apply to repairs arising out of the malfunction of non-genuine Canon accessories, although you may request such repairs on a chargeable basis.

### Wireless LAN Precautions

- The model number is PC1882/PC1819 (including WLAN module model WM217).
- Countries and Regions Permitting WLAN Use
  - Use of WLAN is restricted in some countries and regions, and illegal use may be punishable under national or local regulations. To avoid violating WLAN regulations, visit the Canon website to check where use is allowed.
  - Note that Canon cannot be held liable for any problems arising from WLAN use in other countries and regions.