

Canon

EOS 77D



Camera

Wi-Fi (Wireless Communication) Function

Basic Instruction Manual

Instruction manuals (PDF files) and software can be downloaded from the Canon Web site (p.4, 167).

www.canon.com/icpd



Canon

EOS 77D

Camera Basic Instruction Manual

The Camera Basic Instruction Manual covers the most basic operations and functions.

Introduction

The EOS 77D is a digital single-lens reflex camera featuring a fine-detail CMOS sensor with approx. 24.2 effective megapixels, DIGIC 7, high-precision and high-speed 45-point AF (up to 45 cross-type AF points), maximum continuous shooting speed of approx. 6.0 shots/sec., Live View shooting, Full High-Definition (Full HD) movie shooting, and Wi-Fi/NFC/Bluetooth (wireless communication) function.

Before Starting to Shoot, Be Sure to Read the Following

To avoid botched pictures and accidents, first read the “Safety Precautions” (p.15-17) and “Handling Precautions” (p.18-20). Also, read this manual carefully to ensure that you use the camera correctly.

Refer to This Manual while Using the Camera to Further Familiarize Yourself with the Camera

While reading this manual, take a few test shots and see how they come out. You can then better understand the camera. Be sure to store this manual safely, too, so that you can refer to it again when necessary.

Testing the Camera Before Use and Liability

After shooting, play images back and check whether they have been properly recorded. If the camera or memory card is faulty and the images cannot be recorded or downloaded to a computer, Canon cannot be held liable for any loss or inconvenience caused.

Copyrights

Copyright laws in your country may prohibit the use of your recorded images or copyrighted music and images with music on the memory card for anything other than private enjoyment. Also be aware that certain public performances, exhibitions, etc., may prohibit photography even for private enjoyment.

Item Check List

Before starting, check that all the following items are included with your camera. If anything is missing, contact your dealer.



Camera

(with eyecup and body cap)



Strap



**Battery Pack
LP-E17**

(with protective cover)



**Battery Charger
LC-E17/LC-E17E***

* Battery Charger LC-E17 or LC-E17E is provided. (The LC-E17E comes with a power cord.)

- **The camera does not come with the Software CD-ROM, an interface cable or HDMI cable.**
- The Instruction Manuals are listed on the next page.
- If you purchased a Lens Kit, check that the lenses are included.
- Be careful not to lose any of the above items.



When you need Lens Instruction Manuals, download them from the Canon Web site (p.4).

The Lens Instruction Manuals (PDF) are for lenses sold individually. Note that when purchasing the Lens Kit, some of the accessories included with the lens may not match those listed in the Lens Instruction Manual.



Software can be downloaded from the Canon Web site (p.167) for your use.

Instruction Manuals



Camera and Wi-Fi (Wireless Communication) Function Basic Instruction Manual

The booklet is the Basic Instruction Manual.

More detailed Instruction Manuals (PDF files) can be downloaded from the Canon Web site.

Downloading and Viewing the Instruction Manuals (PDF Files)

1 Download the Instruction Manuals (PDF files).

- Connect to the Internet and access the following Canon Web site.

www.canon.com/icpd

- Select your country or region of residence and download the Instruction Manuals.

Instruction Manuals Available for Download

- **Camera Instruction Manual**
- **Wi-Fi (Wireless Communication) Function Instruction Manual**
- **Camera and Wi-Fi (Wireless Communication) Function Basic Instruction Manual**
- **Lens Instruction Manuals**
- **Software Instruction Manuals**

2 View the Instruction Manuals (PDF files).

- Double-click a downloaded Instruction Manual (PDF file) to open it.
- To view the Instruction Manuals (PDF files), Adobe Acrobat Reader DC or other Adobe PDF viewer (most recent version recommended) is required.
- Adobe Acrobat Reader DC can be downloaded for free from the Internet.
- To learn how to use PDF viewing software, refer to the software's Help section.

The Instruction Manuals (PDF files) can also be downloaded using the QR code.



www.canon.com/icpd

- A software application is required to read out the QR code.
- Select your country or region of residence, then download the Instruction Manuals.
- The QR code can also be displayed under [**4**: **Manual/software URL**].

Quick Start Guide

1

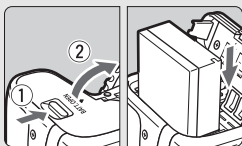

Insert the battery (p.32).

- Upon purchase, charge the battery to start using (p.30).

2

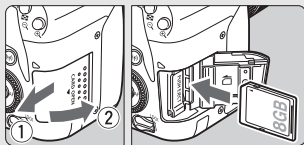

Insert the card (p.33).

- With the card's label facing toward the back of the camera, insert it into the card slot.

3

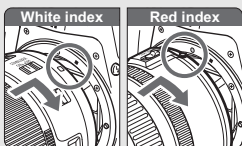

Attach the lens (p.42).

- Align the lens's white or red mount index with the camera's mount index of the same color to attach the lens.

4

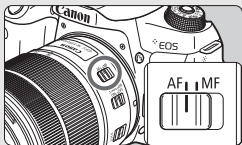

Set the lens's focus mode switch to <AF> (p.42).

5

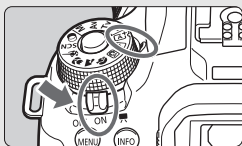

Set the power switch to <ON>, then set the Mode Dial to <AI+> (Scene Intelligent Auto) (p.70).

- Turn the Mode Dial while holding down the lock release button at the center.
- All the necessary camera settings will be set automatically.

6

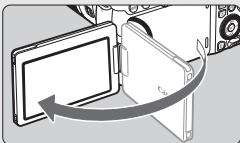
**Flip out the LCD monitor** (p.35).

- When the LCD monitor displays the date/time/zone setting screen, see page 38.

7

**Focus on the subject** (p.45).

- Look through the viewfinder and aim the viewfinder center over the subject.
- Press the shutter button halfway, and the camera will focus on the subject.
- The built-in flash will be raised as necessary.

8

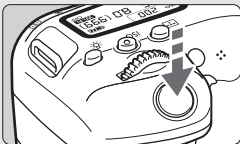
**Take the picture** (p.45).

- Press the shutter button completely to take the picture.

9

**Review the picture.**

- The image just captured will be displayed for approx. 2 sec. on the LCD monitor.
- To display the image again, press the <▶> button (p.94).
- To shoot while looking at the LCD monitor, see “Live View Shooting” (p.131).
- To view the images captured so far, see “Image Playback” (p.94).
- To delete images, see “Erasing Images” (p.164).

Compatible Cards

The following cards can be used with the camera regardless of capacity. **If the card is new or was previously formatted (initialized) by another camera or computer, format the card with this camera (p.65).**

- **SD/SDHC*/SDXC* memory cards**

* UHS-I cards supported.

Cards that Can Record Movies

When shooting movies, use a large-capacity card with a reading/writing speed class at least as high as shown in the following table.

Movie Recording Size (p.150)		Recording Formats	
		MOV	MP4
ALL-I*		UHS Speed Class 3 or faster	-
IPB (Standard)		-	SD Speed Class 10 or faster
	Other than above	-	SD Speed Class 6 or faster
IPB (Light)		-	SD Speed Class 4 or faster

* Image-recording quality that is automatically set for time-lapse movie shooting.

- If you use a slow-writing card when shooting movies, the movie may not be recorded properly. Also, if you play back a movie on a card with a slow reading speed, the movie may not be played back properly.
- To check the card's reading/writing speed, refer to the card manufacturer's Web site.



In this manual, "card" refers to SD memory cards, SDHC memory cards, and SDXC memory cards.





* **The camera does not come with a card for recording photos/movies.** Please purchase it separately.

Chapters





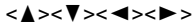

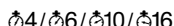
	Introduction	2
1	Getting Started and Basic Camera Operations	29
2	Basic Shooting and Image Playback	69
3	Setting the AF and Drive Modes	97
4	Image Settings	109
5	Advanced Operations for Photographic Effects	121
6	Shooting with the LCD Monitor (Live View Shooting)	131
7	Shooting Movies	147
8	Handy Features	153
9	Image Playback	157
10	Software Start Guide / Downloading Images to a Computer	165

Conventions Used in this Manual

Icons in this Manual

-  : Indicates the Main Dial.
-  : Indicates the Quick Control Dial.
-  : Indicates the direction of the shift or move when the key on the Quick Control Dial is pressed.
-  : Indicates the Setting button.
-  : Indicates that each function remains active for approx. 4 sec., 6 sec., 10 sec., or 16 sec. after you let go of the button.

* In addition to the above, the icons and symbols used on the camera's buttons and displayed on the LCD monitor are also used in this manual when discussing relevant operations and functionality.

-  : Indicates a function that can be changed by pressing the <MENU> button to change its settings.
-  : This icon at the upper right of the page titles indicates that the function is available only in the Creative Zone modes (p.27).
- (p.**)
-  : Warning to prevent shooting problems.
-  : Supplemental information.
-  : Tips or advice for better shooting.
-  : Troubleshooting advice.



Basic Assumptions and Sample Photos

- All operations described in this manual assume that the power switch is set to <ON> and the <LOCK> switch is set downward (Multi function lock released) (p.48).
- It is assumed that all the menu settings and Custom Functions are set to their defaults.
- The illustrations in this manual describe the camera attached with the EF-S18-135mm f/3.5-5.6 IS USM lens as an example.
- The sample photos displayed on the camera and used in this manual are only for illustrative purposes to show the effects more clearly.

Contents

Introduction	2
Item Check List	3
Instruction Manuals	4
Quick Start Guide	6
Compatible Cards	8
Chapters	9
Conventions Used in this Manual	10
Safety Precautions	15
Handling Precautions	18
Nomenclature	21

1 Getting Started and Basic Camera Operations **29**



Charging the Battery	30
Installing and Removing the Battery	32
Installing and Removing the Card	33
Using the LCD Monitor	35
Turning on the Power	36
Setting the Date, Time, and Zone	38
Selecting the Interface Language	41
Attaching and Detaching a Lens	42
Basic Shooting Operations	44
Setting the Screen Display Level	50
 Quick Control for Shooting Functions	56
 Menu Operations and Configurations	58
 Operating the Camera with Touch Screen	62
Formatting the Card	65
Switching the LCD Monitor Display	66
Displaying the Electronic Level	67

2	Basic Shooting and Image Playback	69
	Fully Automatic Shooting (Scene Intelligent Auto).....	70
	Full Auto Techniques (Scene Intelligent Auto).....	73
	Shooting When You Cannot Use Flash.....	74
	Creative Auto Shooting.....	75
	Shooting Portraits.....	76
	Shooting Landscapes.....	77
	Shooting Close-ups.....	78
	Shooting Moving Subjects.....	79
	SCN: Special Scene Mode	80
	Shooting Group Photos.....	81
	Photographing Children.....	82
	Shooting Food.....	83
	Shooting Candlelight Portraits.....	84
	Shooting Night Portraits (With a Tripod).....	85
	Shooting Night Scenes (Handheld).....	86
	Shooting Backlit Scenes.....	87
	Shooting with Creative Filter Effects.....	88
	Quick Control.....	90
	Adjusting the Brightness.....	93
	Image Playback.....	94
3	Setting the AF and Drive Modes	97
	AF: Changing the Autofocus Operation (AF operation)	98
	Selecting the AF Area and AF Point.....	100
	AF Area Selection Modes.....	103
	MF: Manual Focus.....	105
	Selecting the Drive Mode.....	106
	Using the Self-timer.....	107



4 Image Settings 109

Setting the Image-Recording Quality	110
ISO: Setting the ISO Speed for Still Photos.....	112
 Selecting a Picture Style	113
WB: Matching the Light Source (White balance)	115
Auto Correction of Brightness and Contrast (Auto Lighting Optimizer)....	116
Setting Noise Reduction	117
Reducing Flicker	119

5 Advanced Operations for Photographic Effects 121





P : Program AE.....	122
Tv : Conveying the Subject's Movement (Shutter priority AE)	123
Av : Changing the Depth of Field (Aperture priority AE)	124
M : Manual Exposure.....	125
Setting the Desired Exposure Compensation	126
Auto Exposure Bracketing (AEB).....	127
 Locking the Exposure (AE Lock)	128
 Using the Built-in Flash	129

6 Shooting with the LCD Monitor (Live View Shooting) 131



 Shooting with the LCD Monitor	132
 Shooting with Creative Filter Effects	135
Changing the Autofocus Operation (AF operation).....	137
Focusing with AF (AF method)	140
 Shooting with the Touch Shutter	145

7 Shooting Movies 147

 Shooting Movies	148
Autoexposure Shooting	148
Setting the Movie Recording Size	150

8	Handy Features	153
	Handy Features	154
	Disabling the Beeper	154
	Card Reminder	154
	Setting the Image Review Time	155
	Setting the Auto Power Off Time	155
	Reverting the Camera to the Default Settings	156
9	Image Playback	157
	 Searching for Images Quickly	158
	 Playing Back with the Touch Screen	160
	 Playing Back Movies	162
	 Erasing Images.....	164
10	Software Start Guide /	
	Downloading Images to a Computer	165
	Software Start Guide	166
	Downloading and Viewing the Software Instruction Manuals (PDF Files)....	168
	Downloading Images to a Computer	169
	Index.....	177

 For Troubleshooting guide and Specifications, refer to the Instruction Manual downloadable from the Canon Web site. For how to download the Instruction Manual, see page 4.

 **Certification Logo**
 Select [**5**: **Certification Logo Display**]* and press <  > to display some of the logos of the camera's certifications. Other certification logos can be found in this Instruction Manual, on the camera body, and on the camera's package.

* Displayed under the [**4**] tab during movie shooting.

Safety Precautions

The following precautions are provided to prevent harm or injury to yourself and others. Make sure to thoroughly understand and follow these precautions before using the product.

If you experience any malfunctions, problems, or damage to the product, contact the nearest Canon Service Center or the dealer from whom you purchased the product.



Warnings: Follow the warnings below. Otherwise, death or serious injuries may result.

- To prevent fire, excessive heat, chemical leakage, explosions, and electrical shock, follow the safeguards below:
 - Do not use any batteries, power sources, or accessories not specified in the Instruction Manual. Do not use any home-made or modified batteries, or the product if it is damaged.
 - Do not short-circuit, disassemble, or modify the battery. Do not apply heat or solder to the battery. Do not expose the battery to fire or water. Do not subject the battery to strong physical shock.
 - Do not insert the battery's plus and minus ends incorrectly.
 - Do not recharge the battery in temperatures outside the allowable charging (working) temperature range. Also, do not exceed the recharge time indicated in the Instruction Manual.
 - Do not insert any foreign metallic objects into the electrical contacts of the camera, accessories, connecting cables, etc.
- When disposing of a battery, insulate the electrical contacts with tape. Contact with other metallic objects or batteries may cause a fire or an explosion.
- If excessive heat, smoke, or fumes are emitted when recharging the battery, immediately unplug the battery charger from the power outlet to stop recharging. Otherwise, it may cause a fire, heat damage, or electrical shock.
- If the battery leaks, changes color, deforms, or emits smoke or fumes, remove it immediately. Be careful not to get burned in the process. It may cause a fire, electrical shock or burns if you keep using it.
- Prevent any battery leakage from contacting your eyes, skin, and clothing. It can cause blindness or skin problems. If the battery leakage comes in contact with your eyes, skin, or clothing, flush the affected area with lots of clean water without rubbing it. See a physician immediately.
- Do not leave any cords near a heat source. It can deform the cord or melt the insulation and cause a fire or electrical shock.
- Do not hold the camera in the same position for long periods of time. Even if the camera does not feel too hot, prolonged contact with the same body part may cause skin redness or blistering due to low-temperature contact burns. Using a tripod is recommended for people with circulation problems or very sensitive skin, or when using the camera in very hot places.
- Do not fire the flash at anyone driving a car or other vehicle. It may cause an accident.

- When the camera or accessories are not in use, make sure to remove the battery, and disconnect the power plug and connecting cables from the equipment before storing. This is to prevent electrical shock, excessive heat, fire, and corrosion.
- Do not use the equipment where there is flammable gas. This is to prevent an explosion or a fire.
- If you drop the equipment and the casing breaks open to expose the internal parts, do not touch the exposed internal parts. There is a possibility of an electrical shock.
- Do not disassemble or modify the equipment. High-voltage internal parts can cause electrical shock.
- Do not look at the sun or an extremely bright light source through the camera or lens. Doing so may damage your vision.
- Keep equipment out of the reach of children and infants, including when in use. Straps or cords may accidentally cause choking, electrical shock, or injury. Choking or injury may also occur if a child or infant accidentally swallows a camera part or accessory. If a child or infant swallows a part or accessory, consult a physician immediately.
- Do not use or store the equipment in dusty or humid places. Likewise, keep the battery away from metallic items and store it with its protective cover attached to prevent short-circuit. This is to prevent fire, excessive heat, electrical shock, and burns.
- Before using the camera inside an airplane or hospital, check if it is allowed. Electromagnetic waves emitted by the camera may interfere with the plane's instruments or the hospital's medical equipment.
- To prevent a fire and electrical shock, follow the safeguards below:
 - Always insert the power plug all the way in.
 - Do not handle a power plug with wet hands.
 - When unplugging a power plug, grasp and pull the plug instead of the cord.
 - Do not scratch, cut, or excessively bend the cord or put a heavy object on the cord. Also do not twist or tie the cords.
 - Do not connect too many power plugs to the same power outlet.
 - Do not use a cord whose wire is broken or insulation is damaged.
- Unplug the power plug periodically and clean off the dust around the power outlet with a dry cloth. If the surrounding is dusty, humid, or oily, the dust on the power outlet may become moist and short-circuit the outlet, causing a fire.
- Do not connect the battery directly to an electrical outlet or a car's cigarette lighter outlet. The battery may leak, generate excessive heat or explode, causing fire, burns, or injuries.
- A thorough explanation of how to use the product by an adult is required when the product is used by children. Supervise children while they are using the product. Incorrect usage may result in electrical shock or injury.
- Do not leave a lens or lens-attached camera in the sun without the lens cap attached. Otherwise, the lens may concentrate the sun's rays and cause a fire.
- Do not cover or wrap the product with a cloth when using it. Doing so may trap heat within and cause the casing to deform or catch fire.
- Be careful not to get the camera wet. If you drop the product in the water or if water or metal get inside the product, promptly remove the battery. This is to prevent fire, electrical shock, and burns.
- Do not use paint thinner, benzene, or other organic solvents to clean the product. Doing so may cause fire or a health hazard.



Cautions: Follow the cautions below. Otherwise, physical injury or property damage may result.

- Do not use or store the product in a high-temperature location such as inside a car under the hot sun. The product may become hot and cause burns. Doing so may also cause battery leakage or explosion, which will degrade the performance or shorten the life of the product.
- Do not carry the camera around when it is attached to a tripod. Doing so may cause an injury or an accident. Also make sure the tripod is sturdy enough to support the camera and lens.
- Do not leave the product in a low-temperature environment for an extended period of time. The product will become cold and may cause injury when touched.
- Do not fire the flash near the eyes. It may hurt the eyes.

Handling Precautions

Camera Care

- This camera is a precision instrument. Do not drop it or subject it to physical shock.
- The camera is not waterproof and cannot be used underwater. If you accidentally drop the camera into water, promptly consult the nearest Canon Service Center. Wipe off any water droplets with a dry and clean cloth. If the camera has been exposed to salty air, wipe it with a clean, well-wrung wet cloth.
- Never leave the camera near anything having a strong magnetic field such as a magnet or electric motor. Also, avoid using or leaving the camera near anything emitting strong radio waves, such as a large antenna. Strong magnetic fields can cause camera misoperation or destroy image data.
- Do not leave the camera in excessive heat, such as in a car in direct sunlight. High temperatures can cause the camera to malfunction.
- The camera contains precision electronic circuitry. Never attempt to disassemble the camera yourself.
- Do not block the built-in flash or mirror operation with your finger, etc. Doing so may cause a malfunction.
- Use only a commercially-available blower to blow away dust when it adheres to the lens, viewfinder, reflex mirror, focusing screen, etc. Do not use cleaners that contain organic solvents to clean the camera body or lens. For stubborn dirt, take the camera to the nearest Canon Service Center.
- Do not touch the camera's electrical contacts with your fingers. This is to prevent the contacts from corroding. Corroded contacts can cause camera malfunction.
- If the camera is suddenly brought in from the cold into a warm room, condensation may form on the camera and internal parts. To prevent condensation, first put the camera in a sealed plastic bag and let it adjust to the warmer temperature before taking it out of the bag.

- If condensation forms on the camera, do not use the camera. This is to avoid damaging the camera. If there is condensation, remove the lens, card and battery from the camera, and wait until condensation has evaporated before using the camera.
- If the camera will not be used for an extended period, remove the battery and store the camera in a cool, dry, well-ventilated location. Even while the camera is in storage, press the shutter button a few times once in a while to check that the camera is still working.
- Avoid storing the camera where there are chemicals that result in rust and corrosion such as in a chemical lab.
- If the camera has not been used for an extended period, test all its functions before using it. If you have not used the camera for some time or if there is an important shoot such as a foreign trip coming up, have the camera checked by your nearest Canon Service Center or check the camera yourself and make sure it is working properly.
- If you repeat continuous shooting or perform Live View shooting or movie shooting for a prolonged period, the camera may become hot. This is not a malfunction.
- If there is a bright light source inside or outside the image area, ghosting may occur.

LCD Panel and LCD Monitor

- Although the LCD monitor is manufactured with very high precision technology with over 99.99% effective pixels, 0.01% or fewer of the pixels may be dead, and there may also be spots of black, red, or other colors. Dead pixels are not a malfunction. They do not affect the images recorded.
- If the LCD monitor is left on for a prolonged period, screen burn-in may occur where you see remnants of what was displayed. However, this is only temporary and will disappear when the camera is left unused for a few days.
- The LCD monitor display may seem slightly slow in low temperatures, or look black in high temperatures. It will return to normal at room temperature.

Cards

To protect the card and its recorded data, note the following:

- Do not drop, bend, or wet the card. Do not subject it to excessive force, physical shock, or vibration.
- Do not touch the card's electronic contacts with your fingers or anything metallic.
- Do not affix any stickers, etc., on the card.
- Do not store or use the card near anything that has a strong magnetic field, such as a TV set, speakers, or magnets. Also avoid places prone to having static electricity.
- Do not leave the card in direct sunlight or near a heat source.
- Store the card in a case.
- Do not store the card in hot, dusty, or humid locations.

Smudges adhering to the front of the sensor

Besides dust entering the camera from outside, in rare cases, lubricant from the camera's internal parts may adhere to the front of the sensor. If smudges are visible on the images, having the sensor cleaned by a Canon Service Center is recommended.

Lens

After detaching the lens from the camera, put down the lens with the rear end up and attach the rear lens cap to avoid scratching the lens surface and electrical contacts.



Nomenclature

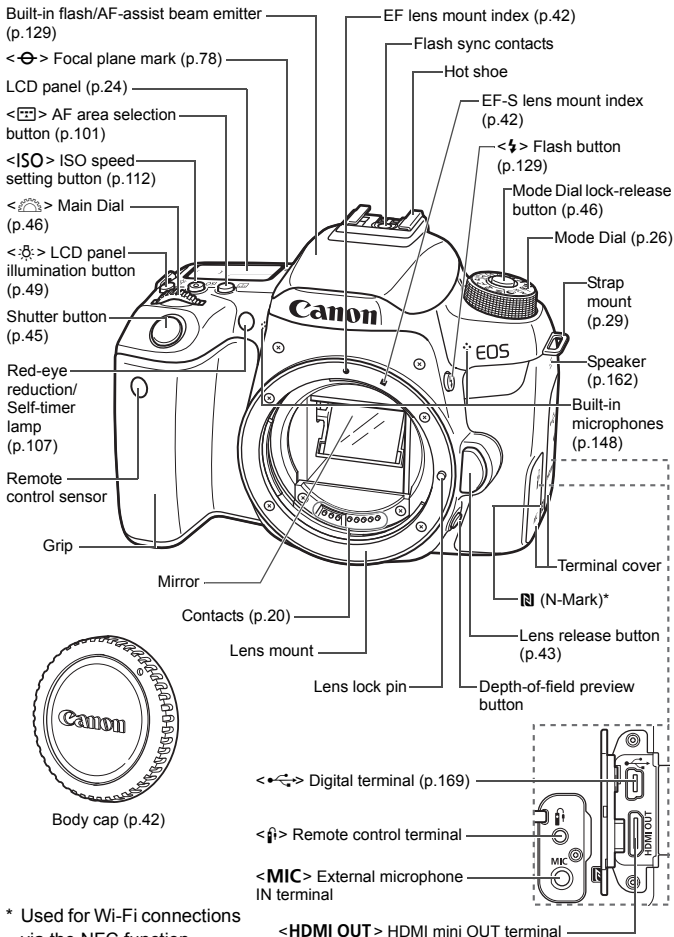

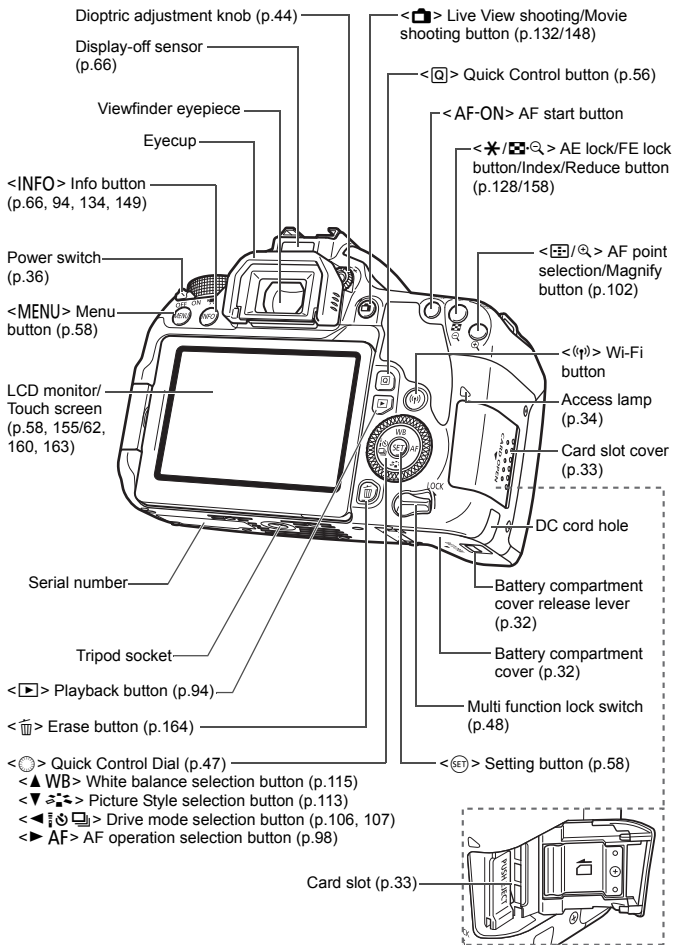

Quick Control Screen

(Example in the <P> mode with [: Shooting screen: Standard] set (p.56))

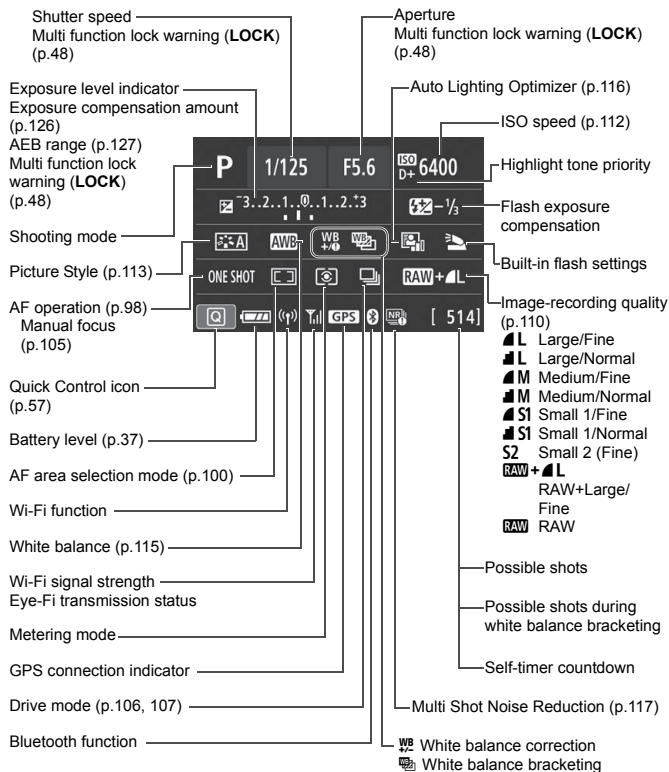

- The display will show only the settings currently applied.

LCD Panel

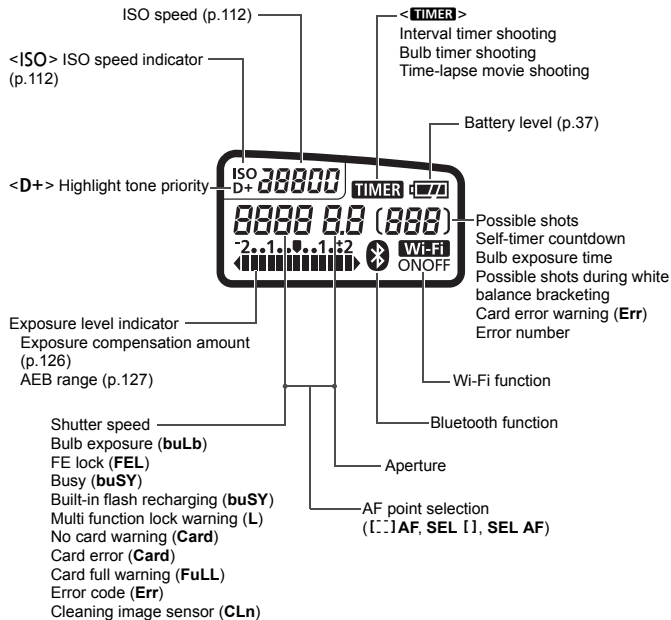

- The display will show only the settings currently applied.

Viewfinder Information

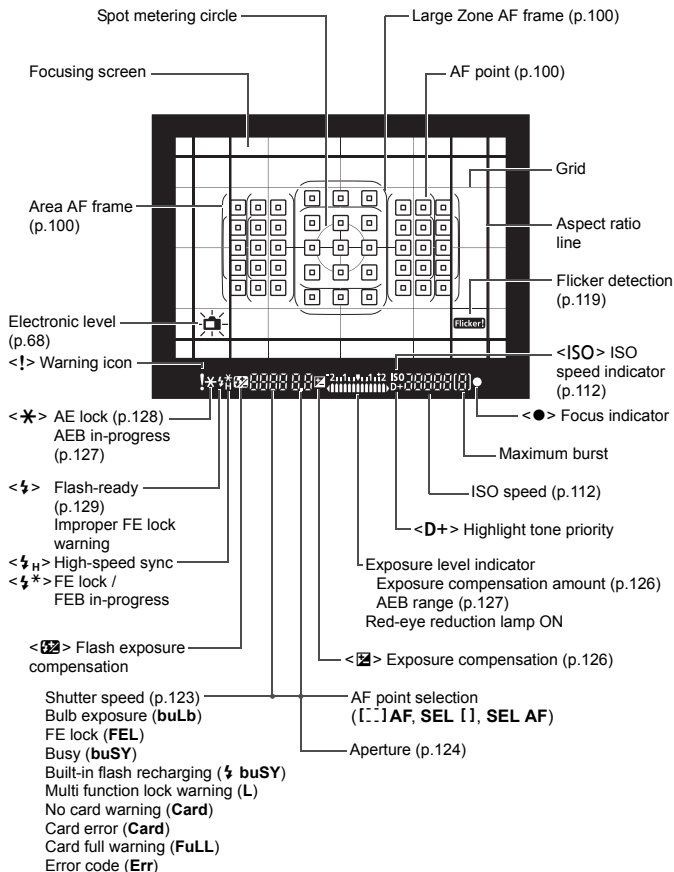

- The display will show only the settings currently applied.

Mode Dial

You can set the shooting mode. Turn the Mode Dial while holding down the Mode Dial center (Mode Dial lock release button).

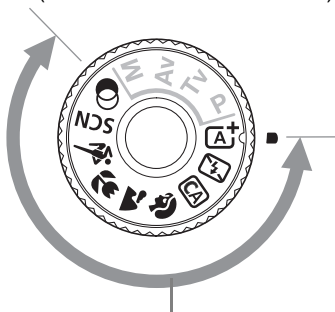

Basic Zone

All you do is press the shutter button. The camera sets everything to suit the subject or scene for shooting.

A+ : **Scene Intelligent Auto**
(p.70)

Flash Off (p.74)

CA : **Creative Auto** (p.75)

Portrait (p.76)

Landscape (p.77)

Close-up (p.78)

Sports (p.79)

SCN: Special scene (p.80)

	Group Photo (p.81)		Night Portrait (p.85)
	Kids (p.82)		Handheld Night Scene (p.86)
	Food (p.83)		HDR Backlight Control (p.87)
	Candlelight (p.84)		

: **Creative filters** (p.88)

	Grainy B/W		Miniature effect
	Soft focus		HDR art standard
	Fish-eye effect		HDR art vivid
	Water painting effect		HDR art bold
	Toy camera effect		HDR art embossed

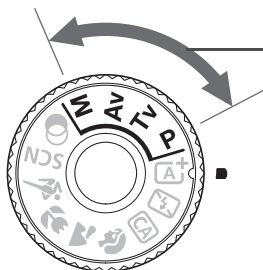

Creative Zone

These modes give you more control for shooting various subjects as desired.

P : Program AE (p.122)

Tv : Shutter-priority AE (p.123)

Av : Aperture-priority AE (p.124)

M : Manual exposure (p.125)

Battery Charger LC-E17

Charger for Battery Pack LP-E17 (p.30).

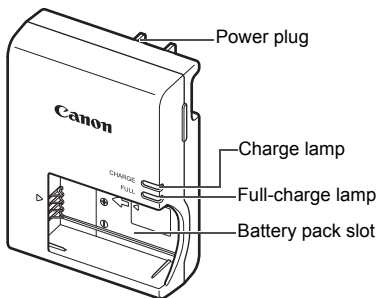

**IMPORTANT SAFETY INSTRUCTIONS-SAVE THESE INSTRUCTIONS.
DANGER-TO REDUCE THE RISK OF FIRE OR ELECTRIC SHOCK,
CAREFULLY FOLLOW THESE INSTRUCTIONS.**

For connection to a supply not in the U.S.A., use an attachment plug adapter of the proper configuration for the power outlet, if needed.

Battery Charger LC-E17E

Charger for Battery Pack LP-E17 (p.30).

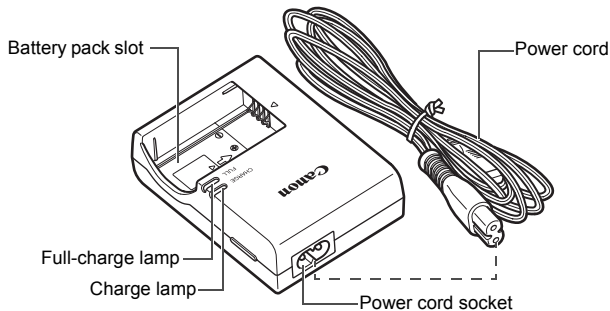

1

Getting Started and Basic Camera Operations

This chapter describes preparatory steps before you start shooting and the basic camera operations.

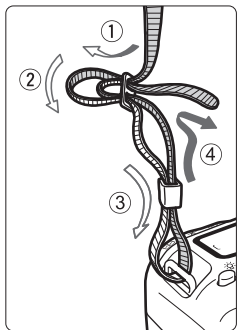

Attaching the Provided Strap

Pass the end of the strap through the camera's strap mount eyelet from the bottom. Then pass it through the strap's buckle as shown in the illustration. Pull the strap to take up any slack and make sure the strap will not loosen from the buckle.

- The eyepiece cover is also attached to the strap.

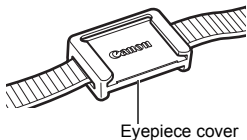

Charging the Battery

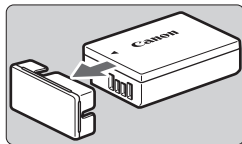

1 Remove the protective cover.

- Detach the protective cover provided with the battery.

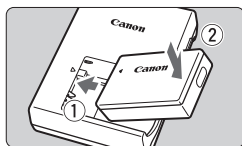

2 Attach the battery.

- As shown in the illustration, attach the battery securely to the charger.
- To detach the battery, follow the above procedure in reverse.

LC-E17

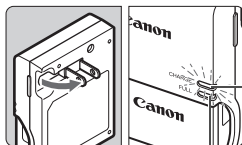

Full-charge lamp

Charge lamp

3 Recharge the battery.

For LC-E17

- As shown by the arrow, flip out the battery charger's prongs and insert the prongs into a power outlet.

For LC-E17E

- Connect the power cord to the charger and insert the plug into a power outlet.

LC-E17E

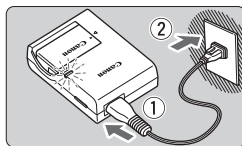

- ▶ Recharging starts automatically and the charge lamp lights up in orange.
- ▶ When the battery is fully recharged, the full-charge lamp will light up in green.

- **It takes approx. 2 hours to fully recharge a completely exhausted battery at room temperature (23°C / 73°F).** The time required to recharge the battery will vary greatly depending on the ambient temperature and the battery's remaining capacity.
- For safety reasons, recharging in low temperatures (5°C - 10°C / 41°F - 50°F) will take longer (up to approx. 4 hr.).



Tips for Using the Battery and Charger

- **Upon purchase, the battery is not fully charged.**
Charge the battery before use.
 - **Recharge the battery on the day before or on the day it is to be used.**
Even during storage, a charged battery will gradually drain and lose its capacity.
 - **After recharging the battery, detach it and disconnect the charger from the power outlet.**
 - **When not using the camera, remove the battery.**
If the battery is left in the camera for a prolonged period, a small amount of power current will keep released, resulting in excess discharge and shorter battery life. Store the battery with the protective cover (provided) attached. Storing the battery when it is fully charged may lower the battery performance.
 - **The battery charger can also be used in foreign countries.**
The battery charger is compatible with a 100 V AC to 240 V AC 50/60 Hz power source. If necessary, attach a commercially-available plug adapter for the respective country or region. Do not attach any portable voltage transformer to the battery charger. Doing so may damage the battery charger.
 - **If the battery becomes exhausted quickly even after having been fully charged, the battery has reached the end of its service life.**
Check the battery's recharge performance and purchase a new battery.
-
- After disconnecting the charger's power plug, do not touch the prongs for approx. 5 sec.
 - Do not charge any battery other than a Battery Pack LP-E17.
 - Battery Pack LP-E17 is dedicated to Canon products only. Using it with an incompatible battery charger or product may result in malfunction or accidents for which Canon cannot be held liable.

Installing and Removing the Battery

Load a fully charged Battery Pack LP-E17 into the camera. The camera's viewfinder becomes bright when a battery is installed, and darkens when the battery is removed. If the battery is not installed, the image in the viewfinder becomes blurred and you cannot perform focusing.

Installing the Battery

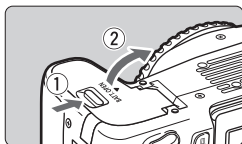

1 Open the cover.

- Slide the lever as shown by the arrows and open the cover.

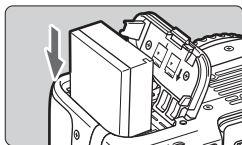

2 Insert the battery.

- Insert the end with the electrical contacts.
- Insert the battery until it locks in place.

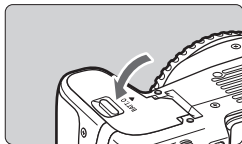

3 Close the cover.

- Press the cover until it snaps shut.

Removing the Battery

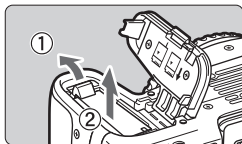

Open the cover and remove the battery.

- Press the battery lock lever as shown by the arrow and remove the battery.
- To prevent short circuiting, be sure to attach the provided protective cover (p.30) to the battery.

Installing and Removing the Card

You can use an SD, SDHC, or SDXC memory card (sold separately) with the camera. SDHC and SDXC memory cards with UHS-I can also be used. The captured images are recorded onto the card.

- Make sure the card's write-protect switch is set upward to enable writing and erasing.

Installing the Card

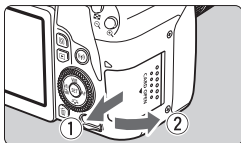

1 Open the cover.

- Slide the cover as shown by the arrows to open it.

Write-protect switch

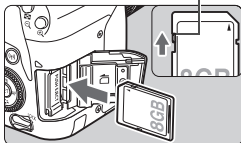

2 Insert the card.

- As shown by the illustration, face the card's label side toward you and insert it until it clicks in place.

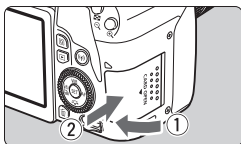

3 Close the cover.

- Close the cover and slide it in the direction shown by the arrows until it snaps shut.
- When you set the power switch to <ON>, the number of possible shots will be displayed on the LCD panel.

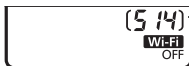

Possible shots

Removing the Card

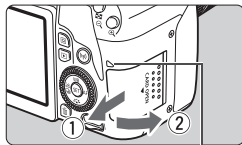

Access lamp

1 Open the cover.

- Set the power switch to <OFF>.
- **Check that the access lamp is off, then open the cover.**
- If [Recording...] is displayed, close the cover.

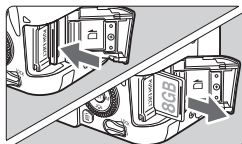

2 Remove the card.

- Gently push in the card, then let it go to eject.
- Pull the card straight out, then close the cover.

! When the access lamp is lit or blinking, it indicates that images are being written to, read from, or erased from the card, or data is being transferred. Do not open the card slot cover during this time.

Also, never do any of the following while the access lamp is lit or blinking. Otherwise, it can damage the image data, card, or camera.

- Removing the card.
- Removing the battery.
- Shaking or banging the camera around.
- Unplugging and connecting a power cord (when household power outlet accessories (sold separately) are used).

Using the LCD Monitor

After you flip out the LCD monitor, you can set menu functions, use Live View shooting, shoot movies, or play back photos and movies. You can change the direction and angle of the LCD monitor.

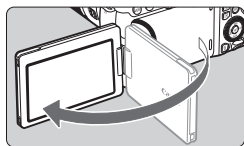

1 Flip out the LCD monitor.

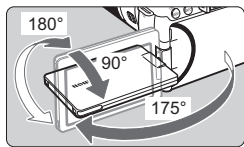

2 Rotate the LCD monitor.

- When the LCD monitor is swung out, you can rotate it up, down, or over 180° to face the subject.
- The indicated angle is only approximate.

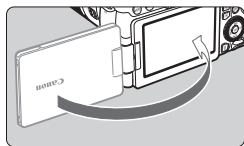

3 Face it toward you.

- Normally, use the camera with the LCD monitor facing you.

Turning on the Power

If you turn on the power switch and the date/time/zone setting screen appears, see page 38 to set the date/time/zone.

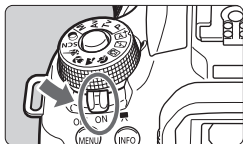

- < > : The camera turns on. You can shoot movies (p.148).
- < ON > : The camera turns on. You can shoot still photos.
- < OFF > : The camera is turned off and does not function. Set the power switch to this position when not using the camera.

Automatic Sensor Cleaning

- Whenever you set the power switch to <ON> or <OFF>, sensor cleaning will be performed automatically. (A small sound may be heard.) During the sensor cleaning, the LCD monitor will display < >.
- Even during the sensor cleaning, if you press the shutter button halfway (p.45), cleaning operation will be stopped, and you can take a picture immediately.
- If you repeatedly turn the power switch <ON>/<OFF> at a short interval, the < > icon may not be displayed. This is normal and not a malfunction.





MENU Auto Power Off

To save battery power, if the camera is not operated for a prolonged period, the power will turn off automatically after the time set under [**2**: **Auto power off**] (p.155). To turn on the camera again, just press the shutter button halfway (p.45).

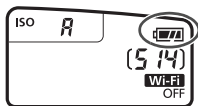
Battery Level Indicator

When the power is turned on, the battery level will be indicated in one of the four levels.



-  : Battery level is sufficient.
-  : Battery level is low, but the camera can still be used.
-  : Battery will be exhausted soon. (Blinks)
-  : Recharge the battery.

Number of Possible Shots with Viewfinder Shooting

(Approx. number of shots)

Temperature	Room Temperature (23°C / 73°F)	Low Temperatures (0°C / 32°F)
No Flash	820	770
50% Flash Use	600	550

- The figures above are based on a fully-charged Battery Pack LP-E17, no Live View shooting, and CIPA (Camera & Imaging Products Association) testing standards.

MENU Setting the Date, Time, and Zone

When you turn on the power for the first time or if the date/time/zone have been reset, the date/time/zone setting screen will appear. Follow the steps below to set the time zone first. Set the camera to the time zone in which you currently live so that, when you travel, you can simply change the setting to the correct time zone for your destination, and the camera will automatically adjust the date/time.

Note that the date/time appended to recorded images will be based on this date/time setting. Be sure to set the correct date/time.



1 Display the menu screen.

- Press the <MENU> button to display the menu screen.

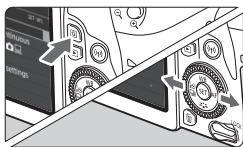

2 Under the [F2] tab, select [Date/Time/Zone].

- Press the <Q> button and select the [F2] tab.
- Press the <◀> <▶> keys to select the [F2] tab.
- Press the <▲> <▼> keys to select [Date/Time/Zone], then press <SET>.

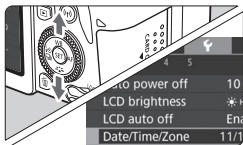

3 Set the time zone.

- [London] is set by default.
- Press the <◀> <▶> keys to select [Time zone], then press <SET>.

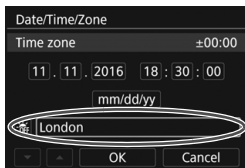

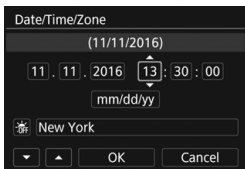
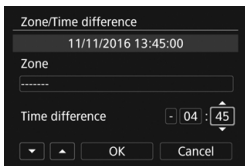
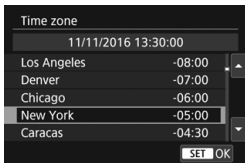
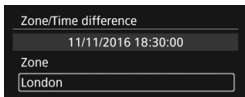

- Press <SET> again.
- Press the <▲> <▼> keys to select the time zone, then press <SET>.
- If your desired time zone is not listed, press the <MENU> button, then proceed to the next step to set it (with the time difference from the Coordinated Universal Time, UTC).
- To set the time difference from UTC, press the <◀> <▶> keys to select a parameter (+/-/hour/minute) for [Time difference].
- Press <SET> so <□> is displayed.
- Press the <▲> <▼> keys to set it, then press <SET>. (Returns to <□>.)
- After entering the time zone or time difference, press the <◀> <▶> keys to select [OK], then press <SET>.

4 Set the date and time.

- Press the <◀> <▶> keys to select the number.
- Press <SET> so <□> is displayed.
- Press the <▲> <▼> keys to set it, then press <SET>. (Returns to <□>.)

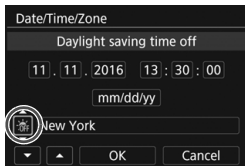

5 Set the daylight saving time.

- Set it if necessary.
- Press the <◀> <▶> keys to select [].
- Press <SET> so <☰> is displayed.
- Press the <▲> <▼> keys to select [], then press <SET>.
- When the daylight saving time is set to [], the time set in step 4 will advance by 1 hour. If [] is set, the daylight saving time will be canceled and the time will go back by 1 hour.

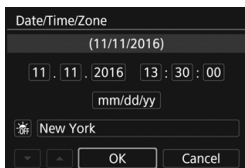

6 Exit the setting.

- Press the <◀> <▶> keys to select [OK], then press <SET>.
- ▶ The date/time/zone and daylight saving time will be set and the menu will reappear.

MENU Selecting the Interface Language



1 Display the menu screen.

- Press the <MENU> button to display the menu screen.

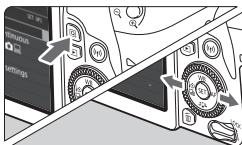

2 Under the [2] tab, select [Language].

- Press the <Q> button and select the [2] tab.
- Press the <◀> <▶> keys to select the [2] tab.
- Press the <▲> <▼> keys to select the [Language], then press <SET>.

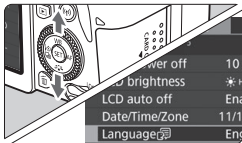

3 Set the desired language.

- Press the <▲> <▼> keys to select the language, then press <SET>.
- ▶ The interface language will change.

English	Norsk	Română
Deutsch	Svenska	Türkçe
Français	Español	العربية
Nederlands	Ελληνικά	עברית
Dansk	Русский	简体中文
Português	Polski	繁體中文
Suomi	Čeština	한국어
Italiano	Magyar	日本語
Українська		SET OK

Attaching and Detaching a Lens

The camera is compatible with all Canon EF and EF-S lenses. **Note that you cannot use the EF-M lenses.**

Attaching a Lens

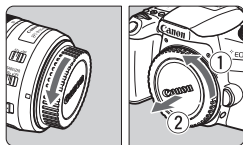

1 Remove the caps.

- Remove the rear lens cap and the body cap by turning them as shown by the arrows.

White index

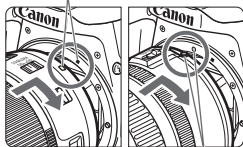

2 Attach the lens.

- Align the lens's red or white index with the camera's index matching the same color. Turn the lens as shown by the arrow until it clicks in place.

Red index

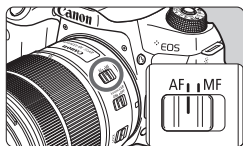

3 Set the lens's focus mode switch to <AF>.

- <AF> stands for autofocus.
- <MF> stands for manual focus.

4 Remove the front lens cap.

Tips for Avoiding Smudges and Dust

- When changing lenses, do it quickly in a place with minimal dust.
- When storing the camera without a lens attached, be sure to attach the body cap to the camera.
- Remove dust on the body cap before attaching it.

Zooming

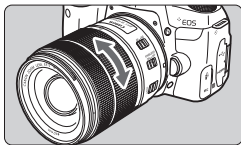

Turn the zoom ring on the lens with your fingers.

- If you want to zoom, do it before focusing. Turning the zoom ring after achieving focus may throw off the focus.

Detaching the Lens

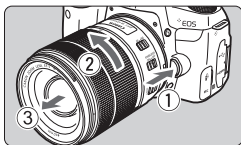

While pressing the lens release button, turn the lens as shown by the arrow.

- Turn the lens until it stops, then detach it.
- Attach the rear lens cap to the detached lens.



Do not look at the sun directly through any lens. Doing so may cause loss of vision.

Basic Shooting Operations

Adjusting the Viewfinder Clarity

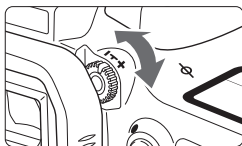

Turn the dioptic adjustment knob.

- Turn the knob left or right so that the AF points in the viewfinder look sharp.
- If the knob is difficult to turn, remove the eyecup.

Holding the Camera

To obtain sharp images, hold the camera still to minimize camera shake.

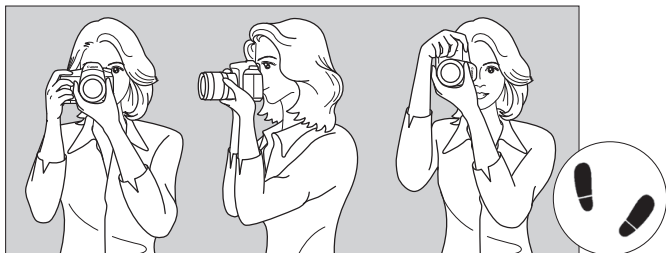

Horizontal shooting

Vertical shooting

1. Wrap your right hand around the camera grip firmly.
2. Hold the lens bottom with your left hand.
3. Rest your right index finger lightly on the shutter button.
4. Press your arms and elbows lightly against the front of your body.
5. To maintain a stable stance, place one foot slightly ahead of the other.
6. Press the camera against your face and look through the viewfinder.

Shutter Button

The shutter button has two steps. You can press the shutter button halfway. Then you can further press the shutter button completely.

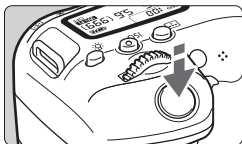

Pressing Halfway

This activates autofocus and the automatic exposure system that sets the shutter speed and aperture.

The exposure setting (shutter speed and aperture) is displayed in the viewfinder and on the LCD panel (ⓘ4).

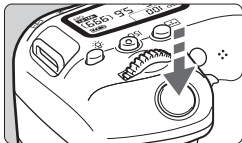

Pressing Completely

This releases the shutter and takes the picture.

Preventing Camera Shake

Hand-held camera movement during the moment of exposure is called camera shake. It can cause blurred pictures. To prevent camera shake, note the following:

- Hold and steady the camera as shown on the preceding page.
- Press the shutter button halfway to autofocus, then slowly press the shutter button completely.

Mode Dial

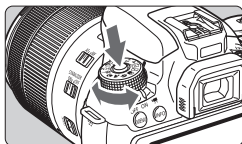

Turn the dial while holding down the lock release button at the center of the dial.

Use it to set the shooting mode.



Main Dial

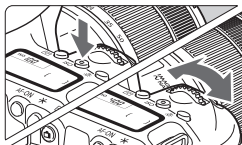

- (1) After pressing a button, turn the <gear> dial.**

After pressing a button such as <ISO> <▲ WB> <▼ > <◀ > <▶ AF>, turn the <gear> dial to change the setting. For the <ISO> button, the function remains selected for approx. 6 sec. (6) after pressing the button.

When the timer ends or if you press the shutter button halfway, the camera will go back to shooting-ready state.

- Use this dial to select or set the ISO speed, white balance, Picture Style, drive mode, AF operation, AF point, etc.

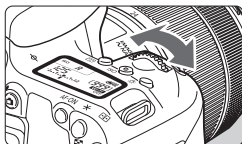



- (2) Turn only the <gear> dial.**

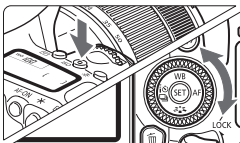

While looking at the viewfinder display or LCD panel, turn the <gear> dial to change the setting.

- Use this dial to set the shutter speed, aperture, etc.

Quick Control Dial



- (1) **After pressing a button, turn the  dial.**

After pressing a button such as **<ISO>** **<▲ WB>** **<▼ >** **<◀ >** **<▶ AF>**, turn the  dial to change the setting. For the **<ISO>** button, the function remains selected for approx. 6 sec. (Ⓜ6) after pressing the button.

When the timer ends or if you press the shutter button halfway, the camera will go back to shooting-ready state.

- Use this dial to select or set the ISO speed, white balance, Picture Style, drive mode, AF operation, AF point, etc.



- (2) **Turn only the  dial.**

While looking at the viewfinder display or LCD panel, turn the  dial to change the setting.

- Use this dial to set the exposure compensation amount, the aperture setting for manual exposures, etc.

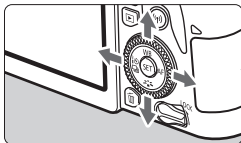

- (3) **After pressing a button, press the **<▲>**, **<▼>**, **<◀>**, or **<▶>** key.**

After pressing the **<MENU>** or **<Q>** button, press the **<▲>** **<▼>** or **<◀>** **<▶>** keys to set menus or Quick Control functions.

LOCK Multi Function Lock

With [**F4**: Multi function lock] set and the <LOCK> switch set upward, you can prevent the settings from being changed by accidentally operating Main Dial or Quick Control Dial or by inadvertently tapping on the touch screen.

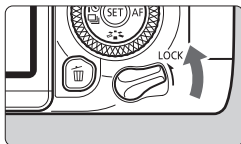

<LOCK> switch set downward:

Lock released

<LOCK> switch set upward:

Lock engaged

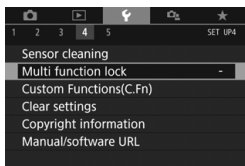

1 Select [Multi function lock].

- Under the [**F4**] tab, select [**Multi function lock**], then press <SET>.





2 Add a checkmark [✓] to the camera control to be locked.

- Select a camera control and press <SET> to add a checkmark [✓].
- Select [**OK**].
- ▶ The selected camera controls will be locked when the multi function lock switch is set in the locked position.

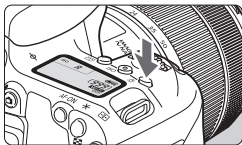
LCD Panel Illumination



You can illuminate the LCD panel by pressing the  button. Turn on () or off the LCD panel illumination by pressing the  button.

Displaying the Quick Control Screen

After you press the **<INFO>** button a number of times, the Quick Control screen will appear. You can then check the current shooting function settings.

Pressing the **<Q>** button enables Quick Control of the shooting function settings (p.56).

Press the **<INFO>** button again to turn off the display.

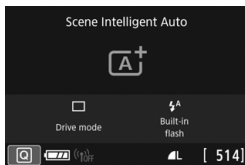

MENU Setting the Screen Display Level

You can set how information is displayed on the screen according to your preference. Change the settings as necessary.



1 Display the menu screen.

- Press the <MENU> button to display the menu screen.

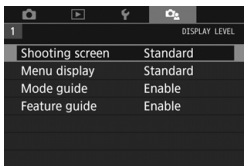

2 Select the [📷] tab.

- Press the <Q> button and select the [📷] tab.

Shooting Screen

You can select [**Standard**] or [**Guided**] (friendly display) for the Quick Control screen in viewfinder shooting. By default, it is set to [**Standard**].

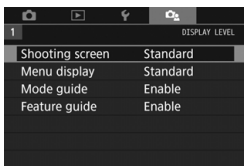

1 Select [**Shooting screen**].

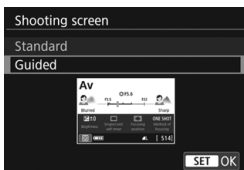

2 Select the display method.

● **Sample Screens**

<[CA]>: Standard

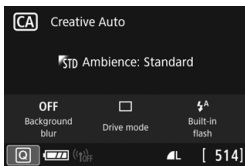

<[CA]>: Guided

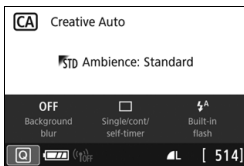

<[Av]>: Standard



<[Av]>: Guided

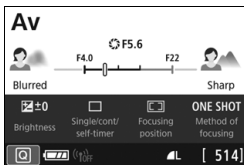

 In Creative Zone modes, when **[Guided]** is set, only the functions particular to the set shooting mode are displayed on the Quick Control screen. Note that items that cannot be set from the Quick Control screen when **[Guided]** is selected can be set via the menu screen (p.59).

Menu Display

You can select the display method from [**Standard**] or [**Guided**]. If you set [**Guided**], main tab descriptions are provided when you press the <MENU> button. If you set [**Standard**], you proceed directly to the menu screen when you press the <MENU> button. By default, it is set to [**Standard**].

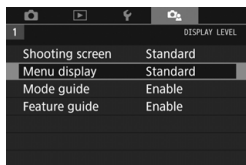

1 Select [Menu display].

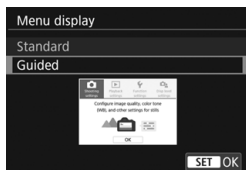

2 Select the display method.

Main tabs

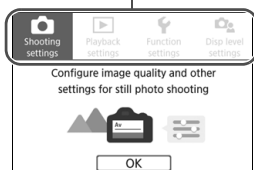

When [**Guided**] is set, the [**★** (My Menu)] tab does not appear. To set My Menu, change the menu display level to [**Standard**].

Shooting Mode Guide

You can display the description of the shooting mode (mode guide) when switching the shooting mode during viewfinder shooting. By default, it is set to **[Enable]**.

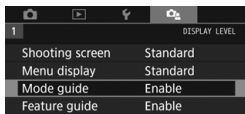

1 Select **[Mode guide]**.

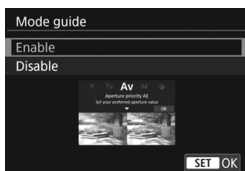

2 Select **[Enable]**.

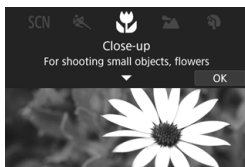

3 Turn the Mode Dial.

- ▶ A description of the selected shooting mode will appear.

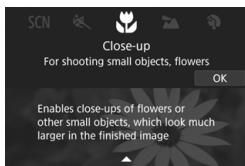

4 Press the **<▼>** key.

- ▶ The rest of the description will appear.
- When you press **<SET>**, the description will disappear and the Quick Control screen will appear.
- In the **<SCN>** and **<Q>** shooting modes, the shooting mode selection screen will appear.



In step 3 and step 4, if you tap on **[OK]** or press the shutter button halfway, the description will disappear and the Quick Control screen will appear.

Feature Guide

When using Quick Control or setting menu items, you can display a brief description of functions and options (feature guide). By default, it is set to **[Enable]**.

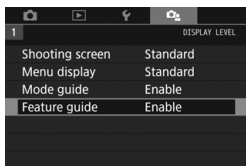

1 Select **[Feature guide]**.

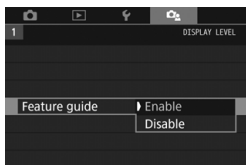

2 Select **[Enable]**.

● Sample Screens

Quick Control screen



Menu screen

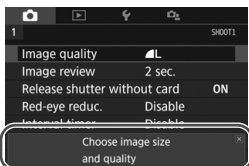

Feature guide

The description will disappear when you tap on it or proceed with the operation.

Shooting Tips

Shooting tips appear when [Shooting screen] is set to [Guided] (p.50) and the camera setting is in any of the following cases. In Basic Zone modes, shooting tips appear regardless of the [Shooting screen] setting.

- To further blur the background (with the lowest aperture value set in the <Av> mode).
- The image is likely to be overexposed.
- The image is likely to be underexposed.
- Camera shake is likely to occur (only in Basic Zone modes).

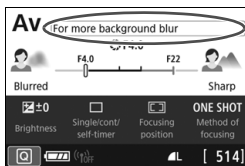

1 Tap on the area within the frame.

- ▶ The shooting tips will appear.
- You can also display the shooting tips by pressing the <⏏> button.

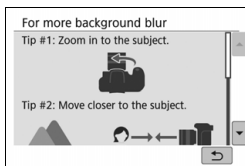

2 Check the shooting tips.

- You can scroll up and down by tapping on the screen.
- You can also scroll by pressing the <▲> <▼> keys.

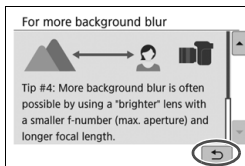

3 Tap on [⏏].

- ▶ Shooting tips will disappear, and the screen in step 1 will reappear.
- You can also hide the shooting tips by pressing <SET>.

Q Quick Control for Shooting Functions

You can directly select and set the shooting functions displayed on the LCD monitor with intuitive operations. This is called Quick Control.

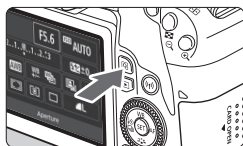

1 Press the <Q> button (10).

- ▶ The Quick Control screen will appear.

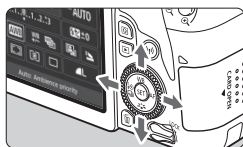

2 Set the desired functions.

- Press the <▲> <▼> or <◀> <▶> keys to select a function.
- ▶ The settings of the selected function and Feature guide (p.54) will appear.
- Turn the <☀> or <☺> dial to change the setting.

Basic Zone modes

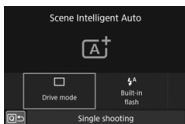

Creative Zone modes

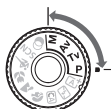

3 Take the picture.

- Press the shutter button completely to take the picture.
- ▶ The captured image will be displayed.

Sample Quick Control Screen

● When [: Shooting screen: Standard] is Set

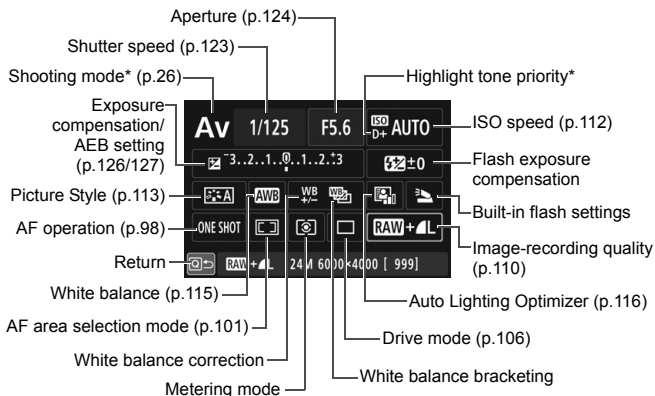

* These functions cannot be set with Quick Control.

● When [: Shooting screen: Guided] is Set

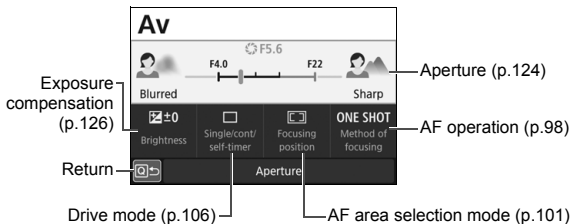

MENU Menu Operations and Configurations

You can configure various settings with the menus such as the image-recording quality, date/time, etc.

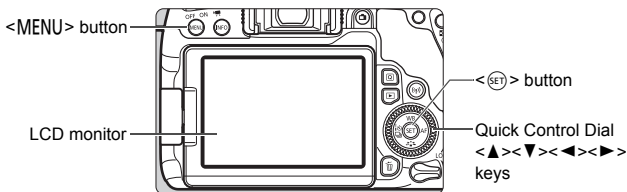

Menu Screen

The menu tabs and items displayed vary depending on the shooting mode.

Basic Zone modes

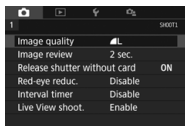

Movie shooting

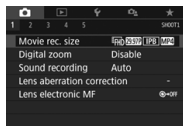

Creative Zone modes

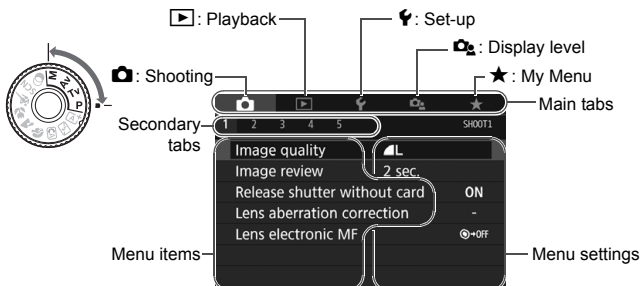

Menu Setting Procedure

- When [MENU: Menu display: Standard] is Set

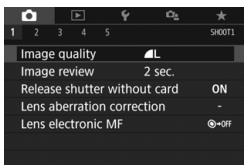

1 Display the menu screen.

- Press the <MENU> button to display the menu screen.

2 Select a tab.

- Each time you press the <Q> button, the main tab (group of functions) will switch.
- Press the Quick Control Dial's <◀> <▶> keys to select a secondary tab.
- For example, in this manual, the [CAMERA 3] tab refers to the screen displayed when the CAMERA (Shooting) tab's [3] is selected.

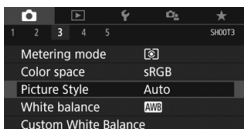

3 Select the desired item.

- Press the Quick Control Dial's <▲> <▼> keys to select the item, then press <SET>.



4 Select the setting.

- Press the Quick Control Dial's <▲> <▼> or <◀> <▶> keys to select the desired setting. (Some settings are selected with the <▲> and <▼> keys, and others are selected with the <◀> and <▶> keys.)
- The current setting is indicated in blue.

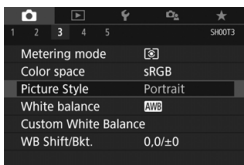

5 Set the setting.

- Press <SET> to set it.
- ▶ If you change the setting from the default, it will be indicated in blue (available only for the menu items under the [CAMERA] tab).

6 Exit the setting.

- Press the <MENU> button to exit the menu and return to shooting-ready state.

- In step 2, you can also turn the <☀> dial to select a menu tab. In step 4, you can also turn the <☀> dial to select certain settings.
- In steps 2 to 6, you can also tap on the LCD monitor to perform the operation (p.62).
- The description of menu functions hereafter assumes that you have pressed the <MENU> button to display the menu screen.
- To cancel the operation, press the <MENU> button.

● When [☑ : Menu display: Guided] is Set

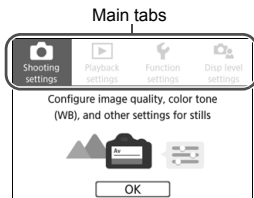

1 Display the main tabs.

- When you press the <MENU> button, the main tabs and a description of the selected tab will appear.

2 Select a main tab.

- Each time you press the Quick Control Dial's <◀> <▶> keys, the main tab (group of functions) will switch.

3 Display the menu screen.

- Press <SET> to display the menu screen.
- To return to the main tab screen, press the <MENU> button.

- In step 2, you can also use the <☀> dial or the <Q> button.
- You can also go to the menu screen by tapping on [OK] in step 3.

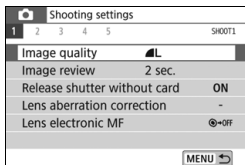

4 Select a secondary tab.

- Press the Quick Control Dial's <◀> <▶> keys to select a secondary tab.
- For example, in this manual, the [📷3] tab refers to the screen displayed when the 📷 (Shooting) tab's [3] is selected.
- The subsequent operations are the same as those for [📷: Menu display: Standard]. See the steps on page 59, starting with step 3.
- To exit the setting, press the <MENU> button twice.

Operating the Camera with Touch Screen

You can operate the camera by tapping on the LCD monitor (touch-sensitive panel) with your fingers.

Tap

Sample Screen (Quick Control)



- Use your finger to tap on (touch briefly and then remove your finger from) the LCD monitor.
- By tapping, you can select menus, icons, etc., displayed on the LCD monitor.
- For example, when you tap on [Q], the Quick Control screen appears. By tapping on [Q↔], you can return to the preceding screen.

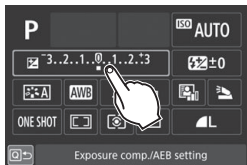

Operations possible by tapping on the screen

- Setting menu functions after pressing the <MENU> button
- Quick Control
- Setting functions after pressing the <MFn>, <ISO>, <Fn>, <▲WB>, <▼WB>, <◀AF-ON/AF-ON/AF-ON>, or <▶AF> button
- Touch AF and touch shutter in Live View shooting
- AF point selection in movie shooting
- Setting functions in Live View shooting and movie shooting
- Playback operations

Drag

Sample Screen (Menu screen)

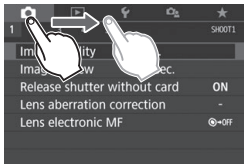

- Slide your finger while touching the LCD monitor.

Sample Screen (Scale display)

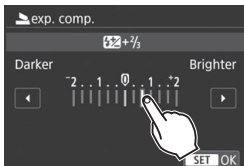

Operations possible by dragging your finger on the screen

- Selecting a menu tab or item after pressing the <MENU> button
- Setting with scale display
- Quick Control
- Selecting AF points
- Setting functions in Live View shooting and movie shooting
- Playback operations

MENU Setting the Touch Control Response

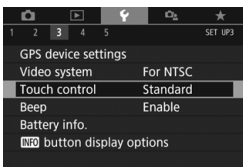

1 Select [Touch control].

- Under the [**3**] tab, select [**Touch control**], then press < **SET** >.



2 Set the touch control response setting.

- Select the desired setting, then press < **SET** >.
- [**Standard**] is the normal setting.
- [**Sensitive**] provides a more reactive touch screen response than [**Standard**]. Try using both settings and select the one you prefer.
- To disable touch operations, select [**Disable**].

⚠ Cautions for Touch Control Operations

- Since the LCD monitor is not pressure sensitive, do not use any sharp objects, such as your fingernail or a ballpoint pen, for touch operations.
- Do not use wet fingers for touch operations.
- If the LCD monitor has any moisture or if your fingers are wet, the touch screen may not respond or malfunction may occur. In such a case, turn off the power and wipe off the moisture with a cloth.
- Attaching any commercially-available protective sheet or sticker on the LCD monitor may degrade the touch operation response.
- If you quickly perform touch operation when [**Sensitive**] is set, the touch operation response may be slower.

MENU Formatting the Card

If the card is new or was previously formatted by another camera or computer, format the card with this camera.

! When the card is formatted, all images and data on the card will be erased. Even protected images will be erased, so make sure there is nothing you need to keep. If necessary, transfer the images and data to a computer, etc., before formatting the card.

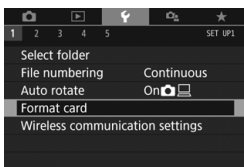

1 Select [Format card].

- Under the [1] tab, select [Format card], then press <SET>.

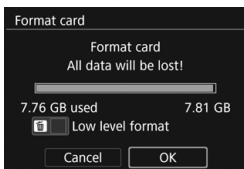

2 Format the card.

- Select [OK], then press <SET>.
 - ▶ The card will be formatted.
 - ▶ When the formatting is complete, the menu will reappear.
- For low-level formatting, press the <✓> button to add a checkmark <✓> to [Low level format], then select [OK].

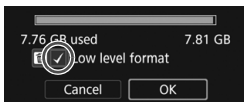

Switching the LCD Monitor Display

The LCD monitor can display the Quick Control screen, menu screen, captured images, etc.

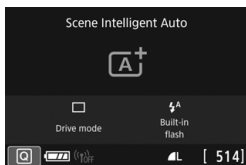

- When you turn on the power, the Quick Control screen will appear. You can then check the current shooting function settings.
- When your eye is near the viewfinder, the display-off sensor (p.22) will turn off the LCD monitor to prevent glare. When your eye leaves the viewfinder, the LCD monitor will turn on again.
- By pressing the <INFO> button, you can switch the LCD monitor screen as follows: Display the electronic level, display the Quick Control screen, and turn off the LCD monitor screen.

Menu Functions

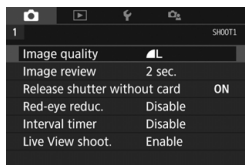

- Appears when you press the <MENU> button. Press the button again to return to the previous screen.

Captured Image



- Appears when you press the <▶> button. Press the button again to return to the previous screen.

MENU Displaying the Electronic Level

You can display the electronic level on the LCD monitor and in the viewfinder to help you correct the camera tilt. Note that you can check only the horizontal tilt and not the forward/backward tilt.

Displaying the Electronic Level on the LCD Monitor

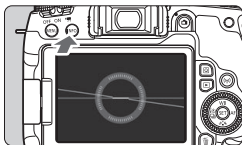

1 Press the <INFO> button.

- Each time you press the <INFO> button, the screen display will change.
- Display the electronic level.
- If the electronic level does not appear, set [**43**: **INFO** button display options] so that the electronic level can be displayed.

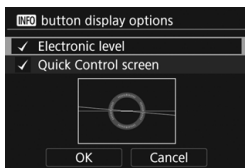

Horizontal level



2 Check the camera's tilt.

- The horizontal tilt is displayed in 1° increments. The tilt scale is marked in 5° increments.
- When the red line turns green, it indicates that the tilt is almost corrected.

Displaying the Electronic Level in the Viewfinder

A simple electronic level using a camera icon can be displayed in the viewfinder. Since this indicator is displayed during shooting, you can take the picture while checking the camera tilt.

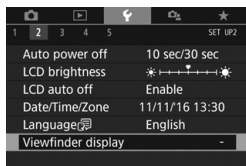

1 Select [Viewfinder display].

- Under the [2] tab, select [Viewfinder display], then press <SET>.

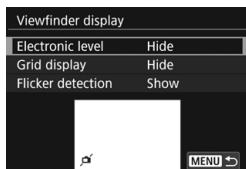

2 Select [Electronic level].



3 Select [Show].

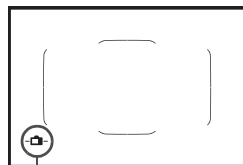

Electronic level

4 Press the shutter button halfway.

- The electronic level will appear at the position shown in the illustration.



- This level also works with vertical shooting.

2

Basic Shooting and Image Playback

This chapter describes how to use the Basic Zone modes on the Mode Dial for best results and how to play back images.

With Basic Zone modes, all you do is point and shoot, and the camera sets everything automatically (p.91). Also, because advanced shooting function settings cannot be changed, you can enjoy shooting photographs without worrying about botched pictures due to misoperation.

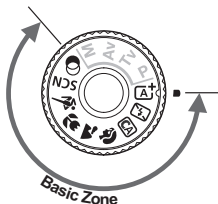
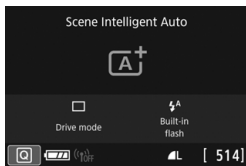

Before Shooting in the <SCN> or <A+> Mode

When the LCD monitor is turned off, press the <Q> button or <INFO> button (p.80, 88) to check which shooting mode is set before shooting.

- * <SCN>: Special scene
- * <A+> : Creative filters

[A⁺] Fully Automatic Shooting (Scene Intelligent Auto) ■

<[A⁺]> is a fully automatic mode. The camera analyzes the scene and sets the optimum settings automatically. It can also adjust focus automatically on either the still or moving subject by detecting the motion of the subject (p.73).



1 Set the Mode Dial to <[A⁺]>.

- Turn the Mode Dial while holding down the lock release button at the center.

Area AF frame



2 Aim the Area AF frame over the subject.

- All the AF points will be used to focus, and the camera will focus on the closest object.
- Aiming the center of the Area AF frame over the subject will make focusing easier.

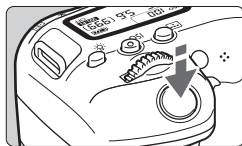

3 Focus on the subject.

- Press the shutter button halfway. The lens elements will shift to focus.
- ▶ When achieving focus, the AF point that has achieved focus will be displayed. At the same time, the beeper will sound and the focus indicator <●> in the viewfinder will light up.
- ▶ In low light, the AF point(s) will light up briefly in red.
- ▶ If necessary, the built-in flash will be raised automatically.



Focus indicator

If a description of the shooting mode appears in step 1, press <[SET]> to hide it (p.53).



4 Take the picture.

- Press the shutter button completely to take the picture.
- ▶ The captured image will be displayed for approx. 2 sec. on the LCD monitor.
- When you finish shooting, push down the built-in flash with your fingers.



The **A⁺** mode makes the colors look more impressive in nature, outdoor, and sunset scenes. If you do not obtain the desired color tones, change the mode to a Creative Zone mode and select a Picture Style other than **A**, then shoot again (p.113).



FAQ

- **The focus indicator <●> blinks and focus is not achieved.**
 - Aim the Area AF frame over an area with good contrast, then press the shutter button halfway (p.45).
 - If you are too close to the subject, move away and shoot again.
 - Change the AF area selection mode and shoot again (p.100). The default setting is Automatic selection AF.
- **When focus is achieved, the AF points do not light up in red.**
The AF points light up in red only when focus is achieved in low light or with a dark subject.
- **Multiple AF points light up simultaneously.**
Focus has been achieved at all those points. You can take the picture as long as an AF point covering the target subject is lighting up.

- **The beeper continues to beep softly. (The focus indicator <●> does not light up.)**

It indicates that the camera is focusing continuously on a moving subject. (The focus indicator <●> does not light up.) You can take sharp pictures of a moving subject.

Note that focus lock (p.73) will not work in this case.

- **Pressing the shutter button halfway does not focus on the subject.**

If the focus mode switch of the lens is set to <MF> (manual focus), set it to <AF> (autofocus).

- **The flash fired even if it was daylight.**

For a backlit subject, the flash may fire to help lighten the subject's dark areas. If you do not want the flash to fire, use the Quick Control to set [Built-in flash firing] to [☺] (p.90) or set the <☒> (Flash Off) mode and shoot (p.74).

- **The built-in flash fired and the picture came out extremely bright.**

Move further away from the subject and shoot. When shooting with flash, if the subject is too close to the camera, the picture may come out extremely bright (overexposure).

- **In low light, the built-in flash fired a series of flashes.**

Pressing the shutter button halfway may trigger the built-in flash to fire a series of flashes to assist autofocusing. This is called the AF-assist beam. Its effective range is approx. 4 meters / 13.1 feet. The built-in flash will make a sound when firing continuously. This is normal and not a malfunction.

- **When flash was used, the bottom part of the picture came out unnaturally dark.**

The shadow of the lens barrel was captured in the picture because the subject was too close to the camera. Move further away from the subject and shoot. If a hood is attached to the lens, remove it before taking the flash picture.

[A⁺] Full Auto Techniques (Scene Intelligent Auto) ■

Recomposing the Shot



Depending on the scene, positioning the subject toward the left or right to include a balanced background will result in a picture with better perspective. In the <[A⁺]> mode, pressing the shutter button halfway to focus on a still subject will lock the focus on that subject. Recompose the shot while keeping the shutter button pressed halfway, and then press the shutter button completely to take the picture. This is called “focus lock”. Focus lock is also possible in other Basic Zone modes (except <[A] > <SCN: [M]>).

Shooting a Moving Subject



In the <[A⁺]> mode, if the subject moves (distance to camera changes) during or after focusing, AI Servo AF will take effect to focus on the subject continuously. (The beeper will continue beeping softly.) As long as you keep the Area AF frame positioned over the subject while pressing the shutter button halfway, focusing will be continuous. At the decisive moment, press the shutter button completely to take the picture.

Shooting When You Cannot Use Flash

The camera analyzes the scene and sets the optimum settings automatically. In places where flash photography is prohibited such as in a museum or an aquarium, use the < > (Flash Off) mode.

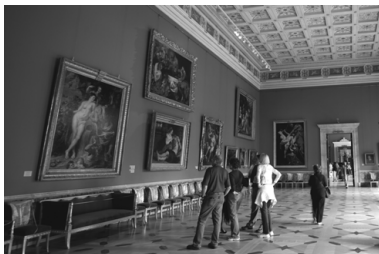
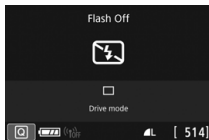
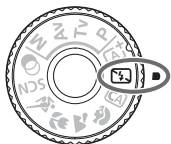

Shooting Tips

- **Prevent camera shake if the numeric display (shutter speed) in the viewfinder blinks.**

Under low light when camera shake is prone to occur, the viewfinder's shutter speed display will blink. Hold the camera steady or use a tripod. When using a zoom lens, use the wide-angle end to reduce blur caused by camera shake even with handheld shooting.

- **Take portraits without flash.**

In low-light conditions, tell the subject to keep still until the picture is taken. Any movement by the subject during shooting may result in the subject being blurred in the picture.

CA Creative Auto Shooting

In the <CA> mode, you can set the following functions for shooting: (1) Ambience-based shots, (2) Background blur, (3) Drive mode, and (4) Built-in flash firing. The default settings are the same as the <A+> mode.

* CA stands for Creative Auto.



1 Set the Mode Dial to <CA>.

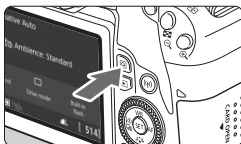

2 Press the <Q> button (10).

▶ The Quick Control screen will appear.

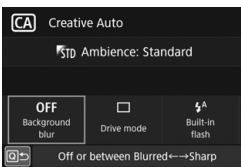

3 Set the desired functions.

- Press the <▲> <▼> or <◀> <▶> keys to select a function.
- ▶ The settings of the selected function and Feature guide (p.54) will appear.

4 Take the picture.

- Press the shutter button completely to take the picture.

Shooting Portraits

The (Portrait) mode blurs the background to make the human subject stand out. It also makes skin tones and hair look softer.

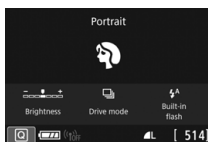

Shooting Tips

- **Select the location where the distance between the subject and the background is the farthest.**
The further the distance between the subject and background, the more blurred the background will look. The subject will also stand out better against an uncluttered dark background.
- **Use a telephoto lens.**
If you have a zoom lens, use the telephoto end to fill the frame with the subject from the waist up. Move in closer if necessary.
- **Focus on the face.**
Check that the AF point covering the face lights up. For close-ups of the face, focus on the eyes.

Shooting Landscapes

Use the <> (Landscape) mode for wide scenery or to have everything in focus from near to far. For vivid blues and greens, and very sharp and crisp images.

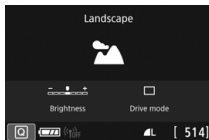

Shooting Tips

- **With a zoom lens, use the wide-angle end.**
When using a zoom lens, set the lens to the wide-angle end to make the objects near and far in focus. It also adds breadth to landscapes.
- **Shooting night scenes.**
The <> mode is also good for night scenes because it disables the built-in flash. When shooting night scenes, use a tripod to prevent camera shake.

Shooting Close-ups

When you want to shoot flowers or small things up close, use the <> (Close-up) mode. To make small things appear much larger, use a macro lens (sold separately).

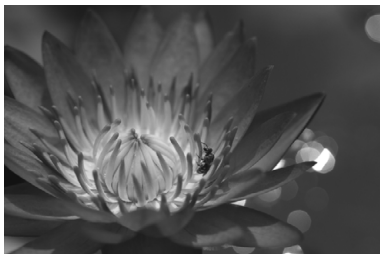
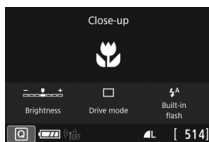



Shooting Tips

- **Use a simple background.**

A simple background makes small objects such as flowers stand out better.

- **Move in as close as possible to the subject.**

Check the lens for its minimum focusing distance. Some lenses have indications such as <**0.39m/1.3ft**> on them. The lens minimum focusing distance is measured from the <> (focal plane) mark on the top of the camera to the subject. If you are too close to the subject, the focus indicator <> will blink.

If the built-in flash is fired and the bottom part of the picture comes out unnaturally dark, move away a little from the subject and try again.

- **With a zoom lens, use the telephoto end.**

If you have a zoom lens, using the telephoto end will make the subject look larger.

Shooting Moving Subjects

Use the < > (Sports) mode to shoot a moving subject, such as a running person or a moving vehicle.

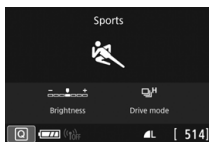

Shooting Tips

- **Use a telephoto lens.**

Use of a telephoto lens is recommended for shooting from a distance.

- **Track the subject with the Area AF frame.**

Press the shutter button halfway to start autofocusing in Area AF frame. During autofocusing, the beeper will continue beeping softly. If focus cannot be achieved, the focus indicator <●> will blink. The default setting is <H> (High-speed continuous shooting*). At the decisive moment, press the shutter button completely to take the picture. If you keep holding down the shutter button, you can shoot continuously while maintaining autofocusing to capture changes in the subject's movement.

* Viewfinder shooting: max. approx. 6.0 shots/sec., Live View shooting: max. approx. 4.5 shots/sec.

SCN: Special Scene Mode

The camera will automatically choose the appropriate settings when you select a shooting mode for your subject or scene.



1 Set the Mode Dial to <SCN>.



2 Press the <Q> button (10).
▶ The Quick Control screen will appear.

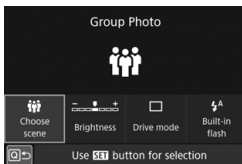

3 Select a shooting mode.

- Select [Choose scene], then press <SET>.

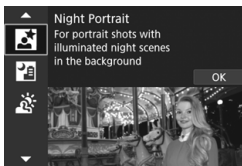

- Press the <▲> <▼> keys to select the desired shooting mode, then press <SET>.
- You can also select by turning the <SCN> or <Q> dial.

If [Mode guide] is set to [Enable], press <SET> after step 1 to go to the shooting mode selection screen.

Available Shooting Modes in the <SCN> Mode

Shooting Mode	Page
Group Photo	p.81
Kids	p.82
Food	p.83
Candlelight	p.84

Shooting Mode	Page
Night Portrait	p.85
Handheld Night Scene	p.86
HDR Backlight Control	p.87

Shooting Group Photos

Use the <> (Group Photo) mode to shoot group photos. You can take a picture in which both the people in the front and people in the back are all in focus.

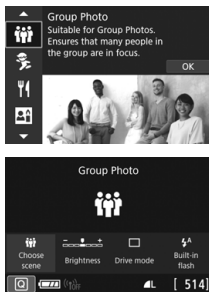

Shooting Tips

- **Use a wide-angle lens.**
When using a zoom lens, use the wide-angle end to make it easy to get all the people in the group in focus at once, from the front row to the back. Also, if you place a little distance between the camera and the subjects (so that the subjects' entire bodies are in the shot), the focus range increases.
- **Use continuous shooting.**
It is recommended to use continuous shooting to shoot multiple photos in case some people close their eyes.

Photographing Children

When you want to continuously focus on and photograph children running around, use  (Kids). Skin tones will look healthy.

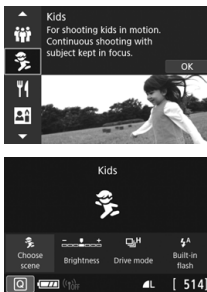

Shooting Tips

- **Track the subject with the Area AF frame.**

Press the shutter button halfway to start autofocusing in Area AF frame. During autofocusing, the beeper will continue beeping softly. If focus cannot be achieved, the focus indicator  will blink.

- **Shoot continuously.**

The default setting is  (High-speed continuous shooting^{*}). At the decisive moment, press the shutter button completely to take the picture. If you keep holding down the shutter button, you can shoot continuously while maintaining autofocusing to capture changes in the subject's facial expression and movement.

^{*} Viewfinder shooting: max. approx. 6.0 shots/sec., Live View shooting: max. approx. 4.5 shots/sec.

🍴 Shooting Food

When shooting food, use <🍴> (Food). The photo will look bright and appetizing. Also, depending on the light source, the reddish tinge will be suppressed in the pictures taken under tungsten lights, etc.

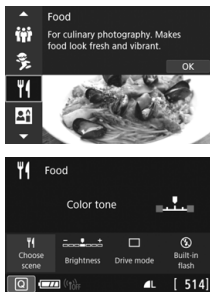

💡 Shooting Tips

- **Change the color tone.**
You can change [**Color tone**]. To increase the food's reddish tinge, set it toward [**Warm**]. Set it toward [**Cool**] if it looks too red.
- **Avoid using flash.**
If you use flash, the light may reflect off the dish or food and results in unnatural shadows. Therefore, <🚫> (Built-in flash off) is set by default. Try to prevent camera shake when shooting in low-light locations.

Shooting Candlelight Portraits

When photographing a human subject lit in candlelight, use  (Candlelight). The atmosphere of candlelight is reflected in the color tones of the picture.

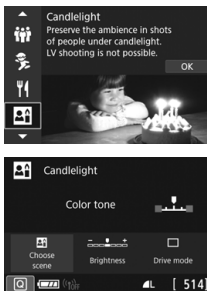

Shooting Tips



- **Use the center AF point to focus.**
Aim the center AF point in the viewfinder over the subject, then shoot.
- **Prevent camera shake if the numeric display (shutter speed) in the viewfinder blinks.**
Under low light where camera shake is prone to occur, the viewfinder's shutter speed display will blink. Hold the camera steady or use a tripod. When using a zoom lens, you can reduce blur caused by camera shake by setting the lens to the wide-angle end, even with handheld shooting.
- **Change the color tone.**
You can change [Color tone]. To increase the candlelight's reddish tinge, set it toward [Warm]. Set it toward [Cool] if it looks too red.

Shooting Night Portraits (With a Tripod) ■

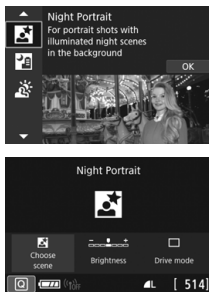
To photograph people at night and obtain a natural-looking night scene in the background, use the < > (Night Portrait) mode. Using a tripod is recommended.



Shooting Tips

- **Use a wide-angle lens and a tripod.**
When using a zoom lens, use the wide-angle end to obtain a wide night view. Also, since camera shake is prone to occur with handheld shooting, use a tripod.
- **Check the subject's brightness.**
Under low light, the built-in flash will fire automatically to obtain a good exposure of the subject.
Note that it is recommended to play back the captured image on location to check the image brightness. If the subject looks dark, move nearer and shoot again.
- **Also shoot in other shooting modes.**
Since camera shake is prone to occur with night shots, shooting also with < > and < > is recommended.

Shooting Night Scenes (Handheld)

Using a tripod when shooting a night scene gives the best results. However, the  (Handheld Night Scene) mode enables you to shoot night scenes even while handholding the camera. In this shooting mode, four shots are taken consecutively for each picture, and the resulting one image with reduced camera shake is recorded.

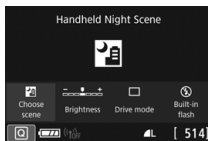
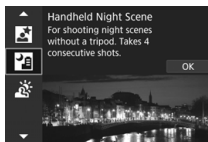



Shooting Tips

- **Hold the camera firmly.**

During shooting, hold the camera firmly and steadily. In this mode, four shots are aligned and merged into a single image. However, if there is significant misalignment in any of the four shots due to camera shake, they may not align properly in the final image.

- **For shots including people, fire the flash.**

If you want to include people in the night scene shot, press the  button to set  (Built-in flash on). To take a nice portrait, the first shot will use flash. Tell the subject not to move until all four consecutive shots are taken.

Shooting Backlit Scenes

When shooting a scene having both the bright and dark areas, use the  (HDR Backlight Control) mode. When you take one picture in this mode, three consecutive shots are taken at different exposures. This results in one image, with a wide tonal range, that has minimized the clipped shadows caused by backlighting.

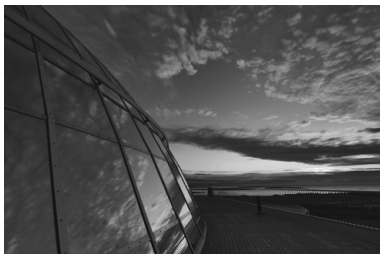
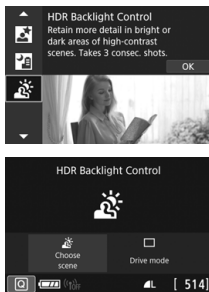

Shooting Tips

- **Hold the camera firmly.**

During shooting, hold the camera firmly and steadily. In this mode, three shots are aligned and merged into a single image. However, if there is significant misalignment in any of the three shots due to camera shake, they may not align properly in the final image.

Shooting with Creative Filter Effects

In the  (Creative filter) mode, you can apply one of ten filter effects (Grainy B/W*, Soft focus*, Fish-eye effect*, Water painting effect*, Toy camera effect*, Miniature effect*, HDR art standard, HDR art vivid, HDR art bold, and HDR art embossed) for shooting. When the camera is set for Live View shooting, you can see the effect on the screen before you start shooting. The camera saves only the image with the Creative filter applied.

For the effects marked with an asterisk, you can also take a picture without a Creative filter, then apply the effect afterward and save it as a new image.



1 Set the Mode Dial to .









2 Display the Live View image.

- Press the  button to display the Live View image.



3 Select [Creative filters] with Quick Control.

- Press the  button (.
- Press the   keys to select  on the upper left of the screen, then press .

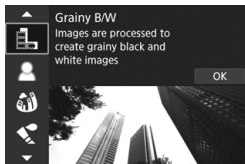

4 Select a shooting mode.

- Press the <▲> <▼> keys to select a shooting mode, then press <SET>.
- ▶ The image will be displayed with the effects of the filter applied.

Available Shooting Modes in the Mode

Shooting Mode	
	Grainy B/W
	Soft focus
	Fish-eye effect
	Water painting effect
	Toy camera effect

Shooting Mode	
	Miniature effect
	HDR art standard
	HDR art vivid
	HDR art bold
	HDR art embossed



5 Adjust the effect.

- Press the <[Q]> button and select the icon below [**Creative filters**] (except for , , , , and).
- Press the <◀> <▶> keys to adjust the filter effect, then press <SET>.

6 Take the picture.

- Press the shutter button completely to take the picture.
- To return to viewfinder shooting, press the <[]> button to exit Live View shooting. Then press the shutter button completely to take the picture.

Q Quick Control

In Basic Zone modes, press the <Q> button to display the Quick Control screen. You can set the items shown in the tables on pages 91-92.

1 Set the Mode Dial to a Basic Zone mode.

Example: <CA>

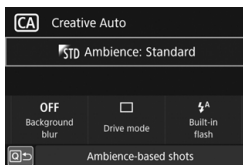

2 Press the <Q> button (10).

▶ The Quick Control screen will appear.

3 Set the desired functions.

- Press the <▲> <▼> or <◀> <▶> keys to select a function. (This step is not necessary in the mode.)
▶ The settings of the selected function and Feature guide (p.54) will appear.
- Turn the <☀> or <☺> dial to change the setting.
- You can also select from a list by selecting a function and pressing <SET>.

- When [📷: Shooting screen: Guided] is set, a screen such as the following will appear.

Example: <CA>

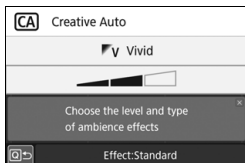
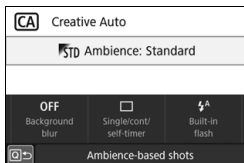

Settable Functions in Basic Zone Modes













●: Default setting* ○: User selectable □: Not selectable















Function								
Drive mode (p.106)	: Single shooting	●	●	●	○	●	●	○
	: High-speed continuous shooting	○	○	○	○	○	○	●
	: Low-speed continuous shooting	○	○	○	●	○	○	○
	: 10sec.	○	○	○	○	○	○	○
	: 2sec.	○	○	○	○	○	○	○
	: Continuous shooting	○	○	○	○	○	○	○
Built-in flash firing	: Automatic firing	●	□	●	●	□	●	□
	: Flash on (Fires at all times)	○	□	○	○	□	○	□
	: Flash off	○	●	○	○	●	○	●
Ambience-based shots		□	□	○	□	□	□	□
Background blur		□	□	○	□	□	□	□
Brightness (p.93)		□	□	□	○	○	○	○

Function		SCN						
Drive mode (p.106)	: Single shooting	●	○	●	●	●	●	●
	: High-speed continuous shooting	○	●	○	○	○	○	○
	: Low-speed continuous shooting	○	○	○	○	○	○	○
	: 10sec.	○	○	○	○	○	○	○
	: 2sec.	○	○	○	○	○	○	○
	: Continuous shooting	○	○	○	○	○	○	○
Built-in flash firing	: Automatic firing	●	●	□	□	●	□	□
	: Flash on (Fires at all times)	○	○	○	□	□	○	□
	: Flash off	○	○	●	●	□	●	●
Brightness (p.93)		○	○	○	○	○	○	□
Color tone (p.83, 84)		□	□	○	○	□	□	□

* If you change the shooting mode or set the power switch to <OFF>, all the functions will revert to the default settings (except the self-timer).

●: Default setting* ○: User selectable □: Not selectable

Function		    				
Drive mode (p.106)	<input type="checkbox"/> : Single shooting	●	●	●	●	●
	 : High-speed continuous shooting					
	 : Low-speed continuous shooting					
	 : 10sec.	○	○	○	○	○
	 : 2sec.	○	○	○	○	○
	 : Continuous shooting	○	○	○	○	○
Built-in flash firing	 : Automatic firing	●	●	●	●	●
	 : Flash on (Fires at all times)	○	○	○	○	○
	 : Flash off	○	○	○	○	○
Adjustment of effects (p.88)		○	○	○	○	○

Function						
						
Drive mode (p.106)	<input type="checkbox"/> : Single shooting	●	●	●	●	●
	 : High-speed continuous shooting		○	○	○	○
	 : Low-speed continuous shooting		○	○	○	○
	 : 10sec.	○	○	○	○	○
	 : 2sec.	○	○	○	○	○
	 : Continuous shooting	○	○	○	○	○
Built-in flash firing	 : Automatic firing	○				
	 : Flash on (Fires at all times)	○				
	 : Flash off	●	●	●	●	●
Adjustment of effects (p.88)						

* If you change the shooting mode or set the power switch to <OFF>, all the functions will revert to the default settings (except the self-timer).

Adjusting the Brightness

In Basic Zone modes, when a mode other than <A+>, <M>, <CA>, <SCN: 🌞>, or <🌙> is set, you can adjust the brightness for shooting. You can adjust both the brightness and darkness across 3-step ranges with 0 being the standard.

1 Set the Mode Dial to <🌙>, <🌞>, <🌱>, <🌿>, or <SCN>.

- When <SCN> is set, set to <👤>, <👦>, <👧>, <👨>, <👩>, or <👪>.



2 Display the Live View image.

- Press the <📷> button to display the Live View image (except <👨>).



3 With Quick Control, select the desired brightness.

- Press the <Q> button (🕒10).
- Press the <▲> <▼> keys to select [📷📷📷 Brightness], then press the <◀> <▶> keys to select the desired brightness.
- ▶ The image with the selected brightness adjustment applied will appear.

4 Take the picture.

- Press the shutter button completely to take the picture.
- To return to viewfinder shooting, press the <📷> button to exit Live View shooting. Then press the shutter button completely to take the picture.
- If you change the shooting mode or set the power switch to <OFF>, the setting will revert to [0] (standard).

▶ Image Playback

The easiest way to play back images is described below. For more details on the playback procedure, see page 157.



1 Play back the image.

- Press the <▶> button.
- ▶ The last image captured or played back will appear.



2 Select an image.

- To play back images starting with the last image captured, turn the <◀> dial counterclockwise. To play back images starting with the first captured image, turn the <◀> dial clockwise.
- Each time you press the <INFO> button, the display will change.



No information



Basic information display

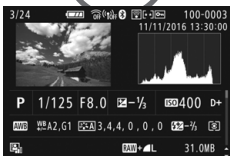

Shooting information display

3 Exit the image playback.

- Press the <▶> button to exit the image playback and return to shooting-ready state.

Shooting Information Display

With the shooting information screen displayed (p.94), you can press the <▲> <▼> keys to change the shooting information displayed at the screen bottom as follows.

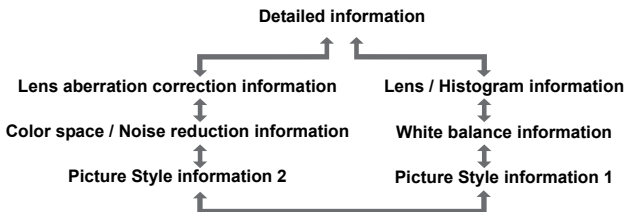

3

Setting the AF and Drive Modes

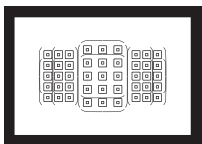

The AF points in the viewfinder are arranged to make AF shooting suitable for a wide variety of subjects and scenes.

You can also select the AF operation and drive mode that best match the shooting conditions and subject.

- The ☆ icon at the upper right of the page title indicates that the function is available only in Creative Zone modes (p.27).
- In Basic Zone modes, the AF operation is set automatically.



<AF> stands for autofocus. <MF> stands for manual focus.

AF: Changing the Autofocus Operation [☆]

You can select the AF (autofocus) operation characteristics to suit the shooting conditions or subject. In Basic Zone modes, the optimum AF operation is set automatically for the respective shooting mode.

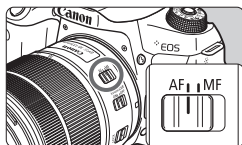

1 Set the lens's focus mode switch to <AF>.

2 Turn the Mode Dial to a Creative Zone mode.

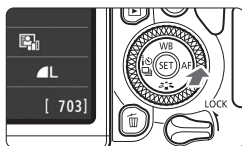

3 Press the <▶ AF> button.

▶ [AF operation] will appear.

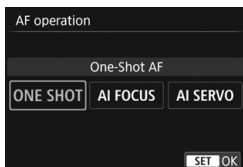

4 Select the AF operation.

- Press the <◀> <▶> keys to select the desired AF operation, then press <SET>.

5 Focus on the subject.

- Aim the AF point over the subject and press the shutter button halfway. The camera will then autofocus in the selected AF operation.

One-Shot AF for Still Subjects

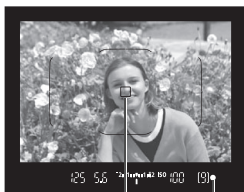

AF point
Focus indicator

Suited for still subjects. When you press the shutter button halfway, the camera will focus only once.

- The AF point that achieves focus is displayed, and the focus indicator <●> in the viewfinder will also light up.
 - With evaluative metering, the exposure setting will be set at the same time focus is achieved.
- While you hold down the shutter button halfway, the focus will be locked. You can then recompose the shot if desired.

AI Servo AF for Moving Subjects

This AF operation is suited for moving subjects when the focusing distance keeps changing. While you hold down the shutter button halfway, the camera will keep focusing on the subject continuously.

- The exposure is set at the moment the picture is taken.
- When the AF area selection mode (p.100) is set to Automatic selection AF, focus tracking will continue as long as the Area AF frame covers the subject.

AI Focus AF for Switching the AF Operation Automatically

AI Focus AF switches the AF operation from One-Shot AF to AI Servo AF automatically if a still subject starts moving.

- After the subject is focused in One-Shot AF, if the subject starts moving, the camera will detect the movement, change the AF operation automatically to AI Servo AF, and start tracking the moving subject.

Selecting the AF Area and AF Point

The camera has 45 AF points for autofocusing. You can select the AF area selection mode and AF point(s) suiting the scene or subject.

 Depending on the lens used, the number of usable AF points, AF point patterns, Area AF frame shape, etc. vary.

AF Area Selection Mode

You can select one of four AF area selection modes. For the selection procedure, see the next page.

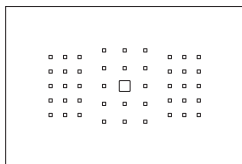

Single-point AF (Manual selection)

Select one AF point to focus.

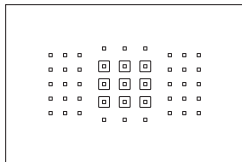

Zone AF (Manual selection of zone)

One of nine focusing zones is used to focus.

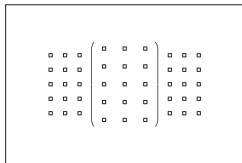

Large Zone AF (Manual selection of zone)

One of three focusing zones (left, center, and right) is used to focus.

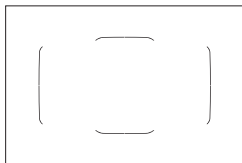

Automatic selection AF

The Area AF frame (entire AF area) is used to focus.

Selecting the AF Area Selection Mode

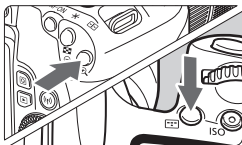

1 Press the <☐> or <☐> button (Ⓜ6).

- Look through the viewfinder and press the <☐> or <☐> button.

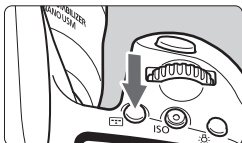

2 Press the <☐> button.

- Each time you press the <☐> button, the AF area selection mode changes.

Selecting the AF Point Manually

You can manually select the AF point or zone.

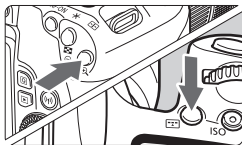

1 Press the or button (6).

- ▶ The AF points will be displayed in the viewfinder.
- In the Zone AF mode or Large Zone AF mode, the selected zone will be displayed.

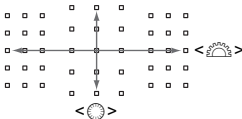

2 Select an AF point.

- You can select an AF point in horizontal direction with the dial or vertical direction with the .
- If you press , the center AF point (or center zone) will be selected.
- In the Zone AF mode, turning the or dial will change the zone in a looping sequence.
- You can also select an AF point or zone in horizontal direction with the keys or vertical direction with the keys.

AF Point Display Indications

Pressing the or button lights up the AF points that are cross-type AF points for high-precision autofocusing. The blinking AF points are horizontal-line or vertical-line sensitive.

AF Area Selection Modes

Single-point AF (Manual selection)

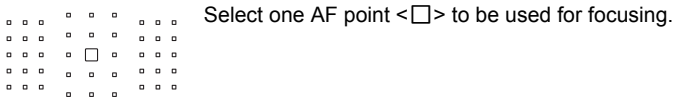

Zone AF (Manual selection of zone)

The AF area is divided into nine focusing zones for focusing. Since all the AF points in the selected zone are used for Automatic selection AF, it is superior to Single-point AF in tracking the subject, and it is also effective for moving subjects.

However, since it is inclined to focus on the nearest subject, focusing on a specific target may be more difficult.

The AF point(s) achieving focus is displayed as <□>.

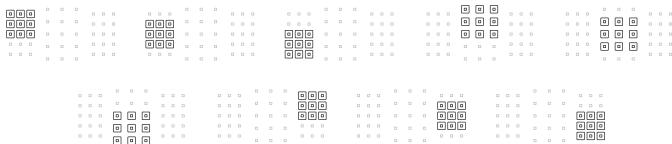

Large Zone AF (Manual selection of zone)

The AF area is divided into three focusing zones (left, center, and right) for focusing. Since the focusing area is larger than with Zone AF and all the AF points in the selected zone are used for Automatic selection AF, it is superior to Single-point AF in tracking the subject, and it is also effective for moving subjects.

However, since it is inclined to focus on the nearest subject, focusing on a specific target may be more difficult.

The AF point(s) achieving focus is displayed as <□>.



Automatic selection AF

The Area AF frame (entire AF area) is used to focus. The AF point(s) achieving focus is displayed as <□>.



With One-Shot AF, pressing the shutter button halfway will display the AF point(s) <□> that achieved focus. If multiple AF points are displayed, it means they all have achieved focus. This mode tends to focus on the nearest subject.

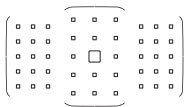

With AI Servo AF, the manually-selected (p.102) AF point <□> is used first to achieve focus. The AF point(s) achieving focus is displayed as <□>.

MF: Manual Focus

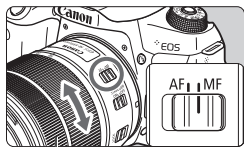

Focusing ring

1 Set the lens's focus mode switch to <MF>.

2 Focus on the subject.

- Focus by turning the lens focusing ring until the subject looks sharp in the viewfinder.

Selecting the Drive Mode

Single and continuous drive modes are provided.

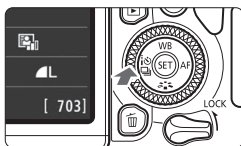

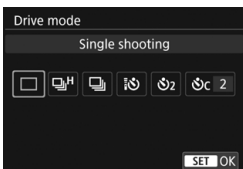

1 Press the    button.

▶ [Drive mode] will appear.



2 Select the drive mode.

- Press the   keys to select the desired drive mode, then press .

: **Single shooting**

When you press the shutter button completely, only one shot will be taken.

H : **High-speed continuous shooting** (Max. approx. 6.0 shots/sec.)

When you press the shutter button completely, the camera will shoot continuously while you keep holding it down.

L : **Low-speed continuous shooting** (Max. approx. 3.0 shots/sec.)

When you press the shutter button completely, the camera will shoot continuously while you keep holding it down.

i : **10-sec. self-timer/remote control**

2 : **2-sec. self-timer**

c : **Self-timer: Continuous**

For self-timer shooting, see page 107.

Using the Self-timer

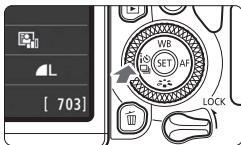

1 Press the << [Self-timer] >> button.

- ▶ [Drive mode] will appear.

2 Select the self-timer.

- Press the << >> keys to select the self-timer, then press <SET>.

: 10-sec. self-timer

The remote controller can also be used.

: 2-sec. self-timer

: 10-sec. self-timer plus continuous shots

Press the <▲> <▼> keys to set the number of multiple shots (2 to 10) to be taken with the self-timer.

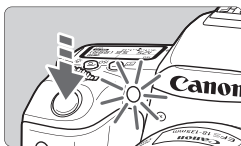
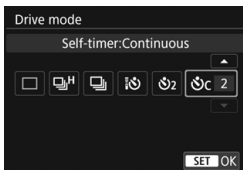

3 Take the picture.

- Look through the viewfinder, focus on the subject, then press the shutter button completely.
- ▶ You can check the self-timer operation with the self-timer lamp, beeper, and countdown display (in seconds) on the LCD panel.
- ▶ 2 sec. before the picture is taken, the self-timer lamp will light up and the beeper will sound faster.



4

Image Settings

This chapter describes image-related function settings: Image-recording quality, ISO speed, Picture Style, white balance, Auto Lighting Optimizer, noise reduction, anti-flicker shooting, and other functions.

- The ☆ icon at the upper right of the page title indicates that the function is available only in Creative Zone modes (p.27).

MENU Setting the Image-Recording Quality

You can select the pixel count and its image quality. Nine image-recording quality settings are provided: **L**, **L**, **M**, **M**, **S1**, **S1**, **S2**, **RAW** + **L**, **RAW**.

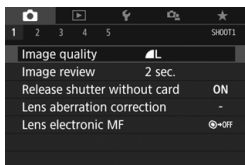

1 Select the image-recording quality.

- Under the [**1**] tab, select [**Image quality**], then press <SET>.
- ▶ [**Image quality**] will appear.

Pixels recorded (pixel count) Possible shots

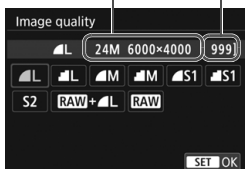









2 Set the image-recording quality.

- The respective quality's pixel count and number of possible shots will be displayed to help you select the desired quality. Then press <SET>.

Guide to Image-recording Quality Settings

(Approx.)

Image Quality			Pixels Recorded	File Size (MB)	Possible Shots	Maximum Burst
 L	High quality	JPEG	24M	7.6	950	190 (Full)
 L				3.9	1840	Full (Full)
 M	Medium quality		11M	4.1	1790	Full (Full)
 M				2.0	3480	Full (Full)
 S1	Low quality		5.9M	2.6	2730	Full (Full)
 S1				1.3	5260	Full (Full)
S2		3.8M		1.8	3810	Full (Full)
 RAW +  L	High quality	24M	29.4+7.6	170	19 (23)	
 RAW			29.4	210	21 (27)	

* The file size, possible shots, and maximum burst are based on Canon's testing standards (3:2 aspect ratio, ISO 100 and Standard Picture Style) using an 8 GB card. **These figures will vary depending on the subject, card brand, aspect ratio, ISO speed, Picture Style, Custom Functions, and other settings.**

* Figures in parentheses for the maximum burst apply to  high-speed continuous shooting. Figures in parentheses apply to an UHS-I class 16 GB card based on Canon's testing standards.

- "Full" indicates that shooting is possible until the card becomes full with the listed conditions.

ISO: Setting the ISO Speed for Still Photos ★ ■

Set the ISO speed (image sensor's sensitivity to light) to suit the ambient light level. In Basic Zone modes, the ISO speed is set automatically.

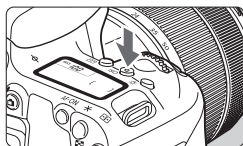

1 Press the <ISO> button (⚙6).

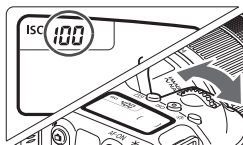

2 Set the ISO speed.

- While looking at the LCD panel or in the viewfinder, turn the <⚙> or <⚙> dial.
- ISO speed can be set within ISO 100 - ISO 25600.
- “A” indicates ISO Auto. The ISO speed will be set automatically.
- When the screen shown on the left is displayed, you can press the <INFO> button to set it to “AUTO”.

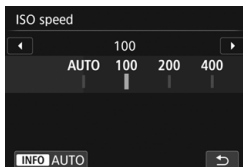

ISO Speed Guide

ISO Speed	Shooting Situation (No flash)	Flash Range
ISO 100 - ISO 400	Sunny outdoors	The higher the ISO speed, the farther the effective flash range will be (p.129).
ISO 400 - ISO 1600	Overcast skies or evening time	
ISO 1600 - ISO 25600, H	Dark indoors or night	

* High ISO speeds will result in grainier images.

Selecting a Picture Style ☆

Just by selecting a preset Picture Style, you can obtain image characteristics effectively matching your photographic expression or the subject.

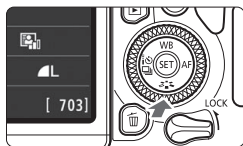

1 Press the <▼ > button.

- ▶ The Picture Style selection screen will appear.

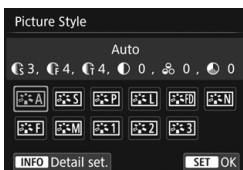

2 Select a Picture Style.

- Select a Picture Style, then press <SET>.
- ▶ The Picture Style will be set.



You can also set the Picture Style with [ 3: Picture Style].

Picture Style Characteristics

Auto

The color tone will be adjusted automatically to suit the scene. The colors will look vivid for blue skies, greenery and sunsets, particularly in nature, outdoor and sunset scenes.



If the desired color tone is not obtained with [**Auto**], use another Picture Style.

Standard

The image looks vivid, sharp, and crisp. This is a general-purpose Picture Style suitable for most scenes.

 **Portrait**

For nice skin tones. The image looks softer. Suited for close-up portraits.

By changing the [**Color tone**], you can adjust the skin tone.

 **Landscape**

For vivid blues and greens, and very sharp and crisp images. Effective for impressive landscapes.

 **Fine Detail**

Suited for detailed outline and fine texture description of the subject. The colors will be slightly vivid.

 **Neutral**

Geared for users who prefer to process images with their computer. For natural colors and subdued images with modest brightness and color saturation.

 **Faithful**

Geared for users who prefer to process images with their computer. The color of a subject that is captured in ambient light at a color temperature of 5200K will be adjusted to match the subject's colorimetric color. For subdued images with modest brightness and color saturation.

 **Monochrome**

Creates black-and-white images.

 **User Defined 1-3**

You can register a basic style such as [**Portrait**], [**Landscape**], a Picture Style file, etc. and adjust it as desired. Any User Defined Picture Style that has not been set will have the same default settings as the [**Auto**] Picture Style.

WB: Matching the Light Source ☆

White balance (WB) is for making the white areas look white. Normally, the Auto [AWB] (Ambience priority) or [AWBw] (White priority) setting will obtain the correct white balance. If natural-looking colors cannot be obtained with Auto, you can select the white balance to match the light source or set it manually by shooting a white object.

In Basic Zone modes, [AWB] (Ambience priority) is set automatically. (In the <P> mode, [AWBw] (White priority) is set.)



- 1 Press the <▲ WB> button.
▶ [White balance] will appear.

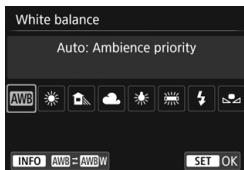

- 2 Select a white balance setting.

- Select the desired setting, then press <SET>.
- The “Approx. ****K” (K: Kelvin) displayed for the white balance settings <☀>, <🏠>, <☁>, <☀> or <🌧> is the respective color temperature to be set.



You can also set with [CAMERA 3: White balance].

White Balance

To the human eye, a white object looks white regardless of the type of lighting. With a digital camera, the white for color correction basis is decided depending on the color temperature of the illumination, and then the color is adjusted with software to make the white areas look white. With this function, pictures with natural color tones can be taken.

MENU Auto Correction of Brightness and Contrast ☆

If the image comes out dark or the contrast is low, the brightness and contrast can be corrected automatically. This function is called Auto Lighting Optimizer. The default setting is **[Standard]**. With JPEG images, the correction is applied when the image is captured.

In Basic Zone modes, **[Standard]** is set automatically.

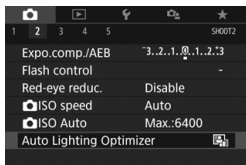

1 Select **[Auto Lighting Optimizer]**.

- Under the [**2**] tab, select **[Auto Lighting Optimizer]**, then press **< (SET) >**.

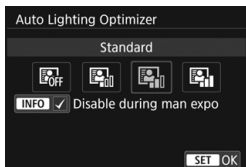

2 Select the setting.

- Select the desired setting, then press **< (SET) >**.

3 Take the picture.

- The image will be recorded with the brightness and contrast corrected as necessary.

MENU Setting Noise Reduction ☆

High ISO Speed Noise Reduction

This function reduces the noise generated in the image. Although noise reduction is applied at all ISO speeds, it is particularly effective at high ISO speeds. When shooting at low ISO speeds, the noise in the darker parts of the image (shadow areas) can further be reduced. Change the setting to match the noise level.

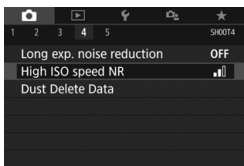

1 Select [High ISO speed NR].

- Under the [**4**] tab, select [**High ISO speed NR**], then press <SET>.

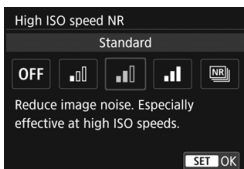

2 Set the level.

- Select the desired noise reduction level, then press <SET>.

● [**NR**]: Multi Shot Noise Reduction

Applies the noise reduction with higher image quality than [**High**]. For a single photo, four shots are taken continuously and aligned and merged automatically into a single JPEG image.

If the image-recording quality is set to **RAW** or **RAW + L**, you cannot set [**Multi Shot Noise Reduction**].

3 Take the picture.

- The image will be recorded with noise reduction applied.

Long Exposure Noise Reduction

Noise reduction is possible with images exposed for 1 sec. or longer.

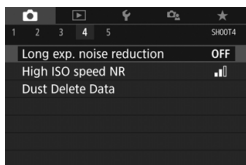

1 Select [Long exp. noise reduction].

- Under the [**4**] tab, select [**Long exp. noise reduction**], then press < **SET** >.

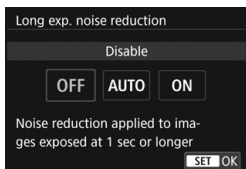

2 Set the desired setting.

- Select the desired setting, then press < **SET** >.

● [Auto]

For exposures of 1 sec. or longer, noise reduction is performed automatically if noise typical of long exposures is detected. This [**Auto**] setting is effective enough in most cases.

● [Enable]

Noise reduction is performed for all exposures of 1 sec. or longer. The [**Enable**] setting may reduce noise that cannot be detected with the [**Auto**] setting.

3 Take the picture.

- The image will be recorded with noise reduction applied.

MENU Reducing Flicker ☆

If you shoot an image with a fast shutter speed under a light source such as fluorescent light, the blinking of the light source causes flicker and the image may be vertically unevenly exposed. If continuous shooting is used under these conditions, uneven exposures or colors across the images may result. When you use this feature during viewfinder shooting, the camera detects the flickering frequency of the light source and takes the picture when the flicker causes less effect on exposure or color tone.

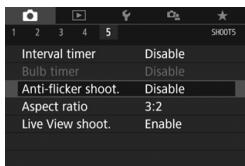

1 Select [Anti-flicker shoot.].

- Under the [**5**] tab, select [**Anti-flicker shoot.**], then press < **SET** >.

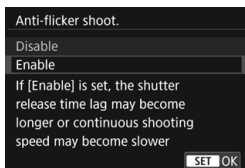

2 Select [Enable].

3 Take the picture.

- The picture will be taken with reduced unevenness of exposure or color tone caused by the flicker.



5

Advanced Operations for Photographic Effects

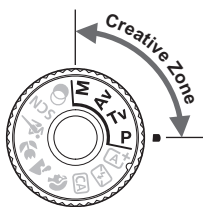

In Creative Zone modes, you can change various settings of the camera as you desire to obtain a wide variety of shooting results, by selecting the shutter speed and/or aperture, adjusting the exposure as you prefer, etc.

- The ☆ icon at the upper right of the page title indicates that the function is available only in Creative Zone modes.
- After you press the shutter button halfway and let it go, the exposure settings will remain displayed in the viewfinder and on the LCD panel for approx. 4 sec. (⌚4) by the metering timer function.



Set the <LOCK> switch downward.

P: Program AE

The camera automatically sets the shutter speed and aperture to suit the subject's brightness. This is called Program AE.

* <P> stands for Program.

* AE stands for Auto Exposure.



1 Set the Mode Dial to <P>.

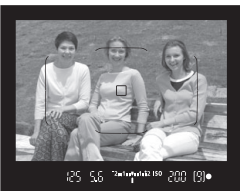

2 Focus on the subject.

- Look through the viewfinder and aim the AF point over the subject. Then press the shutter button halfway.
- ▶ When focus is achieved, the focus indicator <●> on the viewfinder's bottom right will light up (in One-Shot AF mode).
- ▶ The shutter speed and aperture will be set automatically and displayed in the viewfinder and on the LCD panel.



3 Check the display.

- The standard exposure will be obtained as long as the shutter speed and aperture displays do not blink.



4 Take the picture.

- Compose the shot and press the shutter button completely.

If a description of the shooting mode appears in step 1, press <SET> to hide it (p.53).

Tv: Conveying the Subject's Movement

You can either freeze the action or create motion blur with the **<Tv>** (Shutter-priority AE) mode on the Mode Dial.

* **<Tv>** stands for Time value.



Blurred motion
(Slow shutter speed: 1/30 sec.)





Frozen motion
(Fast shutter speed: 1/2000 sec.)

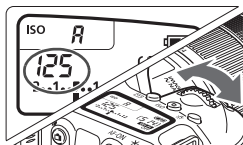

1 Set the Mode Dial to **<Tv>**.



2 Set the desired shutter speed.

- While looking at the LCD panel or in the viewfinder, turn the  dial.
- Turning the  dial clockwise sets a faster shutter speed, and turning it counterclockwise sets a slower one.



3 Take the picture.

- When you focus and press the shutter button completely, the picture will be taken at the set shutter speed.

Av: Changing the Depth of Field

To blur the background or to make everything near and far look sharp, set the Mode Dial to <Av> (Aperture-priority AE) to adjust the depth of field (range of acceptable focus).

* <Av> stands for Aperture value (the size of the lens diaphragm opening).



Blurred background
(With a low aperture f/number: f/5.6)



Sharp foreground and background
(With a high aperture f/number: f/32)



1 Set the Mode Dial to <Av>.

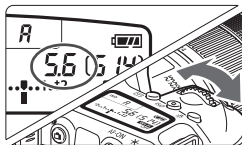

2 Set the desired aperture.

- While looking at the LCD panel or in the viewfinder, turn the <Sun> dial.
- The higher the f/number, the wider the depth of field where sharper focus is obtained in both the foreground and background.
- Turning the <Sun> dial clockwise sets a higher f/number (smaller aperture opening), and turning it counterclockwise sets a lower f/number (larger aperture opening).



3 Take the picture.

- When you focus and press the shutter button completely, the picture will be taken with the set aperture.

M: Manual Exposure

You can set both the shutter speed and aperture manually as desired. While referring to the exposure level indicator in the viewfinder, you can set the exposure as desired. This method is called manual exposure.

* <M> stands for Manual.





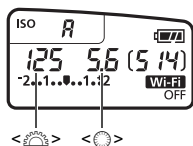

1 Set the Mode Dial to <M>.

2 Set the ISO speed (p.112).



3 Set the shutter speed and aperture.

- To set the shutter speed, turn the <  > dial.
- To set the aperture, turn the <  > dial.
- If it cannot be set, set the <LOCK> switch downward, then turn the <  > or <  > dial.

Standard exposure index







Exposure level mark

4 Focus on the subject.

- Press the shutter button halfway.
- ▶ The exposure setting will be displayed in the viewfinder and on the LCD panel.
- Check the exposure level mark <  > to see how far the current exposure level is from the standard exposure level.

5 Set the exposure and take the picture.

- Check the exposure level indicator and set the desired shutter speed and aperture.
- If the exposure level exceeds ± 2 stops from the standard exposure, the end of the exposure level indicator will display <  > or <  > in the viewfinder and on the LCD panel. (On the LCD monitor, if the exposure level exceeds ± 3 stops, <  > or <  > will be displayed.)

Setting the Desired Exposure Compensation ★ ■

Set exposure compensation if the exposure (without flash) does not come out as desired. This feature can be used in Creative Zone modes (except **<M>**). You can set the exposure compensation up to ± 5 stops* in 1/3-stop increments.

* In Live View shooting/movie shooting, or when [**Ⓛ**: Shooting screen] is set to [Guided], exposure compensation can be set up to ± 3 stops.

1 Check the exposure level indicator.

- Press the shutter button halfway (**Ⓢ**) and check the exposure level indicator.

Increased exposure
for a brighter image



2 Set the compensation amount.

- While looking at the viewfinder or LCD panel, turn the **<Ⓢ>** dial.
- If it cannot be set, set the **<LOCK>** switch downward, then turn the **<Ⓢ>** dial.
- ▶ For exposure compensation, the **<Ⓛ>** icon will be displayed in the viewfinder and on the LCD monitor.

Decreased exposure
for a darker image



3 Take the picture.

- To cancel the exposure compensation, set the compensation amount back to **<0>**.



MENU Auto Exposure Bracketing ☆

This feature takes exposure compensation a step further by varying the exposure automatically in the range of ± 2 stops in 1/3-stop increments with three shots as shown below. You can then choose the best exposure. This is called AEB (Auto Exposure Bracketing).



Standard exposure



Darker exposure
(Decreased exposure)



Brighter exposure
(Increased exposure)

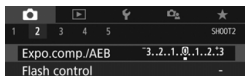

1 Select [Expo.comp./AEB].

- Under the [CAMERA] tab, select [Expo.comp./AEB], then press <SET>.

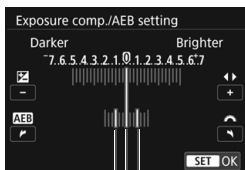

2 Set the AEB range.

- Turn the <DISP> dial to set the AEB range.
- Press the <◀> <▶> keys to set the exposure compensation amount. If AEB is combined with exposure compensation, AEB will be applied centering on level of exposure compensation.
- Press <SET> to set it.
- When you press the <MENU> button to exit the menu, the AEB range will be displayed on the LCD panel.

AEB range

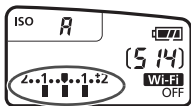

3 Take the picture.

- Focus and press the shutter button completely. The three bracketed shots will be taken in this sequence: standard exposure, decreased exposure, and increased exposure.

✳ Locking the Exposure ☆

You can lock the exposure when you want to set the focus and exposure separately or when you are to take multiple shots at the same exposure setting. Press the <✳> button to lock the exposure, then recompose and take the picture. This is called AE lock. It is effective for shooting backlit subjects, etc.

1 Focus on the subject.

- Press the shutter button halfway.
- ▶ The exposure setting will be displayed.

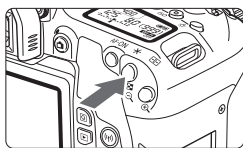

2 Press the <✳> button (ⓘ4).



- ▶ The <✳> icon lights up in the viewfinder to indicate that the exposure setting is locked (AE lock).
- Each time you press the <✳> button, the current exposure setting is locked.



3 Recompose and take the picture.

- When you are to take more pictures while maintaining the AE lock, keep holding down the <✳> button and press the shutter button to take another picture.

AE Lock Effects

Metering Mode	AF Point Selection Method (p.102)	
	Automatic Selection	Manual Selection
 *	AE lock is applied at the AF point that achieved focus.	AE lock is applied at the selected AF point.
	AE lock is applied at the center AF point.	

* When the lens's focus mode switch is set to <MF>, AE lock is implemented with the exposure weighting centered on the center AF point.

⚡ Using the Built-in Flash

In indoor, low light, or backlit conditions in daylight, just raise the built-in flash and press the shutter button to easily take beautiful pictures. In the <P> mode, the shutter speed (1/60 sec. - 1/200 sec.) will be set automatically to prevent camera shake.

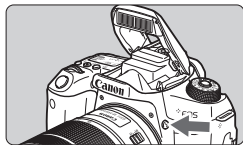

1 Press the <⚡> button.

- In Creative Zone modes, you can press the <⚡> button anytime to take flash pictures.
- While the flash is recharging, “buSY” is displayed in the viewfinder and on the LCD panel.



2 Press the shutter button halfway.

- In the bottom left of the viewfinder, check that the <⚡> icon is displayed.

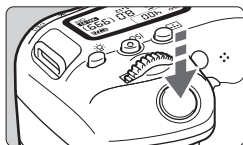

3 Take the picture.

- When focus is achieved and you press the shutter button completely, the flash will fire at all times.

Effective Range of Built-in Flash

(Approx. in meters / feet)

ISO Speed (p.112)	EF-S18-135mm f/3.5-5.6 IS USM	
	Wide Angle	Telephoto
	f/3.5	f/5.6
ISO 100	1 - 3.4 / 3.3 - 11.2	1 - 2.1 / 3.3 - 6.9
ISO 400	1 - 6.9 / 3.3 - 22.6	1 - 4.3 / 3.3 - 14.1
ISO 1600	1.7 - 13.7 / 5.6 - 44.9	1.1 - 8.6 / 3.6 - 28.2
ISO 6400	3.4 - 27.4 / 11.2 - 89.9	2.1 - 17.1 / 6.9 - 56.1

* When a high ISO speed is set and focusing distance is long, appropriate exposure may not be obtained depending on the subject conditions, etc.

6

Shooting with the LCD Monitor (Live View Shooting)

You can shoot while viewing the image on the camera's LCD monitor. This is called "Live View shooting".

- If you handhold the camera and shoot while viewing the LCD monitor, camera shake may cause blurred images. Using a tripod is recommended in such cases.





Remote Live View Shooting

With EOS Utility (EOS software, p.166) installed on your computer, you can connect the camera to the computer and shoot remotely while viewing the computer screen. For details, refer to the EOS Utility Instruction Manual.

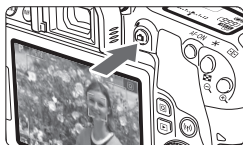
Shooting with the LCD Monitor



1 Display the Live View image.

- Press the  button.
- ▶ The Live View image will appear on the LCD monitor. In the  mode, the scene icon for the scene detected by the camera is displayed on the upper left of the screen.
- The Live View image will be displayed in the brightness level closely matching that of the actual image to be captured.



2 Focus on the subject.

- When you press the shutter button halfway, the camera will focus with the current AF method (p.140).
- You can also tap on the screen to select the face or subject (p.145).

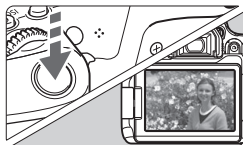

3 Take the picture.

- Press the shutter button completely.
- ▶ The picture is taken and the captured image is displayed on the LCD monitor.
- ▶ When the playback display ends, the camera will return to Live View shooting automatically.
- Press the  button to exit the Live View shooting.

MENU Enabling Live View Shooting

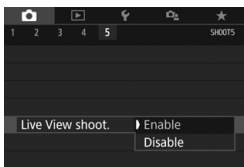

Set [**5: Live View shoot.**] (the [**1**] tab in Basic Zone modes) to [**Enable**].

Number of Possible Shots with Live View Shooting

(Approx. number of shots)

Temperature	Room Temperature (23°C / 73°F)	Low Temperatures (0°C / 32°F)
No Flash	310	270
50% Flash Use	270	230

- The figures above are based on a fully-charged Battery Pack LP-E17 and CIPA (Camera & Imaging Products Association) testing standards.
- With a fully-charged Battery Pack LP-E17, continuous Live View shooting is possible for approx. 2 hr. 25 min. at room temperature (23°C / 73°F).

Do not hold the camera in the same position for long periods of time. Even if the camera does not feel too hot, prolonged contact with the same body part may cause skin redness or blistering due to low-temperature contact burns. Using a tripod is recommended for people with circulation problems or very sensitive skin, or when using the camera in very hot places.

Do not point the camera toward an intense light source, such as the sun or an intense artificial light source. Doing so may damage the image sensor or the camera's internal components.

Information Display

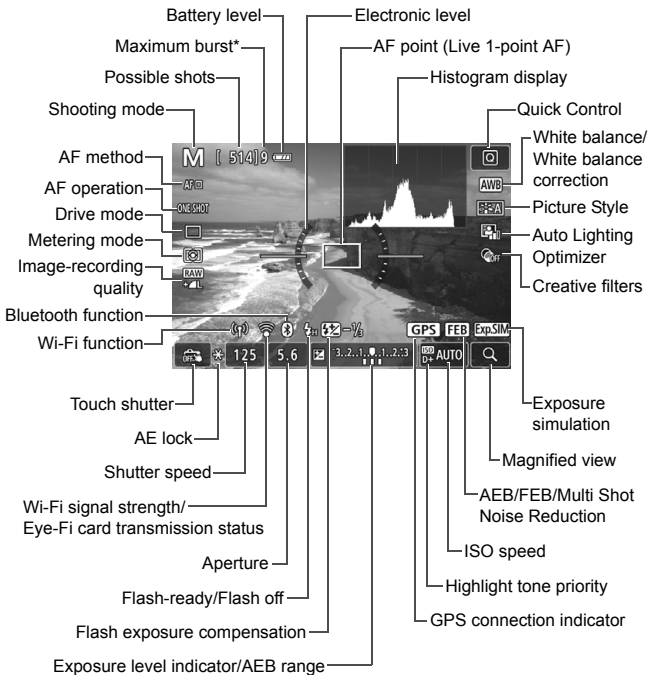

- Each time you press the <INFO> button, the information display will change.



* The number will be displayed when the maximum burst decreases to nine or lower.

Shooting with Creative Filter Effects [☆]

While viewing the Live View image, you can apply one of seven filter effects (Grainy B/W, Soft focus, Fish-eye effect, Art bold effect, Water painting effect, Toy camera effect, and Miniature effect) for shooting. The camera saves only the image with the Creative filter applied. You can also take a picture without a Creative filter, then apply an effect afterward and save it as a new image.

- 1 Turn the Mode Dial to a Creative Zone mode.**
- 2 Press the $\langle \text{Q} \rangle$ button (⓪10).**
 - ▶ The Quick Control screen will appear.
- 3 Select [].**
 - Press the $\langle \blacktriangle \rangle$ $\langle \blacktriangledown \rangle$ keys to select [] (Creative filter) on the right side of the screen.
- 4 Select a filter.**
 - Press the $\langle \blacktriangleleft \rangle$ $\langle \blacktriangleright \rangle$ keys to select a filter.
 - ▶ The image will be displayed with the effects of the filter applied.

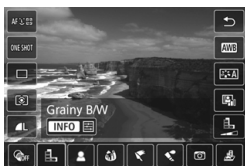



5 Adjust the filter effect.

- Press the <INFO> button (except for )
- Press the <◀> <▶> keys to adjust the filter effect, then press <SET>.

6 Take the picture.

- ▶ The image is shot with the filter effect applied.

Changing the Autofocus Operation ☆

You can select the AF (autofocus) operation characteristics to suit the shooting conditions or subject. In Basic Zone modes, the optimum AF operation is set automatically for the respective shooting mode.

1 Press the <Q> button.

- ▶ The Quick Control screen will appear.

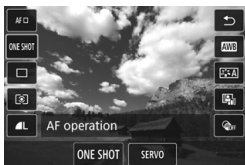

2 Select [ONE SHOT].

- Press the <▲> <▼> keys to select [ONE SHOT] (AF operation) on the left side of the screen.

3 Select the AF operation.

- Press the <◀> <▶> keys to select the desired AF operation, then press <SET>.

ONE SHOT: One-Shot AF

SERVO: Servo AF

4 Focus on the subject.

- Aim the AF point over the subject and press the shutter button halfway. The camera will then autofocus in the selected AF operation.

One-Shot AF for Still Subjects

Suited for still subjects. When you press the shutter button halfway, the camera will focus only once.

- When focus is achieved, the AF point will turn green and the beeper will sound.
- The focus remains locked while you hold down the shutter button halfway, allowing you to recompose the image before taking the picture.
- When the drive mode is set to <[H]> for high-speed continuous shooting, the maximum continuous shooting speed is approx. 6.0 shots/sec.
- When the drive mode is set to <[]> for low-speed continuous shooting, the maximum continuous shooting speed is approx. 3.5 shots/sec.
- For flash photography, the continuous shooting speed will become slower. Regardless of the <[H]> and <[]> settings, the continuous shooting speed will be the same (max. approx. 2.0 shots/sec.).

Servo AF for Moving Subjects

This AF operation is suited for moving subjects. While you hold down the shutter button halfway, the camera keeps focusing on the subject continuously.

- When the drive mode is set to <[H]> for high-speed continuous shooting, the maximum continuous shooting speed is approx. 4.5 shots/sec. The pictures will be taken with priority given to the continuous shooting speed.
- When the drive mode is set to <[L]> for low-speed continuous shooting, the maximum continuous shooting speed is approx. 3.5 shots/sec. The pictures will be taken with priority given to subject tracking.
- For flash photography, the continuous shooting speed will become slower. Regardless of the <[H]> and <[L]> settings, the continuous shooting speed will be the same (max. approx. 2.0 shots/sec.).
- When focus is achieved, the AF point will turn blue.
- The exposure is set at the moment the picture is taken.
- When [AF method] is set to [L+Tracking], focusing will be continuous as long as the Area AF frame can track the subject.

MENU Focusing with AF

Selecting the AF Method

You can select an AF method to suit the shooting conditions and your subject. The following AF methods are provided: [**L** (face)+Tracking] (p.141), [**Smooth zone**] (p.142), and [**Live 1-point AF**] (p.144).

If you want to achieve precise focus, set the lens's focus mode switch to <MF>, magnify the image, and focus manually.

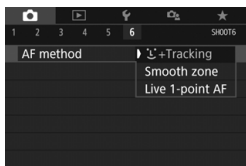

Select the AF method.

- Under the [**6**] tab (the [**2**] tab in Basic Zone modes), select [**AF method**].
- Select the desired AF method, then press <SET>.
- While the Live View image is displayed, you can also press the <Q> button to select the AF method on the Quick Control screen.

(face)+Tracking: AF

The camera detects and focuses on human faces. If a face moves, the AF point <[]> also moves to track the face.



Area AF frame

1 Display the Live View image.

- Press the <[]> button.
- ▶ The Live View image will appear on the LCD monitor.
- ▶ The Area AF frame will be displayed.

2 Check the AF point.

- When a face is detected, the AF point <[]> will appear over the face to be focused on.
- If multiple faces are detected, <[]> will be displayed. Use the <◀> <▶> keys to move <[]> over the face you want to focus on.
- You can also tap on the LCD monitor screen to select the face or subject. If you tap on a subject other than a human face, the AF point will be switched to <[]>.

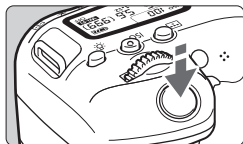

3 Focus on the subject.

- Press the shutter button halfway to focus.
- ▶ If no faces can be detected or if you do not tap anything on the screen, focus will be achieved within the Area AF frame.
- ▶ When focus is achieved, the AF point will turn green and the beeper will sound.
- ▶ If focus is not achieved, the AF point will turn orange.



4 Take the picture.

- Check the focus and exposure, then press the shutter button completely to take the picture (p.132).

● Focusing on a subject other than a human face

If you press <SET> or the <AF-ON> button, the AF point <AF-ON> will appear at the center and you can use the <▲> <▼> or <◀> <▶> keys to move the AF point. Once the AF point <AF-ON> achieves focus, it will track the subject even if you change the composition or the subject moves.

Smooth Zone: AF()

The selected Zone AF frame is used to focus. The AF area is larger than with [Live 1-point AF].



Zone AF frame

1 Display the Live View image.

- Press the <Live View> button.
- ▶ The Live View image will appear on the LCD monitor.
- ▶ The Zone AF frame will be displayed.



2 Select the AF point.

- Press the <▲> <▼> or <◀> <▶> keys to select a zone. To return to the center zone, press <SET> or the <🗑️> button.
- You can also touch the LCD monitor screen to move the Zone AF frame.

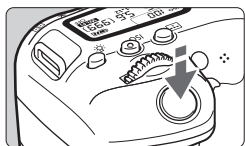

3 Focus on the subject.

- Aim the Zone AF frame over the subject and press the shutter button halfway.
- ▶ When focus is achieved, the AF point will turn green and the beeper will sound.
- ▶ If focus is not achieved, the Zone AF frame will turn orange.



4 Take the picture.

- Check the focus and exposure, then press the shutter button completely to take the picture (p.132).



Live 1-point AF: AF □

The camera focuses with a single AF point. This is effective when you want to focus on a particular subject.









AF point

1 Display the Live View image.

- Press the <  > button.
- ▶ The Live View image will appear on the LCD monitor.
- ▶ The AF point <  > will appear.
- During movie shooting, if [Movie Servo AF] is set to [Enable], a larger AF point will be displayed.



2 Move the AF point.

- Press the <  > <  > or <  > <  > keys to move the AF point to where you want to focus. (It cannot be moved to the edge of the screen.)
- Pressing <  > or the <  > button will return the AF point to the screen center.
- You can also touch the LCD monitor screen to move the AF point.

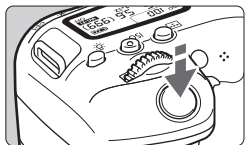

3 Focus on the subject.

- Aim the AF point over the subject and press the shutter button halfway.
- ▶ When focus is achieved, the AF point will turn green and the beeper will sound.
- ▶ If focus is not achieved, the AF point will turn orange.



4 Take the picture.

- Check the focus and exposure, then press the shutter button completely to take the picture (p.132).

Shooting with the Touch Shutter

Just by tapping on the LCD monitor screen, you can focus and take the picture automatically.







1 Display the Live View image.

- Press the  button.
- ▶ The Live View image will appear on the LCD monitor.



2 Enable the touch shutter.

- Tap  on the screen's bottom left. Each time you tap on the icon, it will toggle between  and .
-  (Touch shutter: Enable)
The camera will focus on the spot you tap on, then the picture will be taken.
-  (Touch shutter: Disable)
You can tap on a spot to perform focusing on the spot (Touch AF). Press the shutter button completely to take the picture.



3 Tap on the screen to shoot.

- Tap on the face or subject on the screen.
- ▶ On the point you tap, the camera will focus with the AF method that was set (p.140-144). When [**Smooth zone**] is set, it will switch to [**Live 1-point AF**].
- ▶ When focus is achieved, the AF point turns green and the picture is taken automatically.
- If focus is not achieved, the AF point turns orange and the picture cannot be taken. Tap on the face or subject on the screen again.



7

Shooting Movies

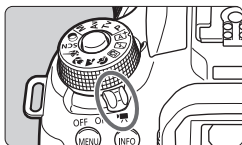

Movie shooting is enabled by setting the power switch to .

- For cards that can record movies, see page 8.
- If you handhold the camera and shoot movies, camera shake can cause blurred movies. In such a case, using a tripod is recommended.



Full HD 1080

Full HD 1080 indicates compatibility with High-Definition featuring 1080 vertical pixels (scanning lines).



Shooting Movies

Connecting the camera to a TV set is recommended to play back the shot movies.

Autoexposure Shooting

When the shooting mode is set to any mode other than **<M>**, autoexposure control will take effect to suit the scene's current brightness.

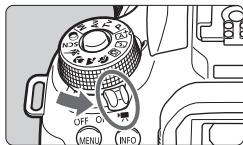

1 Set the power switch to **<Movie icon>**.

- ▶ The reflex mirror will make a sound, then the image will appear on the LCD monitor.

2 Set the Mode Dial to a mode other than **<SCN>**, **<Movie icon>**, or **<M>**.

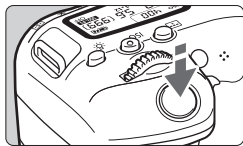

3 Focus on the subject.

- Before shooting a movie, focus with AF or manual focus (p.140-144).
- By default, **[Movie Servo AF: Enable]** is set so that the camera always keeps focusing.

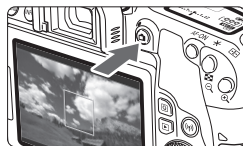

4 Shoot the movie.

- Press the **<Movie icon>** button to start shooting a movie. To stop movie shooting, press the **<Movie icon>** button again.
- ▶ While the movie is being shot, the “●” mark will be displayed on the upper right of the screen.
- ▶ Sound will be recorded by the built-in microphones.

Recording movie

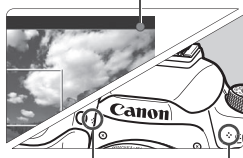

Built-in microphones

Information Display

- Each time you press the <INFO> button, the information display will change.

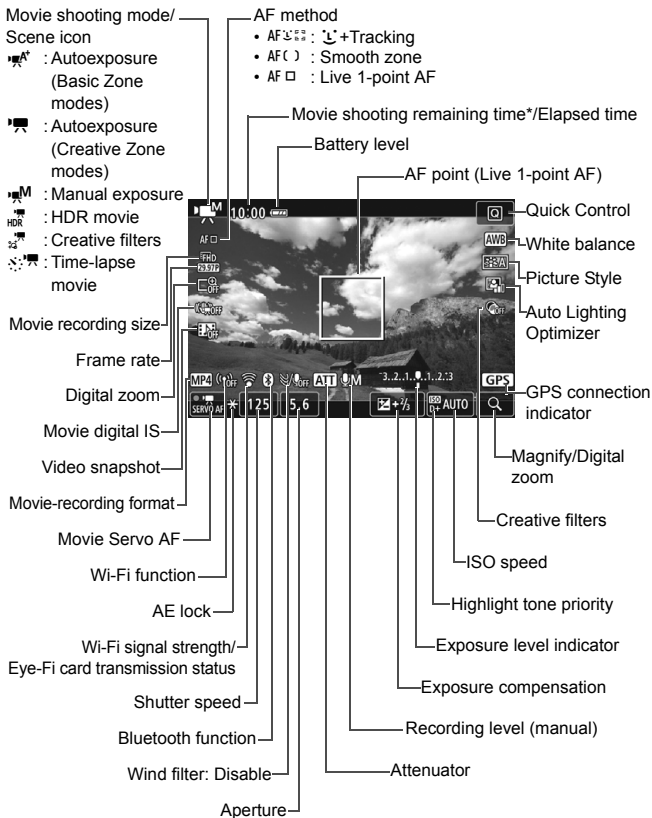

* Applies to a single movie clip.

MENU Setting the Movie Recording Size



With [**1**: **Movie rec. size**], you can set the movie recording size (image size, frame rate, and compression method) and other functions.

Movies will be recorded in the MP4 format.

● Image Size

FHD 1920x1080

Full High-Definition (Full HD) recording quality. The aspect ratio is 16:9.

FHD 1280x720

High-Definition (HD) recording quality. The aspect ratio is 16:9.

EVGA 640x480

Standard-definition recording quality. The aspect ratio is 4:3.

● Frame Rate (fps: frame per second)

29.97P 29.97 fps/59.94P 59.94 fps

For areas where the TV system is NTSC (North America, Japan, South Korea, Mexico, etc.).

25.00P 25.00 fps/50.00P 50.00 fps

For areas where the TV system is PAL (Europe, Russia, China, Australia, etc.).

23.98P 23.98 fps

Mainly for motion pictures.

- **Compression method**

-  **IPB (Standard)**

- Compresses multiple frames at a time efficiently for recording.

-   **IPB (Light)**

- Since the movie is recorded at a low bit rate for playback on various devices, the file size will be smaller than with IPB (Standard).

- Therefore, you can shoot longer than with IPB (Standard).



Do not hold the camera in the same position for long periods of time.

Even if the camera does not feel too hot, prolonged contact with the same body part may cause skin redness or blistering due to low-temperature contact burns. Using a tripod is recommended for people with circulation problems or very sensitive skin, or when using the camera in very hot places.



8

Handy Features

- Disabling the Beeper (p.154)
- Card Reminder (p.154)
- Setting the Image Review Time (p.155)
- Setting the Auto Power Off Time (p.155)
- Reverting the Camera to the Default Settings (p.156)

Handy Features

MENU Disabling the Beeper

You can prevent the beeper from sounding when focus is achieved, during self-timer shooting, and during touch operations.

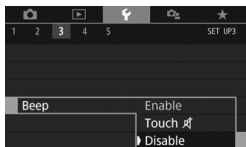

Under the [**3**] tab, select [**Beep**], then press <SET>. Select [**Disable**], then press <SET>.

To silence the beeper only for touch operations, select [**Touch**].

MENU Card Reminder

This setting prevents shooting if there is no card in the camera.

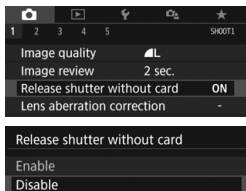

Under the [**1**] tab, select [**Release shutter without card**], then press <SET>. Select [**Disable**], then press <SET>.

If there is no card inserted in the camera and you press the shutter button, “**Card**” will be displayed in the viewfinder and on the LCD panel, and you cannot release the shutter.

MENU Setting the Image Review Time

You can change how long the image is displayed on the LCD monitor immediately after shooting. If **[Off]** is set, the image will not be displayed immediately after shooting. If **[Hold]** is set, the image review will be displayed up until the **[Auto power off]** time has elapsed.

Note that during image review, if you operate any camera controls such as pressing the shutter button halfway, the image review will end.

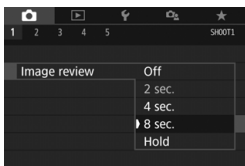

Under the [**1**] tab, select **[Image review]**, then press **<SET>**. Select the desired setting, then press **<SET>**.

MENU Setting the Auto Power Off Time

To save battery power, the camera turns off automatically after a set time of idle operation elapses. When the camera is turned off due to auto power off, you can turn it on again by pressing the shutter button, etc.

If [Disable] is set, either turn off the camera or press the <INFO> button to turn off the LCD monitor to save battery power.

Even if [Disable] is set, the LCD monitor will turn off after the camera is left idle for approx. 30 min. To turn on the LCD monitor again, press the <INFO> button.

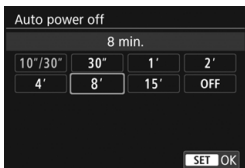

Under the [**2**] tab, select **[Auto power off]**, then press **<SET>**. Select the desired setting, then press **<SET>**.

MENU Reverting the Camera to the Default Settings ☆

The camera's shooting function settings and menu settings can be reverted to their defaults. This option is available in Creative Zone modes.

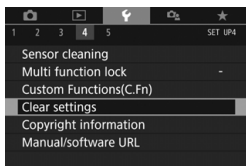

- 1 Select [Clear settings].**
- Under the [**4**] tab, select [**Clear settings**], then press <SET>.

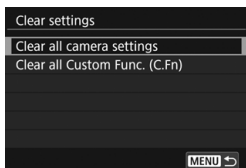

- 2 Select [Clear all camera settings].**
- Select [**Clear all camera settings**], then press <SET>.



- 3 Select [OK].**
- Select [**OK**], then press <SET>.

? FAQ● **Clearing all camera settings**

After the procedure above, select [**Clear all Custom Func. (C.Fn)**] in [**4: Clear settings**] to clear all the Custom Function settings.

9

Image Playback

This chapter explains basic procedures to play back images and movies.

Images shot and saved with another device

The camera may not be able to properly display images captured with a different camera, edited with a computer, or that have had their file names changed.

▶ Searching for Images Quickly

▣ Display Multiple Images on One Screen (Index Display)

Search for images quickly with the index display showing 4, 9, 36, or 100 images on one screen.



1 Play back the image.

- When you press the <▶> button, the last image captured will be displayed.

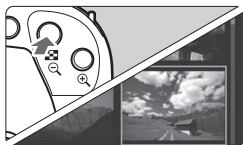

2 Switch to the index display.

- Press the <▣·Q> button.
- ▶ The 4-image index display will appear. The selected image is highlighted with an orange frame.
- Pressing the <▣·Q> button will switch the display as follows: 9 images → 36 images → 100 images.
- Pressing the <Q> button will switch the display as follows: 100 images → 36 images → 9 images → 4 images → 1 image.



3 Select an image.



- Turn the <☉> dial to move the orange frame and select the image. You can also press the <▲> <▼> or <◀> <▶> keys to select the image.
- Turning the <☀> dial will display image(s) on the next or previous screen.
- Press <SET> in the index display to display the selected image in the single-image display.

Jumping through Images (Jump Display)

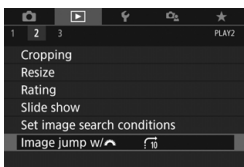
In the single-image display, you can turn the < > dial to jump through the images forward or backward according to the jump method set.



1 Select [Image jump w/].

- Under the [ 2] tab, select [Image jump w/ ], then press <SET>.

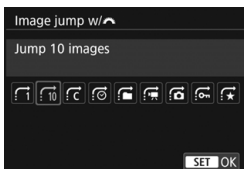



2 Select the jump method.

- Turn the < > dial to select the jump method, then press <SET>.



3 Browse by jumping.

- Press the < > button to play back images.
- In the single-image display, turn the < > dial.
- ▶ You can browse by the set method.

Jump method

Playback position



Playing Back with the Touch Screen

The LCD monitor is a touch-sensitive panel that you can touch with your fingers for various playback operations. **First, press the <▶> button to play back images.**

Browsing Images



Swipe with one finger.

- With single-image display, touch the LCD monitor with **one finger**. You can browse to the next or previous image by swiping your finger to the left or right.

Swipe to the left to see the next (newer) image, or swipe to the right to see the previous (older) image.

- With index display, also touch the LCD monitor with **one finger**. You can browse to the next or previous screen by swiping your finger up or down.

Swipe up to see the next (newer) images or swipe down to see the previous (older) images.

When you select an image, the orange frame will appear. Tap on the image again to display it as a single image.

Jumping through Images (Jump Display)

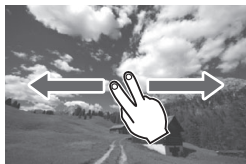

Swipe with two fingers.

Touch the LCD monitor with **two fingers**. When you swipe two fingers to the left or right, you can jump through images with the method set in [Image jump w/] under the [▶2] tab.

Reducing Image (Index Display)



Pinch two fingers.

Touch the screen with two fingers spread apart, and pinch your fingers together on the screen.

- Each time you pinch your fingers, the single-image display will change to the index display.
- When you select an image, the orange frame will appear. Tap on the image again to display it as a single image.

Magnifying Image

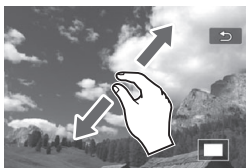

Spread two fingers apart.

Touch the screen with two fingers together, then spread your fingers apart on the screen.

- As you spread your fingers, the image will be magnified.
- The image can be magnified up to approx. 10x.

Double-tap.

- When you double-tap on the image with your finger, the recorded image's pixels will be displayed at approx. 100% centered around the point that you tapped on.
- To return to the single-image display, double-tap on the image again.

▶▶▶ Playing Back Movies



1 Play back the image.

- Press the <▶> button to display an image.

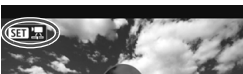

2 Select a movie.

- Turn the <◉> dial to select the movie to be played back.
- In the single-image display, the <SET [movie camera]> icon displayed on the upper left indicates a movie. If the movie is a video snapshot, <SET [video snapshot]> will be displayed.
- In the index display, perforations at the left edge of a thumbnail indicate a movie. **As movies cannot be played back from the index display, press <SET> to switch to the single-image display.**



3 In the single-image display, press <SET>.

- ▶ The movie playback panel will appear at the bottom of the screen.



4 Play back the movie.

- Select [▶] (Play), then press <SET>.
- ▶ The movie will start playing back.
- You can pause the playback by pressing <SET>.
- You can adjust the sound volume during movie playback by turning the <◉> dial.
- For more details on the playback procedure, see the next page.

Speaker

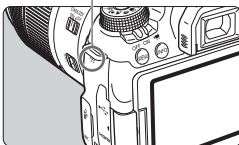

Movie Playback Panel

Operation	Playback Description
▶ Play	Pressing <SET> toggles between play and stop.
▶ Slow motion	Adjust the slow motion speed by pressing the <◀> <▶> keys. The slow motion speed is indicated on the upper right of the screen.
◀◀ First frame	Displays the movie's first frame.
◀◀◀ Previous frame	Displays the previous frame each time you press <SET>. Holding <SET> down will rewind the movie.
◀◀◀ Next frame	Plays the movie frame-by-frame each time you press <SET>. Holding <SET> down will fast forward the movie.
▶▶▶ Last frame	Displays the movie's last frame.
🎵 Background music*	Plays back a movie with the selected background music.
✂ Edit	Displays the editing screen.
	Playback position
mm' ss"	Playback time (minutes:seconds)
🔊 Volume	Turn the <🔊> dial to adjust the volume of the built-in speaker (p.162).
MENU ↶	Press the <MENU> button to return to the single-image display.

* When background music is set, the movie sound will not be played back.

Playback with the Touch Screen

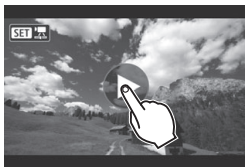

Tap [▶] at the center of the screen.

- ▶ The movie will start playing back.
- To display the movie playback panel, tap <SET>  on the upper left of the screen.
- To pause the movie while it is playing back, tap on the screen. The movie playback panel will also appear.

Erasing Images

You can either select and erase unnecessary images one by one or erase them in one batch. Protected images will not be erased.

! Once an image is erased, it cannot be recovered. Make sure you no longer need the image before erasing it. To prevent important images from being erased accidentally, protect them. Erasing an image shot in RAW+JPEG will erase both the RAW and JPEG images.

Erasing a Single Image



1 Play back the image to be erased.

2 Press the  button.

▶ The Erase menu will appear.



3 Erase the image.

- Select [Erase], then press . The image displayed will be erased.

10

Software Start Guide / Downloading Images to a Computer

This chapter describes the following:

- Overview of the software for EOS DIGITAL cameras
- How to download and install the software on a computer
- How to download and view the Software Instruction Manuals (PDF files)
- How to download images from the camera to a computer

Software Start Guide

Software Overview

This section describes an overview of various software applications for EOS DIGITAL cameras. An Internet connection is required to download and install the software. Download and installation are not possible in environments with no Internet connection.

EOS Utility

With the camera connected to a computer, EOS Utility enables you to transfer still photos and movies shot with the camera to the computer. You can also use this software to set various camera settings and shoot remotely from the computer connected to the camera. Also, you can copy background music tracks, such as EOS Sample Music*, to the card.

* You can use the background music as the soundtrack for a video snapshot album, movie, or slide show played back with your camera.

Digital Photo Professional

This software is recommended for users who shoot RAW images. You can view, edit, and print RAW and JPEG images.

* Certain functions differ between the version to be installed on a 64-bit computer and that to be installed on a 32-bit computer.

Picture Style Editor

You can edit Picture Styles, and create and save original Picture Style files. This software is aimed at advanced users who are experienced in image processing.

Downloading and Installing the Software



- **Do not connect the camera to a computer before you install the software. The software will not be installed correctly.**
- Even if a previous version of the software is installed on your computer, follow the procedure below to install the latest version. (The previous version will be overwritten.)

1 Download the software.

- Connect to the Internet from a computer and access the following Canon Web site.

www.canon.com/icpd

- Select your country or region of residence and download the software.
- Decompress it on the computer.

For Windows: Click the displayed installer file to start the installer.

For Macintosh: A dmg file will be created and displayed. Follow the steps below to start the installer.

- (1) Double-click the dmg file.
 - ▶ A drive icon and installer file will appear on the desktop. If the installer file does not appear, double-click the drive icon to display it.
- (2) Double-click the installer file.
 - ▶ The installer starts.

2 Follow the on-screen instructions to install.

Downloading and Viewing the Software Instruction Manuals (PDF Files)

Internet connection is required to download the Software Instruction Manuals (PDF files). Download is not possible in environments with no Internet connection.

1 Download the Software Instruction Manuals (PDF files).

- Connect to the Internet and access the following Canon Web site.
www.canon.com/icpd

2 View the Software Instruction Manuals (PDF files).

- Double-click a downloaded Instruction Manual (PDF file) to open it.
- To view the Instruction Manuals (PDF files), Adobe Acrobat Reader DC or other Adobe PDF viewer (most recent version recommended) is required.
- Adobe Acrobat Reader DC can be downloaded for free from the Internet.
- To learn how to use PDF viewing software, refer to the software's Help section.

Downloading Images to a Computer

You can use EOS software to download images from the camera to a computer. There are two ways to do this.

Downloading by Connecting the Camera to the Computer

1 Install the software (p.167).

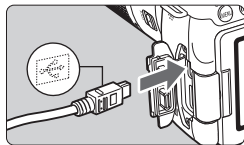

2 Use an interface cable (sold separately) to connect the camera to the computer.

- Connect the cable to the camera's digital terminal with the cable plug's icon facing the front of the camera.
- Connect the cord's plug to the computer's USB terminal.

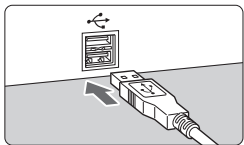

3 Use EOS Utility to transfer the images.

- Refer to the EOS Utility Instruction Manual.

 While a Wi-Fi connection is established, the camera cannot be connected to a computer with an interface cable.

Downloading Images with a Card Reader

You can use a card reader to download images to a computer.

1 Install the software (p.167).

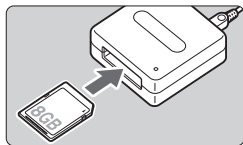

2 Insert the card into the card reader.

3 Use Digital Photo Professional to download the images.

- Refer to the Digital Photo Professional Instruction Manual.

 When downloading images from the camera to a computer with a card reader without using EOS software, copy the DCIM folder on the card to the computer.

Trademarks

- Adobe is a trademark of Adobe Systems Incorporated.
- Microsoft and Windows are trademarks or registered trademarks of Microsoft Corporation in the United States and/or other countries.
- Macintosh and Mac OS are trademarks of Apple Inc., registered in the U.S. and other countries.
- SDXC logo is a trademark of SD-3C, LLC.
- HDMI, HDMI logo, and High-Definition Multimedia Interface are trademarks or registered trademarks of HDMI Licensing LLC.
- The Bluetooth[®] word mark and logos are registered trademarks owned by Bluetooth SIG, Inc. and any use of such marks by Canon Inc. is under license. Other trademarks and trade names are those of their respective owners.
- All other trademarks are the property of their respective owners.

About MPEG-4 Licensing

“This product is licensed under AT&T patents for the MPEG-4 standard and may be used for encoding MPEG-4 compliant video and/or decoding MPEG-4 compliant video that was encoded only (1) for a personal and non-commercial purpose or (2) by a video provider licensed under the AT&T patents to provide MPEG-4 compliant video. No license is granted or implied for any other use for MPEG-4 standard.”

* Notice displayed in English as required.

Third party software

This product includes third party software.

- expat.h

Copyright (c) 1998, 1999, 2000 Thai Open Source Software Center Ltd

Permission is hereby granted, free of charge, to any person obtaining a copy of this software and associated documentation files (the "Software"), to deal in the Software without restriction, including without limitation the rights to use, copy, modify, merge, publish, distribute, sublicense, and/or sell copies of the Software, and to permit persons to whom the Software is furnished to do so, subject to the following conditions:

The above copyright notice and this permission notice shall be included in all copies or substantial portions of the Software.

THE SOFTWARE IS PROVIDED "AS IS", WITHOUT WARRANTY OF ANY KIND, EXPRESS OR IMPLIED, INCLUDING BUT NOT LIMITED TO THE WARRANTIES OF MERCHANTABILITY, FITNESS FOR A PARTICULAR PURPOSE AND NONINFRINGEMENT. IN NO EVENT SHALL THE AUTHORS OR COPYRIGHT HOLDERS BE LIABLE FOR ANY CLAIM, DAMAGES OR OTHER LIABILITY, WHETHER IN AN ACTION OF CONTRACT, TORT OR OTHERWISE, ARISING FROM, OUT OF OR IN CONNECTION WITH THE SOFTWARE OR THE USE OR OTHER DEALINGS IN THE SOFTWARE.

Use of Genuine Canon Accessories Is Recommended

This product is designed to achieve optimum performance when used with genuine Canon accessories. Therefore, using this product with genuine accessories is highly recommended.

Canon shall not be liable for any damage to this product and/or accidents such as malfunction, fire, etc., caused by the failure of non-genuine Canon accessories (e.g., a leakage and/or explosion of a battery pack). Please note that repairs arising out of the malfunction of non-genuine accessories will not be covered by the warranty for repairs, although you may request such repairs on a chargeable basis.

Digital Camera Model DS126651 Systems

This device complies with Part 15 of the FCC Rules. Operation is subject to the following two conditions: (1) This device may not cause harmful interference, and (2) this device must accept any interference received, including interference that may cause undesired operation.

Note: This equipment has been tested and found to comply with the limits for class B digital devices, pursuant to Part 15 of the FCC Rules. These limits are designed to provide reasonable protection against harmful interference in a residential installation. This equipment generates, uses and can radiate radio frequency energy and, if not installed and used in accordance with the instructions, may cause harmful interference to radio communications. However, there is no guarantee that interference will not occur in a particular installation. If this equipment does cause harmful interference to radio or television reception, which can be determined by turning the equipment off and on, the user is encouraged to try to correct the interference by one or more of the following measures:

- Reorient or relocate the receiving antenna.
- Increase the separation between the equipment and receiver.
- Connect the equipment into an outlet on a circuit different from that to which the receiver is connected.
- Consult the dealer or an experienced radio/TV technician for help.

The cable with the ferrite core provided with the digital camera must be used with this equipment in order to comply with Class B limits in Subpart B of Part 15 of the FCC rules.

Do not make any changes or modifications to the equipment unless otherwise specified in the manual. If such changes or modifications should be made, you could be required to stop operation of the equipment.

Canon U.S.A. Inc.
One Canon Park, Melville, NY 11747, U.S.A.
Tel No. 1-800-OK-CANON (1-800-652-2666)

CAN ICES-3 (B) / NMB-3 (B)



USA and Canada only:

The Lithium ion/polymer battery that powers the product is recyclable. Please call 1-800-8-BATTERY for information on how to recycle this battery.

For CA, USA only

Included lithium battery contains Perchlorate Material – special handling may apply. See www.dtsc.ca.gov/hazardouswaste/perchlorate/ for details.

CAUTION

RISK OF EXPLOSION IF BATTERY IS REPLACED BY AN INCORRECT TYPE.
DISPOSE OF USED BATTERIES ACCORDING TO LOCAL REGULATION.

Index

Numerics

10- or 2-sec. self-timer	107
1280x720 (movie)	150
1920x1080 (movie)	150
640x480 (movie)	150

A

 (Scene Intelligent Auto)	70
Access lamp	34
Accessories	3
AE lock	128
AEB (Auto Exposure Bracketing) ...	127
AF	
AF area selection	
mode	100, 101, 103
AF method	140
AF operation	98, 137
AF point	100
AF point automatic	
selection	100, 104
AF point selection	102
Area AF frame	100, 104, 141
Beeper	154
Manual focusing (MF)	105
Out of focus	44
Recomposing	73
AI FOCUS (AI Focus AF)	99
AI SERVO (AI Servo AF)	73, 99
ALL-I	8
Anti-flicker shooting	119
Aperture-priority AE	124
Area AF frame	100, 104, 141
Auto Lighting Optimizer	116
Auto power off	36, 155
Autofocus → AF	
Automatic selection (AF)	100, 104
Av (Aperture-priority AE)	124

B

Basic Zone modes	26
Battery	30, 32, 37
Beep (Beeper)	154
Black-and-white images	114
Bracketing	127
Built-in flash	129

C

















 (Creative Auto)	75
Cable	169
Camera	
Clearing the camera settings to	
default	156
Holding the camera	44
Candlelight	84
Cards	8, 20, 33, 65
Formatting	65
Write-protect switch	33
Charger	28, 30
Clearing the camera settings to	
default	156
Close-ups	78
Color temperature	115
Color tone	83, 84
Continuous shooting	106
Creative Auto	75
Creative filters	88, 135
Creative Zone modes	27

D

Date/time	38
Daylight saving time	40
Default settings	156
Dials	
Main Dial	46
Quick Control Dial	47

- Digital terminal 21
- Dioptic adjustment 44
- Display level 50
- Dragging 63
- Drive mode 23, 106, 107
- E**
- Electronic level 67
- Erasing images 164
- Exposure compensation 126
- Exposure level indicator 25
- Eyepiece cover 29
- F**
- Feature guide 54
- File size 111
- Fine (image-recording quality) 23
- Flash (Speedlite)
- Built-in flash 129
 - Effective range 129
 - Flash off 74
 - Flash sync contacts 21
- Focus indicator 70
- Focus lock 73
- Focus mode switch 42, 105
- Focusing → AF
- Focusing point (AF point) 100
- Food 83
- Formatting (card initialization) 65
- Frame rate 150
- Full High-Definition
(Full HD) (movie) 147, 150
- G**
- Group Photo 81
- H**
- Handheld Night Scene 86
- HD (movie) 150
- HDR Backlight Control 87
- High ISO speed noise reduction ... 117
- High-speed continuous shooting ... 106
- Hot shoe 21
- I**
- Illumination (LCD panel) 49
- Image review time 155
- Image-recording quality 110
- Images
- Erasing 164
 - Index display 158
 - Jump display (image browsing) ... 159
 - Playback 94, 157
 - Review time 155
- Index display 158
- INFO button 94, 134, 149
- IPB (Light) 151
- IPB (Standard) 151
- ISO speed 112
- J**
- JPEG 111
- Jump display 159
- K**
- Kids 82
- L**
- Landscape 77, 114
- Language 41
- Large (image-recording quality) 23
- Large Zone AF 100
- LCD monitor 19, 35
- Adjusting angle 35
 - Electronic level 67
 - Image playback 94, 157
 - Menu display 58
- LCD panel 24

- Lens 20, 42
 - Lock release 43
- Live View shooting 131
 - AF operation 137
 - Creative filters 135
 - Face+Tracking 141
 - Information display 134
 - Live 1-point AF 144
 - Possible shots 133
 - Smooth zone 142
- LOCK 48
- Long exposure noise reduction 118
- Low-speed continuous shooting ... 106
- M**
- M (Manual exposure) 125
- Macro photography 78
- Main Dial 46
- Manual exposure 125
- Manual focusing (MF) 105
- Manual selection (AF point) 102
- Maximum burst 111
- Medium (image-recording quality) ... 23
- Memory cards → Cards
- Menu 58
 - Display level 50
 - Setting procedure 59
- Menu display 52
- MENU** icon 10
- MF (Manual focusing) 105
- Microphone 148
- Mode Dial 26, 46
- Monochrome images 114
- Movies 147
 - AE lock 128
 - Autoexposure 148
 - Compression method 151
 - Frame rate 150
- Information display 149
- Microphone 148
- Movie recording size 150
- Playback 162
- MP4 150
- Multi function lock 48
- Multi Shot Noise Reduction 117
- N**
- Night Portrait 85
- Night scenes 85, 86
- Noise reduction
 - High ISO speed 117
 - Long exposures 118
- Nomenclature 21
- Normal (Image-recording quality) ... 23
- NTSC 150
- O**
- ONE SHOT (One-Shot AF) 99, 138
- P**
- P (Program AE) 122
- PAL 150
- Picture Style 113
- Pixel count 110
- Playback 94, 157
- Portrait 76, 114
- Possible shots 37, 111, 133
- Power
 - Auto power off 155
 - Battery level 37
 - Charging 30
 - Possible shots 37, 111, 133
- Pressing completely 45
- Pressing halfway 45
- Program AE 122

- Q**
-  (Quick Control)..... 56, 90
 - Quick Control Dial..... 47
- R**
- RAW 23, 110, 111
 - RAW+JPEG 110, 111
 - Recharging 30
 - Reduced display 158
 - Release shutter without card 154
- S**
- Scene Intelligent Auto..... 70
 - SD, SDHC, SDXC cards → Cards
 - Self-timer 107
 - Sensitivity → ISO speed
 - Servo AF
 - AI Servo (AI Servo AF)..... 99
 - Servo (Servo AF)..... 139
 - Shooting mode guide..... 53
 - Shooting modes..... 26
 - Av (Aperture-priority AE) 124
 - M (Manual exposure) 125
 - P (Program AE) 122
 - Tv (Shutter-priority AE)..... 123
 -  (Scene Intelligent Auto) 70
 -  (Flash Off) 74
 -  (Creative Auto) 75
 -  (Portrait) 76
 -  (Landscape) 77
 -  (Close-up)..... 78
 -  (Sports)..... 79
 - SCN (Special scene)..... 80
 -  (Group Photo)..... 81
 -  (Kids) 82
 -  (Food)..... 83
 -  (Candlelight)..... 84
 -  (Night Portrait)..... 85
 -  (Handheld Night Scene).... 86
 -  (HDR Backlight Control) ... 87
 -  (Creative filters) 88
 - Shooting screen 50
 - Shooting tips 55
 - Shutter button..... 45
 - Shutter-priority AE..... 123
 - Single shooting..... 106
 - Single-image display 94
 - Single-point AF..... 100
 - Small (image-recording quality) 23
 - Smooth zone 142
 - Software 166
 - Speaker 162
 - Special scene mode (SCN)..... 80
 - Sports 79
 - ★ icon 10
 - Strap..... 29
- T**
- Time zone..... 38
 - Touch beeping..... 154
 - Touch operation..... 62
 - Touch screen..... 62, 160
 - Touch shutter..... 145
 - Tripod socket..... 22
 - Tv (Shutter-priority AE) 123
- U**
- USB (digital) terminal 169
- V**
- Vari-angle LCD monitor..... 35
 - Viewfinder 25
 - Dioptric adjustment 44
 - Electronic level..... 67
 - Volume (movie playback) 163
- W**
- White balance (WB) 115
- Z**
- Zone AF 100



Canon

EOS 77D

**Wi-Fi (Wireless Communication) Function
Basic Instruction Manual**

In Wi-Fi (Wireless Communication) Function Basic Instruction Manual, basic operation procedures for easy-to-use “Communicate with a smartphone” are explained.

Introduction

What You Can Do Using the Wi-Fi® (Wireless Communication) Functions

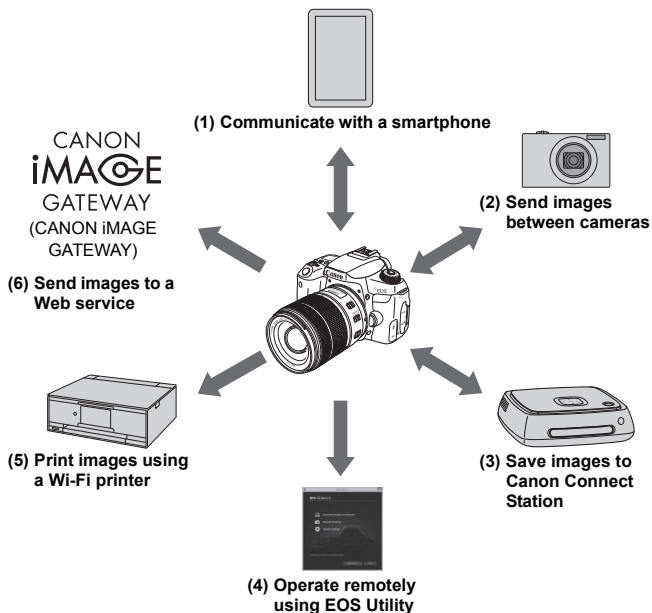

(1)  Communicate with a smartphone (p.W-9, W-23, W-31)

Connect the camera to a smartphone or tablet via Wi-Fi and use the dedicated application “Camera Connect” to operate the camera remotely or view images stored in the camera.

In this manual and on the camera’s LCD monitor, “smartphone” refers to smartphones and tablets.

(2)  Send images between cameras

Connect this camera and other Canon cameras with built-in wireless communication functions via Wi-Fi and send images between them.

(3) Save images to Connect Station

Hold the camera close to Connect Station (sold separately) to connect to it via Wi-Fi and save images to it.

(4)  Operate remotely using EOS Utility

Connect the camera to a computer via Wi-Fi and operate the camera remotely using EOS Utility (EOS software).

(5)  Print images using a Wi-Fi printer

Connect the camera to a printer supporting PictBridge (Wireless LAN) via Wi-Fi to print images.

(6)  Send images to a Web service

Share images with your family and friends or share images using various Web services via CANON iMAGE GATEWAY, an online photo service for Canon users (free registration required).



- Update the Connect Station firmware to the latest version.
- CANON iMAGE GATEWAY Web services are not supported in certain countries and areas. For information on supported countries and areas, refer to the Canon Web site (www.canon.com/cig).

Wi-Fi Connection Using the Bluetooth® Function

This camera can be connected easily to a smartphone compatible with Bluetooth low energy technology* via Wi-Fi. For details, see page W-9.

* Hereafter referred to as “Bluetooth”.

Wi-Fi Connection Using the NFC Function

This camera is compatible with NFC (Near Field Communication) that enables you to easily establish a Wi-Fi connection between the camera and a smartphone or Connect Station (sold separately). For details, see page W-23.

Wi-Fi Connection Using the <(P)> Button

This camera enables you to establish a Wi-Fi connection by displaying the Wi-Fi function menu with the <(P)> button. For details, see page W-31.

Instruction Manual

For more detailed procedures, refer to the Instruction Manual downloadable from the Canon Web site. For how to download the Instruction Manual, see page 4.

- Note that Canon cannot be held liable for any loss or damage from erroneous wireless communication settings when using the camera. In addition, Canon cannot be held liable for any other loss or damage caused by use of the camera.
- When using wireless communication functions, establish appropriate security at your own risk and discretion. Canon cannot be held liable for any loss or damage caused by unauthorized access or other security breaches.

Contents

Introduction W-2

What You Can Do Using the Wi-Fi, (Wireless Communication) Functions	W-2
Setting Wi-Fi Settings	W-6
Preparation for Smartphones	W-8

1 Connecting to a Bluetooth-compatible Smartphone via Wi-Fi W-9

Bluetooth Connection.....	W-10
Establishing a Bluetooth Connection	W-11
Establishing a Wi-Fi Connection	W-15
Operating the Camera Using a Smartphone.....	W-18
Sending Images to a Smartphone from the Camera	W-20

2 Connecting to an NFC-compatible Smartphone via Wi-Fi W-23

Wi-Fi Connection to an NFC-compatible Smartphone.....	W-24
Establishing a Wi-Fi Connection	W-25
Sending Images from the Camera to a Smartphone	W-28

3 Connecting to a Smartphone via Wi-Fi with the <(P)> Button W-31

Establishing a Wi-Fi Connection	W-32
Reconnecting via Wi-Fi	W-37
Wireless Communication Function Precautions	W-39
Index	W-41



For Troubleshooting guide and Specifications, refer to the Instruction Manual downloadable from the Canon Web site. For how to download the Instruction Manual, see page 4.

Setting Wi-Fi Settings

First, follow the steps below to set the Wi-Fi settings.

1 Press the <((P))> button.

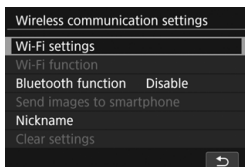

2 Select [Wi-Fi settings].

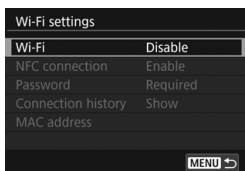

3 Select [Wi-Fi].



4 Select [Enable].

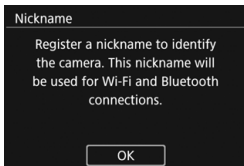

5 Register [Nickname].

- When the screen on the left appears, press <SET>.



- ▶ The screen on the left will appear.
- When using the displayed nickname, press the <MENU> button.
- Otherwise, enter any characters between 1 to 8 characters in length. When you finish entering, press the <MENU> button.

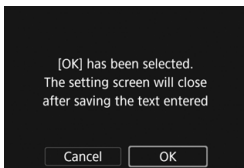

6 Exit the setting.

- When the screen on the left appears, select [OK], then press <SET>.
- To return to the screen that appears when the <(r)> button is pressed, press the <MENU> button.

Preparation for Smartphones

To connect the camera to a smartphone, a smartphone on which Android or iOS is installed is necessary. In addition, the dedicated application Camera Connect (free of charge) must be installed on the smartphone.

- Camera Connect can be installed from the Google Play or App Store. The Google Play or App Store can also be accessed using the QR codes that appear when connecting the camera to a smartphone (p.W-12, W-33).



- For the operating system versions supported by Camera Connect, refer to the download site of Camera Connect.
- When an NFC-compatible smartphone is touched to the camera before installing Camera Connect, the download screen of Camera Connect will be displayed on the smartphone.
- Interface or functions of the camera and Camera Connect are subject to change for firmware update of the camera or application update of Camera Connect, Android, iOS, etc. In such a case, features of the camera or Camera Connect may differ from sample screens or operation instructions in this manual.

1

Connecting to a Bluetooth-compatible Smartphone via Wi-Fi

This section describes how to connect the camera to a Bluetooth-compatible smartphone via Wi-Fi.

Connecting to a smartphone via Wi-Fi enables you to perform the following:

- View images stored in the camera on a smartphone or save viewed images to a smartphone.
- Operate the camera to take a picture or change camera settings using a smartphone.
- Send images to a smartphone from the camera.
- Install Camera Connect on the smartphone before setting up a connection (p.W-8).
- For procedures to connect to an NFC-compatible smartphone via Wi-Fi, see “Connecting to an NFC-compatible Smartphone via Wi-Fi” (p.W-23).
- If the smartphone you want to connect to via Wi-Fi is not Bluetooth-compatible or NFC-compatible, see “Connecting to a Smartphone via Wi-Fi with the <(r)> Button” (p.W-31).

Bluetooth Connection

When you connect the camera to a Bluetooth-compatible smartphone via Bluetooth, you can establish a Wi-Fi connection by operating only the camera or the smartphone.

Note that pairing between the camera and smartphone is required to connect the camera to a smartphone via Bluetooth. Pairing will be done as part of the Bluetooth connection procedure.

Establishing a Bluetooth Connection

To connect the camera to a smartphone via Bluetooth, refer to the Camera Connect's "Easy Connection Guide" or follow the steps below. Set [Wi-Fi] to [Enable] on the [Wi-Fi settings] screen in advance (p.W-6).

Operation on the Camera-1

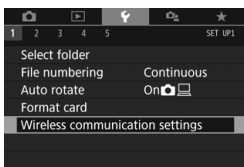

1 Select [Wireless communication settings].

- Press the <MENU> button, select [Wireless communication settings] under the [1] tab, then press <SET>.

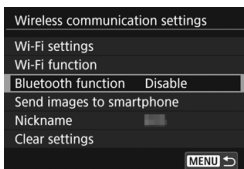

2 Select [Bluetooth function].

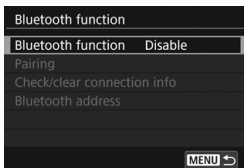

3 Select [Bluetooth function].

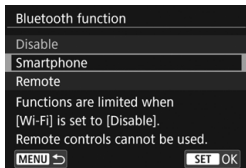

4 Select [Smartphone].

- ▶ <Bluetooth> will be displayed on the camera's LCD panel.

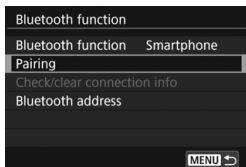
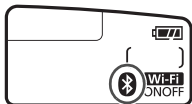

5 Select [Pairing].

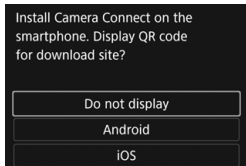

6 Select [Do not display].

- If Camera Connect is already installed, select [**Do not display**] and press <SET>.
- If Camera Connect is not installed, select [**Android**] or [**iOS**] on the screen on the left, scan the displayed QR code with the smartphone, then access Google Play or the App Store and install Camera Connect.
- ▶ The screen on the left will appear and pairing will start.

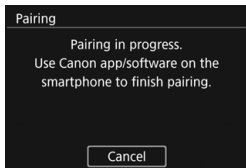

Operation on the Smartphone

7 Activate the smartphone's Bluetooth function.

8 Start Camera Connect.



9 Select the camera to pair with.

- Tap on the nickname of the camera to be paired.

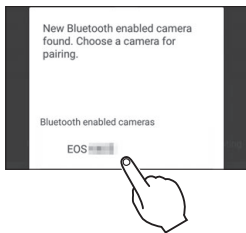

iOS

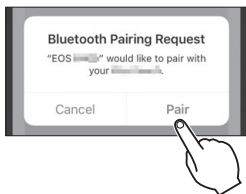

- When the screen on the left appears, tap on **[Pair]**.

Operation on the Camera-2

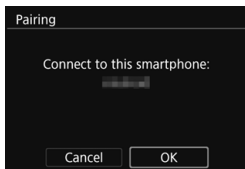

10 Select [OK].



11 Press <SET>.

- Pairing will complete and the camera will be connected to the smartphone via Bluetooth.
- ▶ An illustration indicating that a Bluetooth connection has been established will appear on Camera Connect.

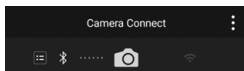

With a Bluetooth connection established, you can operate the camera to send images to the smartphone. For details, see page W-20.

Establishing a Wi-Fi Connection

When a Bluetooth connection is established, follow the steps below to establish a Wi-Fi connection.

Set **[Wi-Fi]** to **[Enable]** on the **[Wi-Fi settings]** screen in advance (p.W-6).

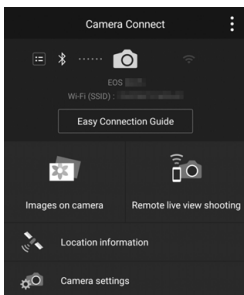

1 Select a Camera Connect function.

- Select the Camera Connect function you want to use.
- For the Camera Connect functions, see page W-18.

Android

- A Wi-Fi connection will be established automatically.
- ▶ When a Wi-Fi connection is established, the screen for the selected function will appear.

iOS

SSID (network name)

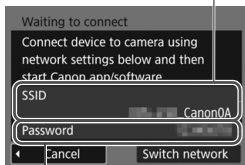

Password

2 Check the SSID and password.

- Check the SSID (network name) and password displayed on the camera.



3 Operate the smartphone to establish a Wi-Fi connection.

- On the smartphone's Wi-Fi function screen, select the SSID checked in step 2.
- For the password, enter the password checked in step 2. The password will not be required from the next time you connect the camera to the smartphone via Wi-Fi.
- Camera Connect will appear.
- ▶ When a Wi-Fi connection is established, the screen for the selected function will appear.

Android and iOS

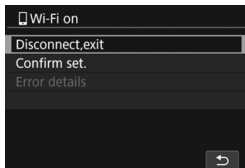

- ▶ The [Wi-Fi on] screen will appear on the camera's LCD monitor.
- ▶ An illustration indicating that a Wi-Fi connection has been established will appear on Camera Connect.

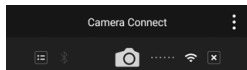

The Wi-Fi connection to a Bluetooth-compatible smartphone is now complete.

- For how to terminate the Wi-Fi connection, see "Terminating the Wi-Fi Connection" (p.W-19).
- Terminating the Wi-Fi connection will switch the camera to the Bluetooth connection.

[Wi-Fi on] Screen

[Disconnect,exit]

- Terminates the Wi-Fi connection.

[Confirm set.]

- You can check the settings.

[Error details]

- When a Wi-Fi connection error occurs, you can check the details of the error.

To switch to the menu, press the <MENU> button.

Operating the Camera Using a Smartphone

You can use a smartphone with Camera Connect installed to view images stored in the camera or perform remote shooting, etc.

Camera Connect Main Window

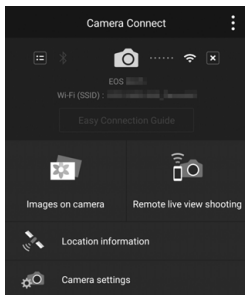

The main functions of Camera Connect are described below.

[Images on camera]

- Images stored in the camera can be viewed.
- Images stored in the camera can be saved on a smartphone.
- Operations such as deletion can be performed on images stored in the camera.

[Remote live view shooting]

- The camera's Live View image can be viewed on a smartphone.
- You can shoot with remote operation.

[Location information]

- Not supported on this camera.

[Camera settings]

- Camera settings can be changed.

Terminating the Wi-Fi Connection

To terminate the Wi-Fi connection, perform either of the following operations.

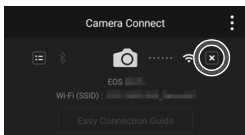

On the smartphone's **Camera Connect** screen, tap on [X].



On the camera's [Wi-Fi on] screen, select [Disconnect,exit].

- If the [Wi-Fi on] screen is not displayed, press the <(P)> button.
- Select [Disconnect,exit], then select [OK] on the confirmation dialog to terminate the Wi-Fi connection.

Sending Images to a Smartphone from the Camera

While a Bluetooth connection (Android only) or Wi-Fi connection is established, you can operate the camera to send images to a smartphone. There are two send methods.

- (1) Select [**Send images to smartphone**] from the camera menu.
- (2) Send images from the Quick Control screen during playback (p.W-21).

(1) Selecting [Send images to smartphone]

Select [**Send images to smartphone**] from the camera menu and send images.

- 1** Connect the camera to a smartphone via Bluetooth (Android only) or Wi-Fi (p.W-15).

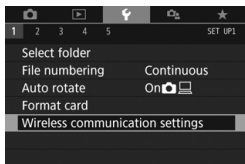

- 2** Select [**Wireless communication settings**].

- Under the [**1**] tab, select [**Wireless communication settings**], then press < (SET) >.

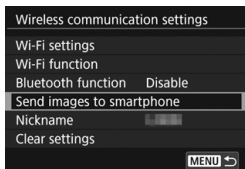

- 3** Select [**Send images to smartphone**].

- ▶ If you perform this step with a Bluetooth connection established, a message will appear and a Wi-Fi connection will start.



- 4** Select the images to send.

- ▶ Select and send image(s). For information on how to send images, see page W-22.

(2) Quick Control During Playback

Send images from the Quick Control screen during playback.

- 1 **Connect the camera to a smartphone via Bluetooth (Android only) or Wi-Fi (p.W-15).**



- 2 **Play back the image.**
 - Press the <▶> button to play back images.



- 3 **Press the <Q> button.**
 - ▶ The Quick Control screen will appear.



- 4 **Select [☐].**
 - ▶ If you perform this step with a Bluetooth connection established, a message will appear and a Wi-Fi connection will start.



- 5 **Select the images to send.**
 - ▶ Select and send image(s). For information on how to send images, see page W-22.

Sending Images Individually

Select and send images individually.



1 Select an image to send.

- Turn the <⊙> dial to select an image to send, then press <SET>.
- By pressing the <☒-Q> button, you can switch to the index display and select an image.



2 Select [Send img shown].

- To select a size at which to send the image, select **[Resize image]** and press <SET>.
- Select **[Send img shown]** and press <SET> to send the image displayed.
- ▶ When the transfer is complete, the screen for step 1 will reappear.
- To send another image, repeat steps 1 and 2.



Connecting to an NFC-compatible Smartphone via Wi-Fi



This section describes how to connect the camera to an NFC-compatible smartphone via Wi-Fi.

Connecting to a smartphone via Wi-Fi enables you to perform the following:

- View images stored in the camera on a smartphone or save viewed images to a smartphone.
- Operate the camera to take a picture or change camera settings using a smartphone.
- Send images to a smartphone from the camera.
- Install Camera Connect on the smartphone before setting up a connection (p.W-8).
- For procedures to connect to a Bluetooth-compatible smartphone via Wi-Fi, see “Connecting to a Bluetooth-compatible Smartphone via Wi-Fi” (p.W-9).
- If the smartphone you want to connect to via Wi-Fi is not Bluetooth-compatible or NFC-compatible, see “Connecting to a Smartphone via Wi-Fi with the <(r)> Button” (p.W-31).

Wi-Fi Connection to an NFC-compatible Smartphone

NFC-compatible smartphones can be connected via Wi-Fi by touching them to the camera.

- Smartphones labeled with the  mark are NFC-compatible.
- Some smartphones are NFC-compatible even if they are not labeled with the  mark. In such a case, check the NFC antenna position by referring to the smartphone's instruction manual.
- For the smartphone's NFC setting, refer to the smartphone's instruction manual.
- If you do not know whether your smartphone is NFC-compatible, contact the manufacturer of the smartphone.

 A Wi-Fi connection may not be established with the NFC function even if the smartphone is NFC-compatible. In such a case, establish a Wi-Fi connection using the procedure in “Connecting to a Smartphone via Wi-Fi with the <(P)> Button” (p.W-31).

Establishing a Wi-Fi Connection

To connect the camera to an NFC-compatible smartphone via Wi-Fi, refer to the Camera Connect's "Easy Connection Guide" or follow the steps below.

(1) Turn on the camera and smartphone.

(2) Enable the NFC function on the camera and smartphone.

(3) Touch the smartphone to the camera so that they come into contact with each other.

- For the camera's NFC setting, see page W-6.
- For the smartphone's Wi-Fi setting, NFC setting, and NFC antenna position, refer to the smartphone's instruction manual.

1 Enable the NFC function on the camera and smartphone

(p.W-6).

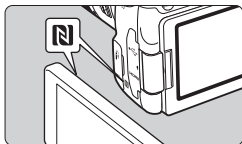

2 Touch a smartphone to the camera.

- If the download site of Camera Connect appears on the smartphone, install Camera Connect (p.W-8).
- If an image is being played back on the camera, press the <▶> button to end the playback.
- Touch the **N** mark on the smartphone to that on the camera so that they come into contact with each other.
- **When a message indicating the connection is being established is displayed on the camera's LCD monitor**, move the smartphone away from the camera.
- ▶ Camera Connect starts on the smartphone and establishes a connection.

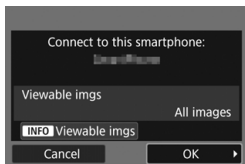

3 Establish a Wi-Fi connection.

- ▶ When a connection is established, the screen on the left will appear on the camera's LCD monitor. When connecting to the same smartphone via NFC, this screen will not appear again.
- Select **[OK]** and press **<SET>**. After a message is displayed, the **[Wi-Fi on]** screen will appear.

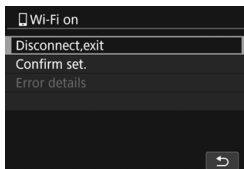

[Wi-Fi on] Screen

[Disconnect,exit]

- Terminates the Wi-Fi connection.

[Confirm set.]

- You can check the settings.

[Error details]

- When a Wi-Fi connection error occurs, you can check the details of the error.

To switch to the menu, press the **<MENU>** button.

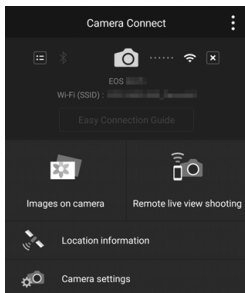

- ▶ The main window of Camera Connect will be displayed on the smartphone.

The Wi-Fi connection to a smartphone is now complete.

- ▶ Operate the camera using Camera Connect. See page W-18.
- For how to terminate the Wi-Fi connection, see “Terminating the Wi-Fi Connection” (p.W-19).

Sending Images from the Camera to a Smartphone ■

By touching an NFC-compatible smartphone to the camera while playing back an image on the camera, you can establish a Wi-Fi connection automatically and send the image to the smartphone even if a Bluetooth or Wi-Fi connection has not been established beforehand.

- On the **[Wi-Fi settings]** screen, set **[Wi-Fi]** to **[Enable]** and set **[NFC connection]** to **[Enable]** in advance (p.W-6).
- For the smartphone's Wi-Fi setting, NFC setting, and NFC antenna position, refer to the smartphone's instruction manual.



1 Play back the image.

- Press the **<▶>** button to play back images.

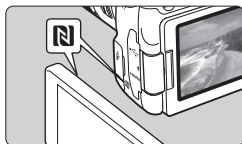

2 Touch a smartphone to the camera.

- Touch the **N** mark on the smartphone to that on the camera so that they come into contact with each other.
- When a message indicating the established connection is displayed on the camera's LCD monitor, move the smartphone away.



3 Select the images to send.

- Select and send image(s). For information on how to send images, see page W-22.



4 End the image transfer.

- Press the <MENU> button on the image transfer screen.
- Select [OK] on the screen on the left, then press <SET> to end the image transfer and terminate the Wi-Fi connection.

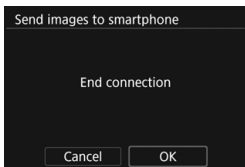

3

Connecting to a Smartphone via Wi-Fi with the <(i)> Button

This section describes how to connect the camera to a smartphone via Wi-Fi using the <(i)> button.

Connecting to a smartphone via Wi-Fi enables you to perform the following:

- View images stored in the camera on a smartphone or save viewed images to a smartphone.
- Operate the camera to take a picture or change camera settings using a smartphone.
- Send images to a smartphone from the camera.
- Install Camera Connect on the smartphone before setting up a connection (p.W-8).
- For procedures to connect to a Bluetooth-compatible smartphone via Wi-Fi, see “Connecting to a Bluetooth-compatible Smartphone via Wi-Fi” (p.W-9).
- For procedures to connect to an NFC-compatible smartphone via Wi-Fi, see “Connecting to an NFC-compatible Smartphone via Wi-Fi” (p.W-23).

Establishing a Wi-Fi Connection

To connect the camera to a smartphone via Wi-Fi, refer to the Camera Connect's "Easy Connection Guide" or follow the steps below. Set **[Wi-Fi]** to **[Enable]** on the **[Wi-Fi settings]** screen in advance (p.W-6).

Operation on the Camera-1

1 Press the **<(P)>** button.

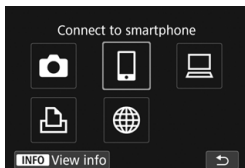

2 Select **[☐] (Connect to smartphone)**.

- If the history (p.W-37) is displayed, switch the screen with the **<◀> <▶>** keys.
- If the **[Wireless communication settings]** screen is displayed, set the Wi-Fi settings (p.W-6).

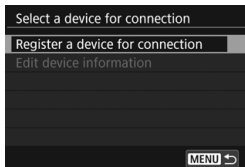

3 Select **[Register a device for connection]**.

Install Camera Connect on the smartphone. Display QR code for download site?

Do not display

Android

iOS

4 Select [Do not display].

- If Camera Connect is already installed, select **[Do not display]** and press **< (SET) >**.
- If Camera Connect is not installed, select **[Android]** or **[iOS]** on the screen on the left, scan the displayed QR code with the smartphone, then access Google Play or the App Store and install Camera Connect.

SSID (network name)

5 Check the SSID and password.

- Check the SSID (network name) and password displayed on the camera's LCD monitor.

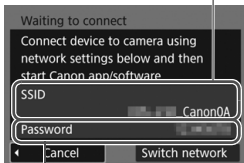

Password

Operation on the Smartphone

Smartphone's screen
(sample)



6 Operate the smartphone to establish a Wi-Fi connection.

- Activate the smartphone's Wi-Fi function, then select the SSID (network name) checked in step 5.
- For the password, enter the password checked in step 5.

7 Start Camera Connect.

- When the [Waiting to connect] screen is displayed on the camera's LCD monitor, start Camera Connect on the smartphone.



8 Select the camera to connect to via Wi-Fi.

- Select and tap on the camera to connect to via Wi-Fi from [Cameras] on Camera Connect.

Operation on the Camera-2

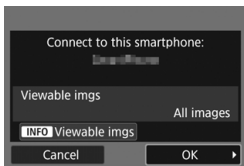

9 Establish a Wi-Fi connection.

- ▶ When a connection is established, the screen on the left will appear on the camera's LCD monitor. When connecting to the same smartphone via NFC, this screen will not appear again.
- Select **[OK]** and press **<SET>**. After a message is displayed, the **[Wi-Fi on]** screen will appear.

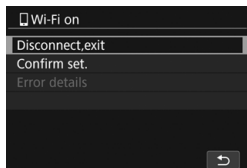

[Wi-Fi on] Screen

[Disconnect,exit]

- Terminates the Wi-Fi connection.

[Confirm set.]

- You can check the settings.

[Error details]

- When a Wi-Fi connection error occurs, you can check the details of the error.

To switch to the menu, press the **<MENU>** button.

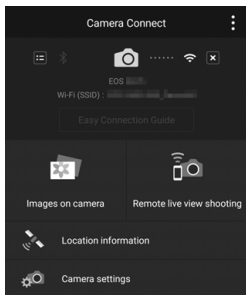

- ▶ The main window of Camera Connect will be displayed on the smartphone.

The Wi-Fi connection to a smartphone is now complete.

- ▶ Operate the camera using Camera Connect. See page W-18.

- For how to terminate the Wi-Fi connection, see “Terminating the Wi-Fi Connection” (p.W-19).
- To reconnect via Wi-Fi, see “Reconnecting via Wi-Fi” (p.W-37).

With a Wi-Fi connection established, you can send images to a smartphone from the camera menu ([**Send images to smartphone**]) or from the Quick Control screen during playback. For details, see page W-20.

Reconnecting via Wi-Fi

Reconnect the camera via Wi-Fi to a device or service that you have connected to and registered connection settings for in the past.

1 Press the <((P))> button.

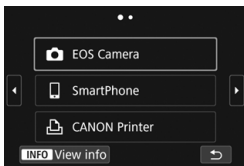

2 Select an item.

- Select the item to connect to via Wi-Fi from the displayed history. If the item is not displayed, press the <◀> <▶> keys to switch the screen.
- After selecting the item, press <SET>.

3 Operate the connected device.

📱 Smartphone

- Activate the smartphone's Wi-Fi function, then start Camera Connect.
- If the smartphone's connection destination has been changed, restore the setting to connect via Wi-Fi to the camera.

Wireless Communication Function Precautions ■

■ Countries and Regions Permitting Wireless Communication Function Use

Use of wireless communication functions is restricted in some countries and regions, and illegal use may be punishable under national or local regulations. To avoid violating wireless communication function regulations, visit the Canon Web site to check where use is allowed.

Note that Canon cannot be held liable for any problems arising from wireless communication function use in other countries and regions.

■ Model Number

EOS 77D: DS126651

(including WLAN module model: ES200, Bluetooth module model: WM500)

Complies with IMDA Standards DB00671
--

FCC/IC NOTICE

Model: DS126651 (including WLAN module: ES200, FCC ID: AZD230/ IC: 498J-230, Bluetooth Module Model: WM500, FCC ID: AZD500/ IC: 498J-500)

This device complies with Part 15 of FCC Rules and Industry Canada's licence-exempt RSSs. Operation is subject to the following two conditions:

- (1) this device may not cause harmful interference, and
- (2) this device must accept any interference received, including interference that may cause undesired operation.

This device must not be co-located or operated in conjunction with any other antenna or device except Canon accessories supplied or designated for this product.

The available scientific evidence does not show that any health problems are associated with using low power wireless devices. There is no proof, however, that these low power wireless devices are absolutely safe. Low power Wireless devices emit low levels of radio frequency energy (RF) in the microwave range while being used. Whereas high levels of RF can produce health effects (by heating tissue), exposure of low-level RF that does not produce heating effects causes no known adverse health effects. Many studies of low-level RF exposures have not found any biological effects. Some studies have suggested that some biological effects might occur, but such findings have not been confirmed by additional research. This model has been tested and found to comply with FCC/IC radiation exposure limits set forth for an uncontrolled environment and meets the FCC radio frequency (RF) Exposure Guidelines and RSS-102 of the IC radio frequency (RF) Exposure rules.

Hereby, Canon Inc., declares that this DS126651 is in compliance with the essential requirements and other relevant provisions of Directive 2014/53/EU. The full text of the EU declaration of conformity is available at the following internet address: <http://www.canon-europe.com/ce-documentation>

Wi-Fi Frequency range: 2401 MHz - 2473 MHz
Wi-Fi Maximum output power: 13.64 dBm
Bluetooth Frequency range: 2402 MHz - 2480 MHz
Bluetooth Maximum output power: 7.14 dBm

Please contact the following address for the original Declaration of Conformity:

CANON EUROPA N.V.

Bovenkerkerweg 59, 1185 XB Amstelveen, The Netherlands

CANON INC.

30-2, Shimomaruko 3-chome, Ohta-ku, Tokyo 146-8501, Japan

Trademarks

- Microsoft and Windows are trademarks or registered trademarks of Microsoft Corporation in the United States and/or other countries.
- Macintosh and Mac OS are trademarks of Apple Inc., registered in the U.S. and other countries.
- The Wi-Fi CERTIFIED logo and the Wi-Fi Protected Setup mark are trademarks of the Wi-Fi Alliance.
- WPS used on camera settings screens and in this manual stands for Wi-Fi Protected Setup.
- UPnP is a trademark of the UPnP Implementers Corporation.
- The Bluetooth[®] word mark and logos are registered trademarks owned by Bluetooth SIG, Inc. and any use of such marks by Canon Inc. is under license. Other trademarks and trade names are those of their respective owners.
- The N-Mark is a trademark or registered trademark of NFC Forum, Inc. in the United States and in other countries.
- All other trademarks are the property of their respective owners.

Index

A

Android..... W-8

B

Bluetooth..... W-9, W-10
Connecting W-11

C

Camera Connect..... W-8, W-18
Communicating with a
smartphone W-9, W-23, W-31

I

iOS W-8

N

Network name → SSID
NFC..... W-23, W-24, W-25
Sending images..... W-28
Nickname W-7

P

Pairing..... W-12
Password W-16, W-33

Q

Quick Control W-21

R

Reconnecting..... W-37
Remote operation W-18

S

Send images to
smartphone W-20, W-28
Send img shown W-22
Sending images W-20, W-28
SSID..... W-16, W-33

V

Viewing images W-18

W

Wi-Fi button W-31, W-32
Wi-Fi settings..... W-6



The descriptions in this Instruction Manual are current as of December 2016. For information on the compatibility with any products introduced after this date, contact any Canon Service Center. For the latest version Instruction Manual, refer to the Canon Web site.