

Canon

DVD Camcorder
Instruction Manual

English

Caméscope DVD
Manuel d'instruction

Français

Cámara DVD
Manual de Instrucciones

Español

DC40

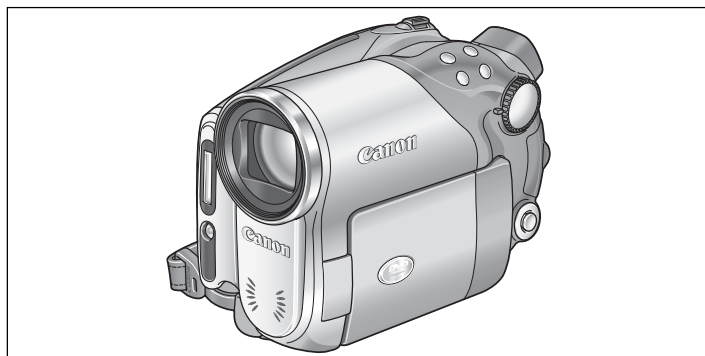

PictBridge

Please read also the following instruction manual (electronic version on PDF file). For further details refer to the installation guide.

Veuillez lire aussi le manuel d'instruction suivant (version électronique sur fichier PDF). Pour d'autres détails référez-vous au guide d'installation.

Lea también el siguiente manual de instrucciones (versión electrónica en archivo PDF). Para mayores detalles, refiérase a la guía de instalación.



- **Digital Video Software**

NTSC

Important Usage Instructions

WARNING!

TO REDUCE THE RISK OF FIRE OR ELECTRIC SHOCK, DO NOT EXPOSE THIS PRODUCT TO RAIN OR MOISTURE.



WARNING!

TO REDUCE THE RISK OF ELECTRIC SHOCK AND TO REDUCE ANNOYING INTERFERENCE, USE THE RECOMMENDED ACCESSORIES ONLY.



COPYRIGHT WARNING:

Unauthorized recording of copyrighted materials may infringe on the rights of copyright owners and be contrary to copyright laws.

DVD Camcorder, DC40 A systems

This device complies with Part 15 of the FCC Rules. Operation is subject to the following two conditions: (1) This device may not cause harmful interference, and (2) this device must accept any interference received, including interference that may cause undesired operation.

Note: This equipment has been tested and found to comply with the limits for class B digital device, pursuant to Part 15 of the FCC Rules. These limits are designed to provide reasonable protection against harmful interference in a residential installation. This equipment generates, uses and can radiate radio frequency energy and, if not installed and use in accordance with the instructions, may cause harmful interference to radio communications. However, there is no guarantee that interference will not occur in a particular installation. If this equipment does cause harmful interference to radio or television reception, which can be determined by turning the equipment off and on, the user is encouraged to try to correct the interference by one or more of the following measures:

- Reorient or relocate the receiving antenna.
- Increase the separation between the equipment and receiver.
- Connect the equipment into an outlet on a circuit different from that to which the receiver is connected.
- Consult the dealer or an experienced radio/TV technician for help.

Use of shielded cable is required to comply with class B limits in Subpart B of Part 15 of FCC Rules. Do not make any changes or modifications to the equipment unless otherwise specified in the manual. If such changes or modifications should be made, you could be required to stop operation of the equipment.

Canon U.S.A. Inc.
One Canon Plaza, Lake Success, NY 11042, U.S.A.
Tel No. (516)328-5600

CAUTION:

TO PREVENT ELECTRIC SHOCK, MATCH WIDE BLADE OF PLUG TO WIDE SLOT, FULLY INSERT.

Important Warning



**CAUTION:
TO REDUCE THE RISK OF ELECTRIC SHOCK, DO NOT REMOVE COVER (OR BACK). NO USER-SERVICEABLE PARTS INSIDE. REFER SERVICING TO QUALIFIED SERVICE PERSONNEL.**



The lightning flash with arrowhead symbol, within an equilateral triangle, is intended to alert the user to the presence of uninsulated "dangerous voltage" within the product's enclosure, that may be of sufficient magnitude to constitute a risk of electric shock to persons.

The exclamation point, within an equilateral triangle, is intended to alert the user to the presence of important operating and maintenance (servicing) instructions in the literature accompanying the product.

IMPORTANT SAFETY INSTRUCTIONS

In these safety instructions the word “product” refers to the Canon DVD Camcorder DC40 A and all its accessories.

1. **Read Instructions** — All the safety and operating instructions should be read before the product is operated.
 2. **Retain Instructions** — The safety and operating instructions should be retained for future reference.
 3. **Heed Warnings** — All warnings on the product and in the operating instructions should be adhered to.
 4. **Follow Instructions** — All operating and maintenance instructions should be followed.
 5. **Cleaning** — Unplug this product from the wall outlet before cleaning. Do not use liquid or aerosol cleaners. The product should be cleaned only as recommended in this manual.
 6. **Accessories** — Do not use accessories not recommended in this manual as they may be hazardous.
 7. **Avoid magnetic or electric fields** — Do not use the camera close to TV transmitters, portable communication devices or other sources of electric or magnetic radiation. They may cause picture interference, or permanently damage the camera.
 8. **Water and Moisture** — Hazard of electric shock — Do not use this product near water or in rainy/moist situations.
 9. **Placing or Moving** — Do not place on an unstable cart, stand, tripod, bracket or table. The product may fall, causing serious injury to a child or adult, and serious damage to the product.
A product and cart combination should be moved with care. Quick stops, excessive force, and uneven surfaces may cause the product and cart combination to overturn.
- 

10. **Power Sources** — The CA-570 Compact Power Adapter should be operated only from the type of power source indicated on the marking label. If you are not sure of the type of power supply to your home, consult your product dealer or local power company. Regarding other power sources such as battery power, refer to instructions in this manual.

11. **Polarization** — The CA-570 Compact Power Adapter is equipped with a polarized 2-prong plug (a plug having one blade wider than the other). The 2-prong polarized plug will fit into the power outlet only one way. This is a safety feature. If you are unable to insert the plug fully into the outlet, try reversing the plug. If the plug still fails to fit, contact your electrician to replace your obsolete outlet. Do not defeat the safety purpose of the polarized plug.

12. **Power Cord Protection** — Power cords should be routed so that they are not likely to be walked on or pinched by items placed upon or against them. Pay particular attention to plugs and the point from which the cords exit the product.

13. **Outdoor Antenna Grounding** — If an outside antenna is connected to the product, be sure the antenna is grounded so as to provide some protection against voltage surges and built-up static charges. Section 810 of the National Electrical Code, ANSI / NFPA No. 70—1984, provides information with respect to proper grounding of the mast and supporting structure, grounding of the lead-in wire to an antenna discharge unit, size of grounding conductors, location of antenna discharge unit, connection to grounding electrodes, and requirements for the grounding electrode. See figure 1.

Fig. 1 EXAMPLE OF ANTENNA GROUNDING AS PER NATIONAL ELECTRICAL CODE

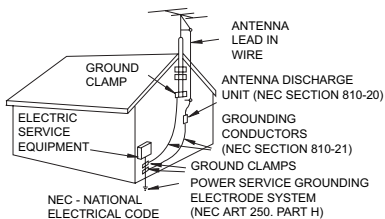

14. Lightning — For added protection of this product during a lightning storm, or when it is left unattended and unused for long periods of time, disconnect it from the wall outlet and disconnect the antenna. This will prevent damage to the product due to lightning and power-line surges.

15. Overloading — Do not overload wall outlets and extension cords as this can result in a risk of fire or electric shock.

16. Objects and Liquid Entry — Never push objects of any kind into this product through openings as they may touch dangerous voltage points or short out parts that could result in a fire or electric shock. Be careful not to spill liquid of any kind onto the product.

17. Servicing — Do not attempt to service this product yourself as opening or removing covers may expose you to dangerous voltage or other hazards. Refer all servicing to qualified service personnel.

18. Damage Requiring Service — Disconnect this product from the wall outlet and all power sources including battery, and refer servicing to qualified service personnel under the following conditions:

- When the power-supply cord or plug is damaged.
- If any liquid has been spilled onto, or objects have fallen into, the product.
- If the product has been exposed to rain or water.
- If the product does not operate normally even if you follow the operating instructions. Adjust only those controls that are covered by the operation instructions. Improper adjustment of other controls may result in damage and will often require extensive work by a qualified technician to restore the product to its normal operation.
- If the product has been dropped or the cabinet has been damaged.
- When the product exhibits a distinct change in performance. This indicates a need for service.

19. Replacement Parts — When replacement parts are required, be sure the service technician has used replacement parts that are specified by Canon or that have the same characteristics as the original part. Unauthorized substitutions may result in fire, electric shock or other hazards.

20. Safety Check — Upon completion of any service or repairs to this product, ask the service technician to perform safety checks to determine that the product is in safe operating order.

When replacement of the power supply is required, please return it to the responsible nearest Canon Service Center and please replace it with the same type number CA-570.

The Adapter can be used with a power supply between 100 and 240 V AC. For areas where 120 V AC power is not used, you will need a special plug adapter. Contact your nearest Canon Service Center for further information.

This Class B digital apparatus complies with Canadian ICES-003.

The Advantages of DVDs

RECORDING

With a DVD you just press the recording start/stop button and the camcorder will find the empty space on the disc (□ 33). Don't waste time fast forwarding and rewinding a tape to find from where to start a new recording.

Never worry about mistakenly recording over a precious memory!



PLAYING

Just select a scene from the index screen!

Just insert your finalized* disc into a DVD player and immediately find the scene you want to play back from the index (□ 39). No need to play the whole thing or run the tape forward and back to find that scene you want.



* Finalization is a process required to make the DVD discs you recorded playable on common DVD players (□ 98).

SHARING YOUR VIDEOS

Windows** users:

With the supplied Roxio MyDVD for Canon software you can easily create copies of your DVDs to share with family and friends and transfer your recordings to a computer for further editing.

** Windows 2000/Windows Me/Windows XP systems.



For inquiries regarding Roxio MyDVD for Canon, please contact directly the customer support centers of Sonic Solutions (□ 106).

An Introduction to DVDs

You have probably heard of DVD discs and they come in various types and in two sizes - the more common 12 cm DVDs and 8 cm Mini DVDs. This camcorder uses 8 cm DVD-R discs (like the supplied one) or DVD-RW discs (commercially available).



So... what disc to choose?



DVD-R

Can be recorded only once.

You cannot edit or delete the recordings.



DVD-RW

You can record on it many times.

You can delete scenes or initialize the disc and start recording again.



Now that I have the disc... What disc standard do I choose to initialize it?



VIDEO mode

Once finalized, a disc recorded in VIDEO mode will play in most common DVD players. However, you cannot edit the recordings.

VR* mode

You can easily edit the recordings. However, the disc can only be played back with DVD players compatible with DVD-RW discs in VR mode.

* Video Recording



Differences in Available Features Depending on the Disc

The camcorder's features and functions available will differ depending on the type of disc you use and the disc specification selected when initializing it.

Disc Type/Specification Feature	DVD-R	DVD-RW		📖
	VIDEO mode	VIDEO mode	VR mode	
Editing scenes with this camcorder (deleting scenes, editing the Playlist)	—	—	●	85
Deleting a scene or still image immediately after recording it	—	●	●	86 92
Initializing the disc in order to use it again for recording	—	●	●	90
Giving a title to the disc	●	●	●	91
Finalizing the disc in order to play it with a DVD player	●	●	●	98
Adding recordings to a disc already finalized	—	●*	●	101
Copying still images	●	●	●	94
Converting still images into Photomovie scenes	●	●	●	95
Editing scenes on a computer	●	●	●	105

* You will need to unfinalize the disc first.

- **Recommended Discs:** This camcorder's performance was tested using the supplied discs and Hitachi-Maxell HG-series DVD discs. For use of other DVD media, contact directly the manufacturer's customer support center.
- Attempting to record or play with this camcorder DVD discs that were recorded, initialized or finalized with other digital devices can result in lost data.
- You need to initialize newly bought DVD-RW discs with this camcorder before using them for the first time.

Table of contents

Introduction

The Advantages of DVDs	5
An Introduction to DVDs	6
Differences in Available Features Depending on the Disc	7
About this Manual	11
Checking the Supplied Accessories	13
Components Guide	14
Screen Displays	18

Preparations

Step 1: Preparing the Power Supply	21
Step 2: Preparing the Camcorder	24
Step 3: Using the Wireless Controller	25
Step 4: Adjusting the LCD Screen	26
Step 5: Changing the Display Language	27
Step 6: Setting the Time Zone, Date and Time	28
Step 7: Inserting a Memory Card	30
Step 8: Loading and Removing a Disc	31

Basic Functions

Recording



Recording Movies	33
Recording Still Images	35
Zooming	37
Selecting the Aspect Ratio of your Recordings (16:9 Widescreen or 4:3)	38

Playback

Playing Back Movies	39
Viewing Still Images	41
Adjusting the Volume	43
Magnifying the Image	44
Selecting the Recording Data Display	45

Advanced Features

Recording Programs

Using the Recording Programs	46
Selecting the Recording Program	47
Using the  Night and  Super Night Modes	48
SCN Using the Special Scene Modes	49
P Using the Program AE Mode	50
Tv Using the Shutter-Priority AE Mode	51
Av Using the Aperture-Priority AE Mode	52

More Recording Options

Manually Adjusting the Exposure	53
Manually Adjusting the Focus	54
Changing the Focusing Mode	55
Using the Mini Video Light	56
Using the Flash	57
Using the Self Timer	59

Changing the FUNC. Settings

Changing Settings with the FUNC. Button	60
Available Settings List (FUNC.)	61

Changing the Metering Method	63
Setting the White Balance	64
Applying Image Enhancing Effects	66
Continuous Shooting and Exposure Bracketing	67
Creating Panoramic Images	69
Using the Digital Effects	71
Selecting the Size and Quality of Still Images	76
Capturing a Still Image while Recording Movies	78
Changing the MENU Settings	
Changing Settings with the MENU Button	79
Available Settings List (MENU)	80
Camera Setup (Digital Zoom, Image Stabilizer, etc.)	80
Disc Operations (Photomovie, Finalize, etc.)	82
Still Image Operations (Card Initialization, Disc-Card Copy, etc.)	82
Display Setup (LCD Brightness, Language, etc.)	83
System Setup (Volume, Beep, Media Select  , etc.)	83
Date/Time Setup	84
Editing Functions	
Disc Options (DVD-RW in VR mode only)	
Creating a Playlist	85
Deleting Scenes	86
Dividing a Scene	88
Protecting the Disc	89
Initializing the Disc	90
Changing the Disc Title	91
Still Image Options	
Erasing Still Images	92
Copying Still Images Between the Disc and Memory Card	94
Converting Still Images into Photomovie Scenes	95
Protecting Still Images on the Memory Card	96
Initializing the Memory Card	97
Disc Finalization	
Preparing your Disc for Playing on a DVD Player	98
Playing Back your Disc on a DVD Player or a Computer's DVD Drive	100
Recording Additional Movies on a Finalized Disc	101
External Connections	
Connecting to a TV and VCR	
Playing Back on a TV Screen	102
Recording to a VCR	104
Connecting to a Computer	
Transferring Recordings to a Computer	105
Roxio MyDVD for Canon	105
Transferring Still Images to a Computer (Direct Transfer)	110
Transferring Images with Transfer Order Settings	113
Printing	
Printing Still Images	115
Selecting Print Settings	118
Selecting Trimming Settings	119
Printing with Print Order Settings	120

Trouble?

Troubleshooting	122
List of Messages.....	126

Do's & Don'ts

Handling Precautions	129
Maintenance/Others	132

Additional Information

System Diagram	134
Optional Accessories	135
Specifications.....	137
Product Codes.....	139
Index.....	140

About this Manual

Thank you for purchasing the Canon DC40. Please read this manual carefully before you use the camcorder and retain it for future reference. Should your camcorder fail to operate correctly, refer to the *Troubleshooting* table (122).

E

Conventions Used in the Manual

- ⓘ : Precautions related to the camcorder operation.
- 📖 : Additional topics that complement the basic operating procedures.
- 📖 : Reference page number.
- Ⓜ : Capital letters are used to refer to buttons on the camcorder or the wireless controller.
- [] are used to refer to menu items displayed on the screen.
- “Screen” refers to the LCD and the viewfinder screen.
- 📷 The photos included in the manual are simulated pictures taken with a still camera.

Introduction

Step 6: Setting the Time Zone, Date and Time

Setting the Time Zone/Daylight Saving Time

Menu item shown at its default position

Buttons and switches to be operated

1. Turn on the camcorder.
2. Press the MENU button to open the menu.
3. Use the multi selector to select (▲▼) the [D/TIME SETUP] menu and press (○).
4. Use the multi selector to select (▲▼) the [T.ZONE/DST] option and press (○).
The time zone setting appears. The default setting is New York or Singapore depending on the region.
5. Use the multi selector to select (▲▼) your time zone and press (○) to save the setting.

About the Multi Selector

Use the multi selector to select options in a menu and change settings.

Push the multi selector like a joystick up, down, left or right (▲/▼/◀/▶) to select an item. In most places, press the multi selector itself (○) to make a selection or change a setting.

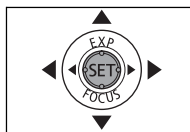

About the Power Switch

In addition to turning the camcorder on and off, the power switch also toggles the camcorder's operating mode.

To turn on the camcorder:



Hold the lock button pressed down and move the power switch down to ON.



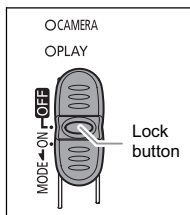











To change the operating mode:

From the ON position, slide down the power switch momentarily towards MODE and release it. This action will toggle the operating mode between recording (CAMERA - red indicator) and playback (PLAY - green indicator).



About the Operating Modes

The camcorder's operating mode is determined by the positions of the power switch and the / switch.

Operating Mode	Operating Mode Indicator	 /  Switch	Icon Display	Operation	
	CAMERA (Red)	 (Movies)		Recording movies on the disc	33
	PLAY (Green)			Playing movies from the disc	39
	CAMERA (Red)	 (Still images)	 or  *	Recording still images on the memory card or disc	35
	PLAY (Green)		 or  *	Viewing still images from the memory card or disc	41







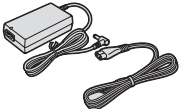
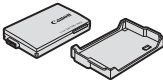

* Depending on whether you choose to save the still images on the disc or memory card.

Trademark Acknowledgements

- miniSD™ is a trademark of SD Card Association.
- Windows® is a registered trademark of Microsoft Corporation in the United States and/or other countries.
- Macintosh and Mac OS are trademarks of Apple Computer, Inc., registered in the United States and other countries.
-  is a trademark of DVD Format/Logo Licensing Corporation.
- Manufactured under license from Dolby Laboratories.
"Dolby" and the double-D symbol are trademarks of Dolby Laboratories.
- Other names and products not mentioned above may be trademarks or registered trademarks of their respective companies.

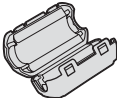

Checking the Supplied Accessories

<p>CA-570 Compact Power Adapter (incl. power cord)</p> 	<p>BP-208 Battery Pack</p> 	<p>WL-D86 Wireless Controller</p> 	<p>Lithium Button Battery CR2025 for Wireless Controller</p> 
<p>MTC-100 Multi Cable</p> 	<p>IFC-300PCU USB Cable</p> 	<p>Blank DVD-R Disc (8 cm Mini DVD)</p> 	<p>DIGITAL VIDEO SOLUTION DISK Software CD-ROM*</p> 
<p>Roxio MyDVD for Canon Software CD-ROM</p> 	<p>Ferrite Core (Asia only)</p> 		

* Includes the electronic version of the *Digital Video Software* instruction manual on PDF file.

The serial number of this product can be found at the battery attachment unit of the camcorder. Write down the number and other information here and retain this book as a permanent record of your purchase to aid identification in case of theft.

Date of Purchase:

Model Name: DC40 A

Purchased From:

Serial No.:

Dealer Address:

Dealer Phone No.:

Components Guide

Left side view

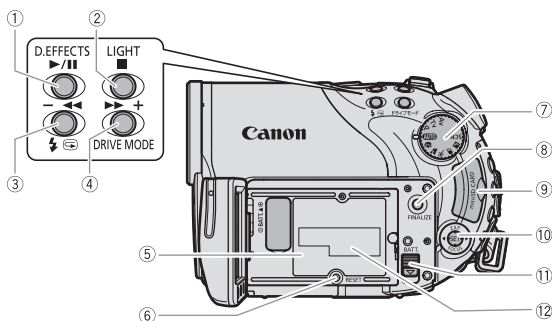

Front view

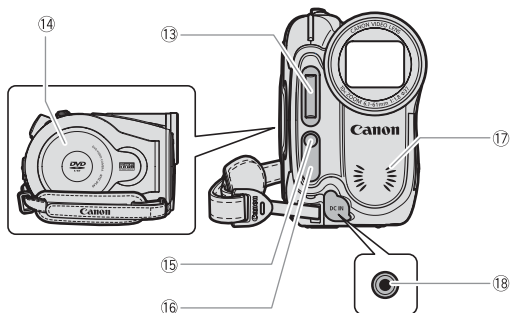

① D.EFFECTS button (71) /

▶/|| (play/pause) button (39)

② LIGHT button (56) /

■ (stop) button (39)

③ ◀ (record review) button (34) /

⚡ (flash) button (57) /

◀◀ (fast reverse) button (40) /

Index screen – button (39)

④ DRIVE MODE button (67) /

▶▶ (fast forward) button (40) /

Index screen + button (39)

⑤ Battery attachment unit (21)

⑥ RESET button (122)

⑦ Mode dial (46)

⑧ FINALIZE button (98)

⑨ Memory card slot (30)

⑩ Multi selector (11) /

EXP button (53) /

FOCUS button (54)

⑪ BATT. (battery release) button (21)

⑫ Serial number

⑬ Flash (57)

⑭ Disc compartment cover (31)

⑮ Mini video light (56)

⑯ Remote sensor (25)

⑰ Stereo microphone

⑱ DC IN terminal (21)

Back view

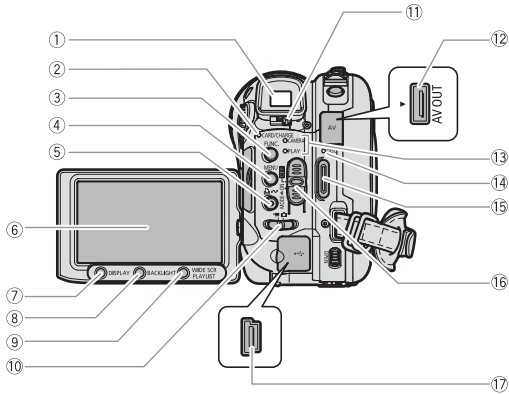

① Viewfinder (☞ 24)

② CARD access indicator (☞ 35) /
CHARGE indicator (☞ 21)

③ FUNC. button (☞ 60)

④ MENU button (☞ 79)

⑤ (print/share) button
(☞ 107, 110, 116)

⑥ LCD screen (☞ 26)

⑦ DISPLAY button (☞ 45)

⑧ BACKLIGHT button (☞ 26)

⑨ WIDE SCR button (☞ 38) /
PLAYLIST button (☞ 85)

⑩ (Movies/Still images) switch
(☞ 12)

⑪ Dioptic adjustment lever (☞ 24)

⑫ AV OUT terminal (☞ 102, 104)

⑬ Operating mode indicator (☞ 12)
CAMERA (red), PLAY (green)

⑭ DISC access indicator (☞ 33)

⑮ Start/stop button (☞ 33)

⑯ Power switch (☞ 11)

⑰ USB terminal (☞ 105, 110, 115)

Top view

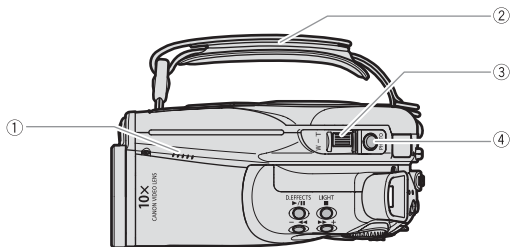

Bottom view

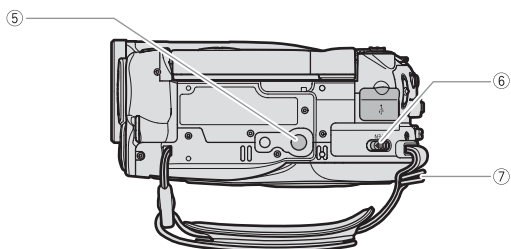

① Speaker (□□ 43)

② Grip belt (□□ 24)

③ Zoom lever (□□ 37)

④ PHOTO button (□□ 35)

⑤ Tripod socket (□□ 34)

⑥ OPEN (disc cover) switch (□□ 31)

⑦ Strap mount (□□ 136)

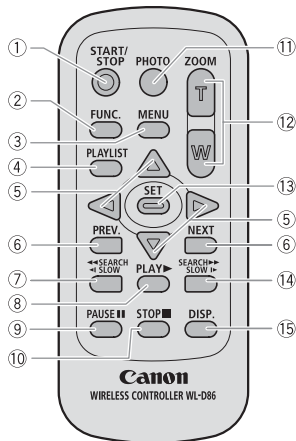









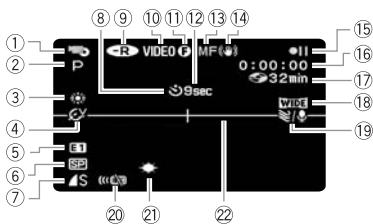



- ① START/STOP button (33)
- ② FUNC. button (60)
- ③ MENU button (79)
- ④ PLAYLIST button (85)
- ⑤ Navigation buttons (▲/▼/◀/▶)
- ⑥ PREV./NEXT buttons:
Scene skip (40)/
Index screen page up/down (39)
- ⑦ Reverse ◀◀ SEARCH button (40) /
Reverse ◀ SLOW button (40)

- ⑧ PLAY ► button (39)
- ⑨ PAUSE || button (39)
- ⑩ STOP ■ button (39)
- ⑪ PHOTO button (35)
- ⑫ Zoom buttons (37)
- ⑬ SET button
- ⑭ Forward SEARCH ►► button (40) /
Forward SLOW ►► button (40)
- ⑮ DISP. (on-screen display) button (45)

Screen Displays









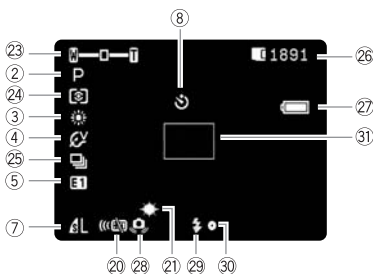











CAMERA · Recording Movies



- ① Operating mode ( 12)
- ② Recording program ( 46)
- ③ White balance ( 64)
- ④ Image effect ( 66)
- ⑤ Digital effects ( 71)
- ⑥ Recording mode ( 61)
- ⑦ Still image quality/size ( 76)
- ⑧ Self timer ( 59)
- ⑨ Disc type
 DVD-R,  DVD-RW ( 6)
- ⑩ Disc specification
 (VIDEO mode, VR mode) ( 6)

CAMERA · Recording Still Images



- ⑪ Finalized disc mark ( 98)
- ⑫ Recording reminder
- ⑬ Manual focus ( 54)
- ⑭ Image stabilizer ( 81)
- ⑮ Disc operation
- ⑯ Time code (hours : minutes : seconds)
- ⑰ Remaining recording time on disc ( 33)
- ⑱ Widescreen mode ( 38)
- ⑲ Wind screen ( 81)
- ⑳ Remote sensor mode ( 25)
- ㉑ Mini video light ( 56)
- ㉒ Level marker ( 83)
- ㉓ Zoom ( 37), Exposure (   53)
- ㉔ Metering mode ( 63)
- ㉕ Drive mode ( 67)
- ㉖ Number of still images available
 on the card,  on the disc
- ㉗ Remaining battery charge
- ㉘ Camcorder shake warning ( 80)
- ㉙ Flash ( 57)
- ㉚ AF/AE locked during still image recording
 ( 55)
- ㉛ AF frame ( 55)

12 Recording reminder

The camcorder counts from 1 to 10 seconds when you start recording. This is helpful to avoid scenes that are too short.

15 Disc operation

- Record, ●|| Record pause,
- ▶ Playback, ||| Playback pause,
- ▶▶ Fast playback,
- ◀◀ Fast reverse playback,
- ▶ Slow playback,
- ◀ Slow reverse playback,
- ||▶ Frame advance,
- ◀|| Frame reverse

17 Remaining recording time

When there is no more disc space available, “END” will be displayed and the recording will stop.

26 Number of still images available on the card

- 🔴 flashing in red: No card
 - 🟢 in green: 6 or more images
 - 🟡 in yellow: 1 to 5 images
 - 🔴 in red: No more images can be recorded
- When viewing the still images, the display will always be in green.
 - Depending on the recording conditions, the number of still images available displayed may not decrease even after a recording has been made, or may decrease by 2 still images at once.

Card/Disc Access Display

“▶” is displayed next to the number of images available while the camcorder is writing on the memory card or disc.

27 Remaining battery charge



- When “🔴” starts flashing in red replace the battery pack with a fully charged one.
- When you attach an empty battery pack, the power may turn off without displaying “🔴”.
- Depending on the conditions under which the camcorder and the battery pack are used, the actual battery charge may not be indicated accurately.

PLAY Playing Movies (Index Screen)



- ① Current scene number/Total number of scenes ( 39)
- ② Date and time of recording





PLAY Playing Movies (During Playback)

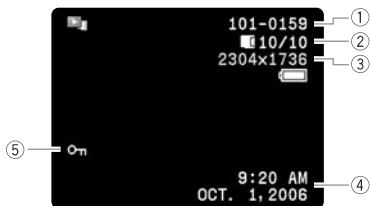

- ① Disc operation
- ② Playback time (hours : minutes : seconds)
- ③ Scene number
- ④ Data code ( 45)

PLAY Viewing Still Images



- ① Image number ( 84)
- ② Current image / Number of images
 recorded on the card,
 recorded on the disc
- ③ Still image size
- ④ Data code ( 45)
- ⑤ Image protection mark ( 96)

Step 1: Preparing the Power Supply

The camcorder can be powered by a battery pack or be connected to a household power outlet. Charge the battery pack before use.

Attaching and Charging the Battery Pack

1. Turn off the camcorder.
2. Attach the battery pack to the camcorder.
Slide in the connector end of the battery in the direction of the arrow and press it gently until it clicks.
3. Connect the power cord to the adapter.
4. Plug the power cord into a power outlet.
5. Connect the power adapter to the camcorder's DC IN terminal.
The CHARGE indicator starts flashing. The indicator will stay on when the charging is completed.

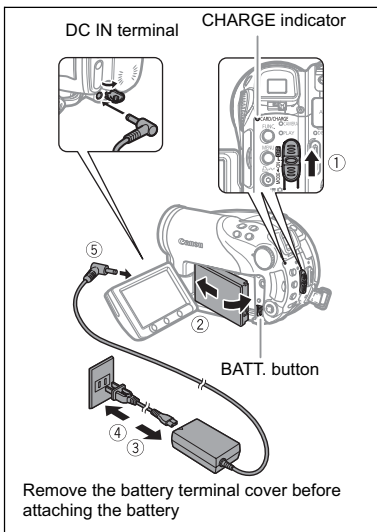

Once the battery is fully charged:

1. Disconnect the power adapter from the camcorder.
2. Unplug the power cord from the power outlet and the adapter.

To remove the battery pack:

Hold the BATT. button pressed down to release it, and pull out the battery from the ridge on its bottom part.

Attaching the Ferrite Core (Asia only)

Attach the enclosed ferrite core before you connect the CA-570 Compact Power Adapter to the camcorder.

Attach the ferrite core to the cable about 7 cm from the plug end (the plug to be connected to the camcorder) of the CA-570 Compact Power Adapter.

Pass the cable through the centre of the core and wrap it around the core twice, then close the unit until it clicks shut.

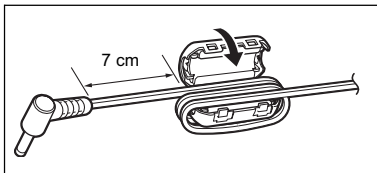



Charging, Recording and Playback Times with the BP-208 Battery Pack

The charging time of the BP-208 battery pack is 155 min.

The following recording and playback times are approximate and vary according to the charging, recording or playback conditions.

Recording Mode		Max. Recording Time	Typical Recording Time*	Playback Time
XP	Viewfinder	65 min.	40 min.	75 min.
	LCD (normal)	65 min.	40 min.	
	LCD (backlight)	65 min.	40 min.	
SP	Viewfinder	75 min.	45 min.	85 min.
	LCD (normal)	75 min.	45 min.	
	LCD (backlight)	70 min.	40 min.	
LP	Viewfinder	80 min.	45 min.	90 min.
	LCD (normal)	80 min.	45 min.	
	LCD (backlight)	75 min.	45 min.	

* Approximate times for recording with repeated operations such as start/stop, zooming, power on/off.

Using a Household Power Outlet

Connect to a household power outlet to use the camcorder without worrying about the battery power. You can keep the battery pack attached; the battery power will not be consumed.

1. Turn off the camcorder.
2. Connect the power cord to the power adapter.
3. Plug the power cord into a power outlet.
4. Connect the power adapter to the camcorder's DC IN terminal.

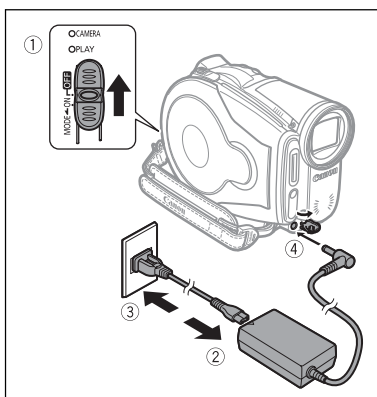

- Turn off the camcorder before connecting or disconnecting the power adapter.
- Do not connect to the camcorder's DC IN terminal or to the power adapter any electrical equipment that is not expressly recommended for use with this camcorder.
- You may hear some noise from the power adapter during use. This is not a malfunction.
- To prevent equipment breakdowns and excessive heating, do not connect the supplied compact power adapter to voltage converters for overseas travels or special power sources such as those on aircraft and ships, DC-AC inverters, etc.

- We recommend charging the battery pack in temperatures between 10 °C and 30 °C (50 °F and 86 °F). Outside the temperature range of 0 °C to 40 °C (32 °F to 104 °F), the charging will not start.



- If you connect a faulty power adapter or battery pack, the CHARGE indicator flashes rapidly (approx. twice per second) and the charging stops.
- The CHARGE indicator also serves as a rough estimate of the battery charge status.
 - Continuously on: Battery fully charged.
 - Flashes rapidly (approx. twice per second): Battery over 50% charged.
 - Flashes slowly (approx. once per second): Battery less than 50% charged.
- We recommend that you prepare battery packs 2 to 3 times longer than you think you might need.
- The charging time will vary depending on the surrounding temperature and the battery pack's initial charge condition.
- In cold surroundings the usable time of the battery pack will decrease.

Step 2: Preparing the Camcorder

Adjusting the Viewfinder (Dioptric Adjustment)

1. Turn on the camcorder and keep the LCD panel closed.
2. Adjust the dioptic adjustment lever as necessary.

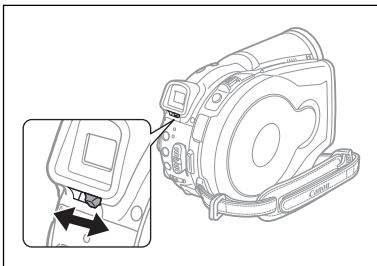

Fastening the Grip Belt

Adjust the grip belt so that you can reach the zoom lever with your index finger, and the start/stop button with your thumb.

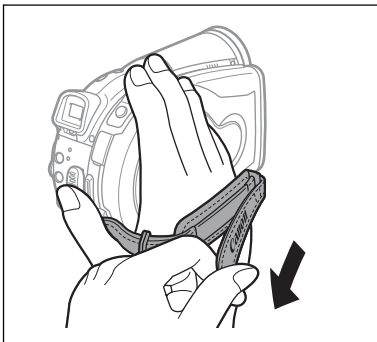

Step 3: Using the Wireless Controller

E

Inserting the Battery (Lithium Button Battery CR2025)

1. Press the tab in the direction of the arrow and pull out the battery holder.
2. Place the lithium button battery with the + side facing up.
3. Insert the battery holder.

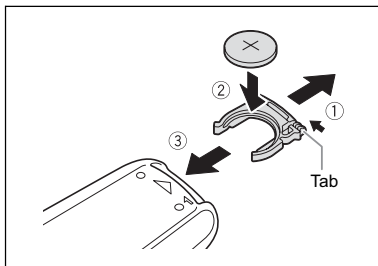

Using the Wireless Controller

Point the controller at the camcorder's remote sensor when you press the buttons.

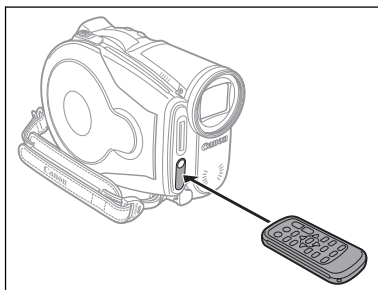

Preparations



- The wireless controller may not work properly when the remote sensor is situated under strong light sources or direct sunlight.
- If the wireless controller does not work, check that the remote sensor is not set to [OFF] (OFF) (p. 84).
- When the camcorder cannot be operated with the wireless controller, or when it can only be operated at a very close range, replace the battery.

Step 4: Adjusting the LCD Screen

Rotating the LCD Panel

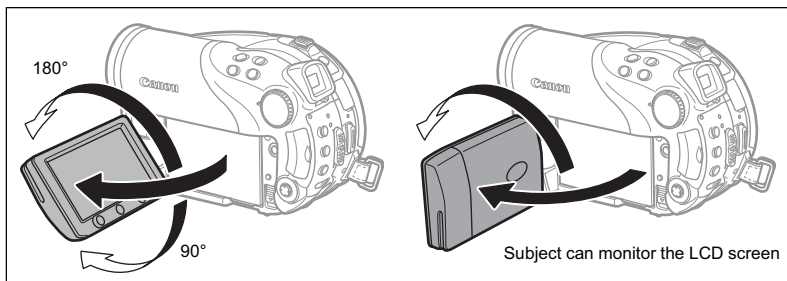

Open the LCD panel 90 degrees.

- You can rotate the panel downward by 90 degrees.
- You can rotate the panel by 180 degrees toward the lens (allowing the subject to monitor the LCD screen while you use the viewfinder). Rotating the panel by 180 degrees is also useful if you wish to include yourself when recording with the self timer.

LCD Backlight

You can switch the brightness of the LCD screen between normal and bright by pressing the BACKLIGHT button. This is useful when recording outdoors.

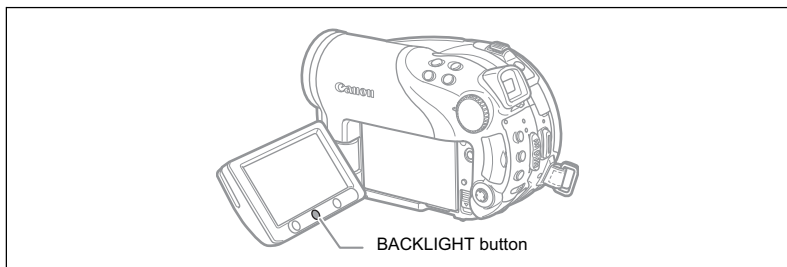

Press the BACKLIGHT button.

Repeatedly pressing the BACKLIGHT button will toggle the LCD brightness on and off.



- This setting does not affect the brightness of the recording or the viewfinder screen.
- Using the brighter LCD setting will shorten the effective usage time of the battery.

Step 5: Changing the Display Language

The language used in the camcorder displays and menu items can be changed to German, Spanish, French, Italian, Polish, Russian, Simplified Chinese, Traditional Chinese, Korean, Thai or Japanese.









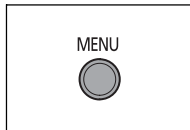



MENU

( 79)



1. Turn on the camcorder.
2. Press the MENU button.



3. Use the multi selector to select () () the [DISPLAY SETUP] menu and press () .
4. Use the multi selector to select () () the [LANGUAGE ] option and press () .
5. Use the multi selector to select () () () () the language desired and press () to select it.
6. Press the MENU button to save the setting and close the menu.

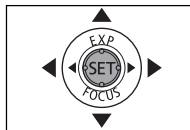

- If you changed the language by mistake, follow the  mark next to the menu item to change the setting.
- The displays **SET** and **MENU** that appear on screen while changing the print and direct transfer settings will not change regardless of the language selected.

Step 6: Setting the Time Zone, Date and Time

Setting the Time Zone/Daylight Saving Time

MENU
(79)



1. Turn on the camcorder.
2. Press the MENU button to open the menu.

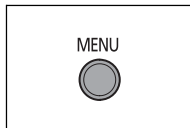

3. Use the multi selector to select (**▲▼**) the [DATE/TIME SETUP] menu and press (**SET**).
4. Use the multi selector to select (**▲▼**) the [T.ZONE/DST] option and press (**SET**).

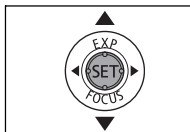

The time zone setting appears. The default setting is New York.

5. Use the multi selector to select (**▲▼**) your time zone and press (**SET**) to save the setting.

To adjust for daylight saving time, select the time zone with the mark next to the area.

Setting the Date and Time

MENU
(79)



6. Use the multi selector to select (**▲▼**) the [DATE/TIME] option and press (**SET**).
7. Use the multi selector to select (**▲▼**) the month and push it to (**▶**) to move to the day setting.

- The next part of the date/time is displayed in orange.
- Set the day, year, hours and minutes in the same way.

- If you do not need to change all settings, you can use the multi selector (**◀▶**) to move to a specific setting you want to change.

8. Press the MENU button to close the menu and start the clock.

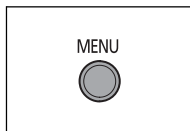



- When you do not use the camcorder for about 3 months, the built-in rechargeable lithium battery may discharge completely and the date and time setting may be lost. In such case, recharge the built-in lithium battery (131) and set the time zone, date and time again.
- You can also change the date format (84).

Time Zones

Once you have set the time zone, date and time, you do not need to reset the clock every time you travel to another time zone. Select the time zone referring to the date and time displayed on the screen.

Time Zones and Difference from GMT/UTC

London	GMT/UTC	Wellington (WELLINGTN)	+12
Paris	+1	Samoa	-11
Cairo	+2	Honolulu	-10
Moscow	+3	Anchorage	-9
Dubai	+4	Los Angeles (L.A.)	-8
Karachi	+5	Denver	-7
Dacca	+6	Chicago	-6
Bangkok	+7	New York	-5
Singapore	+8	Caracas	-4
Tokyo	+9	Rio de Janeiro (RIO)	-3
Sydney	+10	Fernando de Noronha (FERNANDO)	-2
Solomon	+11	Azores	-1

Step 7: Inserting a Memory Card

Only miniSD cards can be used with this camcorder.

Inserting the Card

1. Turn off the camcorder.

Make sure the CARD access indicator is not flashing before you turn the camcorder off.

2. Open the cover.

3. Insert the memory card straight all the way into the memory card slot.

4. Close the cover.

Do not force the cover closed if the memory card is not correctly inserted.

To remove the memory card:

First push the memory card once to release it, and then pull the card out.

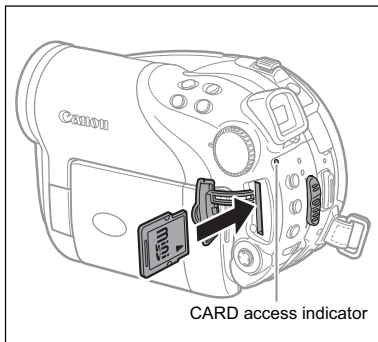

Make sure to initialize all memory cards before using them with this camcorder (p. 97).





Performance cannot be guaranteed for all miniSD cards.



Step 8: Loading and Removing a Disc

Inserting the Disc

E

Preparations:

Use only 8 cm (3 in.) mini DVD discs marked with the DVD-R  or DVD-RW  logo. Before inserting the disc be sure to check that the recording surface is clean. If necessary, use a soft lens-cleaning cloth to remove any fingerprints, dirt buildup or smudges from the disc surface.

1. Move the power switch to ON to set the camcorder in CAMERA mode (□ 11).
2. Move the  /  switch to the  (Movies) position.
3. Slide the OPEN switch fully in the direction of the arrow and gently open the disc cover completely until it stops.

Retract the grip belt under the camcorder so it will not get in the way of the disc cover.

4. Insert the disc and press its center firmly until it clicks in place.

- Insert the disc with the recording side facing down (single sided discs - label side facing out).
- Be careful not to touch the recording surface of the disc or the pick up lens.

5. Close the disc cover.

Do not force the cover closed if the disc is not correctly inserted and firmly set in place.

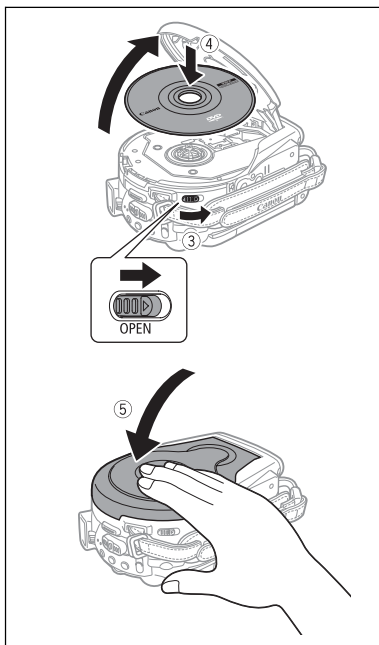



Preparations

When using DVD-R discs (including the supplied blank disc):

You can start recording movies once the record pause  indication appears.

When using a DVD-RW:

You need to initialize new discs before you can start recording. The disc initialization screen will appear when a new DVD-RW is first inserted (it will not appear when inserting a disc already initialized – in that case, you can start recording once the record pause  indication appears).

- ① Use the multi selector to select () the disc specification desired and press () to make the selection. For a comparison between the specifications [VIDEO] and [VR] see *An Introduction to DVDs* (□ 6).

- ② You will be asked to confirm the disc specification you selected. Use the multi selector to select (▲▼) [YES] and press (SET) to continue, or select [NO] and press (SET) to return and select a different disc specification.
- ③ A confirmation message will appear on the screen. Use the multi selector to select (▲▼) [YES] and press (SET) to start the disc initialization.
 - The disc initialization will take approximately one minute. Avoid moving the camcorder while the operation is in progress.
 - You can start recording movies once the record pause ●|| indication appears.



- The disc initialization screen may not appear automatically if you operated the camcorder's buttons while the disc recognition was in progress. In that case, initialize the disc using the menu option (□ 90).
- The process of recognizing a disc may take a moment. The (👁) display will move while the disc is being read. Wait until the camcorder finishes recognizing the disc before you start recording.

Removing the Disc

1. **Move the power switch to ON to set the camcorder in CAMERA mode (□ 11).**
2. **Slide the OPEN switch fully in the direction of the arrow and gently open the disc cover completely until it stops.**
 - Do not subject the camcorder to strong impacts while the DISC access indicator is on or flashing.
 - Retract the grip belt under the camcorder so it will not get in the way of the disc cover.
 - It may take a moment after pressing the OPEN switch for the disc cover to open.
3. **Grab the edges of the disc and gently pull it out.**

Be careful not to touch the recording surface of the disc or the pick up lens.
4. **Close the disc cover.**





When you press the OPEN switch after recording, important data is recorded on the disc. While the DISC access indicator is on or flashing do not subject the camcorder to shocks such as forcefully laying it on a table.

Recording Movies

Before You Begin Recording

Make a test recording first to check if the camcorder operates correctly. Since recordings made on a DVD-R cannot be deleted, we recommend you use a DVD-RW disc (commercially available) to make the test recordings.

1. Move the power switch to ON to set the camcorder in CAMERA mode.
2. Move the /CAM switch to the  (Movies) position.
3. Press the start/stop button to begin recording.
 - Press the start/stop button again to pause recording.
 - While recording and immediately after pausing, the DISC access indicator will flash as the scene is being recorded on the disc.

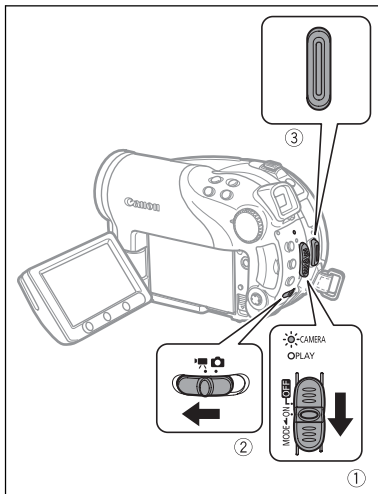

When you have finished recording:

1. Remove the disc.
2. Turn off the camcorder.
3. Disconnect the power source and remove the battery pack.
4. Close the LCD panel.



When the DISC access indicator is on or flashing do not perform the following actions. Doing so may result in permanent data loss.

- Do not subject the camcorder to vibrations or strong impacts.
- Do not open the disc cover and do not remove the disc.
- Do not disconnect the power source or turn off the camcorder.
- Do not change the position of the /CAM switch or the operating mode.





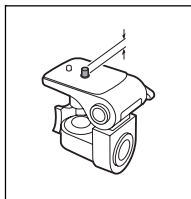

- **About the recording time:** By changing the recording mode you can change the recording time available on the disc (□ 61).
- When recording in bright places it may be difficult to use the LCD screen. In such case, use the viewfinder instead.
- When recording in very loud places (such as fireworks shows or concerts), sound may become distorted or it may not be recorded at the actual levels. This is not a malfunction.

- **About the Power Save mode:** In order to save power when the camcorder is powered by a battery pack, the camcorder will automatically shut off if left without any operations for 5 minutes (☐ 84). To restore the power, slide the power switch towards MODE and release it, or move the power switch to **OFF** and back to ON.
- **About the LCD and viewfinder screen:** The screens are produced using extremely high-precision manufacturing techniques, with more than 99.99% of the pixels operating to specification. Less than 0.01% of the pixels may occasionally misfire or appear as black, red, blue or green dots. This has no effect on the recorded image and does not constitute a malfunction.
- **When using a tripod:** Do not leave the viewfinder exposed to direct sunlight as it may melt (due to concentration of the light by the lens). Do not use tripods with fastening screws longer than 5.5 mm (0.2 inch). Doing so may damage the camcorder.



Reviewing the Last Scene Recorded

Press and release the  (record review) button.

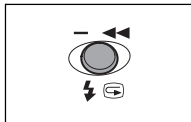

- The camcorder plays back the last scene and returns to record pause mode.
- While reviewing the scene, use the multi selector to select () the  icon and press () to return to the recording mode.
- While reviewing a scene immediately after recording it, you can also delete the scene by selecting () the  icon (☐ 86).



Recording Still Images

E

Before using a memory card for the first time, be sure to initialize it with this camcorder (☐ 97).

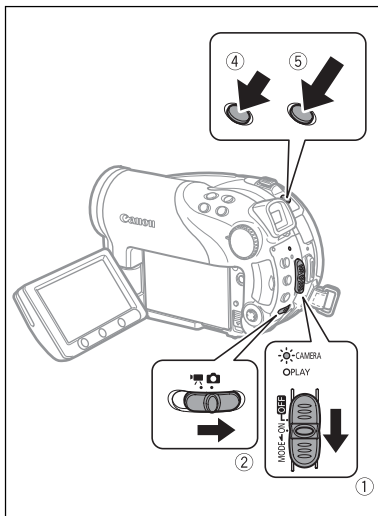

1. Move the power switch to ON to set the camcorder in CAMERA mode (☐ 11).
2. Move the /📷 switch to the 📷 (Still images) position.
3. If necessary, change the media for recording the still images using the procedure described in the next page (☐ 36).
4. Press the PHOTO button halfway.
 - Once the focus is automatically adjusted, the  mark will turn green and one or more AF frames appear.
 - When you press the PHOTO button on the wireless controller, the still image is recorded immediately.
5. Press the PHOTO button fully.

The CARD access or DISC access indicator will flash as the image is being recorded.



Basic Functions
Recording



When the disc/card access display (“▶ ” or “▶ ”) appears on screen and when either the DISC access or CARD access indicator is on or flashing do not perform the following actions. Doing so may result in permanent data loss.

- Do not subject the camcorder to vibrations or strong impacts.
- Do not open the disc or memory card cover and do not remove the disc or memory card.
- Do not disconnect the power source or turn off the camcorder.
- Do not change the position of the /📷 switch or the operating mode.















○ If the subject is not suitable for autofocus,  turns yellow. Keep the PHOTO button pressed halfway and adjust the focus manually with the multi selector (◀▶).

○ When the subject is too bright, “OVEREXP.” starts flashing. In such case, use the optional FS-H37U ND filter.



Selecting the Media for the Still Images

You can record still images on the memory card or the disc. The default media for still images is the memory card. As long as you do not change the recording destination, still images will be recorded to the last selected media.

1. **Set the camcorder to record or view still images** ( or ).
2. **Press the MENU button. Using the multi selector select** () **the [SYSTEM SETUP] menu and press** ().
3. **Select** () **the [MEDIA SEL. ] option and press** ().
4. **Change** () **the setting to [DISC] or [CARD] and press** () **to save the selection and close the menu.**

When recording, the operating mode symbol will change to  (DISC stills) or  (CARD stills), depending on the media selected. In playback mode, the operating mode symbol will change to  (DISC stills) or  (CARD stills), respectively.

Zooming

The zoom is available when recording movies or still images. When recording movies (CAMERA ) , in addition to the 10x optical zoom you can also use the 200x digital zoom ( 80).

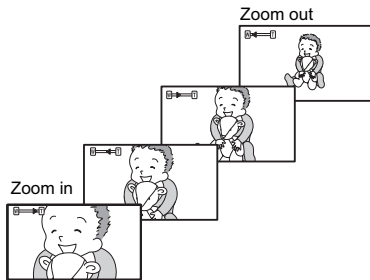

10x Optical Zoom

Move the zoom lever toward **W** to zoom out (wide-angle). Move it toward **T** to zoom in (telephoto).

When operating the zoom from the camcorder you can also change the zoom speed ( 80). You can select one of three fixed zoom speeds or a variable speed that depends on how you operate the zoom lever: Press lightly for a slow zoom; press harder for faster zooms.

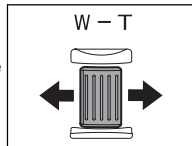

- You can also use the **T** and **W** buttons on the wireless controller. The zoom speed with the wireless controller will be the same as with the camcorder (when one of the fixed zoom speed levels is selected) or fixed at [SPEED 3] (when [VARIABLE] is selected).
- When set to [VARIABLE], the zoom speed will be faster in the record pause mode.
- Keep a distance of at least 1 m (3.3 ft.) to the subject. At wide-angle, you can focus on a subject as close as 1 cm (0.39 in.).

Selecting the Aspect Ratio of your Recordings (16:9 Widescreen or 4:3)

You can select the aspect ratio of your recordings to match your TV.

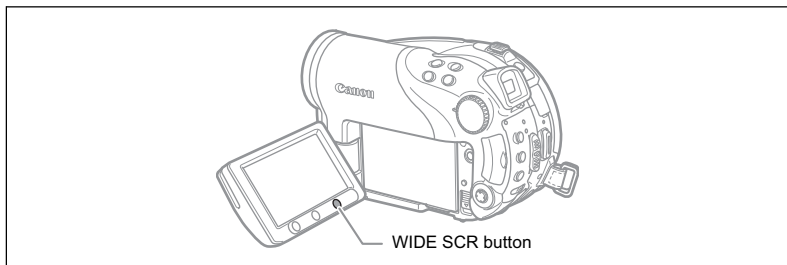



1. Set the camcorder to record movies (**CAMERA** ).

2. Press the **WIDE SCR** button.

Repeatedly pressing the WIDE SCR button will toggle the screen between the Widescreen (16:9) and normal (4:3) aspect ratios.



- Widescreen is not available when recording in LP mode if the disc specification is VIDEO mode (DVD-R or DVD-RW). Selecting the LP recording mode will cancel the 16:9 aspect ratio.
- When recording in Widescreen mode, if you set the image stabilizer to [OFF] you can achieve a wider view angle ( 81).
- **Playing back a Widescreen recording:** TV sets compatible with the Video ID-1 system will automatically switch to wide (16:9) mode. Otherwise, change the aspect ratio of the TV manually. To play back on a TV with normal aspect ratio (4:3) change the [TV TYPE] setting accordingly ( 84).

Playing Back Movies

E





1. Move the power switch to ON.
2. Slide down the power switch towards MODE and release it to set the camcorder in PLAY mode (11).

The green PLAY indicator will turn on.

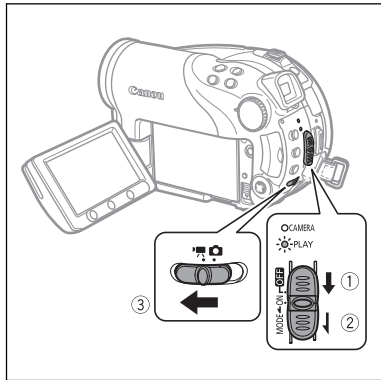
3. Move the  switch to the  (Movies) position.

The scene index screen appears with the selection frame on the first scene.



4. Use the multi selector (, , , ) to move the selection frame to the scene you want to playback.



Press the + or - button on the camcorder or the NEXT/PREV. buttons on the wireless controller to move to the next or previous index page.

5. Press the /|| button to begin the playback.

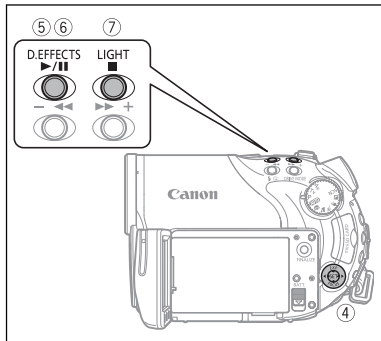
Playback of the scenes recorded on the disc will start from the scene selected.



During Playback:

6. Press the /|| button again to pause the playback.
7. Press the  button to stop the playback and return to the scene index screen.



- To use the viewfinder, close the LCD panel.
- **About the screen display:** During playback, the recording's time code will be displayed at the upper right corner of the screen in hours : minutes : seconds.
- You can also choose to display instead the date and time when the scene was recorded and additional recording data (45).
- As long as you don't turn off the camcorder you can resume playback from the point you stopped last.

Special Playback Modes

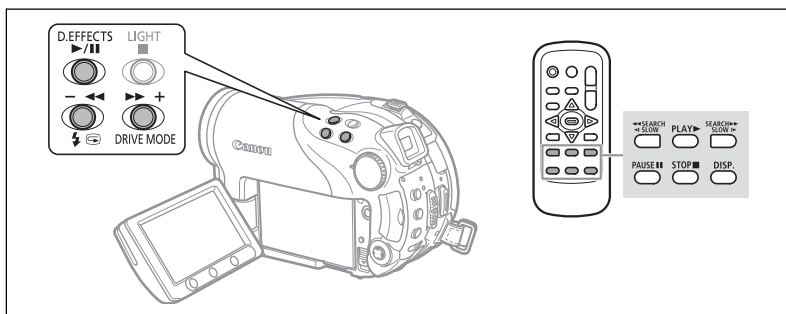

▶▶ Fast Forward Playback / ◀◀ Fast Reverse Playback

During playback, press the ▶▶ or ◀◀ button on the camcorder or the SEARCH ▶▶ or ◀◀ SEARCH button on the wireless controller. Repeatedly press the button to increase the playback speed. Fast forward playback will start at 1.5x the normal playback speed and will increase to 5x, 15x and 25x normal speed with each press of the button. Fast reverse playback will start at 2.5x the normal playback speed and will increase to 5x, 15x and 25x normal playback speed with each press of the button.

|| Playback Pause

During normal playback, press the ▶/|| button on the camcorder or the PAUSE || on the wireless controller.

▶| Slow Forward Playback / ◀| Slow Reverse Playback

During playback pause, press the ▶▶ or ◀◀ button on the camcorder or the SLOW ▶| or ◀| SLOW button on the wireless controller. Repeatedly press the button to increase the playback speed. Playback will start at 1/16 the normal playback speed and will increase to 1/8, 1/4 and 1/2 the normal speed with each press of the button.

Skipping Scenes

During normal playback, push the multi selector (▶) or press the NEXT button on the wireless controller to skip to the beginning of the next scene. Push (◀) or press the PREV. button on the wireless controller to return to the beginning of the current scene. Repeat to skip to the beginning of the previous scene.



- Except for fast playback at 1.5x the normal speed, there is no sound during special playback modes.
- The picture may become distorted during some special playback modes.
- Slow playback is not available with discs recorded in VIDEO mode (DVD-R or DVD-RW).
- Depending on the recording, you might occasionally notice a brief stop of the picture or sound at the point where the scene changes.
- During the playback of a Photomovie scene, even though the on-screen display may change according to the fast forward/reverse playback, the actual playback speed will not change.

Viewing Still Images

1. Move the power switch to ON.
2. Slide down the power switch towards **MODE** and release it to set the camcorder in **PLAY** mode (12).

The green **PLAY** indicator will turn on.

3. Move the **VIEW/SHOOT** switch to the **SHOOT** (Still images) position.
4. If necessary, change the media for the still images using the procedure described in the **Recording Still Images** section (36).

As long as you do not change the media selection, the camcorder will show the still images recorded on the media that was selected last.

5. Use the multi selector to move (◀ ▶) between images.

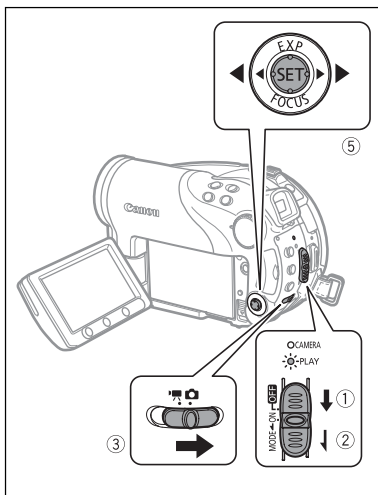

- The following may not be displayed correctly: Images not recorded with this camcorder, images edited on or uploaded from a computer (except for the sample images for the Card Mix function), and images whose file names have been changed.
- When the disc/card access display ("▶" or "▶" with a disc icon) appears on screen and when either the DISC access or CARD access indicator is on or flashing do not perform the following actions. Doing so may result in permanent data loss.
 - Do not open the disc or memory card cover and do not remove the disc or memory card.
 - Do not disconnect the power source or turn off the camcorder.
 - Do not change the position of the **VIEW/SHOOT** switch or the operating mode.

Slideshow

FUNC.
(60)



SLIDESHOW

1. Press the **FUNC.** button.
2. Use the multi selector to select (▲▼) [**SLIDESHOW**] and press (**SET**).
3. Use the multi selector to select (◀ ▶) [**START**] and press (**SET**).

Press the **FUNC.** button to stop the slideshow.

Index Screen

1. Move the zoom lever toward **W**.

The stills index screen appears with the first six still images.

2. Use the multi selector to select (**▲▼**, **◀▶**) an image.

- Move the cursor  to the image you wish to view.
- You can switch between index pages by pressing the + or – button.

3. Move the zoom lever toward **T**.

The index screen closes and the selected image is displayed.

Image Jump Function

You can also quickly locate a specific image without having to browse all of them one by one.

Push the multi selector (**◀▶**) and keep it pressed down.

Image numbers will quickly run in sequence. When you release the multi selector the image corresponding to the number selected will be displayed.

Adjusting the Volume

While playing a movie (**PLAY** ): If you use the LCD screen for playback the camcorder will play the sound using the built-in speaker. If you close the LCD panel the sound will be muted.

E

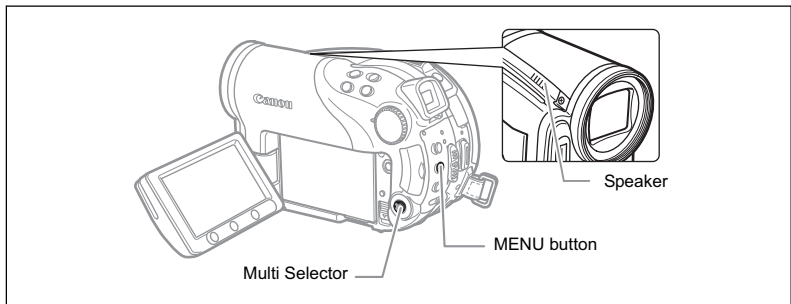







MENU
 79



1. Set the camcorder to play movies (**PLAY** ).



2. Press the **MENU** button.

3. Use the multi selector to select ( ) the [SYSTEM SETUP] menu and press ().

4. Use the multi selector to select ( ) the [VOLUME] option and press ().



5. Adjust ( ) the volume as desired and press ().

To turn off the volume completely, keep pressing () until the volume icon changes to .

6. Press the **MENU** button to save the setting and close the menu.

Basic Functions
Playback

Magnifying the Image

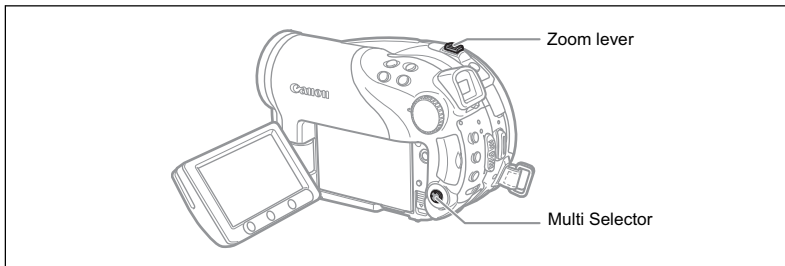

While viewing a still image (**PLAY** ), the playback image can be magnified up to 5 times.



1. Move the zoom lever toward **T**.

- The image is magnified by 2 times and a frame appears indicating the position of the magnified area.
- To further enlarge the image, move the zoom lever toward **T**. To reduce the magnification to less than 2 times, move the zoom lever toward **W**.
-  will appear for images that cannot be enlarged.

2. Select the part of the image to be magnified with the multi selector.

- Use the multi selector to move (, ) the frame to the part of the image you want to see enlarged.
- To cancel the magnification, move the zoom lever toward **W** until the frame disappears.

Selecting the Recording Data Display

The camcorder keeps a data code containing the recording date and time and other camera data such as shutter speed and exposure (f-stop). You can select the data to be displayed when playing back a movie (**PLAY**) or viewing a still image (**PLAY**).

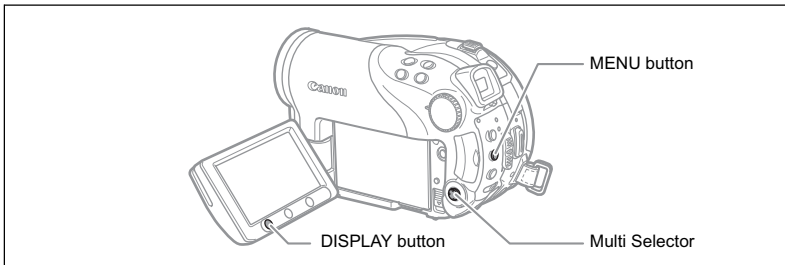

MENU
(79)



1. Press the **MENU** button.
2. Use the multi selector to select (**▲▼**) the **[DISPLAY SETUP]** menu and press (**SET**).
3. Use the multi selector to select (**▲▼**) the **[DATA CODE]** option and press (**SET**).
4. Use the multi selector to select (**▲▼**) the data combination desired and press (**SET**) to select it.

In **PLAY** mode you can only choose to display the recording date, the time or both.

5. Press the **MENU** button to save the setting and close the menu.
6. While playing back a movie or viewing a still image, press the **DISPLAY** button to turn on the data code display.

Repeatedly pressing the **DISPLAY** button will toggle the on-screen displays on and off in the following sequence:

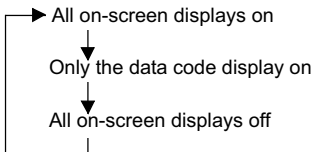

Using the Recording Programs



P Program AE (📖 50)

Tv Shutter-Priority AE (📖 51)

Av Aperture-Priority AE (📖 52)

Easy Recording:

Let the camcorder select the best settings according to your subject.

Flexible Recording:

Have the freedom to change the settings to get the picture you want.

AUTO Auto

The camcorder adjusts the focus, exposure and other settings automatically, allowing you to just point and shoot.



Portrait

The camcorder uses a large aperture, achieving a focus on the subject while blurring other distracting details.



Landscape

The camcorder chooses a small aperture to achieve a broad depth of field in the entire composition.



Sports

Use this mode to record sports scenes such as tennis or golf.



Slow Shutter

Use this mode to record moving subjects, such as the flow of rivers with a motion blur.



Night

Use the Night modes to record in poorly lit places (📖 48).



SCN Special Scene



Select from 6 Special Scene modes to record with the most appropriate settings for each scene (📖 49).

Selecting the Recording Program

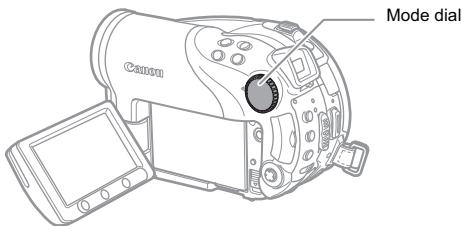
E





1. Set the camcorder to a recording mode

(**CAMERA** ·  or **CAMERA** · ).

2. Turn the mode dial to switch between the recording programs.

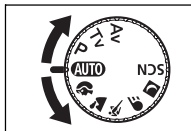
The symbol of the selected recording program will appear.



- Do not change the recording program while recording as the brightness of the image may change abruptly.
- Portrait:
 - The blur effect of the background increases the more you zoom in (**T**).
 - The picture may not appear smooth when played back.
- Landscape:
 - Zooming out (**W**) will result in a more effective picture.
- Sports:
 - The picture may not appear smooth when played back.
- Slow Shutter:
 - When recording movies (**CAMERA** · ), the picture quality may not be as good as in other modes.
 - Autofocus may not work as well as in other modes. In such case, adjust the focus manually.

Using the Night and Super Night Modes

The night modes allow you to record in poorly illuminated and even dark surroundings without sacrificing the color in your picture. The assist lamp will automatically light up as necessary depending on the illumination level.

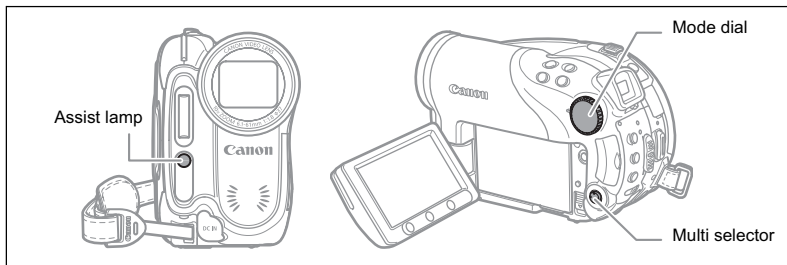

Night Mode



Super Night Mode

1. Set the camcorder to a recording mode ( or ).
2. Turn the mode dial to  and press ().
3. Select () [ NIGHT] or [ SUPER NIGHT] and press ().

The symbol of the selected mode appears on the screen.

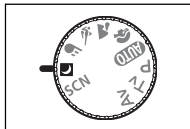

- Moving subjects may leave a trailing afterimage.
- Picture quality may not be as good as in other modes.
- White points may appear on the screen.
- Autofocus may not work as well as in other modes. In such case, adjust the focus manually.

SCN *Using the Special Scene Modes*

Foliage

Use this mode to record images with flowers, leaves or trees.



Snow

Use this mode to record in bright ski resorts. It prevents the subject from being underexposed.



Beach

Use this mode to record on a sunny beach. It prevents the subject from being underexposed.



Sunset

Use this mode to record sunsets in vibrant colors.



Spotlight



Use this mode to record spotlit scenes.



Fireworks

Use this mode to record fireworks.



1. Set the camcorder to a recording mode ( or ).

2. Turn the mode dial to SCN and press ().

A list of special scene (SCN) modes appears.

3. Select () the desired SCN mode and press ().

The symbol of the selected SCN mode appears.



○ Snow/Beach:



- The subject may become overexposed on cloudy days or in shaded places. Check the image on the screen.
- The picture may not appear smooth when played back.

○ Fireworks:

To avoid camcorder shake, we recommend using a tripod. Make sure to use a tripod especially in  , as the shutter speed slows down.



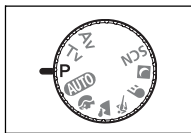

P Using the Program AE Mode

The camcorder automatically adjusts the aperture and shutter speed according to the subject to achieve the best exposure conditions. In **P** Program AE mode, you can point and shoot as in **AUTO** mode, while still enjoying the option to manually adjust some settings.

Set the camcorder to a recording mode (**CAMERA** · ) or (**CAMERA** · ) and turn the mode dial to **P**.





If the optimal exposure cannot be obtained, try the following actions:

- Manually adjust the exposure ( 53).
- Change the metering method ( 63).
- Use the flash ( 57).
- Use the mini video light ( 56).

Tv Using the Shutter-Priority AE Mode

You can select a shutter speed, and the camcorder automatically sets the aperture setting most appropriate for the subject. Select a high shutter speed for recording fast moving subjects, and a slow shutter speed to add a motion blur to moving objects, enhancing the feel of movement of the image.

Guidelines for selecting the shutter speed

 CAMERA	 CAMERA	
1/8, 1/15, 1/30	1/2, 1/4, 1/8, 1/15, 1/30	For recording subjects in dark places.
1/60	1/60	For general recordings.
1/100	1/100	For recording indoor sports scenes.
1/250, 1/500, 1/1000	1/250, 1/500, 1/720	For recording from within a car or train, or for recording moving subjects such as roller coasters.
1/2000	-	For recording outdoor sports such as golf or tennis on sunny days.

1. Set the camcorder to a recording mode

( or ) and turn the mode dial to **Tv**.

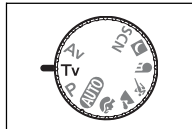

2. Press ().

The denominator of the current shutter speed will be displayed with a blue background.

3. Change () the shutter speed and press () to save the setting.



- The shutter speed denominator flashes when the selected shutter speed is not appropriate for the recording condition. In such case, readjust the shutter speed.
- When using a slow shutter speed in dark places, you can obtain a brighter image, but the image quality may be lower, and the autofocus may not work well.
- Do not point the camcorder directly at the sun when the shutter speed is set to 1/1000 or higher.
- The image may flicker when recording with high shutter speeds.
- Recording movies under fluorescent lights: When the mode dial is set to **AUTO**, **P** or , the camcorder automatically detects the flicker of fluorescent lighting and adjusts the shutter speed accordingly. However, if the screen starts to flicker, select the **Tv** mode and set the shutter speed to 1/100.

Av Using the Aperture-Priority AE Mode

You can select an aperture value, and the camcorder automatically sets the shutter speed most appropriate for the subject. Use low aperture values (large aperture) to blur the background for a portrait, or high aperture values (small aperture) to achieve a broad depth of field for recording landscapes.

Aperture values: 1.8, 2.0, 2.4, 2.8, 3.4, 4.0, 4.8, 5.6, 6.7, 8.0

1. Set the camcorder to a recording mode

( or ) and turn the mode dial to **Av**.

2. Press ().

The current aperture value will be displayed with a blue background.

3. Change (/) the aperture value and press () to save the setting.

Larger aperture values mean smaller aperture diameters of the lens.

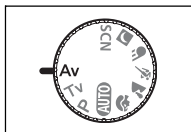

- Available aperture values vary depending on the zoom position.
- The aperture value flashes when the selected aperture is not appropriate for the recording condition. In such case, readjust the aperture.

Manually Adjusting the Exposure

Adjust the exposure when a subject is underexposed (for example, when backlit subjects appear too dark in the image) or overexposed (for example, when recording subjects under very strong light and they appear too bright or glaring in the image).

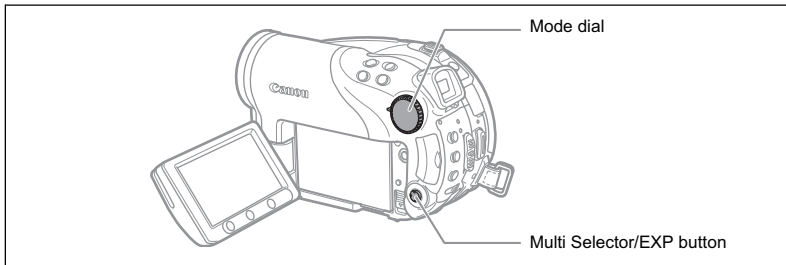

Exposure Lock

1. Set the camcorder to a recording mode (**CAMERA · []** or **CAMERA · []**) and set the mode dial to a position other than **AUTO**.

Exposure cannot be adjusted in the **[]** Fireworks recording program (SCN).

2. Push the multi selector (**[]**) towards **EXP**.

- The exposure adjustment indicator **[]** and the neutral value "±0" appear on the screen.
- If you operate the zoom during exposure lock, the brightness of the image may change.

Exposure Adjustment

During exposure lock:

Adjust (**[]) the brightness of the image as required.**

- The adjustment range depends on the brightness of the picture at the time you locked the exposure.
- Pushing the multi selector (**[]**) will cancel the exposure lock and return the camcorder to the previous setting.

Manually Adjusting the Focus

Autofocus may not work well on the following subjects. In such case, focus manually.

Reflective surfaces



Subjects with low contrast or without vertical lines



Fast Moving Subjects



Through dirty or wet windows



Night Scenes

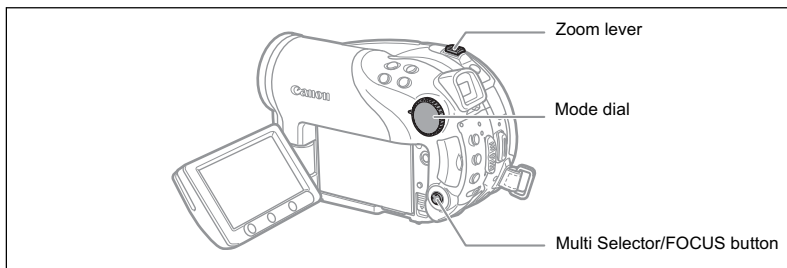

1. Set the camcorder to a recording mode (or) and set the mode dial to a position other than **AUTO**.
2. Adjust the zoom.
3. Push the multi selector () towards **FOCUS**.
"MF" appears.
4. Adjust () the focus as required until the image appears focused.
Pushing the multi selector () will return to autofocus.



- The camcorder will automatically return to autofocus when you set the mode dial to **AUTO**.
- Readjust the focus when you have turned off the camcorder.

Infinity Focus

Use this function when you wish to focus on faraway subjects such as mountains or fireworks.

After step 2 above, hold the multi selector pushed () towards FOCUS for more than 2 seconds.

- "∞" appears.
- Pushing the multi selector () will return to autofocus.



If you operate the zoom or the multi selector () during infinity focus, "∞" changes to "MF" and the camcorder returns to manual focusing mode.

Changing the Focusing Mode

You can change the AF (autofocus) frame selection mode.





9 Point AiAF (Auto selection)	Depending on the shooting conditions, one or more AF frames out of the nine frames available are automatically selected and focused on.
Center point	Out of the nine frames available, the center AF frame is selected to focus. This is convenient for making sure the focus is exactly where you want it.
AF Frame Selection	You can select the AF frame you want to focus on, out of the nine frames available.

E

1. Set the camcorder to record still images () and set the mode dial to a position other than .

The setting differs depending on the position of the mode dial.

: 9 Point AiAF only.

, , , , : 9 Point AiAF or Center point.

P, **Tv**, **Av**: AF frame selection.

* Except for the  Fireworks recording program.

2. Select () the focusing mode.

- 9 Point AiAF: Four framing corners will appear on the screen when making the selection; the frame corners do not appear while actually recording.
- Center point: A single focusing frame appears in the center of the screen.
- AF Frame Selection: All 9 AF frames appear on the screen. Select () the frame where you want to focus.

Using the Mini Video Light

You can turn on the mini video light (assist lamp) at any time regardless of the recording program.

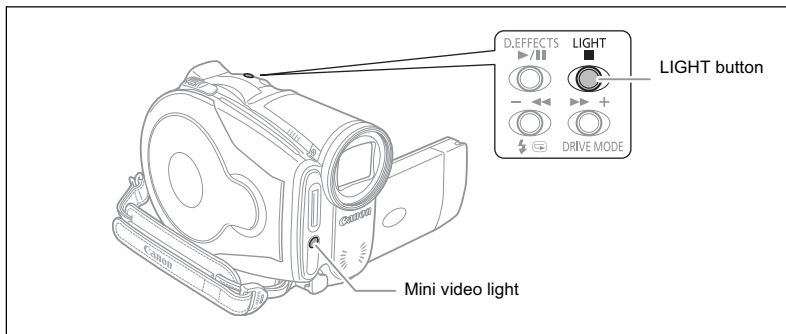

Set the camcorder to a recording mode (**CAMERA** -  or **CAMERA** - ) and press the **LIGHT** button.

- "⚙️" appears on the screen.
- Press again to turn the mini video light off.

Using the Flash

You can use the built-in flash for recording still images in dark places. The flash is equipped with the red-eye reduction function.

⚡ ^A (auto)	The flash fires automatically according to the brightness of the subject.
⊕ (red-eye reduction, auto)	The flash fires automatically according to the brightness of the subject. The assist lamp lights up to reduce the red-eye effect.
⚡ (flash on)	The flash always fires.
⊖ (flash off)	The flash does not fire.

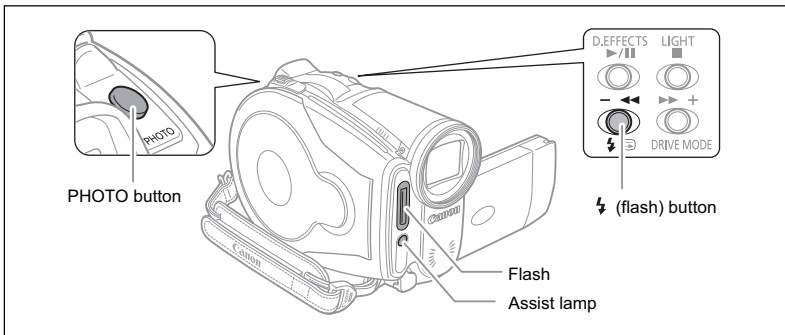

1. Set the camcorder to record still images (**CAMERA** · 📷) and select a recording program other than 🎆 Fireworks (SCN).
2. Press the ⚡ (flash) button.
 - Repeatedly pressing the ⚡ button will cycle between the flash modes.
 - The symbol “⚡^A” disappears after 4 seconds.
3. Press the PHOTO button, first halfway to activate the autofocus and then fully to record the still image.



- The practical range of the flash is approx. 1 to 2 m (3.3 to 6.6 ft.). The range depends upon the recording conditions.
- The range of the flash decreases in continuous shooting mode.
- For the red-eye reduction to be effective, the subject needs to look at the assist lamp. The degree of reduction depends on the distance and on each individual.
- The red-eye reduction mode cannot be used in Stitch Assist mode.
- The flash will not fire in the following cases:
 - When you manually adjust the exposure in ⚡^A (auto) or ⊕ (red-eye reduction) mode.
 - During auto exposure bracketing.
- The flash mode cannot be selected when the exposure is locked, or after the first still image in Stitch Assist mode.
- We recommend not using the flash when the optional Wide-converter or Tele-converter is attached. Their shadows appear on the screen.

○ **About the AF-Assist Lamp:**

While you press the PHOTO button halfway, if the subject is too dark the assist lamp may light up briefly in order to enable the camcorder to focus more accurately (AF-assist lamp). You can also set [AF AST LAMP] to [OFF] so the assist lamp does not light up.

- The camcorder may not be able to focus even if the AF-assist lamp is on.
- The brightness of the AF-assist lamp could be an inconvenience. Consider turning it off in public places such as restaurants or theaters.

Using the Self Timer

E

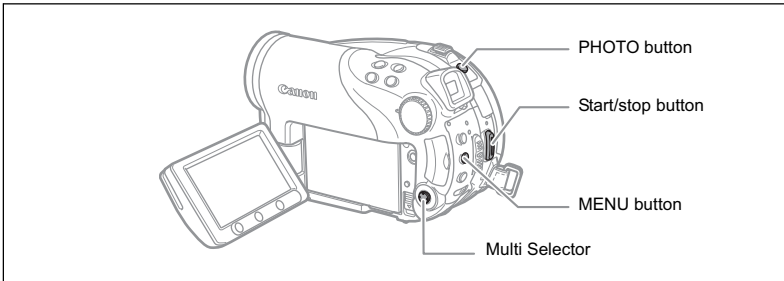

MENU

(book icon) 79



CAMERA SETUP



SELF TIMER

OFF

OFF

1. Set the camcorder to a recording mode (**CAMERA** · or **CAMERA** ·).

When recording movies (**CAMERA** ·) set the camcorder to record pause.

2. Press the **MENU** button.

3. Using the multi selector (, , ,) select the [CAMERA SETUP] menu and then select the [SELF TIMER] option.

4. Set () it to [ON] and press () to save the setting.

To cancel the self timer, set it to [OFF].

5. Press the **MENU** button to close the menu.

"" appears.

When recording a movie:

6. Press the **start/stop** button.

The camcorder starts recording after a 10-second countdown (2 seconds when using the wireless controller). The countdown appears on the screen.

When recording a still image:

6. Press the **PHOTO** button, first halfway to activate the autofocus and then fully to record the still image.

The camcorder will record the still image after a 10-second countdown (2 seconds when using the wireless controller). The countdown appears on the screen.



Once the countdown has begun, you can also press the start/stop button (when recording movies) or the PHOTO button (when recording still images) to cancel the self timer. The self timer will be canceled if you turn off the camcorder.

Changing Settings with the FUNC. Button

Many of the camcorder's functions can be adjusted from the menu that opens after pressing the FUNC. button. For a list of the settings that can be changed using this menu, see *Available Settings List (FUNC.)* (□ 61).

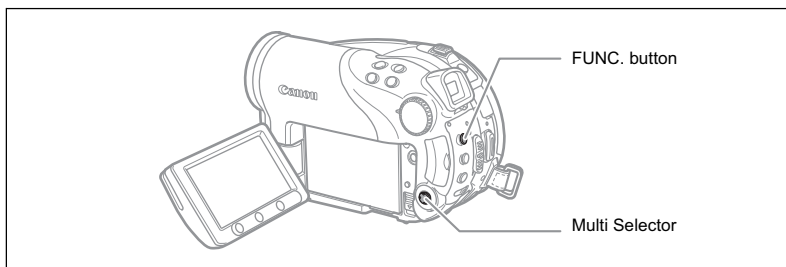

1. Press the FUNC. button.

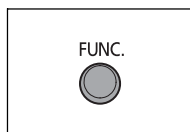

In the recording modes (**CAMERA** or **CAMERA**):

2. Use the multi selector (▲▼) to select the function you want to change.

3. Use the multi selector (◀▶) to move through the available options at the bottom bar.

Refer to the following pages for further details on setting the [SET] option for the white balance function (□ 64), the [CUSTOM] option for the image effect function (□ 66), or the [MULTI-S] option for the digital effect function (□ 73).



4. Press the FUNC. button to save the settings and close the menu.

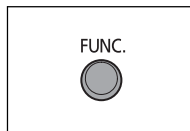



- The symbols of functions or setting options not available appear grayed out on the left side column.
- Pressing the FUNC. button at any time closes the menu.

Available Settings List (FUNC.)









































Available menu items vary depending on the operation mode. Default settings are in boldface text. For details on each function, see the reference page.

E

CAMERA, PLAY,  : Refer to the operating mode ( 12).

: Movies/Still images on the disc.

: Still images on the memory card.







Menu Items	Setting Options	CAMERA			
					
Light metering mode	 EVALUATIVE ,  CENT.WEIGHT.AVERAGE,  SPOT		<input type="radio"/>	<input type="radio"/>	63
White balance	 AUTO ,  DAYLIGHT,  SHADE,  CLOUDY,  TUNGSTEN,  FLUORESCENT,  FLUORESCENT H,  SET	<input type="radio"/>	<input type="radio"/>	<input type="radio"/>	64
Image effect	 IMAGE EFFECT OFF ,  VIVID,  NEUTRAL,  LOW SHARPENING,  SOFT SKIN DETAIL,  CUSTOM	<input type="radio"/>	<input type="radio"/>	<input type="radio"/>	66
Drive mode	<input type="checkbox"/> SINGLE ,  CONT.SHOOT.,  HISPEED CONT.SHOOT.,  AEB,  STITCH AST			<input type="radio"/>	67 69
Digital effects	 D.EFFECT OFF ,  FADER,  EFFECT,  MULTI-S,  CARD MIX	<input type="radio"/>			71
	 D.EFFECT OFF ,  BLK&WHT		<input type="radio"/>	<input type="radio"/>	
Recording mode	 HIGH QUALITY ,  STANDARD PLAY ,  LONG PLAY	<input type="radio"/>			-
Still image recording	 STILL I. REC OFF ,  FINE/640x480 ,  NORMAL/640x480	<input type="radio"/>			78
Still image size/quality	L 2304x1736 , M1 1632x1224 , M2 1280x960 , S 640x480		<input type="radio"/>	<input type="radio"/>	76
	 SUPER FINE,  FINE,  NORMAL				
Still image erase ¹	-		<input type="radio"/>	<input type="radio"/>	92
Still image protect ¹	-			<input type="radio"/>	96

¹ When recording still images with the drive mode set to [SINGLE], this menu item will appear only if you press the FUNC. button while reviewing the still image within the time selected for the [REVIEW] setting (or immediately after recording it, if set to [OFF]).

Recording mode: You can choose between XP (high quality), SP (standard play) or LP (long play).

- Approximate recording times with the supplied DVD-R blank disc are as follows:
XP : 20 min., SP : 30 minutes, LP : 60 minutes.
- Recording in LP mode gives you a longer recording time; however, depending on the condition of the disc (long usage, imperfections, etc.) the picture and sound recorded in LP mode may be distorted. We recommend using the XP or SP mode for important recordings.**

- Depending on the recording mode, you might occasionally notice a brief stop of the picture or sound at the point where the scene changes.
- The camcorder uses a variable bit rate (VBR) when encoding the video data so the actual recording times will vary depending on the content of the scenes.

Menu Items	Setting Options	PLAY			85
					
Add to playlist ¹	ALL SCENES, ONE SCENE, CANCEL	○			85
Move a scene ²	–	○			85
Divide a scene	–	○			88
Delete a scene	–	○			86
Convert to scene	–		○	○	95
Copy [ → 	–		○		94
Copy [ → 	–			○	94
Still image erase	–		○	○	92
Slideshow	CANCEL, START		○	○	41
Still image protect	OFF, ON			○	96
Print order	0 ~ 99 COPIES			○	120
Transfer order	OFF, ON			○	113

¹ This option is available only from the original movies index screen.

² This option is available only from the playlist index screen.

Changing the Metering Method

You can select the light metering mode.

<input checked="" type="checkbox"/> EVALUATIVE	Appropriate for standard shooting conditions, including backlit scenes. The camcorder divides the picture into several zones for light metering and evaluates complex lighting conditions in order to achieve the optimal exposure of the subject.
<input type="checkbox"/> CENT.WEIGHT.AVERAGE	Averages the light metered from the entire screen, giving more weight to the subject in the center.
<input type="checkbox"/> SPOT	Meters the area within the spot AE point frame. Use this setting for adjusting the exposure to match the subject in the center of the screen.



1. Set the camcorder to record still images (**CAMERA**) and set the mode dial to **P**, **Tv** or **Av**.
2. Press the **FUNC.** button.
3. First, select (**▲▼**) the current light metering symbol from the left side column and then select (**◀▶**) the desired option from the bottom bar.
4. Press the **FUNC.** button to save the setting and close the menu.

E

Setting the White Balance

You can choose one of the preset settings to reproduce colors more accurately, or set a custom white balance to obtain the setting best suited to your specific recording conditions.

AWB AUTO	Settings are automatically set by the camcorder. Use this setting for outdoor scenes.
☀ DAYLIGHT	For recording outdoors on a bright day.
☁ SHADE	For recording in shaded places.
☁ CLOUDY	For recording on a cloudy day.
💡 TUNGSTEN	For recording under tungsten and tungsten type (3-wavelength) fluorescent lighting.
💡 FLUORESCENT	For recording under warm white, cool white or warm white type (3-wavelength) fluorescent lighting.
💡 FLUORESCENT H	For recording under daylight or daylight type (3-wavelength) fluorescent lighting.
📷 SET	Use the custom white balance setting to make white subjects appear white under colored lighting.

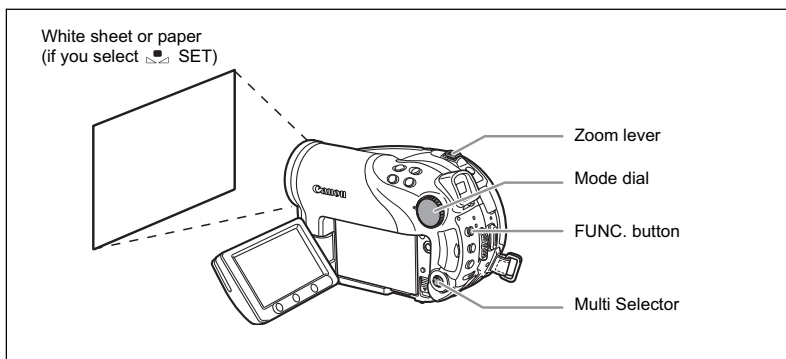

1. Set the camcorder to a recording mode (**CAMERA** · or **CAMERA** ·) and set the mode dial to a position other than **AUTO** or **SCN**.
2. Press the **FUNC.** button.
3. First, select (**▲▼**) the current white balance symbol from the left side column and then select (**◀▶**) the desired option from the bottom bar. If you select a white balance setting other than [SET], continue directly to step 5.

To set the custom white balance when you select [SET]:

4. Point the camcorder at a white object, zoom in until it fills the whole screen and press (**SET**).

- Keep the camcorder zoomed at the white object until step 5 is completed.
-  flashes and stops flashing when the adjustment is complete.







5. Press the FUNC. button to save the setting and close the menu.



- Depending on the type of fluorescent light, optimal color balance may not be obtained with [FLUORESCENT] or [FLUORESCENT H]. If the color looks unnatural, adjust it using [AUTO] or [SET].
- **When you have set the custom white balance:**
 - Depending on the light source,  may keep flashing. The result will still be better than with the [AUTO] setting.
 - Reset the white balance when the lighting condition changes.
 - Turn off the digital zoom.
- The camcorder retains the custom white balance setting even if you turn it off.
- Custom white balance may provide better results in the following cases:
 - Changing lighting conditions
 - Close-ups
 - Subjects in a single color (sky, sea or forest)
 - Under mercury lamps and certain types of fluorescent lights

Applying Image Enhancing Effects





You can record with different color saturation and contrast effects.

 IMAGE EFFECT OFF	Records with no image enhancing effects.
 VIVID	Emphasizes the contrast and color saturation.
 NEUTRAL	Tones down the contrast and color saturation.
 LOW SHARPENING	Records subjects with softened outlines.
 SOFT SKIN DETAIL	Softens the details in the skin tone area for a more complimentary appearance.
 CUSTOM	Allows you to adjust the brightness, contrast, sharpness and color depth of the image. [BRIGHTN.]: (-) Darker picture, (+) Brighter picture [CONTRAST]: (-) Flatter picture, (+) More defined light and shade [SHARPNESS]: (-) Vaguer outlines, (+) Sharper outlines [COL.DEPTH]: (-) Shallower colors, (+) Richer color tonality





FUNC.
( 60)



IMAGE EFFECT OFF

1. Set the camcorder to a recording mode ( or ) and set the mode dial to **P**.
2. Press the **FUNC.** button.
3. First, select () the current image effect symbol from the left side column and then select () the desired option from the bottom bar.

To set the custom image effect when you select [ CUSTOM]:



4. Press () . Select () the custom setting option (brightness, contrast, sharpness and color depth) and adjust () each setting as desired. Press () again to save the customized adjustments.
5. Press the **FUNC.** button to save the setting and close the menu.



[SOFT SKIN DETAIL]: To obtain the best effect, use this function when recording a person in close-up. Note that areas similar to the skin color may lack in detail.



Continuous Shooting and Exposure Bracketing

E

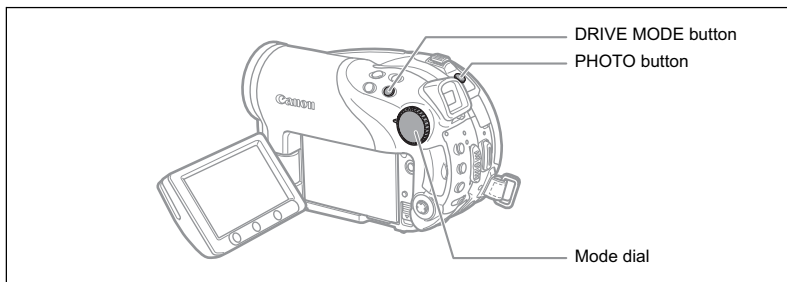
<input type="checkbox"/> SINGLE	Records a single still image.
 CONT.SHOOT. (Continuous Shooting)	Captures a series of still images as long as you hold the PHOTO button pressed down. For the number of frames per second, refer to the table on the next page.
 HISPEED CONT.SHOOT. (High-Speed Continuous Shooting)	
 AEB (Auto Exposure Bracketing)	The camcorder records a still image in three different exposures (dark, normal, light in 1/2 EV steps), allowing you to choose the shot you like the best.



1. Set the camcorder to record still images on the card ( / ) and set the mode dial to a position other than **AUTO**.

If you are recording still images on the disc (), change the media for the still images ( 36).

2. Press the **DRIVE MODE** button repeatedly to cycle between the drive modes.
3. Press the **PHOTO** button halfway to activate the autofocus.

Continuous Shooting/High-Speed Continuous Shooting:

4. Press the **PHOTO** button fully and hold it pressed down.

A series of still images will be recorded as long as you hold the PHOTO button pressed.

Auto Exposure Bracketing:

4. Press the **PHOTO** button fully.

Three still images in different exposures will be recorded on the memory card.



- The drive mode can also be selected from the FUNC. menu ( 60).
- The **DRIVE MODE** button cannot be used while the FUNC. menu is being displayed.

○ Maximum number of continuous shots at one time:

Still Image Size	Frames per Second			Maximum Number of Continuous Shots
	Normal speed	High speed	Using the Flash	
L 2304x1736	2.1 frames	2.1 frames	2.1 frames	10 images
M1 1632x1224	2.5 frames	3.8 frames	2.1 frames	10 images
M2 1280x960	3.0 frames	5.0 frames	2.5 frames	60 images
S 640x480	3.0 frames	5.0 frames	2.5 frames	60 images

These figures are approximate and vary with the recording conditions and subjects. The actual number of frames per second will be lower when “” (camcorder shake warning) is displayed on the screen.

Creating Panoramic Images

You can shoot a series of overlapping images and merge them on a computer into one large panoramic image using the supplied software (PhotoStitch). For further details about the procedure refer to the software's instruction manual on the supplied software CD-ROM.

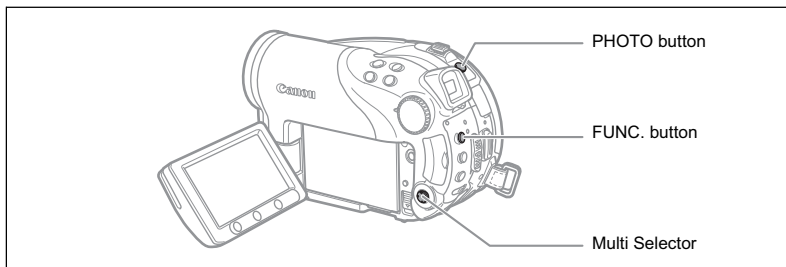

1. Set the camcorder to record still images on the card (/) and set the mode dial to a position other than **AUTO**.

If you are recording still images on the disc (), change the media for the still images (36).

2. Press the **FUNC.** button.
3. First, select () the current drive mode symbol from the left side column and then select () the [STITCH AST] option from the bottom bar and press ().
The Stitch Assist screen appears.
4. Select () the direction in which you will take the sequence of still images.
5. Select the recording program and zoom on the subject.
 - The manual focus and manual exposure adjustment cannot be used with the Stitch Assist mode.
 - Once the sequence has started, you cannot change the recording program or zoom.
6. Press the **PHOTO** button to record the first image.

The number of images recorded so far and the direction and number of the next image appear below the image.

7. Record the next image so that it overlaps a portion of the previous one. Repeat this step until you complete the panoramic image.



- Try to include a distinctive item (landmark, etc.) in the overlapping portion. Minor discrepancies in the overlapping area can be corrected with the software.
- You can retake an image using the multi selector (◀▶) to cancel the image recorded last and return to the previous one.
- Up to 26 images can be recorded.

8. Press the FUNC. button after the last image.











- Compose each image so that it overlaps 30 to 50% of the adjoining image. Try to keep the vertical misalignment within 10%.
- Do not include a moving subject in the overlapping portion.
- Do not try to stitch images that include both distant and close subjects. They may appear warped or doubled up.

Using the Digital Effects

The digital effects include faders, video effects, multi-image screen and card mix. All digital effects are available only when recording movies (**CAMERA** · ), except for the **[BLK & WHT]** (Black and White) effect, which is available also when recording still images (**CAMERA** · ).









Faders (72)

Begin or end scenes with a fade to or from black.

[1] Fade Trigger (FADE-T) 	[2] Wipe (WIPE) 	[3] Corner Wipe (CORNER) 
[4] Jump (JUMP) 	[5] Flip (FLIP) 	[6] Puzzle (PUZZLE) 
[7] Zigzag (ZIGZAG) 	[8] Beam (BEAM) 	[9] Tide (TIDE) 

Effects (73)

Add flavor to your recordings. Sound will be recorded normally.

[1] Black and White (BLK&WHT) 	[2] Sepia (SEPIA) 	[3] Art (ART) 
[4] Mosaic (MOSAIC) 	[5] Ball (BALL) 	[6] Cube (CUBE) 
[7] Wave (WAVE) 	[8] Color Mask (COLOR M.) 	[9] Mirror (MIRROR) 

Multi-Image Screen (📖 73)

Captures moving subjects as a sequence of 4, 9 or 16 still images and displays them as one split screen. Sound will be recorded normally.

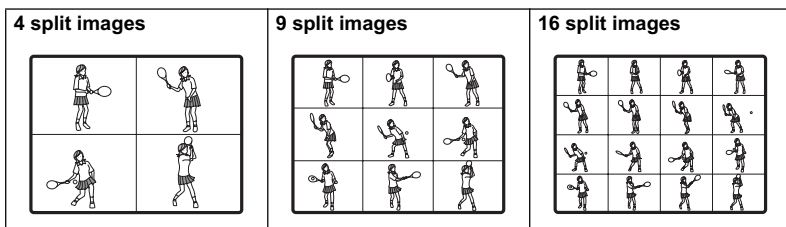

Card Mix (📖 74)

Combines a still image from the memory card with your recording.



- Turn off the digital effects [D.EFFECT OFF] when you are not using them.
- The camcorder retains the setting last used even if you turn off the digital effects or change the recording program. However, you will need to select again the still image for the Card Mix effect.

Selecting a Fader



1. Set the camcorder to record movies (**CAMERA**) and set the mode dial to a position other than **AUTO**.

2. Press the **FUNC.** button.

3. First, select (▲▼) the current digital effects symbol from the left side column and then select (◀▶) the [**FADER**] option from the bottom bar and press (SET).

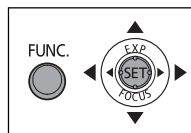

4. Select (◀▶) a fader from the list.

The selected fader will be demonstrated on the current screen and will also be shown in a small animation at the right corner of the bottom bar.

5. Press the **FUNC.** button to save the setting and close the menu.

The symbol of the selected fader appears.

6. Press the **D.EFFECTS** button.

- The symbol changes to green and the fader is activated.
- Pressing the **D.EFFECTS** button again deactivates the fader.



7. **Fade in:** Press the start/stop button in record pause mode.

Fade out: Press the start/stop button in record mode.

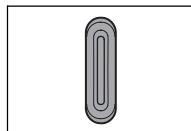

Selecting an Effect

FUNC.
(60)

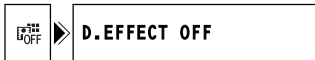

1. Set the camcorder to a recording mode (**CAMERA** · or **CAMERA** ·) and set the mode dial to a position other than **AUTO**.
2. Press the **FUNC.** button.
3. First, select (**▲▼**) the current digital effects symbol from the left side column and then select (**◀▶**) the [**EFFECT**] option from the bottom bar and press (**SET**).

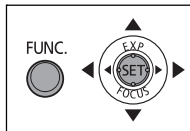

When recording still images, only the [**BLK&WHT**] effect is available. Select it and continue directly to step 5.

4. Select (**◀▶**) an effect from the list.

The selected effect will be demonstrated on the current screen and will also be shown in a small animation at the right corner of the bottom bar.

5. Press the **FUNC.** button to save the setting and close the menu.

The symbol of the selected effect appears.

6. Press the **D.EFFECTS** button.

- The symbol changes to green and the effect is activated.
- Pressing the **D.EFFECTS** button again deactivates the effect.

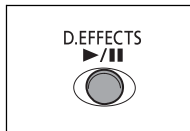



Using the Multi-Image Screen

FUNC.
(60)

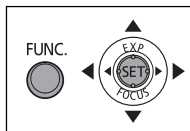

1. Set the camcorder to record movies (**CAMERA** ·) and turn the mode dial to a position other than **AUTO** or .
2. Press the **FUNC.** button.
3. First, select (**▲▼**) the current digital effects symbol from the left side column and then select (**◀▶**) the [**MULTI-S**] option from the bottom bar and press (**SET**).
4. Select (**▲▼**) the [**S.SPEED**] option and set (**◀▶**) the transition speed.
 - Manual: For capturing images manually.
 - Fast: Every 4 frames
 - Moderate [MOD.]: Every 6 frames
 - Slow: Every 8 frames
5. Select (**▲▼**) the [**S.SPLIT**] option and set (**◀▶**) the number of split images to capture.



6. Press () to save the setting and press the FUNC. button to close the menu.

"  " appears.

7. Press the D.EFFECTS button.

- "  " changes to green.
- [FAST], [MOD.], [SLOW]: The number of images selected will be captured at the set speed. To cancel the multi-image screen, press the D.EFFECTS button.
- [MANUAL]: Images will be captured every time you press the D.EFFECTS button. The blue frame indicating the next split image in the sequence disappears after the last image. Holding the D.EFFECTS button pressed down for more than 1 second cancels the images one after another.



Combining Images (Card Mix)

You can choose one of the sample images (including picture frames, backgrounds and animations) from the collection on the supplied DIGITAL VIDEO SOLUTION DISK and combine it with your live video recording to add a note of playfulness to your movies.

Card Chroma Key [CARD CHROMA]

Combines frames with your recordings. The live video recording will appear instead of the blue area of the card mix image.

Mix level adjustment: Blue area of the still image.



Card Luminance Key [CARD LUMI.]

Combines illustrations or titles with your recordings. The live video recording will appear instead of the light area of the card mix image.

Mix level adjustment: Light area of the still image.



Camera Chroma Key [CAM. CHROMA]

Combines backgrounds with your recordings. Record your subject in front of a blue background and any part of your subject that is not blue will appear superimposed on the picture with the card mix image serving as background.

Mix level adjustment: Blue area of the live video recording.



Card Animation [C. ANIMATION]

Combines animations with your recordings. You can choose from three types of card animation effects.

- Corner: The animation appears on the upper left and the lower right corner of the screen.
- Straight: The animation appears on the top and bottom of the screen and moves right and left.
- Random: The animation moves randomly on the screen.

Mix level adjustment: Blue area of the card animation image.



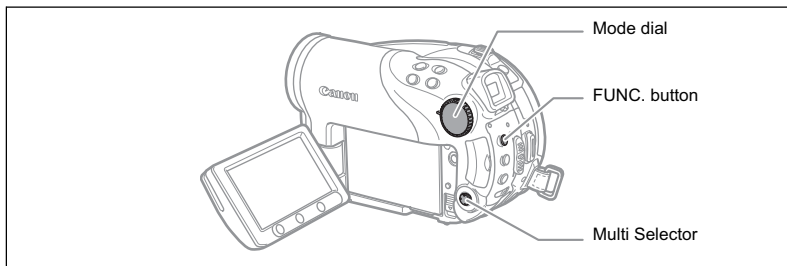

FUNC.
(60)



D.EFFECT OFF













1. Set the camcorder to record movies (**CAMERA** ·).
2. Upload a sample image from the supplied CD-ROM to the memory card.
Refer to *Adding Still Images from Your Computer to the Memory Card* in the *Digital Video Software* instruction manual (electronic version on PDF file).
3. Set the mode dial to a position other than **AUTO**.
4. Press the **FUNC.** button.
5. First, select () the current digital effects symbol from the left side column and then select () the [**CARD MIX**] option from the bottom bar and press ().
6. Select () the [**IMAGE SELECT**] option, and then select () the still image you want to combine.
7. Select () the [**MIX TYPE**] option, and set () a mix type appropriate for the image you selected.
If you selected [**C.ANIMATION**], select () [**ANIMAT.TYPE**] and set () the animation type preferred.
8. If you want to adjust the mix level, select () [**MIX LEVEL**] and set () the level preferred.
9. Press () to save the settings and press the **FUNC.** button to close the menu.
“ ” appears.
10. Press the **D.EFFECTS** button.
 - “ ” changes to green and the combined image appears.
 - Still images cannot be recorded on the memory card while the Card Mix function is activated.

Selecting the Size and Quality of Still Images













Still images are recorded on the memory card or the disc using the JPEG (Joint Photographic Experts Group) compression.

You can select the size and quality of still images. As a general rule select a larger image size for higher quality stills (for example for printing and enlarging); or a smaller image size if you want to record more images on the memory card or want smaller file sizes (for example for e-mail attachments or for web pages).

Approximate number of still images that can be recorded on a memory card:

Image Size	L 2304X1736			M1 1632X1224			M2 1280X960			S 640X480		
Image Quality												
16 MB Card	3	6	15	9	13	25	15	20	40	75	105	170
128 MB Card	45	70	155	85	135	250	140	215	395	690	955	1525
256 MB Card	90	145	310	175	275	500	280	430	795	1380	1900	3040

Approximate number of still images that can be recorded on a disc:

Image Size	L 2304X1736			M1 1632X1224			M2 1280X960			S 640X480		
Image Quality												
DVD-R/RW VIDEO Mode	545	855	1815	1025	1585	2910	1630	2495	4595	7945	9999	9999
DVD-RW VR Mode	545	855	1820	1025	1590	2915	1635	2500	4605	7960	11680*	19470*

 : Super Fine,  : Fine,  : Normal

* This number is the number of images that can be recorded on the disc; however, the maximum number of remaining images displayed on the screen will be 9999.



- Depending on the number of images on the memory card or disc (Windows: more than 1800 images; Macintosh: more than 1000 images), you may not be able to download images to a computer. Try using a card reader to download the still images recorded on the memory card.
- Connection to a PictBridge compliant printer will not work when the memory card contains more than 1800 images. For best performance, we recommend to keep the number of images on the memory card under 100.

FUNC.
(60)

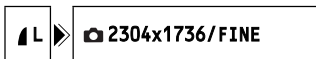

1. Set the camcorder to record still images (**CAMERA** ·).
2. Press the **FUNC.** button.
3. First, select () the current image size and quality symbol from the left side column and then select () the desired image size from the bottom bar.

The number on the right indicates the approximate number of images that can be recorded on the memory card or disc at the current image size/quality setting.

4. If you want to change also the image quality: Press () and select () the desired image quality from the bottom bar.

You can press () again to go back to select the image size (step 3).

5. Press the **FUNC.** button to save the setting and close the menu.

Capturing a Still Image while Recording Movies

While you are recording a movie on the disc you can simultaneously capture the same picture as a still image on the memory card without interrupting your recording to change modes. The size of the still image will be 640x480 and cannot be changed, but the image quality can be selected.

FUNC.
(60)



STILL I. REC OFF

1. Set the camcorder to record movies (**CAMERA**).
2. Press the **FUNC.** button.
3. First, select (**▲▼**) the current image recording symbol from the left side column and then select (**◀▶**) the desired image quality from the bottom bar.
4. Press the **FUNC.** button to save the setting and close the menu.
5. While you are recording a movie, press the **PHOTO** button.

The still image is recorded on the memory card while the screen continues to show the video recording.



- The still image cannot be recorded simultaneously on the disc.
- The quality of the still image is slightly lower than a still image of the same size recorded in the **CAMERA** mode.
- The still image cannot be recorded on the memory card while recording in Widescreen or while a digital effect is activated.

Changing Settings with the MENU Button

You can modify many aspects of how your camcorder operates from the various setup menus that open after pressing the MENU button. For a list of the settings that can be changed using these setup menus, see *Available Settings List (MENU)* (□ 80).

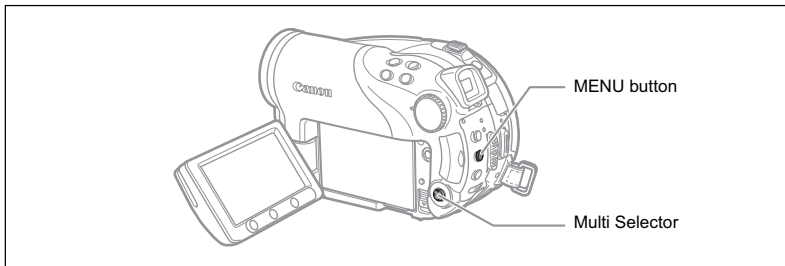

Selecting Menus and Settings

1. Press the MENU button.

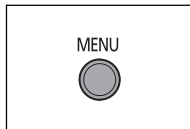

2. Use the multi selector (▲▼) to select the setup menu from the left side column and press (SET).

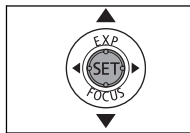

3. Select (▲▼) the setting you want to change and press (SET) to make the selection.

4. Select (▲▼) the desired option and press (SET) to save the setting.

5. Press the MENU button.

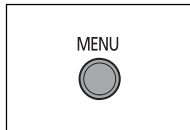



○ Menu items not available appear in black.

○ Pressing the MENU button at any time closes the menu.

Available Settings List (MENU)







Available menu items vary depending on the operation mode. Default settings are in boldface text. For details on each function, see the reference page. Functions without a reference page are explained below the tables.

CAMERA, PLAY, , : Refer to the operating mode ( 12).



: Movies/Still images on the disc.

: Still images on the memory card.

CAMERA SETUP

Menu Items	Setting Options	CAMERA			
					
A.SL SHUTTER	ON ON , OFF OFF	<input type="radio"/>	<input type="radio"/>	<input type="radio"/>	-
D.ZOOM	OFF OFF , 40x 40x , 200x 200x	<input type="radio"/>	<input type="radio"/>	<input type="radio"/>	-
AF AST LAMP	A AUTO , OFF OFF	<input type="radio"/>	<input type="radio"/>	<input type="radio"/>	58
ZOOM SPEED	VAR VARIABLE , >>> SPEED 3 , >> SPEED 2 , > SPEED 1	<input type="radio"/>	<input type="radio"/>	<input type="radio"/>	-
IMG STAB	ON ON () , OFF OFF	<input type="radio"/>	<input type="radio"/>	<input type="radio"/>	-
FOCUS PRI.	ON ON , OFF OFF	<input type="radio"/>	<input type="radio"/>	<input type="radio"/>	-
SPOT AE PT.	[] CENTER , [E] AF POINT	<input type="radio"/>	<input type="radio"/>	<input type="radio"/>	-
ND	A AUTO , OFF OFF	<input type="radio"/>	<input type="radio"/>	<input type="radio"/>	-
REVIEW	OFF OFF , 2s 2sec , 4s 4sec , 6s 6sec , 8s 8sec , 10s 10sec	<input type="radio"/>	<input type="radio"/>	<input type="radio"/>	-
WIND SCREEN	ON ON () , OFF OFF	<input type="radio"/>	<input type="radio"/>	<input type="radio"/>	-
SELF TIMER	ON ON () , OFF OFF	<input type="radio"/>	<input type="radio"/>	<input type="radio"/>	59

A.SL SHUTTER: The camcorder automatically uses slow shutter speeds to obtain brighter recordings in places with insufficient lighting.

- The camcorder uses shutter speeds down to 1/30 (1/15 when recording still images).
- The auto slow shutter can only be used when the mode dial is set to **AUTO** or **P**.
- When recording still images, set the flash mode to  (flash off).
- If a trailing afterimage appears, set the slow shutter to [OFF].
- If "" (camcorder shake warning) appears, we recommend stabilizing the camcorder, for example, by mounting it on a tripod.

D.ZOOM: Determines the operation of the digital zoom.

- When the digital zoom is activated, the camcorder will switch automatically to the digital zoom when you zoom in beyond the optical zoom range.
- With the digital zoom the image is digitally processed, so image resolution will deteriorate the more you zoom in.
- The digital zoom indicator will appear in light blue from 10x up to 40x and dark blue from 40x to 200x.
- The digital zoom cannot be used in the  Night modes or with the multi-image screen.

IMG STAB (📷): The image stabilizer compensates for camcorder shake even at full telephoto.

- The image stabilizer is designed to compensate for a normal degree of camcorder shake.
- The image stabilizer may not be effective when recording in dark places using the Night modes.
- The image stabilizer cannot be turned off when the mode dial is set to **AUTO**.
- We recommend turning off the image stabilizer when using a tripod.

FOCUS PRI.: The camcorder records the still image only after the focus has been adjusted.

- Set it to [OFF] if you wish to record a still image as soon as you press the PHOTO button. When set to [OFF], no focusing frame appears.
- Focus priority cannot be turned off when the mode dial is set to **AUTO**.
- In the Fireworks recording program (SCN) the setting is automatically turned off.



SPOT AE PT.: Decides what frame will be used for measuring the light when the metering method in the FUNC. menu is set to [SPOT].

- [CENTER]: The exposure will be adjusted according to the subject in the center of the picture.
- [AF POINT]: The exposure will be tied to the autofocus frames and adjusted according to the subject or subjects in the one or more AF frames selected.
- The spot AE point is set to [CENTER] in all recording programs except **P**, **Tv** or **Av**.
- The last setting will be retained even if you change the position of the mode dial.

ND: Will automatically activate the ND (neutral density) filter in surroundings that are too bright.

- The ND filter can only be used when the mode dial is set to **P**.





REVIEW: Selects the time to display a still image after it has been recorded on the memory card.

- You can erase (🗑 92) or protect (🔒 96) the image if you press the FUNC. button while you are reviewing the image (or immediately after recording it, if set to [OFF]).
- This menu item will not be available when  (continuous shooting),  (high-speed continuous shooting) or  (auto exposure bracketing) is selected.

WIND SCREEN: When activated, the camcorder will reduce the background sound of wind when recording outdoors.

- Set the mode dial to a position other than **AUTO**.
- Some low-frequency sounds will be suppressed along with the sound of wind. We recommend to leave the wind screen [OFF] for most recording environments.



DISC OPERATIONS

Menu Items	Setting Options	CAMERA		PLAY		
						
DISC INFO	–	<input type="radio"/>	<input type="radio"/>	<input type="radio"/>	<input type="radio"/>	–
DISC INITIALIZE	VIDEO, VR	<input type="radio"/>	<input type="radio"/>	<input type="radio"/>	<input type="radio"/>	90
FINALIZE	NO, YES	<input type="radio"/>	<input type="radio"/>	<input type="radio"/>	<input type="radio"/>	98
UNFINALIZE	NO, YES	<input type="radio"/>	<input type="radio"/>	<input type="radio"/>	<input type="radio"/>	101
MOVIES ALL DEL ¹	NO, YES			<input type="radio"/>		87
PLAYLST ALL DEL ²	NO, YES			<input type="radio"/>		87
DISC PROTECT	NO, YES			<input type="radio"/>	<input type="radio"/>	89
PHOTOMOVIE	NO, YES				<input type="radio"/>	95
DISC TITLE	–			<input type="radio"/>		91













¹ This option is available only in the original movies mode.

² This option is available only in the playlist mode.

DISC INFO: Displays a screen where you can verify the details regarding the disc.

- The disc information includes the disc title, the disc type (DVD-R or DVD-RW), the disc specification (VIDEO mode or VR mode), and icons that indicate if the disc is finalized () or protected ()

STILL IMAGE OPERATIONS

Menu Items	Setting Options	PLAY		
				
 ORD. ALL ERASE	NO, YES		<input type="radio"/>	121
 ORD. ALL ERASE	NO, YES		<input type="radio"/>	114
ERASE ALL IMAGES	NO, YES		<input type="radio"/>	93
CARD INITIALIZE	NO, YES		<input type="radio"/>	97
ALL COPY [ → 	NO, YES		<input type="radio"/>	94
ALL COPY [ → 	NO, YES		<input type="radio"/>	94
⇒  PROTECT ¹			<input type="radio"/>	96
⇒  PRINT ORDER ¹			<input type="radio"/>	120
⇒  TRANSFER ORDER ¹			<input type="radio"/>	113

¹ This option is available only when you press the MENU button in the index screen.

DISPLAY SETUP

Menu Items	Setting Options	CAMERA		PLAY		📖
BRIGHTNESS		○	○	○	○	-
LCD MIRROR	ON ON , OFF OFF	○	○			-
DATA CODE	DATE, TIME, DATE & TIME , CAMERA DATA, CAM. & D/T			○		45
	DATE, TIME, DATE & TIME				○	
LEVEL MARKER	ON ON , OFF OFF	○				-
LANGUAGE	DEUTSCH, ENGLISH , ESPAÑOL, FRANÇAIS, ITALIANO, POLSKI, РУССКИЙ, 简体中文, 繁體中文, 한국어, ภาษาไทย, 日本語	○	○	○	○	27
DEMO MODE	ON ON , OFF OFF	○	○			-

BRIGHTNESS: Adjusts the brightness of the LCD screen.

- Use the multi selector (◀▶) to adjust the brightness to your preference.
- Changing the brightness of the LCD screen does not affect that of the viewfinder or the recordings.

LCD MIRROR: When you rotate the LCD panel 180 degrees to face the subject, the picture displayed will be a mirror image (right and left reversed) so that the image on the display will match that of the subject. All on-screen displays will also be reversed.

LEVEL MARKER: A horizontal line will appear at the center of the screen. You can frame the picture better by referring to the level marker.

DEMO MODE: The demonstration mode displays the camcorder's main features. It starts automatically when the camcorder is powered with the power adapter if you leave it turned on without loading a recording media for more than 5 minutes.

- To cancel the demo mode once it started, press any button, turn off the camcorder or load a recording media.

SYSTEM SETUP

Menu Items	Setting Options	CAMERA		PLAY		📖
MEDIA SEL.	CARD , DISC		○		○	36
WL. REMOTE	ON ON , OFF OFF	○	○	○	○	-
VOLUME				○		43
BEEP	HIGH VOLUME , LOW VOLUME , OFF OFF	○	○	○	○	-
POWER SAVE	ON ON , OFF OFF	○	○			-
FILE NOS.	RESET , CONTINUOUS	○	○			-
TV TYPE	4:3 NORMAL TV, 16:9 WIDE TV			○		-

WL. REMOTE: Allows the camcorder to be operated with the wireless controller.

BEEP: A beep will accompany some operations like turning on the camcorder, the self-timer countdown, etc. It also serves as a warning beep under unusual conditions.

POWER SAVE: In order to save power when the camcorder is powered by a battery pack, it will automatically shut off if left without any operation for five minutes.

Approximately 30 seconds before the camcorder shuts off the message “ AUTO POWER OFF” will appear.

FILE NOS.: Select the image numbering method to be used on a new memory card or disc.

Images are automatically assigned consecutive image numbers from 0101 to 9900, and stored in folders containing up to 100 images. Folders are numbered from 101 to 998.

[RESET]: Image numbering will start anew from 101-0101 every time you insert a new memory card or disc. If it already contains image files, a new image will be given the number following that of the last image on the card or disc.

[CONTINUOUS]: Image numbering will start from the number following that of the last image recorded with the camcorder. If the memory card or disc already contains an image with a larger image number, a new image will be given the number following that of the last image on the recording media. This method is useful for organizing images on a computer. We recommend using the [CONTINUOUS] setting.

○ The [FILE NOS.] setting is common to the memory card and the disc.

TV TYPE: In order to display the picture in full and in the correct aspect ratio, select the setting according to the type of television to which you will connect the camcorder.

[NORMAL TV]: TV sets with 4:3 aspect ratio.

[WIDE TV]: TV sets with 16:9 aspect ratio.

DATE/TIME SETUP

Menu Items		Setting Options		CAMERA		PLAY		
T.ZONE/DST				<input type="radio"/>	<input type="radio"/>	<input type="radio"/>	<input type="radio"/>	
DATE/TIME				<input type="radio"/>	<input type="radio"/>	<input type="radio"/>	<input type="radio"/>	
DATE FORMAT	Y.M.D (2006.1.1 AM12:00), M.D,Y (JAN.1,2006 12:00AM), D.M.Y (1.JAN.2006 12:00AM)			<input type="radio"/>	<input type="radio"/>	<input type="radio"/>	<input type="radio"/>	28











DATE FORMAT: Changes the displayed date format (including the date format for printing).

Creating a Playlist

Create a playlist to easily edit your movies (for example, change the order in which the scenes you recorded will be played back or edit scenes including only the best parts and cutting out the rest) without affecting your original recordings. After you create a playlist you will have two index screens: that of your original recordings (the scene index screen) and the one you edit as a playlist (the playlist index screen).











Available only with DVD-RW discs recorded in VR mode.

Adding Scenes to the Playlist

1. Set the camcorder to play movies ().
2. From the index screen, select (, ) the scene you want to add to the playlist and press the FUNC. button.
To add all the movies to the playlist there is no need to select any particular scene.
3. Select () the  (ADD TO PLAYLIST) icon and press ().
4. Select (, ) either [ALL SCENES] to add all the movies to the playlist or [ONE SCENE] to add only the selected scene and press ().
5. Select () [YES] and press ().

When the operation is completed "ADDED TO PLAYLIST" will be displayed. Press the PLAYLIST button to check the scenes in the playlist index screen.

Moving Scenes in the Playlist

1. Set the camcorder to play movies ().
2. Press the PLAYLIST button to open the playlist index screen.
3. Select (, ) the scene you want to move.
The scene to be moved will be marked by the orange selection frame.
4. Press the FUNC. button.
5. Select () the  (MOVE) icon and press ().
6. Move (, ) the orange marker to indicate where you want to move the scene and press ().
7. Select () [YES] and press () to move the scene to the selected destination.

Deleting Scenes

You can delete those scenes that you are not interested in keeping. Remember that when you delete scenes in the playlist, you do not affect your original recordings; However, when you delete an original recording, it will be deleted also from the playlist.

This option is only available with DVD-RW discs (VIDEO or VR mode). However, with DVD-RW discs recorded in VIDEO mode only the last scene can be deleted and only while reviewing it immediately after recording the scene (□ 34).



Be careful when deleting original recordings. Once deleted, an original scene cannot be recovered.



- Scenes cannot be deleted when the disc is protected (□ 89).
- You may not be able to delete scenes shorter than 5 seconds long.

Deleting a Single Scene

This option is only available with DVD-RW discs recorded in VR mode.

1. **Set the camcorder to play movies** (**PLAY**).
2. **From the index screen, select** (**▲▼**, **◀▶**) **the scene you want to delete and press the FUNC. button.**
3. **Select** (**◀▶**) **the** (**DELETE**) **icon and press** (**SET**).
4. **Select** (**◀▶**) **[YES] and press** (**SET**) **to delete the scene.**

To Delete a Scene only from the Playlist

After Step 1 above, press the PLAYLIST button to open the playlist index screen and continue the procedure as described.

Deleting a Scene After Recording

As long as you haven't turned the camcorder off or changed the operation mode after recording a scene, you can delete it while reviewing it. This option is only available with DVD-RW discs (VIDEO or VR mode).

1. **Immediately after recording a scene** (**CAMERA**), **press the** **(record review) button.**
2. **While reviewing the scene, use the multi selector** (**◀▶**) **to select the** **icon and press** (**SET**).
3. **Select** (**◀▶**) **[YES] and press** (**SET**) **to delete the scene.**



Do not change the position of the power switch or the / switch while the scene is being deleted.





Deleting All Scenes

This option is only available with DVD-RW discs recorded in VR mode.

MENU
(MENU 79)



E

1. Set the camcorder to play movies ().
2. Press the MENU button.
3. Use the multi selector (, ) to select the [DISC OPERATIONS] menu and then select the [MOVIES ALL DEL] option.
4. Select () [YES] and press () to delete all the scenes.
Deleting all the original scenes will also delete the whole playlist.
5. Press the MENU button to close the menu.

To Delete the Whole Playlist















After Step 1 above, press the PLAYLIST button to open the playlist index screen and in Step 3 select the [PLAYLST ALL DEL] option. Continue the procedure as described.

Dividing a Scene

You can divide your recordings in order to leave only the best parts and later cut out the rest. Remember that when you divide scenes in the playlist, you do not affect your original recordings. Photomovie scenes and scenes created by converting single still images cannot be divided.

Available only with DVD-RW discs recorded in VR mode.

Dividing Scenes

1. Set the camcorder to play movies ().
2. From the index screen, select (, ) the scene you want to divide and press the FUNC. button.
3. Select () the  (DIVIDE) icon and press ().
The scene will be played back.
4. At the place where you want to divide the scene, press ().
5. You can use the following icons and the special playback modes ( 40) to bring the scene to a precise point.
 : Skip to the beginning of the current/next scene.
 : One frame reverse/advance.
6. Select () the  icon and press ().
7. Select () [YES] and press () to divide the scene.
The second part of the scene (starting from the dividing point) will be added as a separate scene immediately after the original one.

To Divide a Scene only in the Playlist

After Step 1 above, press the PLAYLIST button to open the playlist index screen and continue the procedure as described.

Protecting the Disc

You can protect the whole disc in order to prevent the accidental erasure of important recordings.

Available only with DVD-RW discs recorded in VR mode.



Initializing the disc (ⓘ 90) will permanently erase all recordings, even if the disc is protected.

MENU

(ⓘ 79)



1. Set the camcorder to play movies or view still images recorded on the disc (or /).
2. Press the MENU button.
3. Use the multi selector (,) to select the [DISC OPERATIONS] menu and then select the [DISC PROTECT] option.
4. Select () [YES] and press () to protect the disc.
5. Press the MENU button to close the menu.

Initializing the Disc

You need to initialize a DVD-RW disc when first inserting it into the camcorder and you may have to initialize a disc if you get the "DISC ERROR" message. You can also choose to initialize the disc if you wish to erase all the recordings on the disc or in order to change the disc specification.

















- Initializing the disc will erase all recordings, even if the disc is protected. The original recordings cannot be recovered.
- Initialize all DVD-RW discs before using them with this camcorder.

MENU

(79)



- 1. Set the camcorder either to record or play movies or to record or view still images on the disc (, ,  /  or  / ).**
- 2. Press the MENU button.**
- 3. Use the multi selector (, ) to select the [DISC OPERATIONS] menu and then select the [DISC INITIALIZE] option.**
- 4. Select () the disc specification and press ().**
 - [VIDEO] mode: Most DVD players will play the disc, but except for the disc title, the recordings cannot be edited with the camcorder.
 - [VR] mode: You will have the option to edit the recordings with the camcorder, but the disc can only be played in VR mode-compatible DVD players and computer DVD drives.
- 5. You will be asked to confirm the disc specification you selected. Select () [YES] and press () to continue.**

Select [NO] and press () to return and select a different disc specification.
- 6. Select () [YES] and press () to initialize the disc.**











The disc initialization will take approximately one minute. Avoid moving the camcorder while the operation is in progress.
- 7. Once the [DISC OPERATIONS] menu is displayed, press the MENU button to close the menu**

Changing the Disc Title

Before you finalize your disc, you can give it a title. The disc title will be displayed on the index screen when playing the finalized disc in most DVD players.

MENU
( 79)



1. Set the camcorder to play movies ().
2. Press the MENU button.
3. Use the multi selector (, ) to select the [DISC OPERATIONS] menu and then select the [DISC TITLE] option.
4. Select (, ) one character at a time and press () to add it to the title.
 - Select [BACKSPACE] and press () to delete the last character in the title.
 - You can set a title up to 20 characters long.
5. Once you finish entering the title, select [SET] and press ().
6. Select (, [YES]) and press () to save the title.
7. Press the MENU button to close the menu.

Erasing Still Images

You can erase still images recorded on the memory card or on the disc (DVD-RW only), one at a time or all at once.



Be careful when erasing images. Erased images cannot be recovered.



Protected images on the memory card and images on a protected disc cannot be erased.

Erasing a Single Image

Still images recorded on the disc: This option is only available with DVD-RW discs recorded in VR mode.



1. Set the camcorder to view still images (**PLAY · 📷**).
2. Press the **FUNC.** button.
3. Select (**▲▼**) the [**👁️ IMAGE ERASE**] symbol and press (**⊙**).
4. Select (**◀▶**) [**ERASE**] and press (**⊙**) to erase the still image.
5. Press the **FUNC.** button to close the menu.

Erasing a Single Image After Recording

You can erase the still image you recorded last while you are reviewing it within the time selected for the [REVIEW] setting (or immediately after recording it, if set to [OFF]). Still images on the disc: This option is only available with DVD-RW discs (VIDEO or VR mode).







1. While reviewing the image after recording it (**CAMERA · 📷**) press the **FUNC.** button.
2. Select (**▲▼**) the [**👁️ IMAGE ERASE**] symbol and press (**⊙**).
3. Select (**◀▶**) the [**ERASE**] option and press (**⊙**) to erase the still image.
4. Press the **FUNC.** button to close the menu.

Erasing All Images

Still images recorded on the disc: This option is only available with DVD-RW discs recorded in VR mode.

MENU
( 79)



1. Set the camcorder to view still images ().
2. Press the MENU button.
3. Use the multi selector (, ) to select the [STILL IMG OPER.] menu and then select the [ERASE ALL IMAGES] option.
4. Select () [YES] and press () to erase the still images.
All the non protected still images on the currently selected media will be erased.
5. Press the MENU button to close the menu.

Copying Still Images Between the Disc and Memory Card

You can copy still images recorded on the memory card to the disc (for example, to add them to a Photomovie scene (□ 95)), or from the disc to the memory card (for example, to set print orders for a DPOF compatible printer (□ 120)).

Copying a Single Image

FUNC.
(□ 60)



1. Set the camcorder to view still images (**PLAY**).
Select as the media for the still images, the media from where you want to copy images.
2. Press the **FUNC.** button.
3. Select (**▲▼**) the [**Disc icon**] symbol (from the disc to the card) or the [**Card icon**] symbol (from the card to the disc).
4. Select (**◀▶**) [EXECUTE] and press (**SET**) to copy the still image.
5. Press the **FUNC.** button to close the menu.

Copying All Images

MENU
(□ 79)

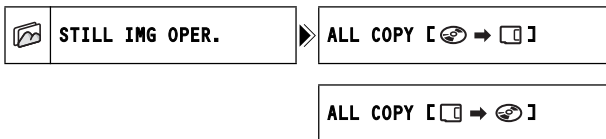

1. Set the camcorder to view still images (**PLAY**).
Select as the media for the still images, the media from where you want to copy images.
2. Press the **MENU** button.
3. Use the multi selector (**▲▼** , **SET**) to select the [STILL IMG OPER.] menu and then select the [ALL COPY [**Disc icon**] → [**Card icon**]] option (from the disc to the card) or the [ALL COPY [**Card icon**] → [**Disc icon**]] option (from the card to the disc).
The total size of all image files and the available space on the destination media will be displayed.
4. Select (**▲▼**) [YES] and press (**SET**) to copy the still images.
5. Press the **MENU** button to close the menu.





- Still images not recorded with this camera may not be copied correctly.
- When the available space on the copy destination is not enough, the copy operation will be canceled without copying all images.
- The copy operation may take a while to complete depending on the number and total size of the image files.

Converting Still Images into Photomovie Scenes

Still images are recorded using JPEG compression, but a DVD player only recognizes the MPEG standard. That is why in order to display your still images as scenes in your DVD, first you have to create a Photomovie scene – a slideshow of all still images on the disc, where each image will be displayed for approx. 3 seconds.



Converting a Single Image

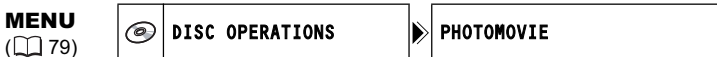

1. Set the camcorder to view still images (**PLAY · **).
2. Select (**◀▶**) the still image you want to convert to a scene and press the **FUNC.** button.
3. Select (**▲▼**) the [** CONVERT TO SCENE**] symbol and press (**SET**).
4. Select (**◀▶**) [**EXECUTE**] and press (**SET**) to convert the still image.
The image will be added as a new scene to the original recordings index.
5. Press the **FUNC.** button to close the menu.

Converting All Images



1. Set the camcorder to view still images recorded on the disc (**PLAY ·  / **).
If you want to add still images recorded on the memory card to your Photomovie scene, copy them to the disc in advance (**□ 94**).
2. Press the **MENU** button.
3. Use the multi selector (**▲▼**, **SET**) to select the [**DISC OPERATIONS**] menu and then select the [**PHOTOMOVIE**] option.
4. Select (**▲▼**) [**YES**] and press (**SET**) to create the Photomovie.
5. Press the **MENU** button to close the menu.
The slideshow will be added as a new scene to the original recordings index.



- If during the creation of a Photomovie scene the disc becomes full, the operation will be canceled.
- Even after being converted to Photomovie scenes, the original still images will remain recorded on the disc without change.

Protecting Still Images on the Memory Card

You can protect still images recorded on the memory card from accidental erasure while displaying a single image or from the index screen.

 Initializing the memory card (□ 97) will permanently erase all recorded still images, even the protected ones.

Protecting a Single Image



1. Set the camcorder to view still images recorded on the memory card ( / ).

2. Press the FUNC. button.

The option is also available while recording still images () but only if you press the FUNC. button while reviewing the still image (□ 81) within the time selected for the [REVIEW] setting (or immediately after recording it, if set to [OFF]).

3. Select () the [ PROTECT] symbol and press ().

4. Select () [ON] and press () to protect the still image.

To cancel the protection, select [OFF].

5. Press the FUNC. button to close the menu.

“O_{PROT}” appears, and now the image cannot be erased.

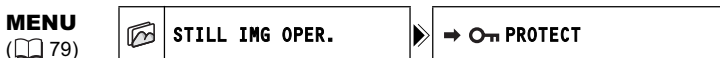

Protecting Still Images from the Index Screen





1. Set the camcorder to view still images recorded on the memory card ( / ).

2. Move the zoom lever toward **W**.

The stills index screen appears with up to six still images.

3. Press the MENU button and use the multi selector ( , ) to select the [STILL IMG OPER.] menu and then select the [ PROTECT] option.

4. Bring ( , ) the cursor () to the image you want to protect and press (). Repeat this step to select other images as desired.

• “O_{PROT}” appears on the image.

• To cancel the protection, press () again.

5. Press the MENU button to close the menu and return to the index screen.

Initializing the Memory Card

Initialize a new memory card when first inserting it into the camcorder. You may have to initialize a card if you get the "CARD ERROR" message or you may choose to do so to erase all data recorded on it.



- Initializing the memory card will erase all still images, even the protected ones. The original still images cannot be recovered.
- Initialize all memory cards before using them with this camcorder.

MENU

(79)



1. Set the camcorder to view still images recorded on the memory card (/).
2. Press the MENU button.
3. Use the multi selector () to select the [STILL IMG OPER.] menu and then select the [CARD INITIALIZE] option.
4. Select () [YES] and press ().
- A confirmation screen will appear.
5. Select () [YES] again and press ().
6. Press the MENU button to close the menu.

Preparing your Disc for Playing on a DVD Player

In order to play the disc you recorded on a DVD player, a computer's DVD drive or other digital device, you need to finalize it first. To view your still images on a DVD player you will need to convert them to Photomovie scenes beforehand (□ 95).



- Be sure to finalize the disc in normal room temperatures. If the procedure was not completed correctly due to high temperature, let the camcorder cool off before resuming operation.
- Place the camcorder on a table or other stable surface before starting the procedure. Subjecting the camcorder even to slight impacts (for example to place it on a table or to disconnect the AV cable) after you press the FINALIZE button or select the menu option may result in permanent data loss.
- When finalizing a disc, always power the camcorder using the compact power adapter. The finalization process cannot be started if the camcorder is powered only with the battery pack.
- Do not disconnect the power adapter while the disc finalization is in progress. Doing so can interrupt the process and result in lost data.
- Depending on the type of disc and the disc specification, after finalizing the disc you may not be able to initialize the disc, edit your recordings or add new recordings to the disc.
- Do not finalize with the camcorder discs that were not recorded using this camcorder.



- The time required to complete the disc finalization will vary depending on the scene recording conditions and the amount of free space remaining on the disc.
- The disc finalization can be started using the FINALIZE button or from the [DISC OPERATIONS] menu using the MENU button (□ 79).

Restrictions after Disc Finalization

	Additional Recordings	Edit Recordings	Initializing the Disc	Unfinalizing the Disc
DVD-R in VIDEO mode	–	–	–	–
DVD-RW in VIDEO mode	●*	–	●	●
DVD-RW in VR mode	●	●	●	–

* You will need to unfinalize the disc first.

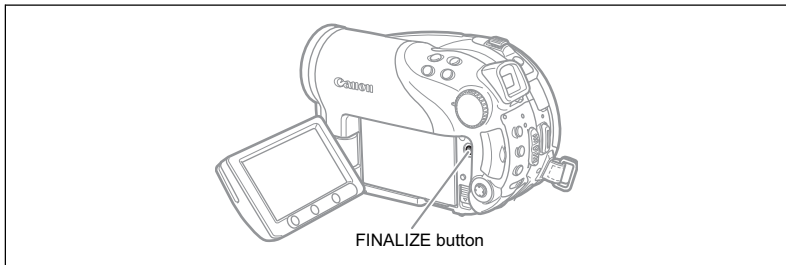

1. Set the camcorder either to record or play movies or to record or view still images on the disc (**CAMERA** · , **PLAY** · , **CAMERA** · / or **PLAY** · /).
2. Press the **FINALIZE** button.
3. Select **[YES]** and press (**SET**) to start the disc finalization.
 - A progress bar and the remaining time are displayed.
 - Avoid moving the camcorder while the disc finalization is in progress.
 - When using a finalized disc in a recording mode, the finalization mark “**F**” will appear next to the disc type display.

Playing Back your Disc on a DVD Player or a Computer's DVD Drive

After you finalized your disc, you can play it on a DVD-R or DVD-RW compatible DVD player, DVD recorder or DVD drive on a computer. On most DVD players look for the DVD-R/RW compatibility logo . Refer also to the instruction manual of your DVD player or DVD recorder.

Playing the Disc on a DVD Player

1. Turn on the TV and DVD player.
2. Insert a finalized disc in the DVD player.
3. Select the scene you want to play from the index screen.

Playing the Disc on a Computer's DVD Drive

1. Insert a finalized disc in the computer's DVD drive.
2. If your DVD playback software does not launch automatically when inserting a DVD, run the DVD playback software.
 - Refer also to the instruction manual and help modules of your DVD playback software.
 - To view still images recorded on the disc, close first any DVD playback software that may be running.



You need to have DVD playback software installed in your computer to play the DVD.



- DVD-RW discs recorded in VR mode can only be played on VR compatible DVD players. Depending on your DVD player/recorder you may not be able to play the disc.
- In order to view the still images recorded on the disc in a DVD player, you have to convert individual images to scenes, or create a Photomovie scene (□ 95) before you finalize the disc.
- The resolution of Photomovie scenes will be lower than that of the original still images.

Recording Additional Movies on a Finalized Disc

You can unfinalize a disc to allow recording additional scenes after it was finalized.

This option is only available with DVD-RW discs in VIDEO mode.



- Be sure to unfinalize the disc in normal room temperatures. If the procedure was not completed correctly due to high temperature, let the camcorder cool before resuming operation.
- Place the camcorder on a table or other stable surface before starting the procedure. Subjecting the camcorder even to slight impacts (for example to place it on a table or to disconnect the AV cable) after you select the menu option may result in permanent data loss.
- When unfinalizing a disc, always power the camcorder using the compact power adapter. The unfinalization process cannot be started if the camcorder is powered only with the battery pack.
- Do not disconnect the power adapter while the disc unfinalization is in progress. Doing so can interrupt the process and result in a disc that cannot be recognized.
- Only discs that were finalized using this camcorder can be unfinalized with this camcorder.

	Disc Can Be Unfinalized
DVD-R in VIDEO mode	—
DVD-RW in VIDEO mode	●
DVD-RW in VR mode	—
You can record additional scenes even without unfinalizing the disc	

MENU

(79)



1. Set the camcorder either to record or play movies or to record or view still images on the disc (, , / or /).
2. Press the MENU button.
3. Use the multi selector (,) to select the [DISC OPERATIONS] menu and then select the [UNFINALIZE] option.
4. Select () [YES] and press () to start the disc unfinalization.
 - A progress bar is displayed.
 - Avoid moving the camcorder while the disc unfinalization is in progress.
5. Once the [DISC OPERATIONS] menu is displayed press the MENU button to close the menu.

Playing Back on a TV Screen

Selecting the Type of TV

During playback set the [TV TYPE] option according to the TV set to which you connect the camcorder – [WIDE TV]: TV sets with 16:9 aspect ratio or [NORMAL TV]: TV sets with 4:3 aspect ratio (84).

Connection Diagram



When connecting the MTC-100 Multi Cable to the camcorder, make sure to insert the cable straight and in the correct direction – aligning the ▲ marks on the cable's connector and on the AV OUT terminal.

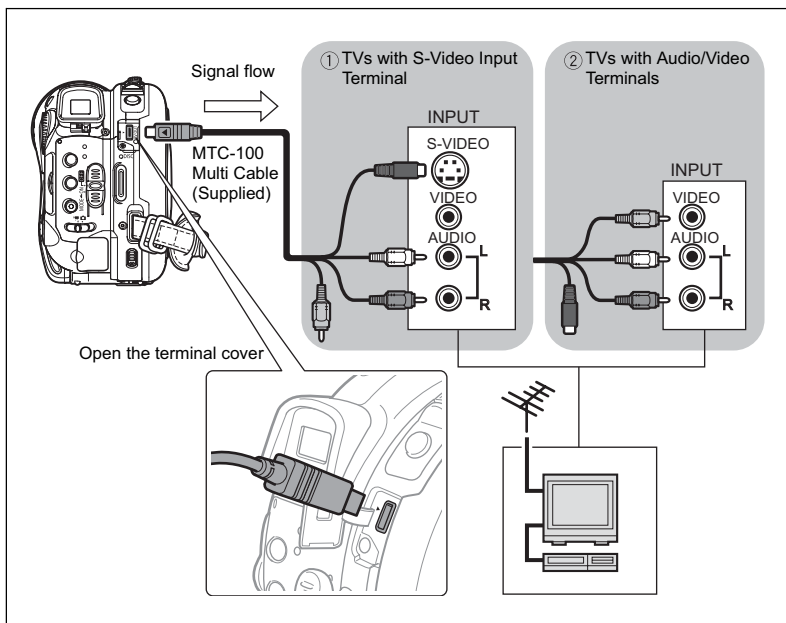

1. Turn off all devices before starting the connections.
2. Connect the MTC-100 Multi Cable to the camcorder's AV OUT terminal and the audio and video terminals on the TV or VCR.
 - Connect the white plug to the white audio terminal L (left) and the red plug to the red audio terminal R (right).
 - If your TV or VCR has an S-Video input, connect the black plug to the S-VIDEO terminal and do not connect the yellow plug. Otherwise, connect the yellow plug to the yellow VIDEO terminal.
3. If connecting to a TV, set the input selector to VIDEO. If connecting to a VCR, set the input selector to LINE.



- We recommend powering the camcorder using the compact power adapter.
- Picture quality is better when connecting to a TV with an S-Video terminal.
- TV sets compatible with the Video ID-1 system will automatically switch to the appropriate aspect ratio. Otherwise, change the aspect ratio of the TV manually.

Recording to a VCR

You can copy your recordings by connecting the camcorder to a VCR or a digital video device. For a connection diagram showing how to connect the camcorder to a VCR see the previous section *Playing Back on a TV Screen* (□ 102).

- 1. Set the camcorder to play movies () and load a recorded disc.**
- 2. Connected device: Load a blank cassette and set the device to record pause mode.**
- 3. This camcorder: Locate the scene you wish to copy and pause playback shortly before the scene.**
- 4. This camcorder: Resume the movie playback.**
- 5. Connected device: Begin recording when the scene you wish to copy appears. Stop recording when copying is complete.**
- 6. This camcorder: Stop playback.**







- We recommend powering the camcorder using the compact power adapter.
- By default, the on-screen displays will be embedded in the output video signal, but you can select to turn off the screen displays or select the data that will be displayed instead (□ 45).

Transferring Recordings to a Computer

Windows users only:

With the supplied USB cable and the Roxio MyDVD for Canon software you can transfer the movies and still images you recorded, from the disc to a computer and easily edit them. For further details about using Roxio MyDVD for Canon, refer also to the software's tutorial and help modules.

One-touch dubbing (Windows XP only)	Insert a blank DVD disc in your computer's DVD drive (with writing capabilities), connect the camcorder and with only pressing the  (print/share) button, create a copy of your DVD you can instantly share ( 107).
Transfer recordings to your computer	You can transfer your recordings to edit them on your computer ( 108).
Create a backup disc of your DVD	Transfer your recordings to the computer and even if your computer does not have a DVD drive with writing capabilities, use your camcorder itself to create a copy of your DVD ( 109).

System Requirements

Operating System: Microsoft Windows 2000, Windows Me, Windows XP

Minimum Hardware: Pentium III 1 GHz or higher (1.5 GHz or greater, recommended)
 128 MB RAM (256 MB or greater, recommended)
 10 GB hard drive space (20 GB or greater, recommended)
 Video adapter and display supporting at least 1024 x 768 resolution, 16 bit color

Software Requirements: Microsoft Windows Media Player 9 or later

Internet connection (for user registration).



○ **After installing the Roxio MyDVD for Canon Software:**

You will need an Internet connection to complete the user registration. Without completing the online user registration, you will not be able to use any of the software's functions.

○ **For support concerning Roxio MyDVD for Canon:**

Canon Inc. and the Canon related customer support centers do not provide support concerning the Roxio MyDVD for Canon software. For any questions or technical issues regarding the software, its installation and operation, please contact directly Sonic Solutions customer support representatives or access online the Internet pages listed in the information box in the next page.

○ Operation may not work correctly depending on the specifications and settings of your computer.

• North America
Web Based Service: <http://support.roxio.com>
Phone assistance: 866-279-7694 (toll free) or 905-482-5555 (Canada only), 9:00 A.M. to 6:00 P.M., U.S Pacific Time - excluding Weekend and Holidays

• Europe
Web Based Service:
Germany
<http://www.roxio.com/en/support/de/emc/index.jhtml>
France
<http://www.roxio.com/en/support/fr/emc/index.jhtml>
U.K
<http://www.roxio.com/en/support/uk/>
Phone assistance: Germany 0190-735096; France 0892-460909; U.K 0906-7320288, 1:00 P.M. to 10:00 P.M., GMT - excluding Weekend and Holidays

• China/Taiwan
Web Based Service:
<http://www.sonictaiwan.com/support/techsupport.aspx>
sonicsupport@gil.com.tw
Phone assistance: 02-2658-8765 (Taiwan)

Installing the Software

Start your computer and insert the Roxio MyDVD for Canon software CD-ROM to your computer's CD or DVD drive. Continue the installation process following the indications on the screen.

If the installation program does not run automatically:

1. Open Windows "My Computer".
2. Double-click on the icon of the CD-ROM or DVD drive where you inserted the disc.
3. Double-click on the "SETUP.EXE" file to run it. (On some computers, the ".EXE" suffix may not be displayed.).



- Once the installation of Roxio MyDVD for Canon finishes, make sure to connect to the Internet to complete the user registration online.
- You need to install the software and register online only the first time you connect the camcorder to the computer. From the second time on, you can connect the camcorder and run the software as described in the next section (□ 107).



Depending on the speed of your Internet connection, the registration process may take some time.

Connecting the Camcorder and Running the Software

1. Power the camcorder using the compact power adapter.
2. Start the computer and turn on the camcorder and set it to play movies ().
3. Connect the camcorder to the computer using the USB cable.
4. Run the program from the desktop shortcut or from Windows Start menu.



- Check the orientation of the USB cable and make sure you connect it properly.
- Do not connect the camcorder to a computer with the USB cable during the following operations:
 - Deleting all scenes
 - Initializing the disc
 - Protecting the disc
 - Finalizing or Unfinalizing the disc
 - Setting the disc title



DVD copies and DVD backup discs created with MyDVD for Canon cannot be unfinalized using the camcorder.





One-Touch Dubbing (Windows XP only)

If your computer is equipped with a DVD drive with writing capabilities, with the touch of one button you can make a copy of your DVD and burn it to an empty media in your computer's drive without the need to run the program.

1. **Connect the camcorder to the computer but do not run MyDVD for Canon.**

Steps 1 through 3 above.

2. **Insert a finalized disc in the camcorder and load a brand new DVD-R/RW in your computer's DVD drive.**

- To make a copy of a DVD-RW recorded in VR mode, load a blank DVD-RW in your computer's DVD drive. To make a copy of a disc recorded in VIDEO mode, you can load a blank DVD-R or DVD-RW.
- When all the connections are completed and the software recognizes a blank media ready in the DVD drive, the  (print/share) button will light on and the message "PRESS  TO COPY DISC" will appear on the camcorder's display.
- If you did not complete the online user registration after installing the software (□ 106), the  (print/share) button will not light up even though all the preparations are completed correctly.
- If the  (print/share) button does not light up even if you completed the user registration, verify that the  icon appears on your computer's desktop toolbar. If it does not, disconnect the USB cable, restart the computer and connect the camcorder to the computer again.

3. Once the button's blue light is on, press the (print/share) button.

- The  button will flash while the copying is in progress, and will go off once the copy is completed.
- The copied disc will automatically be finalized and ejected from the drive.



Operation may not work properly if you connect more than one Canon camcorder to the computer at the same time.



○ If the operation is interrupted:

"OPERATION CANCELED" will be displayed on the camcorder's screen. The message disappears when you remove the disc or run the Roxio MyDVD for Canon program.

- When the DISC access indicator is on or flashing do not perform the following actions. Doing so may result in permanent data loss.
 - Do not subject the camcorder to vibrations or strong impacts.
 - Do not open the disc cover and do not remove the disc.
 - Do not disconnect the USB cable.
 - Do not turn off the camcorder or the computer.
 - Do not change the position of the  switch or the operating mode.
- You need to have DVD playback software installed in your computer in order to play the disc.
- We recommend powering the camcorder using the compact power adapter while it is connected to the computer.
- Refer also to the computer's instruction manual.
- For further details about restrictions when using MyDVD for Canon, refer also to the "README" section in the software's help modules.
- Recordings made in LP mode in Widescreen (16:9 aspect ratio) on a DVD-RW that was initialized in VR mode cannot be transferred to the computer.
- Depending on the number and length of the scenes recorded, the One-Touch Dubbing may take some time.

Transferring Recordings to the Computer

You can transfer the movies and still images recorded on a disc, even one not yet finalized, to your computer for further editing.

1. **Connect the camcorder to the computer and run MyDVD for Canon as previously described ( 107).**
2. **Click on the "DVD-Video" option in the New Project tab.**
3. **Click on the "Open Disc" icon.**
4. **Click on the "Import" button.**

Thumbnails of the imported scenes and still images will be displayed in the video project screen.
5. **To save the project, click on "Save Project" from the Project Tasks palette.**

The scenes and still images displayed in the main screen will be saved.



Recordings made in LP mode in Widescreen (16:9 aspect ratio) on a DVD-RW that was initialized in VR mode cannot be transferred to the computer.

Creating Backup Copies of your DVD

You can create a backup copy of your finalized disc on a common (12 cm) DVD disc. Even if your computer does not have a DVD drive with writing capabilities, you can use the camcorder itself to create a backup disc on an 8 cm Mini DVD disc.

- 1. Connect the camcorder to the computer and run MyDVD for Canon as previously described (107).**
- 2. Insert a finalized disc in the camcorder and load a brand new media in your computer's DVD drive.**
 - To make a copy of a DVD-RW recorded in VR mode, load a blank DVD-RW in your computer's DVD drive. To make a copy of a DVD-R or DVD-RW recorded in VIDEO mode, you can load a blank DVD-R or DVD-RW.
 - You can also use a fully erased DVD-RW disc instead of a brand new media. However, depending on the condition of the disc, the operation will take longer. To fully erase a DVD-RW disc you will need DVD authoring/mastering software installed in your computer.
- 3. Click on the "Make a Backup DVD" option in the New Project tab.**
- 4. Select the camcorder as the "Device to read from".**
- 5. Select the computer's DVD drive (with writing capabilities) as the "Device to write to".**

If your computer is not equipped with a DVD drive with writing capabilities, select the camcorder also as the "Device to write to".

- 6. Click on the "Copy" button and follow the indications on the screen.**
 - When the "Your disc was created successfully" screen appears, click on "OK" to finish the task and eject the backup disc.
 - When the "Please insert a blank or rewritable DVD into the DVD drive" dialog box appears, if the tray of a DVD drive other than the one selected in step 5 is ejected, click on "Cancel" and start again from step 4. If this happens and the source disc is a DVD-RW disc, some recordings on the source disc might be lost.

Transferring Still Images to a Computer (Direct Transfer)

With the supplied USB cable and Digital Video Software, you can transfer still images to a computer by simply pressing the  (print/share) button.

Preparations

The first time you connect the camcorder to the computer, you need to install the software and set the auto-launch setting. From the second time on, you will only need to connect the camcorder to the computer to transfer images.

1. Install the supplied Digital Video Software.

See *Installing the Software* in the *Digital Video Software* instruction manual (electronic version on PDF file).

2. Set the camcorder to view still images ().

3. Connect the camcorder to the computer using the USB cable.

See *Connecting the Camcorder to a Computer* in the *Digital Video Software* instruction manual (electronic version on PDF file).

4. Set the auto-launch setting.

- See *Starting CameraWindow* in the *Digital Video Software* instruction manual (electronic version on PDF file).
- The direct transfer menu appears on the camcorder screen and the  button lights up.



- Correct performance cannot be guaranteed for discs recorded on another digital device and inserted in this camcorder.
- When the DISC or CARD access indicator is on or flashing do not perform the following actions. Doing so may result in permanent data loss.
 - Do not subject the camcorder to vibrations or strong impacts.
 - Do not open the disc cover/memory card slot cover and do not remove the disc or memory card.
 - Do not disconnect the USB cable.
 - Do not turn off the camcorder or the computer.
 - Do not change the position of the  switch or the operating mode.
- Operation may not work correctly depending on the software and the specifications/settings of your computer.
- The image files on your disc or memory card are valuable, original data files. If you wish to use the image files on your computer, make copies of them first, and use the copied file, retaining the original.
- Do not connect the camcorder to a computer with the USB cable during the following operations:
 - Protecting the disc
 - Initializing the disc
 - Finalizing or Unfinalizing the disc
 - Erasing all still images from the disc or card
 - Copying still images between the disc and card
 - Erasing all transfer orders
 - Erasing all print orders







- We recommend powering the camcorder using the compact power adapter while it is connected to the computer.
- Refer also to the computer's instruction manual.

○ Users of Windows XP and Mac OS X:

Your camcorder is equipped with the standard Picture Transfer Protocol (PTP) allowing you to download still images (JPEG only) by simply connecting the camcorder to a computer via USB cable without installing the software from the DIGITAL VIDEO SOLUTION DISK.

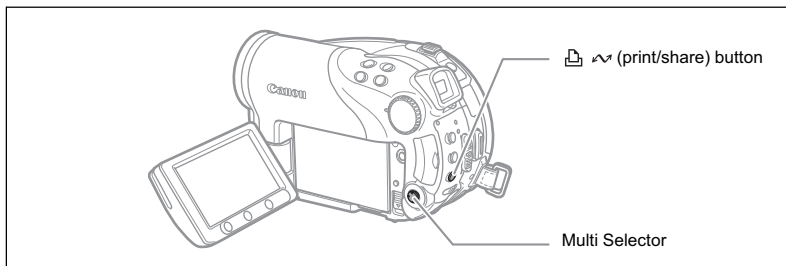

Transferring Images

 ALL IMAGES...	Transfers all images to the computer.
 NEW IMAGES...	Transfers only those images that have not yet been transferred to the computer.
 TRANSFER ORDERS...	Transfers images with transfer orders to the computer. Transfer orders (□ 113) are only available for images recorded on the memory card.
 SELECT & TRANSFER...	Allows you to select the still image you want to transfer to the computer.
 WALLPAPER...	Allows you to select the still image you want to transfer and set it as your computer's desktop background.



1. Select (▲▼) a transfer option.

2. Press the  button.

[ ALL IMAGES] [ NEW IMAGES] [ TRANSFER ORDERS]:

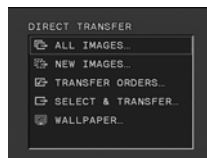

- The images are transferred and displayed on the computer.
- The camcorder returns to the transfer menu once the transfer is complete.
- To cancel the transfer, select (◀▶) [CANCEL] and press (⊙) or press the MENU button.



If you select [ SELECT & TRANSFER] or [ WALLPAPER]:

3. Select (◀▶) the image you wish to transfer.

4. Press the  button.

- [ SELECT & TRANSFER]: The selected image is transferred and displayed on the computer. To continue transferring, select another image.
- [ WALLPAPER]: The selected image is transferred to the computer and displayed as the desktop's background.
- The  button will flash while the images are being transferred.
- Press the MENU button to return to the transfer menu.



- You can press (SET) to transfer the images, instead of the  button. With [ALL IMAGES], [NEW IMAGES] or [TRANSFER ORDERS], a confirmation message appears. Select [OK] and press (SET).
- When the camcorder is connected to the computer and the image selection screen is displayed, press the MENU button to return to the transfer menu.
- Even when still images recorded on the disc are correctly transferred to the computer, they will still be marked as images not yet transferred ("NEW IMAGES").

Transferring Images with Transfer Order Settings

You can mark the still images you want to transfer to the computer, out of those recorded on the memory card, as a transfer order. These transfer order settings are compatible with the Digital Print Order Format (DPOF) standards. Up to 998 images can be selected.

Selecting Still Images to Transfer (Transfer Order)

Do not connect the USB cable to the camcorder while setting the transfer orders.



1. Set the camcorder to view still images recorded on the memory card (**PLAY** / **▶**).
2. Press the **FUNC.** button.
3. Select (**▲▼**) the [**▶** TRANSFER ORDER] symbol and press (**SET**). Set it (**◀▶**) to [ON] and press (**SET**).
To cancel the transfer order, select [OFF].
4. Press the **FUNC.** button to close the menu.

Setting Transfer Orders from the Index Screen

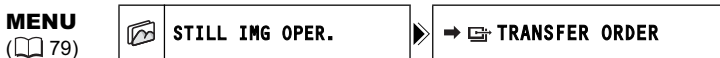











1. Set the camcorder to view still images recorded on the memory card (**PLAY** / **▶**).
2. Move the zoom lever toward **W**.
The stills index screen appears with up to six still images.
3. Press the **MENU** button and use the multi selector (**▲▼** , **SET**) to select the [STILL IMG OPER.] menu and then select the [**▶** TRANSFER ORDER] option.
4. Bring (**▲▼** , **◀▶**) the cursor **☞** to the image you want to transfer and press (**SET**). Repeat this step to select other images as desired.
 - " **▶** " appears on the image.
 - To cancel the transfer order, press (**SET**) again.
5. Press the **MENU** button to close the menu and return to the index screen.

Erasing All Transfer Orders

MENU

( 79)



1. Set the camcorder to view still images recorded on the memory card (  / ).
2. Press the MENU button and use the multi selector (, , ) to select the [STILL IMG OPER.] menu and then select the [ ORD. ALL ERASE] option.
3. Select (, ) [YES] and press ().
4. Press the MENU button to close the menu.

Printing Still Images



The camcorder can be connected to any PictBridge compatible printer. You can use the print order settings for direct printing of still images recorded on the memory card (□ 120).
Canon printers: SELPHY CP, SELPHY DS and PIXMA printers

E

Connecting the Camcorder to the Printer

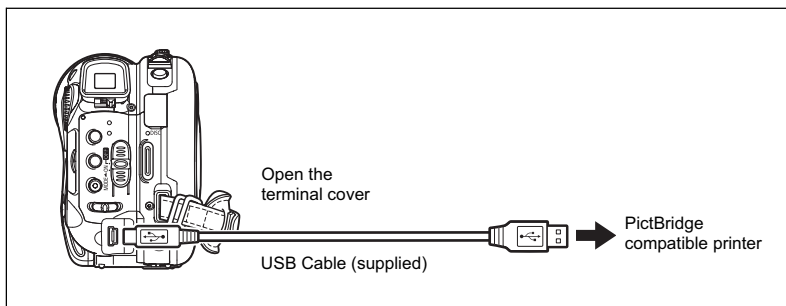

1. Set the camcorder to view still images (**PLAY** ·).
2. Insert the memory card or disc containing the still images you want to print.
3. Turn on the printer.
4. Select as the media for the still images, the media from where you want to print the images.
5. Connect the camcorder to the printer using the supplied USB cable.
 - appears and changes to . The symbol will not appear if the memory card or disc contains still images that cannot be viewed with this camcorder.
 - The (print/share) button lights up and the current print setting will be displayed for approx. 6 seconds.



- If continues to flash (for more than 1 minute) or if does not appear, the camcorder is not correctly connected to the printer. In such case, disconnect the cable from the camcorder and the printer. Turn them both off and then on again and reconnect the camcorder to the printer.
- While performing the following operations, even if you connect a printer to the camcorder it will not be recognized.
 - Deleting all scenes
 - Erasing all still images from the disc or card
 - Protecting the disc
 - Copying still images between the disc and card
 - Setting the disc title
 - Erasing all transfer orders
 - Initializing the disc
 - Erasing all print orders
 - Finalizing or Unfinalizing the disc
- Correct performance cannot be guaranteed when printing images from a disc recorded on another digital device and inserted in this camcorder.



- will appear for images that cannot be printed.
- We recommend powering the camcorder using the compact power adapter.
- Refer also to the printer's instruction manual.

Printing with the (Print/Share) Button

You can print a still image without changing the settings by simply pressing the (print/share) button.

1. Select () the still image you wish to print.



2. Press the (print/share) button.

- Printing starts. The button flashes and stays on when the printing is completed.
- To continue printing, select () another still image.

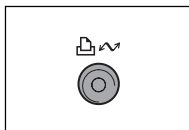

Printing after Selecting the Print Settings

You can select the number of copies and other settings for printing. The setting options vary depending on your printer model.

1. Press ().

- The print setting menu appears.
- Depending on the printer, the message "BUSY." may appear before the camcorder displays the print setting menu.



2. Select the print settings (118).

3. Select (,) the [PRINT] option and press ().



- Printing starts. The print setting menu disappears when the printing is completed.
- To continue printing, select () another still image.



- Images not recorded with this camcorder, uploaded from a computer, edited on a computer and images whose file names have been changed may not be printed correctly.
- Observe the following precautions during printing:
 - Do not turn off the camcorder or the printer.
 - Do not change the position of the switch.
 - Do not disconnect the USB cable.
 - Do not remove the disc or memory card.
- If the message "BUSY" does not disappear, disconnect the USB cable from both the camcorder and the printer and then reconnect them again.





○ **Cancel Printing**

Press () during printing. A confirmation dialog appears. Select [OK] and press (). With Canon's PictBridge compatible printers, the printing will stop immediately (even if not completed) and the paper will be fed through.

○ **Printing Errors**

If an error occurs during the printing process, an error message appears ( 127).

- Canon's PictBridge compatible printers: Resolve the error. When printing does not resume automatically, select [CONTINUE] and press (). If [CONTINUE] cannot be selected, select [STOP], press () and retry printing. Refer also to the printer's instruction manual for details.
- If the error still persists and printing does not restart, disconnect the USB cable and turn the camcorder off. Turn it on again, set it to view still images () and reconnect the cable.

- **When you have finished printing:** Disconnect the cable from the camcorder and printer and turn off the camcorder.

Selecting Print Settings

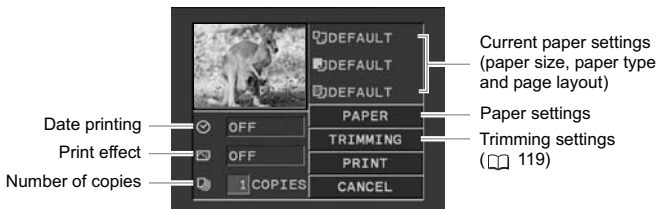

PAPER	PAPER SIZE	Available paper sizes vary depending on the printer model.
	PAPER TYPE	PHOTO, FAST PHOTO, DEFAULT
	PAGE LAYOUT	BORDERLESS, BORDERED, 2-UP, 4-UP, 8-UP, 9-UP, 16-UP, DEFAULT
☺ (date print)		ON, OFF, DEFAULT
☒ (print effect)		ON, OFF, VIVID, NR, VIVID+NR, DEFAULT
📄 (number of copies)		1-99 copies

1. In the print setting menu, select (▲▼, ◀▶) the setting you want to change and press (SET).

2. Select (▲▼) a setting option and press (SET).



- Print setting options and [DEFAULT] settings vary depending on the printer model. For details, refer to the printer's instruction manual.
- [BORDERED]: The image area remains relatively unchanged from the recorded image when it is printed.
[BORDERLESS]: The center portion of the recorded image is printed at an enlarged size. The top, bottom and sides of the still image may be slightly trimmed out.
- The print effect can be used with printers compatible with the Image Optimize function to get higher quality prints.

Canon printers:

- [VIVID], [VIVID+NR] and [NR] can be selected with Canon PIXMA/SELPHY DS printers.
- When selecting [2-UP], [4-UP], [9-UP] or [16-UP] for [PAGE LAYOUT], set the [PAPER SIZE] to [10 x 14.8 cm] or [9 x 13 cm]. Canon PIXMA/SELPHY DS printers: You can also print on the specially designed Photo Stickers sheets. When selecting [8-UP], set the [PAPER SIZE] to [CREDITCARD]. Canon PIXMA/SELPHY CP printers: You can also print on the specially designed Photo Stickers sheets.

Selecting Trimming Settings

Set the print style before changing the trimming settings.

1. In the print setting menu, select (▲▼, ◀▶) [TRIMMING] and press (SET).

The trimming frame appears.



E

2. Change the size of the trimming frame.

- Move the zoom lever toward **T** to shrink the frame, and toward **W** to enlarge it. Press (SET) to change the orientation of the frame (portrait/landscape).
- To cancel the trimming settings, move the zoom lever toward **W** until the trimming frame disappears.



3. Move (▲▼, ◀▶) the trimming frame.

Pressing the MENU button brings you back to the print settings menu.



- About the color of the trimming frame:
 - White: No trimming settings.
 - Green: Recommended trimming size. (The trimming frame may not appear in green depending on the image size, paper size or borders settings.)
- The trimming setting applies only to one image.
- The trimming setting is canceled in the following cases:
 - When you turn off the camcorder.
 - When you disconnect the USB cable.
 - When you expand the trimming frame beyond its maximum size.
 - When you change the [PAPER SIZE] setting.

Printing with Print Order Settings

You can mark the still images you want to print, out of those recorded on the memory card, and set the desired number of copies as a print order. These print order settings are compatible with the Digital Print Order Format (DPOF) standards and can be used for printing on DPOF compatible printers (115). Up to 998 still images can be selected.

Selecting Still Images for Printing (Print Order)

Do not connect the USB cable to the camcorder while setting the print orders.



1. Set the camcorder to view still images recorded on the memory card (/).
2. Press the FUNC. button.
3. Select () the [PRINT ORDER] symbol and press ().
4. Select () the number of copies and press ().
To cancel the print order, set the number of copies to 0.
5. Press the FUNC. button to save the setting and close the menu.

Setting Print Orders from the Index Screen

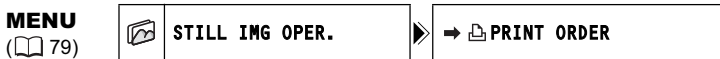

1. Set the camcorder to view still images recorded on the memory card (/).
2. Move the zoom lever toward **W**.
The stills index screen appears with up to six still images.
3. Press the MENU button and use the multi selector (,) to select the [STILL IMG OPER.] menu and then select the [PRINT ORDER] option.
4. Bring (,) the cursor to the image you want to print and press ().
5. Set () the desired number of copies and press ().
 - and the selected number of copies appear on the image.
 - To cancel the print order, set the number of copies to 0.
6. Press the MENU button to close the menu and return to the index screen.

Erasing All Print Orders

MENU

(79)



1. Set the camcorder to view still images recorded on the memory card (/).
2. Press the MENU button and use the multi selector (, ,) to select the [STILL IMG OPER.] menu and then select the [ORD. ALL ERASE] option.
3. Select [YES] and press ().
All print orders are canceled.
4. Press the MENU button to close the menu.

Printing

MENU

(79)



1. Set the camcorder to view still images recorded on the memory card (/).
2. Connect the printer to the camcorder (115).
3. Press the MENU button and select [PRINT].
 - The print setting menu appears.
 - The error message “SET PRINT ORDER” appears if you connect a printer with direct print function and select [PRINT] without having set any print orders.
4. Make sure that [PRINT] is selected and press ().
Printing starts. The print setting menu disappears when the printing is completed.



- Depending on the connected printer, you can change some print settings before step 4 (118).
- **Cancel Printing/Printing Errors** (117)
- **Restarting Printing**
Press the MENU button and select [PRINT]. Select [RESUME] in the print setting menu and press (). The remaining images will be printed.
Printing cannot be restarted when the print order settings have been changed or if you deleted a still image with print order settings.



Troubleshooting



If you have a problem with your camcorder, refer to this checklist. Consult your dealer or a Canon Service Center if the problem persists.

Power Source



Problem	Solution	
<ul style="list-style-type: none">• Camcorder will not turn on.• The camcorder switches off by itself.• The disc compartment cover will not open.• LCD/viewfinder switches on and off.	Battery pack is exhausted. Replace or charge the battery pack.	21
	Attach the battery pack correctly.	
Battery pack will not charge.	Charge the battery pack in temperatures between 0 °C and 40 °C (32 °F and 104 °F).	–
	Battery packs become hot with use and may not charge. The charging will restart once the battery pack temperature is below 40 °C (104 °F).	–
	The battery pack is damaged. Use a different battery pack.	–

Recording/Playback

Problem	Solution	
Buttons will not work.	Turn on the camcorder.	–
	Load a disc.	31
Abnormal characters appear on the screen. The camcorder does not operate properly.	Disconnect the power source and reconnect it after a short time. If the problem still persists, disconnect the power source and press the RESET button with a pointed item. Pressing the RESET button resets all settings.	–
"  flashes on the screen.	Load a disc.	31
"  flashes on the screen.	Battery pack is exhausted. Replace or charge the battery pack.	21
The wireless controller will not work.	Set [WL.REMOTE] to [ON].	83
	The battery of the wireless controller is exhausted. Replace the battery.	25
Video noise appears on screen.	When using the camcorder in a room where a plasma TV is located, keep a distance between the camcorder and the plasma TV.	–
Video noise appears on the TV screen.	When using the camcorder in a room where a TV is located, keep a distance between the compact power adapter and the power or antenna cables of the TV.	–
Even without a disc loaded, when closing the disc compartment cover a motor sound can be heard.	The camcorder is checking if a disc is loaded or not. This is not a malfunction.	–
The disc cannot be ejected.	Turn off the camcorder, disconnect the compact power adapter and remove the battery pack. Restore the power supply and try again.	–
	The camcorder has exceeded its operational temperature. Disconnect the compact power adapter and remove the battery pack and let the camcorder cool down before resuming use.	







Problem	Solution	
The disc cannot be recognized.	The disc is dirty. Clean the disc with a soft lens-cleaning cloth. If the problem persists replace the disc.	-
	The disc is not correctly loaded. Check the disc.	
The camcorder vibrates.	Depending on the condition of the disc, the camcorder might vibrate occasionally. This is not a malfunction.	-
<ul style="list-style-type: none"> The disc's rotation can be faintly heard. Occasionally the operation sound can be heard. 	The disc is activated from time to time. This is not a malfunction.	-
After using the camcorder for a long time the  lights up in red.	This is not a malfunction. Turn the camcorder off and let it cool for a while before resuming operation.	-

Recording

Problem	Solution	
"4" flashes red on the screen.	The camcorder malfunctions. Consult a Canon Service Center.	-
Image will not appear on the screen.	Set the camcorder to  .	33
"SET THE TIME ZONE, DATE AND TIME" appears on the screen.	Set the time zone, date and time.	28
	Recharge the built-in lithium battery and set the time zone, date and time.	131
Pressing the start/stop button will not start recording.	Set the camcorder to  .	33
	Load a disc.	31
	The disc is full ("END" flashes on the screen). Delete some recordings (DVD-RW in VR mode) to free some space or replace the disc.	31 86
	The camcorder has exceeded its operational temperature. Disconnect the compact power adapter and remove the battery pack and let the camcorder cool down before resuming use.	-
	Cancel the disc protection.	89
	Unfinalize the disc (DVD-RW in VIDEO mode).	101
	Even after stopping recording, the DISC access indicator does not go off.	The scene or still image is being recorded on the disc.
The point where the start/stop button was pressed does not match the beginning/end of the recording.	There is a slight interval between pressing the start/stop button and the actual start of the recording on the disc. This is not a malfunction.	-
The recording suddenly stops shortly after starting recording.	The disc is dirty. Clean the disc with a soft lens-cleaning cloth. If the problem persists replace the disc.	-
	The camcorder has exceeded its operational temperature. Disconnect the compact power adapter and remove the battery pack and let the camcorder cool down before resuming use.	
Camcorder will not focus.	Autofocus does not work on that subject. Focus manually.	54
	Adjust the viewfinder with the dioptic adjustment lever.	24
	Lens is dirty. Clean the lens with a soft lens-cleaning cloth; never use tissue paper to clean the lens.	132
Sound is distorted.	When recording near loud sounds (such as fireworks or concerts), sound may become distorted. This is not a malfunction.	-

Problem	Solution	
A vertical light bar appears on the screen.	Bright light in a dark scene may cause a vertical light bar (smear) to appear. This is not a malfunction.	–
Viewfinder picture is blurred.	Adjust the viewfinder with the dioptic adjustment lever.	24

Playback/Editing

Problem	Solution	
Pressing the playback button does not start playback.	Check that the disc contains recorded scenes.	–
	Load a disc.	31
	Set the camcorder to  .	39
	You may not be able to play with this camcorder discs recorded or edited with other DVD recorders or computer DVD drives.	–
	If using a single-sided disc, check that the disc is inserted with the label side facing up.	31
	The camcorder has exceeded its operational temperature. Disconnect the power adapter and remove the battery pack and let the camcorder cool down before resuming use.	–
During playback there is video noise, the sound is distorted or the disc cannot be read.	The disc is dirty. Clean the disc with a soft lens-cleaning cloth.	130
	You may not be able to play with the camcorder discs recorded or edited with other DVD recorders or computer DVD drives.	–
Cannot add scenes to the playlist.	The disc is full (“  END” flashes on the screen). Delete some recordings to free some space.	31 86
	You cannot add more than 999 scenes to the playlist.	–
Cannot divide the scene.	You cannot edit or delete scenes on a disc that was protected in another digital device.	–
Cannot edit the disc title.	You cannot add a title to a DVD-R disc after it was finalized.	98
	Unfinalize the disc first (DVD-RW in VIDEO mode).	101
	You may not be able to edit the title if you entered it with another digital device.	–
	Cancel the disc protection.	89
Cannot create a Photomovie scene.	There are no still images recorded on the disc.	–
	The disc is full (“  END” flashes on the screen). Delete some recordings (DVD-RW in VR mode) to free some space.	31 86
Cannot edit or delete scenes.	Remove the disc protection.	89
	Scenes cannot be edited or deleted in a DVD-R disc or a DVD-RW disc recorded in VIDEO mode.	–
	You cannot edit or delete scenes on a disc that was protected with another digital device.	–
No sound from the built-in speaker.	Open the LCD panel.	–
	Speaker volume is turned off. Adjust the volume from the [SYSTEM SETUP] menu in the  mode.	43
The keys on the wireless controller do not function.	Check that you did not lay the camcorder on its side so the multi selector’s  button is pressed down. Place the camcorder upright.	–

Playing Back the Disc in an External DVD Device

External DVD device refers to DVD players, DVD recorders, computer's DVD drives and other digital devices.

Problem	Solution	
There is a brief stop between scenes.	Depending on the DVD player, there might be a very short stop between scenes during playback.	–
Disc is running, but image will not appear on the TV screen.	TV/VIDEO selector on the TV is not set to VIDEO. Set the selector to VIDEO.	102
	You attempted to play back or dub an incompatible disc. Stop playback/dubbing.	–
The disc cannot be recognized by the device. Or, even though the disc is read, cannot play back the disc or the picture is distorted.	The disc is dirty. Clean the disc with a soft lens-cleaning cloth.	–
	The disc has not been finalized.	98
	If you recorded a DVD-RW disc in VR mode, only VR mode compatible DVD players will be able to play the disc. To check the compatibility refer to the instruction manual of your DVD device.	–
Cannot edit my recordings or add recordings to the disc with the DVD device.	It may not be possible with an external DVD recorder to edit or add recordings to a DVD disc recorded with this camcorder.	–
When writing on a disc in this camcorder recordings transferred from a computer an error message appears.	The camcorder has exceeded its operational temperature. Disconnect the compact power adapter and remove the battery pack and let the camcorder cool down before resuming use.	–

Memory Card Operation



Problem	Solution	
Memory card cannot be inserted.	Memory card was not facing the correct direction. Turn the memory card over and reinsert it.	30
Memory card cannot be recorded.	Memory card is full. Erase still images to free some space or replace the memory card.	92
	Memory card was not initialized. Initialize the memory card.	97
	The folder and file numbers have reached their maximum value. Set [FILE NOS.] to [RESET] and insert a new memory card.	84
Memory card cannot be played back.	Insert a memory card.	30
	Set the camcorder to PLAY .	41
	Make sure the memory card is selected as the media for still images.	36
Image cannot be erased.	Image is protected. Cancel the protection.	96
" " flashes in red.	Card error occurred. Turn off the camcorder. Remove and reinsert the memory card. Initialize the memory card if flashing persists.	97

Printing

Problem	Solution	
The printer is not operating even though the camcorder and printer are correctly connected.	1. Set the camcorder to PLAY . 2. Disconnect and reconnect the USB cable. 3. Turn off the printer and turn it back on.	–

List of Messages









Message	Explanation	
SET THE TIME ZONE, DATE AND TIME	You have not set the time zone, date and time. This message appears each time you turn the power on until you set the time zone, date and time.	28
CHANGE THE BATTERY PACK	Battery pack is exhausted. Replace or charge the battery pack.	21
TEMPERATURE TOO HIGH CANNOT RECORD	The camcorder has exceeded its operational temperature. Disconnect the compact power adapter and remove the battery and let the camcorder cool down before resuming use.	–
TEMPERATURE TOO HIGH CANNOT REMOVE DISC		–
CANNOT RECORD CHECK THE DISC	There is a problem with the disc. Replace the disc.	31
	This message can also appear if condensation has formed. Wait until the camcorder dries completely before resuming use.	132
	The disc's recording surface may be dirty or scratched.	–
REACHED THE MAXIMUM NUMBER OF SCENES	The maximum number of scenes has been reached. Delete some recordings (DVD-RW) to free some space or replace the disc.	31
		86
CANNOT PLAY DISC	The disc is dirty or you attempted to play back a disc type not supported (not DVD-R/RW).	–
	This message can also appear if condensation has formed. Wait until the camcorder dries completely before resuming use.	132
CANNOT EDIT DISC	There are no scenes to edit or the recording is damaged.	–
	This message can also appear if condensation has formed. Wait until the camcorder dries completely before resuming use.	132
CANNOT DIVIDE THE SCENE	Photomovie scenes cannot be divided.	88
	You may not be able to divide very short scenes.	–
	Scenes cannot be divided when the disc contains 999 scenes.	–
	You may not be able to further divide scenes shorter than 5 seconds that were created by dividing a previous scene.	–
DISC IS FINALIZED CANNOT RECORD	You cannot record additional scenes on a finalized DVD-R disc.	–
	You cannot record additional scenes or unfinalize a DVD-RW disc in VIDEO mode that was finalized with another digital device.	–
UNFINALIZE THE DISC	You cannot record additional scenes or convert still images to a Photomovie scene on a finalized DVD-RW recorded in VIDEO mode. Unfinalize the disc first.	101
DISC IS PROTECTED	The disc is protected. Replace the disc or remove the disc protection.	89
DISC ERROR	Initialize new DVD-RW discs before using them.	90
CANNOT READ THE DISC CHECK THE DISC	Disc could not be read. Try cleaning it or replace the disc.	130
	This message can also appear if the camcorder has exceeded its operational temperature. Disconnect the power adapter and remove the battery and let the camcorder cool down before resuming use.	–
	This message can also appear if condensation has formed. Wait until the camcorder dries completely before resuming use.	132
	The disc may not be loaded correctly. Try removing the disc and reinserting it.	–

Message	Explanation	
DISC ACCESS FAILURE CHECK THE DISC	There was an error when reading the disc or attempting to write onto it. Try cleaning the disc or replace it.	130
	This message can also appear if condensation has formed. Wait until the camcorder dries completely before resuming use.	132
	The disc may not be loaded correctly. Try removing the disc and reinserting it.	–
DISC COVER IS OPEN	Verify the disc is correctly inserted and close the disc cover.	31
NO DISC	No disc is loaded. Insert a disc.	31
	You inserted a disc recorded in a different Television System (PAL or SECAM).	–
	This message can also appear if condensation has formed. Wait until the camcorder dries completely before resuming use.	132
LOADING THE DISC	The disc is being read. Wait before you start recording.	–
AVOID MOVING THE CAMCORDER	Try not to move the camcorder while the image is being recorded.	–
UNABLE TO RECOVER DATA	Could not recover a corrupted file.	90
	This message can also appear if condensation has formed. If you suspect condensation is the reason, do not initialize the disc and wait until the camcorder dries completely before resuming use.	132
DISC FULL	The disc is full ("END" flashes on the screen). Delete some recordings (DVD-RW in VR mode) to free some space or replace the disc.	31 86
NO CARD	Memory card not is inserted into the camcorder.	30
NO IMAGES	No images are recorded on the memory card.	–
CARD ERROR	A memory card error occurred. The camcorder cannot record or display the image. The error may be temporary. If the message disappears after 4 seconds and " " flashes red, turn the camcorder off, remove the card and reinsert the card. If " " changes to green, you can continue recording/playback.	–
CARD FULL	Memory card is full. Erase some images to free some space or replace the memory card.	92
NAMING ERROR	The folder and file numbers have reached their maximum value. Set the [FILE NOS.] option to [RESET] and initialize the disc or memory card, erase all the images on the memory card or replace the disc.	–
UNIDENTIFIABLE IMAGE	The image file is corrupted or it was saved using a compression method other than that compatible with this camcorder (JPEG).	–
 TRANSFER ORDER ERROR	You attempted to set more than 998 transfer orders.	113
TOO MANY STILL IMAGES DISCONNECT USB CABLE	Disconnect the USB cable and decrease the number of still images on the memory card or disc to less than 1800. Images cannot be erased from a DVD-R or DVD-RW disc recorded in VIDEO mode. If a dialog appeared on the computer screen, close it and then reconnect the USB cable.	–

Direct Print Related Messages



About Canon PIXMA/SELPHY DS Printers: If the printer's error indicator flashes or an error message appears on the printer's operation panel, refer to the printer's instruction manual.

Message	Explanation
PAPER ERROR	There is a problem with the paper. Wrong paper size is inserted, the ink cannot be used with the selected paper or paper output tray is open.
NO PAPER	Paper is not correctly inserted or there is no paper.
PAPER JAM	The paper jammed during printing. Select [STOP] to cancel printing. After removing the paper, set some paper again and retry printing.
INK ERROR	There is a problem with the ink.
NO INK	The ink cartridge is not inserted or is out of ink.
LOW INK LEVEL	The ink cartridge needs to be replaced soon. Select [CONTINUE] to restart printing.
WASTE TANK FULL	Waste tank is full. Select [CONTINUE] to restart printing. Consult a Canon Service Center listed in the Contact List provided with the printer manual to replace the waste ink absorber.
• FILE ERROR • CANNOT PRINT!	You attempted to print an image that was recorded with another camcorder, with a different compression, or was edited on a computer.
COULD NOT PRINT X IMAGES	You attempted to use the print order settings to print X images that were recorded with another camcorder, with a different compression or were edited on a computer.
SET  PRINT ORDER	No still image on the memory card has been marked with a  print order.
 PRINT ORDER ERROR	You attempted to set more than 998 still images in the print order.
CANNOT TRIM	You attempted to trim an image that was recorded with another camcorder.
READJUST TRIMMING	You changed the print style after you set the trimming settings.
PRINTER ERROR	Cancel printing. Turn off the printer and turn it back on. Check the printer status. If the error still persists, refer to the printer's instruction manual and contact the appropriate customer support center or service center.
PRINT ERROR	Cancel printing, disconnect the USB cable and turn off the printer. After a while, turn the printer back on and reconnect the USB cable. Check the printer status. When you are printing using the   button, check the print settings.
HARDWARE ERROR	Cancel printing. Turn off the printer and turn it back on. Check the printer status. If the printer is equipped with a battery, it might be exhausted. In such case, turn off the printer, replace the battery and turn it back on.
COMMUNICATION ERROR	The printer is experiencing a data transfer error. Cancel printing, disconnect the USB cable and turn off the printer. After a while, turn the printer back on and reconnect the USB cable. When you are printing using the   button, check the print settings. Or, you attempted to print from a memory card that contains a large number of images. Reduce the number of images.
CHECK PRINT SETTINGS	The print setting cannot be used for printing with the   button.
INCOMPATIBLE PAPER SIZE	The paper settings of the camcorder conflict with the printer's settings.
PRINTER IN USE	The printer is in use. Check the printer status.
PAPER LEVER ERROR	Paper lever error occurred. Adjust the paper selection lever to the proper position.
PRINTER COVER OPEN	Close the printer cover securely.
NO PRINTHEAD	No print head is installed in the printer or the print head is defective.

Handling Precautions

E

Camcorder

- Do not subject the camcorder to vibrations or strong impacts while the DISC access indicator is on or flashing. The data may not be correctly recorded on the disc, and the recording may be permanently lost.
- Do not touch the pick up lens.
- Do not carry the camcorder by the LCD panel or the disc cover. Be careful when closing the LCD panel.
- Do not leave the camcorder in places subject to high temperatures (like the inside of a car under direct sunlight), or high humidity.
- Do not use the camcorder near strong electric or magnetic fields such as above TVs, near plasma TVs or mobile phones.
- Do not point the lens or viewfinder at strong light sources. Do not leave the camcorder pointed at a bright subject.
- Do not use or store the camcorder in dusty or sandy places. The camcorder is not waterproof – avoid also water, mud or salt. If any of the above should get into the camcorder it may damage the camcorder and/or the lens. Be sure to close the disc compartment cover after use.
- Be careful of heat generated by lighting equipment.
- Do not disassemble the camcorder. If the camcorder does not function properly, consult qualified service personnel.
- Handle the camcorder with care. Do not subject the camcorder to shocks or vibration as this may cause damage.

Battery Pack

DANGER!

Treat the battery pack with care.

- Keep it away from fire (or it might explode).
 - Do not expose the battery pack to temperature higher than 60 °C (140 °F). Do not leave it near a heater or inside a car in hot weather.
 - Do not try to disassemble or modify it.
 - Do not drop or knock it.
 - Do not get it wet.
- Charged battery packs continue to discharge naturally. Therefore, charge them on the day of use, or the day before, to ensure a full charge.
 - Attach the terminal cover whenever a battery pack is not in use. Contact with metallic objects may cause a short circuit and damage the battery pack.
 - Dirty terminals may cause a poor contact between the battery pack and the camcorder. Wipe the terminals with a soft cloth.
 - Since storing a charged battery pack for a long time (about 1 year) can shorten its lifecycle or affect performance, we recommend to discharge the battery pack fully and to store it in a dry place at temperatures no higher than 30 °C (86 °F). If you do not use the battery pack for long periods, charge and discharge it fully at least once a year. If you have more than one battery pack, perform these precautions at the same time for all battery packs.

- Although the battery pack's operating temperature range is from 0 °C to 40 °C (32 °F to 104 °F), the optimal range is from 10 °C to 30 °C (50 °F to 86 °F). At cold temperatures, performance will temporarily decline. Warm it in your pocket before use.
- Replace the battery pack if the usable time after full charge diminishes substantially at normal temperatures.

About the battery terminal cover

The battery terminal cover has a []-shaped hole. This is useful when you wish to differentiate between charged and uncharged battery packs.

Back side of the battery pack



Terminal cover attached
Charged

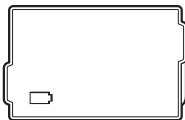

Uncharged

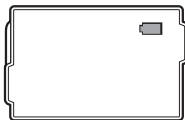

Mini DVD Disc

The recording surface of DVD discs is extremely delicate. Be sure to observe the following precautions when handling your discs.

- Keep the disc clean of dust, dirt or smudges. Even very small smudges or particles of dust can lead to problems when recording or playing back the disc. Carefully inspect the recording surface of the disc before inserting it in the camcorder. If the disc gets dirty use a dry, soft lens-cleaning cloth to remove any fingerprints, dirt buildup or smudges from the disc surface. Clean the disc in a radial motion from its center outwards.
- Never use a chemically treated cloth or flammable solvents such as paint thinner to clean the disc.
- Do not bend, scratch or wet the disc and do not subject it to strong shocks.
- Do not attach labels or stickers on the disc surfaces. The disc may not rotate in a stable manner and this may cause malfunctions.
- Return discs to their case for storage.
- When writing on the label side of the disc, avoid hard tip pens. Use waterproof soft-tipped felt pens instead.
- Moving a disc rapidly between hot and cold temperatures may cause condensation to form on its surfaces. If condensation forms on the disc, put it aside until the water droplets have evaporated completely.
- Never expose the disc to direct sunlight and do not store it in places subject to high temperatures or high humidity.
- Make sure to finalize a disc before inserting it in a DVD player, DVD recorder or a computer's DVD drive. Failing to do so can result in the loss of the recorded data.

Memory Card

- We recommend saving backups of memory card images on your computer. Image data may be corrupted or lost due to memory card defects or exposure to static electricity. Canon Inc. makes no warranties for corrupted or lost data.
- Do not turn off the camcorder, disconnect the power source or remove the memory card while the CARD access indicator is flashing.
- Do not use memory cards in places subject to strong magnetic fields.
- Do not leave memory cards in places subject to high humidity and high temperature.
- Do not disassemble, bend, drop, or subject memory cards to shocks and do not expose them to water.
- Do not touch or expose the terminals to dust or dirt.
- Check the direction before inserting the memory card. Forcing a memory card into the slot if it is not correctly oriented may damage the memory card or the camcorder.
- Do not attach any labels or stickers on the memory card.

Lithium Button Battery

WARNING!

- The battery used in this device may present a fire or chemical burn hazard if mishandled. Do not recharge, disassemble, heat above 100 °C (212 °F) or incinerate the battery.
 - Replace the battery with a CR2025 made by Panasonic, Hitachi Maxell, Sony, Sanyo, or with Duracell2025. Use of other batteries may present a risk of fire or explosion.
 - Dispose of the used battery according to applicable recycling regulations.
- Do not pick up the battery using tweezers or other metal tools as this will cause a short circuit.
 - Wipe the battery with a clean dry cloth to ensure proper contact.
 - Keep the battery out of the reach of children. If swallowed, seek medical assistance immediately. The battery case may break and the battery fluids may cause internal damage.
 - Do not disassemble, heat or immerse the battery in water to avoid the risk of explosion.

Built-in Rechargeable Lithium Battery

The camcorder has a built-in rechargeable lithium battery to keep the date/time and other settings. The built-in lithium battery is recharged while you use the camcorder, however, it will become totally discharged if you do not use the camcorder for about 3 months.

To recharge the built-in lithium battery: Connect the power adapter to the camcorder and leave it connected for 24 hours with the power switch set to **OFF**.

Maintenance/Others

Storage

- If you do not intend to use the camcorder for a long time, store it in a place free of dust, in low humidity, and at temperatures not higher than 30 °C (86 °F).

Cleaning

Camcorder Body

- Use a soft, dry cloth to clean the camcorder body. Never use chemically treated cloth or volatile solvents such as paint thinner.

Pick Up Lens

- Remove any dust or dirt particles using a non-aerosol type blower brush. Never touch the pick up lens directly to clean it.

Lens and Viewfinder

- If the lens surface is dirty, the autofocus may not work properly.
- Remove any dust or dirt particles using a non-aerosol type blower brush.
- Use a clean, soft lens-cleaning cloth to gently wipe the lens or viewfinder. Never use tissue paper.

LCD Screen

- Clean the LCD screen using a clean, soft lens-cleaning cloth.
- Condensation may form on the surface of the screen when the temperature changes suddenly. Wipe it with a soft dry cloth.

Condensation

Moving the camcorder rapidly between hot and cold temperatures may cause condensation (water droplets) to form on its internal surfaces. Stop using the camcorder if condensation is detected. Continued use may damage the camcorder.

Condensation may form in the following cases:

When the camcorder is moved from an air-conditioned room to a warm, humid place

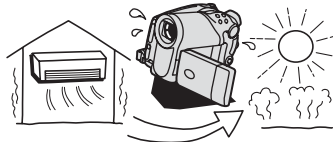

When the camcorder is left in a humid room

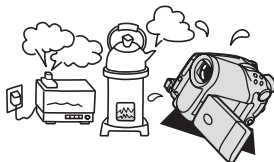

When the camcorder is moved from a cold place to a warm room

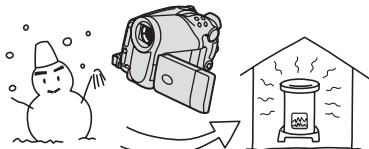

When a cold room is heated rapidly

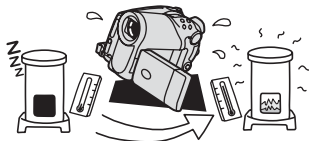

How to avoid condensation:

- Do not expose the camcorder to sudden or extreme changes in temperature.
- Unload the disc, place the camcorder in an airtight plastic bag and let it adjust to temperature changes slowly before removing it from the bag.

When condensation is detected:

- The camcorder automatically shuts off. If a disc is loaded, remove the disc immediately and leave the disc cover open. Leaving the disc in the camcorder may damage it.
- A disc cannot be loaded when condensation is detected.

Resuming use:

- The precise time required for water droplets to evaporate will vary depending on the location and weather conditions. As a general criterion, wait for 2 hours before resuming use of the camcorder.

Using the Camcorder Abroad

Power Sources

You can use the compact power adapter to operate the camcorder and to charge battery packs in any country with power supply between 100 and 240 V AC, 50/60 Hz. Consult the Canon Service Center for information on plug adapters for overseas use.

Playback on a TV Screen

You can only play back your recordings on TVs compatible with the NTSC system. The NTSC system is used in the following countries/areas:

American Samoa, Antigua, Aruba, Bahamas, Barbados, Bermuda, Bolivia, Canada, Chile, Colombia, Costa Rica, Cuba, Ecuador, El Salvador, Guam, Guatemala, Greenland, Haiti, Honduras, Jamaica, Japan, Korea, Mexico, Micronesia, Myanmar, Nicaragua, Panama, Peru, Philippines, Puerto Rico, Saint Kitts and Nevis, Saint Lucia, Saint Vincent and the Grenadines, Surinam, Taiwan, Trinidad and Tobago, USA, Venezuela, Virgin Islands.

System Diagram (Availability differs from area to area)

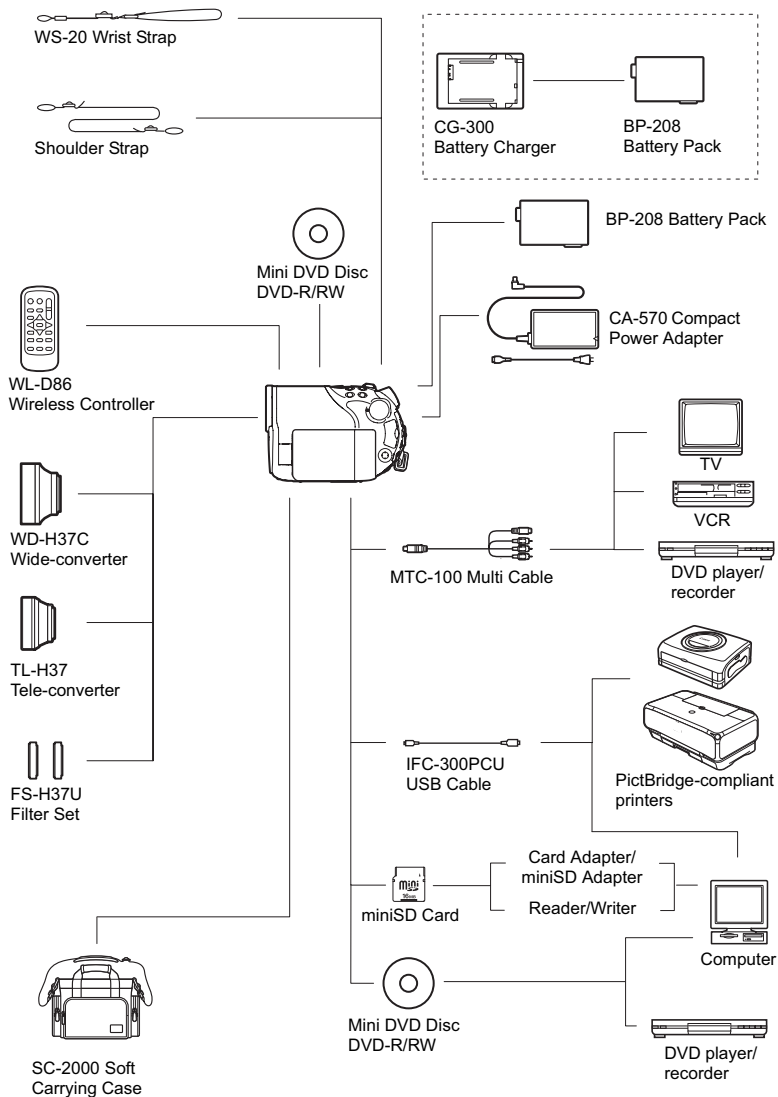

Optional Accessories

Call or visit your local retailer/dealer for genuine Canon video accessories. You can also obtain genuine accessories for your Canon camcorder by calling: 1-800-828-4040, Canon U.S.A. Information Center.

Use of genuine Canon accessories is recommended.

This product is designed to achieve excellent performance when used with genuine Canon accessories. Canon shall not be liable for any damage to this product and/or accidents such as fire, etc., caused by the malfunction of non-genuine Canon accessories (e.g., a leakage and/or explosion of a battery pack). Please note that this warranty does not apply to repairs arising out of the malfunction of non-genuine Canon accessories, although you may request such repairs on a chargeable basis.

Battery Packs

When you need extra battery packs, select only the BP-208 battery pack.

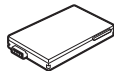

CG-300 Battery Charger

Use the battery charger for charging the battery packs. It plugs directly into a power outlet without a cable.

Charging Time: 105 min.

Charging time varies according to the charging condition.

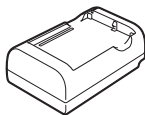

TL-H37 Tele-converter

This Tele-converter lens increases the focal length of the camcorder lens by a factor of 1.5.

- The image stabilizer is not as effective when the Tele-converter is attached.
- The minimum focusing distance with the TL-H37 is 2.3 m (7.5 ft.); 2.3 cm (0.91 in.) at maximum wide angle.
- When the Tele-converter is attached, a shadow may appear in the picture when you record with flash or assist lamp.



WD-H37C Wide-converter

This lens decreases focal length by a factor of 0.7, giving you a wide perspective for indoor shots or panoramic views.

- When the Wide-converter is attached, a shadow may appear in the picture when you record with flash or assist lamp.

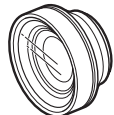

FS-H37U Filter Set

Neutral density and MC protector filters help you to control difficult lighting conditions.

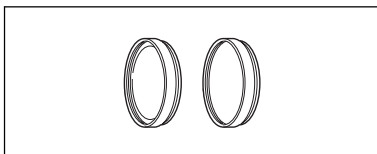

Shoulder Strap

You can attach a shoulder strap for more security and portability. Pass the ends through the strap mount and adjust the length of the strap.

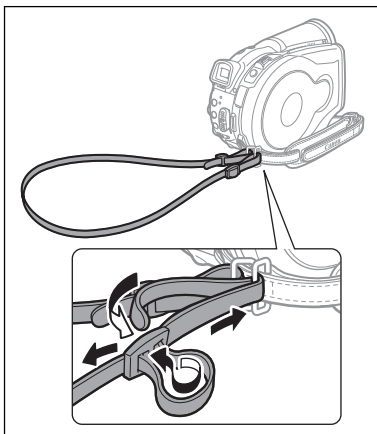

WS-20 Wrist Strap

Use this for extra additional protection for active shooting.

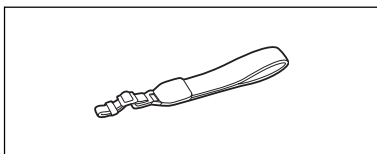

SC-2000 Soft Carrying Case

A handy camcorder bag with padded compartments and plenty of space for accessories.



This mark identifies genuine Canon video accessories. When you use Canon video equipment, we recommend Canon-brand accessories or products bearing the same mark.





Specifications

E

DC40

System

Disc Recording System	Video: DVD-VIDEO (VIDEO mode) DVD-VR (VR mode) only with 8 cm DVD-RW Video Compression: MPEG2 Audio Compression: Dolby Digital 2ch Still Images: Exif 2.2** compliant with JPEG compression
Television System	EIA standard (525 lines, 60 fields) NTSC color signal
Image Sensor	1/2.8 in. CCD, approx. 4,290,000 pixels Effective pixels: Movies: 16:9 (Image stabilizer ON): approx. 2,740,000 16:9 (Image stabilizer OFF): approx. 2,990,000 4:3 recording: approx. 3,500,000 Still images: approx. 4,000,000
Compatible Media	8 cm (3 in.) mini DVD discs marked with the DVD-R or DVD-RW logo  
Maximum Recording Time (1.4 GB single-sided 8 cm Mini DVD)	XP: approx. 20 min., SP: approx. 30 min., LP: approx. 60 min.
LCD Screen	2.7 in., wide, TFT color, approx. 123,000 pixels
Viewfinder	0.3 in. TFT color, approx. 123,000 pixels
Microphone	Stereo electret condenser microphone
Lens	f=6.1-61 mm, F/1.8-3.0, 10x power zoom 35 mm equivalent: Movies: 16:9 (Image stabilizer ON): approx. 47.4-474 mm 16:9 (Image stabilizer OFF): approx. 45.4-454 mm 4:3 recording: approx. 44.5-445 mm Still images: approx. 41.6-416 mm
Lens Configuration	11 elements in 9 groups
Filter Diameter	37 mm
AF System	TTL autofocus, manual focusing possible
Minimum Focusing Distance	1 m (3.3 ft.); 1 cm (0.39 in.) on maximum wide angle
White Balance	Auto white balance, preset white balance (DAYLIGHT, SHADE, CLOUDY, TUNGSTEN, FLUORESCENT, FLUORESCENT H) or custom white balance
Minimum Illumination	0.6 lx (Night recording program, Shutter speed at 1/2) 9 lx (Auto mode, Auto slow shutter [ON], Shutter speed at 1/30)
Recommended Illumination	More than 100 lx
Image Stabilization	Electronic

Memory Card

Recording Media	miniSD Card*
Size of Still Images	2304 x 1736, 1632 x 1224, 1280 x 960, 640 x 480 pixels
File Format	Design rule for Camera File system (DCF), Exif 2.2** compliant, DPOF compliant
Image Compression Method	JPEG (compression: Super Fine, Fine, Normal)

* This camcorder has been tested with miniSD cards up to 256 MB. Performance cannot be guaranteed for all miniSD cards.

** This camcorder supports Exif 2.2 (also called "Exif Print"). Exif Print is a standard for enhancing the communication between camcorders and printers. By connecting to an Exif Print-compliant printer, the camcorder's image data at the time of shooting is used and optimized, yielding extremely high quality prints.

Input/Output Terminals

AV OUT Terminal	10-pin multiconnector; Output only Video: 1 Vp-p/75 ohms unbalanced S-Video: Luminance (Y) signal –1 Vp-p/75 ohms; Chrominance (C) signal –0.286 Vp-p/75 ohms Audio: –10 dBV (47 kohm load)/3 kohm or less
USB Terminal	mini-B

Power/Others

Power supply (rated)	7.4 V DC (battery pack), 8.4 V DC (compact power adapter)
Power consumption (SP mode, AF on)	4.9 W (viewfinder), 4.9 W (LCD screen in normal brightness)
Operating temperature	0 – 40 °C (32 – 104 °F)
Dimensions (W x H x D)	60 x 87 x 126 mm (2.4 x 3.4 x 5.0 in.) excluding protrusions
Weight (camcorder body only)	480 g (1.1 lb.)

CA-570 Compact Power Adapter

Power supply	100 – 240 V AC, 50/60 Hz
Power consumption	17 W
Rated output	8.4 V DC, 1.5 A
Operating temperature	0 – 40 °C (32 – 104 °F)
Dimensions	52 x 90 x 29 mm (2.1 x 3.5 x 1.1 in.)
Weight	135 g (4.8 oz.)

BP-208 Battery Pack

Battery type	Rechargeable Lithium Ion Battery
Rated voltage	7.4 V DC
Operating temperature	0 – 40 °C (32 – 104 °F)
Battery capacity	850 mAh
Dimensions	39 x 8 x 63 mm (1.5 x 0.31 x 2.5 in.)
Weight	40 g (1.4 oz.)

Weight and dimensions are approximate. Errors and omissions excepted. Subject to change without notice.

Product Codes

Provided Accessories

CA-570 Compact Power Adapter	8468A002AA
BP-208 Battery Pack	0802B002AA
WL-D86 Wireless Controller	D83-0722-000
MTC-100 Multi Cable	D82-0790-000
IFC-300PCU USB Cable	D82-0710-001

Optional Accessories

CG-300 Battery Charger	0784B002AA
TL-H37 Tele-converter	8835A001AA
WD-H37C Wide-converter	1305B001AA
FS-H37U Filter Set	8837A001AA
WS-20 Wrist Strap	3118A002AA (D81-0190-202)
SC-2000 Soft Carrying Case	9389A001AA

E

Index

16:9 aspect ratio	38
9 Point AiAF	55

A

Abroad, using the camcorder	133
AEB - Exposure bracketing	67
AF (autofocus) frame selection	55
AF-assist lamp	58
Auto slow shutter	80
Av (recording program)	52
AV OUT terminal	102

B

Battery pack, charging	21
Battery pack, remaining charge	19
Beach (SCN)	49
Beep	84

C

Card mix	74
Condensation	132
Connection to a computer	105
Connection to a TV	102
Continuous shooting	67
Copying still images	94

D

Data code	45
Date and time	28
Daylight saving time	28
Digital effects	71
Digital zoom	80
Direct printing	115
Direct transfer	110
Disc title	91
Drive mode	67
DVD discs	6
DVD-R/RW discs	6

E

Effects	71
Erasing still images	92
Error messages	126
Exposure adjustment	53
Exposure bracketing	67

F

Faders	71
File numbers	84
Finalizing the disc	98
Fireworks (SCN)	49
Flash	57
Focus priority	81
Focusing mode	55
Foliage (SCN)	49
FUNC. menu	60

G

Grip belt	24
-----------	----

H

High-speed continuous shooting	67
--------------------------------	----

I

Image enhancing effects	66
Image jump	42
Image stabilizer	81
Index screen, movies	39
Index screen, still images	42
Initialization, card	97
Initialization, disc	90

L

Landscape (recording program)	46
Language	27
LCD backlight	26
LCD screen, rotating the	26
Lithium button battery	25, 131
LP mode	61

M

Magnifying a still image	44
Maintenance	132
Memory card	30
MENU	79
Metering method	63
Mini video light	56
miniSD card	30
Mode dial	46
Multi selector	11
Multi-image screen	72

N

ND filter	81, 136
Night (recording program)	46
Night mode	48
Normal TV (4:3)	84

O

On-screen displays	45
Original recordings	85

P

P (recording program)	50
Panoramic images	69
Photovie scene	95
Playback - Movies	39
Playback - Still images	41
Playlist	85
Portrait (recording program)	46
Power - Battery pack	21
Power - Compact power adapter	22
Power save	84
Print order	120
Print/share button	107, 111, 116
Printing	115
Protecting still images	96
Protecting the disc	89

R

Record review	34
Recording - Movies	33
Recording - Still images	35
Recording data	45
Recording mode	61
Recording programs	46
Recording reminder	19
Remote sensor	25
RESET	122
Review - Movies	34
Review - Still images	81
Roxio MyDVD for Canon	105

S

Scene Editing	85
SCN - Special Scene (recording programs)	46
Screen displays	18
Screen messages	126
Self timer	59
Serial number	14

Shoulder strap	136
Shutter speed	51
Slideshow	41
Slow Shutter (recording program)	46
Snow (SCN)	49
SP mode	61
Special Scene modes	49
Sports (recording program)	46
Spotlight (SCN)	49
Still image quality	76
Still image size	76
Stitch Assist	69
Sunset (SCN)	49
Super Night mode	48
S-video terminal	102

T

Telephoto	37
Time zone	28
Transfer order	113
Transferring still images	110
Troubleshooting	122
Tv (recording program)	51

U

USB terminal	115
--------------	-----

V

VIDEO mode (disc specification)	6
Viewfinder - Dioptic adjustment	24
Volume	43
VR mode (disc specification)	6

W

White balance	64
Wide angle	37
Wide TV (16:9)	84
Widescreen	38
Wind screen	81
Wireless controller	25

X

XP mode	61
---------	----

Z

Zoom	37
Zoom speed	37

CANON CONSUMER DIGITAL VIDEO EQUIPMENT LIMITED WARRANTY FOR THE UNITED STATES

The warranty set forward below is given by Canon U.S.A., Inc. with respect to equipment purchased in the United States. The limited warranty is only effective upon presentation of your Bill of Sale or other proof of purchase.

Canon consumer DVD equipment is warranted under normal, non-commercial, personal use, against defective materials or workmanship as follows:

Parts: Defective parts will be exchanged for new parts or comparable rebuilt parts for a period of ONE YEAR from the date of original purchase, except for a defective Video Head, which will be exchanged for a period of three months from the date of purchase.

Labor: For a period of ONE YEAR from the date of original purchase, labor will be provided free of charge by our factory service centers or designated service facilities located in the United States.

When returning equipment under this warranty, you must pre-pay the shipping charges, and you must enclose the Bill of Sale or other proof of purchase with a complete explanation of the problem. During your ONE-YEAR warranty period, repairs will be made and the equipment return-shipped to you free of charge. After your warranty period is over, you will be given an estimate of the cost of repair and an opportunity to approve or disapprove of the repair expense before it is incurred. If you approve, repairs will be made and the equipment return-shipped to you. (shipping charges apply). If you disapprove, we will return-ship the equipment at no charge to you.

Non-Canon brand peripheral equipment and software which may be distributed with Canon DVD camcorders are sold "AS IS" without warranty of any kind by CUSA, including any implied warranty regarding merchantability or fitness for a particular purpose. The sole warranty with respect to such non-Canon brand items is given by the manufacturer or producer thereof.

CUSA shall have no responsibility under this limited warranty for use of Canon DVD Camcorders in conjunction with incompatible peripheral equipment and incompatible software.

In order to obtain warranty service, contact the authorized Canon retail dealer from whom you purchased the DVD Camcorder or call the CANON INFORMATION CENTER AT 1-800-828-4040). You will be directed to the nearest service facility for your product.

This Limited Warranty covers all defects encountered in normal use of the equipment and does not apply in the following cases:

- A) Loss or damage to the equipment due to abuse, mishandling, accident, improper maintenance, or failure to follow operating instructions;
- B) If the equipment is defective as a result of leaking batteries, sand, dirt or water damage;
- C) If defects or damages are caused by the use of unauthorized parts or by service other than our authorized agent;
- D) If the equipment is used for commercial or industrial use.

This Limited Warranty does not cover cabinet (exterior finish), DVD discs, nor does it apply to equipment purchased outside the United States. This warranty does not cover units sold to rental firms, military operations, hotels, schools, hospitals or for other commercial, industrial, or institutional applications. These uses are covered only by such specific warranty as Canon may issue with such sales.

This Limited Warranty does not apply to accessories or consumables for the DVD Camcorder, which are sold "AS IS", without warranty of any kind by CUSA.

Please retain this warranty card and your Bill of Sale as a permanent record of your purchase. This card is most important in order to be sure you are contacted right away should there be a safety inspection, modification or product recall under applicable laws or regulations.

NO IMPLIED WARRANTY, INCLUDING MERCHANTABILITY AND FITNESS FOR A PARTICULAR PURPOSE APPLIES TO THIS EQUIPMENT AFTER THE APPLICABLE PERIOD OF EXPRESS WARRANTY OR GUARANTY, EXCEPT AS MENTIONED ABOVE, GIVEN BY ANY PERSON, FIRM OR CORPORATION WITH RESPECT TO THIS EQUIPMENT SHALL BIND THE UNDERSIGNED. (SOME STATES DO NOT ALLOW LIMITATIONS ON HOW LONG AN IMPLIED WARRANTY LASTS, SO THE ABOVE LIMITATION OR EXCLUSION MAY NOT APPLY TO YOU). CUSA SHALL NOT BE LIABLE FOR LOSS OF REVENUES OR PROFITS, EXPENSE FOR SUBSTITUTE EQUIPMENT OR SERVICE, STORAGE CHARGES, LOSS OF DATA, OR ANY OTHER SPECIAL, INCIDENTAL OR CONSEQUENTIAL DAMAGES CAUSED BY THE USE, MISUSE OR INABILITY TO USE THE DV CAMCORDER, REGARDLESS OF THE LEGAL THEORY ON WHICH THE CLAIM IS BASED, AND EVEN IF CUSA HAS BEEN ADVISED OF THE POSSIBILITY OF SUCH DAMAGES. NOR SHALL RECOVERY OF ANY KIND AGAINST CUSA BE GREATER THAN THE PURCHASE PRICE OF THE DV CAMCORDER SOLD BY CUSA AND CAUSING THE ALLEGED DAMAGE. WITHOUT LIMITING THE FOREGOING, YOU ASSUME ALL RISK AND LIABILITY FOR LOSS, DAMAGE OR INJURY TO YOU AND YOUR PROPERTY AND TO OTHERS AND THEIR PROPERTY ARISING OUT OF USE, MISUSE OR INABILITY TO USE THE DV CAMCORDER NOT CAUSED DIRECTLY BY THE NEGLIGENCE OF CUSA. (SOME STATES DO NOT ALLOW THE EXCLUSION OR LIMITATION OF INCIDENTAL OR CONSEQUENTIAL DAMAGES, SO THE ABOVE LIMITATION MAY NOT APPLY TO YOU). THIS WARRANTY SHALL NOT EXTEND TO ANYONE OTHER THAN THE ORIGINAL PURCHASER OF THIS EQUIPMENT OR THE PERSON FOR WHOM IT WAS PURCHASED AS A GIFT.

This warranty gives you specific legal rights, and you may also have other rights which vary from state to state. CANON U.S.A., INC.

CANON CONSUMER DIGITAL VIDEO EQUIPMENT LIMITED WARRANTY

The limited warranty set forth below is given by Canon Canada Inc. ("Canon Canada") with respect to Canon DVD equipment purchased in Canada. This limited warranty is only effective upon presentation of a bill of sale or other proof of purchase for this Canon digital video equipment to a Canon Service Facility when repairs are required.

Canon consumer video digital equipment is warranted under normal, non-commercial, personal use, against defective materials or workmanship as follows:

Parts: Defective parts will be exchanged for new parts or, at Canon Canada's option, comparable rebuilt parts for a period of one year from the date of original purchase, except Video Heads which will be exchanged for a period of 3 months from the date of purchase.

Labour: For a period of one year from the date of original purchase, labour will be provided free of charge by our Canon Service Facilities in Canada.

This limited warranty covers all defects except where:

(a) The loss or damage to the product results from:

- i) accident, natural disaster, mishandling, abuse, neglect, unauthorized product modification or failure to follow instructions contained in the instruction manual;
- ii) the use of accessories, attachments, products, supplies, parts or devices with this Canon product that do not conform to Canon specifications or that cause abnormally frequent service problems;
- iii) repairs or services performed by any party other than a Canon Service Facility;
- iv) defective batteries or any exposure to water, sand or dirt;
- v) shipping (claim must be presented to the shipper);

(b) Any serial number on the video equipment is altered or removed.

(c) The digital video equipment is used for commercial, professional or industrial purposes.

This limited warranty does not cover the cabinet (exterior finish) of the DVD equipment, DVD discs, nor does it apply to DVD equipment purchased outside Canada.

TO OBTAIN WARRANTY SERVICE

Ship your Canon digital video equipment in its original carton, box or equivalent, properly packed, fully insured with shipping charges prepaid, together with a copy of your bill of sale or other proof of purchase and a description of the problem to any of the Canon Service Facilities in Canada.

LIMITATIONS

Except as otherwise required by applicable legislation, this warranty is in lieu of all other warranties, conditions, guarantees or representations, express or implied, statutory or otherwise, relative to this Canon product, including implied warranties or conditions of merchantability or fitness for a particular purpose.

Canon Canada assumes no liability for special, consequential or incidental damages or loss that may arise, whether on account of negligence or otherwise, from the use, misuse or inability to use this Canon product (including loss of profit, revenue, discs or enjoyment) or from failure to conform to any express or implied warranties, conditions, guarantees or representations. Any recovery under this limited warranty shall not exceed the purchase price of the product. Canon Canada does not assume or authorize any other person to assume for Canon Canada any other liability with respect to this Canon product.

This warranty does not extend to any person other than the original purchaser of this Canon product or the person for whom it was purchased as a gift and states your exclusive remedy.

NOTICE TO CONSUMER

If you plan to take important videos or if the product has not been used for some time, please check all functions with the instruction book before using it.



CANON INC.

U.S.A.

CANON U.S.A., INC. NEW JERSEY OFFICE

100 Jamesburg Road, Jamesburg, NJ 08831 USA

CANON U.S.A., INC. CHICAGO OFFICE

100 Park Blvd., Itasca, IL 60143 USA

CANON U.S.A., INC. LOS ANGELES OFFICE

15955 Alton Parkway, Irvine, CA 92618 USA

CANON U.S.A., INC. HONOLULU OFFICE

210 Ward Avenue, Suite 200, Honolulu, HI 96814 USA

- If you have any questions, call the Canon U.S.A. Information Center toll-free at 1-800-828-4040 (U.S.A. only).

CANADA

CANON CANADA INC. NATIONAL HEADQUARTERS

6390 Dixie Road, Mississauga, Ontario L5T 1P7

CANON CANADA INC. CALGARY

2828, 16th Street, N.E. Calgary, Alberta T2E 7K7

CANON CANADA INC. MONTREAL

5990 Côte de Liesse, Quebec H4T 1V7

- If you have any questions, call the Canon Canada Information Center toll-free at 1-800-828-4040 (CANADA only).

- Si vous avez des questions, veuillez téléphoner sans frais au Canada 1-800-828-4040 (CANADA seulement).

MEXICO

CANON MEXICANA, S. DE R.L. DE C.V.

Periferico Sur No. 4124 Col. Ex-Rancho de Anzaldo C.P. 01900 México, D.F., México

CANON U.S.A., INC. NEW JERSEY OFFICE

100 Jamesburg Road, Jamesburg, NJ 08831 USA

CENTRO Y SURAMÉRICA

CANON LATIN AMERICA, INC.

703 Waterford Way Suite 400 Miami, FL 33126 USA

ASIA

CANON HONGKONG COMPANY LTD.

19/F, The Metropolis Tower, 10 Metropolis Drive, Hunghom, Kowloon, Hong Kong



The information on this manual is verified as of February 1st, 2006.
Les informations contenues dans ce manuel ont été vérifiées le 1er Février 2006.
La información de este manual fue verificada el 1 de Febrero de 2006.



Printed on 100% reused paper.
Document réalisé avec du papier recyclé à 100%.
El papel aquí utilizado es 100% reciclado.