

Canon



Photo Printer

PIXMA iP6310D Series

Direct Printing Guide

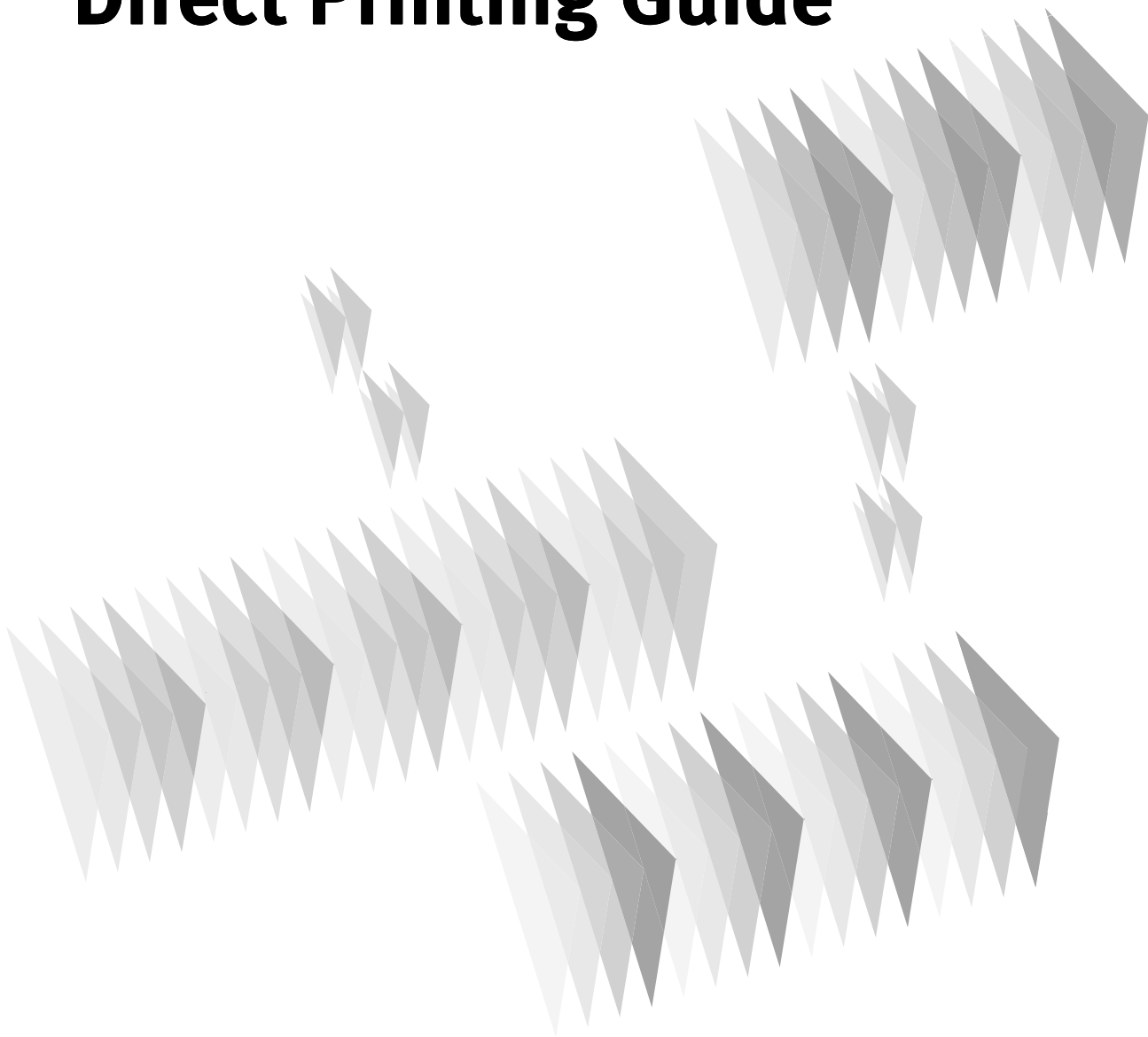

Canon

PIXMA iP6310D

Photo Printer

Direct Printing Guide

Contents

Operation Panel and Menu Display	3
Operation Panel Names and Functions	3
LCD Monitor	5
Memory Card Mode	5
Configuration	6
Printing Flow	7
Using a Memory Card	9
Memory Cards Supported by This Printer	9
Inserting a Memory Card	10
Removing a Memory Card	11
Loading Paper	12
Printing a Photograph	15
Printing a Photo List – Print Index	15
Specifying Photos to Print	16
Specifying the Range of Photos in the Memory Card	18
Printing on the Sticker – Sticker Print	19
Printing All Photos	20
Printing According to the Settings Made on the Camera – DPOF Printing	20
Other Settings	23
Changing Other Settings	23
Printing Photographs Directly from a Digital Camera	24
Printing Photographs Directly from a PictBridge Compliant Device	24
Printing Photographs from a Wireless Communication Device	29
Setting the Page Size, Media Type, and Layout When Printing From a Mobile Phone	29
Performing Bluetooth Communication	31
Using Data in the Memory Card on the Computer	33
Browsing Photos in the Memory Card on the Computer	33
Saving Data in the Memory Card onto the Computer	33
Setting up the Card Slot as the Memory Card Drive of the Computer	34
Printing Maintenance	35
When Printing Becomes Faint or Colors are Incorrect	35
Printing the Nozzle Check Pattern	36
Examining the Nozzle Check Pattern	36
Print Head Cleaning	37
Print Head Deep Cleaning	38
Aligning the Print Head - Auto head align	38

Replacing a FINE Cartridge 39
 Replacing a FINE Cartridge..... 39
 What is Low Ink Warning? 42

Troubleshooting 43

Index 52

Operation Panel and Menu Display

The names and functions of the controls on the operation panel, how to display the menus, and the items in the menus are described below:

Operation Panel Names and Functions

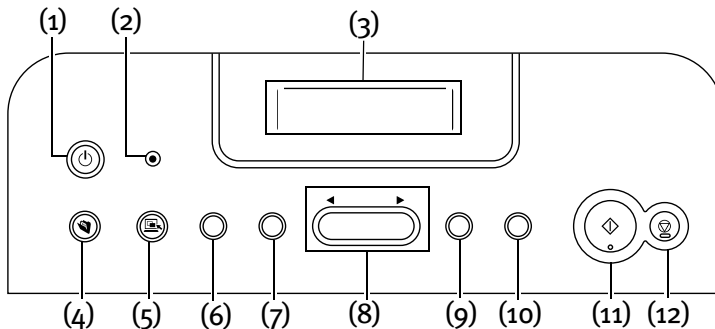

- (1) POWER Button**
Press to turn the printer on or off.

POWER Lamp
Off: the printer is turned off.
Lighting: the printer is ready to print, is currently printing, or is currently initializing.
Flashing: the printer is preparing to turn on or off.
- (2) Alarm Lamp**
Lighting: an error has occurred and the printer is not ready to print.
When the **POWER** lamp and the **Alarm** lamp flash alternately, an error has occurred that may require a service call.
- (3) LCD Monitor**
When you perform direct printing, the menus and the setting items are displayed here.
- (4) Save Button**
Saves data in the memory card onto the computer's hard disk. See "Saving Data in the Memory Card onto the Computer" on page 33.
- (5) Easy-PhotoPrint Startup Button**
Starts Easy-PhotoPrint. See "Browsing Photos in the Memory Card on the Computer" on page 33.
- (6) Menu Button**
Displays menus. See "Memory Card Mode" on page 5.
- (7) Configuration Button**
Allows you to set print settings and maintenance of the printer. See "Configuration" on page 6.

(8) ◀ ▶ Buttons

Use these buttons to select a menu item or the number of photo, to specify the number of copies to print, and to make print settings.

(9) OK Button

Allows you to make a selection. For example, selecting a photo to be printed, selecting a menu item or other settings.
If an error occurs, press to resume printing after resolving the printer problem.

(10) Back Button

Allows you to return to the previous screen.

(11) Print Button

Press to start printing according to the settings displayed on the LCD.

(12) Stop/Reset Button

Press to cancel the settings you have made. If this button is pressed during printing, the printer aborts printing.

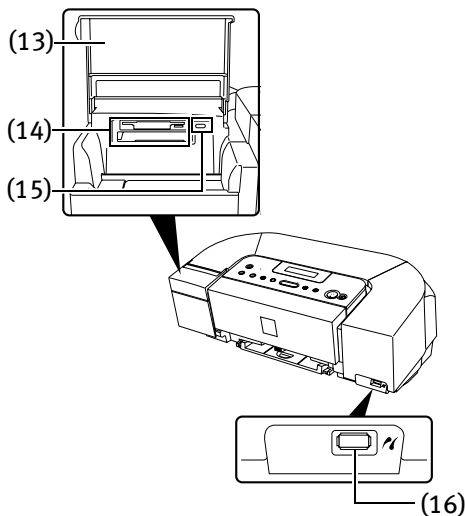

(13) Card Slot Cover

Close this after inserting a memory card.

(14) Card Slot

Set the memory card containing photos here.

(15) Indicator Lamp

The indicator lamp lights when memory card reading is enable and flashes while the printer is accessing the memory card.

(16) Direct Print Port

Connects the printer to a PictBridge-compatible digital camera or digital video camcorder. See “Connecting to a PictBridge Compliant Device” on page 24.

When using optional Bluetooth unit*, connect this port.

*The Bluetooth unit is not available to some regions due to the law of the countries or the regulations. For details, contact the Customer Care Center.

See “Printing Photographs from a Wireless Communication Device” on page 29 or the *Bluetooth User’s Guide*.

LCD Monitor

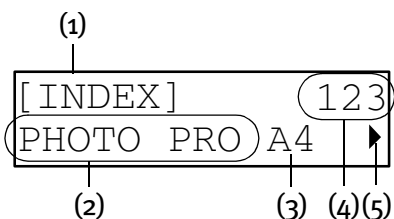

- (1) Shows Memory Card Mode.
- (2) Shows the Media Type.
- (3) Shows the Page Size.
- (4) Shows the number of photo in the memory card (only for INDEX printing).
- (5) The ◀▶ buttons are activated when this mark is displayed.

For the print settings of page size and media type etc. see the section of Memory Card Modes.

Memory Card Mode

When you press the **Menu** button, Memory Card Mode screens appear on the LCD. By using ◀▶ button, you can select the following modes.

INDEX

See “Printing a Photo List – Print Index” on page 15.

PRINT ALL PHOTOS

See “Printing All Photos” on page 20.

SELECT PHOTO

See “Specifying Photos to Print” on page 16.

SELECT RANGE

See “Specifying the Range of Photos in the Memory Card” on page 18.

STICKR

See “Printing on the Sticker – Sticker Print” on page 19.

DPOF

See “Printing According to the Settings Made on the Camera – DPOF Printing” on page 20.

Configuration

Each time you press **Configuration** button, following setting items are displayed on the LCD.

PRINT SETTINGS

QUIET MODE

See “Other Settings” on page 23.

WIRELESS SETTINGS

PAGE SIZE

MEDIA TYPE

LAYOUT

IMAGE OPTIMIZER

See “Printing Photographs from a Wireless Communication Device” on page 29.

BLUETOOTH SET

DEVICE NAME

ACCESS REFUSAL

SECURITY

PASSKEY

See “Printing Photographs from a Wireless Communication Device” on page 29.

PICTBRIDGE SET

PAGE SIZE

MEDIA TYPE

PRINT QLTY

BORDERLESS PRINT

IMAGE ENHANCEMENT

See “Printing Photographs Directly from a Digital Camera” on page 24.

OTHERS

DATE/TIME SETUP

See “Other Settings” on page 23.

READ-ONLY MODE

See “Setting up the Card Slot as the Memory Card Drive of the Computer” on page 34.

LANGUAGE SETTING

See “Other Settings” on page 23.

MAINTENANCE

NOZZLE CHECK

See “Printing the Nozzle Check Pattern” on page 36.

CLEANING

See “Print Head Cleaning” on page 37.

DEEP CLEANING

See “Print Head Deep Cleaning” on page 38.

AUTO HEAD ALIGN

See “Aligning the Print Head - Auto head align” on page 38.

ALIGN PRINT HEAD

See “Adjusting the Print Head Manually” on page 44.

HEAD ALIGN PRINT

See “Aligning the Print Head - Auto head align” on page 38.

ROLLER CLEANING

See “Back of Paper is Smudged/Paper Does Not Feed Properly/Printed Surface is Scratched” on page 46.

BOTTOM CLEANING

See “Back of Paper is Smudged/Paper Does Not Feed Properly/Printed Surface is Scratched” on page 46.

RESTORE DEFAULT

See “Other Settings” on page 23.

SAVE CONFIGURATION

See page 17.

LOAD CONFIGURATION

See page 17.

Printing Flow

This is the procedure for printing photos from the memory card inserted in the card slot of the printer.

Print a Photo List of All Photos in the Memory Card

Step 1 Turn on the Printer.

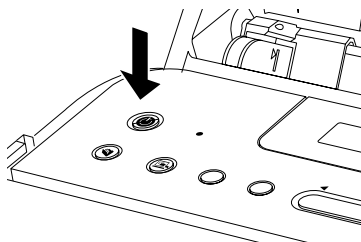

Step 2 Load the paper.

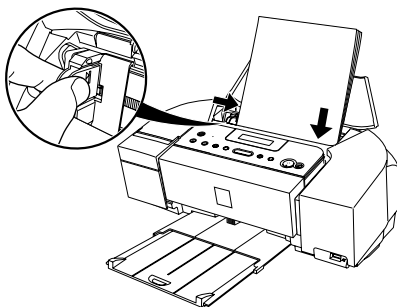

See “Loading Paper” on page 12.

Step 3 Insert the memory card.

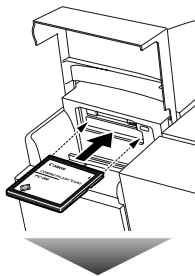

See “Using a Memory Card” on page 9.

Step 4 Print a Photo List in the Memory Card.

See “Printing a Photo List – Print Index” on page 15.

Print the Photos by Other Printing Menus

Select the photos you want to print in the printed photo list.

Step 5 Select Memory Card Mode.

PRINT ALL PHOTOS

Prints all photos in the memory card. See “Printing All Photos” on page 20.

SELECT PHOTO

You can specify photos you want to print saved in the memory card.

See “Specifying Photos to Print” on page 16.

SELECT RANGE

You can specify the range of photos you want to print using the file number or shooting date.

See “Specifying the Range of Photos in the Memory Card” on page 18.

STICKR

You can print your favorite photo on the Canon Photo Stickers.

See “Printing on the Sticker – Sticker Print” on page 19.

DPOF

Prints photos according to the DPOF settings set on the digital camera.

See “Printing According to the Settings Made on the Camera – DPOF Printing” on page 20.



Step 6 Start printing.







Press the **Print** button to start printing.

Using a Memory Card

Let's take a look at different types of memory cards and how to insert and remove them.

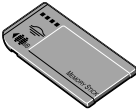
Memory Cards Supported by This Printer

Supported memory cards are as follows:

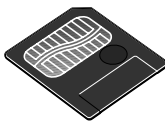
Memory Cards which can be inserted directly	Memory Cards which can be used through a special adapter
<ul style="list-style-type: none"> ● CompactFlash (CF) Card ● Microdrive <p>*Supports TYPE I/TYPE II (3.3V).</p> 	<ul style="list-style-type: none"> ● xD-Picture Card*¹ 
<ul style="list-style-type: none"> ● Memory Stick ● Memory Stick PRO 	<ul style="list-style-type: none"> ● Memory Stick Duo*² ● Memory Stick PRO Duo*² 
<ul style="list-style-type: none"> ● Secure Digital (SD) Card ● MultiMedia Card (ver.3.31) 	<ul style="list-style-type: none"> ● miniSD Card*² 
<ul style="list-style-type: none"> ● SmartMedia Card <p>*Supports 3.3V card only (1MB and 2MB cards not supported)</p> 	<p>*¹ Purchase the CompactFlash Card Adapter for xD-Picture Card separately.</p> <p>*² Use the special adapter supplied with the card.</p>

Important

- This printer accepts images taken with a camera compatible with the Design rule for Camera File system (Exif2.21 compliant), TIFF (Exif2.21 compliant), and DPOF (Ver. 1.00 compliant).
- Photos stored in a memory card not supported by the digital camera may fail in loading or be damaged. For types of memory cards supported by the digital camera, refer to your digital camera user's manual.
- Use the digital camera to format a memory card. Memory card data formats may not be compatible with computer-specific formats.
- Images edited on the computer may result in improper printing.
- Please use only one type of memory card at a time.

Inserting a Memory Card

1 Open the card slot cover.

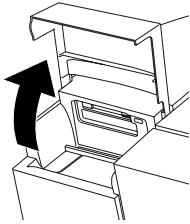

2 Insert the memory card in the card slot.

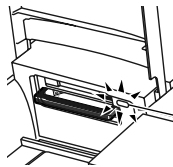
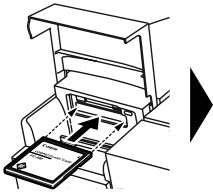

- If you use a CompactFlash (CF) card or Microdrive
Insert it into the slot on the lower until it stops with its end projecting as shown.

The indicator lamp lights.

*For xD-Picture Card, use the compliant adapter.

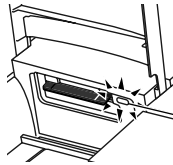
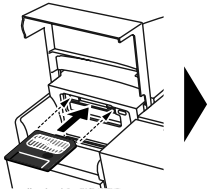

- If you use a SmartMedia card
Insert it into the slot on the upper until it stops with its end projecting as shown.

The indicator lamp lights.

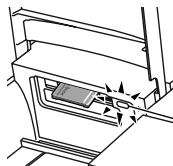
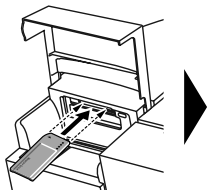

- If you use a Memory Stick/Memory Stick PRO/SD card/Multimedia card (ver.3.31)
Insert it into the slot on the upper until it stops with its end projecting as shown.

The indicator lamp lights.

*For Memory Stick Duo/Memory Stick PRO Duo/
miniSD Card, use the special adapter.



Important

Do not try to insert the memory card into the card slot any further than the position it stops; otherwise the printer or the memory card will be damaged.

-
- 3 Ensure that the indicator lamp lights after flashing for a moment and then close the card slot cover.

-  **Notes**
- When **OFF** is selected in the **READ-ONLY MODE** screen, you cannot print photos in the memory card. After using the card slot as the memory card drive of the computer, remove the memory card, then be sure to select **ON** in the **READ-ONLY MODE** screen again. See “Setting up the Card Slot as the Memory Card Drive of the Computer” on page 34.
 - If you have used a computer to edit or process the data stored in the memory card, be sure to print photos from the computer. Using the operation panel to print photos may result in improper printing.

Removing a Memory Card

-  **Note** If you use the printer connected to your computer, follow the instructions for removal of the memory card from the computer. For the procedure, see “Setting up the Card Slot as the Memory Card Drive of the Computer” on page 34.

- 1 Open the card slot cover.
- 2 Ensure that the indicator lamp is not flashing, then remove the memory card.

-  **Important** Removing the memory card or turning off the printer while the indicator lamp is flashing can damage the data stored in the memory card.

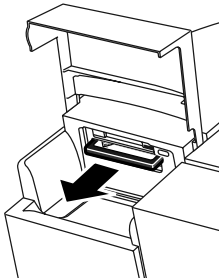

- 3 Close the card slot cover.

Loading Paper

This section describes how to load the paper and select the page sizes and media types from the operation panel.

■ Print Media to Avoid

Do not use the following types of paper. Using such paper will not only produce unsatisfactory results, but can also cause the printer to jam or malfunction.

- Folded, curled or wrinkled paper
- Damp paper
- Excessively thin paper (less than 64 gsm or 17 lb)
- Excessively thick paper* (more than 105 gsm or 28 lb)
*non-Canon genuine paper
- Picture postcards
- Postcards with an affixed photos or stickers
- Envelopes
- Any type of paper with holes

■ Loading the Print Media in the Auto Sheet Feeder

In this example, description is provided using Photo Paper Plus Glossy 4" x 6"/101.6 x 152.4 mm in your printer.

See “Media Types for Card Direct Printing” on page 14 for compatible paper.

1 Flatten the four corners of the paper before loading it.

-  **Note** If the paper is curled, gently bend the corners in the opposite direction until the paper becomes completely flat. See “Back of Paper is Smudged/Paper Does Not Feed Properly/Printed Surface is Scratched” on page 46.

2 Prepare to load paper.

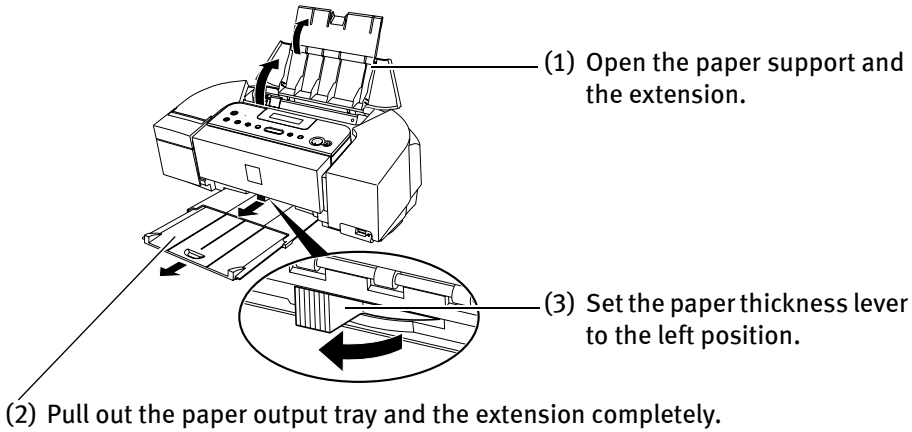

3 Load the paper.

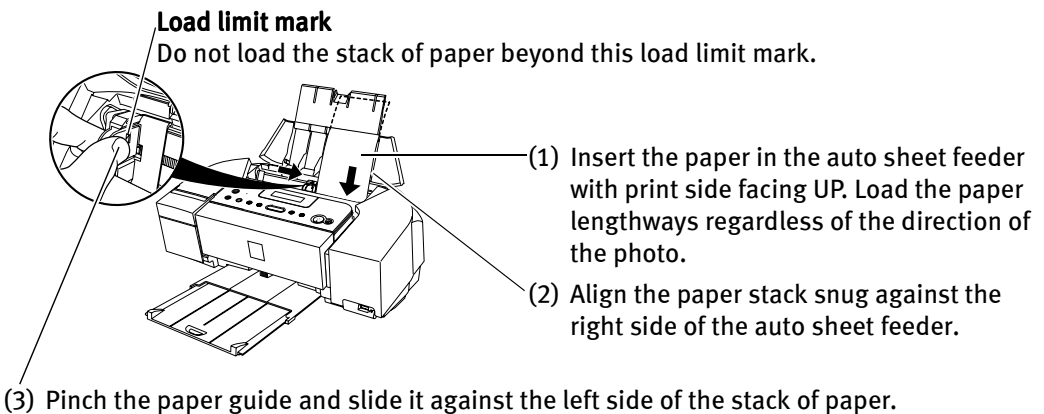

Important Always load paper in portrait orientation. Loading paper in landscape orientation can cause paper to be jammed.

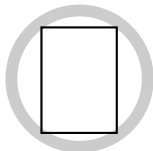

Portrait

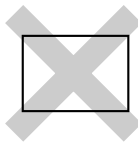

Landscape

Note Do not touch the printed surface until the ink dries. For specific drying times, refer to the instructions packaged with your media.

■ Media Types for Card Direct Printing

You can use the following Canon genuine paper:

Media Type	Paper Support Load Limit	PAGE SIZE	MEDIA TYPE
Plain Paper	A4/Letter: up to 100 sheets	[A4]/[8.5"x11"]	[PLAIN PAPER]
Photo Paper Pro ^{*1}	A4/Letter: up to 10 sheets	[A4]/[8.5"x11"]	[PHOTO PAPER PRO]
	101.6 x 152.4 mm/4" x 6": up to 20 sheets	[4"x6"]	
Photo Paper Plus Glossy ^{*1}	A4/Letter: up to 10 sheets	[A4]/[8.5"x11"]	[PHOTO PAPER PLUS]
	101.6 x 152.4 mm/ 4" x 6": up to 20 sheets	[4"x6"]	
	127 x 177.8 mm/ 5" x 7": up to 10 sheets	[5"x7"]	
Photo Paper Plus Semi-Gloss ^{*1}	A4/Letter: up to 10 sheets	[A4]/[8.5"x11"]	[PHOTO PAPER PLUS]
	101.6 x 152.4 mm/4" x 6": up to 20 sheets	[4"x6"]	
Matte Photo Paper	A4/Letter: up to 10 sheets	[A4]/[8.5"x11"]	[MATTE PHOTO PAPER]
	101.6 x 152.4 mm/4" x 6": up to 20 sheets	[4"x6"]	
Glossy Photo Paper	A4/Letter: up to 10 sheets	[A4]/[8.5"x11"]	[GLOSSY]
	101.6 x 152.4 mm/4" x 6": up to 20 sheets	[4"x6"]	
	Credit Card: up to 20 sheets	[CREDIT CARD SIZE]	
Photo Stickers ^{*2}	1 sheet	–	–

Notes

- When using plain paper (64 gsm or 17 lb) up to 100 sheets can be set.
- *1: When loading a stack of paper, the printed side may be marked when it is fed in. If this happens, load paper one sheet at a time.
- *2: When printing on sticker paper, select **STICKR** from Memory Card Mode. When printing photos in a mobile phone on sticker paper, select **STICKR x16** in the **WIRELESS SETTINGS** screen. See “Printing Photographs from a Wireless Communication Device” on page 29.

Printing a Photograph

Let's print a photo list of all photos in the memory card at first.

Printing a Photo List – Print Index

1 Prepare to print.

- (1) Turn on the printer.
- (2) Load the paper.
See “Loading Paper” on page 12.
- (3) Insert the memory card in the card slot.
See “Inserting a Memory Card” on page 10.

2 Select the **INDEX** from the Memory Card Mode.

- (1) Press the **Menu** button.



- (2) Use the ◀▶ buttons to select **INDEX** and then press the **OK** button.

3 Check the print setting items

- PAGE SIZE:** Use the ◀▶ buttons to select the page size and then press the **OK** button.
You can select the following page size:
8.5"x11"/A4/4"x6"/5"x7"/CREDIT CARD SIZE
- MEDIA TYPE:** Use the ◀▶ buttons to select the media type and then press the **OK** button.
You can select the following media type:
PLAIN PAPER/PHOTO PAPER PRO/PHOTO PAPER PLUS/MATTE PHOTO PAPER/GLOSSY
- PRINT QLTY:** Use the ◀▶ buttons to select the print quality and then press the **OK** button.
STANDARD: Print the standard print quality.
HIGH: Print the priority for print quality.
- PRINT DATE:** Use the ◀▶ buttons to select whether or not to print the shooting date and then press the **OK** button.

 **Note** Press the **Back** button to return to the previous screen.

4 Start Printing.

Press the **Print** button.

Specifying Photos to Print

You can specify photos to print in the memory card.

1 Print a photo list.

See “Printing a Photo List – Print Index” on page 15.

2 Select the **SELECT PHOTO** from the Memory Card Mode.

(1) Press the **Menu** button.

(2) Use the ◀▶ buttons to select **SELECT PHOTO** and then press the **OK** button.

3 Specify the photos to print.

(1) Select the photo (the file number) from the printed photo list.

(2) Use the ◀▶ buttons to select a file number and then press the **OK** button.

(3) Use the ◀▶ buttons to select **YES** or **NO**, and then press the **OK** button.

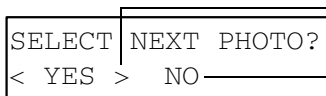

YES: Select when you want to specify other photos.

NO: Select when you finished specifying all the photos you want to print.

4 Confirm the file numbers to print.

Confirm the file numbers on the display correspond with the numbers you selected on Step **3** and then press the **OK** button.

You can use the ◀▶ buttons to confirm the numbers when ◀▶ is displayed on the screen.

5 Specify the number of copies to print.

Using the ◀▶ buttons, specify the number of copies and then press the **OK** button.

6 Check the print setting items.

For the details of the print setting items, see “Print Setting Items” on page 22.

PAGE SIZE:	Use the ◀▶ buttons to select the page size and then press the OK button.
MEDIA TYPE:	Use the ◀▶ buttons to select the media type and then press the OK button.
PRINT QLTY:	Use the ◀▶ buttons to select STANDARD or HIGH and then press the OK button.
BORDERLESS PRINT**:	Use the ◀▶ buttons to select whether or not to print borderless prints and then press the OK button.
PRINT DATE*:	Use the ◀▶ buttons to select whether or not to print the shooting date and then press the OK button.
FILE NO. PRINT*:	Use the ◀▶ buttons to select whether or not to print the DCF number (file number) and then press the OK button.
IMAGE ENHANCEMENT**:	Use the ◀▶ buttons to select SET or SKIP and then press the OK button. Selecting SET allows you to optimize photos with various functions. For details, see “Print Setting Items” on page 22.

* This item is not available for DPOF printing.

** This item is not available for INDEX printing.

 **Note** Press the **Back** button to return to the previous screen.

7 Start printing.

Press the **Print** button.

-  **Notes**
- You can save the current settings. Once you save the settings, the saved settings are loaded when the printer is turned on.
 1. Press the **Configuration** button repeatedly to select **SAVE CONFIGURATION**.
 2. Press the ▶ button to select **YES** and then press the **OK** button.
 3. Press the **Stop/Reset** button.
 - You can load the saved print settings.
 1. Press the **Configuration** button repeatedly to select **LOAD CONFIGURATION**.
 2. Press the ▶ button to select **YES** and then press the **OK** button.
 3. Press the **Stop/Reset** button.

Specifying the Range of Photos in the Memory Card

You can specify the range of photos you want to print by the file number or shooting date.

1 Print a photo list.

See “Printing a Photo List – Print Index” on page 15.

2 Select the **SELECT RANGE** from the Memory Card Mode.

(1) Press the **Menu** button.

(2) Use the ◀▶ buttons to select **SELECT RANGE** and then press the **OK** button.

3 Select the specification method.

Use the ◀▶ buttons to select **PHOTO NO.** or **DATE** and then press the **OK** button.

PHOTO NO.: You can specify the range of photos by photo number of the printed photo list.

DATE: You can specify the range of photos by date of the printed photo list.

4 Specify the range of photos you want to print looking at the printed photo list.

If you selected PHOTO NO.:

(1) Use the ◀▶ buttons to specify the first file number and then press the **OK** button.

(2) Use the ◀▶ buttons to specify the last file number and then press the **OK** button.

If you selected DATE:

(1) Use the ◀▶ buttons to specify the earliest shooting date and then press the **OK** button.

(2) Use the ◀▶ buttons to specify the latest shooting date and then press the **OK** button.

5 Check the print setting items.

See “Specifying Photos to Print” on page 16.

6 Start printing.

Press the **Print** button.

Printing on the Sticker – Sticker Print

You can print your favorite photo on the Canon Photo Stickers.

1 Print a photo list.

See “Printing a Photo List – Print Index” on page 15.

2 Select the **STICKR** from the Memory Card Mode.

(1) Press the **Menu** button.

(2) Use the ◀▶ buttons to select **STICKR** and then press the **OK** button.

3 Select a photo to print on the sticker looking at the printed photo list.

(1) Select a photo (a file number) to print from the printed photo list.

(2) Use the ◀▶ buttons to select a file number and then press the **OK** button.

 **Note** You can select one file as the photo to print on the sticker.

4 Specify the number of copies to print.

Using the ◀▶ buttons to specify the number of copies and then press the **OK** button.

5 Specify the layout.

Using the ◀▶ buttons to select **STICKR x16** and then press the **OK** button.

6 Start printing.

Press the **Print** button.

Printing All Photos

You can print all photos in a memory card.

1 Prepare to print.

See “Printing a Photo List – Print Index” on page 15.

2 Select the **PRINT ALL PHOTOS** from the Memory Card Mode.

(1) Press the **Menu** button.

(2) Use the ◀▶ buttons to select **PRINT ALL PHOTOS** and then press the **OK** button.

3 Check the print setting items.

See “Specifying Photos to Print” on page 16.

4 Start printing.

Press the **Print** button.

Printing According to the Settings Made on the Camera – DPOF Printing

If DPOF (Digital Print Order Format) settings made on the camera, photos are printed automatically according to those settings.

Notes

- This printer allows you to make the following DPOF settings:
 - Image format : CIFF, Exif (Tiff), JFIF
 - Print type - Standard: The photos for which you specified “Standard” using the DPOF function are printed.
 - Print type - Index : The photos for which you specified “Index” using the DPOF function are printed according to the printer’s index print layout.
 - Photos to Print : Only the photos specified using the DPOF function are printed (photos cannot be specified on the operation panel).
 - Copies : The photos are printed according to the numbers of copies specified using the DPOF function (numbers of copies cannot be specified on the operation panel).
 - Other functions (addition of comments, trimming/rotation, etc.) are not supported.
- Photos are automatically scaled according to the paper size. The upper, lower, left, and/or right portion(s) of the photo may be missing depending on the size of the paper you use.
- The shooting date format is as specified in the DPOF setting from DPOF printing.

1 Prepare to print.

See “Printing a Photo List – Print Index” on page 15.

2 Select the DPOF from the Memory Card Mode.

(1) Press the **Menu** button.

(2) Use the ◀▶ buttons to select **DPOF** and then press the **OK** button.

3 Check the print setting items.

See “Specifying Photos to Print” on page 16.

4 Start printing.

Press the **Print** button.

■ Print Setting Items

PAGE SIZE

Select the page size.

8.5"x11", A4, 4"x6", 5"x7", CREDIT CARD SIZE

MEDIA TYPE

Select the media type.

PLAIN PAPER, PHOTO PAPER PRO, PHOTO PAPER PLUS, MATTE PHOTO PAPER, GLOSSY

PRINT QLTY

Select the printing quality.

STANDARD, HIGH

BORDERLESS PRINT

Select bordered or borderless print.

PRINT DATE

Select whether to print the shooting date or not.

FILE NO. PRINT

Select whether to print the DCF (the file number) or not.

IMAGE ENHANCEMENT

Select SET or SKIP.

Selecting SET allows you to optimize photos with the functions below.

RED EYE CORR

Correct the red eyes caused by the reflection when the flash hits a person's eyes.

VIVID

This function makes green and blue more lively.

POP

This function automatically optimizes brightness and tone of a photo.

REMOVE NOISE

This function reduces the noise on blue areas like the sky as well as on black areas.

FACE BRIGHT

This function brightens a darkened face on the photo taken against the light.

OPTIMIZER

Corrects the contours and smooths out the jaggedness.

BRIGHTNESS

Adjust brightness.

-2, -1, 0, +1, +2

CONTRAST

Adjust contrast.

-2, -1, 0, +1, +2

COLOR

Adjust color hue.

R+2, R+1, 0, Y+1, Y+2

(R: Color hue Red/Y: Color hue Yellow)

Other Settings

Changing Other Settings

■ Quiet mode

You can reduce the sound that the printer generates during operation.

- (1) Press the **Configuration** button to select **QUIET MODE** and then press the **OK** button.
- (2) Use the ◀▶ buttons to select **ON** and then press the **OK** button.
- (3) Press the **Stop/Reset** button.

-  **Important**
- Print speed may be somewhat slower than in the normal operating mode.
 - Sound reduction is not as effective when certain printing options are selected. Sound generated during printer warm up is the same as during normal operation.
 - Changing the item in this menu is effective only when you are printing from a memory card or from a digital camera connected to this printer. If you are printing with your computer connected, specify the required settings in the printer driver.

■ Date Display Format

You can change the format for printing the date.

- (1) Press the **Configuration** button repeatedly to select **OTHERS**.
- (2) Use the ◀▶ buttons to select **DATE/TIME SETUP** and then press the **OK** button.
- (3) Use the ◀▶ buttons to select date display format and then press the **OK** button.
- (4) Press the **Stop/Reset** button.

 **Note** The shooting date format is as specified in the DPOF setting from DPOF printing.

■ Language

You can change the language displayed on the LCD.

- (1) Press the **Configuration** button repeatedly to select **OTHERS**.
- (2) Use the ◀▶ buttons to select **LANGUAGE SETTING** and then press the **OK** button.
- (3) Use the ◀▶ buttons to select a language and then press the **OK** button.
- (4) Press the **Stop/Reset** button.

■ Reset

You can reset all settings, other than the language setting and the print head position, to the initial state.

- (1) Press the **Configuration** button repeatedly to select **RESTORE DEFAULT**.
- (2) Use the ◀▶ buttons to select **YES** and then press the **OK** button.

Printing Photographs Directly from a Digital Camera

Printing Photographs Directly from a PictBridge Compliant Device

Connecting a PictBridge compliant device such as digital camera, camcorder or mobile phone to the printer allows you to print recorded images directly without using a computer.

 **Note** PictBridge is an Industry standard enabling a range of digital photo solutions, including the direct printing of photos from a digital still camera, camcorder or mobile phone* without the need to use a computer.

*Hereafter, the PictBridge compliant digital camera, digital camcorder, or camera-equipped mobile phone are collectively called a PictBridge compliant device.

■ Connecting to a PictBridge Compliant Device

To connect a PictBridge compliant device to this printer, use the USB cable supplied with the device.

 **Caution** Do not connect any equipment other than PictBridge compliant devices, or the Bluetooth unit (option) to the direct print port of the printer. If you do so, electric shock, fire, or damage to the device could result.

 **Note** When producing photos with the digital device connected to the printer, it is advisable to use the AC adapter supplied with the device. If you use the device battery, be sure to charge it fully.

- 1** Turn on the printer.
- 2** Load the paper in the auto sheet feeder.
See “Loading Paper” on page 12.
- 3** Connect the PictBridge compliant device to the printer.

 **Note** Depending on the model or brand of your PictBridge compliant device, you may have to select a print mode before connecting the device.

You may also have to turn on the device or select Play mode manually after connecting the device to the printer.

Perform necessary operations according to the instruction manual supplied with your device.

- (1) Ensure that the device is turned off.
- (2) Connect the camera to the printer using the USB cable (for connection to a computer) supplied with the device.

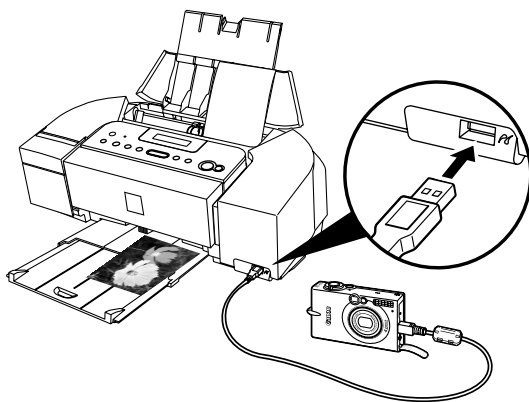

 **Note** Some types of the PictBridge compliant devices turn on automatically when connected to the printer. If the device does not turn on automatically, turn it on manually.

- (3) Turn on and set up the device for direct printing.
When the connection between the device and printer has been established, the **POWER** lamp on the printer flashes twice.

* The power-on sequence may differ depending on the model or brand of the device.

 will appear on the LCD display of the device when the printer is correctly connected.

■ Confirming or Changing the Device Settings

To change the paper size or paper type, operate the device to select the PictBridge print setup mode and confirm or change the settings.

You can change the following settings on the PictBridge setting screen displayed by pressing **Configuration** button. However, changes can be made on the PictBridge setting screen only when the corresponding items below are in the **Default** (selections based on the printer setting) using the controls of the device.

PictBridge compliant device setting items	PictBridge setting items (PICTBRIDGE SET) on the printer
Paper size: Default	PAGE SIZE
Paper type: Default	MEDIA TYPE
Print quality: Default	PRINT QLTY
Layout: Default	BORDERLESS PRINT
Image Optimize: Default	IMAGE ENHANCEMENT

You can select the page size, media type, borderless printing, and optimize on the printer when printing from a PictBridge compliant device.

- (1) Turn on the printer.
- (2) Press the **Configuration** button repeatedly to select the **PICTBRIDGE SET** and then press the **OK** button.
- (3) Confirm or change the settings.

Use the ◀▶ buttons to select the item to set and then press the **OK** button.

About the Settings Explained Below

The settings explained on the following pages cannot be made on some devices. If any setting cannot be made, the default setting explained above is used.

Names of settings that are displayed on Canon PictBridge compliant devices are used in the description given below.

Different names may be displayed on your device depending on the brand or model. For details, refer to your device's instruction manual.

■ About Image Data Format for Printing

This printer accepts images* taken with a camera compatible with the Design rule for Camera File system and PNG files.

*Exif2.21 compliant

■ About “Paper size” and “Paper type”

When you have selected the **Default** (selections based on the printer setting), the printer operates based on the PictBridge setting screen.

The following sizes and types of paper can be loaded in the printer by selecting options from **Paper Size** and **Paper Type**.

"Paper size" setting	"Paper type" setting	Paper loaded in printer
10 x 15 cm/4" x 6"	Photo	Photo Paper Plus Glossy
	Fast Photo	Photo Paper Pro
	Photo	Photo Paper Plus Semi-Gloss
	Photo	Glossy Photo Paper
	Photo	Photo Stickers* ¹
13 x 18 cm/5" x 7"* ²	Photo	Photo Paper Plus Glossy
A4/8.5" x 11" (Letter)* ³ * ⁴	Photo	Photo Paper Plus Glossy
	Fast Photo	Photo Paper Pro
	Photo	Photo Paper Plus Semi-Gloss
	Photo	Glossy Photo Paper
5.4 x 8.6 cm/Credit Card	Photo	Glossy Photo Paper Credit Card

*1 This paper is exclusively used to print photo stickers. When printing on sticker paper, select **10 x 15 cm/4" x 6"** in **Paper size**.

*2 This size can be selected only for Canon PictBridge compliant devices (note that it cannot be selected for some models).

*3 **Plain Paper** can be selected for **Paper type** when **A4** or **8.5" x 11" (Letter)** is selected for **Paper size**. When **Plain Paper** is selected for **Paper type**, bordered printing will be performed even when **Borderless** is selected for **Layout**.

*4 When **A4** or **8.5" x 11" (Letter)** is selected for **Paper size**, you can print in 4-up layout.

■ About "Layout" and "Trimming"

For **Layout**, when you have selected **Default** (selections based on the printer setting), the printer operates based on the PictBridge setting screen.

 **Note** When printing onto Photo Stickers (PS-101) (16-up), use the following settings.

1. Load Photo Stickers (PS-101) in the auto sheet feeder.
2. Select **10 x 15 cm/4" x 6"** for the **Paper size**, and **Photo** for the **Paper type**.
3. Select **N-up** for **Layout**, then select **16**.
Some PictBridge compliant devices display the **Layout** option; **2-up**, **4-up**, **9-up**, and **16-up**. In this case always select **16-up**.
If there are no options on the PictBridge compliant device that correspond to 2-up, 4-up, 9-up, or 16-up, printing on stickers is not possible.

By default, **Off (No trimming)** is selected for **Trimming**.

■ About “Image optimize”

When you have selected **Default** (selections based on the printer setting), the printer operates based on the PictBridge setting screen.

If you use a Canon PictBridge-compliant device, you can select **VIVID**, **NR**, **VIVID+NR**, or **Face**. (Note that these options cannot be selected for some models.)

-  **Notes**
- When **VIVID** is selected, green and blue portions of photos are printed vividly.
 - When **NR** (Noise Reduction) is selected, noise in blue portions, such as the sky, and dark portions is removed.
 - When **VIVID+NR** is selected, functions of both **VIVID** and **NR** are performed.
 - When **Face** is selected, backlit images are corrected when printed.

■ About “Date/File No. print”

By default, **Off** is selected for this printer.

If you select an image which has had the shooting date embedded in it using a camera with print mode, select **Off** for this function. If you select **Date**, **File No.**, or **Both**, the date and/or file number will be printed over the embedded date.

■ Other Settings

If you use a Canon PictBridge-compliant device, you can use the following print settings. (Note that these print settings cannot be used for some models.) For details, refer to your device’s instruction manual.

● **Shooting Info (Exif Data)**

You can print shooting Info (Exif Data) on photos in list format, or in the margins of specified photos.

Select **Layout**, then select the item displayed with the [i] icon.

● **35mm Film Style Layout (Contact Printing Layout)**

You can print selected photos or index-specified photos in 35 mm film style layout (contact printing layout).

Select **Layout**, then select the item displayed with the film icon.

-  **Notes**
- Never disconnect the USB cable during printing.
When disconnecting the USB cable between the product and printer, follow the device instructions given in the Instruction manual.
 - Controls of the digital camera cannot be used for the following:
 - Print quality setting
 - Printer maintenance
 - For the device operation method and troubleshooting, refer to your device’s manual.
 - For print error messages, see “Cannot Print Properly from the Digital Camera” on page 49.

Printing Photographs from a Wireless Communication Device

This section explains the printer's settings when printing photos through Bluetooth communication. If the optional Bluetooth unit BU-20 is connected to the printer, you can also print photos through Bluetooth communication. For details, refer to the *Bluetooth User's Guide*.

 **Note** The mobile phone supporting the OPP (Object Push Profile) or BIP (Basic Imaging Profile) can print photos. For details of profiles, refer to your product's instruction manual.

- When printing photos through Bluetooth communication:
 - See “Setting the Page Size, Media Type, and Layout When Printing From a Mobile Phone” below.
 - See “Performing Bluetooth Communication” on page 31.

Setting the Page Size, Media Type, and Layout When Printing From a Mobile Phone

You can select the page size, media type, layout and borderless printing on the wireless print setting screen when printing from a mobile phone through Bluetooth communication.

* The initial setting is borderless printing on 4"x6" Photo Paper Plus Glossy.

- 1** Turn on the printer.
- 2** Connect the Bluetooth unit BU-20 to the direct print port.

 **Note** **WIRELESS SETTINGS** cannot be selected until the Bluetooth unit is connected.

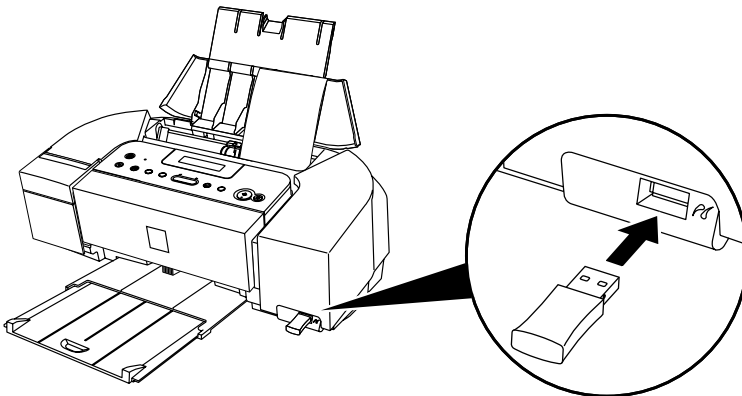

3 Press the **Configuration** button repeatedly to select the **WIRELESS SETTINGS** and then press the **OK** button.

4 Confirm or change the settings.

- (1) Use the ◀▶ buttons to select the item to set and then press the **OK** button. The photos in the mobile phone can be printed according to the following settings.

■ Setting Items

PAGE SIZE: Select the page size for the wireless print.

MEDIA TYPE: Select the media type for the wireless print.

 **Note** For information on wireless compatible page size and media type, see “Media Types for Card Direct Printing” on page 14.

LAYOUT: Select the layout of photos as below.
Sticker print: STICKR x16
Printing on paper other than sticker: Borderless print ON/OFF

IMAGE OPTIMIZER: Correct the contours and smooths out the jaggedness.

 **Note** When printing on Canon Photo Stickers, make the settings as below.

PAGE SIZE	MEDIA TYPE	LAYOUT
STICKER	PHOTO PAPER PLUS	STICKR x16

Performing Bluetooth Communication

■ Printing through Bluetooth communication

When you print through Bluetooth communication from a mobile phone, refer to your mobile phone manual.

1 Prepare to print.

- (1) Confirm the printer is ON.
- (2) Load the paper in the auto sheet feeder
See “Loading Paper” on page 12.

2 Connect the Bluetooth unit BU-20 to the direct print port.

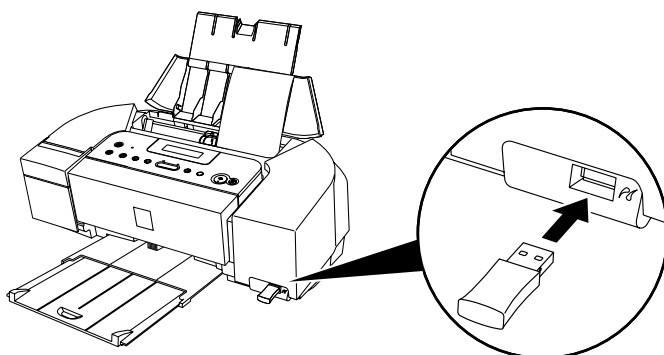

3 Set the print setting.

See “Setting the Page Size, Media Type, and Layout When Printing From a Mobile Phone” on page 29.

4 Start printing from a mobile phone.

- When you select the device name, select the initial value of this printer “Canon iP6310D-1”.
- If you are required to enter the passkey, enter the initial value “0000”.

You can change the device name of the printer or passkey in Bluetooth settings on the printer. See “Changing the Bluetooth Settings-Bluetooth settings” on page 32.

-  **Notes**
- Communication is possible up to about ten meters depending on the conditions below. The printing speed may change depending on the following conditions:
 - Presence of obstacles between the communication equipment and radio wave conditions.
 - Presence of magnetic fields, static electricity or electromagnetic interference.
 - Receiver sensitivity and antenna performance of the communication equipment.

About transmittable data

- It does not support printing a downloaded content or photo and a photo attached to an E-mail for security reason.
- It does not support printing video files.
- Depending on your device, it may not print data stored in a memory card.
- Depending on the size of a photo, it may take a while for this printer to start to print after starting the infrared transfer.
- It automatically sets the photo quality and orientation (horizontal or vertical) according to the photo size.
- It automatically sets to the margin according to the photo size.

■ Changing the Bluetooth Settings-Bluetooth settings

You can change the Bluetooth settings such as the device name of a printer and passkey.

1 Turn on the printer.

2 Connect the Bluetooth unit BU-20 to direct print port.

 **Note** **BLUETOOTH SET** cannot be selected until the Bluetooth unit is connected.

3 Press the **Configuration** button repeatedly to select the **BLUETOOTH SET** and then press the **OK** button.

4 Change the setting.

Use the ◀▶ buttons to select the setting item you want to change and then press the **OK** button.

■ Setting Items

- **DEVICE NAME:** Select the device name of this printer displayed on the screen of the Bluetooth devices.
When you set **iP6310D-2**, the printer name on the Bluetooth device is "Canon iP6310D-2".
The initial value is set to **iP6310D-1**.
- **ACCESS REFUSAL:** Selecting **ON** will disable search for this printer from Bluetooth devices.
- **SECURITY:** Selecting **ON** will enable a passkey.
Setting a passkey will prevent incorrect access from other Bluetooth devices.
- **PASSKEY:** You can change the passkey. The passkey refers to an identification number to be determined. It is used to prevent incorrect access from other Bluetooth devices.
The initial value is set to "0000".
After you change the passkey, you are require to enter the new passkey again. Enter the new passkey to the Bluetooth device.

Using Data in the Memory Card on the Computer

Browsing Photos in the Memory Card on the Computer

By pressing the **Easy-PhotoPrint Startup** button, you can display photos in the memory card on the computer display with Easy-PhotoPrint, if the printer is connected to the computer. You can print the photos from Easy-PhotoPrint.

 **Important** To use the **Easy-PhotoPrint Startup** button, connect the printer to the computer and install the printer driver, Memory Card Utility, and Easy-PhotoPrint. For more information on installation, refer to the *Easy Setup Instructions*.

1 Ensure that both the printer and the computer are turned on, and connected by a USB cable.

2 Press the **Easy-PhotoPrint Startup** button.

Easy-PhotoPrint starts on the computer.

 **Note** For information on printing with Easy-PhotoPrint and other details, refer to the *Photo Application Guide*.

Saving Data in the Memory Card onto the Computer

By pressing the **Save** button, you can save the data in the memory card on the hard disk of the computer.

 **Important** To use the **Save** button, connect the printer to the computer and install the Memory Card Utility. For more information on installation, refer to the *Easy Setup Instructions*.

1 Ensure that both the printer and the computer are turned on, and connected by a USB cable.

2 Press the **Save** button.

The photos will be saved to a folder created in the location specified below. The folder will be named automatically according to the date that it was created (YYYY_MM_DD).

Windows XP/Windows 2000/Windows Me: **My Pictures** folder

Windows 98: **My Documents** folder

Mac OS X v.10.2.8 or later: **Pictures** folder

Setting up the Card Slot as the Memory Card Drive of the Computer

The card slot of the printer can also be used as the memory card drive of the computer.

-  **Important**
- To use the card slot of the printer as the memory card drive of the computer, the printer must be connected to the computer and the Memory Card Utility must have been installed for Windows Me/Windows 98/Windows 98 Second Edition. If the utility is not installed, install it following the installation procedure explained in the *Easy Setup Instructions*.
 - When **OFF** is selected in the **READ-ONLY MODE** screen, you cannot print photos in the memory card. After using the card slot as the memory card drive of the computer, remove the memory card, then be sure to select **ON** in the **READ-ONLY MODE** screen again.

- 1** Ensure that both the printer and the computer are turned on, and connected by a USB cable.
- 2** Press the **Configuration** button repeatedly to select **OTHERS**.
- 3** Use the **◀▶** buttons to select **READ-ONLY MODE** and then press the **OK** button.
- 4** Specify the **READ-ONLY MODE**.
 - (1) Use the **◀▶** buttons to select a mode.
 - When selecting **OFF**, the card slot is used as the memory card drive of the computer. Photo data can be written into the memory card.
 - When selecting **ON**, the card slot is used only for reading. Be sure to select this mode when printing photos.
 - (2) Press the **OK** button.

 **Notes** If you use the card slot of the printer as the memory card drive of the computer, follow the instructions for removal of the memory card from the computer, before removing it.

- Windows: Right-click the removable disk icon and click **Eject**.
If **Eject** is not displayed on the screen, ensure that the indicator lamp is not flashing and remove the memory card.
- Macintosh: Be sure to drag the  icon into the **Trash**.

Printing Maintenance

When Printing Becomes Faint or Colors are Incorrect

When printing becomes faint or colors are incorrect, the print head nozzles are probably clogged. Follow the procedures below to clean the nozzles.

 **Note Before Performing Maintenance**

Remove the FINE Cartridge once, then insert it into place again. See “Replacing a FINE Cartridge” on page 39.

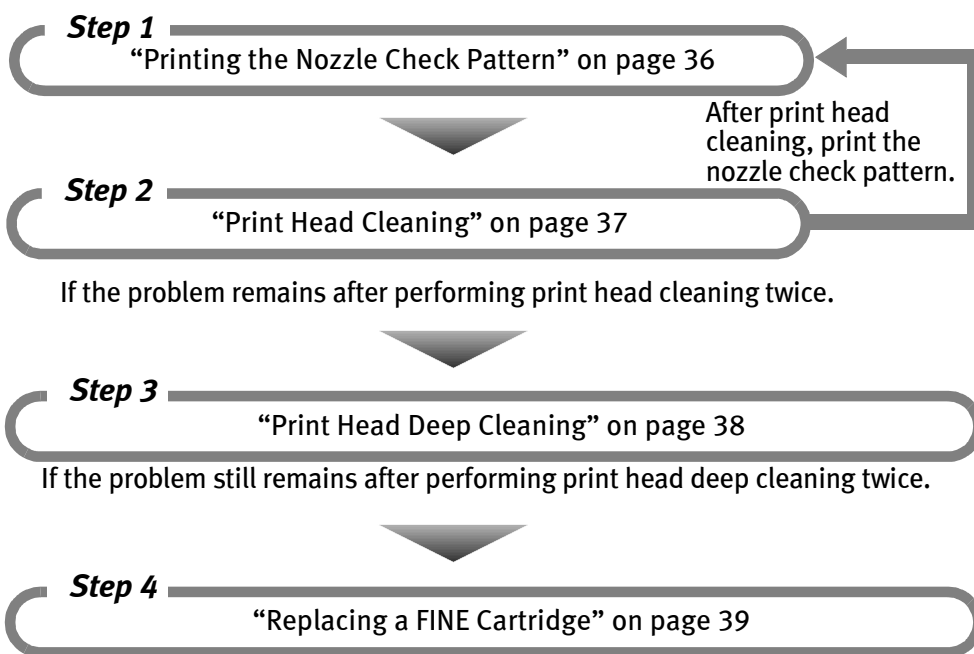

 **Note** If ruled lines are misaligned, adjust the print head position. See “Aligning the Print Head - Auto head align” on page 38.

Printing the Nozzle Check Pattern

Print the nozzle check pattern to determine whether the ink ejects properly from the print head nozzles. Use this function when printed results are blurred or the colors are incorrect.

- 1 With the printer on, load a sheet of A4/Letter-sized plain paper in the auto sheet feeder.

Move the paper thickness lever to the left position.

- 2 Print the nozzle check pattern.

- (1) Press the **Configuration** button repeatedly to select **MAINTENANCE**.
- (2) Use the ◀▶ buttons to select **NOZZLE CHECK** and then press the **OK** button. Do not open the front cover while printing.
- (3) Examine the nozzle check pattern.
See below.

Examining the Nozzle Check Pattern

The nozzle check pattern should appear as follows when ink is discharged properly. Examine the nozzle check pattern output by the printer.

 **Note** If the ink level is low, the nozzle check pattern is not printed properly. Stop printing the nozzle check pattern, and replace the FINE Cartridge. See “Replacing a FINE Cartridge” on page 39.

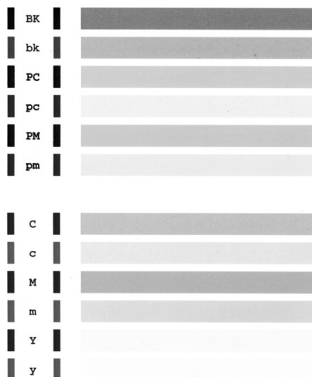

- 1 Confirm the printed nozzle check pattern.

White stripes in this pattern indicate that the FINE Cartridges require cleaning.



When white stripes appear

See “Print Head Cleaning” on page 37.

Print Head Cleaning

If white stripes are found in the printed nozzle check pattern, perform the print head cleaning to unclog the print head nozzles. Cleaning the print head consumes ink, so perform the print head cleaning only when necessary.

1 Ensure that the printer is on.

2 Start print head cleaning.

(1) Press the **Configuration** button repeatedly to select **MAINTENANCE**.

(2) Use the ◀▶ buttons to select **CLEANING** and then press the **OK** button.

 **Important** Do not perform any other operations until the print head cleaning finishes. This takes about 30-50 seconds.

 **Note** **After print head cleaning finishes**
After print head cleaning finishes, print the nozzle check pattern to verify that the print head nozzles are clean.
See “Printing the Nozzle Check Pattern” on page 36.

If the problem remains after performing print head cleaning twice, try print head deep cleaning.

See “Print Head Deep Cleaning” on page 38.

Print Head Deep Cleaning

If print quality does not improve by the standard print head cleaning, try print head deep cleaning, which is a more powerful cleaning process. Print head deep cleaning consumes more ink than standard print head cleaning, so perform this procedure only when necessary.

1 Ensure that the printer is on.

2 Start print head deep cleaning.

- (1) Press the **Configuration** button repeatedly to select **MAINTENANCE**.
- (2) Use the ◀▶ buttons to select **DEEP CLEANING** and then press the **OK** button.

 **Important** Do not perform any other operation until the print head deep cleaning finishes. This takes about 1-2 minutes.

 **Note** After print head deep cleaning finishes, print the nozzle check pattern to verify that the print head nozzles are clean.
See “Printing the Nozzle Check Pattern” on page 36.
If the problem persists, perform the print head deep cleaning again.
If the problem remains, the printer may have run out of ink.
See “Replacing a FINE Cartridge” on page 39.
If the problem continues to exist, the printer may be damaged. Contact the Customer Care Center.

Aligning the Print Head - Auto head align

If ruled lines are misaligned or a printout is unsatisfactory, print head alignment is required.

1 With the printer on, load a sheet of A4/Letter-sized plain paper in the auto sheet feeder.

Move the paper thickness lever to the left position.

2 Align the print head automatically.

- (1) Press the **Configuration** button repeatedly to select **MAINTENANCE**.
- (2) Use the ◀▶ buttons to select **AUTO HEAD ALIGN** and then press the **OK** button.
Do not open the front cover while printing.

 **Notes**

- You can print the current settings of the print head position by selecting **HEAD ALIGN PRINT**.
- **When Automatic Print Head Alignment Cannot Be Executed Correctly**
When automatic print head alignment cannot be executed correctly, the message “**HEAD ALIGNMENT ERROR**” is displayed on the LCD. See “An Error Message is Displayed on the LCD” on page 44.

Replacing a FINE Cartridge

If there is no improvement with the quality of printing following such maintenance as print head cleaning, a FINE Cartridge is probably empty. Replace the empty FINE Cartridge with a new one. When replacing a FINE Cartridge, check the model number very carefully. The printer will not print properly if a wrong FINE Cartridge is used, or installed wrong.

Color: CL-41



Photo: CL-52



 **Note** The High Yield Color FINE Cartridge (CL-51) can be installed as option.

Replacing a FINE Cartridge

When a FINE Cartridge runs out of ink, replace them using the following steps.

- 1** Ensure that the printer is on.
- 2** Open the card slot cover first and then open the front cover.
The FINE Cartridge holder moves to the left.
- 3** Remove the empty FINE Cartridge.

(1) Push down the FINE Cartridge. (2) Remove the FINE Cartridge.

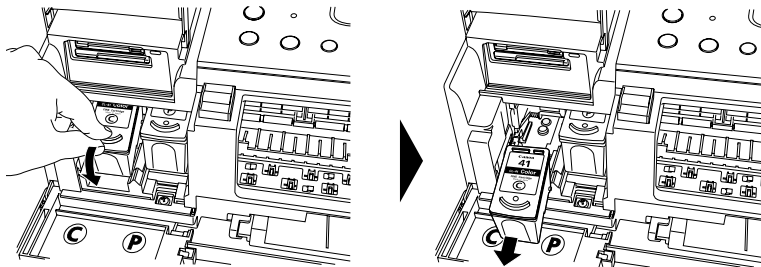

-  **Important**
- Handle the FINE Cartridge carefully to avoid staining clothing or the surrounding area.
 - Discard the empty FINE Cartridge according to the local laws and regulations.

4 Prepare a replacement FINE Cartridge.

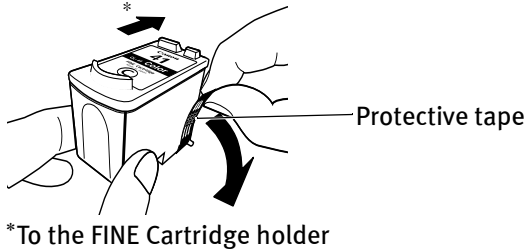

Unpack a new FINE Cartridge and remove the orange protective tape gently.

- Important**
- Do not reattach the protective tape once you have removed it.
 - Handle the removed protective tape carefully to avoid getting your hands dirty or staining surrounding work area.
 - Once the protective tape is removed, do not touch the electrical contacts or print head nozzles on a FINE Cartridge. The printer may not print out properly if you touch it.

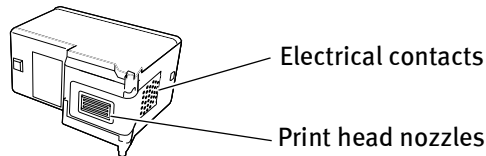

5 Install the new FINE Cartridge.

The Color FINE Cartridge should be installed into the left slot (C) and the Photo FINE Cartridge should be into the right slot (P).

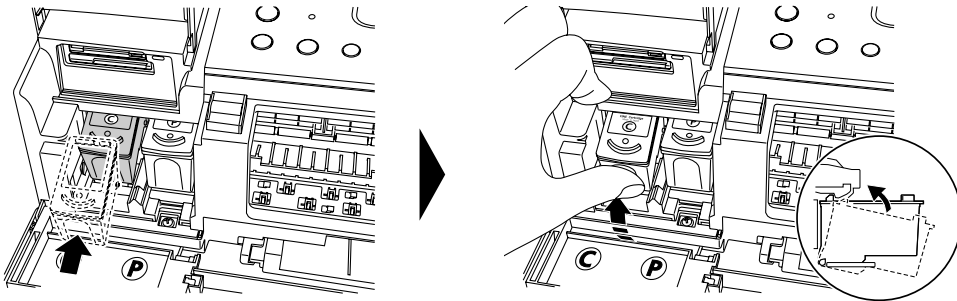

- (1) Insert a new FINE Cartridge slightly slanted.
- (2) Push up the FINE Cartridge until it clicks into place.

6 Close the front cover first and then close the card slot cover.

The FINE Cartridge holder moves to the right.

 **Note** If straight lines are misaligned or the resulting output is unsatisfactory, align the print head position.
See “Aligning the Print Head - Auto head align” on page 38.

-  **Important**
- To maintain optimal print quality, we recommend that you use Canon brand FINE Cartridge. Replenishing ink only is also not recommended.
 - Replace the FINE Cartridge promptly. Do not leave the FINE Cartridge removed.
 - When a FINE Cartridge runs out of ink, replace the FINE Cartridge with a new one immediately. If you replace it with the FINE Cartridge that has been removed once, the printer may not print properly due to clogged print head nozzles. And, the low ink warning message which relays the exchange time of a FINE Cartridge will be off.
 - To maintain optimal print quality, FINE Cartridge should be installed until the “recommended date of replacement”. And, use up all ink in the FINE Cartridge within six months from its first use (We recommend that you take note of the date when the FINE Cartridge is installed to the printer).

What is Low Ink Warning?

The low ink warning is that the ink counter counts a remaining level of ink and tells you that FINE Cartridges are running out of ink before printing.

The ink counter considers as ink is full when new FINE Cartridge is installed, and then starts counting a remaining level of ink. For this, if old FINE Cartridge is installed, a remaining level of ink cannot be displayed correctly.

- When the following message appears on the LCD:

C INK LOW

P INK LOW

You should purchase new FINE Cartridge.

CHECK INK

U162

Printing stops. Possible causes are as follows:

- This FINE Cartridge has previously been used.
- Ink may have run out.

The function for detecting the remaining ink level will be disabled since the remaining ink level cannot be correctly detected.

Pressing the **OK** button cancels the error messages and enables continuation of printing. However, error detection function will be disabled after the error indication is canceled, therefore, the low ink warning message does not appear later on. When you install new FINE Cartridge, the low ink warning is enabled automatically.

Troubleshooting

Let's take a look at countermeasures against troubles which may occur during use of the printer.

 **Note** Here, we will discuss errors indicated on the LCD, problems that might occur during direct printing from the digital camera. If you cannot find the symptom corresponding to a certain problem, refer to the *User's Guide*.

- “An Error Message is Displayed on the LCD” on page 43
- “POWER Lamp and Alarm Lamp Flash Alternately” on page 45
- “An Unintended Language is Displayed on the LCD” on page 45
- “Ink Does Not Come Out/ Printing is Blurred/Colors are Wrong/White Streaks” on page 45
- “Back of Paper is Smudged/Paper Does Not Feed Properly/Printed Surface is Scratched” on page 46
- “Paper Jams” on page 48
- “Cannot Print Properly from the Digital Camera” on page 49

■ An Error Message is Displayed on the LCD

If **Alarm** lamp lights and an error message is displayed on the LCD, take the corresponding countermeasure described below.

Message	Try This
NO PHOTOS ON CARD	<ul style="list-style-type: none"> • Photo data edited/processed on the computer should be printed from the computer, not from the camera. • There is no proper data in the memory card. See “Memory Cards Supported by This Printer” on page 9.
LOAD PAPER	Reload the paper correctly and press the OK button.
PAPER JAMMED	If paper has jammed in the printer, clear the jam, reload the paper in the printer correctly and then press the OK button. See “Paper Jams” on page 48.
CHECK INK U041	Replace the FINE Cartridge, and close the front cover. If lines are misaligned or the resulting output is not satisfactory, carry out the Print Head Alignment. If printing is in progress and you want to continue printing, press the OK button. Then printing can continue under the ink out condition with the FINE cartridge installed. Replace the empty FINE cartridge immediately after the printing. The resulting print quality is not satisfactory, if printing is continued under the ink out condition.
CHECK INK U051 U052 U053 U059	Possible causes are as follows: <ul style="list-style-type: none"> • The FINE Cartridge may not be installed properly. • The FINE Cartridge may not be the compatible with this printer. Install the appropriate FINE Cartridge. If lines are misaligned or the resulting output is not satisfactory, carry out the Print Head Alignment.
CHECK INK U075 U076	Some FINE Cartridges are not installed in place. Install the FINE Cartridges in the appropriate positions.
WASTE INK NEAR FULL	The printer has a built-in ink absorber to hold the ink used during print head cleaning, for example. This error message indicates that the ink absorber is nearly full. Press the OK button to cancel the error so you can continue printing. Before the ink absorber becomes completely full, contact the Customer Care Center. (You will need to replace a particular part of the printer.) Canon recommends that you call for service as soon as this error occurs. Once the ink absorber becomes completely full, printing cannot be performed until the ink tank is replaced.

Message	Try This
INCOMPATIBLE CAMERA	<p>Disconnect the camera cable and reconnect it.</p> <p>Depending on the model or brand of your PictBridge compliant device, you may have to select a print mode before connecting the device.</p> <p>You may also have to turn on the device or select Play mode manually after connecting the device to the printer.</p> <p>Perform necessary operations according to the instruction manual supplied with your device.</p> <p>If the error is still unresolved, there is a possibility that you are using a digital camera or digital video camcorder that is not supported by this printer. PictBridge-compatible digital camera or digital video camcorder can be connected to your printer for Direct Printing.</p>
HEAD ALIGNMENT ERROR	<p>Possible causes are as follows:</p> <ul style="list-style-type: none"> • Other than A4/Letter-sized plain paper is loaded. Press the OK button to clear the error, and then load A4/Letter-sized plain paper in the auto sheet feeder. • Print head nozzles are clogged. Press the OK button to clear the error, and then print the nozzle check pattern to examine the print head condition. For information on how to print a nozzle check pattern, See “Printing the Nozzle Check Pattern” on page 36. • The paper output slot has been exposed to a strong light source preventing current print head alignment. Press the OK button to clear the error and move the printer to a darker location. <p>After carrying out the above measures, if the problem continues after aligning the print head again, press the OK button to clear the error, and then perform manual print head alignment. For details on manual print head alignment, see “Adjusting the Print Head Manually” on page 44.</p>
CHECK INK U140	<p>The FINE Cartridge may not be the compatible with this printer.</p> <p>Install the appropriate FINE Cartridge. If lines are misaligned or the resulting output is not satisfactory, carry out the Print Head Alignment.</p>
CHECK INK U162	<p>Possible causes are as follows:</p> <ul style="list-style-type: none"> • This FINE Cartridge has previously been used. • Ink may have run out. <p>The function for detecting the remaining ink level will be disabled since the remaining ink level cannot be correctly detected. If you want to continue printing without this function, press the OK button.</p> <p>Canon recommends to use new genuine Canon cartridges in order to obtain optimum qualities.</p>
CHECK PRINTER	<p>An error that requires contacting the Customer Care Center may have occurred. (POWER lamp and Alarm lamp alternately.)</p> <p>Disconnect the printer cable from the printer, and then turn the printer off and unplug the printer from the power supply. Plug the printer back in and turn the printer back on after leaving it for a while.</p> <p>If the problem remains, contact the Customer Care Center.</p>



Adjusting the Print Head Manually

If the automatic print head adjustment does not work or if you wish to adjust the print heads manually, follow the procedure below.

1. With the printer on, load a sheet of A4/Letter-sized plain paper in the auto sheet feeder.
2. Press the **Configuration** button repeatedly to select **MAINTENANCE**.
3. Use the **◀▶** buttons to select **ALIGN PRINT HEAD** and then press the **OK** button.



4. Examine the printed pattern and enter the number of column “A” with fewest white stripes using the **◀▶** buttons.
5. Press the **OK** button.
6. Repeat Steps (4) through (5) and enter the pattern numbers up to column “N”.

■ POWER Lamp and Alarm Lamp Flash Alternately

Possible Cause	Try This
An error that requires contacting the Customer Care Center may have occurred	Disconnect the printer cable from the printer, and then turn the printer off and unplug the printer from the power supply. Plug the printer back in and turn the printer back on after leaving it for a while. If the problem remains, contact the Customer Care Center.

■ An Unintended Language is Displayed on the LCD

Possible Cause	Try This																																
The language you want to be displayed is not selected	<p>Select the language according to the following procedure.</p> <ol style="list-style-type: none"> (1) Press the POWER button to turn off the printer. (2) Press the POWER button to turn on the printer. (3) Press the Configuration button three times. If the Bluetooth unit is attached to the printer, press the Configuration button five times. (4) Press the ▶ button twice. (5) Press the OK button. (6) Press the ◀ button repeatedly to select the leftmost language. (7) Press the ▶ button the number of times in the following table according to your desired language. <table border="1"> <thead> <tr> <th>Language</th> <th>Time(s)</th> <th>Language</th> <th>Time(s)</th> </tr> </thead> <tbody> <tr> <td>Japanese</td> <td>0</td> <td>Portuguese</td> <td>7</td> </tr> <tr> <td>English</td> <td>1</td> <td>Swedish</td> <td>8</td> </tr> <tr> <td>German</td> <td>2</td> <td>Russian</td> <td>9</td> </tr> <tr> <td>French</td> <td>3</td> <td>Czech</td> <td>10</td> </tr> <tr> <td>Italian</td> <td>4</td> <td>Hungarian</td> <td>11</td> </tr> <tr> <td>Spanish</td> <td>5</td> <td>Polish</td> <td>12</td> </tr> <tr> <td>Dutch</td> <td>6</td> <td>Turkish</td> <td>13</td> </tr> </tbody> </table> <ol style="list-style-type: none"> (8) Press the OK button. The desired language is displayed on the LCD. (9) Press the Stop/Reset button. 	Language	Time(s)	Language	Time(s)	Japanese	0	Portuguese	7	English	1	Swedish	8	German	2	Russian	9	French	3	Czech	10	Italian	4	Hungarian	11	Spanish	5	Polish	12	Dutch	6	Turkish	13
Language	Time(s)	Language	Time(s)																														
Japanese	0	Portuguese	7																														
English	1	Swedish	8																														
German	2	Russian	9																														
French	3	Czech	10																														
Italian	4	Hungarian	11																														
Spanish	5	Polish	12																														
Dutch	6	Turkish	13																														

■ Ink Does Not Come Out/ Printing is Blurred/Colors are Wrong/White Streaks

Possible Cause	Try This
A FINE Cartridge is not seated properly/FINE Cartridge is empty	<ul style="list-style-type: none"> • Open the card slot cover first and the front cover next, and press up the FINE Cartridge to install it properly. • Ensure that the specified FINE Cartridge is installed. If the specified FINE Cartridge is not used, good printing color quality cannot be expected. See "Replacing a FINE Cartridge" on page 39.
Incorrect media type	On the operation panel, confirm that the media type selected matches the paper loaded.
Print head nozzles clogged or shifted	<p>Print the nozzle check pattern to check for uneven ink output. When a specific color is missing from the nozzle check pattern, clean the print head.</p> <ul style="list-style-type: none"> • If ink supply is uneven: See "Print Head Cleaning" on page 37. • If straight lines are shifted: See "Aligning the Print Head - Auto head align" on page 38.
Media not loaded print-side up	<p>Check that your paper is loaded with the correct print side facing up.</p> <p> Note Follow the instructions packaged with your specialty media for loading and handling.</p>

■ Back of Paper is Smudged/Paper Does Not Feed Properly/Printed Surface is Scratched

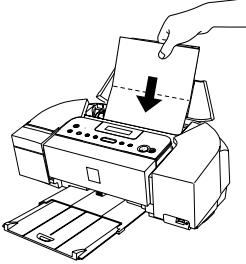
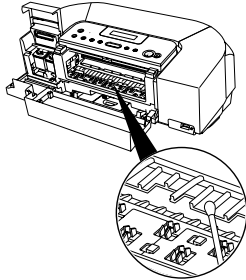
Possible Cause	Try This
<p>Inside of the printer is dirty</p>	<p>If the inside of the printer is dirty, printed paper may be smudged. Follow the steps described below to clean the inside of the printer.</p> <ol style="list-style-type: none"> (1) Ensure that the printer is turned on and there is no paper loaded in the auto sheet feeder. (2) Place A4/Letter-sized plain paper in landscape, horizontally fold it in half. (3) Unfold the paper, and load the paper in the auto sheet feeder with the inverted-V edge down.  <ol style="list-style-type: none"> (4) Press the Configuration button repeatedly to select MAINTENANCE. (5) Use the ◀▶ buttons to select BOTTOM CLEANING and then press the OK button. Paper will be ejected. <p>If protrusions inside the printer are stained, wipe ink off the protrusions using a swab or the like.</p>  <p>Important</p> <p>Before cleaning, be sure to turn off the printer.</p>
<p>Paper feed roller is dirty</p>	<p>Follow the steps described below to clean the paper feed rollers.</p> <p>Since the paper feed roller cleaning exhausts the paper feed roller, perform only when it is needed.</p> <ol style="list-style-type: none"> (1) Ensure that the printer is turned on. If the paper is loaded in the printer, remove the paper. (2) Press the Configuration button repeatedly to select MAINTENANCE. (3) Use the ◀▶ buttons to select ROLLER CLEANING and then press the OK button. The paper feed roller will rotate as it cleans. (4) Repeat (2) through (3) twice. (5) Load three or more sheets of A4/Letter-sized plain paper lengthways in the auto sheet feeder. (6) Press the Configuration button repeatedly to select MAINTENANCE. (7) Use the ◀▶ buttons to select ROLLER CLEANING and then press the OK button. The paper that is loaded in the printer will feed through the printer and be ejected. (8) Repeat (6) through (7) three times. <p>If repeating this procedure three times or more does not solve the problem, contact the Customer Care Center.</p>

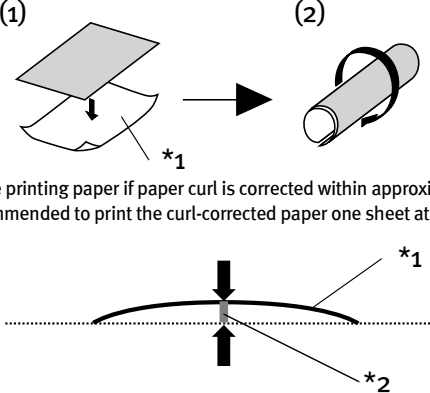
Possible Cause	Try This
<p>Inappropriate media type is used</p>	<ul style="list-style-type: none"> • Check to see if the paper you are printing on is too thick. See “Print Media to Avoid” on page 12. • Note that smudging may occur at the top and bottom edges of the paper when using borderless printing. Ensure that the paper you are using is compatible with borderless printing. <p>If all four corners or the printing surface of the paper is curled, the paper may become dirty or not feed properly through the printer. Use the paper after correcting paper curl as follows.</p> <ol style="list-style-type: none"> (1) Place the paper on a flat surface with the print side^{*1} face up, then cover it with plain regular paper to avoid damaging the surface. (2) Roll up the paper in the opposite direction as shown in the figure below.  <ol style="list-style-type: none"> (3) Check the printing paper if paper curl is corrected within approximately 2 to 5 mm/0.08 to 0.2 inches^{*2}. It is recommended to print the curl-corrected paper one sheet at a time.
<p>Paper thickness lever position is not proper</p>	<p>Set the paper thickness lever to the left position. If the paper is scratched even when printing on plain paper, set the paper thickness lever to the right position. Return the paper thickness lever to the left after printing.</p>

■ Paper Jams

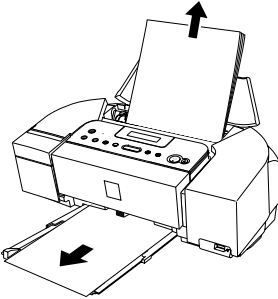
Possible Cause	Try This
Landscape credit card-sized paper jams inside the printer	You cannot load credit card-sized paper in the landscape orientation. Slowly pull the paper out from the auto sheet feeder.
Paper jams in the paper output slot	<p>Remove the paper according to the following procedure.</p> <p>(1) Slowly pull the paper out, either from the auto sheet feeder or from the paper output slot, whichever is easier.</p>  <ul style="list-style-type: none">• If the paper tears and a piece remains inside the printer, open the card slot cover first and the front cover next, and remove it. <p>⚠ Caution</p> <p>Be careful not to touch any components inside the printer.</p> <p>After removing all paper, close the front cover first and the card slot cover next.</p> <p>If you cannot pull the paper out, turn the printer off and turn it back on. The paper will be ejected automatically.</p> <p>(2) Reload the paper into the printer and press the OK button.</p> <p>If you cannot remove the paper or if the paper tears inside the printer, or if the paper jam error continues after removing the paper, contact the Customer Care Center.</p>

■ Cannot Print Properly from the Digital Camera

The following are the possible errors that may occur when printing directly from a digital still camera or digital video camcorder*, and the countermeasures to eliminate them.

* Hereafter, the digital still camera and digital video camcorder are collectively called a digital camera or camera.



Note

This section describes errors that are indicated on Canon-brand PictBridge-compatible cameras.

The error messages and operations may vary depending on the camera you are using. If you cannot clear the error on your device, check the error message displayed on the LCD of the printer, and then clear it. For details, see “An Error Message is Displayed on the LCD” on page 43.

Error message on camera	Try This
Printer in use	Images are being printed from the computer. Wait until printing ends. The printer automatically starts printing the images from the camera after completing the current printing. If the printer is warning up, wait until warm-up ends. When it is ready, the printer starts printing automatically.
No paper	Load paper in the auto sheet feeder, and select Continue ^{*1} in the display on your camera.
Paper jam	Select Stop in the display on your camera to stop printing. Remove the jammed paper, load new paper, and press the OK button on the printer and retry printing.
Paper lever error	Set the paper thickness lever to the left position. If the paper is scratched even when printing on plain paper, set the paper thickness lever to the right position. Return the paper thickness lever to the left after printing.
Printer cover open	Close the front cover on the printer.
No printhead	Possible causes are as follows: <ul style="list-style-type: none"> • The FINE Cartridge may not be installed properly. • The FINE Cartridge may not be the compatible with this printer. Install the appropriate FINE Cartridge. If lines are misaligned or the resulting output is not satisfactory, carry out the print head alignment. • Some FINE Cartridges are not installed in place. Install the FINE Cartridges in the appropriate positions.
Waste tank (ink absorber ^{*2}) full/ Ink absorber ^{*2} full	The printer has a built-in ink absorber to hold the ink used during print head cleaning, for example. You can continue printing for a while by selecting Continue ^{*1} in the display on your camera. However, because printing is disabled once the ink absorber becomes completely full and until the ink tank is replaced, you are recommended to contact the Customer Care Center as early as possible. (You will need to replace a particular part of the printer.)

Error message on camera	Try This
No ink	<p>Possible causes are as follows:</p> <ul style="list-style-type: none"> • The ink has run out. Replace the FINE Cartridge, and close the front cover. If lines are misaligned or the resulting output is not satisfactory, carry out the print head alignment. If printing is in progress and you want to continue printing, press the OK button on the printer. Then printing can continue under the ink out condition with the FINE Cartridge installed. Replace the empty FINE Cartridge immediately after the printing. The resulting print quality is not satisfactory, if printing is continued under the ink out condition. • Some FINE Cartridges are not installed in place. Install the FINE Cartridges in the appropriate positions. • The FINE Cartridge may not be compatible with this printer. Install the appropriate FINE Cartridge. If lines are misaligned or the resulting output is not satisfactory, carry out the print head alignment. • This FINE Cartridge has previously been used. • Ink may have run out. The function for detecting the remaining ink level will be disabled since the remaining ink level cannot be correctly detected. If you want to continue printing without this function, press the OK button. Canon recommends to use new genuine Canon cartridges in order to obtain optimum qualities.
Printer error	<p>An error requiring servicing might have occurred. (Printer POWER lamp and Alarm lamp flash alternately.) Disconnect the cable between the printer and the camera. Turn off the printer and unplug the power cord of the printer from the power supply. After a while, plug the power cord of the printer back in, turn on the printer, and then reconnect the camera to the printer. If the same problem occurs, contact the Customer Care Center.</p>
Hardware Error	<p>FINE Cartridge errors have occurred. Replace the FINE Cartridge. See "Replacing a FINE Cartridge" on page 39.</p>

*1 To resume printing, you can press the **OK** button on the printer instead of selecting **Continue**.
*2 The ink absorber absorbs ink used during cleaning, for example. If this message appears, you will need to call for servicing to replace the absorber and to check the printer for proper operation.

Notes

- PictBridge-compatible digital cameras can be connected to your printer for direct printing.
- A communication time out occurs if printing takes a long time or if it takes too much time to send data. This may stop printing. In such a case, disconnect the cable between the printer and the camera, and reconnect it. Then, turn the camera on, if it does not automatically turn on just by connecting the cable. If the problem is still unresolved, select some other photo and check if it can be printed or not.
- Depending on the model or brand of your PictBridge compliant device, you may have to select a print mode before connecting the device. You may also have to turn on the device or select Play mode manually after connecting the device to the printer. Perform necessary operations according to the instruction manual supplied with your device.
- The print head nozzles may be clogged if printing becomes faint or colors are incorrect. See “When Printing Becomes Faint or Colors are Incorrect” on page 35.
- If the paper is curled or its surface is scratched during printing, make sure that you are using the correct type of paper. If this error occurs even when you are using the correct type of paper, set the paper thickness lever to the right position.
- To disconnect the cable connected between a digital camera and printer, follow the procedure below.
 1. Disconnect the cable from the printer.
 2. Turn off the digital camera.
 3. Disconnect the cable from the digital camera.

When disconnecting the cable, be sure to hold the connector by its sides.
- For the errors indicated on the camera and their solution, also refer to the user’s manual of the camera. For other troubles on the digital camera, contact the manufacturer of the camera.

Index

- A**
- Adjusting the Print Head Manually 44
 - Alarm Lamp 3
 - ALIGN PRINT HEAD 6, 44
 - Aligning the Print Head 38
 - AUTO HEAD ALIGN 6, 38
 - Auto sheet feeder 12
- B**
- BLUETOOTH SET 6
 - BORDERLESS PRINT 22
 - BORDERLESS PRINT (PictBridge) 6, 26
 - BOTTOM CLEANING 6, 46
 - BRIGHTNESS 22
- C**
- Card slot 10
 - Card slot cover 10
 - CL-41 39
 - CL-51 39
 - CL-52 39
 - CLEANING 6, 37
 - COLOR 22
 - Configuration Button 3, 6
 - CONTRAST 22
- D**
- Date/File No. print (PictBridge) 28
 - DATE/TIME SETUP 6, 23
 - DEEP CLEANING 6, 38
 - Digital Camera 24
 - Digital Camera (Troubleshooting) 49
 - Direct Print Port 4
 - DPOF 5, 21
- E**
- Easy-PhotoPrint Startup Button 3, 33
- F**
- FACE BRIGHT 22
 - FILE NO. PRINT 22
 - FINE Cartridge 39
- H**
- HEAD ALIGN PRINT 6, 38
- I**
- IMAGE ENHANCEMENT 22
 - IMAGE ENHANCEMENT (PictBridge) 6, 26
 - Image optimize (PictBridge) 28
 - IMAGE OPTIMIZER (Wireless) 6, 30
 - INDEX 5, 15
 - Ink absorber 49
 - Ink Does Not Come Out 45
- L**
- LANGUAGE SETTING 6
 - Layout (PictBridge) 27
 - LAYOUT (Wireless) 6, 30
 - LCD 5
 - LCD (Troubleshooting) 43
 - LOAD CONFIGURATION 6, 17
 - Load limit mark 13
 - Loading Paper 12
 - Low ink warning 42
- M**
- MAINTENANCE 6
 - MEDIA TYPE 22
 - Memory Card Utility 33, 34
 - Menu Button 3, 5
- N**
- NOZZLE CHECK 6, 36
 - NR (Noise Reduction) 28
- O**
- OPTIMIZER 22
 - OTHERS 6, 23
- P**
- PAGE SIZE 22
 - Paper Jams 48
 - Paper size (PictBridge) 26
 - Paper type (PictBridge) 26
 - PictBridge 24
 - PICTBRIDGE SET 6, 26
 - POP 22
 - POWER Button 3
 - POWER Lamp 3
 - PRINT ALL PHOTOS 5, 20
 - PRINT DATE 22
 - PRINT QLTY 22
 - PRINT SETTINGS 6
 - Printing a Photo List – Print Index 15
 - Printing According to the Settings Made on the Camera –
DPOF Printing 20

Printing All Photos	20
Printing is Blurred	45
Printing Maintenance	35
Printing on the Sticker – Sticker Print	19

Q

QUIET MODE	6, 23
------------------	-------

R

READ-ONLY MODE	6
RED EYE CORR	22
REMOVE NOISE	22
RESTORE DEFAULT	6, 23
ROLLER CLEANING	6, 46

S

Save Button	3, 33
SAVE CONFIGURATION	6, 17
SELECT PHOTO	5, 16
SELECT RANGE	5, 18
Specifying Photos to Print	16
Specifying the Range of Photos in the Memory Card	18
STICKR	5, 19

T

Trimming (PictBridge)	27
-----------------------------	----

V

VIVID	22
-------------	----

W

White Streaks	45
WIRELESS SETTINGS	6, 29

Direct Printing Guide

Canon U.S.A., Inc.

One Canon Plaza, Lake Success, NY 11042, U.S.A.

Canon Inc.

30-2, Shimomaruko 3-chome, Ohta-ku, Tokyo 146-8501, Japan

Canon Canada, Inc.

6390 Dixie Road, Mississauga, Ontario, L5T 1P7, Canada

Canon Latin America, Inc.

703 Waterford Way, Suite 400, Miami, FL 33126, U.S.A.

Canon Mexicana

Boulevard Manuel Avila Camacho No. 138 PB
y Pisos 15, 16 y 17, Colonia Lomas de Chapultepec
Delegación Miguel Hidalgo, CP 11000, Mexico D.F.



The following FINE Cartridges are compatible with this printer.



CL-41



CL-52

The following FINE Cartridge (High Yield) is compatible with this printer as an option.



CL-51

For details on FINE Cartridge replacement, refer to “Replacing a FINE Cartridge” in this guide.