



Canon

IXUS 230 HS

Camera User Guide

- Make sure you read this guide, including the “Safety Precautions” section, before using the camera.
- Reading this guide will help you learn to use the camera properly.
- Store this guide safely so that you can use it in the future.

ENGLISH

Checking the Package Contents

Check if the following items are included in your camera package.
If anything is missing, contact the retailer where you purchased the camera.



Camera

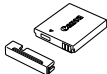

Battery Pack NB-4L
(with Terminal Cover)



Battery Charger
CB-2LV/CB-2LVE

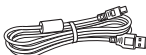

Interface Cable
IFC-400PCU



Wrist Strap
WS-DC11



Getting Started



DIGITAL CAMERA
Solution Disk



Warranty System
Booklet

Using the Manuals

Also refer to the manuals on the DIGITAL CAMERA Manuals Disk.

- **Camera User Guide (This Guide)**

Once you have mastered the basics, use the camera's many features to shoot more challenging photos.

- **Software Guide**

Read when you want to use the included software.



- A memory card is not included (p. 16).
- Adobe Reader is required to view the PDF manuals. Microsoft Word/Word Viewer can be installed to view the Word manuals (required only for manuals for the Middle East).

Read This First

- Take some initial test shots and play them back to make sure the images were recorded correctly. Please note that Canon Inc., its subsidiaries and affiliates, and its distributors are not liable for any consequential damages arising from any malfunction of a camera or accessory, including memory cards, that results in the failure of an image to be recorded or to be recorded in a way that is machine readable.
- The images recorded with this camera are intended for personal use. Do not record images that infringe upon copyright laws without the prior permission of the copyright holder. Please be advised that in certain cases the copying of images from performances, exhibitions, or commercial properties by means of a camera or other device may contravene copyright or other legal rights even if the image was shot for personal use.
- For information on your camera's warranty, please refer to the Canon Warranty System Booklet supplied with your camera. For Canon Customer Support contacts, please see the Warranty System Booklet.
- The LCD monitor is produced with extremely high-precision manufacturing techniques. More than 99.99% of the pixels operate to specification, but occasionally non-performing pixels may appear as bright or dark dots. This is not a malfunction and has no effect on the recorded image.
- The LCD monitor may be covered with a thin plastic film for protection against scratches during shipment. If covered, remove the film before using the camera.
- Please take care when operating the camera for an extended period as the camera body may become warm. This is not a malfunction.

What Do You Want to Do?



Shoot

- Shoot, leaving it to the camera to make settings (Auto mode) 26

Take good people shots



Portraits
(p. 62)



Kids and Pets
(p. 62)



At the Beach
(p. 63)



Against Snow
(p. 63)



Facial Expressions
(p. 79)

Shoot various other scenes



Night Scenes
(p. 63)



Low Light
(p. 63)



Foliage
(p. 63)



Fireworks
(p. 64)

Shoot with special effects



Vivid Colors (p. 65)



Poster Effect
(p. 65)



Fish-eye Effect
(p. 66)



Miniature Effect
(p. 66)



Toy Camera Effect
(p. 67)



Monochrome
(p. 68)

- Focus on faces 26, 62, 92
- Shoot in places where I cannot use the flash (turn off the flash) .. 52
- Take pictures with me in them too (self-timer)..... 55, 75
- Insert the date and time into my shots..... 54
- Shoot a movie clip just before taking a picture 72

**View**

- Look at my pictures 29
- Automatically play back pictures (slideshow) 117
- Look at my pictures on a TV 170
- Look at my pictures on a computer 34
- Quickly search pictures 114
- Erase pictures..... 30, 128

**Shoot/View Movies**

- Shoot movies 31, 103
- View movies 33
- Shoot fast moving subjects and play them back in slow motion. 106

**Print**

- Print pictures..... 142

**Save**

- Save images to a computer 34

**Other**

- Turn off sounds..... 46
- Use the camera abroad 16, 164
- Understand what is displayed on the screen 183

Table of Contents

Checking the Package Contents	2
Read This First	3
What Do You Want to Do?	4
Table of Contents	6
Conventions Used in This Guide	9
Safety Precautions.....	10

1 Getting Started 13

Charging the Battery.....	14
Compatible Memory Cards (Sold Separately).....	16
Inserting the Battery and Memory Card.....	17
Setting the Date and Time	20
Setting the Display Language.....	22
Formatting Memory Cards	23
Pressing the Shutter Button.....	25
Taking Pictures (Smart Auto).....	26
Viewing Images	29
Erasing Images.....	30
Shooting Movies	31
Viewing Movies.....	33
Transferring Images to a Computer for Viewing.....	34

2 Learning More 39

Components Guide.....	40
Screen Display.....	42
Indicator	43
FUNC. Menu – Basic Operations	44
MENU – Basic Operations.....	45
Changing the Sound Settings.....	46
Adjusting the Screen Brightness.....	48
Returning the Camera to Default Settings.....	49

Power Saving Function (Auto Power Down).....	50
Clock Function	50

3 Shooting with Commonly Used Functions 51

Turning the Flash Off	52
Zooming In More Closely on Subjects (Digital Zoom).....	53
Inserting the Date and Time.....	54
Using the Self-Timer	55
Changing the Aspect Ratio	58
Changing the Recording Pixel Setting (Image Size)	59
Changing the Compression Ratio (Image Quality)	59

4 Adding Effects and Shooting in Various Conditions 61

Shooting in Various Conditions	62
Adding Effects and Shooting.....	65
Making Short Movies Automatically (Movie Digest).....	72
Detecting a Face and Shooting (Smart Shutter)	73
Shooting Long Exposures	77
High-Speed Continuous Shooting (High-speed Burst).....	78
Capturing the Best Facial Expressions (Best Image Selection).....	79
Shooting Stitch Assist Images.....	80

5 Choosing Settings Yourself.....	81	Shoot Movies That Look Like a Miniature Model (Miniature Effect).....	105
Shooting in Program AE	82	Shooting Super Slow Motion Movies.....	106
Adjusting the Brightness (Exposure Compensation).....	83	Changing the Image Quality.....	108
Turning the Flash On	83	Using the Wind Filter	109
Adjusting the White Balance.....	84	Other Shooting Functions.....	110
Changing the ISO Speed	85	Editing	111
Correcting the Brightness and Shooting (i-Contrast).....	86		
Continuous Shooting.....	87	7 Using Various Playback and Editing Functions.....	113
Changing the Tone of an Image (My Colors).....	88	Quickly Searching Images.....	114
Shooting Close-ups (Macro)	90	Viewing Images in Filtered Playback.....	115
Shooting Far Away Subjects (Infinity).....	90	Viewing Slideshows.....	117
Changing the AF Frame Mode.....	92	Checking the Focus.....	119
Choosing the Subject to Focus On (Tracking AF).....	94	Magnifying Images	120
Magnifying the Focal Point.....	95	Viewing Each Image in a Group....	121
Shooting with the AF Lock	96	Displaying Various Images (Smart Shuffle).....	123
Shooting with Servo AF	97	Changing Image Transitions	124
Changing the Metering Method.....	98	Protecting Images	124
Shooting with the AE Lock.....	99	Erasing Images	128
Shooting with the FE Lock	99	Tagging Images as Favorites	130
Shooting with Slow Synchro	100	Organizing Images by Category (My Category)	132
Red-Eye Correction	101	Rotating Images	135
Checking for Shut Eyes	102	Resizing Images.....	136
		Trimming	137
6 Using Various Functions for Shooting Movies	103	Adding Effects with the My Colors Function	138
Shooting Various Kinds of Movies	104	Correcting the Brightness (i-Contrast)	139
		Correcting the Red-Eye Effect.....	140

8 Printing.....	141	10 Useful Information	169
Printing Images.....	142	Viewing Images on a TV	170
Choosing Images for Printing (DPOF).....	149	Using Household Power.....	174
Choosing Images for a Photobook	154	Using an Eye-Fi Card.....	175
		Troubleshooting	177
		List of Messages That Appear on the Screen.....	180
9 Customizing Camera Settings	157	Information Displayed on the Screen.....	183
Changing Camera Settings.....	158	Functions and Menu Lists	188
Changing Shooting Function Settings.....	165	Handling Precautions	197
Changing Playback Function Settings.....	168	Specifications	198
		Accessories	202
		Separately Sold Accessories	203
		Index	205

Conventions Used in This Guide

- Icons are used in the text to represent the camera buttons and switches.
- Language that displays on the screen appears inside [] (square brackets).
- The directional buttons and FUNC./SET button are represented by the following icons.

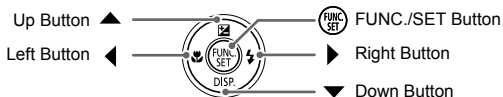

- : Things you should be careful about
- : Troubleshooting tips
- : Hints for getting more out of your camera
- : Supplemental information
- (p. xx): Reference pages (“xx” stands for a page number)
- This guide assumes all functions are at their default settings.
- The various types of memory cards that can be used in this camera are collectively referred to as memory cards in this guide.

Safety Precautions

- Before using the product, please ensure that you read the safety precautions described below. Always ensure that the product is used correctly.
- The safety precautions noted on the following pages are intended to prevent injuries to yourself and other persons, or damage to the equipment.
- Be sure to also check the guides included with any separately sold accessories you use.



Warning

Denotes the possibility of serious injury or death.

- **Do not trigger the flash in close proximity to people's eyes.**

Exposure to the intense light produced by the flash could damage eyesight. In particular, remain at least 1 meter (39 inches) away from infants when using the flash.

- **Store this equipment out of the reach of children and infants.**

Strap: Putting the strap around a child's neck could result in asphyxiation.

- **Use only recommended power sources.**
- **Do not attempt to disassemble, alter or apply heat to the product.**
- **Avoid dropping or subjecting the product to severe impacts.**
- **To avoid the risk of injury, do not touch the interior of the product if it has been dropped or otherwise damaged.**
- **Stop using the product immediately if it emits smoke, a strange smell, or otherwise behaves abnormally.**
- **Do not use organic solvents such as alcohol, benzine, or thinner to clean the product.**
- **Do not let the product come into contact with water (e.g. sea water) or other liquids.**
- **Do not allow liquids or foreign objects to enter the camera.**

This could result in electrical shock or fire.

If liquids or foreign objects come into contact with the camera interior, immediately turn the camera off and remove the battery.

If the battery charger becomes wet, unplug it from the outlet and consult your camera distributor or a Canon Customer Support Help Desk.

- **Use only the recommended battery.**
- **Do not place the battery near or in direct flame.**
- **Unplug the power cord periodically, and using a dry cloth, wipe away any dust and dirt that has collected on the plug, the exterior of the power outlet, and the surrounding area.**
- **Do not handle the power cord with wet hands.**
- **Do not use the equipment in a manner that exceeds the rated capacity of the electrical outlet or wiring accessories. Do not use if the power cord or plug are damaged, or not fully plugged into the outlet.**
- **Do not allow dirt or metal objects (such as pins or keys) to contact the terminals or plug.**

The battery may explode or leak, resulting in electrical shock or fire. This could cause injury and damage the surroundings. In the event that a battery leaks and the battery electrolyte contacts eyes, mouth, skin or clothing, immediately flush with water.

- **Turn the camera off in places where camera use is prohibited.**

The electromagnetic waves emitted by the camera may interfere with the operation of electronic instruments and other devices. Exercise adequate caution when using the camera in places where use of electronic devices is restricted, such as inside airplanes and medical facilities.

- **Do not play the supplied CD-ROM(s) in any CD player that does not support data CD-ROMs.**

It is possible to suffer hearing loss from listening with headphones to the loud sounds of a CD-ROM played on an audio CD player (music player). Additionally, this could damage the speakers.



Caution

Denotes the possibility of injury.

- **When holding the camera by the strap, be careful not to bang it, subject it to strong impacts or shocks, or let it get caught on other objects.**
- **Be careful not to bump or push strongly on the lens.**

This could lead to injury or damage the camera.

- **Be careful not to subject the screen to strong impacts.**

If the screen cracks, injury may result from the broken fragments.

- **When using the flash, be careful not to cover it with your fingers or clothing.**

This could result in burns or damage to the flash.

- **Avoid using, placing or storing the product in the following places:**

- Places subject to strong sunlight
- Places subject to temperatures above 40 °C (104 °F)
- Humid or dusty areas

These could cause leakage, overheating or an explosion of the battery, resulting in electrical shock, fire, burns or other injuries.

High temperatures may cause deformation of the camera or battery charger casing.

- **The slideshow transition effects may cause discomfort when viewed for prolonged periods.**

Caution

Denotes the possibility of damage to the equipment.

- **Do not aim the camera at bright light sources (such as the sun on a clear day).** Doing so may damage the image sensor.

- **When using the camera on a beach or at a windy location, be careful not to allow dust or sand to enter the camera.**

This may cause the product to malfunction.

Safety Precautions

- **In regular use, small amounts of smoke may be emitted from the flash.**

This is due to the high intensity of the flash burning dust and foreign materials stuck to the front of the unit. Please use a cotton swab to remove dirt, dust or other foreign matter from the flash to prevent heat build-up and damage to the unit.

-
- **Remove and store the battery when you are not using the camera.**

If the battery is left inside the camera, damage caused by leakage may occur.

-
- **Before you discard the battery, cover the terminals with tape or other insulators.**

Contacting other metal materials may lead to fire or explosions.

-
- **Unplug the battery charger from the power outlet after charging is complete, or when you are not using it.**

- **Do not place anything, such as cloth on top of the battery charger while it is charging.**

Leaving the unit plugged in for a long period of time may cause it to overheat and distort, resulting in fire.

-
- **Do not place the battery near pets.**

Pets biting the battery could cause leakage, overheating or explosion, resulting in fire or damage.

-
- **Do not sit down with the camera in your pocket.**

Doing so may cause malfunctions or damage the screen.

-
- **When putting the camera in your bag, ensure that hard objects do not come into contact with the screen.**

- **Do not attach any hard objects to the camera.**

Doing so may cause malfunctions or damage the screen.

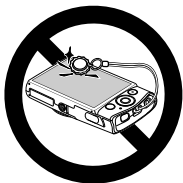

Getting Started

This chapter explains preparations before shooting, how to shoot in **AUTO** mode, and then how to view and erase the images you take. The latter part of this chapter explains how to shoot and view movies and transfer images to a computer.

Attaching the Strap/Holding the Camera

- Attach the included strap and wrap it around your wrist to avoid dropping the camera during use.
- Keep your arms tight against your body while holding the camera firmly by the sides when shooting. Be sure that your fingers do not block the flash.

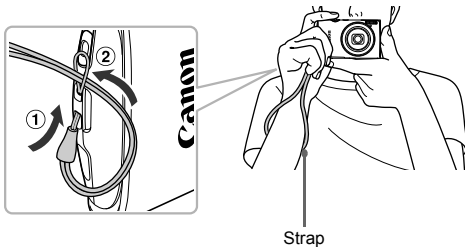

Charging the Battery

Use the included charger to charge the battery. Be sure to charge the battery as it is not charged at the time of purchase.

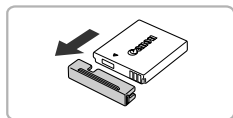

1 Remove the cover.

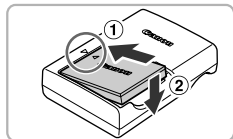

2 Insert the battery.

- Align the ▲ marks on the battery and charger, then insert the battery by sliding it in (1) and down (2).

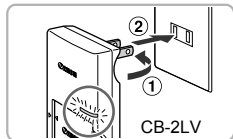

3 Charge the battery.

- For **CB-2LV**: Flip out the plug (1) and plug the charger into a power outlet (2).
- For **CB-2LVE**: Plug the power cord into the charger, then plug the other end into a power outlet.
- ▶ The charge lamp lights orange and charging starts.
- ▶ The charge lamp will light green when charging has finished. Charging takes approx. 1 hour and 30 minutes.

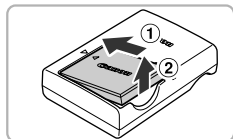
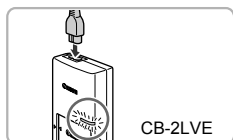

4 Remove the battery.

- Unplug the battery charger from the power outlet, then remove the battery by sliding it in (1) and up (2).



To protect the battery and prolong its life, do not charge it for longer than 24 hours continuously.

Number of Possible Shots/Shooting and Playback Times

Number of Shots*¹	Approx. 210
Movie Shooting Time*²	Approx. 40 minutes
Continuous Shooting*³	Approx. 1 hour 10 minutes
Playback Time	Approx. 4 hours

*¹ The number of shots that can be taken is based on the Camera & Imaging Products Association (CIPA) measurement standard.



*² Times are based on default settings, starting and stopping shooting, turning the camera on and off, and operations such as using the zoom.

*³ Times are based on repeatedly shooting until the maximum clip length is reached or recording stops automatically.

• Under some shooting conditions, the number of possible shots and shooting time may be less than mentioned above.

Battery Charge Indicator

An icon or message will appear on the screen indicating the battery's charge state.

Display	Summary
	Sufficient charge.
	Slightly depleted, but sufficient.
 (Blinking red)	Nearly depleted. Charge the battery.
"Change the battery pack."	Depleted. Charge the battery.



What if...

- What if the battery develops a bulge?
This is a normal characteristic of the battery and does not indicate a problem. However, if the battery bulges to the point where it will no longer fit into the camera, please contact a Canon Customer Support Help Desk.
- What if the battery is quickly depleted even after charging?
The battery has reached the end of its life span. Purchase a new battery.



Using the battery and charger effectively

- Charge the battery on the day, or the day before, it will be used.

Charged batteries continue to discharge naturally even if they are not used.

Attach the cover to a charged battery so that the ▲ mark is visible.

- How to store the battery for long periods:

Deplete and remove the battery from the camera. Attach the terminal cover and store the battery. Storing a battery for long periods of time (about a year) without depleting it may shorten its life span or affect its performance.

- The battery charger can also be used when abroad.

The charger can be used in regions that have 100 – 240 V (50/60 Hz) AC power. If the plug does not fit the outlet, use a commercially available plug adapter.

Do not use electrical transformers for foreign travel as they will cause damage.



Compatible Memory Cards (Sold Separately)

The cards below can be used without restrictions on their capacities.

- SD memory cards*
- SDHC memory cards*
- SDXC memory cards *
- Eye-Fi cards

* This memory card complies with SD standards. Some cards may not operate properly depending on the brand of card used.



Depending on your computer's OS version, SDXC memory cards may not be recognized even when using a commercially available card reader. Check to make sure that your OS supports SDXC memory cards beforehand.

About Eye-Fi Cards

This product is not guaranteed to support Eye-Fi card functions (including wireless transfer). In case of an issue with an Eye-Fi card, please check with the card manufacturer.

Also note that an approval is required to use Eye-Fi cards in many countries or regions. Without approval, use of the card is not permitted. If it is unclear whether the card has been approved for use in the area, please check with the card manufacturer.

Inserting the Battery and Memory Card

Insert the included battery and a memory card (sold separately).

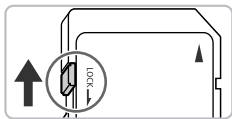

1 Check the card's write-protect tab.

- If the memory card has a write-protect tab, you will not be able to record images if the tab is in the locked position. Slide the tab up until you hear a click.

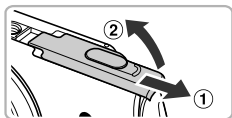

2 Open the cover.

- Slide the cover (1) and open it (2).

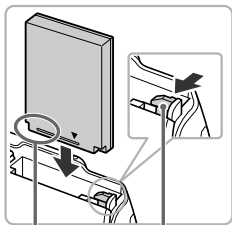

3 Insert the battery.

- Press the battery lock in the direction of the arrow, then insert the battery as shown until it locks into place with a click.
- Be sure to insert the battery in the correct direction or it will not properly lock into place.

Terminals

Battery
Lock

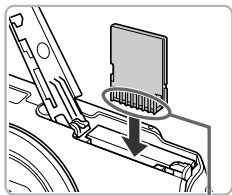

4 Insert the memory card.

- Insert the memory card as shown until it locks into place with a click.
- Be sure the memory card is oriented correctly. Inserting the memory card in the wrong direction could damage the camera.

Terminals

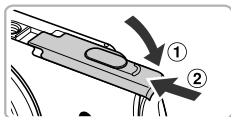

5 Close the cover.

- Close the cover (①), and press downward as you slide it until it clicks into place (②).



What if [Memory card locked] appears on the screen?

If the write-protect tab is in the locked position, [Memory card locked] will appear on the screen and you will not be able to take or erase images.

Removing the Battery and Memory Card

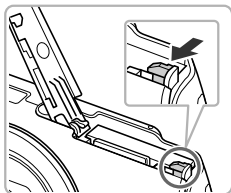

Remove the battery.

- Open the cover and press the battery lock in the direction of the arrow.
- ▶ The battery will pop up.

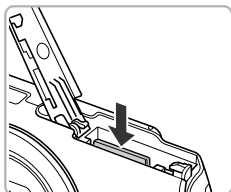

Remove the memory card.

- Push the memory card in until you hear a click, then slowly release it.
- ▶ The memory card will pop up.

Number of Shots per Memory Card

Memory Card	4 GB	16 GB
Number of Shots	Approx. 1231	Approx. 5042

- Values are based on the default settings.
- The number of shots that can be taken will vary depending on camera settings, the subject and the memory card used.



Can you check the number of shots that can be taken?

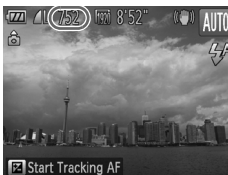

You can check the number of shots that can be taken when the camera is in a Shooting mode (p. 26).

Setting the Date and Time

The Date/Time settings screen will appear the first time the camera is turned on. Since the dates and times recorded into your images are based on these settings, be sure to set them.

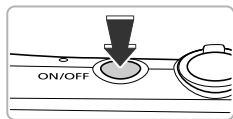

1 Turn on the camera.

- Press the ON/OFF button.
- ▶ The Date/Time screen will appear.

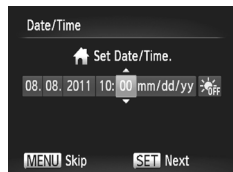

2 Set the date and time.

- Press the ◀▶ buttons to choose an option.
- Press the ▲▼ buttons to set a value.
- Once all settings are complete, press the  button.

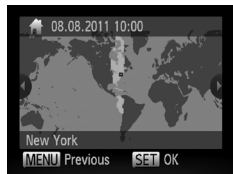

3 Set the home time zone.

- Press the ◀▶ buttons to choose your home time zone.







4 Complete the setting.

- Press the  button to complete the setting. After a confirmation screen appears, the shooting screen will reappear.
- Pressing the ON/OFF button will turn off the camera.

? Reappearing Date/Time screen

Set the correct date and time. If you have not set the date and time and the home time zone, the Date/Time screen will appear each time you turn on the camera.

Daylight saving time settings

If you choose  in Step 2 on p. 20 and press the   buttons to choose , you will set the time to daylight saving (1 hour ahead).

Changing the Date and Time

You can change the current date and time settings.

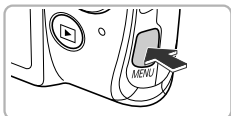



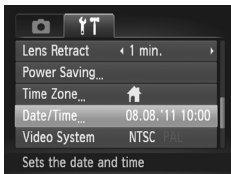

1 Display the menu.

- Press the **MENU** button.



2 Choose [Date/Time].

- Move the zoom lever to choose the  tab.
- Press the   buttons to choose [Date/Time], then press the  button.

3 Change the date and time.

- Follow Step 2 on p. 20 to adjust the settings.
- Press the **MENU** button to close the menu.



Date/Time battery

- The camera has a built-in date/time battery (backup battery) that allows the date/time settings to be retained for about 3 weeks after the battery pack has been removed.
- By inserting a charged battery or connecting an AC adapter kit (sold separately, p. 203) the date/time battery can be charged in about 4 hours even if the camera is not turned on.
- If the date/time battery is depleted, the Date/Time screen will appear when you turn the camera on. Follow the steps on p. 20 to set the date and time.

Setting the Display Language

You can change the language that displays on the screen.

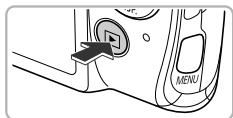

1 Enter Playback mode.

- Press the button.

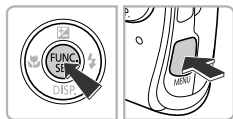

2 Display the settings screen.

- Press and hold the button, then immediately press the **MENU** button.

A screenshot of a car's display screen showing a list of languages. The list is organized into three columns. The first column contains: English, Deutsch, Français, Nederlands, Dansk, Suomi, Italiano, Norsk, Українська. The second column contains: Svenska, Español, 繁體中文, 简体中文, Português, Ελληνικά, Polski, Čeština, Magyar. The third column contains: Türkçe, 繁體中文, 한국어, русский, العربية, Română, فارسی, हिन्दी, 日本語. The 'English' option is highlighted with a grey background.

English	Svenska	Türkçe
Deutsch	Español	繁體中文
Français	简体中文	한국어
Nederlands	русский	العربية
Dansk	Português	العربية
Suomi	Ελληνικά	Română
Italiano	Polski	فارسی
Norsk	Čeština	हिन्दी
Українська	Magyar	日本語

3 Set the display language.

- Press the buttons to choose a language, then press the button.
- ▶ Once the display language has been set, the settings screen will close.



? What if the clock appears when the button is pressed?

The clock will appear if too much time passes between pressing the button and the **MENU** button in Step 2. If the clock appears, press the button to remove the clock and repeat Step 2.



You can also change the display language by pressing the **MENU** button to choose [Language] in the tab.

Formatting Memory Cards

Before you use a new memory card or one that has been formatted in other devices, you should format the card with this camera.

Formatting (initializing) a memory card erases all data on the memory card. As you cannot retrieve the erased data, exercise adequate caution before formatting the memory card.

Before formatting an Eye-Fi card (p. 175), be sure to install the software contained on the card to a computer.

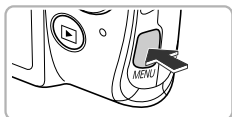

1 Display the menu.

- Press the **MENU** button.



2 Choose [Format].

- Move the zoom lever to choose the **↑↑** tab.
- Press the **▲▼** buttons to choose [Format], then press the **FUNC/SET** button.

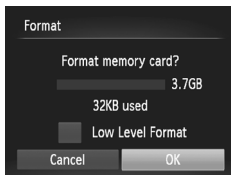
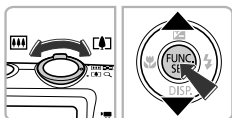



3 Choose [OK].

- Press the **◀▶** buttons to choose [OK], then press the **FUNC/SET** button.

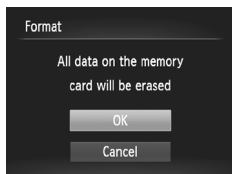



4 Format the memory card.

- Press the ▲▼ buttons to choose [OK], then press the  button to start formatting.
- When formatting ends, [Memory card formatting complete] appears on the screen. Press the  button.



Formatting or erasing data on a memory card merely changes the file management information on the card and does not ensure its contents are completely erased. Be careful when transferring or disposing of a memory card. When disposing of a memory card, take precautions such as physically destroying the card to prevent personal information leaks.



- The total capacity of the memory card displayed in the formatting screen may be less than indicated on the memory card.
- Perform a low-level format (p. 159) of the memory card when the camera does not operate properly, the recording/reading speed of a memory card has dropped, when continuous shooting speed slows down, or when movie recording stops suddenly.

Pressing the Shutter Button

To take images that are in focus, be sure to first press the shutter button lightly (halfway) to focus, then press fully to shoot.

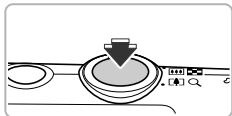

1 Press halfway (Press lightly to focus).

- Press lightly until the camera beeps twice and AF frames appear where the camera focused.

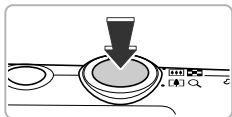

2 Press fully (Press fully to shoot).

- ▶ The camera plays the shutter sound and takes the shot.
- Since the shot is being taken while the shutter sound plays, be careful not to move the camera.



Does the length of the shutter sound change?

- Since the time required to shoot differs depending on the scene you want to take, the length of the shutter sound may change.
- If the camera or subject moves while the shutter sound is playing, the recorded image may be blurry.



If you shoot without pressing the shutter button halfway, the image may not be in focus.

Taking Pictures (Smart Auto)

Since the camera can determine the subject and shooting conditions, you can let it automatically select the best settings for the scene and just shoot.

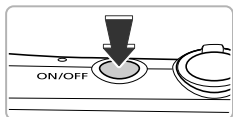

1 Turn on the camera.

- Press the ON/OFF button.
- ▶ The start-up screen will appear.



2 Enter **AUTO** mode.

- Set the mode switch to **AUTO**.
- When you point the camera toward the subject, the camera will make a slight noise as it determines the scene.
- ▶ The icon for the determined scene, and the IS mode icon will appear in the upper right of the screen (pp. 184, 185).
- ▶ The camera will focus on detected subjects and display frames on them.



3 Compose the shot.

- Moving the zoom lever toward [T] (telephoto) will zoom in on your subject, making it appear larger. Moving the lever toward [W] (wide angle) will zoom out from your subject, making it appear smaller. (The zoom bar showing the zoom position appears on the screen.)

Zoom Bar

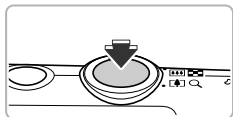

4 Focus.

- Press the shutter button halfway to focus.

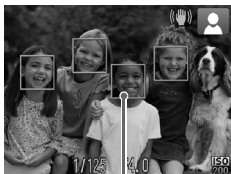

AF Frame

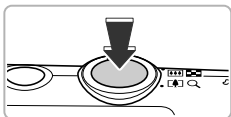

5 Shoot.

- Press the shutter button fully to shoot.
- ▶ The camera will play the shutter sound and shoot. The flash will automatically fire in low light conditions.
- ▶ The image will appear on the screen for approximately 2 seconds.
- You can take a second picture even while an image is displayed by pressing the shutter button again.

? What if...

- **What if the color and brightness of the images do not turn out as expected?**

The scene icon (p. 184) that appears on the screen may not match the actual scene, and you may not obtain the expected results. If this happens, try shooting in **P** mode (p. 81).











- **What if white and gray frames appear when you point the camera toward a subject?**

A white frame appears on the face or subject that the camera detected as the main subject, while gray frames appear on other detected faces. The frames will follow the subjects within a certain range.

If the subject moves, however, the gray frames will disappear, leaving only the white frame.

- **What if a frame does not appear on the subject you want to shoot?**

The subject may not be detected, and frames may appear on the background. If this happens, try shooting in **P** mode (p. 81).

- **What if a blue frame appears when you press the shutter button halfway?**
A blue frame appears when a moving subject is detected; the focus and exposure will continuously adjust (Servo AF).
- **What if a flashing  appears?**
Attach the camera to a tripod so that the camera does not move and blur the image.
- **What if the camera does not play any sounds?**
You may have been pressing the  button while turning on the camera, which will turn off all sounds except for warning sounds. To turn the sounds on, press the **MENU** button to choose [Mute] in the  tab, then press the   buttons to choose [Off].
- **What if the image comes out dark even if the flash fired when shooting?**
The subject is too far away for the flash to reach. The effective flash range is approximately 50 cm – 4.0 m (1.6 – 13 ft.) at maximum wide angle (), and approximately 50 cm – 2.0 m (1.6 – 6.6 ft.) at maximum telephoto ().
- **What if the camera beeps once when the shutter button is pressed halfway?**
Your subject may be too close. When the camera is at maximum wide angle (), move about 1 cm (0.4 in.) or more away from your subject and shoot. Move about 1 m (3.3 ft.) or more away when the camera is at maximum telephoto ().
- **What if the lamp lights when the shutter button is pressed halfway?**
To reduce red-eye and to assist in focusing, the lamp may light when shooting in low light conditions.
- **What if the  icon blinks when you try to shoot?**
The flash is charging. You can shoot when recharging ends.





Icons that appear on the screen

The icon for the determined scene, and the IS mode icon will appear on the screen. For details on the icons that appear, see “Scene Icons” (p. 184) and “IS Mode Icons” (p. 185).



Choosing the subject to focus on (Tracking AF)

After pressing the  button and displaying , point the camera so that  is on the subject you want to focus on. Press and hold the shutter button halfway to display a blue frame where focus and exposure will be maintained (Servo AF). Press the shutter button fully to shoot.

Viewing Images

You can view the images you have taken on the screen.

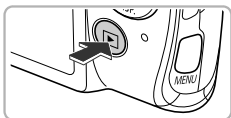





1 Enter Playback mode.

- Press the  button.
- ▶ The last image you took will appear.



2 Choose an image.

- Pressing the  button will cycle through the images from newest to oldest.
- Pressing the  button will cycle through the images from oldest to newest.
- Pressing and holding the  buttons will display images in a line letting you quickly search them. Pressing the  button restores single image playback (p. 114).
- The lens will retract after approximately 1 minute elapses.
- Pressing the button again while the lens is retracted will turn the camera off.

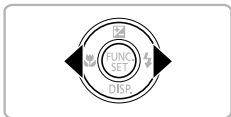

Switching to Shooting mode

Pressing the shutter button halfway while in Playback mode switches the camera to Shooting mode.

Erasing Images

You can choose and erase images one at a time. Please note that erased images cannot be recovered. Exercise adequate caution before erasing an image.

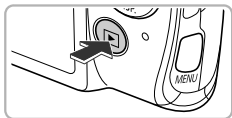

1 Enter Playback mode.

- Press the  button.
- ▶ The last image you took will appear.

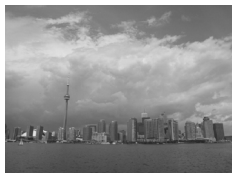





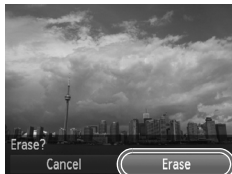



2 Choose an image to erase.

- Press the  buttons to display an image to erase.



3 Erase the image.

- After pressing the  button, press the  buttons to choose , then press the  button again.
- When [Erase?] appears on the screen, press the  buttons to choose [Erase], then press the  button.
- ▶ The displayed image will be erased.
- To exit instead of erasing, press the  buttons to choose [Cancel], then press the  button.



Shooting Movies

The camera will determine the subject and shooting conditions, and select the best settings for the scene.

The audio will record in stereo.

If you continue shooting for a long time, the camera may become warm. This is not a malfunction.

Remaining Time



1 Enter **AUTO** mode and compose the shot.

- Follow Steps 1 – 3 on p. 26 to compose the shot.
- You can check the amount of time you can shoot on the screen.



2 Shoot.

- Press the movie button.
- Black bars appear at the top and bottom of the screen. These areas cannot be recorded.

Elapsed Time



- ▶ The camera will beep once, recording will start, and [●Rec] and the elapsed time will appear on the screen.

- Once shooting begins, take your finger off the movie button.
- If you change the composition of your shot during shooting, the focus, brightness and tone will automatically adjust.
- Do not touch the microphones while shooting.
- Do not press any buttons other than the movie button while shooting. The sound the buttons make will be recorded in the movie.

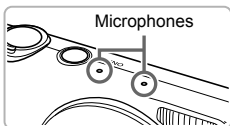



3 Stop shooting.

- Press the movie button again.
- ▶ The camera will beep twice and stop shooting the movie.
- ▶ Shooting will automatically stop when the memory card fills.



Zooming while shooting

Moving the zoom lever while shooting will zoom in on or out from the subject. However, operation sounds will be recorded.



- When the mode switch is set to **AUTO**, the icon for the determined scene will appear (p. 184). “When Moving” icons will not appear, however. Under certain conditions, the icon that appears may not match the actual scene.
- If you change the composition while shooting and the white balance is not optimal, press the movie button to stop recording, then start recording again (only when the image quality is set to **F1920** (p. 108)).
- Movies can be shot by pressing the movie button even when the mode switch is set to **📷** (p. 103).

Shooting Time

Memory Card	4 GB	16 GB
Shooting Time	Approx. 14 min. 34 sec.	Approx. 59 min. 40 sec.

- Maximum clip length is approx. 10 minutes.
- Recording may stop even if the maximum clip length has not been reached on some memory cards. SD Speed Class 6 or higher memory cards are recommended.

Viewing Movies

You can view the movies you have shot on the screen.

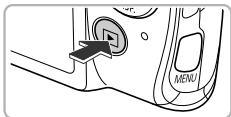

1 Enter Playback mode.

- Press the button.
- ▶ The last image you took will appear.
- ▶ **SET** appears on movies.



2 Choose a movie.

- Press the buttons to choose a movie, then press the button.

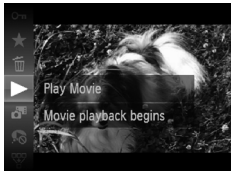
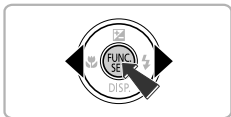

3 Play the movie.

- Press the buttons to choose , then press the .
- ▶ The movie will play.
- Press the buttons to adjust the volume.
- If you press the button, the movie will pause and the movie control panel will appear. Press the buttons to choose , then press the button to resume playback.
- ▶ After the movie finishes, **SET** appears.



? How can I play back movies on a computer?

Install the included software (p. 35).

- When watching a movie on a computer, frames may drop, it may not play smoothly, and the audio may stop suddenly depending on the computer's capabilities. Use the supplied software to copy the movie back onto the memory card, then play back the movie with the camera. If you connect the camera to a TV, you can view images on the larger screen.

Transferring Images to a Computer for Viewing

You can use the included software to transfer images you have shot with the camera to a computer for viewing. If you are already using software included with another Canon-brand compact digital camera, install the software from the included CD-ROM, overwriting your current installation.

System Requirements

Windows

OS	Windows 7 (Including SP1) Windows Vista SP2 Windows XP SP3
Computer Model	The above OS should be pre-installed on computers with built-in USB ports.
CPU	Pentium 1.3 GHz or higher (still images), Core 2 Duo 2.6 GHz or higher (movies)
RAM	Windows 7 (64 bit): 2 GB or more Windows 7 (32 bit), Windows Vista (64 bit, 32 bit): 1 GB or more (still images), 2 GB or more (movies) Windows XP: 512 MB or more (still images), 2 GB or more (movies)
Interface	USB
Free Hard Disk Space	420 MB or more*
Display	1,024 x 768 pixels or higher

* For Windows XP, Microsoft .NET Framework 3.0 or later (max. 500 MB) must be installed. Installation may take some time depending on your computer's capabilities.

Macintosh

OS	Mac OS X (v10.5 – v10.6)
Computer Model	The above OS should be pre-installed on computers with built-in USB ports.
CPU	Intel Processor (still images), Core 2 Duo 2.6 GHz or higher (movies)
RAM	Mac OS X v10.6: 1 GB or more (still images), 2 GB or more (movies) Mac OS X v10.5: 512 MB or more (still images), 2 GB or more (movies)
Interface	USB
Free Hard Disk Space	480 MB or more
Display	1,024 x 768 pixels or higher

Installing the Software

Windows Vista and Mac OS X (v10.5) are used for these explanations.

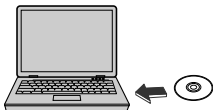

1 Place the CD-ROM in the computer's CD-ROM drive.

- Place the supplied CD-ROM (DIGITAL CAMERA Solution Disk) (p. 2) into the computer's CD-ROM drive.
- When the CD-ROM is placed in a Macintosh, a CD-ROM icon will appear on the desktop. Double-click the icon to open the CD-ROM, then double click  when it appears.



2 Install the software.

- For Windows, click [Easy Installation], and for Macintosh click [Install], then follow the on-screen instructions to proceed with the installation.
- If the [User Account Control] window appears in Windows, follow the on-screen instructions to proceed.



3 Complete the installation.

- For Windows, click [Restart] or [Finish], then remove the CD-ROM when your desktop screen appears.
- For Macintosh, click [Finish] in the screen that appears when the installation is complete, then remove the CD-ROM when your desktop screen appears.

Transferring and Viewing Images

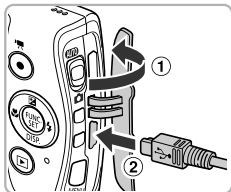

1 Connect the camera to the computer.

- Turn off the camera.
- Open the cover (1) and insert the included interface cable's smaller plug (p. 2) firmly into the camera terminal in the direction shown (2).
- Insert the interface cable's larger plug into the computer's USB port. For details on the computer's USB port, refer to the user guide provided with the computer.

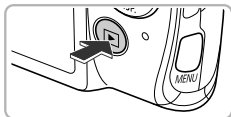
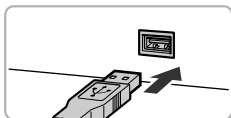

2 Turn on the camera to open CameraWindow.

- Press the  button to turn on the camera.
- For Windows, click [Downloads Images From Canon Camera using Canon CameraWindow] when it appears on the screen. CameraWindow will appear when a connection is established between the camera and computer.
- For Macintosh, CameraWindow will appear when a connection is established between the camera and computer.



CameraWindow

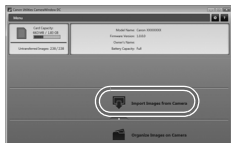



3 Transfer Images.

- Click [Import Images from Camera], and then click [Import Untransferred Images].
- ▶ Images will transfer to the computer. Images will be sorted by date and saved in separate folders in the Pictures folder.

- When image transfer is complete, close CameraWindow and press the  button to turn the camera off, then unplug the cable.
- For details on how to view images using a computer, refer to the *Software Guide*.



- If CameraWindow does not appear even after following Step 2 for Windows, click the [Start] menu and choose [All Programs], followed by [Canon Utilities], [CameraWindow] and [CameraWindow].
- If CameraWindow does not appear even after following Step 2 for Macintosh, click the CameraWindow icon on the Dock (the bar which appears at the bottom of the desktop).
- For Windows 7, use the following steps to display CameraWindow.
 - ① Click  on the task bar.
 - ② In the screen that appears, click the  link to modify the program.
 - ③ Choose [Downloads Images From Canon Camera using Canon CameraWindow] and click [OK].
 - ④ Double click .
- You can transfer images even without using the image transfer function in the included software by simply connecting your camera to a computer. There are, however, the following limitations.
 - It may take a few minutes from when you connect the camera to the computer until you can transfer images.
 - Images shot in the vertical orientation may be transferred in the horizontal orientation.
 - Protection settings for images may be lost when transferred to a computer.
 - There may be problems transferring images or image information correctly depending on the version of the operating system in use, the file size, or the software in use.
 - Some functions in the included software may not be available, such as editing movies, and transferring images to the camera.

2

Learning More

This chapter explains the parts of the camera and what appears on the screen, as well as the basic operating instructions.



Components Guide

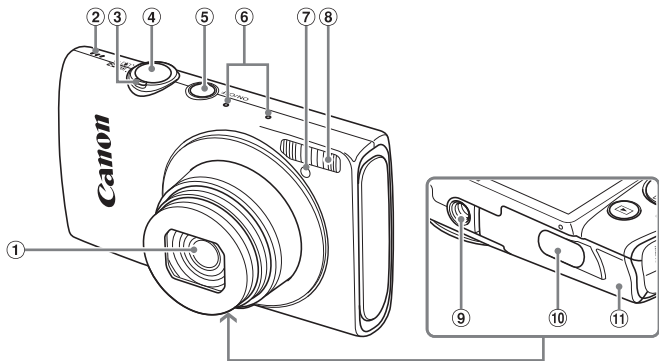

- ① Lens
- ② Speaker
- ③ Zoom Lever
Shooting: (Telephoto) /
 (Wide Angle) (pp. 26, 32, 53)
Playback: (Magnify) / (Index)
(pp. 114, 120)
- ④ Shutter Button (p. 25)
- ⑤ ON/OFF button (p. 20)
- ⑥ Microphones (p. 31)
- ⑦ Lamp (pp. 55, 73, 74, 75, 165, 165)
- ⑧ Flash (pp. 52, 83, 100)
- ⑨ Tripod Socket
- ⑩ DC Coupler Terminal Cover (p. 174)
- ⑪ Memory Card / Battery Cover (p. 17)

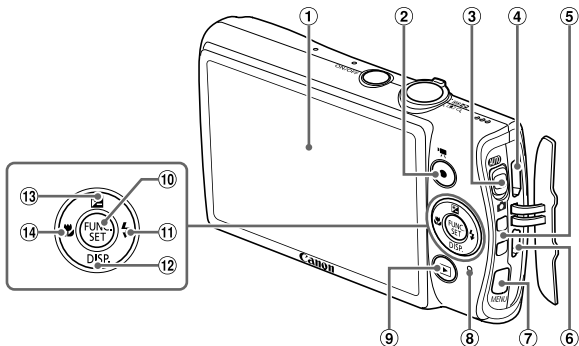

- ① Screen (LCD Monitor) (pp. 42, 183, 186)
- ② Movie Button (pp. 31, 103)
- ③ Mode Switch
- ④ HDMI™ Terminal (p. 171)
- ⑤ Strap Mount (p. 13)
- ⑥ A/V OUT (Audio/Video Output) / DIGITAL Terminal (pp. 36, 142, 170)
- ⑦ MENU Button (p. 45)
- ⑧ Indicator (p. 43)
- ⑨ (Playback) Button (pp. 29, 113)
- ⑩ FUNC./SET Button (p. 44)
- ⑪ (Flash) (pp. 52, 83, 100) / Button
- ⑫ DISP. (Display) (p. 42) / Button
- ⑬ (Exposure Compensation) (p. 83) / Button
- ⑭ (Macro) (p. 90) / Button

Mode Switch

Use the mode switch to change the Shooting mode.

- AUTO** — You can leave it to the camera to select settings for fully automatic shooting (p. 26).
- You can shoot with the best settings for the scene (p. 62) or choose settings yourself to take various types of pictures (p. 81).

Screen Display

Switching the Display

You can change the screen display using the ▼ button. Refer to p. 183 for details on information that appears on the screen.

Shooting



Information Display



No Information Display

Playback



No Information Display



Simple Information Display



Detailed Information Display



Focus Check Display (p. 119)



You can also switch the display by pressing the ▼ button while the image displays right after shooting. However, Simple Information Display is not available. You can change the display that appears first by pressing the MENU button, then choosing [Review info] in the tab (p. 166).

Screen Display in Low Light Conditions

The display automatically brightens when shooting in low light conditions, allowing you to check the composition (Night Display function). However, the brightness of the image on the screen, and the brightness of the actual image recorded may be different. Screen noise may appear and the movement of the subject may appear somewhat rough on the screen. This has no effect on the recorded image.

Overexposure Warning during Playback

In Detailed Information Display (p. 42), overexposed areas of the image flash on the screen.

Histogram during Playback

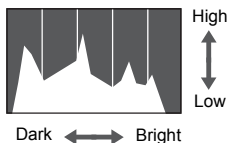

- The graph that appears in Detailed Information Display (p. 186) is called the histogram. The histogram shows the distribution of brightness in an image horizontally, and the amount of brightness vertically, and in this way you can judge the exposure.

Indicator

The indicator on the back of the camera (p. 41) will light or blink depending on the camera's status.

Color	Status	Operation Status
Green	Lights	When connected to a computer (p. 36), display off
	Blinks	During camera start-up, recording/reading/transmitting image data, or when shooting long exposures (p. 77)



When the indicator blinks green, do not turn the camera off, open the memory card slot/battery cover, shake or jolt the camera. These actions may corrupt the image data or cause the camera or memory card to malfunction.

FUNC. Menu – Basic Operations

Commonly used functions can be set with the FUNC. menu. The menu items and options differ depending on the Shooting mode (pp. 190 – 191) or Playback mode (p. 196).



1 Display the FUNC. menu.

- Press the button.

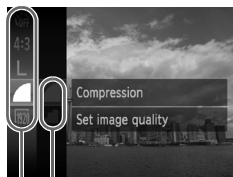

Available Options
Menu Items

2 Choose a menu item.

- Press the ▲▼ buttons to choose a menu item, then press the or ► button.
- Choosing some menu items changes the screen to display further menu options.

3 Choose an option.

- Press the ▲▼ buttons to choose an option.
- You can also choose settings by pressing the **MENU** button on options that display **MENU**.
- To return to the menu items, press the ◀ button.



4 Complete the setting.

- Press the button.
- ▶ The shooting screen will reappear and the setting you chose will display on the screen.

MENU – Basic Operations

Various functions can be set from the menus. The menu items are organized under tabs, such as for shooting (📷) and playback (▶). The options differ depending on the Shooting mode and the Playback mode (pp. 192 – 196).

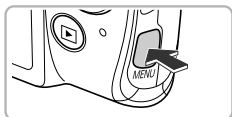

1 Display the menu.

- Press the **MENU** button.



2 Choose a tab.

- Move the zoom lever or press the ◀▶ buttons to choose a tab.

3 Choose an item.

- Press the ▲▼ buttons to choose an item.
- Some items require you to press the **FUNC. SET** or ▶ button to display a submenu in which you change the setting.

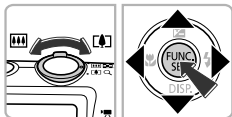

4 Choose an option.

- Press the ◀▶ buttons to choose an option.

5 Complete the setting.

- Press the **MENU** button to restore the normal screen.

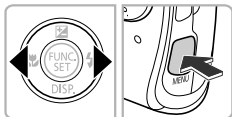

Changing the Sound Settings

You can silence or adjust the volume of camera sounds.

Muting Sounds

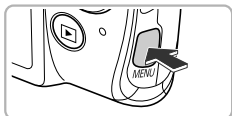

1 Display the menu.

- Press the **MENU** button.



2 Choose [Mute].

- Move the zoom lever to choose the **YT** tab.
- Press the **▲▼** buttons to choose [Mute], then press the **◀▶** buttons to choose [On].
- Press the **MENU** button to restore the normal screen.

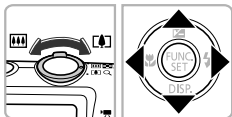

- You can also mute camera sounds by holding down the **▼** button and turning the camera on.
- If you mute camera sounds, the sound will also be muted when playing back movies (p. 33). If you press the **▲** button while playing back a movie, the sound will play back, and you can adjust the volume with the **▲▼** buttons.

Adjusting the Volume

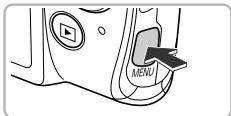

1 Display the menu.

- Press the **MENU** button.

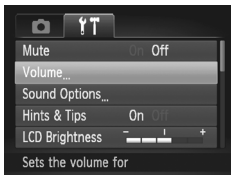

2 Choose [Volume].

- Move the zoom lever to choose the **YT** tab.
- Press the **▲▼** buttons to choose [Volume], then press the **FUNC SET** button.

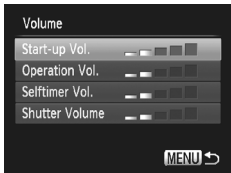
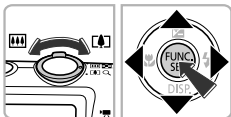

3 Adjust the volume.

- Press the **▲▼** buttons to choose an item, then press the **◀▶** buttons to adjust the volume.
- Press the **MENU** button twice to restore the normal screen.

Adjusting the Screen Brightness

The screen brightness can be adjusted in 2 ways.

Using the Menu

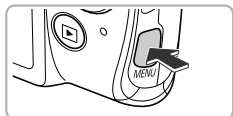

1 Display the menu.

- Press the **MENU** button.



2 Choose [LCD Brightness].

- Move the zoom lever to choose the **↑↑** tab.
- Press the **▲▼** buttons to choose [LCD Brightness].

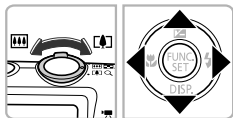

3 Adjust the brightness.

- Press the **◀▶** buttons to adjust the brightness.
- Press the **MENU** button twice to restore the normal screen.

Using the ▼ Button



- Press and hold the **▼** button for more than 1 second.
- ▶ The screen increases to maximum brightness (The settings made in [LCD Brightness] in the **↑↑** tab will be disabled).
- Press and hold the **▼** button again for more than 1 second to return the screen to the original brightness.



- The next time you turn on the camera, the screen will be at the brightness setting chosen in the **↑↑** tab.
- When you have [LCD Brightness] set to its highest setting in the **↑↑** tab, you cannot adjust the brightness with the **▼** button.

Returning the Camera to Default Settings

When you have mistakenly changed a setting, you can reset the camera to the default settings.

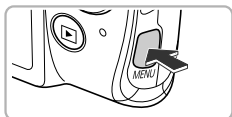

1 Display the menu.

- Press the MENU button.



2 Choose [Reset All].

- Move the zoom lever to choose the tab.
- Press the buttons to choose [Reset All], then press the button.

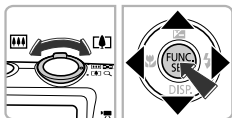

3 Reset the settings.

- Press the buttons to choose [OK], then press the button.
- ▶ The camera will reset to the default settings.

? Are there functions that cannot be reset?

- The [Date/Time] (p. 21), [Language] (p. 22), the image registered in [Start-up Image] (p. 160), [Time Zone] (p. 164) and [Video System] (p. 170) in the tab.
- The recorded custom white balance data (p. 84).
- Colors that were chosen in Color Accent (p. 69) or Color Swap (p. 70).
- Shooting modes set when the mode switch was set to (p. 61).

Power Saving Function (Auto Power Down)

To save battery power, the screen turns off, and the camera turns off automatically when it is not operated for a certain time.

Power Saving during Shooting

The screen will turn off approximately 1 minute after you stop operating the camera. After about 2 more minutes, the lens will retract and the camera will turn off. When the screen has turned off but the lens has not yet retracted, pressing the shutter button halfway (p. 25) turns on the screen and shooting can continue.

Power Saving during Playback

The camera will turn off approximately 5 minutes after you stop operating the camera.





- You can turn off the power saving function (p. 163).
- You can adjust the time before the screen turns off (p. 163).

Clock Function

You can check the current time.



- Press and hold the  button.
- ▶ The current time appears.
- If you hold the camera vertically while using the clock function, it will switch to vertical display. Press the ◀▶ buttons to change the display color.
- Press the  button again to cancel the clock display.



When the camera is off, press and hold the  button, then press the ON/OFF button to display the clock.

3

Shooting with Commonly Used Functions

This chapter explains how to use common functions, such as the self-timer, and how to turn off the flash.

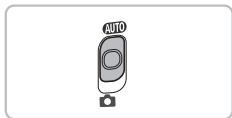

- This chapter assumes that the camera is set to **AUTO** mode. When shooting in another mode, check which functions are available in that mode (pp. 188 – 193).

Turning the Flash Off

You can shoot with the flash turned off.

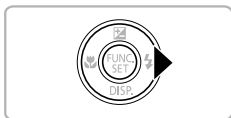

1 Press the ► button.



2 Choose ⚡.

- Press the ◀► buttons to choose ⚡, then press the FUNC SET button.
- ▶ Once set, ⚡ will appear on the screen.
- To turn the flash back on, follow the steps above to choose ⚡^A.



? What if a flashing ⚡ appears?

When you press the shutter button halfway in low light conditions where camera shake is likely, a flashing ⚡ will appear on the screen. Attach the camera to a tripod to prevent it from moving.

Zooming In More Closely on Subjects (Digital Zoom)

You can use the digital zoom to zoom up to approximately 32x maximum, and capture subjects that are too far away for the optical zoom to enlarge.

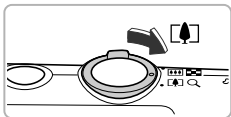

1 Move the zoom lever toward [1].

- Hold the lever until zooming stops.
- ▶ Zooming stops at the largest possible zoom factor without image deterioration. The zoom factor will appear on the screen when you release the zoom lever.

Zoom Factor



2 Move the zoom lever toward [1] again.

- ▶ The digital zoom will zoom in even further on the subject.



Turning off the digital zoom

To turn off the digital zoom, press the **MENU** button to choose [Digital Zoom] in the  tab, then choose [Off].



- The focal lengths when using the optical zoom and digital zoom together are as follows (all focal lengths are 35mm film equivalent):
28 – 896 mm (28 – 224 mm when using the optical zoom alone)
- Depending on the recording pixel setting (p. 59) and zoom factor, the images may appear coarse (the zoom factor will appear in blue).

Inserting the Date and Time

You can insert the shooting date and time in the lower right corner of an image. Once inserted, however, they cannot be deleted. Be sure to check beforehand that the date and time are correctly set (p. 20).

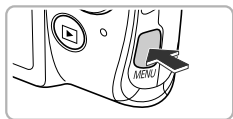



1 Display the menu.

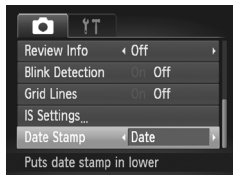

- Press the **MENU** button.



2 Choose [Date Stamp].

- Move the zoom lever to choose the  tab.
- Press the   buttons to choose [Date Stamp].

3 Choose the setting.

- Press the   buttons to choose [Date] or [Date & Time].
- Press the **MENU** button to complete the setting and restore the shooting screen.
- ▶ Once set, [DATE] will appear on the screen.

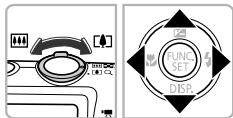

4 Shoot.

- ▶ The shooting date or time will be recorded in the image's lower right corner.
- To restore to the original setting, choose [Off] in Step 3.



You can insert and print the shooting date in images which do not have an embedded date and time as follows. However, if you do this for images with an embedded date and time, the date and time may be printed twice.

- Use the **DPOF print settings (p. 149)** to print.
- Use the **included software to print.**
Refer to the *Software Guide* for details.
- **Print using printer functions (p. 142).**

Using the Self-Timer

The self-timer can be used to shoot a group photo that includes the photographer. The camera will shoot approximately 10 seconds after the shutter button is pressed.



1 Choose OFF.

- After pressing the **FUNC. SET** button, press the **▲▼** buttons to choose **OFF**, then press the **FUNC. SET** button again.

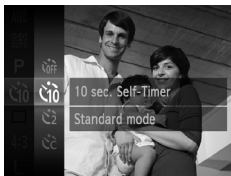

2 Choose 10.

- Press the **▲▼** buttons to choose **10**, then press the **FUNC. SET** button.
- ▶ Once set, **10** will appear on the screen.

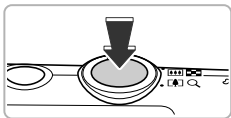

3 Shoot.

- Press the shutter button halfway to focus on the subject, then press it fully.
- ▶ When the self-timer starts, the lamp blinks and the self-timer sound plays.
- ▶ Two seconds before the shutter releases, the lamp and sound speed up (the lamp remains lit when the flash will fire).
- To cancel shooting with the self-timer after the countdown has started, press the **MENU** button.
- To restore the original setting, choose **OFF** in Step 2.

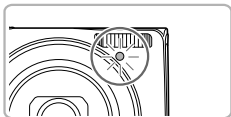



Using the Self-Timer to Prevent Camera Shake

The camera will shoot approximately 2 seconds after the shutter button is pressed, preventing any camera shake that occurs when pressing the shutter button.



Choose .

- Follow Steps 1 – 2 on p. 55 to choose .
- ▶ Once set,  will appear on the screen.
- Follow Step 3 on p. 55 to shoot.

Customizing the Self-Timer

You can set the delay (0 – 30 seconds) and the number of shots (1 – 10 shots).

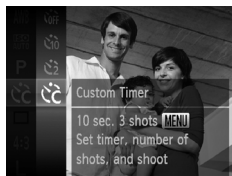





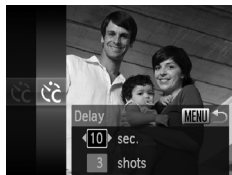

1 Choose .

- Follow Steps 1 – 2 on p. 55 to choose , then press the **MENU** button.



2 Choose the settings.

- Press the   buttons to choose [Delay] or [Shots].
- Press the   buttons to choose a value, then press the  button.
- ▶ Once set,  will appear on the screen.
- Follow Step 3 on p. 55 to shoot.



- When 2 or more shots are set, the exposure and white balance settings are set with the first shot. If the flash fires or you set a high number of shots, the shooting interval may take longer than usual. Shooting will stop automatically if the memory card fills.
- When you set the delay for more than 2 seconds, the lamp and self-timer sound speed up 2 seconds before the shutter releases (the lamp remains lit when the flash will fire).

Changing the Aspect Ratio

You can change the width to height ratio of an image.

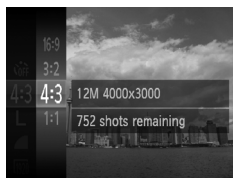

1 Choose 4:3.

- After pressing the **FUNC SET** button, press the **▲▼** buttons to choose **4:3**, then press the **FUNC SET** button again.

2 Choose an option.

- Press the **▲▼** buttons to choose an option, then press the **FUNC SET** button.
- ▶ Once set, the aspect ratio of the screen will change.
- To restore the original setting, choose **4:3** in Step 2.



16:9 The same aspect ratio as HD TVs, used for displaying on wide-screen HD TVs.

3:2 The same aspect ratio as 35mm film, used for printing out 5 x 7 in. or postcard sized images.

4:3 The same aspect ratio as the screen of this camera, used for printing images on 3.5 x 5 in. to various A-sized papers.

1:1 A square-shaped aspect ratio.





The digital zoom (p. 53) is only available in the **4:3** aspect ratio since [Digital Zoom] is fixed to [Off] in all other ratios.

Changing the Recording Pixel Setting (Image Size)

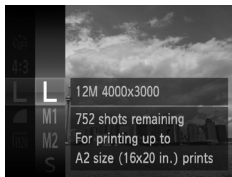

You can choose from 4 recording pixel settings.



1 Choose the recording pixel setting.



- After pressing the  button, press the  buttons to choose **L**, then press the  button again.

2 Choose an option.

- Press the  buttons to choose an option, then press the  button.
- ▶ The setting will appear on the screen.
- To restore to the original setting, choose **L** in Steps 1 – 2.





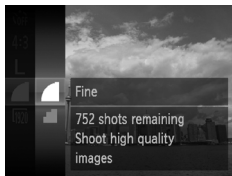

Changing the Compression Ratio (Image Quality)



You can choose from the following 2 compression ratios (image quality):  (Fine),  (Normal).



1 Choose the compression ratio setting.









- After pressing the  button, press the  buttons to choose , then press the  button again.

2 Choose an option.

- Press the  buttons to choose an option, then press the  button.
- ▶ The setting will appear on the screen.
- To restore the original setting, choose  in Steps 1 – 2.



Approximate Values for Recording Pixels and Compression Ratio (for 4:3 Aspect Ratios)

Recording Pixels	Compression Ratio	Single Image Data Size (Approx. KB)	Number of Shots per Memory Card (Approx. shots)	
			4 GB	16 GB
L (Large) 12M/4000x3000		3084	1231	5042
		1474	2514	10295
M1 (Medium 1) 6M/2816x2112		1620	2320	9503
		780	4641	19007
M2 (Medium 2) 2M/1600x1200		558	6352	26010
		278	12069	49420
S (Small) 0.3M/640x480		150	20116	82367
		84	30174	123550

- The values in the table are measured according to Canon standards and may change depending on the subject, memory card and camera settings.
- The values in the table are based on 4:3 aspect ratio. If the aspect ratio is changed (p. 58), more images can be shot because the data size per image will be smaller than with 4:3 images. However, since **M2** 16:9 images have a setting of 1920 x 1080 pixels, their data size will be larger than 4:3 images.

Approximate Values for Paper Size (for 4:3 Aspect Ratios)

A2 (16.5 x 23.4 in.)	L
A3 – A5 (11.7 x 16.5 – 5.8 x 8.3 in.)	M1
5 x 7 in. Postcard size 3.5 x 5 in.	M2

- **S** For sending images as e-mail attachments.

4

Adding Effects and Shooting in Various Conditions

This chapter explains how to add effects and how to shoot in various conditions.

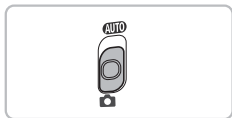

Shooting in Various Conditions

The camera will select the necessary settings for the conditions in which you wish to shoot when you choose the matching mode.





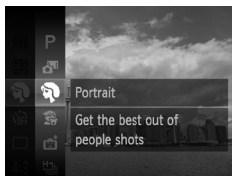

1 Enter mode.

- Set the mode switch to .



2 Choose a Shooting mode.

- After pressing the  button, press the  buttons to choose **P**, then press the  button again.
- Press the  buttons to choose a Shooting mode, then press the  button.



3 Shoot.



Take portraits (Portrait)

- Produces a soft effect when photographing people.



Take shots of kids and pets (Kids&Pets)

- Lets you capture subjects that move around, such as children and pets, without missing photo opportunities.
- At maximum wide angle, move approximately 1 m (3.3 ft.) or more away from your subject. At maximum telephoto, move approximately 3 m (9.8 ft.) or more away from your subject and shoot.



Take nightscapes without using a tripod (Handheld NightScene)

- Lets you take beautiful snapshots of city nightscapes by combining several continuous shots to reduce camera shake and noise.
- When using a tripod, you should shoot in **AUTO** mode (p. 26).



Take shots in low light conditions (Low Light)

- Lets you take shots in dark places with reduced camera shake and subject blur.



At the beach (Beach)

- Lets you take shots of brightly lit people on sandy beaches where the reflected sunlight is strong.



Take shots of foliage (Foliage)

- Lets you shoot trees and leaves, such as new growth, autumn leaves or blossoms, in vivid colors.



Against snow (Snow)



- Lets you take bright, natural-colored shots of people against snowy backgrounds.







Take shots of fireworks (Fireworks)

- Lets you take shots of fireworks in vivid colors.



- In  mode, hold the camera firmly while shooting as multiple images are captured in succession.
- In  mode, attach the camera to a tripod to prevent the camera from moving and blurring the image. Additionally, you should set [IS Mode] to [Off] when shooting with a tripod (p. 167).



- In  or  mode, images may appear coarse because the ISO speed (p. 85) is increased to match the shooting conditions.
- If camera shake is too strong while shooting in  mode, the camera may not be able to combine images or you may not obtain the expected result depending on shooting conditions.
- In  mode, the recording pixel setting will be fixed at **M** (1984 x 1488 pixels).

Adding Effects and Shooting





You can add various effects to images when shooting.

1 Choose a Shooting mode.

- Follow Steps 1 – 2 on p. 62 to choose a Shooting mode.

2 Shoot.



Since you may not achieve the expected results with images shot in , , ,  and  modes, try taking some test shots first.



Shoot images with vivid colors (Super Vivid)

- Lets you take shots with vivid, intense colors.



Take posterized shots (Poster Effect)

- Lets you take shots that look like an old poster or illustration.

Shooting with the Effects of a Fish-Eye Lens (Fish-eye Effect)

Lets you shoot with the distorting effect of a fish-eye lens.

1 Choose .

- Follow Steps 1 – 2 on p. 62 to choose .



2 Choose an effect level.

- If you press the ▼ button, [Effect Level] will appear on the screen.
- Press the ◀▶ buttons to choose an effect level, then press the  button.
- ▶ You can check the effect on the screen.

3 Shoot.

Taking Shots That Look Like a Miniature Model (Miniature Effect)

Blurs chosen portions in the top and bottom of an image to produce the effect of a miniature model.

1 Choose .

- Follow Steps 1 – 2 on p. 62 to choose .
- ▶ A white frame (the area that will not be blurred) appears on the screen.



2 Choose the area to keep in focus.

- Press the ▼ button.
- Move the zoom lever to change the frame size, and press the ▲▼ buttons to change the frame position, then press the  button.

3 Shoot.



- If you press the ◀▶ buttons in Step 2, the frame will switch to vertical orientation, and you can change the area to focus in by pressing the ◀▶ buttons again. Press the ▲▼ buttons to return the frame orientation to horizontal.
- Holding the camera vertically will change the orientation of the frame.
- Be sure to set [] (playback speed) before shooting a Miniature Effect movie (p. 105).

Shooting with the Effects of a Toy Camera (Toy Camera Effect)

This effect darkens and blurs the corners of the image, and changes the overall color so that it looks like an image shot with a toy camera.

1 Choose [].

- Follow Steps 1 – 2 on p. 62 to choose [].

2 Choose a color tone.

- Press the ▼ button.
- ▶ [Color Tone] will appear on the screen.
- Press the ◀▶ buttons to choose a color tone, then press the [] button.
- ▶ You can check the color tone on the screen.



3 Shoot.

Standard	Images will look like they were shot with a toy camera.
Warm	Gives images a warmer tone than [Standard].
Cool	Gives images a cooler tone than [Standard].

Shooting in Monochrome





You can shoot images in black and white, sepia or blue and white.

1 Choose .

- Follow Steps 1 – 2 on p. 62 to choose .



2 Choose a color tone.

- Press the  button.
- ▶ [Color Tone] will appear on the screen.
- Press the   buttons to choose a color tone, then press the  button.
- ▶ You can check the color tone on the screen.

3 Shoot.

B/W	Lets you shoot black and white images.
Sepia	Lets you shoot sepia toned images.
Blue	Lets you shoot blue and white images.

Shooting with Color Accent

You can choose to retain a single color and change the rest to black and white in a composition.



Recorded color

1 Choose .

- Follow Steps 1 – 2 on p. 62 to choose .



2 Press the button.

- ▶ The unchanged image and the Color Accent image will alternately display.
- ▶ The color for default settings is green.

3 Specify the color.

- Position the center frame so it is filled with the color you want and press the  button.
- ▶ The specified color will be recorded.

4 Specify the range of colors.

- Press the   buttons to change the range of colors to be retained.
- Choose a negative value to limit the range of colors. Choose a positive value to extend the range of colors to similar colors.
- Press the  button to complete the setting and restore the shooting screen.



- Using the flash may cause unexpected results in this mode.
- Depending on shooting conditions, the image may become coarse, or the colors may not come out as expected.

Shooting with Color Swap

You can swap one color in an image for another when recording it. You can only swap one color.



1 Choose .

- Follow Steps 1 – 2 on p. 62 to choose .



2 Press the button.

- ▶ The unchanged image and the Color Swap image will alternately display.
- ▶ The default setting is to change green to gray.



3 Specify the color to be swapped.

- Position the center frame so it is filled with the color you want and press the  button.
- ▶ The specified color will be recorded.



4 Specify the target color.

- Position the center frame so it is filled with the color you want and press the  button.
- ▶ The specified color will be recorded.

5 Specify the range of colors to be swapped.

- Press the ▲▼ buttons to adjust the range of colors to be swapped.
- Choose a negative value to limit the range of colors. Choose a positive value to extend the range of colors to similar colors.
- Press the  button to complete the setting and restore the shooting screen.



- Using the flash may cause unexpected results in this mode.
- Depending on shooting conditions, the image may become coarse, or the colors may not come out as expected.

Making Short Movies Automatically (Movie Digest)

You can make a short movie of a day just by taking still images. Each time you take a picture, the scene just before taking your shot will be recorded as a movie. All the movies recorded that day will be saved as a single file.

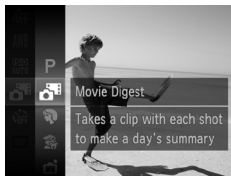

1 Choose .

- Follow Steps 1 – 2 on p. 62 to choose .

2 Shoot.

- Press the shutter button fully to shoot a still image.
- ▶ A movie of approx. 2 – 4 sec. will be recorded just before the image is taken.



What if a movie is not recorded?



If you take a picture just after turning on the camera, selecting  mode or otherwise operating the camera, a movie may not be recorded.



Viewing movies made with Movie Digest mode

You can select movies made in  mode by date for viewing (p. 115).



- Since you are also shooting movies when you shoot still images, the battery will be depleted more quickly than in **AUTO** mode.
- The image quality will be fixed at $\overline{640}$ for movies made in  mode.
- In the following cases, movies will be saved as separate files even if they were made on the same day with  mode.
 - If the clip file size reaches 4 GB or the recording time reaches approximately 1 hour
 - If the movie is protected (p. 124)
 - If the Time Zone setting is changed (p. 164)
 - If a new folder is created (p. 162)
- If you operate the camera while shooting a movie, the sounds made will be recorded in the movie.
- The camera will not play sounds, such as when pressing the shutter button halfway, using the controls or the self-timer (p. 158).



Detecting a Face and Shooting (Smart Shutter)

Detecting a Smile and Shooting

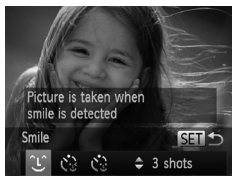
The camera will shoot, even without pressing the shutter button, when it detects a smile.



1 Choose ☺.

- Follow Steps 1 – 2 on p. 62 to choose , then press the ▼ button.
- Press the ◀▶ buttons to choose ☺, then press the  button.
- ▶ The camera will enter shooting stand-by, and [Smile Detection on] will appear on the screen.

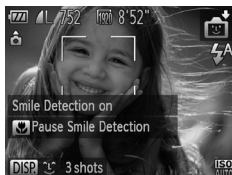

2 Point the camera at a person.

- Each time the camera detects a smile it will shoot after the lamp lights.
- Press the ◀ button to pause smile detection. Press the ◀ button again to resume smile detection.

? What if a smile is not detected?

Smiles are easier to detect if the subject faces the camera, and opens their mouth enough to show some teeth when smiling.

Changing the number of shots

After choosing ☺ in Step 1, press the ▲▼ buttons.







- You should switch to another mode when you finish shooting, or the camera will continue taking shots each time the camera detects a smile.
- You can also shoot by pressing the shutter button.

Using the Wink Self-Timer

Point the camera at a person and press the shutter button fully. The camera will shoot approximately 2 seconds after it detects a wink.



1 Choose .

- Follow Steps 1 – 2 on p. 62 to choose , then press the  button.
- Press the  buttons to choose , then press the  button.

2 Compose the shot and press the shutter button halfway.

- Confirm that a green frame appears around the face of the person who will wink.

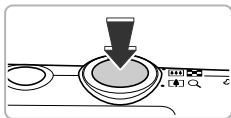

3 Press the shutter button fully.

- ▶ The camera will enter shooting stand-by, and [Wink to take picture] will appear on the screen.
- ▶ The lamp will blink and the self-timer sound will play.



4 Face the camera and wink.

- ▶ The shutter will release approximately 2 seconds after a wink is detected from the person inside the frame.
- To cancel shooting with the self-timer after the countdown has started, press the **MENU** button.

What if a wink is not detected?

- Wink a bit slowly.
- A wink may not be detected if eyes are covered by hair or a hat, or when wearing glasses.



Changing the number of shots

After choosing  in Step 1, press the   buttons.









- Shutting both eyes will also be detected as a wink.
- If a wink is not detected, the shutter will release approximately 15 seconds later.
- If there are no people in the shot when the shutter button is pressed fully, the camera will shoot after a person enters the shot and winks.

Using the Face Self-Timer

The shutter will release approximately 2 seconds after the camera detects a new face (p. 92). You can use this when the photographer wants to be in the image, such as a group photo.



1 Choose .

- Follow Steps 1 – 2 on p. 62 to choose ,
- then press the .
- Press the   buttons to choose ,
- then press the .

2 Compose the shot and press the shutter button halfway.

- Make sure a green frame appears on the face focused on and white frames appear on other faces.

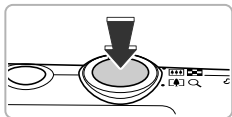

3 Press the shutter button fully.

- ▶ The camera will enter shooting stand-by, and [Look straight at camera to start count down] will appear on the screen.
- ▶ The lamp will blink and the self-timer sound will play.



4 Join the subjects and look at the camera.

- ▶ When the camera detects a new face, the lamp and self-timer sound will speed up (the lamp remains lit when the flash will fire), and approximately 2 seconds later the shutter will release.
- To cancel shooting with the timer after countdown has started, press the **MENU** button.



Changing the number of shots

After choosing  in Step 1, press the ▲▼ buttons.



Even if your face is not detected after joining the subjects, the shutter will release approximately 15 seconds later.

Shooting Long Exposures

You can set the shutter speed to a range between 1 and 15 seconds to shoot long exposures. However, you should attach the camera to a tripod to prevent the camera from moving and blurring the image.

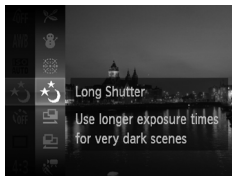

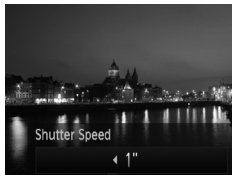

1 Choose .

- Follow Steps 1 – 2 on p. 62 to choose .



2 Choose the shutter speed.

- Press the  button.
- Press the  buttons to choose the shutter speed, then press the .

3 Confirm the exposure.

- When you press the shutter button halfway, the exposure for the chosen shutter speed will appear on the screen.

4 Shoot.



- The brightness of the recorded image may differ from the brightness of the screen in Step 3 when the shutter button was pressed halfway.
- When shutter speeds of 1.3 seconds or slower are used, images are processed to reduce noise after being taken. A certain amount of processing time may be needed before you can take the next shot.
- You should set [IS Mode] to [Off] when shooting with a tripod (p. 167).



If the flash fires, the image may be overexposed. If this happens, set the flash to  and shoot.

High-Speed Continuous Shooting (High-speed Burst)

You can shoot continuously at a maximum speed of approximately 8.7 images/second while the shutter button is pressed fully and held.



1 Choose .

- Follow Steps 1 – 2 on p. 62 to choose .

2 Shoot.

- ▶ As long as you hold the shutter button down, the camera will shoot successive images.



- The recording pixel setting will be fixed at **M** (1984 x 1488 pixels).
- The focus, brightness and white balance will be set with the first shot.
- Depending on the shooting conditions, camera settings and the zoom position, the camera may stop shooting momentarily, or the shooting speed may slow down.
- As the number of images increases, the shooting speed may slow down.

Images Displayed During Playback

Since each set of continuous images will become a single group, only the first image captured in that group will be displayed. To indicate that the image is part of a group,  will appear in the upper left of the screen.



If you erase a grouped image (p. 128), all the images in the group will also be erased. Be sure to exercise adequate caution.



- You can play back images individually (p. 121), and cancel grouping (p. 122).
- Protecting (p. 124) a grouped image will protect all of the images in the group.
- If you play back grouped images using Filtered Playback (p. 115) or Smart Shuffle (p. 123), grouping is temporarily canceled and images are played back individually.
- Grouped images cannot be tagged as favorites (p. 130), edited (pp. 135 – 140), categorized (p. 132), printed (p. 142), have print settings (p. 151) or photobook settings (p. 154) applied. Play back grouped images individually (p. 121), or cancel grouping (p. 122) before trying the above.

Capturing the Best Facial Expressions (Best Image Selection)

The camera takes 5 continuous shots, then detects various aspects of the shot such as facial expressions, and saves only one picture detected as the best.

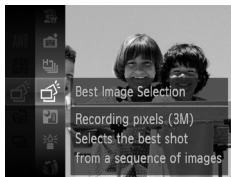

1 Choose .

- Follow Steps 1 – 2 on p. 62 to choose .

2 Shoot.

- ▶ When the shutter button is pressed fully, the camera takes 5 continuous shots, and saves one picture only.





- The recording pixel setting will be fixed at **M** (1984 x 1488 pixels).
- The focus, brightness and white balance will be set with the first shot.
- Depending on the shooting conditions, you may not obtain the expected results.

Shooting Stitch Assist Images

Large subjects can be split into several shots that can later be merged together using the included software on a computer to create a panoramic image.

1 Choose or .

- Follow Steps 1 – 2 on p. 62 to choose  or .



2 Take the first shot.

- ▶ The exposure and white balance will be set with the first shot.

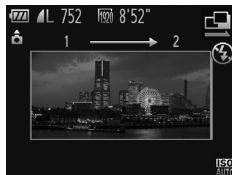

3 Take subsequent shots.

- Overlap part of the first shot when taking the second shot.
- Minor discrepancies in the overlapping portions will be corrected when the images are merged.
- Up to 26 shots can be recorded with the same procedures.

4 Finish shooting.

- Press the  button.



5 Merge the images on a computer.

- For details on how to merge the images, refer to the *Software Guide*.





This function is not available when a TV is used as a display (p. 171).

5

Choosing Settings Yourself

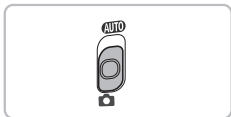
In this chapter you will learn how to use the various functions in **P** mode to progressively advance your shooting skills.



- This chapter assumes that you have set the mode switch to  and the camera is in **P** mode.
- **P** stands for Program AE.
- Before attempting to shoot using a function explained in this chapter in modes other than **P** mode, check if the function is available in those modes (pp. 188 – 193).

Shooting in Program AE

You can choose the settings for various functions to suit your preferences. AE stands for Auto Exposure.

The focusing range is approximately 5 cm (2.0 in.) – infinity at maximum wide angle (☐), and approximately 1 m (3.3 ft.) – infinity at maximum telephoto (☐).



1 Enter **P** mode.

- Follow Steps 1 – 2 on p. 62 to choose **P**.

2 Adjust the settings according to your purposes (pp. 83 – 102).

3 Shoot.

? What if the shutter speed and aperture value appear in orange?

If a correct exposure cannot be obtained when pressing the shutter button halfway, the shutter speed and aperture value appear in orange. Try the following settings to obtain the correct exposure.

- Turn on the flash (p. 83)
- Choose a higher ISO speed (p. 85)

Adjusting the Brightness (Exposure Compensation)

You can adjust the standard exposure set by the camera in 1/3-stop increments in the range of -2 to +2.

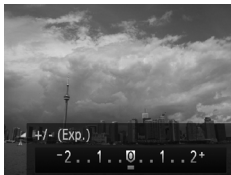

1 Enter Exposure Compensation mode.



- Press the ▲ button.

2 Adjust the brightness.

- While watching the screen, press the ◀▶ buttons to adjust the brightness, then press the  button.
- ▶ The exposure compensation amount will appear on the screen.



Turning the Flash On

You can make the flash fire every time you shoot.

The effective flash range is approximately 50 cm – 4.0 m (1.6 – 13 ft.) at maximum wide angle () , and approximately 50 cm – 2.0 m (1.6 – 6.6 ft.) at maximum telephoto () .



Choose .



- After pressing the ▶ button, press the ◀▶ buttons to choose , then press the  button.
- ▶ Once set,  will appear on the screen.

Adjusting the White Balance

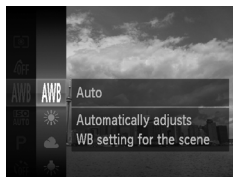

The white balance (WB) function sets the optimal white balance for natural looking colors to match the shooting conditions.









1 Choose the white balance function.

- After pressing the  button, press the  buttons to choose **AWB**, then press the  button again.

2 Choose an option.

- Press the  buttons to choose an option, then press the  button.
- ▶ The setting will appear on the screen.

 Auto	Automatically sets the optimal white balance for the shooting conditions.
 Day Light	For shooting outdoors, in fine weather conditions.
 Cloudy	For shooting in cloudy, shady or twilight conditions.
 Tungsten	For shooting under tungsten and bulb-type (3-wavelength) fluorescent lighting.
 Fluorescent	For shooting under warm-white fluorescent, cool-white fluorescent and warm-white-type (3-wavelength) fluorescent lighting.
 Fluorescent H	For shooting under daylight fluorescent and daylight-type (3-wavelength) fluorescent lighting.
 Custom	For manually setting a custom white balance.

Custom White Balance

You can adjust the white balance to match the light source at the shooting location. Make sure that you set the white balance under the light source of the actual scene you will shoot.

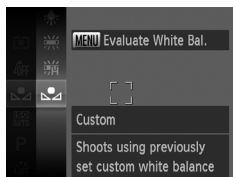

- In Step 2 above, choose .
- Make sure the entire screen is filled with a plain, white colored subject, then press the **MENU** button.
- ▶ The tint on the screen will change when white balance data is set.





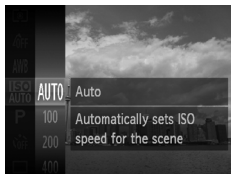

If you change camera settings after recording white balance data, the tone may not turn out properly.



Changing the ISO Speed











1 Choose the ISO speed.

- After pressing the  button, press the  buttons to choose , then press the  button again.

2 Choose an option.

- Press the  buttons to choose an option, then press the  button.
- ▶ The setting will appear on the screen.

	Automatically adjusts the ISO speed to the Shooting mode and shooting conditions.	
 	Low	For shooting outdoors, in fine weather conditions.
 		For shooting in cloudy or twilight conditions.
 	High	For shooting nightscapes or in dark interiors.



Changing the ISO speed

- Lowering the ISO speed results in sharper images, but there may be an increased chance of image blurring in certain shooting conditions.
- Raising the ISO speed results in a faster shutter speed, reducing image blurring and letting the flash reach greater distances to the subject. The images, however, will appear coarse.





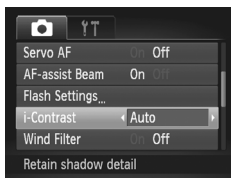

When the camera is set to , you can press the shutter button halfway to display the automatically set ISO speed.

Correcting the Brightness and Shooting (i-Contrast)

The camera can detect areas in the scene, such as faces or backgrounds, that are too bright or dark and automatically adjust them to the optimum brightness when shooting. Also, when the overall image is lacking in contrast, the camera will automatically correct the image for a sharper impression when shooting.



Choose [i-Contrast].

- Press the **MENU** button to choose [i-Contrast] in the  tab, then press the   buttons to choose [Auto].
- ▶ Once set,  will appear on the screen.





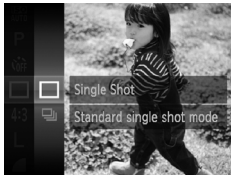

- Under some conditions, the image may appear coarse or may not be corrected properly.
- You can correct recorded images (p. 139).

Continuous Shooting





You can shoot continuously at a maximum speed of approximately 3.5 images/second while the shutter button is pressed fully and held.



1 Choose a Drive mode.

- After pressing the  button, press the  buttons to choose , then press the  button again.

2 Choose an option.

- Press the  buttons to choose , then press the  button.
- ▶ Once set,  will appear on the screen.

3 Shoot.

- ▶ As long as you hold the shutter button down, the camera will shoot successive images.





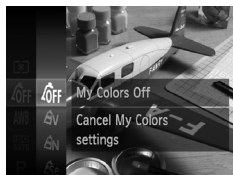

- Cannot be used with the self-timer (p. 55).
- Continuous shooting speed increases in  mode (p. 63).
- For continuous shooting, the focus and exposure are locked when the shutter button is pressed halfway.
- Depending on the shooting conditions, camera settings and the zoom position, the camera may stop shooting momentarily, or the shooting speed may slow down.
- As the number of images increases, the shooting speed may slow down.
- If the flash fires, the shooting speed may slow down.

Changing the Tone of an Image (My Colors)



You can change the tone of an image, for example to sepia or black and white, when shooting.















1 Choose My Colors.





- After pressing the  button, press the  buttons to choose , then press the  button again.

2 Choose an option.

- Press the  buttons to choose an option, then press the  button.
- ▶ The setting will appear on the screen.

 My Colors Off	—
 Vivid	Emphasizes the contrast and color saturation for a vivid impression.
 Neutral	Tones down the contrast and color saturation for neutral hues.
 Sepia	Changes the image to sepia tones.
 B/W	Changes the image to black and white.
 Positive Film	Combines the effects of Vivid Red, Vivid Green and Vivid Blue to produce intense natural appearing colors like those obtained with positive film.
 Lighter Skin Tone	Makes skin tones lighter.
 Darker Skin Tone	Makes skin tones darker.
 Vivid Blue	Emphasizes blue tints. Makes the sky, ocean and other blue subjects more vivid.
 Vivid Green	Emphasizes green tints. Makes mountains, foliage and other green subjects more vivid.
 Vivid Red	Emphasizes red tints. Makes red subjects more vivid.
 Custom Color	You can adjust contrast, sharpness, and color saturation etc. to your preference (p. 89).



- The white balance cannot be set in  and  (p. 84).
- In  and , colors other than people's skin color may change. You may not obtain the expected results with some skin colors.

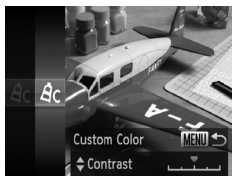

Custom Color

The contrast, sharpness, color saturation, red, green, blue, and skin tones in an image can be chosen and set at 5 different levels.







- Follow Step 2 on p. 88 to choose **AC**, then press the **MENU** button.
- Press the **▲▼** buttons to choose an option, then press the **◀▶** buttons to choose a value.
- The more to the right, the stronger/darker (skin tone) the effect gets, the more to the left, the weaker/lighter (skin tone) the effect gets.
- Press the **MENU** button to complete the setting.

Shooting Close-ups (Macro)

If you set the camera to , it focuses on close subjects only. The focusing range is approximately 1 – 50 cm (0.4 in. – 1.6 ft.) from the end of the lens at maximum wide angle ()



Choose .

- After pressing the  button, press the  buttons to choose , then press the  button.
- ▶ Once set,  will appear on the screen.



The edges of the image may darken if the flash fires.





How can I take better close-ups?

Try attaching the camera to a tripod and shooting in  to prevent the camera from moving and blurring the image (p. 56).







 will turn gray in the area that displays in the yellow bar underneath the zoom bar, and the camera will not focus.

Shooting Far Away Subjects (Infinity)

If you set the camera to , it focuses on far-away subjects only. Set the camera to  to focus more reliably on far away subjects (3 m (9.8 ft.) or more away from the camera).



Choose .



- After pressing the  button, press the  buttons to choose , then press the  button.
- ▶ Once set,  will appear on the screen.

Using the Digital Tele-Converter

The focal length of the lens can be increased by 1.5x or 2.0x. This enables a faster shutter speed and less chance of camera shake than the zoom (including digital zoom) used by itself at the same zoom factor.



Choose [Digital Zoom].

- Press the **MENU** button to choose [Digital Zoom] in the  tab, then press the   buttons to choose an option.
- ▶ The view will be enlarged and the zoom factor will appear on the screen.



- The respective focal lengths when using [1.5x] and [2.0x] are 42.0 – 336 mm and 56.0 – 448 mm (35mm film equivalent).
- A recording pixel setting (p. 59) of **L** or **M1** will cause images to appear coarse (the zoom factor will appear in blue).
- The digital tele-converter cannot be used together with the digital zoom (p. 53).
- The digital-teleconverter can only be used with the 4:3 aspect ratio.
- The shutter speeds may be the same when at maximum telephoto [, and when zoomed in on the subject using Step 2 on p. 53.

Changing the AF Frame Mode

You can change the AF (Auto Focus) frame mode to match the scene you want to shoot.

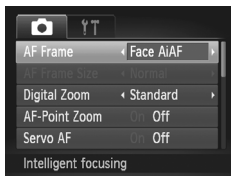

Choose [AF Frame].

- Press the **MENU** button to choose [AF Frame] in the  tab, then press the **◀▶** buttons to choose an option.

Face AiAF

- Detects people's faces and sets the focus, exposure (evaluative metering only) and white balance (AWB only).
- When the camera is pointed at subjects, a white frame appears on the face the camera judges to be the main subject, and gray frames (max. 2) will appear on other faces.
- A frame will follow a moving subject within a certain range.
- When the shutter button is pressed halfway, up to 9 green frames will appear on faces that the camera focuses on.



- If a face is not detected, or only gray frames (no white frame) appear, up to 9 green frames will appear on the areas the camera focuses on when the shutter button is pressed halfway.
- If a face is not detected when [Servo AF] (p. 97) is set to [On], the AF frame will appear in the center of the screen when you press the shutter button halfway.
- Examples of faces that cannot be detected:
 - Subjects that are far away or extremely close
 - Subjects that are dark or light
 - Faces turned to the side or at an angle, or faces with a portion hidden
- The camera may mistakenly identify non-human subjects as a face.
- If the camera cannot focus when you press the shutter button halfway, the AF frame will not appear.

Tracking AF

You can choose the subject you want to focus on and shoot (p. 94).

Center

The AF frame is locked to the center. This is effective for focusing on a specific point.



You can reduce the AF frame size

- Press the **MENU** button to choose [AF Frame Size] in the  tab, then choose [Small].
- The AF frame is set to [Normal] when using the digital zoom (p. 53) or digital tele-converter (p. 91).



If the camera cannot focus when you press the shutter button halfway, the AF frame will turn yellow and  will appear.

Changing the Composition with the Focus Lock

While you keep the shutter button pressed halfway, the focus and exposure are locked. You can now recompose and shoot. This is called Focus Lock.



1 Focus.

- Center the subject you want in focus, and press the shutter button halfway.
- Confirm that the AF frame on the subject is green.



2 Recompose.

- Keep the shutter button pressed halfway and move the camera to recompose the scene.

3 Shoot.

- Press the shutter button fully.

Choosing the Subject to Focus On (Tracking AF)

You can choose the subject you want to focus on and shoot.



1 Choose [Tracking AF].

- Press the **MENU** button to choose [AF Frame] in the tab, then press the buttons to choose [Tracking AF].
- ▶ will appear in the center of the screen.



2 Choose the subject to focus on.

- Point the camera so that is on the subject you want to focus on and press the button.







- ▶ The camera will beep and will appear when a subject is detected. The camera will continue to track the subject within a certain range even if the subject moves.
- ▶ If the camera does not detect the subject, will appear on the screen.
- To cancel tracking, press the button again.

3 Shoot.

- Press the shutter button halfway. will change into a blue which will follow the subject while the camera continues to adjust the focus and exposure (Servo AF) (p. 97).
- Press the shutter button fully to shoot.
- ▶ Even after shooting completes, will appear, and the camera will continue to track the subject.





- The camera will detect a subject even if you press the shutter button halfway without pressing the  button. When shooting completes,  will appear in the center of the screen.
- [Servo AF] (p. 97) is fixed to [On].
- The camera may not be able to track the subject if the subject is too small, moves too quickly or if the contrast between the subject and the background is too low.
- Not available in  or .

Magnifying the Focal Point

If you press the shutter button halfway, the AF frame will magnify and you can check the focus.



1 Choose [AF-Point Zoom].

- Press the **MENU** button to choose [AF-Point Zoom] in the  tab, then press the  buttons to choose [On].



2 Check the focus.

- Press the shutter button halfway.
 - ▶ In [Face AiAF] (p. 92), the face detected as the main subject will appear magnified.
 - ▶ In [Center] (p. 93), the contents of the center AF frame will appear magnified.



What if the display does not magnify?

The display will not appear magnified in [Face AiAF] if a face cannot be detected or is too big in relation to the screen. In [Center], it will not appear magnified if the camera cannot focus.



The magnified display will not appear when using the digital zoom (p. 53), digital tele-converter (p. 91), Tracking AF (p. 94), Servo AF (p. 97) or when using a TV as a display (p. 171).

Shooting with the AF Lock

The focus can be locked. After locking the focus, the focal distance will not change even when you release your finger from the shutter button.

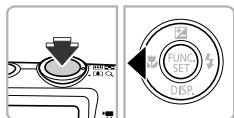

1 Lock the focus.

- Keep the shutter button pressed halfway and press the ◀ button.
- ▶ The focus locks and AFL appears on the screen.
- If you release your finger from the shutter button and press the ◀ button again, AFL will disappear and the focus will unlock.

2 Compose the scene and shoot.

Shooting with Servo AF

While the shutter button is pressed halfway, the focus and exposure will continue to adjust, allowing you to take pictures of moving subjects without missing a shot.

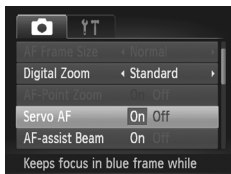

1 Choose [Servo AF].

- Press the **MENU** button to choose [Servo AF] in the tab, then press the **◀▶** buttons to choose [On].

2 Focus.

- The focus and exposure will be maintained where the blue AF frame appears while you press the shutter button halfway.





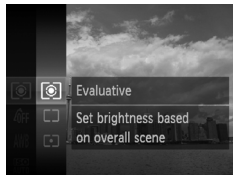

- The camera may not be able to focus in some conditions.
- In low light conditions, AF frames may not turn blue even after pressing the shutter button halfway. In this case, you can set the focus and exposure with the AF frame setting.
- If a correct exposure cannot be obtained, the shutter speed and aperture value appear in orange. Release your finger from the shutter button, then press it again halfway.
- You cannot shoot with the AF lock in this mode.
- The [AF-Point Zoom] option in the tab is not available in Servo AF mode.
- Not available when using the self-timer (p. 55).

Changing the Metering Method



You can change the metering method (brightness measuring function) to match the shooting conditions.





1 Choose the metering method.

- After pressing the  button, press the  buttons to choose , then press the  button again.

2 Choose an option.

- Press the  buttons to choose an option, then press the  button.
- ▶ The setting will appear on the screen.

 Evaluative	For standard shooting conditions, including back lit shots. Automatically adjusts the exposure to match the shooting conditions.
 Center Weighted Avg.	Averages the light metered from the entire frame, but gives greater weight to the center.
 Spot	Only meters within the [] (Spot AE Point frame) that appears at the center of the screen.

Shooting with the AE Lock

You can lock the exposure and shoot, or set the focus and exposure separately to shoot. AE stands for “Auto Exposure”.

1 Choose (p. 52).

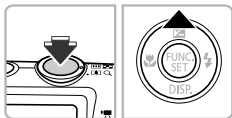

2 Lock the exposure.

- Point the camera toward the subject and press the ▲ button while pressing the shutter button halfway.
- ▶ When AEL appears, the exposure will be locked.
- If you release your finger from the shutter button and press the ▲ button again, AEL will disappear and AE will unlock.

3 Compose the scene and shoot.

Shooting with the FE Lock

Just as with the AE lock, you can lock the exposure for shooting with the flash. FE stands for “Flash Exposure”.

1 Choose (p. 83).

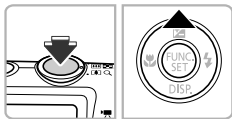

2 Lock the flash exposure.

- Point the camera toward the subject and press the ▲ button while pressing the shutter button halfway.
- ▶ The flash will fire and when FEL appears, the flash output will be retained.
- If you release your finger from the shutter button and press the ▲ button again, FEL will disappear and FE will unlock.



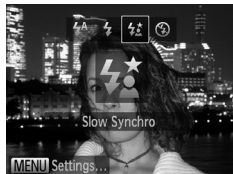

3 Compose the scene and shoot.

Shooting with Slow Synchro

You can make the main subject, such as people, appear bright by having the camera provide the appropriate illumination with the flash. At the same time, you can use a slow shutter speed to brighten the background that the light from the flash cannot reach.



1 Choose .

- After pressing the  button, press the  buttons to choose , then press the  button.
- ▶ Once set,  will appear on the screen.

2 Shoot.

- Even if the flash fires, ensure that the main subject does not move until the shutter sound ends.



Attach the camera to a tripod to prevent the camera from moving and blurring the image. Additionally, you should set [IS Mode] to [Off] when shooting with a tripod (p. 167).

Red-Eye Correction

You can automatically correct red-eye that occurs in images taken with the flash.

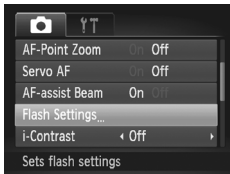

1 Choose [Flash Settings].

- Press the **MENU** button to choose [Flash Settings] in the tab, then press the button.

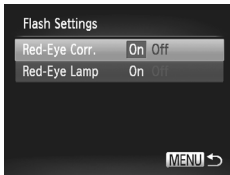

2 Choose the setting.

- Press the buttons to choose [Red-Eye Corr.], then press the buttons to choose [On].
- ▶ Once set, will appear on the screen.



Red-eye correction may be applied to areas other than red eyes. For example, when red make-up has been used around eyes.





- You can also correct recorded images (p. 140).
- You can also display the screen in Step 2 by pressing the button, then the **MENU** button.

Checking for Shut Eyes

When the camera detects the possibility that people have their eyes shut,  appears on the screen.





1 Choose [Blink Detection].

- Press the **MENU** button to choose [Blink Detection] in the  tab, then press the   buttons to choose [On].

2 Shoot.

- ▶ When a person with shut eyes is detected, a frame and  appear on the screen.





- This function is only available for the last image shot when you have set the camera to 2 or more shots in  or  mode.
- Not available in  mode.

6

Using Various Functions for Shooting Movies

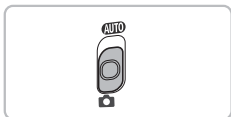
This chapter serves as a more advanced version of the “Shooting Movies” and “Viewing Movies” sections in Chapter 1, and explains how to use various functions for shooting and viewing movies.



- This chapter assumes that you have set the mode switch to .
- The latter half of the chapter explaining movie playback and editing assumes that you have pressed the  button to enter Playback mode.

Shooting Various Kinds of Movies

Just as with still images, you can let the camera select the best settings for the scene or add various effects while shooting movies.

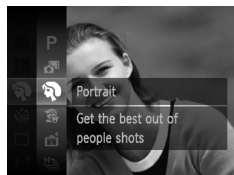











1 Choose a Shooting mode.

- Follow Steps 1 – 2 on p. 62 to choose a Shooting mode.

2 Shoot.



- Press the movie button.
- ▶ Depending on the Shooting mode or movie image quality (p. 108) you choose, black bars may appear on the top and bottom of the screen. These areas will not be recorded when shooting.
- To stop shooting the movie, press the movie button again.

 Portrait	p. 62
 Miniature Effect	p. 105
 Monochrome	p. 68
 Super Vivid	p. 65
 Poster Effect	p. 65
 Color Accent	p. 69

 Color Swap	p. 70
 Beach	p. 63
 Foliage	p. 63
 Snow	p. 63
 Fireworks	p. 64

Other Shooting Modes



You can shoot the following kinds of movies in  and  mode.

 iFrame Movie	Shoots movies that can be edited with iFrame*1 compatible software*2 or devices. The recording pixel setting will be fixed at  (p. 108).
 Super Slow Motion Movie	Shoots fast moving subjects and plays them back in slow motion (p. 106).

*1 Video type advocated by Apple.

*2 You can quickly edit and save iFrame movies if you use the included software.



- You can also record movies in other Shooting modes by pressing the movie button.
- Certain settings made in the FUNC. and Shooting menus will automatically change to match settings for shooting movies.
- Even in  or  mode, you can shoot still images when you press the shutter button. However, this is not possible while shooting a movie.

Shoot Movies That Look Like a Miniature Model (Miniature Effect)

You can shoot movies that look like moving miniature models. You create the miniature model effect by choosing the upper and lower portions of the scene that will be blurred, and the playback speed, which makes people and objects in the scene move quickly during playback. Audio will not be recorded.

1 Choose .

- Follow Steps 1 – 2 on p. 62 to choose .
- ▶ A white frame (the area that will not be blurred) appears on the screen.



2 Choose the area to keep in focus.

- Press the ▼ button.
- Move the zoom lever to change the frame size, and press the ▲▼ buttons to change the frame position.

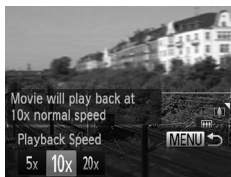

3 Choose a playback speed.

- Press the MENU button.
- Press the ◀▶ buttons to choose a playback speed.
- Press the MENU button to complete the setting and restore the shooting screen.

4 Shoot.

- Press the movie button.
- To stop shooting the movie, press the movie button again.

Playback Speeds and Estimated Playback Times (for 1 Min. Clips)

Speed	Playback Time
5x	Approx. 12 sec.
10x	Approx. 6 sec.
20x	Approx. 3 sec.



- The image quality will be fixed at 640 when an aspect ratio of 4:3 is chosen, and 1280 when an aspect ratio of 16:9 is chosen (p. 58).
- If you press the ◀▶ buttons in Step 2, the frame will switch to vertical orientation, and you can change the area to focus in by pressing the ◀▶ buttons again. Pressing the ▲▼ buttons will return the frame to horizontal orientation.
- Holding the camera vertically will change the orientation of the frame.
- Since you may not achieve the expected results depending on the shooting conditions, try taking some test shots first.

Shooting Super Slow Motion Movies



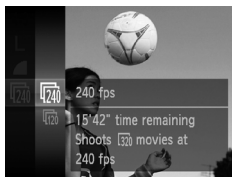

You can shoot fast moving subjects and play them back in slow motion. Audio will not be recorded.

1 Choose .

- Follow Steps 1 – 2 on p. 62 to choose .



2 Choose a frame rate.

- After pressing the  button, press the ▲▼ buttons to choose , then press the  button again.
- Press the ▲▼ buttons to choose an option, then press the  button.
- ▶ The option you set will appear on the screen.



3 Shoot.

- Press the movie button.
- ▶ The bar showing the shooting time will appear. Maximum clip length is approx. 30 sec.
- To stop shooting the movie, press the movie button again.

Frame Rates and Playback Times (for 30 Sec. Clips)

Frame Rate	Playback Time
$\overline{240}$ 240 fps	Approx. 4 min.
$\overline{120}$ 120 fps	Approx. 2 min.



Viewing super slow motion movies

- The movie will play back in slow motion when you follow Steps 1 – 3 on p. 33.
- You can use the included software to change the playback speed of movies shot in  mode. Refer to the *Software Guide* for details.







- The recording pixel setting will be fixed at $\overline{320}$ (320 x 240 pixels) when shooting in $\overline{240}$, and $\overline{640}$ when shooting in $\overline{120}$.
- Even if you move the zoom lever, the zoom will not operate while shooting.
- The focus, exposure and white balance will be set when the movie button is pressed.

Changing the Image Quality

You can choose among 3 different image quality settings.



1 Choose the image quality setting.

- After pressing the  button, press the  buttons to choose , then press the  button again.

2 Choose an option.









- Press the  buttons to choose an option, then press the .
- ▶ The option you set will appear on the screen.

Image Quality and Shooting Time per Memory Card



Image Quality	Recording Pixels, Frame Rate	Content	Memory Card Capacity	
			4 GB	16 GB
	1920 x 1080 pixels, 24 frames/sec.	For shooting Full HD movies.	Approx. 14 min. 34 sec.	Approx. 59 min. 40 sec.
	1280 x 720 pixels, 30 frames/sec.	For shooting high-definition (HD) movies.	Approx. 20 min. 43 sec.*1	Approx. 1 hr. 24 min. 54 sec.*2
	640 x 480 pixels, 30 frames/sec.	For shooting standard definition (SD) movies.	Approx. 43 min. 43 sec.	Approx. 2 hr. 59 min. 3 sec.

*1 Approx. 13 min. 35 sec. for iFrame movies (p. 104).

*2 Approx. 55 min. 38 sec. for iFrame movies (p. 104).

- Based on Canon's testing standards.
- Recording will automatically stop when the clip file size reaches 4 GB, or when the recording time reaches approximately 10 minutes when shooting in  or , and approximately 1 hour when shooting in .
- Recording may stop even if the maximum clip length has not been reached on some memory cards. SD Speed Class 6 or higher memory cards are recommended.





In  and , black bars appear on the top and bottom of the screen. These areas cannot be recorded.

Using the Wind Filter

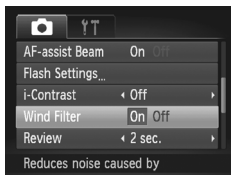
Wind Filter suppresses noise when the wind is strong. However, unnatural sound may result when used to record in locations with no wind.



- Press the **MENU** button to choose [Wind Filter] in the  tab, then press the   buttons to choose [On].

Other Shooting Functions

The following functions can be used in the same way as for still images. However, depending on the Shooting mode, settings may not be available or may not have any effect.

- **Zooming in More Closely On Subjects**
The sound of zoom operations will be recorded.
- **Using the Self-Timer (p. 55)**
The number of shots cannot be set.
- **Adjusting the Brightness (Exposure Compensation) (p. 83)**
Follow Step 2 on p. 83 to press the  button followed by the movie button.
- **Adjusting the White Balance (p. 84)**
- **Changing the Tone of an Image (My Colors) (p. 88)**
- **Shooting Close-ups (Macro) (p. 90)**
- **Shooting Far Away Subjects (Infinity) (p. 90)**
- **Shooting with the AF Lock (p. 96)**
- **Shooting with the AE Lock (p. 99)**
- **Shooting Using a TV as the Display (p. 171)**
- **Turning Off the AF Assist Beam (p. 165)**
- **Displaying Grid Lines (p. 166)**
- **Changing the IS-Mode Settings (p. 167)**
You can switch between [Continuous] and [Off].

Editing

You can trim the beginnings and ends of recorded movies.

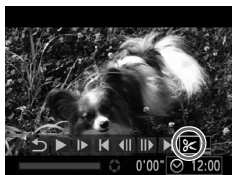



Movie Editing Panel



















Movie Editing Bar









1 Choose .

- Follow Steps 1 – 3 on p. 33 to choose , then press the  button.
- ▶ The movie editing panel and the movie editing bar will appear.

2 Set the editing range.



- Press the  buttons to choose  or .
- If you press the  buttons to move ,  will appear at points where the movie can be edited. If you choose , you can trim the beginning of the movie from . If you choose , you can trim the end of the movie from .
- Even if you move  to a point other than a , only the portion from the nearest  to the left will be trimmed when  is chosen. Only the portion from the nearest  to the right will be trimmed when  is chosen.

3 Check the edited movie.

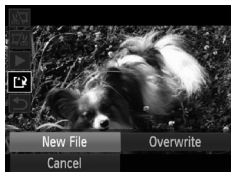
- Press the  buttons to choose , then press the  button. The edited movie will play.
- To edit the movie again, repeat Step 2.
- To cancel editing, press the  buttons to choose . After pressing the  button, press the  buttons to choose [OK], then press the  button again.



4 Save the edited movie.

- Press the ▲▼ buttons to choose [↵], then press the  button.
- Press the ◀▶ buttons to choose [New File], then press the  button.
- ▶ The movie will be saved as a new file.



- When [Overwrite] is chosen in Step 4, the unedited movie is overwritten with the edited movie, erasing the original.
- When there is not enough space left on the memory card, only [Overwrite] can be chosen.
- If the battery is depleted partway through saving, the edited movie clips may not be saved.
- When editing movies, you should use a fully charged battery, or an AC adapter kit (sold separately) (p. 203).

7

Using Various Playback and Editing Functions

This chapter explains various ways to play back and edit images.

- Press the  button to enter Playback mode before operating the camera.



- It may not be possible to play back or edit images that have been edited on a computer, have had their file names changed, or have been taken on a different camera.
- The edit function (pp. 136 – 140) cannot be used if the memory card does not have enough free space available.



Quickly Searching Images

Searching Images Using Index Display

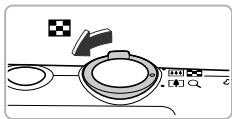
Displaying multiple images at the same time lets you quickly find the image you want.







1 Move the zoom lever toward .



- ▶ Images will display in an index.
- The number of images increases each time you move the lever toward .
- The number of images decreases each time you move the lever toward .



2 Choose an image.







- Press the     buttons to choose an image.
- ▶ An orange frame appears on the chosen image.
- Press the  button to display the chosen image by itself.

Searching Images by Scrolling

Pressing the   buttons for more than 1 second will display images in a line letting you quickly search them. You can also jump by the shooting date (Scroll Display).



Choose an image.

- If you set the camera to single image playback and press the   buttons for more than 1 second, the images will display as shown on the left. Press the   buttons to choose an image.
- Press the  button to restore single image playback.
- Press the   buttons during scroll display to search images by the shooting date.



To turn off this effect, press the **MENU** button to choose [Scroll Display] in the tab, then choose [Off].

Viewing Movies Made with Movie Digest

You can select movies made in mode (p. 72) by date for viewing.

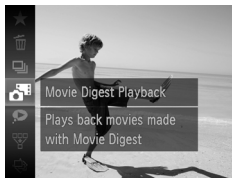

1 Choose .

- After pressing the button, press the to choose , then press the button again.

2 Choose a movie date.

- Press the .

3 Play the movie.

- Press the .
- ▶ The movie will play.

Viewing Images in Filtered Playback

When there are many images on the memory card, you can filter and display them by a specified filter. You can also protect (p. 124) or delete (p. 128) images at once while filtered.

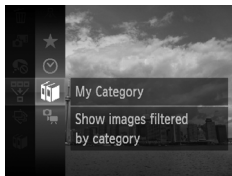

1 Choose .



- After pressing the button, press the to choose , then press the button again.

2 Choose a filter.

- Press the to choose a filter, then press the .



3 View the filtered images.

- Press the ▲▼ buttons to choose a filter for playback, then press the  button (except for ★).
- ▶ Filtered playback starts and a yellow frame appears.
- If you press the ◀▶ buttons, only the chosen target images will display.
- If you choose  in Step 2, filtered playback will be canceled.

Search filters

★ Favorites	Displays the images tagged as favorites (p. 130)
🕒 Shot Date	Displays the images shot on a specified date
📁 My Category	Displays the images of a specified category (p. 132)
📷 Still image/Movie	Displays still images, movies or movies shot in  mode

? What if you cannot choose a filter?

Filters that do not have any corresponding images cannot be chosen.

Filtered playback

In filtered playback (Step 3), you can view filtered images with “Quickly Searching Images” (p. 114), “Viewing Slideshows” (p. 117), and “Magnifying Images” (p. 120). You can process all filtered images at once while performing operations in “Protecting Images” (p. 124), “Erasing Images” (p. 128), “Choosing Images for Printing (DPOF)” (p. 149), or “Choosing Images for a Photobook” (p. 154) by choosing all of the filtered images.





However, if you change the category (p. 132), or edit an image and save it as a new image (p. 136), a message will appear, and filtered playback will cancel.

Viewing Slideshows



You can automatically play back images recorded to a memory card. Each image displays for approximately 3 seconds.





1 Choose .

- After pressing the  button, press the  buttons to choose , then press the  button again.

2 Choose a transition effect.

- Press the  buttons to choose an effect, then press the .
- ▶ The slideshow will start a few seconds after [Loading image...] appears on the screen.
- In filtered playback (p. 115), only images matching a filter play back.
- You can pause/restart a slideshow by pressing the  button again.
- Press the **MENU** button to stop the slideshow.





- If you press the  buttons during playback, the image will switch. If you keep the  buttons pressed, you can fast-forward through images.
- The power saving function (p. 50) does not work during slideshows.

Changing Settings



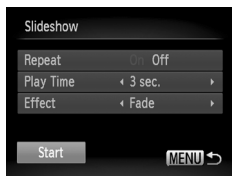

You can set a slideshow to repeat, or change transition effects and the time that slideshow images are displayed. You can choose from 6 transition effects when switching between images.

1 Choose [Slideshow].

- Press the **MENU** button to choose [Slideshow] in the  tab, then press the  button.



2 Choose a setting.

- Press the   buttons to choose an item, then press the   buttons to adjust the setting.
- If you choose [Start] and press the  button, the slideshow starts with your settings.
- Press the **MENU** button to restore the menu screen.



You cannot change [Play Time] if [Bubble] is chosen in [Effect].

Checking the Focus

You can magnify the area of a recorded image that was inside the AF Frame to check the focus.

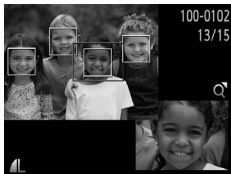

1 Press the ▼ button to switch to the focus check display (p. 42).

- ▶ A white frame will appear where the AF frame was when the focus was set.
- ▶ A gray frame will appear on a face detected during playback.
- ▶ The area within the orange frame appears magnified.



2 Switch frames.

- Move the zoom lever toward Q once.
- ▶ The screen shown on the left will appear.
- Press the  button to move to a different frame when multiple frames appear.

3 Change the magnification level or location.

- Use the zoom lever to change the display size, and the ▲▼◀▶ buttons to change the display position while checking the focus.
- Press the **MENU** button to reset the display to Step 1.







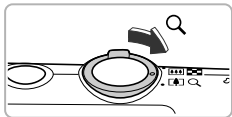





The focus check display is not available for movies.

Magnifying Images



Approximate Location of Displayed Area

Move the zoom lever toward .

- The display will zoom in on the image. If you continue to hold the zoom lever, it will zoom in up to a maximum factor of approximately 10x.
- If you press the     buttons, you can move the location of the displayed area.
- Move the zoom lever toward  to zoom out, or continue to hold it to return to single image playback.
- When  appears on the screen, press the  button to switch to . Press the   buttons to switch between images while zoomed. Press the  button again to return to the original setting.





- In magnified display, pressing the **MENU** button restores single image playback.
- Movies cannot be magnified.

Viewing Each Image in a Group

Grouped images taken in  mode (p. 78) can also be viewed individually.





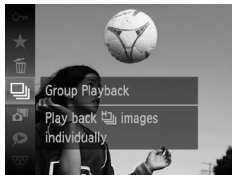

1 Choose an image group.

- Press the   buttons to choose an image that displays .









2 Choose .

- After pressing the  button, press the   buttons to choose , then press the  button again.



3 View each image in the group.

- If you press the   buttons, only the images in the group will be displayed.
- After pressing the  button, press the   buttons to choose , then press the  button again to cancel group playback.



Group playback

In group playback (Step 3), you can use the FUNC. menu functions that appear when you press the , as well as search (p. 114) and magnify (p. 120) images. You can process all the images in a group at once while in “Protecting Images” (p. 124), “Erasing Images” (p. 128), “Choosing Images for Printing (DPOF)” (p. 149), or “Choosing Images for a Photobook” (p. 154), by choosing a set of grouped images.

Ungrouping Images

Grouped images taken in  mode can be ungrouped and viewed individually.

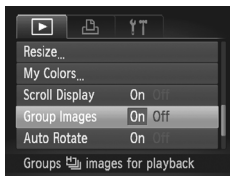

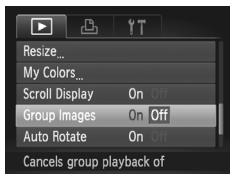

1 Choose [Group Images].

- Press the **MENU** button to choose [Group Images] in the  tab.



2 Choose a setting.

- Press the   buttons to choose [Off].
- Press the **MENU** button to complete the setting and restore single image playback.
- ▶ Grouped images taken in  mode are ungrouped and appear individually.
- To regroup the images, follow the steps above to choose [On].





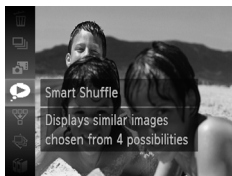

Grouping cannot be canceled while viewing images individually (p. 121).

Displaying Various Images (Smart Shuffle)

The camera will choose 4 images based on the displayed image. If you choose one of those images, the camera will select 4 more images letting you enjoy playing back images in an unexpected order. This will work best if you take many shots of various scenes.





1 Choose .

- After pressing the  button, press the  buttons to choose , then press the  button again.
- ▶ Four images will appear as possibilities.



2 Choose an image.

- Press the  buttons to choose the image you want to view next.
- ▶ The chosen image will be displayed in the center, and the next 4 possibilities will appear.
- Press the  button to display the center image at full size. Press the  button again to restore the original display.
- Press the **MENU** button to restore single image playback.



- Only still images shot with this camera will play back in Smart Shuffle.
-  is not available in the following situations:
 - If there are less than 50 images taken with this camera on the memory card
 - If you play back images not supported by Smart Shuffle
 - During filtered playback

Changing Image Transitions

You can choose from 3 transition effects when switching between images in single image playback.

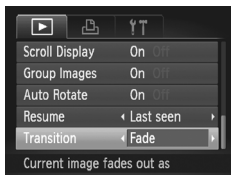

Choose [Transition].

- Press the **MENU** button to choose [Transition] in the **▶** tab, then press the **◀▶** buttons to choose a transition effect.

Protecting Images

You can protect important images so that they cannot be accidentally erased with the camera (pp. 30, 128).

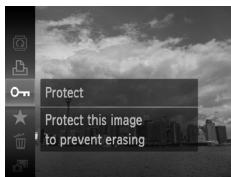

Protect the image.

- After pressing the **FUNC SET** button, press the **▲▼** buttons to choose **Protect**, then press the **FUNC SET** button again.
- ▶ [Protected] will appear on the screen.
- To unlock an image, follow the step above to choose **Protect** again, then press the **FUNC SET** button.



If you format the memory card (pp. 23, 159), protected images will also be erased.



Protected images cannot be erased with the camera's erase function. To erase an image, cancel protection settings first.

Using the Menu



1 Choose [Protect].

- Press the **MENU** button to choose [Protect] in the tab, then press the button.

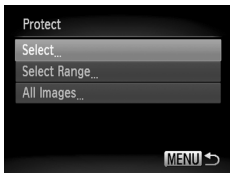

2 Choose a selection method.

- Press the buttons to choose a selection method, then press the button.
- Press the **MENU** button to complete the setting and restore the menu screen.

Choosing Images Individually

1 Choose [Select].

- Follow Step 2 above to choose [Select], then press the button.



2 Choose images.

- Press the buttons to choose an image, then press the button.
- ▶ will appear on the screen.
- Press the button again to deselect the image. will disappear.
- To choose additional images, repeat the above procedure.



3 Protect the image.

- If you press the **MENU** button, a confirmation screen will appear.
- Press the ◀▶ buttons to choose [OK], then press the **FUNC. SET** button.



If you switch to Shooting mode or turn off the camera before performing the operations in Step 3, images will not be protected.

Selecting a Range

1 Choose [Select Range].

- Follow Step 2 on p. 125 to choose [Select Range], then press the **FUNC. SET** button.



2 Choose a starting image.

- Press the **FUNC. SET** button.



- Press the ◀▶ buttons to choose an image, then press the **FUNC. SET** button.



3 Choose an ending image.

- Press the ► button to choose [Last image], then press the  button.



- Press the ◀▶ buttons to choose an image, then press the  button.
- You cannot choose images before the first image.

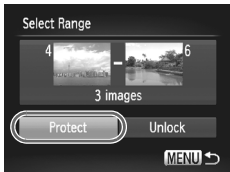

4 Protect images.

- Press the ▼ button to choose [Protect], then press the  button.

Choosing All Images

1 Choose [All Images].

- Follow Step 2 on p. 125 to choose [All Images], then press the  button.

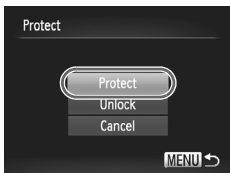

2 Protect images.

- Press the ▲▼ buttons to choose [Protect], then press the  button.



You can unlock groups of protected images if you choose [Unlock] in Step 4 in “Selecting a Range”, or Step 2 in “Choosing All Images”.

Erasing Images

You can choose images and then erase them in groups. Since erased images cannot be recovered, exercise adequate caution before erasing. Protected images (p. 124) cannot be erased.

Choosing a Selection Method

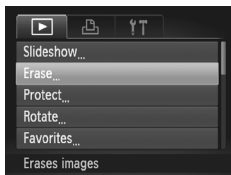

1 Choose [Erase].

- Press the **MENU** button to choose [Erase] in the tab, then press the button.

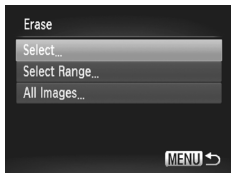

2 Choose a selection method.

- Press the buttons to choose a selection method, then press the .
- Press the **MENU** button to restore the menu screen.

Choosing Images Individually

1 Choose [Select].

- Follow Step 2 above to choose [Select], then press the .



2 Choose an image.

- If you follow Step 2 on p. 125 to choose images, will appear on the screen.
- Press the button again to deselect the image. will disappear.
- To choose additional images, repeat the above procedure.



3 Erase.

- If you press the **MENU** button, a confirmation screen will appear.
- Press the ◀▶ buttons to choose [OK], then press the  button.

Selecting a Range

1 Choose [Select Range].

- Follow Step 2 on p. 128 to choose [Select Range], then press the  button.

2 Choose images.

- Follow Steps 2 and 3 on p. 126 to choose images.



3 Erase.

- Press the ▼ button to choose [Erase], then press the  button.

Choosing All Images

1 Choose [All Images].

- Follow Step 2 on p. 128 to choose [All Images], then press the  button.



2 Erase.

- Press the ◀▶ buttons to choose [OK], then press the  button.

Tagging Images as Favorites

When you tag images as favorites, you can easily categorize just those images. You can also filter out just those images for viewing, protecting or erasing (p. 115).

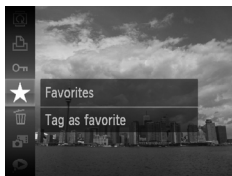

Make the setting.

- After pressing the **FUNC SET** button, press the **▲▼** buttons to choose **★**, then press the **FUNC SET** button again.
- ▶ [Tagged as Favorite] will appear on the screen.
- To unlock an image, follow the step above to choose **★** again, then press the **FUNC SET** button.

Using the Menu



1 Choose [Favorites].

- Press the **MENU** button to choose [Favorites] in the **▶** tab, then press the **FUNC SET** button.





2 Choose an image.

- Press the **◀▶** buttons to choose an image, then press the **FUNC SET** button.
- ▶ **★** will appear on the screen.
- Press the **FUNC SET** button again to untag the image. **★** disappears.
- To choose additional images, repeat the above procedure.



3 Complete the setting.

- If you press the **MENU** button, a confirmation screen will appear.
- Press the  buttons to choose [OK], then press the  button.



If you switch to Shooting mode or turn off the camera before completing the setting in Step 3, images will not be tagged as favorites.



If you use Windows 7 or Windows Vista and transfer tagged images to the computer, they will be given a star rating of 3 (★★☆☆☆) (except for movies).

Organizing Images by Category (My Category)

You can organize images into categories. You can display the images in a category in filtered playback (p. 115) and process all images at once by using the functions below.

- “Viewing Slideshows” (p. 117), “Protecting Images” (p. 124), “Erasing Images” (p. 128), “Choosing Images for Printing (DPOF)” (p. 149), “Choosing Images for a Photobook” (p. 154)



Images are automatically categorized by shooting condition as they are shot.

: Images with detected faces, or images shot in or .

: Images detected as , or in **AUTO** mode, or images shot in or .

: Images shot in , or .

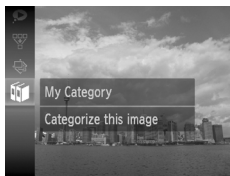

1 Choose .

- After pressing the button, press the to choose , then press the button again.



2 Choose a category.

- Press the to choose a category, then press the button.
- ▶ will appear on the screen.
- Press the button again to deselect the image. will disappear.



3 Complete the setting.

- If you press the **MENU** button, a confirmation screen will appear.
- Press the to choose [OK], then press the .



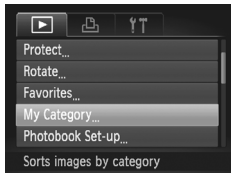

If you switch to Shooting mode or turn off the camera before completing the setting in Step 3, images will not be tagged as My Category.

Using the Menu



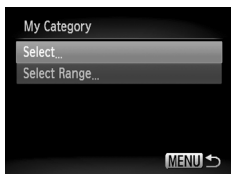

1 Choose [My Category].

- Press the **MENU** button to choose [My Category] in the  tab, then press the  button.



2 Choose a selection method.

- Press the   buttons to choose a selection method, then press the  button.
- Press the **MENU** button to restore the menu screen.

Choosing Images Individually

1 Choose [Select].







- Follow Step 2 above to choose [Select], then press the  button.

2 Choose an image.

- Press the   buttons to choose an image.



3 Choose a category.

- Press the   buttons to choose a category, then press the  button.
- ▶  will appear on the screen.
- Press the  button again to deselect the image.  will disappear.
- To choose additional images, repeat the above procedure.

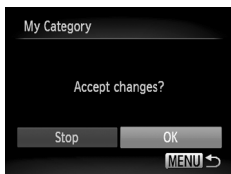

4 Complete the setting.

- If you press the **MENU** button, a confirmation screen will appear.
- Press the ◀▶ buttons to choose [OK], then press the  button.



If you switch to Shooting mode or turn off the camera before completing the setting in Step 4, images will not be tagged as My Category.

Selecting a Range

1 Choose [Select Range].

- Follow Step 2 on p. 133 to choose [Select Range], then press the  button.

2 Choose images.

- Follow Steps 2 and 3 on p. 126 to choose images.



3 Choose a category.

- Press the ▼ button to choose an item, then press the ◀▶ buttons to choose a category.

4 Complete the setting.

- Press the ▼ button to choose [Select], then press the  button.







If you choose [Deselect] in Step 4, you can deselect all of the images in the [Select Range] category.

Rotating Images

You can change the orientation of an image and save it.





1 Choose .

- After pressing the  button, press the  buttons to choose , then press the  button again.





2 Rotate the image.

- Press the  buttons to rotate the image 90° in the chosen direction.
- Press the  button to complete the setting.

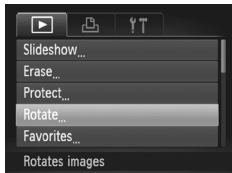
Using the Menu





1 Choose [Rotate].



- Press the **MENU** button to choose [Rotate] in the  tab, then press the  button.



2 Rotate the image.

- Press the  buttons to choose an image.
- The image will rotate 90° with each press of the  button.
- Press the **MENU** button to restore the menu screen.



- Movies with an image quality setting of  or  cannot be rotated.
- Images cannot be rotated (p. 168) if [Auto Rotate] is set to [Off].

Resizing Images

You can resize images to a lower pixel setting and save the resized image as a separate file.

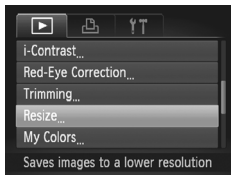

1 Choose [Resize].

- Press the **MENU** button to choose [Resize] in the tab, then press the button.

2 Choose an image.

- Press the buttons to choose an image, then press the button.

3 Choose an image size.

- Press the buttons to choose an option, then press the button.
- ▶ [Save new image?] will appear on the screen.



4 Save the new image.

- Press the buttons to choose [OK], then press the button.
- ▶ The image will be saved as a new file.

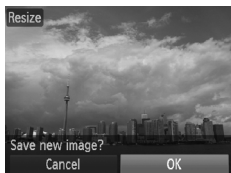

5 Display the new image.

- When you press the **MENU** button, [Display new image?] will appear on the screen.
- Press the buttons to choose [Yes], then press the button.
- ▶ The saved image will be displayed.

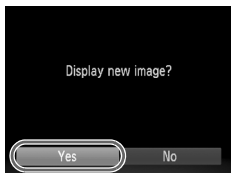

- You cannot resize an image to a larger size.
- Images saved as **XS** in Step 3 cannot be edited.
- Movies cannot be edited.

Trimming

You can cut out a portion of a recorded image and save it as a new image file.

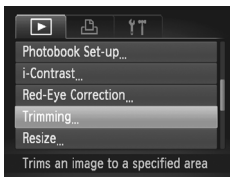

Trimming Area

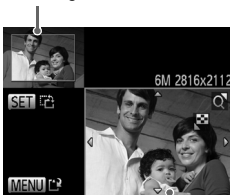

Trimming Area Display

Recorded pixels after trimming



1 Choose [Trimming].

- Press the **MENU** button to choose [Trimming] in the tab, then press the button.

2 Choose an image.

- Press the buttons to choose an image, then press the button.

3 Adjust the trimming area.

- ▶ A frame will appear around the portion of the image to be trimmed.
- ▶ The original image will display in the upper left and the trimmed image will display in the lower right.
- Move the zoom lever to change the frame size.
- Press the buttons to move the frame.
- Press the button to change the frame orientation.
- Press the **MENU** button.

4 Save as a new image and display.

- Follow Steps 4 and 5 on p. 136.



- Images recorded at a pixel setting of **S** (p. 60), or images resized to **XS** (p. 136) cannot be edited.
- Images that can be trimmed will have the same width and height ratio after trimming.
- The number of recorded pixels in a trimmed image will be smaller than before trimming.
- Movies cannot be edited.

Adding Effects with the My Colors Function

You can change the color of an image and save it as a separate image. Refer to p. 88 for details on each menu item.

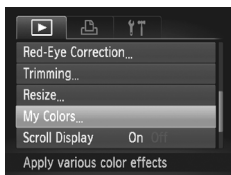

1 Choose [My Colors].

- Press the **MENU** button to choose [My Colors] in the tab, then press the button.

2 Choose an image.

- Press the buttons to choose an image, then press the button.

3 Choose an option.

- Press the buttons to choose an option, then press the button.

4 Save as a new image and display.

- Follow Steps 4 and 5 on p. 136.



If you repeatedly change the color of the same image, the quality will gradually deteriorate and you may not achieve the expected color.





- The color of images changed with this function may vary from those recorded with the My Colors function (p. 88).
- My Colors settings cannot be applied to movies.

Correcting the Brightness (i-Contrast)

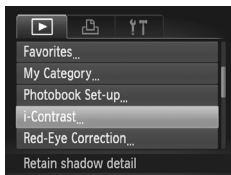
The camera can detect areas in an image, such as faces or backgrounds, that are too dark and automatically adjust them to the optimum brightness. Also, when the overall image is lacking in contrast, the camera will automatically correct the image for a sharper impression. You can choose from 4 levels of correction, and save the image as a new file.



1 Choose [i-Contrast].

- Press the **MENU** button to choose [i-Contrast] in the  tab, then press the  button.

2 Choose an image.

- Press the   buttons to choose an image, then press the  button.

3 Choose an option.

- Press the   buttons to choose an option, then press the  button.

4 Save as a new image and display.

- Follow Steps 4 and 5 on p. 136.



- Under some conditions, the image may appear coarse or may not be corrected properly.
- Repeatedly adjusting the same image may cause it to appear coarse.



What if the image wasn't corrected by the [Auto] option as well as you would like?

Choose [Low], [Medium] or [High] and adjust the image.



Movies cannot be corrected.

Correcting the Red-Eye Effect

You can automatically correct red eyes in images and save them as new files.

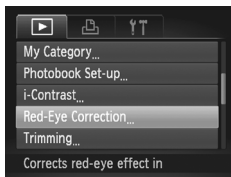

1 Choose [Red-Eye Correction].

- Press the **MENU** button to choose [Red-Eye Correction] in the tab, then press the button.

2 Choose an image.

- Press the buttons to choose an image.

3 Correct the image.

- Press the .
- ▶ Red-eye detected by the camera will be corrected and a frame will appear around the corrected portion.
- You can magnify or reduce the size of the image using the procedures in “Magnifying Images” (p. 120).



4 Save as a new image and display.

- Press the buttons to choose [New File], then press the .
- ▶ The image will be saved as a new file.
- Follow Step 5 on p. 136.



- Some images may not be corrected properly.
- When [Overwrite] in Step 4 is chosen, the uncorrected image is overwritten with the corrected data, erasing the original image.
- Protected images cannot be overwritten.



Movies cannot be corrected.

Printing

This chapter explains how to choose images for printing, and print using a Canon-brand PictBridge compliant printer (sold separately).

Canon-Brand PictBridge Compliant Printers

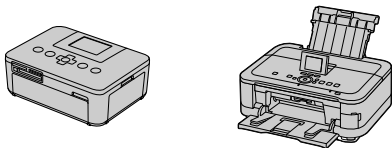

- This chapter uses Canon-brand SELPHY CP series printers in the explanations. The displayed screens and available functions will differ depending on the printer. Please also refer to the Printer User Guide.

Printing Images

Easy Print

You can easily print the pictures you take by connecting the camera to a PictBridge compliant printer (sold separately) using the supplied interface cable (p. 2).

1 Turn off the camera and printer.

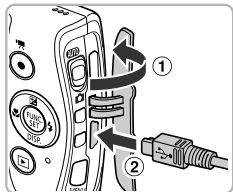

2 Connect the camera to the printer.

- Open the cover (①) and insert the cable's small plug firmly into the camera terminal in the direction shown (②).
- Insert the cable's large plug into the printer. For connection details, refer to the user guide provided with the printer.

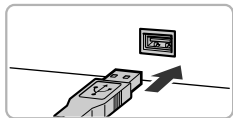

3 Turn on the printer.

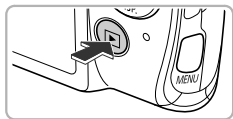

4 Turn on the camera.

- Press the  button to turn on the camera.

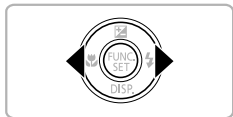



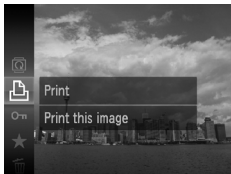

5 Choose an image.

- Press the  buttons to choose an image.





6 Choose .

- After pressing the  button, press the  buttons to choose , then press the  button again.



7 Print images.

- Press the  buttons to choose [Print], then press the .
- ▶ Printing will start.
- If you want to print additional images, repeat Steps 5 and 6 after printing has completed.
- After printing has completed, turn off the camera and printer, and unplug the interface cable.



- Refer to p. 204 for Canon-brand PictBridge compliant printers (sold separately).
- Index printing is not available on certain Canon-brand PictBridge compliant printers (sold separately).

Making Print Settings



1 Connect the camera to the printer.

- Follow Steps 1 – 6 on pp. 142 - 143 to display the screen on the left.

2 Choose a menu option.

- Press the ▲▼ buttons to choose an option.

3 Choose the option settings.

- Press the ◀▶ buttons to choose the option setting.

	Default	Follows the printer's settings.
	Date	Prints the date.
	File No.	Prints the file number.
	Both	Prints both the date and file number.
	Off	—
	Default	Follows the printer's settings.
	Off	—
	On	Uses shooting information to optimize print settings.
	Red-Eye1	Corrects red-eye.
	No. of Copies	Choose the number of copies (p. 145).
Trimming	—	Choose the area for printing (p. 146).
Paper Settings	—	Sets the paper size and layout.

Trimming and Printing (Trimming)

You can cut out a portion of an image for printing.



1 Choose [Trimming].

- Follow Steps 1 – 2 on p. 144 to choose [Trimming], then press the **FUNC SET** button.
- ▶ A frame will appear around the portion of the image to be trimmed.



2 Choose the trimming area.

- Move the zoom lever to change the frame size.
- Press the **▲▼◀▶** buttons to change the frame position.
- Press the **FUNC SET** button to rotate the frame.
- After pressing the **MENU** button, press the **▲▼** buttons to choose [OK], then press the **FUNC SET** button.

3 Print images.

- Follow Step 7 on p. 143 to print.



- You may not be able to trim images depending on the aspect ratio, or if they are too small.
- Trimming photos with embedded dates may not show the dates properly.

Choosing the Paper Size and Layout for Printing



1 Choose [Paper Settings].

- Follow Steps 1 – 2 on p. 144 to choose [Paper Settings], then press the  button.

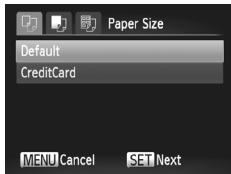

2 Choose a paper size.

- Press the ▲▼ buttons to choose an option, then press the  button.

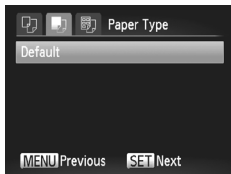

3 Choose the paper type.

- Press the ▲▼ buttons to choose an option, then press the  button.

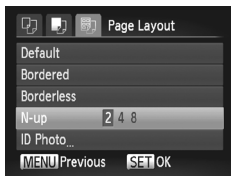

4 Choose the layout.

- Press the ▲▼ buttons to choose an option, then press the  button.
- Press the ◀▶ buttons to set the number of prints when [N-up] is chosen.

5 Print images.

Available Layout Options

Default	Follows the printer's settings.
Bordered	Prints with a border.
Borderless	Prints without a border.
N-up	Selects how many copies of an image are printed on a sheet.
ID Photo	Prints ID photos. Only images with a recording pixel setting of L and an aspect ratio of 4:3 can be chosen.
Fixed Size	Choose the print size. Choose from 3.5 x 5 in., postcard and wide sized prints.

Printing ID Photos

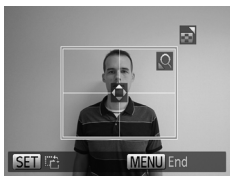

1 Choose [ID Photo].

- Follow Steps 1 – 4 on p. 146 to choose [ID Photo], then press the  button.

2 Choose the length of the long side and short side.

- Press the ▲▼ buttons to choose an option.
- Press the ◀▶ buttons to choose the length, then press the  button.

3 Choose the printing area.

- Follow Step 2 on p. 145 to choose the printing area.

4 Print images.

Printing Movies

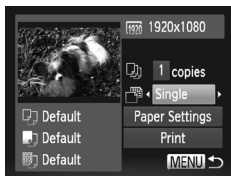

1 Connect the camera to the printer.

- Follow Steps 1 – 6 on p. 142 to choose a movie and display the screen on the left.

2 Choose a printing method.

- Press the ▲▼ buttons to choose , then press the ◀▶ buttons to choose a printing method.

3 Print images.

Printing Options for Movies

Single	Prints currently displayed scene as a still image.
Sequence	Prints a sequence of images from a specified scene on a single sheet of paper. If [Caption] is set to [On], you can print the folder number, file number, and the elapsed time for the frame at the same time.



- Pressing the  button during printing will cancel printing.
- [ID Photo] and [Sequence] cannot be chosen on Canon brand PictBridge compliant printers from CP720/CP730 and earlier models.

Choosing Images for Printing (DPOF)

You can choose up to 998 images on a memory card for printing and specify settings such as the number of copies so that they can be printed as a batch (p. 153) or processed at a photo developer service. These selection methods comply with the DPOF (Digital Print Order Format) standards.



Movies cannot be chosen.



Adding Images to a Print List with the FUNC. Menu

You can add images to the print list (DPOF) directly after shooting or during playback in the FUNC. menu.

1 Choose an image.

- Press the ◀▶ buttons to choose an image, then press the  button.

2 Choose .

- Press the ▲▼ buttons to choose , then press the  button.

3 Add images to the print list.

- Press the ▲▼ buttons to choose the number of prints, then press the ◀▶ buttons to choose [Add] and press the  button.

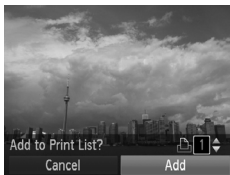

Print Settings

You can set the print type, date and file number. These settings apply to all images chosen for printing.



1 Choose [Print Settings].

- Press the **MENU** button to choose [Print Settings] in the tab, then press the button.

2 Choose a setting.

- Press the buttons to choose a menu item, then press the buttons to choose an option.
- Press the **MENU** button to complete the setting and restore the menu screen.

Print Type	Standard	Prints 1 image per page.
	Index	Prints several reduced size images per page.
	Both	Prints both standard and index formats.
Date	On	Prints the shooting date.
	Off	—
File No.	On	Prints the file number.
	Off	—
Clear DPOF data	On	Removes all print settings after printing.
	Off	—



- Some printers or photo developer services may not be able to reflect all of the settings in the prints.
- may appear when using a memory card with print settings set by a different camera. If you change the settings using this camera, all the previous settings may be overwritten.
- If [Date] is set to [On], some printers may print the date twice.



- With [Index] chosen, the [Date] and [File No.] options cannot be set to [On] at the same time.
- The date will be printed in the style set in the [Date/Time] function in the **↑↑** tab, which can be chosen after you press the **MENU** button (p. 20).

Choosing the Number of Copies



1 Choose [Select Images & Qty.].

- Press the **MENU** button to choose [Select Images & Qty.] in the tab, then press the button.

2 Choose an image.

- Press the buttons to choose an image, then press the .
- ▶ You will be able to set the number of print copies.
- If you choose images in [Index], appears on the screen. Press the button again to deselect the image. will disappear.



3 Set the number of prints.

- Press the buttons to set the number of prints (maximum 99).
- Repeat Steps 2 and 3 to choose other images and the number of prints for each.
- You cannot set the number of copies for index prints. You can only choose which images to print (as shown in Step 2).
- Press the **MENU** button to complete the setting and restore the menu screen.

Selecting a Range

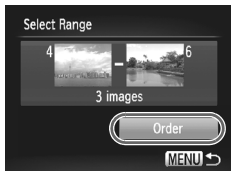

1 Choose [Select Range].

- Follow Step 1 on p. 151 to choose [Select Range], then press the  button.

2 Choose images.

- Follow Steps 2 – 3 on p. 126 to choose images.

3 Make print settings.

- Press the   buttons to choose [Order], then press the  button.

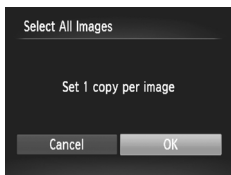

Setting All Images to Print Once



1 Choose [Select All Images].

- Follow Step 1 on p. 151 to choose [Select All Images], then press the  button.

2 Make print settings.

- Press the   buttons to choose [OK], then press the  button.

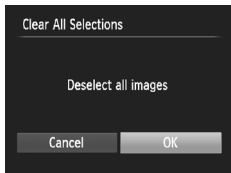

Clearing All Selections



1 Choose [Clear All Selections].

- Follow Step 1 on p. 151 to choose [Clear All Selections], then press the  button.

2 All selections will be cleared.

- Press the   buttons to choose [OK], then press the  button.



Printing chosen images (DPOF)



- When there are images added to the print list (pp. 149 – 152), the screen on the left will appear when you connect the camera to a PictBridge compliant printer. Press the ▲▼ buttons to choose [Print now], then press the  button to easily print images added to the print list.
- If you stop the printer during printing and start again, it will start from the next print.



Choosing Images for a Photobook

When you choose images on a memory card to use in Photobooks (max. 998 images) and use the included software to transfer them to a computer, the chosen images will be copied into a dedicated folder. This function is useful for ordering Photobooks online and for printing Photobooks on a printer.

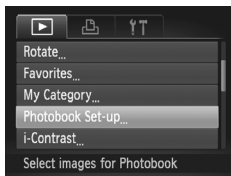

Choosing a Selection Method



1 Choose [Photobook Set-up].

- Press the  button to choose [Photobook Set-up] in the  tab, then press the **MENU** button.

2 Complete the selection method.

- Press the  buttons to choose a selection method, then press the  button.
- Press the **MENU** button to restore the menu screen.



 may appear when using a memory card with print settings set by a different camera. If you change the settings using this camera, all the previous settings may be overwritten.



For details on printing images downloaded to a computer, refer to the *Software Guide* or the user guide included with your printer.

Choosing Images Individually





1 Choose [Select].

- Follow Step 2 above to choose [Select], then press the  button.



2 Choose an image.

- Press the ◀▶ buttons to choose an image, then press the  button.
- ▶ ✓ will appear on the screen.
- Press the  button again to deselect the image, and ✓ will disappear.
- To choose additional images, repeat the above procedure.
- Press the MENU button to complete the setting and restore the menu screen.

Setting All Images to Print Once



1 Choose [Select All Images].

- Follow Step 2 on p. 154 to choose [Select All Images], then press the  button.

2 Make print settings.

- Press the ◀▶ buttons to choose [OK], then press the  button.

Clearing All Selections

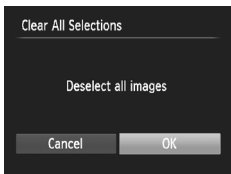

1 Choose [Clear All Selections].

- Follow Step 2 on p. 154 to choose [Clear All Selections], then press the  button.

2 All selections will be cleared.

- Press the ◀▶ buttons to choose [OK], then press the  button.

9

Customizing Camera Settings

You can customize various settings to suit your shooting preferences. The first part of this chapter explains convenient and commonly used functions. The latter part explains how to change shooting and playback settings to suit your purposes.



Changing Camera Settings

You can customize convenient and commonly used functions in the **F/T** tab (p. 45).

Changing Sounds

You can change each of the camera's operation sounds.

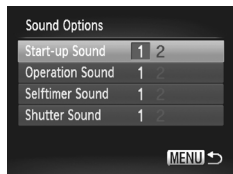

- Choose [Sound Options], then press the **FUNC. SET** button.
- Press the **▲▼** buttons to choose a menu item.
- Press the **◀▶** buttons to choose an option.

1	Preset sounds (cannot be modified)
2	Preset sounds You can use the included software to change the sounds (p. 2).



Even if you change the [Shutter Sound], it will not be reflected in the shutter sound option in **H** (p. 78).

Turning Off Hints & Tips

When you choose an item in the **FUNC.** menu (p. 44) or **MENU** (p. 45), a description of the function (hints and tips) is displayed. You can turn off this function.





- Choose [Hints & Tips], then press the **◀▶** buttons to choose [Off].

Low Level Memory Card Formatting

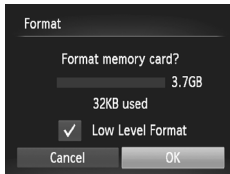
Perform low level formatting when [Memory card error] appears, the camera does not operate properly, you think that the recording/reading speed of a memory card has dropped, the continuous shooting speed slows down, or recording suddenly stops while shooting a movie. As you cannot retrieve the erased data, exercise adequate caution before formatting the memory card.



1 Choose [Low Level Format].

- Choose [Format], then press the  button.
- Press the ▲▼ buttons to choose [Low Level Format], then press the ◀▶ buttons to display ✓.
- Press the ▲▼◀▶ buttons to choose [OK], then press the  button.

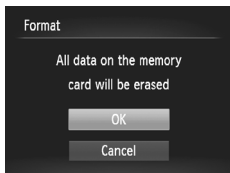

2 Start the low level format.

- Press the ▲▼ buttons to choose [OK], then press the  button.
- ▶ Low level formatting starts.
- ▶ When low level formatting ends, [Memory card formatting complete] will appear on the screen.

3 Complete the low level format.

- Press the  button.





- Low level formatting may take longer than standard formatting (p. 23), since all recorded data is erased.
- You can stop a low level format of a memory card by choosing [Stop]. When stopping low level formatting, the data will be erased but the memory card can be used without problem.

Changing the Start-up Screen

You can change the start-up screen that appears when you turn on the camera.



- Choose [Start-up Image], then press the  button.
- Press the   buttons to choose an option.

<input checked="" type="checkbox"/>	No start-up image
1	Preset images (cannot be modified)
2	Preset images You can set recorded images, and use the included software to change the images.



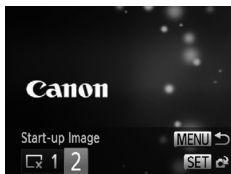

Registering Recorded Images as the Start-up Screen

1 Enter Playback mode.

- Press the  button.





2 Choose [Start-up Image].

- Choose [Start-up Image], then press the  button.
- Press the   buttons to choose [2], then press the  button.



3 Choose an image.

- Press the   buttons to choose [OK], then press the  button to complete registration.



Any previously registered start-up image will be overwritten when registering a new start-up image.



Register the start-up image or sounds with the included software

The dedicated operation sounds and start-up images on the included software can be registered to the camera. Refer to the *Software Guide* for details.

Changing the File Number Assignment

Images you shoot are automatically assigned file numbers in the order they were taken, from 0001 – 9999, and saved to folders of up to 2,000 images. You can change the file number assignment.



- Choose [File Numbering], then press the ◀▶ buttons to choose an option.

Continuous	Even if you shoot using a new memory card, the file numbers are assigned consecutively until an image with the number 9999 is taken/saved.
Auto Reset	If you replace the memory card with a new one, or a new folder is created, file numbering begins with 0001 again.



- If you use a memory card already containing images, the newly assigned file numbers may continue the existing numbering for both [Continuous] and [Auto Reset]. If you want to start over with file number 0001, format the memory card before use (p. 23).
- Refer to the *Software Guide* for information regarding folder structure or image types.



Creating Folders by Shooting Date

Images are saved into folders created each month, however, you can also create folders by shooting date.



- Choose [Create Folder], then press the ◀▶ buttons to choose [Daily].
- Images will be saved into folders created on each shooting date.

Changing the Lens Retract Time

For safety reasons, the lens retracts about 1 minute after pressing the  button when in a Shooting mode (p. 29). If you want the lens to retract immediately when you press the  button, set the retract time to [0 sec.].

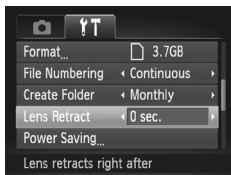

- Choose [Lens Retract], then press the ◀▶ buttons to choose [0 sec.].

Turning Off the Power Saving Function

You can set the power saving function (p. 50) to [Off]. Setting it to [On] is recommended to save battery power.

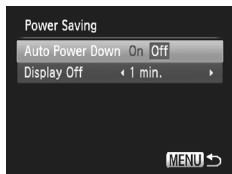

- Choose [Power Saving], then press the  button.
- Press the ▲▼ buttons to choose [Auto Power Down], then press the ◀▶ buttons to choose [Off].
- If you set the power saving function to [Off], be sure to turn the camera off after use.

Setting the Screen Shut-Off Time

You can adjust the time the screen takes to shut off automatically (p. 50). This also works when [Auto Power Down] is set to [Off].



- Choose [Power Saving], then press the  button.
- Press the ▲▼ buttons to choose [Display Off], then use the ◀▶ buttons to choose a time.
- In order to save battery power, you should choose less than [1 min.].



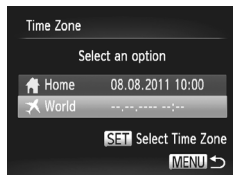

Using the World Clock

When traveling abroad, you can record images with local dates and times simply by switching the time zone setting. If you pre-register the destination time zones, you can enjoy the convenience of not having to switch the Date/Time settings.

To use the world clock, be sure to set the date/time (p. 20) and your home time zone beforehand.





1 Set the world time zone.

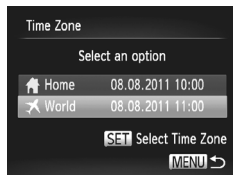

- Choose [Time Zone], then press the  button.
- Press the ▲▼ buttons to choose [ World], then press the  button.
- Press the ◀▶ buttons to choose the world time zone.
- To set daylight saving time (adds 1 hour), press the ▲▼ buttons to choose .
- Press the  button.





2 Choose the world time zone.

- Press the ▲▼ buttons to choose [ World], then press the **MENU** button.
- ▶  will appear on the shooting screen (p. 183).



If you change the date or time in the  setting (p. 21), your [ Home] time and date will automatically change.

Changing Shooting Function Settings

If you set the mode switch to , and the mode to **P**, you can change the settings in the  tab (p. 45).





Before attempting to shoot using a function explained in this section in modes other than **P**, check if the function is available in those modes (pp. 192 – 193).

Turning Off the AF Assist Beam

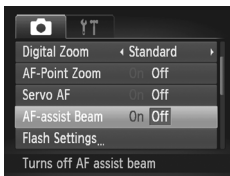
The lamp will automatically light to assist focusing in low light conditions when you press the shutter button halfway. You can turn off the lamp.





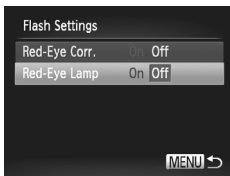

- Choose [AF-assist Beam], then press the   buttons to choose [Off].

Turning Off the Red-Eye Reduction Function

The red-eye reduction lamp lights in order to reduce the red-eye effect that occurs when shooting in dark conditions with the flash. You can turn off this function.



- Choose [Flash Settings], then press the  button.
- Press the   buttons to choose [Red-Eye Lamp], then press the   buttons to choose [Off].

Changing the Image Display Time Right After Shooting

You can change the length of time the images display right after shooting.



- Choose [Review], then press the ◀▶ buttons to choose an option.

2 – 10 sec.	Displays images for the set time.
Hold	The image displays until you press the shutter button halfway.
Off	Images will not display.

Changing the Way the Image Displays Right After Shooting

You can change the way the image displays right after shooting.



- Choose [Review Info], then press the ◀▶ buttons to choose an option.

Off	Displays the image only.
Detailed	Displays detailed information (p. 186).
Focus Check	The area inside the AF frame is magnified, allowing you to check the focus. The procedure is the same as in “Checking the Focus” (p. 119).

Displaying Grid Lines

You can display grid lines on the screen for vertical and horizontal guidance while shooting.

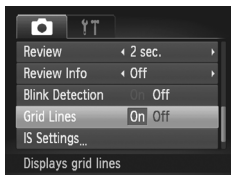





- Choose [Grid Lines], then press the ◀▶ buttons to choose [On].

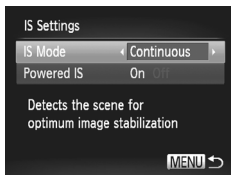

Grid lines will not be recorded on the image.

Changing the IS-Mode Settings



- Choose [IS Settings], then press the  button.
- Press the  buttons to choose [IS Mode], then press the  buttons to choose an option.

Continuous	Automatically sets the optimal image stabilization for the scene (Intelligent IS) (p. 185).
Shoot Only*	Image stabilization is only active at the moment of shooting.
Off	Turns off image stabilization.

* Setting changes to [Continuous] when shooting movies.





If camera shake is too strong, attach the camera to a tripod. You should also set the IS Mode to [Off] when the camera is attached to a tripod.

Turning Off the Powered IS Function

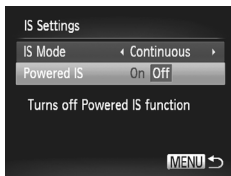
Powered IS reduces subtle camera shake when shooting movies at max telephoto. However, shooting a moving subject while walking, or such things as severe camera movement may cause unexpected results in the movie. In such cases, set Powered IS to [Off].



- Choose [IS Settings], then press the  button.
- Press the  buttons to choose [Powered IS], then press the  buttons to choose [Off].



[Powered IS] settings will be disabled if [IS Mode] is set to [Off].



Changing Playback Function Settings

You can adjust the settings in the  tab by pressing the  button (p. 45).

Turning Off the Auto Rotate Function

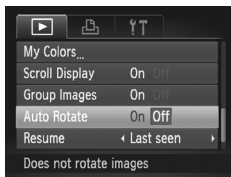
When you play back images on the camera, images shot in vertical orientation automatically rotate and display vertically. You can turn off this function.





- Select [Auto Rotate], then press the   buttons to choose [Off].

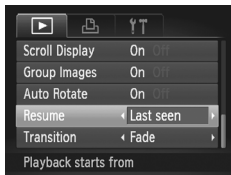

- Images cannot be rotated (p. 135) if you have set [Auto Rotate] to [Off]. Rotated images will also appear in their original orientation.
- In Smart Shuffle (p. 123), even if [Auto Rotate] is set to [Off], images taken vertically will be displayed vertically, while rotated images will appear in their rotated orientation.

Choosing the Image that First Displays in Playback



- Choose [Resume], then press the   buttons to choose an option.

Last seen	Resumes with the image last viewed.
Last shot	Resumes with the most recently shot image.

10

Useful Information

This chapter introduces how to use the separately sold accessories and Eye-Fi card (also sold separately), troubleshooting tips, and contains lists of functions and items that appear on the screen.

Viewing Images on a TV

Using Stereo AV Cable AVC-DC400ST (sold separately) (p. 204), you can connect the camera to a TV to view images you have shot.

1 Turn off the camera and TV.

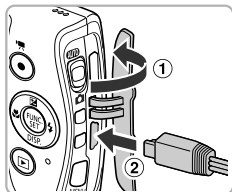

2 Connect the camera to the TV.

- Open the camera's terminal cover (1) and fully insert the cable plug into the camera's terminal (2).
- Insert the cable plug fully into the video input terminals as shown in the illustration.

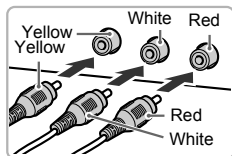

3 Turn on the TV and switch it to the input the cable is connected to.

4 Turn on the camera.

- Press the  button to turn on the camera.
- ▶ The image will appear on the TV (nothing will appear on the screen of the camera).
- After you finish, turn off the camera and TV, and unplug the cable.



What if the images don't display correctly on the TV?

Images will not display correctly if the camera's video output setting (NTSC/PAL) does not match the TV system. Press the **MENU** button and choose [Video System] in the  tab to switch to the correct video system.

Shooting Using a TV as the Display

You can use a TV to display the camera screen content while shooting.

- To connect the camera to a TV, follow the Steps in “Viewing Images on a TV” (p. 170).
- Shooting procedures are the same as when using the camera screen.



TV display is not available when using HDMI Cable HTC-100 (sold separately) to connect the camera to an HD TV.

Using the HDMI Cable (Sold Separately) with an HD TV

Using the separately sold HDMI Cable HTC-100 (p. 204), you can connect the camera to an HD TV to view images you have shot.

1 Turn off the camera and TV.

2 Connect the camera to the TV.

- Open the camera's terminal cover (①) and fully insert the cable plug into the camera's terminal (②).
- Fully insert the cable plug into the TV's HDMI input terminal as shown.

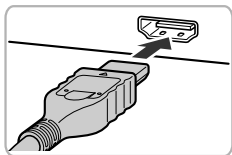
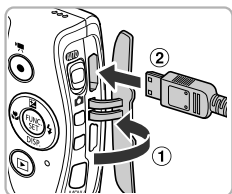

3 Display images.

- Follow Steps 3 and 4 on p. 170 to display the images.



Operation sounds will not play when connected to an HD TV.

Using a TV Remote to Control the Camera

When you connect the camera to an HDMI CEC compatible TV, you can use the TV's remote control to operate the camera and play back images or view slideshows.

You may need to make settings on some TVs. For details, refer to the user guide supplied with the TV.



1 Choose [Ctrl via HDMI].

- Press the **MENU** button to choose [Ctrl via HDMI] in the **☰** tab, then press the **◀▶** buttons to choose [Enable].

2 Connect the camera to the TV.

- Follow Steps 1 – 2 on p. 171 to connect the camera to the TV.





3 Display images.

- Turn on the TV and press the camera's **▶** button.
- ▶ The image will appear on the TV (nothing will appear on the screen of the camera).

4 Use the TV's remote control.

- Press the remote control's **◀▶** buttons to choose an image.
- Press the **OK/Select** button to display the camera control panel. Press the **◀▶** buttons to choose an item, then press the **OK/Select** button again.

Summary of the Camera Control Panel Displayed on the TV

 Return	Closes the menu.
 Group playback	Displays groups of High-speed Burst images (only appears when grouped images are chosen).
 Play movie	Plays a movie (only appears when a movie is chosen).
 Slideshow	Plays back images automatically. During playback, you can press the remote control's ◀▶ buttons to switch images.
 Index playback	Displays images in an index.
DISP. Change display	Changes the screen display (p. 42).



- If you operate the controls on the camera, you will not be able to control the camera with the TV's remote control until you return to single image playback.
- Some TVs may not be able to control the camera properly even though they are HDMI CEC compatible.

Using Household Power

If you use AC Adapter Kit ACK-DC60 (sold separately), you can use the camera without worrying about how much charge is left in the battery.

1 Turn off the camera.

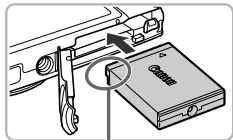

Terminals

2 Insert the coupler.

- Follow Step 2 on p. 17 to open the cover.
- The coupler can be inserted in the same way as the battery. Insert the coupler as shown in Step 3 on p. 17.
- Follow Step 5 on p. 18 to close the cover.

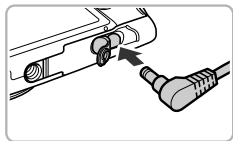

3 Plug the cord into the coupler.

- Open the cover and fully insert the plug into the coupler.

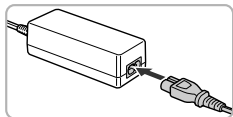

4 Connect the power cord.

- Connect the power cord to the compact power adapter, then plug the other end into a power outlet.
- Turn the camera on to use it.
- After you finish, turn off the camera and unplug the power cord from the power outlet.



Do not unplug the plug or power cord with the camera turned on. This could erase images you have taken or damage the camera.



AC Adapter Kit ACK-DC10 (sold separately) can also be used.

Using an Eye-Fi Card

Before using an Eye-Fi card, be sure to check whether Eye-Fi card use is authorized in the country or territory of use (p. 16).

When you put a prepared Eye-Fi card into the camera, you can automatically transfer your images wirelessly to a computer, or upload them to a web service.

Image transfer is a function of the Eye-Fi card. For details on how to setup and use the card, and concerning problems transferring images, please refer to the Eye-Fi card user guide, or contact the manufacturer.



Please keep the following things in mind when using an Eye-Fi card.

- Even if you set [Eye-Fi trans.] to [Disable] (p. 176), the Eye-Fi card may transmit radio waves. Be sure to remove the Eye-Fi card from the camera before entering areas that prevent unauthorized transmission of radio waves, such as hospitals and airplanes.
- If you have trouble transferring images, check the card or computer settings. For details, refer to the user guide supplied with the card.
- Depending on the connection status of the wireless network, it may take time to transfer images, or image transfer may be interrupted.
- Due to its transfer function, the Eye-Fi card may become hot.
- Battery consumption will be quicker than in normal use.
- Camera operations will be slower than in normal use. This may be resolved by setting [Eye-Fi trans.] to [Disable].

If you put an Eye-Fi card into the camera, the connection status can be checked in the shooting screen (information display) and playback screen (simple information display).

(Gray)	Not connected
(Flashing white)	Connecting
(White)	Connected
(Animated)	Transferring
	Interrupted
	Error retrieving Eye-Fi card info (Turn the camera off and on again. If this continues to appear, there may be a problem with the card.)

will appear on transferred images.



- The power saving function does not work while transferring images (p. 50).
- If mode is chosen, the Eye-Fi connection will be interrupted. Choosing another Shooting mode or entering Playback mode will reopen the Eye-Fi connection, but movies made with mode may be retransferred.

Checking Connection Information

You can check the Eye-Fi card's access point SSID, or connection status.

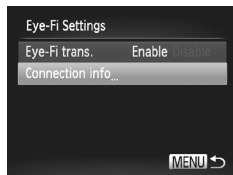

Choose [Connection info].

- Press the **MENU** button to choose [Eye-Fi Settings] in the **Y↑** tab, then press the **FUNC SET** button.
- Press the **▲▼** buttons to choose [Connection info], then press the **FUNC SET** button.
- ▶ The connection info screen will appear.

Disabling Eye-Fi Transfer

You can set the card to disable Eye-Fi transfer.

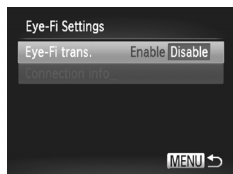

Choose [Disable] in [Eye-Fi trans.].

- Press the **MENU** button to choose [Eye-Fi Settings] in the **Y↑** tab, then press the **FUNC SET** button.
- Press the **▲▼** buttons to choose [Eye-Fi trans.], then press the **◀▶** buttons to choose [Disable].

? What if [Eye-Fi Settings] does not appear?

[Eye-Fi Settings] will not appear when an Eye-Fi card is not inserted in the camera, and when an Eye-Fi card's write-protect tab is in the locked position. For this reason, settings cannot be changed for Eye-Fi cards equipped with a write-protect tab when the tab is in the locked position.

Troubleshooting

If you think there is a problem with the camera, first check the following. If the items below do not solve your problem, contact a Canon Customer Support Help Desk.

Power

You pressed the ON/OFF button, but nothing happened.

- Confirm that the battery is the correct type, and is not depleted (p. 15).
- Confirm that the battery is properly inserted (p. 17).
- Confirm that the memory card/battery cover is securely closed (p. 18).
- If the battery terminals are dirty, battery performance will decrease. Clean the terminals with a cotton swab and re-insert the battery several times.

Battery is consumed quickly.

- Battery performance decreases at low temperatures. Warm the battery, for example, by placing it in your pocket with the terminal cover on.

Lens will not retract.

- Do not open the memory card/battery cover while the power is on. After closing the memory card/battery cover, turn the power on then back off (p. 18).

TV output

Image is distorted or not showing on TV (p. 170).

Shooting

Cannot shoot.

- When in Playback mode (p. 22), press the shutter button halfway (p. 25).

Screen does not display properly in dark places (p. 43).

Screen does not display properly while shooting.

Please note, the following will not be recorded in still images, but will be recorded in movies.

- When shooting under fluorescent or LED lighting, the screen may flicker, and a horizontal bar may appear.

A flashing appears on the screen and the shot cannot be taken even though the shutter button was pressed fully (p. 28).

appears when the shutter button is pressed halfway (p. 52).

- Set [IS Mode] to [Continuous] (p. 167).
- Set the flash to  (p. 83).
- Increase the ISO speed (p. 85).
- Attach the camera to a tripod. Additionally, you should set [IS Mode] to [Off] when shooting with a tripod (p. 167).

Image is blurred.

- Press the shutter button halfway to focus on the subject, then press fully to shoot (p. 25).
- Shoot the subject within the focusing distance (p. 198).
- Set the [AF-assist Beam] to [On] (p. 165).
- Confirm that functions which you do not intend to use (macro, etc.) are not set.
- Shoot using the focus lock or AF lock (pp. 93, 96).

Even when you press the shutter button halfway, the AF frame does not appear, and the camera does not focus.

- If you center on the light and dark contrasting area of the subject and push the shutter button halfway, or repeatedly push the shutter button halfway, the AF frame will appear and the camera will focus.

Subject is too dark.

- Set the flash to  (p. 83).
- Correct the brightness with exposure compensation (p. 83).
- Adjust the image with i-Contrast (pp. 86, 139).
- Use spot metering or AE Lock to shoot (pp. 98, 99).

Subject is too bright (overexposed).



- Set the flash to  (p. 52).
- Correct the brightness with exposure compensation (p. 83).
- Use spot metering or AE Lock to shoot (pp. 98, 99).
- Reduce the light illuminating the subject.

Image is dark even though the flash fired (p. 28).

- Shoot within an appropriate distance for flash photography (p. 83).
- Increase the ISO speed (p. 85).

Image taken using the flash is too bright (overexposed).

- Shoot within an appropriate distance for flash photography (p. 83).
- Set the flash to  (p. 52).

White dots appear on the image when shooting with the flash.

- Light from the flash has reflected off dust particles or other objects in the air.

Image appears rough or grainy.

- Shoot with the ISO speed on a lower setting (p. 85).
- Depending on the Shooting mode, when shooting in a high ISO speed the image may appear rough or grainy (p. 64).

Eyes appear red (p. 101).

- Set the [Red-Eye Lamp] to [On] (p. 165). When shooting with the flash, the lamp lights (p. 40), and for approximately 1 second while the camera is reducing red-eye, it is not possible to shoot. It is more effective if the subject is looking directly at the lamp. Even better results can be obtained by increasing the lighting in indoor settings or approaching closer to the subject.
- Correct images with red-eye correction (p. 140).

Recording images to the memory card takes a long time, or continuous shooting slows down.

- Perform a low-level format of the memory card in the camera (p. 159).

Cannot make settings for shooting functions or FUNC. menu.

- The items in which settings can be made differ depending on the shooting mode. Refer to “Functions Available in Each Shooting Mode”, “FUNC. Menu” and “Shooting Menu” (pp. 188 – 193).

Shooting movies

Correct shooting time does not display, or stops.

- Format the memory card in the camera, or use a memory card capable of recording at high speeds. Even when the shooting time does not display properly, the recorded video will be the length that it was actually shot (pp. 23, 32).

! appeared on the screen and shooting ended automatically.

The camera’s internal memory was insufficient. Try one of the following:

- Perform a low-level format of the memory card in the camera (p. 159).
- Change the image quality setting (p. 108).
- Use a memory card capable of recording at high speeds (p. 108).

Subject appears distorted.

- The subject may appear distorted if it passes quickly in front of the camera while shooting. This is not a malfunction.

Playback

Cannot play back images or movies.

- If the file name or folder structure is changed on a computer, you may not be able to play back images or movies. Refer to the *Software Guide* for information regarding folder structure or file names.

Playback stops, or audio cuts out.

- Use a memory card that has had a low-level format performed on it with this camera (p. 159).
- If you copy a movie to a memory card that reads slowly, playback may interrupt momentarily.
- Depending on its capabilities, when playing movies on a computer, frames may drop or the audio may cut out.

Memory Card





Memory card not recognized.

- Leaving the card in the camera, turn the camera off then on again (p. 17).

Computer

Cannot transfer images to a computer.

It may be possible to solve the problem when the camera is connected to a computer via cable by reducing the transfer speed.

- After pressing the  button to enter Playback mode, press and hold the **MENU** button and the  and  buttons together. In the screen that appears, press the  buttons to choose [B], then press the  button.

Eye-Fi Card

Cannot transfer images (p. 175).

List of Messages That Appear on the Screen

If error messages appear on the screen, try one of the following solutions.

No memory card

- The memory card is not installed in the correct direction. Install the memory card in the correct direction (p. 17).

Memory card locked

- The SD memory card, SDHC memory card, SDXC memory card or Eye-Fi card's write protect tab is set to "LOCK". Unlock the write protect tab (p. 17).

Cannot record!

- You attempted to shoot an image without a memory card. Insert the memory card in the correct direction to shoot (p. 17).

Memory card error (p. 159)

- If the same message appears even when a formatted memory card is inserted in the correct direction, contact a Canon Customer Support Help Desk (p. 17).

Insufficient space on card

- There is not enough free space on the memory card to shoot (pp. 26, 31, 51, 61, 81, 103) or edit images (pp. 136 – 140). Erase the images (pp. 30, 128) to open space for new images, or insert an empty memory card (p. 17).

Change the battery pack. (p. 17)

No Image.

- There are no images recorded on the memory card that can be displayed.

Protected! (p. 124)

Unidentified Image/Incompatible JPEG/Image too large./Cannot play back AVI/RAW

- Unsupported images, or images with corrupted data cannot be displayed.
- Images manipulated on a computer, that have had their file name changed, or have been taken with a different camera may not display.

Cannot magnify!/Cannot play back this content in Smart Shuffle/Cannot rotate/Cannot modify image/Cannot register this image!/Cannot modify/ Cannot assign to category/Unselectable image.

- Incompatible images cannot be magnified (p. 120), played back in Smart Shuffle (p. 123), tagged as favorites (p. 130), categorized (p. 132), rotated (p. 135), edited (pp. 136 – 140), added to a print list (p. 149), chosen for a Photobook (p. 154), or registered to the start-up screen (p. 160).
- Images manipulated on a computer, that have had their file name changed, or have been taken with a different camera may not be magnified, played back in Smart Shuffle, tagged as favorites, categorized, rotated, edited, added to a print list, chosen for a Photobook, or registered to the start-up screen.
- Movies cannot be magnified (p. 120), played back in Smart Shuffle (p. 123), edited (pp. 136 – 140), added to a print list (p. 149), chosen for a Photobook (p. 154), or registered to the start-up screen (p. 160).

Invalid selection range

- When choosing the selection range (pp. 126, 129, 134, 152), you tried to choose a starting image that was after the last image or you tried to choose an ending image that was before the starting image.

Exceeded selection limit

- You chose more than 998 images in print settings (p. 149) or photobook settings (p. 154). Choose 998 or less images.
- Print settings (p. 149) or photobook settings (p. 154) could not be saved correctly. Reduce the number of selected images and try again.
- You chose 501 or more images in Protect (p. 124), Erase (p. 128), Favorites (p. 130), My Category (p. 132), Print Settings (p. 149) or Photobook Set-up (p. 154).

Communication error

- Images could not be transferred to the computer or printed due to the large amount of images (approx. 1000) stored on the memory card. Use a commercially available USB card reader to transfer the images. Insert the memory card into the printer's card slot to print.

Naming error!

- The folder or image could not be created because there is an image with the same file name as the folder or image that the camera is attempting to create, or the highest possible file number has already been reached. In the **⏏** menu, change [File Numbering] to [Auto Reset] (p. 161) or format the memory card (p. 23).

Lens Error

- This error can occur if you hold the lens while it is in motion or when using it in a location with excessive dust or sand in the air.
 - If this error message continues to appear, contact a Canon Customer Support Help Desk as there may be a problem with the lens.
-

A camera error was detected (Error number)

- If an error code appears directly after taking a picture, the shot may not have been recorded. Check the image in Playback mode.
 - If this error code reappears, note the Error number (Exx) and contact a Canon Customer Support Help Desk as there may be a problem with the camera.
-

File Error

- Photos from other cameras or images that have been altered using computer software may not be printable.
-

Print error

- Check the paper size settings. If this message appears when the settings are correct, turn the printer off and back on, then make the settings again.
-

Ink absorber full

- Contact a Canon Customer Support Help Desk for an ink absorber replacement.

Information Displayed on the Screen

Shooting (Information Display)

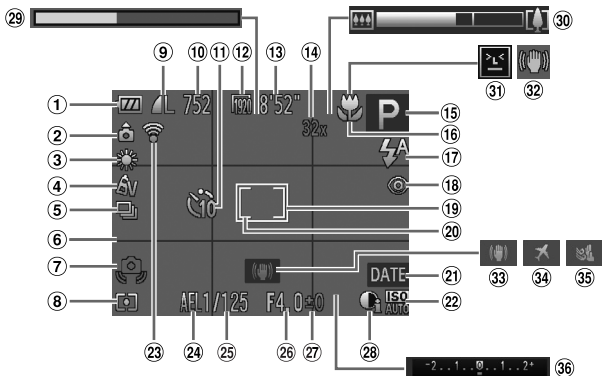

- | | | |
|--|---|--|
| ① Battery Charge Indicator (p. 15) | ⑭ Digital Zoom Magnification (p. 53) / Digital Tele-converter (p. 91) | ⑳ AE Lock (p. 99), FE Lock (p. 99) |
| ② Camera Orientation* | ⑮ Shooting Mode (p. 188), Scene Icon (p. 184) | ㉑ Shutter Speed |
| ③ White Balance (p. 84) | ⑯ Focusing Range (p. 90), AF Lock (p. 96) | ㉒ Aperture Value |
| ④ My Colors (p. 88) | ⑰ Flash Mode (pp. 52, 83, 100) | ㉓ Exposure Compensation Amount (p. 83) |
| ⑤ Drive Mode (p. 87) | ⑱ Red-Eye Correction (p. 140) | ㉔ i-Contrast (p. 86) |
| ⑥ Grid Lines (p. 166) | ⑲ AF Frame (p. 92) | ㉕ Super Slow Motion Movie Shooting Time (p. 106) |
| ⑦ Camera Shake Warning (p. 28) | ㉚ Spot AE Point Frame (p. 98) | ㉖ Zoom Bar (p. 26) |
| ⑧ Metering Method (p. 98) | ㉛ Date Stamp (p. 54) | ㉗ Blink Detection (p. 102) |
| ⑨ Compression (Image Quality) (p. 59) / Recording Pixels (pp. 59, 108) | ㉜ ISO Speed (p. 85) | ㉘ IS Mode Icon (p. 185) |
| ⑩ Recordable Shots (p. 30) | ㉝ Eye-Fi Connection Status (p. 175) | ㉙ IS Mode (p. 167) |
| ⑪ Self-Timer (pp. 55, 56) | | ㉚ Time Zone (p. 164) |
| ⑫ Image Quality (p. 108) | | ㉛ Wind Filter (p. 109) |
| ⑬ Remaining Time (p. 108) | | ㉜ Exposure Compensation Bar (p. 83) |

* : Standard, : Held vertically

When shooting, the camera detects if it is held vertically or horizontally, and adjusts settings accordingly for the best shot. It also detects orientation during playback, so you can hold the camera in either orientation and it will automatically rotate images for correct viewing. This function may not operate correctly when the camera is pointed straight up or down.

Scene Icons







In **AUTO** mode, the camera displays an icon for the scene it has determined and then automatically focuses and selects the optimum settings for subject brightness and color.

Subject Background	People			Non-Human Subjects			Icon Background Color
	When Moving	With Strong Facial Shadows		When Moving	When Close		
Bright				AUTO			Gray
Backlit			—				
Including Blue Skies				AUTO			Light Blue
Backlit			—				
Sunsets	—				—		Orange
Spotlights							Dark Blue
Dark				AUTO			
When Using Tripod	*	—		*	—		

* Appears when the scene is dark and the camera is attached to a tripod.

IS Mode Icons

Automatically sets the optimal image stabilization for the scene (Intelligent IS). In addition, the following icons appear in **AUTO** mode.

	Reduces camera shake when shooting still images.		Reduces camera shake when shooting movies, as well as, strong camera shake while walking (Dynamic mode).
	Reduces camera shake during panning shots.*		Reduces subtle camera shake when shooting movies at max telephoto (Powered IS).
	Reduces camera shake for macro photography (Hybrid IS).		Disables image stabilization when the camera is attached to a tripod and image stabilization is unnecessary.

* Appears on the screen when following the motion of a subject while shooting (panning). While following a subject moving horizontally, only vertical camera shake will be reduced (horizontal image stabilization will be disabled). Additionally, when shooting subjects moving vertically, only horizontal camera shake will be reduced.



If you set IS Mode to [Off] (p. 167), camera shake will not be stabilized and the icons will not appear.

Playback (Detailed Information Display)

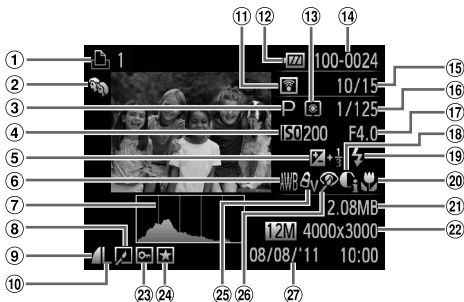













- | | | |
|--|---|---|
| ① Movies (pp. 31, 33),
High-speed Burst (p. 78),
Print List (p. 149) | ⑩ Recording Pixels (pp. 59,
108), MOV (Movies) | ⑱ i-Contrast (pp. 86, 139) |
| ② My Category (p. 132) | ⑪ Eye-Fi Transfer
Complete (p. 175) | ⑲ Flash (p. 83) |
| ③ Shooting Mode (p. 188) | ⑫ Battery Charge Indicator
(p. 15) | ⑳ Focusing Range (p. 90) |
| ④ ISO Speed (p. 85),
Playback Speed (p. 105) | ⑬ Metering Method (p. 98) | ㉑ File Size (pp. 60, 108) |
| ⑤ Exposure Compensation
Amount (p. 83) | ⑭ Folder Number – File
Number (p. 161) | ㉒ Still Images: Recording
Pixels (p. 60) |
| ⑥ White Balance (p. 84) | ⑮ Displayed Image Number
/ Total Number of Images | ㉓ Movies: Movie Length
(p. 108) |
| ⑦ Histogram (p. 43) | ⑯ Shutter Speed (Still
Images), Image Quality /
Frame Rate (Movies) | ㉔ Protect (p. 124) |
| ⑧ Group Playback (p. 121),
Image Editing
(pp. 136 – 140) | ⑰ Aperture Value | ㉕ Favorites (p. 130) |
| ⑨ Compression (Image
Quality) (p. 59) | | ⑳ My Colors (pp. 88, 138) |
| | | ㉖ Red-Eye Correction
(pp. 101, 140) |
| | | ㉗ Shooting Date and Time
(p. 20) |



Some information may not appear when displayed on a television.

Summary of Movie Control Panel in “Viewing Movies” (p. 33)

	Exit
	Play
	Slow Motion (You can use the ◀▶ buttons to adjust the speed. Sound will not play back.)
	Skip Backward* (Continues to skip backward if you hold down the  button.)
	Previous Frame (Rewind if you hold down the  button.)
	Next Frame (Fast forward if you hold down the  button.)
	Skip Forward* (Continues to skip forward if you hold down the  button.)
	Edit (p. 111)
	Appears when connected to a PictBridge compliant printer (p. 142).















* Displays the frame of approx. 4 sec. before or after the current frame.



You can skip forward and skip backward during movie playback by pressing the ◀▶ buttons.

Functions and Menu Lists





















Functions Available in Each Shooting Mode

Function		Shooting Modes							
		AUTO	P						
Exposure Compensation (p. 83)		—	○	○	○	○	○	○	○
AE Lock/FE Lock*1 (p. 99)		—	○	○	—	—	—	—	—
Focusing Range (p. 90)		  	○	○	○	○	○	○	○
Tracking AF (p. 94)			○	○	—	○	○	—	—
Flash (pp. 52, 83, 100)		   	○	○	○	○	○	○	○
AF Lock (p. 96)			—	○	○	—	—	—	—
Screen Display (p. 42)		No Information Display	○	○	○	○	○	—	—
		Information Display	○	○	○	○	○	○	○

*1 FE Lock not available when set to .















































*2 Cannot be set, but switches to  depending on the circumstances.

*3 Cannot be set, but switches to  when the flash fires.

																			
																			
○	—	○	○	○	○	○	○	○	—	—	○	○	○	○	○	—	○	—	—
—	—	—	—	—	—	—	—	—	—	—	—	—	—	—	—	—	—	—	—
○	○	○	○	○	○	○	○	○	○	○	○	○	○	○	○	○	○	○	○
○	○	○	○	○	○	○	○	○	○	○	○	○	○	○	—	○	○	○	○
○	—	—	○	—	—	—	○	○	○	○	○	○	○	○	—	○	—	—	—
—	—	—	○	○	○	○	○	○	○	○	○	○	○	○	—	—	—	—	—
—	—	—	—	○	○	○	○	○	○	○	○	○	○	○	—	○	○	—	—
—	—	—	—	—	—	—	—	—	—	—	—	—	—	—	*3	○	—	—	—
○	○	○	○	○	○	○	○	○	○	○	○	○	○	○	○	○	○	○	○
—	—	—	—	—	—	—	—	—	—	—	—	—	—	—	○	—	—	—	—
○	○	○	○	—	—	—	—	○	○	—	○	○	○	○	○	○	—	○	○
○	○	○	○	○	○	○	○	○	○	○	○	○	○	○	○	○	○	○	○



○ Selectable, or set automatically. — Not selectable.

FUNC. Menu

Function		Shooting Modes							
		AUTO	P						
Metering Method (p. 98)		○	○	○	○	○	○	○	○
		—	○	○	—	—	○	—	—
My Colors (p. 88)	    ^{*1}  ^{*1}        ^{*2}	○	○	○	○	○	○	○	○
	—	—	○	○	—	—	○	○	○
White Balance (p. 84)	AWB	○	○	○	○	○	○	○	○
	      ^{*3}	—	○	○	—	—	○	○	○
ISO Speed (p. 85)	      	○	○	○	○	○	○	○	○
	—	—	○	○	—	—	—	—	—
Self-Timer (pp. 55, 56)	   	○	○	○	○	○	○	○	○
	○	○	○	○	○	—	—	—	—
Self-Timer Settings (p. 56)	Delay ^{*4}	○	○	○	○	○	—	—	—
	Shots ^{*5}	○	○	—	○	○	—	—	—
Drive Mode (p. 87)	 	○	○	○	○	○	○	○	○
	—	—	○	—	○	○	—	—	—
Still Image Aspect Ratio (p. 58)	16:9 3:2 4:3 1:1	○	○	—	○	○	○	○	○
Recording Pixels (p. 59)	L M1 M2 M S	○	○	○	○	○	○	○	○
	—	—	—	—	—	—	—	—	—
Compression Ratio (p. 59)	 	○	○	○	○	○	○	○	○
Movie Quality (pp. 106, 108)	    	○	○	○	○	○	○	○	○
	—	—	—	—	—	—	—	—	—





















*1 White balance is not selectable.

*2 Contrast, sharpness, color saturation, red, green, blue, and skin tone can be set in 5 levels.

*3 Not available in  and .

*4 Cannot be set to 0 seconds when in modes where the number of shots cannot be set.

*5 Fixed to 1 shot when in modes where the number of shots cannot be set.







																		
																		
○	○	○	○	○	○	○	○	○	○	○	○	○	○	○	○	○	○	○
—	—	—	—	—	—	—	—	—	—	—	—	—	—	—	—	—	—	—
○	○	○	○	○	○	○	○	○	○	○	○	○	○	○	○	○	○	○
—	—	—	—	—	—	—	—	—	—	—	—	—	—	○	○	○	—	—
○	○	○	○	○	○	○	○	○	○	○	○	○	○	○	○	○	○	○
○	○	—	○	—	—	—	—	—	—	—	—	—	—	○	○	○	○	—
○	○	○	○	○	○	○	○	○	○	○	○	○	○	○	○	○	○	○
—	—	—	—	—	—	—	—	—	—	—	—	—	—	—	—	—	—	—
○	○	○	○	○	○	○	○	○	○	○	○	○	○	○	○	○	○	○
—	—	○	○	○	○	○	○	○	○	○	○	○	○	○	○	○	○	○
—	—	○	○	○	○	○	○	○	○	○	○	○	○	○	○	○	○	○
—	—	○	○	○	○	○	○	○	○	○	○	○	○	○	○	○	○	○
○	○	—	○	○	○	○	○	○	○	○	○	○	○	—	—	—	—	—
—	—	—	—	—	*6	—	○	○	○	○	○	○	○	○	○	—	—	—
—	—	○	—	○	○	○	○	○	○	○	○	○	○	○	○	○	○	○
—	—	—	—	—	—	—	—	—	—	—	○	○	○	○	○	○	○	○
○	○	—	○	—	—	—	—	—	—	—	—	—	—	—	—	—	—	—
—	—	—	—	—	—	—	—	—	—	—	○	○	○	○	○	○	○	○
○	○	○	○	○	○	○	○	○	○	○	○	○	○	○	○	○	○	○
○	○	○	○	○	—	○	○	○	○	○	○	○	○	○	○	○	—	—
○	○	○	○	○	*7	○	○	○	○	○	○	○	○	○	○	○	○	—
○	○	○	○	○	*7	○	○	○	○	○	○	○	○	○	○	○	—	—
—	—	—	—	—	—	—	—	—	—	—	—	—	—	—	—	—	—	○

*6 Only 4:3 and 16:9 are available.

○ Selectable, or set automatically. — Not selectable.

*7 Linked to aspect ratio and automatically set (p. 106).

Shooting Menu

Function		Shooting Modes							
		AUTO	P						
AF Frame (p. 92)	Face AiAF*1	○	○	○	○	○	○	○	○
	Tracking AF	*2	○	—	○	○	—	—	—
	Center	—	○	○	○	○	—	—	—
AF Frame Size*3 (p. 93)	Normal	—	○	○	○	○	—	—	—
	Small	—	○	○	○	○	—	—	—
	Standard	○	○	○	○	○	○	○	○
Digital Zoom (p. 53)	Off	○	○	○	○	○	○	○	○
	Digital Tele-converter (1.5x/2.0x)	—	○	—	—	—	—	—	—
AF-Point Zoom (p. 95)	On	○	○	—	○	—	○	○	○
	Off	○	○	○	○	○	○	○	○
Servo AF (p. 97)	On	—	○	—	○	○	—	—	—
	Off*4	○	○	○	○	—	○	○	○
AF-assist Beam (p. 165)	On	○	○	○	○	○	○	○	○
	Off	○	○	○	○	○	—	○	○
Flash Settings (pp. 101, 165)	Red-Eye Corr.	On	○	○	○	○	○	○	○
		Off	○	○	○	○	○	○	○
	Red-Eye Lamp	On/Off	○	○	○	○	○	○	○
i-Contrast (p. 86)	Auto	○	○	○	—	—	—	—	—
	Off	—	○	○	○	○	○	○	○
Wind Filter (p. 109)	On/Off	○	○	○	○	○	○	○	○
Review (p. 166)	Off/2 – 10 sec./Hold	○	○	○	○	○	○	○	○
Review Info (p. 166)	Off	○	○	○	○	○	○	○	○
	Detailed/Focus Check	○	○	○	○	○	○	○	○
Blink Detection (p. 102)	On	○	○	○	○	○	○	○	○
	Off	○	○	○	○	○	○	○	○
Grid Lines (p. 166)	On	○	○	○	○	○	○	○	○
	Off	○	○	○	○	○	○	○	○
IS Settings (p. 167)	IS Mode	Off	○	○	○	○	○	○	○
		Continuous	○	○	○	○	○	○	○
		Shoot Only	○	○	○	○	○	○	○
	Powered IS	On	○	○	○	○	○	○	○
		Off	○	○	○	○	○	○	○
Date Stamp (p. 54)	Off	○	○	○	○	○	○	○	○
	Date/Date & Time	○	○	○	○	○	○	○	○

*1 Operation differs depending on the shooting mode when faces are not detected.

*2 Only available by pressing the  button (p. 28).

*3 Available when the AF frame is set to [Center].

*4 [On] when moving people are detected in  mode.

↑↑ Set up Menu

Item	Content	Ref. Page
Mute	On/Off*	p. 46
Volume	Set all operation sounds (5 levels).	p. 47
Sound Options	Set the sounds for each camera operation.	p. 158
Hints & Tips	On*/Off	p. 158
LCD Brightness	Sets screen brightness (5 levels).	p. 48
Start-up Image	Add an image as a start-up image.	p. 160
Format	Formats memory card, erasing all data	pp. 23, 159
File Numbering	Continuous*/Auto Reset	p. 161
Create Folder	Monthly*/Daily	p. 162
Lens Retract	1 min.*/0 sec.	p. 162
Power Saving	Auto Power Down: On*/Off Display Off: 10, 20 or 30 sec./1*, 2 or 3 min.	pp. 50, 163
Time Zone	Home*/World	p. 164
Date/Time	Date and time settings.	p. 21
Video System	NTSC/PAL	p. 170
Ctrl via HDMI	Enable/Disable*	p. 172
Eye-Fi Settings	Eye-Fi connection settings (only appears when Eye-Fi card is inserted)	p. 175
Language 	Choose display language.	p. 22
Reset All	Returns camera to default settings.	p. 49

* Default setting

Playback Menu

Item	Content	Ref. Page
Slideshow	Plays back images automatically.	p. 117
Erase	Erases images (Select, Select Range, All Images).	p. 128
Protect	Protects images (Select, Select Range, All Images).	p. 124
Rotate	Rotates images.	p. 135
Favorites	Tags or untags images as favorites.	p. 130
My Category	Categorizes images (Select, Select Range).	p. 132
Photobook Set-up	Chooses or clears photobook settings for images.	p. 154
i-Contrast	Corrects dark portions and contrast in still images.	p. 139
Red-Eye Correction	Corrects red eyes in still images.	p. 140
Trimming	Trims portions of still images.	p. 137
Resize	Resizes and saves still images.	p. 136
My Colors	Adjusts colors in still images.	p. 138
Scroll Display	On*/Off	p. 114
Group Images	On*/Off	p. 122
Auto Rotate	On*/Off	p. 168
Resume	Last seen*/Last shot	p. 168
Transition	Fade*/Scroll/Slide/Off	p. 124

* Default setting

Print Menu

Item	Content	Ref. Page
Print	Displays printing screen (When connected to a printer).	—
Select Images & Qty.	Chooses individual images for printing.	p. 151
Select Range	Chooses starting and ending images for printing.	p. 152
Select All Images	Chooses all images for printing.	p. 152
Clear All Selections	Cancels all settings for printing.	p. 152
Print Settings	Sets the printing style.	p. 150

Playback Mode FUNC. Menu

Item	Content	Ref. Page
Rotate	Rotates displayed image.	p. 135
Print List	Selects or clears settings for printing displayed image ([Print] appears when the camera is connected to the printer).	p. 149
Protect	Protects/unlocks displayed image.	p. 124
Favorites	Tags/untags displayed image as favorites.	p. 130
Erase	Erases displayed image.	p. 30
Group Playback	Plays back images taken with High-speed Burst one by one.	p. 121
Play Movie	Starts movie playback.	p. 33
Movie Digest Playback	Plays back movies made in Movie Digest mode.	p. 115
Smart Shuffle	Starts Smart Shuffle.	p. 123
Filtered Playback	Filters/cancels filter for displayed image.	p. 115
Slideshow	Plays back images automatically.	p. 117
My Category	Categorizes images.	p. 132

Handling Precautions

- This camera is a high-precision electronic device. Do not drop it or subject it to strong impacts.
- Never place the camera close to magnets, motors or other devices that generate strong electromagnetic fields. Exposure to strong magnetic fields may cause malfunctions or corrupt image data.
- If water droplets or dirt become stuck on the camera or screen, wipe with a dry soft cloth or eyeglass wiper. Do not rub or apply force.
- Never use cleaners containing organic solvents to wipe the camera or screen.
- Use a commercially available blower brush to remove dust from the lens. For stubborn dirt contact a Canon Customer Support Help Desk.
- When you move the camera rapidly from cold to hot temperatures, condensation may form on the internal or external surfaces of the camera. To avoid condensation, put the camera in an airtight, resealable plastic bag and let it adjust to temperature changes slowly before removing it from the bag.
- If condensation has formed on the camera, stop using it immediately, as continued use may damage the camera. Remove the battery and memory card, and wait until the moisture has completely evaporated before resuming use.

Specifications

Image Sensor

Camera Effective Pixels Approx. 12.1 million pixels

Lens

Focal Length 5.0 (W) – 40.0 (T) mm
(35mm film equivalent: 28 (W) – 224 (T) mm)

Zoom Magnification 8x

Focusing Range 1 cm (0.4 in.) – infinity (W), 1 m (3.3 ft.) – infinity (T)
• Macro 1 – 50 cm (W) (0.4 in. – 1.6 ft. (W))

Image Stabilizer System Lens-shift type

Imaging Processor DIGIC 4

LCD Monitor

Type TFT color (wide viewing angle type)

Size 7.5 cm (3.0 in.)

Effective Pixels Approx. 461,000 dots

Aspect Ratio 4:3

Features Brightness adjustment (5 levels), Quick-bright LCD

Focus

Control System Autofocus: Single (Continuous in Auto mode),
Servo AF/Servo AE

AF Frame Face AiAF, Tracking AF, Center

Metering System Evaluative, Center-weighted average, Spot

Exposure Compensation

(Still Images) /

Exposure Shift (Movies) ± 2 stops in 1/3-stop increments

ISO Speed

(Standard Output Sensitivity,

Recommended Exposure Index) Auto, ISO 100/200/400/800/1600/3200 (In P mode)

White Balance Auto, Day Light, Cloudy, Tungsten, Fluorescent,
Fluorescent H, Custom

Shutter Speed 1 – 1/2000 sec.
15 – 1/2000 sec. (Total shutter speed range)

Aperture

Type Circular

f/number f/3.0 – f/9.0 (W), f/5.9 – f/18 (T)

Flash

Modes Auto, on, Slow Synchro, off

Range 50 cm – 4.0 m (W), 50 cm – 2.0 m (T)
(1.6 – 13 ft. (W), 1.6 – 6.6 ft. (T))

Shooting Modes.....	Auto*1, P, Movie Digest, Portrait, Kids&Pets, Smart Shutter*2, High-speed Burst, Best Image Selection, Handheld Night Scene, Low Light, Fish-eye Effect, Miniature Effect, Toy Camera Effect, Monochrome, Super Vivid, Poster Effect, Color Accent, Color Swap, Beach, Foliage, Snow, Fireworks, Long Shutter, Stitch Assist, iFrame Movie, Super Slow Motion Movie • Shooting movies is possible with the movie button. *1 Smart Auto also available for movies *2 Smile, Wink Self-timer, Face Self-timer
Digital Zoom	Still images/Movies: Approx. 4.0x (up to approx. 32x in combination with the optical zoom) Safety Zoom, Digital tele-converter
Continuous Shooting	
Speed	Approx. 3.5 shots/sec. (In P mode) Approx. 8.7 shots/sec. (In High-speed Burst mode)
Number of Shots (CIPA compliant)	Approx. 210
Recording Media	SD memory card, SDHC memory card, SDXC memory card
File Format	Design rule for Camera File system, DPOF (Version 1.1) compliant
Data Type	
Still Images.....	Exif 2.3 (JPEG)
Movies.....	MOV (Image data: H.264; Audio data: Linear PCM (stereo))

Specifications

Number of Recording Pixels

Still Images	16:9 Large: 4000 x 2248, Medium 1: 2816 x 1584, Medium 2: 1920 x 1080, Small: 640 x 360 3:2 Large: 4000 x 2664, Medium 1: 2816 x 1880, Medium 2: 1600 x 1064, Small: 640 x 424 4:3 Large: 4000 x 3000, Medium 1: 2816 x 2112, Medium 2: 1600 x 1200, Small: 640 x 480 1:1 Large: 2992 x 2992, Medium 1: 2112 x 2112, Medium 2: 1200 x 1200, Small: 480 x 480
--------------------	---

Movies.....	iFrame Movie: 1280 x 720 (30 fps*1) Super Slow Motion Movie: 640 x 480 (120 fps*2 when shooting, 30 fps*1 during playback), 320 x 240 (240 fps*3 when shooting, 30 fps*1 during playback) Miniature Effect: 1280 x 720*4, 640 x 480*4 Other than the above: 1920 x 1080 (24 fps*5), 1280 x 720 (30 fps*1), 640 x 480 (30 fps*1) *1 Actual frame rate is 29.97 fps. *2 Actual frame rate is 119.88 fps. *3 Actual frame rate is 239.76 fps. *4 Shooting: 6 fps/3 fps/1.5 fps, Playback: 30 fps*1 *5 Actual frame rate is 23.976 fps.
-------------	---

Interface	Hi-Speed USB HDMI output Analog audio output (stereo) Analog video output (NTSC/PAL)
-----------------	---

Direct Print Standard.....	PictBridge
----------------------------	------------

Power Source.....	Battery Pack NB-4L Compact Power Adapter CA-DC10 (included with AC Adapter Kit ACK-DC60)
-------------------	---

Dimensions (CIPA compliant)	95.8 x 56.8 x 22.1 mm (3.77 x 2.24 x 0.87 in.)
-----------------------------------	--

Weight (CIPA compliant).....	Approx. 140 g (4.94 oz.) (Including the battery and memory card) Approx. 121 g (4.27 oz.) (camera body only)
------------------------------	---

Battery Pack NB-4L

Type.....	Rechargeable lithium-ion battery
Nominal Voltage	3.7 V DC
Nominal Capacity	760 mAh
Charge Cycles.....	Approx. 300 times
Operating Temperatures	0 – 40 °C (32 – 104 °F)
Dimensions.....	35.4 x 40.3 x 5.9 mm (1.39 x 1.59 x 0.23 in.)
Weight	Approx. 17 g (Approx. 0.60 oz.)

Battery Charger CB-2LV/CB-2LVE

Rated Input.....	100 V – 240 V AC (50/60 Hz), 0.1 A (100 V) – 0.06 A (240 V)
Rated Output.....	4.2 V DC, 0.65 A
Charge Time.....	Approx. 1 hour 30 min. (When using NB-4L)
Charge Indicator.....	Charging: Orange, Fully charged: Green
Operating Temperatures	0 – 40 °C (32 – 104 °F)
Dimensions.....	53.0 x 86.0 x 19.5 mm (2.09 x 3.39 x 0.77 in.)
Weight	Approx. 60 g (Approx. 2.12 oz.) (CB-2LV) Approx. 55 g (Approx. 1.94 oz.) (CB-2LVE, excluding power cord)

- All data is based on tests by Canon.
- Camera specifications or appearance are subject to change without notice.

CAUTION

RISK OF EXPLOSION IF BATTERY IS REPLACED BY AN INCORRECT TYPE.
DISPOSE OF USED BATTERIES ACCORDING TO LOCAL REGULATION.

Accessories

Supplied with Camera



Wrist Strap
WS-DC11



Battery Pack NB-4L
with Terminal Cover*

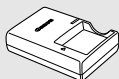

Battery Charger
CB-2LV/CB-2LVE*

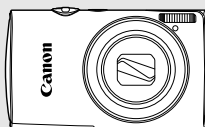

DIGITAL CAMERA
Solution Disk

Interface Cable
IFC-400PCU*

*Also available for purchase separately.

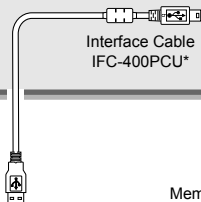

Memory Card



USB Card Reader



Windows/Macintosh

Canon-Brand PictBridge Compliant Printers



Stereo AV Cable AVC-DC400ST



HDMI Cable HTC-100



TV

Separately Sold Accessories

The following camera accessories are sold separately. Some accessories are not sold in some regions, or may no longer be available.

Power Supplies

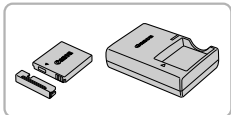

Battery Pack NB-4L

- Rechargeable lithium-ion battery.

Battery Charger CB-2LV/CB-2LVE

- A charger for charging Battery Pack NB-4L.

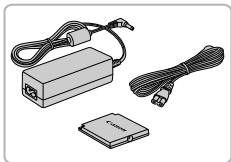

AC Adapter Kit ACK-DC60

- This kit lets you power the camera using household power. Recommended for powering the camera for an extended period of time or when connecting to a computer or printer. Cannot be used to charge the camera battery.



AC Adapter Kit ACK-DC10 can also be used.



Using accessories abroad

The battery charger and the AC adapter kit can be used in regions that have 100 – 240 V (50/60 Hz) AC power.

If the plug does not fit the outlet, use a commercially available plug adapter.

Do not use electrical transformers for foreign travel as they will cause damage.

Flash

High-Power Flash HF-DC2

- This externally mounted flash can be used to capture photographic subjects that are too distant for the built-in flash to illuminate.

High-Power Flash HF-DC1 can also be used.

Other Accessories

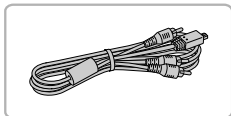

Stereo AV Cable AVC-DC400ST

- Use this cable to connect to a TV for shooting and viewing images.

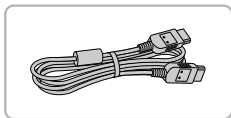

HDMI Cable HTC-100

- Use this cable to connect the camera to the HDMI terminal on a high-definition TV set.

Printers

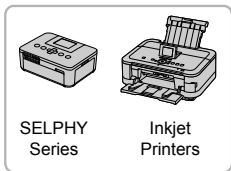

SELPHY
Series

Inkjet
Printers

Canon-Brand PictBridge Compliant Printers

- By connecting your camera to a Canon-brand PictBridge compliant printer, you can print your images without having to use a computer.
For more information, visit your nearest Canon retailer.

Use of genuine Canon accessories is recommended.

This product is designed to achieve excellent performance when used with genuine Canon accessories. Canon shall not be liable for any damage to this product and/or accidents such as fire, etc., caused by the malfunction of non-genuine Canon accessories (e.g., a leakage and/or explosion of a battery pack). Please note that this warranty does not apply to repairs arising out of the malfunction of non-genuine Canon accessories, although you may request such repairs on a chargeable basis.

- A**
- AC Adapter Kit..... 174, 203
 - Accessories..... 203
 - AE Lock..... 99
 - AF Frames..... 27, 92
 - AF → Focus
 - AF Lock..... 96
 - AF-Point Zoom..... 95
 - Aspect Ratio..... 58
 - AUTO Mode (Shooting Mode)..... 26
- B**
- Battery
 - Charge Indicator..... 15
 - Charging..... 14
 - Power Saving..... 50, 163
 - Battery Charger..... 2, 203
 - Beach (Shooting Mode)..... 63
 - Best Image Selection (Shooting Mode)..... 79
 - Black and White Images..... 88
 - Blink Detection..... 102
- C**
- Camera
 - Default Settings..... 49
 - Holding the Camera..... 13
 - Camera Shake..... 28, 167
 - Center (AF Frame Mode)..... 93
 - Clock Function..... 50
 - Color Accent (Shooting Mode)..... 69
 - Color Swap (Shooting Mode)..... 70
 - Components Guide..... 40
 - Compression Ratio (Image Quality)..... 59
 - Continuous Shooting..... 87
 - Continuous Shooting
 - Best Image Selection (Shooting Mode)..... 79
 - High-speed Burst (Shooting Mode)..... 78
 - Custom White Balance..... 84
- D**
- Date/Time
 - Adding to Image..... 54
 - Changing..... 21
 - Setting..... 20
 - World Clock..... 164
 - Date and Time → Date/Time
 - Default Settings..... 49
 - DIGITAL CAMERA Solution Disk..... 2
 - Digital Tele-Converter..... 91
 - Digital Zoom..... 53
 - Display Language..... 22
 - DPOF..... 149
 - Drive Mode..... 87
- E**
- Editing
 - i-Contrast..... 139
 - My Colors..... 138
 - Red-Eye Correction..... 140
 - Resizing (Making Images Smaller)..... 136
 - Trimming..... 137
 - Erasing Images..... 30
 - Error Messages..... 180
 - Exposure
 - AE Lock..... 99
 - Correction..... 83
 - FE Lock..... 99
 - Eye-Fi Card..... 16, 175
- F**
- Face AiAF (AF Frame Mode)..... 92
 - Face Self-Timer (Shooting Mode)..... 75
 - Factory Settings → Default Settings
 - FE Lock..... 99
 - File Numbering..... 161
 - Fireworks (Shooting Mode)..... 64
 - Fish-eye Effect (Shooting Mode)..... 66
 - Flash
 - Off..... 52
 - On..... 83
 - Slow Synchro..... 100

- Focus
 AF Frames 27, 92
 AF Lock 96
 AF-Point Zoom 95
 Servo AF 97
 Focus Check 119
 Focusing Range
 Infinity 90
 Macro 90
 Focus Lock 93
 Foliage (Shooting Mode) 63
 Format → Memory Cards, Formatting
 Formatting (Memory Card) 23, 159
 FUNC. Menu
 Basic Operations 44
 List 190, 196
- G**
- Grid Lines 166
- H**
- Handheld NightScene
 (Shooting Mode) 63
 High-speed Burst (Shooting Mode) 78
 Household Power 174
 Hybrid IS 185
- I**
- i-Contrast 86, 139
 iFrame Movie (Movie Mode) 104
 Image Quality → Compression Ratio
 Images
 Display Time 166
 Editing → Editing
 Erasing Images 30, 128
 Playback → Viewing
 Protecting 124
 Included Items → Accessories
 Indicator 41, 43
 Intelligent IS 167, 185
 Interface Cable 2, 36, 142
 ISO Speed 85
- K**
- Kids&Pets (Shooting Mode) 62
- L**
- Lamp 40, 165
 LCD Monitor → Screen
 Long Shutter (Shooting Mode) 77
 Low Light (Shooting Mode) 63
- M**
- Macro (Focus Mode) 90
 Magnified Display 120
 Memory Cards 16
 Available Shots 19, 60
 Formatting 23, 159
 Shooting Time 32, 108
 Menu
 Basic Operations 45
 List 188
 Metering Method 98
 Miniature Effect (Shooting Mode) 66, 105
 Monochrome (Shooting Mode) 68
 Movie Digest (Shooting Mode) 72
 Movies
 Editing 111
 Image Quality (Recording Pixels/
 Frame Rate) 108
 Shooting Time 32, 108
 Viewing (Playback) 33
 My Category 132
 My Colors (Playback) 138
 My Colors (Shooting) 88
- P**
- P (Shooting mode) 82
 Photobooks 154
 PictBridge 142, 204
 Playback → Viewing
 Playback With Transition Effects 124
 Portrait (Shooting Mode) 62
 Poster Effect (Shooting Mode) 65
 Powered IS 167
 Power → Battery, AC Adapter kit
 Power Saving 50, 163
 Printing 142
 Program AE 82
 Protect 124

R

Recording Pixels (Image Size)	59
Red-Eye Correction	101, 140
Resizing (Making Images Smaller)	136
Rotate	135

S

Screen	
Display Language	22
Information Display	183, 186
Menu → FUNC. Menu, Menu	
Switching the Display	42
SD/SDHC/SDXC Memory Card → Memory Cards	
Self-Timer	55
Changing Delay and Number of Shots	56
Face Self-Timer (Shooting Mode)	75
Two Second Self-Timer	56
Wink Self-Timer (Shooting Mode)	74
Sepia Tones	88
Servo AF	97
Shooting	
Number of Shots	15, 19, 60
Shooting Date and Time → Date/Time	
Shooting Info	183
Shooting Time	32
Shooting Using a TV	171
Slideshow	117
Smart Shuffle	123
Smart Shutter (Shooting Mode)	73
Smile (Shooting Mode)	73
Snow (Shooting Mode)	63
Software	
DIGITAL CAMERA Solution Disk	2
Installation	35
Software Guide	2
Transferring Images to a Computer for Viewing	34
Sound Settings	46
Stitch Assist (Shooting Mode)	80
Strap	2, 13
Super Slow Motion (Movie Mode)	106
Super Vivid (Shooting Mode)	65

T

Tag Images as Favorites	130
Terminal	36, 142, 170, 171, 174
Toy Camera Effect (Shooting Mode)	67
Tracking AF	28, 94
Travel Abroad	16, 164, 203
Trimming	137
Troubleshooting	177

V

Video → Movies	
Viewing	
Filtered Playback	115
Images on a TV	170
Index Display	114
Magnified Display	120
Scroll Display	114
Single Image Playback	29
Slideshow	117
Smart Shuffle	123
Viewing Images on a TV	170

W

White Balance	84
Wink Self-Timer (Shooting Mode)	74
World Clock	164
Wrist Strap → Strap	

Z

Zoom	26, 53
------------	--------

Trademark Acknowledgments

- The SDXC logo is a trademark of SD-3C, LLC.
- This device incorporates exFAT technology licensed from Microsoft.
- HDMI, the HDMI logo and High-Definition Multimedia Interface are trademarks or registered trademarks of HDMI Licensing LLC.
- The iFrame logo and the iFrame symbol are trademarks of Apple Inc.

About MPEG-4 Licensing

This product is licensed under AT&T patents for the MPEG-4 standard and may be used for encoding MPEG-4 compliant video and/or decoding MPEG-4 compliant video that was encoded only (1) for a personal and non-commercial purpose or (2) by a video provider licensed under the AT&T patents to provide MPEG-4 compliant video.

No license is granted or implied for any other use for MPEG-4 standard.

* Notice displayed in English as required.

Disclaimer

- Reprinting, transmitting, or storing in a retrieval system any part of this guide without the permission of Canon is prohibited.
- Canon reserves the right to change the contents of this guide at any time without prior notice.
- Illustrations and screenshots in this guide may differ slightly from the actual equipment.
- The above items notwithstanding, Canon accepts no liability for damages due to mistaken operation of the products.