

Canon

PUB. DIE-0436-000B

HD Camcorder  
Instruction Manual



VIXIA  
HF G30

NTSC

MP4

HDMI

AVCHD  
Progressive

WiFi  
CERTIFIED

# Important Usage Instructions

## WARNING

TO REDUCE THE RISK OF FIRE OR ELECTRIC SHOCK, DO NOT EXPOSE THIS PRODUCT TO RAIN OR MOISTURE.

## WARNING

TO REDUCE THE RISK OF ELECTRIC SHOCK AND TO REDUCE ANNOYING INTERFERENCE, USE THE RECOMMENDED ACCESSORIES ONLY.

## COPYRIGHT WARNING:

Unauthorized recording of copyrighted materials may infringe on the rights of copyright owners and be contrary to copyright laws.

## FCC/IC NOTICE

HD Camcorder, VIXIA HF G30 systems

This device complies with Part 15 of the FCC Rules. Operation is subject to the following two conditions: (1) This device may not cause harmful interference, and (2) this device must accept any interference received, including interference that may cause undesired operation.

Note: This equipment has been tested and found to comply with the limits for a class B digital device, pursuant to Part 15 of the FCC Rules. These limits are designed to provide reasonable protection against harmful interference in a residential installation. This equipment generates, uses and can radiate radio frequency energy and, if not installed and used in accordance with the instructions, may cause harmful interference to radio communications. However, there is no guarantee that interference will not occur in a particular installation. If this equipment does cause harmful interference to radio or television reception, which can be determined by turning the equipment off and on, the user is encouraged to try to correct the interference by one or more of the following measures:

- Reorient or relocate the receiving antenna.
- Increase the separation between the equipment and receiver.
- Connect the equipment into an outlet on a circuit different from that to which the receiver is connected.
- Consult the dealer or an experienced radio/TV technician for help.

Use of shielded cable is required to comply with class B limits in Subpart B of Part 15 of FCC Rules.

Do not make any changes or modifications to the equipment unless otherwise specified in the manual. If such changes or modifications should be made, you could be required to stop operation of the equipment.

## Model ID0025 (including WLAN Module Model RF400, FCC ID: AZD400)

This device complies with Industry Canada license-exempt RSS standard(s). Operation is subject to the following two conditions: (1) this device may not cause interference, and (2) this device must accept any interference, including interference that may cause undesired operation of the device.

This transmitter must not be co-located or operated in conjunction with any other antenna or transmitter.

The available scientific evidence does not show that any health problems are associated with using low power wireless devices. There is no proof, however, that these low power wireless devices are absolutely safe. Low power wireless devices emit low levels of radio frequency energy (RF) in the microwave range while being used. Whereas high levels of RF can produce health effects (by heating tissue), exposure of low-level RF that does not produce heating effects causes no known adverse health effects. Many studies of low-level RF exposures have not found any biological effects. Some studies have suggested that some biological effects might occur, but such findings have not been confirmed by additional research. This model has been tested and found to comply with FCC/IC radiation exposure limits set forth for an uncontrolled equipment and meets the FCC radio frequency (RF) Exposure Guidelines and RSS-102 of the IC radio frequency (RF) Exposure rules.

Compliance with FCC requirement 15.407(c)

Data transmission is always initiated by software, which is passed down through the MAC, through the digital and analog baseband, and finally to the RF chip. Several special packets are initiated by the MAC. These are the only ways the digital baseband portion will turn on the RF transmitter, which it then turns off at the end of the packet. Therefore, the transmitter will be on only while one of the aforementioned packets is being transmitted. In other words, this device automatically discontinues transmission in case of either absence of information to transmit or operational failure.

Frequency Tolerance: 25 ppm

Canon U.S.A., Inc.

One Canon Park, Melville, NY 11747, USA

Tel No. 1-800-OK-CANON (1-800-652-2666)

The Mains plug is used as the disconnect device. The Mains plug shall remain readily operable to disconnect the plug in case of an accident.

## CAUTION:

- Danger of explosion if the wrong type of batteries are attached. Use only the same type of batteries.
- Do not expose batteries or product to excessive heat such as the inside of a car under direct sunlight, fire, etc.

## Important Warning



The lightning flash with arrowhead symbol, within an equilateral triangle, is intended to alert the user to the presence of uninsulated "dangerous voltage" within the product's enclosure, that may be of sufficient magnitude to constitute a risk of electric shock to persons.

**CAUTION:**  
TO REDUCE THE RISK OF ELECTRIC SHOCK, DO NOT REMOVE COVER (OR BACK). NO USER-SERVICEABLE PARTS INSIDE. REFER SERVICING TO QUALIFIED SERVICE PERSONNEL.



The exclamation point, within an equilateral triangle, is intended to alert the user to the presence of important operating and maintenance (servicing) instructions in the literature accompanying the product.

# IMPORTANT SAFETY INSTRUCTIONS

In these safety instructions the word "product" refers to the Canon HD Camcorder VIXIA HF G30 and all its accessories.

- 1 Read these instructions.
- 2 Keep these instructions.
- 3 Heed all warnings.
- 4 Follow all instructions.
- 5 Do not use this apparatus near water.
- 6 Clean only with dry cloth.
- 7 Do not install near any heat sources such as radiators, heat registers, stoves, or other apparatus (including amplifiers) that produce heat.
- 8 Do not defeat the safety purpose of the polarized or grounding-type plug. A polarized plug has two blades with one wider than the other. A grounding type plug has two blades and a third grounding prong. The wide blade or the third prong are provided for your safety. If the provided plug does not fit into your outlet, consult an electrician for replacement of the obsolete outlet.
- 9 Protect the power cord from being walked on or pinched particularly at plugs, convenience receptacles, and the point where they exit from the apparatus.
- 10 Only use attachments/accessories specified by the manufacturer.
- 11 Unplug this apparatus during lightning storms or when unused for long periods of time.
- 12 Refer all servicing to qualified service personnel. Servicing is required when the apparatus has been damaged in any way, such as power-supply cord or plug is damaged, liquid has been spilled or objects have fallen into the apparatus, the apparatus has been exposed to rain or moisture, does not operate normally, or has been dropped.

CA-570 identification plate is located on the bottom.

CAN ICES-3(B)/NMB-3(B)



### WARNING

#### DO NOT INGEST BATTERY, CHEMICAL BURN HAZARD

The wireless controller contains a coin/button cell battery. If the coin/button cell battery is swallowed, it can cause severe internal burns in just 2 hours and can lead to death. Keep new and used batteries away from children. If the battery compartment does not close securely, stop using the product and keep it away from children. If you think batteries might have been swallowed or placed inside any part of the body, seek immediate medical attention.

## REGIONS OF USE

VIXIA HF G30 is in compliance (as of April 2013) with the radio signal regulations of the regions listed below. For details on other regions where they can be used, make inquiries with the contacts listed on the back side of this instruction manual.

### REGIONS

Canada, Hong Kong S.A.R., USA, South Korea

Model  
ID0025: VIXIA HF G30

## Trademark Acknowledgements

- SD, SDHC and SDXC Logos are trademarks of SD-3C, LLC.
- Microsoft and Windows are trademarks or registered trademarks of Microsoft Corporation in the United States and/or other countries.
- App Store, iPad, iPhone, iPod, iTunes and Mac OS are trademarks of Apple Inc., registered in the U.S. and other countries.
- HDMI, the HDMI logo and High-Definition Multimedia Interface are trademarks or registered trademarks of HDMI Licensing LLC in the United States and other countries.
- "AVCHD", "AVCHD Progressive" and the "AVCHD Progressive" logo are trademarks of Panasonic Corporation and Sony Corporation.
- Manufactured under license from Dolby Laboratories.  
"Dolby" and the double-D symbol are trademarks of Dolby Laboratories.
- Google, Android, Google Play, YouTube are trademarks of Google Inc.
- Facebook is a registered trademark of Facebook, Inc.
- IOS is a trademark or registered trademark of Cisco in the U.S. and other countries and is used under license.
- The Twitter name and marks are trademarks of Twitter, Inc.
- Wi-Fi is a registered trademark of the Wi-Fi Alliance.
- Wi-Fi Certified, WPA, WPA2, and the Wi-Fi Certified logo are trademarks of the Wi-Fi Alliance.
- WPS as used on the camcorder's settings, onscreen displays and in this manual signifies Wi-Fi Protected Setup.
- The Wi-Fi Protected Setup Identifier Mark is a mark of the Wi-Fi Alliance.
- JavaScript is a trademark or registered trademark of Oracle Corporation, its affiliates or subsidiaries in the United States and other countries.
- Other names and products not mentioned above may be trademarks or registered trademarks of their respective companies.
- This device incorporates exFAT technology licensed from Microsoft.
- "Full HD 1080" refers to Canon camcorders compliant with high-definition video composed of 1,080 vertical pixels (scanning lines).
- This product is licensed under AT&T patents for the MPEG-4 standard and may be used for encoding MPEG-4 compliant video and/or decoding MPEG-4 compliant video that was encoded only (1) for a personal and non-commercial purpose or (2) by a video provider licensed under the AT&T patents to provide MPEG-4 compliant video. No license is granted or implied for any other use for MPEG-4 standard.



# Highlights of the VIXIA HF G30

The Canon VIXIA HF G30 HD Camcorder is a high-performance camcorder whose compact size makes it ideal in a variety of situations. The following are just some of the many functions featured in the camcorder.

## HD Recording

### HD CMOS PRO sensor and DIGIC DV 4 processor

The camcorder is equipped with a 1/2.84-inch CMOS sensor that captures video at an effective pixel count of approximately 2.91 megapixels (2136x1362). The video is then processed by the state-of-the-art DIGIC DV 4 image processor. This allows the camcorder to excel in low-light situations and achieve improved image stabilization.

### Wide zoom lens

With a focal length at full wide angle of 28.8 mm\* (35 mm equivalent), the camcorder has superb wide-angle shooting capability. The newly developed lens is also capable of 20x optical zoom.

\* 28.8 mm when using Dynamic IS.

### Shoot cinematic video

Using CINEMA mode and the cinema-look filters (☞ 50), you can make recordings that truly look and feel cinematic.

## Operability

### Emphasis on versatility

This camcorder has features to make it usable as a main camera but is also small enough to be very portable. The advanced image stabilization (☞ 61) will let you shoot in a variety of situations in the field.

### Manual controls at your fingertips

The focus/zoom ring helps you achieve the focus you are looking for. You can also easily change the ring's functionality so that you can operate the zoom. Furthermore, you can assign certain frequently used functions to a customizable button and adjust those functions with the accompanying dial (☞ 91). If those were not enough, the camcorder also features 5 assignable buttons to which you can assign a variety of functions so that you can access them with ease (☞ 92).

### Face detection

When a subject's face is detected, the camcorder can track and focus on it (☞ 55). Furthermore, you can have the camcorder in manual focus but switch to autofocus only when a face is detected, ensuring that important subjects are in focus.

### AVCHD/MP4 recording and dual recording

When you record, you can choose between AVCHD and MP4 formats (☞ 37). You can also use dual recording (☞ 47) to record the same scene to both memory cards and even record on both memory cards using different formats. Dual recording is convenient, for example, to create a backup of your recording.

## Other Features

### Audio scene select

With the audio scene select function (📖 79), you can optimize the audio settings of the built-in microphone by selecting the audio scene that matches your surroundings. Your audience will feel even more immersed in the scene during playback.

### Smart AUTO

Smart AUTO (📖 40) automatically selects the best scene mode for the scene you want to shoot. You get spectacular recordings every time without worrying about settings.

### Wi-Fi functions

Because the camcorder is compatible with Wi-Fi, you have access to a variety of convenient functions such as using a smartphone or tablet as a remote control (📖 120), using the Web browser on a smartphone or tablet to view the camcorder's recordings (📖 126), and using an iOS device to share your videos on the Internet (📖 128).

### OLED screen and LCD viewfinder

The OLED screen and LCD viewfinder both have 100% frame coverage, which will ensure that you can accurately check that your shots are framed how you want them. The OLED screen has incredible clarity, which is indispensable in checking the details of those important shots. The viewfinder can be tilted 45 degrees upward, which gives you additional range and versatility while you shoot.

### Touch AE

By simply touching the screen, you can make dark areas in the picture appear brighter (📖 66). This operation is simple yet allows you to shoot with the desired exposure.

### Added and improved functionality

Other functions include relay recording (📖 47) and conversion to MP4 (📖 114).

## Enjoying your Recordings on Other Devices

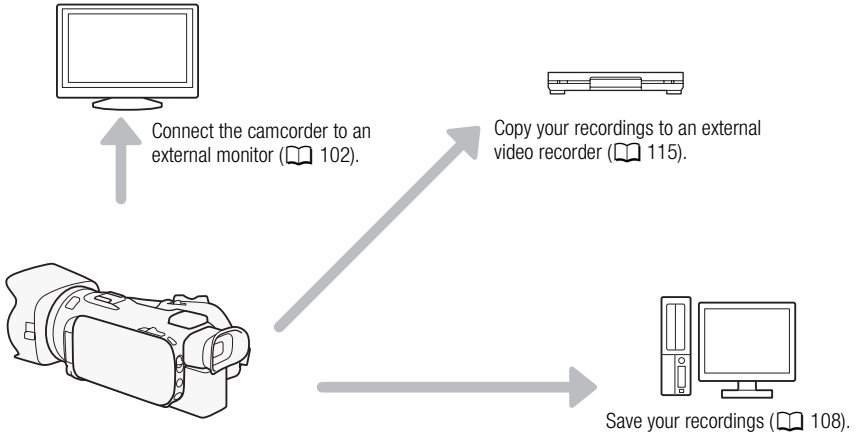

## Enjoying Your Recordings Using the Camcorder's Wi-Fi Functions



Use your iOS or Android device to remotely control the camcorder and view the image on its screen (📖 120).

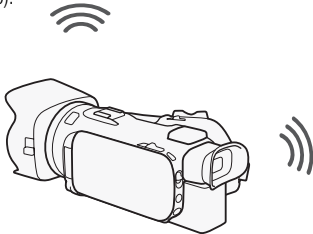

Use the Web browser on your iOS or Android device to view the recordings on the camcorder (📖 126).

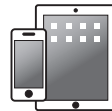

Use an iOS device to upload your recordings to the Internet (📖 128).



Connect the camcorder to an access point on a Wi-Fi network. After doing so, you can save your recordings on a computer (📖 131) or play back your recordings using the camcorder as a media server (📖 130).

# Table of contents

## 1 Introduction 11

- About this Manual 11
  - Conventions Used in this Manual 11
- Supplied Accessories and CD-ROMs 13
- Names of Parts 15

## 2 Preparations 21

- Attaching the Ferrite Core 21
- Charging the Battery Pack 21
- Preparing the Camcorder 24
  - Using the Lens Hood and Lens Cap 24
  - Using the Viewfinder 24
  - Adjusting the OLED Screen 25
  - Grip Belt and Straps 26
  - Wireless Controller 26
  - Using a Tripod 27

- Basic Operation of the Camcorder 28
  - Turning the Camcorder On and Off 28
  - Setting the Shooting Mode 29
  - Using the Touch Screen 29
  - Using the FUNC. Button and Joystick 30
  - Using the Menu 31

- First Time Settings 33
  - Setting the Date and Time 33
  - Changing the Language 34
  - Changing the Time Zone 34

- Using a Memory Card 35
  - Memory Cards Compatible for Use with the Camcorder 35
  - Inserting and Removing a Memory Card 35
  - Initializing a Memory Card 36
  - Selecting the Movie Format (AVCHD/MP4) 37
  - Selecting the Memory Card for Recordings 37

## 3 Recording 38

- Recording Movies and Photos 38
  - Preparing to Record 38
  - Recording in AUTO Mode 39
  - Recording in **M** (Manual) Mode 43
  - Reviewing the Latest Scene Recorded 44
- Selecting the Recording Mode (Video Quality) 45
- Dual Recording and Relay Recording 47

- Selecting the Frame Rate 48
- Slow & Fast Motion Recording 49
- CINEMA Mode and Cinema-Look Filters 50
- Focus Adjustment 52
  - Manual Focus 52
  - Autofocus 54
  - Face Detection & Tracking 55
- Zooming 57
  - Using the Focus/Zoom Ring 57
  - Using the Zoom Rocker or Wireless Controller 57
  - Using the Touch Screen's Zoom Controls 59
  - Soft Zoom Control 60
  - Digital Tele-Converter 60
- Advanced Image Stabilization 61
- Automatic Gain Control (AGC) Limit 62
- Automatic Exposure Recording Programs 63
- Exposure Adjustment 65
  - Using the Manual Exposure Recording Program 65
  - Exposure Compensation 66
- White Balance 68
- Special Scene Recording Programs 70
- Image Effects 72
- Setting the Time Code 73
  - Selecting the Running Mode 73
  - Selecting Drop Frame or Non-Drop Frame 74
- Setting the User Bit 75
  - User Bit Output 75
- Using the Mini Advanced Shoe 76
- Using an External Video Light 77
- Recording Audio 78
  - Using an External Microphone 78
  - Audio Scenes and Other Audio Settings 79
    - Audio Recording Level 81
    - Wind Screen (Built-in Microphone) 81
    - Microphone Attenuator 82
    - Audio Equalizer (Built-in Microphone) 82
    - Microphone Directionality (Built-in Microphone) 83
    - Switching the Input (MIC Terminal) 84
    - Low Cut Filter (MIC Terminal) 84
    - Audio Mix 84
- Using Headphones 85



- Color Bars/Audio Reference Signal 86
  - Recording Color Bars 86
  - Recording an Audio Reference Signal 86
- Video Snapshot 87
- Pre-Recording 88
- Onscreen Displays and Data Code 89
- Using the GP-E2 GPS Receiver 90

## 4 Customization 91

- CUSTOM Dial and Button 91
- Assignable Buttons 92
  - Changing the Assigned Function 92
  - Using an Assignable Button 93
- Saving and Loading Menu Settings 94
  - Saving Menu Settings to a Memory Card 94
  - Loading Menu Settings from a Memory Card 94

## 5 Playback 95

- Playing Back Video 95
  - Adjusting the volume 96
  - Displaying scene information 97
  - Capturing Photos During Movie Playback 97
- Deleting Scenes 98
  - Deleting a Single Scene 98
  - Deleting Scenes from the Index Screen 98
- Dividing Scenes 100
- Trimming Scenes 101

## 6 External Connections 102

- Connecting to an External Monitor 102
  - Connection Diagram 102
  - Using the HDMI OUT Terminal 103
  - Using the AV OUT Terminal 103
- Audio Output 104
  - Synchronizing the Video with the Audio being Monitored 104

## 7 Photos 105

- Viewing Photos 105
  - Photo Jump Function 105
- Deleting Photos 107
  - Deleting a Single Photo 107
  - Deleting Photos from the Index Screen 107

## 8 Saving/Sharing Recordings 108

- Saving Recordings to a Computer 108
  - Connection Diagram 108
  - Saving Movies Using Data Import Utility 108
  - Saving MP4 Movies and Photos Using ImageBrowser EX 109
- Copying Recordings Between Memory Cards 112
  - Copying Scenes from the Movie Index Screen 112
  - Copying a Single Photo 112
  - Copying Photos from the Index Screen 113
- Converting Movies to MP4 Format 114
- Copying Recordings to an External Video Recorder 115
  - In High Definition 115
  - In Standard Definition 115

## 9 Wi-Fi Functions 117

- Introduction to Wi-Fi 117
- Remote Operation Via the Wi-Fi Remote Application 120
  - Setting the Camcorder's Password 120
  - Operating the Camcorder Remotely 121
  - Wi-Fi Remote Onscreen Controls and Displays 121
  - Remote Operation Using Wi-Fi Remote 123
- Remote Browse: Viewing Recordings Using a Web Browser on Your iOS or Android Device 126
- Uploading Recordings Using an iOS Device 128
- Playback on a Computer 130
- Transferring Files to a Computer or FTP Server 131

**Sharing Recordings with CANON IMAGE**

GATEWAY 133

Setting the Desired Web Services in the  
Camcorder 133Sharing Your Recordings Using Web  
Services 135Sending Links to Recordings by  
E-mail 136**Wi-Fi Connection Using an Access  
Point 138**

Wi-Fi Protected Setup (WPS) 138

Searching for Access Points 139

Manual Setup 140

**Viewing and Changing Wi-Fi**

Settings 141

**10 Additional Information 143****Appendix: Menu Options Lists 143**

FUNC. Panel 143

Setup Menus 144

**Appendix: Onscreen Icons and  
Displays 153****Troubleshooting 157**

List of Messages 162

List of Messages for Wi-Fi

Functions 165

List of Messages for Web Services 167

**Handling Precautions 169**

Camcorder 169

Battery Pack 170

Memory Card 171

Built-in Rechargeable Lithium

Battery 171

Lithium Button Battery 172

Disposal 172

**Maintenance/Others 173**

Cleaning 173

Condensation 173





Using the Camcorder Abroad 174

**Optional Accessories 175****Specifications 181****Index 185**

## About this Manual

Thank you for purchasing the Canon VIXIA HF G30. Please read this manual carefully before you use the camcorder and retain it for future reference. Should your camcorder fail to operate correctly, refer to *Troubleshooting* (📖 157).

## Conventions Used in this Manual

-  **IMPORTANT:** Precautions related to the camcorder's operation.
-  **NOTES:** Additional topics that complement the basic operating procedures.
-  **POINTS TO CHECK:** Restrictions or requirements regarding the function described.
- : Reference page number within this manual.
- The following terms are used in this manual:
  - “Memory card” refers to an SD, SDHC or SDXC memory card.
  - “Screen” refers to the OLED screen and the viewfinder screen.
  - “Scene” refers to one movie unit from the point you press the **START/STOP** button to start recording until you press again to pause the recording.
  - “iOS device” is used in this text to refer to Wi-Fi-enabled iPhones, iPods and iPads while “Android device” refers to Wi-Fi-enabled Android smartphones and tablets.
- The photos included in this manual are simulated pictures taken with a still camera.
- Some screenshots in this manual have been simplified to show only relevant icons.

The three sets of icons indicate the operating mode and whether a function is available in that mode.

**CAMERA MEDIA**: Indicates whether the camcorder is in shooting (CAMERA) or playback (MEDIA) mode. In this example, the function is available only in **CAMERA** mode. For details, refer to *Turning the Camcorder On and Off* (□ 28).

**AVCHD MP4**: Indicates the movie format. For details, refer to *Selecting the Movie Format (AVCHD/MP4)* (□ 37).

**AUTO M CINEMA**: Indicates the shooting mode. For details, refer to *Setting the Shooting Mode* (□ 29).

Focus Adjustment

### Autofocus

When autofocus is activated, the camcorder continuously adjusts the focus on the subject in the center of the screen. The focusing range is 1 cm (0.39 in.; at full wide-angle, measured from the front of the lens barrel) to ∞ and 60 cm (2 ft.; throughout the zoom range, measured from the front of the lens barrel) to ∞. Perform the following procedure to set the autofocus speed.

Operating modes: **CAMERA MEDIA** | **AVCHD MP4** | **AUTO M CINEMA**

- 1 **M** and **CINEMA** modes only: Press **AF/MF**.
- 2 Open the [AF Mode] screen.  
[FUNC.] [MENU] [ ] [AF Mode]
- 3 Touch the desired option and then touch [X].
  - The icon of the selected option appears on the screen.

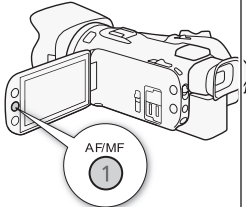

The focus is adjusted at the highest speed. This mode uses both the light surroundings. This mode uses both the

Brackets [ ] are used to refer to control buttons and menu options you will select and to other onscreen messages and displays.

The  arrow is used to abbreviate menu selections. For details on how to use the menus, refer to *Using the Menu* (□ 31). For a summary of available menu options and settings, refer to the appendix *Menu Options Lists* (□ 143).

The names of physical buttons and switches on the camcorder are indicated within a “button” frame. For example **AF/MF**.

## Supplied Accessories and CD-ROMs

The following accessories are supplied with the camcorder:

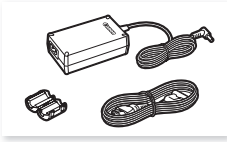

CA-570 Compact Power Adapter  
(incl. power cord and ferrite core)



BP-820 Battery Pack



WL-D89 Wireless Controller  
(incl. CR2025 lithium button battery)

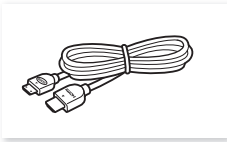

HTC-100/S High Speed HDMI Cable

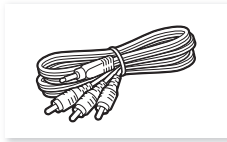

STV-250N Stereo Video Cable

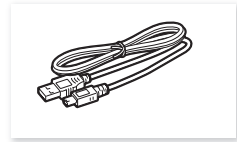

IFC-300PCU/S USB Cable



Lens hood with lens barrier



Lens cap



Quick Guide



Wi-Fi Basic Setup Guide

The following CD-ROMs and software are supplied with the camcorder:

- Data Import Utility CD-ROM
  - Use **Data Import Utility** to transfer your scenes to a computer. Refer to *Saving Recordings to a Computer* (□ 108). The CD-ROM includes the instruction manual of the software (on PDF file).
- **Canon VIXIA** CD-ROM. Contains the following components.
  - Instruction Manual - The full-version instruction manual of the camcorder (this PDF file).
  - **ImageBrowser EX** - Software for saving, managing and editing your photos. The supplied VIXIA CD-ROM contains an automatic installer for **ImageBrowser EX**. An Internet connection is required to fully install the software.

## Names of Parts

## Left side view

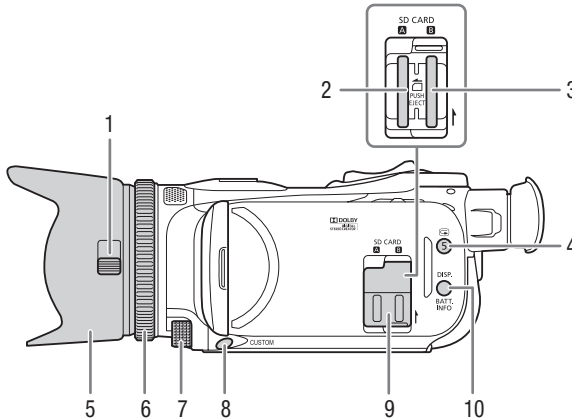

- |   |  |    |  |
|---|--|----|--|
| 1 | Lens barrier switch (📖 38)                                     | 8  | CUSTOM (customizable) button (📖 91)  |
| 2 | Memory card slot <b>A</b> (📖 35)                               | 9  | Double memory card slot cover  |
| 3 | Memory card slot <b>B</b> (📖 35)                               | 10 | DISP. (onscreen display) button (📖 89)/BATT. INFO (battery information) button (📖 156) |
| 4 | ⏮ (review recording) button (📖 44)/ Assignable button 5 (📖 92) |    |  |
| 5 | Lens hood (📖 24)   |    |  |
| 6 | Focus/Zoom ring (📖 52, 57)                                     |    |  |
| 7 | CUSTOM (customizable) dial (📖 91)                              |    |  |

Right side view

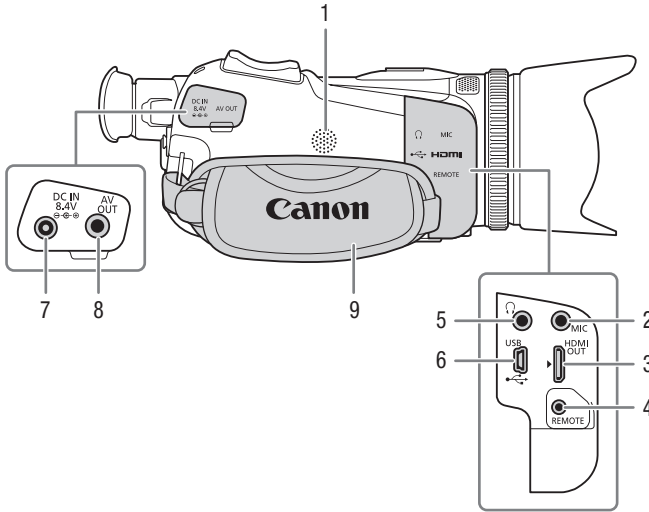

- 1 Built-in speaker (📖 96)
- 2 MIC terminal (📖 79)
- 3 HDMI OUT terminal (📖 102, 103)
- 4 REMOTE terminal  
For connecting commercially available remote controllers.
- 5 🎧 (headphones) terminal (📖 85)
- 6 USB terminal (📖 108)
- 7 DC IN terminal (📖 21)
- 8 AV OUT terminal (📖 102, 103)
- 9 Grip belt (📖 26)



## Front view

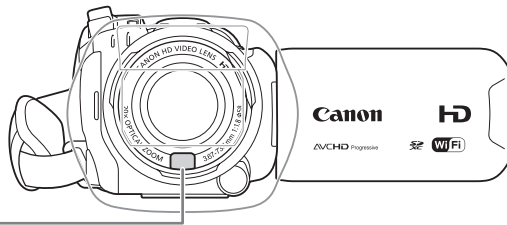

1

## Back view

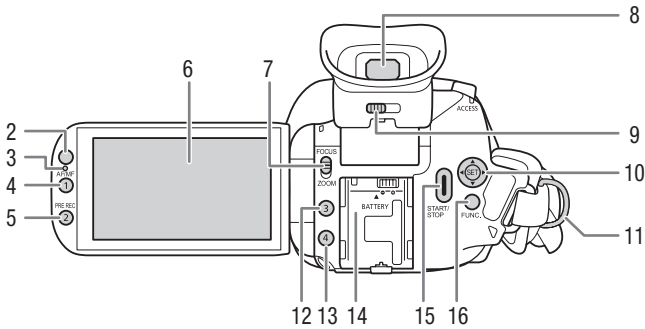

- |   |                                    |
|---|------------------------------------|
| 1 Instant AF sensor ( 54, 173)  | 8 Viewfinder ( 24)                 |
| 2 Remote sensor ( 27)   | 9 Dioptric adjustment lever ( 24)  |
| 3 Illumination sensor ( 150)  | 10 Joystick ( 30)/SET button ( 30) |
| 4 AF/MF button ( 52)/<br>Assignable button 1 ( 92)                      | 11 Strap mount ( 26)               |
| 5 PRE REC (pre-recording) button<br>( 88)/<br>Assignable button 2 ( 92) | 12 Assignable button 3 ( 92)       |
| 6 OLED touch screen ( 25, 29)   | 13 Assignable button 4 ( 92)       |
| 7 Focus/Zoom ring switch ( 57)  | 14 Battery attachment unit ( 21)   |
|   | 15 START/STOP button ( 38)         |
|   | 16 FUNC. button ( 30)              |

Top view

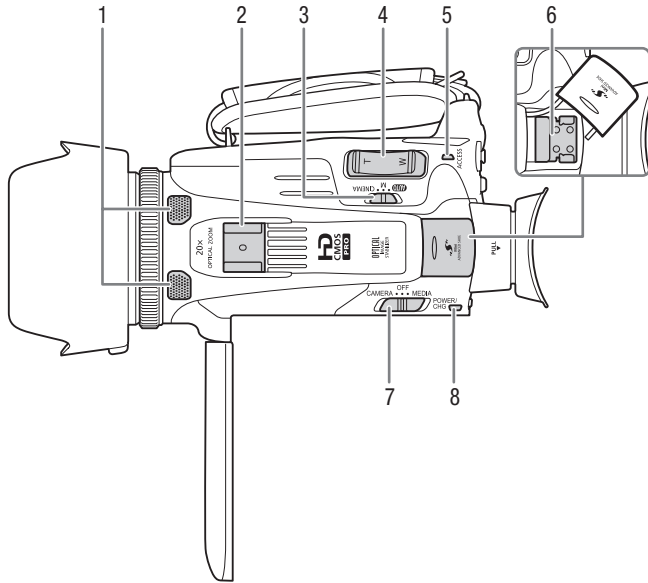

- 1 Built-in stereo microphone ( 78)
- 2 Accessory shoe  
Cold shoe for attaching accessories.
- 3 Mode switch ( 29)
- 4 Zoom rocker ( 57)
- 5 ACCESS indicator ( 38)

- 6 Mini advanced shoe ( 76)
- 7 Power switch ( 28)
- 8 POWER / CHG (battery charging)  
indicator ( 21)



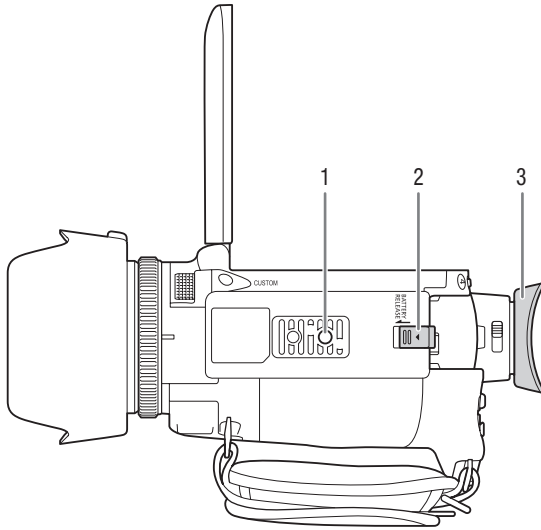



## Bottom view

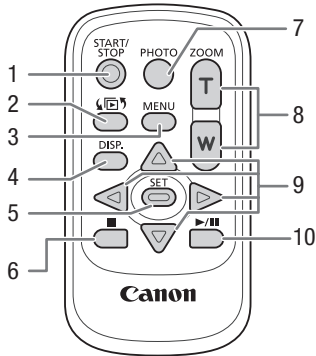

- 1 Tripod socket (📖 27)
- 2 BATTERY RELEASE switch (📖 22)
- 3 Eye cup (📖 24)

## WL-D89 Wireless Controller



- 1 START/STOP button (📖 38)
- 2  (mode selection) button (📖 95)
- 3 MENU button (📖 32, 144)
- 4 DISP. (onscreen display) button (📖 89)
- 5 SET button
- 6  (stop) button (📖 95)
- 7 PHOTO button (📖 38)
- 8 Zoom buttons (📖 57)
- 9 Navigation buttons (///
- 10  (play/pause) button (📖 95)

# 2 Preparations

## Attaching the Ferrite Core

Attach the enclosed ferrite core before you connect the compact power adapter to the camcorder. Attaching the ferrite core to the compact power adapter cable is necessary to suppress RF interference.

Attach the ferrite core to the cable about 6 cm (2.4 in.) from the plug end (the plug to be connected to the camcorder) of the compact power adapter cable.

Pass the cable through the center of the core and wrap it around the core, then close the unit until it clicks shut.

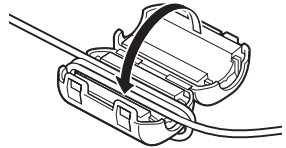

## Charging the Battery Pack

The camcorder can be powered with a battery pack or directly using the compact power adapter. For approximate charging times and recording/playback times with a fully charged battery pack, refer to *Charging, Recording and Playback Times* (□ 177).

- 1 Connect the power cord to the compact power adapter.
- 2 Plug the power cord into a power outlet.
- 3 Connect the compact power adapter to the camcorder's DC IN terminal.

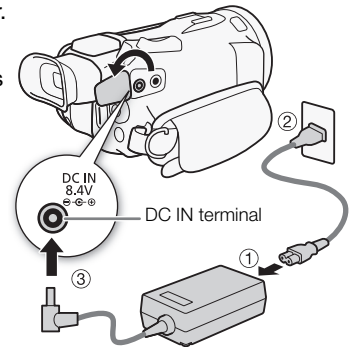

- 4 Attach the battery pack to the camcorder.
  - Press the battery pack softly into the battery attachment unit and slide it forward until it clicks in place.

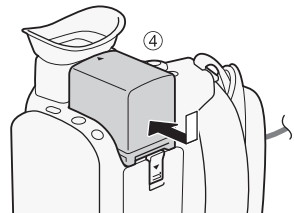

**5 Charging will start when the camcorder is turned off.**

POWER/CHG (battery charging) indicator

- If the camcorder was on, the green POWER/CHG indicator will go out when you turn off the camcorder. After a moment, the POWER/CHG indicator will turn on in red (battery pack charging). The red POWER/CHG indicator will go out when the battery pack is fully charged.
- If the indicator flashes, refer to *Troubleshooting* (📖 159).

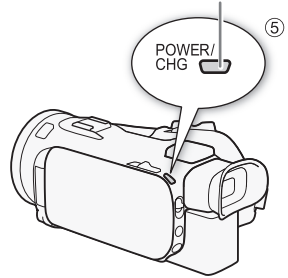

**To remove the battery pack**

- 1 Slide **BATTERY RELEASE** in the direction of the arrow and hold it pressed down.
- 2 Slide the battery pack and then pull it out.

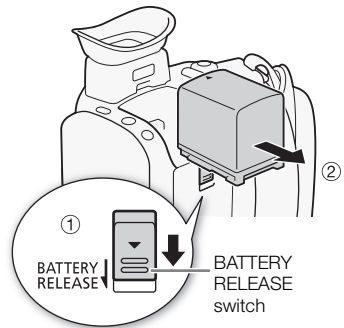

**! IMPORTANT**

- Turn off the camcorder before connecting or disconnecting the compact power adapter. After you turn off the camcorder, important data is updated on the memory card. Be sure to wait until the green POWER/CHG indicator goes out.
- Do not connect to the camcorder's DC IN terminal or to the compact power adapter any electrical equipment that is not expressly recommended for use with this camcorder.
- To prevent equipment breakdowns and excessive heating, do not connect the supplied compact power adapter to voltage converters for overseas travels or special power sources such as those on aircraft and ships, DC-AC inverters, etc.

 NOTES

- We recommend charging the battery pack in temperatures between 10 °C and 30 °C (50 °F and 86 °F). If either the ambient temperature or the battery pack's temperature is outside the range of approx. 0 °C to 40 °C (32 °F to 104 °F), charging will not start.
- The battery pack will be charged only when the camcorder is off.
- If the power supply was disconnected while charging a battery pack, make sure the POWER/CHG indicator has gone out before restoring the power supply.
- If remaining battery time is an issue, you can power the camcorder using the compact power adapter so the battery pack will not be consumed.
- Charged battery packs continue to discharge naturally. Therefore, charge them on the day of use, or the day before, to ensure a full charge.
- The first time you use a battery pack, fully charge it and then use the camcorder until the battery pack is completely exhausted. Doing so will ensure that the remaining recording time will be displayed accurately.
- We recommend that you prepare battery packs to last 2 to 3 times longer than you think you might need.
- **USA and Canada only:** The Lithium ion/polymer battery that powers the product is recyclable. Please call 1-800-8-BATTERY for information on how to recycle this battery.



## Preparing the Camcorder

This section covers the basic preparations for the camcorder such as attaching the lens hood, adjusting the grip belt and adjusting the viewfinder and OLED screen. When attaching the lens hood, grip belt and straps, be careful not to drop the camcorder by placing it on a table or other stable surface.

### Using the Lens Hood and Lens Cap

While recording, the supplied lens hood with lens barrier is effective for reducing stray light that can be the cause of lens flare and ghost images. Additionally, closing the lens barrier can help prevent fingerprints and dirt accumulation on the lens. Use the supplied lens cap when carrying the camcorder or storing it after use.

\* Note that the lens cap and the lens hood with lens barrier cannot be used simultaneously.

- 1 Remove the lens cap.
- 2 Place the lens hood on the front of the lens so that the groove on the lens hood is aligned with the bottom of the lens (①), and then turn the lens hood clockwise until it stops with a click (②).

- Be careful not to deform the lens hood.
- Make sure that the lens hood is aligned with the thread.
- To remove the lens hood, turn it counterclockwise.

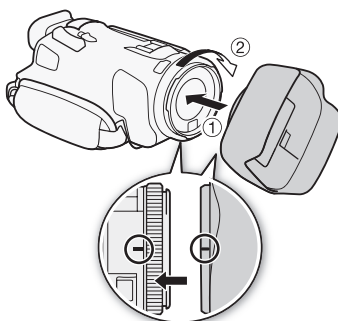

### Using the Viewfinder

If it is difficult to use the OLED screen, you can use the viewfinder, which can be tilted 45 degrees upward. You can also use the viewfinder when you rotate the OLED panel 180 degrees to let the subject watch the recording.

- 1 Pull out the viewfinder.
- 2 Use the power switch to turn on the camcorder.
- 3 Adjust the viewfinder using the dioptic adjustment lever.

- You can close the OLED panel or rotate it toward the subject as you prefer.
- You can tilt the viewfinder 45 degrees upward.

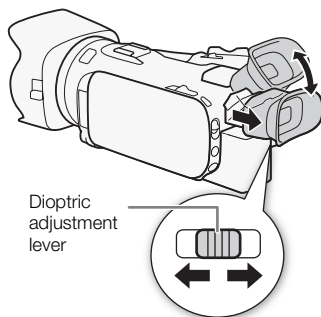



- If you wear glasses, you may find the viewfinder easier to use if you flip back the outer edge of the eye cup toward the camcorder body.

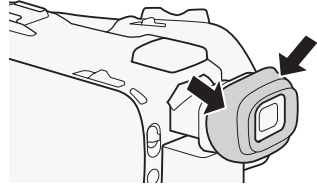

**i** NOTES

- Make sure you keep the eye cup attached when using the camcorder.
- For details about how to take care of the viewfinder, refer to *Handling Precautions* (📖 169), *Cleaning* (📖 173).

### Adjusting the OLED Screen

Open the OLED panel 90 degrees.

- You can rotate the panel 90 degrees downward.
- You can rotate the panel 180 degrees toward the lens. Rotating the OLED panel 180 degrees can be useful in the following cases:
  - To allow the subject to monitor the OLED screen while you use the viewfinder.
  - To allow the camcorder to be operated with the wireless controller from the front.

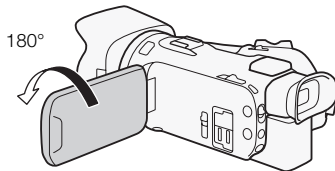
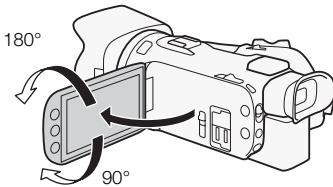

Subject can monitor the OLED screen  
(you can use the viewfinder at the same time)

**i** NOTES

- When you rotate the OLED panel, video noise may appear on the screen momentarily. This is not a malfunction.
- You can adjust the brightness of the OLED screen with the [OLED Brightness] setting or by holding pressed down for more than 2 seconds. You can also adjust the brightness of the viewfinder with the [VF Brightness] setting.
- Adjusting the brightness does not affect the brightness of the recordings.
- Using a brighter setting will shorten the effective usage time of the battery pack.
- For details about how to take care of the touch screen, refer to *Handling Precautions* (📖 169), *Cleaning* (📖 173).
- **About the OLED and viewfinder screens:** The screens are produced using extremely high-precision manufacturing techniques, with more than 99.99% of the pixels operating to specification. Less than 0.01% of the pixels may occasionally misfire or appear as black dots. Misfired pixels in the viewfinder may appear instead as white dots. This has no effect on the recorded image and does not constitute a malfunction.

## Grip Belt and Straps

Fasten the grip belt.

- Adjust the grip belt so that you can reach the zoom rocker with your index finger, and the **START/STOP** button with your thumb.

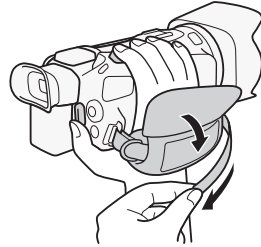

## Attaching an optional wrist strap

Attach the wrist strap to the strap mount on the grip belt, adjust the length and fasten.

- You can use both for extra convenience and protection.

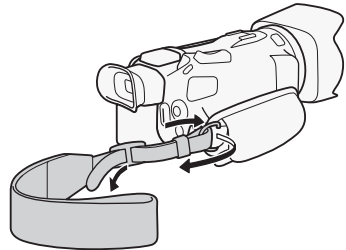

## Attaching an optional shoulder strap

Pass the ends of the shoulder strap through the strap mount on the grip belt and adjust the length of the strap.

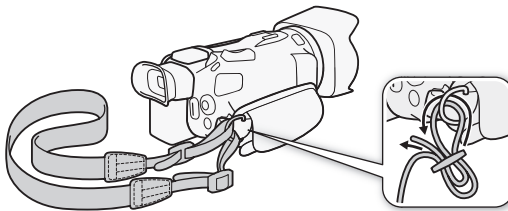

## Wireless Controller

First, insert the supplied CR2025 lithium button battery into the wireless controller.

- 1 Press the tab in the direction of the arrow and pull out the battery holder.
- 2 Place the lithium button battery with the + side facing up.
- 3 Insert the battery holder.

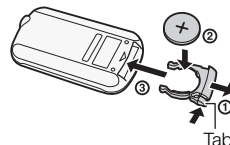

## To use the wireless controller

Point the wireless controller at the camcorder's remote sensor when you press the buttons.

- You can rotate the OLED panel 180 degrees to use the wireless controller from the front of the camcorder.

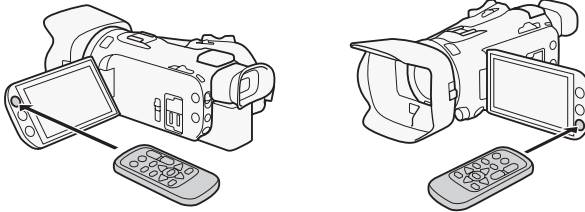

### **i** NOTES

- When the camcorder cannot be operated with the wireless controller, or when it can only be operated at very close range, replace the battery.
- The wireless controller may not work properly when the remote sensor is situated under strong light sources or direct sunlight.

## Using a Tripod

You can mount the camcorder on a tripod but do not use tripods with mounting screws longer than 6.5 mm (0.26 in.) as this may cause damage to the camcorder.

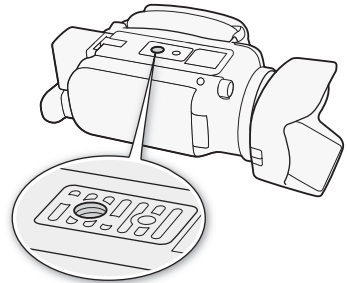

## Basic Operation of the Camcorder

### Turning the Camcorder On and Off

You can choose to turn the camcorder on in CAMERA (CAMERA) mode for making recordings or MEDIA (MEDIA) mode for playing back recordings. Select the mode using the power switch.

28

#### To turn on the camcorder

Set the power switch to CAMERA for CAMERA mode (38) or MEDIA for MEDIA mode (95).

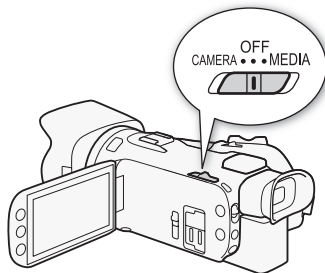
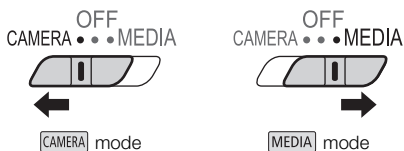

#### To turn off the camcorder

Set the power switch to OFF.

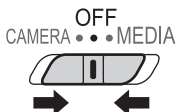

## Setting the Shooting Mode

In **CAMERA** mode, you can change the shooting mode to match your shooting style.

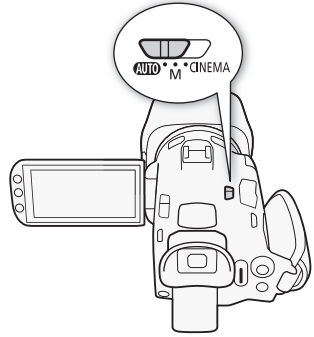

29

### **AUTO** (Auto) mode

Set the mode switch to **AUTO**. With this mode, the camcorder takes care of all the settings while you concentrate on recording ( 39). This operating mode is suitable if you just prefer not to bother with detailed camcorder settings.



### **M** (Manual) mode

Set the mode switch to **M**. With this mode, you can enjoy full access to menus, settings and advanced functions ( 43).



### **CINEMA** (Cinema) mode

Set the mode switch to **CINEMA**. With this mode, you can give your recordings a cinematic look and use cinema-look filters to create unique movies ( 50).



## Using the Touch Screen

The control buttons and menu items that appear on the touch screen change dynamically depending on the operating mode and the task you are performing. With the intuitive touch screen interface you have all the controls at your fingertips.

### Touch

Press on an element displayed on the touch screen.  
Used to start playing back a scene in an index screen, to select a setting from the menus, etc.

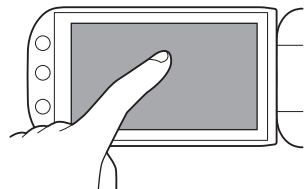

## Drag

Swipe your finger up and down or left and right across the screen. Used to scroll menus, to browse through index screen pages or to adjust slider controls like the volume. On some screens, you can achieve the same effect by touching the triangle control buttons.

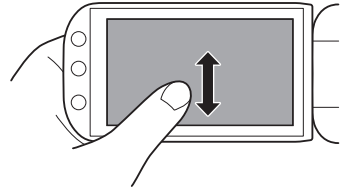

### ! IMPORTANT

- The camcorder features a capacitive touch screen. In the following cases, you may not be able to perform touch operations correctly.
  - Using your fingernails or hard-tipped objects, such as ballpoint pens.
  - Operating the touch screen with wet or gloved hands.
  - Applying excessive force or forcefully scratching the touch screen.
  - Attaching commercially available screen protectors or adhesive film onto the touch screen's surface.

## Using the FUNC. Button and Joystick

You can navigate some of the camcorder's menus and screens using the FUNC. button and joystick instead of using the touch panel.

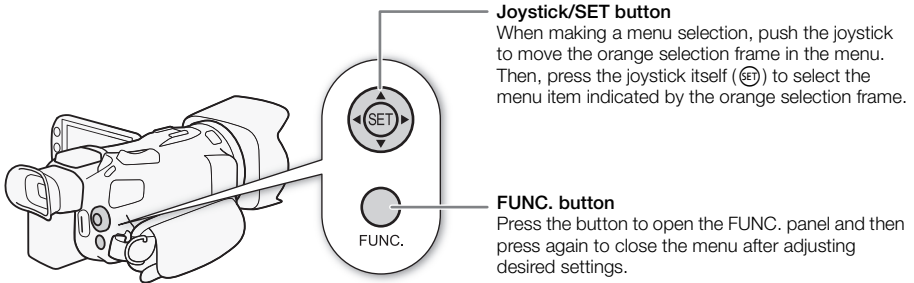

## Using the Menus

Many of the camcorder's functions can be adjusted from the FUNC. panel and the setup menus. For details about the available menu options and settings, refer to the appendix *Menu Options Lists* (143).

### FUNC. Panel

In **CAMERA** mode:

Operating modes: **CAMERA** **MEDIA** | **AVCHD** **MP4** | **AUTO** **M** **CINEMA**

There are three ways to access the FUNC. panel: by touching [FUNC.] on the OLED screen, by pressing [FUNC.] or by pushing the joystick (▲▼/◀▶) to select [FUNC.] and then pressing (SET). After the FUNC. panel is open, select the function you want to use. You may need to scroll up and down the screen or touch ▲/▼ to find the control button of the desired function. In **AUTO** mode, access to functions is limited.

FUNC. panel in **M** mode

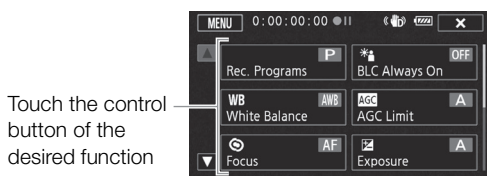

In **MEDIA** mode:

Operating modes: **CAMERA** **MEDIA** | **AVCHD** **MP4** | **AUTO** **M** **CINEMA**

Just like during **CAMERA** mode, you can open the FUNC. panel by touching [FUNC.] on the OLED screen, by pressing [FUNC.] or by pushing the joystick (▲▼/◀▶) to select [FUNC.] and then pressing (SET). After the FUNC. panel is open, select the function you want to use.

FUNC. panel in **MEDIA** mode

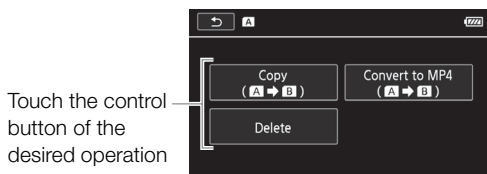

## Setup Menus

In this manual, navigating the setup menus is explained using the touch panel controls but they can also be navigated using the joystick and other buttons. The procedure below explains how to use both methods. If necessary, refer back to this section for details on using the joystick.

Operating modes: **CAMERA** **MEDIA** | **AVCHD** **MP4** | **AUTO** **M** **CINEMA**

32

### To use touch panel controls

- 1 **CAMERA** mode only: Touch [FUNC.].
- 2 Touch [MENU].
- 3 Touch the tab of the desired menu.
- 4 Drag your finger up and down to bring the desired setting into the orange selection bar.
  - You can also touch [▲] and [▼] to scroll up and down.
  - Menu items not available appear grayed out.
  - You can touch any menu item on the screen to bring it directly into the selection bar.
- 5 When the desired menu item is inside the selection bar, touch [▶].
- 6 Touch the desired option and then touch [X].
  - You can touch [X] to close the menu at any time.

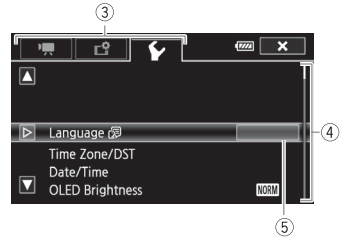

### To use the joystick

- 1 **CAMERA** mode only: Push the joystick (▲▼/◀▶) to select [FUNC.] and then press (SET).
- Alternatively, you can press [FUNC.].
- 2 Push the joystick (▲▼/◀▶) to select [MENU] and then press (SET).
- 3 Push the joystick (◀▶) to select the desired tab and then press (SET).
- 4 Push the joystick (▲▼) to move the selection bar to the desired setting and then press (SET).
  - Menu items not available appear grayed out.
- 5 Push the joystick (▲▼/◀▶) to select the desired option and then press (SET).
- 6 Push the joystick (▲▼/◀▶) to select [X] and then press (SET).
  - You can press [FUNC.] to close the menu at any time.

### (i) NOTES

- For brevity's sake, references in the text to settings in the setup menus will include only the tab of the desired menu and the setting name. For example, "You can adjust the date and time later on with the [▶] [Date/Time] setting."
- You can also press [MENU] on the wireless controller to open the setup menus.



## First Time Settings

### Setting the Date and Time

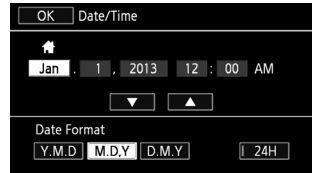

You will need to set the date and time of the camcorder before you can start using it. The [Date/Time] screen will appear automatically when the camcorder's clock is not set.



Operating modes: **CAMERA** **MEDIA** | **AVCHD** **MP4** | **AUTO** **M** **CINEMA**

- 1 Use the power switch to turn on the camcorder.
  - The [Date/Time] screen will appear.
- 2 Touch a field you want to change (year, month, day, hours or minutes).
  - You can also push the joystick (◀▶) to move between the fields.
- 3 Touch [▲] or [▼] to change the field as necessary.
  - You can also push the joystick (▲▼) to change the field.
- 4 Set the correct date and time by changing all the fields in the same way.
- 5 Touch [Y.M.D], [M.D,Y] or [D.M.Y] to select the date format you prefer.
  - In some screens, the date will be displayed in short form (numbers instead of month names or only the day and month), but it will still follow the order you selected.
- 6 Touch [24H] to use 24-hour clock or leave it unselected to use 12-hour clock (AM/PM).
- 7 Touch [OK] to start the clock and close the setup screen.

#### NOTES

- You can adjust the date and time later on with the   [Date/Time] setting.
- When you do not use the camcorder for about 3 months, the built-in rechargeable lithium battery may discharge completely and the date and time setting may be lost. In such case, recharge the built-in lithium battery ( 171) and set the time zone, date and time again.

## Changing the Language

The default language of the camcorder is English. You can set it to one of 27 languages.



Operating modes: CAMERA MEDIA | AVCHD MP4 | AUTO M CINEMA

1 Open the [Language] screen.

[FUNC.] ➤ [MENU] ➤ [Language]

- Touching [FUNC.] is necessary only when performing the procedure in CAMERA mode.

2 Touch the desired language and then touch [OK].

3 Touch [X] to close the menu.

### NOTES

- Some control buttons, such as [ZOOM], [FUNC.] and [MENU], will appear in English regardless of the language selected.

## Changing the Time Zone

Change the time zone to match your location. The default setting is New York. In addition, the camcorder is able to retain the date and time of an additional location. This is convenient when you travel so that you can set the camcorder to match the time of your home location or that of your travel destination.

Operating modes: CAMERA MEDIA | AVCHD MP4 | AUTO M CINEMA

1 Open the [Time Zone/DST] screen.

[FUNC.] ➤ [MENU] ➤ [Time Zone/DST]

- Touching [FUNC.] is necessary only when performing the procedure in CAMERA mode.

2 Touch [Home] to set the home time zone, or [X] to set the time zone of your destination when you are traveling.

3 Touch [▲] or [▼] to set the desired time zone. If necessary, touch [⌘] to adjust for daylight saving time.







4 Touch [X] to close the menu.

## Using a Memory Card

### Memory Cards Compatible for Use with the Camcorder (as of April 2013)

You can use the following types of commercially available Secure Digital (SD) cards with this camcorder.

The movie recording function has been tested using SD/SDHC/SDXC memory cards made by Panasonic, Toshiba and SanDisk. For the latest information on cards that can be used, visit your local Canon Web site.

Memory card type:  SD memory card,  SDHC memory card,  SDXC memory card  
 SD Speed Class\*:  CLASS 2  CLASS 4  CLASS 6  CLASS 10  
 Capacity: 128 MB or larger\*\*.

\* When using an SD memory card without a speed class rating or one rated SD Speed Class 2, you may not be able to record movies, depending on the memory card used.

\*\* SD memory cards with a capacity of 64 MB or smaller cannot be used to record movies.

#### NOTES

- **About the Speed Class:** Speed Class is a standard that indicates the minimum guaranteed data transfer speed of memory cards. When you buy a new memory card, look for the Speed Class logo on the package.

To record movies using a recording mode with a video quality of 28 Mbps or 35 Mbps, we recommend using memory cards rated SD Speed Class 6 or 10. When you record movies using other recording modes, we recommend using memory cards rated SD Speed Class 4, 6 or 10. To record movies using slow & fast motion, we recommend using memory cards rated SD Speed Class 10.

### SDXC Memory Cards

You can use SDXC memory cards with this camcorder. When using memory cards with other devices, such as digital recorders, computers and card readers, **make sure that the external device is compatible with SDXC cards**. For information about the compatibility of SDXC cards, contact the computer, operating system or memory card manufacturer.

#### IMPORTANT

- If you use an SDXC memory card with a computer OS that is not SDXC-compatible, you may be prompted to format the memory card. In such case, **cancel the operation to prevent data loss**.
- After repeatedly recording, deleting and editing scenes (fragmented memory), it will take longer to write data on the memory card and recording may stop. Save your recordings and initialize the memory card.

## Inserting and Removing a Memory Card

Make sure to initialize ( 36) all memory cards before using them with this camcorder.

1 Turn off the camcorder.

- Make sure the POWER/CHG indicator is off.

2 Open the double memory card slot cover.

3 Insert the memory card straight, with the label facing the front of the camcorder, all the way into one of the memory card slots until it clicks.

- You can also use two memory cards, one in each memory card slot.

4 Close the double memory card slot cover.

- Do not force the cover closed if the memory card is not correctly inserted.

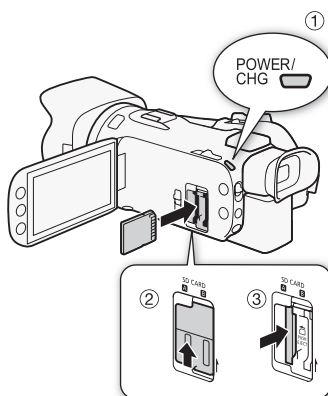

### To remove the memory card

Push the memory card once to release it. When the memory card springs out, pull it all the way out.

#### ! IMPORTANT

- Observe the following precautions while the ACCESS indicator is flashing. Failure to do so may result in permanent data loss.
  - Do not disconnect the power source or turn off the camcorder.
  - Do not remove the memory card.
- Turn off the camcorder before inserting or removing a memory card. Inserting or removing the memory card with the camcorder on may result in permanent data loss.
- Memory cards have front and back sides that are not interchangeable. Inserting a memory card facing the wrong direction can cause a malfunction of the camcorder. Be sure to insert the memory card as described in step 3.

### Initializing a Memory Card

Initialize memory cards when you use them with this camcorder for the first time. You can also initialize a memory card to permanently delete all the recordings it contains.

Operating modes: **CAMERA** **MEDIA** | **AVCHD** **MP4** | **AUTO** **M** **CINEMA**

1 Power the camcorder using the compact power adapter.

- Do not disconnect the power source or turn off the camcorder until the initialization is completed.

2 Open the initialization screen for the desired memory card.

[FUNC.] ➤ [MENU] ➤ [ ] ➤ [Initialize **SD**] ➤ [**A** Mem. Card A] or [**B** Mem. Card B] ➤ [Initialize]

- Touching [FUNC.] is necessary only when performing the procedure in **CAMERA** mode.
- In the initialization screen, touch [Complete Initialization] to physically erase all the data rather than just clear the file allocation table of the memory card.

**3 Touch [Yes].**

- If you selected the [Complete Initialization] option, you can touch [Cancel] to cancel the initialization while it is in progress. All recordings will be erased and the memory card can be used without any problem.

**4 Touch [OK] and then touch [X].****! IMPORTANT**

- Initializing a memory card will permanently erase all recordings. Lost original recordings cannot be recovered. Make sure you save important recordings in advance using an external device (□ 108).

**Selecting the Movie Format (AVCHD/MP4)**

You can choose to record movies in AVCHD or MP4 format. AVCHD movies are ideal for playback with fantastic picture quality. MP4 movies are versatile and can easily be played back on smartphones and tablets or uploaded to the Web.



Operating modes: CAMERA MEDIA | AVCHD MP4 | AUTO M CINEMA

- 1 Open the [Movie Format] screen.  
[FUNC.] ➤ [MENU] ➤  ➤ [Movie Format]
- 2 Select the desired movie format.
- 3 Touch [X].

**Selecting the Memory Card for Recordings**

Movies and photos are recorded on a memory card. You can select on which memory card your movies and photos will be recorded.

Operating modes: CAMERA MEDIA | AVCHD MP4 | AUTO M CINEMA

- 1 Open the [Recording Media] screen.  
[FUNC.] ➤ [MENU] ➤  ➤ [Recording Media]
- 2 Touch the desired memory card ([A Mem. Card A] or [B Mem. Card B]) for recording movies ([ Rec Media for Movies]) or for taking photos ([ Rec Media for Photos]).
- 3 Touch [X].
  - After closing the menu, the icon of the memory card selected for recording movies will appear on the screen.

# 3 Recording

## Recording Movies and Photos

You can select the memory card that will be used to record movies and photos (☞ 37). For details on recording audio, refer to *Recording Audio* (☞ 78).

38

### ✔ POINTS TO CHECK

- **Before you begin recording**, make a test recording first to check that the camcorder is operating correctly.

## Preparing to Record

- 1 Attach a charged battery pack to the camcorder (☞ 21).
- 2 Insert a memory card into a memory card slot.
  - To use relay recording or dual recording (☞ 47), insert memory cards into both memory card slots.
- 3 Open the lens barrier.
- 4 If you need to use the viewfinder, pull it out and adjust it, if necessary.
  - You can use the dioptic adjustment lever and tilt the viewfinder 45 degrees upward.

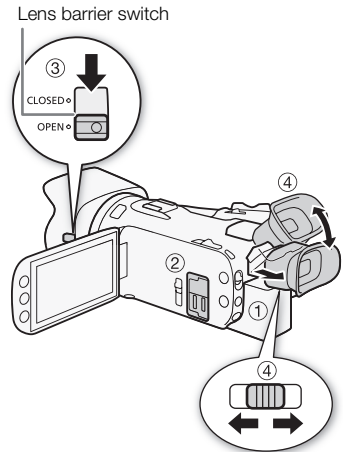

## Recording in AUTO Mode

When you use **AUTO** mode to shoot video and take photos, the camcorder will automatically adjust various settings for you.

Operating modes: **CAMERA** **MEDIA** | **AVCHD** **MP4** | **AUTO** **M** **CINEMA**

- 1 Set the mode switch to **AUTO**.
- 2 Set the power switch to **CAMERA**.

### To record video

Press **START/STOP** to begin recording.

- During recording, ● will appear on the screen.
- The ACCESS indicator will flash from time to time while the scene is being recorded.
- Press **START/STOP** again to pause the recording. ● will change to ●■ and the scene will be recorded on the memory card selected for recording movies.
- You can also press **START/STOP** on the wireless controller.

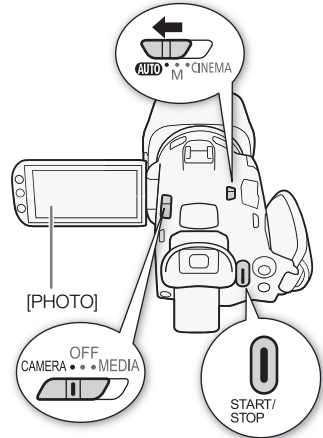

### To take photos

Touch **[PHOTO]**.

- In the lower center of the screen, a green icon (●) will appear. Also, in the upper right of the screen, 📷▶ will appear with the icon of the memory card selected for recording photos. The ACCESS indicator will flash as the photo is being recorded.
- You can record photos simultaneously while recording a movie. In that case, the green icon will not appear.
- You can also press **[PHOTO]** on the wireless controller.































### When you have finished recording







- 1 Set the lens barrier switch to **CLOSED** to close the lens barrier.
- 2 Make sure that the ACCESS indicator is off.
- 3 Set the power switch to **OFF**.
- 4 Close the OLED panel and return the viewfinder to its retracted position.

### Smart AUTO

In **AUTO** mode, the camcorder will automatically detect certain characteristics of the subject, background, lighting conditions, etc. It will then adjust various settings (focus, exposure, color, image stabilization, image quality, among others), selecting the best settings for the scene you want to shoot. The Smart AUTO icon will change to one of the icons in the following table.

### Smart AUTO icons

Background (color of the icon) →	Bright <sup>1</sup> (gray)	Blue skies <sup>1</sup> (light blue)	Vivid colors <sup>1</sup> (yellow/green/ red)	Sunsets <sup>1</sup> (orange)
Subject ↓				
People (stationary)	 (  )	 (  )	 (  )	—
People (moving)	 (  )	 (  )	 (  )	—
Subjects other than people, such as landscapes	 (  )	 (  )	 (  )	
Close objects	 /  <sup>2</sup> (  /  <sup>2</sup> )	 /  <sup>2</sup> (  /  <sup>2</sup> )	 /  <sup>2</sup> (  /  <sup>2</sup> )	—

Background (color of the icon) →	Dark (dark blue)		
Subject ↓		Spotlight	Night scene
People (stationary)		—	—
People (moving)		—	—
Subjects other than people, such as landscapes			
Close objects	 /  <sup>2</sup>	—	—





<sup>1</sup> The icon in parentheses appears under backlight conditions.

<sup>2</sup> This icon will appear under tele macro conditions. Tele macro is activated automatically when you zoom toward the telephoto end and close in on the subject. Tele macro allows you to get closer shots of small subjects and adds a soft focus to the background, so the subject not only looks larger but also stands out more.



## Intelligent IS

Intelligent IS allows the camcorder to select the best image stabilization option based on your shooting method. The Intelligent IS icon will change to one of the following icons. In **[M]** and **[CINEMA]** modes, you can set the image stabilization mode manually (📖 61).



Shooting method	Icon
Most general situations; Zooming out (zooming toward <b>W</b> ); Following subjects at a distance moving left or right	 (Dynamic IS)
Zooming in (zooming toward <b>T</b> )	 (Powered IS)*
Close-up of a subject	 (Macro IS)
Remaining stationary, such as when using a tripod	 (Tripod mode)

\* With the  ➤ [Intelligent IS] setting, you can select whether Powered IS can be set automatically as one of the Intelligent IS modes.

## ! IMPORTANT

- Observe the following precautions while the ACCESS indicator is on or flashing. Failing to do so may result in permanent data loss or damage to the memory card.
  - Do not open the double memory card slot cover.
  - Do not disconnect the power source or turn off the camcorder.
  - Do not change the camcorder's operating mode.
- Be sure to save your recordings regularly (📖 108), especially after making important recordings. Canon shall not be liable for any loss or corruption of data.

## i NOTES

- When you set the  ➤ [Rec Command] setting to **[ON On]** and you use the HDMI terminal to connect the camcorder to a device capable of receiving recording commands through a connection via the HDMI terminal, if you start or stop recording with the camcorder, the connected device will also start or stop recording.
- When the camcorder switches from recording on one memory card to another during relay recording, the video will be recorded as two separate relay scenes. With the supplied software, **Data Import Utility**, you can join relay scenes recorded on both memory cards as a single scene and save it on a computer (📖 108).
- For scenes with a long recording time, the video (stream) file in a scene will be split approximately every 4 GB. Even in such case, playback will be continuous. With the supplied software, **Data Import Utility**, you can join such split files into a single scene and save it on a computer (📖 108).
- About the power saving mode:** If  ➤ [Auto Power Off] is set to **[ON On]**, the camcorder will shut off automatically to save power when it is powered by a battery pack and is left without any operation for 5 minutes. Use the power switch to turn on the camcorder.
- When recording in bright places, it may be difficult to use the OLED screen. In such cases, you can adjust the brightness of the OLED screen with the  ➤ [OLED Brightness] setting. Alternatively, you can also use the viewfinder (📖 24).
- Under certain conditions, the Smart AUTO icon that appears on the screen may not match the actual scene. Especially when shooting against orange or blue backgrounds, the sunset or one of the blue skies icons may appear and the colors may not look natural. In such case, we recommend recording in **[M]** mode (📖 43).

- Photos are recorded as JPG files. During **AUTO** and **M** modes, the camcorder can take photos during record pause mode or capture photos from a movie during playback (📖 97). The photo size and number of photos that can be saved on a 1 GB memory card are summarized in the following table. However, the actual number of photos that can be recorded will vary depending on the subject and shooting conditions.

Movie Format	Recording mode	Photo size	Number of photos
AVCHD	Any	1920x1080	660
MP4	35 Mbps, 24 Mbps, 17 Mbps	1920x1080	660
	4 Mbps	1280x720	1,490
	3 Mbps	640x360	5,800

- Photos cannot be recorded while the digital zoom is activated or during dual recording.
- You can capture a photo from a scene during playback (📖 97).
- When you need to record for a long time with the camcorder set on a tripod, you can close the OLED panel and use only the viewfinder in order to save power when using a battery pack (📖 24).

## Recording in **M** (Manual) Mode

When the mode switch is set to **M** (Manual), you can enjoy full access to the menus and manually adjust the exposure, focus, white balance and many more of the camcorder's settings to your preference. Even in **M** mode, though, the camcorder can help you with the settings, for example, by using Special Scene recording programs (□ 70).

Operating modes: **CAMERA** **MEDIA** | **AVCHD** **MP4** | **AUTO** **M** **CINEMA**

- 1 Set the mode switch to **M**.
- 2 Set the power switch to **CAMERA**.
- 3 Record movies and photos.
  - The procedure is the same as in **AUTO** mode (□ 39).

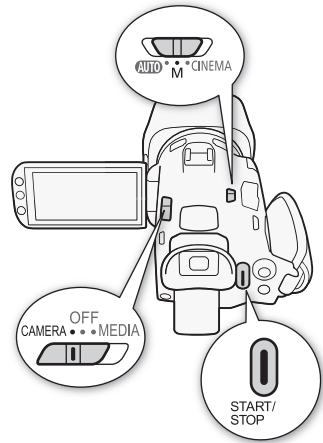







### ! IMPORTANT



- Observe the following precautions while the ACCESS indicator is on or flashing. Failing to do so may result in permanent data loss or damage to the memory card.
  - Do not open the double memory card slot cover.
  - Do not disconnect the power source or turn off the camcorder.
  - Do not change the camcorder's operating mode.
- Be sure to save your recordings regularly (□ 108), especially after making important recordings. Canon shall not be liable for any loss or corruption of data.

### i NOTES

- When you set the [Rec Command] setting to **[ON On]** and you use the HDMI terminal to connect the camcorder to a device capable of receiving recording commands through a connection via the HDMI terminal, if you start or stop recording with the camcorder, the connected device will also start or stop recording.
- When the camcorder switches from recording on one memory card to another during relay recording, the video will be recorded as two separate relay scenes. With the supplied software, **Data Import Utility**, you can join relay scenes recorded on both memory cards as a single scene and save it on a computer (□ 108).
- For scenes with a long recording time, the video (stream) file in a scene will be split approximately every 4 GB. Even in such case, playback will be continuous. With the supplied software, **Data Import Utility**, you can join such split files into a single scene and save it on a computer (□ 108).

- **About the power saving mode:** If   [Auto Power Off] is set to **[ON On]**, the camcorder will shut off automatically to save power when it is powered by a battery pack and is left without any operation for 5 minutes. Use the power switch to turn on the camcorder.
- When recording in bright places, it may be difficult to use the OLED screen. In such cases, you can adjust the brightness of the OLED screen with the   [OLED Brightness] setting. Alternatively, you can also use the viewfinder ( 24).
- Photos are recorded as JPG files. During **[AUTO]** and **[M]** modes, the camcorder can take photos during record pause mode or capture photos from a movie during playback ( 97). The photo size and number of photos that can be saved on a 1 GB memory card are summarized in the following table. However, the actual number of photos that can be recorded will vary depending on the subject and shooting conditions.

Movie Format	Recording mode	Photo size	Number of photos
AVCHD	Any	1920x1080	660
MP4	35 Mbps, 24 Mbps, 17 Mbps	1920x1080	660
	4 Mbps	1280x720	1,490
	3 Mbps	640x360	5,800

- Photos cannot be recorded while the digital zoom is activated or during dual recording.
- You can capture a photo from a scene during playback ( 97).
- When you need to record for a long time with the camcorder set on a tripod, you can close the OLED panel and use only the viewfinder in order to save power when using a battery pack ( 24).

## Reviewing the Latest Scene Recorded

You can review the last 4 seconds of the last scene recorded with the camcorder without switching to **[MEDIA]** mode. While reviewing the latest scene, the picture will be played back without sound. By default, assignable button 5 is set to **[REVIEW]** Rec Review] but you can set another assignable button to this function ( 92).

Operating modes: **[CAMERA]** **[MEDIA]** | **[AVCHD]** **[MP4]** | **[AUTO]** **[M]** **[CINEMA]**

- 1 Record a scene.
- 2 After you finish recording a scene, press .

## Selecting the Recording Mode (Video Quality)

The camcorder offers various recording modes, depending on whether the movie format is AVCHD or MP4. When you record an MP4 movie with a recording mode of 3 Mbps, you can upload it to an FTP server and begin editing right away. In addition, for AVCHD movies, when the recording mode is set to 28 Mbps LPCM (59.94P) or 24 Mbps LPCM, you can enjoy two-channel linear PCM audio recording with a sampling frequency of 48 kHz. Refer to the following tables for details.

Operating modes: **CAMERA** **MEDIA** | **AVCHD** **MP4** | **AUTO** **M** **CINEMA**

### 1 Open the [Recording Mode] screen.

[FUNC.] ➤ [MENU] ➤  ➤ [Recording Mode]

### 2 Touch the desired recording mode and then touch [X].

### NOTES

- Depending on the portable device, you may not be able to play back your recordings.
- AVCHD scenes recorded at 28 Mbps cannot be saved on AVCHD discs. Use an external Blu-ray Disc recorder compliant with AVCHD Ver. 2.0 specifications to copy those movies onto Blu-ray discs.
- The following types of MP4 scenes will be recognized as multiple files on other devices.
  - Scenes exceeding 4 GB
  - Scenes recorded at 35 Mbps exceeding 30 minutes
  - Scenes recorded with a recording mode other than 35 Mbps exceeding 1 hour
- Depending on the TV, you may not be able to play back scenes recorded at 28 Mbps (AVCHD) or 35 Mbps (MP4).
- When the recording mode is set to 28 Mbps (AVCHD) or 35 Mbps (MP4), dual recording is not available.
- In **CINEMA** mode, 28 Mbps (AVCHD) and 35 Mbps (MP4) recording modes are not available.
- When the recording mode is set to 28 Mbps LPCM (59.94P) or 24 Mbps LPCM, recording with 5.1ch surround sound is not available when using the optional SM-V1 Surround Microphone.
- The camcorder uses a variable bit rate (VBR) to encode video so the actual recording times will vary depending on the subject.

### Recording modes by movie format

Movie format	Recording mode	Resolution	Audio format
AVCHD	28 Mbps LPCM (59.94P)	1920x1080	Linear PCM
	28 Mbps (59.94P)		Dolby Digital
	24 Mbps LPCM		Linear PCM
	24 Mbps		Dolby Digital
	17 Mbps		
	5 Mbps	1440x1080	
MP4	35 Mbps (59.94P)	1920x1080	AAC
	24 Mbps		
	17 Mbps		
	4 Mbps	1280x720	
	3 Mbps	640x360	

### Approximate recording times

◆ Default value

For AVCHD movies:

Recording mode →	28 Mbps LPCM (59.94P) and 28 Mbps (59.94P)	24 Mbps LPCM and 24 Mbps	17 Mbps	5 Mbps
Memory card ↓				
8 GB Memory card	35 min.	40 min.	1 hr.	3 hr.
16 GB Memory card	1 hr. 15 min.	1 hr. 25 min.	2 hr. 5 min.	6 hr. 5 min.
32 GB Memory card	2 hr. 30 min.	2 hr. 55 min.	4 hr. 10 min.	12 hr. 15 min.*
64 GB Memory card	5 hr. 5 min.	5 hr. 55 min.	8 hr. 20 min.	24 hr. 30 min.*
128 GB Memory card	10 hr. 10 min.	11 hr. 55 min.	16 hr. 45 min.*	49 hr.*

For MP4 movies:

Recording mode →	35 Mbps (59.94P)	24 Mbps	17 Mbps	4 Mbps	3 Mbps
Memory card ↓					
8 GB Memory card	30 min.	40 min.	1 hr.	4 hr. 20 min.	5 hr. 40 min.
16 GB Memory card	1 hr.	1 hr. 25 min.	2 hr. 5 min.	8 hr. 40 min.	11 hr. 25 min.
32 GB Memory card	2 hr.	2 hr. 55 min.	4 hr. 10 min.	17 hr. 20 min.*	22 hr. 55 min.*
64 GB Memory card	4 hr.	5 hr. 55 min.	8 hr. 20 min.	34 hr. 45 min.*	45 hr. 55 min.*
128 GB Memory card	8 hr.	11 hr. 55 min.	16 hr. 45 min.*	69 hr. 30 min.*	91 hr. 55 min.*

\* A single scene can be recorded continuously for 12 hours; at that point, the camcorder will stop.

## Dual Recording and Relay Recording

When you record, you can use dual recording to record simultaneously on both memory cards so that you can use one of the movies as a backup.

Alternatively, you can use relay recording so that if the memory card being recorded on becomes full, the recording will continue uninterrupted on the other memory card.

### Activating dual recording

The backup movie is recorded on memory card **B**. After you activate dual recording, select the backup movie's recording mode.

Operating modes: **CAMERA** **MEDIA** | **AVCHD** **MP4** | **AUTO** **M** **CINEMA**

#### 1 Open the [Dual Recording] screen.

[FUNC.] ➤ [MENU] ➤  ➤ [Dual/Relay Recording] ➤ [Dual Recording]

- The screen shows the movie format and recording mode of the movies that will be recorded on each card.

#### 2 Select the movie format and recording mode for the backup movie that will be recorded on memory card **B**.

- The first option is always the same movie format and recording mode of the movie that will be recorded on memory card **A**. The second two options are always **[MP4 4Mbps]** and **[MP4 3Mbps]**, which result in small files that are ideal for transferring to a computer.

#### 3 Touch **[X]**.

### Activating relay recording

Operating modes: **CAMERA** **MEDIA** | **AVCHD** **MP4** | **AUTO** **M** **CINEMA**

#### 1 Open the [Dual/Relay Recording] screen.

[FUNC.] ➤ [MENU] ➤  ➤ [Dual/Relay Recording]

#### 2 Touch [Relay Recording] and then touch **[X]**.

### NOTES

- To use neither function, select [Standard Recording] on the [Dual/Relay Recording] screen.
- When you use relay recording, it does not matter which memory card the recording starts on. The recording will continue on the other memory card. However, the camcorder will switch to another memory card only one time.
- With the supplied software, **Data Import Utility**, you can join relay scenes (either AVCHD or MP4 format) recorded on both memory cards as a single scene and save it on a computer ( 108).
- Dual recording is not available when the recording mode is set to 28 Mbps LPCM (59.94P), 28 Mbps (59.94P) or 35 Mbps (59.94P).

## Selecting the Frame Rate

You can change the frame rate (the number of frames recorded per second) to change the look of your movies. When the recording mode is set to 28 Mbps LPCM (59.94P) or 28 Mbps (59.94P) for AVCHD movies or 35 Mbps (59.94P) for MP4 movies, the frame rate will automatically be set to 59.94P so you will not be able to select the frame rate.

Operating modes: **CAMERA** **MEDIA** | **AVCHD** **MP4** | **AUTO** **M** **CINEMA**

1 Open the [Frame Rate] screen.

[FUNC.] ➤ [MENU] ➤ [ ] ➤ [Frame Rate]

2 Touch the desired frame rate and then touch [X].

### Options for AVCHD movies (♦ Default value)

**[59.94i 59.94i]♦** 59.94 fields per second, interlaced. Standard frame rate of NTSC analog TV signals.

**[PF29.97 PF29.97]** 29.97 frames per second, progressive\*. Use this frame rate to easily edit your recordings, for example, to post them on the Web.

**[23.98P 23.98P]** 23.98 frames per second, progressive.

\* Recorded as 59.94i.

### Options for MP4 movies (♦ Default value)

**[29.97P 29.97P]♦** 29.97 frames per second, progressive.

**[23.98P 23.98P]** 23.98 frames per second, progressive.

### NOTES

- The frame rate can be set independently for **M** and **CINEMA** modes.



## Slow & Fast Motion Recording

When you record MP4 movies, the camcorder can record with a frame rate (shooting frame rate) that is different from the playback frame rate. When you record with a shooting frame rate that is faster than the playback frame rate (overcranking), you create a slow motion effect. Oppositely, a slower frame rate will result in a fast motion effect (undercranking). Sound is not recorded in this mode.

Operating modes: **CAMERA** **MEDIA** | **AVCHD** **MP4** | **AUTO** **M** **CINEMA**

### 1 Open the [Slow & Fast Motion] screen.

[FUNC.] ➤ [MENU] ➤  ➤ [Slow & Fast Motion]

### 2 Select the desired frame rate.

- Available frame rates depend on the recording mode and frame rate. Refer to the following table.

### 3 Touch [X].

#### Available frame rates for slow & fast motion

Recording mode	Frame rate	Available shooting frame rates
35 Mbps (59.94P)	–	29.97P, 23.98P
24 Mbps, 17 Mbps	29.97P	59.94P, 23.98P
	23.98P	59.94P, 29.97P

### NOTES

- During slow & fast motion recording mode, the following functions are not available.
  - Dual recording
  - Relay recording
  - Pre-recording
  - Video snapshot
  - Color bars
  - Face detection & tracking
  - Taking photos
- During slow & fast motion recording mode, the running mode of the time code ( 73) is set to [Rec Run] or [Regen.] and the time code will advance by the number of frames recorded. If you activate slow & fast motion recording mode while the running mode is set to [Free Run], the running mode will automatically change to [Rec Run]. When you end slow & fast motion recording mode, the running mode will return to its previous setting.
- For low shooting frame rates, it may take approximately 1 second to stop recording.
- To record movies using slow & fast motion, we recommend using memory cards rated SD Speed Class 10.
- The amount of video that can be recorded at one time is approximately 12 hours' worth of video at normal playback speed. When that amount is exceeded, the camcorder will automatically stop recording. However, when you use slow & fast motion recording, the recording time will change. For example, when the frame rate is set to 29.97P and you select 59.94P for the shooting frame rate, the recording time will be 6 hours (playback time will be 12 hours).

## CINEMA Mode and Cinema-Look Filters

In **CINEMA** mode, you can use a variety of professional cinema-look filters to create unique movies with a distinctive appearance. You can also use cinema-look filters when you convert movies to MP4 (114).

Operating modes: **CAMERA** **MEDIA** | **AVCHD** **MP4** | **AUTO** **M** **CINEMA**

- 50
- 1 Set the mode switch to **CINEMA**.
  - 2 Touch **[FILTER 1]** to open the cinema-look filter selection screen.
  - 3 Drag your finger up and down along the photos to select the desired cinema-look filter and then touch **[OK]**.
    - You can change the effect level before touching **[OK]**. **[Cinema Standard]** offers different adjustment options than the other cinema-look filters.
    - The selected cinema-look filter will be applied and its number will appear on the control button.

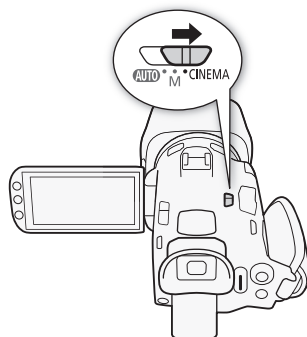

### To select the effect level of **[Cinema Standard]**

- 1 Open the parameter selection screen.  
**[F]** **[ON]**
- 2 Touch **[Color Depth]**, **[Softening Filter]**, **[Key (Brightness)]** or **[Contrast]**.
- 3 Touch the desired level or touch **[◀]** or **[▶]** to adjust the parameter.
  - You can also drag your finger along the dial.
  - The picture will change immediately according to the adjustment.
  - To adjust other parameters, touch **[↶]** to return to the previous screen. Touch the desired control button and repeat step 3.
- 4 Touch **[↷]** and then touch **[OK]**.

### To select the effect level of the other cinema-look filters

- 1 Touch **[F]** to open the adjustment screen.
- 2 Touch **[L]** (low), **[M]** (medium) or **[H]** (high).
- 3 Touch **[↷]** and then touch **[OK]**.

**Options** (♦ Default value)

The camcorder offers 9 cinema-look filters. Select the desired filter while previewing the effect on the screen.

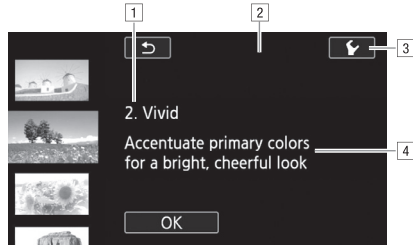
**[1. Cinema Standard]♦****[2. Vivid]****[3. Dream]****[4. Cool]****[5. Nostalgic]****[6. Sepia]****[7. Old Movies]****[8. Memory]****[9. Dramatic B&W]**

- 1 Filter number (will appear on the control button) and name
- 2 Preview the effect on the screen
- 3 Select the effect level
- 4 Brief description (onscreen guidance)

**i** NOTES

- During **CINEMA** mode, the following functions are not available.
  - Taking photos
  - Dual recording
  - Recording movies at 28 Mbps or 35 Mbps.

## Focus Adjustment

You can adjust the focus manually and use the peaking function to assist you or you can let the camcorder focus for you by using autofocus. With autofocus, you can set the autofocus speed. The camcorder also features face detection & tracking.



### POINTS TO CHECK

- Adjust the zoom before you start the procedure.

## Manual Focus

Use the focus/zoom ring to focus manually. You can also use peaking to help you focus more accurately.

Operating modes: **CAMERA** **MEDIA** | **AVCHD** **MP4** | **AUTO** **M** **CINEMA**

1 Set the focus/zoom ring switch to FOCUS.

2 Open the focus controls.

[FUNC.] ➤ [Focus]

- To switch to autofocus without opening the focus controls, press **AF/MF**. In such case, Touch AF (step 4) will not be available. Skip directly to step 5.

3 Touch **[MF]**.

4 Touch a subject that appears inside the **⦿** frame.

- The Touch AF mark (⦿) will flash and the focusing distance will be adjusted automatically. You have the option to further adjust the focus manually as necessary.

5 If necessary, turn the focus/zoom ring to further adjust the focus.

- The center of the screen will be magnified to help you focus more easily. You can also turn off this function with the **[Focus Assistance]** setting.
- The focusing distance displayed will change as you adjust the focus with the focus/zoom ring. You can change the units used for the distance display with the **[Distance Units]** setting.
- You can use the **[Focus/Zoom Ring Response]** setting to adjust the sensitivity of the focus/zoom ring.
- You can use the **[Focus/Zoom Ring Direction]** setting to select which direction to turn the focus/zoom ring.

Focus/zoom ring

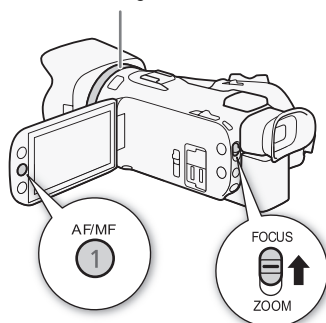

## Focus Preset

When focusing manually, you can set a preset position for the focus in advance so that you can later return to that preset focus position instantly.

### 1 Open the focus/zoom controls.

[FUNC.] ➤ [👁 Focus]

### 2 Touch [MF].

### 3 Use Touch AF or turn the focus/zoom ring to obtain the desired focus position.

### 4 Touch [SET] to set the preset focus position.

### 5 After adjusting the focus, touch [ON] to return to the preset focus position.

- Touch [SET] again to cancel the current preset focus position.
- [ON] will be grayed out while adjusting the focus or zoom.
- You can use the [👉] ➤ [Focus Preset Speed] setting to adjust the speed at which the camcorder returns to the preset focus position.

## NOTES

- The preset focus position will be canceled when the camcorder is turned off.

## Peaking

When peaking is activated, the edges of objects in focus will be highlighted in red, blue or yellow on the screen. In addition, you can choose to switch the screen to black & white, further emphasizing the edges.

### 1 Open the focus controls.

[FUNC.] ➤ [👁 Focus]

### 2 Touch [👉].

For the black & white setting: Touch [Off] or [On]

For the peaking color: Touch [Red], [Blue] or [Yellow]

### 3 Touch [↔].

### 4 Touch [PEAK].

- Peaking is activated and edges are highlighted. You can turn the focus/zoom ring on this screen or touch [X] to hide the focus controls.
- Touch [PEAK] again to turn off the peaking effect.

## NOTES

- The peaking effect and black & white picture will not appear in your recordings.

## Autofocus

When autofocus is activated, the camcorder continuously adjusts the focus on the subject in the center of the screen. The focusing range is 1 cm (0.39 in.; at full wide-angle, measured from the front of the lens barrel) to  $\infty$  and 60 cm (2 ft.; throughout the zoom range, measured from the front of the lens barrel) to  $\infty$ . Perform the following procedure to set the autofocus speed.

Operating modes: **CAMERA** **MEDIA** | **AVCHD** **MP4** | **AUTO** **M** **CINEMA**

- 1 **M** and **CINEMA** modes only: Press **AF/MF**.
- 2 Open the **[AF Mode]** screen.  
[FUNC.] ➤ [MENU] ➤  ➤ [AF Mode]
- 3 Touch the desired option and then touch **[X]**.
  - The icon of the selected option appears on the screen.

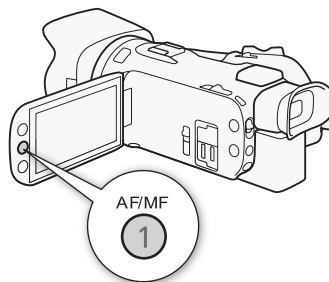



### Options <sup>♦</sup> Default value)

**[LAF Instant AF]**<sup>♦</sup> Sets the autofocus to Instant AF. The focus is adjusted at the highest speed. This mode is useful even when recording in very bright or low-light surroundings. This mode uses both the TTL system and external sensor for focusing.

**[MAF Medium AF]** Sets the autofocus to Medium AF. The camcorder focuses more smoothly on the subject than when using the **[LAF Instant AF]** setting. This mode uses both the TTL system and external sensor for focusing.

**[AF Normal AF]** Sets the autofocus to Normal AF. The autofocus adjustment is made at a stable speed.

### NOTES

- When recording in bright surroundings, the camcorder closes down the aperture. This may cause the picture to appear blurred and is more noticeable toward the wide angle end of the zoom range. In such case, in **M** and **CINEMA** modes, select **[P Programmed AE]**, **[Tv Shutter-Pri. AE]**, **[Av Aperture-Pri. AE]** or **[M Manual Exposure]** recording program and set  ➤ [ND Filter] to **[A Automatic]**.
- When you set  ➤ [Conversion Lens] to a setting other than **[OFF Off]**, the **[LAF Instant AF]** and **[MAF Medium AF]** settings are not available.
- Autofocus takes longer to focus when the frame rate is PF29.97 or 23.98P than when it is 59.94P or 59.94i.
- When recording under dark conditions, the focusing range narrows and the picture may appear blurred.
- While using autofocus, you can turn the focus/zoom ring to focus manually. When you stop turning the ring, the camcorder returns to autofocus. This is useful in situations such as when focusing on a subject on the other side of a window.
- When the recording program is set to  [Fireworks], the focus will be set to  $\infty$  and cannot be changed.

- Autofocus may not work well on the following subjects or in the following cases. In such case, focus manually.
  - Reflective surfaces
  - Subjects with low contrast or without vertical lines
  - Fast moving subjects
  - Through dirty or wet windows
  - Night scenes

## Face Detection & Tracking

The camcorder automatically detects people's faces and uses this information to select the optimal focus and exposure settings. You can use tracking to have the camcorder track and optimize settings for a different subject. You can also use tracking to optimize settings for moving subjects such as pets. You must use the touch screen to select the subject.

Operating modes: **CAMERA** **MEDIA** | **AVCHD** **MP4** | **AUTO** **M** **CINEMA**



### POINTS TO CHECK

- Select a recording program other than [🌃 Night Scene], [🌙 Low Light] or [🎆 Fireworks].

By default, face detection & tracking are activated. If the function was turned off, perform the following procedure to turn it on.

- 1 Open the [Face Detection & Tracking] screen.  
[FUNC.] ➤ [MENU] ➤ [📷] ➤ [Face Detection & Tracking]
- 2 Touch [**ON**] On [📷] and then touch [**X**].

### To select the main subject

If there is more than one person in the picture, the camcorder will automatically select one person it determines is the main subject. The main subject is indicated by a white face-detection frame and the camcorder will optimize the settings for that person. Other faces will have gray frames.

Touch a different face on the touch screen to optimize the camcorder's settings for that person.

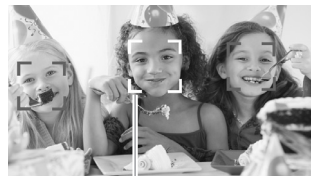

- You can also touch other moving objects, such as a pet.
- A white double frame will appear around the subject and track it as it moves.
- Touch [Cancel [📷]] to remove the frame and cancel the tracking.



Main subject

## Limiting Autofocus to Faces

While using autofocus, you can limit the autofocus function only to cases when a subject's face is detected and use manual focus for all other scenes. The camcorder will also adjust the brightness when focusing automatically on the subject's face.

Set an assignable button to  Face Only AF (  92) and press the button.

-  appears on the screen.

56

### NOTES



- The camcorder may mistakenly detect the faces of non-human subjects. In such case, turn face detection & tracking off.
- When face detection is activated, the slowest shutter speed used by the camcorder is 1/30 (1/24 if the frame rate is set to 23.98P).
- In certain cases, faces may not be detected correctly. Typical examples include:
  - Faces extremely small, large, dark or bright in relation to the overall picture.
  - Faces turned to the side, at a diagonal or partially hidden.
- Face detection & tracking cannot be used in the following cases.
  - When the shutter speed used is slower than 1/30 (1/24 if the frame rate is set to 23.98P).
  - When the digital zoom is activated at more than 80x zoom.
- Touching somewhere with a color or pattern unique to the subject will make it easier to track. However, if there is another subject in the vicinity that shares similar characteristics to the selected subject, the camcorder may start tracking the incorrect subject. Touch the screen again to select the desired subject.
- In certain cases, the camcorder may not be able to track the subject. Typical examples include:
  - Subjects extremely small or large in relation to the overall picture.
  - Subjects too similar to the background.
  - Subjects lacking sufficient contrast.
  - Fast moving subjects.
  - When shooting indoors with insufficient lighting.



## Zooming

Operating modes: **CAMERA** **MEDIA** | **AVCHD** **MP4** | **AUTO** **M** **CINEMA**

To zoom in and out, you can use the focus/zoom ring, the zoom rocker on the camcorder, the zoom buttons on the wireless controller or the zoom controls on the touch screen.

In addition to the 20x optical zoom, in **M** mode, you can turn on the digital zoom\* (400x) with the   [Digital Zoom] setting.

This camcorder also features a digital tele-converter, which allows you to enlarge the image on the screen digitally.

\* Digital zoom is not available in **AUTO** mode or when   [Conversion Lens] is set to [WA-H58].

### Using the Focus/Zoom Ring

- 1 Set the focus/zoom ring switch to **ZOOM**.
- 2 Turn the focus/zoom ring to adjust the zoom.
  - Turn the focus/zoom ring slowly for a slow zoom; turn it faster for faster zooms.
  - The zoom bar that appears on the screen indicates the approximate zoom position.

#### NOTES

- If you turn the focus/zoom ring too quickly, the camcorder may not be able to zoom immediately. In such case, the camcorder will zoom after you finish turning the ring.



### Using the Zoom Rocker or Wireless Controller

Move the zoom rocker toward **W** (wide angle) to zoom out. Move it toward **T** (telephoto) to zoom in.

- You can also use the zoom buttons on the wireless controller.
- By default, the camcorder's zoom rocker operates at a variable speed – press gently for a slow zoom; press harder for faster zooms.

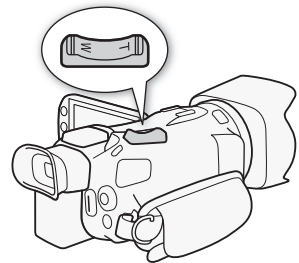

### Setting the Zoom Speed

You can set the zoom speed for the zoom rocker and wireless controller.

To set the zoom speed of the camcorder's zoom rocker

First, set the overall zoom speed to one of three levels. Next, select whether the zoom rocker operates at a constant or variable speed. Refer to the following table for a summary of the zoom speed.



1 Open the [Zoom Speed Level] screen.

[FUNC.] ➤ [MENU] ➤ ➤ [Zoom Speed Level]

2 Touch [ Fast], [ Normal] or [ Slow] and then touch [].

- When [Zoom Speed Level] is set to [ Fast], the sound made by the camcorder's internal machinery will increase and may be recorded in the scene.

3 Touch [Zoom Rocker Zoom Speed].

4 Touch [ VAR] for variable speed or [ CONST] for constant speed.

- If you selected [ CONST], touch [] or [] or drag your finger along the bar to select a constant speed.

5 Touch [ X].

Approximate zoom speeds\* (camcorder's zoom rocker)

[Zoom Rocker Zoom Speed] setting	Selected constant speed	[Zoom Speed Level] setting		
		[ Slow]	[ Normal]	[ Fast]
[ VAR] (variable)	–	4 sec. to 4 min. 45 sec.	2.5 sec. to 3 min.	1.9 sec.** to 1 min.
[ CONST] (constant)	1 (slowest)	4 min. 45 sec.	3 min.	1 min.
	16 (fastest)	4 sec.	2.5 sec.	1.9 sec.**

\* Measured from full wide-angle to full telephoto.

\*\* When the zoom speed is too fast (approximately 1.9 seconds end-to-end), the camcorder will have more trouble focusing automatically while zooming.

### NOTES

- When [High-Speed Zoom] is set to [ On] and [Zoom Rocker Zoom Speed] is set to [ VAR], [Zoom Speed Level] during record pause mode will automatically be set to [ Fast]. Also, when pre-recording is activated during record pause mode, the zoom speed will be determined by the [Zoom Speed Level] setting.

### To use high-speed zoom

During record pause mode, you can use high-speed zoom when [Zoom Speed Level] is set to [ Fast]. During recording, the zoom speed is determined by [Zoom Speed Level].

1 Open the [High-Speed Zoom] screen.

[FUNC.] ➤ [MENU] ➤ ➤ [High-Speed Zoom]

2 Touch [ On] and then touch [ X].

### NOTES

- When you are using an external microphone while recording, the sound made by the camcorder's internal machinery while zooming may be recorded in the scene.

### To set the zoom speed of the wireless controller

For the wireless controller, first set the overall zoom speed to one of three levels. The wireless controller operates at a constant speed that you can select. Refer to the following table for a summary of the zoom speed.

- 1 Open the [Zoom Speed Level] screen.  
[FUNC.] ➤ [MENU] ➤ [ ] ➤ [Zoom Speed Level]
- 2 Touch [Fast], [Normal] or [Slow] and then touch [↩].
  - When [Zoom Speed Level] is set to [Fast], the sound made by the camcorder's internal machinery will increase and may be recorded in the scene.
- 3 Touch [Wireless Ctrl Zoom Speed].
- 4 Touch [↑] or [↓] or drag your finger along the bar to select the desired constant speed.
- 5 Touch [X].

Approximate zoom speeds\* (wireless controller)

[Wireless Ctrl Zoom Speed] setting	[Zoom Speed Level] setting		
	[Slow]	[Normal]	[Fast]
1 (slowest)	4 min. 45 sec.	3 min.	1 min.
16 (fastest)	4 sec.	2.5 sec.	1.9 sec.**

\* Measured from full wide-angle to full telephoto.

\*\* When the zoom speed is too fast (approximately 1.9 seconds end-to-end), the camcorder will have more trouble focusing automatically while zooming.

## Using the Touch Screen's Zoom Controls

- 1 Display the zoom controls on the touch screen.  
[FUNC.] ➤ [ZOOM]
  - The zoom controls appear on the left side of the screen.
- 2 Touch the zoom controls to operate the zoom.
  - Touch anywhere within the **W** area to zoom out or anywhere within the **T** area to zoom in. Touch closer to the center for a slow zoom; touch closer to the **W/T** icons for faster zooms.
- 3 Touch [X] to hide the zoom controls.



## Soft Zoom Control

Soft zoom control allows you to start and/or stop the zoom gradually.

1 Open the [Soft Zoom Control] screen.

[FUNC.] ➤ [MENU] ➤  ➤ [Soft Zoom Control]

2 Touch the desired option and then touch [X].

**Options** (\* Default value)

**[OFF Off]**\* Use this setting if you do not intend to use soft zoom control.

**[START Start]** Zoom starts gradually.

**[STOP Stop]** Zoom stops gradually.

**[START/STOP Start & Stop]** Zoom start and stops gradually.

## Digital Tele-Converter

Using the digital tele-converter, you can digitally increase the focal length of the camcorder by a factor of approx. 2 and record the enlarged image at full HD resolution.

Operating modes:   |   |   

1 Open the [Digital Zoom] screen.



[FUNC.] ➤ [MENU] ➤  ➤ [Digital Zoom]

2 Touch [ Digital Tele-conv.] and then touch [X].

3 Open the zoom controls.

[FUNC.] ➤ [ZOOM]

4 Touch [] (digital tele-converter) and then touch [X].

- The center of the screen will be enlarged approximately 2 times and the  icon will appear.
- Touch [] again before closing the screen to deactivate the digital tele-converter.

### NOTES

- You can attach the optional tele-converter and use it in conjunction with this function to increase the effect.
- The digital tele-converter cannot be set while recording or when  ➤ [Conversion Lens] is set to [WA-H58].
- The image is digitally processed so the image will deteriorate throughout the zoom range.

## Advanced Image Stabilization

The image stabilizer reduces camcorder blur (blur due to the camcorder moving) so you can get nice, stable shots. Select the image stabilization mode according to the shooting conditions.

Operating modes: **CAMERA** **MEDIA** | **AVCHD** **MP4** | **AUTO** **M** **CINEMA**

- 1 Open the [Image Stabilizer] screen.  
[FUNC.] ➤ [Image Stabilizer]
- 2 Touch the desired IS mode and then touch [X].

### Options <sup>(\*)</sup> Default value

**[Dynamic]** <sup>(\*)</sup> Compensates for a higher degree of camcorder shake, such as when shooting while walking, and is more effective as the zoom approaches full wide angle.

**[Standard]** Compensates for a lower degree of camcorder shake, such as when shooting while remaining stationary, and is suitable for shooting natural-looking scenes.

**[Off]** Use this setting when the camcorder is mounted on a tripod.

### Powered IS

After setting an assignable button to [Powered IS], you can use Powered IS to make the image stabilization even more powerful. Powered IS is most effective when you are stationary and zooming in on far subjects using high zoom ratios (the more you approach the telephoto end). Holding the OLED panel with your left hand will add to the stability of the shot.

Operating modes: **CAMERA** **MEDIA** | **AVCHD** **MP4** | **AUTO** **M** **CINEMA**

- 1 Set an assignable button to [Powered IS] (92).
- 2 Press and hold the assignable button as long as you want to activate Powered IS.
  - [Powered IS] appears in yellow while Powered IS is activated.
  - You can change the operation of the assignable button set to [Powered IS] (long press or toggle on/off) with the [ ] ➤ [Powered IS Button] setting.
  - Powered IS is available even when [Image Stabilizer] is set to [Off].

### **i** NOTES

- If the degree of camcorder shake is too high, the image stabilizer may not be able to fully compensate.
- For surveying and following shots, when you pan the camcorder from side to side or tilt it up and down, we recommend setting [Image Stabilizer] to [Dynamic] or [Standard].
- The angle of view will change when [Image Stabilizer] is set to [Dynamic].

## Automatic Gain Control (AGC) Limit

When recording in dark surroundings, the camcorder will automatically increase the gain to try to get a brighter picture. However, using higher gain values may result in more noticeable video noise. You can select the AGC limit to curb the amount of noise by setting the maximum gain value to be used. The smaller the AGC limit, the darker the picture but the less noise it will contain.

Operating modes: **CAMERA** **MEDIA** | **AVCHD** **MP4** | **AUTO** **M** **CINEMA**



### POINTS TO CHECK

- Select a recording program other than the Special Scene recording programs or **[M Manual Exposure]**.

#### 1 Open the AGC limit adjustment screen.

[FUNC.] ➤ **[AGC AGC Limit]** ➤ **[M Manual]**

- Touch **[A Automatic]** to remove the AGC limit.

#### 2 Touch **[◀]** or **[▶]** to set the AGC limit.

- You can also drag your finger along the dial.

#### 3 Touch **[X]**.

- The selected AGC limit will appear on the screen.



### NOTES

- If you set **[CUSTOM Dial & Button]** to **[AGC AGC Limit]** (**[91]**), you can adjust the AGC limit with the CUSTOM dial and button.
- Setting the AGC limit is not available when **[Exposure]** is set to **[M]**.

## Automatic Exposure Recording Programs

With the automatic exposure (AE) recording programs, the camcorder will adjust the shutter speed and/or aperture value to obtain the optimal exposure. When using the AE recording programs, you can change functions like the white balance and image effects.

Operating modes: **CAMERA** **MEDIA** | **AVCHD** **MP4** | **AUTO** **M** **CINEMA**

### 1 Open the screen of the desired recording program.

[FUNC.] ➤ [Rec. Programs] ➤ [Tv Shutter-Pri. AE] or [Av Aperture-Pri. AE]

### 2 Touch [◀] or [▶] to set the desired shutter speed (Tv) or aperture value (Av) and then touch [X].

- You can also drag your finger along the dial.
- The selected shutter speed or aperture value will appear on the screen next to the recording program icon.

### Options (\* Default value)

**[P Programmed AE]\*** The camcorder automatically adjusts the aperture and shutter speed to obtain the optimal exposure for the subject.

**[Tv Shutter-Pri. AE]** Set the shutter speed value. The camcorder automatically sets the appropriate aperture value.

**[Av Aperture-Pri. AE]** Set the aperture value. The camcorder automatically sets the appropriate shutter speed.

### Available shutter speed settings

[1/8]	[1/15]	[1/30]	[1/60]	[1/100]
[1/250]	[1/500]	[1/1000]	[1/2000]	

### Available shutter speed settings when the frame rate is set to 23.98P



[1/6]	[1/12]	[1/24]	[1/48]	[1/60]
[1/100]	[1/250]	[1/500]	[1/1000]	[1/2000]

### Available aperture value settings

ND filter settings will be available when the aperture value is [F4.0].

[F1.8]	[F2.0]	[F2.2]	[F2.4]	[F2.6]	[F2.8]
[F3.2]	[F3.4]	[F3.7]	[F4.0]	[F4.4]	[F4.8]
[F5.2]	[F5.6]	[F6.2]	[F6.7]	[F7.3]	[F8.0]

 NOTES

- [TV Shutter-Pri. AE]:
  - On screen only the denominator is displayed – [TV 250] indicates a shutter speed of 1/250 second, etc.
  - When recording in dark surroundings, you can obtain a brighter picture by using slow shutter speeds; however, image quality may not be as good and autofocus may not work well.
  - The image may flicker when recording with fast shutter speeds.
  - **Recording movies under fluorescent lights:** If the screen starts to flicker, select [TV Shutter-Pri. AE] and set the shutter speed to 1/100.
- [Av Aperture-Pri. AE]: The actual range of values available for selection will vary depending on the initial zoom position.
- When setting a numeric value (aperture or shutter speed), the number displayed will flash if the aperture value or shutter speed is not appropriate for the recording conditions. In such case, select a different value.
- During exposure lock, the aperture value/shutter speed cannot be changed. Set the aperture value or shutter speed before manually adjusting the exposure.
- If you set  [CUSTOM Dial & Button] to  Tv / Av ( 91), you can adjust the shutter speed or aperture value with the CUSTOM dial and button.



## Exposure Adjustment

At times, backlit subjects may appear too dark (underexposed) or subjects under very strong lights may appear too bright or glaring (overexposed). In such cases, adjusting the exposure will correct this. This camcorder features a dedicated recording program, **[M Manual Exposure]**, for adjusting the exposure manually. However, you can also compensate the exposure when using other recording programs.

### Using the Manual Exposure Recording Program

Using the **[M Manual Exposure]** recording program, you can adjust the aperture, shutter speed and gain to achieve the desired exposure.

Operating modes: **CAMERA** **MEDIA** | **AVCHD** **MP4** | **AUTO** **M** **CINEMA**

- 1 Activate the **[M Manual Exposure]** recording program.  
[FUNC.] ➤ [Rec. Programs] ➤ **[M Manual Exposure]**
- 2 Touch the control button of the setting you wish to adjust.

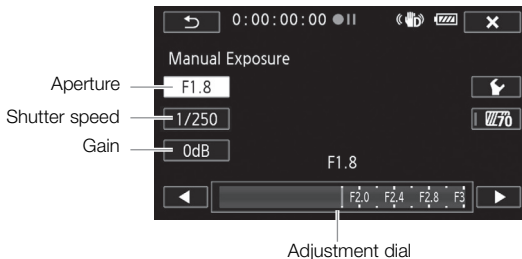

- 3 Touch **[◀]** or **[▶]** to set the desired value.
  - You can also drag your finger along the dial.
  - The exposure will change according to the setting's new value. Repeat steps 2 and 3 to adjust other settings.
  - Before touching **[X]**, you can also use the zebra pattern (see below).
- 4 Touch **[X]**.

#### **i** NOTES

- If you set **[CUSTOM Dial & Button]** to **[M Manual Exposure]** (91), you can adjust the aperture, shutter speed and gain with the CUSTOM dial and button.

### Using the Zebra Pattern

You can use the zebra pattern to identify areas that might be overexposed, so you can correct the exposure appropriately. The camcorder offers two levels of zebra pattern: With 100% only areas that will lose detail in the highlight areas will be identified, while 70% will identify also areas that are dangerously close to losing detail.

- 1 From the exposure adjustment screen, touch [] to select the zebra level.
- 2 Touch [70%] or [100%] and then touch [].
- 3 Touch [] or [] and then touch [].
  - The zebra pattern will appear on the overexposed areas of the picture.
  - Touch again to turn off the zebra pattern.

NOTES

- Using the zebra pattern will not affect your recordings.

## Exposure Compensation

When you use a recording program other than [**M** Manual Exposure], the camcorder will adjust the exposure automatically. However, you can compensate and lock the exposure or use the Touch AE function to automatically set the optimal exposure for the subject you select. This is convenient when the brightness of the subject you want to shoot is noticeably brighter/darker than the general brightness of the image.

Operating modes: | |

POINTS TO CHECK

- Select a recording program other than [: Fireworks] or [**M** Manual Exposure].

### 1 Open the exposure adjustment screen.

[FUNC.] ➤ [ Exposure]

### 2 Touch a subject that appears inside the frame.

- The Touch AE mark () will flash and the exposure will be adjusted automatically so the area you touched will be correctly exposed. You have the option to further adjust the exposure manually as necessary. Depending on the subject, you may want to use the [Highlights] setting as described below.
- You can touch [**M**] instead to compensate the exposure without activating the Touch AE function.
- The manual adjustment dial appears and the adjustment value is set at  $\pm 0$ .
- Touch [**M**] again to return the camcorder to automatic exposure.

### 3 Touch [] or [] or drag your finger along the dial to set the exposure compensation value.

- The adjustment range may vary depending on the initial brightness of the image, and some values may be grayed out.
- Before touching [], you can also use the zebra pattern ( 65).



### 4 Touch [] to lock the exposure at the selected value.

- During exposure lock, and the selected exposure compensation value will appear on the screen.



### To adjust the Touch AE function for highlights (Highlight AE)







Certain subjects, like clouds or white objects, are easily overexposed and can end up appearing as bright areas where all detail is lost. Using the [Highlights] setting, you can touch the brightest area inside the  frame and the camcorder will automatically make corrections so that area is not overexposed. When you touch a dark area in the picture or the highlights are too bright, the camcorder may not be able to correctly adjust the exposure.

After step 1 above:





- 1 Touch .
- 2 Touch [Highlights] and then touch .
  - Touch [Normal] to return the camcorder to normal Touch AE settings.

### To use backlight correction

When recording in situations in which the subject is constantly backlit, you can use backlight correction to make the entire picture brighter, especially dark areas. This will take precedence over the   [Auto Backlight Correction] setting, which is useful in situations in which the subject is not constantly backlit.

- 1 Open the [ BLC Always On] screen.  
[FUNC.]  [ BLC Always On]
- 2 Touch [ON] and then touch .
  -  appears on the screen.
  - Alternatively, you can set an assignable button to [ BLC Always On] ( 92). In that case, press the assignable button to turn the backlight correction on and off.

### NOTES

- The camcorder will return to automatic exposure if the camcorder is turned off, the power switch is operated or the recording program is changed.
- If you set   [CUSTOM Dial & Button] to [ Exposure] ( 91), you can adjust the exposure compensation value with the CUSTOM dial and button.

## White Balance

The white balance function helps you to accurately reproduce colors under different lighting conditions.

Operating modes:   |   |   



### POINTS TO CHECK

- Select a recording program other than the Special Scene recording programs.

#### 1 Open the white balance screen.

[FUNC.] ➤ [WB White Balance]

#### 2 Touch the desired option and then touch [X].

- When you select [**K** Color Temperature], [**S1** Set 1] or [**S2** Set 2], set the color temperature or a custom white balance with the appropriate procedure below before touching [X].
- The icon of the selected option will appear on the screen.

#### To set the color temperature ([**K** Color Temperature])

Touch [◀] or [▶] to set the desired value.

- You can also drag your finger along the dial.

#### To set a custom white balance ([**S1** Set 1] or [**S2** Set 2])

Point the camcorder at a white object, so it fills the whole screen, and touch [Set WB].

When the adjustment is completed,  stops flashing and disappears. The camcorder will retain the custom white balance even if you turn it off.

#### Options (♦ Default value)

[**AWB Automatic**]♦ The camcorder automatically sets the white balance for natural looking colors.

[ **Daylight**] To record outdoors on a bright day.

[ **Shade**] To record in shaded places.

[ **Cloudy**] To record on a cloudy day.

[ **Fluorescent**] To record under warm white, cool white or warm-white-type (3-wavelength) fluorescent lighting.









[ **Fluorescent H**] To record under daylight or daylight-type (3-wavelength) fluorescent lighting.

[ **Tungsten**] To record under tungsten and tungsten-type (3-wavelength) fluorescent lighting.

[**K Color Temperature**] Allows you to set the color temperature between 2,000 K and 15,000 K.

[**S1 Set 1**], [**S2 Set 2**] Use the custom white balance settings to make white subjects appear white under colored lighting.

 NOTES**• When you select a custom white balance:**

- Set   [Digital Zoom] to  Off].
  - Reset the white balance when you change locations or the lighting or other conditions change.
  - Depending on the light source,  may keep flashing. The result will still be better than with  Automatic].
- Using a custom white balance may provide better results in the following cases:
    - Changing lighting conditions
    - Close-ups
    - Subjects in a single color (sky, sea or forest)
    - Under mercury lamps, certain types of fluorescent lights and LED lights
- Depending on the type of fluorescent light, optimal color balance may not be obtained with  Fluorescent] or  Fluorescent H]. If the color looks unnatural, select  Automatic] or a custom white balance setting.

## Special Scene Recording Programs

Recording in a very bright ski resort or capturing the full colors of a sunset or a fireworks display becomes as easy as selecting a Special Scene recording program.

Operating modes: CAMERA MEDIA | AVCHD MP4 | AUTO M CINEMA

1 Open the recording programs screen.

[FUNC.] ► [Rec. Programs] ► [Portrait]

2 Touch the desired recording program and then touch [X].

**Options** (♦ Default value)

[Portrait]♦ The camcorder uses a large aperture, to achieve a sharp focus on the subject while blurring the background.



[Sports] To record sports scenes such as tennis or golf.



[Night Scene] To record nightscapes with lower noise.



[Snow] To record in bright ski resorts without the subject being underexposed.



[Beach] To record on a sunny beach without the subject being underexposed.



[Sunset] To record sunsets in vibrant colors.



[Low Light] To record in low-light situations.











[ **Spotlight**] To record spotlit scenes.



[ **Fireworks**] To record fireworks.



### NOTES

- [ Portrait]/[ Sports]/[ Snow]/[ Beach]: The picture may not appear smooth during playback.
- [ Portrait]: The blur effect of the background increases the more you zoom in (**T**).
- [ Snow]/[ Beach]: The subject may become overexposed on cloudy days or in shaded places. Check the image on the screen.
- [ Low Light]:
  - Moving subjects may leave a trailing afterimage.
  - Picture quality may not be as good as in other modes.
  - White points may appear on the screen.
  - Autofocus may not work as well as in other modes. In such case, adjust the focus manually.
- [ Fireworks]: To avoid camcorder blur (blur due to the camcorder moving) we recommend using a tripod.

## Image Effects

You can adjust the color depth, brightness, contrast, and sharpness of the image.

Operating modes: **CAMERA** **MEDIA** | **AVCHD** **MP4** | **AUTO** **M** **CINEMA**



### POINTS TO CHECK

- Select a recording program other than the Special Scene recording programs.

#### 1 Open the image effects screen.

[FUNC.] ➤ [Image Effects]

#### 2 Touch [ON] and then touch [Color Depth], [Sharpness], [Contrast] or [Brightness].

- Select [OFF] to turn off the image effects.

#### 3 Touch [◀] or [▶] or drag your finger along the dial to adjust the effect level.

- + levels: richer colors, sharper image, stronger contrast, brighter image.
- levels: shallower colors, softer image, softer contrast, darker image.
- To adjust other parameters, touch [↶] to return to the image effects screen. Touch the desired control button and repeat step 3.

#### 4 Touch [X] to save and apply the customized picture settings.

- **A<sub>c</sub>** will appear on the screen.



### NOTES

- [Brightness] cannot be adjusted in **M** mode or when [☑ Exposure] is set to **[M]**.



## Setting the Time Code

The camcorder can generate a time code signal and embed it in your recordings. In addition, the time code will appear in the recordings output from the HDMI terminal. You can select whether the time code is output from the HDMI terminal (📄 151). You can also select between a drop frame and non-drop frame time code.

Operating modes: **CAMERA** **MEDIA** | **AVCHD** **MP4** | **AUTO** **M** **CINEMA**

### Selecting the Running Mode

You can select the running mode of the camcorder's time code.

#### 1 Open the [Time Code Mode] screen.

[FUNC.] ➤ [MENU] ➤ [📄] ➤ [Time Code Mode]

#### 2 Touch the desired option.

- If you selected [**PRESET** Preset], touch [↩] and continue to step 3. If you selected [**REGEN.** Regen.], touch [✕]; you do not need to perform the rest of this procedure.

#### 3 Touch [Time Code Running Mode].

- If you would like to set the time code's initial value, see the following section *Setting the Time Code's Initial Value*.

#### 4 Touch the desired option and then touch [✕].

- If you selected [**FRERUN** Free Run], the time code will start running.

### Options

**[PRESET Preset]** After you select this option, select a [Time Code Running Mode] option. With [**RECRUN** Rec Run], the time code runs only when recording and scenes on the same memory card will have a continuous time code; with [**FRERUN** Free Run], the time code runs regardless of the camcorder's operation. You can also choose to set the time code's initial value for either [Time Code Running Mode] option.

**[REGEN. Regen.]** The time code runs while recording. Use this running mode to continue from the last time code recorded on the memory card.

### Setting the Time Code's Initial Value

If you set the running mode to [**PRESET** Preset], you can set the initial value of the time code.

#### 1 Open the [Initial Time Code] screen.

[FUNC.] ➤ [MENU] ➤ [📄] ➤ [Initial Time Code]

- The time code setting screen will appear with the orange selection frame indicating the hours.
- To reset the time code to [00:00:00:00], select [Reset] instead.
- Touch [Cancel] to close the screen without setting the time code.

#### 2 Touch [▲] or [▼] to change the field as necessary.

#### 3 Touch another field you want to change (hours, minutes, seconds, frames).

#### 4 Change the rest of the fields in the same way.

#### 5 Touch [OK].

## Selecting Drop Frame or Non-Drop Frame

You can select between a drop frame (DF) or non-drop frame (NDF) time code, depending on how you plan to use your recording. When the frame rate is set to 23.98P, the time code will be set to non-drop frame.

1 Open the [DF/NDF] screen.

[FUNC.] ➤ [MENU] ➤  ➤ [DF/NDF]

74 2 Select [**DF** DF] or [**NDF** NDF] and then touch [**X**].

- The time code's display will differ depending on the setting. If you selected [**DF** DF], the time code will appear as [00:00:00.00]; if you select [**NDF** NDF], it will appear as [00:00:00:00].

### NOTES

- When the frame rate is set to 23.98P, the frames value in the time code runs from 0 to 23. For other settings, it runs from 0 to 29.
- When you are using pre-recording mode, [Free Run] is automatically set and cannot be changed.
- When you mix drop frame and non-drop frame time codes, there might be a discontinuity in the time code at the point where the recordings starts.
- As long as the built-in rechargeable lithium battery is charged and you selected the [Free Run] option, the time code continues to run even if you disconnect all other power sources. However, this is less accurate than when the camcorder is on.

## Setting the User Bit

The user bit display can be selected from the date or the time of recording, or an identification code consisting of 8 characters in the hexadecimal system. There are sixteen possible characters: the numbers 0 to 9 and the letters A to F. When you record a scene, the user bit will be recorded with it. The user bit is also output from the HDMI terminal.

Operating modes: **CAMERA** **MEDIA** | **AVCHD** **MP4** | **AUTO** **M** **CINEMA**

### 1 Open the user bit [Setting] screen.

[FUNC.] ➤ [MENU] ➤  ➤ [User Bit Type] ➤ **SET** Setting

- To set the time for the user bit, select **TIME** [Time] instead; to set the date for the user bit, select **DATE** [Date]. In such case, the rest of the procedure is not necessary.
- The user bit setting screen will appear with the orange selection frame on the leftmost digit.
- To reset the user bit to [00 00 00 00], touch [Reset] and then touch **✕**.
- Touch [Cancel] to close the screen without setting the user bit.

### 2 Touch **▲** or **▼** to change the digit as necessary.

### 3 Touch another digit you want to change.

### 4 Change the rest of the digits in the same way.

### 5 Touch [OK] and then touch **✕**.

## User Bit Output

When the frame rate is set to 23.98P and  ➤ [User Bit Output Mode] is set to [Pulldown], the user bit will be 2:3 pulldown data.

### NOTES

- When playing back MP4 movies, the user bit embedded in the signal output from the HDMI terminal will have a value of 0 and cannot be changed.

## Using the Mini Advanced Shoe

Using the mini advanced shoe, you can attach to the camcorder a range of optional accessories to expand its functionality. For details about optional accessories available for use with your camcorder, refer to *Optional Accessories* (□ 175). For details about how to attach and use the accessories, refer also to the instruction manual of the accessory used.

- 1 Open the mini advanced shoe cover.
- 2 Attach the optional accessory to the mini advanced shoe.

- When a compatible accessory is attached to the mini advanced shoe,  will appear on the screen.

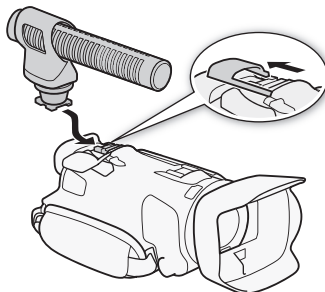

Example: Attaching an optional DM-100 Directional Stereo Microphone.

### NOTES

- Accessories designed for the Advanced Accessory Shoe cannot be used with this camcorder. Look for video accessories bearing this logo to ensure compatibility with the **mini advanced shoe**.



## Using an External Video Light

You can use the optional VL-5 Video Light or VFL-2 Video Flash Light when you need to record movies in dark locations.

Operating modes: CAMERA MEDIA | AVCHD MP4 | AUTO M CINEMA

Attach the optional video light to the mini advanced shoe.

- Refer to *Using the Mini Advanced Shoe* (□□ 76).
-  will appear on the screen when you turn on the optional video light (ON or AUTO). For details about using the optional video light, refer to the instruction manual of the accessory used.
- The optional VFL-2 Video Flash Light cannot be used as a flash with this camcorder.



## Recording Audio

The camcorder features many audio-related functions you can use when recording. You can record audio using the built-in stereo microphone, an optional external microphone (mini advanced shoe or MIC terminal) or a commercially available microphone (MIC terminal). Using an external microphone is useful when recording in very quiet surroundings, where the built-in microphone may pick up the sound of the camcorder's internal machinery, or when recording outside, where the built-in microphone may pick up excessive noise from wind.

### Using an External Microphone

#### Using the SM-V1 Surround Microphone or DM-100 Directional Stereo Microphone

Using the SM-V1 you can add a sense of depth and presence to your recordings with 5.1ch surround sound. Using the DM-100 you can accurately record audio coming directly from the direction you are recording. In either case, to reduce the amount of noise due to wind, we recommend that you use the wind screen supplied with the microphone.

When you use the optional SM-V1 Surround Microphone with this camcorder for the first time, you will need to update the camcorder's firmware using the memory card supplied with the SM-V1. Please note an important change to the firmware update procedure in the instruction manual of the SM-V1. It states that you must set the camcorder to photo playback mode and open the [Firmware] setting in the setup menu. In this camcorder, however, you must set the camcorder to **CAMERA** mode and open   [Firmware].

Operating modes: **CAMERA** **MEDIA** | **AVCHD** **MP4** | **AUTO** **M** **CINEMA**

**Attach the optional SM-V1 Surround Microphone or DM-100 Directional Stereo Microphone to the mini advanced shoe.**

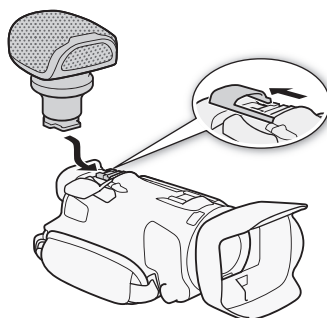

Refer to *Using the Mini Advanced Shoe* (76).

 will appear on the screen. For details about using the optional external microphone, refer to the instruction manual of the accessory used.



## **i** NOTES

### • When using the optional SM-V1 Surround Microphone:

- Change the microphone's directionality mode with the  ➤ [Surround Mic Directionality] setting.
- You can enjoy the full effect of recordings made with 5.1 ch surround sound on HDTVs compatible with 5.1 ch surround sound connected to the camcorder using the supplied High Speed HDMI cable. Audio output from the AV OUT and  (headphones) terminals will be converted to 2ch stereo. The camcorder's built-in speaker is monaural.

## Using the WM-V1 Wireless Microphone

Using the optional WM-V1 Wireless Microphone, you can reliably record sound even when recording subjects at a distance exceeding the practical range of the built-in microphone. You can also mix and record audio from the WM-V1 with audio from the built-in microphone. For details about using the WM-V1, refer to the instruction manual supplied with the microphone.

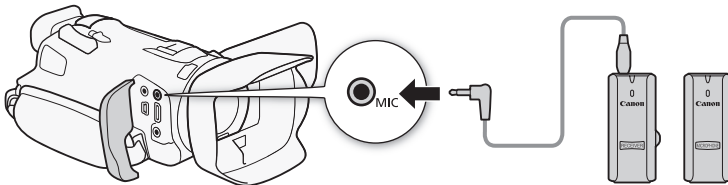

## Using Commercially Available Microphones

You can also use commercially available condenser microphones with their own power supply. You can connect almost any stereo microphone with a  $\varnothing$  3.5 mm plug but audio recording levels may vary.

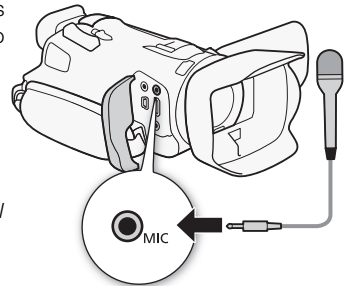

## **i** NOTES

- To adjust the audio recording level of an external microphone connected to the MIC terminal, refer to *Audio Recording Level* (📖 81).

## Audio Scenes and Other Audio Settings

You can have the camcorder optimize the audio settings of the built-in microphone by selecting the audio scene that matches your surroundings. This will greatly enhance the sense of "being there". Alternatively, you can select [**🎵** Custom Setting]\* in order to adjust the camcorder's various audio settings to your liking.

See the following table for the settings used by each audio scene.

\* Not available in **AUTO** mode.

Operating modes: **CAMERA** | **MEDIA** | **AVCHD** | **MP4** | **AUTO** | **M** | **CINEMA**

## 1 Open the audio scene selection screen.

[FUNC.] ➤ [AUDIO Audio Scene]

## 2 Touch the desired option and then touch [X].

- When you select [♪ Custom Setting], customize the audio settings to your preference with the relevant procedures (see the reference pages in the following table).

## Options (♦ Default value)

[STD Standard] To record most general situations. The camcorder records with standard settings.

[🎵 Music] To vibrantly record music performances and singing indoors.

[👤 Speech] Best for recording human voices and dialog.

[🌳 Forest and Birds] To record birds and scenes in forests. The camcorder clearly captures sound as it spreads.

[🔊 Noise Suppression] To record scenes while reducing noise from wind, passing vehicles and similar ambient sound. Ideal for recording at the beach or in places with a lot of noise.

[♪ Custom Setting]♦ Allows you to adjust the audio settings to your liking. The settings that you can adjust are the [🔊 Mic Level] setting in the FUNC. panel and the following settings in the [📄] menu: [Built-in Mic Wind Screen], [Microphone Attenuator], [Built-in Mic Freq. Response] (audio equalizer), and [Built-in Mic Directionality].

## Settings for each audio scene

	[🔊 Mic Level]	[Microphone Attenuator]	[Built-in Mic Wind Screen]	[Built-in Mic Freq. Response]	[Built-in Mic Directionality]
[STD Standard]	[M] (manual): 70	[A] Automatic	[H] Auto (High)	[NORM] Normal	[NORM] Normal
[🎵 Music]	[M] (manual): 70	[A] Automatic	[L] Auto (Low) 🌀🌀	[LHB] Boost HF+LF Range	[2ch WIDE] Wide
[👤 Speech]	[M] (manual): 86	[A] Automatic	[H] Auto (High)	[MB] Boost MF Range	[2ch MONO] Monaural
[🌳 Forest and Birds]	[M] (manual): 80	[A] Automatic	[H] Auto (High)	[LC] Low Cut Filter	[2ch WIDE] Wide
[🔊 Noise Suppression]	[M] (manual): 70	[A] Automatic	[H] Auto (High)	[LC] Low Cut Filter	[2ch MONO] Monaural
[♪ Custom Setting]	Selected by user				
	(📖 81)	(📖 82)	(📖 81)	(📖 82)	(📖 83)

## i NOTES

- Audio scenes cannot be selected in the following cases:
  - When an external microphone is attached to the mini advanced shoe.
  - When an external microphone is connected to the MIC terminal with [📄] ➤ [Audio Mix] set to [OFF Off].
- [♪ Custom Setting] is not available in [AUTO] mode. After setting [AUDIO Audio Scene] to [♪ Custom Setting], if the camcorder is then set to [AUTO] mode, this setting will change to [STD Standard].



## Audio Recording Level

You can adjust the audio recording level of the built-in microphone or an external microphone connected to the MIC terminal. You can display the audio level indicator while recording.

Operating modes: CAMERA MEDIA | AVCHD MP4 | AUTO M CINEMA



### POINTS TO CHECK

- Set [AUDIO Audio Scene] to [🎵 Custom Setting] (📖 79).

#### 1 Open the manual audio recording level adjustment screen.

[FUNC.] ➤ [🔇 Mic Level] ➤ [M] (manual)

- The audio level indicator and current audio recording level will appear on the screen.
- Touch [A] (automatic) to return the camcorder to automatic audio recording levels.

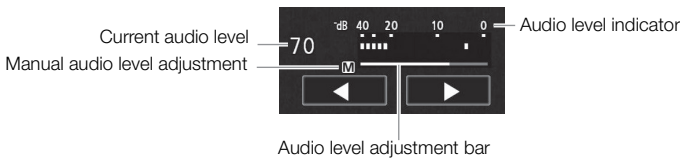

#### 2 Touch and hold [◀] or [▶] to adjust the audio recording level as necessary.

- As a guideline, adjust the audio recording level so that the audio level meter will go to the right of the 18 dB mark (one mark right of the 20 dB mark) only occasionally.
- When [🎧] ➤ [Audio Mix] is set to [ON On], two audio level indicators will appear; the top one ([INT]) for the built-in microphone, and the bottom one ([MIC]) for the external audio connected to the MIC terminal.

#### 3 Touch [X] to lock the audio recording level at the current level.

### To display the audio level indicator

Usually, the audio level indicator will be displayed only after activating the manual adjustment of the audio recording level. You can choose to display it also when the audio level is adjusted automatically.

#### 1 Open the automatic audio recording level screen.

[FUNC.] ➤ [🔇 Mic Level] ➤ [A] (automatic)

#### 2 Touch [Audio Level Indicator] and then touch [X].



### NOTES

- When the audio level meter reaches the red point (0 dB), the sound may be distorted.
- We recommend using headphones to check the sound level while adjusting the audio recording level or when the microphone attenuator is activated.

## Wind Screen (Built-in Microphone)

The camcorder automatically reduces the background sound of wind when recording outdoors. You can select from two levels or turn off the auto wind screen.

Operating modes: CAMERA MEDIA | AVCHD MP4 | AUTO M CINEMA

 POINTS TO CHECK

- Set [AUDIO Audio Scene] to [🎵 Custom Setting] (📖 79).

- 1 Open the [Built-in Mic Wind Screen] screen.  
[FUNC.] ➤ [MENU] ➤  ➤ [Built-in Mic Wind Screen]
- 2 Touch the desired option and then touch [X].

**Options** (⬆ Default value)

**[H Auto (High)]**⬆ The camcorder will automatically activate the built-in microphone wind screen at a high level, as necessary.

**[L Auto (Low)]**  The camcorder will automatically activate the built-in microphone wind screen at a low level, as necessary.

**[OFF Off]**  The built-in microphone wind screen will be deactivated at all times.

 NOTES

- Some low-frequency sounds will be suppressed along with the sound of wind. When recording in surroundings unaffected by wind or if you want to record low-frequency sounds, we recommend setting [Built-in Mic Wind Screen] to **[OFF Off]** .

## Microphone Attenuator

If the audio level is too high and the audio sounds distorted while recording, activate the microphone attenuator (12 dB).

Operating modes:   |   |   

 POINTS TO CHECK

- Set [AUDIO Audio Scene] to [🎵 Custom Setting] (📖 79).

- 1 Open the [Microphone Attenuator] screen.  
[FUNC.] ➤ [MENU] ➤  ➤ [Microphone Attenuator]
- 2 Touch the desired option and then touch [X].

**Options** (⬆ Default value)

**[A Automatic]**⬆ The camcorder will automatically activate the microphone attenuator as necessary for optimal audio recording levels so high audio levels will not be distorted.

**[ON On ATT]** The microphone attenuator will be activated at all times to reproduce more faithfully the sound dynamics.

## Audio Equalizer (Built-in Microphone)

You can use the audio equalizer to adjust sound levels by specifically targeting the high- or low-frequency range and selecting one of 3 available levels.

Operating modes:   |   |   



## POINTS TO CHECK

- Set [AUDIO Audio Scene] to [🎵 Custom Setting] (📖 79).

1 Open the [Built-in Mic Freq. Response] screen.

[FUNC.] ➤ [MENU] ➤ [🔊] ➤ [Built-in Mic Freq. Response]

2 Touch the desired option and then touch [✕].

## Options (👆 Default value)

[**NORM** Normal]👆 Appropriate for balanced sound under most normal recording conditions.

[**LB** Boost LF Range] Accentuates the low-frequency range for more powerful sound.

[**LC** Low Cut Filter] Filters the low-frequency range to reduce the noise of blowing wind, a car's engine and similar ambient sounds.

[**MB** Boost MF Range] Best for recording human voices and dialog.

[**LHB** Boost HF+LF Range] Best, for example, for recording live music and clearly capture the special sound characteristics of a variety of instruments.

## Microphone Directionality (Built-in Microphone)

You can change the directionality of the built-in microphone to have more control over how sound is recorded.

Operating modes: CAMERA MEDIA | AVCHD MP4 | AUTO M CINEMA



## POINTS TO CHECK

- Set [AUDIO Audio Scene] to [🎵 Custom Setting] (📖 79).

1 Open the [Built-in Mic Directionality] screen.

[FUNC.] ➤ [MENU] ➤ [🔊] ➤ [Built-in Mic Directionality]

2 Touch the desired option and then touch [✕].

## Options (👆 Default value)

[**2ch MONO** Monaural] Mono recording that emphasizes sound coming from the front of the camcorder/microphone.

[**NORM** Normal]👆 Standard stereo recording; a middle point between the [**2ch WIDE** Wide] and [**2ch MONO** Monaural] settings in reach.

[**2ch WIDE** Wide] Stereo recording of ambient sound over a more extensive area that adds to the sense of presence of movies.

[**2ch ZOOM** Zoom] Stereo recording with the sound linked to the zoom position. The larger the subject appears on the screen, the louder the sound will be.

## Switching the Input (MIC Terminal)

You can switch the input of the MIC terminal depending on whether you are using an external microphone or an external audio source, such as a digital audio player.

Operating modes: CAMERA MEDIA | AVCHD MP4 | AUTO M CINEMA

1 Open the [MIC Terminal Input] screen.

[FUNC.] ➤ [MENU] ➤  ➤ [MIC Terminal Input]

2 Touch [**LINE** External Audio] or [**MIC** Microphone] and then touch [**✕**].

- If necessary, activate and adjust the audio mix balance ( 84).

## Low Cut Filter (MIC Terminal)

When you are recording using a microphone connected to the MIC terminal, you can activate the low cut filter to reduce the sound of blowing wind, a car's engine and similar ambient sounds.

Operating modes: CAMERA MEDIA | AVCHD MP4 | AUTO M CINEMA

1 Open the [MIC Low Cut] screen.

[FUNC.] ➤ [MENU] ➤  ➤ [MIC Low Cut]

2 Touch [**ON** On] and then touch [**✕**].

## Audio Mix

When recording, you can mix audio from the built-in microphone with external audio from the MIC terminal and adjust the mix balance for original sound effects. The external audio input can be from the optional WM-V1 Wireless Microphone, a commercially available external microphone or from an external audio player (analog Line In).

Operating modes: CAMERA MEDIA | AVCHD MP4 | AUTO M CINEMA

1 Connect the external source to the MIC terminal.

2 Open the [MIC Terminal Input] screen.

[FUNC.] ➤ [MENU] ➤  ➤ [MIC Terminal Input]

3 Touch [**LINE** External Audio] or [**MIC** Microphone] and then touch [**↔**].

- This step is not necessary after connecting the optional WM-V1 Wireless Microphone.

4 Activate the audio mix.

[Audio Mix] ➤ [**ON** On]

5 Adjust the audio mix balance as necessary.

- Touch [INT] (more of the sound from the built-in microphone) or [EXT] (more of the sound from the external audio) or drag your finger along the audio mix bar to adjust the mix balance as desired.

6 Touch [**✕**] to set the audio mix and close the menu.

## Using Headphones

Use headphones for playback or to check the audio level while recording. The following procedure explains how to adjust the volume.

Operating modes: **CAMERA** **MEDIA** | **AVCHD** **MP4** | **AUTO** **M** **CINEMA**

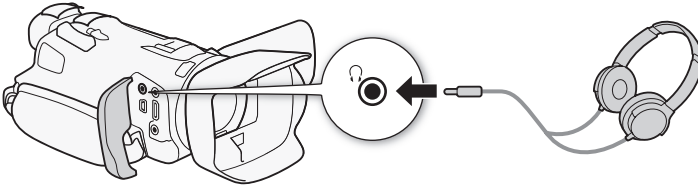

### 1 Open the [Headphone Volume] screen.

[FUNC.] ➤ [MENU] ➤ [Headphone Volume]

- Touching [FUNC.] is necessary only when performing the procedure in **CAMERA** mode.

### 2 Touch [🔊] or [🔊] to adjust the volume and then touch [X].

- You can also drag your finger along the volume bar.

### To adjust the volume during playback

During playback, adjust the headphones volume the same way you adjust the speaker's volume (📖 96).

#### ! IMPORTANT

- When using headphones, make sure to lower the volume to an appropriate level.

#### i NOTES

- Use commercially available headphones with a  $\varnothing$  3.5 mm minijack.
- When you are monitoring the audio, you can choose to synchronize the audio signal with the video signal or monitor the audio in real time. Use the [🔊] ➤ [Monitor Delay] setting to select the method. Note that there will be a slight delay when you monitor in real time. Regardless of the setting, however, the audio and video signals recorded will be synchronized.

## Color Bars/Audio Reference Signal

You can have the camcorder output and record color bars and a 1 kHz audio reference signal and output them from the HDMI OUT terminal, AV OUT terminal, and  (headphone) terminal (audio reference signal only).

Operating modes:   |   |   

### Recording Color Bars

You can choose between SMPTE standard-definition color bars and ARIB multi-format HDTV color bars.

1 Open the [Color Bars] menu.

[FUNC.]  [MENU]    [Color Bars]

2 Touch the desired option and then touch [X].

- The selected color bars appear on the screen and will be recorded when you press .



### Recording an Audio Reference Signal

The camcorder can output a 1 kHz audio reference signal with the color bars.

1 Open the [1 kHz Tone] submenu.

[FUNC.]  [MENU]    [1 kHz Tone]





2 Select the desired level and then touch [X].

- Available levels are -12 dB, -18 dB and -20 dB.
- Select  Off] to turn off the signal.
- The signal is output at the selected level and will be recorded when you press .



## Video Snapshot

Record a series of short scenes. To record a video snapshot scene, set an assignable button to [  Video Snapshot] in advance.

Operating modes:   |   |   

- 1 Set an assignable button to [  Video Snapshot] ( 92).
- 2 Press the assignable button to activate video snapshot mode.
  -  (the default length of a video snapshot scene) appears on the screen.
  - Press the button again to deactivate video snapshot mode.
- 3 Press .
  - The camcorder records for a few seconds and then automatically returns to record pause mode.
  - When the camcorder stops recording, the screen will momentarily turn black as if a camera shutter had released.

### NOTES

- The default length of a video snapshot scene is 4 seconds but you can change it to 2 or 8 seconds with the   [Video Snapshot Length] setting.
- Any of the following will deactivate video snapshot mode:
  - Turning off the camcorder.
  - Changing the camcorder's operating mode.
  - Changing the movie format or frame rate.

## Pre-Recording

The camcorder will start recording 3 seconds before you press **START/STOP**, ensuring you do not miss important shooting opportunities. This is especially useful when it is difficult to predict when to start recording.

By default, the pre-recording function is assigned to assignable button 2.

Operating modes: **CAMERA** **MEDIA** | **AVCHD** **MP4** | **AUTO** **M** **CINEMA**

1 Press **PRE REC**.

-  will appear on the screen.
- Press **PRE REC** again to turn off pre-recording.

2 Press **START/STOP**.

- The scene recorded on the memory card will start 3 seconds before **START/STOP** was pressed.

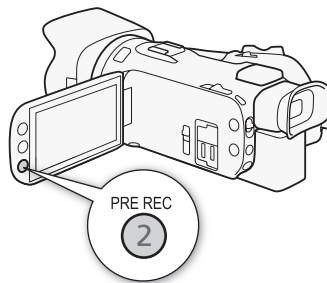

### NOTES

- The camcorder will not record the full 3 seconds prior to pressing **START/STOP** if the button was pressed within 3 seconds of having turned on pre-recording or having finished the previous recording.
- Any of the following actions will deactivate the pre-recording function.
  - Leaving the camcorder without any operation for 1 hour.
  - Changing the camcorder's operating mode.
  - Activating video snapshot.
  - Touching any of the following control buttons in the FUNC. panel: **[MENU]**, **[Rec. Programs]**, **[WB White Balance]**, **[AGC AGC Limit]**, **[AUDIO Audio Scene]** or **[Image Stabilizer]**.



## Onscreen Displays and Data Code

You can turn most onscreen displays on or off.

Operating modes: **CAMERA** **MEDIA** | **AVCHD** **MP4** | **AUTO** **M** **CINEMA**



Repeatedly press **[DISP.]** to turn the onscreen displays on/off in the following sequence:

**CAMERA** mode:

- All displays on
- Onscreen markers<sup>1</sup>
- Displays off

**MEDIA** mode<sup>2</sup>:

- Only data code on
- All displays on

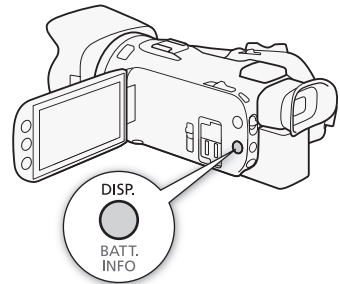

<sup>1</sup> The onscreen markers will be displayed only when   [Onscreen Markers] is set to an option other than **[OFF Off]**.

<sup>2</sup> Pressing **[DISP.]** has the same effect as touching the screen. During single photo view and while playing back a scene, the playback controls are displayed only momentarily.



### About the Data Code

With every scene or photo recorded, the camcorder keeps a data code (date/time of recording, information about the camera setup, etc.).

You can select the information to be displayed with the  /   [Data Code] setting.

## Using the GP-E2 GPS Receiver

When you attach the optional GP-E2 GPS Receiver to the camcorder, you can acquire GPS information and add it to your movies and photos. For details about how to attach and use the receiver, refer also to the receiver's instruction manual.

Operating modes: CAMERA MEDIA | AVCHD MP4 | AUTO M CINEMA

90

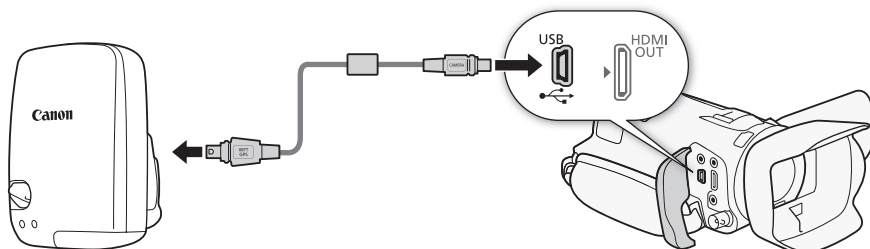

When connecting the GP-E2 GPS Receiver to the camcorder, use the connecting cable supplied with the receiver.

After connecting the receiver, we recommend that you attach the receiver to the grip belt or the carrying case supplied with the receiver.

### ! IMPORTANT

- In certain countries and regions, the use of GPS may be restricted. Therefore, be sure to use GPS in accordance with the laws and regulations of your country or region. Be particularly careful when traveling outside your home country.
- Be careful about using GPS functions where the operation of electronic devices is restricted.
- Others may be able to locate or identify you by using location data in your geotagged pictures or movies. Be careful when sharing these images with others, as when posting them online where many others can view them.
- GPS signal reception may take some time.
- Never leave the receiver near any equipment that generates a strong magnetic field, such as magnets or electric motors.

### i NOTES

- The camcorder is not compatible with the receiver's digital compass and positioning interval functions. Also, [Set Now] is not available for [GPS Auto Time Setting].
- The GPS receiver's time will be set once when the receiver is attached to the camcorder. While recording movies and or when Wi-Fi Remote is activated, the time will not be set.
- You cannot add GPS information to the following types of recordings.
  - Photos captured from a movie.
  - MP4 movies that were converted from another movie.

# 4 Customization

## CUSTOM Dial and Button

You can assign to **CUSTOM** and the CUSTOM dial one of several frequently used functions. You can then adjust the selected function using **CUSTOM** and the CUSTOM dial, without having to access the menu.

Operating modes: **CAMERA** **MEDIA** | **AVCHD** **MP4** | **AUTO** **M** **CINEMA**

- 1 Open the **[CUSTOM Dial & Button]** screen.  
[FUNC.] ➤ [MENU] ➤ [ ] ➤ [CUSTOM Dial & Button]
- 2 Touch the desired option and then touch **[X]**.

### Options (♦ Default value)

**[Tv Av Tv/Av]** When you set the recording program to **[Tv Shutter-Pri. AE]** or **[Av Aperture-Pri. AE]**, you can adjust the shutter speed or aperture value with the CUSTOM dial.

**[M Manual Exposure]** When you set the recording program to **[M Manual Exposure]**, repeatedly press **CUSTOM** to toggle between the aperture value, shutter speed and gain. Next, use the CUSTOM dial to adjust the setting.

**[AGC AGC Limit]** Adjusts the AGC limit. Press **CUSTOM** to display the current AGC limit value and then use the CUSTOM dial to adjust it.

**[Exposure]♦** When using a recording program other than **[Fireworks]** or **[M Manual Exposure]**, you can compensate the automatic exposure set by the camcorder. Press **CUSTOM** to display the exposure compensation value and then use the CUSTOM dial to adjust it.

**[OFF Off]** Use this setting if you do not intend to use **CUSTOM** or the CUSTOM dial.

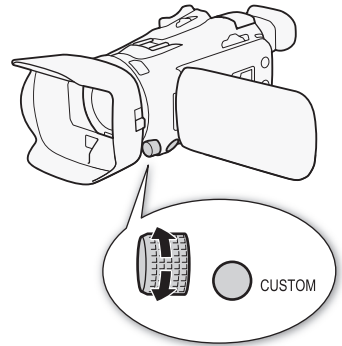

### **i** NOTES

- Instead of the procedure above, you can press and hold **CUSTOM** to display a quick menu of the options. Use the CUSTOM dial to select an option and then press **CUSTOM**.

## Assignable Buttons

The camcorder conveniently features 5 buttons to which you can assign various functions. By assigning often used functions, you can quickly access them with a single press of a button.

Operating modes: **CAMERA** **MEDIA** | **AVCHD** **MP4** | **AUTO** **M** **CINEMA**

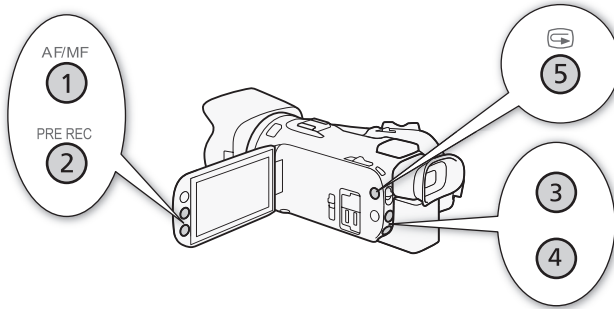

### Changing the Assigned Function

1 Open the selection screen for the desired assignable button.

[FUNC.] ➤ [MENU] ➤ ➤ Select from [Assign Button 1] to [Assign Button 5]

2 Select the desired option and then touch [X].

#### Options

**Powered IS**\* Turns Powered IS on/off ( 61).

**BLC Always On**\* Turns backlight correction on/off ( 67).

**Face Only AF**\* Turns face only autofocus on/off ( 56).

**Video Snapshot** Turns video snapshot on/off ( 87).

**WB Priority**\* Turns white balance priority on/off ( 151).

**Pre REC** Turns pre-recording on/off ( 88). Default setting for assignable button 2.

**AF/MF**\* Switches between autofocus and manual focus ( 52). Default setting for assignable button 1.

**Rec Review** Reviews the last scene that was recorded ( 44). Default setting for assignable button 5.

**Func. Rec. Programs**\* Functions the same as selecting [Rec. Programs] ( 63, 65, 70) in the FUNC. panel.

**Func. BLC Always On**\* Functions the same as selecting [ BLC Always On] ( 67) in the FUNC. panel.

**Func. White Balance**\* Functions the same as selecting [**WB** White Balance] ( 68) in the FUNC. panel.

**Func. AGC Limit**\* Functions the same as selecting [**AGC** AGC Limit] ( 62) in the FUNC. panel.

**Func. Focus**\* Functions the same as selecting [ Focus] ( 52) in the FUNC. panel.

**Func. Exposure**\* Functions the same as selecting [ Exposure] ( 65) in the FUNC. panel.

**[FUNC. Audio Scene]** Functions the same as selecting [**AUDIO** Audio Scene] (📖 79) in the FUNC. panel.

**[FUNC. Mic Level]\*** Functions the same as selecting [**🔊** Mic Level] (📖 81) in the FUNC. panel.

**[FUNC. Zoom]** Functions the same as selecting [**ZOOM** Zoom] (📖 57) in the FUNC. panel.

**[FUNC. Image Stabilizer]\*** Functions the same as selecting [Image Stabilizer] (📖 61) in the FUNC. panel.

**[FUNC. Image Effects]\*** Functions the same as selecting [Image Effects] (📖 72) in the FUNC. panel.

**[FUNC. Wi-Fi Remote]** Functions the same as selecting [**Wi-Fi** Wi-Fi Remote] (📖 120) in the FUNC. panel.

**[OFF Off]** Does not assign a function to the assignable button. Default setting for assignable button 3 and assignable button 4.

\* Even if this function is assigned to an assignable button in **[M]** or **[CINEMA]** mode, the button will be disabled if you set the camcorder to **[AUTO]** mode.

## Using an Assignable Button

After you assign a function to one of the buttons, press the button to activate the function.

## Saving and Loading Menu Settings



After you adjust the cinema-look filters and other settings in the FUNC. panel and setup menus, you can save those settings on a memory card. You can load those settings at a later date or on another HF G30 camcorder so that you can use that camcorder in the same way.

Operating modes:   |   |   



94

### Saving Menu Settings to a Memory Card

Menu settings must be saved to memory card **B**. If the memory card already has menu settings on it, they will be overwritten.

- 1 Insert a memory card into memory card slot **B**.
- 2 Open the [Backup Menu Settings **B**] screen.  
[FUNC.] ➤ [MENU] ➤  ➤ [Backup Menu Settings **B**]
  - Touching [FUNC.] is necessary only when performing the procedure in  mode.
- 3 Touch [Save] and then touch [Yes].
  - The current settings are saved to the memory card.
- 4 Touch [OK] and then touch [**X**].

### Loading Menu Settings from a Memory Card

- 1 Insert a memory card with menu settings into memory card slot **B**.
- 2 Open the [Backup Menu Settings **B**] screen.  
[FUNC.] ➤ [MENU] ➤  ➤ [Backup Menu Settings **B**]
  - Touching [FUNC.] is necessary only when performing the procedure in  mode.
- 3 Touch [Load] and then touch [Yes].
  - After the camcorder's current settings are replaced with the settings saved on the memory card, the screen will turn black momentarily and the camcorder will restart.

# 5 Playback

## Playing Back Video

This section explains how to play back scenes. For details on playing back scenes using an external monitor, refer to *Connecting to an External Monitor* (102).

Operating modes: **CAMERA** **MEDIA** | **AVCHD** **MP4** | **AUTO** **M** **CINEMA**

- 1 Set the power switch to **MEDIA**.
  - The AVCHD movie index screen will appear.

- 2 If necessary, change the index screen.

[**A** **MP4**] ➤ Tab of the desired memory card ([**A**] or [**B**]) ➤

Control button of the content you want to play back ([**▶**] **AVCHD** Movies] or [**▶**] **MP4** Movies]).

- 3 Look for the scene you want to play back.

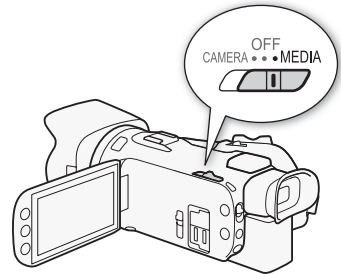

- 1 Index screen button. Displays the currently selected memory card and movie format. Press to change the index screen.
- 2 Drag your finger left/right for the next/previous index page.
- 3 Display the next/previous index page.
- 4 Scene information.
- 5 Recording date (for AVCHD movies) or folder name (for MP4 movies; see *About folder names* in the following sidebar).

- 4 Look for the scene you want to play back.

- 5 Touch the desired scene to play it back.

- The camcorder will play back the scene selected and continue until the end of the last scene in the index screen.
- Touch the screen to display the playback controls. During playback, the playback controls will disappear automatically after a few seconds without operation. In playback pause, touch the screen again to hide the playback controls.

### About folder names

MP4 movies and photos are saved as files in folders. The folder names appear in a format such as "101\_0501." The first three digits indicate the folder number and the last four digits indicate the month and day (May 1, for the example folder above).

### During playback:

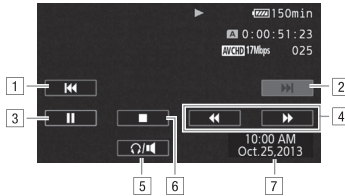

- 1 Jump to the beginning of the scene. Double-tap to jump to the previous scene.
- 2 Jump to the beginning of the next scene.
- 3 Pause the playback.
- 4 Fast playback\* backward/forward.
- 5 Display the volume controls (📖 96).
- 6 Stop the playback.
- 7 Data code (📖 89)

\* Touch several times to increase the playback speed to approximately 5x → 15x → 60x normal speed.

### Adjusting the volume

- 1 During playback, touch the screen to display the playback controls.
- 2 Touch [🔊/🔇].
- 3 Touch [🔊/🔇] or [🔊/🔇] to adjust the volume and then touch [↶].

### During playback pause:

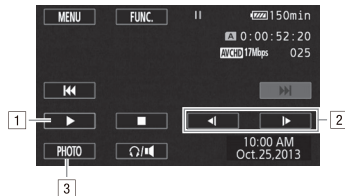

- 1 Resume playback.
- 2 Slow playback\* backward/forward.
- 3 Capture the displayed frame as a photo (📖 97).

\* Touch several times to increase the playback speed 1/8 → 1/4 the normal speed.



## Displaying scene information

- 1 In either the AVCHD or MP4 movie index screen, touch **[i]**.
- 2 Touch the desired scene.
  - The scene information screen appears.
  - If the optional GP-E2 Receiver was attached to the camcorder during recording, GPS information will also appear.
  - Touch ◀/▶ to select the previous/next scene.
- 3 Touch **[↵]** twice when finished.

### IMPORTANT

- Observe the following precautions while the ACCESS indicator is on or flashing. Failing to do so may result in permanent data loss.
  - Do not open the double memory card slot cover.
  - Do not disconnect the power source or turn off the camcorder.
  - Do not change the camcorder's operating mode.
- You may not be able to play back with this camcorder movies recorded on a memory card using another device.

### NOTES

- You can turn off the recording date and time display or change the information displayed with the  **[Data Code]** setting.
- Depending on the recording conditions, you may notice brief stops in video or sound playback between scenes.
- During fast/slow playback, you may notice some anomalies (blocky video artifacts, banding, etc.) in the playback picture.
- The speed indicated on the screen is approximate.
- Slow reverse playback will look the same as continuous frame reverse.

## Capturing Photos During Movie Playback

You can capture a photo while a movie is being played back.

- 1 Play back the scene from which you want to capture the photo.
- 2 Pause the playback at the point where you want to capture the photo.
- 3 Touch **[PHOTO]**.
- 4 Touch **[■]** to stop the playback.

### NOTES



- The size of the captured photos will be 1920x1080.
- The date of the photos will reflect the date and time of recording of the original scene.
- Photos captured from a scene with a lot of fast movement may be blurred.
- Photos will be recorded on the memory card selected for recording photos.

## Deleting Scenes

You can delete those scenes that you are not interested in keeping. Deleting scenes allows you also to free up space on the memory card.

Operating modes:   |   |   



### Deleting a Single Scene

- 1 Play back the scene you wish to delete (📖 95).
- 2 Touch the screen to display the playback controls.
- 3 Open the [Delete] screen.  
  [FUNC.]  [Delete]
- 4 Touch [Yes].
  - The scene is deleted.
- 5 Touch [OK].

### Deleting Scenes from the Index Screen

- 1 Open the index screen (📖 95).
  - To delete all the scenes recorded on a specific date, drag your finger left/right until a scene you want to delete appears.
- 2 Open the [Delete] screen.  
[FUNC.]  [Delete]
- 3 Touch the desired option.
  - When you touch [Select], perform the following procedure to select the individual scenes you want to delete before touching [Yes].
- 4 Touch [Yes].
  - Touch [Stop] to interrupt the operation while it is in progress. Some scenes may be deleted nevertheless.
  - The selected scenes are deleted.
- 5 Touch [OK].

#### To select individual scenes

- 1 Touch on the individual scenes you want to delete.
  - A checkmark ✓ will appear on the scenes you touch. The total number of selected scenes will appear next to the  icon.
  - Touch a selected scene to remove the checkmark. To remove all checkmarks at once, touch [Remove All]  [Yes].
- 2 After selecting all the desired scenes, touch [OK].

## Options

**[date/folder name]** Delete all the scenes recorded on a particular date. For AVCHD movies, the date will appear in the control button. For MP4 movies, the folder name (📁 96) will appear, with the last four digits indicating the month and day.

**[Select]** Select individual scenes to delete.

**[All Scenes]** Delete all the scenes.



### IMPORTANT

- Be careful when deleting recordings. Once deleted, scenes cannot be recovered.
- Save copies of important scenes before deleting them (📁 108).
- Observe the following precautions while the ACCESS indicator is on or flashing (while scenes are being deleted).
  - Do not open the double memory card slot cover.
  - Do not disconnect the power source or turn off the camcorder.
  - Do not change the camcorder's operating mode.



### NOTES

- To delete all movies and make all recordable space available again you may prefer to initialize the memory card (📁 36).

## Dividing Scenes

You can divide AVCHD scenes in order to leave out the best parts and later cut out the rest.

Operating modes: CAMERA MEDIA | AVCHD MP4 | AUTO M CINEMA

- 1 Play back the desired scene (📖 95).
- 2 Pause the playback at the point where you want to divide the scene.
- 3 Open the screen for dividing scenes.  
[FUNC.] ➡ [Divide]
- 4 Bring the scene to a precise point, if necessary.
  - The point at which the movie will be divided is indicated by the ▼ marker.
  - Playback controls will appear on the screen (📖 97). Use any special playback modes as necessary to locate the desired point.
- 5 Divide the scene.  
[🔪 Divide] ➡ [Yes]
  - The video from the division point to the end of the scene will appear as a new scene in the index screen.

### NOTES

- When advancing/reversing frames while dividing the scenes, the interval between frames is about 0.5 seconds.
- If the scene cannot be divided at the point where you paused the playback, advance/reverse a frame and then divide the scene.
- During the playback of a scene that was divided, you may notice some anomalies in the picture/sound at the point where the scene was cut.
- Scenes that are too short (less than 3 seconds) cannot be divided.
- Scenes cannot be divided within 1 second from the beginning or the end of the scene.

## Trimming Scenes

You can trim MP4 scenes by removing everything up to a certain point or everything after a certain point.

Operating modes: CAMERA MEDIA | AVCHD **MP4** | AUTO M CINEMA

- 1 Play back the desired scene (📖 95).
- 2 Pause the playback.
- 3 Open the screen for trimming scenes.  
[Edit] ▶ [Trim]
- 4 Bring the scene to a precise point, if necessary.
  - The point at which the movie will be trimmed is indicated by the ▼ marker.
  - Playback controls will appear on the screen (📖 97). Use any special playback modes as necessary to locate the desired point.
- 5 Trim the scene.  
[Trim] ▶ Select whether to trim before ([Trim Before Marker]) or after ([Trim After Marker]) the ▼ marker ▶ Select whether to save as a new scene ([Save as New]) or overwrite the existing scene ([Overwrite])
  - If you chose to save the trimmed scene as a new scene, you can touch [Stop] to interrupt the operation while it is in progress.

# 6 External Connections

## Connecting to an External Monitor

When you connect the camcorder to an external monitor for recording or playback, use the terminal on the camcorder that matches the one you wish to use on the monitor. Then, select the video signal output configuration. The camcorder will automatically switch between the AV OUT and HDMI OUT terminals based on the external connection.

Operating modes: **CAMERA** **MEDIA** | **AVCHD** **MP4** | **AUTO** **M** **CINEMA**

## Connection Diagram

We recommend that you power the camcorder from a household power outlet using the compact power adapter.

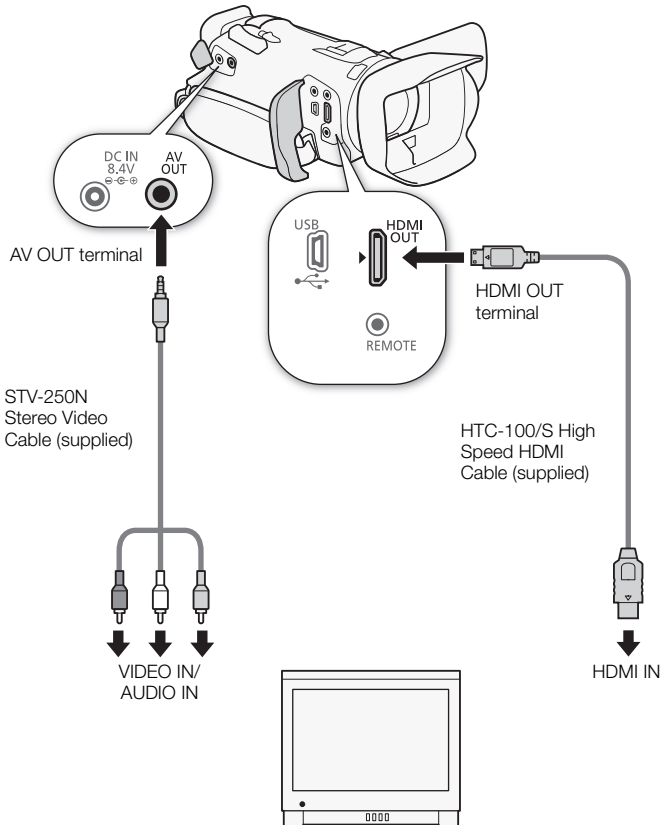

## Using the HDMI OUT Terminal

The HDMI™ OUT terminal also offers a digital connection and outputs both a video and audio signal. If you selected [**A** Automatic], the output signal will automatically switch to HD or SD depending on the capability of the external monitor. In [CAMERA] mode, when the recording mode is set to 28 Mbps LPCM (59.94P) or 24 Mbps LPCM, the HDMI OUT terminal outputs two-channel linear PCM audio with a sampling frequency of 48 kHz.

### 1 Open the [HDMI Output] screen.

[FUNC.] ➤ [MENU] ➤  ➤ [HDMI Output]

- Touching [FUNC.] is necessary only when performing the procedure in [CAMERA] mode.

### 2 Touch the desired option and then touch [**X**].

#### NOTES

- The HDMI OUT terminal on the camcorder is for output only. Do not connect it to an HDMI output terminal on an external device, as this may damage the camcorder.
- There will be no video output from the AV OUT terminal while an external monitor is connected to the HDMI OUT terminal.
- Correct operation cannot be guaranteed when connecting the camcorder to DVI monitors.
- Video may not be output correctly depending on the monitor. In such case, use another terminal.
- If you selected an option other than [**A** Automatic] and the connected monitor is not compatible with the signal output from the camcorder, then HDMI output will stop.
- By default, onscreen displays will be embedded in the output video signal. You can change this using the  ➤ [Output Onscreen Displays] setting.

## Using the AV OUT Terminal

The AV OUT terminal outputs a down-converted analog video signal and audio signal for connection to monitors with a composite audio/video input.

#### NOTES

- When you play back a scene on a monitor with a 4:3 aspect ratio, the monitor will switch automatically to widescreen mode if it is compatible with the Video ID-1 system.
- If you are connecting the camcorder to a standard definition monitor without widescreen mode, make sure to change the  ➤ [TV Type] setting.

## Audio Output

The camcorder can output audio from the HDMI OUT terminal, AV OUT terminal or  (headphone) terminal.

### Synchronizing the Video with the Audio being Monitored

104

When audio is output from the AV OUT terminal or  (headphone) terminal, you can choose to synchronize the audio signal with the video signal or have the camcorder output the audio in real time. When the audio is output in real time, there will be a slight delay. Regardless of the setting, however, the audio and video signals recorded will be synchronized.

Operating modes:   |   |   

#### 1 Open the [Monitor Delay] submenu.

[FUNC.]  [MENU]    [Monitor Delay]

- Touching [FUNC.] is necessary only when performing the procedure in  mode.

#### 2 Touch the desired option and then touch [X].

**Options** (\* Default value)

**[Line Out]** Synchronizes the audio and video signals.

**[Normal]**\* Allows you to monitor the audio in real time.



# 7 Photos

## Viewing Photos

Operating modes: **CAMERA** **MEDIA** | **AVCHD** **MP4** | **AUTO** **M** **CINEMA**

- 1 Set the power switch to MEDIA.
  - The AVCHD movie index screen will appear.

- 2 Open the photo index screen.

[A] **AVCHD** ▶ Tab of the desired memory card ([A] or [B]) ▶  
[📷] Photos

- 3 Look for the photo you want to play back.

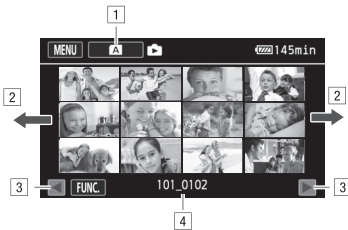

- 1] Index screen button. Displays the currently selected memory card. Press to change the index screen.
- 2] Drag your finger left/right for the next/previous index page\*.
- 3] Display the next/previous index page.
- 4] Folder name (📁 96).

\* While browsing through index pages, a scroll bar will appear at the bottom of the screen for a few seconds. When you have a large number of photos it may be more convenient to drag your finger along the scroll bar.

- 4 Touch the photo you wish to view.

- The photo is displayed in single photo view.
- Drag your finger left/right to browse through the photos one by one.
- If the optional GP-E2 Receiver was attached to the camcorder during recording, GPS information will also appear.

To return to the index screen from single photo view

- 1 Touch the screen to display the playback controls.
- 2 Touch [📷].

## Photo Jump Function

When you have recorded a large number of photos, you can jump easily through the photos using the scroll bar.

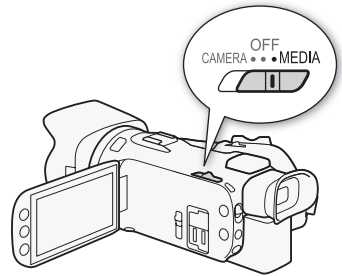

1 Touch the screen to display the playback controls.

2 Touch [⏮].

3 Drag your finger left and right along the scroll bar and then touch [⏮].



**IMPORTANT**



- Observe the following precautions while the ACCESS indicator is on or flashing. Failing to do so may result in permanent data loss.
  - Do not open the double memory card slot cover.
  - Do not disconnect the power source or turn off the camcorder.
  - Do not change the camcorder's operating mode.
- The following image files may not be displayed correctly.
  - Images not recorded with this camcorder.
  - Images edited on a computer.
  - Images whose file names have been changed.

## Deleting Photos

You can delete those photos that you are not interested in keeping.

Operating modes: CAMERA MEDIA | AVCHD MP4 | AUTO M CINEMA

### Deleting a Single Photo

- 1 In single photo view, select the photo you want to delete.
- 2 Touch the screen to display the playback controls.
- 3 Open the [Delete] screen.  
[FUNC.] ➤ [Delete]
- 4 Touch [ Proceed] and then touch [Yes].
  - The photo is deleted.
- 5 Drag your finger left/right to select another photo to delete or touch [].

### Deleting Photos from the Index Screen

- 1 Open the photo index screen.
- 2 Open the [Delete] screen.  
[FUNC.] ➤ [Delete]
- 3 Touch the desired option and then touch [Yes].
  - When you select [Select], perform the following procedure to select the individual photos you want to delete before touching [Yes].
  - Touch [Stop] to interrupt the operation while it is in progress. Some photos will be deleted nevertheless.
- 4 Touch [OK].

#### To select individual photos

- 1 Touch on the individual photos you want to delete.
  - A checkmark ✓ will appear on the photos you touch. The total number of selected photos will appear next to the  icon.
  - Touch a selected photo to remove the checkmark. To remove all checkmarks at once, touch [Remove All] ➤ [Yes].
- 2 After selecting all the desired photos, touch [OK].

#### Options

**[folder name]** Delete all the photos taken on a particular date. The folder name ( 96) will appear in the control button, with the last four digits indicating the month and day.

**[Select]** Select individual photos to delete.

**[All Photos]** Delete all the photos.

#### IMPORTANT

- Be careful when deleting photos. Deleted photos cannot be recovered.
- Photos that were protected with other devices cannot be deleted with this camcorder.

## Saving Recordings to a Computer

Using the supplied software **Data Import Utility** to save your AVCHD movies, you have the additional advantage of automatically joining scenes that were saved as multiple files so you can work with them as single scenes with the editing software of your choice. Using the supplied software **ImageBrowser EX**, you can save your MP4 movies and photos.

### Connection Diagram

We recommend that you power the camcorder from a household power outlet using the compact power adapter.

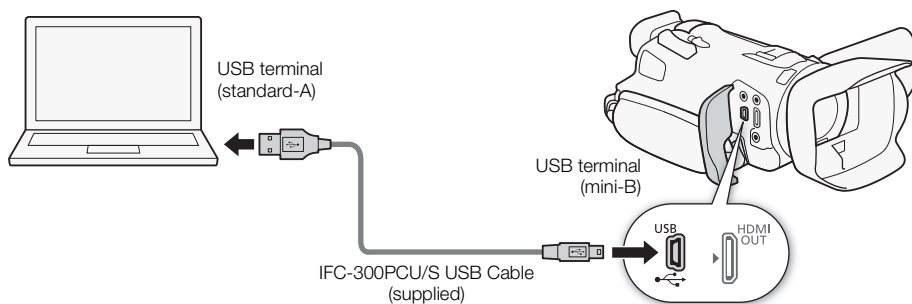

### Saving Movies Using Data Import Utility

Operating modes: **CAMERA** **MEDIA** | **AVCHD** **MP4** | **AUTO** **M** **CINEMA**

- Save scenes to the computer (all scenes/new scenes only).
- Join relay scenes (either AVCHD or MP4 format) that were saved on separate memory cards (47) and save them as a single scene.
- Join multiple video stream files of a single scene (either AVCHD or MP4 format) split because of the 4 GB maximum file size restriction and save them as a single scene.

For more details, check the **Data Import Utility** Software Guide, a PDF file\* in the [Manual\English] folder of the supplied Data Import Utility CD-ROM.

\* Adobe® Reader® 6 or later is required to view the PDF file.

## Installing the Software

See *Installation* and *System requirements* in the **Data Import Utility** Software Guide (PDF file) for step-by-step installation instructions and full system requirements. Below are the main system requirements.

OS	Windows XP <sup>1</sup> , SP3 Windows Vista <sup>2</sup> , SP2 Windows 7 <sup>2</sup> , SP1 Windows 8 <sup>2</sup>	Mac OS X 10.6, 10.7 or 10.8
CPU	Intel® Core or equivalent	Intel® CPU (not compatible with Power PC)
RAM	1 GB (2 GB for Windows 7 and 8, 64-bit version and Mac OS X 10.7 and 10.8)	
Display	1024 x 768 pixels	

<sup>1</sup> 32-bit version only.

<sup>2</sup> 32-bit and 64-bit versions.

### ! IMPORTANT

- Before saving scenes to your computer with **Data Import Utility** using a memory card reader or your computer's memory card slot, do not access or manipulate the files on the memory card with other software. Failing to do so may result in not being able to save the files to your computer.

## Transferring Movies to the Computer

After you install the supplied software **Data Import Utility**, you can save movies to your computer.

- 1 Camcorder: Power the camcorder using the compact power adapter.
- 2 Camcorder: Set the power switch to MEDIA.
- 3 Camcorder: Open the desired AVCHD movie index screen ( 95).
- 4 Connect the camcorder to the computer using the supplied USB cable.
- 5 Camcorder: Touch [All (for PC only)].
- 6 Computer: Click the  icon on the desktop to start Data Import Utility.
- 7 Computer: Use Data Import Utility to save the movies onto the computer.
  - Follow the onscreen instructions and refer to the **Data Import Utility** Software Guide (PDF file).

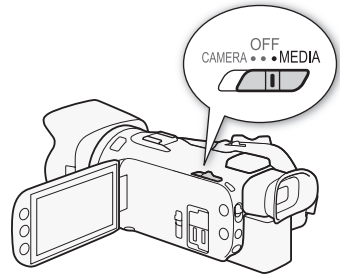

## Saving MP4 Movies and Photos Using ImageBrowser EX

With the supplied software **ImageBrowser EX** you can save MP4 movies and photos to your computer and easily organize them. Refer to the 'ImageBrowser EX Instruction Manual' (PDF file) for the full system requirements and other information.

Operating modes: CAMERA MEDIA | AVCHD MP4 | AUTO M CINEMA

## Installing the Software

Install the software before you connect the camcorder to the computer for the first time. Make sure to install the software even if you have a different version of **ImageBrowser EX** on your computer. The auto-update function of the software may make available to you features optimized for this camcorder. The 'ImageBrowser EX Instruction Manual' will also be installed with the software.

110



### POINTS TO CHECK

- Before installing the software, make sure your computer is connected to the Internet.
- 1 Insert the VIXIA CD-ROM into the computer's disc drive.
  - 2 Windows: Open the drive into which you inserted the CD-ROM using Windows Explorer.  
Mac OS: Use Finder and click on the CD-ROM icon.
  - 3 Click/Double-click the Disc\_Setup.exe icon .
  - 4 Click [ImageBrowser EX].
  - 5 Follow the onscreen instructions to select your area (continent), country/region and language.
    - Available options will vary depending on your country/region.
  - 6 In the main installer panel, click [Easy Installation].
    - For Windows users, if a User Account Control dialog box appears, follow the instructions.
  - 7 Follow the onscreen instructions to complete the installation.
    - During the installation process, you may be prompted to install Microsoft Silverlight. Follow the instructions to do so.
    - **CameraWindow** will also be installed.



### To check that the software was installed correctly

You can check that the software was installed correctly by looking for the ImageBrowser EX icon in the following location.

**Windows:** From the Start menu, All Programs ➤ Canon Utilities ➤ ImageBrowser EX

**Windows 8:** On the Desktop screen.

**Mac OS:** In the Dock, on the Desktop.



If you cannot find the icon, check your Internet connection and install the software again.

### First-time connection to a computer running Windows

The first time you connect the camcorder to the computer, you also need to select the **CameraWindow** auto-launch setting.

## Connecting the Camcorder to a Computer

- 1 Power the camcorder using the compact power adapter.
- 2 Open the MP4 movie index screen (📖 95) or photo index screen (📖 105).
- 3 Connect the camcorder to the computer using the supplied USB cable.
  - Camcorder: When the connection is successfully established, [USB Connection] appears on the screen.
- 4 Save the recordings onto the computer.
  - Refer to relevant sections in the 'ImageBrowser EX Instruction Manual', which can be accessed through the ? menu on the upper right of the software's screen.



### IMPORTANT

- **When the camcorder is connected to a computer:**
  - Do not open the double memory card slot cover and do not remove the memory card.
  - Do not access, change or delete any of the camcorder's folders or files directly from the computer as this may result in permanent data loss.
- Observe the following precautions while the ACCESS indicator is on or flashing. Failing to do so may result in permanent data loss.
  - Do not open the double memory card slot cover.
  - Do not disconnect the USB cable.
  - Do not turn off the camcorder or the computer.
  - Do not change the camcorder's operating mode.
- Operation may not work correctly depending on the specifications/settings of your computer.
- If you wish to use the recordings on your computer, make copies of them first. Use the copied files, retaining the originals.



### NOTES

- Depending on the computer, you may not be able to play back movies.
- The following types of MP4 scenes will be recognized as multiple files on other devices.
  - Scenes exceeding 4 GB
  - Scenes recorded at 35 Mbps exceeding 30 minutes
  - Scenes recorded with a recording mode other than 35 Mbps exceeding 1 hour
- **Users of Windows 8, Windows 7, Windows Vista, Windows XP and Mac OS X:**

Your camcorder is equipped with the standard Picture Transfer Protocol (PTP) allowing you to transfer photos (JPEG only) simply by connecting the camcorder to a computer using the supplied USB cable, without having to install the supplied software **ImageBrowser EX**.

## Copying Recordings Between Memory Cards

You can copy recordings from one memory card to the other.

### Copying Scenes from the Movie Index Screen

Operating modes: CAMERA MEDIA | AVCHD MP4 | AUTO M CINEMA

- 1 Open the desired movie index screen (📖 95).
  - To copy all the scenes recorded on a specific date, drag your finger left/right until a scene you want to copy appears.
- 2 Open the screen to copy scenes.  
[FUNC.] ➤ [Copy (A ↔ B)] or [Copy (B ↔ A)]
- 3 Touch the desired option and then touch [Yes].
  - When you select [Select], perform the following procedure to select the individual scenes you want to copy before touching [Yes].
  - Touch [Stop] to interrupt the operation while it is in progress.
- 4 Touch [OK].

#### To select individual scenes

- 1 Touch on the individual scenes you want to copy.
  - A checkmark ✓ will appear on the scenes you touch. The total number of selected scenes will appear next to the ☑ icon.
  - Touch a selected scene to remove the checkmark. To remove all checkmarks at once, touch [Remove All] ➤ [Yes].
- 2 After selecting all the desired scenes, touch [OK].

#### Options

**[date/folder name]** Copy all the scenes recorded on a particular date. For AVCHD movies, the date will appear in the control button. For MP4 movies, the folder name (📖 96) will appear in the control button, with the last four digits indicating the month and day.

**[Select]** Select individual scenes to copy.

**[All Scenes]** Copy all the scenes.

### Copying a Single Photo

Operating modes: CAMERA MEDIA | AVCHD MP4 | AUTO M CINEMA

- 1 In single photo view, select the photo you want to copy.
- 2 Touch the screen to display the playback controls.
- 3 Open the screen to copy photos.  
[FUNC.] ➤ [Copy (A ↔ B)] or [Copy (B ↔ A)]
- 4 Touch [📄 Proceed] and then touch [Yes].
  - The photo is copied.
- 5 Drag your finger left/right to select another photo to copy or touch [✕].



## Copying Photos from the Index Screen

Operating modes: CAMERA MEDIA | AVCHD MP4 | AUTO M CINEMA

- 1 Open the desired photo index screen (☐ 105).
- 2 Open the screen to copy photos.  
[FUNC.] ➤ [Copy ((A) • (B))] or [Copy ((B) • (A))]
- 3 Touch the desired option and then touch [Yes].
  - When you select [Select], perform the following procedure to select the individual photos you want to copy before touching [Yes].
  - Touch [Stop] to interrupt the operation while it is in progress.
  - The selected photos are copied.
- 4 Touch [OK].

### To select individual photos

- 1 Touch on the individual photos you want to copy.
  - A checkmark ✓ will appear on the photos you touch. The total number of selected photos will appear next to the ☑ icon.
  - Touch a selected photo to remove the checkmark. To remove all checkmarks at once, touch [Remove All] ➤ [Yes].
- 2 After selecting all the desired photos, touch [OK].

### Options

**[folder name]** Copy all the photos taken on a particular date. The folder name (☐ 96) will appear in the control button, with the last four digits indicating the month and day.

**[Select]** Select individual photos to copy.

**[All Photos]** Copy all the photos.

### ! IMPORTANT

- Observe the following precautions while the ACCESS indicator is on or flashing. Failing to do so may result in permanent data loss.
  - Do not open the double memory card slot cover.
  - Do not disconnect the power source or turn off the camcorder.
  - Do not change the camcorder's operating mode.

### i NOTES

- In the following cases, you will not be able to copy recordings to the memory card:
  - If the double memory card slot is open.
  - If the LOCK switch on the memory card is set to prevent writing.
  - If a file number (☐ 148) cannot be created because the number of folders and files in the memory card has reached its maximum.
- If there is not enough space on the memory card, as many photos as possible will be copied before stopping the operation.

## Converting Movies to MP4 Format

You can convert AVCHD movies into MP4 movies or even convert MP4 movies into smaller MP4 movies. This is convenient, for example, when you want to upload the MP4 movies to the Web. When you convert movies on one memory card, they will be saved to the other memory card. While converting movies, the camcorder can add a cinema-look filter to the converted movie.

114

Operating modes: CAMERA MEDIA | AVCHD MP4 | AUTO M CINEMA

1 Open the desired movie index screen (📖 95).

2 Open the screen to convert scenes.

[FUNC.] ➤ [Convert to MP4 ([A] ➤ [B])] or [Convert to MP4 ([B] ➤ [A])] ➤ [OK] ➤

Desired video quality (resolution and bit rate) of converted movies\*

\* Before selecting the video quality, you can touch [Join Scenes] to join the converted movies into one movie.

- When converting movies with a frame rate of 23.98P, the converted MP4 movie will also have a frame rate of 23.98P. When converting movies with other frame rates, the converted MP4 movie will have a frame rate of 29.97P.

3 Touch the individual scenes you want to convert.

- A checkmark ✓ will appear on the scenes you touch. The total number of selected scenes will appear next to the  icon.
- Touch a selected scene to remove the checkmark. To remove all checkmarks at once, touch [Remove All] ➤ [Yes].

4 After selecting all the desired scenes, touch [OK] and then touch [Next].

- To add a cinema-look filter (📖 50): Touch [FILTER 1] and then select the desired filter. Touch the button again to deactivate the filter.

5 Touch [START] to convert the scene.

- Touch [STOP] to interrupt the operation while it is in progress.

6 Touch [OK].

Recording mode before conversion		Video quality options
AVCHD	MP4	
28 Mbps LPCM (59.94P), 28 Mbps (59.94P)	35 Mbps (59.94P)	Cannot be converted
24 Mbps LPCM, 17 Mbps, 5 Mbps	24 Mbps, 17 Mbps	24 Mbps, 17 Mbps, 4 Mbps, 3 Mbps
–	4 Mbps	4 Mbps, 3 Mbps
–	3 Mbps	3 Mbps

### NOTES

- Scenes with a frame rate of 23.98P can be joined only with other scenes with a frame rate of 23.98P. They cannot be joined with scenes with other frame rates.
- While converting movies, video and audio signals will not be output from the camcorder's terminals.

## Copying Recordings to an External Video Recorder

Operating modes: CAMERA MEDIA | AVCHD MP4 | AUTO M CINEMA

### In High Definition

Connect the camcorder to Blu-ray Disc recorders and other AVCHD-compatible digital video recorders using the supplied USB cable to make perfect copies of your movies in high definition. If the external digital video recorder has an SD memory card slot\*, you can use the memory card to copy your movies without connecting the camcorder.

\* Make sure the external device is compatible with the type of memory card used.

### Connecting

- 1 Power the camcorder using the compact power adapter.
- 2 Open the desired AVCHD movie index screen (📖 95).
- 3 Connect the camcorder to the digital video recorder using the supplied USB cable.
- 4 Select the memory card that contains the scenes you want to copy.
  - Select an option other than [All (for PC only)].
  - Camcorder: When the connection is successfully established, [USB Connection] appears on the screen.

### Recording

Details will vary depending on the device used so be sure to refer to the instruction manual of the digital video recorder.

### In Standard Definition

You can copy your movies by connecting the camcorder to a VCR or a digital video recorder with analog audio/video inputs. Video output will be in standard definition, although the original scenes may be in high definition.

### Connecting

Connect the camcorder to the VCR using the supplied STV-250N Stereo Video Cable. Refer to *Connection Diagram* (📖 102).

## Recording

- 1 Camcorder: Power the camcorder using the compact power adapter.
- 2 External recorder: Load a blank cassette or disc and set the recorder to record pause mode.
- 3 Camcorder: Open the desired movie index screen (📖 95).
  - Verify that [👉] ➤ [Output Terminal] is set to [AV] AV OUT.
- 4 Camcorder: Locate the scene you wish to copy and pause the playback just before the desired scene.
- 5 Camcorder: Resume playback.
  - By default, the data code will be embedded in the output video signal. You can change this using the [👉] ➤ [Data Code] setting.
- 6 External recorder: Start recording when the scene you wish to copy appears; stop recording when it ends.
- 7 Camcorder: Stop playback.

# 9 Wi-Fi Functions

## Introduction to Wi-Fi

When you use the camcorder's Wi-Fi function to connect to a smartphone or tablet, you can wirelessly save, play back and upload your recordings. You can even use a smartphone or tablet (iOS or Android device<sup>1</sup>) as a remote control and record using the device's Web browser. Refer to *Glossary* (📖 142) for a definition of the frequently used terms in this text.

<sup>1</sup> "iOS device" is used in this text to refer to Wi-Fi-enabled iPhones, iPods and iPads while "Android device" refers to Wi-Fi-enabled Android smartphones and tablets.

### Wi-Fi connection **A**

When you use the Wi-Fi Remote app, you can use your iOS or Android device to remotely control the camcorder and make recordings (📖 120).



### Wi-Fi connection **B**

Wirelessly connect the camcorder to your iOS device, Android device or computer<sup>2</sup> and use the device's Web browser to view recordings in the camcorder (📖 126).

<sup>2</sup> You can also use a computer connected via an access point.



### Wi-Fi connection **C**

After you download the Movie Uploader app<sup>3</sup>, wirelessly connect the camcorder to an iOS device (📖 128) to save, play back and upload your recordings. You can even use this connection type if you plan to share videos on YouTube and Facebook on the go.

<sup>3</sup> The Movie Uploader app, provided by PIXELA, is available for free from the App Store.

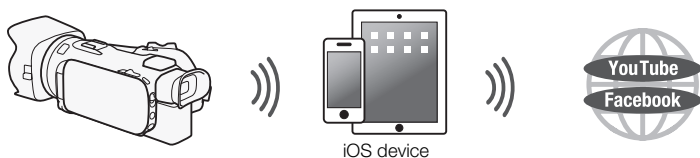

Wi-Fi connection **D**

Wirelessly connect the camcorder to a wireless router (access point) on a Wi-Fi network (📖 138). Use this connection if you plan to save your recordings on a computer or FTP server (📖 131).

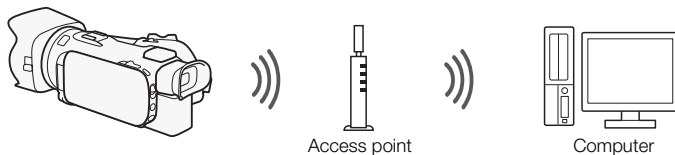

Wi-Fi connection **E**

Wirelessly connect the camcorder to a network and use the media server function and play back your recordings on a device connected to the network using a LAN cable (📖 130).

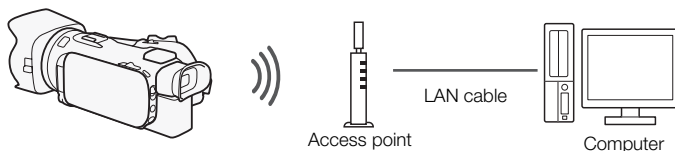

Wi-Fi connection **F**

Wirelessly connect the camcorder to a wireless router (access point) on a Wi-Fi network. Use this connection if you plan to connect to CANON iMAGE GATEWAY (📖 133). After doing so, you can even share videos on YouTube and Facebook.



**!** IMPORTANT

- Using an unprotected Wi-Fi network can expose your files and data to monitoring by unauthorized third parties. Be aware of the risks involved.
- Using the Wi-Fi functions outdoors while the camcorder is operating in the 5 GHz band may be prohibited depending on the laws of the country/region you are in.

**i** NOTES

- While using Wi-Fi functions other than remotely controlling the camcorder using the Wi-Fi Remote application, do not open the double memory card slot cover.
- While using Wi-Fi functions other than remotely controlling the camcorder using the Wi-Fi Remote application, the camcorder's automatic power off function will be disabled.

### Before using Wi-Fi functions

Based on the function, the camcorder will wirelessly connect to a Wi-Fi-enabled device, such as a smartphone, or directly to a Wi-Fi network via an access point (wireless router)\*. After selecting the function you want to use, follow the onscreen directions to connect the camcorder.

\* Depending on the manufacturer, the access point may be referred to using a different name, such as wireless LAN router or wireless network router.

- Make sure the optional WM-V1 Wireless Microphone is not attached to the camcorder. Wi-Fi functions are not available when the microphone is attached.

### About the Wi-Fi antenna

When using the camcorder's Wi-Fi functions, do not cover the Wi-Fi antenna with your hand or other object. Covering it may interfere with wireless signals.

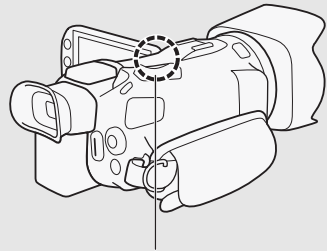

Wi-Fi antenna

### About the camcorder's Wi-Fi standard

The specifications of the camcorder's Wi-Fi standard are as follows.

Wi-Fi protocol, operating frequency: IEEE 802.11b/g/n-compliant, 2.4 GHz  
IEEE 802.11a/n-compliant, 5 GHz

Maximum data transfer rate: 11 Mbps (IEEE 802.11b)  
54 Mbps (IEEE 802.11a/g)  
150 Mbps (IEEE 802.11n)

These are theoretical values and actual data transfer rates may differ.

## Remote Operation Via the Wi-Fi Remote Application

You can operate the camcorder remotely via Wi-Fi Remote, a Web browser application that can be accessed using the Web browser\* of devices compatible with Wi-Fi networks\*\*. The Wi-Fi Remote application lets you monitor the image through live view, start and stop recording, and remotely control the shooting mode, exposure, white balance, aperture, gain, shutter speed, focus and zoom.

\* A Web browser that has JavaScript and cookies enabled is required.

\*\* For details about compatible devices, operating systems, Web browsers, etc. please visit your local Canon Web site.

Operating modes: **CAMERA** **MEDIA** | **AVCHD** **MP4** | **AUTO** **M** **CINEMA**

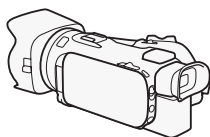

iOS or Android device

### Setting the Camcorder's Password

For Wi-Fi functions that require an iOS or Android device, you will need to set the camcorder's password. After you enter the password once, you will not need to enter it again (unless you reset or overwrite the camcorder's settings).

1 Open the [Smartphone Connection] screen.

[FUNC.] ➤ [MENU] ➤ [Wi-Fi] / [Wi-Fi]\* ➤ [Wi-Fi] ➤ [Smartphone Connection]

\* Touch [Wi-Fi] for the Remote Browse and Media Server functions.

2 Touch the camcorder's password.

3 Enter an 8-character password and touch [OK].

- To enter a password, use the virtual keyboard (132).

4 Touch [OK] and then touch [X].



#### NOTES

- After setting the camcorder's password, it will not be displayed on the screen for you to check. Please make a note of your password so that you do not forget it. To change the password, perform the procedure above again.



## Operating the Camcorder Remotely

- 1 Camcorder: Open the [Wi-Fi Remote] screen.  
[FUNC.] ➤ [Wi-Fi] Wi-Fi Remote]
- 2 Camcorder: Touch [ON].
  - The camcorder's SSID (network name) and the URL to be entered in the Web browser will appear.
  - The camcorder will be ready to connect with the device.
- 3 iOS/Android device: Activate Wi-Fi in the settings screen.
  - The network names of detected access points will appear.
- 4 iOS/Android device: Touch the access point with the same SSID displayed in step 2.
  - If you have performed this procedure before and you have not changed the camcorder's password, the connection will be established automatically.
- 5 iOS/Android device: Enter the camcorder's password set previously.
- 6 iOS/Android device: Enter the URL displayed on the camcorder's screen into the Web browser to start the Wi-Fi Remote application.
  - The Wi-Fi Remote screen will appear.
  - As long as you do not change the port settings, the URL is always the same so you may find it convenient to bookmark it.
- 7 Camcorder: Touch [X].
  - When the connection has been established, [Wi-Fi] appears on the camcorder's screen. If an iOS or Android device is not connected, the icon will appear in yellow.
- 8 iOS/Android device: Operate the controls on the screen while viewing the image from the camcorder.
- 9 Camcorder: Touch [FUNC.] ➤ [Wi-Fi Remote] and then touch [Off] when finished.
  - The Wi-Fi Remote application will end.

## Wi-Fi Remote Onscreen Controls and Displays

The Wi-Fi Remote application features advanced controls for devices with larger screens and basic controls for devices with smaller screens. For more details on each of the functions, see the reference page in parentheses after the function name.

Advanced controls

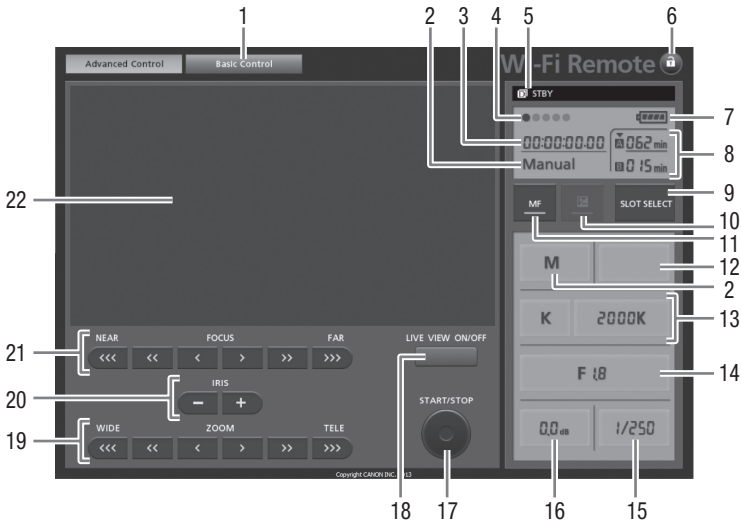

When the recording program is set to [Av Aperture-Pri. AE]:

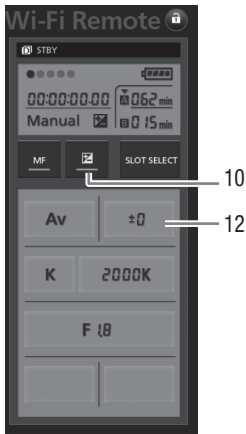

- ① Screen selection tab: Switch between advanced controls and basic controls.
- ② Recording program (📖 63, 70)
- ③ Time code (📖 73)
- ④ Wi-Fi Remote connection status
- ⑤ Operation (📖 156)
- ⑥ 🔒 (key lock): Press to lock all the controls on the application's screens. When pressed, the icon turns orange and the entire screen becomes grayed out.
- ⑦ 🔋 Remaining battery level (📖 156)

- ⑧ Memory card status/Remaining recording time: The currently selected memory card slot will be indicated with a ▼ mark above it.
- ⑨ SLOT SELECT (memory card slot selection) button
- ⑩ Exposure mode button (📖 66)
- ⑪ MF (manual focus) button (📖 52)
- ⑫ Exposure compensation value button (📖 66)
- ⑬ White balance mode and setting buttons (📖 68)
- ⑭ Aperture button (📖 63, 65)
- ⑮ Shutter speed (📖 63, 65)
- ⑯ Gain (📖 65)
- ⑰ START/STOP button (📖 38)
- ⑱ LIVE VIEW ON/OFF button
- ⑲ ZOOM (zoom adjustment) buttons (📖 57)
- ⑳ IRIS (aperture adjustment) buttons (📖 63, 65)
- ㉑ FOCUS (focus adjustment) buttons (📖 52)
- ㉒ Live view image area

## Basic controls

Use the basic controls when using the application on devices with smaller screens. With the basic controls, the following functions are available: turning live view on and off, starting and stopping recording, zoom and key lock.



## Remote Operation Using Wi-Fi Remote

### Recording movies

- 1 Press [LIVE VIEW ON/OFF] to show the camcorder's live view image on the Wi-Fi Remote screen.
- 2 Press [START/STOP] to begin recording.
  - The recording operation indicator changes from [STBY] to [●REC], the center of the START/STOP button lights up in red and the time code display starts running on the Wi-Fi Remote screen.
  - Press [START/STOP] again to pause the recording.

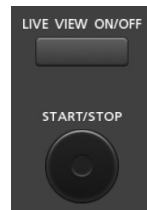

## Selecting the recording program

- 1 Press the recording program button.
  - The recording programs will appear.
- 2 Select the desired recording program.



## Adjusting the exposure compensation value

- 1 Touch [☒].
- 2 Press the exposure compensation value button.
  - The exposure compensation screen will appear.
- 3 Select the desired exposure compensation value.
  - The selected value will be displayed on the Wi-Fi Remote screen and will be applied to the camcorder.



## Adjusting the white balance

- 1 Press the white balance mode button.
  - The white balance modes will appear.
- 2 Select the desired white balance mode.

If you selected **K**:

- 3 Press the color temperature and then select the desired value from the list.
  - The selected value will be displayed on the Wi-Fi Remote screen and will be applied to the camcorder.



If you selected **W1** or **W2**:

- 3 Point the camcorder at a white object so that it fills the whole screen.
  - Use the same lighting conditions you plan to use when recording.
  - Make sure the white object fills the screen until the procedure is completed.
- 4 Press [☒].
  - If a custom white balance has not yet been stored, [☒] will flash slowly.
  - During the procedure, [☒] will flash quickly. When it stops flashing, the procedure is completed and the setting will be applied to the camcorder.

## Adjusting the aperture

- 1 Press the aperture button.
  - The available aperture values will appear.
- 2 Select the desired aperture value.
  - Alternatively, you can press IRIS [+] to open the aperture or IRIS [-] to close the aperture in 1/4-stop increments. (Onscreen displays will show the closest 1/3-stop aperture value.)
  - The selected value will be displayed on the Wi-Fi Remote screen and will be applied to the camcorder.

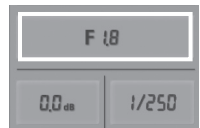

## Adjusting the gain

### 1 Press the gain button.

- The available gain values will appear.

### 2 Select the desired gain value.

- The selected value will be displayed on the Wi-Fi Remote screen and will be applied to the camcorder.



## Adjusting the shutter speed

### 1 Press the shutter speed button.

- The available shutter speed values will appear.

### 2 Select the desired shutter speed value.

- The selected value will be displayed on the Wi-Fi Remote screen and will be applied to the camcorder.

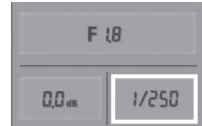

## Adjusting the focus

### 1 Touch MF.

### 2 Press one of the focus controls to adjust the focus as necessary.

- Press one of the controls on the [NEAR] side to focus closer or one of the controls on the [FAR] side to focus farther away.
- There are three levels of adjustment - [ $\leftarrow$ ]/[ $\rightarrow$ ] is the smallest and [ $\lll$ ]/[ $\ggg$ ] the largest.





## Adjusting the zoom

Press one of the zoom controls to adjust the zoom position as necessary.

- Press one of the controls on the [WIDE] side to zoom out or one of the controls on the [TELE] side to zoom in.
- There are three levels of adjustment - [ $\leftarrow$ ]/[ $\rightarrow$ ] is the slowest and [ $\lll$ ]/[ $\ggg$ ] is the fastest.



## NOTES

- Depending on the network setup and conditions, there may be a delay when using live view and configuring settings.
- When color bars are being displayed, live view updates will stop.
- When Wi-Fi remote is activated,   [Time Zone/DST], [Date/Time] and [GPS Auto Time Setting] are not available. If [GPS Auto Time Setting] had previously been set to [Auto Update], it will automatically be set to [Disable] and cannot be changed. It will return to its previous setting when you deactivate Wi-Fi Remote.
- Only one device may be connected to the camcorder at a time.

## Remote Browse: Viewing Recordings Using a Web Browser on Your iOS or Android Device

With the Remote Browse function, you can use the Web browser on your iOS device, Android device, computer or similar device to show a list of recordings in the camcorder, play them back and even download them.\* This conveniently allows you to view your recordings while you are out.

\* Depending on the device, OS, browser, movie format and recording mode, you may not be able to play back or download recordings. For details, visit your local Canon Web site.

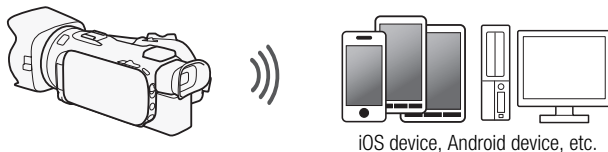

Operating modes: CAMERA MEDIA | AVCHD MP4 | AUTO M CINEMA

- 1 Camcorder: Open the desired index screen (📖 95).
- 2 Camcorder: Open the [Playback via Browser] screen.  
[MENU] ➤ [📶] ➤ [Wi-Fi] ➤ [Playback via Browser]
  - The camcorder's SSID (network name) will appear.
  - The camcorder will be ready to connect with the device.
  - To set or change the camcorder's password, perform the procedure in *Setting the Camcorder's Password* (📖 120) starting from step 2.
- 3 iOS/Android device: Activate Wi-Fi in the settings screen.
  - The network names of detected access points will appear.
- 4 iOS/Android device: Touch the access point with the same SSID displayed in step 2.
  - If you have performed this procedure before and you have not changed the camcorder's password, the connection will be established automatically.
- 5 iOS/Android device: Enter the camcorder's password set previously.
  - [Connected] will appear on the camcorder's screen and the connection will be established.
- 6 iOS/Android device: Start the Web browser.
- 7 iOS/Android device: Enter the URL that appears on the camcorder's screen into the Web browser's address bar.
  - The Remote Browse screen will appear.
  - As long as you do not change the port settings, the URL is always the same so you may find it convenient to bookmark the URL.
- 8 iOS/Android device: Touch [A AVCHD] on the upper left of the screen and open the desired index screen. Next, touch the desired recording.
  - For movies, touch the playback icon to start playback. For photos, the photo will be displayed.
- 9 Android device: Touch 📁 to save the recording on the device.
  - The icon above will not appear on an iOS device. To save recordings using an iOS device, use the Movie Uploader app (📖 128).
- 10 iOS/Android device: Touch 🏠 to return to the index screen.
- 11 Camcorder: Touch [End] ➤ [OK] when finished.

 NOTES

- The following types of MP4 scenes will be recognized as multiple files on other devices.
  - Scenes exceeding 4 GB
  - Scenes recorded at 35 Mbps exceeding 30 minutes
  - Scenes recorded with a recording mode other than 35 Mbps exceeding 1 hour
- Only one device may be connected to the camcorder at a time.

## Uploading Recordings Using an iOS Device

Using the Movie Uploader app\* for iOS devices, you can wirelessly connect the camcorder to the device to upload your movies to YouTube and your movies and photos to Facebook even when you are away from your home network. You can even save\*\* and play back MP4 movies and photos on the iOS device.

\* The Movie Uploader app, provided by PIXELA, is available for free from the App Store.

\*\* Not available for MP4 movies recorded at 35 Mbps.

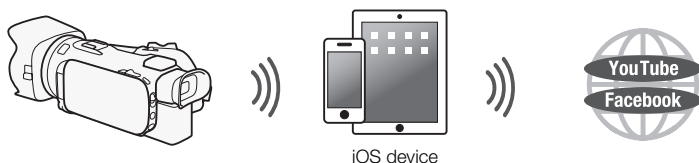

Operating modes: **CAMERA** **MEDIA** | **AVCHD** **MP4** | **AUTO** **M** **CINEMA**

### POINTS TO CHECK

- Before you perform this procedure for the first time, install the Movie Uploader app on your iOS device. The app can be downloaded for free from the following site.  
<http://appstore.com/movieuploader>

1 Camcorder: Open the desired movie index screen (📖 95).

2 Camcorder: Open the [Movie Uploader] screen.

[MENU] ➤  ➤ [Wi-Fi] ➤ [Movie Uploader]

- The camcorder's SSID (network name) will appear.
- The camcorder will be ready to connect with the iOS device.
- To set or change the camcorder's password, perform the procedure in *Setting the Camcorder's Password* (📖 120) starting from step 2.

3 iOS device: Activate Wi-Fi in the settings screen.

- The network names of detected access points will appear.

4 iOS device: Touch the access point with the same SSID displayed in step 2.

- If you have performed this procedure before and you have not changed the camcorder's password, the connection will be established automatically.

5 iOS device: Enter the camcorder's password set previously.

- [Connected] will appear on the camcorder's screen and the connection will be established.

6 iOS device: Use the Movie Uploader app to upload the camcorder's movies (and photos, if applicable).

- You can also play back or save MP4 movies.

7 Camcorder: Touch [End] ➤ [OK] when finished.

- After the connection has ended, the index screen will appear.



 NOTES

- Depending on factors such as the wireless network conditions, it can take some time to upload video files.
- The procedure above may differ depending on the version of iOS you are using.
- For details about the Movie Uploader app, visit PIXELA's Web site.  
<http://www.pixela.co.jp/oem/canon/e/movieuploader/> (English only)
- The following types of MP4 scenes will be recognized as multiple files on other devices.
  - Scenes exceeding 4 GB
  - Scenes recorded at 35 Mbps exceeding 30 minutes
  - Scenes recorded with a recording mode other than 35 Mbps exceeding 1 hour

## Playback on a Computer

Using the Media Server function, you can wirelessly view your movies and photos from your computer or similar device. You will need an access point connected to your home network and software installed on your computer that can play back movies and photos on the media server. We recommend that you connect the computer to the access point using a LAN cable. Refer also to the instruction manuals for the computer, software and access point.

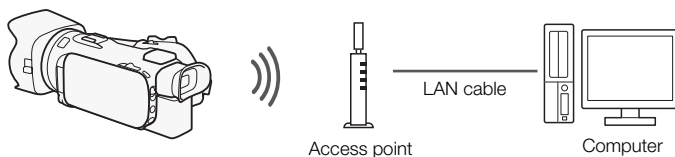

Operating modes: **CAMERA** **MEDIA** | **AVCHD** **MP4** | **AUTO** **M** **CINEMA**

- 1 Camcorder: Open the desired movie index screen (☞ 95).
- 2 Camcorder: Open the [Media Server] screen.  
[MENU] ➤ [Wi-Fi] ➤ [Media Server]
- 3 Camcorder: Touch [OK].
  - The camcorder will connect to the access point selected in *Wi-Fi Connection Using an Access Point* (☞ 138).
- 4 Camcorder: When [Save the access point] appears on the screen, touch [OK].
- 5 Camcorder: Perform the connection in *Wi-Fi Connection Using an Access Point* (☞ 138).
  - [Connected] will appear on the camcorder's screen and the connection will be established.
  - After the connection is established, you can touch [View Information] to view the access point's SSID, connection protocol, and the camcorder's IP address and MAC address. You can also select the access point to which the camcorder will connect.
- 6 Computer: Select your camcorder's model number from the list of servers.
- 7 Computer: Select the folder for the desired memory card and play back the movies and photos.
- 8 Camcorder: Touch [End] ➤ [OK] when finished.

### **i** NOTES

- Depending on the access point's settings and capability, playback may take time to start or may not appear smooth. For details, refer to *Troubleshooting* (☞ 157).
- The following types of MP4 scenes will be recognized as multiple files on other devices.
  - Scenes exceeding 4 GB
  - Scenes recorded at 35 Mbps exceeding 30 minutes
  - Scenes recorded with a recording mode other than 35 Mbps exceeding 1 hour

## Transferring Files to a Computer or FTP Server

You can wirelessly transfer files (recordings) directly to a computer or an FTP server. You will need a correctly configured FTP server. During the manual setup procedure, you will need to enter the FTP server's IP address, port, user name, password and file transfer destination (where the files will be transferred to).

To enter text for the various settings, use the virtual keyboard (📖 132).

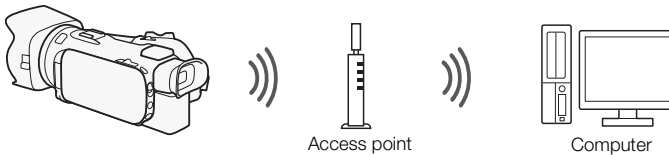

Operating modes: CAMERA MEDIA | AVCHD MP4 | AUTO M CINEMA

- 1 Camcorder: Open the desired movie index screen (📖 95).
- 2 Open the [FTP Transfer] screen.  
[MENU] ➤ [Wi-Fi] ➤ [Wi-Fi] ➤ [FTP Transfer]
- 3 Enter the FTP server's IP address for [FTP Server] and the port number for [Port].
- 4 Touch [Next].
- 5 Enter the user name and password and then touch [Next].
- 6 Enter [/] for [Destination Folder] and then touch [OK].
  - Depending on the FTP server's settings, the required text for the port number and destination folder may differ. Check the settings on your FTP server.
  - The camcorder will connect to the access point selected in *Wi-Fi Connection Using an Access Point* (📖 138).
- 7 When [Save the access point] appears on the screen, touch [OK] and then perform the procedure in *Wi-Fi Connection Using an Access Point* (📖 138).
- 8 Touch the desired memory card and then touch [OK].
  - You can select both memory cards.
  - Touch [All files] to transfer all the recordings or [New files] to transfer only those recordings that have not been previously transferred.
  - Once connected, the wireless transfer will begin.
  - You can touch [Stop] and then [X] to stop the wireless transfer while it is in progress. However, depending on when you stop the operation, some files will be transferred.
- 9 Touch [OK].
  - The wireless transfer will end.

### Using the virtual keyboard

When you need to enter text for various settings, touch the text field and a virtual keyboard will appear on the screen. You must use the touch screen to operate the virtual keyboard. The illustrations below explain the various keys you can use.

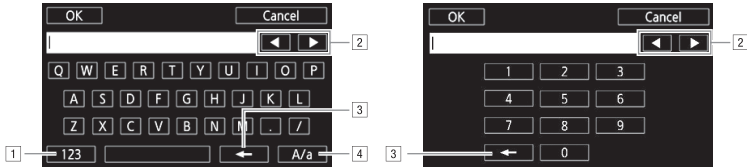

- 1 Switch between letters and numbers/special characters.
- 2 Change the position of the cursor.
- 3 Delete the character to the cursor's left (backspace).
- 4 Caps Lock. When the numerical keyboard is displayed, [#%?] switches between set 1 and set 2 of special characters.

### ! IMPORTANT

- Observe the following precautions when transferring files. Failing to do so may interrupt the transfer and incomplete files may remain at the transfer destination.
  - Do not open the double memory card slot cover.
  - Do not disconnect the power source or turn off the camcorder.
- If the file transfer is interrupted, select [New files] and perform the file transfer again.
- If incomplete files remain at the transfer destination, check the content and make sure they are safe to delete before deleting them.

### i NOTES

- Depending on the access point's settings and capability, it may take some time to transfer files.

## Sharing Recordings with CANON iMAGE GATEWAY

After you register for CANON iMAGE GATEWAY\*, you will be able to access various Web services\*\*. You will be able to upload movies and photos to online albums, share the albums on Twitter, upload movies to Facebook and YouTube, send links to your online albums by e-mail to friends and family, and more! To use this function, you will need an access point connected to the Internet.

\* Availability differs from area to area.

\*\* "Web services" is used in this text to refer to various Internet services supported by CANON iMAGE GATEWAY.



### CANON iMAGE GATEWAY

CANON iMAGE GATEWAY is a site that provides various photo-related services for owners of qualified Canon products. After you complete the free registration online, you can use the Web services, create online photo albums, and more. Visit Canon's Web site for information on registration and countries/regions where you can use this service.  
<http://canon.com/cig>



### General requirements

- Computer with the supplied software **ImageBrowser EX** and **CameraWindow** correctly installed. For details on installing the software, refer to *Saving MP4 Movies and Photos Using ImageBrowser EX* (📖 109).
- Completed free registration online for CANON iMAGE GATEWAY.
- Account settings for YouTube, Facebook and Twitter (depending on the services you plan to use).

### Setting the Desired Web Services in the Camcorder

Using the supplied software **CameraWindow**, log in to CANON iMAGE GATEWAY and set the Web services you want to use. Refer to 'CameraWindow Instruction Manual' for details on using the software.

Operating modes: CAMERA MEDIA | AVCHD MP4 | AUTO M CINEMA

- 1 Open the desired MP4 movie index screen (📖 95).
  - Alternatively, you can open the photo index screen (📖 105).
- 2 Connect the camcorder to the computer using the supplied USB cable.
- 3 Computer: Start CameraWindow.
  - Windows: If the AutoPlay dialog box appears, click Downloads Images From Canon Camera to open the main screen.
  - Mac OS: **CameraWindow** will automatically start and the main screen will appear.
- 4 Computer: Click Camera Settings > Set Up Web Services.

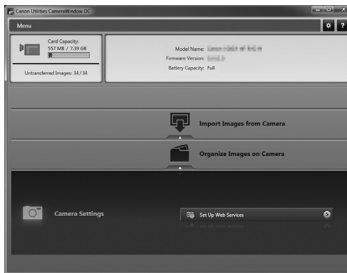

5 Computer: Enter your account information > click Login.

- After you log in, the camera settings screen will appear.

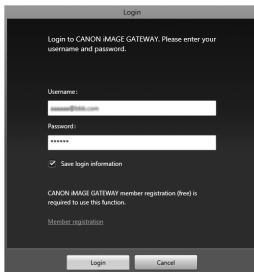

6 Computer: Click Edit Web Services > Desired Web service > Edit > Follow the onscreen instructions and enter your account information for the selected Web service > Set > Finish.

- The camera settings screen will appear again.

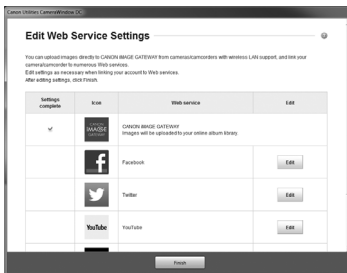

7 Computer: Select the Web service to set in the camcorder and then click .

- Repeat to select multiple Web services.
- The selected Web services will appear in the camera panel.
- You can click ▲ and ▼ to change the order in which the Web services appear in the camcorder.

8 Computer: Click Menu in the upper left.

- The selected Web services will be set in the camcorder and the **CameraWindow** menu screen will appear.

9 Computer: Exit CameraWindow and then end the connection between the camcorder and computer.

**Available Web services\***

Web service	What you can do
CANON iMAGE GATEWAY	Upload MP4 movies and photos to your online photo albums.
Facebook	You can upload movies and photos directly to Facebook.
Twitter	Share recordings on Twitter. You can post a link to your online photo album on your Twitter feed.
YouTube	You can upload movies directly to YouTube.
E-mail notification	You can send e-mail notifications with a link to your online photo album. You can even set up to 20 e-mail addresses.

\* The available Web services may be updated. For details, refer to the help module of CANON iMAGE GATEWAY.

 NOTES

- If the date set in the camcorder is not correct, the camcorder cannot connect to CANON iMAGE GATEWAY. Make sure the date is correct before trying to establish a connection.
- When the number of set Web services reaches maximum, you cannot set any more. Delete unnecessary Web services and then set the desired Web service.
- You cannot set multiple accounts for Web services other than e-mail.
- CANON iMAGE GATEWAY, Facebook, Twitter and e-mail notifications are available only for MP4 movies and photos when you use CameraWindow.

**Sharing Your Recordings Using Web Services**

Conveniently share your recordings with family and friends using Web services. You can upload movies to YouTube and your movies and photos to Facebook. Also, you can upload movies and photos to online albums on CANON iMAGE GATEWAY. Then, you can post links to those online albums on Twitter.

Operating modes:   |   |   

**1 Open the [To Web Service] screen.**

[MENU] ➤  ➤ [Wi-Fi] ➤ [To Web Service]

**2 Select the desired Web service.**

- Select one of the available Web services other than e-mail.
- You can send an e-mail notification of the when your movies and photos are uploaded ( 136).

**3 Touch the type of upload (AVCHD movie, MP4 movie or photo) and the memory card on which the desired recordings are saved.****4 Touch the scene or photo to upload.**

- If you are uploading to YouTube, read the YouTube agreement carefully and touch [I Agree] if you agree.
- The upload will begin automatically.
- You can touch [Stop] and then [**X**] to cancel the wireless transfer while it is in progress.

**5 Touch [OK].**

### Checking your uploads using CANON iIMAGE GATEWAY Library

You can use the CANON iIMAGE GATEWAY Library screen to see the movies and photos you uploaded. You can also check what files you have sent and the various settings for the Web services. For details on CANON iIMAGE GATEWAY, refer to the Help module (in the upper right of the screen).

### NOTES

- **Upload limits for movies:** The maximum length of movies you can upload is 10 minutes (15 minutes for YouTube); the maximum size is less than 2 GB.
- For movies, you can upload one at a time; for photos, up to 10 at a time.
- Depending on the access point's settings and capability, it can take some time to upload files.

### Sending Links to Recordings by E-mail

After you upload movies and photos to online albums on CANON iIMAGE GATEWAY, you can send links to those albums by e-mail to family and friends.



Operating modes: CAMERA MEDIA | AVCHD MP4 | AUTO M CINEMA

#### To set e-mail addresses in the camcorder

You can set up to 20 e-mail addresses in the camcorder.

- 1 **Computer:** Start CameraWindow and log in to CANON iIMAGE GATEWAY.
  - Refer to *Setting the Desired Web Services in the Camcorder* (133).
- 2 **Computer:** Click Edit Web Services > Desired Web service > Edit > Follow the onscreen instructions and set the e-mail address > Set > Finish.
- 3 **Computer:** Select the Web service to set in the camcorder and then click .
  - Repeat to select multiple Web services.
  - The selected Web services will appear in the camera panel.
  - You can click ▲ and ▼ to change the order in which the Web services appear in the camcorder.
- 4 **Computer:** Click Menu in the upper left.
  - The selected Web services will be set in the camcorder and the **CameraWindow** menu screen will appear.
- 5 **Computer:** Exit CameraWindow and then end the connection between the camcorder and computer.

#### To set e-mail notifications

- 1 **Camcorder:** Open the [To Web Service] screen.  
[MENU] ➤  ➤ [Wi-Fi] ➤ [[To Web Service]
- 2 **Touch** .
- 3 **Touch** the desired destination.
- 4 **Perform** steps 3 to 5 of *Sharing Your Recordings Using Web Services* (135).



 NOTES

- E-mail addresses must consist of single-byte characters. Only e-mail addresses with 16 or less characters before the @ mark can be set in the camcorder.

## Wi-Fi Connection Using an Access Point

The camcorder can connect to a Wi-Fi network using a wireless router (access point) and even remember the settings for the four most recently used access points.

### General requirements

- Correctly configured router that complies with the 802.11 a/b/g/n protocol and is Wi-Fi certified (bears the logo shown on the right) and a home network.



Operating modes: **CAMERA** **MEDIA** | **AVCHD** **MP4** | **AUTO** **M** **CINEMA**

Select the desired connection method.

### Options

**[WPS: Button]\*** Simply press and hold the WPS button on your access point and then touch the camcorder's screen. This is the easiest connection method if you are using a WPS-compatible router. For details, see *Wi-Fi Protected Setup (WPS)* (□ 138).

**[WPS: PIN Code]\*** Access the access point's configuration screen using your Web browser. The camcorder will give you a PIN code, which you will enter into the browser. You will need a WPS-compatible router and a computer or other device connected to it. For details, see *Wi-Fi Protected Setup (WPS)* (□ 138).

**[Search for Access Points]** Following the camcorder's onscreen instructions, you select your access point from a list of detected SSIDs and then enter your password. For details, see *Searching for Access Points* (□ 139).

**[Manual Setup]** You manually enter the access point's SSID, password and other network settings. This method is recommended for advanced users of Wi-Fi networks. For details, see *Manual Setup* (□ 140).

\* WPS, which stands for Wi-Fi Protected Setup, is a standard that makes connecting to a access point easier.

## Wi-Fi Protected Setup (WPS)

If your access point is WPS-compatible (bears the logo shown on the right), connecting the camcorder to it can be very easy. With WPS, you will either use the [WPS: Button] method or [WPS: PIN Code] method (see the description in the previous section). If you cannot successfully connect the camcorder using WPS, try using the [Search for Access Points] method. Refer also to the router's instruction manual.



### 1 [WPS: Button] method

Press and hold the WPS button on the access point.

- Depending on the access point, the amount of time required may differ.
- Make sure the router's WPS function is activated.

### [WPS: PIN Code] method

From a computer or similar device connected to the access point, use the Web browser to open the router's WPS settings screen. After the 8-digit PIN code appears on the camcorder's screen, enter it into your router's WPS settings screen.

**2 Within 2 minutes, touch [OK] on the camcorder's screen.**

- The camcorder will connect to the access point.
- You can touch [Stop] and then [OK] to interrupt the Wi-Fi Protected Setup while it is in progress.
- After the connection is established, continue using the function you were previously using. For details, refer to the procedure in *Playback on a Computer* (□ 130), *Transferring Files to a Computer or FTP Server* (□ 131) or *Viewing and Changing Wi-Fi Settings* (□ 141), as necessary.

**Searching for Access Points**

The camcorder will automatically detect access points in the vicinity. After you select the desired access point, you simply enter the password (encryption key) to connect the camcorder. To enter text for the various settings, use the virtual keyboard (□ 132).

**1 Note the access point's network name (SSID) and encryption key.****2 When the detected access points appear, touch [OK].**

- You can touch [▲] and [▼] to go through the detected access points.

**3 In the [Encryption Key] field, enter the encryption key and then touch [OK].**

- If the access point selected in step 2 did not have a [🔒] icon, this step is not necessary.

**4 Touch [OK] twice.**

- After the connection is established, continue using the function you were previously using. For details, refer to the procedure in *Playback on a Computer* (□ 130), *Transferring Files to a Computer or FTP Server* (□ 131) or *Viewing and Changing Wi-Fi Settings* (□ 141), as necessary.

## Manual Setup

Perform this procedure to manually configure the wireless connection settings. This may be necessary, for example, if your access point's network name (SSID) cannot be detected due to the stealth function being enabled. Manual setup is for advanced users of Wi-Fi networks.

To enter text for the various settings, use the virtual keyboard (📄 132).

- 1 In the [SSID] field, enter the SSID and then touch [OK] ➤ [Next].
- 2 In the [Authentication/Encryption Method] field, touch [OPEN NONE] and then touch the desired method.
  - If you selected [OPEN WEP], the WEP index is 1.
- 3 In the [Encryption Key] field, enter the encryption key and then touch [OK] ➤ [Next].
  - In step 2, if you selected [OPEN NONE], entering the encryption key is not necessary.
- 4 Touch [Automatic] or [Manual] to select how to obtain the IP address.
  - If you selected [Automatic], proceed to step 11.
- 5 For the [IP Address] and [Subnet Mask] fields, touch [0.0.0.0] and then touch [▲]/[▼] to change the value and then touch [Next].
  - Touch the next field to change the value, as necessary.
- 6 Touch [Next].
- 7 In the [Default Gateway] field, touch [0.0.0.0] and then touch [▲]/[▼] to change the value and then touch [Next].
  - Touch the next field to change the value, as necessary.
- 8 Touch [Next].
- 9 For the [Primary DNS Server] and [Secondary DNS Server] fields, touch [0.0.0.0] and then touch [▲]/[▼] to change the value and then touch [Next].
  - Touch the next field to change the value, as necessary.
- 10 Touch [Next].
- 11 Touch [OK].
  - After the connection is established, continue using the function you were previously using. For details, refer to the procedure in *Playback on a Computer* (📄 130), *Transferring Files to a Computer or FTP Server* (📄 131) or *Viewing and Changing Wi-Fi Settings* (📄 141), as necessary.

### NOTES

- The Wi-Fi functions available and the setup method will vary depending on the specifications and characteristics of the Wi-Fi network you want to use.

## Viewing and Changing Wi-Fi Settings

When the camcorder is connected to an access point or to a Wi-Fi-enabled device, you can view the Wi-Fi connection settings and even change them, if necessary.

To enter text for the various settings, use the virtual keyboard (📖 132).

Operating modes: CAMERA MEDIA | AVCHD MP4 | AUTO M CINEMA

1 Open the [Wi-Fi] screen.

[MENU] ➤  ➤ [Wi-Fi]

To view the smartphone's connection settings

2 Touch [Smartphone Connection].

- The camcorder's SSID will appear.
- Touch [▲] and [▼] to view more information.
- You can change the camcorder's password, port and operating frequency (2.4 GHz or 5 GHz).

To view the access point's connection settings

2 Touch [Access Point Connection].

- The four access points' SSID settings in the camcorder's memory will appear.
- To add an access point, touch [Not configured] and then perform the procedure in *Wi-Fi Connection Using an Access Point* (📖 138). After doing so, the screen from this step will appear again.

3 Touch  next to the SSID of the access point whose settings you want to view.

- The access point's settings will appear.
- Touch [▲] and [▼] to view more information.
- To delete the settings, touch [Edit] ➤ [Delete] ➤ [Yes].

4 If necessary, touch [Edit] ➤ [Manual Setup] to change the settings and then perform the procedure in *Manual Setup* (📖 140).

To view the FTP server's connection settings

2 Touch [FTP Server Settings].

- The FTP server's settings will appear.
- Touch [▲] and [▼] to view more information.

3 If necessary, touch [Edit] to change the settings.

**Glossary**

This is a glossary of some of the basic terms used frequently in this chapter. The documentation for your access point may also contain a glossary you can refer to.

**Access Point**

A wireless access point (WAP) is a device that allows wireless devices, like your camcorder, to connect to a wired network (including to the Internet) using the Wi-Fi standard. In most cases, this will be your wireless router.

**FTP Server**

An FTP server is an application running on a computer that allows users to transfer files to and from that computer.

**IP Address**

Exclusive number assigned to each device connected to the network.

**SSID**

Service Set Identifier. This is simply the public name of a Wi-Fi network.

**WPS**

Wi-Fi Protected Setup. Standard for easy and secure setup of Wi-Fi networks created by the Wi-Fi Alliance.

# 10 Additional Information



































## Appendix: Menu Options Lists

Menu items not available appear grayed out. For details about how to select an item, refer to *Using the Menus* (□ 31). For details about each function, see the reference page. Menu options without a reference page are explained after the tables. Underlined menu options indicate default values.

143

### FUNC. Panel

FUNC. Panel -  Mode

Control Button	Setting options/Function	AUTO	M	CINEMA	
[MENU]	Open the setup menus	●	●	●	32
[Rec. Programs]	[ <b>P</b> Programmed AE], [ <b>Tv</b> Shutter-Pri. AE], [ <b>Av</b> Aperture-Pri. AE], [ <b>M</b> Manual Exposure]	–	●	●	63, 65
	[  Portrait], [  Sports], [  Night Scene], [  Snow], [  Beach], [  Sunset], [  Low Light], [  Spotlight], [  Fireworks]	–	●	–	70
[  BLC Always On]	[ON], [ <u>OFF</u> ]	–	●	●	67
[WB White Balance]	[ <b>AWB</b> Automatic], [  Daylight], [  Shade], [  Cloudy], [  Fluorescent], [  Fluorescent H], [  Tungsten], [ <b>K</b> Color Temperature], [  Set 1], [  Set 2]	–	●	●	68
[ <b>AGC</b> AGC Limit]	[ <b>A</b> Automatic], [ <b>M</b> Manual]	–	●	●	62
[  Focus]	Touch AF frame; [ <b>MF</b> ] (manual focus): Toggle on or <u>off</u> ; [ <b>PEAK</b> ] (peaking): Toggle on or off; [  ] (settings): [Peaking and B&W], [Peaking Color] When [ <b>MF</b> ] is on - [SET] (focus preset) When [SET] is on - [ON] (return to preset focus position)	–	●	●	52
[  Exposure]	Touch AE frame; [ <b>M</b> ] (exposure compensation): Toggle on or off, [  ] (settings): [AE Lock (touch)], [Zebra Pattern]; [  70] or [  100] (zebra pattern): Toggle on or <u>off</u> When [ <b>M</b> ] is on - exposure adjustment dial	–	●	●	66
[AUDIO Audio Scene] <sup>1, 2</sup>	[  Standard], [  Music], [  Speech], [  Forest and Birds], [  Noise Suppression]	●	●	●	79
	[  Custom Setting]	–	●	●	
[  Mic Level] <sup>1</sup>	[ <b>A</b> ] (automatic), [ <b>M</b> ] (manual) When [ <b>A</b> ] is on - [Audio Level Indicator]: Toggle on or <u>off</u>	–	●	●	81
[ZOOM] <sup>2</sup>	Zoom controls, [START]/[STOP] control (for movies)	●	●	●	59
	[PHOTO] control (for photos)	●	●	–	
[Image Stabilizer]	[  Dynamic], [  Standard], [  Off]	–	●	●	61
[Image Effects]	[ON], [ <u>OFF</u> ] When [ON] - [Color Depth], [Sharpness], [Contrast], [Brightness]: $\pm 0$ (-2 to +2)	–	●	–	72

Control Button	Setting options/Function	AUTO	M	CINEMA	
[Wi-Fi] Wi-Fi Remote]	[ON], [OFF]	●	●	●	120

<sup>1</sup> Option available only for recording movies.

<sup>2</sup> The setting is maintained when the camcorder is switched from **M** or **CINEMA** mode to **AUTO** mode. (Except for **Custom Setting** under **AUDIO** Audio Scene.)

**FUNC. Panel - Mode (Movies)**

Control Button	Movie Index Screen	Playback Pause	
[Copy (A) → (B)]	<date/folder name>, [Select], [All Scenes]	-	112
[Copy (B) → (A)]			
[Convert to MP4 (A) → (B)]	Conversion quality settings, [Join Scenes]	-	114
[Convert to MP4 (B) → (A)]			
[Delete]	<date/folder name>, [Select], [All Scenes]	[This Scene]	98
[Divide]	-	●	100
[Trim]	-	●	101

**FUNC. Panel - Mode (Photos)**















Control Button	Photo Index Screen	Single Photo View	
[Copy (A) → (B)]	<folder name>, [Select], [All Photos]	●	112
[Copy (B) → (A)]			
[Delete]			107

**Setup Menus**

**Camera Setup**

Menu item	Setting options	
[Digital Zoom]	[OFF] Off, [400x] 400x, [20x] Digital Tele-conv.]	-
[Soft Zoom Control]	[OFF] Off, [START] Start, [STOP] Stop, [START/STOP] Start & Stop]	60
[Zoom Speed Level]	[>>>] Fast, [>>] Normal, [>] Slow]	57
[Zoom Rocker Zoom Speed]	[VAR] (variable speed), [CONST] (constant speed) When [CONST]: 1-16 (8)	57
[Wireless Ctrlr Zoom Speed]	1-16 (8)	58
[High-Speed Zoom]	[ON] On, [OFF] Off]	58
[AF Mode]	[LAF] Instant AF, [MAF] Medium AF, [AF] Normal AF]	54
[Focus Assistance]	[ON] On, [OFF] Off]	-
[Face Detection & Tracking]	[ON] On , [OFF] Off]	55



Menu item	Setting options	
[Auto Backlight Correction]	[ <b>ON</b> On], [ <b>OFF</b> Off]	67
[Auto Slow Shutter]	[ <b>ON</b> On], [ <b>OFF</b> Off]	–
[ND Filter]	[ <b>A</b> Automatic], [ <b>OFF</b> Off]	–
[Conversion Lens]	[ <b>Tele</b> TL-H58], [ <b>Wide</b> WA-H58], [ <b>OFF</b> Off]	–
[Intelligent IS]	[  With  , [  Without 	41
[Onscreen Markers]	[ <b>OFF</b> Off], [  Level (Gray)], [  Level (Black)], [  Grid (Gray)], [  Grid (Black)]	–
[Microphone Attenuator]	[ <b>A</b> Automatic], [ <b>ON</b> On <b>ATT</b> ]	–
[Built-in Mic Wind Screen]	[ <b>H</b> Auto (High)], [ <b>L</b> Auto (Low)  , [ <b>OFF</b> Off]	81
[Built-in Mic Freq. Response]	[ <b>NORM</b> Normal], [ <b>LB</b> Boost LF Range], [ <b>LC</b> Low Cut Filter], [ <b>MB</b> Boost MF Range], [ <b>LHB</b> Boost HF+LF Range]	82
[Built-in Mic Directionality]	[  Monoaural], [ <b>NORM</b> Normal], [  Wide], [  Zoom]	83
[MIC Low Cut]	[ <b>ON</b> On], [ <b>OFF</b> Off]	84
[MIC Terminal Input]	[ <b>LINE</b> External Audio], [ <b>MIC</b> Microphone]	84
[Audio Mix]	[ <b>OFF</b> Off], [ <b>ON</b> On] When [ <b>ON</b> On] is selected: [INT] ..... [EXT], [Internal Microphone]/[MIC Terminal Input]	84
[Surround Mic Directionality]*	[ <b>5.1ch</b> Surround], [  Zoom], [  Shotgun]	–
[Wi-Fi]	[Smartphone Connection], [Access Point Connection], [FTP Server Settings]	141

\* Option available only when the optional SM-V1 Surround Microphone is attached to the camcorder after having updated the camcorder's firmware using the memory card supplied with the SM-V1.

**[Digital Zoom]:** Determines the operation of the digital zoom. The color of the indicator indicates the zoom.

- With the digital zoom the image is digitally processed, so the image resolution will deteriorate the more you zoom in.
- Digital zoom is available only for movies.

**[Focus Assistance]:** When focus assistance is activated, the image at the center of the screen is magnified to help you focus manually ( 52).

- Using focus assistance will not affect the recordings. It will be cancelled automatically after 4 seconds or when you start recording.
- Focus assistance is available only for movies.

**[Auto Slow Shutter]:** The camcorder automatically uses slow shutter speeds to obtain brighter recordings in places with insufficient lighting.

- Minimum shutter speed used: 1/30; 1/15 when the frame rate is set to PF29.97 or 29.97P; 1/12 when the frame rate is set to 23.98P.
- The auto slow shutter can be activated only during **[AUTO]** mode, when the recording program is set to **[P]** Programmed AE].
- If a trailing afterimage appears, set the slow shutter to [**OFF** Off].
- If  (camcorder shake warning) appears, we recommend stabilizing the camcorder, for example, by mounting it on a tripod.

**[ND Filter]:** Available in any recording program other than the Special Scene recording programs. When set to **[A Automatic]**, ND filter settings will be available when the aperture value is F4.0.

**[Conversion Lens]:** When you attach to the camcorder the optional TL-H58 Tele-converter or WA-H58 Wide Attachment, set the appropriate conversion lens setting. The camcorder will then optimize the image stabilization and adjust the minimum object distance. The minimum object distance throughout the entire zoom range will be 130 cm (4 ft. 3 in.) for the Tele-converter and about 60 cm (2 ft.) for the Wide Attachment. When you select **[Wide WA-H58]** and you zoom in, the zoom position marker will stop before reaching the end of the zoom bar.

- This Wide Attachment decreases the focal length by a factor of 0.75.
- When you select a setting other than **[OFF Off]**, the AF mode is automatically set to **[AF Normal AF]**.
- The approximate subject distance displayed on the screen will change depending on the setting. If you are not using an optional lens, select **[OFF Off]**.

**[Onscreen Markers]:** You can display a grid or a horizontal line at the center of the screen. Use the markers as a reference to make sure your subject is framed correctly (vertically and/or horizontally).

- Using the onscreen markers will not affect the recordings.

**[Microphone Attenuator]:** Helps prevent audio distortions. You can use this setting when using an external microphone or when **[AUDIO Audio Scene]** is set to **[Jc Custom Setting]**.

**[A Automatic]:** The camcorder will automatically activate the microphone attenuator as necessary for optimal audio recording levels so high audio levels will not be distorted.

**[ON On]:** The microphone attenuator will be activated at all times to reproduce more faithfully the sound dynamics.



**[Surround Mic Directionality]:** Sets the directionality mode of the optional SM-V1 Surround Microphone.

**[5.1ch Surround]:** Records 5.1ch surround sound.

**[5.1ch Zoom]:** Records 5.1 audio channels. Additionally, the audio is linked to the zoom position. The larger the subject appears on the screen, the louder the sound will be as well.

**[5.1ch Shotgun]:** Records monaural audio with a highly directional setting that is most sensitive to sound coming directly from the front of the camcorder/microphone.

 /  Playback Setup

Menu item	Setting options	MEDIA		
				
[Data Code]	For AVCHD movies: <b>[OFF Off]</b> , <b>[Date]</b> , <b>[Time]</b> , <b>[Date and Time]</b> , <b>[Camera Data]</b> For MP4 movies: <b>[OFF Off]</b> , <b>[Date]</b>	●	●	–
[TV Type]	<b>[4:3 4:3 TV]</b> , <b>[16:9 Wide TV]</b>	●	●	–
[Wi-Fi]	<b>[Movie Uploader]</b> , <b>[Playback via Browser]</b> , <b>[To Web Service]</b> , <b>[Media Server]</b> , <b>[FTP Transfer]</b> , <b>[Smartphone Connection]</b> , <b>[Access Point Connection]</b> , <b>[FTP Server Settings]</b>	●	–	117

**[Data Code]:** Displays the date and/or time when the scene or photo was recorded.

**[CAMERA] Camera Data:** Displays the aperture (f-stop) and shutter speed used when recording the scene or photo.



**[TV Type]:** When you connect the camcorder to a TV using the supplied STV-250N Stereo Video Cable, select the setting according to the type of TV in order to display the picture in full and in the correct aspect ratio.

**[4:3] 4:3 TV:** TV sets with 4:3 aspect ratio.

**[16:9] Wide TV:** TV sets with 16:9 aspect ratio.

- When the TV type is set to **[4:3] 4:3 TV**, during the playback of video originally recorded with an aspect ratio of 16:9, the picture will not be displayed fullscreen.

## Recording Setup

Menu item	Setting options	MEDIA			
		CAMERA			
[Movie Format]	[AVCHD AVCHD], [MP4 MP4]	●	–	–	37
[Recording Mode]	For AVCHD movies: [28 Mbps LPCM (59.94P)], [28 Mbps (59.94P)], [24 Mbps LPCM], [24 Mbps], [17 Mbps], [5 Mbps] For MP4 movies: [35 Mbps (59.94P)], [24 Mbps], [17 Mbps], [4 Mbps], [3 Mbps]	●	–	–	45
[Recording Media]	[CAMERA] Rec Media for Movies: [A Mem. Card A], [B Mem. Card B]	●	–	–	37
	[CAMERA] Rec Media for Photos: [A Mem. Card A], [B Mem. Card B]	●	●	●	
[Dual/Relay Recording]	[Standard Recording], [Dual Recording], [Relay Recording]	●	–	–	47
[Frame Rate]	For AVCHD movies: [59.94i 59.94i], [PF29.97 PF29.97], [23.98P 23.98P] For MP4 movies: [29.97P 29.97P], [23.98P 23.98P]	●	–	–	48
[Slow & Fast Motion]	When [Recording Mode] is set to [35 Mbps (59.94P)]: [OFF Off], [29.97P 29.97P], [23.98P 23.98P] When [Recording Mode] is set to [24 Mbps] or [17 Mbps] and [Frame Rate] is set to [29.97P 29.97P]: [OFF Off], [59.94P 59.94P], [23.98P 23.98P] When [Recording Mode] is set to [24 Mbps] or [17 Mbps] and [Frame Rate] is set to [23.98P 23.98P]: [OFF Off], [59.94P 59.94P], [29.97P 29.97P]	●	–	–	49
[Video Snapshot Length]	[2sec 2 sec], [4sec 4 sec], [8sec 8 sec]	●	–	–	87
[Time Code Mode]	[PRESET Preset], [REGEN. Regen.]	●	–	–	73
[Time Code Running Mode]	[RECRUN Rec Run], [FREERUN Free Run]	●	–	–	73
[DF/NDF]	[DF DF], [NDF NDF]	●	–	–	74

Menu item	Setting options	CAMERA			MEDIA		📖
		📷	📹	📷	📹		
[Initial Time Code]	[Reset], [OK]	●	–	–	–	–	73
[User Bit Output Mode]	[FIXED Fixed], [PULLDOWN Pulldown]	●	–	–	–	–	75
[User Bit Type]	[SET Setting], [TIME Time], [DATE Date]	●	–	–	–	–	75
[Color Bars]	[OFF Off], [SMPTE SMPTE], [ARIB ARIB]	●	–	–	–	–	86
[1 kHz Tone]	[-12dB -12 dB], [-18dB -18 dB], [-20dB -20 dB], [OFF Off]	●	–	–	–	–	86
[File Numbering]	[🔄 Reset], [➡ Continuous]	●	●	●	●	–	–
[Available Space in Memory]	[A], [B]	●	–	–	–	–	–
[Used Space in Memory]	[A], [B]	–	●	●	●	–	–
[Initialize SD]	[A Mem. Card A], [B Mem. Card B]	●	●	●	●	–	36

**[File Numbering]:** MP4 movies and photos are saved as files in folders. You can select the file numbering method for those files. File numbers appear on screens in playback mode in a format such as "101-0107". The first three digits indicate the folder number and the last four digits are different for each file in a folder.

[🔄 Reset]: File numbers will restart from 100-0001 every time you record on a memory card that has been initialized.

[➡ Continuous]: File numbers will continue from the number following that of the last file recorded with the camcorder.

- If the memory card you insert already contains a file with a larger number, a new file will be assigned a number one higher than that of the last file on the memory card.
- We recommend using the [➡ Continuous] setting.
- When you use a computer to view the contents of a memory card with MP4 movies or photos, an MP4 movie with a file number of "100-0107" recorded on May 1st will be saved in the "DCIM\100\_0501" folder as the file "MVI\_0107.MP4"; a photo with the same file number will be saved in the same folder as the file "IMG\_0107.JPG".
- Folders can contain up to 500 files (MP4 movies and photos combined) and a new folder is created every time a folder exceeds this number.
- The first three digits of the file number range from 100 to 999 and the last four digits range from 0001 to 9999. File numbers are automatically assigned consecutive numbers.

**[Available Space in Memory]/[Used Space in Memory]:** Displays a screen where you can verify how much of the memory card is currently available for recording or how much is in use (📷 total recording time and 📷 total number of photos).

- Estimated figures about available movie recording time and available number of photos are approximate and based on the recording mode currently in use and a photo size of 1920x1080.
- You can also check the memory card's Speed Class.

 System Setup

Menu item	Setting options	CAMERA	MEDIA		
					
[Language 	[Česky], [Dansk], [Deutsch], [Ελληνικά], [English], [Español], [Français], [Italiano], [Magyar], [Melayu], [Nederlands], [Norsk], [Polski], [Português], [Română], [Suomi], [Svenska], [Türkçe], [Русский], [Українська], [العربية], [فارسی], [தமிழ்], [简体中文], [繁體中文], [한국어], [日本語]	●	●	●	34
[Time Zone/DST]	[🏠] (home time zone) or [✈️] (travel time zone): [New York], list of world time zones [✳️] (DST adjustment): Toggle on or off	●	●	●	34
[Date/Time]	[Date/Time]: – [Date Format]: [Y.M.D], [M.D.Y], [D.M.Y] (Y- year, M- month, D- day) [24H]: Toggle on (24-hour clock) or off (12-hour clock)	●	●	●	33
[OLED Brightness]	[HIGH Bright], [NORM Normal] [OLED Dimmer]: Toggle on or off	●	●	●	–
[OLED Mirror Image]	[ON On], [OFF Off]	●	–	–	–
[OLED Color Balance]	[B] (blue): -25 to +25 (0), [R] (red): -25 to +25 (0)	●	●	●	–
[VF Brightness]	[HIGH Bright], [NORM Normal]	●	●	●	–
[Headphone Volume]	   OFF	●	●	●	85, 115
[Speaker Volume]	   OFF	–	●	●	96
[Notification Sounds]	[🔊] High Volume, [🔊] Low Volume, [OFF Off]	●	●	●	–
[Monitor Delay]	[LINE Line Out], [NORM Normal]	●	–	–	85
[Wireless Remote Control]	[ON On], [OFF Off] 	●	●	●	–
[CUSTOM Dial & Button]	[  Tv/Av], [  Manual Exposure], [  AGC AGC Limit], [  Exposure], [OFF Off]	●	–	–	91
[Assign Button 1] to [Assign Button 5]*	[  Powered IS], [  BLC Always On], [  Face Only AF], [  Video Snapshot], [WB WB Priority], [  Pre REC], [AF/MF AF/MF], [REVIEW Rec Review], [FUNC Rec. Programs], [FUNC BLC Always On], [FUNC White Balance], [FUNC AGC Limit], [FUNC Focus], [FUNC Exposure], [FUNC Audio Scene], [FUNC Mic Level], [FUNC Zoom], [FUNC Image Stabilizer], [FUNC Image Effects], [FUNC Wi-Fi Remote], [OFF Off]	●	–	–	92
[Powered IS Button]	[ON] Press and Hold, [  Toggle On/Off]	●	–	–	–
[Set WB Priority]	[AWB Automatic], [  Daylight], [  Shade], [  Cloudy], [  Fluorescent], [  Fluorescent H], [  Tungsten], [  Color Temperature], [  Set 1], [  Set 2]	●	–	–	–

Menu item	Setting options	CAMERA	MEDIA		📖
			📷	📺	
[Focus/Zoom Ring Direction]	[ <b>NORM</b> Normal], [ <b>REV</b> Reverse]	●	-	-	-
[Focus/Zoom Ring Response]	[ <b>▶▶▶</b> Fast], [ <b>▶▶</b> Normal], [ <b>▶</b> Slow]	●	-	-	-
[Focus Preset Speed]	[ <b>▶▶▶</b> Fast], [ <b>▶▶</b> Normal], [ <b>▶</b> Slow]	●	-	-	-
[Auto Power Off]	[ <b>ON</b> On], [ <b>OFF</b> Off]	●	●	●	-
[Battery Info]	-	●	●	●	-
[Rec Command]	[ <b>ON</b> On], [ <b>OFF</b> Off]	●	-	-	41
[HDMI Output]	[ <b>A</b> Automatic], [ <b>480i</b> 480i], [ <b>480P</b> 480P], [ <b>720P</b> 720P], [ <b>1080i</b> 1080i], [ <b>1080P</b> 1080P]	●	●	●	103
[HDMI Time Code]	[ <b>ON</b> On], [ <b>OFF</b> Off]	●	●	●	-
[HDMI Status]	-	●	●	●	-
[Output Onscreen Displays]	[ <b>ON</b> On], [ <b>OFF</b> Off]	●	●	●	-
[Distance Units]	[ <b>m</b> meters], [ <b>ft</b> feet]	●	●	●	-
[Backup Menu Settings <b>(B)</b> ]	[Save], [Load]	●	-	-	94
[GPS Auto Time Setting]**	[Disable], [Auto Update]	●	-	-	-
[GPS Information Display]**	-	●	-	-	-
[Demo Mode]	[ <b>ON</b> On], [ <b>OFF</b> Off]	●	-	-	-
[Firmware]	-	●	-	-	-
[Reset All]	[No], [Yes]	●	●	●	-

\* The default settings are as follows. [Assign Button 1]: [**AF/MF** AF/MF], [Assign Button 2]: [**PRE REC**], [Assign Button 3]: [**OFF** Off], [Assign Button 4]: [**OFF** Off], [Assign Button 5]: [**REC REVIEW** Rec Review].

\*\* Option available only when the optional GP-E2 GPS Receiver is attached to the camcorder.

**[OLED Brightness]:** Sets the OLED screen to one of two brightness levels. You can use this to make the screen brighter when recording in bright places, for example.

**[OLED Dimmer]:** When set to on, the illumination sensor will detect the surrounding brightness and the camcorder will automatically adjust the screen's brightness accordingly. When you need to carefully monitor picture quality when recording, keep this setting set to off.

- Changing the brightness of the OLED screen does not affect the brightness of your recordings or the brightness of the playback image on a TV.
- Using the [**HIGH** Bright] setting will shorten the effective usage time of the battery pack.
- When demo mode is not on or activated and the compact power adapter is connected, this setting will automatically change to [**HIGH** Bright].
- When [OLED Dimmer] is set to on, the camcorder's screen will automatically become dimmer if the camcorder is left without any operation for 3 minutes. Operate any control on the camcorder to return the screen to its previous setting.

**[OLED Mirror Image]:** When set to **[ON On]**, this function reverses the image on the screen horizontally when you rotate the OLED panel 180 degrees toward the subject. In other words, the screen will show a mirror image of the subject.

**[OLED Color Balance]:** Allows you to adjust the color balance of the OLED screen. Adjust the **[B]** (blue) and **[R]** (red) bars by touching **[+]** and **[-]**. You can check the results on the screen.

**[VF Brightness]:** Sets the viewfinder screen to one of two brightness levels. You can use this to make the screen brighter if it is difficult to see.

**[Notification Sounds]:** A beep will accompany some of the camcorder's operations.

- While pre-recording (**[ ]** 88) is activated, the camcorder will not emit any notification sounds.

**[Wireless Remote Control]:** Allows the camcorder to be operated with the wireless controller.

**[Powered IS Button]:** Determines the operation mode of the assignable button set to **[ Powered IS]** (**[ ]** 61).

**[ Press and Hold]:** Powered IS will be activated while you hold the button pressed down.

**[ Toggle On/Off]:** Each press of the button will turn the Powered IS function on and off.

**[Set WB Priority]:** You can press an assignable button set to **[WB WB Priority]** to switch between the current white balance and the white balance setting selected for **[Set WB Priority]**.

**[Focus/Zoom Ring Direction]:** Changes the direction the focus/zoom ring needs to be turned.

**[Focus/Zoom Ring Response]:** Selects the sensitivity of the response when operating the focus/zoom ring.

**[Focus Preset Speed]:** Determines the speed at which the focus changes to the preset position.

**[Auto Power Off]:** In order to save power when the camcorder is powered by a battery pack, it will automatically shut off if left without any operation for 5 minutes.

- Approximately 30 seconds before the camcorder shuts off, **[Auto Power Off]** will appear.

**[Battery Info]:** When you are using a battery pack that is compatible with Intelligent System, this option displays a screen where you can verify the battery charge (as a percentage) and the remaining recording time (**[CAMERA]** mode) or playback time (**[MEDIA]** mode).

- If the battery pack is exhausted, the battery information may not be displayed.

**[HDMI Time Code]:** When set to **[ON On]**, the HDMI signal output from the camcorder includes the camcorder's time code.

**[HDMI Status]:** Displays a screen where you can verify the standard of the output signal from the HDMI OUT terminal.

**[Output Onscreen Displays]:** When set to **[ON On]**, the camcorder's onscreen displays will appear also on the screen of a TV or monitor connected to the camcorder.

**[Distance Units]:** Selects the units to use for the focusing distance display while focusing manually. This setting also affects units for GPS information when using the optional GP-E2 GPS Receiver.

**[GPS Auto Time Setting]:** When the optional GP-E2 GPS Receiver is attached to the camcorder, you can have the camcorder automatically set the time based on the information acquired from GPS. For more details, refer to *Setting Time from GPS on the Camera* in the receiver's instruction manual.

**[GPS Information Display]:** When the optional GP-E2 GPS Receiver is attached to the camcorder, this function allows you to view GPS information. For more details, refer to *Viewing GPS Information* in the receiver's instruction manual.

**[Demo Mode]:** The demonstration mode displays the camcorder's main features. It starts automatically when the camcorder is powered with the compact power adapter if you leave it turned on without a memory card for more than 5 minutes.

- To cancel the demo mode once it has started, press any button or turn off the camcorder.

**[Firmware]:** You can verify the current version of the camcorder's firmware. This menu option is usually unavailable.

**[Reset All]:** Resets all of the camcorder's settings.



## Appendix: Onscreen Icons and Displays

### **AUTO** Recording Movies

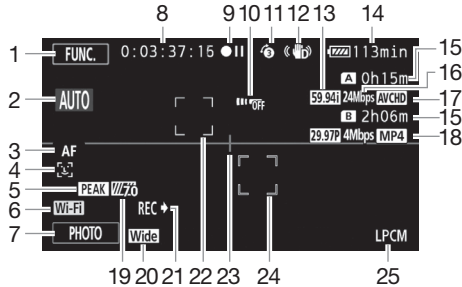

- |  |  |
|--|--|
| <ol style="list-style-type: none"> <li>1 Control button [FUNC.]: Open the FUNC. panel ( 31)</li> <li>2 Smart AUTO ( 40)</li> <li>3 Autofocus mode ( 54)</li> <li>4  Face detection ( 55);<br/> Autofocus only for faces ( 56)</li> <li>5 Peaking ( 53)</li> <li>6 Wi-Fi Remote function ( 120)</li> <li>7 Control button [PHOTO]: Take a photo ( 39, 97)</li> <li>8 While recording/during playback:<br/>Time code (hours : minutes : seconds : frames)</li> <li>9 Operation ( 156)</li> <li>10 Remote sensor off ( 151)</li> <li>11 Pre-recording ( 88);<br/><b>4sec</b> Video snapshot length ( 87)</li> <li>12 Image stabilizer ( 61)</li> <li>13 Frame rate ( 48)</li> <li>14 Remaining battery time ( 156)</li> </ol> | <ol style="list-style-type: none"> <li>15 Remaining recording time<sup>1</sup><br/> On the memory card<br/> Relay recording ( 47)</li> <li>16 Recording mode ( 45)</li> <li>17 Movie format ( 37)</li> <li>18 Frame rate, recording mode and movie format for dual recording<sup>2</sup> ( 47)</li> <li>19 Zebra pattern ( 65)</li> <li>20 Conversion lens (Wide attachment shown) ( 146)</li> <li>21 Recording command ( 150)</li> <li>22 Face detection frame ( 55)</li> <li>23 Level marker ( 146)</li> <li>24 Tracking frame ( 55)</li> <li>25 Linear PCM audio ( 45)</li> </ol> |
|--|--|

### Recording Movies

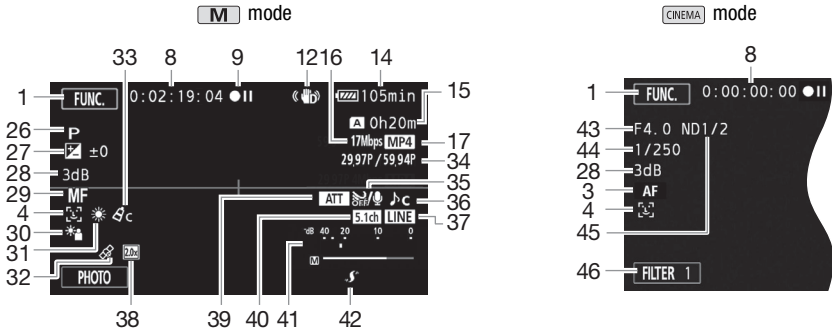

- 26 Recording program (📖 63, 65, 70)
- 27 Exposure compensation (📖 66)
- 28 AGC limit (📖 62); Gain (during the [M Manual Exposure] recording program) (📖 65)
- 29 Manual focus (📖 52)
- 30 Backlight correction (📖 67)
- 31 White balance (📖 68)
- 32 GPS (📖 90)
- 33 Image effects (📖 72)
- 34 Slow & fast motion recording (shooting frame rate/playback frame rate) (📖 49)
- 35 Wind screen (📖 81)
- 36 Audio scene select (📖 79)
- 37 External audio input from the MIC terminal (📖 84)
- 38 Digital tele-converter (📖 60)
- 39 Microphone attenuator (📖 146)
- 40 Directionality of the optional SM-V1 Surround Microphone (📖 146)
- 41 Audio level indicator (built-in microphone/MIC terminal) (📖 81)
- 42 Mini advanced shoe (📖 76)
- 43 Aperture value (📖 63, 65)
- 44 Shutter speed (📖 63, 65)
- 45 ND filter (📖 146)
- 46 Control button [FILTER 1]: Cinema-look filters (📖 50)

<sup>1</sup> During slow & fast motion recording mode, the shooting frame rate and playback frame rate will be displayed.

<sup>2</sup> When dual recording is activated, information for both memory cards will be displayed.

 Playing Movies (during playback)

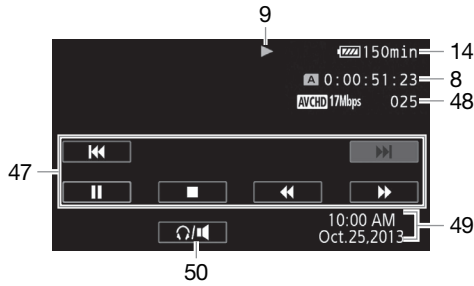

47 Playback control buttons (📖 96)

48 Scene number

49 Data code (📖 89, 147)

50 Volume controls (📖 96)

 Viewing Photos

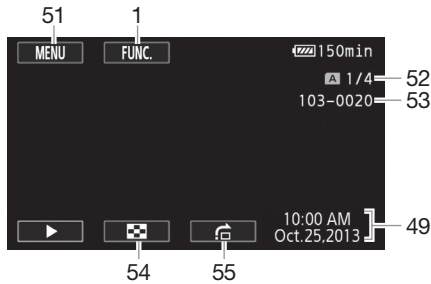

51 Control button [MENU]: Open the setup menus (📖 32, 144)

52 Current photo / Total number of photos

53 File number (📖 148)

54 Control button [▶]: Return to the photo index screen (📖 105)

55 Control button [📄]: Photo jump (📖 105)

 NOTES

- You can press **[DISP.]** to turn off most icons and displays.

### 9 Operation

- Record, ●|| Record pause, ► Playback, || Playback pause, ►► Fast playback, ◀◀ Fast reverse playback, ► Slow playback, ◀ Slow reverse playback, ||► Frame advance, ◀|| Frame reverse.

### 14 Remaining battery time

- The icon shows a rough estimate of the remaining charge as a percentage of the full charge of the battery pack. The remaining recording/playback time of the battery pack is displayed, in minutes, next to the icon.

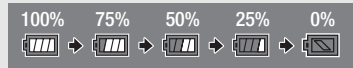

- When the battery charge becomes low, the battery icon will appear in yellow. When the battery pack is exhausted, the battery icon will appear in red. Replace or charge the battery pack.
- When you attach an empty battery pack, the power may turn off without displaying the battery icon.
- Depending on the conditions under which the camcorder and the battery pack are used, the actual battery charge may not be indicated accurately.
- When the camcorder is off, press **[BATT.INFO]** to display the charge status of a battery pack. The Intelligent System will display the charge status (as a percentage) and the remaining recording time (in minutes) for 5 seconds. If the battery pack is exhausted, the battery information may not be displayed.

### 15 Remaining recording time

When there is no more free space on a memory card, **[A End]** (memory card **A**) or **[B End]** (memory card **B**) will be displayed in red and the recording will stop.

## Troubleshooting

If you have a problem with your camcorder, refer to this section. Sometimes what you think is a malfunction of the camcorder may have the simplest of solutions - please read the "CHECK THIS FIRST" box before going on to the more detailed problems and solutions. Consult your dealer or a Canon Service Center if the problem persists.

### CHECK THIS FIRST

#### Power supply

- Is the battery charged? Is the compact power adapter correctly connected to the camcorder? (□ 21)

#### Recording

- Did you turn the camcorder on and correctly set it to **CAMERA** mode? (□ 38) Is a memory card correctly inserted into the camcorder? (□ 35)

#### Playback

- Did you turn the camcorder on and correctly set it to **MEDIA** mode? (□ 95, 105) Is a memory card correctly inserted into the camcorder? (□ 35) Does it contain any recordings?

#### Other

- Does the camcorder make a rattling sound? The internal lens fixture can move when the camcorder is turned off or in **MEDIA** mode. This is not a malfunction.

### Power source

#### The camcorder will not turn on or it turns off by itself.

- The battery pack is exhausted. Replace or charge the battery pack.
- Remove the battery pack and reattach it correctly.

#### Cannot charge the battery pack.

- Make sure the camcorder is off so charging can start.
- The temperature of the battery pack is outside its operating range (approximately 0 – 40 °C (32 – 104 °F)). Remove the battery pack, warm it or let it cool down, as necessary, and try charging it again.
- Charge the battery pack in temperatures between approximately 0 °C and 40 °C (32 °F and 104 °F).
- The battery pack is faulty. Replace the battery pack.
- The camcorder cannot communicate with the battery pack attached. Battery packs not recommended by Canon for use with this camcorder cannot be charged using this camcorder.
- If you are using a battery pack recommended by Canon for use with this camcorder, there may be a problem with the camcorder or battery pack. Consult a Canon Service Center.

#### A noise can be heard from the compact power adapter.

- A faint sound can be heard while the compact power adapter is connected to a power outlet. This is not a malfunction.

#### The battery pack is exhausted extremely quickly even at normal temperatures.

- The battery may have reached the end of its battery life. Buy a new battery pack.

## Recording

### Pressing **[START/STOP]** will not start recording.

- You cannot record while the camcorder is writing previous recordings onto a memory card (while the ACCESS indicator is on or flashing). Wait until the camcorder has finished.
- The memory card is full or it already contains 3,999 scenes (the maximum number of scenes for AVCHD movies). Delete some recordings (□ 98, 107) or initialize the memory card (□ 36) to free some space.
- The file numbers have reached their maximum value. Insert a new memory card in to the camcorder and set **[ ]** **[ ]** **[ ]** **[ ]** [File Numbering] to [Reset].

### The point where **[START/STOP]** was pressed does not match the beginning/end of the recording.

- There may be a slight interval between pressing **[START/STOP]** and the actual start/end of recording. This is not a malfunction.

### The camcorder will not focus.

- Autofocus does not work on the subject. Focus manually (□ 52).
- The lens or Instant AF sensor is dirty. Clean the lens or sensor with a soft lens-cleaning cloth (□ 173). Never use tissue paper to clean the lens.

### When a subject flits across in front of the lens, the image appears slightly bent.

- This is a phenomenon typical of CMOS image sensors. When a subject crosses very quickly in front of the camcorder, the image may seem slightly warped. This is not a malfunction.

### Changing the operating mode between recording (**●**)/record pause (**●||**)/playback (**▶**) takes longer than usual.

- When the memory card contains a large number of scenes, some operations may take longer than usual. Save your recordings (□ 108) and initialize the memory card (□ 36).

### Movies or photos cannot be recorded properly.

- This may occur as movies and photos are recorded/deleted over time. Save your recordings (□ 108) and initialize the memory card (□ 36).

### Cannot record a photo while recording movies.

- You cannot take photos in **[CINEMA]** mode.

### After using the camcorder for a long time, it becomes hot.

- The camcorder may become hot after using it continuously for long periods of time; this is not a malfunction. If the camcorder becomes unusually hot or it becomes hot after using it only for a short while, it may indicate a problem with the camcorder. Consult a Canon Service Center.

## Playback

### Cannot delete a scene.

- You may not be able to delete scenes recorded or edited using another device.

### Deleting scenes takes longer than usual.

- When the memory card contains a large number of scenes, some operations may take longer than usual. Save your recordings (□ 108) and initialize the memory card (□ 36).

### Cannot divide scenes

- You cannot divide scenes recorded or edited using another device and then transferred to a memory card connected to the computer.
- The memory card is full. Delete some recordings (□ 98, 107) to free some space.

### Cannot copy scenes/photos

- You may not be able to copy scenes/photos recorded or edited using another device and then transferred to a memory card connected to the computer.

**Cannot mark individual scenes/photos in the index screen with a checkmark ✓**

- You cannot select more than 100 scenes/photos individually. Select the [All Scenes] or [All Photos] option instead of [Select].

**Indicators and Onscreen Displays**** lights up in red.**

- Battery pack is exhausted. Replace or charge the battery pack.

** appears on the screen.**

- The camcorder cannot communicate with the battery pack attached so the remaining battery time cannot be displayed.

** /  lights up in red.**

- The memory card is full. Delete some recordings ( 98, 107) to free some space or replace the memory card.

** /  lights up in red.**

- A memory card error occurred. Turn off the camcorder. Remove and reinsert the memory card. Initialize the memory card if the display does not change back to normal.



**Even after stopping recording, the ACCESS indicator does not go off.**

- The scene is being recorded on the memory card. This is not a malfunction.

**The red POWER/CHG indicator flashes rapidly (one flash at 0.5-second intervals).**

- The temperature of the battery pack is outside its operating range (approximately 0 – 40 °C (32 – 104 °F)). Remove the battery pack, warm it or let it cool down, as necessary, and try charging it again.
- Charge the battery pack in temperatures between approximately 0 °C and 40 °C (32 °F and 104 °F).
- The battery pack is damaged. Use a different battery pack.
- Charging has stopped because the compact power adapter or the battery pack is faulty. Consult a Canon Service Center.

**Picture and Sound****The screen appears too dark.**

- Adjust the brightness with the   [OLED Brightness] or [VF Brightness] setting.

**Screen displays turn on and off repeatedly.**

- The battery pack is exhausted. Replace or charge the battery pack.
- Remove the battery pack and reattach it correctly.

**Abnormal characters appear on the screen and the camcorder does not operate properly.**

- Disconnect the power source and reconnect it after a short time.

**Video noise appears on screen.**

- Keep a distance between the camcorder and devices that emit strong electromagnetic fields (plasma TVs, cellular phones, etc.).

**Horizontal bands appear on the screen.**

- This is a phenomenon typical of CMOS image sensors when recording under some types of fluorescent, mercury or sodium lamps. To reduce the symptoms, set the recording program to [Programmed AE] or [Shutter-Pri. AE] ( 63). This is not a malfunction.

**Viewfinder picture is blurred.**

- Adjust the viewfinder with the dioptic adjustment lever ( 24).

**No picture appears on the viewfinder.**

- Pull out the viewfinder to activate it.

**Audio cannot be recorded.**

- When using a microphone connected to the MIC terminal, make sure the microphone is turned on. Also, make sure its battery is not exhausted.
- The audio recording level is not set correctly (☞ 81).

**Sound is distorted or is recorded at lower levels.**

- When recording near loud sounds (such as fireworks, shows or concerts), sound may become distorted or it may not be recorded at the actual levels. Adjust the audio recording level manually (☞ 81).

**The picture is displayed correctly but there is no sound from the built-in speaker.**



- Speaker volume is turned off. Adjust the volume (☞ 96).
- If the STV-250N Stereo Video Cable is connected to the camcorder, disconnect it.

## Memory Card and Accessories



**Cannot insert the memory card.**

- The memory card was not facing the correct direction. Turn the memory card over and insert it.

**Cannot record on the memory card.**

- The memory card is full. Delete some recordings (☞ 98, 107) to free some space or replace the memory card.
- Initialize the memory card (☞ 36) when you use it with the camcorder for the first time.
- The LOCK switch on the memory card is set to prevent accidental erasure. Change the position of the LOCK switch.
- A compatible memory card must be used to be able to record movies on a memory card (☞ 35).
- The folder and file numbers have reached their maximum value. Set   [File Numbering] to [Reset] and insert a new memory card.

**The wireless controller will not work.**

- Set   [Wireless Remote Control] to [On].
- Replace the battery of the wireless controller.

## Connections with External Devices





**Video noise appears on the TV screen.**

- When using the camcorder in a room where a TV is located, keep a distance between the compact power adapter and the power or antenna cables of the TV.

**Playback looks fine on the camcorder but there is no image on the TV screen.**

- The video input on the TV is not set to the video terminal to which you connected the camcorder. Select the correct video input.

**The camcorder is connected using the supplied High Speed HDMI cable, but there is no picture or sound from the HDTV.**

- Disconnect the High Speed HDMI cable and then restore the connection or turn the camcorder off and then on again.
- When   [HDMI Output] is set to an option other than [ Automatic], the external monitor is not compatible with the signal output from the camcorder. Set [HDMI Output] to [ Automatic] or an option compatible with the monitor.



**The computer does not recognize the camcorder even though the camcorder is connected correctly.**

- Disconnect the USB cable and turn off the camcorder. After a short while, turn it on again and restore the connection.
- Connect the camcorder to a different USB port on the computer.

**Cannot save MP4 movies or photos on my computer**

- When the memory card contains too many MP4 movies and photos combined (Windows – 2,500 or more, Mac OS – 1,000 or more), you may not be able to transfer photos to a computer. Try using a card reader to transfer the photos on the memory card.

## Wi-Fi Functions

Refer also to the instruction manual of your access point and other devices you will use.

**Cannot connect with the access point.**

- Check that the access point is working correctly.
- The effective communication range between the camcorder and access point may vary depending on the strength of the wireless signal. Try using the camcorder closer to the access point.
- Cordless phones, microwave ovens, refrigerators and other appliances in the line of sight between the access point and the camcorder may interfere with the wireless signal. Try using the camcorder in a location farther away from such appliances.
- Wi-Fi networks with a stealth function that do not broadcast their network name (SSID) will not be detected by the camcorder during the Wi-Fi network setup. Perform the setup manually (☞ 140) or turn off the stealth function of the access point.
- The wireless router is using a Wi-Fi channel not supported by the camcorder. Refer to *About available Wi-Fi frequencies and channels* (☞ 184) and change the channel setting in the wireless router so that it uses a channel supported by the camcorder.

**Wireless playback on a computer or similar device is not smooth.**

- Playback may not be smooth depending on the access point's settings and capability.
- Connect the computer or similar device to the access point using a LAN cable.
- Remove any objects between the camcorder and access point that may interfere with the wireless signal.
- Move the camcorder closer to the access point.
- Turn off the wireless functions of other wireless devices other than the computer or similar device being used for playback.
- Switch the wireless router to IEEE 802.11n. Refer to its instruction manual for details.
- If these do not solve the issue, the cause may be due the device or conditions unique to the surrounding area. Use the supplied High Speed HDMI cable to connect the camcorder to a TV (☞ 174).

**The wireless connection was interrupted while transferring files.**

- Incomplete files may remain at the transfer destination. If incomplete files remain at the transfer destination, check the content and make sure they are safe to delete before deleting them.
- Select [New Files] and perform the file transfer again.

**Cannot connect a Wi-Fi-enabled external device wirelessly to the camcorder.**

- Use the  [Reset All] setting to reset the camcorder. The camcorder's SSID will return to the default setting and the password will return to not being configured so set the password again. Then, delete the previous network settings from the external device and try connect it to the camcorder.

## List of Messages (in alphabetical order)

Refer to *List of Messages for Wi-Fi Functions* (□ 165) for a list of messages related to Wi-Fi functions and *List of Messages for Web Services* (□ 167) for messages related to Web services when using Wi-Fi functions.

### Accessing the memory card. Do not remove the memory card.

- You opened the double memory card slot cover while the camcorder was accessing the memory card or the camcorder started accessing the memory card as you opened the double memory card slot cover. Do not remove the memory card until this message disappears.

### Back up recordings regularly

- This message may appear when you turn on the camcorder. In the event of a malfunction, recordings may be lost so back up your recordings regularly.

### Battery pack is not compatible. Turning off the camcorder.

- A battery pack not recommended by Canon for use with this camcorder was attached and the camcorder was turned on. The camcorder will automatically turn off in 4 seconds.

### Cannot communicate with the battery pack. Continue using this battery pack?

- You attached a battery pack that is not recommended by Canon for use with this camcorder.
- If you are using a battery pack recommended by Canon for use with this camcorder, there may be a problem with the camcorder or battery pack. Consult a Canon Service Center.

### Cannot convert scenes recorded at 59.94P

- Scenes that were recorded with a recording mode of 28 Mbps LPCM (59.94P), 28 Mbps (59.94P) or 35 Mbps (59.94P) cannot be converted.

### Cannot convert the scene

- The camcorder cannot convert scenes that were recorded using a video configuration that is not supported (PAL or SECAM).
- You cannot convert scenes that were recorded or edited using another device and then transferred to a memory card connected to a computer.
- MP4 scenes recorded with a recording mode of 4 Mbps can only be converted to MP4 movies with a recording mode of 4 Mbps or 3 Mbps. Similarly, MP4 scenes recorded with a recording mode of 3 Mbps can only be converted to MP4 movies with a recording mode of 3 Mbps.

### Cannot divide the scene. Initialize only using the camcorder.

- The scene could not be divided because the camcorder's internal scene management data log is full. Save your recordings (□ 108) and initialize the memory card (□ 36). Try dividing the scene again.
- Use the supplied software to save the scene and divide it on the computer.

### Cannot join 23.98P and 29.97P scenes to convert them

### Cannot join 59.94i and 23.98P scenes to convert them

### Cannot join PF29.97 and 23.98P scenes to convert them

- The combination of scenes you are trying to convert do not allow for joining scenes due to the scenes' frame rate settings. Convert the scenes to MP4 without joining them.

### Cannot play back

- Movies cannot be played back from a 64 MB or smaller memory card. Use a recommended memory card (□ 35).

### Cannot play back Check the memory card

- There is a problem with the memory card. Save your recordings (□ 108) and initialize the memory card using the [Complete Initialization] option (□ 36). If the problem persists, use a different memory card.

### Cannot play back Initialize only using the camcorder

- The memory card in the camcorder was initialized using a computer. Initialize the memory card with this camcorder (□ 36).

**Cannot record**

- There is a problem with the memory card. If this message appears often without apparent reason, contact a Canon Service Center.

**Cannot record Check the memory card**

- There is a problem with the memory card. Save your recordings (□ 108) and initialize the memory card using the [Complete Initialization] option (□ 36). If the problem persists, use a different memory card.

**Cannot record movies on this memory card**

- Movies cannot be recorded on a 64 MB or smaller memory card. Use a recommended memory card (□ 35).

**Cannot trim the scene**

- MP4 movies that were copied to a memory card with a larger cluster size than the memory card they were recorded on cannot be trimmed.
- MP4 movies that were recorded or copied using other devices cannot be trimmed.

**Charge the battery pack**

- Battery pack is exhausted. Charge the battery pack.



**Check the memory card**

- Cannot access the memory card. Check the memory card and make sure it is inserted correctly.
- A memory card error occurred. The camcorder cannot record or display the image. Try removing and reinserting the memory card, or use a different memory card.
- You inserted a MultiMedia Card (MMC) into the camcorder. Use a recommended memory card (□ 35).
- If after the message disappears, **A/B** appears in red, perform the following: Turn off the camcorder and remove and reinsert the memory card. If **A/B** turns back to green you can resume recording/playback. If the problem persists, save your recordings (□ 108) and initialize the memory card (□ 36).

**Do not disconnect the power source. Do not disconnect the USB cable unless you first use the computer to safely end the connection.**

- When the camcorder is in **MEDIA** mode and is connected to the computer with the supplied USB cable, the camcorder cannot be operated. Disconnecting the USB cable or power source while this message appears may result in permanent loss of the recordings on the memory card. Use the computer's Safely Remove Hardware function to end the connection and disconnect the USB cable before using the camcorder.

**File name error**

- The folder and file numbers have reached their maximum value. Set   [File Numbering] to [Reset] and delete all the MP4 movies (□ 98) and photos (□ 107) on the memory card or initialize it (□ 36).

**Initialize only using the camcorder**

- Initialize the memory card with this camcorder (□ 36).

**May not be possible to record movies on this memory card**

- You may not be able to record movies on a memory card without a Speed Class rating or rated SD Speed Class 2. Replace the memory card with one rated SD Speed Class 4, 6 or 10.

**Mem. Card Number of scenes already at maximum**

- The memory card already contains 3,999 scenes (the maximum number of scenes for AVCHD movies); no further scenes can be copied onto the memory card. Delete some scenes (□ 98) to free some space.

**Mem. Card Unable to recognize the data**

- The memory card contains scenes recorded using a video configuration that is not supported (PAL or SECAM). Play back the recordings in the memory card with the device originally used to record them.

**Memory card A/B writing error Attempt to recover the data? (Can take up to 3 min.)**

- This message will appear the next time you turn on the camcorder if power supply was accidentally interrupted while the camcorder was writing to the memory card. Select [Recover] to try to recover the recordings. If you inserted a memory card that contains scenes recorded using another device, we recommend that you select [No].

**Memory card cover is open**

- After inserting a memory card, close the double memory card slot cover.

**Memory card is full**

- The memory card is full. Delete some recordings (☞ 98, 107) to free some space or replace the memory card.

**Memory card is write-protected**

- The LOCK switch on the memory card is set to prevent accidental erasure. Change the position of the LOCK switch.

**Need to recover files from the memory card. Change the position of the LOCK switch on the memory card.**

- This message will appear the next time you turn on the camcorder if power supply was accidentally interrupted while the camcorder was writing on the memory card and later the position of the card's LOCK switch was changed to prevent erasure. Change the position of the LOCK switch.

**No memory card**

- Insert a compatible memory card into the camcorder (☞ 35).

**No photos**

- There are no photos to play back.

**No scenes**

- There are no scenes on the memory card selected.

**Not enough available space**

- Delete some recordings to free some space (☞ 98, 107).
- Set the recording mode to 5 Mbps for AVCHD movies or 3 Mbps for MP4 movies.
- The available space on the memory card is less than the size of the recordings you are trying to copy. Delete some recordings to free some space (☞ 98, 107) or reduce the number of recordings to copy.

**Number of scenes already at maximum**

- The number of scenes on the memory card has reached 3,999 (the maximum number of scenes for AVCHD movies). Delete some scenes (☞ 98) to free some space.

**Recording was stopped due to insufficient write speed of the memory card**

- The write speed of the memory card was too slow so recording was stopped. Replace the memory card with one rated SD Speed Class 4, 6 or 10.
- When the recording mode is 28 Mbps LPCM (59.94P), 28 Mbps (59.94P) or 35 Mbps (59.94P), you must use a memory card rated SD Speed Class 6 or 10.
- When recording movies using slow & fast motion, you must use a memory card rated SD Speed Class 10.
- After repeatedly recording, deleting and editing scenes (fragmented memory), it will take longer to write data on the memory card and recording may stop. Save your recordings (☞ 108) and initialize the memory card (☞ 36).

**Scene recorded using another device. Cannot copy the scene.**

**Scene recorded using another device. Cannot divide the scene.**

- Scenes that were not recorded with this camcorder cannot be copied or divided with this camcorder.

**Some scenes could not be deleted**

- Movies that were protected/edited with other devices and then transferred to a memory card connected to the computer cannot be deleted with this camcorder.

**Some scenes were recorded using another device and cannot be copied.**

- Scenes that were not recorded with this camcorder cannot be copied.

**Task in progress. Do not disconnect the power source.**

- The camcorder is updating the memory card. Wait until the operation ends and do not disconnect the compact power adapter or remove the battery pack.

**This photo cannot be displayed**

- You may not be able to display photos taken with other devices or image files created or edited on a computer and then transferred to a memory card connected to the computer.

**To record video on this memory card, it is recommended to use a video quality setting other than [59.94P Recording].**

- When using a memory card rated SD Speed Class 2 or 4, you may not be able to record movies if you use a recording mode of 28 Mbps LPCM (59.94P), 28 Mbps (59.94P) or 35 Mbps (59.94P).

**To use this function change the camera mode to Manual or Cinema**

- [CUSTOM], the CUSTOM dial (□ 91) and some of the functions that can be assigned to the assignable buttons (□ 92) cannot be used in [AUTO] mode. Set the mode switch to **M** (M mode) or **CINEMA** (CINEMA mode) to use them.

**Too many photos and MP4 movies. Disconnect the USB cable.**

- Disconnect the USB cable. Try using a memory card reader or decrease the number of photos and MP4 movies on the memory card to fewer than 2,500 (Windows), or 1,000 (Mac OS).
- If a dialog box appeared on the computer screen, close it. Disconnect the USB cable, and restore the connection after a short while.

**Unable to recognize the data**

- The camcorder cannot recognize data that was recorded using a video configuration that is not supported (PAL or SECAM).

**Unable to recover data**

- Could not recover a corrupted file. Save your recordings (□ 108) and initialize the memory card using the [Complete Initialization] option (□ 36).

## List of Messages for Wi-Fi Functions

Refer also to the instruction manual of your access point and other devices you will use.

**Another user is already controlling the camcorder. Try again later.**

- This message appears on the screen of the Wi-Fi device. Multiple Wi-Fi devices are trying to connect with the camcorder. Make sure only one Wi-Fi device is trying to connect and then touch Retry.

**IP address conflict**

- Change the camcorder's IP address to avoid any conflict with devices connected to the same network. Alternatively, change the IP address of the conflicting device.

**Memory card cover is open**

- The double memory card slot cover was opened while the memory card was being accessed. Stop the Wi-Fi function in use and end the Wi-Fi connection.

**Multiple access points detected. Try the operation again.**

- There are multiple access points sending out a WPS signal at the same time. Try the operation again later or perform setup using the [WPS: PIN Code] or [Search for Access Points] option (☐ 138).

166

**No access points found**

- The access point set in the camcorder could not be found.
- Cordless phones, microwave ovens, refrigerators and other appliances may interfere with the wireless signal. Try using the camcorder in a location farther away from such appliances.
- Make sure that you use the access point's SSID for the camcorder's Wi-Fi settings (☐ 139).
- If the access point is using MAC address filtering, enter the camcorder's MAC address in the access point's configuration screen.

**Unable to access configuration files**

- Turn off the camcorder. After a short while, turn it on again. If the problem persists contact a Canon Service Center.

**Unable to complete WPS.**

- Turn off the camcorder and access point. After a short while, turn them on again and try again. If the problem persists, perform setup using the [Search for Access Points] option (☐ 138).

**Unable to complete WPS. Try the operation again.**

- Some access points require pressing and holding the Wi-Fi Protected Setup (WPS) button. For details, refer to the instruction manual of your access point.
- Make sure to touch [OK] on the camcorder's screen within 2 minutes of activating the Wi-Fi Protected Setup signal on the access point, whether by pressing the button or by entering the PIN code.

**Unable to connect**

- Cordless phones, microwave ovens, refrigerators and other appliances may interfere with the wireless signal. Try using the camcorder in a location farther away from such appliances.

**Unable to obtain an IP address**

- If you are not using a DHCP server, connect using the [Manual Setup] option and enter the IP address using the [Manual] option (☐ 140).
- Turn on the DHCP server. If it is already on, make sure it is functioning properly.
- Make sure the address range for the DHCP server is sufficient.
- Turn on the DNS server. If it is already on, make sure it is functioning properly.
- Make sure that the DNS server's IP address and the name for that address are correctly configured.
- Set the DNS server's IP address in the camcorder.
- If you are not using a DNS server, set the DNS address to [0.0.0.0].
- If you are using a wireless gateway router, make sure all of the devices in the network, including the camcorder, are configured with the correct gateway address.

**Wi-Fi authentication unsuccessful**

- Make sure the camcorder and access point are using the same authentication/encryption method and encryption key.
- If the access point is using MAC address filtering, enter the camcorder's MAC address in the access point's configuration screen.

**Wi-Fi cannot be used while the wireless microphone is attached**

- The camcorder's Wi-Fi functions cannot be used while the optional WM-V1 Wireless Microphone is connected to the camcorder. Disconnect the microphone from the MIC terminal and turn it off.

**Wi-Fi connection terminated**

- Cordless phones, microwave ovens, refrigerators and other appliances may interfere with the wireless signal. Try using the camcorder in a location farther away from such appliances.
- The camcorder may not be able to connect to the access point if too many devices are accessing it. After a short while, establish the connection again.

**Wi-Fi error Incorrect authentication method**

- Make sure the camcorder and access point are correctly configured.
- Make sure the camcorder and access point are using the same authentication/encryption method and encryption key.
- If the access point is using MAC address filtering, enter the camcorder's MAC address in the access point's configuration screen.

**Wi-Fi error Incorrect encryption key**

- The encryption key (password) is case sensitive so make sure to enter it correctly.

**Wi-Fi error Incorrect encryption method**

- Make sure the camcorder and access point are using the same authentication/encryption method.
- If the access point is using MAC address filtering, enter the camcorder's MAC address in the access point's configuration screen.

**Wireless communication is not working correctly**

- Cordless phones, microwave ovens, refrigerators and other appliances may interfere with the wireless signal. Try using the camcorder in a location farther away from such appliances.
- Turn off the camcorder and access point. After a short while, turn them on again and perform the Wi-Fi network setup again. If the problem persists contact a Canon Service Center.

## List of Messages for Web Services

**Check network settings**

- The network settings in the camcorder are not correctly configured. Check the connection point, SSID and other network settings.

**Connect to a computer and use supplied software to set up This service may not be available in your region**

- To use Web services, set in the camcorder the settings saved on CANON iIMAGE GATEWAY. Install ImageBrowser EX and CameraWindow in your computer and configure the settings using CANON iIMAGE GATEWAY.

**Connect to a computer and use the supplied software to set again**

- An error occurred when connecting to the CANON iIMAGE GATEWAY server. Check the settings saved on CANON iIMAGE GATEWAY and set them again in the camcorder.

**Insufficient space on server**

- You have exceeded the amount of data you can save on the CANON iIMAGE GATEWAY server. Delete some data to free some space.

**Movie must be less than X min.**

- You attempted to send a movie whose length exceeds the maximum length allowed by the Web service (the maximum length differs according to the Web service). Shorten the movie and try sending it again.

**Server busy Try again later**

- The CANON iIMAGE GATEWAY server is busy due to a high number of users trying to connect to the server. End the Wi-Fi connection and try again later.

**This image cannot be sent**

- You attempted to send a type of recording or a file with a size that is not supported by the selected Web service. Check the recording before sending.

**Try again**

- An error occurred when connecting to the CANON IMAGE GATEWAY server or the server is temporarily down. End the Wi-Fi connection and try again.



---

## Handling Precautions

### Camcorder

Be sure to observe the following precautions to ensure maximum performance.

- **Save your recordings periodically.** Make sure to transfer your recordings to an external device such as a computer or digital video recorder (□ 108) and save them on a regular basis. This will protect your important recordings in case of damage and create more free space on the memory card. Canon shall not be liable for any data loss.
- Do not carry the camcorder by the OLED panel. Be careful when closing the OLED panel. When using a wrist strap, do not allow the camcorder to swing and hit an object.
- **Handle the touch screen with care.** Do not apply excessive force and do not use ballpoint pens or other hard-tipped tools to operate the touch screen. This may damage the touch screen's surface.
- Do not attach protective film on the touch screen. The camcorder features a capacitive touch screen so you may not be able to correctly operate the touch screen with an additional protective layer.
- Do not hold the camcorder in the same posture for long periods of times as this may cause low-temperature contact burns. Even if the camcorder does not feel too hot, prolonged contact with the same body part may cause skin redness or blistering. The use of a tripod is recommended for people with circulation problems or very sensitive skin, or when using the camcorder in very hot places.
- Do not leave the camcorder in places subject to high temperatures (like the inside of a car parked under direct sunlight), or high humidity.
- Do not use the camcorder near strong electromagnetic fields such as above TVs, near plasma TVs or mobile phones.
- Do not use the camcorder's Wi-Fi functions inside hospitals, medical clinics or onboard aircraft. In addition, do not use them near medical equipment or sensitive electronic devices as it may affect their performance. In the case of pacemakers, keep the camcorder at least 22 cm (8.7 in.) away from the device.
- The camcorder's Wi-Fi functions may be subject to interference from devices such as cordless phones and microwave ovens. Keeping as much distance as possible from these devices or using the camcorder's Wi-Fi functions at a different time of day may reduce such interference.
- Do not point the lens or viewfinder at strong light sources. Do not leave the camcorder pointed at a bright subject.
- Do not use or store the camcorder in dusty or sandy places. The camcorder is not waterproof – avoid also water, mud or salt. If any of the above should get into the camcorder it may damage the camcorder and/or the lens.
- Be careful of heat generated by lighting equipment.
- Do not disassemble the camcorder. If the camcorder does not function properly, consult qualified service personnel.
- Handle the camcorder with care. Do not subject the camcorder to shocks or vibration as this may cause damage.

- When mounting the camcorder on a tripod, make sure that the tripod's fastening screw is shorter than 6.5 mm (0.26 in.). Using other tripods may damage the camcorder.

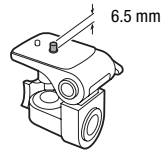

- **When recording movies, try to get a calm, stable picture.**

Excessive camcorder movement while shooting and extensive use of fast zooms and panning can result in jittery scenes. In extreme cases, the playback of such scenes may result in visually induced motion sickness. If you experience such a reaction, stop the playback immediately and take a rest break as necessary.

170

## Long-term storage

If you do not intend to use the camcorder for a long time, store it in a place free of dust, in low humidity, and at temperatures not higher than 30 °C (86 °F).

## Battery Pack

### **DANGER!**

#### **Treat the battery pack with care.**

- Keep it away from fire (or it might explode).
  - Do not expose the battery pack to temperature higher than 60 °C (140 °F). Do not leave it near a heater or inside a car in hot weather.
  - Do not try to disassemble or modify it.
  - Do not drop it or subject it to shocks.
  - Do not get it wet.
- Dirty terminals may cause a poor contact between the battery pack and the camcorder. Wipe the terminals with a soft cloth.



## Long-term storage

- Store battery packs in a dry place at temperatures no higher than 30 °C (86 °F).
- To extend the battery life of the battery pack, discharge it completely before storing it.
- Charge and discharge all your battery packs fully at least once a year.

## Remaining battery time

When you are using a battery pack that is compatible with Intelligent System, if the remaining battery time displayed is not correct, charge the battery pack fully. Still, the correct time may not be displayed after a large number of repeated uses, if a fully charged battery pack is left unused, or if a battery pack is used for long periods of time in high temperatures. Use the time shown on the screen as an approximation.

## Regarding the use of non-Canon battery packs

- For your safety, battery packs that are not genuine Canon battery packs will not be charged even if you attach them to this camcorder or to the optional CG-800 Battery Charger.
- We recommend using genuine Canon battery packs bearing the  Intelligent Li-ion Battery mark.
- If you attach to the camcorder battery packs that are not genuine Canon battery packs,  will appear and the remaining battery time will not be displayed.

## Memory Card

- We recommend backing up the recordings on the memory card onto your computer. Data may be corrupted or lost due to memory card defects or exposure to static electricity. Canon shall not be liable for lost or corrupted data.
- Do not touch or expose the terminals to dust or dirt.
- Do not use memory cards in places subject to strong magnetic fields.
- Do not leave memory cards in places subject to high humidity and high temperature.
- Do not disassemble, bend, drop, or subject memory cards to shocks and do not expose them to water.
- Check the direction before inserting the memory card. Forcing a memory card into a slot if it is not correctly oriented may damage the memory card or the camcorder.
- Do not attach any labels or stickers on the memory card.
- Secure Digital (SD) memory cards have a physical switch to prevent writing on the card so as to avoid the accidental erasure of the card's content. To write-protect the memory card set the switch to the LOCK position.

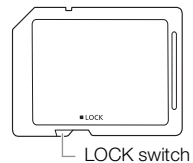

## Built-in Rechargeable Lithium Battery

The camcorder has a built-in rechargeable lithium battery to keep the date/time and other settings. The built-in lithium battery is recharged while you use the camcorder; however, it will discharge completely if you do not use the camcorder for about 3 months.

**To recharge the built-in lithium battery:** Connect the compact power adapter to the camcorder and leave it connected for 24 hours with the camcorder off.

## Lithium Button Battery

### WARNING!

- The battery used in this device may present a fire or chemical burn hazard if mishandled.
- Do not disassemble, modify, immerse in water, heat above 100 °C (212 °F) or incinerate the battery.
- Replace with a CR2025 battery made by Panasonic, Hitachi Maxell, Sony, FDK, or with Duracell2025. Use of other batteries may present a risk of fire or explosion.
- Do not insert the battery into the mouth. If swallowed, seek medical assistance immediately. The battery case may break and the battery fluids may cause internal injuries.
- Keep the battery out of the reach of children.
- Do not recharge, short-circuit or insert the battery in the wrong direction.
- Dispose of the used battery according to applicable recycling regulations.

- Do not pick up the battery using tweezers or other metal tools, as this will cause a short circuit.
- Wipe the battery with a clean dry cloth to ensure proper contact.
- **For California, USA only:** The lithium battery included contains Perchlorate Material – special handling may apply.  
See [www.dtsc.ca.gov/hazardouswaste/perchlorate](http://www.dtsc.ca.gov/hazardouswaste/perchlorate) for details.

## Disposal

When you delete movies or initialize a memory card, only the file allocation table is altered and stored data is not physically erased. When you dispose of a memory card or give either to another person, initialize it using the [Complete Initialization] option (□ 36). Fill it up with unimportant recordings, and then initialize it again using the same option. This makes recovering the original recordings very difficult.

---

## Maintenance/Others

### Cleaning

#### Camcorder Body

- Use a soft, dry cloth to clean the camcorder body. Never use chemically treated cloths or volatile solvents such as paint thinner.

173

#### Lens, Viewfinder and Instant AF Sensor

- If the lens surface or Instant AF sensor is dirty, autofocus may not work properly.
- Remove any dust or dirt particles using a non-aerosol type blower brush.
- Use a clean, soft lens-cleaning cloth to gently wipe the lens or viewfinder. Never use tissue paper.

#### OLED Touch Screen

- Clean the OLED touch screen using a clean, soft lens-cleaning cloth.
- Condensation may form on the surface of the screen when the temperature changes suddenly. Wipe it with a soft dry cloth.

### Condensation

Moving the camcorder rapidly between hot and cold temperatures may cause condensation (water droplets) to form on its internal surfaces. Stop using the camcorder if condensation is detected. Continued use may damage the camcorder.

#### Condensation may form in the following cases:

- When the camcorder is moved quickly from cold to warm places
- When the camcorder is left in a humid room
- When a cold room is heated rapidly

#### To avoid condensation

- Do not expose the camcorder to sudden or extreme changes in temperature.
- Remove the memory card and battery pack. Then, place the camcorder in an airtight plastic bag and let it adjust gradually to temperature changes before removing it from the bag.

#### When condensation is detected

The precise time required for water droplets to evaporate will vary depending on the location and weather conditions. As a general rule, wait for 2 hours before resuming use of the camcorder.

## Using the Camcorder Abroad

### Power Sources

You can use the compact power adapter to operate the camcorder and to charge battery packs in any country with power supply between 100 and 240 V AC, 50/60 Hz. Consult a Canon Service Center for information on plug adapters for overseas use.

---

174

### Playback on a TV Screen

You can only play back your recordings on TVs compatible with the NTSC system. NTSC is used in the following regions/countries:

**Americas:** All of North America and Central America; most Caribbean islands (except in French territories like Guadeloupe and Martinique); most of South America (except in Argentina, Brazil and Uruguay). **Asia:** Only in Japan, the Philippines, South Korea, Taiwan and Myanmar. **Oceania:** US territories (Guam, American Samoa, etc.) and some Pacific islands like Micronesia, Samoa and Tonga.

## Optional Accessories (Availability differs from area to area)

The following optional accessories are compatible with this camcorder. Select accessories are described in more detail in the following pages.



BP-820, BP-828  
Battery Pack



CG-800  
Battery Charger



CA-570 Compact  
Power Adapter



TL-H58  
Tele-converter



WA-H58 Wide  
Attachment

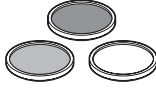

Protect Filter 58 mm,  
ND4L Filter 58 mm,  
ND8L Filter 58 mm

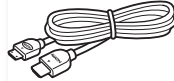

HTC-100/S High  
Speed HDMI Cable

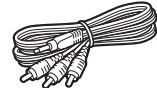

STV-250N  
Stereo Video Cable

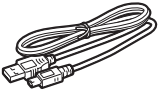

IFC-400PCU  
USB Cable



VL-5 Video Light



VFL-2 Video Flash  
Light



SM-V1  
Surround Microphone

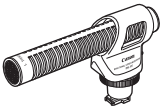

DM-100 Directional  
Stereo Microphone



WM-V1 Wireless  
Microphone



GP-E2  
GPS Receiver

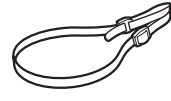

SS-600/SS-650  
Shoulder Strap



WS-20  
Wrist Strap



SC-2000  
Soft Carrying Case

 NOTES

- Accessories that are compatible with the Advanced Accessory Shoe cannot be attached to this camcorder. Look for the **Mini ADVANCED SHOE** logo to ensure compatibility with the mini advanced shoe.



Call or visit your local retailer/dealer for genuine Canon video accessories. You can also obtain genuine accessories for your Canon camcorder by calling: 1-800-828-4040, Canon U.S.A. Information Center.

**Use of genuine Canon accessories is recommended.**

This product is designed to achieve excellent performance when used with genuine Canon accessories. Canon shall not be liable for any damage to this product and/or accidents such as fire, etc., caused by the malfunction of non-genuine Canon accessories (e.g., a leakage and/or explosion of a battery pack). Please note that this warranty does not apply to repairs arising out of the malfunction of non-genuine Canon accessories, although you may request such repairs on a chargeable basis.

## Battery Packs

When you need extra battery packs, select one of the following models: BP-820 or BP-828.

When you use battery packs bearing the Intelligent System mark, the camcorder will communicate with the battery and display the remaining usage time (accurate to 1 minute). You can only use and charge these battery packs with camcorders and chargers compatible with Intelligent System.

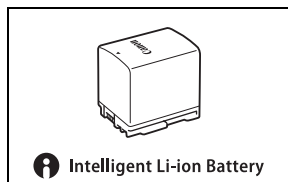

## CG-800 Battery Charger

Use the battery charger to charge the battery packs. It plugs directly into a power outlet without a cable.

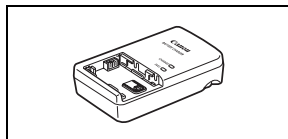

## Charging, Recording and Playback Times

The charging times given in the following table are approximate and vary according to charging conditions and initial charge of the battery pack.

Battery pack→	BP-820	BP-828
Charging conditions↓		
Using the camcorder	275 min.	405 min.
Using the CG-800 Battery Charger	190 min.	260 min.

Recording and playback times given in the following tables are approximate and vary according to recording mode and charging, recording or playback conditions. The effective usage time of the battery pack may decrease when recording in cold surroundings, when using the brighter screen settings, etc.

### Recording AVCHD movies

Battery pack	Recording mode	Recording (maximum)		Recording (typical)*		Playback
		OLED	Viewfinder	OLED	Viewfinder	OLED
BP-820	28 Mbps LPCM (59.94P) / 28 Mbps (59.94P)	150 min.	155 min.	90 min.	90 min.	260 min.
	24 Mbps LPCM / 24 Mbps	170 min.	165 min.	100 min.	100 min.	275 min.
	17 Mbps	170 min.	170 min.	100 min.	100 min.	275 min.
	5 Mbps	170 min.	170 min.	100 min.	100 min.	280 min.
BP-828	28 Mbps LPCM (59.94P) / 28 Mbps (59.94P)	225 min.	230 min.	140 min.	140 min.	395 min.
	24 Mbps LPCM / 24 Mbps	250 min.	245 min.	150 min.	150 min.	410 min.
	17 Mbps	250 min.	250 min.	150 min.	150 min.	410 min.
	5 Mbps	260 min.	260 min.	155 min.	155 min.	415 min.

### Recording MP4 movies

Battery pack	Recording mode	Recording (maximum)		Recording (typical)*		Playback
		OLED	Viewfinder	OLED	Viewfinder	OLED
BP-820	35 Mbps (59.94P)	155 min.	150 min.	90 min.	90 min.	260 min.
	24 Mbps	180 min.	175 min.	105 min.	105 min.	280 min.
	17 Mbps	180 min.	180 min.	105 min.	105 min.	280 min.
	4 Mbps	190 min.	185 min.	110 min.	110 min.	290 min.
	3 Mbps	190 min.	190 min.	110 min.	110 min.	300 min.
BP-828	35 Mbps (59.94P)	230 min.	225 min.	140 min.	140 min.	395 min.
	24 Mbps	275 min.	270 min.	160 min.	160 min.	415 min.
	17 Mbps	275 min.	275 min.	165 min.	160 min.	415 min.
	4 Mbps	290 min.	285 min.	170 min.	165 min.	450 min.
	3 Mbps	295 min.	295 min.	170 min.	170 min.	455 min.

\* Approximate times for recording with repeated operations such as start/stop, zooming, and power on/off.

### TL-H58 Tele-converter

This Tele-converter lens increases the focal length of the camcorder lens by a factor of 1.5.

- The Tele-converter cannot be used together with the supplied lens hood with lens barrier.
- The image stabilizer is not as effective when the Tele-converter is attached.
- The minimum focusing distance at full telephoto with the Tele-converter is 1.3 m (4.3 ft.).

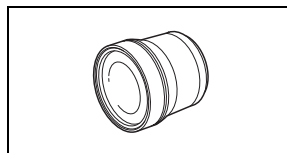

### WA-H58 Wide Attachment

This Wide Attachment lens decreases the focal length by a factor of 0.75, giving you a wide perspective for indoor shots or panoramic views.

- The Wide Attachment cannot be used together with the supplied lens hood with lens barrier.

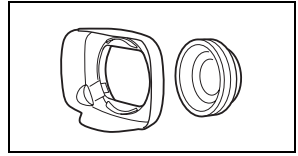

### Protect Filter 58 mm, ND4L Filter 58 mm, ND8L Filter 58 mm

Neutral density and MC protector filters help you to control difficult lighting conditions.

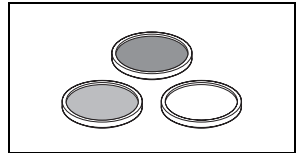

### VL-5 Video Light

This video light enables you to record brightly in color even in dark places. It attaches to the camcorder's mini advanced shoe for cable-free operation.

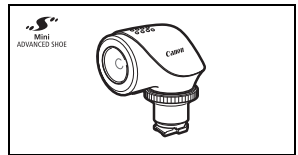

### VFL-2 Video Flash Light

This video flash light allows you to record photos and movies even at night or in dark places. It attaches to the camcorder's mini advanced shoe for cable-free operation.

- The VFL-2 cannot be used as a flash with this camcorder.

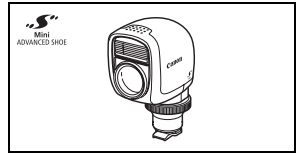

### SM-V1 Surround Microphone

Use 5.1ch surround sound to add a sense of presence to your movies. You can link the surround sound to the zoom position or use the microphone as a highly directional shotgun microphone (monaural).

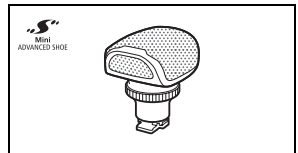

### DM-100 Directional Stereo Microphone

This highly sensitive, super-directional microphone attaches to the camcorder's mini advanced shoe. It can be used as directional microphone (monaural) or stereo microphone.

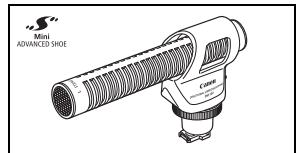

### WM-V1 Wireless Microphone

Reliably record rich sound even when shooting subjects at a distance. The transmitter is conveniently equipped with a clothing clip and the receiver can be attached to the camcorder's grip belt.

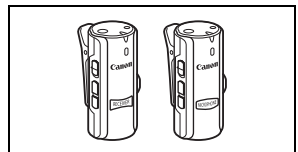

### SC-2000 Soft Carrying Case

A handy camcorder bag with padded compartments and plenty of space for accessories.

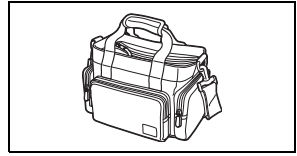

This mark identifies genuine Canon video accessories. When you use Canon video equipment, we recommend Canon-brand accessories or products bearing the same mark.



# Specifications

## VIXIA HF G30

◆ – Values given are approximate figures.

### System

- Recording System

Movies: AVCHD<sup>1</sup> Video: MPEG-4 AVC/H.264;  
 Audio: Linear PCM, 16 bits, 48 kHz, 2ch<sup>2</sup>  
 Dolby Digital 2ch; Dolby Digital 5.1ch<sup>3</sup>  
 MP4 Video: MPEG-4 AVC/H.264  
 Audio: MPEG-2 AAC-LC (2ch)

Photos: DCF (Design rule for Camera File system), compatible with Exif<sup>4</sup> Ver. 2.3  
 Image type: JPEG

<sup>1</sup> Compatible with AVCHD ver. 2.0 specifications.

<sup>2</sup> Linear PCM is available only when the recording mode is 28 Mbps LPCM (59.94P) or 24 Mbps LPCM.

<sup>3</sup> Dolby Digital 5.1ch is available only when using the optional SM-V1 Surround Microphone.

<sup>4</sup> This camcorder supports Exif 2.3 (also called "Exif Print"). Exif Print is a standard for enhancing the communication between camcorders and printers. By connecting to an Exif Print-compliant printer, the camcorder's image data at the time of shooting is used and optimized, yielding extremely high quality prints.

- Video Signal Configuration

AVCHD, MP4

- Recording Media

SD, SDHC (SD High Capacity) or SDXC (SD eXtended Capacity) memory card (not included);  
 two memory card slots

- Maximum Recording Time◆

Commercially available 32 GB memory card:

AVCHD movies:

28 Mbps LPCM (59.94P) and 28 Mbps (59.94P): 2 hr. 30 min.

24 Mbps LPCM and 24 Mbps: 2 hr. 55 min.      17 Mbps: 4 hr. 10 min.

5 Mbps: 12 hr. 15 min.

MP4 movies:

35 Mbps (59.94P): 2 hr.      24 Mbps: 2 hr. 55 min.

17 Mbps: 4 hr. 10 min.      4 Mbps: 17 hr. 20 min.

3 Mbps: 22 hr. 55 min.

Commercially available 8 GB memory card:

AVCHD movies:

28 Mbps LPCM (59.94P) and 28 Mbps (59.94P): 35 min.

24 Mbps LPCM and 24 Mbps: 40 min.      17 Mbps: 1 hr.

5 Mbps: 3 hr.

MP4 movies:

35 Mbps (59.94P): 30 min.      24 Mbps: 40 min.

17 Mbps: 1 hr.      4 Mbps: 4 hr. 20 min.

3 Mbps: 5 hr. 40 min.

- **Image Sensor**  
1/2.84-inch CMOS, 3,090,000 pixels ♦  
Effective pixels: 2,910,000 pixels ♦
- **OLED Touch Screen:** 3.5 in., wide, TFT color, equivalent to 1,230,000 dots ♦, 100% coverage, touch operation
- **Viewfinder:** 0.24 in., wide, color, equivalent to 1,560,000 dots ♦, 100% coverage
- **Microphone:** Stereo electret condenser microphone
- **Lens**  
f=3.67-73.4 mm, F/1.8-2.8, 20x optical zoom, 8-bladed circular aperture  
35 mm equivalent: 26.8 – 576 mm ♦  
28.8 – 576 mm ♦ (when Dynamic IS is activated)
- **Lens Configuration:** 12 elements in 10 groups (double-sided aspheric element)
- **AF System**  
Autofocus (TTL + external distance sensor when set to [Instant AF] or [Medium AF]) or Manual focus
- **Filter Diameter:** 58 mm
- **Minimum Focusing Distance**  
60 cm (2 ft.); 1 cm (0.39 in.) at full wide angle
- **White Balance**  
Auto white balance, Custom white balance (2 settings), User-defined color temperature or Preset white balance settings: Daylight, Shade, Cloudy, Fluorescent, Fluorescent H, Tungsten
- **Minimum Illumination**  
0.1 lx ([Low Light] recording program, Shutter speed at 1/2)  
1.2 lx ([Programmed AE] recording program, Auto slow shutter [On], Shutter speed at 1/30)
- **Recommended Illumination:** More than 100 lx
- **Image Stabilization:** Optical-Shift Image Stabilizer
- **Size of Video Recordings**  
AVCHD movies:  
28 Mbps LPCM (59.94P), 28 Mbps (59.94P), 24 Mbps LPCM, 24 Mbps, 17 Mbps:  
1920 x 1080 pixels; 5 Mbps: 1440 x 1080 pixels  
MP4 movies:  
35 Mbps (59.94P), 24 Mbps, 17 Mbps: 1920 x 1080 pixels; 4 Mbps: 1280 x 720 pixels;  
3 Mbps: 640 x 360 pixels
- **Size of Photos:** 1920 x 1080 pixels  
1280 x 720 pixels (photos captured from MP4 movies at 4 Mbps)  
640 x 360 pixels (photos captured from MP4 movies at 3 Mbps)  
1920 x 1080 pixels (photos captured from movies)

## Terminals

- **HDMI OUT Terminal**  
HDMI mini connector; output only
- **USB Terminal:** mini-B receptacle, Hi-Speed USB; output only
- **AV OUT Terminal**  
Ø 3.5 mm 4-pole minijack; output only  
Video: 1 V<sub>p-p</sub> / 75 Ω unbalanced  
Audio: -10 dBV (47 kΩ load) / 3 kΩ or less
- **MIC Terminal**  
Ø 3.5 mm stereo minijack (unbalanced)  
-65 dBV (auto volume, full scale -12 dB) / 5 kΩ or more  
Microphone attenuator: 20 dB
- **🎧 (headphone) Terminal**  
Ø 3.5 mm stereo minijack (unbalanced)  
-29 dBV (16 Ω load, Max volume) / 100 Ω
- **REMOTE Terminal**  
Ø 2.5 mm stereo minijack; input only

## Power/Others

- **Power supply (rated)**  
7.4 V DC (battery pack), 8.4 V DC (compact power adapter)
- **Power consumption♦:**  
4.3 W (17 Mbps, AF on, OLED normal brightness)  
4.4 W (17 Mbps, AF on, viewfinder)  
Maximum rated power consumption: 14.2 W
- **Operating temperature♦:** 0 – 40 °C (32 – 104 °F)
- **Dimensions♦ [W x H x D] (excluding the grip belt)**  
Camcorder only: 109 x 84 x 182 mm (4.3 x 3.3 x 7.2 in.)  
Camcorder with the lens hood attached: 115 x 84 x 231 mm (4.5 x 3.3 x 9.1 in.)
- **Weight♦ (camcorder with lens hood attached):** 900 g (2.0 lb)

## CA-570 Compact Power Adapter

- **Power supply:** 100 – 240 V AC, 50/60 Hz
- **Rated output / consumption:** 8.4 V DC, 1.5 A / 29 VA (100 V) – 39 VA (240 V)
- **Operating temperature♦:** 0 – 40 °C (32 – 104 °F)
- **Dimensions♦:** 52 x 29 x 90 mm (2.1 x 1.1 x 3.5 in.)
- **Weight♦:** 135 g (4.8 oz.)

## BP-820 Battery Pack

- **Battery type**  
Rechargeable lithium ion battery, compatible with Intelligent System
- **Rated voltage:** 7.4 V DC
- **Operating temperature**♦: 0 – 40 °C (32 – 104 °F)
- **Battery capacity:** 1780 mAh (typical); 13 Wh / 1700 mAh (minimum)
- **Dimensions**♦: 30.7 x 39.4 x 40.2 mm (1.2 x 1.6 x 1.6 in.)
- **Weight**♦: 85 g (3.0 oz.)

### About available Wi-Fi frequencies and channels

The camcorder's Wi-Fi functions operate in a predetermined range of frequencies and channels, which also determines whether the camcorder can connect with iOS and Android devices within that range.

Frequency	Channel	Connect with iOS and Android devices
2412 to 2462 MHz	1 to 11	Yes
5280 to 5320 MHz	56 to 64	No
5745 to 5805 MHz	149 to 161	Yes



# Index

## A

- Abroad, using the camcorder . . . . . 174
- AGC (automatic gain control) limit . . . . . 62
- Aperture (f number) . . . . . 63, 65
- Aspect ratio of a connected  
TV (TV type) . . . . . 147
- Assignable buttons . . . . . 92
- Audio equalizer . . . . . 82
- Audio mix . . . . . 84
- Audio output . . . . . 104
- Audio recording level . . . . . 81
- Audio reference signal . . . . . 86
- Audio scene select . . . . . 79
- AUTO mode . . . . . 39
- Auto slow shutter . . . . . 145
- Av (recording program) . . . . . 63
- AV OUT terminal . . . . . 102, 103

## B

- Backlight correction . . . . . 67
- Battery pack
  - Battery information . . . . . 151
  - Charging . . . . . 21
  - Remaining charge indicator . . . . . 156
- Beach (recording program) . . . . . 70
- Built-in backup battery . . . . . 171

## C

- CANON IMAGE GATEWAY . . . . . 133
- Capturing photos from a movie . . . . . 97
- CINEMA mode . . . . . 50
- Cinema-look filters . . . . . 50
- Color bars . . . . . 86
- Compact power adapter . . . . . 21
- Condensation . . . . . 173
- Connection to an external monitor . . . . . 102
- Converting movies to MP4 format . . . . . 114
- Copying recordings to a memory card . . . . . 112
- CUSTOM button . . . . . 91
- CUSTOM dial . . . . . 91

## D

- Data code . . . . . 89, 147
- Date and time . . . . . 33
- Deleting
  - Movies . . . . . 98
  - Photos . . . . . 107
- Digital tele-converter . . . . . 60
- Dividing scenes . . . . . 100

- Dual recording . . . . . 47

## E

- Error messages . . . . . 162
- Exposure compensation . . . . . 66
- External audio input . . . . . 84
- External microphone . . . . . 78

## F

- Face detection . . . . . 55
- Fireworks (recording program) . . . . . 71
- Focus preset . . . . . 53
- Focus/zoom ring . . . . . 52, 57
- Frame rate . . . . . 48
- FTP transfer . . . . . 131
- FUNC. panel . . . . . 31, 143

## H

- HDMI OUT terminal . . . . . 102, 103
- Headphones . . . . . 85
- ⌂ (headphones) terminal . . . . . 85
- High-speed zoom . . . . . 58
- Highlight AE . . . . . 67

## I

- Image effects . . . . . 72
- Image stabilizer . . . . . 61
- Initializing a memory card . . . . . 36
- Intelligent IS . . . . . 41

## L

- Language . . . . . 34
- Lens barrier switch . . . . . 38
- Lens hood . . . . . 24
- Low cut filter . . . . . 84
- Low light (recording program) . . . . . 70

## M

- M (Manual) mode . . . . . 43
- Maintenance . . . . . 173
- Manual exposure . . . . . 65
- Manual focus . . . . . 52
- Markers . . . . . 146
- Memory card . . . . . 35, 171
- Menu settings, saving and loading . . . . . 94
- MIC terminal . . . . . 79
- Microphone attenuator . . . . . 146
- Microphone directionality . . . . . 83
- Mini advanced shoe . . . . . 76

Mode switch .....	29
Monitor delay .....	104
Movie format (AVCHD/MP4) .....	37
Movie Uploader .....	128

## N

ND filter .....	146
Night scene (recording program) .....	70
Notification sounds .....	151

## O

OLED touch screen .....	29
Onscreen display selection .....	89
Onscreen icons .....	153

## P

P (recording program) .....	63
Peaking .....	53
Playback	
Movies .....	95
Photos .....	105
Portrait (recording program) .....	70
Powered IS .....	61
Pre-recording .....	88

## R

Recording	
Movies .....	39, 43, 50
Photos .....	39, 43
Recording mode .....	45
Recording programs .....	63, 65, 70
Recording time .....	46
Relay recording .....	47
Remote Browse .....	126
Remote sensor .....	27
Resetting all camcorder settings .....	152
Reviewing recordings .....	44

## S

Saving recordings	
Using a computer .....	108
Using external video recorders .....	115
Selecting the memory card	
for recording .....	37
Setup menus .....	32, 144
Shutter speed .....	63, 65
Slow & fast motion .....	49
Smart AUTO .....	40
Snow (recording program) .....	70

Sports (recording program) .....	70
Spotlight (recording program) .....	71
Sunset (recording program) .....	70

## T

Telephoto .....	57
Time code .....	73
Time zone/DST .....	34
Touch AE .....	66
Touch AF .....	52
Touch screen operations .....	29
Trimming scenes .....	101
Tripod .....	27, 170
Troubleshooting .....	157
Turning off notification sounds .....	151
Tv (recording program) .....	63

## U

Uploading movies .....	128, 133
USB terminal .....	102, 108, 115
User bit .....	75

## V

Video snapshot .....	87
Viewfinder .....	24
Volume .....	96

## W

White balance .....	68
Wi-Fi .....	117
Wi-Fi Remote .....	120
Wide angle .....	57
Wind screen .....	81
Wireless controller .....	20, 26

## Z

Zebra pattern .....	65
Zoom .....	57
Digital zoom .....	145
Soft zoom control .....	60
Zoom speed .....	57

## CANON CONSUMER DIGITAL VIDEO EQUIPMENT LIMITED WARRANTY FOR THE UNITED STATES

The limited warranty set forth below is given by Canon U.S.A., Inc. ("Canon USA") with respect to Canon Consumer Digital Video Equipment (the "Equipment") purchased in the United States. This limited warranty is only effective upon presentation of your Bill of Sale or other proof of purchase.

The Equipment is warranted under normal, non-commercial, personal use, against defective materials or workmanship as follows:

**Parts:** Defective parts will be exchanged for new parts or comparable rebuilt parts for a period of ONE YEAR from the date of original purchase, except for a defective Video Head, which will be exchanged for a period of three months from the date of purchase.

**Labor:** For a period of ONE YEAR from the date of original purchase, labor will be provided free of charge by our factory service centers or designated service facilities located in the United States.

When returning Equipment under this warranty, you must pre-pay the shipping charges, and you must enclose the Bill of Sale or other proof of purchase with a complete explanation of the problem. During the ONE-YEAR warranty period, repairs will be made and the Equipment will be return-shipped to you free of charge. For repairs after the warranty period is over, you will be given an estimate of the cost of repair and an opportunity to approve or disapprove of the repair expense before it is incurred. If you approve, repairs will be made and the Equipment will be return-shipped to you. (shipping charges apply). If you disapprove, we will return-ship the equipment at no charge to you.

**Non-Canon brand peripheral equipment and software which may be distributed with, or factory loaded on, the Equipment, are sold "AS IS" without warranty of any kind by Canon USA, including any implied warranty regarding merchantability or fitness for a particular purpose. The sole warranty with respect to such non-Canon brand items is given by the manufacturer or producer thereof. If the Equipment contains a hard disk drive, Canon USA recommends that data stored on that drive be duplicated or backed up to prevent its loss in the event of failure or other malfunction of such drive.**

Canon USA shall have no responsibility under this limited warranty for use of the Equipment in conjunction with incompatible peripheral equipment and incompatible software.

In order to obtain warranty service, contact the authorized Canon retail dealer from whom you purchased the Equipment or call the CANON INFORMATION CENTER AT 1-800-OK-CANON). You will be directed to the nearest service facility for your Equipment.

This Limited Warranty covers all defects encountered in normal use of the Equipment and does not apply in the following cases:

- A) Loss or damage to the Equipment due to abuse, mishandling, accident, improper maintenance, or failure to follow operating instructions;
- B) If the Equipment is defective as a result of leaking batteries, sand, dirt or water damage;
- C) If defects or damages are caused by the use of unauthorized parts or by service other than by Canon USA's factory service centers or authorized service facilities;
- D) If the Equipment is used for commercial or industrial use.

This Limited Warranty does not cover cabinet (exterior finish), video cassette tape, head cleanings, nor does it apply to Equipment purchased outside the United States. This warranty does not cover units sold to rental firms, military operations, hotels, schools, hospitals or for other commercial, industrial, or institutional applications. These uses are covered only by such specific warranty as Canon may issue with such sales.

This Limited Warranty does not apply to accessories or consumables for the Equipment, which are sold "AS IS", without warranty of any kind by Canon USA. Please retain this warranty card and your Bill of Sale as a permanent record of your purchase. This card is most important in order to be sure you are contacted right away should there be a safety inspection, modification or product recall under applicable laws or regulations.

**NO IMPLIED WARRANTY, INCLUDING MERCHANTABILITY AND FITNESS FOR A PARTICULAR PURPOSE APPLIES TO THIS EQUIPMENT AFTER THE APPLICABLE PERIOD OF EXPRESS WARRANTY OR GUARANTY, EXCEPT AS MENTIONED ABOVE. GIVEN BY ANY PERSON, FIRM OR CORPORATION WITH RESPECT TO THIS EQUIPMENT SHALL BIND THE UNDERSIGNED (SOME STATES DO NOT ALLOW LIMITATIONS ON HOW LONG AN IMPLIED WARRANTY LASTS, SO THE ABOVE LIMITATION OR EXCLUSION MAY NOT APPLY TO YOU). CANON USA SHALL NOT BE LIABLE FOR LOSS OF REVENUES OR PROFITS, EXPENSE FOR SUBSTITUTE EQUIPMENT OR SERVICE, STORAGE CHARGES, LOSS OR CORRUPTION OF DATA, INCLUDING WITHOUT LIMITATION, LOSS OR CORRUPTION OF DATA STORED ON THE EQUIPMENT'S HARD DRIVE, OR ANY OTHER SPECIAL, INCIDENTAL OR CONSEQUENTIAL DAMAGES CAUSED BY THE USE, MISUSE OR INABILITY TO USE THE EQUIPMENT, REGARDLESS OF THE LEGAL THEORY ON WHICH THE CLAIM IS BASED, AND EVEN IF CANON USA HAS BEEN ADVISED OF THE POSSIBILITY OF SUCH DAMAGES. NOR SHALL RECOVERY OF ANY KIND AGAINST CANON USA BE GREATER THAN THE PURCHASE PRICE OF THE EQUIPMENT SOLD BY CANON USA AND CAUSING THE ALLEGED DAMAGE. WITHOUT LIMITING THE FOREGOING, YOU ASSUME ALL RISK AND LIABILITY FOR LOSS, DAMAGE OR INJURY TO YOU AND YOUR PROPERTY AND TO OTHERS AND THEIR PROPERTY ARISING OUT OF USE, MISUSE OR INABILITY TO USE THE EQUIPMENT NOT CAUSED DIRECTLY BY THE NEGLIGENCE OF CANON USA. (SOME STATES DO NOT ALLOW THE EXCLUSION OR LIMITATION OF INCIDENTAL OR CONSEQUENTIAL DAMAGES, SO THE ABOVE LIMITATION MAY NOT APPLY TO YOU). THIS WARRANTY SHALL NOT EXTEND TO ANYONE OTHER THAN THE ORIGINAL PURCHASER OF THIS EQUIPMENT OR THE PERSON FOR WHOM IT WAS PURCHASED AS A GIFT.**

This warranty gives you specific legal rights, and you may also have other rights which vary from state to state.  
CANON U.S.A., INC.

**CANON CONSUMER DIGITAL VIDEO EQUIPMENT LIMITED WARRANTY**

The limited warranty set forth below is given by Canon Canada Inc. ("Canon Canada") with respect to Canon Consumer Digital Video Equipment (the "Equipment") purchased in Canada. This limited warranty is only effective upon presentation of a bill of sale or other proof of purchase for this Equipment to a Canon Service Facility when repairs are required.

The Equipment is warranted under normal, non-commercial, personal use, against defective materials or workmanship as follows:

Parts: Defective parts will be exchanged for new parts or, at Canon Canada's option, comparable rebuilt parts for a period of one year from the date of original purchase, except Video Heads which will be exchanged for a period of 3 months from the date of purchase.

Labour: For a period of one year from the date of original purchase, labour will be provided free of charge by our Canon Service Facilities in Canada.

This limited warranty covers all defects except where:

(a) The loss or damage to the product results from:

- i) accident, natural disaster, mishandling, abuse, neglect, unauthorized product modification or failure to follow instructions contained in the instruction manual;
- ii) the use of accessories, attachments, products, supplies, parts or devices with the Equipment that do not conform to Canon specifications or that cause abnormally frequent service problems;
- iii) repairs or services performed by any party other than a Canon Service Facility;
- iv) defective batteries or any exposure to water, sand or dirt;
- v) shipping (claim must be presented to the shipper);

(b) Any serial number on the video equipment is altered or removed.

(c) The Equipment is used for commercial, professional or industrial purposes.

This limited warranty does not cover the cabinet (exterior finish) of the Equipment, media, nor does it apply to Equipment purchased outside Canada.

If the Equipment contains a hard disk drive, Canon Canada recommends that data stored on that drive be duplicated or backed up to prevent its loss in the event of a failure or other malfunction of such drive.

**TO OBTAIN WARRANTY SERVICE**

Ship your Equipment in its original carton, box or equivalent, properly packed, fully insured with shipping charges prepaid, together with a copy of your bill of sale or other proof of purchase and a description of the problem to any of the Canon Service Facilities in Canada.

**LIMITATIONS**

Except as otherwise required by applicable legislation, this warranty is in lieu of all other warranties, conditions, guarantees or representations, express or implied, statutory or otherwise, relative to the Equipment, including implied warranties or conditions of merchantability or fitness for a particular purpose.

Canon Canada assumes no liability for special, consequential or incidental damages, loss or corruption of data including, without limitation, data stored on the hard disk drive of the Equipment or loss that may arise, whether on account of negligence or otherwise, from the use, misuse or inability to use the Equipment (including loss of profit, revenue, media or enjoyment) or from failure to conform to any express or implied warranties, conditions, guarantees or representations. Any recovery under this limited warranty shall not exceed the purchase price of the equipment. Canon Canada does not assume or authorize any other person to assume for Canon Canada any other liability with respect to this equipment.

This warranty does not extend to any person other than the original purchaser of the Equipment or the person for whom it was purchased as a gift and states your exclusive remedy.

**NOTICE TO CONSUMER**

If you plan to take important videos or if the product has not been used for some time, please check all functions with the instruction book before using it.



---

<b>USA</b>	<p><b>CANON U.S.A., INC. NEW JERSEY OFFICE</b> 100 Jamesburg Road, Jamesburg, NJ 08831 USA</p> <p><b>CANON U.S.A., INC. CHICAGO OFFICE</b> 100 Park Blvd., Itasca, IL 60143 USA</p> <p><b>CANON U.S.A., INC. LOS ANGELES OFFICE</b> 15955 Alton Parkway, Irvine, CA 92618 USA</p> <p><b>CANON U.S.A., INC. HONOLULU OFFICE</b> 210 Ward Avenue, Suite 200, Honolulu, HI 96814 USA</p> <p>❖ If you have any questions, call the Canon U.S.A. Information Center toll-free at 1-800-828-4040 (USA only).</p>
<b>CANADA</b>	<p><b>CANON CANADA INC.</b> 6390 Dixie Road, Mississauga, ON L5T 1P7</p> <p>❖ If you have any questions, call the Canon Canada Information Center toll free (in Canada only) at 1-800-OK-CANON (1-800-652-2666).</p> <p>❖ Si vous avez des questions, veuillez téléphoner 1-800-OK-CANON (1-800-652-2666, sans frais au Canada seulement).</p>
<b>MÉXICO</b>	<p><b>CANON MEXICANA, S DE RL DE CV</b> Blvd. Manuel Ávila Camacho No. 138, Piso 17 Col. Lomas de Chapultepec, C.P. 11000 México, D.F., México</p> <p><b>CANON U.S.A., INC. NEW JERSEY OFFICE</b> 100 Jamesburg Road, Jamesburg, NJ 08831 USA</p>
<b>CENTRO Y SURAMÉRICA</b>	<p><b>CANON LATIN AMERICA, INC.</b> One Canon Park, Melville, NY 11747 USA</p>
<b>ASIA</b>	<p><b>CANON HONGKONG COMPANY LTD.</b> 19/F, The Metropolis Tower, 10 Metropolis Drive, Hung Hom, Kowloon, Hong Kong Tel: +852 3191 2333, Fax: +852 2428 3963</p>

---

Visit your local Canon Web site to download the latest version of this Instruction Manual.  
For support concerning the supplied software, contact your local Canon Service Center.