



## *PowerShot SX720 HS* Camera User Guide

ENGLISH

- Make sure you read this guide, including the “Safety Precautions” (14) section, before using the camera.
- Reading this guide will help you learn to use the camera properly.
- Store this guide safely so that you can use it in the future.

- Click the buttons in the lower right to access other pages.
  - : Next page
  - : Previous page
  - : Page before you clicked a link
- To jump to the beginning of a chapter, click the chapter title at right.

Before Use

Basic Guide

Advanced Guide

Camera Basics

Auto Mode /  
Hybrid Auto Mode

Other Shooting Modes

P Mode

Tv, Av, and M Mode

Playback Mode

Wi-Fi Functions

Setting Menu

Accessories

Appendix

Index

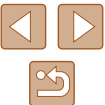

# Before Use

## Initial Information

### Package Contents

Before use, make sure the following items are included in the package. If anything is missing, contact your camera retailer.

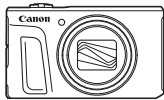

Camera



Battery Pack  
NB-13L\*

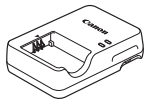

Battery Charger  
CB-2LH/CB-2LHE



Wrist Strap

\* Do not peel off the adhesive covering from a battery pack.

- Printed matter is also included.
- A memory card is not included (📖2).

## Compatible Memory Cards

The following memory cards (commercially available) can be used, regardless of capacity.

- SD memory cards\*<sup>1</sup>
- SDHC memory cards\*<sup>1\*2</sup>
- SDXC memory cards\*<sup>1\*2</sup>



\*<sup>1</sup> Cards conforming to SD standards. However, not all memory cards have been verified to work with the camera.

\*<sup>2</sup> UHS-I memory cards are also supported.

Before Use

Basic Guide

Advanced Guide

Camera Basics

Auto Mode /  
Hybrid Auto Mode

Other Shooting Modes

P Mode

Tv, Av, and M Mode

Playback Mode

Wi-Fi Functions

Setting Menu

Accessories

Appendix

Index



## Preliminary Notes and Legal Information

- Take and review some test shots initially to make sure the images were recorded correctly. Please note that Canon Inc., its subsidiaries and affiliates, and its distributors are not liable for any consequential damages arising from any malfunction of a camera or accessory, including memory cards, that result in the failure of an image to be recorded or to be recorded in a way that is machine readable.
- Images recorded by the camera shall be for personal use. Refrain from unauthorized recording that infringes on copyright law, and note that even for personal use, photography may contravene copyright or other legal rights at some performances or exhibitions, or in some commercial settings.
- The camera warranty is valid only in the area of purchase. In case of camera problems while abroad, return to the area of purchase before contacting a Canon Customer Support Help Desk.
- Although the screen (monitor) is produced under extremely high-precision manufacturing conditions and more than 99.99% of the pixels meet design specifications, in rare cases some pixels may be defective or may appear as red or black dots. This is not a malfunction. This will not affect recorded images.
- When the camera is used over an extended period, it may become warm. This does not indicate damage.

## Conventions in This Guide

- In this guide, icons are used to represent the corresponding camera buttons and dials on which they appear or which they resemble.
- The following camera buttons and controls are represented by icons. Numbers in parentheses indicate the numbers of corresponding controls in “Part Names” (📖4).
  - [▲] Up button (12) on back
  - [◀] Left button (8) on back
  - [▶] Right button (13) on back
  - [▼] Down button (15) on back
  - [🌀] Control dial (7) on back
- Shooting modes and on-screen icons and text are indicated in brackets.
- ⓘ: Important information you should know
- 📌: Notes and tips for expert camera use
- 📖 xx: Pages with related information (in this example, “xx” represents a page number)
- Instructions in this guide apply to the camera under default settings.
- For convenience, all supported memory cards are simply referred to as the “memory card”.
- The symbols “▶ Still Images” and “▶ Movies” below titles indicate how the function is used—whether for still images or movies.

Before Use

Basic Guide

Advanced Guide

Camera Basics

Auto Mode /  
Hybrid Auto Mode

Other Shooting Modes

P Mode

Tv, Av, and M Mode

Playback Mode

Wi-Fi Functions

Setting Menu

Accessories

Appendix

Index



## Part Names

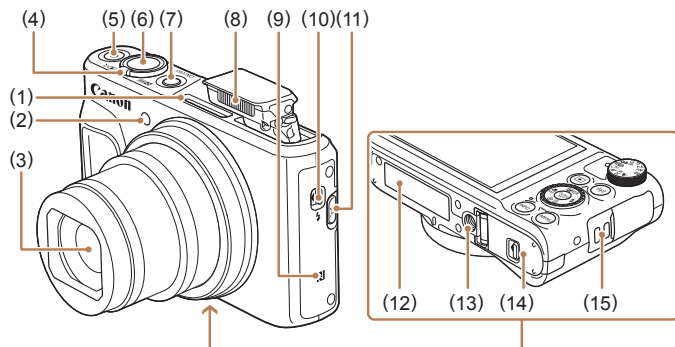

- |   |                                      |
|---|--------------------------------------|
| (1) Microphone  | (7) Power button                     |
| (2) Lamp  | (8) Flash                            |
| (3) Lens  | (9) <b>N</b> (N-Mark)*               |
| (4) Zoom lever<br>Shooting:  (telephoto) /<br>(wide angle)<br>Playback:  (magnify) /<br>(index) | (10)  (Flash pop up) switch          |
| (5) Movie button  | (11)  (Framing Assist – Seek) button |
| (6) Shutter button  | (12) Serial number (Body number)     |
|   | (13) Tripod socket                   |
|   | (14) Memory card/battery cover       |
|   | (15) Strap mount                     |

\* Used with NFC feature (113).

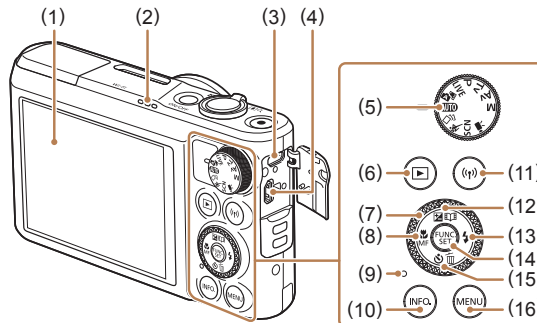

- |   |  |
|---|--|
| (1) Screen (Monitor)                                  | (10) <b>INFO</b> , (Information) button                              |
| (2) Speaker   | (11)  (Wi-Fi) button   |
| (3) DIGITAL terminal                                  | (12)  (Exposure compensation) /<br>(Story Highlights) /<br>Up button |
| (4) HDMI™ terminal                                    | (13)  (Flash) / Right button   |
| (5) Mode dial   | (14) FUNC./SET (Function/Set) button                                 |
| (6)  (Playback) button                                | (15)  (Self-timer) /  (Single-image erase) / Down button             |
| (7) Control dial                                      | (16) <b>MENU</b> button  |
| (8)  (Macro) / <b>MF</b> (Manual focus) / Left button |  |
| (9) Indicator   |  |



- Turning the control dial is one way to choose setting items, switch images, and perform other operations. Most of these operations are also possible with the buttons.

Before Use
Basic Guide
Advanced Guide
Camera Basics
Auto Mode / Hybrid Auto Mode
Other Shooting Modes
P Mode
Tv, Av, and M Mode
Playback Mode
Wi-Fi Functions
Setting Menu
Accessories
Appendix
Index



# Table of Contents

## Before Use

<b>Initial Information</b> .....	<b>2</b>
Package Contents .....	2
Compatible Memory Cards .....	2
Preliminary Notes and Legal Information .....	3
Conventions in This Guide .....	3
Part Names .....	4
Common Camera Operations .....	12
Safety Precautions .....	14

## Basic Guide

<b>Basic Operations</b> .....	<b>17</b>
Initial Preparations .....	17
Attaching the Strap .....	17
Holding the Camera .....	17
Charging the Battery Pack .....	18
Inserting the Battery Pack and Your Memory Card (Commercially Available) .....	18
Removing the Battery Pack and Memory Card .....	19
Setting the Date and Time .....	20
Changing the Date and Time .....	20
Display Language .....	21
Trying the Camera Out .....	22
Shooting (Smart Auto) .....	22
Viewing .....	23
Erasing Images .....	24

## Advanced Guide

<b>Camera Basics</b> .....	<b>25</b>
On/Off .....	25
Power-Saving Features (Auto Power Down) .....	26
Power Saving in Shooting Mode .....	26
Power Saving in Playback Mode .....	26
Shutter Button .....	26
Shooting Modes .....	27
Shooting Display Options .....	27
Using the FUNC. Menu .....	28
Using the Menu Screen .....	29
On-Screen Keyboard .....	30
Indicator Display .....	31
Clock .....	31
<b>Auto Mode / Hybrid Auto Mode</b> .....	<b>32</b>
Shooting with Camera-Determined Settings .....	32
Shooting (Smart Auto) .....	32
Shooting in Hybrid Auto Mode .....	34
Digest Movie Playback .....	35
Still Images/Movies .....	35
Still Images .....	35
Movies .....	35
Scene Icons .....	36
Continuous Shooting Scenes .....	37
Image Stabilization Icons .....	37
On-Screen Frames .....	38

Before Use
Basic Guide
Advanced Guide
Camera Basics
Auto Mode / Hybrid Auto Mode
Other Shooting Modes
P Mode
Tv, Av, and M Mode
Playback Mode
Wi-Fi Functions
Setting Menu
Accessories
Appendix
Index

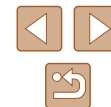

Common, Convenient Features .....	38
Zooming In Closer on Subjects (Digital Zoom).....	38
Easily Reacquiring Subjects after Manual Zooming (Framing Assist – Seek) .....	39
Zooming Automatically According to the Movement of the Subject (Auto Zoom).....	40
Adjusting the Constant Face Display Size .....	41
Easily Reacquiring Subjects with Auto Zooming (Seek Assist).....	41
Using the Self-Timer .....	42
Using the Self-Timer to Avoid Camera Shake .....	42
Customizing the Self-Timer .....	43
Continuous Shooting .....	43
Image Display during Playback .....	44
Using Face ID.....	44
Personal Information .....	44
Registering Face ID Information.....	45
Shooting .....	46
Checking and Editing Registered Information .....	46
Overwriting and Adding Face Information .....	47
Erasing Registered Information .....	48
Image Customization Features .....	49
Changing the Aspect Ratio .....	49
Changing Image Resolution (Size).....	49
Guidelines for Choosing Resolution Based on Paper Size (for 4:3 Images) .....	49
Correcting Greenish Image Areas from Mercury Lamps .....	50
Changing Movie Image Quality .....	50
Helpful Shooting Features.....	51
Displaying Grid Lines.....	51
Magnifying the Area in Focus .....	51
Deactivating Auto Level.....	52

Changing the IS Mode Settings.....	52
Deactivating Image Stabilization .....	52
Recording Movies with Subjects at the Same Size Shown before Recording .....	53
Customizing Camera Operation .....	53
Deactivating the AF-Assist Beam .....	53
Preventing the Red-Eye Reduction Lamp from Lighting Up.....	54
Changing the Image Display Style after Shots .....	54
Changing the Image Display Period after Shots .....	54
Changing the Screen Displayed after Shots .....	55
<b>Other Shooting Modes.....</b>	<b>56</b>
Brightness / Color Customization (Live View Control).....	56
Applying Effects Automatically (Creative Shot) .....	57
Enjoying a Variety of Images from Each Shot .....	57
Choosing Effects .....	57
Recording Movies with a Variety of Effects.....	58
Creative Shot Movie Playback .....	58
Moving Subjects (Sports) .....	58
Specific Scenes.....	59
Applying Special Effects.....	60
Shooting with a Fish-Eye Lens Effect (Fish-Eye Effect).....	60
Shots Resembling Miniature Models (Miniature Effect).....	61
Playback Speed and Estimated Playback Time (for One-Minute Clips) .....	61
Shooting with a Toy Camera Effect (Toy Camera Effect).....	62
Shooting with a Soft Focus Effect.....	62
Shooting in Monochrome.....	63
Special Modes for Other Purposes .....	63
Auto Shooting after Face Detection (Smart Shutter).....	63
Auto Shooting after Smile Detection (Smile).....	63
Auto Shooting after Wink Detection (Wink Self-Timer).....	64

<b>Before Use</b>
<b>Basic Guide</b>
<b>Advanced Guide</b>
<b>Camera Basics</b>
<b>Auto Mode / Hybrid Auto Mode</b>
<b>Other Shooting Modes</b>
<b>P Mode</b>
<b>Tv, Av, and M Mode</b>
<b>Playback Mode</b>
<b>Wi-Fi Functions</b>
<b>Setting Menu</b>
<b>Accessories</b>
<b>Appendix</b>
<b>Index</b>



Auto Shooting after Detecting New Person (Face Self-Timer).....	65
Recording Various Movies.....	66
Recording Movies in Standard Mode.....	66
Recording Movies with Smoother Motion.....	66
Locking or Changing Image Brightness before Recording....	66
Disabling Auto Slow Shutter.....	67
Correcting Severe Camera Shake.....	67
Sound Settings.....	67
Deactivating the Wind Filter.....	67
Using the Attenuator.....	67
Recording Movies in Short Clip Mode.....	68
Playback Effects.....	68
Recording iFrame Movies.....	69
<b>P Mode .....</b>	<b>70</b>
Shooting in Program AE ([P] Mode).....	70
Image Brightness (Exposure).....	71
Adjusting Image Brightness (Exposure Compensation).....	71
Locking Image Brightness / Exposure (AE Lock).....	71
Changing the Metering Method.....	71
Changing the ISO Speed.....	72
Correcting Image Brightness (i-Contrast).....	72
Image Colors.....	73
Capturing Natural Colors (White Balance).....	73
Custom White Balance.....	73
Changing Image Color Tones (My Colors).....	74
Custom Color.....	74
Shooting Range and Focusing.....	75
Shooting Close-Ups (Macro).....	75
Shooting in Manual Focus Mode.....	75
Easily Identifying the Focus Area (MF Peaking).....	76

Digital Tele-Converter.....	77
Changing the AF Frame Mode.....	77
Center.....	77
Face AiAF.....	77
Choosing Subjects to Focus On (Tracking AF).....	78
Shooting with Servo AF.....	79
Changing the Focus Setting.....	79
Shooting with the AF Lock.....	80
Shooting Continuously as the Camera Keeps the Subject in Focus.....	80
Flash.....	81
Changing the Flash Mode.....	81
Auto.....	81
On.....	81
Slow Synchro.....	81
Off.....	81
Adjusting the Flash Exposure Compensation.....	82
Shooting with the FE Lock.....	82
Other Settings.....	83
Changing the Compression Ratio (Image Quality).....	83
Changing the IS Mode Settings.....	83
<b>Tv, Av, and M mode .....</b>	<b>84</b>
Specific Shutter Speeds ([Tv] Mode).....	84
Specific Aperture Values ([Av] Mode).....	85
Specific Shutter Speeds and Aperture Values ([M] Mode).....	85
Adjusting the Flash Output.....	86
<b>Playback Mode .....</b>	<b>87</b>
Viewing.....	87
Switching Display Modes.....	88
Overexposure Warning (for Image Highlights).....	89
Histogram.....	89

<b>Before Use</b>
<b>Basic Guide</b>
<b>Advanced Guide</b>
<b>Camera Basics</b>
<b>Auto Mode / Hybrid Auto Mode</b>
<b>Other Shooting Modes</b>
<b>P Mode</b>
<b>Tv, Av, and M Mode</b>
<b>Playback Mode</b>
<b>Wi-Fi Functions</b>
<b>Setting Menu</b>
<b>Accessories</b>
<b>Appendix</b>
<b>Index</b>

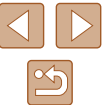

GPS Information Display .....	89
Viewing Short Movies Recorded in Creative Shot Mode (Creative Shot Movies) .....	89
Viewing Short Movies Created When Shooting Still Images (Digest Movies) .....	90
Viewing by Date .....	90
Checking People Detected in Face ID .....	90
Browsing and Filtering Images .....	91
Navigating through Images in an Index .....	91
Finding Images Matching Specified Conditions .....	91
Viewing Individual Images in a Group .....	92
Editing Face ID Information .....	93
Changing Names .....	93
Erasing Names .....	93
Image Viewing Options .....	94
Magnifying Images .....	94
Viewing Slideshows .....	94
Changing Slideshow Settings .....	95
Auto Playback of Related Images (Smart Shuffle) .....	95
Protecting Images .....	96
Using the Menu .....	96
Choosing Images Individually .....	96
Selecting a Range .....	97
Protecting All Images at Once .....	97
Clearing All Protection at Once .....	97
Erasing Images .....	98
Erasing Multiple Images at Once .....	98
Choosing a Selection Method .....	98
Choosing Images Individually .....	99
Selecting a Range .....	99
Specifying All Images at Once .....	99

Rotating Images .....	100
Using the Menu .....	100
Deactivating Auto Rotation .....	100
Tagging Images as Favorites .....	101
Using the Menu .....	101
Editing Still Images .....	102
Resizing Images .....	102
Cropping .....	102
Changing Image Color Tones (My Colors) .....	103
Correcting Image Brightness (i-Contrast) .....	104
Correcting Red-Eye .....	104
Editing Movies .....	105
Reducing File Sizes .....	106
Erasing Movie Chapters .....	107
Viewing Albums (Story Highlights) .....	108
Choosing Themes for Albums .....	108
Adding Background Music to Albums .....	109
Creating Your Own Albums .....	110
Combining Short Clips .....	111
<b>Wi-Fi Functions .....</b>	<b>112</b>
Available Wi-Fi Features .....	112
Sending Images to a Smartphone .....	113
Sending Images to an NFC-Compatible Smartphone .....	113
Connecting via NFC When Camera Is Off or in Shooting Mode .....	113
Connecting via NFC When Camera Is in Playback Mode .....	115
Adding a Smartphone .....	116
Using Another Access Point .....	118
Previous Access Points .....	118

<b>Before Use</b>
<b>Basic Guide</b>
<b>Advanced Guide</b>
<b>Camera Basics</b>
<b>Auto Mode / Hybrid Auto Mode</b>
<b>Other Shooting Modes</b>
<b>P Mode</b>
<b>Tv, Av, and M Mode</b>
<b>Playback Mode</b>
<b>Wi-Fi Functions</b>
<b>Setting Menu</b>
<b>Accessories</b>
<b>Appendix</b>
<b>Index</b>





Saving Images to a Computer.....	119
Preparing to Register a Computer.....	119
Installing the Software.....	119
Configuring the Computer for a Wi-Fi Connection (Windows Only).....	120
Saving Images to a Connected Computer.....	120
Confirming Access Point Compatibility.....	120
Using WPS-Compatible Access Points.....	121
Connecting to Listed Access Points.....	123
Previous Access Points.....	124
Sending Images to a Registered Web Service.....	124
Registering Web Services.....	124
Registering CANON iIMAGE GATEWAY.....	125
Registering Other Web Services.....	126
Uploading Images to Web Services.....	127
Printing Images Wirelessly from a Connected Printer.....	128
Sending Images to Another Camera.....	129
Image Sending Options.....	131
Sending Multiple Images.....	131
Selecting a Range.....	131
Sending Images Tagged as Favorites.....	131
Notes on Sending Images.....	132
Choosing the Number of Recording Pixels (Image Size).....	132
Adding Comments.....	132
Sending Images Automatically (Image Sync).....	133
Initial Preparations.....	133
Preparing the Camera.....	133
Preparing the Computer.....	134
Sending Images.....	134
Viewing Images Sent via Image Sync on Your Smartphone.....	135

Using a Smartphone to View Camera Images and Control the Camera.....	135
Geotagging Images on the Camera.....	135
Shooting Remotely.....	136
Editing or Erasing Wi-Fi Settings.....	137
Editing Connection Information.....	137
Changing a Device Nickname.....	137
Erasing Connection Information.....	137
Changing the Camera Nickname.....	138
Returning the Wi-Fi Settings to Default.....	138

## Setting Menu..... 139

Adjusting Basic Camera Functions.....	139
Silencing Camera Operations.....	139
Adjusting the Volume.....	139
Hiding Hints and Tips.....	140
Date and Time.....	140
World Clock.....	140
Lens Retraction Timing.....	141
Using Eco Mode.....	141
Power-Saving Adjustment.....	141
Screen Brightness.....	142
Hiding the Start-Up Screen.....	142
Formatting Memory Cards.....	142
Low-Level Formatting.....	143
File Numbering.....	143
Date-Based Image Storage.....	144
Metric / Non-Metric Display.....	144
Checking Certification Logos.....	144
Display Language.....	144
Adjusting Other Settings.....	145
Restoring Default Camera Settings.....	145

Before Use
Basic Guide
Advanced Guide
Camera Basics
Auto Mode / Hybrid Auto Mode
Other Shooting Modes
P Mode
Tv, Av, and M Mode
Playback Mode
Wi-Fi Functions
Setting Menu
Accessories
Appendix
Index



<b>Accessories</b> .....	<b>146</b>
System Map .....	146
Optional Accessories.....	147
Power Supplies.....	147
Other Accessories .....	148
Printers .....	148
Photo Storage.....	148
Using Optional Accessories.....	148
Playback on a TV .....	148
Playback on a High-Definition TV.....	148
Inserting and Charging the Battery Pack.....	149
Using a Computer to Charge the Battery .....	150
Using the Software .....	151
Computer Connections via a Cable.....	151
Checking Your Computer Environment .....	151
Installing the Software .....	151
Saving Images to a Computer .....	151
Printing Images .....	153
Easy Print .....	153
Configuring Print Settings.....	154
Cropping Images before Printing.....	154
Choosing Paper Size and Layout before Printing .....	155
Available Layout Options.....	155
Printing ID Photos .....	155
Printing Movie Scenes.....	156
Movie Printing Options .....	156
Adding Images to the Print List (DPOF) .....	156
Configuring Print Settings.....	156
Setting Up Printing for Individual Images .....	157
Setting Up Printing for a Range of Images.....	157
Setting Up Printing for All Images.....	157
Clearing All Images from the Print List .....	158

Printing Images Added to the Print List (DPOF).....	158
Adding Images to a Photobook .....	158
Choosing a Selection Method .....	158
Adding Images Individually.....	158
Adding All Images to a Photobook .....	159
Removing All Images from a Photobook .....	159

<b>Appendix</b> .....	<b>160</b>
Troubleshooting.....	160
On-Screen Messages.....	164
On-Screen Information .....	166
Shooting (Information Display) .....	166
Battery Level .....	166
Playback (Detailed Information Display).....	167
Summary of Movie Control Panel.....	167
Functions and Menu Tables .....	168
Functions Available in Each Shooting Mode .....	168
FUNC. Menu.....	169
Shooting Tab.....	171
Set Up Tab.....	175
Playback Tab .....	175
Print Tab .....	176
Playback Mode FUNC. Menu .....	176
Handling Precautions .....	176
Specifications .....	177
Camera .....	177
Number of Shots/Recording Time, Playback Time .....	178
Shooting Range.....	178
Number of Shots per Memory Card .....	179
Recording Time per Memory Card .....	179
Battery Pack NB-13L .....	180
Battery Charger CB-2LH/CB-2LHE .....	180

<b>Before Use</b>
<b>Basic Guide</b>
<b>Advanced Guide</b>
<b>Camera Basics</b>
Auto Mode / Hybrid Auto Mode
Other Shooting Modes
P Mode
Tv, Av, and M Mode
Playback Mode
Wi-Fi Functions
Setting Menu
Accessories
Appendix
<b>Index</b>

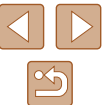

Compact Power Adapter CA-DC30/CA-DC30E ..... 180

Index..... 181

Wi-Fi (Wireless LAN) Precautions..... 183

    Radio Wave Interference Precautions ..... 183

    Security Precautions..... 183

    Trademarks and Licensing ..... 184

    Disclaimer..... 185

**Before Use**

**Basic Guide**

**Advanced Guide**

**Camera Basics**

**Auto Mode / Hybrid Auto Mode**

**Other Shooting Modes**

**P Mode**

**Tv, Av, and M Mode**

**Playback Mode**

**Wi-Fi Functions**

**Setting Menu**

**Accessories**

**Appendix**

**Index**

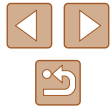

# Common Camera Operations

## Shoot

- Use camera-determined settings (Auto Mode, Hybrid Auto Mode)
  - [32](#), [34](#)
- See several effects applied to each shot, using camera-determined settings (Creative Shot Mode)
  - [57](#)

Shooting people well



Portraits  
([59](#))

Matching specific scenes



Sports  
([58](#))



Night Scenes  
([59](#))



Low Light  
([59](#))



Fireworks  
([59](#))

Applying special effects



Vivid Colors  
([60](#))



Poster Effect  
([60](#))



Fish-Eye Effect  
([60](#))



Miniature Effect  
([61](#))



Toy Camera Effect  
([62](#))



Soft Focus  
([62](#))



Monochrome  
([63](#))

- Focus on faces
  - [32](#), [59](#), [77](#)
- Without using the flash (Flash Off)
  - [32](#)
- Include yourself in the shot (Self-Timer)
  - [42](#), [65](#)
- Movie clips and photos together (Movie Digest)
  - [34](#)

Before Use

Basic Guide

Advanced Guide

Camera Basics

Auto Mode /  
Hybrid Auto Mode

Other Shooting Modes

P Mode

Tv, Av, and M Mode

Playback Mode

Wi-Fi Functions

Setting Menu







Accessories

Appendix



Index



## View

- View images (Playback Mode)
  -  87
- Automatic playback (Slideshow)
  -  94
- On a TV
  -  148
- On a computer
  -  151
- Browse through images quickly
  -  91
- Erase images
  -  98
- Create an album automatically
  -  108

## Record/View Movies

- Record movies
  -  32,  66
- View movies (Playback Mode)
  -  87



## Print

- Print pictures
  -  153

## Save

- Save images to a computer
  -  151

## Use Wi-Fi Functions

- Send images to a smartphone
  -  113
- Share images online
  -  124
- Send images to a computer
  -  133

## Before Use

### Basic Guide

### Advanced Guide

#### Camera Basics

#### Auto Mode / Hybrid Auto Mode

#### Other Shooting Modes

#### P Mode

#### Tv, Av, and M Mode

#### Playback Mode

#### Wi-Fi Functions

#### Setting Menu

#### Accessories

#### Appendix

## Index

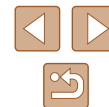

## Safety Precautions

- Before using the product, ensure that you read the safety precautions described below. Always ensure that the product is used correctly.
- The safety precautions noted here are intended to prevent you and other persons from being injured or incurring property damage.
- Be sure to also check the guides included with any separately sold accessories you use.



### Warning

Denotes the possibility of serious injury or death.

- Do not trigger the flash in close proximity to people's eyes. Exposure to the intense light produced by the flash could damage eyesight. In particular, remain at least 1 meter (3.3 feet) away from infants when using the flash.

- Store this equipment out of the reach of children and infants. A strap wound around a child's neck may result in asphyxiation. If your product uses a power cord, mistakenly winding the cord around a child's neck may result in asphyxiation.

- Use only recommended power sources.
- Do not disassemble, alter, or apply heat to the product.
- Do not peel off the adhesive covering, if the battery pack has it.
- Avoid dropping or subjecting the product to severe impacts.
- Do not touch the interior of the product if it is broken, such as when dropped.
- Stop using the product immediately if it emits smoke or a strange smell, or otherwise behaves abnormally.
- Do not use organic solvents such as alcohol, benzene, or thinner to clean the product.
- Avoid contact with liquid, and do not allow liquid or foreign objects inside.

This could result in electrical shock or fire.

If the product gets wet, or if liquid or foreign objects get inside, remove the battery pack/batteries or unplug immediately.

- If your model has a viewfinder or interchangeable lens, do not look through the viewfinder or lens at bright light sources (such as the sun on a clear day, or a bright artificial light source).

This may damage your eyesight.

- When using products with interchangeable lenses, do not leave the camera with a lens attached or a lens itself out in direct sunlight without the lens cap on.

This may cause a fire to start.

- Do not touch the product during thunderstorms if it is plugged in. This could result in electrical shock or fire. Immediately stop using the product and distance yourself from it.

- Use only the recommended battery pack/batteries.

- Do not place the battery pack/batteries near or in direct flame. This may cause the battery pack/batteries to explode or leak, resulting in electrical shock, fire, or injuries. If leaking battery electrolyte comes into contact with eyes, mouth, skin, or clothing, immediately flush with water.

- If the product uses a battery charger, note the following precautions.
  - Remove the plug periodically and, using a dry cloth, wipe away any dust and dirt that has collected on the plug, the exterior of the power outlet, and the surrounding area.
  - Do not insert or remove the plug with wet hands.
  - Do not use the equipment in a manner that exceeds the rated capacity of the electrical outlet or wiring accessories. Do not use if the plug is damaged or not fully inserted in the outlet.
  - Do not allow dust or metal objects (such as pins or keys) to contact the terminals or plug.
  - Do not cut, damage, alter, or place heavy items on the power cord, if your product uses one.

This could result in electrical shock or fire.

- Turn the camera off in places where camera use is prohibited. The electromagnetic waves emitted by the camera may interfere with the operation of electronic instruments and other devices. Exercise adequate caution when using the product in places where use of electronic devices is restricted, such as inside airplanes and medical facilities.

Before Use

Basic Guide

Advanced Guide

Camera Basics

Auto Mode /  
Hybrid Auto Mode

Other Shooting Modes

P Mode

Tv, Av, and M Mode

Playback Mode

Wi-Fi Functions

Setting Menu

Accessories

Appendix

Index



- Do not allow the camera to maintain contact with skin for extended periods.

Even if the camera does not feel hot, this may cause low-temperature burns, manifested in redness of the skin or blistering. Use a tripod in hot places, or if you have poor circulation or insensitive skin.



## Caution

Denotes the possibility of injury.

- When carrying the product by the strap, be careful not to bang it, subject it to strong impacts or shocks, or let it get caught on other objects.
- Be careful not to bump or push strongly on the lens. This could lead to injury or damage the camera.

- Be careful not to subject the screen to strong impacts. If the screen cracks, injury may result from the broken fragments.

- When using the flash, be careful not to cover it with your fingers or clothing.

This could result in burns or damage to the flash.

- Avoid using, placing, or storing the product in the following places:
  - Places subject to direct sunlight
  - Places subject to temperatures above 40 °C (104 °F)
  - Humid or dusty places

These could cause leakage, overheating, or an explosion of the battery pack/batteries, resulting in electrical shock, fire, burns, or other injuries. Overheating and damage may result in electrical shock, fire, burns, or other injuries.

- The slideshow transition effects may cause discomfort when viewed for prolonged periods.
- When using optional lenses, lens filters, or filter adapters (if applicable), be sure to attach these accessories firmly.

If the lens accessory becomes loose and falls off, it may crack, and the shards of glass may lead to cuts.

- On products that raise and lower the flash automatically, make sure to avoid pinching your fingers with the lowering flash.

This could result in injury.

## Caution

Denotes the possibility of property damage.

- Do not aim the camera at intense light sources, such as the sun on a clear day or an intense artificial light source.

Doing so may damage the image sensor or other internal components.

- When using the camera on a sandy beach or at a windy location, be careful not to allow dust or sand to enter the camera.

- On products that raise and lower the flash automatically, do not push the flash down or pry it open.

This may cause the product to malfunction.

- Wipe off any dust, grime, or other foreign matter on the flash with a cotton swab or cloth.

The heat emitted from the flash may cause foreign matter to smoke or the product to malfunction.

- Remove and store the battery pack/batteries when you are not using the product.

Any battery leakage that occurs may cause product damage.

- Before you discard the battery pack/batteries, cover the terminals with tape or other insulators.

Contacting other metal materials may lead to fire or explosions.

- Unplug any battery charger used with the product when not in use. Do not cover with a cloth or other objects when in use.

Leaving the unit plugged in for a long period of time may cause it to overheat and distort, resulting in fire.

- Do not leave any dedicated battery packs near pets. Pets biting the battery pack could cause leakage, overheating, or explosion, resulting in product damage or fire.

## Before Use

## Basic Guide

## Advanced Guide

### Camera Basics

### Auto Mode / Hybrid Auto Mode

### Other Shooting Modes

### P Mode

### Tv, Av, and M Mode

### Playback Mode

### Wi-Fi Functions

### Setting Menu

### Accessories

### Appendix

## Index



- If your product uses multiple batteries, do not use batteries that have different levels of charge together, and do not use old and new batteries together. Do not insert the batteries with the + and – terminals reversed.

This may cause the product to malfunction.

- Do not sit down with the camera in your pant pocket. Doing so may cause malfunctions or damage the screen.
- When putting the camera in your bag, ensure that hard objects do not come into contact with the screen. Also close the screen (so that it faces the body), if your product's screen closes.
- Do not attach any hard objects to the product. Doing so may cause malfunctions or damage the screen.

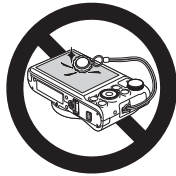

Before Use
Basic Guide
Advanced Guide
Camera Basics
Auto Mode / Hybrid Auto Mode
Other Shooting Modes
P Mode
Tv, Av, and M Mode
Playback Mode
Wi-Fi Functions
Setting Menu
Accessories
Appendix
Index

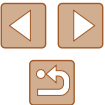



# Basic Guide

## Basic Operations

Basic information and instructions, from initial preparations to shooting and playback

### Initial Preparations

Prepare for shooting as follows.

#### Attaching the Strap

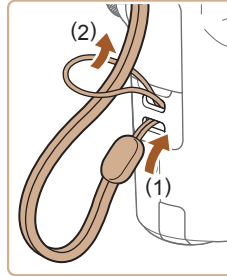

- Thread the end of the strap through the strap mount (1), and then pull the other end of the strap through the loop on the threaded end (2).

#### Holding the Camera

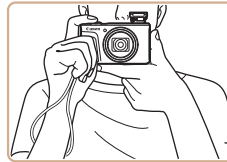

- Place the strap around your wrist.
- When shooting, keep your arms close to your body and hold the camera securely to prevent it from moving. If you have raised the flash, do not rest your fingers on it.

Before Use

Basic Guide

Advanced Guide

Camera Basics

Auto Mode /  
Hybrid Auto Mode

Other Shooting Modes

P Mode

Tv, Av, and M Mode

Playback Mode

Wi-Fi Functions

Setting Menu

Accessories

Appendix

Index

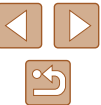

## Charging the Battery Pack

Before use, charge the battery pack with the included charger. Be sure to charge the battery pack initially, because the camera is not sold with the battery pack charged.

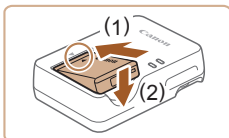

### 1 Insert the battery pack.

- After aligning the ▲ marks on the battery pack and charger, insert the battery pack by pushing it in (1) and down (2).

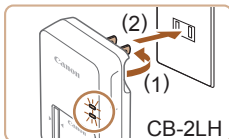

### 2 Charge the battery pack.

- CB-2LH: Flip out the plug (1) and plug the charger into a power outlet (2).
- CB-2LHE: Plug the power cord into the charger, then plug the other end into a power outlet.
- The charging lamp turns orange, and charging begins.
- When charging is finished, the lamp turns green.

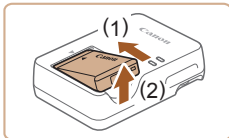
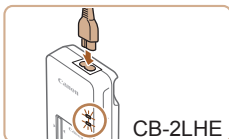

### 3 Remove the battery pack.

- After unplugging the battery charger, remove the battery pack by pushing it in (1) and up (2).



- To protect the battery pack and keep it in optimal condition, do not charge it continuously for more than 24 hours.
- For battery chargers that use a power cord, do not attach the charger or cord to other objects. Doing so could result in malfunction or damage to the product.



- For details on charging time and the number of shots and recording time possible with a fully charged battery pack, see “Number of Shots/Recording Time, Playback Time” (p.178).
- Charged battery packs gradually lose their charge, even when they are not used. Charge the battery pack on (or immediately before) the day of use.
- The charger can be used in areas with 100 – 240 V AC power (50/60 Hz). For power outlets in a different format, use a commercially available adapter for the plug. Never use an electrical transformer designed for traveling, which may damage the battery pack.

## Inserting the Battery Pack and Your Memory Card (Commercially Available)

Insert the included battery pack and a memory card (commercially available).

Note that before using a memory card that is new or has been formatted in another device, you should format the memory card with this camera (p.142).

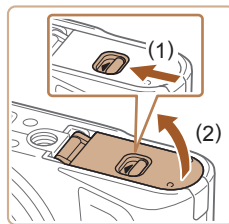

### 1 Open the cover.

- Slide the switch (1) and open the cover (2).

Before Use

Basic Guide

Advanced Guide

Camera Basics

Auto Mode /  
Hybrid Auto Mode

Other Shooting Modes

P Mode

Tv, Av, and M Mode

Playback Mode

Wi-Fi Functions

Setting Menu

Accessories

Appendix

Index



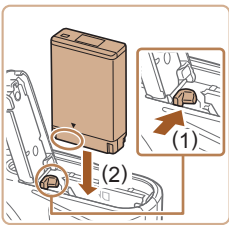

## 2 Insert the battery pack.

- Holding the battery pack with the terminals in the position shown, hold the battery lock toward (1) and insert the battery pack toward (2) until the lock clicks shut.
- If you insert the battery pack facing the wrong way, it cannot be locked into the correct position. Always confirm that the battery pack is facing the right way and locks when inserted.

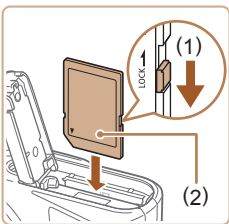

## 3 Check your card's write-protect switch and insert the memory card.

- Recording is not possible on memory cards with a write-protect switch when the switch is in the locked position. Move the switch toward (1).
- Insert the memory card with the label (2) facing as shown until it clicks into place.
- Make sure the memory card is facing the right way when you insert it. Inserting memory cards facing the wrong way may damage the camera.

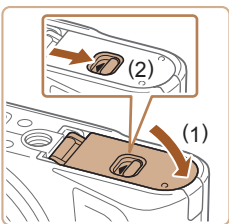

## 4 Close the cover.

- Lower the cover (1) and hold it down as you slide the switch, until it clicks into the closed position (2).



- For guidelines on how many shots or hours of recording can be saved on one memory card, see “Number of Shots per Memory Card” (p.179).

## Removing the Battery Pack and Memory Card

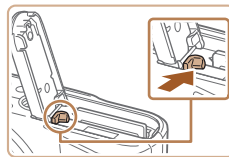

### Remove the battery pack.

- Open the cover and press the battery lock in the direction of the arrow.
- The battery pack will pop up.

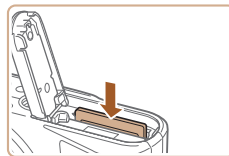

### Remove the memory card.

- Push the memory card in until it clicks, and then slowly release it.
- The memory card will pop up.

Before Use
Basic Guide
Advanced Guide
Camera Basics
Auto Mode / Hybrid Auto Mode
Other Shooting Modes
P Mode
Tv, Av, and M Mode
Playback Mode
Wi-Fi Functions
Setting Menu
Accessories
Appendix
Index



## Setting the Date and Time

Set the current date and time correctly as follows if the [Date/Time] screen is displayed when you turn the camera on. Information you specify this way is recorded in image properties when you shoot, and it is used when you manage images by shooting date or print images showing the date.

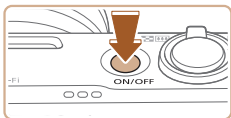

### 1 Turn the camera on.

- Press the power button.
- The [Date/Time] screen is displayed.

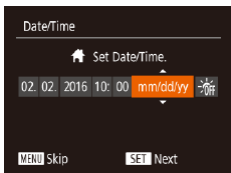

### 2 Set the date and time.

- Press the [◀][▶] buttons to choose an option.
- Press the [▲][▼] buttons or turn the [DISP.] dial to specify the date and time.
- When finished, press the [OK] button.

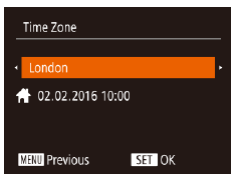

### 3 Specify your home time zone.

- Press the [◀][▶] buttons to choose your home time zone.

### 4 Finish the setup process.

- Press the [OK] button when finished. After a confirmation message, the setting screen is no longer displayed.
- To turn off the camera, press the power button.



- Unless you set the date, time, and home time zone, the [Date/Time] screen will be displayed each time you turn the camera on. Specify the correct information.



- To set daylight saving time (1 hour ahead), choose [DST] in step 2 and then choose [ON] by pressing the [▲][▼] buttons or turning the [DISP.] dial.

## Changing the Date and Time

Adjust the date and time as follows.

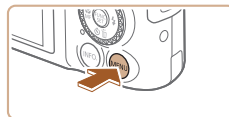

### 1 Access the menu screen.

- Press the [MENU] button.

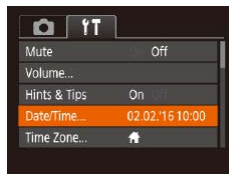

### 2 Choose [Date/Time].

- Move the zoom lever to choose the [↑][↓] tab.
- Press the [▲][▼] buttons or turn the [DISP.] dial to choose [Date/Time], and then press the [OK] button.

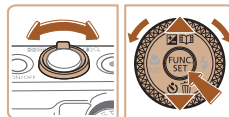

### 3 Change the date and time.

- Follow step 2 in “Setting the Date and Time” (p.20) to adjust the settings.
- Press the [MENU] button to close the menu screen.

Before Use

Basic Guide

Advanced Guide

Camera Basics

Auto Mode /  
Hybrid Auto Mode

Other Shooting Modes

P Mode

Tv, Av, and M Mode

Playback Mode

Wi-Fi Functions

Setting Menu

Accessories

Appendix

Index





- The camera has a built-in date/time battery (backup battery). Date/time settings can be retained for about 3 weeks after the battery pack is removed.
- The date/time battery will be charged in about 4 hours once you insert a charged battery pack even if the camera is left off.
- Once the date/time battery is depleted, the [Date/Time] screen will be displayed when you turn the camera on. Set the correct date and time as described in "Setting the Date and Time" (P20).



- The current time is displayed if you wait too long in step 2 after pressing the [FUNC/SET] button before you press the [MENU] button. In this case, press the [FUNC/SET] button to dismiss the time display and repeat step 2.
- You can also change the display language by pressing the [MENU] button and choosing [Language] on the [TAB] tab.

## Display Language

Change the display language as needed.



### 1 Enter Playback mode.

- Press the [▶] button.

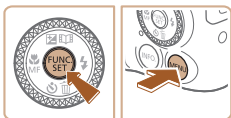

### 2 Access the setting screen.

- Press and hold the [FUNC/SET] button, and then immediately press the [MENU] button.



### 3 Set the display language.

- Press the [▲][▼][◀][▶] buttons or turn the [DISP] dial to choose a language, and then press the [FUNC/SET] button.
- Once the display language has been set, the setting screen is no longer displayed.



Before Use

Basic Guide

Advanced Guide

Camera Basics

Auto Mode /  
Hybrid Auto Mode

Other Shooting Modes

P Mode

Tv, Av, and M Mode

Playback Mode

Wi-Fi Functions

Setting Menu

Accessories

Appendix

Index



# Trying the Camera Out

► Still Images ► Movies

Follow these instructions to turn the camera on, shoot still images or movies, and then view them.

## Shooting (Smart Auto)

For fully automatic selection of the optimal settings for specific scenes, simply let the camera determine the subject and shooting conditions.

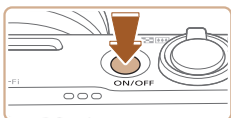

### 1 Turn the camera on.

- Press the power button.
- The startup screen is displayed.



### 2 Enter [AUTO] mode.

- Set the mode dial to [AUTO].
- Aim the camera at the subject. The camera will make a slight clicking noise as it determines the scene.
- Icons representing the scene and image stabilization mode are displayed in the upper left of the screen.
- Frames displayed around any detected subjects indicate that they are in focus.

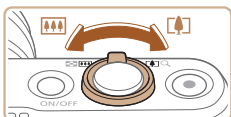

### 3 Compose the shot.

- To zoom in and enlarge the subject, move the zoom lever toward [T] (telephoto), and to zoom away from the subject, move it toward [W] (wide angle).

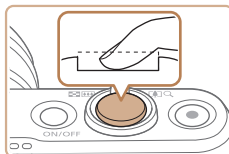
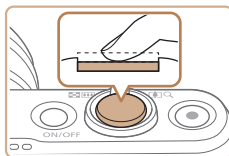

## 4 Shoot. Shooting Still Images

### 1) Focus.

- Press the shutter button lightly, halfway down. The camera beeps twice after focusing, and frames are displayed to indicate image areas in focus.

### 2) Shoot.

- Press the shutter button all the way down.
- As the camera shoots, a shutter sound is played, and in low-light conditions when you have raised the flash, it fires automatically.
- Keep the camera still until the shutter sound ends.
- After displaying your shot, the camera will revert to the shooting screen.

Before Use
Basic Guide
Advanced Guide
Camera Basics
Auto Mode / Hybrid Auto Mode
Other Shooting Modes
P Mode
Tv, Av, and M Mode
Playback Mode
Wi-Fi Functions
Setting Menu
Accessories
Appendix
Index





(1)

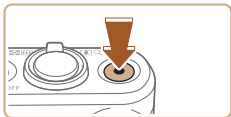
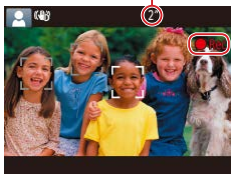

## Recording Movies

### 1) Start recording.

- Press the movie button. The camera beeps once as recording begins, and [●Rec] is displayed with the elapsed time (1).
- Black bars are displayed on the top and bottom edges of the screen, and the subject is slightly enlarged. The black bars indicate image areas not recorded.
- Frames displayed around any detected faces indicate that they are in focus.
- Once recording begins, take your finger off the movie button.

### 2) Finish recording.

- Press the movie button again to stop recording. The camera beeps twice as recording stops.

## Viewing

After shooting images or movies, you can view them on the screen as follows.

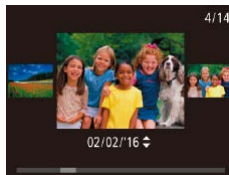

### 1 Enter Playback mode.

- Press the [▶] button.
- Your last shot is displayed.

### 2 Choose an image.

- To view the previous image, press the [◀] button or turn the [●] dial counterclockwise. To view the next image, press the [▶] button or turn the [●] dial clockwise.
- Press and hold the [◀] [▶] buttons to browse through images quickly.
- To access this screen (Scroll Display mode), turn the [●] dial rapidly. In this mode, turn the [●] dial to browse through images.
- To return to single-image display, press the [●] button.

- Movies are identified by a [SET ▶] icon. To play movies, go to step 3.

Before Use

Basic Guide

Advanced Guide

Camera Basics

Auto Mode /  
Hybrid Auto Mode

Other Shooting Modes

P Mode

Tv, Av, and M Mode

Playback Mode

Wi-Fi Functions

Setting Menu

Accessories

Appendix

Index



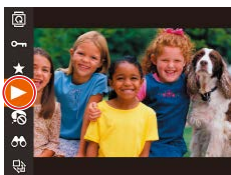

### 3 Play movies.

- Press the **[M/SET]** button, choose **[▶]** (either press the **[▲][▼]** buttons or turn the **[DISP]** dial), and then press the **[M/SET]** button again.
- Playback now begins, and after the movie is finished, **[SET ▶]** is displayed.
- To adjust the volume, press the **[▲][▼]** buttons during playback.



- To switch to Shooting mode from Playback mode, press the shutter button halfway.

## Erasing Images

You can choose and erase unneeded images one by one. Note that erased images cannot be recovered. Be sure that you want to erase images before using this option.



### 1 Choose an image to erase.

- Press the **[◀][▶]** buttons or turn the **[DISP]** dial to choose an image.



### 2 Erase the image.

- Press the **[▼]** button.
- After **[Erase?]** is displayed, press the **[◀][▶]** buttons or turn the **[DISP]** dial to choose **[Erase]**, and then press the **[M/SET]** button.
- The current image is now erased.
- To cancel erasure, press the **[◀][▶]** buttons or turn the **[DISP]** dial to choose **[Cancel]**, and then press the **[M/SET]** button.



- You can choose multiple images to erase at once (📖98).

Before Use

Basic Guide

Advanced Guide

Camera Basics

Auto Mode /  
Hybrid Auto Mode

Other Shooting Modes

P Mode

Tv, Av, and M Mode

Playback Mode

Wi-Fi Functions

Setting Menu

Accessories

Appendix

Index





# Advanced Guide

## Camera Basics

Other basic operations and more ways to enjoy your camera, including shooting and playback options

### On/Off

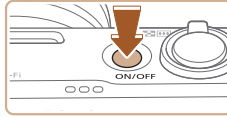

#### Shooting Mode

- Press the power button to turn the camera on and prepare for shooting.
- To turn the camera off, press the power button again.



#### Playback Mode

- Press the [▶] button to turn the camera on and view your shots.
- To turn the camera off, press the [▶] button again.



- To switch to Playback mode from Shooting mode, press the [▶] button.
- To switch to Shooting mode from Playback mode, press the shutter button halfway (▶▶26).
- The lens will be retracted after about one minute once the camera is in Playback mode. You can turn the camera off when the lens is retracted by pressing the [▶] button.

Before Use

Basic Guide

Advanced Guide

Camera Basics

Auto Mode /  
Hybrid Auto Mode

Other Shooting Modes

P Mode

Tv, Av, and M Mode

Playback Mode

Wi-Fi Functions

Setting Menu

Accessories

Appendix

Index

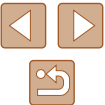

## Power-Saving Features (Auto Power Down)

As a way to conserve battery power, the camera automatically deactivates the screen (Display Off) and then turns itself off after a specific period of inactivity.

### Power Saving in Shooting Mode

The screen is automatically deactivated after about one minute of inactivity. In about two more minutes, the lens is retracted and the camera turns itself off. To activate the screen and prepare for shooting when the screen is off but the lens is still out, press the shutter button halfway (📖26).

### Power Saving in Playback Mode

The camera turns itself off automatically after about five minutes of inactivity.



- You can deactivate Auto Power Down and adjust the timing of Display Off, if you prefer (📖141).
- Power saving is not active while the camera is connected to other devices via Wi-Fi (📖112), or when connected to a computer (📖151).

## Shutter Button

To ensure your shots are in focus, always begin by holding the shutter button halfway down, and once the subject is in focus, press the button all the way down to shoot.

In this manual, shutter button operations are described as pressing the button halfway or all the way down.

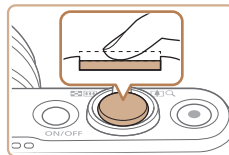

### 1 Press halfway. (Press lightly to focus.)

- Press the shutter button halfway. The camera beeps twice, and frames are displayed around image areas in focus.

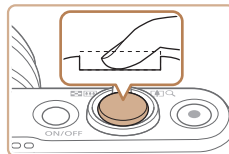

### 2 Press all the way down. (From the halfway position, press fully to shoot.)

- The camera shoots, as a shutter sound is played.
- Keep the camera still until the shutter sound ends.



- Images may be out of focus if you shoot without initially pressing the shutter button halfway.
- Length of shutter sound playback varies depending on the time required for the shot. It may take longer in some shooting scenes, and images will be blurry if you move the camera (or the subject moves) before the shutter sound ends.

Before Use

Basic Guide

Advanced Guide

Camera Basics

Auto Mode /  
Hybrid Auto Mode

Other Shooting Modes

P Mode

Tv, Av, and M Mode

Playback Mode

Wi-Fi Functions

Setting Menu

Accessories

Appendix

Index



## Shooting Modes

Use the mode dial to access each shooting mode.

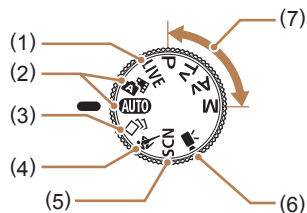

- |   |  |
|---|--|
| <p>(1) <b>Live View Control Mode</b><br/>Customize image brightness or colors when shooting (📖56).</p> <p>(2) <b>Auto Mode / Hybrid Auto Mode</b><br/>Fully automatic shooting, with camera-determined settings (📖22, 📖32, 📖34).</p> <p>(3) <b>Creative Shot Mode</b><br/>You can capture multiple images with effects using camera-determined settings (📖57).</p> <p>(4) <b>Sports Mode</b><br/>Shoot continuously as the camera focuses on moving subjects (📖58).</p> | <p>(5) <b>Special Scene Mode</b><br/>Shoot with settings designed for specific scenes, or add a variety of effects (📖59).</p> <p>(6) <b>Movie Mode</b><br/>For shooting movies (📖66). You can also shoot movies when the mode dial is not set to Movie mode, simply by pressing the movie button.</p> <p>(7) <b>P, Tv, Av, and M Modes</b><br/>Take a variety of shots using your preferred settings (📖70, 📖84).</p> |
|---|--|

## Shooting Display Options

Press the [INFO] button to view other information on the screen, or to hide the information. For details on the information displayed, see "On-Screen Information" (📖166).

	Information Display
	No Information Display



- Screen brightness is automatically increased by the night view function when you are shooting under low light, making it easier to check how shots are composed. However, on-screen image brightness may not match the brightness of your shots. Note that any on-screen image distortion or jerky subject motion will not affect recorded images.
- For playback display options, see "Switching Display Modes" (📖88).

Before Use

Basic Guide

Advanced Guide

Camera Basics

Auto Mode /  
Hybrid Auto Mode

Other Shooting Modes

P Mode

Tv, Av, and M Mode

Playback Mode

Wi-Fi Functions

Setting Menu

Accessories

Appendix

Index



## Using the FUNC. Menu

Configure commonly used shooting functions through the FUNC. menu as follows.

Note that menu items and options vary depending on the shooting mode (169).



### 1 Access the FUNC. menu.

- Press the [FUNC.] button.



(1)(2)

### 2 Choose a menu item.

- Press the [▲][▼] buttons or turn the [DISP.] dial to choose a menu item (1), and then press the [FUNC.] or [▶] button.
- Available options (2) are listed next to menu items, on the right.
- Depending on the menu item, functions can be specified simply by pressing the [FUNC.] or [▶] button, or another screen is displayed for configuring the function.



### 3 Choose an option.

- Press the [▲][▼] buttons or turn the [DISP.] dial to choose an option.
- Items labeled with a [INFO.] icon can be configured by pressing the [INFO.] button.
- To return to the menu items, press the [◀] button.



### 4 Finish the setup process.

- Press the [FUNC.] button.
- The screen before you pressed the [FUNC.] button in step 1 is displayed again, showing the option you configured.



- To undo any accidental setting changes, you can restore the camera's default settings (145).

Before Use

Basic Guide

Advanced Guide

Camera Basics

Auto Mode /  
Hybrid Auto Mode

Other Shooting Modes

P Mode

Tv, Av, and M Mode

Playback Mode

Wi-Fi Functions

Setting Menu

Accessories

Appendix

Index

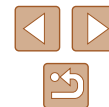

## Using the Menu Screen

Configure a variety of camera functions through the menu screen as follows. Menu items are grouped by purpose on tabs, such as shooting [CAMERA], playback [PLAYBACK], and so on. Note that available menu items vary depending on the selected shooting or playback mode (📖171 – 📖175).

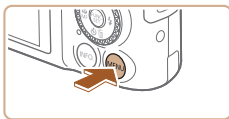

### 1 Access the menu screen.

- Press the [MENU] button.

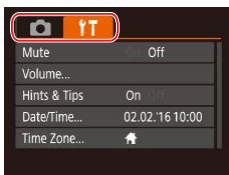

### 2 Choose a tab.

- Move the zoom lever to choose a tab.
- After you have pressed the [▲][▼] buttons or turned the [DIAL] dial to choose a tab initially, you can switch between tabs by pressing the [◀][▶] buttons.

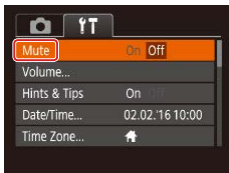

### 3 Choose a menu item.

- Press the [▲][▼] buttons or turn the [DIAL] dial to choose a menu item.
- For menu items with options not shown, first press the [⊕] or [▶] button to switch screens, and then either press the [▲][▼] buttons or turn the [DIAL] dial to select the menu item.
- To return to the previous screen, press the [MENU] button.

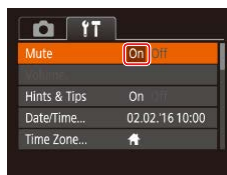

### 4 Choose an option.

- Press the [◀][▶] buttons to choose an option.

### 5 Finish the setup process.

- Press the [MENU] button to return to the screen displayed before you pressed the [MENU] button in step 1.



- To undo any accidental setting changes, you can restore the camera's default settings (📖145).

Before Use
Basic Guide
Advanced Guide
Camera Basics
Auto Mode / Hybrid Auto Mode
Other Shooting Modes
P Mode
Tv, Av, and M Mode
Playback Mode
Wi-Fi Functions
Setting Menu
Accessories
Appendix
Index



## On-Screen Keyboard

Use the on-screen keyboard to enter information for Face ID (📖 44), Wi-Fi connections (📖 121), and so on. Note that the length and type of information you can enter varies depending on the function you are using.

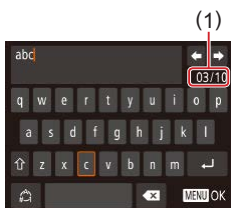

(1)

### Entering Characters

- Press the [▲][▼][◀][▶] buttons or turn the [🌀] dial to choose a character, and then press the [⊕] button to enter it.
- The amount of information you can enter (1) varies depending on the function you are using.

### Moving the Cursor

- Choose [◀] or [▶] and press the [⊕] button.

### Entering Line Breaks

- Choose [↵] and press the [⊕] button.

### Switching Input Modes

- To switch to numbers or symbols, choose [123] and press the [⊕] button.
- To switch between uppercase and lowercase letters, choose [↕] and press the [⊕] button.
- Available input modes vary depending on the function you are using.

### Deleting Characters

- Choose [✖] and press the [⊕] button. The previous character will be deleted.
- Choosing [✖] and holding down the [⊕] button will erase five characters at a time.



## Confirming Input and Returning to the Previous Screen

- Press the [MENU] button.

Before Use
Basic Guide
Advanced Guide
Camera Basics
Auto Mode / Hybrid Auto Mode
Other Shooting Modes
P Mode
Tv, Av, and M Mode
Playback Mode
Wi-Fi Functions
Setting Menu
Accessories
Appendix
Index

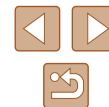

## Indicator Display

The indicator on the back of the camera (📖4) lights up or blinks depending on the camera status.

Color	Indicator Status	Camera Status
Green	Blinking	Starting up, recording/reading/transmitting images, shooting long exposures (📖84, 📖85), connected to a computer (📖151), connecting/transmitting via Wi-Fi, or display off (📖26, 📖141, 📖141)
Orange	On	Charging via USB



- When the indicator blinks green, never turn the camera off, open the memory card/battery cover, or shake or jolt the camera. This may corrupt images or damage the camera or memory card.

## Clock

You can check the current time.

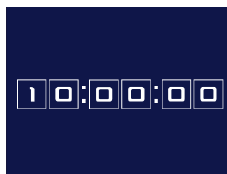

- When the camera is off, press and hold the [FUNC SET] button, then press the power button to display the clock.

- Press and hold the [FUNC SET] button.
- The current time appears.
- If you hold the camera vertically while using the clock function, it will switch to vertical display. Press the [◀][▶] buttons or turn the [DIAL] dial to change the display color.
- Press the [FUNC SET] button again to cancel the clock display.

Before Use

Basic Guide

Advanced Guide

Camera Basics

Auto Mode /  
Hybrid Auto Mode

Other Shooting Modes

P Mode

Tv, Av, and M Mode

Playback Mode

Wi-Fi Functions

Setting Menu

Accessories

Appendix

Index



# Auto Mode / Hybrid Auto Mode

Convenient mode for easy shots with greater control over shooting

## Shooting with Camera-Determined Settings

For fully automatic selection of the optimal settings for specific scenes, simply let the camera determine the subject and shooting conditions.

### Shooting (Smart Auto)

▶ Still Images ▶ Movies

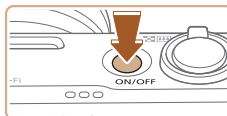

#### 1 Turn the camera on.

- Press the power button.
- The startup screen is displayed.



#### 2 Enter [AUTO] mode.

- Set the mode dial to [AUTO].
- Aim the camera at the subject. The camera will make a slight clicking noise as it determines the scene.
- Icons representing the scene and image stabilization mode are displayed in the upper left of the screen ( 36, 37).
- Frames displayed around any detected subjects indicate that they are in focus.

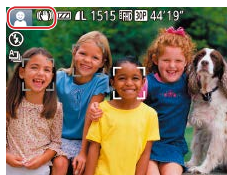

Before Use

Basic Guide

Advanced Guide

Camera Basics

Auto Mode /  
Hybrid Auto Mode

Other Shooting Modes

P Mode

Tv, Av, and M Mode

Playback Mode

Wi-Fi Functions

Setting Menu

Accessories

Appendix

Index





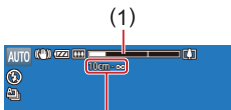
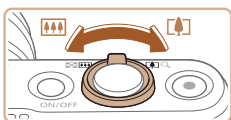

(1)  
(2)

### 3 Compose the shot.

- To zoom in and enlarge the subject, move the zoom lever toward [T] (telephoto), and to zoom away from the subject, move it toward [W] (wide angle). (A zoom bar (1) showing the zoom position is displayed, along with the range of focus (2).)
- To zoom in or out quickly, move the zoom lever all the way toward [T] (telephoto) or [W] (wide angle), and to zoom in or out slowly, move it just a little in the desired direction.

### 4 Shoot.

#### Shooting Still Images

##### 1) Focus.

- Press the shutter button halfway. The camera beeps twice after focusing, and frames are displayed to indicate image areas in focus.
- Several frames are displayed when multiple areas are in focus.

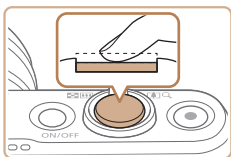

- If [Raise the flash] is displayed, move the [Flash] switch to raise the flash. It will fire when shooting. If you prefer not to use the flash, push it down with your finger, into the camera.

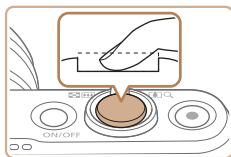

##### 2) Shoot.

- Press the shutter button all the way down.
- As the camera shoots, a shutter sound is played, and in low-light conditions when you have raised the flash, it fires automatically.
- Keep the camera still until the shutter sound ends.
- After displaying your shot, the camera will revert to the shooting screen.



(1)

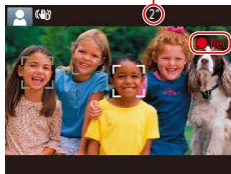

#### Recording Movies

##### 1) Start recording.

- Press the movie button. The camera beeps once as recording begins, and [Rec] is displayed with the elapsed time (1).
- Black bars are displayed on the top and bottom edges of the screen, and the subject is slightly enlarged. The black bars indicate image areas not recorded.
- Frames displayed around any detected faces indicate that they are in focus.
- Once recording begins, take your finger off the movie button.

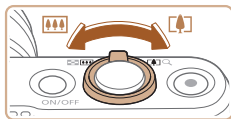

##### 2) Resize the subject and recompose the shot as needed.

- To resize the subject, repeat the operations in step 3. However, note that the sound of camera operations will be recorded. Note that movies shot at zoom factors shown in blue will look grainy.
- When you recompose shots, the focus, brightness, and colors will be automatically adjusted.

Before Use
Basic Guide
Advanced Guide
Camera Basics
Auto Mode / Hybrid Auto Mode
Other Shooting Modes
P Mode
Tv, Av, and M Mode
Playback Mode
Wi-Fi Functions
Setting Menu
Accessories
Appendix
Index

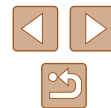



### 3) Finish recording.

- Press the movie button again to stop recording. The camera beeps twice as recording stops.
- Recording will stop automatically when the memory card becomes full.



- The flash firing during shots indicates that the camera has automatically attempted to ensure optimal colors in the main subject and background (Multi-area White Balance).

## Shooting in Hybrid Auto Mode

► Still Images ► Movies

You can make a short movie of the day just by shooting still images. The camera records 2 – 4-second clips of scenes before each shot, which are later combined in a digest movie. Clips recorded in this mode may be included in Story Highlights albums (108).



### 1 Enter [Hybrid Auto] mode.

- Follow step 2 in “Shooting (Smart Auto)” (32) and choose [Hybrid Auto].

### 2 Compose the shot.

- Follow steps 3 – 4 in “Shooting (Smart Auto)” (32) to compose the shot and focus.
- For more impressive digest movies, aim the camera at subjects about four seconds before shooting still images.



### 3 Shoot.

- Follow step 4 in “Shooting (Smart Auto)” (32) to shoot a still image.
- The camera records both a still image and movie clip. The clip, which ends with the still image and a shutter sound, forms a single chapter in the digest movie.



- Battery life is shorter in this mode than in [AUTO] mode, because digest movies are recorded for each shot.
- A digest movie may not be recorded if you shoot a still image immediately after turning the camera on, choosing [Hybrid Auto] mode, or operating the camera in other ways.
- Sounds and vibrations from operating the camera will be recorded in digest movies.



- Digest movie quality is [FHD 30P] and cannot be changed.
- Sounds are not played when you press the shutter button halfway or trigger the self-timer (139).
- Digest movies are saved as separate movie files in the following cases even if they were recorded on the same day in [Hybrid Auto] mode.
  - The digest movie file size reaches approximately 4 GB, or the total recording time reaches approximately 16 minutes and 40 seconds.
  - The digest movie is protected (96).
  - Daylight saving time (20) or time zone (140) settings are changed.
  - A new folder is created (144).
- Recorded shutter sounds cannot be modified or erased.
- If you prefer to record digest movies without still images, adjust the setting in advance. Choose MENU (29) > [Camera] tab > [Digest Type] > [No Stills].
- Individual chapters can be edited (107).

Before Use
Basic Guide
Advanced Guide
Camera Basics
Auto Mode / Hybrid Auto Mode
Other Shooting Modes
P Mode
Tv, Av, and M Mode
Playback Mode
Wi-Fi Functions
Setting Menu
Accessories
Appendix
Index



## Digest Movie Playback

Display a still image shot in [LIVE] mode to play the digest movie created on the same day, or specify the date of the digest movie to play (p.90).

## Still Images/Movies



- If the camera makes no operating sounds, it may have been turned on while holding down the [INFO.] button. To activate sounds again, press the [MENU] button and choose [Mute] on the [Fn] tab, and then press the [M] buttons to choose [Off].

## Still Images



- A blinking [S] icon warns that images are more likely to be blurred by camera shake. In this case, mount the camera on a tripod or take other measures to keep it still.
- If your shots are dark despite the flash firing, move closer to the subject. For details on the flash range, see "Camera" (p.177).
- The subject may be too close if the camera only beeps once when you press the shutter button halfway. For details on the range of focus (shooting range), see "Shooting Range" (p.178).
- To reduce red-eye and to assist in focusing, the lamp may be lit when shooting in low-light conditions.
- A blinking [B] icon displayed when you attempt to shoot indicates that shooting is not possible until the flash has finished recharging. Shooting can resume as soon as the flash is ready, so either press the shutter button all the way down and wait, or release it and press it again.
- The shutter sound will not be played when the Sleeping and Babies (Sleeping) icons (p.36) are displayed.
- Although you can shoot again before the shooting screen is displayed, your previous shot may determine the focus, brightness, and colors used.



- You can change how long images are displayed after shots (p.54).

## Movies



- Keep your fingers away from the microphone (1) while recording movies. Blocking the microphone may prevent audio from being recorded or may cause the recording to sound muffled.

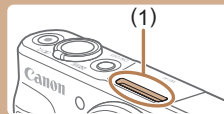

- Avoid touching camera controls other than the movie button when shooting movies, because sounds made by the camera will be recorded.
- Once movie recording begins, the image display area changes and subjects are enlarged to allow for correction of significant camera shake. To record subjects at the same size shown before recording, follow the steps in "Recording Movies with Subjects at the Same Size Shown before Recording" (p.53).



- Audio is recorded in stereo.

Before Use

Basic Guide

Advanced Guide

Camera Basics

Auto Mode /  
Hybrid Auto Mode

Other Shooting Modes

P Mode

Tv, Av, and M Mode

Playback Mode

Wi-Fi Functions

Setting Menu

Accessories

Appendix

Index



## Scene Icons

► Still Images ► Movies

In and [AUTO] modes, shooting scenes determined by the camera are indicated by the icon displayed, and corresponding settings are automatically selected for optimal focusing, subject brightness, and color. Depending on the scene, continuous images may be shot (📖37).

Subject	Background				
	Normal	Backlit	Dark*1	Sunsets	Spotlights
People	*2	*3		—	
Moving People	*3	*3	—	—	—
Shadows on Face	*2	—	—	—	—
Smiling	*3	*3	—	—	—
Sleeping	*2	*3	—	—	—
Babies	*3	*3	—	—	—
Smiling Babies	*3	*3	—	—	—
Sleeping Babies	*2	*3	—	—	—
Moving Children	*3	*3	—	—	—
Other Subjects	*2	*3			
Other Moving Subjects	*3	*3	—	—	—
Other Close-Range Subjects	*2	*3	—	—	

\*1 Tripod used.

\*2 The background color of icons is light blue when the background is a blue sky, dark blue when the background is dark, and gray for all other backgrounds.

\*3 The background color of icons is light blue when the background is a blue sky, and gray for all other backgrounds.

- The background color of , , , , and is dark blue, and the background color of is orange.
- For movies, only People, Other Subjects, and Other Close-Range Subjects icons are displayed.
- In mode, icons are only displayed for People, Shadows on Face, Other Subjects, and Other Close-Range Subjects.
- For self-timer shots, icons are not displayed for the following subjects: moving, smiling, or sleeping people; smiling or sleeping babies; moving children; and other moving subjects.
- Icons are not displayed for smiling or sleeping subjects and moving children in drive modes other than (📖37, 📖43), and when [Hg Lamp Corr.] is set to [On] and scenes are automatically corrected (📖50).
- Backlit icons are not displayed for moving children and smiling people when the flash is set to .
- Icons for babies (including smiling and sleeping babies) and moving children are displayed when [Face ID] is set to [On] and faces of registered babies (less than two years old) or children (2 – 12 years old) are detected (📖45). Confirm beforehand that the date and time are correct (📖20).



- Depending on the scene, the scene icon may not match actual shooting conditions, or it may not be possible to shoot with your expected effect, color, or brightness. Try shooting in mode (📖70).

Before Use

Basic Guide

Advanced Guide

Camera Basics

Auto Mode /  
Hybrid Auto Mode

Other Shooting Modes

P Mode

Tv, Av, and M Mode

Playback Mode

Wi-Fi Functions

Setting Menu



Accessories

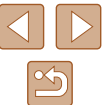

Appendix

Index



## Continuous Shooting Scenes



If you shoot a still image when the following scene icons are displayed, the camera will shoot continuously. If you press the shutter button halfway when one of the following icons in the table is displayed, , , or  icon will be displayed to inform you that the camera will shoot continuous images.

Smiling (including Babies)	 Consecutive images are captured, and the camera analyzes details such as facial expressions to save the image determined to be the best.
Sleeping (including Babies)	 Beautiful shots of sleeping faces, created by combining consecutive shots to reduce camera shake and image noise. The AF-assist beam will not light up, the flash will not fire. The shutter sound will not be played.
Children	 So you don't miss a photo opportunity of children who move around, the camera will capture three consecutive images for each shot.



- In some scenes, expected images may not be saved, and images may not look as expected.
- Focus, image brightness, and color are determined by the first shot.











- When you want to shoot single images only, press the  button, choose  in the menu, and then select .

## Image Stabilization Icons



► Still Images ► Movies

Optimal image stabilization for the shooting conditions (Intelligent IS) is automatically applied, and the following icons are displayed.

	Image stabilization for still images (Normal)
	Image stabilization for still images when panning (Panning)*
	Corrects the angle shake or shift shake when you take a macro shot (Hybrid IS). During movie recording,  is displayed, furthermore,  corrects the camera shake.
	Image stabilization for movies, reducing strong camera shake, as when shooting while walking (Dynamic)
	Image stabilization for slow camera shake, such as when shooting movies at telephoto (Powered)
	No image stabilization, because the camera is mounted on a tripod or held still by other means. However, during movie recording,  is displayed, and image stabilization to counteract wind or other sources of vibration is used (Tripod IS).

\* Displayed when you pan, following moving subjects with the camera. When you follow subjects moving horizontally, image stabilization only counteracts vertical camera shake, and horizontal stabilization stops. Similarly, when you follow subjects moving vertically, image stabilization only counteracts horizontal camera shake.



- To cancel image stabilization, set [IS Mode] to [Off] . In this case, an IS icon is not displayed.
- In  mode, no  icon is displayed.

Before Use
Basic Guide
Advanced Guide
Camera Basics
Auto Mode / Hybrid Auto Mode
Other Shooting Modes
P Mode
Tv, Av, and M Mode
Playback Mode
Wi-Fi Functions
Setting Menu
Accessories
Appendix
Index

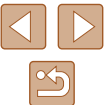

## On-Screen Frames

► Still Images ► Movies

In [AUTO] mode, a variety of frames are displayed once the camera detects subjects you are aiming the camera at.

- A white frame is displayed around the subject (or person's face) determined by the camera to be the main subject, and gray frames are displayed around other detected faces. Frames follow moving subjects within a certain range to keep them in focus. However, if the camera detects subject movement, only the white frame will remain on the screen.
- When you are pressing the shutter button halfway and the camera detects subject movement, a blue frame is displayed, and the focus and image brightness are constantly adjusted (Servo AF).



- Depending on the scene or subject, no frames may be displayed, frames may not be displayed around desired subjects, or frames may be displayed on the background or similar areas. Try shooting in [P] mode (p. 70).

## Common, Convenient Features

### Zooming In Closer on Subjects (Digital Zoom)

► Still Images ► Movies

When distant subjects are too far away to enlarge using the optical zoom, use digital zoom for up to about 160x enlargement.

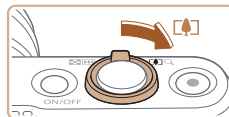

#### 1 Move the zoom lever toward [Z].

- Hold the lever until zooming stops.
- Zooming stops at the largest possible zoom factor (before the image becomes noticeably grainy), which is then indicated on the screen.

#### 2 Move the zoom lever toward [Z] again.

- The camera zooms in even closer on the subject.
- (1) is the current zoom factor.



- Moving the zoom lever will display the zoom bar (which indicates the zoom position). The zoom bar is color-coded to indicate the zoom range.
  - White range: optical zoom range where the image will not appear grainy.
  - Yellow range: digital zoom range where the image is not noticeably grainy (ZoomPlus).
  - Blue range: digital zoom range where the image will appear grainy.
- Because the blue range will not be available at some recording pixel settings (p. 49), the maximum zoom factor can be achieved by following step 1.

Before Use

Basic Guide

Advanced Guide

Camera Basics

Auto Mode /  
Hybrid Auto Mode

Other Shooting Modes

P Mode

Tv, Av, and M Mode

Playback Mode

Wi-Fi Functions

Setting Menu

Accessories

Appendix

Index





- To deactivate digital zoom, choose MENU (📖29) > [📷] tab > [Digital Zoom] > [Off].

## Easily Reacquiring Subjects after Manual Zooming (Framing Assist – Seek)

▶ Still Images ▶ Movies

If you lose track of a subject while zooming in, you can find it more easily by temporarily zooming out.

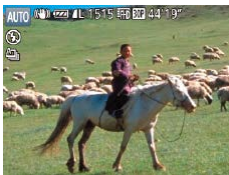
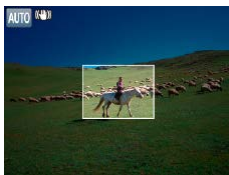
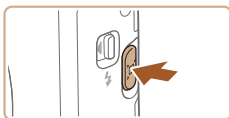

### 1 Look for the lost subject.

- Press and hold the [◀] button.
- The camera zooms out and displays a white frame around the area previously shown (before you pressed the [◀] button).

### 2 Reacquire the subject.

- Aim the camera so that the subject enters the white frame, and then release the [◀] button.
- The previous magnification is now restored, so that the area within the white frame fills the screen again.



- Some shooting information is not displayed while the camera is zoomed out.
- During movie shooting, the white frame is not displayed if you press the [◀] button. Also note that a changed zoom factor and camera operating sounds will be recorded.



- If you prefer to shoot at the zoom factor of the screen in step 1, press the shutter button all the way down.
- You can adjust the zoom factor that the camera reverts to when you release the [◀] button by moving the zoom lever to resize the white frame while you hold the [◀] button.
- To adjust the area displayed when the [◀] button is pressed, access MENU (📖29) > [📷] tab > [◻] Display Area], and choose one of the three options.
- The zoom factor cannot be changed with the [◀] button after you press the shutter button all the way down in self-timer mode (📖42).

Before Use

Basic Guide

Advanced Guide

Camera Basics

Auto Mode / Hybrid Auto Mode

Other Shooting Modes

P Mode

Tv, Av, and M Mode

Playback Mode

Wi-Fi Functions

Setting Menu

Accessories

Appendix

Index



## Zooming Automatically According to the Movement of the Subject (Auto Zoom)

► Still Images ► Movies

The camera automatically zooms in and out to keep the detected face (📖77) at a constant size on the screen. If the person moves closer, the camera will automatically zoom out, and vice versa. This size can also be adjusted, as needed.

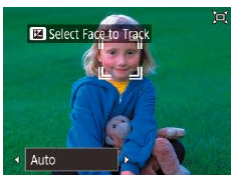
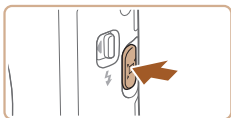

### 1 Enter [ ] Auto mode.

- Press and release the [ ] button quickly.
- [ ] is displayed.
- A white frame is displayed when a face is detected. The camera will zoom automatically to fit the person (subject) in the screen.
- When multiple faces are detected, the main subject is displayed in a white frame and the other faces (maximum of two) are displayed in gray frames. The camera will zoom automatically to fit multiple people in the screen.

### 2 Shoot.

- The frames are displayed even after taking the shot and the camera will zoom automatically.
- To cancel this mode, press the [ ] button again. [ ] Auto: Off is displayed.



- A face may not be displayed at a constant size relative to the screen at some zoom factors, or if the person's head is tilted or facing the camera indirectly.
- During movie recording, a changed zoom factor and camera operating sounds are recorded.
- When [ ] Auto is on, some shooting information is not displayed, and some shooting settings cannot be configured.
- The camera will not auto zoom to fit multiple people in the screen when multiple faces are detected while shooting a movie.
- Auto zoom cannot be used while using the continuous shooting function.



- If multiple faces are detected in step 1, press the [▲] button to choose the face for automatic zooming.
- If the person detected by the camera moves toward the edge of the screen, the camera zooms out to keep the person in view.
- The zoom factor cannot be changed after you press the shutter button all the way down in self-timer mode (📖42).
- Depending on the shoot conditions and the subject's movement, the face size may not be maintained in order to fit the subject on the screen.
- When the camera cannot detect a face, move the zoom to any position and stop the zoom until the face is detected.

Before Use
Basic Guide
Advanced Guide
Camera Basics
Auto Mode / Hybrid Auto Mode
Other Shooting Modes
P Mode
Tv, Av, and M Mode
Playback Mode
Wi-Fi Functions
Setting Menu
Accessories
Appendix
Index

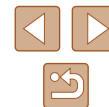



## Adjusting the Constant Face Display Size



- When [Auto: On] is set, press the [Left/Right] buttons to choose the desired option.
- The camera zooms automatically to keep faces at the specified size.

Auto	The camera will auto zoom according to the movement of the person (subject) to keep the person in the screen. When multiple faces are detected, the camera will auto zoom to keep multiple people in the screen.
Face	Keep faces large enough to show facial expressions clearly.
Upper Body	Keep faces small enough to show the person's upper body.
Whole Body	Keep faces small enough to show the person's entire body.
Manual	Keep faces at the size specified by moving the zoom lever. Move the zoom lever, and then release the zoom lever once the desired size has been obtained.



- The face size can also be adjusted in MENU (429) > [Camera] tab > [Auto Settings] > [Auto Zoom]. You can choose [Off] to deactivate this feature and use only the feature described in "Easily Reacquiring Subjects with Auto Zooming (Seek Assist)" (41).
- You can zoom in or out with the zoom lever when [Face], [Upper Body], or [Whole Body] is selected, but the original zoom factor will be restored in a few seconds after you release the lever.
- You can clear your specified face size during movie recording by pressing the [Reset] button.
- Face sizes cannot be changed during movie recording.

## Easily Reacquiring Subjects with Auto Zooming (Seek Assist)

► Still Images ► Movies

If zooming in causes you to lose track of a subject, and you move the camera to look for them, the camera can automatically zoom out to help you find the subject.



### 1 Enter [Auto] Auto mode (40).

### 2 Look for the lost subject.

- When you move the camera to look for the subject, the camera zooms out to help you find it.

### 3 Reacquire the subject.

- Once you find the subject and stop moving the camera, the camera zooms in again.

### 4 Shoot.

- To cancel this mode, press the [Auto] button again. [Auto: Off] is displayed.

Before Use

Basic Guide

Advanced Guide

Camera Basics

Auto Mode /  
Hybrid Auto Mode

Other Shooting Modes

P Mode

Tv, Av, and M Mode

Playback Mode

Wi-Fi Functions

Setting Menu

Accessories

Appendix

Index





- The camera does not zoom out automatically while [ ] is displayed around a detected face, even if you move the camera.
- When the feature described in “Zooming Automatically According to the Movement of the Subject (Auto Zoom)” (40) is deactivated, [ ] is displayed around a detected face, and the camera automatically zooms out when moved.
- Zooming is not possible while the shutter button is pressed halfway.
- To deactivate this feature and use only the feature described in “Zooming Automatically According to the Movement of the Subject (Auto Zoom)” (40), choose MENU (29) > [ ] tab > [ ] Auto Settings > [Seek Assist] > [Off].

## Using the Self-Timer

► Still Images ► Movies

With the self-timer, you can include yourself in group photos or other timed shots. The camera will shoot about 10 seconds after you press the shutter button.



### 1 Configure the setting.

- Press the [ ] button, choose [ ] (either press the [ ] [ ] buttons or turn the [ ] dial), and then press the [ ] button.
- Once the setting is complete, [ ] is displayed.

## 2 Shoot.

- For Still Images: Press the shutter button halfway to focus on the subject, and then press it all the way down.
- For Movies: Press the movie button.
- Once you start the self-timer, the lamp will blink and the camera will play a self-timer sound.
- Two seconds before the shot, the blinking and sound will speed up. (The lamp will remain lit in case the flash fires.)
- To cancel shooting after you have triggered the self-timer, press the [MENU] button.
- To restore the original setting, choose [ ] in step 1.

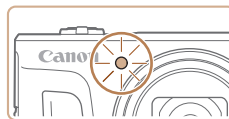

## Using the Self-Timer to Avoid Camera Shake

► Still Images ► Movies

This option delays shutter release until about two seconds after you have pressed the shutter button. If the camera is unsteady while you are pressing the shutter button, it will not affect your shot.

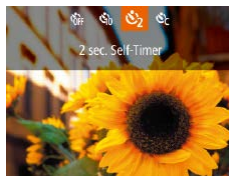

- Follow step 1 in “Using the Self-Timer” (42) and choose [ ].
- Once the setting is complete, [ ] is displayed.
- Follow step 2 in “Using the Self-Timer” (42) to shoot.

Before Use
Basic Guide
Advanced Guide
Camera Basics
Auto Mode / Hybrid Auto Mode
Other Shooting Modes
P Mode
Tv, Av, and M Mode
Playback Mode
Wi-Fi Functions
Setting Menu
Accessories
Appendix
Index

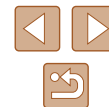

## Customizing the Self-Timer

► Still Images ► Movies

You can specify the delay (0 – 30 seconds) and number of shots (1 – 10).

### 1 Choose [C].

- Following step 1 in “Using the Self-Timer” (42), choose [C] and press the [MENU] button.

### 2 Configure the setting.

- Press the [▲][▼] buttons to choose the delay time or number of shots.
- Press the [◀][▶] buttons or turn the [DISP] dial to choose a value, and then press the [OK] button.
- Once the setting is complete, [C] is displayed.
- Follow step 2 in “Using the Self-Timer” (42) to shoot.



- For movies recorded using the self-timer, recording begins after your specified delay time, but specifying the number of shots has no effect.



- When you specify multiple shots, image brightness and white balance are determined by the first shot. More time is required between shots when the flash fires or when you have specified to take many shots. Shooting will stop automatically when the memory card becomes full.
- When a delay longer than two seconds is specified, two seconds before the shot, the lamp blinking and self-timer sound will speed up. (The lamp will remain lit in case the flash fires.)

## Continuous Shooting

► Still Images ► Movies

In [AUTO] mode, hold the shutter button all the way down to shoot continuously.

For details on the continuous shooting speed, see “Camera” (177).



### 1 Configure the setting.

- Press the [C] button, choose [A] in the menu, and then choose [M] (28).
- Once the setting is complete, [M] is displayed.

### 2 Shoot.

- Hold the shutter button all the way down to shoot continuously.



- During continuous shooting, the focus, exposure, and colors are locked at the position/level determined when you pressed the shutter button halfway.
- Cannot be used with the self-timer (42).
- Shooting may stop momentarily or continuous shooting may slow down depending on shooting conditions, camera settings, and the zoom position.
- As more shots are taken, shooting may slow down.
- Shooting may slow down if the flash fires.
- Multi-area White Balance (50) is not available. Similarly, [Hg Lamp Corr.] (50) is set to [Off] and cannot be changed.

Before Use

Basic Guide

Advanced Guide

Camera Basics

Auto Mode / Hybrid Auto Mode

Other Shooting Modes

P Mode

Tv, Av, and M Mode

Playback Mode

Wi-Fi Functions

Setting Menu

Accessories

Appendix

Index



## Image Display during Playback

Each set of images shot continuously is managed as a single group, and only the first image in that group will be displayed. To indicate that the image is part of a group, **[SET]** is displayed in the upper left of the screen.



- If you erase a grouped image (📖98), all images in the group are also erased. Be careful when erasing images.



- Grouped images can be played back individually (📖92) and ungrouped (📖92).
- Protecting (📖96) a grouped image will protect all images in the group.
- Grouped images can be viewed individually when played back using Image Search (📖91) or Smart Shuffle (📖95). In this case, images are temporarily ungrouped.
- The following actions are not available for grouped images: editing Face ID information (📖93), magnifying (📖94), tagging as favorites (📖101), editing (📖102), printing (📖153), setting up individual image printing (📖157), or adding to a photobook (📖158). To do these things, either view grouped images individually (📖92) or cancel grouping (📖92) first.

## Using Face ID

If you register a person ahead of time, the camera will detect that person's face, and prioritize focus, brightness, and color for that person when shooting. In **[AUTO]** mode, the camera can detect babies and children based on registered birthdays and optimize settings for them when shooting.

This function is also useful when searching for a specific registered person among a large number of images (📖91).

Registering people ahead of time is also a good way to let you extract them easily for a Story Highlights album (📖108).

## Personal Information

- Information such as images of a face (face info) registered with Face ID, and personal information (name, birthday) will be saved on the camera. Additionally, when registered people are detected, their names will be recorded in still images. When using the Face ID function, be careful when sharing the camera or images with others, and when posting images online where many others can view them.
- When disposing of a camera or transferring it to another person after using Face ID, be sure to erase all information (registered faces, names, and birthdays) from the camera (📖48).

Before Use

Basic Guide

Advanced Guide

Camera Basics

Auto Mode /  
Hybrid Auto Mode

Other Shooting Modes

P Mode

Tv, Av, and M Mode

Playback Mode

Wi-Fi Functions

Setting Menu

Accessories

Appendix

Index



## Registering Face ID Information

You can register information (face info, names, and birthdays) for up to 12 people to use with Face ID.

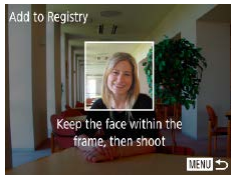
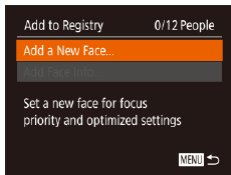
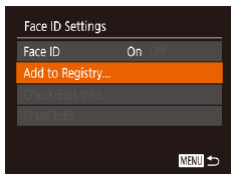
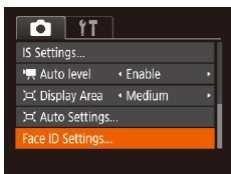

### 1 Access the setting screen.

- Press the [MENU] button, choose [Face ID Settings] on the [CAMERA] tab, and then press the [OK] button (p. 29).
- Press the [▲][▼] buttons or turn the [DIAL] dial to choose [Add to Registry], and then press the [OK] button.
- Press the [▲][▼] buttons or turn the [DIAL] dial to choose [Add a New Face], and then press the [OK] button.

### 2 Register face information.

- Aim the camera so that the face of the person you want to register is inside the gray frame at the center of the screen.
- A white frame on the person's face indicates that the face is recognized. Make sure a white frame is displayed on the face, and then shoot.
- If the face is not recognized, you cannot register face information.

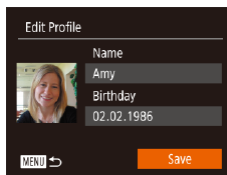
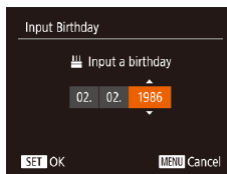
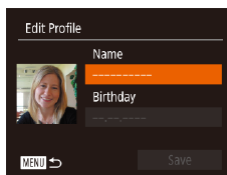
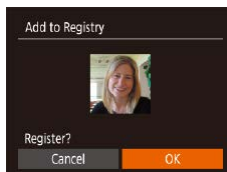

- After [Register?] is displayed, press the [◀][▶] buttons or turn the [DIAL] dial to choose [OK], and then press the [OK] button.
- The [Edit Profile] screen is displayed.

### 3 Register the person's name and birthday.

- Press the [OK] button to access the keyboard, and then enter the name (p. 30).
- To register a birthday, on the [Edit Profile] screen, choose [Birthday] (either press the [▲][▼] buttons or turn the [DIAL] dial), and then press the [OK] button.
- Press the [◀][▶] buttons to choose an option.
- Press the [▲][▼] buttons or turn the [DIAL] dial to specify the date.
- When finished, press the [OK] button.

### 4 Save the settings.

- Press the [▲][▼] buttons or turn the [DIAL] dial to choose [Save], and then press the [OK] button.
- After a message is displayed, press the [◀][▶] buttons or turn the [DIAL] dial to choose [Yes], and then press the [OK] button.

Before Use
Basic Guide
Advanced Guide
Camera Basics
Auto Mode / Hybrid Auto Mode
Other Shooting Modes
P Mode
Tv, Av, and M Mode
Playback Mode
Wi-Fi Functions
Setting Menu
Accessories
Appendix
Index

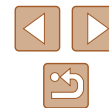

## 5 Continue registering face information.

- To register up to 4 more points of face information (expressions or angles), repeat step 2.
- Registered faces are more easily recognized if you add a variety of face information. In addition to a head-on angle, add a slight side angle, a shot when smiling, and shots inside and outside.



- The flash will not fire when following step 2.
- If you do not register a birthday in step 3, Babies or Children icons (👶👦) will not be displayed in [AUTO] mode.



- You can overwrite registered face info, and add face info later if you have not filled all 5 face info slots (📖45).

## Shooting

If you register a person ahead of time, the camera will prioritize that person as the main subject, and optimize focus, brightness, and color for that person when shooting.



- When you point the camera toward people, the names of up to 3 registered people will be displayed when they are detected.
- Shoot.
- Displayed names will be recorded in still images. The names of detected people (maximum total of 5) will be recorded, even if the names are not displayed.



- People other than those registered may be mistakenly detected as the registered person if they share similar facial features.



- Registered people may not be correctly detected if the captured image or scene differs drastically from the registered face information.
- If a registered face is not detected, or not easily detected, overwrite registered information with new face info. Registering face info right before shooting will allow for easier detection of registered faces.
- If a person is mistakenly detected as another person and you continue shooting, you can edit or erase the name recorded in the image during playback (📖93).
- Because faces of babies and children change quickly as they grow, you should update their face info regularly (📖45).
- If you don't want names to be recorded in still images, choose [Face ID Settings] on the 📷 tab, choose [Face ID], and then choose [Off].
- You can check names recorded in images in the playback screen (simple information display) (📖88).
- In [📷] mode, names are not displayed on the shooting screen, but they will be recorded in still images.
- Names recorded in continuous shooting (📖43, 📖80) continue to be recorded in the same position as the first shot. Names are recorded in the same position as the first shot for additional shots, even if subjects move.

## Checking and Editing Registered Information

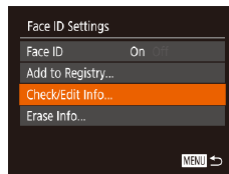

### 1 Access the [Check/Edit Info] screen.

- Following step 1 in “Registering Face ID Information” (📖45), choose [Check/Edit Info] and press the (📷) button.

Before Use

Basic Guide

Advanced Guide

Camera Basics

Auto Mode / Hybrid Auto Mode

Other Shooting Modes

P Mode

Tv, Av, and M Mode

Playback Mode

Wi-Fi Functions

Setting Menu

Accessories

Appendix

Index



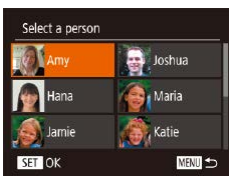

## 2 Choose a person to check or edit their information.

- Press the [▲][▼][◀][▶] buttons or turn the [⦿] dial to choose the person whose information you want to check or edit, and then press the [Ⓜ] button.

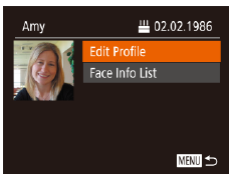

## 3 Check or edit the information as needed.

- To check a name or birthday, choose [Edit Profile] (either press the [▲][▼] buttons or turn the [⦿] dial), and then press the [Ⓜ] button. On the screen displayed, you can edit the name or birthday as described in step 3 of “Registering Face ID Information” (45).
- To check face information, choose [Face Info List] (either press the [▲][▼] buttons or turn the [⦿] dial), and then press the [Ⓜ] button. Press the [Ⓜ] button on the screen displayed, choose face information to erase by pressing the [▲][▼][◀][▶] buttons or turning the [⦿] dial, and then press the [Ⓜ] button. After [Erase?] is displayed, press the [◀][▶] buttons or turn the [⦿] dial to choose [OK], and then press the [Ⓜ] button to erase the face information.



- Even if you change names in [Edit Profile], the names recorded in previously shot images will remain the same.

## Overwriting and Adding Face Information

You can overwrite existing face information with new face info. You should update face information regularly, especially with babies and children, as their faces change quickly as they grow.

You can also add face information when all 5 face info slots have not been filled.

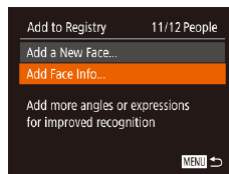

## 1 Access the [Add Face Info] screen.

- Following step 1 in “Registering Face ID Information” (45), choose [Add Face Info] and press the [Ⓜ] button.

## 2 Choose a person to overwrite their face info.

- Press the [▲][▼][◀][▶] buttons or turn the [⦿] dial to choose the name of the person whose face info you want to overwrite, and then press the [Ⓜ] button.
- If five items of face info have already been registered, a message will be displayed. Choose [OK] (either press the [◀][▶] buttons or turn the [⦿] dial), and then press the [Ⓜ] button.
- If less than five items of face info are registered, go to step 4 to add face information.

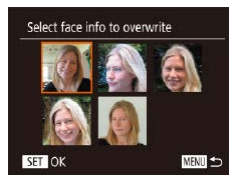

## 3 Choose the face info to overwrite.

- Press the [▲][▼][◀][▶] buttons or turn the [⦿] dial to choose the face info to overwrite, and then press the [Ⓜ] button.

Before Use
Basic Guide
Advanced Guide
Camera Basics
Auto Mode / Hybrid Auto Mode
Other Shooting Modes
P Mode
Tv, Av, and M Mode
Playback Mode
Wi-Fi Functions
Setting Menu
Accessories
Appendix
Index





#### 4 Register face information.

- Follow step 2 in “Registering Face ID Information” (📖45) to shoot, and then register the new face information.
- Registered faces are more easily recognized if you add a variety of face information. In addition to a head-on angle, add a slight side angle, a shot when smiling, and shots inside and outside.



- You cannot add face information if all 5 information slots are filled. Follow the steps above to overwrite face information.
- You can follow the above steps to register new face info when there is at least one slot open; however, you cannot overwrite any face information. Instead of overwriting face info, first erase unwanted existing info (📖46), and then register new face information (📖45) as needed.

#### Erasing Registered Information

You can erase information (face info, names, and birthdays) registered to Face ID. However, names recorded in previously shot images will not be erased.

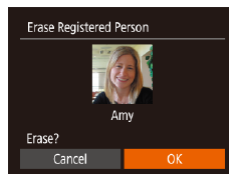
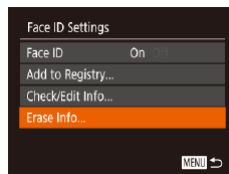

#### 1 Access the [Erase Info] screen.

- Follow step 1 in “Registering Face ID Information” (📖45) and choose [Erase Info].

#### 2 Choose a person to erase their information.

- Press the [▲][▼][◀][▶] buttons or turn the [🔘] dial to choose the name of the person to erase, and then press the [⏏] button.
- After [Erase?] is displayed, press the [◀][▶] buttons or turn the [🔘] dial to choose [OK], and then press the [⏏] button.



- If you erase a registered person's info, you will not be able to display their name (📖90), overwrite their info (📖93), or search for images that include them (📖91).



- You can also erase names in image information (📖93).

Before Use

Basic Guide

Advanced Guide

Camera Basics

Auto Mode /  
Hybrid Auto Mode

Other Shooting Modes

P Mode

Tv, Av, and M Mode

Playback Mode

Wi-Fi Functions

Setting Menu

Accessories

Appendix

Index





## Image Customization Features

### Changing the Aspect Ratio

► Still Images ► Movies

Change the image aspect ratio (ratio of width to height) as follows.



- Press the [FUNC SET] button, choose [4:3] in the menu, and choose the desired option (see page 28).
- Once the setting is complete, the screen aspect ratio will be updated.
- To restore the original setting, repeat this process but choose [4:3].

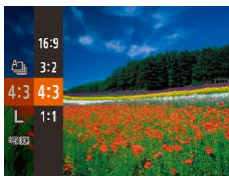

<b>16:9</b>	Used for display on widescreen HDTVs or similar display devices.
<b>3:2</b>	Same aspect ratio as 35mm film. Used for printing images at 5 x 7-inch or postcard sizes.
<b>4:3</b>	Native aspect ratio of the camera screen. Used for display on standard-definition televisions or similar display devices. Also used for printing images at 3.5 x 5-inch or A-series sizes.
<b>1:1</b>	Square aspect ratio.



- Not available in [P/A/S] mode.

### Changing Image Resolution (Size)

► Still Images ► Movies

Choose from 4 levels of image resolution, as follows. For guidelines on how many shots at each resolution setting can fit on a memory card, see “Number of Shots per Memory Card” (see page 179).

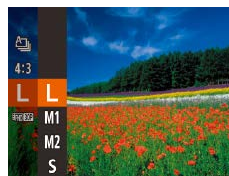

- Press the [FUNC SET] button, choose [L] in the menu, and choose the desired option (see page 28).
- The option you configured is now displayed.
- To restore the original setting, repeat this process but choose [L].

### Guidelines for Choosing Resolution Based on Paper Size (for 4:3 Images)

<b>L</b>	A2 (16.5 x 23.4 in.)
<b>M1</b>	A3 – A5 (11.7 x 16.5 – 5.8 x 8.3 in.)
<b>M2</b>	3.5 x 5 in., 5 x 7 in., Postcard
<b>S</b>	For e-mailing and similar purposes



- Not available in [P/A/S] mode.

Before Use

Basic Guide

Advanced Guide

Camera Basics

Auto Mode /  
Hybrid Auto Mode

Other Shooting Modes

P Mode

Tv, Av, and M Mode

Playback Mode

Wi-Fi Functions

Setting Menu

Accessories

Appendix

Index



## Correcting Greenish Image Areas from Mercury Lamps

► Still Images ► Movies

In [AUTO] mode, subjects or background in shots of evening scenes illuminated by mercury lamps may appear to have a greenish tinge. This greenish tinge can be corrected automatically when shooting, using Multi-area White Balance.

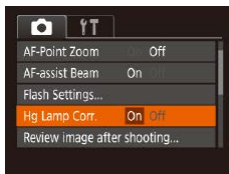
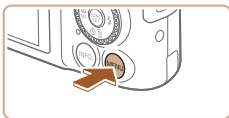

- Press the [MENU] button, choose [Hg Lamp Corr.] on the [CAMERA] tab, and then choose [On] (129).
- Once the setting is complete, [ ] is displayed.
- To restore the original setting, repeat this process but choose [Off].



- After you are finished shooting under mercury lamps, you should set [Hg Lamp Corr.] back to [Off]. Otherwise, green hues not caused by mercury lamps may be corrected by mistake.



- Try taking some test shots first to make sure you obtain the desired results.
- In continuous shooting (43), this setting is set to [Off] and cannot be changed.

## Changing Movie Image Quality

► Still Images ► Movies

3 image quality settings are available. For guidelines on the maximum movie length at each level of image quality that will fit on a memory card, see “Recording Time per Memory Card” (179).

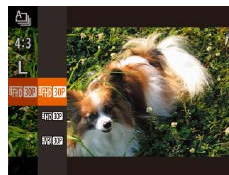

- Press the [ ] button, choose [ ] in the menu, and choose the desired option (28).
- The option you configured is now displayed.
- To restore the original setting, repeat this process but choose [ ].

Image Quality	Resolution	Frame Rate	Details
[ ]	1920 x 1080	30 fps	For shooting in Full HD
[ ]	1280 x 720	30 fps	For shooting in HD
[ ]	640 x 480	30 fps	For shooting in standard definition



- In [ ] and [ ] modes, black bars are displayed on the top and bottom edges of the screen. They indicate that this image area cannot be recorded.
- In [ ] mode, [ ] is also available, offering smoother motion (66).

Before Use

Basic Guide

Advanced Guide

Camera Basics

Auto Mode / Hybrid Auto Mode

Other Shooting Modes

P Mode

Tv, Av, and M Mode

Playback Mode

Wi-Fi Functions

Setting Menu

Accessories

Appendix

Index



## Helpful Shooting Features

### Displaying Grid Lines

► Still Images ► Movies

Grid lines can be displayed on the screen for vertical and horizontal reference while shooting.

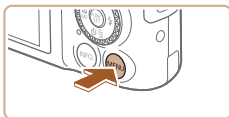

- Press the [MENU] button, choose [Grid Lines] on the [CAMERA] tab, and then choose [On] (📖29).
- Once the setting is complete, grid lines are displayed on the screen.
- To restore the original setting, repeat this process but choose [Off].

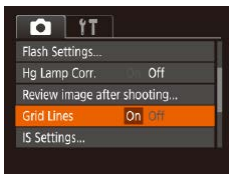

- Grid lines are not recorded in your shots.

## Magnifying the Area in Focus

► Still Images ► Movies

Check the focus by pressing the shutter button halfway to enlarge the portion of the image in the AF frame.

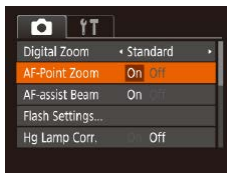
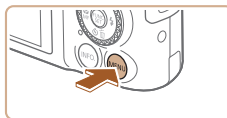

### 1 Configure the setting.

- Press the [MENU] button, choose [AF-Point Zoom] on the [CAMERA] tab, and then choose [On] (📖29).

### 2 Check the focus.

- Press the shutter button halfway. The face detected as the main subject is now magnified.
- To restore the original setting, choose [Off] in step 1.



- The area in focus is not magnified in the following cases when the shutter button is pressed halfway.
  - If a face was not detected, if the person is too close to the camera and their face is too large for the screen, or if the camera detects subject movement
  - When digital zoom is used (📖38)
  - When Tracking AF is used (📖78)
  - When a TV is used as a display (📖148)
- Not available in [CAMERA] mode.

Before Use

Basic Guide

Advanced Guide

Camera Basics

Auto Mode /  
Hybrid Auto Mode

Other Shooting Modes

P Mode

Tv, Av, and M Mode

Playback Mode

Wi-Fi Functions

Setting Menu

Accessories

Appendix

Index



## Deactivating Auto Level

▶ Still Images ▶ Movies

Normally, auto leveling keeps the movie image horizontally level during recording. To cancel this feature, choose [Disable].

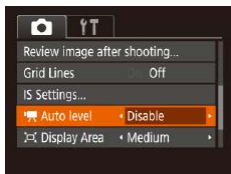

- Press the [MENU] button, choose [Auto level] on the [CAMERA] tab, and then choose [Disable] (📖29).



- Once movie recording begins, the image display area changes and subjects are enlarged (📖53).

## Changing the IS Mode Settings

▶ Still Images ▶ Movies

### Deactivating Image Stabilization

When the camera is held still (as when shooting from a tripod), you should set image stabilization to [Off] to deactivate it.

#### 1 Access the setting screen.

- Press the [MENU] button, choose [IS Settings] on the [CAMERA] tab, and then press the [INFO] button (📖29).

#### 2 Configure the setting.

- Press the [▲][▼] buttons or turn the [DISP] dial to choose [IS Mode], and then choose [Off] by pressing the [◀][▶] buttons.

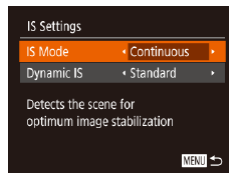

Continuous	Optimal image stabilization for the shooting conditions is automatically applied (Intelligent IS) (📖37).
Off	Deactivates image stabilization.

Before Use

Basic Guide

Advanced Guide

Camera Basics

Auto Mode /  
Hybrid Auto Mode

Other Shooting Modes

P Mode

Tv, Av, and M Mode

Playback Mode

Wi-Fi Functions

Setting Menu

Accessories

Appendix

Index



## Recording Movies with Subjects at the Same Size Shown before Recording

► Still Images ► Movies

Normally, once movie recording begins, the image display area changes and subjects are enlarged to allow the image to be kept as horizontally level as possible and for correction of significant camera shake.

To record movies with subjects at the same size shown before shooting, you can reduce image stabilization and cancel auto leveling.

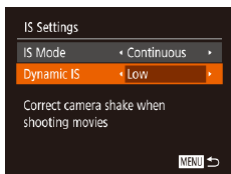

- Set [Auto level] to [Disable] as described in “Deactivating Auto Level” (📖52).
- Follow step 1 in “Deactivating Image Stabilization” (📖52) to access the [IS Settings] screen.
- Choose [Dynamic IS], and then choose [Low] (📖29).



- You can also set [IS Mode] to [Off], so that subjects are recorded at the same size shown before shooting.
- [Dynamic IS] is not available when [IS Mode] is set to [Off] (📖52).
- When the movie quality is [4K 60P], it is set to [Standard] and cannot be changed.

## Customizing Camera Operation

Customize shooting functions on the [📷] tab of the menu screen as follows. For instructions on menu functions, see “Using the Menu Screen” (📖29).

### Deactivating the AF-Assist Beam

► Still Images ► Movies

A lamp lights up to help you focus when you press the shutter button halfway in low-light conditions. You can deactivate the lamp.

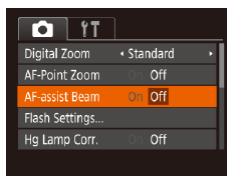

- Press the [MENU] button, choose [AF-assist Beam] on the [📷] tab, and then choose [Off] (📖29).
- To restore the original setting, repeat this process but choose [On].

Before Use

Basic Guide

Advanced Guide

Camera Basics

Auto Mode /  
Hybrid Auto Mode

Other Shooting Modes

P Mode

Tv, Av, and M Mode

Playback Mode

Wi-Fi Functions

Setting Menu

Accessories

Appendix

Index



## Preventing the Red-Eye Reduction Lamp from Lighting Up

► Still Images ► Movies

A red-eye reduction lamp lights up to reduce red-eye when the flash is used in low-light shots. You can deactivate the lamp.

- 1 Access the [Flash Settings] screen.**
  - Press the [MENU] button, choose [Flash Settings] on the [CAMERA] tab, and then press the [INFO] button (29).
- 2 Configure the setting.**
  - Choose [Off] (29).
  - To restore the original setting, repeat this process but choose [On].

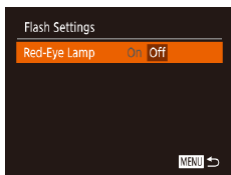

## Changing the Image Display Style after Shots

► Still Images ► Movies

You can change how long images are displayed and what information is displayed immediately after shooting.

### Changing the Image Display Period after Shots

- 1 Access the [Review image after shooting] screen.**
  - Press the [MENU] button, choose [Review image after shooting] on the [CAMERA] tab, and then press the [INFO] button (29).
- 2 Configure the setting.**
  - Choose [Display Time], press the [LEFT] [RIGHT] buttons to choose the desired option.
  - To restore the original setting, repeat this process but choose [Quick].

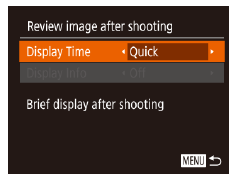

Quick	Displays images only until you can shoot again.
2 sec., 4 sec., 8 sec.	Displays images for the specified time. Even while the shot is displayed, you can take another shot by pressing the shutter button halfway again.
Hold	Displays images until you press the shutter button halfway.
Off	No image display after shots.

Before Use

Basic Guide

Advanced Guide

Camera Basics

Auto Mode /  
Hybrid Auto Mode

Other Shooting Modes

P Mode

Tv, Av, and M Mode

Playback Mode

Wi-Fi Functions

Setting Menu

Accessories

Appendix

Index



## Changing the Screen Displayed after Shots

Change the way images are displayed after shots as follows.

**1** Set [Display Time] to [2 sec.], [4 sec.], [8 sec.], or [Hold] (📖54).

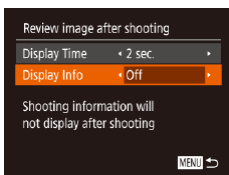

**2** Configure the setting.

- Press the [▲][▼] buttons or turn the [🔘] dial to choose [Display Info]. Press the [◀][▶] buttons to choose the desired option.
- To restore the original setting, repeat this process but choose [Off].



Off	Displays only the image.
Detailed	Displays shooting details (📖167).



- When [Display Time] (📖54) is set to [Off] or [Quick], [Display Info] is set to [Off] and cannot be changed.
- By pressing the [INFO] button while an image is displayed after shooting, you can switch the display information. Note that the settings of [Display Info] are not changed. You can also erase images by pressing the [▼] button, or protect (📖96) or tag images as favorites (📖101) by pressing the [🔘] button.

Before Use

Basic Guide

Advanced Guide

Camera Basics

Auto Mode /  
Hybrid Auto Mode

Other Shooting Modes

P Mode

Tv, Av, and M Mode

Playback Mode

Wi-Fi Functions

Setting Menu

Accessories

Appendix

Index

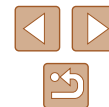

## Other Shooting Modes

Shoot more effectively in various scenes, and take shots enhanced with unique image effects or captured using special functions



## Brightness / Color Customization (Live View Control)

► Still Images ► Movies

Image brightness or colors when shooting can be easily customized as follows.

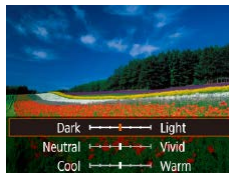

### 1 Enter [LIVE] mode.

- Set the mode dial to [LIVE].

### 2 Configure the setting.

- Press the button to access the setting screen. Press the buttons to choose a setting item, and then press the buttons or turn the dial to adjust the value as you watch the screen.
- Press the button.

### 3 Shoot.

Brightness	For brighter images, adjust the level to the right, and for darker images, adjust it to the left.
Color	For more vivid images, adjust the level to the right, and for more subdued images, adjust it to the left.
Tone	For a warm, reddish tone, adjust the level to the right, and for a cool, bluish tone, adjust it to the left.

Before Use

Basic Guide

Advanced Guide

Camera Basics

Auto Mode /  
Hybrid Auto Mode

Other Shooting Modes

P Mode

Tv, Av, and M Mode

Playback Mode

Wi-Fi Functions

Setting Menu

Accessories

Appendix

Index

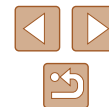



## Applying Effects Automatically (Creative Shot)

► Still Images ► Movies

### Enjoying a Variety of Images from Each Shot

The camera determines the subject and shooting conditions, automatically applying special effects and recomposing the shot to emphasize the subject. Six still images are recorded for each shot. You can capture multiple still images with effects using camera-determined settings.



#### 1 Enter [Creative Shot] mode.

- Set the mode dial to [Creative Shot].

#### 2 Shoot.

- Press the shutter button all the way down. As you shoot, the shutter sound is played three times.
- After the six images are displayed in succession, they are displayed simultaneously for about two seconds.
- To keep the images displayed until you press the shutter button halfway, press the [INFO] button. You can choose an image for full-screen display by pressing the [▲][▼][◀][▶] buttons or turning the [DIAL] dial, and then press the [INFO] button.
- To return to the original display, press the [MENU] button.



- Shooting will take some time when the flash fires, but hold the camera steady until the shutter sound is played three times.
- The six images are managed together as a group (P.92).
- Simultaneous display of the six images as shown in step 2 is only available immediately after you shoot.

### Choosing Effects

You can choose effects for images captured in [Creative Shot] mode.



- After choosing [Creative Shot] mode, press the [INFO] button.
- Press the [◀][▶] buttons or turn the [DIAL] dial to choose the effect, and then press the [INFO] button.

Auto	All effects
Retro	Images resemble old photos
Monochrome	Images are generated in one color
Special	Bold, distinctive-looking images
Natural	Subdued, natural-looking images

Before Use

Basic Guide

Advanced Guide

Camera Basics

Auto Mode /  
Hybrid Auto Mode

Other Shooting Modes

P Mode

Tv, Av, and M Mode

Playback Mode

Wi-Fi Functions

Setting Menu

Accessories

Appendix

Index

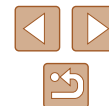

## Recording Movies with a Variety of Effects

Let the camera determine subjects and shooting conditions when you record movies, and filters and effects such as playback in slow or fast motion will be added automatically. Once you have recorded a few movies, up to four are automatically combined to create a Creative Shot movie of 15 – 25 seconds. Note that sound is not recorded in this mode.

### 1 Enter [MOVIE] mode.

- Set the mode dial to [MOVIE].

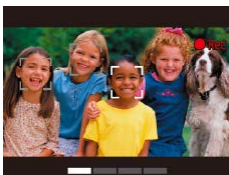

### 2 Record the first movie.

- Press the movie button. Recording begins, and a bar is displayed to indicate the elapsed time.
- Recording stops automatically in 3 – 6 seconds.

### 3 Record the second to fourth movies.

- Repeat step 2 three times to record four movies.



- Even if you do not record four movies that day, a Creative Shot movie will be saved as a separate file once the date changes.



- Effects are generally applied consistently to movies 1 – 4, but you can also change the effect in each movie (157).
- Individual chapters can be edited (107).

## Creative Shot Movie Playback

You can choose and play back Creative Shot movies recorded in [MOVIE] mode (89).

## Moving Subjects (Sports)

► Still Images ► Movies

Shoot continuously as the camera focuses on moving subjects.



### 1 Enter [MOVIE] mode.

- Set the mode dial to [MOVIE].



### 2 Focus.

- While you are pressing the shutter button halfway, the camera will continue to adjust focus and image brightness where the blue frame is displayed.

### 3 Shoot.

- Hold the shutter button all the way down to shoot continuously.



- In [MOVIE] mode, shots may look grainy because the ISO speed (72) is increased to suit the shooting conditions.
- For details on the shooting range in [MOVIE] mode, see “Shooting Range” (178).
- There may be a delay after continuous shooting before you can shoot again. Note that some types of memory cards may delay your next shot even longer.
- Shooting may slow down depending on shooting conditions, camera settings, and the zoom position.
- Even if you are shooting in [Auto] mode (40), continuous shooting is not supported.

Before Use

Basic Guide

Advanced Guide

Camera Basics

Auto Mode /  
Hybrid Auto Mode

Other Shooting Modes

P Mode

Tv, Av, and M Mode

Playback Mode

Wi-Fi Functions

Setting Menu

Accessories

Appendix

Index



## Specific Scenes

Choose a mode matching the shooting scene, and the camera will automatically configure the settings for optimal shots.



### 1 Enter [SCN] mode.

- Set the mode dial to [SCN].



### 2 Choose a shooting mode.

- Press the button, choose in the menu, and then choose a shooting mode (28).



### 3 Shoot.

#### Shooting Portraits (Portrait)

▶ Still Images ▶ Movies

- Take shots of people with a softening effect.

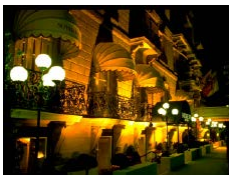

#### Shooting Evening Scenes without Using a Tripod (Handheld Night Scene)

▶ Still Images ▶ Movies

- Beautiful shots of evening scenes or portraits with evening scenery in the background, without the need to hold the camera very still (as with a tripod).
- A single image is created by combining consecutive shots, reducing camera shake and image noise.



#### Shooting under Low Light (Low Light)

▶ Still Images ▶ Movies

- Shoot with minimal camera and subject shake even in low-light conditions.



#### Shooting Fireworks (Fireworks)

▶ Still Images ▶ Movies

- Vivid shots of fireworks.



- Subjects appear larger in mode compared to other modes.
- In mode, shots may look grainy because the ISO speed (72) is increased to suit the shooting conditions.
- Because the camera will shoot continuously in mode, hold it steady while shooting.
- In mode, excessive motion blur or certain shooting conditions may prevent you from obtaining the desired results.
- In mode, mount the camera on a tripod or take other measures to keep it still and prevent camera shake. Additionally, you should set [IS Mode] to [Off] when using a tripod or other means to secure the camera (83).



- When you use a tripod for evening scenes, shooting in mode instead of mode will give better results (32).
- In mode, resolution is (2592 x 1944 pixel) and it cannot be changed.
- In mode, although no frames are displayed when you press the shutter button halfway, optimal focus is still determined.

Before Use

Basic Guide

Advanced Guide

Camera Basics

Auto Mode /  
Hybrid Auto Mode

Other Shooting Modes

P Mode

Tv, Av, and M Mode

Playback Mode

Wi-Fi Functions

Setting Menu

Accessories

Appendix

Index



## Applying Special Effects

Add a variety of effects to images when shooting.



### 1 Choose a shooting mode.

- Follow steps 1 – 2 in “Specific Scenes” (📖59) to choose a shooting mode.

### 2 Shoot.

#### 📷 Shooting in Vivid Colors (Super Vivid)

▶ Still Images ▶ Movies

- Shots in rich, vivid colors.



#### 📷 Posterized Shots (Poster Effect)

▶ Still Images ▶ Movies

- Shots that resemble an old poster or illustration.



- In [📷] and [📷] modes, try taking some test shots first, to make sure you obtain the desired results.

## Shooting with a Fish-Eye Lens Effect (Fish-Eye Effect)

▶ Still Images ▶ Movies

Shoot with the distorting effect of a fish-eye lens.

### 1 Choose [📷].

- Follow steps 1 – 2 in “Specific Scenes” (📖59) and choose [📷].

### 2 Choose an effect level.

- Press the [INFO] button, choose an effect level (either press the [◀][▶] buttons or turn the [📷] dial), and then press the [INFO] button again.
- A preview is shown of how your shot will look with the effect applied.

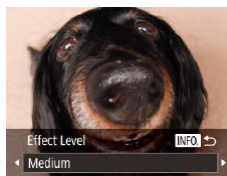

### 3 Shoot.



- Try taking some test shots first, to make sure you obtain the desired results.

Before Use

Basic Guide

Advanced Guide

Camera Basics

Auto Mode /  
Hybrid Auto Mode

Other Shooting Modes

P Mode

Tv, Av, and M Mode

Playback Mode

Wi-Fi Functions

Setting Menu

Accessories

Appendix

Index



## Shots Resembling Miniature Models (Miniature Effect)

► Still Images ► Movies

Creates the effect of a miniature model, by blurring image areas above and below your selected area.  
You can also make movies that look like scenes in miniature models by choosing the playback speed before the movie is recorded. People and objects in the scene will move quickly during playback. Note that sound is not recorded.

### 1 Choose [INFO].

- Follow steps 1 – 2 in “Specific Scenes” (p.59) and choose [INFO].
- A white frame is displayed, indicating the image area that will not be blurred.



### 2 Choose the area to keep in focus.

- Press the [INFO] button.
- Move the zoom lever to resize the frame, and press the [▲][▼] buttons to move it.



### 3 For movies, choose the movie playback speed.

- Press the [MENU] button, and then choose the speed by pressing the [◀][▶] buttons or turning the [DISP] dial.

### 4 Return to the shooting screen and shoot.

- Press the [MENU] button to return to the shooting screen, and then shoot.

## Playback Speed and Estimated Playback Time (for One-Minute Clips)

Speed	Playback Time
5x	Approx. 12 sec.
10x	Approx. 6 sec.
20x	Approx. 3 sec.

Movies are played back at 30 fps.



- The zoom is not available when shooting movies. Be sure to set the zoom before shooting.
- Try taking some test shots first, to make sure you obtain the desired results.



- To switch the orientation of the frame (from horizontal to vertical or vice-versa), press the [DISP] button in step 2. You can move the frame in vertical orientation by pressing the [◀][▶] buttons.
- Holding the camera vertically will change the orientation of the frame.
- Movie image quality is [HQ] at an aspect ratio of [4:3] and [HD] at an aspect ratio of [16:9] (p.49). These quality settings cannot be changed.
- The zoom factor cannot be changed with the [DISP] button while the screens in steps 2 and 3 are displayed, or while shooting movies.

Before Use

Basic Guide

Advanced Guide

Camera Basics

Auto Mode /  
Hybrid Auto Mode

Other Shooting Modes

P Mode

Tv, Av, and M Mode

Playback Mode

Wi-Fi Functions

Setting Menu

Accessories

Appendix

Index

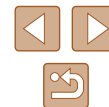

## Shooting with a Toy Camera Effect (Toy Camera Effect)

► Still Images ► Movies

This effect makes images resemble shots from a toy camera by vignetting (darker, blurred image corners) and changing the overall color.

### 1 Choose [📷].

- Follow steps 1 – 2 in “Specific Scenes” (📖59) and choose [📷].



### 2 Choose a color tone.

- Press the [INFO] button, choose a color tone (either press the [◀][▶] buttons or turn the [🌀] dial), and then press the [INFO] button again.
- A preview is shown of how your shot will look with the effect applied.

### 3 Shoot.

Standard	Shots resemble toy camera images.
Warm	Images have a warmer tone than with [Standard].
Cool	Images have a cooler tone than with [Standard].



- Try taking some test shots first, to make sure you obtain the desired results.

## Shooting with a Soft Focus Effect

► Still Images ► Movies

This function allows you to shoot images as if a soft focus filter were attached to the camera. You can adjust the effect level as desired.

### 1 Choose [👤].

- Follow steps 1 – 2 in “Specific Scenes” (📖59) and choose [👤].

### 2 Choose an effect level.

- Press the [INFO] button, choose an effect level (either press the [◀][▶] buttons or turn the [🌀] dial), and then press the [INFO] button again.
- A preview is shown of how your shot will look with the effect applied.



### 3 Shoot.



- Try taking some test shots first, to make sure you obtain the desired results.

Before Use

Basic Guide

Advanced Guide

Camera Basics

Auto Mode /  
Hybrid Auto Mode

Other Shooting Modes

P Mode

Tv, Av, and M Mode

Playback Mode

Wi-Fi Functions

Setting Menu

Accessories

Appendix

Index



## Shooting in Monochrome

► Still Images ► Movies

Shoot images in black and white, sepia, or blue and white.

### 1 Choose [MONO].

- Follow steps 1 – 2 in “Specific Scenes” (p.59) and choose [MONO].



### 2 Choose a color tone.

- Press the [INFO] button, choose a color tone (either press the [◀][▶] buttons or turn the [DISP] dial), and then press the [INFO] button again.
- A preview is shown of how your shot will look with the effect applied.

### 3 Shoot.

B/W	Black and white shots.
Sepia	Sepia tone shots.
Blue	Blue and white shots.

## Special Modes for Other Purposes

### Auto Shooting after Face Detection (Smart Shutter)

► Still Images ► Movies

### Auto Shooting after Smile Detection (Smile)

► Still Images ► Movies

The camera shoots automatically after detecting a smile, even without you pressing the shutter button.

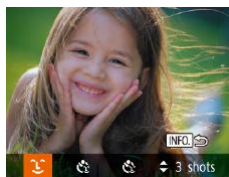

### 1 Choose [SMILE].

- Follow steps 1 – 2 in “Specific Scenes” (p.59) and choose [SMILE], and then press the [INFO] button.
- Press the [◀][▶] buttons or turn the [DISP] dial to choose [SMILE], and then press the [INFO] button.
- The camera now enters shooting standby mode, and [Smile Detection on] is displayed.

### 2 Aim the camera at a person.

- Each time the camera detects a smile, it will shoot after the lamp lights up.
- To pause smile detection, press the [▼] button. Press the [▼] button again to resume detection.



Before Use

Basic Guide

Advanced Guide

Camera Basics

Auto Mode /  
Hybrid Auto Mode

Other Shooting Modes

P Mode

Tv, Av, and M Mode

Playback Mode

Wi-Fi Functions

Setting Menu

Accessories

Appendix

Index







- Switch to another mode when you finish shooting, or the camera will continue shooting each time a smile is detected.



- You can also shoot as usual by pressing the shutter button.
- The camera can detect smiles more easily when subjects face the camera and open their mouth wide enough so that teeth are visible.
- To change the number of shots, press the [▲][▼] buttons after choosing [👤] in step 1.
- Automatic shooting is not available while you are holding down the [📷] button.

## Auto Shooting after Wink Detection (Wink Self-Timer)

► Still Images ► Movies

Aim the camera at a person and press the shutter button all the way down. The camera will shoot about two seconds after a wink is detected.

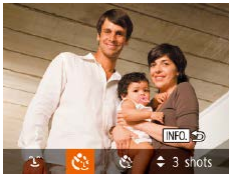

### 1 Choose [👤].

- Follow steps 1 – 2 in “Specific Scenes” (📖59) and choose [📷], and then press the [INFO] button.
- Press the [◀][▶] buttons or turn the [🌀] dial to choose [👤], and then press the [INFO] button.

### 2 Compose the shot and press the shutter button halfway.

- Make sure a green frame is displayed around the face of the person who will wink.



- If the wink is not detected, wink again slowly and deliberately.
- Winking may not be detected if eyes are obscured by hair, a hat, or glasses.
- Closing and opening both eyes at once will also be detected as a wink.
- If winking is not detected, the camera will shoot about 15 seconds later.
- To change the number of shots, press the [▲][▼] buttons after choosing [👤] in step 1.
- If no one is in the shooting area when the shutter button is pressed all the way down, the camera will shoot after a person enters the shooting area and winks.
- The zoom factor cannot be changed with the [📷] button after you press the shutter button all the way down.

### 3 Press the shutter button all the way down.

- The camera now enters shooting standby mode, and [Wink to take picture] is displayed.
- The lamp blinks and the self-timer sound is played.

### 4 Face the camera and wink.

- The camera will shoot about two seconds after detecting a wink by the person whose face is inside the frame.
- To cancel shooting after you have triggered the self-timer, press the [MENU] button.

Before Use

Basic Guide

Advanced Guide

Camera Basics

Auto Mode / Hybrid Auto Mode

Other Shooting Modes

P Mode

Tv, Av, and M Mode

Playback Mode

Wi-Fi Functions

Setting Menu

Accessories

Appendix

Index





## Auto Shooting after Detecting New Person (Face Self-Timer)

► Still Images ► Movies

The camera will shoot about two seconds after detecting that the face of another person (such as the photographer) has entered the shooting area (77). This is useful when including yourself in group photos or similar shots.



### 1 Choose [INFO].

- Follow steps 1 – 2 in “Specific Scenes” (59) and choose [INFO], and then press the [INFO] button.
- Press the [◀][▶] buttons or turn the [DISP.] dial to choose [INFO], and then press the [INFO] button.

### 2 Compose the shot and press the shutter button halfway.

- Make sure a green frame is displayed around the face you focus on and white frames around other faces.

### 3 Press the shutter button all the way down.

- The camera now enters shooting standby mode, and [Look straight at camera to start count down] is displayed.
- The lamp blinks and the self-timer sound is played.



### 4 Join the subjects in the shooting area and look at the camera.

- After the camera detects a new face, the lamp blinking and self-timer sound will speed up. (When the flash fires, the lamp will remain lit.) About two seconds later, the camera will shoot.
- To cancel shooting after you have triggered the self-timer, press the [MENU] button.



- Even if your face is not detected after you join the others in the shooting area, the camera will shoot about 15 seconds later.
- To change the number of shots, press the [▲][▼] buttons after choosing [INFO] in step 1.
- The zoom factor cannot be changed with the [ZOOM] button after you press the shutter button all the way down.

Before Use
Basic Guide
Advanced Guide
Camera Basics
Auto Mode / Hybrid Auto Mode
Other Shooting Modes
P Mode
Tv, Av, and M Mode
Playback Mode
Wi-Fi Functions
Setting Menu
Accessories
Appendix
Index

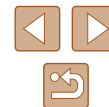

## Recording Various Movies

▶ Still Images ▶ Movies

### Recording Movies in Standard Mode

▶ Still Images ▶ Movies



#### 1 Enter [MOVIE] mode.

- Set the mode dial to [MOVIE].
- Press the [MENU] button, choose [MOVIE] in the menu, and then choose [MOVIE] (book 28).
- Black bars are displayed on the top and bottom edges of the screen, and the subject is slightly enlarged. The black bars indicate image areas not recorded.

#### 2 Configure the settings to suit the movie (book 168).

#### 3 Shoot.

- Press the movie button.
- To stop movie recording, press the movie button again.

### Recording Movies with Smoother Motion

Record movies with smoother motion, at nearly double the frame rate, as follows.



- Follow steps in “Changing Movie Image Quality” (book 50) and choose [FHD 60P].

### Locking or Changing Image Brightness before Recording

▶ Still Images ▶ Movies

You can lock the exposure before or during recording or adjust it in 1/3-stop increments within a range of -2 to +2 stops.



#### 1 Lock the exposure.

- Press the [▲] button to lock the exposure. The exposure shift bar is displayed.
- To unlock the exposure, press the [▲] button again.

#### 2 Adjust the exposure.

- Turn the [DISP.] dial to adjust the exposure, as you watch the screen.

#### 3 Shoot (book 66).

Before Use
Basic Guide
Advanced Guide
Camera Basics
Auto Mode / Hybrid Auto Mode
Other Shooting Modes
P Mode
Tv, Av, and M Mode
Playback Mode
Wi-Fi Functions
Setting Menu
Accessories
Appendix
Index



## Disabling Auto Slow Shutter

▶ Still Images ▶ Movies

Auto slow shutter can be disabled if movement in movies is rough. However, under low light, movies may look dark.



- Press the [MENU] button, choose [Auto slow shutter] on the [CAMERA] tab, and then choose [Disable] (📖29).
- To restore the original setting, repeat this process but choose [Enable].

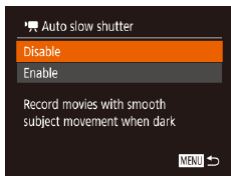

- Auto slow shutter is only available for [4K 60P] movies.

## Correcting Severe Camera Shake

▶ Still Images ▶ Movies

Counteract severe camera shake, such as when recording while moving. The portion of images displayed changes more than for [Standard], and subjects are further enlarged.

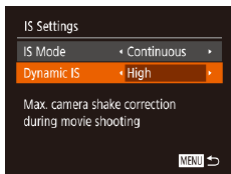

- Follow the steps in “Recording Movies with Subjects at the Same Size Shown before Recording” (📖53) to choose [High].

- [Dynamic IS] is not available when [IS Mode] is set to [Off] (📖52).
- When the movie quality is [4K 30P], it is set to [Standard] and cannot be changed.

## Sound Settings

▶ Still Images ▶ Movies

### Deactivating the Wind Filter

Noise caused by strong wind can be reduced. However, the recording may sound unnatural when this option is used when there is no wind. In this case, you can deactivate the wind filter.



- Press the [MENU] button, choose [Wind Filter] on the [CAMERA] tab, and then choose [Off] (📖29).

### Using the Attenuator

The attenuator can reduce audio distortion in noisy environments. However, in quiet environments, it lowers the sound-recording level.



- Press the [MENU] button, choose [Attenuator] on the [CAMERA] tab, and then choose the desired option (📖29).

Before Use

Basic Guide

Advanced Guide

Camera Basics

Auto Mode /  
Hybrid Auto Mode

Other Shooting Modes

P Mode

Tv, Av, and M Mode

Playback Mode

Wi-Fi Functions

Setting Menu

Accessories

Appendix

Index

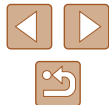

## Recording Movies in Short Clip Mode

▶ Still Images ▶ Movies

Apply playback effects to brief clips of a few seconds, such as fast motion, slow motion, or replay. Clips recorded in this mode may be included in Story Highlights albums (📖108).

### 1 Enter [📷] mode.

- Set the mode dial to [📷].
- Press the [ⓘ] button, choose [📷] in the menu, and then choose [📷] (📖28).
- Black bars are displayed on the top and bottom edges of the screen. They indicate that this image area cannot be recorded.



### 2 Specify the shooting time and playback effect.

- Press the [INFO] button.
- Turn the [🔘] dial to set the shooting time (4 – 6 sec.), and press the [⏪] [⏩] buttons to set the following playback effects.

### 3 Shoot (📖66).

- A bar showing the elapsed time is displayed.

## Playback Effects

	Playback in fast motion
	Playback at normal speed
	Playback in slow motion
	Normal playback with the last two seconds fast-rewound and played again in slow motion



- Sound is not recorded in these clips.
- The movie quality is [HD 60P] (📖50) and cannot be changed.

Before Use

Basic Guide

Advanced Guide

Camera Basics

Auto Mode /  
Hybrid Auto Mode

Other Shooting Modes

P Mode

Tv, Av, and M Mode

Playback Mode

Wi-Fi Functions

Setting Menu

Accessories

Appendix

Index

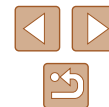

## Recording iFrame Movies

► Still Images ► Movies

Record movies that can be edited with iFrame-compatible software or devices.

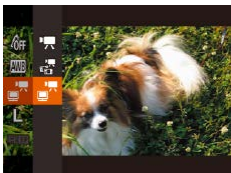

### 1 Choose [📹].

- Set the mode dial to [📹].
- Press the [ⓘ] button, choose [📹] in the menu, and then choose [📹] (📖28).
- Black bars are displayed on the top and bottom edges of the screen. They indicate that this image area cannot be recorded.

### 2 Shoot (📖66).



- iFrame is a video format developed by Apple Inc.
- The movie quality is [FHD 60P] (📖50) and cannot be changed.

Before Use

Basic Guide

Advanced Guide

Camera Basics

Auto Mode /  
Hybrid Auto Mode

Other Shooting Modes

P Mode

Tv, Av, and M Mode

Playback Mode

Wi-Fi Functions

Setting Menu

Accessories

Appendix

Index

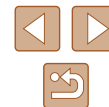

# P Mode

More discerning shots, in your preferred shooting style



- Instructions in this chapter apply to the camera with the mode dial set to **[P]** mode.
- **[P]**: Program AE; AE: Auto Exposure
- Before using a function introduced in this chapter in modes other than **[P]**, make sure the function is available in that mode (📖168).

## Shooting in Program AE ([P] Mode)

▶ Still Images ▶ Movies

You can customize many function settings to suit your preferred shooting style.



### 1 Enter [P] mode.

- Set the mode dial to **[P]**.

### 2 Customize the settings as desired (📖71 – 📖83), and then shoot.



- If the optimum exposure cannot be obtained when you press the shutter button halfway, the shutter speed and aperture value are displayed in orange. In this case, try adjusting the ISO speed (📖72) or activating the flash (if subjects are dark, 📖81), which may enable optimum exposure.
- Movies can be recorded in **[P]** mode as well, by pressing the movie button. However, some FUNC. (📖28) and MENU (📖29) settings may be automatically adjusted for movie recording.

Before Use

Basic Guide

Advanced Guide

Camera Basics

Auto Mode /  
Hybrid Auto Mode

Other Shooting Modes

P Mode

Tv, Av, and M Mode

Playback Mode

Wi-Fi Functions

Setting Menu

Accessories

Appendix

Index

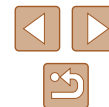

## Image Brightness (Exposure)

### Adjusting Image Brightness (Exposure Compensation)

► Still Images ► Movies

The standard exposure set by the camera can be adjusted in 1/3-stop increments, in a range of -2 to +2.



- Press the [▲] button. As you watch the screen, turn the [DIAL] dial to adjust brightness, and then press the [▲] button again when finished.
- The correction level you specified is now displayed.

### Locking Image Brightness / Exposure (AE Lock)

► Still Images ► Movies

Before shooting, you can lock the exposure, or you can specify focus and exposure separately.



#### 1 Lock the exposure.

- Aim the camera at the subject to shoot with the exposure locked. With the shutter button pressed halfway, press the [▲] button.
- [AE-L] is displayed, and the exposure is locked.
- To unlock AE, release the shutter button and press the [▲] button again. In this case, [AE-L] is no longer displayed.

#### 2 Compose the shot and shoot.

- After one shot, AE is unlocked and [AE-L] is no longer displayed.



- AE: Auto Exposure
- After the exposure is locked, you can adjust the combination of shutter speed and aperture value by turning the [DIAL] dial (Program Shift).

### Changing the Metering Method

► Still Images ► Movies

Adjust the metering method (how brightness is measured) to suit shooting conditions as follows.



- Press the [MENU] button, choose [METERING] in the menu, and choose the desired option (see 28).
- The option you configured is now displayed.

Evaluative	For typical shooting conditions, including backlit shots. Automatically adjusts exposure to match the shooting conditions.
Center Weighted Avg.	Determines the average brightness of light across the entire image area, calculated by treating brightness in the central area as more important.
Spot	Metering restricted to within the [ ] (Spot AE Point frame), displayed in the center of the screen.

Before Use

Basic Guide

Advanced Guide

Camera Basics

Auto Mode / Hybrid Auto Mode

Other Shooting Modes

P Mode

Tv, Av, and M Mode

Playback Mode

Wi-Fi Functions

Setting Menu

Accessories

Appendix

Index

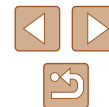

## Changing the ISO Speed

► Still Images ► Movies

Set the ISO speed to [AUTO] for automatic adjustment to suit the shooting mode and conditions. Otherwise, set a higher value for higher sensitivity, or a lower value for lower sensitivity.

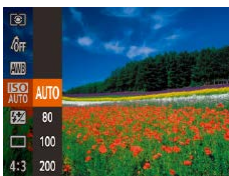

- Press the **[ISO]** button, choose **[ISO]** in the menu, and choose the desired option (128).
- The option you configured is now displayed.



- To view the automatically determined ISO speed when you have set the ISO speed to [AUTO], press the shutter button halfway.
- Although choosing a lower ISO speed may reduce image graininess, there may be a greater risk of subject and camera shake in some shooting conditions.
- Choosing a higher ISO speed will increase shutter speed, which may reduce subject and camera shake and increase the flash range. However, shots may look grainy.

## Correcting Image Brightness (i-Contrast)

► Still Images ► Movies

Before shooting, excessively bright or dark image areas (such as faces or backgrounds) can be detected and automatically adjusted to the optimal brightness. Insufficient overall image contrast can also be automatically corrected before shooting to make subjects stand out better.



- Press the **[MENU]** button, choose **[i-Contrast]** on the **[CAMERA]** tab, and then choose **[Auto]** (129).
- Once the setting is complete, **[Ci]** is displayed.



- Under some shooting conditions, correction may be inaccurate or may cause images to appear grainy.



- You can also correct existing images (104).

Before Use

Basic Guide

Advanced Guide

Camera Basics

Auto Mode /  
Hybrid Auto Mode

Other Shooting Modes

P Mode

Tv, Av, and M Mode

Playback Mode

Wi-Fi Functions

Setting Menu

Accessories

Appendix

Index





# Image Colors





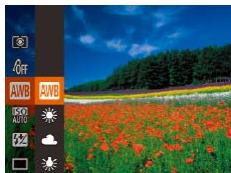

## Capturing Natural Colors (White Balance)

▶ Still Images ▶ Movies

By adjusting white balance (WB), you can make image colors look more natural for the scene you are shooting.



- Press the **[WB]** button, choose **[AWB]** in the menu, and choose the desired option (📖28).
- The option you configured is now displayed.

 Auto	Automatically sets the optimal white balance for the shooting conditions.
 Day Light	For shooting outdoors in fair weather.
 Cloudy	For shooting in cloudy weather or at twilight.
 Tungsten	For shooting under ordinary incandescent lighting.
 Fluorescent	For shooting under white fluorescent lighting.
 Fluorescent H	For shooting under daylight fluorescent lighting.
 Custom	For manually setting a custom white balance (📖73).

## Custom White Balance

▶ Still Images ▶ Movies

For image colors that look natural under the light in your shot, adjust white balance to suit the light source where you are shooting. Set the white balance under the same light source that will illuminate your shot.



- Follow the steps in “Capturing Natural Colors (White Balance)” (📖73) to choose **[WB]**.
- Aim the camera at a plain white subject, so that the entire screen is white. Press the **[INFO]** button.
- The tint of the screen changes once the white balance data has been recorded.



- Colors may look unnatural if you change camera settings after recording white balance data.

Before Use

Basic Guide

Advanced Guide

Camera Basics

Auto Mode /  
Hybrid Auto Mode

Other Shooting Modes

P Mode

Tv, Av, and M Mode

Playback Mode

Wi-Fi Functions

Setting Menu

Accessories

Appendix

Index

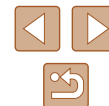

## Changing Image Color Tones (My Colors)

► Still Images ► Movies

Change image color tones as desired, such as converting images to sepia or black and white.

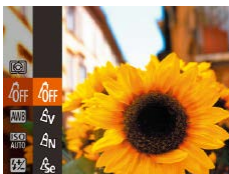

- Press the button, choose in the menu, and choose the desired option (28).
- The option you configured is now displayed.

My Colors Off	–
Vivid	Emphasizes contrast and color saturation, making images sharper.
Neutral	Tones down contrast and color saturation for subdued images.
Sepia	Creates sepia tone images.
B/W	Creates black and white images.
Positive Film	Combines the effects of Vivid Blue, Vivid Green, and Vivid Red to produce intense yet natural-looking colors resembling images on positive film.
Lighter Skin Tone	Lightens skin tones.
Darker Skin Tone	Darkens skin tones.
Vivid Blue	Emphasizes blues in images. Makes the sky, ocean, and other blue subjects more vivid.
Vivid Green	Emphasizes greens in images. Makes mountains, foliage, and other green subjects more vivid.
Vivid Red	Emphasizes reds in images. Makes red subjects more vivid.
Custom Color	Adjust contrast, sharpness, color saturation, and other qualities as desired (74).



- White balance (73) cannot be set in or modes.
- With and modes, colors other than people's skin tone may change. These settings may not produce the expected results with some skin tones.

## Custom Color

► Still Images ► Movies

Choose the desired level of image contrast, sharpness, color saturation, red, green, blue, and skin tones in a range of 1 – 5.

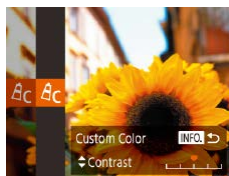

### 1 Access the setting screen.

- Follow the steps in “Changing Image Color Tones (My Colors)” (74) to choose , and then press the button.

### 2 Configure the setting.

- Press the buttons to choose an item, and then specify the value by pressing the buttons or turning the dial.
- For stronger/more intense effects (or darker skin tones), adjust the value to the right, and for weaker/lighter effects (or lighter skin tones), adjust the value to the left.
- Press the button to complete the setting.

Before Use

Basic Guide

Advanced Guide

Camera Basics

Auto Mode /  
Hybrid Auto Mode

Other Shooting Modes

P Mode

Tv, Av, and M Mode

Playback Mode

Wi-Fi Functions

Setting Menu

Accessories

Appendix

Index



## Shooting Range and Focusing

### Shooting Close-Ups (Macro)

► Still Images ► Movies

To restrict the focus to subjects at close range, set the camera to [M]. For details on the range of focus, see “Shooting Range” (178).

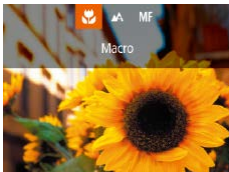

- Press the [L/R] button, choose [M] (either press the [L/R] buttons or turn the [D] dial), and then press the [OK] button.
- Once the setting is complete, [M] is displayed.



- If the flash fires, vignetting may occur.
- When the zoom position is within the range of the yellow bar below the zoom bar, [M] turns gray and the camera cannot focus.



- To prevent camera shake, try mounting the camera on a tripod and shooting with the camera set to [C] (42).

## Shooting in Manual Focus Mode

► Still Images ► Movies

When focusing is not possible in AF mode, use manual focus. You can specify the general focal position and then press the shutter button halfway to have the camera determine the optimal focal position near the position you specified. For details on the range of focus, see “Shooting Range” (178).

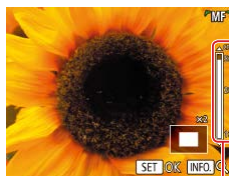
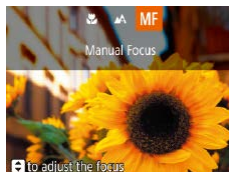

(1)

### 1 Choose [MF].

- Press the [L/R] button, choose [MF] (either press the [L/R] buttons or turn the [D] dial), and then press the [OK] button.
- [MF] and the MF indicator are displayed.

### 2 Specify the general focal position.

- Referring to the on-screen MF indicator (1), which shows the distance and focal position, and the magnified display, press the [▲][▼] buttons or turn the [D] dial to specify the general focal position, and then press the [OK] button.
- To adjust the magnification, press the [INFO] button.

### 3 Fine-tune the focus.

- Press the shutter button halfway to have the camera fine-tune the focal position (Safety MF).

Before Use

Basic Guide

Advanced Guide

Camera Basics

Auto Mode /  
Hybrid Auto Mode

Other Shooting Modes

P Mode

Tv, Av, and M Mode

Playback Mode

Wi-Fi Functions

Setting Menu

Accessories

Appendix

Index





- When you focus manually, the AF frame mode (📖77) is locked to [Center] and AF frame size (📖77) is locked to [Normal].
- Focusing is possible when using the digital zoom (📖38) or digital tele-converter (📖77), or when using a TV as a display (📖148), but the magnified display will not appear.



- To focus more accurately, try attaching the camera to a tripod to stabilize it.
- You can enlarge or hide the magnified display area by adjusting MENU (📖29) > [📷] tab > [MF-Point Zoom] settings.
- To deactivate automatic focus fine-tuning when the shutter button is pressed halfway, choose MENU (📖29) > [📷] tab > [Safety MF] > [Off].

## 📌 Easily Identifying the Focus Area (MF Peaking)

▶ Still Images ▶ Movies

Edges of subjects in focus are displayed in color to make manual focusing easier. You can adjust the colors and the sensitivity (level) of edge detection as needed.



### 1 Access the setting screen.

- Press the [MENU] button, choose [MF Peaking Settings] on the [📷] tab, and then choose [On] (📖29).

### 2 Configure the setting.

- Choose a menu item to configure, and then choose the desired option (📖29).



- Colors displayed for MF peaking are not recorded in your shots.

Before Use

Basic Guide

Advanced Guide

Camera Basics

Auto Mode /  
Hybrid Auto Mode

Other Shooting Modes

P Mode

Tv, Av, and M Mode

Playback Mode

Wi-Fi Functions

Setting Menu

Accessories

Appendix

Index



## Digital Tele-Converter

▶ Still Images ▶ Movies

The focal length of the lens can be increased by approximately 1.6x or 2.0x. This can reduce camera shake because the shutter speed is faster than it would be if you zoomed (including using digital zoom) in to the same zoom factor.

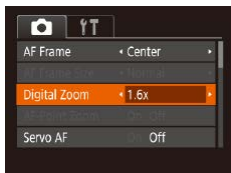

- Press the [MENU] button, choose [Digital Zoom] on the [CAMERA] tab, and then choose the desired option (📖29).
- The view is enlarged and the zoom factor is displayed on the screen.



- The shutter speed may be equivalent when you move the zoom lever all the way toward [T] for maximum telephoto, and when you zoom in to enlarge the subject to the same size following step 2 in "Zooming In Closer on Subjects (Digital Zoom)" (📖38).

## Changing the AF Frame Mode

▶ Still Images ▶ Movies

Change the AF (auto focus) frame mode to suit the shooting conditions as follows.

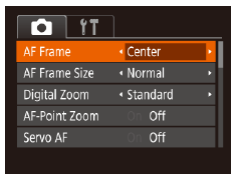

- Press the [MENU] button, choose [AF Frame] on the [CAMERA] tab, and then choose the desired option (📖29).

## Center

▶ Still Images ▶ Movies

One AF frame is displayed in the center. Effective for reliable focusing.



- A yellow AF frame is displayed with [AF-LOCK] if the camera cannot focus when you press the shutter button halfway.



- To reduce the AF frame size, press the [MENU] button and set [AF Frame Size] on the [CAMERA] tab to [Small] (📖29).
- The AF frame size is set to [Normal] when you use the digital zoom (📖38) or digital tele-converter (📖77), and in manual focus mode (📖75).
- To compose shots so that subjects are positioned at the edge or in a corner, first aim the camera to capture the subject in an AF frame, and then hold the shutter button halfway down. As you continue to hold the shutter button halfway, recompose the shot as desired, and then press the shutter button all the way down (Focus Lock).
- The AF frame position is enlarged when you press the shutter button halfway with [AF-Point Zoom] (📖51) set to [On].

## Face AiAF

▶ Still Images ▶ Movies

- Detects people's faces, and then sets the focus, exposure (evaluative metering only), and white balance ([AWB] only).
- After you aim the camera at the subject, a white frame is displayed around the person's face determined by the camera to be the main subject, and up to two gray frames are displayed around other detected faces.
- When the camera detects movement, frames will follow moving subjects, within a certain range.
- After you press the shutter button halfway, up to nine green frames are displayed around faces in focus.

Before Use

Basic Guide

Advanced Guide

Camera Basics

Auto Mode /  
Hybrid Auto Mode

Other Shooting Modes

P Mode

Tv, Av, and M Mode

Playback Mode

Wi-Fi Functions

Setting Menu

Accessories

Appendix

Index





- If faces are not detected, or when only gray frames are displayed (without a white frame), up to nine green frames are displayed in the areas in focus when you press the shutter button halfway.
- If faces are not detected when Servo AF (📖79) is set to [On], the AF frame is displayed in the center of the screen when you press the shutter button halfway.
- Examples of faces that cannot be detected:
  - Subjects that are distant or extremely close
  - Subjects that are dark or light
  - Faces in profile, at an angle, or partly hidden
- The camera may misinterpret non-human subjects as faces.
- No AF frames are displayed if the camera cannot focus when you press the shutter button halfway.



- When the subject is detected, the camera beeps and [📷] is displayed. Even if the subject moves, the camera will continue to track the subject within a certain range.
- If no subject is detected, [📷] is displayed.
- To cancel tracking, press the [◀] button again.

### 3 Shoot.

- Press the shutter button halfway. [📷] changes to a blue [📷], which follows the subject as the camera continues to adjust the focus and exposure (Servo AF) (📖79).
- Press the shutter button all the way down to shoot.
- Even after your shot, [📷] is still displayed and the camera continues to track the subject.

## Choosing Subjects to Focus On (Tracking AF)

▶ Still Images ▶ Movies

Shoot after choosing a subject to focus on as follows.

### 1 Choose [Tracking AF].

- Follow the steps in “Changing the AF Frame Mode” (📖77) to choose [Tracking AF].
- [📷] is displayed in the center of the screen.



### 2 Choose a subject to focus on.

- Aim the camera so that [📷] is on the desired subject, and then press the [▶] button.



- [Servo AF] (📖79) is set to [On] and cannot be changed.
- Tracking may not be possible when subjects are too small or move too rapidly, or when subject color or brightness matches that of the background too closely.
- [AF-Point Zoom] on the [📷] tab of MENU (📖29) is not available.
- [📷] is not available.



- The camera can detect subjects even if you press the shutter button halfway without pressing the [▶] button. After your shot, [📷] is displayed in the center of the screen.
- When shooting in [MF] mode (📖75), press and hold the [▶] button for at least one second.
- If [Face ID] is set to [On], names will not display when registered people are detected, but the names will be recorded in the still images (📖44). However, the name is displayed when a registered person is selected as a subject.

Before Use
Basic Guide
Advanced Guide
Camera Basics
Auto Mode / Hybrid Auto Mode
Other Shooting Modes
P Mode
Tv, Av, and M Mode
Playback Mode
Wi-Fi Functions
Setting Menu
Accessories
Appendix
Index

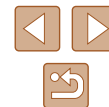

## Shooting with Servo AF

► Still Images ► Movies

This mode helps avoid missing shots of subjects in motion, because the camera continues to focus on the subject and adjust the exposure as long as you press the shutter button halfway.



### 1 Configure the setting.

- Press the [MENU] button, choose [Servo AF] on the [CAMERA] tab, and then choose [On] (📖29).

### 2 Focus.

- The focus and exposure are maintained where the blue AF frame is displayed while you are pressing the shutter button halfway.



- Focusing may not be possible in some shooting conditions.
- In low-light conditions, Servo AF may not be activated (AF frames may not turn blue) when you press the shutter button halfway. In this case, the focus and exposure are set according to the specified AF frame mode.
- If adequate exposure cannot be obtained, the shutter speed and aperture value are displayed in orange. Release the shutter button, and then press it halfway again.
- AF lock shooting is not available.
- [AF-Point Zoom] on the [CAMERA] tab (📖29) is not available.
- Not available when using the self-timer (📖42).

## Changing the Focus Setting

► Still Images ► Movies

You can change default camera operation of constantly focusing on subjects it is aimed at, even when the shutter button is not pressed. Instead, you can limit camera focusing to the moment you press the shutter button halfway.



- Press the [MENU] button, choose [Continuous AF] on the [CAMERA] tab, and then choose [Off] (📖29).

On	Helps avoid missing sudden photo opportunities, because the camera constantly focuses on subjects until you press the shutter button halfway.
Off	Conserves battery power, because the camera does not focus constantly.

Before Use
Basic Guide
Advanced Guide
Camera Basics
Auto Mode / Hybrid Auto Mode
Other Shooting Modes
P Mode
Tv, Av, and M Mode
Playback Mode
Wi-Fi Functions
Setting Menu
Accessories
Appendix
Index

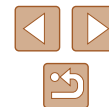

## Shooting with the AF Lock

► Still Images ► Movies

The focus can be locked. After you lock the focus, the focal position will not change even when you release your finger from the shutter button.

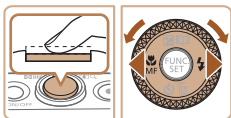

### 1 Lock the focus.

- With the shutter button pressed halfway, press the [L] button.
- The focus is now locked, and [MF] and the MF indicator are displayed.
- To unlock the focus, after you release the shutter button, press the [L] button again and choose [A] (either press the [L][R] buttons or turn the [DIAL] dial).

### 2 Compose the shot and shoot.

## Shooting Continuously as the Camera Keeps the Subject in Focus

► Still Images ► Movies

Shoot continuously as the camera keeps the subject in focus. For details on the continuous shooting speed, see “Camera” (177).

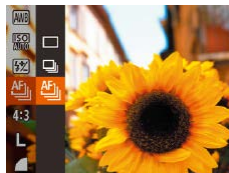

### 1 Configure the setting.

- Press the [MENU] button, choose [ ] in the menu, and then choose [ ] (28).
- Once the setting is complete, [ ] is displayed.

### 2 Shoot.

- Hold the shutter button all the way down to shoot continuously.
- The images are managed together as a group (92).



- In [ ] mode (59), manual focus mode (75), or when AF is locked (80), [ ] is changed to [ ].
- Cannot be used with the self-timer (42).
- Shooting may stop momentarily or continuous shooting may slow down depending on shooting conditions, camera settings, and the zoom position.
- As more shots are taken, shooting may slow down.
- Shooting may slow down if the flash fires.
- Continuous shooting is not available in [ ] Auto mode (40), even if you choose [ ].

Before Use

Basic Guide

Advanced Guide

Camera Basics

Auto Mode /  
Hybrid Auto Mode

Other Shooting Modes

P Mode

Tv, Av, and M Mode

Playback Mode

Wi-Fi Functions

Setting Menu

Accessories

Appendix

Index

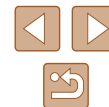



# Flash

## Changing the Flash Mode

► Still Images ► Movies

You can change the flash mode to match the shooting scene. For details on the flash range, see “Camera” (📖177).

### 1 Raise the flash.

- Move the [🔆] switch.

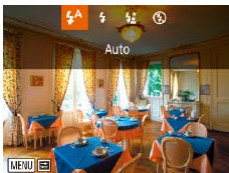

### 2 Configure the setting.

- Press the [▶] button, choose a flash mode (either press the [◀][▶] buttons or turn the [🔆] dial), and then press the [⊞] button.
- The option you configured is now displayed.



- The setting screen cannot be accessed by pressing the [▶] button when the flash is lowered. Move the [🔆] switch to raise the flash, then configure the setting.

## Auto

Fires automatically in low-light conditions.

## On

Fires for each shot.

## Slow Synchro

Fires to illuminate the main subject (such as people) while shooting at a slower shutter speed to illuminate backgrounds out of flash range.



- In [🔆] mode, mount the camera on a tripod or take other measures to keep it still and prevent camera shake. Additionally, you should set [IS Mode] to [Off] when using a tripod or other means to secure the camera (📖83).
- In [🔆] mode, even after the flash fires, ensure that the main subject does not move until the shutter sound is finished playing.

## Off

For shooting without the flash.



- A blinking [🔆] icon may be displayed when you press the shutter button halfway in camera-shake inducing, low-light conditions. In this case, mount the camera on a tripod or take other measures to keep it still.

Before Use

Basic Guide

Advanced Guide

Camera Basics

Auto Mode /  
Hybrid Auto Mode

Other Shooting Modes

P Mode

Tv, Av, and M Mode

Playback Mode

Wi-Fi Functions

Setting Menu

Accessories

Appendix

Index



## Adjusting the Flash Exposure Compensation

► Still Images ► Movies

Just as with regular exposure compensation (81), you can adjust the flash exposure from -2 to +2 stops, in 1/3-stop increments.



- Press the [Fn] button, choose [Fn] in the menu, and adjust the setting by either pressing the [▲][▼] buttons or turning the [DIAL] dial (28).
- The correction level you specified is now displayed.



- When there is a risk of overexposure, the camera automatically adjusts the shutter speed or aperture value for flash shots to reduce washed-out highlights and shoot at optimal exposure. However, you can deactivate automatic adjustment of the shutter speed and aperture value by accessing MENU (29) and choosing [Camera] tab > [Flash Settings] > [Safety FE] > [Off].
- You can also configure the flash exposure compensation by accessing MENU (29) and choosing [Camera] tab > [Flash Settings] > [Flash Exp. Comp].
- You can also access the [Flash Settings] screen (29) when the flash is up by pressing the [Flash] button and immediately pressing the [MENU] button.

## Shooting with the FE Lock

► Still Images ► Movies

Just as with the AE lock (81), you can lock the exposure for flash shots.



### 1 Raise the flash and set it to [Flash]

### 2 Lock the flash exposure.

- Aim the camera at the subject to shoot with the exposure locked. With the shutter button pressed halfway, press the [Flash] button.
- The flash fires, and when [Flash] is displayed, the flash output level is retained.
- To unlock FE, release the shutter button and press the [Flash] button again. In this case, [Flash] is no longer displayed.

### 3 Compose the shot and shoot.

- After one shot, FE is unlocked and [Flash] is no longer displayed.



- FE: Flash Exposure

Before Use

Basic Guide

Advanced Guide

Camera Basics

Auto Mode /  
Hybrid Auto Mode

Other Shooting Modes

P Mode

Tv, Av, and M Mode

Playback Mode

Wi-Fi Functions

Setting Menu

Accessories

Appendix

Index



## Other Settings

### Changing the Compression Ratio (Image Quality)

► Still Images ► Movies

You can choose from two compression ratios. These are [S] (Super Fine) and [L] (Fine). For guidelines on how many shots at each compression ratio can fit on a memory card, see “Number of Shots per Memory Card” (179).



- Press the [Q] button, choose [L] in the menu, and choose the desired option (28).

### Changing the IS Mode Settings

► Still Images ► Movies

You can keep image stabilization off until the moment you shoot.

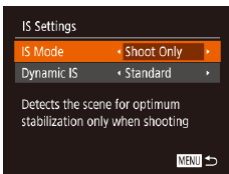

- Choose [Shoot Only] by following steps 1 – 2 in “Deactivating Image Stabilization” (52).



- If image stabilization cannot prevent camera shake, mount the camera on a tripod or take other measures to hold it still. In this case, set [IS Mode] to [Off].
- The setting is changed to [Continuous] for movie recording.

Before Use

Basic Guide

Advanced Guide

Camera Basics

Auto Mode /  
Hybrid Auto Mode

Other Shooting Modes

P Mode

Tv, Av, and M Mode

Playback Mode

Wi-Fi Functions

Setting Menu

Accessories

Appendix

Index



## Tv, Av, and M mode

Take smarter, more sophisticated shots, and customize the camera for your shooting style

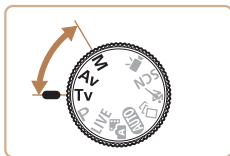

- Instructions in this chapter apply to the camera as set to the respective mode.

## Specific Shutter Speeds ([Tv] Mode)

► Still Images ► Movies

Set your preferred shutter speed before shooting as follows. The camera automatically adjusts the aperture value to suit your shutter speed. For details on available shutter speeds, see “Camera” (177).

### 1 Enter [Tv] mode.

- Set the mode dial to [Tv].

### 2 Set the shutter speed.

- Turn the [S] dial to set the shutter speed.



- In conditions requiring slower shutter speeds, there may be a delay before you can shoot again, as the camera processes images to reduce noise.
- When shooting at low shutter speeds on a tripod, you should set [IS Mode] to [Off] (83).
- Maximum shutter speed with the flash is 1/2000 second. If you specify a faster speed, the camera will automatically reset the speed to 1/2000 second before shooting.
- With shutter speed of 1.3 seconds or slower, ISO speed is fixed at [80].
- Orange display of the aperture value when you press the shutter button halfway indicates that the optimum exposure has not been obtained. Adjust the shutter speed until the aperture value is displayed in white, or use safety shift (85).



- [Tv]: Time value

Before Use

Basic Guide

Advanced Guide

Camera Basics

Auto Mode /  
Hybrid Auto Mode

Other Shooting Modes

P Mode

Tv, Av, and M Mode

Playback Mode

Wi-Fi Functions

Setting Menu

Accessories

Appendix

Index



## Specific Aperture Values ([Av] Mode)

► Still Images ► Movies

Set your preferred aperture value before shooting as follows. The camera automatically adjusts the shutter speed to suit your aperture value. For details on available aperture values, see “Camera” (177).

### 1 Enter [Av] mode.

- Set the mode dial to [Av].



### 2 Set the aperture value.

- Turn the [Q] dial to set the aperture value.



- Orange display of the shutter speed when you press the shutter button halfway indicates that the optimum exposure has not been obtained. Adjust the aperture value until the shutter speed is displayed in white, or use safety shift (see below).



- [Av]: Aperture value (size of the opening made by the diaphragm in the lens)
- In [Tv] and [Av] modes, press the [MENU] button and set [Safety Shift] on the [CAMERA] tab to [On] (29) to have the camera automatically adjust the shutter speed and aperture value when there are exposure problems, so that you can shoot at the optimum exposure. However, safety shift is disabled when the flash fires.

## Specific Shutter Speeds and Aperture Values ([M] Mode)

► Still Images ► Movies

Follow these steps before shooting to set your preferred shutter speed and aperture value to obtain the desired exposure. For details on available shutter speeds and aperture values, see “Camera” (177).

### 1 Enter [M] mode.

- Set the mode dial to [M].



- (1)
- (2)
- (3)
- (4)



### 2 Configure the setting.

- Press the [▲] button to choose shutter speed (1) or aperture value (2), and turn the [Q] dial to specify a value.
- An exposure level mark (4) based on your specified value is shown on the exposure level indicator for comparison to the standard exposure level (3).
- The exposure level mark is shown in orange when the difference from standard exposure exceeds 2 stops.

Before Use

Basic Guide

Advanced Guide

Camera Basics

Auto Mode / Hybrid Auto Mode

Other Shooting Modes

P Mode

Tv, Av, and M Mode

Playback Mode

Wi-Fi Functions

Setting Menu

Accessories

Appendix

Index





- After you set the shutter speed and aperture value, the exposure level may change if you adjust the zoom or recompose the shot.
- Screen brightness may change depending on your specified shutter speed and aperture value. However, screen brightness remains the same when the flash is up and the mode is set to [⚡].
- To have the setting that is not chosen in step 2 (whether shutter speed or aperture value) automatically adjusted to obtain standard exposure, hold the shutter button halfway and press the [▲] button. Note that standard exposure may not be possible with some settings.
- With shutter speed of 1.3 seconds or slower, ISO speed is fixed at [80].
- [☐] Auto mode cannot be used in [M] mode.



- [M]: Manual
- Calculation of standard exposure is based on the specified metering method (☞71).

## Adjusting the Flash Output

▶ Still Images ▶ Movies

Choose from the three flash levels in [M] mode.



### 1 Enter [M] mode.

- Set the mode dial to [M].

### 2 Configure the setting.

- Press the [⊕] button, choose [⚡] in the menu, and adjust the setting by either pressing the [▲][▼] buttons or turning the [⦿] dial (☞28).
- Once the setting is complete, the flash output level is displayed.  
[⚡]: Minimum, [⚡.⦿]: Medium, [⚡.⦿.⦿]: Maximum



- You can also set the flash level by accessing MENU (☞29) and choosing [📷] tab > [Flash Settings] > [Flash Output].
- You can set the flash level in [Tv] or [Av] mode by accessing MENU (☞29) and choosing [📷] tab > [Flash Settings] > [Flash Mode] > [Manual].
- You can also access the [Flash Settings] screen (☞29) when the flash is up by pressing the [▶] button and immediately pressing the [MENU] button.

Before Use

Basic Guide

Advanced Guide

Camera Basics

Auto Mode /  
Hybrid Auto Mode

Other Shooting Modes

P Mode

Tv, Av, and M Mode

Playback Mode

Wi-Fi Functions

Setting Menu

Accessories

Appendix

Index

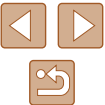

# Playback Mode

Have fun reviewing your shots, and browse or edit them in many ways

- To prepare the camera for these operations, press the [▶] button to enter Playback mode.



- It may not be possible to play back or edit images that were renamed or already edited on a computer, or images from other cameras.

## Viewing

▶ Still Images ▶ Movies

After shooting images or movies, you can view them on the screen as follows.

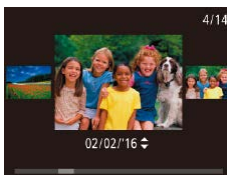

### 1 Enter Playback mode.

- Press the [▶] button.
- Your last shot is displayed.

### 2 Choose images.

- To view the previous image, press the [◀] button or turn the [⦿] dial counterclockwise. To view the next image, press the [▶] button or turn the [⦿] dial clockwise.
- Press and hold the [◀] [▶] buttons to browse through images quickly.
- To access this screen (Scroll Display mode), turn the [⦿] dial rapidly. In this mode, turn the [⦿] dial to browse through images.
- To return to single-image display, press the [⦿] button.
- To browse images grouped by shooting date, press the [▲] [▼] buttons in Scroll Display mode.

Before Use

Basic Guide

Advanced Guide

Camera Basics

Auto Mode /  
Hybrid Auto Mode

Other Shooting Modes

P Mode

Tv, Av, and M Mode

Playback Mode

Wi-Fi Functions

Setting Menu

Accessories

Appendix

Index





- Movies are identified by a [SET ▶] icon. To play movies, go to step 3.

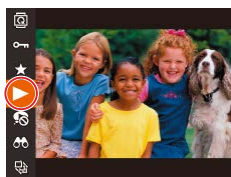

### 3 Play movies.

- To start playback, press the [▶] button, choose [▶] (either press the [▲][▼] buttons or turn the [◻] dial), and then press the [▶] button again.



### 4 Adjust the volume.

- Press the [▲][▼] buttons to adjust the volume.
- To adjust the volume when the volume indicator (1) is no longer displayed, press the [▲][▼] buttons.

(1)

### 5 Pause playback.

- To pause or resume playback, press the [⏸] button.
- After the movie is finished, [SET ▶] is displayed.







- To switch to Shooting mode from Playback mode, press the shutter button halfway.
- To deactivate Scroll Display, choose MENU (29) > [▶] tab > [Scroll Display] > [Off].
- To have the most recent shot displayed when you enter Playback mode, choose MENU (29) > [▶] tab > [Resume] > [Last shot].
- To change the transition shown between images, access MENU (29) and choose your desired effect on the [▶] tab > [Transition Effect].

## Switching Display Modes

▶ Still Images ▶ Movies

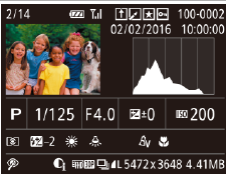
Press the [INFO] button to view other information on the screen, or to hide the information. For details on the information displayed, see “Playback (Detailed Information Display)” (167).

	No Information Display
	Simple Information Display
	Detailed Information Display
	GPS Information Display

Before Use
Basic Guide
Advanced Guide
Camera Basics
Auto Mode / Hybrid Auto Mode
Other Shooting Modes
P Mode
Tv, Av, and M Mode
Playback Mode
Wi-Fi Functions
Setting Menu
Accessories
Appendix
Index





## Overexposure Warning (for Image Highlights)

▶ Still Images ▶ Movies

Washed-out highlights in the image flash on the screen in detailed information display (📖88).

## Histogram

▶ Still Images ▶ Movies

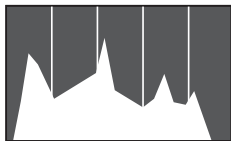

- The graph in detailed information display (📖88) is a histogram showing the distribution of brightness in the image. The horizontal axis represents the degree of brightness, and the vertical axis, how much of the image is at each level of brightness. Viewing the histogram is a way to check exposure.

## GPS Information Display

▶ Still Images ▶ Movies



- Using a smartphone connected to the camera via Wi-Fi, you can geotag images on the camera, adding information such as latitude, longitude, and elevation (📖135). You can review this information in the GPS information display.
- Latitude, longitude, elevation, and UTC (shooting date and time) are listed from top to bottom.



- GPS information display is not available for images that lack this information.
- [---] is shown instead of numerical values for items not available on your smartphone or items not recorded correctly.



- UTC: Coordinated Universal Time, essentially the same as Greenwich Mean Time

## Viewing Short Movies Recorded in Creative Shot Mode (Creative Shot Movies)

▶ Still Images ▶ Movies

Play back Creative Shot movies recorded in [📷] mode (📖57).

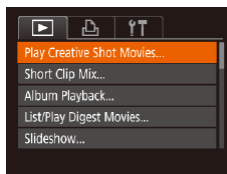

### 1 Choose a movie.

- Press the [MENU] button and choose [Play Creative Shot Movies] on the [▶] tab (📖29).

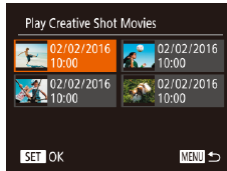

### 2 Play the movie.

- Select a movie and press the [▶] button to play it.

Before Use

Basic Guide

Advanced Guide

Camera Basics

Auto Mode / Hybrid Auto Mode

Other Shooting Modes

P Mode

Tv, Av, and M Mode

Playback Mode

Wi-Fi Functions

Setting Menu

Accessories

Appendix

Index



## Viewing Short Movies Created When Shooting Still Images (Digest Movies)

▶ Still Images ▶ Movies

View digest movies recorded automatically in [A] mode (📖34) on a day of still image shooting as follows.

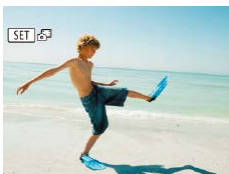

### 1 Choose an image.

- Press the [◀][▶] buttons or turn the [🔍] dial to choose a still image labeled with [SET 📷].

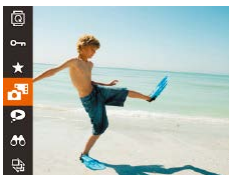

### 2 Play the digest movie.

- Press the [🔍] button, and then choose [📷] in the menu (📖28).
- The digest movie recorded automatically on the day of still image shooting is played back, from the beginning.



- After a moment, [SET 📷] will no longer be displayed when you are using the camera with information display deactivated (📖88).

## Viewing by Date

Digest movies can be viewed by date.

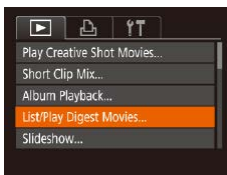

### 1 Choose a movie.

- Press the [MENU] button, choose [List/Play Digest Movies] on the [▶] tab, and then choose a date (📖29).

### 2 Play the movie.

- Press the [🔍] button to start playback.

## Checking People Detected in Face ID

▶ Still Images ▶ Movies

If you switch the camera to simple information display mode (📖88), the names of up to five detected people registered in Face ID (📖44) will be displayed.



- Press the [INFO] button several times until simple information display is activated, and then press the [◀][▶] buttons or turn the [🔍] dial to choose an image.
- Names will be displayed on detected people.



- If you prefer not to have names displayed on images shot using Face ID, choose MENU (📖29) > [▶] tab > [Face ID Info] > [Name Display] > [Off].

Before Use

Basic Guide

Advanced Guide

Camera Basics

Auto Mode / Hybrid Auto Mode

Other Shooting Modes

P Mode

Tv, Av, and M Mode

Playback Mode

Wi-Fi Functions

Setting Menu

Accessories

Appendix

Index



## Browsing and Filtering Images

### Navigating through Images in an Index

► Still Images ► Movies

By displaying multiple images in an index, you can quickly find the images you are looking for.

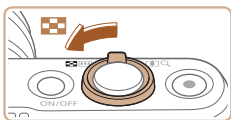

#### 1 Display images in an index.

- Move the zoom lever toward to display images in an index. Moving the lever again will increase the number of images shown.
- To display fewer images, move the zoom lever toward . Fewer images are shown each time you move the lever.



#### 2 Choose an image.

- Turn the dial to scroll through the images.
- Press the buttons to choose an image.
- An orange frame is displayed around the selected image.
- Press the button to view the selected image in single-image display.



- To deactivate the 3D display effect (shown if you hold down the buttons or turn the dial rapidly), choose MENU 29 > tab > [Index Effect] > [Off].

### Finding Images Matching Specified Conditions

► Still Images ► Movies

Find desired images quickly on a memory card full of images by filtering image display according to your specified conditions. You can also protect 96 or delete 98 these images all at once.

Name	Displays images of a registered person 45).
People	Displays images with detected faces.
Shot Date	Displays the images shot on a specific date.
Favorites	Displays images tagged as favorites 101).
Still image/Movie	Displays still images, movies, or movies shot in  mode 34).

#### 1 Choose a search condition.

- Press the button, choose in the menu, and choose a condition 28).
- When you have selected , , or , choose the condition by pressing the buttons on the screen displayed, and then press the button.

#### 2 View the filtered images.

- Images matching your conditions are displayed in yellow frames. To view only these images, press the buttons, or turn the dial.
- To cancel filtered display, choose in step 1.

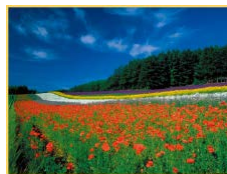

- When the camera has found no corresponding images for some conditions, those conditions will not be available.

Before Use

Basic Guide

Advanced Guide

Camera Basics

Auto Mode /  
Hybrid Auto Mode

Other Shooting Modes

P Mode

Tv, Av, and M Mode

Playback Mode

Wi-Fi Functions

Setting Menu

Accessories

Appendix

Index





- To hide or view other information, press the [INFO] button in step 2.
- Options for viewing the images found (in step 2) include "Navigating through Images in an Index" (p.91), "Magnifying Images" (p.94), and "Viewing Slideshows" (p.94). You can also apply image operations to all images found, by choosing [Protect All Images in Search] in "Protecting Images" (p.96) or [Select All Images in Search] in "Erasing Multiple Images at Once" (p.98), "Adding Images to the Print List (DPOF)" (p.156), or "Adding Images to a Photobook" (p.158).
- If you edit images and save them as new images (p.102 – p.106), a message is displayed, and the images that were found are no longer shown.

## Viewing Individual Images in a Group

► Still Images ► Movies

Images shot consecutively (p.43, p.58, p.80) or in [L] mode (p.57) are displayed as a group but can also be viewed individually.



### 1 Choose a grouped image.

- Press the [◀][▶] buttons or turn the [DISP] dial to choose an image labeled with [SET].

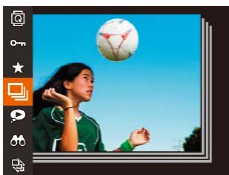

### 2 Choose [SET].

- Press the [DISP] button, and then choose [SET] in the menu (p.28).



### 3 View images in the group individually.

- Pressing the [◀][▶] buttons or turning the [DISP] dial will display only images in the group.
- To cancel group playback, press the [DISP] button, choose [L] in the menu, and press the [DISP] button again (p.28).



- During group playback (step 3), you can browse through images quickly "Navigating through Images in an Index" (p.91) and magnify them "Magnifying Images" (p.94). You can apply your actions to all images in the group at once by choosing [Protect All Images in Group] in "Protecting Images" (p.96), [All images in Group] in "Erasing Multiple Images at Once" (p.98), [Select All in Group] in "Adding Images to the Print List (DPOF)" (p.156), or [Select All in Group] in "Adding Images to a Photobook" (p.158).
- To ungroup images so that they are displayed only as single still images, choose MENU (p.29) > [L] tab > [Group Images] > [Off]. However, grouped images cannot be ungrouped during individual playback.
- In [L] mode, the simultaneous display after step 2 in "Enjoying a Variety of Images from Each Shot" (p.57) is only shown immediately after you shoot.

Before Use
Basic Guide
Advanced Guide
Camera Basics
Auto Mode / Hybrid Auto Mode
Other Shooting Modes
P Mode
Tv, Av, and M Mode
Playback Mode
Wi-Fi Functions
Setting Menu
Accessories
Appendix
Index

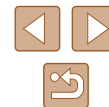

## Editing Face ID Information

If you notice that a name is incorrect during playback, you can change it or erase it.

However, you cannot add names for people who are not detected by Face ID (names are not displayed), and for people whose names have been erased.

## Changing Names

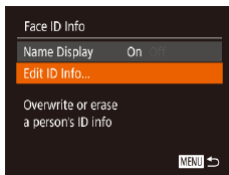

### 1 Access the setting screen.

- Press the [MENU] button and choose [Face ID Info] on the [D] tab (📖29).
- Press the [▲][▼] buttons or turn the [🌀] dial to choose [Edit ID Info], and then press the [📄] button.



### 2 Choose an image.

- Following the procedure in “Checking People Detected in Face ID” (📖90), choose an image and press the [📄] button.
- An orange frame is displayed around the selected face. When multiple names are displayed in an image, press the [◀][▶] buttons or turn the [🌀] dial to choose the name to change, and then press the [📄] button.

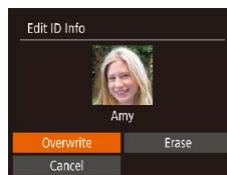

### 3 Choose the editing option.

- Press the [▲][▼][◀][▶] buttons or turn the [🌀] dial to choose [Overwrite], and then press the [📄] button.

### 4 Choose the name of the person to overwrite with.

- Follow step 2 in “Overwriting and Adding Face Information” (📖47) to choose the name of the person you want to overwrite with.

## Erasing Names

- On the screen displayed in step 3 in “Changing Names” (📖93), choose [Erase] and press the [📄] button.
- After [Erase?] is displayed, press the [◀][▶] buttons or turn the [🌀] dial to choose [OK], and then press the [📄] button.

Before Use

Basic Guide

Advanced Guide

Camera Basics

Auto Mode /  
Hybrid Auto Mode

Other Shooting Modes

P Mode

Tv, Av, and M Mode

Playback Mode

Wi-Fi Functions

Setting Menu

Accessories

Appendix

Index

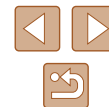

## Image Viewing Options

### Magnifying Images

► Still Images ► Movies

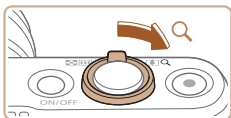

(1)

#### 1 Magnify an image.

- Moving the zoom lever toward [Q] will zoom in and magnify the image. You can magnify images up to about 10x by continuing to hold the zoom lever.
- The approximate position of the displayed area (1) is shown for reference.
- To zoom out, move the zoom lever toward [Z]. You can return to single-image display by continuing to hold it.

#### 2 Move the display position and switch images as needed.

- To move the display position, press the [▲][▼][◀][▶] buttons.
- To switch to other images while zoomed, turn the [DISP] dial.



- You can return to single-image display from magnified display by pressing the [MENU] button.

## Viewing Slideshows

► Still Images ► Movies

Automatically play back images from a memory card as follows. Each image is displayed for about three seconds.



- Press the [DISP] button, choose [S] in the menu, and choose the desired option (p.28).
- The slideshow will start after [Loading image] is displayed for a few seconds.
- Press the [MENU] button to stop the slideshow.



- The camera's power-saving functions (p.26) are deactivated during slideshows.



- To pause or resume slideshows, press the [DISP] button.
- You can switch to other images during playback by pressing the [◀][▶] buttons or turning the [DISP] dial. For fast-forward or fast-rewind, hold the [◀][▶] buttons down.
- In filtered display (p.91), only images matching search conditions are played.

Before Use

Basic Guide

Advanced Guide

Camera Basics

Auto Mode /  
Hybrid Auto Mode

Other Shooting Modes

P Mode

Tv, Av, and M Mode

Playback Mode

Wi-Fi Functions

Setting Menu

Accessories

Appendix

Index



## Changing Slideshow Settings

You can set up slideshows to repeat, and you can change the transitions between images and the display duration of each image.

### 1 Access the setting screen.

- Press the [MENU] button, and then choose [Slideshow] on the [▶] tab (📖29).

### 2 Configure the settings.

- Choose a menu item to configure, and then choose the desired option (📖29).
- To start the slideshow with your settings, choose [Start] and press the [⏪] button.
- To return to the menu screen, press the [MENU] button.



## Auto Playback of Related Images (Smart Shuffle)

▶ Still Images ▶ Movies

Based on the current image, the camera offers four images that you may wish to view. After you choose to view one of those images, the camera offers four more images. This is an enjoyable way to play back images in an unexpected order. Try this feature after you have taken many shots, in many kinds of scenes.

### 1 Choose Smart Shuffle.

- Press the [Ⓜ] button, and then choose [▶] in the menu (📖28).
- Four candidate images are displayed.



### 2 Choose an image.

- Press the [▲][▼][◀][▶] buttons to choose the image you want to view next.
- Your chosen image is displayed in the center, surrounded by the next four candidate images.
- For full-screen display of the center image, press the [Ⓜ] button. To restore the original display, press the [Ⓜ] button again.
- Press the [MENU] button to restore single-image display.

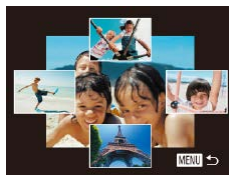

- Smart Shuffle is not available in the following cases:
  - There are less than 50 shots taken with this camera
  - An unsupported image is currently displayed
  - Images are shown in filtered display (📖91)
  - During group playback (📖92)

Before Use

Basic Guide

Advanced Guide

Camera Basics

Auto Mode /  
Hybrid Auto Mode

Other Shooting Modes

P Mode

Tv, Av, and M Mode

Playback Mode

Wi-Fi Functions

Setting Menu

Accessories

Appendix

Index



## Protecting Images

► Still Images ► Movies

Protect important images to prevent accidental erasure (📖98).

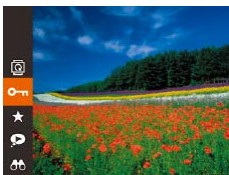

- Press the [MENU] button, and then choose [Protect] in the menu (📖28). [Protected] is displayed.
- To cancel protection, repeat this process and choose [Protect] again, and then press the [MENU] button.



- Protected images on a memory card will be erased if you format the card (📖142).



- Protected images cannot be erased using the camera's erasure function. To erase them this way, first cancel protection.

## Using the Menu

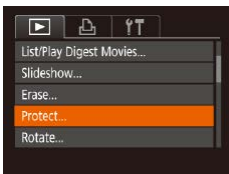

### 1 Access the setting screen.

- Press the [MENU] button and choose [Protect] on the [P] tab (📖29).

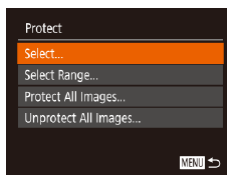

### 2 Choose a selection method.

- Choose an option as desired (📖29).
- To return to the menu screen, press the [MENU] button.

## Choosing Images Individually

### 1 Choose [Select].

- Following step 2 in "Using the Menu" (📖96), choose [Select] and press the [MENU] button.



### 2 Choose an image.

- Press the [Left][Right] buttons or turn the [Dial] dial to choose an image, and then press the [MENU] button. [Protect] is displayed.
- To cancel selection, press the [MENU] button again. [Protect] is no longer displayed.
- Repeat this process to specify other images.

### 3 Protect the image.

- Press the [MENU] button. A confirmation message is displayed.
- Press the [Left][Right] buttons or turn the [Dial] dial to choose [OK], and then press the [MENU] button.

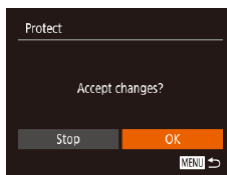

- Images will not be protected if you switch to Shooting mode or turn the camera off before finishing the setup process in step 3.

Before Use

Basic Guide

Advanced Guide

Camera Basics

Auto Mode /  
Hybrid Auto Mode

Other Shooting Modes

P Mode

Tv, Av, and M Mode

Playback Mode

Wi-Fi Functions

Setting Menu

Accessories

Appendix

Index





## Selecting a Range

### 1 Choose [Select Range].

- Following step 2 in “Using the Menu” (96), choose [Select Range] and press the [MENU] button.

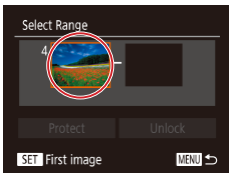

### 2 Choose a starting image.

- Press the [MENU] button.



- Press the [LEFT][RIGHT] buttons or turn the [DISP] dial to choose an image, and then press the [MENU] button.

### 3 Choose an ending image.

- Press the [RIGHT] button to choose [Last image], and then press the [MENU] button.

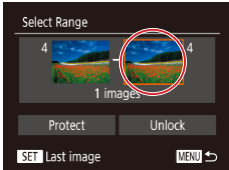

- Press the [LEFT][RIGHT] buttons or turn the [DISP] dial to choose an image, and then press the [MENU] button.
- Images before the first image cannot be selected as the last image.

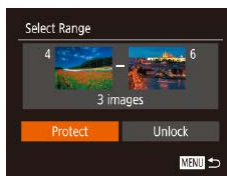

### 4 Protect the images.

- Press the [DOWN] button to choose [Protect], and then press the [MENU] button.



- You can also choose the first or last image by turning the [DISP] dial when the top screen in steps 2 and 3 is displayed.
- To cancel protection for groups of images, choose [Unlock] in step 4.

## Protecting All Images at Once

### 1 Choose [Protect All Images].

- Following step 2 in “Using the Menu” (96), choose [Protect All Images] and press the [MENU] button.

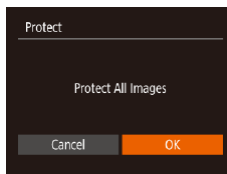

### 2 Protect the images.

- Press the [LEFT][RIGHT] buttons or turn the [DISP] dial to choose [OK], and then press the [MENU] button.

### ■ Clearing All Protection at Once

You can clear protection from all images at once. To clear protection, choose [Unprotect All Images] in step 1 of “Protecting All Images at Once”, and then complete step 2.

Before Use

Basic Guide

Advanced Guide

Camera Basics

Auto Mode /  
Hybrid Auto Mode

Other Shooting Modes

P Mode

Tv, Av, and M Mode

Playback Mode

Wi-Fi Functions

Setting Menu

Accessories

Appendix

Index

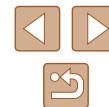

## Erasing Images

► Still Images ► Movies

You can choose and erase unneeded images one by one. Be careful when erasing images, because they cannot be recovered. However, protected images (📖96) cannot be erased.

### 1 Choose an image to erase.

- Press the [◀][▶] buttons or turn the [🔘] dial to choose an image.



### 2 Erase the image.

- Press the [▼] button.
- After [Erase?] is displayed, press the [◀][▶] buttons or turn the [🔘] dial to choose [Erase], and then press the [🔘] button.
- The current image is now erased.
- To cancel erasure, press the [◀][▶] buttons or turn the [🔘] dial to choose [Cancel], and then press the [🔘] button.

## Erasing Multiple Images at Once

You can choose multiple images to erase at once. Be careful when erasing images, because they cannot be recovered. However, protected images (📖96) cannot be erased.

### Choosing a Selection Method

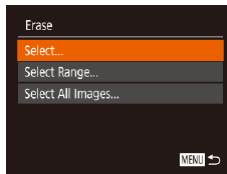
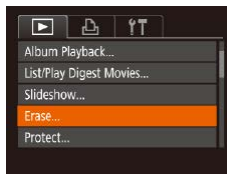

### 1 Access the setting screen.

- Press the [MENU] button, and then choose [Erase] on the [▶] tab (📖29).

### 2 Choose a selection method.

- Choose an option as desired (📖29).
- To return to the menu screen, press the [MENU] button.

Before Use

Basic Guide

Advanced Guide

Camera Basics

Auto Mode /  
Hybrid Auto Mode

Other Shooting Modes

P Mode

Tv, Av, and M Mode

Playback Mode

Wi-Fi Functions

Setting Menu

Accessories

Appendix

Index



## Choosing Images Individually

### 1 Choose [Select].

- Following step 2 in “Choosing a Selection Method” (98), choose [Select] and press the [OK] button.



### 2 Choose an image.

- Once you choose an image following step 2 in “Choosing Images Individually” (96), [✓] is displayed.
- To cancel selection, press the [OK] button again. [✓] is no longer displayed.
- Repeat this process to specify other images.

### 3 Erase the image.

- Press the [MENU] button. A confirmation message is displayed.
- Press the [Left][Right] buttons or turn the [Dial] dial to choose [OK], and then press the [OK] button.

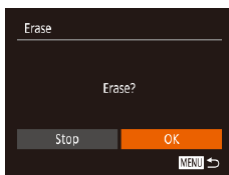

## Selecting a Range

### 1 Choose [Select Range].

- Following step 2 in “Choosing a Selection Method” (98), choose [Select Range] and press the [OK] button.

### 2 Choose images.

- Follow steps 2 – 3 in “Selecting a Range” (97) to specify images.

### 3 Erase the images.

- Press the [Down] button to choose [Erase], and then press the [OK] button.

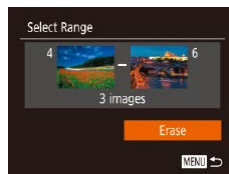

## Specifying All Images at Once

### 1 Choose [Select All Images].

- Following step 2 in “Choosing a Selection Method” (98), choose [Select All Images] and press the [OK] button.

### 2 Erase the images.

- Press the [Left][Right] buttons or turn the [Dial] dial to choose [OK], and then press the [OK] button.

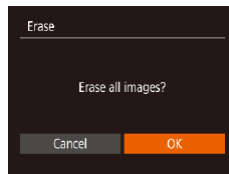

Before Use

Basic Guide

Advanced Guide

Camera Basics

Auto Mode /  
Hybrid Auto Mode

Other Shooting Modes

P Mode

Tv, Av, and M Mode

Playback Mode

Wi-Fi Functions

Setting Menu

Accessories

Appendix

Index

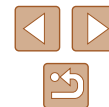

## Rotating Images

► Still Images ► Movies

Change the orientation of images and save them as follows.



### 1 Choose [Rotate].

- Press the [MENU] button, and then choose [Rotate] in the menu (📖28).

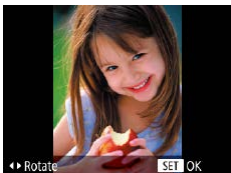

### 2 Rotate the image.

- Press the [◀] or [▶] button, depending on the desired direction. Each time you press the button, the image is rotated 90°. Press the [MENU] button to complete the setting.



- Rotation is not possible when [Auto Rotate] is set to [Off] (📖100).

## Using the Menu

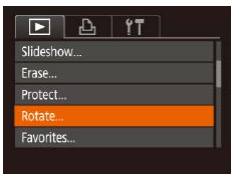

### 1 Choose [Rotate].

- Press the [MENU] button and choose [Rotate] on the [▶] tab (📖29).



### 2 Rotate the image.

- Press the [◀] or [▶] buttons or turn the [DISP] dial to choose an image.
- The image is rotated 90° each time you press the [MENU] button.
- To return to the menu screen, press the [MENU] button.

## Deactivating Auto Rotation

Follow these steps to deactivate automatic image rotation, which rotates images based on the current camera orientation.

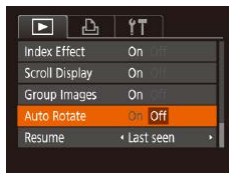

- Press the [MENU] button, choose [Auto Rotate] on the [▶] tab, and then choose [Off] (📖29).



- Images cannot be rotated (📖100) when you set [Auto Rotate] to [Off]. Additionally, images already rotated will be displayed in the original orientation.
- In Smart Shuffle (📖95) mode, even if [Auto Rotate] is set to [Off], images shot vertically will be displayed vertically, and rotated images will be displayed in the rotated orientation.

Before Use

Basic Guide

Advanced Guide

Camera Basics

Auto Mode /  
Hybrid Auto Mode

Other Shooting Modes

P Mode

Tv, Av, and M Mode

Playback Mode

Wi-Fi Functions

Setting Menu

Accessories

Appendix

Index

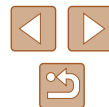

## Tagging Images as Favorites

► Still Images ► Movies

You can organize images by tagging them as favorites. By choosing a category in filtered playback, you can restrict the following operations to all of those images.

- “Viewing” (187), “Viewing Slideshows” (94), “Protecting Images” (96), “Erasing Images” (98), “Adding Images to the Print List (DPOF)” (156), “Adding Images to a Photobook” (158)

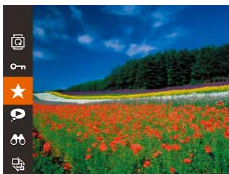

- Press the [MENU] button, and then choose [★] in the menu (28).
- [Tagged as Favorite] is displayed.
- To untag the image, repeat this process and choose [★] again, and then press the [MENU] button.

## Using the Menu

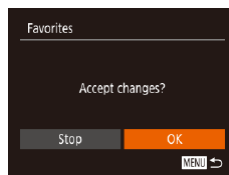
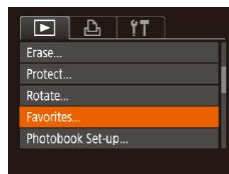

### 1 Choose [Favorites].

- Press the [MENU] button and choose [Favorites] on the [▶] tab (29).

### 2 Choose an image.

- Press the [◀][▶] buttons or turn the [DISP] dial to choose an image, and then press the [MENU] button. [★] is displayed.
- To untag the image, press the [MENU] button again. [★] is no longer displayed.
- Repeat this process to choose additional images.

### 3 Finish the setup process.

- Press the [MENU] button. A confirmation message is displayed.
- Press the [◀][▶] buttons or turn the [DISP] dial to choose [OK], and then press the [MENU] button.



- Images will not be tagged as favorites if you switch to Shooting mode or turn the camera off before finishing the setup process in step 3.



- Tagging images as favorites makes it easier to add them when creating albums (108).

Before Use

Basic Guide

Advanced Guide

Camera Basics

Auto Mode /  
Hybrid Auto Mode

Other Shooting Modes

P Mode

Tv, Av, and M Mode

Playback Mode

Wi-Fi Functions

Setting Menu

Accessories

Appendix

Index



## Editing Still Images



- Image editing (📖102 – 📖104) is only available when the memory card has sufficient free space.

## Resizing Images

▶ Still Images ▶ Movies

Save a copy of images at a lower resolution.

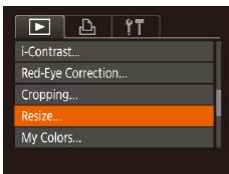

### 1 Choose [Resize].

- Press the [MENU] button and choose [Resize] on the [▶] tab (📖29).

### 2 Choose an image.

- Press the [◀][▶] buttons or turn the [🔍] dial to choose an image, and then press the [⏏] button.

### 3 Choose an image size.

- Press the [◀][▶] buttons or turn the [🔍] dial to choose the size, and then press the [⏏] button.
- [Save new image?] is displayed.

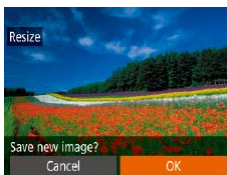

### 4 Save the new image.

- Press the [◀][▶] buttons or turn the [🔍] dial to choose [OK], and then press the [⏏] button.
- The image is now saved as a new file.

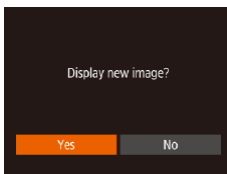

### 5 Review the new image.

- Press the [MENU] button. [Display new image?] is displayed.
- Press the [◀][▶] buttons or turn the [🔍] dial to choose [Yes], and then press the [⏏] button.
- The saved image is now displayed.



- Editing is not possible for images shot at a resolution (📖49) of [S].



- Images cannot be resized to a higher resolution.

## Cropping

▶ Still Images ▶ Movies

You can specify a portion of an image to save as a separate image file.

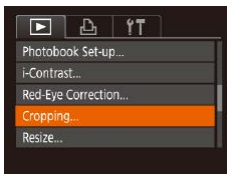

### 1 Choose [Cropping].

- Press the [MENU] button, and then choose [Cropping] on the [▶] tab (📖29).

Before Use

Basic Guide

Advanced Guide

Camera Basics

Auto Mode /  
Hybrid Auto Mode

Other Shooting Modes

P Mode

Tv, Av, and M Mode

Playback Mode

Wi-Fi Functions

Setting Menu

Accessories

Appendix

Index



## 2 Choose an image.

- Press the [◀][▶] buttons or turn the [DISP.] dial to choose an image, and then press the [DISP.] button.

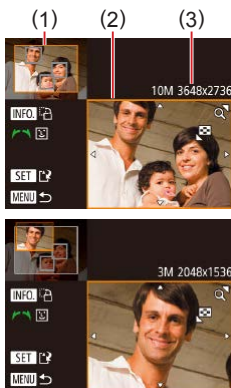

## 3 Adjust the cropping area.

- A frame is displayed around the portion of the image to be cropped (1).
- The original image is shown in the upper left, and a preview of the image as cropped (2) is shown in the lower right. You can also see the resolution after cropping (3).
- To resize the frame, move the zoom lever.
- To move the frame, press the [▲][▼][◀][▶] buttons.
- To change the frame orientation, press the [INFO.] button.
- Faces detected in the image are enclosed in gray frames in the upper-left image. Turn the [DISP.] dial to switch frames, which position the cropping area.
- Press the [DISP.] button.

## 4 Save as a new image and review.

- Follow steps 4 – 5 in “Resizing Images” (102).



- Editing is not possible for images shot at a resolution of [S] (49) or for resized [S] images (102).



- Images supported for cropping will have the same aspect ratio after cropping.
- Cropped images will have a lower resolution than uncropped images.
- If you crop still images shot using Face ID (44), only the names of the people left in the cropped image will remain.

## Changing Image Color Tones (My Colors)

▶ Still Images ▶ Movies

You can adjust image colors and then save the edited image as a separate file. For details on each option, see “Changing Image Color Tones (My Colors)” (74).



### 1 Choose [My Colors].

- Press the [MENU] button, and then choose [My Colors] on the [▶] tab (29).

### 2 Choose an image.

- Press the [◀][▶] buttons or turn the [DISP.] dial to choose an image, and then press the [DISP.] button.

### 3 Choose an option.

- Press the [◀][▶] buttons or turn the [DISP.] dial to choose an option, and then press the [DISP.] button.



Before Use

Basic Guide

Advanced Guide

Camera Basics

Auto Mode /  
Hybrid Auto Mode

Other Shooting Modes

P Mode

Tv, Av, and M Mode

Playback Mode

Wi-Fi Functions

Setting Menu

Accessories

Appendix

Index



#### 4 Save as a new image and review.

- Follow steps 4 – 5 in “Resizing Images” (📖102).



- Image quality of pictures you repeatedly edit this way will be a little lower each time, and you may not be able to obtain the desired color.



- The color of images edited using this function may vary slightly from the color of images shot using My Colors (📖74).

## Correcting Image Brightness (i-Contrast)

▶ Still Images ▶ Movies

Excessively dark image areas (such as faces or backgrounds) can be detected and automatically adjusted to the optimal brightness. Insufficient overall image contrast is also automatically corrected, to make subjects stand out better. Choose from four correction levels, and then save the image as a separate file.

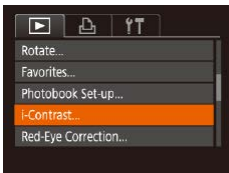

#### 1 Choose [i-Contrast].

- Press the [MENU] button, and then choose [i-Contrast] on the [▶] tab (📖29).

#### 2 Choose an image.

- Press the [◀][▶] buttons or turn the [DISP] dial to choose an image, and then press the [OK] button.



#### 3 Choose an option.

- Press the [◀][▶] buttons or turn the [DISP] dial to choose an option, and then press the [OK] button.

#### 4 Save as a new image and review.

- Follow steps 4 – 5 in “Resizing Images” (📖102).



- For some images, correction may be inaccurate or may cause images to appear grainy.
- Images may look grainy after repeated editing using this function.



- If [Auto] does not produce the expected results, try correcting images using [Low], [Medium], or [High].

## Correcting Red-Eye

▶ Still Images ▶ Movies

Automatically corrects images affected by red-eye. You can save the corrected image as a separate file.

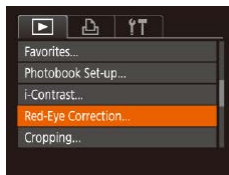

#### 1 Choose [Red-Eye Correction].

- Press the [MENU] button, and then choose [Red-Eye Correction] on the [▶] tab (📖29).

Before Use
Basic Guide
Advanced Guide
Camera Basics
Auto Mode / Hybrid Auto Mode
Other Shooting Modes
P Mode
Tv, Av, and M Mode
Playback Mode
Wi-Fi Functions
Setting Menu
Accessories
Appendix
Index

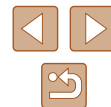



## 2 Choose an image.

- Press the [◀][▶] buttons or turn the [📷] dial to choose an image.

## 3 Correct the image.

- Press the [📷] button.
- Red-eye detected by the camera is now corrected, and frames are displayed around corrected image areas.
- Enlarge or reduce images as needed. Follow the steps in “Magnifying Images” (📖94).

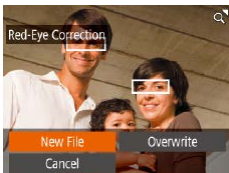

## 4 Save as a new image and review.

- Press the [▲][▼][◀][▶] buttons or turn the [📷] dial to choose [New File], and then press the [📷] button.
- The image is now saved as a new file.
- Follow step 5 in “Resizing Images” (📖102).



- Some images may not be corrected accurately.
- To overwrite the original image with the corrected image, choose [Overwrite] in step 4. In this case, the original image will be erased.
- Protected images cannot be overwritten.

# Editing Movies

▶ Still Images ▶ Movies

You can remove unneeded portions from the beginning and end of movies (excluding digest movies, 📖34).

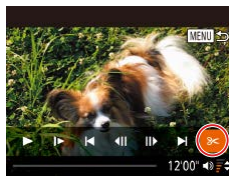

## 1 Choose [📷].

- Following steps 1 – 5 in “Viewing” (📖87), choose [📷] and press the [📷] button.
- The movie editing panel and editing bar are now displayed.

## 2 Specify portions to cut.

- (1) is the movie editing panel, and (2) is the editing bar.
- Press the [▲][▼] buttons to choose [📷] or [📷].
- To view the portions you can cut (identified by [📷] on the screen), press the [◀][▶] buttons or turn the [📷] dial to move [📷]. Cut the beginning of the movie (from [📷]) by choosing [📷], and cut the end of the movie by choosing [📷].
- If you move [📷] to a position other than a [📷] mark, in [📷] the portion before the nearest [📷] mark on the left will be cut, while in [📷] the portion after the nearest [📷] mark on the right will be cut.

Before Use
Basic Guide
Advanced Guide
Camera Basics
Auto Mode / Hybrid Auto Mode
Other Shooting Modes
P Mode
Tv, Av, and M Mode
Playback Mode
Wi-Fi Functions
Setting Menu
Accessories
Appendix
Index

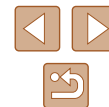

### 3 Review the edited movie.

- Press the [▲][▼] buttons to choose [▶], and then press the [Ⓜ] button. The edited movie is now played.
- To edit the movie again, repeat step 2.
- To cancel editing, press the [MENU] button, choose [OK] (either press the [◀][▶] buttons or turn the [Ⓜ] dial), and then press the [Ⓜ] button.

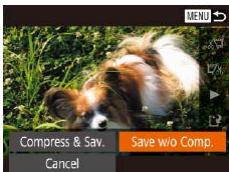
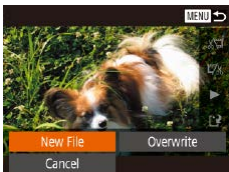

### 4 Save the edited movie.

- Press the [▲][▼] buttons to choose [▶], and then press the [Ⓜ] button.
- Press the [▲][▼][◀][▶] buttons or turn the [Ⓜ] dial to choose [New File], and then press the [Ⓜ] button.
- Choose [Save w/o Comp.], and then press the [Ⓜ] button.
- The movie is now saved as a new file.



- To overwrite the original movie with the cut one, choose [Overwrite] in step 4. In this case, the original movie will be erased.
- If the memory card lacks sufficient space, only [Overwrite] will be available.
- Movies may not be saved if the battery pack runs out while saving is in progress.
- When editing movies, use a fully charged battery pack, if possible.

## Reducing File Sizes

Movie file sizes can be reduced by compressing movies as follows.



- On the screen in step 2 of “Editing Movies”, choose [▶]. Choose [New File], and then press the [Ⓜ] button.
- Choose [Compress & Sav.], and then press the [Ⓜ] button.



- Compressed movies are saved in [HD 30P] format.
- [VGA 30P] movies cannot be compressed.
- Edited movies cannot be saved in compressed format when you choose [Overwrite].

Before Use
Basic Guide
Advanced Guide
Camera Basics
Auto Mode / Hybrid Auto Mode
Other Shooting Modes
P Mode
Tv, Av, and M Mode
Playback Mode
Wi-Fi Functions
Setting Menu
Accessories
Appendix
Index

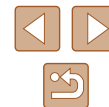

## Erasing Movie Chapters

▶ Still Images ▶ Movies

Individual chapters (clips) recorded in [ ] and [ ] mode (34, 58) can be erased, as needed. Note that erased clips cannot be recovered. Be sure that you want to erase the clips before using this option.



### 1 Select the clip to erase.

- Play a short movie as described in steps 1 – 2 of “Viewing Short Movies Recorded in Creative Shot Mode (Creative Shot Movies)” (89) or in steps 1 – 2 of “Viewing Short Movies Created When Shooting Still Images (Digest Movies)” (90), and then press the [ ] button to access the movie control panel.
- Press the [ ][ ] buttons or turn the [ ] dial to choose [ ] or [ ], and then press the [ ] button to choose a clip.

### 2 Choose [ ].

- Press the [ ][ ] buttons or turn the [ ] dial to choose [ ], and then press the [ ] button.
- The selected clip is played back repeatedly.

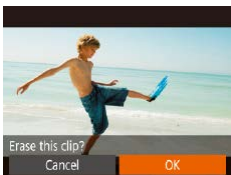

### 3 Confirm erasure.

- Press the [ ][ ] buttons or turn the [ ] dial to choose [OK], and then press the [ ] button.
- The clip is erased, and the short movie is overwritten.



- Albums (109) with BGM cannot be edited.
- [ ] is not displayed if you select a clip when the camera is connected to a printer.

Before Use

Basic Guide

Advanced Guide

Camera Basics

Auto Mode /  
Hybrid Auto Mode

Other Shooting Modes

P Mode

Tv, Av, and M Mode

Playback Mode

Wi-Fi Functions

Setting Menu

Accessories

Appendix

Index



# Viewing Albums (Story Highlights)

► Still Images ► Movies

You can choose themes such as a date or person's name to create an album of automatically selected images that match the theme. These images are combined into a slideshow that can be saved as a short movie of about 2 – 3 minutes.

Before using this feature, make sure the battery pack is fully charged. Creating albums also requires free space on the memory card. As a guideline, use a memory card with a capacity of 16 GB or higher, and ensure at least 1 GB of free space.

## Choosing Themes for Albums

Press the [▲] button to access the home screen and choose the theme for the camera to use when selecting album elements. Note that the camera is more likely to add images tagged as favorites (📖101) to albums.

Date	Creates an album of images shot on the same day. Images are selected from those shot on the same day as the image displayed before you access the home screen.
Person's name	Can be used to create monthly albums of people, such as albums of children as they grow up. Subjects whose Face ID information you registered before shooting may be selected for albums. Images selected are those that have the same subject shot during the same month as the image displayed before you access the home screen.
Event	A good choice for albums of vacations, parties, or other events. Images are selected from those shot during the event before and after the image displayed before you access the home screen.
Custom	Includes images based on your specified images, dates, or people registered in Face ID.

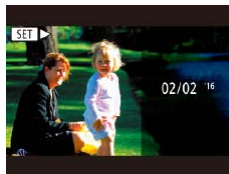
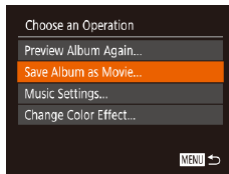
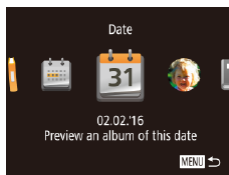

### 1 Choose an image.

- Choose an image in single-image display.
- Themes available in step 3 will vary depending on image shooting date and Face ID information.

### 2 Access the home screen.

- Press the [▲] button.
- After [Busy] is displayed, the home screen is displayed.

### 3 Preview an album.

- Choose a person, [Date], or [Event] (either press the [◀][▶] buttons or turn the [🔘] dial) as the album theme, and then press the [📖] button.
- After [Loading] is displayed for a few seconds, the album is played.

### 4 Save the album.

- Press the [▲][▼] buttons or turn the [🔘] dial to choose [Save Album as Movie], and then press the [📖] button.
- Once the album is saved, [Saved] is displayed.

### 5 Play the album (📖87).

Before Use
Basic Guide
Advanced Guide
Camera Basics
Auto Mode / Hybrid Auto Mode
Other Shooting Modes
P Mode
Tv, Av, and M Mode
Playback Mode
Wi-Fi Functions
Setting Menu
Accessories
Appendix
Index





- Albums can include following images captured by the camera.
  - Still images
  - Digest movies (📖34)
  - Short movie clips (📖68) of two seconds or longer, or Creative Shot movies (📖58), except compressed movies



- Albums cannot be saved unless there is enough space on the memory card.
- While the preview is playing, press the [▶] button to jump to the next chapter, and press the [◀] button to jump to the previous chapter.
- You can specify the color effect in step 4 by choosing [Change Color Effect] and pressing the [🎨] button. To preview how the album looks with your selected effect applied, choose [Preview Album Again] on the screen in step 4 after pressing the [◀▶] buttons to choose a color effect and pressing the [🎨] button.
- To play saved albums, choose [List of Albums] on the Story Highlights home screen, press the [🎧] button, choose a listed album, and press the [🎧] button again.

## Adding Background Music to Albums

▶ Still Images ▶ Movies

Choose from seven kinds of background music to play during album playback.

### 1 Register background music to a memory card.

- Following steps 1 – 4 in “Viewing Albums (Story Highlights)” (📖108), choose [Music Settings] and press the [🎧] button.

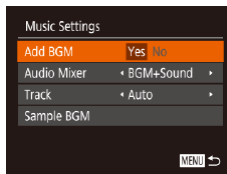
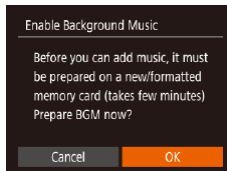

- The first time you use a memory card, or after it has been reset, the screen on the left is displayed. Choose [OK] and press the [🎧] button. In approximately 4 minutes, seven different BGM are recorded in the memory card.
- When using a memory card with music already registered to it, go to step 2.

### 2 Create the album.

- Follow steps 1 – 3 in “Viewing Albums (Story Highlights)” (📖108) to create an album.

### 3 Configure background music settings.

- Choose an item, and then press the [🎧] button to choose an option (📖29).

### 4 Save the album.

- Follow step 4 in “Viewing Albums (Story Highlights)” (📖108) to save albums.



- Once albums are saved, background music cannot be added later. Background music in albums cannot be removed or changed.
- Chapters of albums with background music cannot be edited (📖107).

- Before Use
- Basic Guide
- Advanced Guide
  - Camera Basics
  - Auto Mode / Hybrid Auto Mode
  - Other Shooting Modes
  - P Mode
  - Tv, Av, and M Mode
  - Playback Mode
  - Wi-Fi Functions
  - Setting Menu
  - Accessories
  - Appendix
- Index

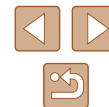



- If you prefer not to add background music, set [Add BGM] to [No] on the screen in step 3.
- To use only background music instead of movie audio, set [Audio Mixer] to [BGM only] on the screen in step 3.
- To listen to a sample of the background music selected in [Track], choose [Sample BGM] on the screen in step 3 and press the [OK] button.

## Creating Your Own Albums

► Still Images ► Movies

Create your own albums by choosing desired images.

### 1 Choose to create a Custom album.

- Following steps 1 – 3 in “Viewing Albums (Story Highlights)” (108), choose [Custom] and press the [OK] button.

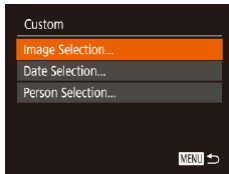

### 2 Choose a selection method.

- Choose [Image Selection], [Date Selection], or [Person Selection], and then press the [OK] button.

### 3 Choose album elements.

- Once you select the elements for your album and press the [OK] button, your selected elements are labeled with [✓].
- After choosing still images, short clip movies, or Creative Shot movies in [Image Selection], and the date or person in [Date Selection] or [Person Selection], press the [MENU] button.

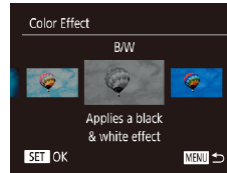
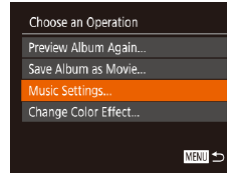

- Press the [◀][▶] buttons or turn the [DIAL] dial to choose [Preview], and then press the [OK] button.

### 4 Choose background music.

- Once the screen on the left is displayed, choose [Music Settings], and after adding BGM using the procedure in “Adding Background Music to Albums” (109), press the [MENU] button.

### 5 Choose a color effect.

- On the screen in step 4 of “Viewing Albums (Story Highlights)” (108), choose [Change Color Effect].
- Press the [◀][▶] buttons to choose a color effect, and then press the [OK] button.

### 6 Save the album.

- Follow step 4 in “Viewing Albums (Story Highlights)” (108) to save albums.



- You can specify up to 40 files (or 10 movie files) after choosing [Image Selection]. From the second time, [Select images based on previous settings?] is displayed, and if you choose [Yes], a multi-playback screen is displayed with the still images, short clip movies or Creative Shot movies that have [✓].
- Up to 15 dates can be selected if you choose [Date Selection].
- The color effect may not be applied to some images.

Before Use

Basic Guide

Advanced Guide

Camera Basics

Auto Mode /  
Hybrid Auto Mode

Other Shooting Modes

P Mode

Tv, Av, and M Mode

Playback Mode

Wi-Fi Functions

Setting Menu

Accessories

Appendix

Index

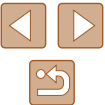

# Combining Short Clips

► Still Images ► Movies

Combine short clips to create a longer movie.

Note that movies created this way are not included in Story Highlights albums (📖108).

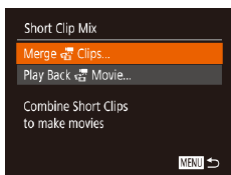

## 1 Access the editing screen.

- Press the [MENU] button, choose [Short Clip Mix] on the [▶] tab, and then choose [Merge Clips] (📖29).

## 2 Specify clips to combine.

- Press the [◀] [▶] or turn the [🔍] dial, choose a clip to combine from the clips on the top of the screen, and press the [🔍] button.
- Your selected clip is displayed on the bottom of the screen.
- To cancel selection, press the [🔍] button again.
- Repeat these steps to specify other clips to combine.
- After you are finished selecting clips, press the [MENU] button.

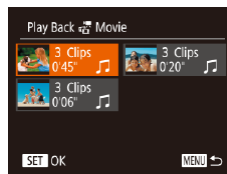
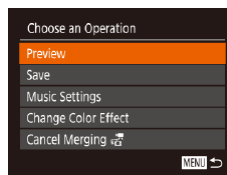

## 3 Preview the movie.

- Choose [Preview] and press the [🔍] button.
- After [Loading] is displayed for a few seconds, a preview of the combined clips is played.

## 4 Save the movie.

- Choose [Save], and then press the [🔍] button.
- Once the movie is saved, [Saved] is displayed.

## 5 Play the movie.

- Choose [Play Back Movie] on the screen in step 1 to view a list of movies you have created.
- Choose the movie to play and press the [🔍] button.



- To play the selected clip, move the zoom lever toward [🔍] on the screen in step 2.
- To rearrange clips, press the [▼] button on the screen in step 2, select a clip, press the [🔍] button, press the [◀] [▶] buttons or turn the [🔍] dial, and then press the [🔍] button again.
- To apply a color effect, choose [Change Color Effect] on the screen in step 3.
- Choosing [Music Settings] on the screen in step 3 will allow you to add BGM (📖109).
- The movie is saved with an image quality of [EHD].
- Use a fully charged battery pack, if possible.

Before Use

Basic Guide

Advanced Guide

Camera Basics

Auto Mode / Hybrid Auto Mode

Other Shooting Modes

P Mode

Tv, Av, and M Mode

Playback Mode

Wi-Fi Functions

Setting Menu

Accessories

Appendix

Index



## Wi-Fi Functions

Send images wirelessly from the camera to a variety of compatible devices, and use the camera with Web services



- Before using Wi-Fi, be sure to read "Wi-Fi (Wireless LAN) Precautions" (183).

## Available Wi-Fi Features

You can send and receive images and control the camera remotely by connecting it to these devices and services via Wi-Fi.

- **Smartphones and Tablets**  
Send images to smartphones and tablet computers that have Wi-Fi functions. You can also shoot remotely and geotag your shots from a smartphone or tablet.  
For convenience in this manual, smartphones, tablets, and other compatible devices are collectively referred to as "smartphones".
- **Computer**  
Use software to save camera images to a computer connected via Wi-Fi.
- **Web Services**  
Add your account information to the camera for CANON iMAGE GATEWAY online photography service or other Web services to send camera images to the services. Unsent images on the camera can also be sent to a computer or Web service via CANON iMAGE GATEWAY.
- **Printers**  
Send images wirelessly to a PictBridge-compatible printer (supporting DPS over IP) to print them.
- **Another Camera**  
Send images wirelessly between Wi-Fi compatible Canon cameras.

Before Use

Basic Guide

Advanced Guide

Camera Basics

Auto Mode /  
Hybrid Auto Mode

Other Shooting Modes

P Mode

Tv, Av, and M Mode

Playback Mode

Wi-Fi Functions

Setting Menu

Accessories

Appendix

Index





## Sending Images to a Smartphone

There are several ways to connect the camera to a smartphone and send images.

- Connect via NFC (📖113)  
Simply touch an NFC-compatible Android smartphone (OS version 4.0 or later) against the camera to connect the devices.
- Use the Wi-Fi menu to connect (📖116)  
You can connect the camera to a smartphone as you would connect it to a computer or other device. Multiple smartphones can be added.

Before connecting to the camera, you must install the free dedicated Camera Connect app on the smartphone. For details on this application (supported smartphones and included functions), refer to the Canon website.



- If you own a Wi-Fi compatible Canon camera and your camera and smartphone are connected to Wi-Fi, it is recommended that you change the app that you use on your smartphone from "CameraWindow" to "Camera Connect".

## Sending Images to an NFC-Compatible Smartphone

Using an NFC-compatible Android smartphone (OS version 4.0 or later) simplifies the process of installing Camera Connect and connecting the devices via NFC.

Operation once the devices are connected via NFC varies depending on the camera mode when the devices are touched together.

- If the camera is off or in Shooting mode when the devices are touched together, you can choose and send images on the image selection screen. Once the devices are connected, you can also shoot remotely and geotag your shots (📖135). It's easy to reconnect to recent devices, which are listed in the Wi-Fi menu.
- When you touch the smartphone in Playback mode, the screen with a list of images that you can choose to send is displayed. Choose an image to send it.

Follow the instructions in the following section for NFC-initiated connection to a camera that is off or in Shooting mode.

### Connecting via NFC When Camera Is Off or in Shooting Mode

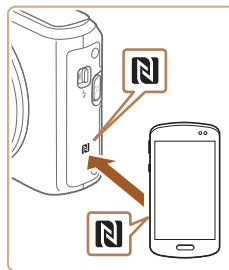

#### 1 Install Camera Connect.

- Activate NFC on the smartphone and touch the device against the camera's N-Mark (N) to start Google Play on the smartphone automatically. Once the Camera Connect download page is displayed, download and install the app.

Before Use

Basic Guide

Advanced Guide

Camera Basics

Auto Mode /  
Hybrid Auto Mode

Other Shooting Modes

P Mode

Tv, Av, and M Mode

Playback Mode

Wi-Fi Functions

Setting Menu

Accessories

Appendix

Index



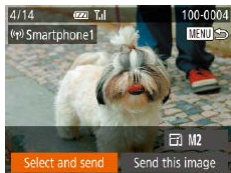
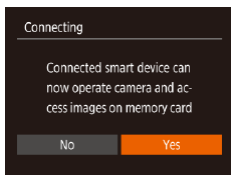
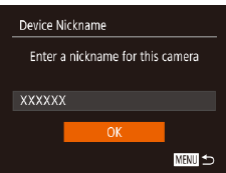

## 2 Establish the connection.

- Make sure the camera is off or in Shooting mode.
- Touch the N-Mark (N) on the smartphone with Camera Connect installed against the camera's N-Mark.
- The camera starts up automatically.
- If the [Device Nickname] screen is displayed, press the [▲][▼] buttons or turn the [DISP] dial to choose [OK], and then press the [MENU] button.

- Camera Connect is started on the smartphone.
- The devices are connected automatically.

## 3 Adjust the privacy setting.

- When this screen is displayed, press the [◀][▶] buttons or turn the [DISP] dial to choose [Yes], and then press the [MENU] button.
- You can now use the smartphone to browse, import, or geotag images on the camera or shoot remotely.

## 4 Send images.

- Press the [▲][▼][◀][▶] buttons or turn the [DISP] dial to choose [Select and send], and then press the [MENU] button.
- Press the [▲][▼] buttons or turn the [DISP] dial and select [Select], and then press the [MENU] button.

- Press the [▲][▼][◀][▶] buttons or turn the [DISP] dial to choose an image to send, press the [MENU] button to mark it as selected (✓), and then press the [MENU] button.
- Press the [◀][▶] buttons or turn the [DISP] dial to choose [OK], and then press the [MENU] button.
- Press the [▲][▼][◀][▶] buttons or turn the [DISP] dial to choose [Send], and then press the [MENU] button.
- [Transfer completed] is displayed after the image is sent, and the image transfer screen is displayed again.
- To end the connection, press the [MENU] button, choose [OK] on the confirmation screen (either press the [◀][▶] buttons or turn the [DISP] dial), and then press the [MENU] button. You can also use the smartphone to end the connection.

Before Use
Basic Guide
Advanced Guide
Camera Basics
Auto Mode / Hybrid Auto Mode
Other Shooting Modes
P Mode
Tv, Av, and M Mode
Playback Mode
Wi-Fi Functions
Setting Menu
Accessories
Appendix
Index

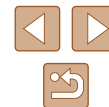



- When using NFC, keep the following points in mind.
  - Avoid strong impact between the camera and smartphone. This may damage the devices.
  - Depending on the smartphone, the devices may not recognize each other immediately. In this case, try holding the devices together in slightly different positions. If connection is not established, keep the devices together until the camera screen is updated.
  - If you try to connect while the camera is off, a message will be displayed on your smartphone to ask you to turn the camera on. Touch and try again after the camera is turned on.
  - Do not place other objects between the camera and smartphone. Also, note that camera or smartphone covers or similar accessories may block communication.
- All images in the camera can be viewed from the connected smartphone when you choose [Yes] in step 3. To keep camera images private, so that they cannot be viewed from the smartphone, choose [No] in step 3.
- Once you have registered a smartphone, you can change privacy settings for it on the camera (137).



- Connections require that a memory card be in the camera.
- You can change the nickname of the camera displayed on the screen of step 2 (137).
- Not all NFC-compatible smartphones have an N-Mark (N). For details, refer to the smartphone user manual.
- You can also send multiple images at once and change the image size before sending (131).
- You can send the current image by choosing [Send this image] on the screen in step 4.
- To disable NFC connections, choose MENU (29) > [Wi-Fi] tab > [Wireless settings] > [Wi-Fi Settings] > [NFC] > [Off].

## Connecting via NFC When Camera Is in Playback Mode



- Press the [▶] button to turn the camera on.
- Touch the N-Mark (N) on the smartphone (113) with Camera Connect installed against the camera's N-Mark.
- Press the [▲][▼][◀][▶] buttons or turn the [●] dial to choose an image to send, and then press the [⊕] button. [✓] is displayed.
- To untag the image, press the [⊕] button again. [✓] is no longer displayed.
- Repeat this process to choose additional images.
- After you finish choosing images, press the [MENU] button.
- Press the [◀][▶] buttons to choose [OK], and then press the [⊕] button.
- Press the [▲][▶][▼][◀] buttons or turn the [●] dial to choose [Send], and then press the [⊕] button.
- The images are sent.



- If a message is displayed on the camera and requests you to enter the nickname during connection, follow step 2 in "Sending Images to an NFC-Compatible Smartphone" (113) to enter it.
- The camera does not keep a record of smartphones you connect to via NFC in Playback mode.
- You can preset images to transfer at your desired size (131).

Before Use

Basic Guide

Advanced Guide

Camera Basics

Auto Mode / Hybrid Auto Mode

Other Shooting Modes

P Mode

Tv, Av, and M Mode

Playback Mode

Wi-Fi Functions

Setting Menu

Accessories

Appendix

Index



## Adding a Smartphone

These steps show how to use the camera as an access point, but you can also use an existing access point (📖 118).



### 1 Install Camera Connect.

- For an iPhone and iPad, find Camera Connect in the App Store and download and install the app.
- For Android smartphones, find Camera Connect in Google Play and download and install the app.



### 2 Access the Wi-Fi menu.

- Press the [Wi-Fi] button.
- If the [Device Nickname] screen is displayed, choose [OK] (📖 114).

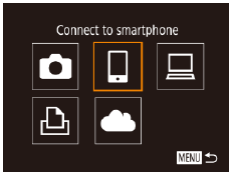

### 3 Choose [Smartphone].

- Press the [Up][Down][Left][Right] buttons or turn the [Dial] to choose [Smartphone], and then press the [OK] button.

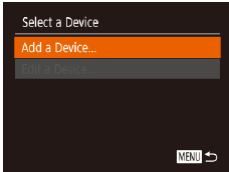

### 4 Choose [Add a Device].

- Press the [Up][Down] buttons or turn the [Dial] to choose [Add a Device], and then press the [OK] button.

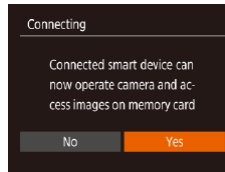
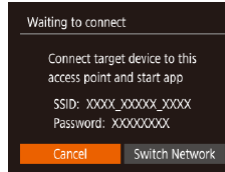

- The camera's SSID and password are displayed.

### 5 Connect the smartphone to the network.

- In the smartphone's Wi-Fi setting menu, choose the SSID (network name) displayed on the camera to establish a connection.
- In the password field, enter the password displayed on the camera.

### 6 Start Camera Connect.

- Start Camera Connect on the smartphone.

### 7 Choose the camera to connect.

- When the screen for choosing the target camera is displayed on your smartphone, choose the camera to pair them.

### 8 Adjust the privacy setting.

- Press the [Left][Right] buttons or turn the [Dial] to choose [Yes], and then press the [OK] button.
- You can now use the smartphone to browse, import, or geotag images on the camera or shoot remotely.

Before Use

Basic Guide

Advanced Guide

Camera Basics

Auto Mode / Hybrid Auto Mode

Other Shooting Modes

P Mode

Tv, Av, and M Mode

Playback Mode

Wi-Fi Functions

Setting Menu

Accessories

Appendix

Index

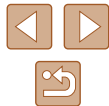

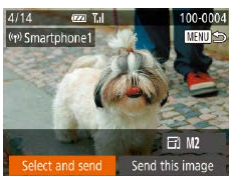

## 9 Send images.

- Press the [▲][▼][◀][▶] buttons or turn the [DISP] dial to choose [Select and send], and then press the [DISP] button.
- Press the [▲][▼] buttons or turn the [DISP] dial and select [Select], and then press the [DISP] button.
- Press the [▲][▼][◀][▶] buttons or turn the [DISP] dial to choose an image to send, press the [DISP] button to mark it as selected ([✓]), and then press the [MENU] button.
- Press the [◀][▶] buttons or turn the [DISP] dial to choose [OK], and then press the [DISP] button.
- Press the [▲][▼][◀][▶] buttons or turn the [DISP] dial to choose [Send], and then press the [DISP] button.
- [Transfer completed] is displayed after the image is sent, and the image transfer screen is displayed again.
- To end the connection, press the [MENU] button, choose [OK] on the confirmation screen (either press the [◀][▶] buttons or turn the [DISP] dial), and then press the [DISP] button. You can also use the smartphone to end the connection.
- To add multiple smartphones, repeat the above procedure starting from step 1.



- All images in the camera can be viewed from the connected smartphone when you choose [Yes] in step 8. To keep camera images private, so that they cannot be viewed from the smartphone, choose [No] in step 8.
- Once you have registered a smartphone, you can change privacy settings for it on the camera (137).



- Connections require that a memory card be in the camera.
- Once you have connected to devices via the Wi-Fi menu, recent destinations will be listed first when you access the Wi-Fi menu. You can easily connect again by pressing the [▲][▼] buttons to choose the device and then pressing the [DISP] button. To add a new device, display the device selection screen by pressing the [◀][▶] buttons, and then configure the setting.
- If you prefer not to display recent target devices, choose MENU (29) > [Wi-Fi] tab > [Wireless settings] > [Wi-Fi Settings] > [Target History] > [Off].
- To be able to connect without entering the password in step 5 and to make it so that [Password] does not display on the SSID display screen (step 4), choose MENU (29) > [Wi-Fi] tab > [Wireless settings] > [Wi-Fi Settings] > [Password] > [Off].
- You can also send multiple images at once and change the image size before sending (131).
- You can send the current image by choosing [Send this image] on the screen in step 9.

Before Use
Basic Guide
Advanced Guide
Camera Basics
Auto Mode / Hybrid Auto Mode
Other Shooting Modes
P Mode
Tv, Av, and M Mode
Playback Mode
Wi-Fi Functions
Setting Menu
Accessories
Appendix
Index



## Using Another Access Point

When connecting the camera to a smartphone through the Wi-Fi menu, you can also use an existing access point.

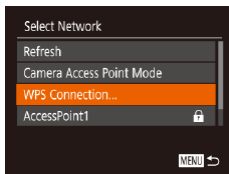
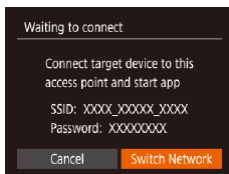

### 1 Prepare for the connection.

- Access the [Waiting to connect] screen by following steps 1 – 4 in “Adding a Smartphone” (📖116).

### 2 Connect the smartphone to the access point.

### 3 Choose [Switch Network].

- Press the [◀][▶] buttons or turn the [🔊] dial to choose [Switch Network], and then press the [🔊] button.
- A list of detected access points will be displayed.

### 4 Connect to the access point.

- For WPS-compatible access points, follow steps 5 – 8 in “Using WPS-Compatible Access Points” (📖121) to connect to the access point.
- For non-WPS access points, follow steps 2 – 4 in “Connecting to Listed Access Points” (📖123) to connect to the access point.



### 5 Choose the camera to connect.

- Once the screen to choose the camera to connect to is displayed on the smartphone, choose the camera and pair it to the smartphone.

### 6 Configure the privacy settings and send images.

- Follow steps 8 – 9 in “Adding a Smartphone” (📖116) to configure the privacy settings and send images.

## Previous Access Points

You can reconnect to any previous access points automatically by following step 4 in “Adding a Smartphone” (📖116).

- To use the camera as an access point, choose [Switch Network] on the screen displayed when you establish a connection, and then choose [Camera Access Point Mode].
- To switch access points, choose [Switch Network] on the screen displayed when you establish a connection, and then follow the procedure in “Using Another Access Point” (📖118) from step 4.

Before Use

Basic Guide

Advanced Guide

Camera Basics

Auto Mode /  
Hybrid Auto Mode

Other Shooting Modes

P Mode

Tv, Av, and M Mode

Playback Mode

Wi-Fi Functions

Setting Menu

Accessories

Appendix

Index



## Saving Images to a Computer

### Preparing to Register a Computer

For detailed system requirements, such as about computers that can connect to the camera and Wi-Fi, and compatibility information, including support in new operating systems, visit the Canon website.



- Windows 7 Starter and Home Basic editions are not supported.
- Windows 7 N (European version) and KN (South Korean version) require a separate download and installation of Windows Media Feature Pack.

For details, check the following website.

<http://go.microsoft.com/fwlink/?LinkId=159730>

### Installing the Software

Windows 7 and Mac OS X 10.8 are used here for the sake of illustration.

#### 1 Download the software.

- With a computer connected to the Internet, access the following website.

<http://www.canon.com/icpd/>

- Choose the country/area where you live, and then follow the on-screen instructions to download the software.
- The software will be downloaded to your computer in a zipped format.



#### 2 Install the software.

- Click [Easy Installation] and follow the on-screen instructions to complete the installation process.
- Installation may take some time, depending on computer performance and the Internet connection.
- Click [Finish] or [Restart] on the screen after installation.



- Internet access is required, and any ISP account charges and access fees must be paid separately.



- Use the following procedure to uninstall (delete) the software.
  - If using Windows, click the [Start] menu > [All Programs] > [Canon Utilities], and choose the software that you want to uninstall.
  - If using Mac OS, click the [Applications] folder > [Canon Utilities], and then move the folder of the software that you want to uninstall to the Trash. Empty the Trash.

Before Use

Basic Guide

Advanced Guide

Camera Basics

Auto Mode /  
Hybrid Auto Mode

Other Shooting Modes

P Mode

Tv, Av, and M Mode

Playback Mode

Wi-Fi Functions

Setting Menu

Accessories

Appendix

Index



## ■ Configuring the Computer for a Wi-Fi Connection (Windows Only)

On a computer running Windows, configure the following settings before connecting the camera to the computer wirelessly.



### 1 Confirm that the computer is connected to an access point.

- For instructions on checking your network connection, refer to the computer user manual.

### 2 Configure the setting.

- Click in the following order: [Start] menu > [All Programs] > [Canon Utilities] > [CameraWindow] > [Wi-Fi connection setup].
- In the application that opens, follow the on-screen instructions and configure the setting.



- The following Windows settings are configured when you run the utility in step 2.
  - Turn on media streaming.  
This will enable the camera to see (find) the computer to access via Wi-Fi.
  - Turn on network discovery.  
This will enable the computer to see (find) the camera.
  - Turn on ICMP (Internet Control Message Protocol).  
This allows you to check the network connection status.
  - Enable Universal Plug & Play (UPnP).  
This will enable network devices to detect each other automatically.
- Some security software may prevent you from completing the settings as described here. Check the settings of your security software.

## Saving Images to a Connected Computer

Connect to your access point via Wi-Fi as follows.  
Also refer to the access point user manual.

### ■ Confirming Access Point Compatibility

Confirm that the Wi-Fi router or base station conforms to the Wi-Fi standards in “Camera” (📖177).  
Connection methods vary depending on whether the access point supports Wi-Fi Protected Setup (WPS, 📖121) or not (📖123). For non-WPS access points, check the following information.

- Network name (SSID/ESSID)  
The SSID or ESSID for the access point you use. Also called the “access point name” or “network name”.
- Network authentication / data encryption (encryption method / encryption mode)  
The method for encrypting data during wireless transmission. Check which security setting is used: WPA2-PSK (AES), WPA2-PSK (TKIP), WPA-PSK (AES), WPA-PSK (TKIP), WEP (open system authentication), or no security.
- Password (encryption key / network key)  
The key used when encrypting data during wireless transmission. Also called the “encryption key” or “network key”.
- Key index (transmit key)  
The key set when WEP is used for network authentication / data encryption. Use “1” as the setting.



- If system administrator status is needed to adjust network settings, contact the system administrator for details.
- These settings are very important for network security. Exercise adequate caution when changing these settings.

Before Use

Basic Guide

Advanced Guide

Camera Basics

Auto Mode / Hybrid Auto Mode

Other Shooting Modes

P Mode

Tv, Av, and M Mode

Playback Mode

Wi-Fi Functions

Setting Menu

Accessories

Appendix

Index







- For information on WPS compatibility and for instructions on checking settings, refer to the access point user manual.
- A router is a device that creates a network (LAN) structure for connecting multiple computers. A router that contains an internal Wi-Fi function is called a “Wi-Fi router”.
- This guide refers to all Wi-Fi routers and base stations as “access points”.
- If you use MAC address filtering on your Wi-Fi network, be sure to add the camera’s MAC address to your access point. You can check your camera’s MAC address by choosing MENU (29) > [Wi-Fi] tab > [Wireless settings] > [Wi-Fi Settings] > [Check MAC Address].

## Using WPS-Compatible Access Points

WPS makes it easy to complete settings when connecting devices over Wi-Fi. You can use either Push Button Configuration Method or PIN Method for settings on a WPS supported device.

### 1 Confirm that the computer is connected to an access point.

- For instructions on checking the connection, refer to the device and access point user manuals.

### 2 Access the Wi-Fi menu.

- Press the [Wi-Fi] button.
- If the [Device Nickname] screen is displayed, press the [▲][▼] buttons or turn the [Dial] dial to choose [OK], and then press the [MENU] button.

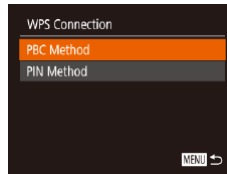
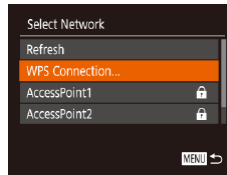
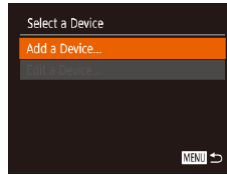
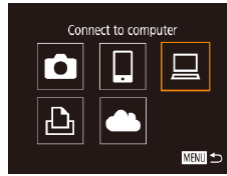
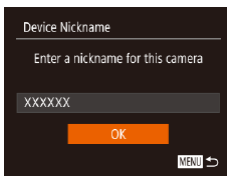

### 3 Choose [Laptop].

- Press the [▲][▼][◀][▶] buttons or turn the [Dial] dial to choose [Laptop], and then press the [MENU] button.

### 4 Choose [Add a Device].

- Press the [▲][▼] buttons or turn the [Dial] dial to choose [Add a Device], and then press the [MENU] button.

### 5 Choose [WPS Connection].

- Press the [▲][▼] buttons or turn the [Dial] dial to choose [WPS Connection], and then press the [MENU] button.

### 6 Choose [PBC Method].

- Press the [▲][▼] buttons or turn the [Dial] dial to choose [PBC Method], and then press the [MENU] button.

### 7 Establish the connection.

- On the access point, hold down the WPS connection button for a few seconds.

Before Use
Basic Guide
Advanced Guide
Camera Basics
Auto Mode / Hybrid Auto Mode
Other Shooting Modes
P Mode
Tv, Av, and M Mode
Playback Mode
Wi-Fi Functions
Setting Menu
Accessories
Appendix
Index

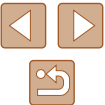

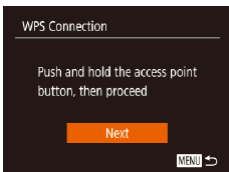

- On the camera, press the [WPS] button to go to the next step.
- The camera connects to the access point and lists devices connected to it on the [Select a Device] screen.

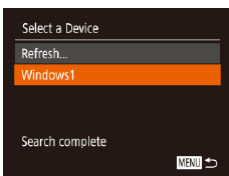

## 8 Choose the target device.

- Choose the target device name (either press the [▲][▼] buttons or turn the [DISP] dial), and then press the [OK] button.



## 9 Install a driver (first Windows connection only).

- When this screen is displayed on the camera, click the Start menu on the computer, click [Control Panel], and then click [Add a device].

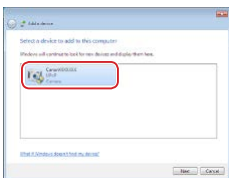
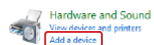

- Double-click the connected camera icon.
- Driver installation will begin.
- After driver installation is complete, and the camera and computer connection is enabled, the AutoPlay screen will be displayed. Nothing will be displayed on the camera screen.

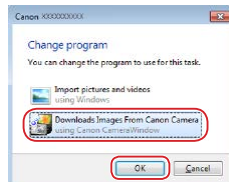

## 10 Display CameraWindow.

- Windows: Access CameraWindow by clicking [Downloads Images From Canon Camera].
- Mac OS: CameraWindow is automatically displayed when a Wi-Fi connection is established between the camera and computer.

## 11 Import images.

- Click [Import Images from Camera], and then click [Import Untransferred Images].
- Images are now saved to the Pictures folder on the computer, in separate folders named by date.
- Click [OK] in the screen that is displayed after image import is complete.
- To look at a image saved on your computer, use a software (such as one installed on your computer by default or general software) that supports images shot with a camera.

Before Use
Basic Guide
Advanced Guide
Camera Basics
Auto Mode / Hybrid Auto Mode
Other Shooting Modes
P Mode
Tv, Av, and M Mode
Playback Mode
Wi-Fi Functions
Setting Menu
Accessories
Appendix
Index





- Once you have connected to devices via the Wi-Fi menu, recent destinations will be listed first when you access the Wi-Fi menu. You can easily connect again by pressing the [▲][▼] buttons to choose the device and then pressing the [⊞] button. To add a new device, display the device selection screen by pressing the [◀][▶] buttons, and then configure the setting.
- If you prefer not to display recent target devices, choose MENU [ⓘ29] > [↑] tab > [Wireless settings] > [Wi-Fi Settings] > [Target History] > [Off].
- You can change the nickname of the camera displayed on the screen of step 2 (ⓘ138).
- When the camera is connected to a computer, the camera screen is blank.
- Mac OS: If CameraWindow is not displayed, click the [CameraWindow] icon in the Dock.
- To disconnect from the camera, turn off the camera.
- If you chose [PIN Method] in step 6, a PIN code will be displayed on the screen. Be sure to set this code in the access point. Choose a device in the [Select a Device] screen. For further details, refer to the user manual included with your access point.

## Connecting to Listed Access Points

### 1 View the listed access points.

- View the listed networks (access points) as described in steps 1 – 4 of “Using WPS-Compatible Access Points” (ⓘ121).

### 2 Choose an access point.

- Press the [▲][▼] buttons or turn the [⊞] dial to choose a network (access point), and then press the [⊞] button.

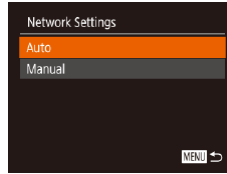
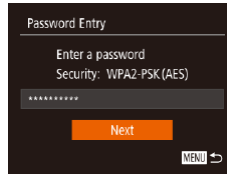
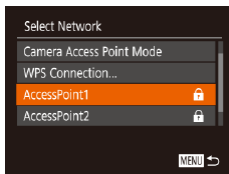

### 3 Enter the access point password.

- Press the [⊞] button to access the keyboard, and then enter the password (ⓘ30).
- Press the [▲][▼] buttons or turn the [⊞] dial to choose [Next], and then press the [⊞] button.

### 4 Choose [Auto].

- Press the [▲][▼] buttons or turn the [⊞] dial to choose [Auto], and then press the [⊞] button.
- To save images to a connected computer, follow the procedure from step 8 in “Using WPS-Compatible Access Points” (ⓘ121).



- To determine the access point password, check on the access point itself or refer to the user manual.
- If no access points are detected even after you choose [Refresh] in step 2 to update the list, choose [Manual Settings] in step 2 to complete access point settings manually. Follow on-screen instructions and enter an SSID, security settings, and a password.
- When you use an access point that you have already connected to for connecting to another device, [\*] is displayed for the password in step 3. To use the same password, choose [Next] (either press the [▲][▼] buttons or turn the [⊞] dial) and press the [⊞] button.

Before Use

Basic Guide

Advanced Guide

Camera Basics

Auto Mode /  
Hybrid Auto Mode

Other Shooting Modes

P Mode

Tv, Av, and M Mode

Playback Mode

Wi-Fi Functions

Setting Menu

Accessories

Appendix

Index



## Previous Access Points

You can reconnect to any previous access points automatically by following step 4 in “Using WPS-Compatible Access Points” (📖121).

- To reconnect to the access point, confirm that the target device is already connected to it, and then follow the procedure from step 8 in “Using WPS-Compatible Access Points” (📖121).
- To switch access points, choose [Switch Network] on the screen displayed when you establish a connection, and then either follow the procedure in “Using WPS-Compatible Access Points” (📖121) from step 5 or the procedure in “Connecting to Listed Access Points” (📖123) from step 2.

## Sending Images to a Registered Web Service

### Registering Web Services

Use a smartphone or computer to add to the camera Web services that you want to use.

- A smartphone or computer with a browser and Internet connection is required to complete camera settings for CANON iMAGE GATEWAY and other Web services.
- Check the CANON iMAGE GATEWAY website for details on browser (Microsoft Internet Explorer, etc.) requirements, including settings and version information.
- For information on countries and regions where CANON iMAGE GATEWAY is available, visit the Canon website (<http://www.canon.com/cig/>).
- You must have an account with Web services other than CANON iMAGE GATEWAY if you desire to use them. For further details, check the websites for each Web service you want to register.
- Separate ISP connection and access point fees may be applicable.



- You can also download the user manual from CANON iMAGE GATEWAY.

Before Use

Basic Guide

Advanced Guide

Camera Basics

Auto Mode /  
Hybrid Auto Mode

Other Shooting Modes

P Mode

Tv, Av, and M Mode

Playback Mode

Wi-Fi Functions

Setting Menu

Accessories

Appendix

Index



## Registering CANON iIMAGE GATEWAY

To link the camera and CANON iIMAGE GATEWAY, add CANON iIMAGE GATEWAY as a destination Web service on the camera. By setting this, an e-mail notification for Camera Web Link Settings will be sent, so you must use the e-mail address that you use on your computer or smartphone.



### 1 Access the Wi-Fi menu.

- Press the **[Wi-Fi]** button.
- If the [Device Nickname] screen is displayed, press the **[▲]****[▼]** buttons or turn the **[DISP.]** dial to choose [OK], and then press the **[DISP.]** button.

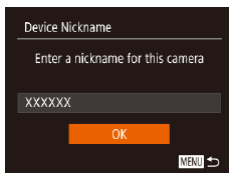

### 2 Choose [Cloud].

- Press the **[▲]****[▼]****[◀]****[▶]** buttons or turn the **[DISP.]** dial to choose **[Cloud]**, and then press the **[DISP.]** button.

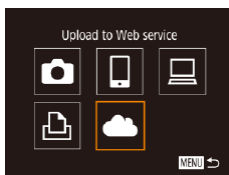

### 3 Consent to entering your e-mail address.

- Read the displayed contents, press the **[◀]****[▶]** buttons or turn the **[DISP.]** dial to choose [I Agree], and then press the **[DISP.]** button.

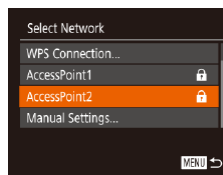
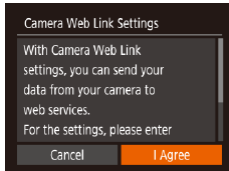

### 4 Establish a connection with an access point.

- Connect to the access point as described in steps 5 – 7 in “Using WPS-Compatible Access Points” (121) or in steps 2 – 4 in “Connecting to Listed Access Points” (123).

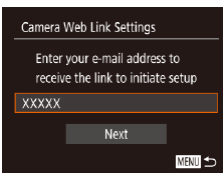

### 5 Enter your e-mail address.

- Once the camera is connected to CANON iIMAGE GATEWAY via the access point, a screen is displayed for entering an e-mail address.
- Enter your e-mail address, press the **[▲]****[▼]** buttons or turn the **[DISP.]** dial to choose [Next], and then press the **[DISP.]** button.

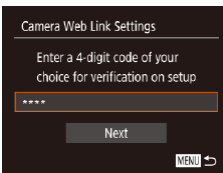

### 6 Enter a four-digit number.

- Enter any four-digit number, press the **[▲]****[▼]** buttons or turn the **[DISP.]** dial to choose [Next], and then press the **[DISP.]** button.
- You will need this four-digit number later when setting up linkage with CANON iIMAGE GATEWAY in step 8.

Before Use

Basic Guide

Advanced Guide

Camera Basics

Auto Mode /  
Hybrid Auto Mode

Other Shooting Modes

P Mode

Tv, Av, and M Mode

Playback Mode

Wi-Fi Functions

Setting Menu

Accessories

Appendix

Index



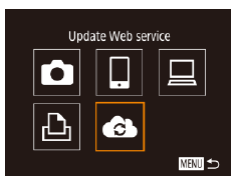
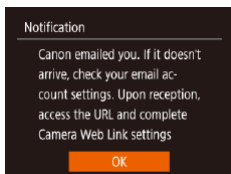

## 7 Confirm the e-mail notification was sent.

- When information is sent from CANON iMAGE GATEWAY, an e-mail notification is sent to the e-mail address you entered in step 5.
- The screen notifying you that the e-mail notification was sent is displayed. Press the [OK] button.
- The [☁] icon changes to [☁].

## 8 Access the URL in the received e-mail notification and set the camera web link.

- From a computer or smartphone, access the page linked in the notification message.
- Follow the directions on the Camera Web Link Settings page to configure the settings.

## 9 Set CANON iMAGE GATEWAY on the camera.

- Press the [▲][▼][◀][▶] buttons or turn the [DISP] dial to choose [☁], and then press the [OK] button.
- [☁] (📖 133) and CANON iMAGE GATEWAY are now added as destinations.
- You can also add other Web services. To add other Web services, follow the procedure in “Registering Other Web Services” (📖 126) from step 2.



- Depending on your e-mail settings on your computer or smartphone, e-mail from specific domains may be rejected, and you may not be able to receive the e-mail notification. Please check your settings ahead of time.



- You can change the nickname of the camera displayed on the screen of step 1 (📖 125).
- Once you have connected to devices via the Wi-Fi menu, recent destinations will be listed first when you access the menu. Press the [◀][▶] buttons to access the device selection screen and then configure the setting.

## Registering Other Web Services

You can also add Web services besides CANON iMAGE GATEWAY to the camera.



### 1 Log in to CANON iMAGE GATEWAY and access the Camera Web Link Settings page.

- From a computer or smartphone, access <http://www.canon.com/cig/> to visit CANON iMAGE GATEWAY.

### 2 Configure the Web service you want to use.

- Using your computer or smartphone, display the Web service settings screen.
- Follow the instructions displayed on the screen to set up the Web service.

Before Use
Basic Guide
Advanced Guide
Camera Basics
Auto Mode / Hybrid Auto Mode
Other Shooting Modes
P Mode
Tv, Av, and M Mode
Playback Mode
Wi-Fi Functions
Setting Menu
Accessories
Appendix
Index



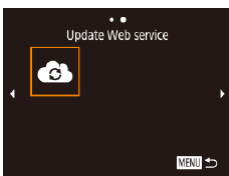

### 3 Choose [Cloud].

- Press the [Fn] button.
- Press the [▲][▼][◀][▶] buttons or turn the [DIAL] dial to choose [Cloud], and then press the [OK] button.
- The Web service settings are now updated.



- If any configured settings change, follow these steps again to update the camera settings.

## Uploading Images to Web Services



### 1 Access the Wi-Fi menu.

- Press the [Fn] button.



### 2 Choose the destination.

- Press the [▲][▼][◀][▶] buttons or turn the [DIAL] dial, and choose the icon of the Web service to connect to target device, and then press the [OK] button.
- If multiple recipients or sharing options are used with a Web service, choose the desired item on the [Select Recipient] screen (either press the [▲][▼] buttons or turn the [DIAL] dial), and then press the [OK] button.



### 3 Send images.

- Press the [▲][▼][◀][▶] buttons or turn the [DIAL] dial to choose [Select and send], and then press the [OK] button.
- Press the [▲][▼] buttons or turn the [DIAL] dial and select [Select], and then press the [OK] button.
- Press the [▲][▼][◀][▶] buttons or turn the [DIAL] dial to choose an image to send, press the [OK] button to mark it as selected ([✓]), and then press the [MENU] button.
- Press the [◀][▶] buttons or turn the [DIAL] dial to choose [OK], and then press the [OK] button.
- Press the [▲][▼][◀][▶] buttons or turn the [DIAL] dial to choose [Send], and then press the [OK] button.
- When uploading to YouTube, read the terms of service, choose [I Agree], and press the [OK] button.
- After the image is sent, [OK] is displayed on the screen. Press the [OK] button to return to the playback screen.



- Connections require that a memory card with saved images be in the camera.
- You can also send multiple images at once, resize images, and add comments before sending (131).
- You can send the current image by choosing [Send this image] on the screen in step 3.
- To look at images sent to CANON IMAGE GATEWAY from your smartphone, it is recommended that you use the specialized application Canon Online Photo Album. For iPhone and iPad, find Canon Online Photo Album in the App Store and download and install the app. For Android smartphones, find Canon Online Photo Album in Google Play and download and install the app.

Before Use
Basic Guide
Advanced Guide
Camera Basics
Auto Mode / Hybrid Auto Mode
Other Shooting Modes
P Mode
Tv, Av, and M Mode
Playback Mode
Wi-Fi Functions
Setting Menu
Accessories
Appendix
Index



# Printing Images Wirelessly from a Connected Printer

Connect the camera to a printer via Wi-Fi to print as follows. These steps show how to use the camera as an access point, but you can also use an existing access point (📖118).



## 1 Access the Wi-Fi menu.

- Press the [Wi-Fi] button.



## 2 Choose [Print].

- Press the [▲][▼][◀][▶] buttons or turn the [Dial] to choose [Print], and then press the [OK] button.

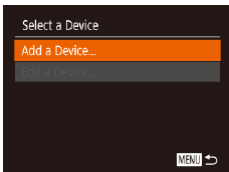

## 3 Choose [Add a Device].

- Press the [▲][▼] buttons or turn the [Dial] to choose [Add a Device], and then press the [OK] button.

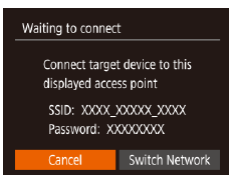

- The camera's SSID and password are displayed.

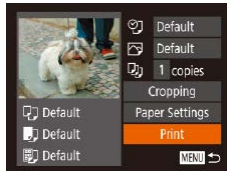
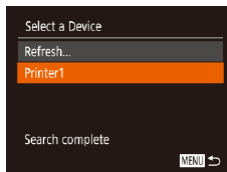

## 4 Connect the printer to the network.

- In the printer's Wi-Fi setting menu, choose the SSID (network name) displayed on the camera to establish a connection.
- In the password field, enter the password displayed on the camera.

## 5 Choose the printer.

- Choose the printer name (either press the [▲][▼] buttons or turn the [Dial], and then press the [OK] button).

## 6 Choose an image to print.

- Press the [◀][▶] buttons or turn the [Dial] to choose an image.
- Press the [OK] button, choose [Print], and press the [OK] button again.
- Press the [▲][▼] buttons or turn the [Dial] to choose [Print], and then press the [OK] button.
- For detailed printing instructions, see “Printing Images” (📖153).
- To end the connection, press the [▲] button, choose [OK] on the confirmation screen (either press the [◀][▶] buttons or turn the [Dial], and then press the [OK] button).

Before Use
Basic Guide
Advanced Guide
Camera Basics
Auto Mode / Hybrid Auto Mode
Other Shooting Modes
P Mode
Tv, Av, and M Mode
Playback Mode
Wi-Fi Functions
Setting Menu
Accessories
Appendix
Index

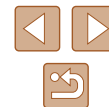





- Connections require that a memory card with saved images be in the camera.
- Once you have connected to devices via the Wi-Fi menu, recent destinations will be listed first when you access the Wi-Fi menu. You can easily connect again by pressing the [▲][▼] buttons to choose the device and then pressing the [MENU] button. To add a new device, display the device selection screen by pressing the [◀][▶] buttons, and then configure the setting.
- If you prefer not to display recent target devices, choose MENU (129) > [Wi-Fi] tab > [Wireless settings] > [Wi-Fi Settings] > [Target History] > [Off].
- To be able to connect without entering the password in step 4 and to make it so that [Password] does not display on the SSID display screen (step 3), choose MENU (129) > [Wi-Fi] tab > [Wireless settings] > [Wi-Fi Settings] > [Password] > [Off].
- To use another access point, follow steps 3 – 4 in “Using Another Access Point” (118).

## Sending Images to Another Camera

Connect two cameras via Wi-Fi and send images between them as follows.

- Only Canon-brand cameras equipped with a Wi-Fi function can be connected to wirelessly. You cannot connect to a Canon-brand camera that does not have a Wi-Fi function, even if it supports FlashAir/Eye-Fi cards.

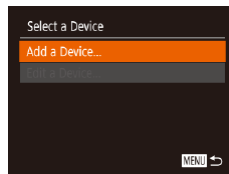
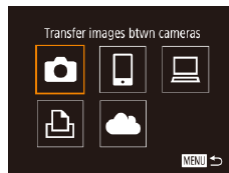

### 1 Access the Wi-Fi menu.

- Press the [Wi-Fi] button.

### 2 Choose [Camera].

- Press the [▲][▼][◀][▶] buttons or turn the [Dial] dial to choose [Camera], and then press the [MENU] button.

### 3 Choose [Add a Device].

- Press the [▲][▼] buttons or turn the [Dial] dial to choose [Add a Device], and then press the [MENU] button.
- Follow steps 1 – 3 on the target camera too.
- Camera connection information will be added when [Start connection on target camera] is displayed on both camera screens.

Before Use

Basic Guide

Advanced Guide

Camera Basics

Auto Mode /  
Hybrid Auto Mode

Other Shooting Modes

P Mode

Tv, Av, and M Mode

Playback Mode

Wi-Fi Functions

Setting Menu

Accessories

Appendix

Index

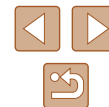

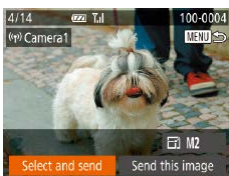

#### 4 Send images.

- Press the [▲][▼][◀][▶] buttons or turn the [DISP] dial to choose [Select and send], and then press the [DISP] button.
- Press the [▲][▼] buttons or turn the [DISP] dial and select [Select], and then press the [DISP] button.
- Press the [▲][▼][◀][▶] buttons or turn the [DISP] dial to choose an image to send, press the [DISP] button to mark it as selected ([✓]), and then press the [MENU] button.
- Press the [◀][▶] buttons or turn the [DISP] dial to choose [OK], and then press the [DISP] button.
- Press the [▲][▼][◀][▶] buttons or turn the [DISP] dial to choose [Send], and then press the [DISP] button.
- [Transfer completed] is displayed after the image is sent, and the image transfer screen is displayed again.
- To end the connection, press the [MENU] button, choose [OK] on the confirmation screen (either press the [◀][▶] buttons or turn the [DISP] dial), and then press the [DISP] button.



- Connections require that a memory card be in the camera.
- Once you have connected to devices via the Wi-Fi menu, recent destinations will be listed first when you access the Wi-Fi menu. You can easily connect again by pressing the [▲][▼] buttons to choose the device and then pressing the [DISP] button. To add a new device, display the device selection screen by pressing the [◀][▶] buttons, and then configure the setting.
- If you prefer not to display recent target devices, choose MENU (p. 29) > [Wi-Fi] tab > [Wireless settings] > [Wi-Fi Settings] > [Target History] > [Off].
- You can also send multiple images at once and change the image size before sending (p. 131).
- You can send the current image by choosing [Send this image] on the screen in step 4.

Before Use
Basic Guide
Advanced Guide
Camera Basics
Auto Mode / Hybrid Auto Mode
Other Shooting Modes
P Mode
Tv, Av, and M Mode
Playback Mode
Wi-Fi Functions
Setting Menu
Accessories
Appendix
Index



## Image Sending Options

You can choose multiple images to send at once and change the image resolution (size) before sending. Some Web services also enable you to annotate the images you send.

### Sending Multiple Images

On the image transfer screen, you can select a range of images to send, and send images tagged as favorites.

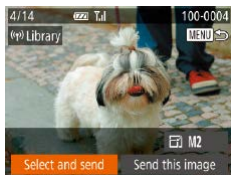

#### 1 Choose [Select and send].

- On the image transfer screen, press the [◀][▶] buttons to choose [Select and send], and then press the [OK] button.

#### 2 Choose a selection method.

- Press the [▲][▼] buttons or turn the [DISP] dial to choose a selection method.

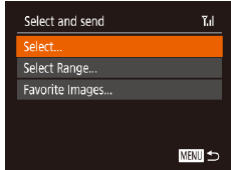

### Selecting a Range

#### 1 Choose [Select Range].

- Following step 2 in “Sending Multiple Images” (📖131), choose [Select Range] and press the [OK] button.

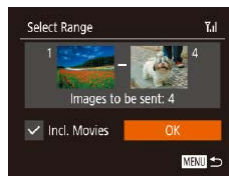

#### 2 Choose images.

- Follow steps 2 – 3 in “Selecting a Range” (📖97) to specify images.
- When sending movies as well, press the [▲][▼][◀][▶] buttons to choose [Incl. Movies], and then press the [OK] button to add [✓].
- Press the [▲][▼][◀][▶] buttons to choose [OK], and then press the [OK] button.

#### 3 Send the image.

- Press the [◀][▶] buttons or turn the [DISP] dial to choose [Send], and then press the [OK] button.

### Sending Images Tagged as Favorites

You can send images tagged as favorites (📖101).

#### 1 Choose [Favorite Images].

- Following step 2 in “Sending Multiple Images” (📖131), choose [Favorite Images] and press the [OK] button.
- The image selection screen that displays only favorite images is displayed. To make it so that an image is not sent, after choosing an image, press the [OK] button to remove [✓].
- Press the [MENU] button.

Before Use

Basic Guide

Advanced Guide

Camera Basics

Auto Mode /  
Hybrid Auto Mode

Other Shooting Modes

P Mode

Tv, Av, and M Mode

Playback Mode

Wi-Fi Functions

Setting Menu

Accessories

Appendix

Index



- Press the [◀][▶] buttons or turn the [🔍] dial to choose [OK], and then press the [📁] button.

## 2 Send the image.

- Press the [◀][▶] buttons or turn the [🔍] dial to choose [Send], and then press the [📁] button.



- If you have no images tagged as favorite, you cannot choose [Favorite Images] in step 1.

## Notes on Sending Images

- Depending on the condition of the network you are using, it may take a long time to send movies. Be sure to keep an eye on the camera battery level.
- Web services may limit the number of images or length of movies you can send.
- For movies that you do not compress (📖106), a separate, compressed file is sent instead of the original file. Note that this may delay transmission, and the file cannot be sent unless there is enough space for it on the memory card.
- When sending movies to smartphones, note that the supported image quality varies depending on the smartphone. For details, refer to the smartphone user manual.
- On the screen, wireless signal strength is indicated by the following icons.  
[📶] high, [📶] medium, [📶] low, [📶] weak
- Sending images to Web services will take less time when resending images you have already sent that are still on the CANON iMAGE GATEWAY server.

## Choosing the Number of Recording Pixels (Image Size)

On the image transfer screen, choose [📷] by pressing the [▲][▼] buttons, and then press the [📁] button. On the screen displayed, choose the resolution (image size) by pressing the [▲][▼] buttons, and then press the [📁] button.

- To send images at original size, select [No] as the resizing option.
- By choosing [M2], you can resize images that are larger than the selected size before sending.
- Movies cannot be resized.



- Image size can also be configured in MENU (📖29) > [🔧] tab > [Wireless settings] > [Wi-Fi Settings] > [Resize for Sending].

## Adding Comments

Using the camera, you can add comments to images that you send to e-mail addresses, social networking services, etc. The number of characters and symbols that can be entered may differ depending on the Web service.

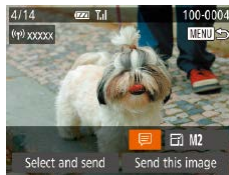

### 1 Access the screen for adding comments.

- On the image transfer screen, choose [📷] by pressing the [▲][▼][◀][▶] buttons, and then press the [📁] button.

### 2 Add a comment (📖30).

### 3 Send the image.

Before Use

Basic Guide

Advanced Guide

Camera Basics

Auto Mode /  
Hybrid Auto Mode

Other Shooting Modes

P Mode

Tv, Av, and M Mode

Playback Mode

Wi-Fi Functions

Setting Menu

Accessories

Appendix

Index





- When a comment is not entered, the comment set in CANON iIMAGE GATEWAY is automatically sent.
- You can also annotate multiple images before sending them. The same comment is added to all images sent together.

## Sending Images Automatically (Image Sync)

Images on the memory card that have not been transferred already can be sent to a computer or Web services via CANON iIMAGE GATEWAY. Note that images cannot be sent only to Web services.

### Initial Preparations

#### ■ Preparing the Camera

Register [☰] as the destination. On the destination computer, install and set up the Image Sync software “ImageTransfer Utility” (free).



#### 1 Add [☰] as a destination.

- Add [☰] as a destination, as described in “Registering CANON iIMAGE GATEWAY” (📖 125).
- When sending images to the Web Service as well, log in to CANON iIMAGE GATEWAY (📖 125). After choosing the camera model, display the Web Service settings screen. Under Image Sync settings, choose the Web service that you want to send the images to. For details, see the CANON iIMAGE GATEWAY Help.

Before Use

Basic Guide

Advanced Guide

Camera Basics

Auto Mode /  
Hybrid Auto Mode

Other Shooting Modes

P Mode

Tv, Av, and M Mode

Playback Mode

Wi-Fi Functions

Setting Menu

Accessories

Appendix

Index

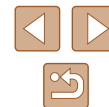

## 2 Choose the type of images to send (only when sending movies with images).

- Press the [MENU] button, choose [Wireless settings] on the [Wi-Fi] tab, and then choose [Wi-Fi Settings] (129).
- Press the [▲][▼] buttons to choose [Image Sync], and then press the [◀][▶] buttons to choose [Stills/Movies].

## ■ Preparing the Computer

Install and configure the software on the destination computer.



### 1 Install Image Transfer Utility.

- Install Image Transfer Utility on a computer connected to the Internet (151).
- You can download the Image Transfer Utility from the CANON iMAGE GATEWAY Image Sync setting screen (125).

### 2 Register the camera.

- Windows: In the taskbar, right-click [Camera icon], and then click [Add new camera].
- Mac OS: In the menu bar, click [Camera icon], and then click [Add new camera].
- A list of cameras linked to CANON iMAGE GATEWAY is displayed. Choose the camera from which images are to be sent.
- Once the camera is registered and the computer is ready to receive images, the icon changes to [Camera icon].

## Sending Images

Images sent from the camera are automatically saved to the computer. If the computer that you intend to send images to is turned off, the images will be stored temporarily on the CANON iMAGE GATEWAY server. Stored images are regularly erased, so make sure to turn on the computer and save the images.

### 1 Send images.

- Following steps 1 – 2 in “Uploading Images to Web Services” (127), choose [Send].
- Images labeled with a [Wi-Fi] icon have been transferred.

### 2 Save the images to the computer.

- Images are automatically saved to the computer when you turn it on.
- Images are automatically sent to Web services from the CANON iMAGE GATEWAY server, even if the computer is off.



- When sending images, you should use a fully charged battery pack.



- Even if images were imported to the computer through a different method, any images not sent to the computer via CANON iMAGE GATEWAY will be sent to the computer.
- Sending is faster when the destination is a computer on the same network as the camera, because images are sent via the access point instead of CANON iMAGE GATEWAY. Note that images stored on the computer are sent to CANON iMAGE GATEWAY, so the computer must be connected to the Internet.

Before Use

Basic Guide

Advanced Guide

Camera Basics

Auto Mode / Hybrid Auto Mode

Other Shooting Modes

P Mode

Tv, Av, and M Mode

Playback Mode

Wi-Fi Functions

Setting Menu

Accessories

Appendix

Index



## Viewing Images Sent via Image Sync on Your Smartphone

When you install Canon Online Photo Album (Canon OPA) on your smartphone, you can see and download images transferred with Image Sync and temporarily saved on CANON iMAGE GATEWAY.

The following preparations are required in advance.

- You must finish the setup process for “Preparing the Computer” (📖134).
- For iPhone and iPad, find Canon Online Photo Album in the App Store and download and install the app. For Android smartphones, find Canon Online Photo Album in Google Play and download and install the app.
- Log in to CANON iMAGE GATEWAY (📖125). After choosing the camera model, display the Web Service settings screen. Under Image Sync settings, change the settings so that you can view and download on your smartphone. For details, see the CANON iMAGE GATEWAY Help.



- After a fixed period of time, you will not be able to view images deleted from CANON iMAGE GATEWAY.
- To view sent images, you must first set Image Sync settings so that you can view and download images on your smartphone.



- For information on Canon Online Photo Album operations, see the Canon Online Photo Album Help.

## Using a Smartphone to View Camera Images and Control the Camera

You can do the following with the dedicated smartphone app Camera Connect.

- Browse images on the camera and save them to the smartphone
- Geotag images on the camera (📖135)
- Shoot remotely (📖136)



- Privacy settings must be configured in advance to allow image viewing on the smartphone (📖116, 📖137).

## Geotagging Images on the Camera

GPS data recorded on a smartphone using the dedicated Camera Connect application can be added to images on the camera. Images are tagged with information including the latitude, longitude, and elevation.



- Before shooting, make sure the date and time and your home time zone are set correctly, as described in “Setting the Date and Time” (📖20). Also follow the steps in “World Clock” (📖140) to specify any shooting destinations in other time zones.
- Others may be able to locate or identify you by using location data in your geotagged still images or movies. Be careful when sharing these images with others, as when posting images online where many others can view them.

Before Use

Basic Guide

Advanced Guide

Camera Basics

Auto Mode /  
Hybrid Auto Mode

Other Shooting Modes

P Mode

Tv, Av, and M Mode

Playback Mode

Wi-Fi Functions

Setting Menu

Accessories

Appendix

Index



## Shooting Remotely

As you check a shooting screen on your smartphone, you can use it to shoot remotely.

### 1 Choose a shooting mode.

- Turn the mode dial to choose mode of **[P]**, **[Tv]**, **[Av]**, or **[M]**.

### 2 Secure the camera.

- Once remote shooting begins, the camera lens will come out. Lens motion from zooming may also move the camera out of position. Keep the camera still by mounting it on a tripod or taking other measures.

### 3 Connect the camera and smartphone (📖 116).

- In the privacy settings, choose [Yes].

### 4 Choose remote shooting.

- In Camera Connect on the smartphone, choose remote shooting.
- The camera lens will come out. Do not press near the lens, and make sure no objects will obstruct it.
- Once the camera is ready for remote shooting, a live image from the camera will be displayed on the smartphone.
- At this time, a message is displayed on the camera, and all operations except pressing the power button are disabled.

### 5 Shoot.

- Use the smartphone to shoot.



- **[P]** mode is set when shooting in other than **[P]**, **[Tv]**, **[Av]**, and **[M]** modes. However, some FUNC. and MENU settings you have configured in advance may be changed automatically.
- Movie shooting is not available.



- Any jerky subject motion shown on the smartphone due to the connection environment will not affect recorded images.
- No AF frames are displayed. Capture a test image to check the focus.
- Captured images are not transferred to the smartphone. Use the smartphone to browse and import images from the camera.

Before Use

Basic Guide

Advanced Guide

Camera Basics

Auto Mode /  
Hybrid Auto Mode

Other Shooting Modes

P Mode

Tv, Av, and M Mode

Playback Mode

Wi-Fi Functions

Setting Menu

Accessories

Appendix

Index





## Editing or Erasing Wi-Fi Settings

Edit or erase Wi-Fi settings as follows.

### Editing Connection Information

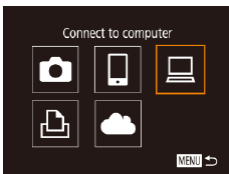

#### 1 Access the Wi-Fi menu and choose a device to edit.

- Press the  $\left[\left(\frac{1}{2}\right)\right]$  button.
- Press the  $\left[\left(\frac{1}{2}\right)\right]$  buttons or turn the  $\left[\left(\frac{1}{2}\right)\right]$  dial to choose the icon of a device to edit, and then press the  $\left[\left(\frac{1}{2}\right)\right]$  button.

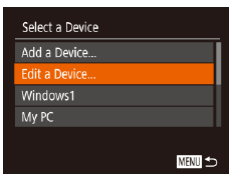

#### 2 Choose [Edit a Device].

- Press the  $\left[\left(\frac{1}{2}\right)\right]$  buttons or turn the  $\left[\left(\frac{1}{2}\right)\right]$  dial to choose [Edit a Device], and then press the  $\left[\left(\frac{1}{2}\right)\right]$  button.

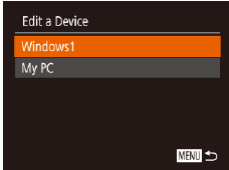

#### 3 Choose the device to edit.

- Press the  $\left[\left(\frac{1}{2}\right)\right]$  buttons or turn the  $\left[\left(\frac{1}{2}\right)\right]$  dial to choose the device to edit, and then press the  $\left[\left(\frac{1}{2}\right)\right]$  button.

#### 4 Choose the item to edit.

- Press the  $\left[\left(\frac{1}{2}\right)\right]$  buttons or turn the  $\left[\left(\frac{1}{2}\right)\right]$  dial to choose the item to edit, and then press the  $\left[\left(\frac{1}{2}\right)\right]$  button.
- The items you can change depend on the device or service.

Configurable Items	Connection				
					Web Services
[Change Device Nickname] (📖137)	○	○	○	○	–
[View Settings] (📖116)	–	○	–	–	–
[Erase Connection Info] (📖137)	○	○	○	○	–

○ : Configurable – : Not configurable

### Changing a Device Nickname

You can change the device nickname (display name) that is displayed on the camera.

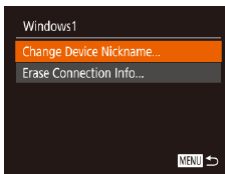

- Following step 4 in “Editing Connection Information” (📖137), choose [Change Device Nickname] and press the  $\left[\left(\frac{1}{2}\right)\right]$  button.
- Select the input field and press the  $\left[\left(\frac{1}{2}\right)\right]$  button. Use the keyboard displayed to enter a new nickname (📖30).

### Erasing Connection Information

Erase connection information (information about devices that you have connected to) as follows.

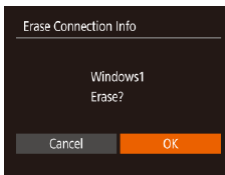

- Following step 4 in “Editing Connection Information” (📖137), choose [Erase Connection Info] and press the  $\left[\left(\frac{1}{2}\right)\right]$  button.
- After [Erase?] is displayed, press the  $\left[\left(\frac{1}{2}\right)\right]$  buttons or turn the  $\left[\left(\frac{1}{2}\right)\right]$  dial to choose [OK], and then press the  $\left[\left(\frac{1}{2}\right)\right]$  button.
- The connection information will be erased.

Before Use

Basic Guide

Advanced Guide

Camera Basics

Auto Mode / Hybrid Auto Mode

Other Shooting Modes

P Mode

Tv, Av, and M Mode

Playback Mode

Wi-Fi Functions

Setting Menu

Accessories

Appendix

Index



## Changing the Camera Nickname

You can change the nickname of the camera displayed on the connected device.

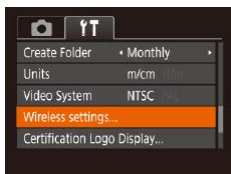

### 1 Choose [Wireless settings].

- Press the [MENU] button and choose [Wireless settings] on the [↑↑] tab (📖29).

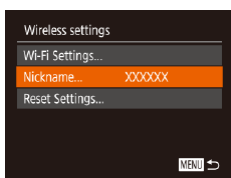

### 2 Choose [Nickname].

- Press the [▲][▼] buttons or turn the [🔘] dial to choose [Nickname], and then press the [OK] button (📖29).

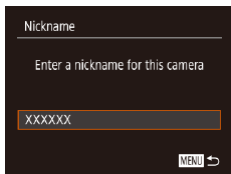

### 3 Change the device nickname.

- Press the [OK] button. Use the keyboard displayed to enter a new nickname (📖30).



- A message is displayed if the nickname you enter begins with a symbol or space. Press the [OK] button and enter a different nickname.
- On the [Device Nickname] screen displayed when using the Wi-Fi function for the first time, choose the field and press [OK] to display the keyboard. You can then enter a nickname.

## Returning the Wi-Fi Settings to Default

Return the Wi-Fi settings to default if you transfer ownership of the camera to another person, or dispose of it.

Resetting the Wi-Fi settings will also clear all Web service settings. Be sure that you want to reset all Wi-Fi settings before using this option.

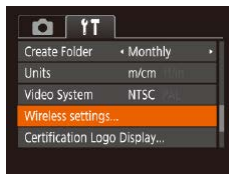

### 1 Choose [Wireless settings].

- Press the [MENU] button and choose [Wireless settings] on the [↑↑] tab (📖29).

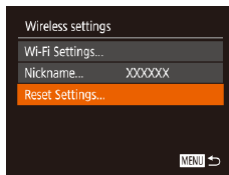

### 2 Choose [Reset Settings].

- Press the [▲][▼] buttons or turn the [🔘] dial to choose [Reset Settings], and then press the [OK] button.

### 3 Restore the default settings.

- Press the [◀][▶] buttons or turn the [🔘] dial to choose [OK], and then press the [OK] button.
- The Wi-Fi settings are now reset.



- To reset other settings (aside from Wi-Fi) to defaults, choose [Reset All] on the [↑↑] tab (📖145).

Before Use

Basic Guide

Advanced Guide

Camera Basics

Auto Mode /  
Hybrid Auto Mode

Other Shooting Modes

P Mode

Tv, Av, and M Mode

Playback Mode

Wi-Fi Functions

Setting Menu

Accessories

Appendix

Index



# Setting Menu

Customize or adjust basic camera functions for greater convenience

## Adjusting Basic Camera Functions

Basic camera functions are configured on the **[F/T]** tab of the MENU **[8]** (29). Customize commonly used functions as desired, for greater convenience.

### Silencing Camera Operations

Silence camera sounds and movies as follows.

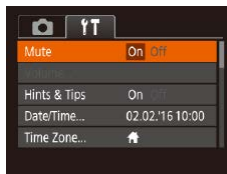

- Choose [Mute], and then choose [On].



- Operation can also be silenced by holding down the **[INFO]** button as you turn the camera on.
- Sound is not played during movies **[8]** (87) if you mute camera sounds. To restore sound during movies, press the **[▲]** button. Adjust volume with the **[▲]**/**[▼]** buttons, as needed.

### Adjusting the Volume

Adjust the volume of individual camera sounds as follows.



- Choose [Volume], and then press the **[M]** button.
- Choose an item, and then press the **[◀]**/**[▶]** buttons to adjust the volume.

Before Use

Basic Guide

Advanced Guide

Camera Basics

Auto Mode /  
Hybrid Auto Mode

Other Shooting Modes

P Mode

Tv, Av, and M Mode

Playback Mode

Wi-Fi Functions

Setting Menu

Accessories

Appendix

Index

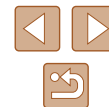

## Hiding Hints and Tips

Hints and tips are normally shown when you choose FUNC. (📖28) or MENU (📖29) items. If you prefer, you can deactivate this information.

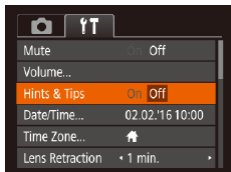

- Choose [Hints & Tips], and then choose [Off].

## Date and Time

Adjust the date and time as follows.

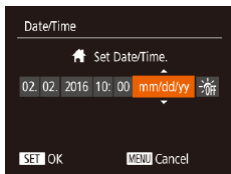

- Choose [Date/Time], and then press the [OK] button.
- Press the [◀][▶] buttons to choose an option, and then adjust the setting, either by pressing the [▲][▼] buttons or turning the [DISP] dial.

## World Clock

To ensure that your shots will have the correct local date and time when you travel abroad, simply register the destination in advance and switch to that time zone. This convenient feature eliminates the need to change the Date/Time setting manually.

Before using the world clock, be sure to set the date and time and your home time zone, as described in “Setting the Date and Time” (📖20).

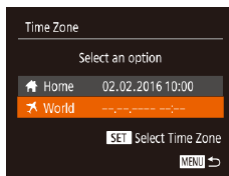

### 1 Specify your destination.

- Choose [Time Zone], and then press the [OK] button.
- Press the [▲][▼] buttons or turn the [DISP] dial to choose [World], and then press the [OK] button.
- Press the [◀][▶] buttons to choose the destination.
- To set daylight saving time (1 hour ahead), choose [DST] by pressing the [▲][▼] buttons or turning the [DISP] dial, and then choose [ON] by pressing the [◀][▶] buttons.
- Press the [OK] button.

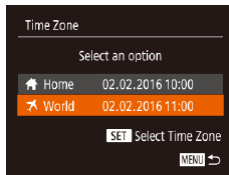

### 2 Switch to the destination time zone.

- Press the [▲][▼] buttons or turn the [DISP] dial to choose [World], and then press the [MENU] button.
- [World] is now shown on the shooting screen (📖166).



- Adjusting the date or time while in [World] mode (📖20) will automatically update your [Home] time and date.

Before Use

Basic Guide

Advanced Guide

Camera Basics

Auto Mode /  
Hybrid Auto Mode

Other Shooting Modes

P Mode

Tv, Av, and M Mode

Playback Mode

Wi-Fi Functions

Setting Menu

Accessories

Appendix

Index



## Lens Retraction Timing

The lens is normally retracted for safety about one minute after you press the [▶] button in Shooting mode (165). To have the lens retracted immediately after you press the [▶] button, set the retraction timing to [0 sec.].

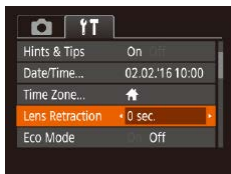

- Choose [Lens Retraction], and then choose [0 sec.].

## Using Eco Mode

This function allows you to conserve battery power in Shooting mode. When the camera is not in use, the screen quickly darkens to reduce battery consumption.

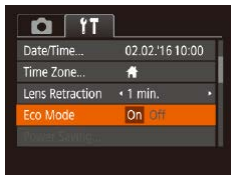

### 1 Configure the setting.

- Choose [Eco Mode], and then choose [On].
- [ECO] is now shown on the shooting screen (166).
- The screen darkens when the camera is not used for approximately two seconds; approximately ten seconds after darkening, the screen turns off. The camera turns off after approximately three minutes of inactivity.

## 2 Shoot.

- To activate the screen and prepare for shooting when the screen is off but the lens is still out, press the shutter button halfway.

## Power-Saving Adjustment

Adjust the timing of automatic camera and screen deactivation (Auto Power Down and Display Off, respectively) as needed (166).

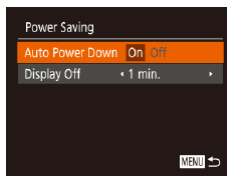

- Choose [Power Saving], and then press the [P] button.
- After choosing an item, press the [◀][▶] buttons to adjust it as needed.



- To conserve battery power, you should normally choose [On] for [Auto Power Down] and [1 min.] or less for [Display Off].



- The [Display Off] setting is applied even if you set [Auto Power Down] to [Off].
- These power-saving functions are not available when you have set Eco mode (141) to [On].

Before Use

Basic Guide

Advanced Guide

Camera Basics

Auto Mode /  
Hybrid Auto Mode

Other Shooting Modes

P Mode

Tv, Av, and M Mode

Playback Mode

Wi-Fi Functions

Setting Menu

Accessories

Appendix

Index

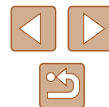

## Screen Brightness

Adjust screen brightness as follows.

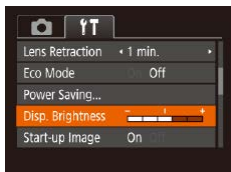

- Choose [Disp. Brightness], and then press the [◀][▶] buttons to adjust the brightness.



- For maximum brightness, press and hold the [INFO] button for at least one second when the shooting screen is displayed or when in single-image display. (This will override the [Disp. Brightness] setting on the [f/TT] tab.) To restore the original brightness, press and hold the [INFO] button again for at least one second or restart the camera.

## Hiding the Start-Up Screen

If you prefer, you can deactivate display of the start-up screen normally shown when you turn the camera on.



- Choose [Start-up Image], and then choose [Off].

## Formatting Memory Cards

Before using a new memory card or a card formatted in another device, you should format the card with this camera.

Formatting erases all data on a memory card. Before formatting, copy images on the memory card to a computer, or take other steps to back them up.

### 1 Access the [Format] screen.

- Choose [Format], and then press the [MENU] button.

### 2 Choose [OK].

- Press the [◀][▶] buttons or turn the [DISP.] dial to choose [OK], and then press the [MENU] button.

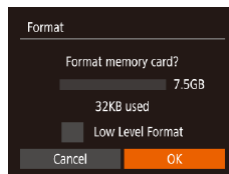

### 3 Format the memory card.

- To begin the formatting process, press the [▲][▼] buttons or turn the [DISP.] dial to choose [OK], and then press the [MENU] button.
- When formatting is finished, [Memory card formatting complete] is displayed. Press the [MENU] button.

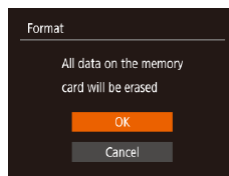

- Formatting or erasing data on a memory card only changes file management information on the card and does not erase the data completely. Be careful when transferring or disposing of memory cards. Take steps to protect personal information if necessary, as by physically destroying cards.

Before Use

Basic Guide

Advanced Guide

Camera Basics

Auto Mode /  
Hybrid Auto Mode

Other Shooting Modes

P Mode

Tv, Av, and M Mode

Playback Mode

Wi-Fi Functions

Setting Menu

Accessories

Appendix

Index





- The total card capacity indicated on the formatting screen may be less than the advertised capacity.

## Low-Level Formatting

Perform low-level formatting in the following cases: [Memory card error] is displayed, the camera is not working correctly, card image reading/writing is slower, continuous shooting is slower, or movie recording suddenly stops. Low-level formatting erases all data on a memory card. Before low-level formatting, copy images on the memory card to a computer, or take other steps to back them up.

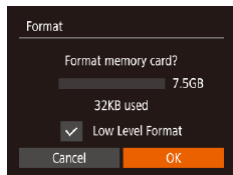

- On the screen in step 2 of “Formatting Memory Cards” (142), press the [▲][▼] buttons or turn the [DISP.] dial to choose [Low Level Format], and then press the [◀][▶] buttons to select this option. A [✓] icon is displayed.
- Follow steps 2 – 3 in “Formatting Memory Cards” (142) to continue with the formatting process.



- Low-level formatting takes longer than “Formatting Memory Cards” (142), because data is erased from all storage regions of the memory card.
- You can cancel low-level formatting in progress by choosing [Stop]. In this case, all data will be erased, but the memory card can be used normally.

## File Numbering

Your shots are automatically numbered in sequential order (0001 – 9999) and saved in folders that store up to 2,000 images each. You can change how the camera assigns file numbers.

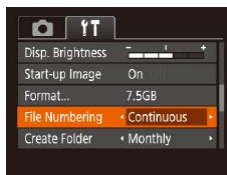

- Choose [File Numbering], and then choose an option.

Continuous	Images are numbered consecutively (until the 9999th shot is taken/saved) even if you switch memory cards.
Auto Reset	Image numbering is reset to 0001 if you switch memory cards, or when a new folder is created.



- Regardless of the option selected in this setting, shots may be numbered consecutively after the last number of existing images on newly inserted memory cards. To start saving shots from 0001, use an empty or formatted (142) memory card.

Before Use

Basic Guide

Advanced Guide

Camera Basics

Auto Mode /  
Hybrid Auto Mode

Other Shooting Modes

P Mode

Tv, Av, and M Mode

Playback Mode

Wi-Fi Functions

Setting Menu

Accessories

Appendix

Index

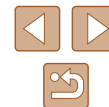

## Date-Based Image Storage

Instead of saving images in folders created each month, you can have the camera create folders each day you shoot to store shots taken that day.

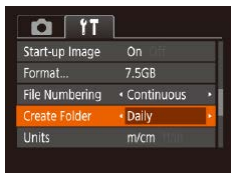

- Choose [Create Folder], and then choose [Daily].
- Images will now be saved in folders created on the shooting date.

## Metric / Non-Metric Display

Change the unit of measurement shown in the zoom bar (32), the MF indicator (75), and elsewhere from m/cm to ft/in as needed.



- Choose [Units], and then choose [ft/in].

## Checking Certification Logos

Some logos for certification requirements met by the camera can be viewed on the screen. Other certification logos are printed in this guide, on the camera packaging, or on the camera body.

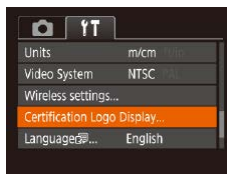

- Choose [Certification Logo Display], and then press the [MENU] button.

## Display Language

Change the display language as needed.



- Choose [Language], and then press the [MENU] button.
- Press the [◀][▶][▲][▼] buttons or turn the [DIAL] dial to choose a language, and then press the [MENU] button.



- You can also access the [Language] screen in Playback mode by pressing and holding the [MENU] button and immediately pressing the [MENU] button.

Before Use

Basic Guide

Advanced Guide

Camera Basics

Auto Mode /  
Hybrid Auto Mode

Other Shooting Modes

P Mode

Tv, Av, and M Mode

Playback Mode

Wi-Fi Functions

Setting Menu

Accessories

Appendix

Index

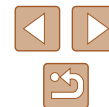



## Adjusting Other Settings

The following settings can also be adjusted on the **[f]** tab.

- [Video System] (📖148)
- [Wireless settings] (📖112)

## Restoring Default Camera Settings

If you accidentally change a setting, you can restore default camera settings.

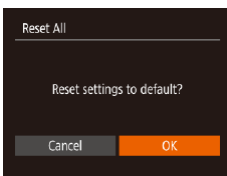

### 1 Access the [Reset All] screen.

- Choose [Reset All], and then press the **[C]** button.

### 2 Restore default settings.

- Press the **[◀]**/**[▶]** buttons or turn the **[DIAL]** dial to choose [OK], and then press the **[C]** button.
- Default settings are now restored.



- The following functions are not restored to default settings.
  - Information registered using Face ID (📖44)
  - **[f]** tab settings [Date/Time] (📖140), [Time Zone] (📖140), [Language] (📖144), and [Video System] (📖148)
  - Custom white balance data you have recorded (📖73)
  - Shooting mode chosen in **ISCM** (📖59).
  - Movie mode (📖66)
  - Wi-Fi settings (📖112)

Before Use

Basic Guide

Advanced Guide

Camera Basics

Auto Mode /  
Hybrid Auto Mode

Other Shooting Modes

P Mode

Tv, Av, and M Mode

Playback Mode

Wi-Fi Functions

Setting Menu

Accessories

Appendix

Index

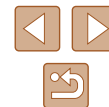

# Accessories

Enjoy the camera in more ways with optional Canon accessories and other compatible accessories sold separately

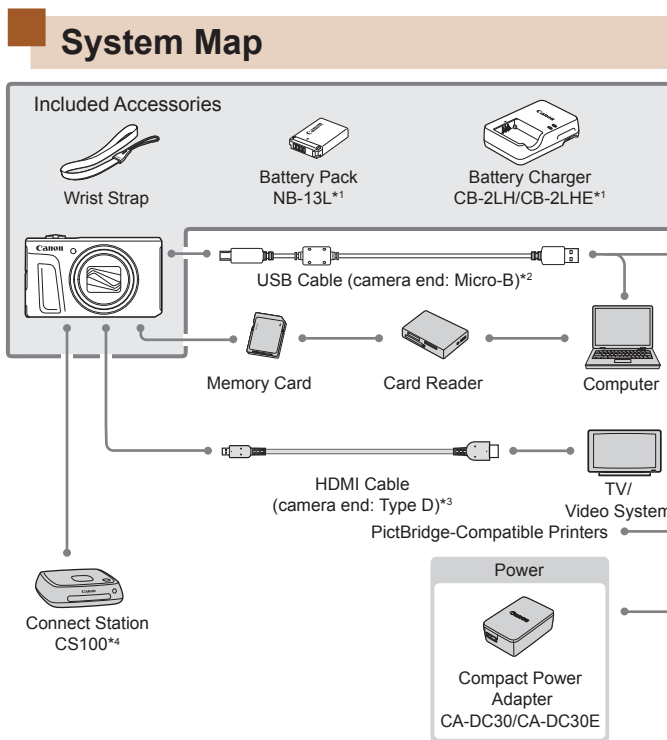

\*1 Also available for purchase separately.

\*2 A genuine Canon accessory is also available (Interface Cable IFC-600PCU).

\*3 Use a commercially available cable no longer than 2.5 m (8.2 ft.).

\*4 Use latest firmware.

- Before Use
- Basic Guide
- Advanced Guide
  - Camera Basics
    - Auto Mode / Hybrid Auto Mode
    - Other Shooting Modes
    - P Mode
    - Tv, Av, and M Mode
    - Playback Mode
    - Wi-Fi Functions
  - Setting Menu
  - Accessories
  - Appendix
- Index



### Use of genuine Canon accessories is recommended.

This product is designed to achieve excellent performance when used with genuine Canon accessories. Canon shall not be liable for any damage to this product and/or accidents such as fire, etc., caused by the malfunction of non-genuine Canon accessories (e.g., a leakage and/or explosion of a battery pack). Please note that this warranty does not apply to repairs arising out of the malfunction of non-genuine Canon accessories, although you may request such repairs on a chargeable basis.

## Optional Accessories

The following camera accessories are sold separately. Note that availability varies by area, and some accessories may no longer be available.

### Power Supplies

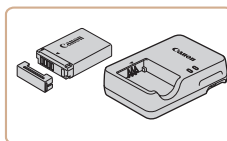

#### Battery Pack NB-13L

- Rechargeable lithium-ion battery

#### Battery Charger CB-2LH/CB-2LHE

- Charger for Battery Pack NB-13L



- The battery charger can be used in areas with 100 – 240 V AC power (50/60 Hz).
- For power outlets in a different format, use a commercially available adapter for the plug. Never use an electrical transformer designed for traveling, which may damage the battery pack.
- The message [Battery communication error] is displayed if you use a non-genuine Canon battery pack, and user response is required. Note that Canon shall not be liable for any damages resulting from accidents, such as malfunction or fire, that occur due to use of non-genuine Canon battery packs.



- The battery pack includes a convenient cover which you can attach to know the charge status at a glance. Attach the cover so that ▲ is visible on a charged battery pack, and attach it so that ▲ is not visible on an uncharged battery pack.

Before Use

Basic Guide

Advanced Guide

Camera Basics

Auto Mode /  
Hybrid Auto Mode

Other Shooting Modes

P Mode

Tv, Av, and M Mode

Playback Mode

Wi-Fi Functions

Setting Menu

Accessories

Appendix

Index





### Compact Power Adapter CA-DC30/CA-DC30E

- Insert the included battery pack into the camera for charging. Interface Cable IFC-600PCU (sold separately) is required to connect the adapter to the camera.

## Other Accessories

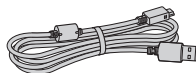

### Interface Cable IFC-600PCU

- For connecting the camera to a computer or printer.

## Printers



### Canon-Brand PictBridge-Compatible Printers

- Even without using a computer, you can print images by connecting the camera directly to a printer. For details, visit your nearest Canon retailer.

## Photo Storage



### Connect Station CS100

- A media hub for storing camera images, viewing on a connected TV, printing wirelessly on a Wi-Fi-compatible printer, sharing over the Internet, and more.

## Using Optional Accessories

▶ Still Images ▶ Movies

### Playback on a TV

▶ Still Images ▶ Movies

By connecting the camera to a TV, you can view your shots on the larger screen of the TV.

For details on connection or how to switch inputs, refer to the TV manual.



- Some information may not be displayed when viewing images on a TV (📖167).

### Playback on a High-Definition TV

▶ Still Images ▶ Movies

You can view your shots on a TV by connecting the camera to an HDTV with a commercially available HDMI cable (not exceeding 2.5 m / 8.2 ft., with a Type D terminal on the camera end). Movies shot at an image quality of [FHD 60P], [FHD 60P], or [HD 60P] can be viewed in high definition.

**1** Make sure the camera and TV are off.

**2** Connect the camera to the TV.

- On the TV, insert the cable plug fully into the HDMI input as shown.

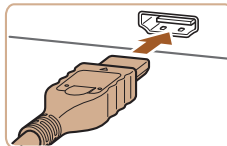

Before Use

Basic Guide

Advanced Guide

Camera Basics

Auto Mode /  
Hybrid Auto Mode

Other Shooting Modes

P Mode

Tv, Av, and M Mode

Playback Mode

Wi-Fi Functions

Setting Menu

Accessories

Appendix

Index



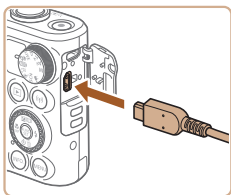

- On the camera, open the terminal cover and insert the cable plug fully into the camera terminal.

### 3 Turn the TV on and switch to external input.

- Switch the TV input to the external input you connected the cable to in step 2.



### 4 Turn the camera on.

- Press the [▶] button to turn the camera on.
- Images from the camera are now displayed on the TV. (Nothing is displayed on the camera screen.)
- When finished, turn off the camera and TV before disconnecting the cable.



- Camera operating sounds are not played while the camera is connected to an HDTV.

## Inserting and Charging the Battery Pack

Charge the battery pack by using the supplied battery pack with an optional Compact Power Adapter CA-DC30/CA-DC30E and Interface Cable IFC-600PCU.

### 1 Insert the battery pack.

- Follow step 1 in “Inserting the Battery Pack and Your Memory Card (Commercially Available)” (📖18) to open the cover.
- Insert the battery pack as described in step 2 of “Inserting the Battery Pack and Your Memory Card (Commercially Available)” (📖19).
- Follow step 3 in “Inserting the Battery Pack and Your Memory Card (Commercially Available)” (📖19) to close the cover.

### 2 Connect the compact power adapter to the camera.

- With the camera turned off, open the cover (1). Hold the smaller plug of the interface cable (sold separately) facing as shown and insert the plug fully into the camera terminal (2).
- Insert the larger plug of the interface cable into the compact power adapter.

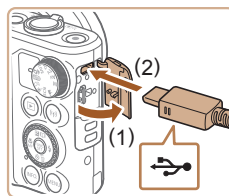

Before Use

Basic Guide

Advanced Guide

Camera Basics

Auto Mode /  
Hybrid Auto Mode

Other Shooting Modes

P Mode

Tv, Av, and M Mode

Playback Mode

Wi-Fi Functions

Setting Menu

Accessories

Appendix

Index



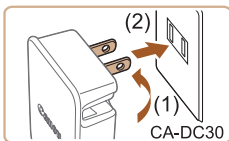

CA-DC30

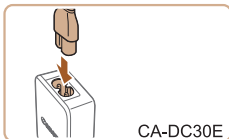

CA-DC30E

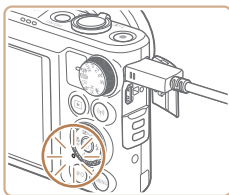

### 3 Charge the battery pack.

- CA-DC30: Flip out the plug (1) and plug the compact power adapter into a power outlet (2).
- CA-DC30E: Plug the power cord into the compact power adapter, then plug the other end into a power outlet.

- Charging begins and the USB charge lamp lights up.
- The lamp turns off when charging finishes.
- Remove the compact power adapter from the power outlet and the interface cable from the camera.



- To protect the battery pack and keep it in optimal condition, do not charge it continuously for more than 24 hours.
- Before charging a different battery, make sure to remove the interface cable from the camera and then replace the battery.



- For details on charging time and the number of shots and recording time possible with a fully charged battery pack, see “Number of Shots/Recording Time, Playback Time” (178).
- You can view images even while the battery is charging, by turning the camera on and entering Playback mode (23). However, you cannot shoot while the battery is charging.
- If the USB charge lamp does not light up, remove the interface cable from the camera and plug it again.
- Charged battery packs gradually lose their charge, even when they are not used. Charge the battery pack on (or immediately before) the day of use.
- The charger can be used in areas with 100 – 240 V AC power (50/60 Hz). For power outlets in a different format, use a commercially available adapter for the plug. Never use an electrical transformer designed for traveling, which may damage the battery pack.

### Using a Computer to Charge the Battery

You can also charge the battery pack by inserting the larger plug of the interface cable into a computer's USB terminal in step 2 of “Inserting and Charging the Battery Pack” (149). For details about USB connections on the computer, refer to the computer user manual.



- Charging is not possible when the camera is off.
- With some computers, battery charging may require the memory card to be in the camera. Insert the memory card in the camera (18) before connecting the cable to the computer's USB port.

- Before Use
- Basic Guide
- Advanced Guide
  - Camera Basics
  - Auto Mode / Hybrid Auto Mode
  - Other Shooting Modes
  - P Mode
  - Tv, Av, and M Mode
  - Playback Mode
  - Wi-Fi Functions
  - Setting Menu
  - Accessories
  - Appendix
- Index

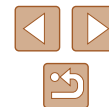

## Using the Software

To utilize the features of the following software, download the software from the Canon website and install it on your computer.

- CameraWindow
  - Import images to your computer
- Image Transfer Utility
  - Set up Image Sync (📖133) and receive images
- Map Utility
  - Use a map to view GPS information that has been added to images



- To view and edit images on a computer, use preinstalled or commonly available software compatible with images taken with the camera.

## Computer Connections via a Cable

### Checking Your Computer Environment

For detailed system requirements and compatibility information, including support in new operating systems on the computers on which the software is used, visit the Canon website.

### Installing the Software

For software installation instructions, see “Installing the Software” (📖119).

## Saving Images to a Computer

Using a USB cable (sold separately; camera end: Micro-B), you can connect the camera to the computer and save images to the computer.

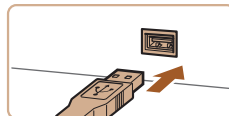
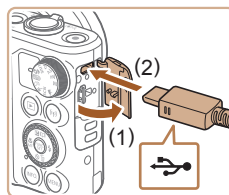

### 1 Connect the camera to the computer.

- With the camera turned off, open the cover (1). With the smaller plug of the USB cable in the orientation shown, insert the plug fully into the camera terminal (2).
- Insert the larger plug of the USB cable in the computer's USB port. For details about USB connections on the computer, refer to the computer user manual.

### 2 Turn the camera on to access CameraWindow.

- Press the [▶] button to turn the camera on.
- Mac OS: CameraWindow is displayed when a connection is established between the camera and computer.
- Windows: Follow the steps introduced below.
- In the screen that is displayed, click the [🖥️] link to modify the program.

Before Use

Basic Guide

Advanced Guide

Camera Basics

Auto Mode /  
Hybrid Auto Mode

Other Shooting Modes

P Mode

Tv, Av, and M Mode

Playback Mode

Wi-Fi Functions

Setting Menu

Accessories

Appendix

Index



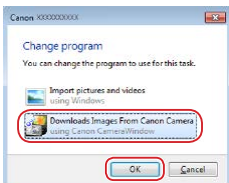

- Choose [Downloads Images From Canon Camera] and then click [OK].



- Double-click [Download Images From Canon Camera].

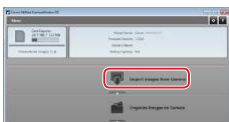

### 3 Save the images to the computer.

- Click [Import Images from Camera], and then click [Import Untransferred Images].
- Images are now saved to the Pictures folder on the computer, in separate folders named by date.
- After images are saved, close CameraWindow, press the [▶] button to turn the camera off, and unplug the cable.
- To view images you save to a computer, use preinstalled or commonly available software compatible with images captured by the camera.



- Windows 7: If the screen in step 2 is not displayed, click the [CameraWindow] icon in the taskbar.
- Mac OS: If CameraWindow is not displayed after step 2, click the [CameraWindow] icon in the Dock.
- Although you can save images to a computer simply by connecting your camera to the computer without using the software, the following limitations apply.
  - It may take a few minutes after you connect the camera to the computer until camera images are accessible.
  - Images shot in vertical orientation may be saved in horizontal orientation.
  - Image protection settings may be cleared from images saved to a computer.
  - Some problems may occur when saving images or image information, depending on the operating system version, the software in use, or image file sizes.

Before Use
Basic Guide
Advanced Guide
Camera Basics
Auto Mode / Hybrid Auto Mode
Other Shooting Modes
P Mode
Tv, Av, and M Mode
Playback Mode
Wi-Fi Functions
Setting Menu
Accessories
Appendix
Index





## Printing Images

► Still Images ► Movies

Your shots can easily be printed by connecting the camera to a printer. On the camera, you can specify images to set up batch printing, prepare orders for photo development services, and prepare orders or print images for photobooks.

A Canon SELPHY CP series compact photo printer is used here for the sake of illustration. Screens displayed and available functions vary by printer. Also refer to the printer manual for additional information.

### Easy Print

► Still Images ► Movies

Print your shots by connecting the camera to a PictBridge-compatible printer with a USB cable (sold separately; camera end: Micro-B).

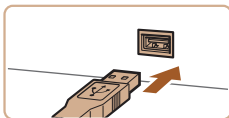
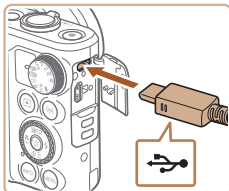

#### 1 Make sure the camera and printer are off.

#### 2 Connect the camera to the printer.

- Open the terminal cover. Holding the smaller cable plug in the orientation shown, insert the plug fully into the camera terminal.
- Connect the larger cable plug to the printer. For other connection details, refer to the printer manual.

#### 3 Turn the printer on.



#### 4 Turn the camera on.

- Press the [▶] button to turn the camera on.

#### 5 Choose an image.

- Press the [◀][▶] buttons or turn the [⊙] dial to choose an image.

#### 6 Access the printing screen.

- Press the [⊙] button, choose [▶], and press the [⊙] button again.

#### 7 Print the image.

- Press the [▲][▼] buttons or turn the [⊙] dial to choose [Print], and then press the [⊙] button.
- Printing now begins.
- To print other images, repeat the above procedures starting from step 5 after printing is finished.
- When you are finished printing, turn the camera and printer off and disconnect the cable.

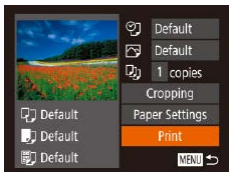

- For Canon-brand PictBridge-compatible printers (sold separately), see "Printers" (148).

Before Use

Basic Guide

Advanced Guide

Camera Basics

Auto Mode /  
Hybrid Auto Mode

Other Shooting Modes

P Mode

Tv, Av, and M Mode

Playback Mode

Wi-Fi Functions

Setting Menu

Accessories

Appendix

Index

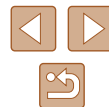

## Configuring Print Settings

▶ Still Images ▶ Movies

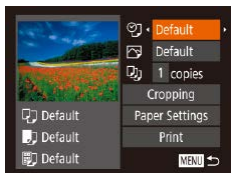

### 1 Access the printing screen.

- Follow steps 1 – 6 in “Easy Print” (📖 153) to access this screen.

### 2 Configure the settings.

- Press the [▲][▼] buttons or turn the [DISP] dial to choose an item, and then choose an option by pressing the [◀][▶] buttons.

📄	Default	Matches current printer settings.
	Date	Prints images with the date added.
	File No.	Prints images with the file number added.
	Both	Prints images with both the date and file number added.
	Off	–
📄	Default	Matches current printer settings.
	Off	–
	On	Uses information from the time of shooting to print under optimal settings.
	Red-Eye 1	Corrects red-eye.
📄	No. of Copies	Choose the number of copies to print.
Cropping	–	Specify a desired image area to print (📖 154).
Paper Settings	–	Specify the paper size, layout, and other details (📖 155).

## ▶ Cropping Images before Printing

▶ Still Images ▶ Movies

By cropping images before printing, you can print a desired image area instead of the entire image.

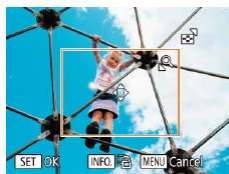
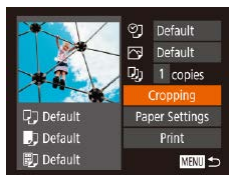

### 1 Choose [Cropping].

- After following step 1 in “Configuring Print Settings” (📖 154) to access the printing screen, choose [Cropping] and press the [DISP] button.
- A cropping frame is now displayed, indicating the image area to print.

### 2 Adjust the cropping frame as needed.

- To resize the frame, move the zoom lever.
- To move the frame, press the [▲][▼][◀][▶] buttons.
- To rotate the frame, press the [INFO] button.
- When finished, press the [DISP] button.

### 3 Print the image.

- Follow step 7 in “Easy Print” (📖 153) to print.



- Cropping may not be possible at small image sizes, or at some aspect ratios.

Before Use
Basic Guide
Advanced Guide
Camera Basics
Auto Mode / Hybrid Auto Mode
Other Shooting Modes
P Mode
Tv, Av, and M Mode
Playback Mode
Wi-Fi Functions
Setting Menu
Accessories
Appendix
Index

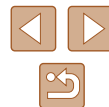

## Choosing Paper Size and Layout before Printing

► Still Images ► Movies

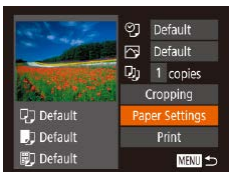

### 1 Choose [Paper Settings].

- After following step 1 in “Configuring Print Settings” (📖 154) to access the printing screen, choose [Paper Settings] and press the [OK] button.

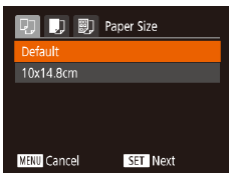

### 2 Choose a paper size.

- Press the [▲][▼] buttons or turn the [DISP] dial to choose an option, and then press the [OK] button.

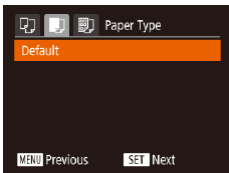

### 3 Choose a type of paper.

- Press the [▲][▼] buttons or turn the [DISP] dial to choose an option, and then press the [OK] button.

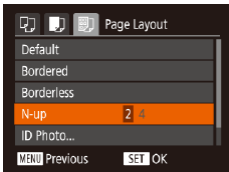

### 4 Choose a layout.

- Press the [▲][▼] buttons or turn the [DISP] dial to choose an option.
- When choosing [N-up], press the [◀][▶] buttons to specify the number of images per sheet.
- Press the [OK] button.

### 5 Print the image.

## Available Layout Options

Default	Matches current printer settings.
Bordered	Prints with blank space around the image.
Borderless	Borderless, edge-to-edge printing.
N-up	Choose how many images to print per sheet.
ID Photo	Prints images for identification purposes. Only available for images with a resolution of L and an aspect ratio of 4:3.
Fixed Size	Choose the print size. Choose from 3.5 x 5 in., postcard, or wide-format prints.

## Printing ID Photos

► Still Images ► Movies

### 1 Choose [ID Photo].

- Following steps 1 – 4 in “Choosing Paper Size and Layout before Printing” (📖 155), choose [ID Photo] and press the [OK] button.

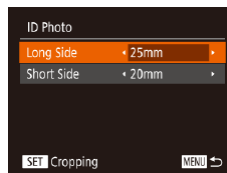

### 2 Choose the long and short side length.

- Press the [▲][▼] buttons or turn the [DISP] dial to choose an item. Choose the length by pressing the [◀][▶] buttons, and then press the [OK] button.



### 3 Choose the printing area.

- Follow step 2 in “Cropping Images before Printing” (📖 154) to choose the printing area.

### 4 Print the image.

Before Use
Basic Guide
Advanced Guide
Camera Basics
Auto Mode / Hybrid Auto Mode
Other Shooting Modes
P Mode
Tv, Av, and M Mode
Playback Mode
Wi-Fi Functions
Setting Menu
Accessories
Appendix
Index



## Printing Movie Scenes

▶ Still Images ▶ Movies

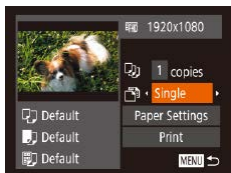

### 1 Access the printing screen.

- Follow steps 1 – 6 in “Easy Print” (153) to choose a movie. The screen at left is displayed.

### 2 Choose a printing method.

- Press the [▲][▼] buttons or turn the [DISP] dial to choose [P], and then press the [◀][▶] buttons to choose the printing method.

### 3 Print the image.

## Movie Printing Options

Single	Prints the current scene as a still image.
Sequence	Prints a series of scenes, a certain interval apart, on a single sheet of paper. You can also print the folder number, file number, and elapsed time for the frame by setting [Caption] to [On].



- To cancel printing in progress, press the [DISP] button, choose [OK], and then press the [DISP] button again.
- The screen in step 1 can also be displayed by the following procedure: display the movie scene to be printed following steps 2 – 5 in “Viewing” (87), press the [◀][▶] buttons to select [P] from the movie control panel, and then press the [DISP] button.

## Adding Images to the Print List (DPOF)

▶ Still Images ▶ Movies

Batch printing (158) and ordering prints from a photo development service can be set up on the camera. Choose up to 998 images on a memory card and configure relevant settings, such as the number of copies, as follows. The printing information you prepare this way will conform to DPOF (Digital Print Order Format) standards.

### Configuring Print Settings

▶ Still Images ▶ Movies

Specify the printing format, whether to add the date or file number, and other settings as follows. These settings apply to all images in the print list.

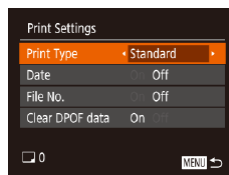

- Press the [MENU] button, and then choose [Print Settings] on the [P] tab. Choose and configure items as desired (29).

Print Type	Standard	One image is printed per sheet.
	Index	Smaller versions of multiple images are printed per sheet.
	Both	Both standard and index formats are printed.
Date	On	Images are printed with the shooting date.
	Off	–
File No.	On	Images are printed with the file number.
	Off	–
Clear DPOF data	On	All image print list settings are cleared after printing.
	Off	–

Before Use

Basic Guide

Advanced Guide

Camera Basics

Auto Mode / Hybrid Auto Mode

Other Shooting Modes

P Mode

Tv, Av, and M Mode

Playback Mode

Wi-Fi Functions

Setting Menu

Accessories

Appendix

Index





- Not all of your DPOF settings may be applied in printing by the printer or photo development service, in some cases.
- may be displayed on the camera to warn you that the memory card has print settings that were configured on another camera. Changing the print settings using this camera may overwrite all previous settings.



- Specifying [Index] will prevent you from choosing [On] for both [Date] and [File No.] at the same time.
- Index printing is not available on some Canon-brand PictBridge-compatible printers (sold separately).
- The date is printed in a format matching setting details in [Date/Time] on the tab (20).

## Setting Up Printing for Individual Images

▶ Still Images ▶ Movies

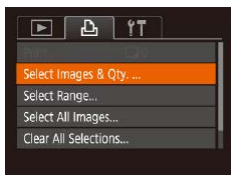

### 1 Choose [Select Images & Qty.].

- Press the [MENU] button, choose [Select Images & Qty.] on the tab, and then press the button.

### 2 Choose an image.

- Press the buttons or turn the dial to choose an image, and then press the button.
- You can now specify the number of copies.
- If you specify index printing for the image, it is labeled with a icon. To cancel index printing for the image, press the button again. is no longer displayed.

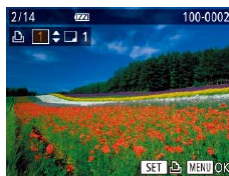

### 3 Specify the number of prints.

- Press the buttons or turn the dial to specify the number of prints (up to 99).
- To set up printing for other images and specify the number of prints, repeat steps 2 – 3.
- Printing quantity cannot be specified for index prints. You can only choose which images to print, by following step 2.
- When finished, press the [MENU] button to return to the menu screen.

## Setting Up Printing for a Range of Images

▶ Still Images ▶ Movies

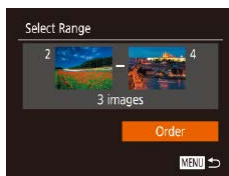

- Following step 1 in “Setting Up Printing for Individual Images” (157), choose [Select Range] and press the button.
- Follow steps 2 – 3 in “Selecting a Range” (97) to specify images.
- Press the buttons to choose [Order], and then press the button.

## Setting Up Printing for All Images

▶ Still Images ▶ Movies

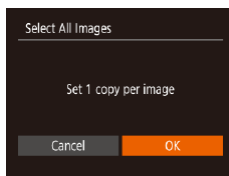

- Following step 1 in “Setting Up Printing for Individual Images” (157), choose [Select All Images] and press the button.
- Press the buttons or turn the dial to choose [OK], and then press the button.

Before Use
Basic Guide
Advanced Guide
Camera Basics
Auto Mode / Hybrid Auto Mode
Other Shooting Modes
P Mode
Tv, Av, and M Mode
Playback Mode
Wi-Fi Functions
Setting Menu
Accessories
Appendix
Index



## Clearing All Images from the Print List

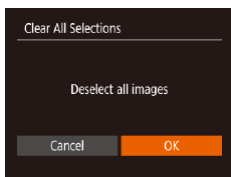

- Following step 1 in “Setting Up Printing for Individual Images” (157), choose [Clear All Selections] and press the [OK] button.
- Press the [◀][▶] buttons or turn the [DISP] dial to choose [OK], and then press the [DISP] button.

## Printing Images Added to the Print List (DPOF)

▶ Still Images ▶ Movies

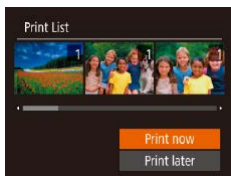

- When images have been added to the print list (156 – 157), this screen is displayed after you connect the camera to a PictBridge-compatible printer. Press the [▲][▼] buttons to choose [Print now], and then simply press the [DISP] button to print the images in the print list.
- Any DPOF print job that you temporarily stop will be resumed from the next image.

## Adding Images to a Photobook

▶ Still Images ▶ Movies

Photobooks can be set up on the camera by choosing up to 998 images on a memory card and importing them into the software on your computer, where they are stored in their own folder. This is convenient when ordering printed photobooks online or printing photobooks with your own printer.

### Choosing a Selection Method

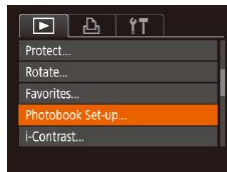

- Press the [MENU] button, choose [Photobook Set-up] on the [▶] tab, and then choose how you will select images.



- [!] may be displayed on the camera to warn you that the memory card has print settings that were configured on another camera. Changing the print settings using this camera may overwrite all previous settings.

### Adding Images Individually

▶ Still Images ▶ Movies

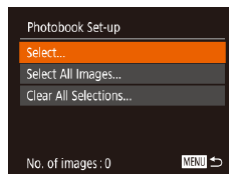

#### 1 Choose [Select].

- Following the procedure in “Choosing a Selection Method” (158), choose [Select] and press the [DISP] button.

Before Use

Basic Guide

Advanced Guide

Camera Basics

Auto Mode /  
Hybrid Auto Mode

Other Shooting Modes

P Mode

Tv, Av, and M Mode

Playback Mode

Wi-Fi Functions

Setting Menu

Accessories

Appendix

Index

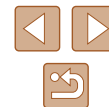



## 2 Choose an image.

- Press the [◀][▶] buttons or turn the [DISP] dial to choose an image, and then press the [DISP] button.
- [✓] is displayed.
- To remove the image from the photobook, press the [DISP] button again. [✓] is no longer displayed.
- Repeat this process to specify other images.
- When finished, press the [MENU] button to return to the menu screen.

## Adding All Images to a Photobook

▶ Still Images ▶ Movies

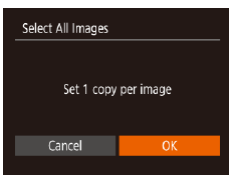

- Following the procedure in “Choosing a Selection Method” (158), choose [Select All Images] and press the [DISP] button.
- Press the [◀][▶] buttons or turn the [DISP] dial to choose [OK], and then press the [DISP] button.

## Removing All Images from a Photobook

▶ Still Images ▶ Movies

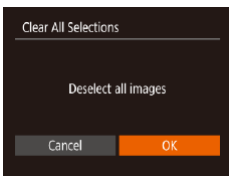

- Following the procedure in “Choosing a Selection Method” (158), choose [Clear All Selections] and press the [DISP] button.
- Press the [◀][▶] buttons or turn the [DISP] dial to choose [OK], and then press the [DISP] button.

Before Use
Basic Guide
Advanced Guide
Camera Basics
Auto Mode / Hybrid Auto Mode
Other Shooting Modes
P Mode
Tv, Av, and M Mode
Playback Mode
Wi-Fi Functions
Setting Menu
Accessories
Appendix
Index

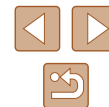

# Appendix

Helpful information when using the camera

## Troubleshooting

If you think there is a problem with the camera, first check the following. If the items below do not solve your problem, contact a Canon Customer Support Help Desk.

### Power

Nothing happens when the power button is pressed.

- Confirm that the battery pack is charged (18).
- Confirm that the battery pack is inserted facing the correct way (18).
- Confirm that the memory card/battery cover is fully closed (18).
- Dirty battery terminals reduce battery performance. Try cleaning the terminals with a cotton swab and reinserting the battery pack a few times.

The battery pack runs out of power quickly.

- Battery performance decreases at low temperatures. Try warming the battery pack a little by putting it in your pocket, for example, ensuring that the terminals do not touch any metal objects.
- Dirty battery terminals reduce battery performance. Try cleaning the terminals with a cotton swab and reinserting the battery pack a few times.
- If these measures do not help and the battery pack still runs out of power soon after charging, it has reached the end of its life. Purchase a new battery pack.

The lens is not retracted.

- Do not open the memory card/battery cover while the camera is on. Close the cover, turn the camera on, and then turn it off again (18).

The battery pack is swollen.

- Battery swelling is normal and does not pose any safety concerns. However, if battery swelling prevents the battery pack from fitting in the camera, contact a Canon Customer Support Help Desk.

### Display on a TV

Camera images look distorted or are not displayed on a TV (148).

Before Use

Basic Guide

Advanced Guide

Camera Basics

Auto Mode /  
Hybrid Auto Mode

Other Shooting Modes

P Mode

Tv, Av, and M Mode

Playback Mode

Wi-Fi Functions

Setting Menu

Accessories

Appendix

Index





## Shooting

Cannot shoot.

- In Playback mode (📖87), press the shutter button halfway (📖26).

Strange display on the screen under low light (📖27).

Strange display on the screen when shooting.

- Note that the following display problems are not recorded in still images but are recorded in movies.
  - The screen may flicker and horizontal banding may appear under fluorescent or LED lighting.

Full-screen display is not available while shooting (📖49).

⚡ flashes on the screen when the shutter button is pressed, and shooting is not possible (📖35).

📷 is displayed when the shutter button is pressed halfway (📖35).

- Set [IS Mode] to [Continuous] (📖83).
- Raise the flash and set the flash mode to ⚡ (📖81).
- Increase the ISO speed (📖72).
- Mount the camera on a tripod or take other measures to keep it still. Additionally, you should set [IS Mode] to [Off] when using a tripod or other means to secure the camera (📖83).

Shots are out of focus.

- Press the shutter button halfway to focus on subjects before pressing it all the way down to shoot (📖26).
- Make sure subjects are within focusing range (📖178).
- Set [AF-assist Beam] to [On] (📖53).
- Confirm that unneeded functions such as macro are deactivated.
- Try shooting with focus lock or AF lock (📖77, 📖80).

No AF frames are displayed and the camera does not focus when the shutter button is pressed halfway.

- To have AF frames displayed and the camera focus correctly, try composing the shot with higher-contrast subject areas centered before you press the shutter button halfway. Otherwise, try pressing the shutter button halfway repeatedly.

Subjects in shots look too dark.

- Raise the flash and set the flash mode to ⚡ (📖81).
- Adjust brightness by using exposure compensation (📖71).
- Adjust contrast by using i-Contrast (📖72, 📖104).
- Use AE lock or spot metering (📖71, 📖71).

Subjects look too bright, highlights are washed-out.

- Lower the flash and set the flash mode to ☀️ (📖32).
- Adjust brightness by using exposure compensation (📖71).
- Use AE lock or spot metering (📖71, 📖71).
- Reduce the lighting on subjects.

Shots look too dark despite the flash firing (📖35).

- Shoot within flash range (📖177).
- Adjust brightness by using flash exposure compensation or changing the flash output level (📖82, 📖86).
- Increase the ISO speed (📖72).

Subjects in flash shots look too bright, highlights are washed-out.

- Shoot within flash range (📖177).
- Lower the flash and set the flash mode to ☀️ (📖32).
- Adjust brightness by using flash exposure compensation or changing the flash output level (📖82, 📖86).

White spots appear in flash shots.

- This is caused by light from the flash reflecting off dust or airborne particles.

Shots look grainy.

- Lower the ISO speed (📖72).
- High ISO speeds in some shooting modes may cause grainy images (📖59).

Subjects are affected by red-eye.

- Set [Red-Eye Lamp] to [On] (📖54). The red-eye reduction lamp (📖4) will light up for flash shots. For best results, have subjects look at the red-eye reduction lamp. Also try increasing the lighting in indoor scenes and shooting at closer range.
- Edit images using red-eye correction (📖104).

Recording to the memory card takes too long, or continuous shooting is slower.

- Use the camera to perform low-level formatting of the memory card (📖143).

Shooting settings or FUNC. menu settings are not available.

- Available setting items vary by shooting mode. Refer to "Functions Available in Each Shooting Mode", "FUNC. Menu", and "Shooting Tab" (📖168 – 📖171).

The Babies or Children icon does not display.

- The Babies and Children icons will not display if the birthday is not set in face information (📖44). If the icons still do not display even when you set the birthday, re-register face information (📖45), or make sure that the date/time are set correctly (📖140).

Before Use

Basic Guide

Advanced Guide

Camera Basics

Auto Mode /  
Hybrid Auto Mode

Other Shooting Modes

P Mode

Tv, Av, and M Mode

Playback Mode

Wi-Fi Functions

Setting Menu

Accessories

Appendix

Index



## Shooting Movies

The elapsed time shown is incorrect, or recording is interrupted.

- Use the camera to format the memory card, or switch to a card that supports high-speed recording. Note that even if the elapsed time display is incorrect, the length of movies on the memory card corresponds to the actual recording time (142, 179).

[!] is displayed and shooting stops automatically.

- The camera's internal memory buffer filled up as the camera could not record to the memory card quickly enough. Try one of the following measures.
  - Use the camera to perform low-level formatting of the memory card (143).
  - Lower the image quality (50).
  - Switch to a memory card that supports high-speed recording (179).

Zooming is not possible.

- Zooming is not possible when shooting movies in [S] (61), [P] (68), and [V] (57) modes.

Subjects look distorted.

- Subjects that pass in front of the camera quickly may look distorted. This is not a malfunction.

## Playback

Playback is not possible.

- Image or movie playback may not be possible if a computer is used to rename files or alter the folder structure.

Playback stops, or audio skips.

- Switch to a memory card that you have performed low-level formatting on with the camera (143).
- There may be brief interruptions when playing movies copied to memory cards that have slow read speeds.
- When movies are played on a computer, frames may be dropped and audio may skip if computer performance is inadequate.

Sound is not played during movies.

- Adjust the volume (139) if you have activated [Mute] (139) or the sound in the movie is faint.
- No sound is played for movies shot in [S] (61), [P] (68), or [V] (57) mode because audio is not recorded in these modes.

Cannot access the Story Highlights home screen by pressing the [▲] button.

- Home screen display is not possible when connected to a printer. Disconnect the camera from the printer.
- Home screen display is not possible during Wi-Fi connections. End the Wi-Fi connection.

A desired subject icon for an album is not displayed on the Story Highlights home screen.

- In simple information display mode (88), choose an image that shows the name of the person for the album before accessing the Story Highlights home screen (108).

## Memory Card

The memory card is not recognized.

- Restart the camera, with the memory card in it (25).

## Computer

Cannot transfer images to a computer.

- When attempting to transfer images to the computer via a cable, try reducing the transfer speed as follows.
  - Press the [▶] button to enter Playback mode. Hold the [MENU] button down as you press the [▲] and [⊕] buttons at the same time. On the next screen, press the [◀][▶] buttons to choose [B], and then press the [⊕] button.

Before Use

Basic Guide

Advanced Guide

Camera Basics

Auto Mode /  
Hybrid Auto Mode

Other Shooting Modes

P Mode

Tv, Av, and M Mode

Playback Mode

Wi-Fi Functions

Setting Menu

Accessories

Appendix

Index

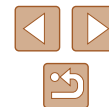

## Wi-Fi

Cannot access the Wi-Fi menu by pressing the **[Wi-Fi]** button.

- The Wi-Fi menu cannot be displayed while the camera is connected to a printer or computer via a cable. Disconnect the cable.

Cannot add a device/destination.

- A total of 20 items of connection information can be added to the camera. Erase unneeded connection information from the camera first, and then add new devices/destinations (137).
- Use a computer or smartphone to register Web services (124).
- To add a smartphone, first install the dedicated application Camera Connect on your smartphone (116).
- To add a computer, first install the software CameraWindow on your computer. Also check your computer and Wi-Fi environment and settings (119, 120).
- Do not use the camera near sources of Wi-Fi signal interference, such as microwave ovens, Bluetooth devices, or other equipment operating on the 2.4 GHz band.
- Bring the camera closer to the other device you are trying to connect to (such as the access point), and make sure there are no objects between the devices.

Cannot connect to the access point.

- Confirm that the access point channel is set to a channel supported by the camera (177). Note that instead of auto channel assignment, it is advisable to specify a supported channel manually.

Cannot send images.

- The destination device has insufficient storage space. Increase the storage space on the destination device and resend the images.
- The write-protect switch of the memory card in the destination camera is set to the locked position. Slide the write-protect switch to the unlocked position.
- Images are not sent to CANON iMAGE GATEWAY or other Web services if you move or rename image files or folders on the computer that received images sent using Image Sync via an access point (133). Before moving or renaming these image files or folders on the computer, make sure the images have already been sent to CANON iMAGE GATEWAY or other Web services.

Cannot resize images for sending.

- Images cannot be resized to be bigger than the resolution setting of their original size.
- Movies cannot be resized.

Images take a long time to send./The wireless connection is disrupted.

- Multiple images may take a long time to send. Try resizing the image to reduce sending time (132).
- Movies may take a long time to send.
- Do not use the camera near sources of Wi-Fi signal interference, such as microwave ovens, Bluetooth devices, or other equipment operating on the 2.4 GHz band. Note that images may take a long time to send even when **[Wi-Fi]** is displayed.
- Bring the camera closer to the other device you are trying to connect to (such as the access point), and make sure there are no objects between the devices.

No notification message is received on a computer or smartphone after adding CANON iMAGE GATEWAY to the camera.

- Make sure the e-mail address you entered is correct, and try adding the destination again.
- Check the e-mail settings on the computer or smartphone. If they are configured to block email from certain domains, you may not be able to receive the notification message.

Want to erase Wi-Fi connection information before disposing of the camera or giving it to someone else.

- Reset the Wi-Fi settings (138).

Before Use
Basic Guide
Advanced Guide
Camera Basics
Auto Mode / Hybrid Auto Mode
Other Shooting Modes
P Mode
Tv, Av, and M Mode
Playback Mode
Wi-Fi Functions
Setting Menu
Accessories
Appendix
Index

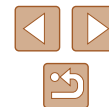

## On-Screen Messages

If an error message is displayed, respond as follows.

### Shooting or Playback

#### No memory card

- The memory card may be inserted facing the wrong way. Reinsert the memory card facing the correct way (118).

#### Memory card locked

- The write-protect switch of the memory card is set to the locked position. Switch the write-protect switch to the unlocked position (118).

#### Cannot record!

- Shooting was attempted without a memory card in the camera. To shoot, insert a memory card facing the correct way (118).

#### Memory card error (1143)

- If the same error message is displayed even after you have formatted a supported memory card (112) and have inserted it facing the correct way (118), contact a Canon Customer Support Help Desk.

#### Insufficient space on card

- There is not enough free space on the memory card to shoot (132, 156, 170, 184) or edit images (102). Either erase unneeded images (198) or insert a memory card with enough free space (118).

#### Charge the battery (118)

#### No Image.

- The memory card does not contain any images that can be displayed.

#### Protected! (196)

#### Unidentified Image/Incompatible JPEG/Image too large./Cannot play back MOV/Cannot play back MP4

- Unsupported or corrupt images cannot be displayed.
- It may not be possible to display images that were edited or renamed on a computer, or images shot with another camera.

#### Cannot magnify!/Cannot play back this content in Smart Shuffle/Cannot rotate/Cannot modify image/Cannot modify!/Cannot assign to category/Unselectable image./No identification information

- The following functions may be unavailable for images that were renamed or already edited on a computer, or images shot with another camera. Note that starred (\*) functions are not available for movies.  
Edit ID Info (193) \*, Magnify (194) \*, Smart Shuffle (195) \*, Rotate (100) \*, Favorites (101) , Edit (102) \*, Print List (156) \*, and Photobook Set-up (158) \*

#### Invalid selection range

- When specifying a range for image selection (197, 199, 157), you attempted to choose an initial image that was after the final image, or vice-versa.

#### Exceeded selection limit

- More than 998 images were selected for Print List (156) or Photobook Set-up (158). Choose 998 images or less.
- Print List (156) or Photobook Set-up (158) settings could not be saved correctly. Reduce the number of selected images and try again.
- You attempted to choose more than 500 images in Protect (196), Erase (198), Favorites (101), Print List (156), or Photobook Set-up (158).

#### Naming error!

- The folder could not be created or images could not be recorded, because the highest supported folder number (999) for storing images on the card has been reached and the highest supported image number (9999) for images in folders has been reached. On the [Fn] tab, change [File Numbering] to [Auto Reset] (143), or format the memory card (142).

#### Lens Error

- This error may occur if the lens is held while it is moving, or when the camera is used in dusty or sandy locations.
- Frequent display of this error message may indicate camera damage. In this case, contact a Canon Customer Support Help Desk.

#### A camera error was detected (*error number*)

- If this error message is displayed immediately after a shot, the image may not have been saved. Switch to Playback mode to check for the image.
- Frequent display of this error message may indicate camera damage. In this case, write down the error number (*Exx*) and contact a Canon Customer Support Help Desk.

Before Use

Basic Guide

Advanced Guide

Camera Basics

Auto Mode /  
Hybrid Auto Mode

Other Shooting Modes

P Mode

Tv, Av, and M Mode

Playback Mode

Wi-Fi Functions

Setting Menu

Accessories

Appendix

Index



## File Error

- Correct printing (📖153) may not be possible for photos from other cameras or images that have been altered using computer software, even if the camera is connected to the printer.

## Print error

- Check the paper size setting (📖155). If this error message is displayed when the setting is correct, restart the printer and complete the setting on the camera again.

## Ink absorber full

- Contact a Canon Customer Support Help Desk to request assistance with ink absorber replacement.

## Wi-Fi

### Connection failed

- No access points were recognized. Check the access point settings (📖120).
- A device could not be found. Turn the camera off and on again, and retry the connection.
- Check the device you want to connect to and make sure it is ready for connection.

### Cannot determine access point

- The WPS buttons on numerous access points were pressed simultaneously. Try reconnecting again.

### No access points found

- Check to make sure that the access point is turned on.
- When connecting to an access point manually, make sure that you entered the correct SSID.

### Incorrect password/Incorrect Wi-Fi security settings

- Check the access point security settings (📖120).

### IP address conflict

- Reset the IP address so that it does not conflict with another.

### Disconnected/Receiving failed/Sending failed

- You may be in an environment where Wi-Fi signals are obstructed.
- Avoid using the camera's Wi-Fi function around microwave ovens, Bluetooth devices, and other devices that operate on the 2.4 GHz band.
- Bring the camera closer to the other device you are trying to connect to (such as the access point), and make sure there are no objects between the devices.
- Check the connected device to make sure it is not experiencing errors.

### Sending failed

#### Memory card error

- If the same error message is displayed even when you have inserted a formatted memory card facing the correct way, contact a Canon Customer Support Help Desk.

### Receiving failed

#### Insufficient space on card

- There is not enough free space on the memory card in the target camera to receive images. Erase images to create space on the memory card, or insert a memory card with sufficient space.

### Receiving failed

#### Memory card locked

- The write-protect switch of the memory card in the camera to receive the images is set to the locked position. Slide the write-protect switch to the unlocked position.

### Receiving failed

#### Naming error!

- When the highest folder number (999), and the highest image number (9999) have been reached on the receiving camera, images cannot be received.

### Insufficient space on server

- Delete unnecessary images uploaded to CANON iMAGE GATEWAY to create space.
- Save the images sent via Image Sync (📖133) to your computer.

### Check network settings

- Check to make sure your computer can connect to the Internet with the current network settings.

## Before Use

## Basic Guide

## Advanced Guide

### Camera Basics

### Auto Mode / Hybrid Auto Mode

### Other Shooting Modes

### P Mode

### Tv, Av, and M Mode

### Playback Mode

### Wi-Fi Functions

### Setting Menu

### Accessories

### Appendix

## Index

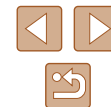

# On-Screen Information

## Shooting (Information Display)

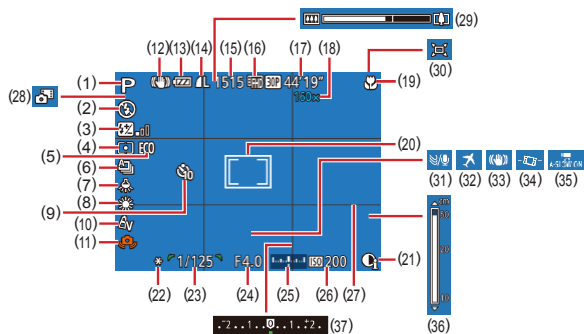

- |   |   |
|---|---|
| (1) Shooting mode (168), Scene icon (36)                      | (13) Battery level (166)  |
| (2) Flash mode (81)   | (14) Still image compression (83), Resolution (49)                |
| (3) Flash exposure compensation / Flash output level (82, 86) | (15) Recordable shots (179)*                                      |
| (4) Metering method (71)                                      | (16) Movie quality (50)   |
| (5) Eco mode (141)  | (17) Remaining time (179)   |
| (6) Drive mode (80)   | (18) Digital zoom magnification (38), Digital tele-converter (77) |
| (7) Mercury lamp correction (50)                              | (19) Focus range (75, 75), AF lock (80)                           |
| (8) White balance (73)  | (20) AF frame (77), Spot AE point frame (71)                      |
| (9) Self-timer (42)   | (21) i-Contrast (72)  |
| (10) My Colors (74)   | (22) AE lock (71), FE lock (82)                                   |
| (11) Camera shake warning (35)                                |   |
| (12) IS mode icon (37)  |   |

- |                              |                                       |
|------------------------------|---------------------------------------|
| (23) Shutter speed (84, 85)  | (31) Wind filter (67)                 |
| (24) Aperture value (85, 85) | (32) Time zone (140)                  |
| (25) Exposure level (85)     | (33) Image stabilization (83)         |
| (26) ISO speed (72)          | (34) Auto level (52)                  |
| (27) Grid lines (51)         | (35) Auto slow shutter (67)           |
| (28) Hybrid Auto mode (34)   | (36) MF indicator (75)                |
| (29) Zoom bar (32)           | (37) Exposure compensation level (71) |
| (30) Auto (40)               |                                       |

\* In [ ] mode, indicates the number of shots available.

## Battery Level

An on-screen icon or message indicates the battery charge level.

Display	Details
	Sufficient charge
	Slightly depleted, but sufficient
	Nearly depleted. Charge the battery pack soon.
[Charge the battery]	Depleted. Charge the battery pack immediately.

- Before Use
- Basic Guide
- Advanced Guide
  - Camera Basics
  - Auto Mode / Hybrid Auto Mode
  - Other Shooting Modes
  - P Mode
  - Tv, Av, and M Mode
  - Playback Mode
  - Wi-Fi Functions
  - Setting Menu
  - Accessories
  - Appendix
- Index



## Playback (Detailed Information Display)

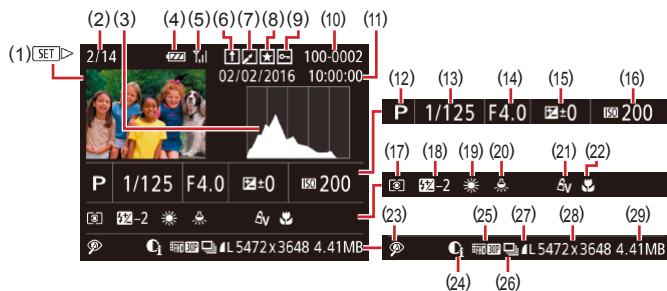

- |  |   |
|--|---|
| (1) Movies (📖32, 📖87)                              | (16) ISO speed (📖72)  |
| (2) Current image no. / Total no. of images        | (17) Metering method (📖71)  |
| (3) Histogram (📖89)                                | (18) Flash (📖81), Flash exposure compensation (📖82)   |
| (4) Battery level (📖166)                           | (19) White balance (📖73)  |
| (5) Wi-Fi signal strength (📖132)                   | (20) Mercury lamp correction (📖50)  |
| (6) Image Sync (📖133)                              | (21) My Colors (📖74, 📖103), Creative Shot effect (📖57)  |
| (7) Image editing (📖102), Movie compression (📖106) | (22) Focus range (📖75, 📖75)   |
| (8) Favorites (📖101)                               | (23) Red-eye correction (📖104), Short clip playback effect (📖68)  |
| (9) Protection (📖96)                               | (24) i-Contrast (📖72)   |
| (10) Folder number - File number (📖143)            | (25) Image quality / Frame rate (movies) (📖49, 📖50)   |
| (11) Shooting date/time (📖20)                      | (26) Group playback (📖92)   |
| (12) Shooting mode (📖168)                          | (27) Compression (image quality) (📖83) / Resolution (📖49, 📖50), Digest movies, (📖34), MP4 (movies), Albums (📖108) |
| (13) Shutter speed (📖84, 📖85)                      |   |
| (14) Aperture value (📖85, 📖85)                     |   |
| (15) Exposure compensation level (📖71)             |   |

- (28) Still images: Resolution (📖179) (29) File size  
 Movies: Playback time (📖179)



- Some information may not be displayed when viewing images on a TV (📖148).

## Summary of Movie Control Panel

The following operations are available on the movie control panel, accessed as described in "Viewing" (📖87).

▶	Play
▶▶	Slow Motion (To adjust the playback speed, press the [◀▶▶] buttons or turn the [🌀] dial. No sound is played.)
◀◀	Skip Backward* or Previous Clip (📖107) (To continue skipping backward, keep holding down the [🌀] button.)
◀	Previous Frame (For fast-rewind, keep holding down the [🌀] button.)
▶▶▶	Next Frame (For fast-forward, keep holding down the [🌀] button.)
▶▶▶▶	Skip Forward* or Next Clip (📖107) (To continue skipping forward, keep holding down the [🌀] button.)
🗑️	Erase Clip (displayed when a digest movie is selected, 📖107)
✂️	Edit (📖105)
🖨️	Shown when the camera is connected to a PictBridge-compatible printer (📖153).

\* Displays the frame approx. 4 sec. before or after the current frame.



- During movie playback, you can skip back or forward (or to the previous or next clip) by pressing the [◀▶▶] buttons.

Before Use

Basic Guide

Advanced Guide

Camera Basics

Auto Mode / Hybrid Auto Mode

Other Shooting Modes

P Mode

Tv, Av, and M Mode

Playback Mode

Wi-Fi Functions

Setting Menu

Accessories

Appendix

Index

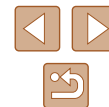

# Functions and Menu Tables

## Functions Available in Each Shooting Mode

Function	Shooting Mode																												
	M	Av	Tv	P	LIVE		AUTO																						
Exposure Compensation (📖71)	-	○	○	○	○	-	-	-	○	○	○	○	○	○	○	○	○	○	○	○	○	○	○	○	○	○	○	○	○
Self-Timer (📖42)																													
	○	○	○	○	○	○	○	○	○	○	○	○	○	○	○	○	○	○	○	○	○	○	○	○	○	○	○	○	○
	○	○	○	○	○	○	○	○	○	○	○	-	-	-	○	○	○	○	○	○	○	○	○	○	○	○	○	○	○
Self-Timer Settings (📖43)																													
Delay*1	○	○	○	○	○	○	○	○	○	○	-	-	-	○	○	○	○	○	○	○	○	○	○	○	○	○	○	○	○
Shots*2	○	○	○	○	○	-	○	-	○	○	-	-	-	○	○	○	○	○	○	○	○	○	○	○	○	○	○	○	○
Flash (📖81)																													
	-	-	-	○	○	○	○	-	○	○	○	○	○	○	○	○	○	○	○	○	○	○	○	○	○	○	○	○	○
	○	○	○	○	○	-	-	-	○	○	○	○	○	-	○	○	○	○	○	○	○	○	○	○	○	○	○	○	○
	-	○	-	○	○	*3	*3	-	-	-	-	-	-	*3	-	-	-	-	-	-	-	-	-	-	-	-	-	-	
	○	○	○	○	○	○	○	○	○	○	○	○	○	○	○	○	○	○	○	○	○	○	○	○	○	○	○	○	○
Aperture Value (📖85)	○	○	-	-	-	-	-	-	-	-	-	-	-	-	-	-	-	-	-	-	-	-	-	-	-	-	-	-	
Shutter Speed (📖85)	○	-	○	-	-	-	-	-	-	-	-	-	-	-	-	-	-	-	-	-	-	-	-	-	-	-	-	-	
Program Shift (📖71)	-	*4	*4	○	-	-	-	-	-	-	-	-	-	-	-	-	-	-	-	-	-	-	-	-	-	-	-	-	
AE Lock (📖71) / FE Lock (📖82)*5	-	○	○	○	-	-	-	-	-	-	-	-	-	-	-	-	-	-	-	-	-	-	-	-	-	-	-	-	
AE Lock (Movie) / Exposure Shift (📖66)	-	-	-	-	-	-	-	-	-	-	-	-	-	-	-	-	-	-	-	-	-	-	-	-	-	-	○	○	
Focus Range (📖75, 📖75, 📖80)																													
	○	○	○	○	○	○	○	○	○	○	○	○	○	○	○	○	○	○	○	○	○	○	○	○	○	○	○	○	○
	○	○	○	○	○	-	-	-	○	-	-	-	○	○	○	○	○	○	○	○	○	○	○	○	○	○	○	○	○
Tracking AF (📖78)	○	○	○	○	○	-	-	-	○	○	-	-	-	○	-	-	-	○	○	○	○	○	○	○	○	○	○	○	○
Change Display (📖27)	○	○	○	○	○	○	○	-	○	○	-	-	-	○	○	-	-	-	-	○	○	○	○	○	○	○	○	○	○

\*1 Cannot be set to 0 seconds in modes without selection of the number of shots.  
 \*2 One shot (cannot be modified) in modes without selection of the number of shots.  
 \*3 Not available but switches to in some cases.  
 \*4 To maintain correct exposure, the ISO speed may be changed in addition to the aperture value or shutter speed.  
 \*5 FE lock not available in flash mode.

○ Can be selected or automatically set. - Cannot be selected.

- Before Use
- Basic Guide
- Advanced Guide
  - Camera Basics
  - Auto Mode / Hybrid Auto Mode
  - Other Shooting Modes
  - P Mode
  - Tv, Av, and M Mode
  - Playback Mode
  - Wi-Fi Functions
  - Setting Menu
  - Accessories
  - Appendix
- Index

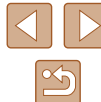



# FUNC. Menu

	Shooting Mode																										
Function	M	Av	Tv	P	LIVE	[Icon]	AUTO	[Icon]	[Icon]	[Icon]	[Icon]	[Icon]	[Icon]	[Icon]	[Icon]	[Icon]	[Icon]	[Icon]	[Icon]	[Icon]	[Icon]						
Metering Method (71)																											
[Icon]	O	O	O	O	O	O	O	O	O	O	O	O	O	O	O	O	O	O	O	O	O						
[Icon]	O	O	O	O	-	-	-	-	-	-	-	-	-	-	-	-	-	-	-	-	-						
My Colors (74)																											
[Icon]	O	O	O	O	O	O	O	O	O	O	O	O	O	O	O	O	O	O	O	O	O						
[Icon]	O	O	O	O	-	-	-	-	-	-	O	O	O	-	-	-	-	-	-	-	O	O	O				
White Balance (73)																											
[Icon]	O	O	O	O	O	O	O	O	O	O	O	O	O	O	O	O	O	O	O	O	O	O	O				
[Icon]	O	O	O	O	-	-	-	-	-	-	O	O	O	-	O	-	-	-	-	-	-	O	O	O			
ISO Speed (72)																											
AUTO	-	O	O	O	O	O	O	O	O	O	O	O	O	O	O	O	O	O	O	O	O	O	O				
80 / 100 / 200 / 400 / 800 / 1600 / 3200	O	O	O	O	-	-	-	-	-	-	-	-	-	-	-	-	-	-	-	-	-	-	-				
Flash Exposure Compensation (82)	-	O	O	O	-	-	-	-	-	-	-	-	-	-	-	-	-	-	-	-	-	-	-				
Flash Output Level (86)	O	O	O	-	-	-	-	-	-	-	-	-	-	-	-	-	-	-	-	-	-	-	-				
Drive Mode (80)																											
[Icon]	O	O	O	O	O	O	O	O	O	O	O	O	O	O	O	O	O	O	O	O	O	O	O				
[Icon]	-	-	-	-	-	-	O	-	-	-	-	-	-	-	-	-	-	-	-	-	-	-	-				
[Icon]	O	O	O	O	-	-	O	-	-	O	-	-	-	-	O	O	O	O	O	O	O	O	-	-			
[Icon]	O	O	O	O	-	-	-	-	-	O	-	-	-	-	O	O	O	O	O	O	O	O	-	-			
Still Image Aspect Ratio (49)																											
16:9	O	O	O	O	-	-	O	-	O	O	O	O	O	O	-	-	-	O	-	-	O	O	O	O	*4	O	O
3:2	O	O	O	O	-	-	O	-	O	O	O	O	O	O	-	-	-	-	-	-	O	O	O	O	-	-	-
4:3	O	O	O	O	O	O	O	O	O	O	O	O	O	O	O	O	O	O	O	O	O	O	O	O	*4	-	-
1:1	O	O	O	O	-	-	O	-	O	O	O	O	O	O	-	-	-	-	-	-	O	O	O	O	-	-	-

- \*1 White balance is not available.
  - \*2 Set in a range of 1 – 5: contrast, sharpness, color saturation, red, green, blue, and skin tone.
  - \*3 [Icon] is set with [MF], AF lock, or [Icon].
  - \*4 Set automatically to suit the aspect ratio of the movie recording size.
- O Can be selected or automatically set. – Cannot be selected.

- Before Use
- Basic Guide
- Advanced Guide
  - Camera Basics
  - Auto Mode / Hybrid Auto Mode
  - Other Shooting Modes
  - P Mode
  - Tv, Av, and M Mode
  - Playback Mode
  - Wi-Fi Functions
  - Setting Menu
  - Accessories
  - Appendix
- Index

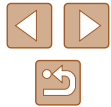

	Shooting Mode																								
Function	M	Av	Tv	P	LIVE	AI	AUTO	⏏	⏏	⏏	⏏	⏏	⏏	⏏	⏏	⏏	⏏	⏏	⏏	⏏	⏏	⏏	⏏	⏏	
Resolution (📖49)																									
<b>L</b>	○	○	○	○	○	○	○	○	○	○	○	○	○	○	○	○	○	○	○	○	○	○	○	○	○
<b>M1/M2/S</b>	○	○	○	○	-	-	○	-	○	○	○	○	○	-	-	-	-	-	-	-	-	○	○	○	○
Compression (📖83)																									
<b>S</b>	○	○	○	○	-	-	-	-	-	-	-	-	-	-	-	-	-	-	-	-	-	-	-	-	-
	○	○	○	○	○	○	○	○	○	○	○	○	○	○	○	○	○	○	○	○	○	○	○	○	○
Movie Quality (📖50)																									
<b>FHD</b> 60P	-	-	-	-	-	-	-	-	-	-	-	-	-	-	-	-	-	-	-	-	-	-	○	-	-
<b>FHD</b> 30P	○	○	○	○	○	○	○	-	○	○	○	○	○	○	○	○	○	○	○	○	○	○	○	○	○
<b>HD</b> 60P	○	○	○	○	-	○	○	○	○	○	○	○	○	○	○	○	○	○	○	○	○	○	○	○	-
<b>VGA</b> 30P	○	○	○	○	-	○	○	-	○	○	○	○	○	○	○	○	○	○	○	○	○	○	○	○	-

\*1 Synchronizes with the aspect ratio setting and is automatically set (📖61).

○ Can be selected or automatically set. - Cannot be selected.

- Before Use
- Basic Guide
- Advanced Guide
  - Camera Basics
  - Auto Mode / Hybrid Auto Mode
  - Other Shooting Modes
  - P Mode
  - Tv, Av, and M Mode
  - Playback Mode
  - Wi-Fi Functions
  - Setting Menu
  - Accessories
  - Appendix
- Index

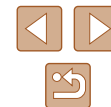

# Shooting Tab

Function	Shooting Mode																			
	M	Av	Tv	P	LIVE		AUTO													
AF Frame (77)																				
Face AiAF*1	<input type="radio"/>	<input type="radio"/>	<input type="radio"/>	<input type="radio"/>	<input type="radio"/>	<input type="radio"/>	<input type="radio"/>	<input type="radio"/>	<input type="radio"/>	<input type="radio"/>	<input type="radio"/>	<input type="radio"/>	<input type="radio"/>	<input type="radio"/>	<input type="radio"/>	<input type="radio"/>	<input type="radio"/>	<input type="radio"/>	<input type="radio"/>	<input type="radio"/>
Tracking AF	<input type="radio"/>	<input type="radio"/>	<input type="radio"/>	<input type="radio"/>	<input type="radio"/>	<input type="radio"/>	<input type="radio"/>	<input type="radio"/>	<input type="radio"/>	<input type="radio"/>	<input type="radio"/>	<input type="radio"/>	<input type="radio"/>	<input type="radio"/>	<input type="radio"/>	<input type="radio"/>	<input type="radio"/>	<input type="radio"/>	<input type="radio"/>	<input type="radio"/>
Center	<input type="radio"/>	<input type="radio"/>	<input type="radio"/>	<input type="radio"/>	<input type="radio"/>	<input type="radio"/>	<input type="radio"/>	<input type="radio"/>	<input type="radio"/>	<input type="radio"/>	<input type="radio"/>	<input type="radio"/>	<input type="radio"/>	<input type="radio"/>	<input type="radio"/>	<input type="radio"/>	<input type="radio"/>	<input type="radio"/>	<input type="radio"/>	<input type="radio"/>
AF Frame Size (77)*2																				
Normal	<input type="radio"/>	<input type="radio"/>	<input type="radio"/>	<input type="radio"/>	<input type="radio"/>	<input type="radio"/>	<input type="radio"/>	<input type="radio"/>	<input type="radio"/>	<input type="radio"/>	<input type="radio"/>	<input type="radio"/>	<input type="radio"/>	<input type="radio"/>	<input type="radio"/>	<input type="radio"/>	<input type="radio"/>	<input type="radio"/>	<input type="radio"/>	<input type="radio"/>
Small	<input type="radio"/>	<input type="radio"/>	<input type="radio"/>	<input type="radio"/>	<input type="radio"/>	<input type="radio"/>	<input type="radio"/>	<input type="radio"/>	<input type="radio"/>	<input type="radio"/>	<input type="radio"/>	<input type="radio"/>	<input type="radio"/>	<input type="radio"/>	<input type="radio"/>	<input type="radio"/>	<input type="radio"/>	<input type="radio"/>	<input type="radio"/>	<input type="radio"/>
Digital Zoom (38)																				
Standard	<input type="radio"/>	<input type="radio"/>	<input type="radio"/>	<input type="radio"/>	<input type="radio"/>	<input type="radio"/>	<input type="radio"/>	<input type="radio"/>	<input type="radio"/>	<input type="radio"/>	<input type="radio"/>	<input type="radio"/>	<input type="radio"/>	<input type="radio"/>	<input type="radio"/>	<input type="radio"/>	<input type="radio"/>	<input type="radio"/>	<input type="radio"/>	<input type="radio"/>
Off*3	<input type="radio"/>	<input type="radio"/>	<input type="radio"/>	<input type="radio"/>	<input type="radio"/>	<input type="radio"/>	<input type="radio"/>	<input type="radio"/>	<input type="radio"/>	<input type="radio"/>	<input type="radio"/>	<input type="radio"/>	<input type="radio"/>	<input type="radio"/>	<input type="radio"/>	<input type="radio"/>	<input type="radio"/>	<input type="radio"/>	<input type="radio"/>	<input type="radio"/>
Lock	<input type="radio"/>	<input type="radio"/>	<input type="radio"/>	<input type="radio"/>	<input type="radio"/>	<input type="radio"/>	<input type="radio"/>	<input type="radio"/>	<input type="radio"/>	<input type="radio"/>	<input type="radio"/>	<input type="radio"/>	<input type="radio"/>	<input type="radio"/>	<input type="radio"/>	<input type="radio"/>	<input type="radio"/>	<input type="radio"/>	<input type="radio"/>	<input type="radio"/>
1.6x / 2.0x	<input type="radio"/>	<input type="radio"/>	<input type="radio"/>	<input type="radio"/>	<input type="radio"/>	<input type="radio"/>	<input type="radio"/>	<input type="radio"/>	<input type="radio"/>	<input type="radio"/>	<input type="radio"/>	<input type="radio"/>	<input type="radio"/>	<input type="radio"/>	<input type="radio"/>	<input type="radio"/>	<input type="radio"/>	<input type="radio"/>	<input type="radio"/>	<input type="radio"/>
AF-Point Zoom (51)																				
On	<input type="radio"/>	<input type="radio"/>	<input type="radio"/>	<input type="radio"/>	<input type="radio"/>	<input type="radio"/>	<input type="radio"/>	<input type="radio"/>	<input type="radio"/>	<input type="radio"/>	<input type="radio"/>	<input type="radio"/>	<input type="radio"/>	<input type="radio"/>	<input type="radio"/>	<input type="radio"/>	<input type="radio"/>	<input type="radio"/>	<input type="radio"/>	<input type="radio"/>
Off	<input type="radio"/>	<input type="radio"/>	<input type="radio"/>	<input type="radio"/>	<input type="radio"/>	<input type="radio"/>	<input type="radio"/>	<input type="radio"/>	<input type="radio"/>	<input type="radio"/>	<input type="radio"/>	<input type="radio"/>	<input type="radio"/>	<input type="radio"/>	<input type="radio"/>	<input type="radio"/>	<input type="radio"/>	<input type="radio"/>	<input type="radio"/>	<input type="radio"/>
Servo AF (79)																				
On	<input type="radio"/>	<input type="radio"/>	<input type="radio"/>	<input type="radio"/>	<input type="radio"/>	<input type="radio"/>	<input type="radio"/>	<input type="radio"/>	<input type="radio"/>	<input type="radio"/>	<input type="radio"/>	<input type="radio"/>	<input type="radio"/>	<input type="radio"/>	<input type="radio"/>	<input type="radio"/>	<input type="radio"/>	<input type="radio"/>	<input type="radio"/>	<input type="radio"/>
Off	<input type="radio"/>	<input type="radio"/>	<input type="radio"/>	<input type="radio"/>	<input type="radio"/>	<input type="radio"/>	<input type="radio"/>	<input type="radio"/>	<input type="radio"/>	<input type="radio"/>	<input type="radio"/>	<input type="radio"/>	<input type="radio"/>	<input type="radio"/>	<input type="radio"/>	<input type="radio"/>	<input type="radio"/>	<input type="radio"/>	<input type="radio"/>	<input type="radio"/>
Continuous AF (79)																				
On	<input type="radio"/>	<input type="radio"/>	<input type="radio"/>	<input type="radio"/>	<input type="radio"/>	<input type="radio"/>	<input type="radio"/>	<input type="radio"/>	<input type="radio"/>	<input type="radio"/>	<input type="radio"/>	<input type="radio"/>	<input type="radio"/>	<input type="radio"/>	<input type="radio"/>	<input type="radio"/>	<input type="radio"/>	<input type="radio"/>	<input type="radio"/>	<input type="radio"/>
Off	<input type="radio"/>	<input type="radio"/>	<input type="radio"/>	<input type="radio"/>	<input type="radio"/>	<input type="radio"/>	<input type="radio"/>	<input type="radio"/>	<input type="radio"/>	<input type="radio"/>	<input type="radio"/>	<input type="radio"/>	<input type="radio"/>	<input type="radio"/>	<input type="radio"/>	<input type="radio"/>	<input type="radio"/>	<input type="radio"/>	<input type="radio"/>	<input type="radio"/>

\*1 Operation when no faces are detected varies by shooting mode. O Can be selected or automatically set. – Cannot be selected.

\*2 Available when the AF frame is set to [Center].

\*3 Digital zoom is canceled when you switch to a shooting mode which does not support digital zoom.

\*4 [On] when subject movement is detected.

- Before Use
- Basic Guide
- Advanced Guide
  - Camera Basics
  - Auto Mode / Hybrid Auto Mode
  - Other Shooting Modes
  - P Mode
  - Tv, Av, and M Mode
  - Playback Mode
  - Wi-Fi Functions
  - Setting Menu
  - Accessories
  - Appendix
- Index



		Shooting Mode																					
Function		M	Av	Tv	P	LIVE		AUTO															
<b>AF-assist Beam</b> (📖53)																							
On		○	○	○	○	○	○	○	○	○	○	○	○	○	○	○	○	○	○	○	○	○	○
Off		○	○	○	○	○	○	○	○	○	○	○	○	○	○	○	○	○	○	○	○	○	○
<b>MF-Point Zoom</b> (📖75)																							
Off		○	○	○	○	○	○	○	○	○	○	○	○	○	○	○	○	○	○	○	○	○	○
2x / 4x		○	○	○	○	○	○	○	○	○	○	○	○	○	○	○	○	○	○	○	○	○	○
<b>Safety MF</b> (📖75)																							
On		○	○	○	○	○	○	○	○	○	○	○	○	○	○	○	○	○	○	○	○	○	○
Off		○	○	○	○	○	○	○	○	○	○	○	○	○	○	○	○	○	○	○	○	○	○
<b>MF Peaking Settings</b> (📖76)																							
Peaking	On	○	○	○	○	○	○	○	○	○	○	○	○	○	○	○	○	○	○	○	○	○	○
	Off	○	○	○	○	○	○	○	○	○	○	○	○	○	○	○	○	○	○	○	○	○	○
Level	High	○	○	○	○	○	○	○	○	○	○	○	○	○	○	○	○	○	○	○	○	○	○
	Low	○	○	○	○	○	○	○	○	○	○	○	○	○	○	○	○	○	○	○	○	○	○
Color	Red / Blue / Yellow	○	○	○	○	○	○	○	○	○	○	○	○	○	○	○	○	○	○	○	○	○	○
<b>Flash Settings</b> (📖54, 📖82, 📖86)																							
Flash Mode	Auto	–	○	○	○	○	○	○	○	○	○	○	○	○	○	○	○	○	○	○	○	○	○
	Manual	○	○	○	○	○	○	○	○	○	○	○	○	○	○	○	○	○	○	○	○	○	○
Red-Eye Lamp	On / Off	○	○	○	○	○	○	○	○	○	○	○	○	○	○	○	○	○	○	○	○	○	○
Flash Exp. Comp	See “Flash Exposure Compensation” in “FUNC. Menu” (📖169).																						
Flash Output	See “Flash Output Level” in “FUNC. Menu” (📖169).																						
Safety FE	On	–	○	○	○	○	○	○	○	○	○	○	○	○	○	○	○	○	○	○	○	○	○
	Off	○	○	○	○	○	○	○	○	○	○	○	○	○	○	○	○	○	○	○	○	○	○
<b>i-Contrast</b> (📖72)																							
Auto		○	○	○	○	○	○	○	○	○	○	○	○	○	○	○	○	○	○	○	○	○	○
Off		○	○	○	○	○	○	○	○	○	○	○	○	○	○	○	○	○	○	○	○	○	○
<b>Hg Lamp Corr.</b> (📖50)																							
On		–	–	–	–	–	○	–	–	–	–	–	–	–	–	–	–	–	–	–	–	–	–
Off		○	○	○	○	○	○	○	○	○	○	○	○	○	○	○	○	○	○	○	○	○	○

○ Can be selected or automatically set. – Cannot be selected.

- Before Use
- Basic Guide
- Advanced Guide
  - Camera Basics
  - Auto Mode / Hybrid Auto Mode
  - Other Shooting Modes
  - P Mode
  - Tv, Av, and M Mode
  - Playback Mode
  - Wi-Fi Functions
  - Setting Menu
  - Accessories
  - Appendix
- Index

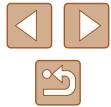

		Shooting Mode																												
		M	Av	Tv	P	LIVE	Ⓜ	AUTO	📷	🔧	🔍	🔄	🔄	🔄	🔄	🔄	🔄	🔄	🔄	🔄	🔄	🔄	🔄	🔄						
Function																														
Safety Shift (📖85)																														
On		-	○	○	-	-	-	-	-	-	-	-	-	-	-	-	-	-	-	-	-	-	-	-						
Off		○	○	○	○	○	○	○	○	○	○	○	○	○	○	○	○	○	○	○	○	○	○	○	○					
Wind Filter (📖67)																														
Auto		○	○	○	○	○	○	○	-	○	○	○	○	○	○	○	○	○	○	○	○	○	○	○	○					
Off		○	○	○	○	-	-	-	○	-	-	-	-	-	-	-	-	-	○	-	-	-	-	-	○	○	○			
Attenuator (📖67)																														
Off / On		○	○	○	○	-	-	-	-	-	-	-	-	-	-	-	-	-	-	-	-	-	-	-	○	-	○			
Auto		○	○	○	○	○	○	○	○	○	○	○	○	○	○	○	○	○	○	○	○	○	○	○	○	○	○	○		
Review image after shooting (📖54)																														
Display Time	Off / Quick	○	○	○	○	○	○	○	-	○	○	○	○	○	○	○	○	○	○	○	○	○	○	○	○	○	○	○		
	2 sec. / 4 sec. / 8 sec. / Hold	○	○	○	○	○	○	○	○	○	○	○	○	○	○	○	○	○	○	○	○	○	○	○	○	○	○	○	○	
Display Info	Off	○	○	○	○	○	○	○	○	○	○	○	○	○	○	○	○	○	○	○	○	○	○	○	○	○	○	○	○	
	Detailed	○	○	○	○	○	○	○	○	-	○	○	○	○	○	○	○	○	○	○	○	○	○	○	○	○	○	○	○	
Grid Lines (📖51)																														
On / Off		○	○	○	○	○	○	○	○	○	○	○	○	○	○	○	○	○	○	○	○	○	○	○	○	○	○	○	○	
IS Settings (📖83)																														
IS Mode	Off	○	○	○	○	○	○	○	○	○	○	○	○	○	○	○	○	○	○	○	○	○	○	○	○	○	○	○	○	
	Continuous	○	○	○	○	○	○	○	○	○	○	○	○	○	○	○	○	○	○	○	○	○	○	○	○	○	○	○	○	
	Shoot Only	○	○	○	○	○	-	-	-	○	○	○	○	○	○	○	○	○	○	○	○	○	○	○	○	-	-	-	-	
Dynamic IS	Low	○	○	○	○	○	○	○	○	○	○	○	○	○	○	○	○	○	○	○	○	○	○	○	○	○	○	○	○	○
	Standard	○	○	○	○	○	○	○	-	○	○	○	○	○	○	○	○	○	○	○	○	○	○	○	○	○	○	○	○	○
	High	-	-	-	-	-	-	-	-	-	-	-	-	-	-	-	-	-	-	-	-	-	-	-	-	-	○	-	○	

○ Can be selected or automatically set. - Cannot be selected.

Before Use

Basic Guide

Advanced Guide

Camera Basics

Auto Mode / Hybrid Auto Mode

Other Shooting Modes

P Mode

Tv, Av, and M Mode

Playback Mode

Wi-Fi Functions

Setting Menu

Accessories

Appendix

Index



		Shooting Mode													Camera Function															
		M	Av	Tv	P	LIVE	AI	AUTO	AF	AE	AF	AE	AF	AE	AF	AE	AF	AE	AF	AE	AF	AE	AF	AE						
<b>Function</b>																														
<b>Auto Level (📖52)</b>																														
Enable		O	O	O	O	O	O	O	-	O	O	O	O	O	O	O	O	O	O	-	O	O	O	O	O	O	O	O	-	O
Disable		O	O	O	O	O	O	O	O	O	O	O	O	O	O	O	O	O	O	O	O	O	O	O	O	O	O	O	O	O
<b>Display Area (📖39)</b>																														
Large / Medium / Small		O	O	O	O	O	O	O	O	O	O	O	O	O	O	O	O	O	O	O	O	O	O	O	O	O	O	O	O	O
<b>Auto Settings (📖40, 📖41)</b>																														
Seek Assist	On	-	O	O	O	O	O	O	O	O	O	O	O	O	O	O	O	O	O	-	-	O	O	O	O	O	-	O	-	O
	Off	O	O	O	O	O	O	O	O	O	O	O	O	O	O	O	O	O	O	O	O	O	O	O	O	O	O	O	O	O
Auto Zoom	Face / Upper Body / Whole Body / Manual / Auto	-	O	O	O	O	O	O	O	O	O	O	O	O	O	O	O	O	O	-	-	O	O	O	O	O	-	O	-	O
	Off	O	O	O	O	O	O	O	O	O	O	O	O	O	O	O	O	O	O	O	O	O	O	O	O	O	O	O	O	O
		O	O	O	O	O	O	O	O	O	O	O	O	O	O	O	O	O	O	O	O	O	O	O	O	O	O	O	O	O
<b>Digest Type (📖34)</b>																														
Include Stills / No Stills		-	-	-	-	-	O	-	-	-	-	-	-	-	-	-	-	-	-	-	-	-	-	-	-	-	-	-	-	
<b>Auto slow shutter (📖67)</b>																														
Enable		-	-	-	-	-	-	-	-	-	-	-	-	-	-	-	-	-	-	-	-	-	-	-	-	-	-	O	-	
Disable		O	O	O	O	O	O	O	O	O	O	O	O	O	O	O	O	O	O	O	O	O	O	O	O	O	O	O	O	O
<b>Face ID Settings (📖45)</b>																														
On		O	O	O	O	O	O	O	-	O	O	O	O	O	O	O	O	O	O	O	O	O	O	O	O	O	O	O	O	O
Off		O	O	O	O	O	O	O	O	O	O	O	O	O	O	O	O	O	O	O	O	O	O	O	O	O	O	O	O	O

- Names of people in shots taken using Face ID (📖44) may not be displayed in some modes or with some settings, but they will be recorded in the still images.

O Can be selected or automatically set. - Cannot be selected.

- Before Use
- Basic Guide
- Advanced Guide
  - Camera Basics
  - Auto Mode / Hybrid Auto Mode
  - Other Shooting Modes
  - P Mode
  - Tv, Av, and M Mode
  - Playback Mode
  - Wi-Fi Functions
  - Setting Menu
  - Accessories
  - Appendix
- Index



## Set Up Tab

Item	Reference Page
Mute	139
Volume	139
Hints & Tips	140
Date/Time	140
Time Zone	140
Lens Retraction	141
Eco Mode	141
Power Saving	26,  141
Disp. Brightness	142
Start-up Image	142
Format	142
File Numbering	143
Create Folder	144
Units	144
Video System	148
Wireless settings	112
Certification Logo Display	144
Language	144
Reset All	145

## Playback Tab

Item	Reference Page
Play Creative Shot Movies	89
Short Clip Mix	111
Album Playback	108
List/Play Digest Movies	90
Slideshow	94
Erase	98
Protect	96
Rotate	100
Favorites	101
Photobook Set-up	158
i-Contrast	104
Red-Eye Correction	104
Cropping	102
Resize	102
My Colors	103
Face ID Info	90
Transition Effect	87
Index Effect	91
Scroll Display	87
Group Images	92
Auto Rotate	100
Resume	87

Before Use

Basic Guide

Advanced Guide

Camera Basics

Auto Mode /  
Hybrid Auto Mode

Other Shooting Modes

P Mode

Tv, Av, and M Mode

Playback Mode

Wi-Fi Functions

Setting Menu

Accessories

Appendix

Index



## Print Tab

Item	Reference Page
Print	–
Select Images & Qty.	157
Select Range	157
Select All Images	157
Clear All Selections	158
Print Settings	156

## Playback Mode FUNC. Menu

Item	Reference Page
Rotate	100
Protect	96
Favorites	101
Print	153
Group Playback	92
Play Movie	87
Play Linked Digest Movie	90
Smart Shuffle	95
Image Search	91
Slideshow	94

## Handling Precautions

- The camera is a high-precision electronic device. Avoid dropping it or subjecting it to strong impact.
- Never bring the camera near magnets, motors, or other devices that generate strong electromagnetic fields. Electromagnetic fields may cause malfunction or erase image data.
- If water droplets or dirt adheres to the camera or screen, wipe with a dry soft cloth, such as an eyeglass cloth. Do not rub hard or apply force.
- Never use cleaners containing organic solvents to clean the camera or screen.
- Use a blower brush to remove dust from the lens. If cleaning is difficult, contact a Canon Customer Support Help Desk.
- Condensation (water droplets) may form on the camera after sudden temperature changes by transferring from cold to warm environments. To prevent condensation from forming by transferring the camera from cold to warm environments, put the camera in an airtight, resealable plastic bag and let it gradually adjust to the temperature before removing it from the bag.
- If condensation does form on the camera, stop using it immediately. Continuing to use the camera in this state may damage it. Remove the battery pack and memory card, and wait until the moisture has evaporated before resuming use.
- Store unused battery packs in a plastic bag or other container. To maintain battery performance if you will not use the battery pack for some time, about once a year charge it and then use the camera until it runs out of power before storing the battery pack.

Before Use

Basic Guide

Advanced Guide

Camera Basics

Auto Mode /  
Hybrid Auto Mode

Other Shooting Modes

P Mode

Tv, Av, and M Mode

Playback Mode

Wi-Fi Functions

Setting Menu

Accessories

Appendix

Index





# Specifications

## Camera

### Image Sensor

#### Camera Effective Pixels

(Image processing may cause a decrease

in the number of pixels.) ..... Approx. 20.3 megapixels

Total Pixels..... Approx. 21.1 megapixels

Image Size..... 1/2.3 type

### Lens

#### Focal Length

(35mm film equivalent) ..... 4.3 – 172 mm

(24 – 960 mm)

Zoom Magnification ..... 40x

### Digital zoom

Magnification..... Approx. 4x

#### Max. Magnification

(digital x optical zoom)..... Approx. 160x

#### Focal Length

(max. telephoto, 35mm film equivalent) .... Equivalent to approx. 3840 mm

### Screen (Monitor)

Type..... TFT color liquid crystal

Screen Size ..... 3.0 type

Effective Pixels ..... Approx. 922,000 dots

### Continuous Shooting

#### Speed

(Varies depending on the subject, zoom position, and other shooting factors, as well as memory card brands.)

..... Normal Continuous Shooting in Auto/P modes: Approx. 5.9 shots/sec.

Continuous Shooting AF in P mode: Approx. 4.6 shots/sec.

Continuous Shooting LV in P mode: Approx. 4.6 shots/sec.

### Built-In Flash

Flash Range (Wide angle end)..... 50 cm – 4.0 m (1.6 – 13 ft.)

Flash Range (Telephoto end)..... 2.0 m (6.6 ft.)

### Shutter Speed

Auto Mode (automatic settings)..... 1 – 1/3200 sec.

Range in all shooting modes

Maximum ..... 15 sec.

Minimum ..... 1/3200 sec.

Speed (unit: sec.)..... Tv, M Modes

15, 13, 10, 8, 6, 5, 4, 3.2, 2.5, 2, 1.6, 1.3, 1, 0.8, 0.6, 0.5, 0.4, 0.3, 1/4, 1/5, 1/6, 1/8, 1/10, 1/13, 1/15, 1/20, 1/25, 1/30, 1/40, 1/50, 1/60, 1/80, 1/100, 1/125, 1/160, 1/200, 1/250, 1/320, 1/400, 1/500, 1/640, 1/800, 1/1000, 1/1250, 1/1600, 1/2000, 1/2500, 1/3200

### Aperture

F number ..... 3.3 – 8.0 (W)

6.9 – 8.0 (T)

### AF

AF frame..... Face AiAF (number of AF frames: max.9), Tracking AF, Center

File Format..... Design rule for Camera File system (DCF) compliant; DPOF (version 1.1) compatible

Before Use

Basic Guide

Advanced Guide

Camera Basics

Auto Mode / Hybrid Auto Mode

Other Shooting Modes

P Mode

Tv, Av, and M Mode

Playback Mode

Wi-Fi Functions

Setting Menu

Accessories

Appendix

Index

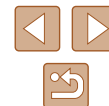

#### Data Type (Still Images)

Image File Format..... Exif 2.3 (DCF 2.0)  
Image Type..... JPEG

#### Data Type (Movies)

Recording Format..... MP4  
Video..... MPEG-4 AVC/H.264  
Audio..... MPEG-4 AAC-LC (stereo)

#### Power Supply

Battery Pack..... NB-13L

#### Interface

Wired..... Hi-Speed USB (Micro)  
HDMI (Type D)  
Wireless..... Wi-Fi  
Specifications: IEEE 802.11b/g/n  
Frequency: 2.4 GHz  
Channels: 1 – 11  
Security: WEP, WPA-PSK (AES/  
TKIP), WPA2-PSK (AES/TKIP)  
NFC

#### Operating Environment

Temperature..... 0 – 40 °C (32 – 104 °F)

#### Dimensions (CIPA compliant)

(WxHxD)..... 109.7 x 63.8 x 35.7 mm  
(4.32 x 2.51 x 1.41 in.)

#### Weight (CIPA compliant)

Including Battery Pack,  
Memory Card..... Approx. 270 g (Approx. 9.52 oz.)  
Camera Body Only..... Approx. 245 g (Approx. 8.64 oz.)

## Number of Shots/Recording Time, Playback Time

Number of Still Image Shots (CIPA compliant)	Approx. 250 shots
Number of Still Image Shots (Eco Mode On)	Approx. 355 shots
Movie Recording Time (CIPA compliant)* <sup>1</sup>	Approx. 50 min.
Movie Recording Time (Continuous Shooting)* <sup>2</sup>	Approx. 1 hr. 25 min.
Playback Time* <sup>3</sup>	Approx. 5 hr.

\*1 Total time when shooting repeatedly with the following conditions





- [AUTO] mode and defaults for other settings
- Shooting/pausing, zooming, turning the camera on and off

\*2 Total time when shooting repeatedly with the following conditions

- [AUTO] mode and defaults for other settings
- If the maximum amount of movie recording time or number of shots is reached, the camera will shut down / restart.

\*3 Time when playing a still image slideshow.

## Shooting Range

Shooting Mode	Focus Range	Maximum Wide Angle (  )	Maximum Telephoto (  )
AUTO*	–	1 cm (0.4 in.) – infinity	2.0 m (6.6 ft.) – infinity
Other modes		5 cm (2.0 in.) – infinity	2.0 m (6.6 ft.) – infinity
		1 – 50 cm (0.4 in. – 1.6 ft.)	–

\* Manual Focus is the same.

Before Use

Basic Guide

Advanced Guide

Camera Basics

Auto Mode /  
Hybrid Auto Mode

Other Shooting Modes

P Mode

Tv, Av, and M Mode

Playback Mode

Wi-Fi Functions

Setting Menu

Accessories

Appendix



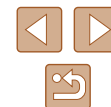





Index



## Number of Shots per Memory Card





The number of shots at an aspect ratio (4:3) of 4:3 per memory card is as follows. Note that the number of shots available varies by aspect ratio.

Number of Shots per 16 GB Memory Card (Approx. shots)

L		1766
		2980
M1		3546
		5925
M2		9344
		16755
S		53992
		80988

- The values in the table are based on Canon measurement conditions and may change depending on the subject, memory card and camera settings.

## Recording Time per Memory Card

Recording Pixels	Total Recording Time per 16 GB Memory Card (Approx.)	Recording Time for One Time (Approx.)
 (1920 x 1080)	59 min. 30 sec.	29 min. 59 sec.
 (1920 x 1080)	1 hour 26 min. 5 sec.	29 min. 59 sec.
 (1280 x 720)	4 hours 5 min. 15 sec.	29 min. 59 sec.
 (640 x 480)	10 hours 22 min. 35 sec.	1 hour

- The values in the table are based on Canon measurement conditions and may change depending on the subject, memory card and camera settings.
- Recording times for individual movies are based on memory cards rated at an SD speed class of 10. Recording may stop when cards rated at lower speed classes are used. Recording will also stop automatically when the file size reaches 4 GB, or when the card becomes full.

- Before Use
- Basic Guide
- Advanced Guide
  - Camera Basics
  - Auto Mode / Hybrid Auto Mode
  - Other Shooting Modes
  - P Mode
  - Tv, Av, and M Mode
  - Playback Mode
  - Wi-Fi Functions
  - Setting Menu
  - Accessories
  - Appendix
- Index



## Battery Pack NB-13L

Type:	Rechargeable lithium-ion battery
Nominal Voltage:	3.6 V DC
Nominal Capacity:	1250 mAh
Charging Cycles:	Approx. 300 times
Operating Temperatures:	0 – 40 °C (32 – 104 °F)

## Battery Charger CB-2LH/CB-2LHE

Rated Input:	100 – 240 V AC (50/60 Hz) 0.09 A (100 V) – 0.06 A (240 V)
Rated Output:	4.2 V DC, 0.7 A
Charging Time:	Approx. 2 hr. 10 min. (when using NB-13L)
Operating Temperatures:	5 – 40 °C (41 – 104 °F)

## Compact Power Adapter CA-DC30/CA-DC30E

Rated Input:	100 – 240 V AC (50/60 Hz) 0.07 A (100 V) – 0.045 A (240 V)
Rated Output:	5.0 V DC, 0.55 A
Charging Time:	Approx. 5 hr.* (when charged with NB-13L in the camera) * Charging time varies considerably depending on the remaining battery level.
Operating Temperatures:	5 – 40 °C (41 – 104 °F)

- The number of shots that can be taken is based on measurement guidelines of the Camera & Imaging Products Association (CIPA).
- Under some shooting conditions, the number of shots and recording time may be less than mentioned above.
- Number of shots/time with a fully charged battery pack.

Before Use

Basic Guide

Advanced Guide

Camera Basics

Auto Mode /  
Hybrid Auto Mode

Other Shooting Modes

P Mode

Tv, Av, and M Mode

Playback Mode

Wi-Fi Functions

Setting Menu

Accessories

Appendix

Index

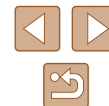

# Index

## A

Accessories 147  
AE lock 71  
AF frames 77  
AF lock 80  
Aspect ratio 49  
AUTO mode (shooting mode) 22, 32  
Av (shooting mode) 85

## B

Batteries → Date/time (date/time battery)  
Battery pack  
    Charging 18  
    Eco mode 141  
    Level 166  
    Power saving 26  
Black and white images 74

## C

Camera  
    Reset all 145  
Camera access point mode 118  
Camera connect 113  
CameraWindow 151  
CANON iMAGE GATEWAY 124  
Center (AF frame mode) 77  
Clock 31  
Color (white balance) 73  
Compression ratio (image quality) 83  
Continuous shooting 37, 43  
Creative shot 57  
Custom white balance 73

## D

Date/time  
    Changing 20  
    Date/time battery 21  
    Settings 20  
    World clock 140  
Defaults → Reset all  
Digital tele-converter 77  
Digital zoom 38  
Display language 21  
DPOF 156

## E

Eco mode 141  
Editing  
    i-Contrast 104  
    My colors 103  
    Red-eye correction 104  
Editing or erasing connection information 137

## Erasing 98

Error messages 164

## Exposure

AE lock 71  
Compensation 71  
FE lock 82

## F

Face ID 44  
Face self-timer (shooting mode) 65  
Favorites 101  
FE lock 82  
File numbering 143

Fireworks (shooting mode) 59  
Fish-eye effect (shooting mode) 60  
Flash  
    Deactivating flash 81  
    Flash exposure compensation 82  
    On 81  
    Slow synchro 81  
Focusing  
    AF frames 77  
    AF lock 80  
    AF-point zoom 51  
    MF peaking 76  
    Servo AF 79

Focus lock 77

## Focus range

Macro 75  
Manual focus 75

Framing assist 39

## FUNC. menu

Basic operations 28  
Table 169

## G

Geotagging images 135  
GPS information display 89  
Grid lines 51

## H

Handheld nightscene (shooting mode) 59  
HDMI cable 148

## I

i-Contrast 72, 104  
iFrame movies (movie mode) 69  
Image quality → Compression ratio (image quality)

## Images

Display period 54  
Erasing 98  
Playback → Viewing  
Protecting 96

Image stabilization 83

Image sync 133

Indicator 31

ISO speed 72

## L

Lamp 53, 54  
Live view control (shooting mode) 56  
Low light (shooting mode) 59

## M

M (shooting mode) 85  
Macro (focus range) 75  
Magnified display 94  
Manual focus (focus range) 75  
Memory cards 2  
    Recording time 179

## Menu

Basic operations 29  
Table 168

Mercury lamp correction 50  
Metering method 71

Miniature effect (shooting mode) 61

Monochrome (shooting mode) 63

## Movies

Editing 105  
Recording time 179

Multi-area white balance 50

My colors 74, 103

## P

P (shooting mode) 70  
Package contents 2

## Before Use

## Basic Guide

## Advanced Guide

### Camera Basics

### Auto Mode / Hybrid Auto Mode

### Other Shooting Modes

### P Mode

### Tv, Av, and M Mode

### Playback Mode

### Wi-Fi Functions

### Setting Menu

### Accessories

### Appendix

## Index



Photobook set-up 158  
Playback → Viewing  
Portrait (shooting mode) 59  
Poster effect (shooting mode) 60  
Power 147 → Battery charger,  
→ Battery pack  
Power saving 26  
Printing 153 → Printing  
Program AE 70  
Protecting 96

**R**  
Recording pixels (image size) 49  
Red-eye correction 104  
Remote shooting 136  
Reset all 145  
Resizing images 102  
Rotating 100

**S**  
Saving images to a computer 151  
Screen  
    Display language 21  
    Icons 166, 167  
    Menu → FUNC. menu, Menu  
SD/SDHC/SDXC memory cards  
→ Memory cards  
Searching 91  
Self-timer 42  
    2-second self-timer 42  
    Wink self-timer (shooting mode)  
    64  
Sending images 129  
Sending images to another camera  
129  
Sending images to a smartphone 113  
Sending images to Web services 124  
Sepia tone images 74

Servo AF 79  
Shooting  
    Shooting date/time → Date/time  
    Shooting information 166  
Short clips (movie mode) 68  
Slideshow 94  
Smart shuffle 95  
Smart shutter (shooting mode) 63  
Smile (shooting mode) 63  
Soft focus (shooting mode) 62  
Software  
    Installation 119, 151  
    Saving images to a computer  
    151  
Sounds 139  
Standard (movie mode) 66  
Story highlights 108  
Strap 2, 17  
Super vivid (shooting mode) 60

**T**  
Terminal 153  
Toy camera effect (shooting mode)  
62  
Tracking AF 78  
Traveling with the camera 140  
Troubleshooting 160  
TV display 148  
Tv (shooting mode) 84

**V**  
Viewing 23  
    Image search 91  
    Index display 91  
    Magnified display 94  
    Single-image display 23  
    Slideshow 94  
    Smart shuffle 95

TV display 148

## W

White balance (color) 73  
Wi-Fi functions 112  
Wi-Fi menu 116  
Wind filter 67  
World clock 140  
Wrist strap → Strap

## Z

Zoom 22, 33, 38

Before Use
Basic Guide
Advanced Guide
Camera Basics
Auto Mode / Hybrid Auto Mode
Other Shooting Modes
P Mode
Tv, Av, and M Mode
Playback Mode
Wi-Fi Functions
Setting Menu
Accessories
Appendix
Index

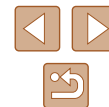

## Wi-Fi (Wireless LAN) Precautions

- Countries and Regions Permitting WLAN Use
  - Use of WLAN is restricted in some countries and regions, and illegal use may be punishable under national or local regulations. To avoid violating WLAN regulations, visit the Canon website to check where use is allowed.  
Note that Canon cannot be held liable for any problems arising from use in other countries and regions.
- Doing any of the following may incur legal penalties:
  - Altering or modifying the product
  - Removing the certification labels from the product
- According to foreign exchange and foreign trade law regulations, export permission (or service transaction permission) from the Japanese government is necessary to export strategic resources or services (including this product) outside Japan.
- Because this product includes American encryption software, it falls under U.S. Export Administration Regulations, and cannot be exported to or brought into a country under U.S. trade embargo.
- Be sure to make notes of the wireless LAN settings you use. The wireless LAN settings saved to this product may change or be erased due to incorrect operation of the product, the effects of radio waves or static electricity, or accident or malfunction. Be sure to make notes of wireless LAN settings as a precaution. Please note that Canon accepts no responsibility for direct or indirect damages or loss of earnings resulting from a degradation or disappearance of content.
- When transferring this product to another person, disposing of it, or sending it for repair, be sure to note the wireless LAN settings and reset the product to its default settings (erase settings) if necessary.
- Canon will not make compensation for damages resulting from loss or theft of the product.  
Canon accepts no responsibility for damages or loss resulting from unauthorized access or use of target devices registered on this product due to loss or theft of the product.

- Be sure to use the product as directed in this guide. Be sure to use the wireless LAN function of this product within the guidelines noted in this guide. Canon accepts no responsibility for damages or loss if the function and product are used in ways other than as described in this guide.
- Do not use the wireless LAN function of this product near medical equipment or other electronic equipment. Use of the wireless LAN function near medical equipment or other electronic equipment may affect operation of those devices.

## Radio Wave Interference Precautions

- This product may receive interference from other devices that emit radio waves. To avoid interference, be sure to use this product as far away as possible from such devices, or avoid using the devices at the same time as this product.

## Security Precautions

Because Wi-Fi uses radio waves to transmit signals, security precautions more stringent than when using a LAN cable are required. Keep the following points in mind when using Wi-Fi.

- Only use networks you are authorized to use. This product searches for Wi-Fi networks in the vicinity and displays the results on the screen. Networks you are not authorized to use (unknown networks) may also be displayed. However, attempting to connect to or using such networks could be regarded as unauthorized access. Be sure to use only networks you are authorized to use, and do not attempt to connect to other unknown networks.

Before Use

Basic Guide

Advanced Guide

Camera Basics

Auto Mode /  
Hybrid Auto Mode

Other Shooting Modes

P Mode

Tv, Av, and M Mode

Playback Mode

Wi-Fi Functions

Setting Menu

Accessories

Appendix

Index



If security settings have not been properly set, the following problems may occur.

- **Transmission monitoring**  
Third parties with malicious intent may monitor Wi-Fi transmissions and attempt to acquire the data you are sending.
- **Unauthorized network access**  
Third parties with malicious intent may gain unauthorized access to the network you are using to steal, modify, or destroy information. Additionally, you could fall victim to other types of unauthorized access such as impersonation (where someone assumes an identity to gain access to unauthorized information) or springboard attacks (where someone gains unauthorized access to your network as a springboard to cover their tracks when infiltrating other systems).

To prevent these types of problems from occurring, be sure to thoroughly secure your Wi-Fi network.

Only use this camera's Wi-Fi function with a proper understanding of Wi-Fi security, and balance risk and convenience when adjusting security settings.



The camera can print to PictBridge-compatible printers via Wi-Fi. PictBridge technical standards make it easy to connect digital cameras, printers, and other devices directly. Additionally, a new standard called DPS over IP enables PictBridge connections in network environments, and the camera is also compatible with this standard.

## Trademarks and Licensing

- Microsoft and Windows are trademarks or registered trademarks of Microsoft Corporation in the United States and/or other countries.
- Macintosh and Mac OS are trademarks of Apple Inc., registered in the U.S. and other countries.
- App Store, iPhone, and iPad are trademarks of Apple Inc.
- The SDXC logo is a trademark of SD-3C, LLC.
- HDMI, the HDMI logo and High-Definition Multimedia Interface are trademarks or registered trademarks of HDMI Licensing, LLC.
- The iFrame logo and the iFrame symbol are trademarks of Apple Inc.
- Wi-Fi®, Wi-Fi Alliance®, WPA™, WPA2™ and Wi-Fi Protected Setup™ are trademarks or registered trademarks of the Wi-Fi Alliance.
- The N-Mark is a trademark or registered trademark of NFC Forum, Inc. in the United States and in other countries.
- All other trademarks are the property of their respective owners.
- This device incorporates exFAT technology licensed from Microsoft.
- This product is licensed under AT&T patents for the MPEG-4 standard and may be used for encoding MPEG-4 compliant video and/or decoding MPEG-4 compliant video that was encoded only (1) for a personal and non-commercial purpose or (2) by a video provider licensed under the AT&T patents to provide MPEG-4 compliant video. No license is granted or implied for any other use for MPEG-4 standard.

Before Use
Basic Guide
Advanced Guide
Camera Basics
Auto Mode / Hybrid Auto Mode
Other Shooting Modes
P Mode
Tv, Av, and M Mode
Playback Mode
Wi-Fi Functions
Setting Menu
Accessories
Appendix
Index

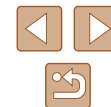



## Disclaimer

- Unauthorized reproduction of this guide is prohibited.
- All measurements based on Canon testing standards.
- Information subject to change without notice, as are product specifications and appearance.
- Illustrations and screenshots in this guide may differ slightly from the actual equipment.
- The above items notwithstanding, Canon cannot be held liable for any loss arising from the use of this product.

Before Use

Basic Guide

Advanced Guide

Camera Basics

Auto Mode /  
Hybrid Auto Mode

Other Shooting Modes

P Mode

Tv, Av, and M Mode

Playback Mode

Wi-Fi Functions

Setting Menu

Accessories

Appendix

Index

