

Canon

Exif Print

PictBridge

Photo All-In-One

PIXMA MP610 series

Quick Start Guide



QT51125V01

Getting Help from Canon

Help Us Help You Better

Before you contact Canon, please record the following information.

Serial Number (located on the inside of the product): _____

Model Number (located on the top of the product): _____

Setup CD-ROM number (located on the CD-ROM): _____

Purchase Date: _____

Customer Technical Support Sequence*

1. Internet — www.canontechsupport.com

For quick and comprehensive self-help in an intuitively guided interactive troubleshooting environment, the place to start is our helpful tech support web site. In addition, the latest driver downloads, answers to frequently asked questions, product information, and "where to buy" instructions are found here.

2. Email Tech Support — www.canontechsupport.com

For individual attention to a special issue, try emailing our friendly technical support representatives, specially trained to communicate quick, easy, and logical solutions to your inquiries within 24 hours.

3. Toll-Free Live Tech Support — (1-800-828-4040)

This option provides live telephone technical support, free of service charges, Monday-Saturday (excluding holidays), during your product's 1 year limited warranty period. Telephone Device for the Deaf (TDD) support is available at **(1-866-251-3752)**.

4. Extended Service and Support — www.canonesp.com

Canon CarePAK Extended Service Plan is a cost-attractive and easy-to-use extended service program that provides up to three full years of service and support coverage at a very attractive price. CarePAK offers toll-free Canon technical support and includes Canon's superb InstantExchange product replacement program. For further information about extending your Canon service and support, call **(1-800-385-2155)**, or visit our Web site at **www.canonesp.com**. CarePAK must be purchased during your product's warranty period.

For more information and updated program specifics, please visit our web site at **www.canontechsupport.com**.

* Support program specifics are subject to change without notice.

Canon

PIXMA MP610 series

Photo All-In-One

Quick Start Guide

Copyright

This manual is copyrighted by Canon U.S.A., Inc. with all rights reserved. Under the copyright laws, this manual may not be reproduced in any form, in whole or in part, without the prior written consent of Canon U.S.A., Inc.

© 2007 Canon U.S.A., Inc.

Disclaimer

Canon U.S.A., Inc. has reviewed this manual thoroughly in order that it will be an easy-to-use guide to your Canon PIXMA MP610 series Photo All-In-One. All statements, technical information and recommendations in this manual and in any guides or related documents are believed reliable, but the accuracy and completeness thereof are not guaranteed or warranted, and they are not intended to be, nor should they be understood to be, representation or warranties concerning the products described.

Depending on your application program, operations may differ. For details, refer to the instruction manual of your application. The steps described in this manual are in Windows Vista™ operating system Ultimate Edition (hereafter referred to as “Windows Vista”) and Mac® OS X v.10.4.x.

As an ENERGY STAR® Partner, Canon Inc. has determined that this product meets the ENERGY STAR guidelines for energy efficiency.



All information regarding non-Canon products was compiled from publicly available information. No representation is made regarding the accuracy thereof.

About Consumables

Consumables (ink tanks / FINE Cartridges) are available for 5 years after production has stopped.

Trademarks

- “Microsoft” is a registered trademark of Microsoft Corporation.
- “Windows” is a trademark of Microsoft Corporation, registered in the U.S. and other countries.
- “Windows Vista” is a trademark of Microsoft Corporation.
- “Macintosh” and “Mac” are trademarks of Apple Inc., registered in the U.S. and other countries.
- “Memory Stick”, “Memory Stick PRO”, “Memory Stick Duo” and “Memory Stick PRO Duo” are trademarks of Sony Corporation.
- “xD-Picture Card” is a trademark of Fuji Film Co. Ltd.
- “MultiMediaCard” is a trademark of the MultiMediaCard Association.
- “SD Card”, “miniSD Card”, and “microSD Card” are trademarks of SD Association.
- “IrDA Feature Trademark” is owned by the Infrared Data Association and used under license therefrom.
- “Bluetooth” is a trademark of Bluetooth SIG, Inc., U.S.A. and licensed to Canon Inc.

Table of Contents

Before Using the Machine	2	Troubleshooting	68
How to Navigate Menus on the LCD	2	An Error Message Is Displayed on the LCD	70
Turning the Machine On and Off	5	LCD Cannot Be Seen At All.....	72
Handling the Original Document.....	6	An Unintended Language Is Displayed on the LCD	72
Loading Printing Paper	8	Cannot Install the MP Drivers.....	73
Hints for Handling the Paper Sources	11	Cannot Connect to Computer Properly	74
Changing the Paper Source	14	Print Results Not Satisfactory	75
Loading Paper	15	The Print Result Not Satisfactory	
Loading Envelopes	19	When Copying	78
Loading Small-Sized Paper	22	Printing Does Not Start.....	79
Copying	24	Machine Moves But Ink Is Not Ejected.....	80
Making Copies	24	Paper Does Not Feed Properly	81
Using Useful Copy Functions	25	Paper Does Not Feed from the Paper Source Specified in the Printer Driver.....	81
Printing from a Memory Card	26	Paper Jams	82
Memory Cards Supported by This Machine	26	Error Message Appears on the Computer Screen	86
Inserting the Memory Card	27	Error Message Appears on a PictBridge Compliant Device	88
Removing the Memory Card.....	28	Cannot Print Properly through Infrared Communication.....	90
Printing Photographs Saved on a Memory Card	28	Cannot Print Properly via Bluetooth Communication.....	90
Using Useful Printing Functions.....	32	Cannot Print Properly from a Photo Index Sheet	90
Using Useful Display Functions	32	Cannot Remove a Memory Card.....	90
Printing by Using the Photo Index Sheet.....	33	Scanning Problems	91
Photo Printing from Printed Photo	34	Appendix	92
Using Useful Printing Functions.....	35	How to Use the Documentation Provided.....	92
Using Useful Display Functions	35	Reading the On-screen Manuals.....	93
Printing from Your Computer	36	Specifications	94
Printing with Windows.....	36	Safety Precautions	97
Printing with Macintosh.....	37	Legal Limitations on Use of Your Product and Use of Images	100
Scanning Images	38	Users in the U.S.A.	101
Scanning Methods	38	Index	105
Printing Photographs Directly from a Pict-Bridge Compliant Device	40		
Printing Photographs Directly from a PictBridge Compliant Device.....	40		
About PictBridge Print Settings.....	42		
Routine Maintenance	46		
Replacing an Ink Tank	46		
Keeping the Best Printing Results	51		
When Printing Becomes Faint or Colors Are Incorrect.....	52		
Printing the Nozzle Check Pattern.....	53		
Examining the Nozzle Check Pattern	54		
Print Head Cleaning.....	56		
Print Head Deep Cleaning	57		
Aligning the Print Head.....	58		
Cleaning Your Machine	63		

Before Using the Machine

How to Navigate Menus on the LCD

You can display the menu screen or setting screen and use various functions on the LCD.

This section describes about the basic operation of the menu screen and buttons on the Operation Panel.

- (1) **HOME** screen
- (2) **Function** buttons
See "Operation of Other Buttons" on page 3.
- (3) **Black** button (top)
Color button (bottom)
- (4) ▲, ▼, ◀ and ▶ buttons
- (5) **OK** button
- (6) **Easy-Scroll Wheel**
- (7) **HOME** button
- (8) **NAVI** button
See "Operation of Other Buttons" on page 3.
- (9) **Back** button
See "Operation of Other Buttons" on page 3.

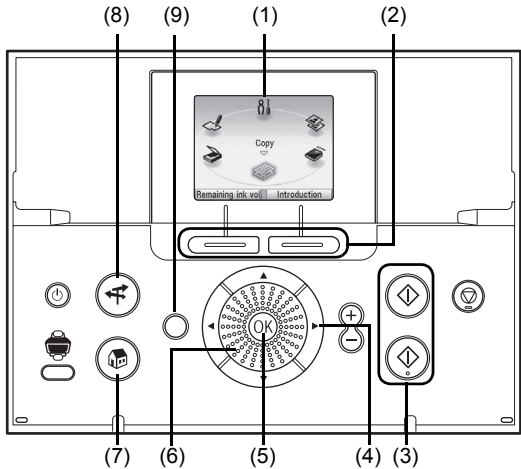

■ Basic Operation

This section describes the operation to navigate menus with the **Easy-Scroll Wheel**, ◀, ▶, and **OK** buttons, taking the **HOME** screen as an example.

- 1 Press the **HOME** button.
The **HOME** screen will be displayed.

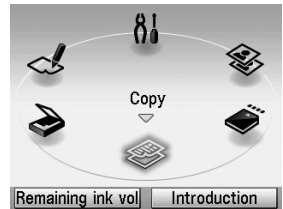

- 2 Turn the **Easy-Scroll Wheel** to select the mode, then press the **OK** button.
You can turn the **Easy-Scroll Wheel** left or right.
You can also use the ◀ or ▶ button to select setting items.
Move the icon of the desired mode to position (A).
The selected mode screen will be displayed.

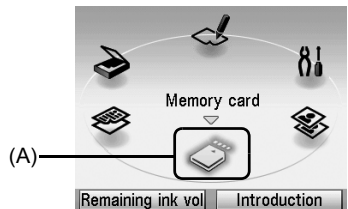

You can select the following modes on the **HOME** screen:

- Copy:** You can copy in various layouts. See “Copying” on page 24.
- Scan:** You can save the scanned data to a connected computer using the Operation Panel. See “Scanning Images” on page 38.
- Photo index sheet:** You can easily print the photos from a memory card using the Photo Index Sheet. See “Printing by Using the Photo Index Sheet” on page 33.
- Settings:** You can perform the maintenance or change the various settings of the machine. For details, see “When Printing Becomes Faint or Colors Are Incorrect” on page 52, “Cleaning Your Machine” on page 63, or “Changing the Machine Settings” in the *User’s Guide* on-screen manual.
- Easy photo reprint:** You can scan printed photos and then print them. See “Photo Printing from Printed Photo” on page 34.
- Memory card:** Print the photo data saved on a memory card of a digital camera. See “Printing from a Memory Card” on page 26.

■ Operation of Other Buttons

● Function Buttons

Two Function buttons enable you to select menus displayed at the bottom of the LCD.

The screen that appears when you press a Function button depends on the screen that is displayed and which Function button you press.

- (1) Left Function button
When you press the left Function button on the **HOME** screen, the remaining ink volume screen is displayed.
- (2) Right Function button
When you press the right Function button on the **HOME** screen, the introductions for the selected mode functions are displayed.

When you press them on screens other than the **HOME** screen, an operation procedure or menus are displayed.

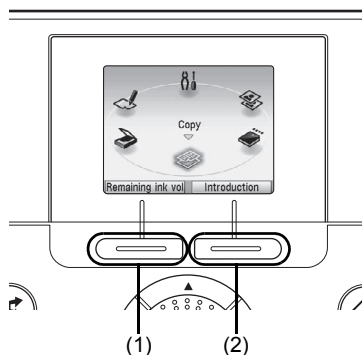

● Back Button

You can return the LCD to the previous screen.

● Display the Print Instruction Using the Navigation Menu

When you do not know how to use the print function for the frequent use or how to refill paper, you can easily get the explanation from the navigation menu.

1 Press the **NAVI** button.

The **NAVI** screen is displayed.

2 Select a menu you would like to use, then press the **OK** button.

The explanation about the work flow is displayed.
Operate as the explanation.

You can select various menus on the **NAVI** screen.

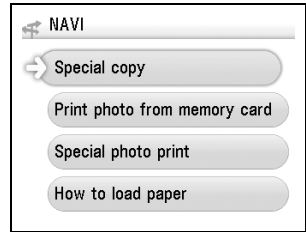

Turning the Machine On and Off

Turn on the machine before printing.

■ Turning on the Machine

Before turning on the machine, confirm the following.

- The Print Head and ink tanks are installed into place.

If you are using the machine connected to a computer, confirm also the following.

- The machine is connected to your computer (or a compatible device).
- The MP Drivers are installed.

Note

If preparatory operations above are not complete, follow your setup sheet to complete them.

- 1 Open the Operation Panel and press the **ON/OFF** button to turn on the machine.

The **Power** lamp flashes and then remains lit green.

Important

If the **Alarm** lamp lights up or flashes orange and an error message is displayed on the LCD, see “An Error Message Is Displayed on the LCD” on page 70.

- 2 If you are using the machine connected to a computer, turn on your computer.

■ Turning off the Machine

- 1 To turn off the machine, press the **ON/OFF** button.

When the **Power** lamp stops flashing, the machine is turned off.

Important

About the Power Plug

When removing the power plug after turning off the machine, be sure to confirm that the **Power** lamp is not lit. If the power plug is removed from the wall outlet with the **Power** lamp still lit or flashing green, the machine may become unable to print.

See “Keeping the Best Printing Results” on page 51.

● Screen-saver Mode

The LCD goes out if the machine is not operated for about five minutes*.

* You cannot change the wait time before the LCD goes out.

Note

When you want to restore the display, perform a print operation or press any button except for the **ON/OFF** button. When you press the **ON/OFF** button while the machine is in Screen-saver mode, the machine turns off.

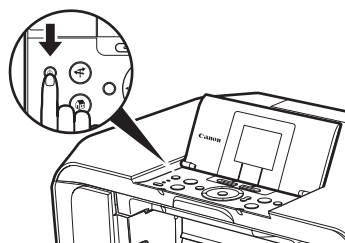

Handling the Original Document

This section describes how to load the original document on the Platen Glass.

■ Original Document Requirements

The original documents you load on the Platen Glass for copying or scanning must meet these requirements:

Document type	<ul style="list-style-type: none">● Paper documents● Photographs● Books
Size (W x L)	Max. 8.5 x 11.7 inches / 216 x 297 mm
Height	Max. 0.71 inches / 18 mm

■ Loading Original Documents

Load originals to copy or scan on the Platen Glass. For details on how to load a photo, see "Photo Printing from Printed Photo" on page 34.

Note

Make sure any glue, ink, correction fluid, or the like on the original document is completely dry before loading it on the Platen Glass.

1 Load the original document on the Platen Glass.

- (1) Lift the Document Cover.
- (2) Load the original with the side to be copied/scanned facing down on the Platen Glass. Align the upper left corner of your original with the alignment mark as shown in the figure on the right.

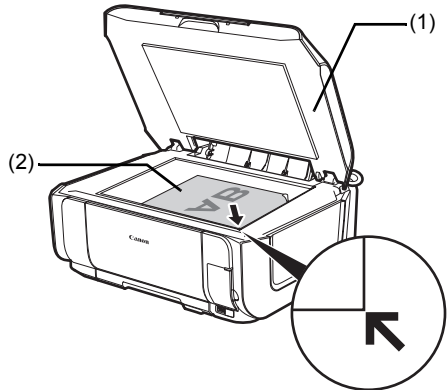

Important

- Do not place any objects weighing more than 4.4 lb / 2.0 kg on the Platen Glass.
 - Do not press or put weight on the original with pressure exceeding 4.4 lb / 2.0 kg. Doing so may cause the scanner to malfunction or the Platen Glass to break.
-

Note

The machine cannot scan the shaded area in the figure below.

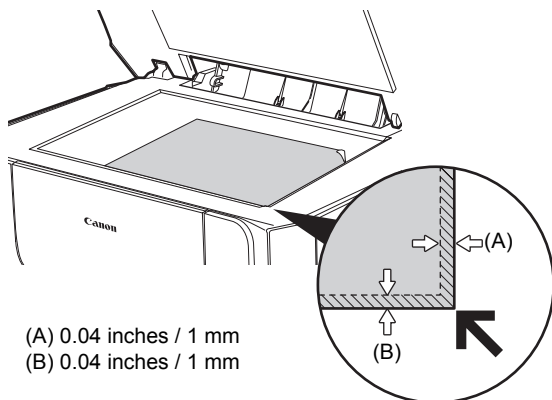

(A) 0.04 inches / 1 mm

(B) 0.04 inches / 1 mm

2 Gently close the Document Cover.

Loading Printing Paper

This section describes how to load printing paper in the Rear Tray and the Cassette.

Note

- At purchase, the machine is set to feed from the Rear Tray. If you are printing without changing paper source settings, load paper in the Rear Tray.
 - Do not place any objects in front of the machine.
-

■ Using Specialty Media

Canon recommends that you use Canon genuine media to ensure optimal print quality.

● Photo Quality Media

- Glossy Photo Paper
- Photo Paper Plus Semi-gloss
- Photo Paper Plus Glossy
- Photo Paper Plus Double Sided
- Photo Paper Pro
- Matte Photo Paper
- Photo Stickers



● Media Suited for Business Documents

- High Resolution Paper



■ Paper Handling

● Recommended Paper and Requirements

Media Type	Model ^{*1}	Paper Support Load Limit		Paper Output Tray Load Limit	Media Type	
		Rear Tray	Cassette		Machine Setting	Printer Driver Setting
Plain Paper ^{*2}	—	150 sheets	150 sheets	50 sheets	Plain paper	Plain Paper
Envelopes ^{*3}	—	10 envelopes	5 envelopes	1 envelope	—	Envelope
Super White Paper	SW-201	100 sheets	100 sheets	50 sheets	Plain paper	Plain Paper
High Resolution Paper ^{*3}	HR-101N	80 sheets	80 sheets	50 sheets	—	High Resolution Paper
Glossy Photo Paper	GP-401	A4, Letter, 5" x 7" / 127.0 x 177.8 mm and 8" x 10" / 203.2 x 254.0 mm: 10 sheets 4" x 6" / 101.6 x 152.4 mm and Wide: 20 sheets Credit card: 20 sheets (Rear Tray only) ^{*5}		*6	Glossy Photo Paper	Glossy Photo Paper
Glossy Photo Paper "Everyday Use"	GP-501				Glossy Photo Paper	Glossy Photo Paper
Photo Paper Glossy	GP-502				Glossy Photo Paper	Glossy Photo Paper
Photo Paper Plus Semi-gloss ^{*4}	SG-201				Photo Plus Glossy	Photo Paper Plus Glossy
Photo Paper Plus Glossy ^{*4}	PP-101				Photo Plus Glossy	Photo Paper Plus Glossy
Photo Paper Pro ^{*4}	PR-101				Photo Paper Pro	Photo Paper Pro
Matte Photo Paper	MP-101				Matte Photo Paper	Matte Photo Paper
Photo Paper Plus Double Sided ^{*3, *4}	PP-101D	—	Photo Paper Plus Double Sided			
T-Shirt Transfers ^{*3}	TR-301	1 sheet	1 sheet	—	—	T-Shirt Transfers
Photo Stickers ^{*7}	PS-101	1 sheet	Not loadable ^{*5}	Photo Plus Glossy	Photo Plus Glossy	Photo Paper Plus Glossy

*1 Paper with a Model Number is Canon specialty media. Refer to the instruction manual supplied with the paper for detailed information on the printable side and notes on handling paper. For information on the paper sizes available for each Canon genuine paper, visit our website. You may not be able to purchase some Canon genuine papers depending on the country or region of purchase. Paper is not sold in the US by Model Number. Purchase paper by name.

- *2 Proper feeding of paper may not be possible at the maximum capacity depending on the type of paper or environmental conditions (either very high or low temperature and humidity). In such cases, reduce the sheets of paper you load at a time to around half.
- *3 Available only when printing from your computer.
- *4 When loading paper in stacks, the print side may be marked as it is fed in or sheets may be stuck to one another causing them not to be fed properly. In this case, load one sheet at a time.
- *5 Feeding this paper from the Cassette can damage the machine. Load in the Rear Tray.
- *6 We recommend that you remove the previously printed sheet from the Paper Output Tray before continuously printing to avoid blurs and discoloration.
- *7 When printing photos saved on a memory card to sticker paper, be sure to select **Sticker print** in the memory card mode. Refer to “Printing on Stickers (Sticker Print)” in “Printing from a Memory Card” of the *User’s Guide* on-screen manual.

When copying printed photos onto sticker paper, be sure to select **Sticker print** in the Easy photo reprint mode. Refer to “Printing on a Stickers (Sticker Print)” in “Photo Printing from Printed Photo” of the *User’s Guide* on-screen manual.

When printing photos saved on your mobile phone to sticker paper, select **Stickers** for paper size in **Wireless print settings**. Refer to “Setting Items” in “Setting the Page Size, Media Type, and Layout When Printing from a Mobile Phone” in “Printing Photographs from a Wireless Communication Device” of the *User’s Guide* on-screen manual.

Important

- Put unused paper back into the package, and store them avoiding heat, humidity, and direct sunlight.
- Do not touch the printed surface nor stack the printed sheets until the ink is fixed.

Note

- To specify the page size and media type when printing photos saved on mobile phones, refer to “Setting the Page Size, Media Type, and Layout When Printing from a Mobile Phone” in “Printing Photographs from a Wireless Communication Device” of the *User’s Guide* on-screen manual.
- For a detailed description of printing media types, refer to “Printing Media” in the *User’s Guide* on-screen manual.

● Media Types You Cannot Use

Do not use the following types of paper. Using such paper will not only produce unsatisfactory results, but can also cause the machine to jam or malfunction. Additionally, when printing on A5 or smaller sized paper, do not use paper thinner than a post card, including plain paper or notepad paper cut to a small size.

- Folded, curled, or wrinkled paper
- Damp paper
- Paper that is too thin (weighing less than 17 lb / 64 gsm)
- Paper that is too thick (plain paper, except for Canon genuine paper, weighing more than 28 lb / 105 gsm)
- Picture postcards
- Postcards affixed with photos or stickers
- Envelopes with double flaps (or sticker flaps)
- Envelopes with an embossed or treated surface
- Envelopes with pressure stickers
- Envelopes whose gummed flaps are already moistened and adhesive
- Any type of paper with holes

- Paper that is not rectangular
- Paper bound with staples or glue
- Paper with adhesives
- Paper decorated with glitter, etc.

Hints for Handling the Paper Sources

This machine offers two paper sources to load printing paper; the Rear Tray (A) and the Cassette (B).

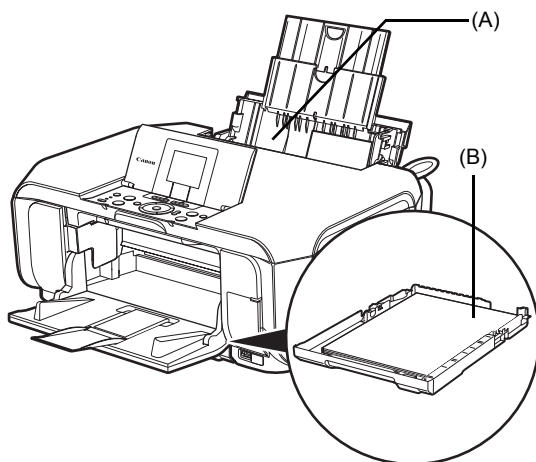

Here are some hints for handling these paper sources according to how you are using them.

Note

- Some types and sizes of paper are not loadable in the Cassette and require the use of the Rear Tray. See “Paper Handling” on page 9. For details on loading paper, see “Loading Paper” on page 15.
 - Printer driver settings may be required depending on the usage. For details on printer driver settings, refer to the *PC Printing Guide* on-screen manual.
-

■ If You Print Regularly on Photo Paper as well as on Plain Paper

If you use photo paper as much as plain paper, you can load photo paper in the Rear Tray and plain paper in the Cassette. This way, you can switch the paper source according to the type of paper just by pressing the **Paper Feed Switch**.

You can also specify the type and size of paper to be fed from the Cassette using the printer driver. You can print more efficiently by specifying the type of paper you use regularly this way, since the paper source will be switched automatically to the Cassette for this paper.

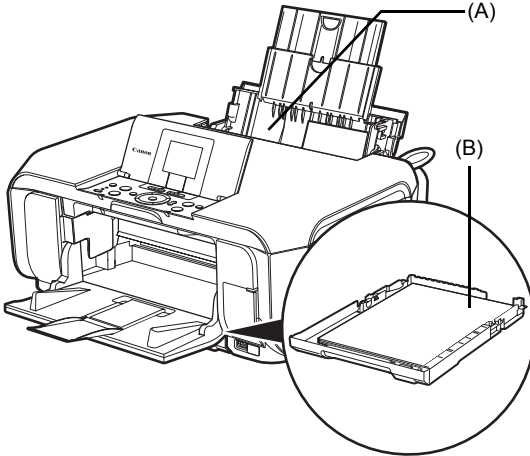

(A) Rear Tray: Load paper of various types and sizes, including photo paper

(B) Cassette: Load paper you use most regularly, such as plain paper

■ If You Print Mainly on Plain Paper

You can load plain paper of the same size in both paper sources, and set the printer driver to automatically switch the paper source when either paper source runs out of paper during printing.

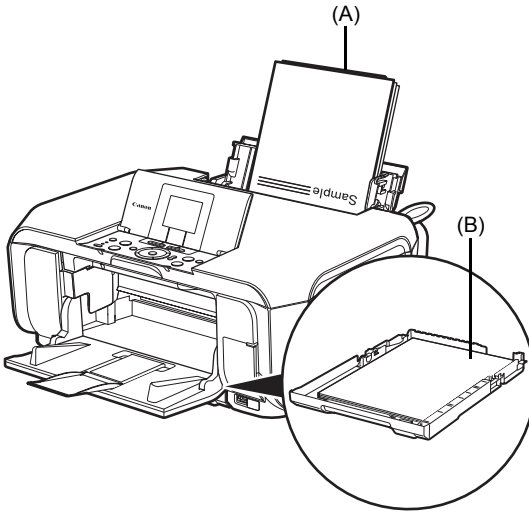

(A) Rear Tray: Load plain paper

(B) Cassette: Load plain paper

Changing the Paper Source

Each time you press the **Paper Feed Switch**, the paper source to be used switches between the Rear Tray and the Cassette. The paper feeds from the paper source whose lamp is lit.

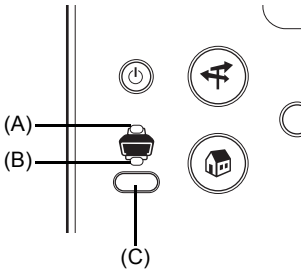

- (A) **Rear Tray** lamp
- (B) **Cassette** lamp
- (C) **Paper Feed Switch**

Important

When Printing from Your Computer

If a setting other than **Paper Feed Switch** is selected for **Paper Source** in the printer driver, the **Paper Feed Switch** on the machine will be disabled and the printer driver settings take precedence when printing. Confirm the setting in the printer driver. See "Printing with Windows" on page 36 or "Printing with Macintosh" on page 37.

For details on paper source selection using the printer driver, refer to the *PC Printing Guide* on-screen manual.

Loading Paper

Important

- If you cut plain paper to 4" x 6" / 101.6 x 152.4 mm, 5" x 7" / 127.0 x 177.8 mm, or 2.13" x 3.39" / 54.0 x 86.0 mm (credit card-size) for a trial print, it can cause paper jams.
- You cannot print on postcards affixed with photos or stickers.
- Always load paper in portrait orientation (A). Loading paper in landscape orientation (B) can cause the paper to be jammed.

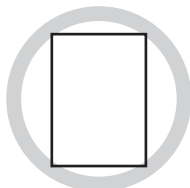

(A)

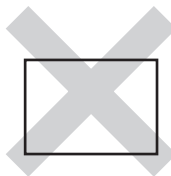

(B)

Note

- We recommend using genuine Canon photo media when printing photographs. For details on the specialty media Canon provides for use with its various printers, refer to "Using Specialty Media" on page 8.

When Printing on Plain Paper

- You can use general copy paper or Canon's Super White Paper. When printing on both sides, we recommend Canon's Super White Paper Double-Sided.

Paper size:

- Standard sizes: A4, B5, A5, Letter, and Legal (Rear Tray only)
- Non-standard sizes for the Rear Tray: 2.13 x 3.39 inches to 8.5 x 23 inches / 54.0 x 86.0 mm to 215.9 x 584.2 mm
- Non-standard sizes for the Cassette: 3.5 x 5 inches to 8.5 x 11.69 inches / 89.0 x 127.0 mm to 215.9 x 297.0 mm

Paper weight: 17 to 28 lb / 64 to 105 gsm (plain paper, except for Canon genuine paper)

■ Loading Paper in the Rear Tray

- 1 Flatten the four corners of the paper before loading it.

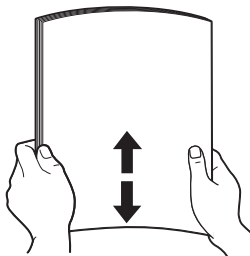

Note

- Align the edges of paper neatly before loading. Loading paper without aligning the edges may cause paper jams.
 - If paper is curled, hold the opposing curled corners and gently bend them in the opposite direction until the paper becomes completely flat. See "Paper is curled." on page 77.
 - To avoid curling, handle paper as follows.
 - When you do not print, remove unused paper from the Rear Tray, put them back into the package, and keep it on a level surface.
 - Take out only the necessary number of sheets from the package, just before printing.
-

2 Prepare to load paper.

- (1) Open the Sheet Feeder Cover and pull out the Paper Support.
Put your finger in the rounded indent of the Paper Support and pull it out until it stops.
- (2) Open the Paper Output Tray.
Put your finger in the indent on the top of the Paper Output Tray and open it gently.
- (3) Open the Output Tray Extension.
- (4) Press the **Paper Feed Switch** so that the **Rear Tray lamp (A)** lights.

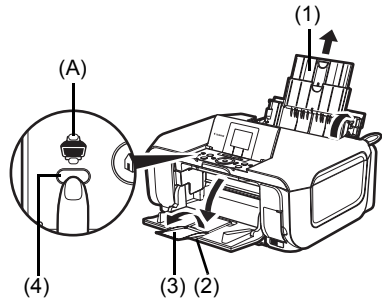

Note

You can also select the paper source with the printer driver.
For details, refer to the *PC Printing Guide* on-screen manual.

3 Load the paper.

- (1) Load the paper in the Rear Tray with the print side facing UP.
- (2) Align the paper stack against the Cover Guide on the right side of the Paper Support.

Note

Make sure that the Cover Guide is set upright when you load paper in the Rear Tray.

- (3) Pinch the Paper Guide and slide it against the left side of the paper stack.

Important

Do not slide the Paper Guide too hard. Paper may not be fed properly.

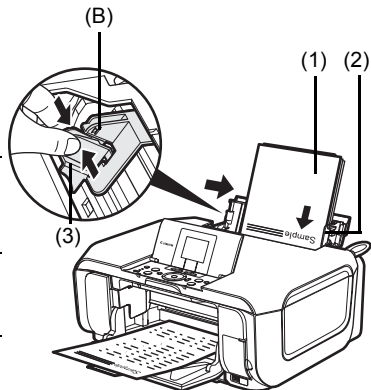

Do not load higher than the Load Limit Mark (B).

4 Specify the page size and media type settings according to the loaded paper.

Note

- When performing copy direct printing without using a computer, select the size and type of the loaded paper in **Page size** and **Media type** in each mode. For details on settings in each menu, see "Setting Items" on page 24 and page 45.
- When using the machine connected to a computer, select the size and type of the loaded paper in **Page Size** (or **Paper Size**) and **Media Type** in the printer driver.
For details on printer driver settings, see "Printing with Windows" on page 36 or "Printing with Macintosh" on page 37.

■ Loading Paper in the Cassette

Some types and sizes of paper are not loadable in the Cassette and require the use of the Rear Tray. If you intend to use only the Cassette, check for any usage restrictions in advance. See "Paper Handling" on page 9.

● Important

- Do not leave photo paper, such as Photo Paper Pro, in the Cassette for a long time. This may cause paper discoloration due to natural aging.
- If you load photo paper such as Photo Paper Pro in the Cassette, you may get roller traces on the print surface. To avoid this, load paper in the Rear Tray.

1 Flatten the four corners of the paper before loading it.

See "Flatten the four corners of the paper before loading it." on page 15.

2 Pull out the Cassette from the machine.

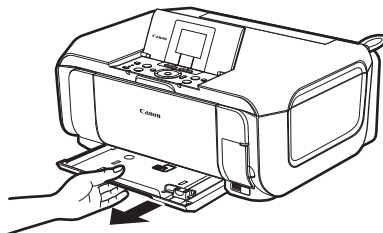

3 Load the paper with the print side facing DOWN.

- (1) Load the paper in the Cassette with the print side facing DOWN and the leading edge to the far side.
- (2) Align the paper stack against the right side of the Cassette.
- (3) Slide the Paper Guides to fit to the loaded paper stack.

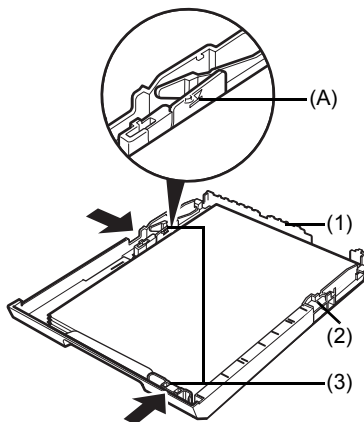

Do not load higher than the Load Limit Mark (A).

- 4** Insert the Cassette into the machine.
Push the Cassette all the way into the machine.

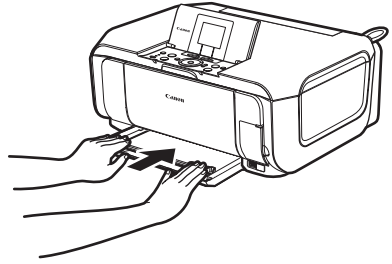

- 5** Prepare the Paper Output Tray.

- (1) Open the Paper Output Tray.
Put your finger in the rounded indent of the Paper Output Tray and open it gently.
- (2) Open the Output Tray Extension.
- (3) Press the **Paper Feed Switch** so that the **Cassette lamp (B)** lights.

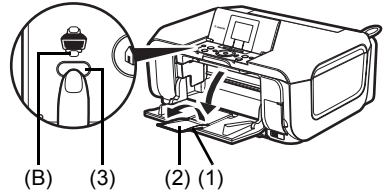

- 6** Specify the page size and media type settings according to the loaded paper.

Note

- When performing copy direct printing without using a computer, select the size and type of the loaded paper in **Page size** and **Media type** in each mode. For details on settings in each mode, see "Setting Items" on page 24 and page 45.
 - When using the machine connected to a computer, select the size and type of the loaded paper in **Page Size** (or **Paper Size**) and **Media Type** in the printer driver.
For details on printer driver settings, see "Printing with Windows" on page 36 or "Printing with Macintosh" on page 37.
 - You can also select the paper source with the printer driver.
For details, refer to the *PC Printing Guide* on-screen manual.
-

Loading Envelopes

Use either European DL or US Comm. Env. #10-sized envelope.

Important

- You need to print from the computer to print on envelopes.
 - Do not use the following envelopes:
 - Envelopes with double flaps (or sticker flaps)
 - Envelopes with an embossed or treated surface
 - Envelopes with pressure stickers
 - Envelopes whose gummed flaps are already moistened and adhesive
-

■ Loading Envelopes in the Rear Tray

1 Prepare the envelopes.

- Press down on all four corners and edges of the envelopes to flatten them.

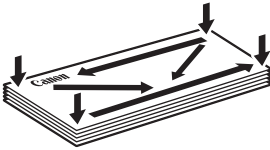

- If the envelopes are curled, hold the opposite corners and gently twist them in the opposite direction.

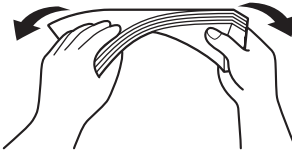

- If the flap of an envelope is curled, flatten it.
- If the leading edge of an envelope is puffed up or curled, use a pen to press the envelope flat and sharpen the crease.
Press the envelope flat, working from the middle to the edge.

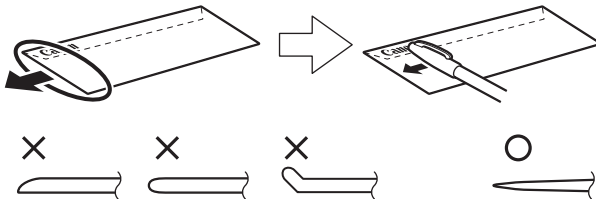

* The above illustrations show a side view of the leading edge of the envelope.

Important

The envelopes may jam in the machine if they are not flat or the edges are not aligned. Make sure that no curl or puff exceeds 0.1 inches / 3 mm.

2 Load the envelopes.

- (1) Load the envelope against the Cover Guide (the right side of the Paper Support). Load with the address side facing UP and the rear flaps DOWN on the left. Up to 10 envelopes can be loaded at once.

Important

Make sure that the Cover Guide is set upright when you load envelopes in the Rear Tray.

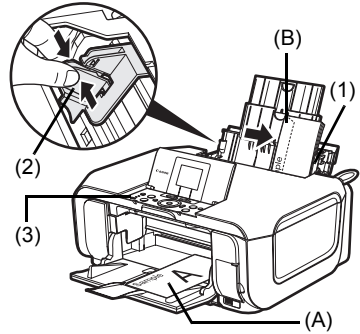

(A) Printing orientation

(B) Make sure the flaps are folded.

- (2) Pinch the Paper Guide and slide it against the left side of the envelope.

Note

Do not slide the Paper Guide too hard. The envelopes may not be fed properly.

- (3) Press the **Paper Feed Switch** so that the **Rear Tray** lamp lights up.

3 Specify the settings in the printer driver.

- (1) Select **Envelope** in **Media Type**.
- (2) Select the size for envelopes.
In Windows®, select **DL Env.** or **Comm. Env. #10** in **Page Size**.
In Macintosh®, select **DL Envelope** or **#10 Envelope** in **Paper Size**.
- (3) Select **Landscape** in **Orientation**.

Important

Be sure to set the printer driver setting properly. If you do not, the address will be printed in the wrong direction.

Note

For details on printer driver settings, see "Printing with Windows" on page 36 or "Printing with Macintosh" on page 37.

■ Loading Envelopes in the Cassette

- 1 Prepare the envelopes.
See "Prepare the envelopes" on page 19.

- 2 Load the envelopes.

- (1) Align the envelope stack against the right side of the Cassette.
Load with the address side facing DOWN. The flap of the envelope will appear facing UP on the left side.
Up to 5 envelopes can be loaded at once.
- (2) Slide the Paper Guides against the sides of the envelope.
- (3) Press the **Paper Feed Switch** so that the **Cassette** lamp lights up.

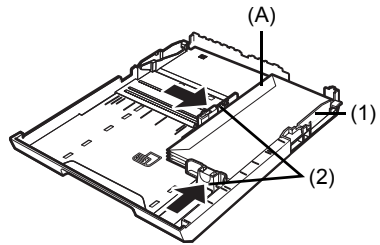

(A) Make sure the flaps are folded.

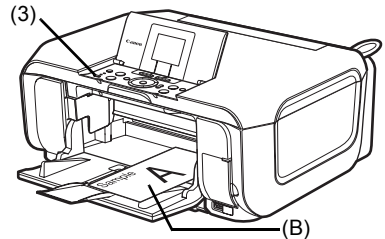

(B) Printing orientation

- 3 Specify the settings in the printer driver.

- (1) Select **Envelope** in **Media Type**.
- (2) Select the size for envelopes.
In Windows, select **DL Env.** or **Comm. Env. #10** in **Page Size**.
In Macintosh, select **DL Envelope** or **#10 Envelope** in **Paper Size**.
- (3) Select **Landscape** in **Orientation**.

⚠ Important

Be sure to set the printer driver setting properly. If you do not, the address may be printed in the wrong direction.

📖 Note

For details on printer driver settings, see "Printing with Windows" on page 36 or "Printing with Macintosh" on page 37.

Loading Small-Sized Paper

You can use 4" x 6" / 101.6 x 152.4 mm, 5" x 7" / 127.0 x 177.8 mm, and Credit card-sized papers.

Note

Load Credit card-sized paper in the Rear Tray.

● Loading Small-Sized Paper in the Rear Tray

- (1) Load the small-sized paper against the Cover Guide (the right side of the Paper Support) with the print side facing UP.

Note

Make sure that the Cover Guide is set upright when you load paper in the Rear Tray.

- (2) Pinch the Paper Guide and slide it against the left side of the paper stack.
- (3) Press the **Paper Feed Switch** so that the **Rear Tray** lamp lights.
- (4) Specify the page size and media type settings according to the loaded paper.

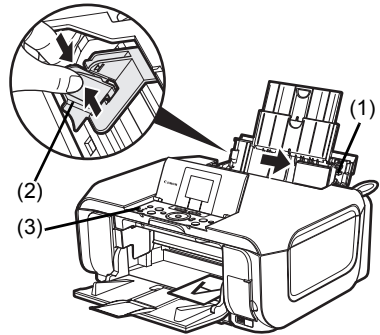

Note

- When performing copy direct printing without using a computer, select the size and type of the loaded paper in **Page size** and **Media type** in each mode. For details on settings in each mode, see "Setting Items" on page 24 and page 45.
 - When using the machine connected to a computer, select the size and type of the loaded paper in **Page Size** (or **Paper Size**) and **Media Type** in the printer driver. For details on printer driver settings, see "Printing with Windows" on page 36 or "Printing with Macintosh" on page 37.
 - You can also select the paper source with the printer driver. For details, refer to the *PC Printing Guide* on-screen manual.
-

● Loading Small-Sized Paper in the Cassette

- (1) Align the paper stack against the right side of the Cassette with the print side facing DOWN.
- (2) Slide the Paper Guides against the sides of the paper stack.

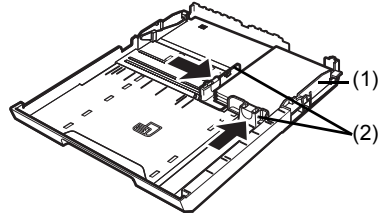

- (3) Press the **Paper Feed Switch** so that the **Cassette** lamp lights.
- (4) Specify the page size and media type settings according to the loaded paper.

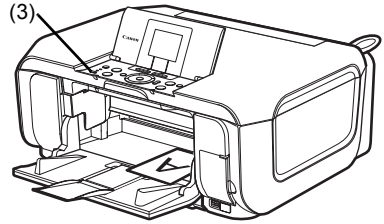

Note

- When performing copy direct printing without using a computer, select the size and type of the loaded paper in **Page size** and **Media type** in each mode. For details on settings in each mode, see “Setting Items” on page 24 and page 45.
 - When using the machine connected to a computer, select the size and type of the loaded paper in **Page Size** (or **Paper Size**) and **Media Type** in the printer driver. For details on printer driver settings, see “Printing with Windows” on page 36 or “Printing with Macintosh” on page 37.
 - You can also select the paper source with the printer driver. For details, refer to the *PC Printing Guide* on-screen manual.
-

Copying

Making Copies

This section describes the basic procedure to make copies. For details, refer to “Copying” in the *User’s Guide* on-screen manual.

- 1 Turn on the machine.
See “Turning the Machine On and Off” on page 5.
- 2 Make sure that **Copy** is selected on the **HOME** screen, then press the **OK** button.
- 3 Load paper.
See “Loading Printing Paper” on page 8.
- 4 Load the original on the Platen Glass.
See “Handling the Original Document” on page 6.
- 5 Specify copy settings.
 - (1) Confirm the paper source, page size, media type, and other settings. To change the settings, select the item and press the **OK** button.
 - (2) Press the **[+]** or **[-]** button to specify the number of copies.
- 6 Press the **Color** button for color copying, or the **Black** button for black & white copying.

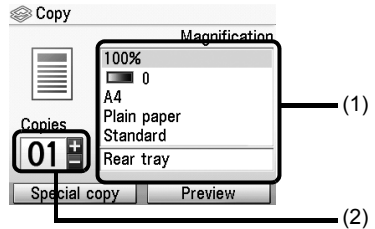

■ Setting Items

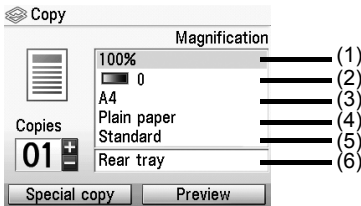

📖 Note

- Page size and media type settings are saved in each mode.
- The settings of the page size, media type, etc. are retained even if the machine is turned off.
- Depending on the functions, some setting items cannot be specified in combination.

- (1) Magnification
Specify the reduction/enlargement method. For details, refer to “Reducing or Enlarging a Copy” in the *User’s Guide* on-screen manual.
- (2) Intensity
Specify the intensity. For details, refer to “Changing Intensity Setting” in the *User’s Guide* on-screen manual.

- (3) Page size
Select the page size of the loaded paper.
- (4) Media type
Select the media type of the loaded paper.
- (5) Print quality
Adjust print quality according to the original.
- (6) Paper source
Select the paper source. Before printing, confirm that the location where you have loaded paper is selected as the paper source.

❗ Important

- If you used **Fast (speed-priority)** with media type set to **Plain paper** and the quality is not as good as expected, select **Standard** or **High (quality-priority)** and try copying again.
- Select **High (quality-priority)** to copy in grayscale. Grayscale renders tones in a range of grays instead of black or white.

Using Useful Copy Functions

For details, refer to “Using Useful Copy Functions” in the *User’s Guide* on-screen manual.

Reduced/Enlarged copy

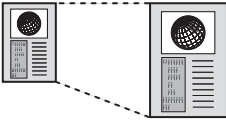

Two-sided copy



Borderless copy

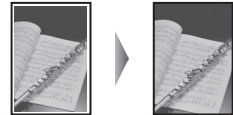

2-on-1 copy



4-on-1 copy



Image repeat

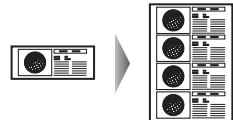

Frame erase

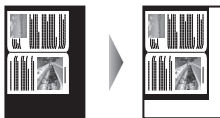

Trimming

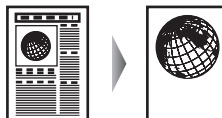

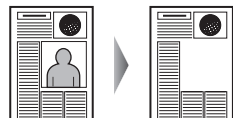

Masking







Printing from a Memory Card

Memory Cards Supported by This Machine

The following memory cards are compatible with this machine.

Memory cards that can be directly inserted into the Card Slot:	
	<ul style="list-style-type: none"> ● SD Secure Digital memory card ● SDHC memory card ● MultiMediaCard
	<ul style="list-style-type: none"> ● Compact Flash (CF) Card Supports Type I/II (3.3 V) ● Microdrive
	<ul style="list-style-type: none"> ● Memory Stick ● Memory Stick PRO

Memory cards that can be inserted in the Card Slot using the adapter:	
<p>Important</p> <p>If one of the following memory cards is inserted without an adapter, you may not be able to remove the card. Be sure to attach it to the adapter before inserting to the Card Slot.</p>	
	miniSD Card ^{*1}
	microSD Card ^{*2}
	xD-Picture Card ^{*3}
	<ul style="list-style-type: none"> ● Memory Stick Duo^{*1} ● Memory Stick PRO Duo^{*1}
	RS-MMC ^{*1}

*1 Use the special adapter provided with the card.

*2 Use "SD Card Adapter" provided with the card.

*3 Requires purchase of a separate compact flash card adapter for xD-Picture Cards.

Inserting the Memory Card

⚠ Caution

When a memory card is inserted into the Card Slot, the **Access** lamp is lit. When this **Access** lamp is flashing, the machine is accessing the memory card. In this case, do not touch the area around the Card Slot.

- 1 Turn on the machine.
See "Turning the Machine On and Off" on page 5.
- 2 Open the Card Slot Cover.

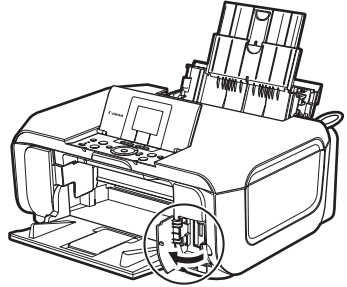

- 3 Insert only one memory card into the Card Slot.

● **How to insert**

Insert a memory card with the labeled side facing to the right.

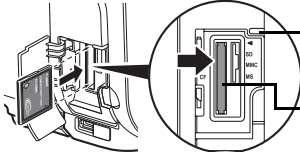
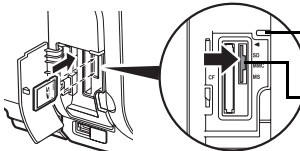
Card Type	Inserting Card
<ul style="list-style-type: none"> ● Compact Flash (CF) Card ● Microdrive ● xD-Picture Card*1 	 <p>The Access lamp lights up. Insert into the left Card Slot.</p>
<ul style="list-style-type: none"> ● SD Secure Digital memory card ● SDHC memory card ● miniSD Card*1 ● microSD Card*2 ● Memory Stick ● Memory Stick PRO ● Memory Stick Duo*1 ● Memory Stick PRO Duo*1 ● MultiMediaCard ● RS-MMC*1 	 <p>The Access lamp lights up. Insert into the right Card Slot.</p>

*1 Be sure to attach the memory card to the special adapter before inserting it into the Card Slot.

*2 Use "SD Card Adapter" provided with the card.

Caution

- The memory card will stick out of the Card Slot, but do not force it into the slot any further. Doing so damages the machine and the memory card.
 - Make sure that the memory card is correctly oriented before inserting it into the Card Slot. If you force the memory card into the Card Slot in the wrong orientation, you may damage the memory card and/or the machine.
-

4 Confirm that the **Access** lamp has lit up.

5 Close the Card Slot Cover.

Removing the Memory Card

1 Open the Card Slot Cover.

2 Make sure that the **Access** lamp is lit, then remove the memory card.

3 Close the Card Slot Cover.

Important

The **Access** lamp flashes while the machine is reading or writing data from/to the memory card. Removing the memory card or turning off the machine while the **Access** lamp is flashing may damage the data saved on the memory card. Do not remove the memory card while the **Access** lamp is flashing.

Printing Photographs Saved on a Memory Card

1 Prepare for printing.

- (1) Turn on the machine.
See "Turning the Machine On and Off" on page 5.
- (2) Load paper.
See "Loading Printing Paper" on page 8.

2 Insert the memory card.

- (1) Select **Memory card** on the **HOME** screen, then press the **OK** button.
- (2) Insert the memory card into the Card Slot.
See "Inserting the Memory Card" on page 27.

3 Select the print menu.

- (1) Make sure that **Select and print** is selected, then press the **OK** button.
- (2) Confirm the paper source, paper size, media type, and other settings.
To change the settings, select the item and press the **OK** button.
- (3) Select **Next**, and then press the **OK** button.

4 Select the photo to print and specify the number of copies for each photo.

- (1) Use the **Easy-Scroll Wheel** or the ◀ or ▶ button to display a photo to print.
- (2) Press the [+] or [-] button to specify the number of copies.

(3) Repeat steps (1) and (2) to specify the number of copies for each photo.

(4) Press the **OK** button.

5 Start printing.

(1) Confirm the print setting.

To change the settings, select the item and press the **OK** button.

(2) Confirm the total number of copies for the selected photos.

Note

For details on the functions associated with **Advanced** and **Check photo**, see "Setting Items" on page 29.

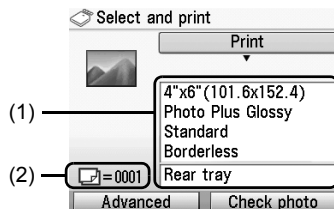

(3) Press the **Color** button.

The specified number of copies of each photo will be printed.

■ Setting Items

● Print Settings Confirmation Screen

Example: Screen displayed in **Select and print** in the memory card mode or the easy photo reprint mode

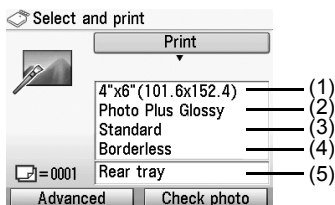

Note

- Page size and media type settings are saved in each mode.
 - Depending on the functions, some setting items cannot be specified in combination.
 - The print settings are retained even if the machine is turned off.
-

(1) Page size

Select the page size of the loaded paper.

(2) Media type

Select the media type of the loaded paper.

(3) Print quality

Adjust the print quality according to the original.

(4) Bordered, Borderless

Select bordered or borderless print.

(5) Paper source

Select the paper source. Before printing, confirm that the location where you have loaded paper is selected as the paper source.

Note

When you set **Plain paper** in media type, the photo will be printed with bordered even you select **Borderless**.

● Advanced Print Settings Screen

When you press the left Function button in the print settings confirmation screen, the **Auto image fix** screen is displayed.



When **Auto image fix ON** is selected, the scene or person's face of a shot photo is recognized and the most suitable correction for each photo is made automatically. It makes a darkened face by backlight brighter to print. It also analyzes a scene such as scenery, night scene, person, etc. and corrects each scene with the most suitable color, brightness, or contrasts automatically to print.

Note

- The Auto image fix is only available in the memory card mode.
- Photos in a memory card are printed in Auto image fix as default. In Auto image fix, you can specify only (1) Date or (2) File no. below.
- If you do not satisfy the print result in Auto image fix, you can select **Manual correction**. If you select **Manual correction**, you can specify each advanced setting item below.

Example: Screen displayed in the memory card mode

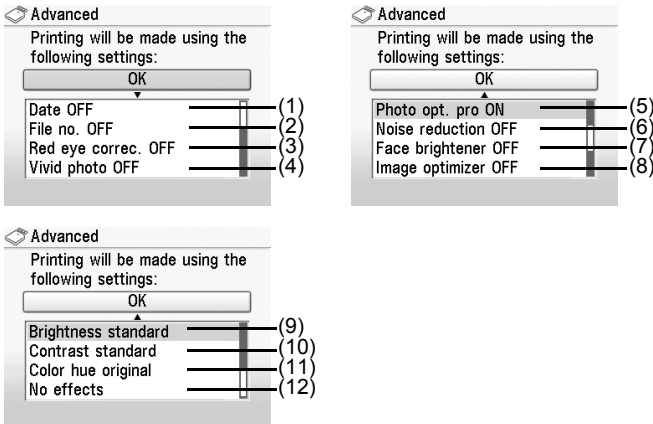

Example: Screen displayed in the easy photo reprint mode

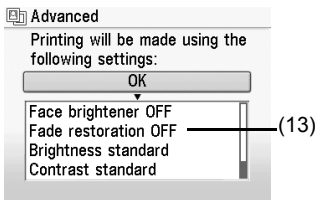

- (1) Date*¹
Activate/deactivate to print the shooting date on a photo.
 - (2) File no.*¹
Activate/deactivate to print the file no. on a photo.
-

Note

It is not possible to print both the shooting date and the file no. under the following conditions:

- **Layout print** is selected as a print function in the memory card mode, and/or
- **Credit card** is selected in **Page size**.

Under these conditions, even if both **Date ON** and **File no. ON** are set, only the shooting date will be printed. If you want to print the file no., select **Date OFF**.

- (3) Red eye correc.*¹
Corrects red eyes in portraits caused by flash photography.
- (4) Vivid photo*¹
Makes green and blue more lively.
- (5) Photo opt. pro*¹
Automatically optimizes brightness and tone of a photo.
- (6) Noise reduction*¹
Reduces the noise on blue areas like the sky as well as on black areas.
- (7) Face brightener
Brightens a darkened face on the photo taken against the light.
- (8) Image optimizer*¹
Corrects and smooths the jagged contours for printing.
- (9) Brightness
Adjust brightness.
- (10) Contrast
Adjust contrast.
- (11) Color hue
Adjust color hue.
For example, you can increase red or yellow to adjust the skin tone.
- (12) Effect*¹
Applies special effects to the photo, such as printing in sepia tones or with a sketch illustration like effect.
- (13) Fade restoration*²
Corrects the color when printing photos that have faded or color cast over time.

*¹ Can be selected only in memory card mode.

*² Can be selected only in easy photo reprint mode.

Using Useful Printing Functions

Layout print

Prints photos you pasted in the specified layout.

Sticker print

Prints your favorite photo with a frame on Canon Photo Stickers.

DPOF print

Prints according to the Digital Print Order Format (DPOF) settings on your digital camera, if you have specified them.

Captured info print

Prints information on photographs at the time of its shooting (Exif info) in the margin of Photo index print or selected individual photos.

Photo index print

Prints an index of all the photos saved on a memory card.

Print all photos

Prints all photos saved on the memory card.

Using Useful Display Functions

Change display

The display method of a photograph can be changed.

Trimming

Edits images displayed on the LCD by cropping them.

Search

When there are a lot of photos saved on the memory card, displays and prints only photos shot on the specified date or within the specified range of dates.

Printing by Using the Photo Index Sheet

- 1 Turn on the machine, and load A4 or Letter-sized plain paper.
See “Turning the Machine On and Off” on page 5 and “Loading Printing Paper” on page 8.
- 2 Make sure that the proper paper source is selected.
See “Changing the Paper Source” on page 14.
- 3 Select **Photo index sheet** on the **HOME** screen, then press the **OK** button.
- 4 Make sure that **Index sheet print** is selected, then press the **OK** button.
- 5 Insert a memory card into the Card Slot.
See “Inserting the Memory Card” on page 27.
- 6 Select a range of images to include in the Photo Index Sheet, then press the **OK** button.
- 7 Press the **Color** button.
The Photo Index Sheet(s) will be printed.
- 8 Fill in the appropriate circles in the Photo Index Sheet.
- 9 Load paper as you specified in the Photo Index Sheet.
- 10 Make sure that **Scan sheet and print** is selected, then press the **OK** button.
- 11 Place the Photo Index Sheet face-down on the Platen Glass, then press the **OK** button.

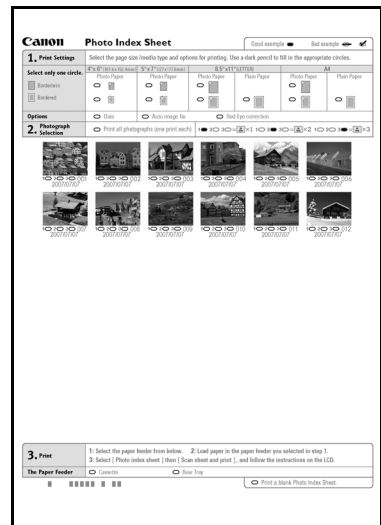

Photo Printing from Printed Photo

You can scan printed photos, specify the number of copies with viewing them on the LCD, and print them.

- 1 Turn on the machine.
See "Turning the Machine On and Off" on page 5.
- 2 Select **Easy photo reprint** on the **HOME** screen, then press the **OK** button.
- 3 Lift the Document Cover and load the photos on the Platen Glass.

Place the photos face down on the Platen Glass as follows.

Credit card-sized originals

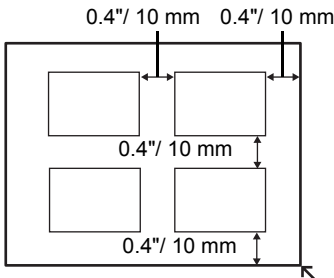

4"x 6" / 101.6 x 152.4 mm or
5"x 7" / 127.0 x 177.8 mm originals

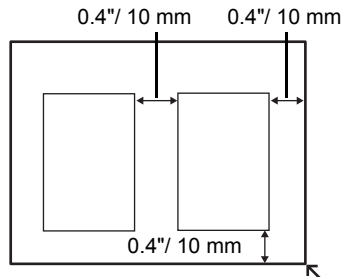

- 4 Gently close the Document Cover and press the **OK** button.
The photographs are scanned.
- 5 Load paper.
See "Loading Printing Paper" on page 8.
- 6 Select the print menu.
 - (1) Make sure that **Select and print** is selected, then press the **OK** button.
 - (2) Confirm the paper source, paper size, media type, and other settings.
To change the settings, select the item and press the **OK** button.
 - (3) Select **Next**, and then press the **OK** button.
- 7 Select the photo to print and specify the number of copies for each photo.
 - (1) Use the **Easy-Scroll Wheel** or the ◀ or ▶ button to display a photo to print.
 - (2) Press the [+] or [-] button to specify the number of copies.
 - (3) Repeat steps (1) and (2) to specify the number of copies for each photo.
 - (4) Press the **OK** button.

8 Start printing.

- (1) Confirm the print setting.
To change the settings, select the item and press the **OK** button.
- (2) Confirm the total number of copies for selected photos.

Note

For details on the function associated with **Advanced**, see “Advanced Print Settings Screen” on page 30.

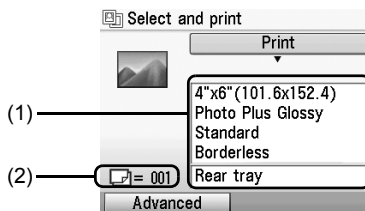

- (3) Press the **Color** button to print in color, or the **Black** button to print in black & white.
The specified number of copies of each photo will be printed.

Using Useful Printing Functions

Sticker print

Prints your favorite photo on Canon Photo Stickers to create your own stickers.

Print all photos

Prints all scanned photos.

Using Useful Display Functions

Change display

The display method of a photograph can be changed.

Trimming

Edits images displayed on the LCD by cropping them.

Printing from Your Computer

This section describes procedure for basic printing.

Printing with Windows

Note

When printing photographs taken by your digital camera, you can perform Borderless Printing in easy steps using Easy-PhotoPrint EX. Easy-PhotoPrint EX is provided on the *Setup CD-ROM*. Easy-PhotoPrint EX supports Exif Print to optimize photographs taken by an Exif-compliant digital camera by using the print information recorded at the time of shooting to achieve higher print quality. For details on using Easy-PhotoPrint EX, refer to the *PC Photo Printing Guide* on-screen manual.

- 1 Turn on the machine and load the paper in the machine.
See “Turning the Machine On and Off” on page 5 and “Loading Printing Paper” on page 8.
- 2 Create a document or open a file to print using an appropriate application software.
- 3 Select **Print** on the application software’s **File** menu.

- 4 Make sure that **Canon XXX Printer** (where “XXX” is your machine’s name) is selected in **Select Printer**, and click **Preferences** (or **Properties**).

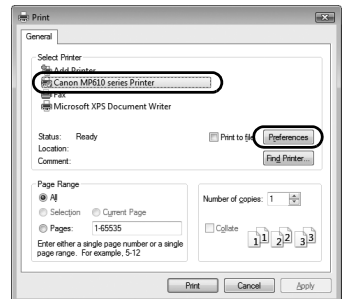

- 5 Specify the required settings and click **OK**.

You can change the paper source to be used with the printer driver as well as the Operation Panel on the machine. For details, see “Changing the Paper Source” on page 14.

Note

For details on other printer driver functions, click **Help** or **Instructions** to view the online help or the *PC Printing Guide* on-screen manual. **Instructions** is only displayed when the on-screen manuals are installed.

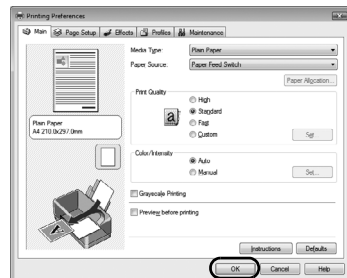

- 6 Click **Print** (or **OK**).

Printing with Macintosh

- 1 Turn on the machine and load the paper in the machine.
See “Turning the Machine On and Off” on page 5 and “Loading Printing Paper” on page 8.
- 2 Create a document or open a file to print using an appropriate application software.
- 3 Select **Page Setup** on the application software’s **File** menu.
- 4 Make sure that your machine’s name is selected in **Format for**.
- 5 Select the page size of the loaded paper in **Paper Size**.

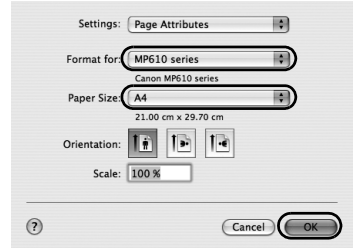

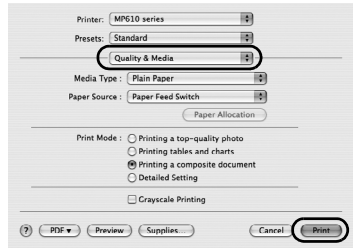

- 6 Click **OK**.
- 7 Select **Print** on the application software’s **File** menu.
- 8 Select **Quality & Media** in the pop-up menu.
- 9 Specify the required settings.

You can change the paper source to be used with the printer driver as well as the Operation Panel on the machine. For details, see “Changing the Paper Source” on page 14.



Note

For details on other printer driver functions, click  to view the *PC Printing Guide* on-screen manual. If the on-screen manuals are not installed, the *PC Printing Guide* on-screen manual is not displayed even if  is clicked.

- 10 Click **Print**.

Scanning Images

You can scan images from the machine to a computer without printing them and save them in popular image types, such as JPEG, TIFF, bitmaps, or PDF. If you are scanning printed text, you can use the OCR (Optical Character Recognition) software to convert it to text data.

Scanning Methods

You can select from the various scanning methods.

● If You Want to Scan Originals Easily From the Machine

You can scan originals by using the Operation Panel of the machine.

See “Scanning Using the Operation Panel of the Machine” on page 38.

● If You Want to Edit or Print the Scanned Images

MP Navigator EX enables you to edit the scanned images, such as optimizing or trimming.

You can also start application software from MP Navigator EX to edit or print the scanned images.

For detailed operations of MP Navigator EX, refer to the *Scanning Guide* on-screen manual.

● If You Want to Scan Originals with Advanced Settings

ScanGear enables you to scan originals with advanced settings such as the resolution.

For detailed operations of ScanGear, refer to the *Scanning Guide* on-screen manual.

Besides the above-mentioned methods, you can use a TWAIN- or WIA- (Windows Vista and Windows XP only) compliant application software and the Control Panel (Windows Vista and Windows XP only) to scan originals with this machine. For detailed operations, refer to the *Scanning Guide* on-screen manual.

■ Scanning Using the Operation Panel of the Machine

For details, refer to “Scanning Methods” in the *User’s Guide* on-screen manual.

- 1** (Macintosh only) Prepare your computer before scanning.
This operation is not necessary for Mac OS X v.10.4.x.
For details, refer to “Scanning Methods” in the *User’s Guide* on-screen manual.
- 2** Turn on the machine.
See “Turning the Machine On and Off” on page 5.
- 3** Load the original document on the Platen Glass.
For scanning documents, see “Handling the Original Document” on page 6.
For scanning printed photos, see “Photo Printing from Printed Photo” on page 34.
- 4** Select **Scan** on the **HOME** screen, then press the **OK** button.

- 5** Select the document type, then press the **OK** button.
-

 **Important**

Make sure that the document is loaded correctly according to the document type you have selected.

For details, refer to “Scanning Methods” in the *User’s Guide* on-screen manual.

- 6** Select the scan operation, then press the **OK** button.

- 7** Press the **Color** or **Black** button.

The operation to be performed after scanning the original depends on the scan operation setting you have selected in step 6. For details on how to modify the operation settings, refer to the *Scanning Guide* on-screen manual.

Printing Photographs Directly from a PictBridge Compliant Device

You can connect a PictBridge compliant device such as a digital camera, camcorder, or mobile phone using a USB cable recommended by the device's manufacturer, and print recorded images directly without using a computer.

● Connectable Devices

PictBridge is an industry standard enabling a range of digital photo solutions, including the direct printing of photos from a digital still camera, camcorder or mobile phone* without the need to use a computer. A device can be connected to this machine for direct printing regardless of the manufacturer or the model as long as it complies with the PictBridge standard.

* PictBridge compliant digital still cameras, digital camcorders, and camera-equipped mobile phones are hereafter collectively referred to as "PictBridge compliant device".



A device with this mark is PictBridge compliant.

● Printable Image Data Format

This machine prints images taken with a DCF (Design rule for Camera File system) ver. 1.0/2.0-compatible digital camera (Exif ver. 2.2/2.21 compliant), as well as PNG files.

Printing Photographs Directly from a PictBridge Compliant Device

To connect a PictBridge compliant device to this machine, use a USB cable recommended by the device's manufacturer.

Warning

Do not connect any equipment other than PictBridge compliant devices or the optional Bluetooth Unit BU-20 to the Direct Print Port of the machine. If you do so, electric shock, fire, or damage to the machine could result.

Important

Never disconnect the USB cable during printing unless when explicitly allowed to by the PictBridge compliant device. When disconnecting the USB cable between the PictBridge compliant device and machine, follow the instructions given in the device's instruction manual.

Note

When printing photos with the PictBridge compliant device connected to the machine, we recommend the use of the AC adapter supplied with the device. If you are using the device battery, be sure to charge it fully.

1 Prepare for printing.

- (1) Turn on the machine.
See "Turning the Machine On and Off" on page 5.
- (2) Load paper.
See "Loading Printing Paper" on page 8.
- (3) Make sure that the proper paper source is selected.

2 Connect the PictBridge compliant device to the machine.

Note

Depending on the model or brand of your device, you may have to select a print mode compliant with PictBridge before connecting the device. You may also have to turn on the device or select Play mode manually after connecting the device to the machine.

Perform necessary operations on the PictBridge compliant device before connecting it to this machine according to instructions given in the device's instruction manual.

- (1) Make sure that the PictBridge compliant device is turned off.
- (2) Connect the PictBridge compliant device to the machine using a USB cable recommended by the manufacturer of the device.
The device turns on automatically.
If your device does not turn on automatically, turn it on manually.
- (3) Set up the PictBridge compliant device for direct printing.

 will appear on the LCD of the device when the machine is correctly connected.

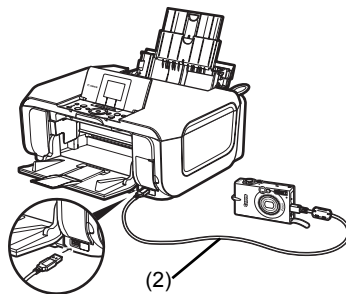

3 Specify the print settings such as paper type and layout.

See “About PictBridge Print Settings” on page 42.

You can make settings using the menu on the LCD of your PictBridge compliant device. Select the size and type of paper that you loaded in the machine.

If your PictBridge compliant device does not have setting menu, change the setting from the machine. For details, see “Setting on the Machine” on page 44.

4 Start printing from your PictBridge compliant device.

About PictBridge Print Settings

■ Settings on a PictBridge Compliant Device

This section describes the print settings on a PictBridge compliant device. When operating the device, be sure to follow the instructions given in the instruction manual of your PictBridge compliant device.

Note

- In the following description, names of setting items are given according to those used in Canon-brand PictBridge compliant devices. Setting item names may be different depending on the brand or model of your device.
- Some setting items explained below may not be available on some devices. In this case, the settings made on the machine are applied. Also, when some items are set to **Default** on a PictBridge compliant device, the machine settings for these items are applied. For details, see "Setting on the Machine" on page 44.

● Paper Size and Paper Type Settings

The following sizes and types of printing paper can be used when printing from a PictBridge compliant device.

● Paper size

4" x 6" / 101.6 x 152.4 mm, 5" x 7" / 127.0 x 177.8 mm^{*1}, Credit card^{*2}, 8" x 10" / 203.2 x 254.0 mm, A4, Letter, Wide^{*1}

● Paper type

Paper Type Setting	Loadable Paper ^{*4}
Plain Paper ^{*3}	Super White Paper or other plain paper
Photo	Photo Paper Plus Glossy
	Glossy Photo Paper
	Glossy Photo Paper "Everyday Use"
	Photo Paper Glossy
	Photo Paper Plus Semi-gloss ^{*5}
	Photo Stickers ^{*2, *6}
Fast Photo	Photo Paper Pro

The available page sizes vary depending on the media type. For details, visit our website.

^{*1} Can be selected only on certain Canon-brand PictBridge compatible devices.

^{*2} Feeding this paper from the Cassette can damage the machine. Load in the Rear Tray.

^{*3} **Plain Paper** can be selected for **Paper type** only when **Paper size** is set to **A4** or **8.5" x 11" (Letter)**. When **Paper type** is set to **Plain Paper**, borderless printing will be disabled even when **Layout** is set to **Borderless**.

^{*4} You may not be able to purchase some Canon genuine papers depending on the country or region of purchase.

^{*5} When printing on Photo Paper Plus Semi-gloss 8" x 10" / 203.2 x 254.0 mm (SG-201), select **20 x 25 cm/8" x 10"** for **Paper size** and **Default** for **Paper type**.

* Select **Photo Plus Glossy** for **Media type** in the **PictBridge settings** screen on the machine. See "Setting on the Machine" on page 44.

^{*6} Exclusively used to print photo stickers. When printing on sticker paper, select **10 x 15 cm/ 4" x 6"** for **Paper size** and **Photo** for **Paper type**. Do not set **Layout** to **Borderless**.

● Layout Setting

Various layout options are available.

- Bordered/Borderless: You can select whether or not to print an image with a border.
- N-up: You can use this option when printing on sticker paper, or A4- or Letter-sized paper.
 - Sticker paper: When you select **10 x 15 cm/4" x 6"** for **Paper size**, you can print 16 images on a single sheet of paper.
 - A4- or Letter-sized paper: When you select **A4** or **8.5" x 11" (Letter)** for **Paper size**, you can print 4 images on a single sheet of paper.
- Shooting Info (Exif Data): You can print shooting info (Exif Data) along with the image. The following two options are available.
 - 1-up^{*1}: Prints the shooting info (Exif Data) in the margin of selected individual images.
 - 20-up^{*2}: Prints 20 images specified with DPOF^{*3} and their shooting info (Exif Data) in list format on a single sheet of paper.
- 35 mm Film Style Layout (Contact Printing Layout)^{*2}: You can print the multiple images specified with DPOF^{*3} in a list format that looks like a negative film.

Besides the above options, you can also specify to print an index of images in the DPOF^{*3} print settings menu.

^{*1} You can use this option only when **10 x 15 cm/4" x 6"**, **13 x 18 cm/5" x 7"**, **20 x 25 cm/8" x 10"**, **A4** or **8.5" x 11" (Letter)** is selected for **Paper size**.

^{*2} You can use this option only when **A4** or **8.5" x 11" (Letter)** is selected for **Paper size**.

^{*3} DPOF (Digital Print Order Format) is a standard format to record the specified information regarding images, such as which image or number of copies to print.

● Date/File No. Print Setting

You can specify whether the date and/or file number will be printed.

Note

- If the images already have dates superimposed when shot, set this PictBridge setting item to **Off**. If you select **Date**, **File No.**, or **Both**, the date and/or file number will be printed over the date printed by the device's function.
 - Depending on the paper size and layout, the date will only be printed even when **Both** is selected.
-

● Image Optimize Setting

You can select the optimization method to obtain high print quality.

When you select **Default**, the most suitable correction for each photo is made using the Auto image fix function of the machine. See "Setting on the Machine" on page 44.

When you select **On**, photos are optimized for printing using the Photo opt. pro function.

If you are using a Canon-brand PictBridge compliant device, the following additional options may be available, depending on the model.

- **VIVID** makes green and blue more lively.
- **NR** (Noise Reduction) reduces the noise on blue areas like the sky as well as on black areas.
- **Face** brightens a darkened face on the photo taken against the light.
- **Red-Eye** corrects red eyes in portraits caused by flash photography.

● Trimming Setting

You can select an area to print.

■ Setting on the Machine

This section describes the PictBridge print settings on the machine.

Set the print settings to **Default** on the PictBridge compliant device when you want to print according to the settings on the machine.

● Displaying the PictBridge Settings Screen and Specifying the Settings

- (1) Turn on the machine.
- (2) Select **Settings** on the **HOME** screen, then press the **OK** button.
- (3) Select **Device settings**, then press the **OK** button.
- (4) Select **PictBridge settings**, then press the **OK** button.
- (5) Select the item to set, then press the **OK** button.
- (6) Select the item, then press the **OK** button.
- (7) Confirm the print settings, select **Next** and then press the **OK** button.
- (8) Select **Auto image fix ON** or **Manual correction**, then press the **OK** button.
When **Auto image fix On** is selected, the scene or person's face of a shot photo is recognized and the most suitable correction for each photo is made automatically. It makes a darkened face by backlight brighter to print. It also analyzes a scene such as scenery, night scene, person, etc. and corrects each scene with the most suitable color, brightness, or contrasts automatically to print.
When **Manual correction** is selected, repeat steps (5) and (6) and then specify each item. After finishing all settings you need, select **OK** and then press the **OK** button. You can print from the PictBridge compliant device with specified settings.

● **Setting Items**

No.	Setting Item	Description	Corresponding Setting of PictBridge Compliant Devices ^{*1}
(1)	Page size	Select the page size, when printing directly from a PictBridge compliant device.	Paper size
(2)	Media type	Select the media type, when printing directly from a PictBridge compliant device.	Paper type
(3)	Print quality	Select the print quality, when printing directly from a PictBridge compliant device.	—
(4)	Bordered/Borderless	Select bordered or borderless print.	Layout
(5)	Photo opt. pro	Automatically optimizes brightness and tone of a photo.	Image optimize
(6)	Vivid photo	Makes green and blue more lively.	
(7)	Face brightener	Brightens a darkened face on the photo taken against the light.	
(8)	Noise reduction	Reduces the noise on blue areas like the sky as well as on black areas.	
(9)	Image optimizer	Corrects and smooths the jagged contours for printing.	
(10)	Red eye correc.	Corrects red eyes in portraits caused by flash photography.	
(11)	Brightness	Adjust brightness.	
(12)	Contrast	Adjust contrast.	
(13)	Color hue	Adjust color hue. For example, you can increase red or yellow to adjust the skin tone.	
(14)	Effects	Applies special effects to the photo, such as printing in sepia tones or with a sketch illustration like effect.	

^{*1} Set the items in this column to **Default** on the PictBridge compliant device when you want to make settings on the machine.

^{*2} When **Manual correction** is selected, the items (5) to (14) are available to specify.

Routine Maintenance

Replacing an Ink Tank

This section explains the way to confirm the ink status and the procedure to replace ink tanks.

When ink runs out or other errors occur, an error message is displayed on the LCD to inform you of the error. See “An Error Message Is Displayed on the LCD” on page 70 and confirm how to handle it.

When printing from your computer, error messages appear on your computer screen as well.

Note

- Be sure to install the ink tanks in the correct order indicated by the label on the Print Head Holder. The machine will not print if an ink tank is installed in the incorrect position.
- For information on the compatible ink tanks, refer to the back cover of this guide.
- If printing becomes faint or white streaks appear despite sufficient ink levels, see “When Printing Becomes Faint or Colors Are Incorrect” on page 52.

Getting the Ink Status Information

You can confirm the status of ink tanks in the following two ways:

- “With the LCD of this Machine” on page 46
- “With the Ink Lamps” on page 47



With the LCD of this Machine

You can confirm the status of each ink tank in the remaining ink volume screen on the LCD.

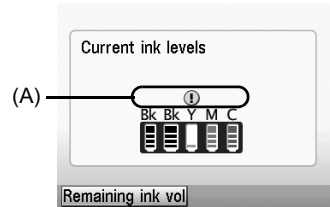
- (1) Make sure that the machine is turned on, then press the **HOME** button. The **HOME** screen will be displayed.
- (2) Press the left Function button. The below screen will be displayed.



(A) Confirm whether any symbols are displayed here.

	Ink is low. You can continue printing for a while, but we recommend you to have a new ink tank available.
	Ink may have run out. See “The following ink may have run out. Replacing the ink tank is recommended.” in “An Error Message Is Displayed on the LCD” on page 70 and take appropriate action.

Note

The ink status information is also displayed in the screen that appears during printing.

An error message may be displayed on the LCD during printing.

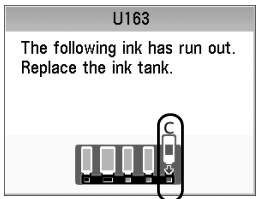
	<p>Ink has run out. See “The following ink has run out. Replace the ink tank.” in “An Error Message Is Displayed on the LCD” on page 70 and take appropriate action.</p>
<p>(B) Empty ink tank.</p>	

● With the Ink Lamps

You can confirm the status of each ink tank by the ink lamps. Open the Scanning Unit (Printer Cover) of the machine to confirm how the ink lamps light or flash.

● Ink lamp is on

The ink tank is correctly set and there is enough ink remaining to print.

● Ink lamp is flashing

Flashing slowly (at around 3-second intervals)



Ink is low. You can continue printing for a while, but we recommend you to have a new ink tank available.

Flashing quickly (at around 1-second intervals)



The ink tank is inserted in the wrong position or it is empty. Ensure that the ink tank is in the correct position as directed by the label on the Print Head Holder. If the position is correct and its lamp flashes, it is empty. Replace it with a new one.

● Ink lamp is off

The tank is not set properly. Press the  mark on the ink tank until the tank clicks into place. If it does not click into place, make sure that the orange protective cap has been removed from the bottom of the ink tank. See “Prepare the replacement tank.” on page 49.

If the lamps are still off after reinserting the ink tanks, there has been an error and the machine cannot print. Check the error message displayed on the LCD. See “An Error Message Is Displayed on the LCD” on page 70.

■ Replacing Ink Tanks

When ink tanks run out of ink, replace them using the following steps.

● Important

Handling Ink

- To maintain optimal printing quality, we recommend the use of specified Canon brand ink tanks. Refilling ink is not recommended.
- Once you remove an ink tank, replace it immediately. Do not leave the machine with ink tanks removed.
- Replace empty tanks with new ones. Inserting partially used ink tanks may cause the nozzles to clog. Furthermore, with such tanks, the machine will not be able to inform you when to replace the tanks properly.
- Once an ink tank has been installed, do not remove it from the machine and leave it out in the open. This will cause the ink tank to dry out, and the machine may not operate properly when it is reinstalled. To maintain optimal printing quality, use an ink tank within six months of first use.
- Color ink may be consumed even when printing a black-and-white document or when black-and-white printing is specified.

Color ink is also consumed in Print Head Cleaning and Print Head Deep Cleaning, which may be necessary to maintain the machine's performance. When an ink tank is out of ink, replace it immediately with a new one.

1 Open the Paper Output Tray.

(1) Put your finger in the rounded indent of the Paper Output Tray and open it gently.

2 Make sure that the machine is turned on, and lift the Scanning Unit (Printer Cover) until it stops.

The Print Head Holder moves to the center.

▲ Caution

- Do not hold the LCD or the Operation Panel.
- Do not hold the Print Head Holder to stop or move it.

● Important

If the Scanning Unit (Printer Cover) is left open for more than 10 minutes, the Print Head Holder moves to the right side. Close and reopen the Scanning Unit (Printer Cover) to return the holder to the center.

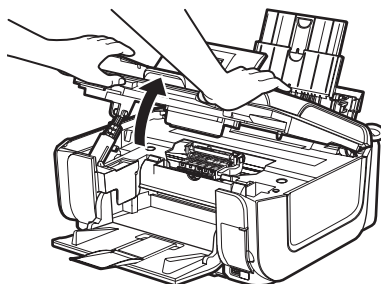

3 Open the Inner Cover.

▲ Caution

Do not touch the metallic parts inside the machine.

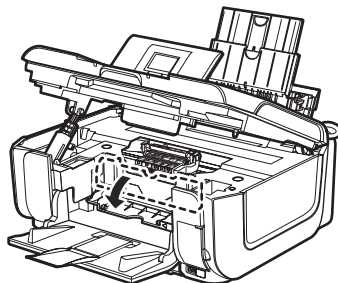

4 Remove the ink tank whose lamp is flashing fast.

- (1) Push the tab and remove the ink tank.

Important

- Handle ink tanks carefully to avoid staining clothing or the surrounding area.
- Discard empty ink tanks according to the local laws and regulations regarding disposal of consumables.

Note

- Do not remove more than one ink tank at a time. Be sure to replace ink tanks one by one when replacing more than one ink tank.
- For details on ink lamp flashing speeds, see "Getting the Ink Status Information" on page 46.

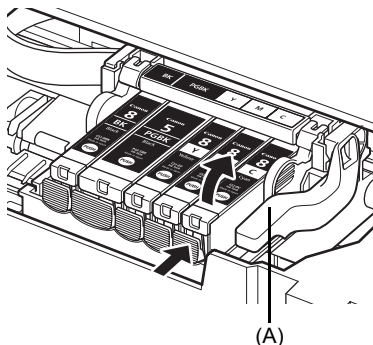

(A) Do NOT touch the Print Head Lock Lever; remove only the ink tank.

5 Prepare the replacement tank.

- (1) Remove the new ink tank from its packaging.
- (2) Pull the orange tape (B) in the direction of the arrow to peel off the protective film.
- (3) Remove the film (C) completely.

Important

Make sure that the protective film does not remain on the air hole (D). If the air hole is blocked with the remaining film, ink may leak out or may not eject properly.

- (4) Remove the orange protective cap from the bottom of the ink tank.
Discard the cap once it is removed.

Important

- Do not touch the electrical contacts (F) on the ink tank. Doing so can cause the machine to malfunction or become unable to print.
- Be sure to remove the clear film from the ink tank in the exact order shown above, as failure to follow this step may cause the ink to leak and stain your clothes and hands.
- Do not squeeze the side of ink tanks as this may cause the ink to leak out and stain your clothes and hands.
- Do not reattach the protective cap once you have removed it. Discard it according to the local laws and regulations regarding disposal of consumables.
- Do not touch the open ink port once the protective cap is removed, as this may prevent the ink from being ejected properly.
- Be careful not to stain your clothes and hands with ink on the removed protective cap.

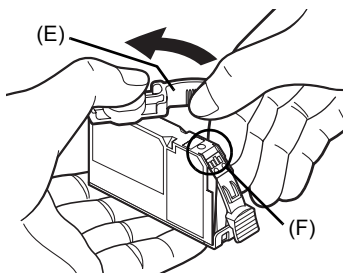
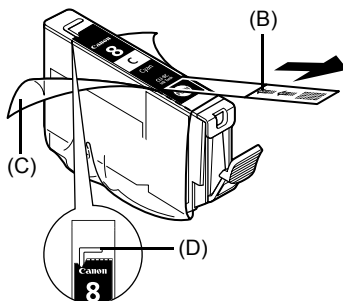

(E) Carefully hold the protective cap when removing it to prevent the ink from staining your fingers.

6 Install the ink tank.

- (1) Insert the front end of the ink tank into the Print Head.
(G) Make sure the position of the tank matches the label.
- (2) Press on the  mark on the ink tank until the ink tank snaps firmly into place.
- (3) Make sure that the ink lamp lights up red.

Important

Install all the ink tanks to print. The machine cannot be used unless all the ink tanks are installed.

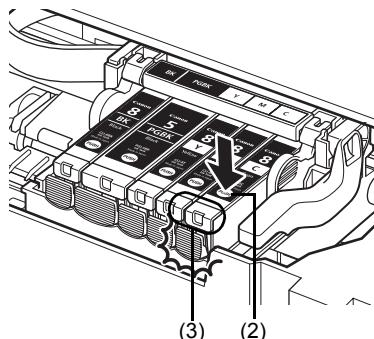
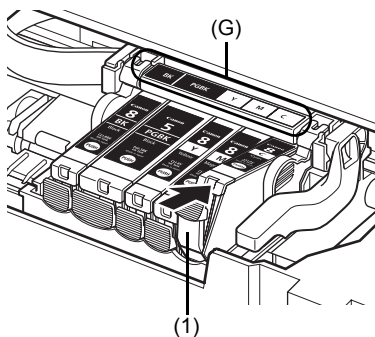

7 Close the Inner Cover.

Note

Make sure that the Inner Cover is closed. Printing will not start with the Inner Cover open since paper cannot be fed properly.

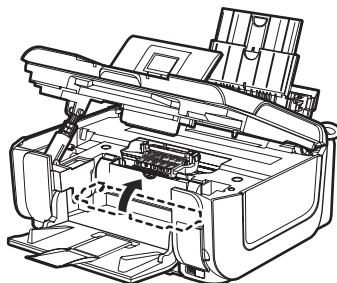

8 Gently close the Scanning Unit (Printer Cover).

Caution

- Be sure to hold the Scanning Unit (Printer Cover) firmly using both hands, and be careful not to get your fingers caught.
- Do not hold the LCD or the Operation Panel.

Note

- If the error message is still displayed after the Scanning Unit (Printer Cover) is closed, see "An Error Message Is Displayed on the LCD" on page 70.
- When you start printing after replacing the ink tank, Print Head Cleaning is performed automatically. Do not start another operation until the machine has stopped making operating noises.

Keeping the Best Printing Results

To avoid drying of the Print Head and clogging of the nozzles, note the following.

Note

- Ink may blur depending on the paper in the following cases;
 - Printed area is traced with a highlight pen or paint-stick
 - Printed area is stained with water or sweat
 - If the print head nozzles get clogged, printouts will become faint or particular colors will not be printed properly. For details, see “When Printing Becomes Faint or Colors Are Incorrect” on page 52.
-

■ When You Turn Off the Machine

Follow the procedure below to turn off the machine.

- (1) Press the **ON/OFF** button to turn off the machine.
- (2) Confirm that the **Power** lamp has gone out.
This takes a few seconds or as long as around 30 seconds.
- (3) Unplug the power cord from the wall outlet.
If you are using a power outlet strip, you can switch it off instead.

When you press the **ON/OFF** button to turn off the machine, the machine automatically puts a protective cap on the Print Head to prevent the ink from drying. If you remove the power cord or switch off the power outlet strip before the **Power** lamp goes out, this capping will not be done properly, causing the Print Head to dry and clog.

■ When You Are Not Using the Machine for a Long Time

When you are not using the machine for a long time, print or copy in both black & white and in color, or perform Print Head Cleaning, about once a month to prevent degradation of the Print Head.

Numerous nozzles are installed in the Print Head for high-precision printing. Just as the uncapped tip of a ballpoint pen or marker becomes dry and unusable if it is not used for a long period of time, the print head nozzles become blocked by dried ink. Periodically printing or cleaning the Print Head can prevent this blockage.

When Printing Becomes Faint or Colors Are Incorrect

When printing becomes faint or colors are incorrect even if ink remains in the ink tanks, the print head nozzles are probably clogged. Print the nozzle check pattern to confirm the condition of the nozzles and then perform Print Head Cleaning.

If print results are not satisfactory, performing Print Head Alignment may improve print quality.

Note

Before performing maintenance

- Open the Scanning Unit (Printer Cover) and make sure that all lamps for the ink tanks are lit red. If not, see “Getting the Ink Status Information” on page 46 and take the appropriate action.
 - Increase the **Print Quality** setting in the printer driver settings. See “Print Results Not Satisfactory” on page 75.
 - You can also perform the maintenance operation from your computer. For details, refer to the *PC Printing Guide* on-screen manual.
-

Step 1

See “Printing the Nozzle Check Pattern” on page 53.

If lines are missing or if white streaks appear



Step 2

See “Print Head Cleaning” on page 56.

If the problem is not resolved after performing Print Head Cleaning twice



Step 3

See “Print Head Deep Cleaning” on page 57.



After cleaning the Print Head, print and examine the nozzle check pattern.

Note

If Print Head Deep Cleaning does not resolve the problem, the Print Head may be damaged. Contact your Canon service representative.

● If the Ruled Lines Are Shifted

See “Aligning the Print Head” on page 58.

Printing the Nozzle Check Pattern

Print the nozzle check pattern to determine whether the ink ejects properly from the print head nozzles.

Note

Make sure that the Inner Cover is closed.

- 1** Make sure that the machine is turned on, then load a sheet of A4 or Letter-sized plain paper in the Rear Tray or Cassette.
- 2** Open the Paper Output Tray, and then open the Output Tray Extension.
 - (1) Put your finger in the rounded indent of the Paper Output Tray and open it gently.
 - (2) Open the Output Tray Extension.
- 3** Press the **Paper Feed Switch** to select the paper source where you have loaded paper.
- 4** Print the nozzle check pattern.
 - (1) Press the **HOME** button.
The **HOME** screen is displayed.
 - (2) Select **Settings**, then press the **OK** button.
The **Settings** screen is displayed.
 - (3) Select **Maintenance**, then press the **OK** button.
The **Maintenance** screen is displayed.
 - (4) Select **Nozzle check pattern** and then press the **OK** button.
The pattern print confirmation screen is displayed.
 - (5) Select **Yes** and then press the **OK** button.
The nozzle check pattern is printed, and the pattern confirmation screens are displayed alternately.
- 5** Examine the pattern and take the appropriate action.
See “Examining the Nozzle Check Pattern” on page 54.

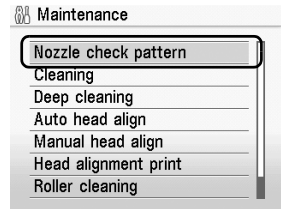

Examining the Nozzle Check Pattern

Examine the nozzle check pattern, and perform cleaning if necessary.

Note

If the ink level is low, the nozzle check pattern is not printed correctly. Replace the relevant ink tank. See “Replacing an Ink Tank” on page 46.

1 Check the nozzle check pattern you printed.

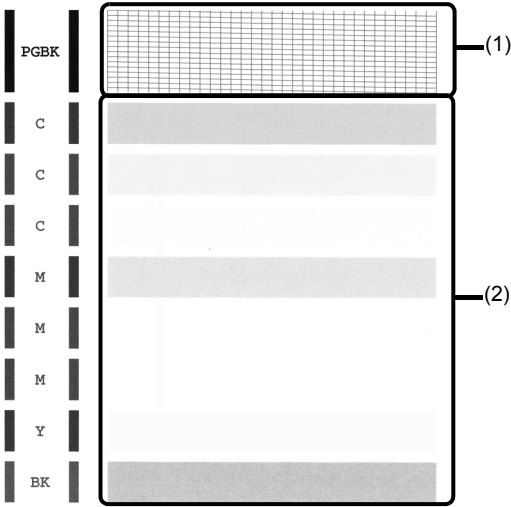

(1) Check if lines in this pattern are missing.

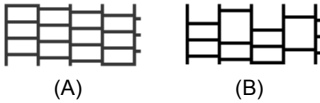

- (A) Good
- (B) Lines are missing

(2) Check if there are white streaks in this pattern.



- (C) Good
- (D) White streaks present

- 2** The confirmation screens for white streaks and missing lines are displayed alternately. Select the pattern that is closer to the nozzle check pattern that you printed.

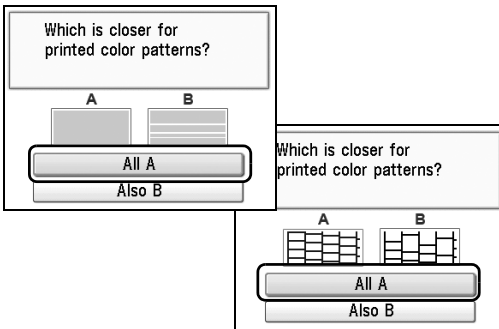

● **If There Are No Missing Lines and No White Streaks**

- (1) Select **All A** and press the **OK** button.
The LCD returns to the Maintenance screen.

● **If Lines Are Missing or White Streaks Are Present**

- (1) Select **Also B** and press the **OK** button.
The cleaning confirmation screen is displayed.
- (2) Select **Yes** and press the **OK** button to start Print Head Cleaning.
See "Print Head Cleaning" on page 56.

Print Head Cleaning

Clean the Print Head if lines are missing or if white streaks appear in the printed nozzle check pattern. Cleaning unclogs the nozzles and restores the print head condition. Note that cleaning the Print Head causes used ink to be absorbed in the ink absorber. Cleaning the Print Head consumes ink, so perform Print Head Cleaning only when necessary.

Note

Make sure that the Inner Cover is closed.

- 1 Make sure that the machine is turned on, then load a sheet of A4 or Letter-sized plain paper in the Rear Tray or Cassette.
 - 2 Open the Paper Output Tray, and then open the Output Tray Extension.
 - (1) Put your finger in the rounded indent of the Paper Output Tray and open it gently.
 - (2) Open the Output Tray Extension.
 - 3 Press the **Paper Feed Switch** to select the paper source where you have loaded paper.
 - 4 Start Print Head Cleaning.
 - (1) Press the **HOME** button.
The **HOME** screen is displayed.
 - (2) Select **Settings**, then press the **OK** button.
The **Settings** screen is displayed.
 - (3) Select **Maintenance**, then press the **OK** button.
The **Maintenance** screen is displayed.
 - (4) Select **Cleaning**, then press the **OK** button.
The confirmation screen is displayed.
 - (5) Select **Yes**, then press the **OK** button.
Print Head Cleaning starts.
Do not perform any other operations until Print Head Cleaning finishes. This takes about 1 minute.
The pattern print confirmation screen is displayed.
 - (6) Select **Yes**, then press the **OK** button.
The nozzle check pattern is printed.
 - 5 Check the print head condition with the printed nozzle check pattern, and take appropriate action.
See “Examining the Nozzle Check Pattern” on page 54.
-

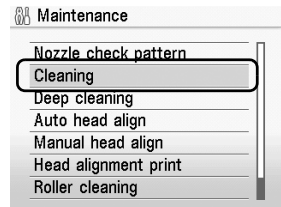

Note

If the problem is not resolved after performing Print Head Cleaning twice, try Print Head Deep Cleaning. See “Print Head Deep Cleaning” on page 57.

Print Head Deep Cleaning

If print quality does not improve by standard Print Head Cleaning, try Print Head Deep Cleaning, which is a more powerful process. Note that cleaning the Print Head causes used ink to be absorbed in the ink absorber. Print Head Deep Cleaning consumes more ink than standard Print Head Cleaning, so perform this procedure only when necessary.

Note

Make sure that the Inner Cover is closed.

- 1 Make sure that the machine is turned on, then load a sheet of A4 or Letter-sized plain paper in the Rear Tray or Cassette.
- 2 Open the Paper Output Tray, and then open the Output Tray Extension.
 - (1) Put your finger in the rounded indent of the Paper Output Tray and open it gently.
 - (2) Open the Output Tray Extension.
- 3 Press the **Paper Feed Switch** to select the paper source where you have loaded paper.
- 4 Start Print Head Deep Cleaning.
 - (1) Press the **HOME** button.
The **HOME** screen is displayed.
 - (2) Select **Settings**, then press the **OK** button.
The **Settings** screen is displayed.
 - (3) Select **Maintenance**, then press the **OK** button.
The **Maintenance** screen is displayed.
 - (4) Select **Deep cleaning**, then press the **OK** button.
The confirmation screen is displayed.
 - (5) Select **Yes**, then press the **OK** button.
Print Head Deep Cleaning starts.
Do not perform any other operations until Print Head Deep Cleaning finishes. This takes about 1 minute 30 seconds.
- 5 Check the condition of the Print Head.
 - (1) Print the nozzle check pattern to check the print head condition.
See "Printing the Nozzle Check Pattern" on page 53.
If a particular color is not printed properly, replace the ink tank of that color.
See "Replacing an Ink Tank" on page 46.
 - (2) If the problem is not resolved, turn off the machine and perform another Print Head Deep Cleaning after 24 hours.
 - (3) If this does not solve the problem, the Print Head may be damaged. Contact your Canon service representative.

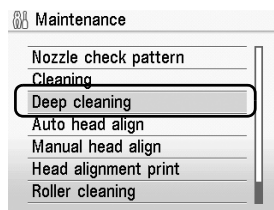

Aligning the Print Head

If ruled lines are printed misaligned or print results are otherwise unsatisfactory, adjust the print head position.

Note

Make sure that the Inner Cover is closed.

■ Automatic Print Head Alignment

Important

You cannot feed paper from the Cassette when performing Automatic Print Head Alignment. Always load paper in the Rear Tray.

- 1 Make sure that the machine is turned on, and then load two sheets of supplied paper or A4/Letter-sized Canon Matte Photo Paper MP-101 with the printing side (whiter side) facing up.
- 2 Open the Paper Output Tray, and then open the Output Tray Extension.
 - (1) Put your finger in the rounded indent of the Paper Output Tray and open it gently.
 - (2) Open the Output Tray Extension.
- 3 Adjust the print head position.
 - (1) Press the **HOME** button.
The **HOME** screen is displayed.
 - (2) Select **Settings**, then press the **OK** button.
The **Settings** screen is displayed.
 - (3) Select **Maintenance**, then press the **OK** button.
The **Maintenance** screen is displayed.
 - (4) Select **Auto head align**, then press the **OK** button.
The confirmation screen is displayed.

Note

If you select **Head alignment print**, the machine exits the process after printing the current head position adjustment values.

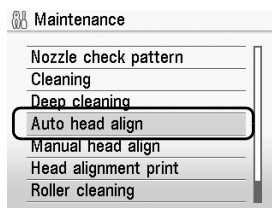

- (5) Select **Yes**, then press the **OK** button.
The print head is aligned automatically, and the print head pattern after the adjustment is printed out. This takes about 10 minutes.
-

Note

- The print head alignment pattern is printed in black and blue.
 - If adjustment was not done successfully, the **"Auto head align has failed."** error message is displayed on the LCD. For details, see "An Error Message Is Displayed on the LCD" on page 70.
 - If results of Automatic Print Head Alignment are not satisfactory, perform Manual Print Head Alignment. For details, see "Manual Print Head Alignment" on page 59.
-

■ Manual Print Head Alignment

If the results of Automatic Print Head Alignment are not satisfactory, follow the procedure below to perform Manual Print Head Alignment.

For details on performing Automatic Print Head Alignment, see “Automatic Print Head Alignment” on page 58.

- 1** Make sure that the machine is turned on, and then load four sheets of A4 or Letter-sized plain paper in the Rear Tray or Cassette.
- 2** Open the Paper Output Tray, and then open the Output Tray Extension.
 - (1) Put your finger in the rounded indent of the Paper Output Tray and open it gently.
 - (2) Open the Output Tray Extension.
- 3** Press the **Paper Feed Switch** to select the paper source where you have loaded paper.
- 4** Print the print head alignment pattern.
 - (1) Press the **HOME** button.
The **HOME** screen is displayed.
 - (2) Select **Settings**, then press the **OK** button.
The **Settings** screen is displayed.
 - (3) Select **Maintenance**, then press the **OK** button.
The **Maintenance** screen is displayed.
 - (4) Select **Manual head align**, then press the **OK** button.
The confirmation screen is displayed.

Note

If you select **Head alignment print**, the machine exits the process after printing the current head position adjustment values.

- (5) Select **Yes**, then press the **OK** button.
The print head alignment pattern is printed.
- (6) When “**Did the patterns print correctly?**” is displayed, confirm that the pattern is printed correctly, select **Yes**, then press the **OK** button.
The input screen for the head position adjustment values is displayed.

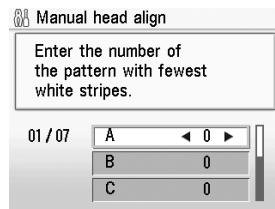

Manual head align	
Enter the number of the pattern with fewest white stripes.	
01 / 07	A ◀ 0 ▶
	B 0
	C 0

5 Look at the first printout, and then adjust the print head position.

- (1) Check the printed patterns and use the ◀ or ▶ button to input the number of the pattern in column A that has the least noticeable vertical streaks.

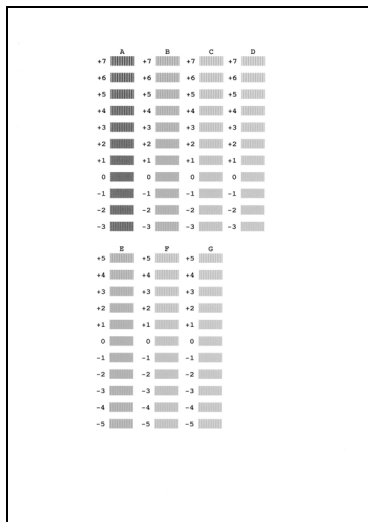

Note

If it is difficult to pick the most even pattern, pick the setting that produces the least noticeable vertical white streaks.



(A)



(B)

- (A) Less noticeable vertical white streaks
(B) More noticeable vertical white streaks

- (2) Repeat the same procedure until you finish inputting the pattern number for columns B to G, then press the **OK** button.
- (3) Confirm the displayed message and press the **OK** button.
The second pattern is printed.

6 Look at the second printout, and then adjust the print head position.

- (1) Check the printed patterns and use the ◀ or ▶ button to input the number of the pattern in column H that has the least noticeable vertical streaks.
- (2) Repeat the same procedure until you finish inputting the pattern number for columns I to O, then press the **OK** button.
- (3) Confirm the displayed message and press the **OK** button.
The third pattern is printed.

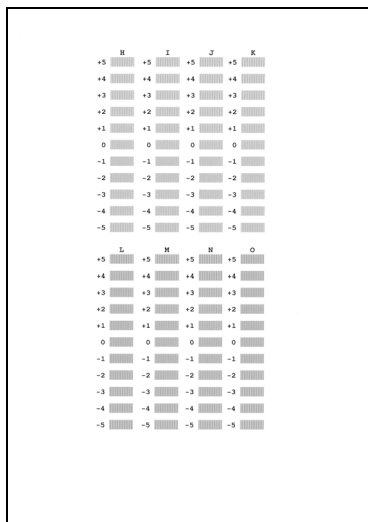

7 Look at the third printout, and then adjust the print head position.

- (1) Check the printed patterns and use the ◀ or ▶ button to input the number of the pattern in column P that has the least noticeable vertical streaks.
- (2) Repeat the same procedure until you finish inputting the pattern number for columns Q to V, then press the **OK** button.
For columns U and V, the best patterns will be smooth and have no streaks in the border indicated by the arrows.

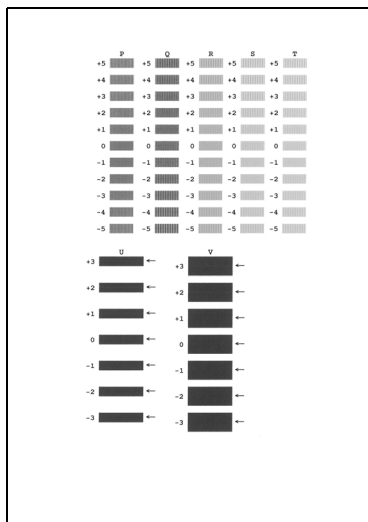

 **Note**

If it is difficult to pick the most even pattern, pick the setting that produces the least noticeable horizontal white streaks.

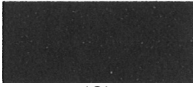

(C)

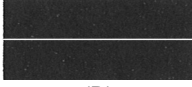

(D)

- (C) Less noticeable horizontal white streaks
(D) More noticeable horizontal white streaks
-

- (3) Confirm the displayed message and press the **OK** button.
The fourth pattern is printed.

8 Look at the fourth printout, and then adjust the print head position.

- (1) Check the printed patterns and use the ◀ or ▶ button to input the number of the pattern in column a that has the least noticeable horizontal streaks.

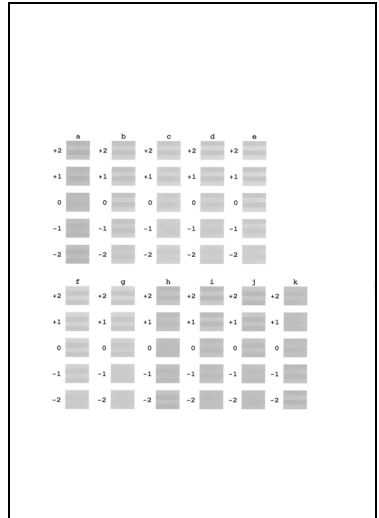

 **Note**

If it is difficult to pick the most even pattern, pick the setting that produces the least noticeable horizontal white streaks.



(E)



(F)

- (E) Less noticeable horizontal white streaks
(F) More noticeable horizontal white streaks
-

- (2) Repeat the same procedure until you finish inputting the pattern number for columns b to k, then press the **OK** button.

Cleaning Your Machine

This section describes the cleaning procedure that is needed to maintain your machine.

⚠ Caution

- Do not use tissue paper, paper towels, or similar materials for cleaning. Paper tissue powders or fine threads may remain inside the machine and cause problems such as a blocked Print Head and poor printing results. Use a soft cloth to avoid scratching the components.
 - Never use volatile liquids such as thinners, benzene, acetone, or any other chemical cleaner to clean the machine, as this may cause a malfunction or damage the machine's surface; these can damage the machine's components.
-

■ **Cleaning the Exterior of the Machine**

⚠ Caution

Be sure to turn off the power and disconnect the power cord before cleaning the machine.

🚫 Important

- When cleaning the exterior of the machine, do not use tissue paper, rough-textured cloth, or similar materials, as this may scratch the surface.
 - Never use neutral detergent or volatile liquids such as thinners, benzene, acetone, or any other chemical cleaner, as this may damage the surface.
-

Be sure to use a soft cloth such as eyeglasses cleaning cloth and wipe off dirt on the surface with it gently. Smooth out wrinkles on the cloth if necessary before cleaning.

■ **Cleaning the Platen Glass and Document Cover**

⚠ Caution

Be sure to turn off the power and disconnect the power cord before cleaning the machine.

🚫 Important

The inner side of the Document Cover (white sheet) (A) is easily damaged, so wipe it gently.

With a clean, soft, lint-free cloth, wipe the Platen Glass (B) and the inner side of the Document Cover (white sheet) (A) gently. Make sure not to leave any residue, especially on the Platen Glass.

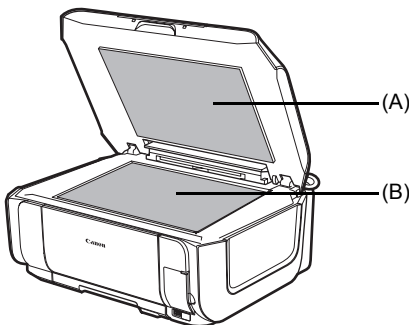

■ Cleaning the Paper Feed Roller (Roller Cleaning)

Clean the paper feed roller if paper is not fed properly. Cleaning the paper feed roller will wear the roller, so perform this only when necessary.

Note

Make sure that the Inner Cover is closed.

- 1** Make sure that the machine is turned on, and then remove any paper from the Rear Tray and Cassette.
- 2** Press the **Paper Feed Switch** to select the paper source to clean.
- 3** Clean the paper feed roller.
 - (1) Press the **HOME** button.
The **HOME** screen is displayed.
 - (2) Select **Settings**, then press the **OK** button.
The **Settings** screen is displayed.
 - (3) Select **Maintenance**, then press the **OK** button.
The **Maintenance** screen is displayed.
 - (4) Select **Roller cleaning**, then press the **OK** button.
The confirmation screen is displayed.
 - (5) Select **Yes**, then press the **OK** button.
The Paper Feed Roller will rotate as it is cleaned.
- 4** Repeat (4) and (5) in step 3 twice.
- 5** Open the Paper Output Tray, and then open the Output Tray Extension.
 - (1) Put your finger in the rounded indent of the Paper Output Tray and open it gently.
 - (2) Open the Output Tray Extension.
- 6** Make sure that the paper feed roller stops rotating, then load three or more sheets of A4 or Letter-sized plain paper in portrait orientation in the paper source you selected in step 2.

7 Repeat (4) and (5) in step 3 three times.

The paper cleans the paper feed roller as it feeds through the machine.

If the problem is not resolved, wipe the paper feed roller (A) located on the right side inside the Rear Tray with a moistened cotton swab or the like. Rotate the roller (A) manually as you clean it. Do not touch the roller with your fingers; rotate it with the cotton swab. If this does not solve the problem, contact your Canon service representative.

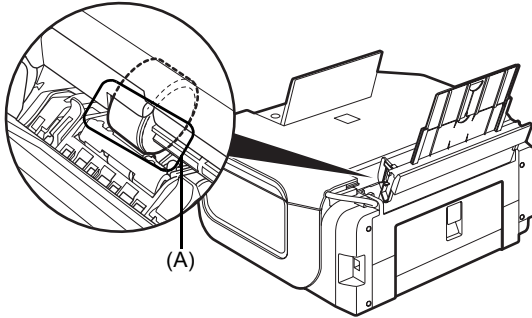

■ Cleaning the Inside of the Machine (Bottom Plate Cleaning)

This section describes how to clean the inside of the machine. If the inside of the machine becomes dirty, printed paper may get dirty, so we recommend performing cleaning regularly.

Important

Do not perform any other operation while the bottom plate is being cleaned.

Note

Make sure that the Inner Cover is closed.

- 1 Make sure that the machine is turned on, and then remove any paper from the Rear Tray.
- 2 Open the Paper Output Tray, and then open the Output Tray Extension.
 - (1) Put your finger in the rounded indent of the Paper Output Tray and open it gently.
 - (2) Open the Output Tray Extension.
- 3 Fold a single sheet of A4 or Letter-sized plain paper in half widthwise, and then unfold the paper.

- 4** Load this and only this sheet of paper in the Rear Tray with the open side to the front.

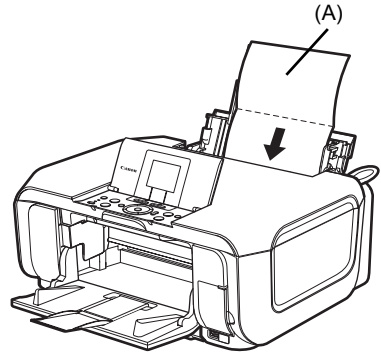

(A) Load the paper after unfolding it.

- 5** Perform bottom plate cleaning.

Important

Even if the Cassette is selected as the paper source, paper will be fed from the Rear Tray.

- (1) Press the **HOME** button.
The **HOME** screen is displayed.
- (2) Select **Settings**, then press the **OK** button.
The **Settings** screen is displayed.
- (3) Select **Maintenance**, then press the **OK** button.
The **Maintenance** screen is displayed.
- (4) Select **Bottom plate cleaning**, then press the **OK** button.
The confirmation screen is displayed.
- (5) Select **Yes**, then press the **OK** button.
The paper cleans the inside of the machine as it feeds through the machine.

Check the folded part of the ejected paper. If it is smudged with ink, perform Bottom Plate Cleaning again.

If the problem is not resolved after performing Bottom Plate Cleaning twice, the protrusions inside the machine may be stained. Clean them according to instructions. See "Cleaning the Protrusions Inside the Machine" on page 67.

Note

When performing Bottom Plate Cleaning again, make sure to use a new piece of paper.

■ Cleaning the Protrusions Inside the Machine

If protrusions inside the machine are stained, wipe off any ink from the protrusions using a cotton swab or the like.

⚠ Caution

Be sure to turn off the power and disconnect the power cord before cleaning the machine.

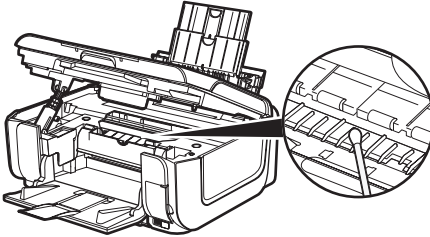

Troubleshooting

This section describes troubleshooting tips for problems you may encounter when using the machine.

Note

This section mainly describes the methods of machine operation for troubleshooting. To handle problems using your computer, refer to "Troubleshooting" in the *User's Guide* on-screen manual. For details on how to view the on-screen manuals, see "Reading the On-screen Manuals" on page 93.

- "An Error Message Is Displayed on the LCD" on page 70
- "LCD Cannot Be Seen At All" on page 72
- "An Unintended Language Is Displayed on the LCD" on page 72
- "Cannot Install the MP Drivers" on page 73
- "Cannot Connect to Computer Properly" on page 74
- "Print Results Not Satisfactory" on page 75
- "The Print Result Not Satisfactory When Copying" on page 78
- "Printing Does Not Start" on page 79
- "Machine Moves But Ink Is Not Ejected" on page 80
- "Paper Does Not Feed Properly" on page 81
- "Paper Does Not Feed from the Paper Source Specified in the Printer Driver" on page 81
- "Paper Jams" on page 82
- "Error Message Appears on the Computer Screen" on page 86
- "Error Message Appears on a PictBridge Compliant Device" on page 88
- "Cannot Print Properly through Infrared Communication" on page 90
- "Cannot Print Properly from a Photo Index Sheet" on page 90
- "Cannot Remove a Memory Card" on page 90
- "Scanning Problems" on page 91

If an Error Occurs When the Machine Is Connected to a Computer



When an error occurs in printing such as the machine is out of paper or paper is jammed, a troubleshooting message is displayed automatically. Take the appropriate action described in the message.

The message may vary depending on the version of your Windows operating system.



An Error Message Is Displayed on the LCD

If an error message is displayed on the LCD, take the corresponding action described below.

Message	Action
"There are no photos in memory card."	<ul style="list-style-type: none"> There are no image data saved on the memory card that can be read by this machine. The machine may not recognize the file if the file name or the folder path contains certain characters. Use only alphanumeric characters. Photo data edited or processed on a computer must be printed from the computer.
"The following ink may have run out. Replacing the ink tank is recommended." U041	<p>If the lamp on the ink tank is flashing, ink may have run out. Replacing the ink tank is recommended.</p> <p>If printing is in progress and you want to continue printing, press the OK button with the ink tank installed. Then printing can continue. Replacing the ink tank is recommended after the printing. The machine may be damaged if printing is continued under the ink out condition. See "Replacing an Ink Tank" on page 46.</p> <p> Note</p> <p>If multiple ink lamps are flashing red, see "Getting the Ink Status Information" on page 46 and check the status of each ink tank.</p>
"The following ink has run out. Replace the ink tank." U163	<p>Ink has run out. (The lamp on the ink tank flashes.) Replace the ink tank and close the Scanning Unit (Printer Cover). Printing under the current condition may damage the machine.</p> <p>If you want to continue printing in this condition, you need to release the function for detecting the remaining ink level. Press and hold the Stop/Reset button for at least 5 seconds, and then release it.</p> <p>With this operation, releasing the function for detecting the remaining ink level is memorized. Please be advised that Canon shall not be liable for any malfunction or trouble which may be caused by continuation of printing under the ink out condition. See "Replacing an Ink Tank" on page 46.</p> <p> Note</p> <p>If the function for detecting the remaining ink level is disabled, the ink tank in gray is displayed in the remaining ink volume screen on the LCD. See "Getting the Ink Status Information" on page 46.</p>
"Print head is not installed. Install the print head." U051 "The type of print head is incorrect. Install the correct print head." U052	<p>Follow the directions given in your setup sheet to install the Print Head. If the Print Head is already installed, remove the Print Head once and then reinstall it.</p> <p>If the error is not resolved, the Print Head may be damaged. Contact your Canon service representative.</p>
"Inner cover is open. Close the inner cover and press OK."	<p>If the Inner Cover is open when starting printing, close it and then press the OK button on the machine. Do not open or close the Inner Cover while printing, as this can damage the machine.</p>
"Some ink tanks are not installed in place." U072 "More than one ink tank of the following color is installed." U071	<p>Possible causes are as follows:</p> <ul style="list-style-type: none"> Some ink tanks are not installed in the correct position. (The lamp on the ink tank flashes.) More than one ink tanks of the same color are installed. (The lamp on the ink tank flashes.) <p>Confirm that the ink tanks are installed in the appropriate positions. See "Replacing an Ink Tank" on page 46.</p>



Message	Action
<p>"The ink absorber is almost full. Press OK to continue printing. Contact the service center."</p>	<p>The machine has a built-in ink absorber to hold the ink used during Print Head Cleaning, for example.</p> <p>This error message indicates that the ink absorber is nearly full. Press the OK button to cancel the error so you can continue printing. However, because printing is disabled once the ink absorber becomes completely full and until the ink absorber is replaced, you are recommended to contact a Canon service representative as early as possible. (You will need to replace a particular part of the machine.)</p>
<p>"The device may be incompatible. Remove the device and check the manual supplied with the connected device."</p>	<ul style="list-style-type: none"> ● A communication time out occurs if an operation takes too long or if it takes too much time to send data. This may cancel printing. In such cases, disconnect and reconnect the USB cable. <p>When printing from a PictBridge compliant device, depending on the model or brand of your device, you may have to select a PictBridge compliant print mode on the device before connecting it to the machine. You may also have to turn on your device or select Play mode manually after connecting the device to the machine. Perform necessary operations before connecting your device referring to its instruction manual.</p> <p>If the error is still not resolved, check if you can print another photograph.</p> <ul style="list-style-type: none"> ● Check your device connected to the machine. Only PictBridge compliant devices or the optional Bluetooth Unit BU-20 can be connected to the machine for direct printing.
<p>"Auto head align has failed. Press OK and repeat operation. <See manual>"</p>	<p>Possible causes are as follows:</p> <ul style="list-style-type: none"> ● Print Head nozzles are clogged. <ul style="list-style-type: none"> Press the OK button to dismiss the error message, and print the nozzle check pattern to check the status of the Print Head. See "Printing the Nozzle Check Pattern" on page 53 and "Printing Does Not Start/Printing Is Blurred/ Colors Are Wrong/Straight Lines Are Misaligned" on page 76. ● Paper of size other than A4 or Letter is loaded in the Rear Tray. <ul style="list-style-type: none"> Press the OK button on the machine to dismiss the error message, then load two sheets of A4/Letter-sized paper (MP-101) in the Rear Tray. Automatic Print Head Alignment cannot be performed using paper from the Cassette. For Automatic Print Head Alignment, always load paper in the Rear Tray. ● The Paper Output Slot is exposed to strong light. <ul style="list-style-type: none"> Press the OK button to dismiss the error message, and then adjust your operating environment and/or the position of the machine so that the Paper Output Slot is not exposed directly to strong light. <p>After carrying out the above measures, if the problem continues after aligning the Print Head again, press the OK button to dismiss the error message, and then perform Manual Print Head Alignment. For details on Manual Print Head Alignment, see "Manual Print Head Alignment" on page 59.</p>
<p>"The remaining level of the following ink cannot be correctly detected. Replace the ink tank." U130</p>	<p>The remaining ink level cannot be correctly detected. (The lamp on the ink tank flashes.)</p> <p>Replace the ink tank and close the Scanning Unit (Printer Cover). Printing with an ink tank that was once empty may damage the machine.</p> <p>If you want to continue printing in this condition, you need to release the function for detecting the remaining ink level. Press and hold the Stop/Reset button for at least 5 seconds, and then release it.</p> <p>With this operation, releasing the function for detecting the remaining ink level is memorized. Please be advised that Canon shall not be liable for any machine malfunction or damage caused by refilled ink tanks.</p> <p>See "Replacing an Ink Tank" on page 46.</p> <p> Note</p> <p>If the function for detecting the remaining ink level is disabled, the ink tank in gray is displayed in the remaining ink volume screen on the LCD.</p> <p>See "Getting the Ink Status Information" on page 46.</p>

Message	Action
<p>"The following ink tank cannot be recognized."</p> <p>U043 U140 U150</p>	<ul style="list-style-type: none"> ● The ink tank is not installed. Install the ink tank. See "Replacing an Ink Tank" on page 46. ● The ink tank is not compatible with this machine. (The lamp on the ink tank is off.) Install an appropriate ink tank. See "Replacing an Ink Tank" on page 46. ● An ink tank error has occurred. (The lamp on the ink tank is off.) Replace the ink tank. See "Replacing an Ink Tank" on page 46.
<p>*****</p> <p>Printer error has occurred. Turn off power then back on again. If problem persists, see the manual."</p>	<p>Turn off the machine, and unplug the power cord of the machine from the power supply. After a while, plug the power cord of the machine back in, and then turn on the machine. If the same error occurs, contact a Canon service representative.</p>
<p>"Scanner is not operating correctly."</p>	<p>Turn off the machine, and unplug the power cord of the machine from the power supply. After a while, plug the power cord of the machine back in, and then turn on the machine. If the same error occurs, contact a Canon service representative.</p>
<p>"The card is currently write-enabled. Set to read-only mode before performing operation."</p>	<p>The Card Slot is set to Read/write mode. You cannot print in this mode. After writing on the memory card, set to Read-only mode again.</p>
<p>"An unsupported USB hub is connected. Remove the hub."</p>	<p>If a PictBridge compliant device is connected via a USB hub, remove the hub and connect it directly to the machine.</p>



LCD Cannot Be Seen At All

Cause	Action
<p>The machine is not powered on or the LCD is in the screen-saver mode.</p>	<ul style="list-style-type: none"> ● If the Power lamp is off The machine is not powered on. Connect the power cord and press the ON/OFF button. The machine will power on and the LCD will display a message. ● If the Power lamp is lit The LCD may be in the screen-saver mode. On the Operation Panel, press a button other than the ON/OFF button.

An Unintended Language Is Displayed on the LCD

Cause	Action
<p>The language you want to be displayed is not selected.</p>	<p>Select the language you want to be displayed according to the following procedure.</p> <ol style="list-style-type: none"> (1) Press the HOME button. Wait for about 5 seconds, select , and then press the OK button. (2) Press the ▶ button to select , then press the OK button. (3) Press the ▼ button four times, then press the OK button. If the Bluetooth unit is connected to the machine, press the ▼ button five times, and then press the OK button. (4) Use the ▲ or ▼ button to select the language you want to be displayed, then press the OK button.

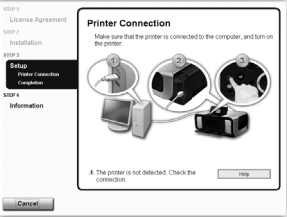
Cannot Install the MP Drivers

Cause	Action
<p>Windows</p> <p>Unable to proceed beyond the Printer Connection screen.</p>	<p>If you were unable to proceed beyond the Printer Connection screen, follow the procedure below to reinstall the MP Drivers.</p>  <ol style="list-style-type: none"> (1) Click Cancel on the Printer Connection screen. (2) Click Start Over on the Installation Failure screen. (3) Click Back on the screen that appears next. (4) Click Exit on the PIXMA XXX screen (where “XXX” is your machine’s name), then remove the CD-ROM. (5) Turn the machine off. (6) Restart the computer. (7) Make sure you have no application software running, including anti-virus software. (8) Follow the procedure described in your setup sheet to reinstall the MP Drivers.
<p>Installation does not start automatically when the <i>Setup CD-ROM</i> is inserted into your computer’s disc drive.</p>	<p>Windows</p> <ol style="list-style-type: none"> (1) Click Start then Computer. In Windows XP, click Start then My Computer. In Windows 2000, double-click the My Computer icon on the desktop. (2) Double-click the CD-ROM icon  on the displayed window. <p>Note</p> <p>To use the Run command to start the setup program, specify your disc drive and then the name of the setup program, MSETUP4.EXE. The drive letter of the disc drive depends on your computer.</p> <p>Macintosh</p> <p>Double-click the CD-ROM icon on your desktop to start installation.</p> <p>If the CD-ROM icon is not displayed, restart your computer.</p> <p>If the icon is still not displayed, try different discs and see if they are displayed. If other discs are displayed, there is a problem with the <i>Setup CD-ROM</i>. Contact a Canon service representative.</p>
<p>Installation procedure not followed correctly.</p>	<p>Follow the procedure described in your setup sheet for proper installation.</p> <p>If the MP Drivers were not installed correctly, uninstall the MP Drivers, restart your computer, and then reinstall the MP Drivers. Refer to the <i>PC Printing Guide</i> on-screen manual.</p> <p>Windows</p> <p>Note</p> <p>If the installer was forced to be terminated due to an Windows error, the system may be in an unstable condition and you may not be able to install the MP Drivers. Restart your computer before reinstalling.</p>

Cannot Connect to Computer Properly

■ Printing Speed Is Slow / USB 2.0 Hi-Speed Connection Does Not Work

Cause	Action
Your system environment is not fully compatible with USB 2.0 Hi-Speed.	<p>If your system environment is not fully compatible with USB 2.0 Hi-Speed, the machine will operate at a lower speed provided under USB 1.1. In this case, the machine operates properly but printing speed may slow down due to communication speed.</p> <p>Check the following to ensure that your system environment supports USB 2.0 Hi-Speed connection.</p> <ul style="list-style-type: none">● The USB port on your computer supports USB 2.0 Hi-Speed connection.● The USB cable, and the USB hub if you are using one, support USB 2.0 Hi-Speed connection. <p>Be sure to use a certified USB 2.0 Hi-Speed cable. We recommend the cable to be no longer than around 10 feet / 3 meters.</p> <ul style="list-style-type: none">● The operating system of your computer supports USB 2.0 Hi-Speed connection. <p>Obtain and install the latest update for your computer.</p> <ul style="list-style-type: none">● The USB 2.0 Hi-Speed driver operates properly. <p>Obtain the latest version of the USB 2.0 Hi-Speed driver compatible with your hardware and install it on your computer.</p> <p> Important</p> <p>For details on USB 2.0 Hi-Speed of your system environment, contact the manufacturer of your computer, USB cable, or USB hub.</p>



■ “This device can perform faster” Message Is Displayed

Cause	Action
Your system environment is not fully compatible with USB 2.0 Hi-Speed.	Your system environment is not compatible with USB 2.0. See “Printing Speed Is Slow / USB 2.0 Hi-Speed Connection Does Not Work” on page 74.

Print Results Not Satisfactory

If the print result is not satisfactory such as white streaks, misaligned lines, and uneven colors, confirm the paper and print quality settings first.

● Check 1: Do the page size and type settings match the size and type of the loaded paper?

When these settings are incorrect, you cannot obtain a proper print result. If you are printing a photograph or an illustration, incorrect paper type setting may reduce the quality of printout color. Also, if you print with an incorrect paper type setting, the printed surface may be scratched. In borderless printing, uneven coloring may occur depending on the combination of the paper type setting and the loaded paper.

● Check 2: Did you set the print quality setting appropriately?

Select a print quality option suitable to the paper and image for printing. If you notice blurs or uneven colors, increase the print quality setting and try printing again.

* When printing from a PictBridge compliant device, set the print quality setting by using the Operation Panel on the machine. You cannot make this setting from a PictBridge compliant device.

* You cannot change the print quality setting when printing from a wireless communication device.

The method to confirm the paper and print quality settings differs depending on what you do with your machine.

To copy or to print from your memory card or printed photo by operating the machine	Confirm by using the Operation Panel on the machine. See the pages where each printing mode is explained in this manual.
To print from a PictBridge compliant device	Confirm by using your PictBridge compliant device or the Operation Panel on the machine. See "Printing Photographs Directly from a PictBridge Compliant Device" on page 40.
To print from a wireless communication device	Confirm by using the Operation Panel on the machine. Refer to "Printing Photographs from a Wireless Communication Device" in the <i>User's Guide</i> on-screen manual.
To print from a computer	Confirm by using the printer driver. Refer to the <i>PC Printing Guide</i> on-screen manual.

● Check 3: If the problem is not resolved, there may be other causes.

See also the sections below.

- "Printing Does Not Start/Printing Is Blurred/Colors Are Wrong/Straight Lines Are Misaligned" on page 76
- "White Streaks" on page 76
- "Printed Paper Curls or Has Ink Blots" on page 76
- "Printed Surface Is Scratched/Paper Is Smudged" on page 76
- "Colors Are Uneven or Streaked" on page 78

■ Printing Does Not Start/Printing Is Blurred/Colors Are Wrong/Straight Lines Are Misaligned

Cause	Action
Ink tank is empty.	See "An Error Message Is Displayed on the LCD" on page 70 to identify the ink error, and then take the appropriate action depending on the error condition.
The protective film is remaining.	<p>Make sure all of the protective film is peeled off and the air hole is exposed, as illustrated in (A). If the orange tape is left as in (B), pull the orange tape and remove it.</p> <div data-bbox="415 331 994 560" style="text-align: center;"> </div> <p>(A) Correct L-shaped air hole is exposed.</p> <p>(B) Incorrect The tape is not peeled off.</p>
Print Head nozzles are clogged.	See "When Printing Becomes Faint or Colors Are Incorrect" on page 52 and perform any necessary maintenance operation.
The media is loaded with the wrong side facing upwards.	<p>Many types of paper are made to be printed on only a particular side of the paper.</p> <p>Printing on the wrong side may cause unclear prints or prints with reduced quality.</p> <p>Refer to the instruction manual supplied with the paper for detailed information on the printable side.</p>
Print Head is misaligned.	<p>If you did not align the Print Head after installation, straight lines may be printed misaligned. Make sure to align the Print Head after you install it.</p> <p>See "Automatic Print Head Alignment" on page 58 and perform Automatic Print Head Alignment. If this does not solve the problem, see "Manual Print Head Alignment" on page 59 and perform Manual Print Head Alignment.</p>

■ White Streaks

Cause	Action
Print Head nozzles are clogged.	See "When Printing Becomes Faint or Colors Are Incorrect" on page 52 and perform any necessary maintenance operation.

■ Printed Paper Curls or Has Ink Blots

Cause	Action
Paper is too thin.	When printing data with high color saturation such as photographs or images in deep color, we recommend using Photo Paper Pro or other Canon specialty paper. See "Media Types You Cannot Use" on page 10.

■ Printed Surface Is Scratched/Paper Is Smudged

Cause	Action
Paper Feed Roller is dirty.	<p>Clean the Paper Feed Roller. Cleaning the Paper Feed Roller will wear the roller, so perform this procedure only when necessary.</p> <p>For details on cleaning, see "Cleaning the Paper Feed Roller (Roller Cleaning)" on page 64.</p>

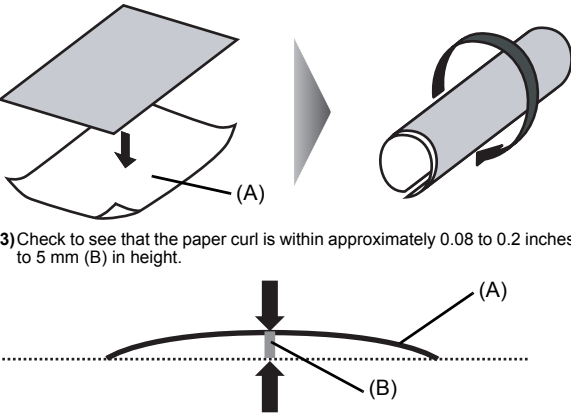
Cause	Action
Inside of the machine is dirty.	<p>When performing duplex printing, if the specified page size does not match the actual size of paper loaded in the paper source, the inside will become stained with ink, causing printed paper to become smudged.</p> <p>Perform the Bottom Plate Cleaning to clean the inside of the machine.</p> <p>For details on cleaning, see "Cleaning the Inside of the Machine (Bottom Plate Cleaning)" on page 65.</p> <p>Note</p> <p>To prevent the inside of the machine from stains, set the page size correctly.</p>
Printing on inappropriate type of paper.	<ul style="list-style-type: none"> ● Check to see if the paper you are printing on is not too thick or curled. See "Media Types You Cannot Use" on page 10. ● When performing Borderless Printing, print quality may be reduced at the top and bottom edges of the paper. Make sure that the paper you are using is suitable for Borderless Printing. <p>For details, refer to "Printing Area" in the <i>User's Guide</i> on-screen manual.</p>
Paper is curled.	<p>If you are using paper with either any of the corners or the whole printing surface curled, the paper may become dirty, not feed properly, or both. Use such paper after correcting paper curl as follows.</p> <p>(1) With the printing side (A) facing up, cover the paper with a fresh sheet of plain paper to avoid staining or scratching the surface.</p> <p>(2) Roll up the paper in a direction opposite to paper curl as seen below.</p>  <p>(3) Check to see that the paper curl is within approximately 0.08 to 0.2 inches / 2 to 5 mm (B) in height.</p> <p>We recommend printing curl-corrected paper one sheet at a time.</p> <p>Note</p> <p>Depending on the media type, the paper may be smudged or may not be fed properly even if it is not curled.</p> <p>In such case, follow the procedure described above to curl the paper before printing.</p> <p>This may improve the print result.</p>

Cause	Action
Printing on thick paper.	<p>Selecting the Prevent paper abrasion setting will widen the clearance between the Print Head and the loaded paper. If you notice abrasion even with the media type set correctly to match the loaded paper, set the machine to prevent paper abrasion by using the Operation Panel on the machine or the printer driver.*</p> <p>* Deactivate the Prevent paper abrasion setting once printing is complete. If not, this setting remains enabled for all subsequent print jobs.</p> <ul style="list-style-type: none"> ● Setting with the Operation Panel on the machine From the HOME screen, select Settings, Device settings, and Print settings in this order, and then set Prevent paper abrasion to ON. For details, refer to "Changing the Machine Settings" in the <i>User's Guide</i> on-screen manual ● Setting with the printer driver Refer to "Print Results Not Satisfactory" in the <i>User's Guide</i> on-screen manual.
Printing graphics with the Intensity setting in the printer driver set too high.	<p>Especially if you are using plain paper to print images with high intensity, the paper may absorb too much ink and become wavy, causing paper abrasion. When copying, refer to "Changing Intensity Setting" in the <i>User's Guide</i> on-screen manual and reduce the Intensity setting. Then try printing again.</p> <p>When printing from your computer, refer to "Print Results Not Satisfactory" in the <i>User's Guide</i> on-screen manual.</p>
Printing beyond the recommended printing area.	<p>If you are printing beyond the recommended printing area of your printing paper, the lower edge of the paper may become stained with ink.</p> <p>For details on recommended printing area, refer to "Printing Area" in the <i>User's Guide</i> on-screen manual.</p>

■ Colors Are Uneven or Streaked



Cause	Action
Print Head nozzles are clogged.	See "When Printing Becomes Faint or Colors Are Incorrect" on page 52 and perform any necessary maintenance operations.
Print Head is misaligned.	See "Automatic Print Head Alignment" on page 58 and perform Automatic Print Head Alignment. If this does not solve the problem, see "Manual Print Head Alignment" on page 59 and perform Manual Print Head Alignment.

The Print Result Not Satisfactory When Copying

Cause	Action
The original document is not loaded correctly.	Check that the original is loaded correctly on the Platen Glass. See "Loading Original Documents" on page 6.
The original document is not loaded with the side to be copied faced down.	When loading the original on the Platen Glass, the side to be copied should be faced down.
The original document is a printout from this machine.	Print quality may be reduced if you copy a printout. Instead of copying a printout, print the original directly either from the digital camera, memory card, or your computer.
The Platen Glass or the inner side of the Document Cover is dirty.	Clean the Platen Glass and the inner side of the Document Cover. See "Cleaning the Exterior of the Machine" on page 63.

If these do not resolve the problem, also see "Print Results Not Satisfactory" on page 75.

Printing Does Not Start

Cause	Action
Ink tank is empty.	See "An Error Message Is Displayed on the LCD" on page 70 to identify the ink error, and then take the appropriate action depending on the error condition.
Ink tank not installed in proper position.	<p>Open the Scanning Unit (Printer Cover) and check the ink lamps.</p> <p>If there is still sufficient ink but its ink lamp is flashing red, an ink tank may be installed in a wrong position.</p> <p>Confirm that the ink tanks are installed in the appropriate positions. See "Replacing an Ink Tank" on page 46.</p>
Ink tank is not installed securely.	<p>Open the Scanning Unit (Printer Cover) and check the ink lamps.</p> <p>If the ink lamp is not lit, press the  mark on the ink tank until it clicks into place. The ink lamp lights up red when the ink tank is fully inserted.</p>
Unnecessary print jobs are left in queue. / Computer problems.	<p>Restarting your computer may solve the problem.</p> <p>If there are any unnecessary print jobs, follow the procedure below to delete them.</p> <p>Windows</p> <p>(1) Open the printer properties dialog box. Refer to "Opening the Printer Properties Dialog Box Directly from the Control Panel" in the <i>User's Guide</i> on-screen manual.</p> <p>(2) Click the Maintenance tab and then View Printer Status. The printer status monitor is displayed.</p> <p>(3) Click Display Print Queue.</p> <p>(4) Select Cancel All Documents on the Printer menu. You may not be able to select this depending on the privileges of the account.</p> <p>(5) When the confirmation message is displayed, click Yes. The print jobs are deleted.</p> <p>Macintosh</p> <p>(1) Click the printer icon in the Dock to display the list of print jobs in progress. In Mac OS X v.10.2.8, click the printer icon in the Dock to start up the Print Center and double-click the name of your machine in the Printer List.</p> <p>(2) Select the print job to delete and click . The print jobs are deleted.</p>
The machine is not ready.	<p>Check if the Power lamp is lit green.</p> <p>If the Power lamp is off, turn the machine on.</p> <p>While the Power lamp is flashing green, the machine is initializing. Wait until the Power lamp stops flashing and remains lit green.</p> <p> Note</p> <p>When printing large data such as a photo or graphics, it may take longer to start printing.</p>

Machine Moves But Ink Is Not Ejected

Cause	Action
Print Head nozzles are clogged.	See "When Printing Becomes Faint or Colors Are Incorrect" on page 52 and perform any necessary maintenance operations.
Ink tank is empty.	See "An Error Message Is Displayed on the LCD" on page 70 to identify the ink error, and then take the appropriate action depending on the error condition.
The protective film is remaining.	<p>Make sure all of the protective film is peeled off and the air hole is exposed, as illustrated in (A). If the orange tape is left as in (B), pull the orange tape and remove it.</p> <div data-bbox="412 389 994 614" style="border: 1px solid black; padding: 10px;"> <p>The diagram shows a small printer on the left with a line pointing to a magnified view of an ink tank. In the magnified view, (A) shows a Canon 8 ink tank with the protective film peeled back, revealing an L-shaped air hole. (B) shows the same ink tank with the orange tape still attached to the top, which is marked with a large 'X' to indicate it is incorrect.</p> </div> <p>(A) Correct L-shaped air hole is exposed.</p> <p>(B) Incorrect The tape is not peeled off.</p>

Paper Does Not Feed Properly

Cause	Action
Printing on inappropriate type of paper.	Check to see if the paper you are printing on is not too thick or curled. See "Paper Handling" on page 9.
Paper Feed Roller is dirty.	Clean the Paper Feed Roller. Cleaning the Paper Feed Roller will wear the roller, so perform this procedure only when necessary. For details on cleaning, see "Cleaning the Paper Feed Roller (Roller Cleaning)" on page 64.
Paper not loaded properly.	Make sure of the following when you load paper in the machine. <ul style="list-style-type: none"> ● When loading two or more sheets of paper, align the edges of the sheets before loading. ● Always load the paper in portrait orientation, either in the Rear Tray or Cassette, regardless of the printing orientation. ● When loading paper in the Rear Tray, load the paper with the print side facing UP. Align the right edge of the paper stack against the Cover Guide and slide the Paper Guide so that it just touches the left edge of the stack. ● When loading paper in the Cassette, load the paper with the print side facing DOWN. Align the right edge of the paper stack against the right edge of the Cassette and slide the Paper Guides against the left and bottom edges of the stack. For details on loading paper, see "Loading Printing Paper" on page 8.
Too much paper loaded.	Make sure that the paper stack does not exceed the load limit. However, proper feeding of paper may not be possible at this maximum capacity depending on the type of paper or environmental conditions (either very high or low temperature and humidity). In such cases, reduce the sheets of paper you load at a time to around half. For details on loading paper, see "Loading Paper" on page 15.
Foreign object in the Rear Tray or Cassette.	Make sure that there are no foreign objects in the Rear Tray or Cassette.
Envelopes not prepared or loaded properly.	When printing on envelopes, see "Loading Envelopes" on page 19, and prepare the envelopes before printing. Once you have prepared the envelopes, load them in the machine in portrait orientation. If the envelopes are placed in landscape orientation, they will not feed properly.
Inner Cover is not completely closed.	Close the Inner Cover completely. Paper does not feed properly if the Inner Cover is even slightly open.

Paper Does Not Feed from the Paper Source Specified in the Printer Driver

Cause	Action
 <p>The paper source is specified in the data created by an application software.</p>	<p>When the paper source setting is inconsistent between an application program and the printer driver, the application software setting takes precedence. Change the application software setting corresponding to the printer driver setting, or click the Print Options on the Page Setup sheet in the printer driver and select Disable the paper source setting of the application software on the Print Options screen.</p> <p>For the print option setting, refer to the <i>PC Printing Guide</i> on-screen manual.</p>

Paper Jams

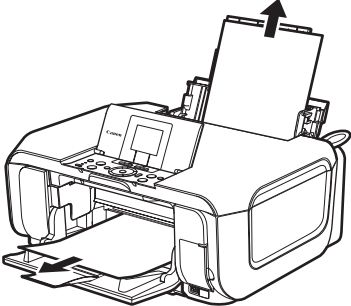
Cause	Action
<p>Paper jammed in the Paper Output Slot or the Rear Tray.</p>	<p>Remove the paper following the procedure below.</p> <p>(1) Slowly pull the paper out, either from the Rear Tray or from the Paper Output Slot, whichever is easier.</p>  <ul style="list-style-type: none"> ● If the paper tears and a piece remains inside the machine, open the Scanning Unit (Printer Cover) and remove it. <p>After removing all paper, close the Scanning Unit (Printer Cover), turn the machine off, and turn it back on.</p> <p>* Be careful not to touch the components inside the machine.</p> <ul style="list-style-type: none"> ● If you cannot pull the paper out, turn the machine off and turn it back on. The paper may be ejected automatically. <p>(2) Reload the paper in the machine, and press the OK button on the machine.</p> <p>If you turned off the machine in step (1), all print jobs in queue are canceled. Reprint if necessary.</p> <p>Note</p> <ul style="list-style-type: none"> ● For details on how to load paper, see “Loading Printing Paper” on page 8. ● When reloading the paper in the machine, see “Paper Does Not Feed Properly” on page 81 to confirm that you are using the correct paper and are loading it into the machine correctly. ● A5-sized paper are suited to print documents consisting mainly of text. We do not recommend using such paper to print documents with photos or graphics, since the printout may curl and cause paper exit jams. <p>If you cannot remove the paper or the paper tears inside the machine, or if the paper jam error continues after removing the paper, contact your Canon service representative.</p>
<p>Landscape credit card-sized paper jammed inside the machine.</p>	<p>Do not load credit card-sized paper in the landscape orientation. Remove the paper following the procedure below.</p> <p>(1) Load a single sheet of the same paper in the Rear Tray in portrait orientation. Do not load it in the landscape orientation.</p> <p>(2) Turn off the machine.</p> <p>(3) Turn on the machine.</p> <p>The paper is fed and then pushes out the jammed paper as it ejects.</p> <p>If you cannot remove the jammed paper or the paper jam error continues after removing the paper, contact your Canon service representative.</p>

Cause	Action
<p>Landscape 4" x 6" / 101.6 x 152.4 mm paper loaded in the Cassette jammed inside the machine.</p>	<p>Always load 4" x 6" / 101.6 x 152.4 mm media in portrait orientation regardless of the printing orientation.</p> <p>Remove the paper following the procedure below.</p> <p>(1) Turn off the machine, and then open the Rear Cover.</p> <p>(2) Fold a piece of A4 or Letter-sized plain paper in four, push it in until it hits the jammed paper, then pull out the paper folded in four.</p> <p>(3) Close the Rear Cover, then turn on the machine.</p> <p>Wait until the jammed paper is automatically ejected.</p> <p>If you cannot remove the jammed paper or the paper jam error continues after removing the paper, contact your Canon service representative.</p>

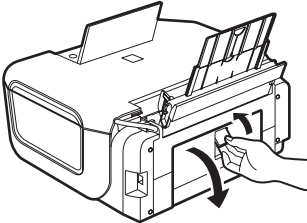
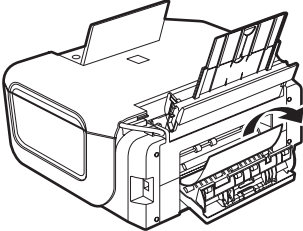
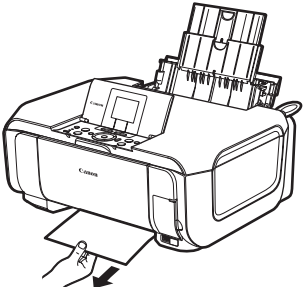
Cause	Action
<p>Paper jammed inside the machine at the transport unit.</p>	<p>Remove the paper following the procedure below.</p> <p>(1) Open the Rear Cover.</p>  <p>(2) If you can see the jammed paper, slowly pull the paper out.</p>  <ul style="list-style-type: none"> ● Be careful not to touch the components inside the machine. ● If you cannot pull the paper out, turn the machine off and turn it back on. The paper may be ejected automatically. <p>(3) Close the Rear Cover.</p> <p>(4) If you were not able to remove the paper out in step (2), remove the Cassette.</p> <p>(5) Slowly pull the jammed paper out.</p>  <p>(6) If any paper is sticking out of the Cassette, align the edges of the paper to reload in the Cassette.</p> <p>(7) Insert the Cassette into the machine again, and press the OK button on the machine.</p> <p>If you turned off the machine in step (2), all print jobs in queue are canceled. Reprint if necessary.</p> <p>Note</p> <p>When reloading the paper in the machine, see “Paper Does Not Feed Properly” on page 81 to confirm that you are using the correct paper and are loading it into the machine correctly.</p> <p>If you cannot remove the paper or if the paper tears inside the machine, or if the paper jam error continues after removing the paper, contact your Canon service representative.</p>

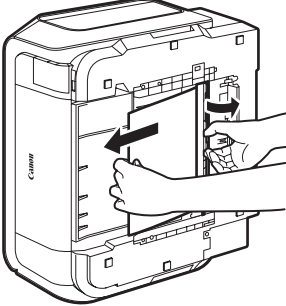
Cause	Action
<p>Paper jammed inside the machine at the Duplexing Transport Unit.</p>	<p>Remove the paper following the procedure below.</p> <p>(1) Remove the Cassette. If the paper is loaded in the Rear Tray, remove the paper from the Rear Tray and close the Sheet Feeder Cover.</p> <p>(2) Stand the machine with the left side down.</p> <p>(3) Slowly pull the jammed paper out while pulling the green cover toward you.</p>  <p>⚠ Caution Set the machine back to its original position immediately after removing the jammed paper.</p> <p>(4) If any paper is sticking out of the Cassette, align the edges of the paper to reload in the Cassette. Reload paper in the Rear Tray, if necessary.</p> <p>(5) Insert the Cassette into the machine again, and press the OK button on the machine.</p> <p>📖 Note When reloading the paper into the machine, see "Paper Does Not Feed Properly" on page 81 to confirm that you are using the correct paper and are loading it into the machine correctly. If you cannot remove a sheet of paper or a teared piece of paper inside the machine, or if the paper jam error continues after removing the paper, contact your Canon service representative.</p>

Error Message Appears on the Computer Screen



■ Writing Error/Output Error/Communication Error

Cause	Action
The machine is not ready.	<p>Confirm that the Power lamp is lit green.</p> <p>If the Power lamp is off, turn the machine on.</p> <p>While the Power lamp is flashing green, the machine is initializing. Wait until the Power lamp stops flashing and remains lit green.</p> <p>If the Alarm lamp is lit orange, an error may have occurred in the machine.</p> <p>For details on how to resolve the error, see "An Error Message Is Displayed on the LCD" on page 70.</p>
Printer port setting does not match the computer's interface connecting the machine.	<p>Check the printer port settings.</p> <p>* In the following instruction, "XXX" signifies your machine's name.</p> <p>(1) Log into a user account with administrator privilege.</p> <p>(2) Click Control Panel, then Printer under Hardware and Sound.</p> <p>In Windows XP, click Control Panel, Printers and Other Hardware, then Printers and Faxes.</p> <p>In Windows 2000, click Control Panel then Printers.</p> <p>(3) Right-click the Canon XXX Printer icon, then select Properties.</p> <p>(4) Click the Ports tab to confirm the port settings.</p> <p>Make sure that a port named USBnnn (where "n" is a number) with Canon XXX Printer appearing in the Printer column is selected for Print to the following port(s).</p> <p>If the port setting is not correct, change the port setting according to the interface you are using, or reinstall the MP Drivers.</p>
The machine is not connected properly.	<p>Make sure that the USB cable is securely plugged in to the machine and the computer.</p> <ul style="list-style-type: none"> ● If you are using a relay device such as a USB hub, disconnect it, connect the machine directly to the computer, and try printing again. If printing starts normally, there is a problem with the relay device. Consult the reseller of the relay device for details. ● There could also be a problem with the USB cable. Replace the USB cable and try printing again.
MP Drivers are not installed properly.	<p>The MP Drivers may not be installed properly. Uninstall them following the procedure described in the <i>PC Printing Guide</i> on-screen manual and reinstall them following the procedure described in your setup sheet.</p>

■ Error Regarding Automatic Duplex Printing Is Displayed

Cause	Action
The correct media size is not selected in the MP Drivers.	Refer to "Cannot Print Properly with Automatic Duplex Printing" in "Troubleshooting" of the <i>User's Guide</i> on-screen manual.

■ Error Regarding Automatic Print Head Alignment Is Displayed

Cause	Action
Automatic Print Head Alignment has failed.	See "Auto head align has failed. Press OK and repeat operation. <See manual>" in "An Error Message Is Displayed on the LCD" on page 71.

■ Error No.: 300 Is Displayed

Cause	Action
The machine is not ready.	<p>Confirm that the Power lamp is lit green.</p> <p>If the Power lamp is off, turn the machine on.</p> <p>If the Power lamp is flashing green, the machine is initializing. Wait until the Power lamp stops flashing and remains lit green.</p> <p>If the Alarm lamp is lit orange, an error may have occurred in the machine. For details on how to resolve the error, see "An Error Message Is Displayed on the LCD" on page 70.</p>
Machine is not connected properly.	<p>Make sure that the USB cable is plugged in securely to the machine and the computer.</p> <ul style="list-style-type: none"> ● If you are using a relay device such as a USB hub, disconnect it, connect the machine directly to the computer, and try printing again. If printing starts normally, there is a problem with the relay device. Consult the reseller of the relay device for details. ● There could also be a problem with the USB cable. Replace the USB cable and try printing again.
Your machine is not selected in Printer on the Print dialog box.	<p>Select your machine's name in Printer on the Print dialog box.</p> <p>If your machine's name does not appear in Printer, follow the procedure below to check that the driver for your machine is installed to your computer.</p> <p>(1) Select Print & Fax Preferences from Printer.</p> <p style="padding-left: 20px;">In Mac OS X v.10.2.8 or 10.3.x, select Edit Printer List from Printer.</p> <p>(2) Check that your machine's name is displayed in the list of printers and that the check box is selected.</p> <p style="padding-left: 20px;">In Mac OS X v.10.2.8, check that your machine's name is displayed in Printer List.</p> <p>(3) If your machine's name is not displayed, click Add(+) to add the machine.</p> <p>If you cannot add the machine, follow the procedure described in your setup sheet to reinstall the MP Drivers.</p>

■ Error No.: 1700 Is Displayed

Cause	Action
The ink absorber is almost full.	<p>See "The ink absorber is almost full. Press OK to continue printing. Contact the service center." in "An Error Message Is Displayed on the LCD" on page 71.</p>

■ Error No.: 1851 Is Displayed

Cause	Action
Inner Cover was open when you started printing.	<p>Close the Inner Cover, press the OK button on the machine. Printing will start again.</p>

Macintosh

■ Error No.: 1856 Is Displayed

Cause	Action
Inner Cover was opened while printing was in progress.	Close the Inner Cover, then press the OK button on the machine. A page of print data being sent at the time of the error will be erased, so print that page again.

Macintosh

■ Error No.: 2001 Is Displayed

Cause	Action
No response from connected digital camera or video camcorder. / Connected digital camera or video camcorder is not compatible with this machine.	See "The device may be incompatible. Remove the device and check the manual supplied with the connected device." in "An Error Message Is Displayed on the LCD" on page 71.

Macintosh

■ Error No.: 2002 Is Displayed

Cause	Action
An unsupported USB hub is connected.	See "An unsupported USB hub is connected. Remove the hub." in "An Error Message Is Displayed on the LCD" on page 72.

Macintosh

■ Error No.: 2500 Is Displayed

Cause	Action
Automatic Print Head Alignment has failed.	See "Auto head align has failed. Press OK and repeat operation. <See manual>" in "An Error Message Is Displayed on the LCD" on page 71.

Error Message Appears on a PictBridge Compliant Device

The following are the possible errors that may occur when printing directly from a PictBridge compliant device, and the actions to resolve them.

Note

- This section describes errors that are indicated on Canon-brand PictBridge compatible device. The error messages and operations may vary depending on the device you are using.
For errors on non-Canon PictBridge compliant devices, check the error message displayed on the LCD and take the appropriate action to clear the error. For details, see "An Error Message Is Displayed on the LCD" on page 70.
- For the errors indicated on the PictBridge compliant device and their solution, also refer to the instruction manual of the device. For other troubles on the device, contact the manufacturer.

Error Message On PictBridge Compliant Device	Action
"Printer in use"	If the machine is printing from the computer or warming up, wait until the job ends. When it is ready, the machine starts printing automatically.
"No paper"	Load paper in the paper source, or press the Paper Feed Switch to select the paper source where you have loaded paper (Rear Tray or Cassette), and select Continue * in the display on your PictBridge compliant device. * To resume printing, you can also press the OK button on the machine instead of selecting Continue .
"Paper Error" / "Media type error"	<ul style="list-style-type: none"> ● The page size that cannot be fed from the Cassette is selected. Load paper in the Rear Tray, press the Paper Feed Switch to select the Rear Tray as the paper source, and try printing again. For details, see "Changing the Paper Source" on page 14. ● If the Paper Output Tray is closed, open it. The machine resumes printing. If the Inner Cover is open, close it and select Stop in the display on your PictBridge compliant device to stop printing.
"Paper jam"	Select Stop in the display on your PictBridge compliant device to stop printing. Remove the jammed paper, load new paper, press the OK button on the machine and try printing again.
"Printer cover open"	Close the Scanning Unit (Printer Cover) on the machine.
"No Print Head"	The Print Head is not installed or is defective. For details on how to resolve the error, see "Print head is not installed. Install the print head. U051" in "An Error Message Is Displayed on the LCD" on page 70.
"Waste tank full" / "Ink absorber full"	The ink absorber is nearly full. For details on how to resolve the error, see "The ink absorber is almost full. Press OK to continue printing. Contact the service center." in "An Error Message Is Displayed on the LCD" on page 71.
"No ink" / "Ink cassette error"	The ink tank is not installed properly or empty. See the error message displayed on the LCD and take the appropriate action to resolve the error. See "An Error Message Is Displayed on the LCD" on page 70.
"Ink Error"	An ink tank that was once empty is installed. For details on how to resolve the error, see "The remaining level of the following ink cannot be correctly detected. Replace the ink tank. U130" in "An Error Message Is Displayed on the LCD" on page 71.
"Hardware Error"	An ink tank error has occurred. Replace the ink tank. See "Replacing an Ink Tank" on page 46.
"Printer error"	An error requiring servicing may have occurred. (Machine's Power lamp flashes green and Alarm lamp flashes orange alternately.) Disconnect the USB cable between the machine and the PictBridge compliant device, turn off the machine, and unplug the power cord of the machine from the power supply. After a while, plug the power cord of the machine back in, turn on the machine, and then reconnect the PictBridge compliant device to the machine. If the same error occurs, contact your Canon service representative.

Cannot Print Properly through Infrared Communication

The following are possible troubles that may occur when printing through infrared communication.

Cause	Action
Machine placement is inadequate.	When printing through infrared communication, confirm that the infrared ports on the machine and the mobile phone are placed face to face with each other at a proper angle and distance, and that there is nothing blocking them. Then, retry printing. Operational distance and angle vary depending on the specifications of your mobile phone and your operating environment, but generally place the machine within around 8 inches / 20 cm from the mobile phone in a position that enables proper communication.
During infrared communication, infrared rays were interrupted.	During receiving data, be careful not to interrupt infrared communication with the machine. If it is interrupted, send the data from the mobile phone again.
The conditions to print properly through the infrared communication are not met.	The infrared communication function of the machine is only compatible with mobile phones with IrDA compliant infrared communication ports. Printing through infrared communication cannot be performed by any other types of mobile phones. For details, refer to "Printing Photographs from a Wireless Communication Device" in the <i>User's Guide</i> on-screen manual.

Cannot Print Properly via Bluetooth Communication

To troubleshoot printing through Bluetooth communication, refer to the *Bluetooth Guide* on-screen manual.

Cannot Print Properly from a Photo Index Sheet

Cause	Action
"Failed to scan Photo Index Sheet." is displayed.	<ul style="list-style-type: none">● Make sure the Photo Index Sheet is set in the correct position and orientation on the Platen Glass.● Make sure the Platen Glass and the Photo Index Sheet are not dirty.● Make sure all required circles on the Photo Index Sheet are filled in. If the filled circles on the sheet are not marked dark enough, the machine may not scan the settings. See "Printing by Using the Photo Index Sheet" on page 33.

Cannot Remove a Memory Card

Cause	Action
miniSD Card, microSD Card, xD-Picture Card, Memory Stick Duo, Memory Stick PRO Duo, or RS-MMC is attempted to insert into the machine without attaching to the special adapter.	Contact your Canon service representative.  Important Never attempt to remove a memory card using a thin stick or a tweezers. Doing so may damage the machine.

Scanning Problems

■ ScanGear Won't Start

Cause	Action
The scanner driver (ScanGear) is not installed.	Follow the procedure described in your setup sheet to reinstall the MP Drivers.

■ Other Scanning Troubles

Refer to the *Scanning Guide* on-screen manual.

Appendix

How to Use the Documentation Provided

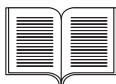

Printed Documentation

Setup Sheet

Be sure to read this sheet first.

This sheet includes instructions for setting up your machine and getting it ready for use.

Quick Start Guide (This guide)

Read this guide when starting to use the machine.

After following instructions in your setup sheet, we recommend you read this guide to familiarize yourself with the basic operation of some of the main functions that can be performed on your machine.



On-screen Manuals

User's Guide

Read this guide when starting to use the machine.

If the *Quick Start Guide* does not provide you enough information please refer to the *User's Guide* which can be installed from the *Setup CD-ROM*. This guide provides detailed instructions for:

- copying
- printing from a memory card
- printing from your computer
- scanning

Additional guides are also available for advanced features.

Scanning Guide

Refer to this guide for full instructions on scanning operation and settings.

PC Printing Guide

Refer to this guide for full instructions on printer driver setting.

PC Photo Printing Guide (Windows only)

Refer to this guide for full instructions on using the various application software included on the *Setup CD-ROM*.

Bluetooth Guide

Refer to this guide for full instructions of printing from computers and devices that support Bluetooth communication, and on troubleshooting them.

Reading the On-screen Manuals

For detailed instructions on installing the on-screen manuals, refer to your setup sheet.

You can view the on-screen manuals in the following way:

Windows

To view the on-screen manual, double-click the **XXX On-screen Manual** shortcut icon on the desktop, or click **Start > All Programs** (or **Programs**) > **Canon XXX Manual > XXX On-screen Manual** (where “**XXX**” is your machine’s name).

System Requirements

Browser: Windows HTML Help Viewer

Note

- Microsoft® Internet Explorer 5.0 or later must be installed.
 - The on-screen manual may not be displayed properly depending on your operating system or Internet Explorer version. We recommend that you keep your system up to date with Windows Update.
-

Macintosh

To view the on-screen manual, double-click the **XXX On-screen Manual** alias (where “**XXX**” is your machine’s name) on the desktop.

Note

Users in Asia

If you installed the *User’s Guide* from the **Manual** folder in the *Setup CD-ROM*, open the folder in which you copied the *User’s Guide* and double-click **top.htm**.

System Requirements

Browser: Help Viewer

Note

- The on-screen manual may not be displayed properly depending on your operating system. We recommend that you keep your system up to date.
 - We recommend using Safari as your Web browser to view the HTML format on-screen manuals. If Safari is not installed on your computer, download it from Apple Inc. website and install it.
-

Specifications

General Specifications	
Printing resolution (dpi)	9600 (horizontal)* x 2400 (vertical) * Ink droplets can be placed with a pitch of 1/9600 inch at minimum.
Interface	USB 2.0 High Speed ^{*1} / IrDA Ver.1.2 ^{*2} / Bluetooth 1.2 (Option) ^{*2*3} / ^{*1} A computer that complies with USB 2.0 Hi-Speed standard is required. Since the USB 2.0 Hi-Speed interface is fully upwardly compatible with USB Full-Speed (USB 1.1), it can be used at USB Full-Speed (USB 1.1). ^{*2} JPEG only ^{*3} Bluetooth connection is for printing only.
Print width	8 inches max. (203.2 mm) (for Borderless Printing: 8.5 inches / 216 mm)
Acoustic noise level	Approx. 33.5 dB (A) (when printing in the highest print quality mode on Photo Paper Pro)
Operating environment	Temperature: 5 to 35°C (41 to 95°F) Humidity: 10 to 90%RH (no condensation)
Storage environment	Temperature: 0 to 40°C (32 to 104°F) Humidity: 5 to 95%RH (no condensation)
Power supply	AC 100-240 V, 50/60 Hz
Power consumption	Printing (Copy): Approx. 19 W Standby (minimum): Approx. 2.5 W OFF: Approx. 1.0 W
External dimensions	Approx. 17.7 (W) x 15.3 (D) x 7.4 (H) inches / Approx. 450 (W) x 389 (D) x 188 (H) mm * With the Paper Support and Paper Output Tray retracted.
Weight	Approx. 10.0 kg (Approx. 22.0 lb.) * With the Print Head and ink tanks installed.
Print Head	Total 4,608 nozzles (Y/DyeBK/PgBK: each 512 nozzles, C/M: each 1536 nozzles)

Copy Specifications	
Multiple copy	1 - 99 pages
Intensity adjustment	9 positions, Auto intensity (AE copy)
Zoom	25% - 400% (1% unit)

Scan Specifications (Platen Glass)

Scanner driver	TWAIN / WIA (Windows Vista or Windows XP only)
Maximum scanning size	A4/Letter, 8.5" x 11.7" / 216 x 297 mm
Scanning resolution	Optical resolution (horizontal x vertical) max: 4800 dpi x 9600 dpi Interpolated resolution max: 19200 dpi x 19200 dpi
Gradation (Input/Output)	Gray: 16bit/8bit Color: 48bit/24bit (RGB each 16bit/8bit)

Camera Direct Print (PictBridge)

Paper size	4" x 6" / 101.6 x 152.4 mm, 5" x 7" / 127.0 x 177.8 mm ^{*1} , Credit card ^{*2} , 8" x 10" / 203.2 x 254.0 mm, A4, Letter, Wide ^{*1} ^{*1} Can be selected only on certain Canon-brand PictBridge compatible devices. ^{*2} Feeding this paper from the Cassette can damage the machine. Load in the Rear Tray.
Paper type	Default (Selections based on the machine setting), Photo (Photo Paper Plus Glossy, Glossy Photo Paper, Glossy Photo Paper "Everyday Use", Photo Paper Glossy, Photo Paper Plus Semi-gloss, Photo Stickers), Fast Photo (Photo Paper Pro), Plain Paper (A4/Letter only)
Layout	Default (Selections based on the machine setting), Borderless, Bordered, N-up (2, 4, 9, 16) ^{*1} , 35-up ^{*2} ^{*1} Layout compatible with Canon-brand sticker above. See "Compatible Media Types" in the <i>User's Guide</i> on-screen manual. ^{*2} Selected photos are printed in 35 mm film style layout (contact printing layout). This print setting is only available with certain Canon PictBridge-compliant devices. You can print shooting Info (Exif Data) on photos in list format, or in the margins of specified photos. Select Layout, then select the item displayed with the [i] icon. (Note that this print setting cannot be used for some models.)
Image optimize	Default (Selections based on the machine setting), On, Off, "VIVID"*, "NR" (Noise Reduction)*, "Face"*, "Red eye"* [*] If using a Canon PictBridge-compatible camera, you can select it.
Print date & file no.	Default (Off: No printing), Date, File No., Both, Off
Trimming	Default (Off: No trimming), On (follow camera's setting), Off

Minimum System Requirements

Note

Conform to the operating system's requirements when higher than those given here.

	Windows	Macintosh
Operating System Processor RAM	<p>Windows Vista Pentium II (including compatible processors) 300 MHz 128 MB</p> <p>Windows XP SP1, SP2 Pentium II (including compatible processors) 300 MHz 128 MB</p> <p>Windows 2000 Professional SP2, SP3, SP4 Pentium II (including compatible processors) 300 MHz 128 MB</p> <p>Note: Operation can only be guaranteed on a PC pre-installed Windows Vista, XP or 2000.</p>	<p>Mac OS X v.10.4 Intel processor PowerPC G3 256 MB</p> <p>Mac OS X v.10.2.8 - v.10.3 PowerPC G3 128 MB</p> <p>Note: Hard disk must be formatted as Mac OS Extended (Journaled) or Mac OS Extended</p>
Browser	Internet Explorer 6.0-	Safari
Hard Disk Space	800 MB Note: For bundled software installation.	450 MB Note: For bundled software installation.
CD-ROM Drive	Required	
Other restrictions	XGA 1024 x 768	

- OmniPage SE: Windows 2000 Professional SP2 and SP3 not supported
- MP Navigator EX: QuickTime v6.4 or later is needed (Macintosh only)
- Some functions may not be available with Windows Media Center.
- To upgrade from Windows XP to Windows Vista, first uninstall software bundled with the Canon inkjet printer.

Additional System Requirements for On-Screen Manuals

Windows	Macintosh
<p>Browser: Windows HTML Help Viewer</p> <p>Note: Microsoft Internet Explorer 5.0 or later must be installed. The on-screen manual may not be displayed properly depending on your operating system or Internet Explorer version. We recommend that you keep your system up to date with Windows Update.</p>	<p>Browser: Help Viewer</p> <p>Note: The on-screen manual may not be displayed properly depending on your operating system. We recommend that you keep your system up to date.</p>

Specifications are subject to change without notice.

▲ Safety Precautions

Please read the safety warnings and cautions provided in this manual to ensure that you use the machine safely. Do not attempt to use the machine in any way not described in this manual.

▲ Warning

- This product emits low level magnetic flux. If you use a cardiac pacemaker and feel abnormalities, please move away from this product and consult your doctor.
- You may cause an electric shock, fire, or damage the machine if you ignore any of these safety precautions.

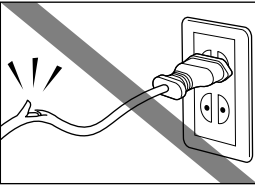
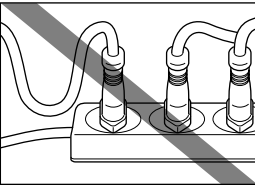
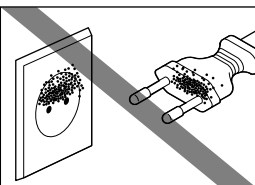
Choosing a location	Do not place the machine close to flammable solvents such as alcohol or thinners.	
Power supply	Never attempt to plug in or unplug the machine from the power supply when your hands are wet.	
	Always push the plug all the way into the power outlet.	
	Never damage, modify, stretch or excessively bend or twist the power cord. Do not place heavy objects on the power cord.	
	Never plug the machine into a power socket that is shared with other equipment (extension lead/cord, 2- or 3-way adapter, etc.).	
	Never use the machine if the power cord is bundled or knotted.	
	If you detect smoke, unusual smells or strange noises around the machine, immediately unplug the machine at the power supply and call for service.	
Periodically, unplug the machine and use a dry cloth to wipe off any dust or dirt collected on the plug and the power outlet. If the machine is placed at a location exposed to a lot of dust, smoke, or high humidity, the dust collected on the plug absorbs moisture and may cause insulation failure and fire.		
If you hear thunder, disconnect the power supply of the machine and refrain from using it. Leaving the machine plugged in may cause fire, electric shock, or damage to the machine, depending on the thunder storm.		
Use the power cable included with the machine.		

<p>Cleaning the machine</p>	<p>Use a damp cloth to clean the machine. Never use flammable solvents such as alcohol, benzene or thinners. If flammable solvents come in contact with electrical components inside the machine, it could cause a fire or electric shock.</p>	
<p>Always unplug the machine from the power outlet before cleaning the machine. If you accidentally switch the machine on while cleaning it, you could injure yourself or damage the machine.</p>		
<p>Maintaining the machine</p>	<p>Do not attempt to disassemble or modify the machine. There are no user serviceable parts inside the machine. The machine contains high-voltage components. Never attempt any maintenance procedure not described in this guide.</p>	
<p>Working around the machine</p>	<p>Do not use highly flammable sprays near the machine. This could cause a fire or electric shock if the spray comes into contact with electrical components inside the machine.</p>	

⚠ Caution

You may cause injury or damage the machine if you ignore any of these safety precautions.

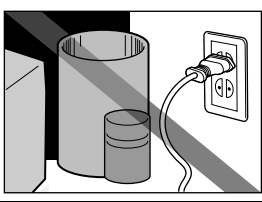
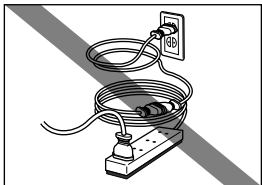
<p>Choosing a location</p>	<p>Do not install the machine in a location that is unstable or subject to excessive vibration. Do not install the machine in locations that are very humid or dusty, in direct sunlight, outdoors, or close to a heating source. To avoid the risk of fire or electric shocks, install the machine in a location with an ambient temperature range of 5°C to 35°C (41°F to 95°F) and humidity of 10% to 90% (condensation free). Do not place the machine on a thick rug or carpet. Do not place the machine with its back attached to the wall.</p>	
<p>Power supply</p>	<p>Ensure that the area around the power outlet is kept clear at all times so you can easily unplug the power cord if necessary.</p>	
<p>Never remove the plug by pulling on the cord.</p>		
<p>Do not use an extension lead/cord.</p>		

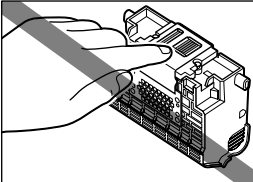
Working around the machine	Never put your hands or fingers in the machine while it is printing.	
	Do not place any object on the machine.	
	Do not place metal objects (paper clips, staples, etc.) or containers of flammable solvents (alcohol, thinners, etc.) on top of the machine.	
	If any foreign object (metal or liquid) fall into the machine, unplug the power cord and call for service.	
	Do not transport or store the machine on a slant, vertically or upside-down, as the ink may leak and damage the machine.	
	When loading a thick book on the Platen Glass, do not press hard on the Document Cover. The Platen Glass may break and cause injury.	
Print Heads and ink tanks	For safety reasons, store Print Heads and ink tanks out of the reach of small children. If a child ingests any ink, consult a doctor immediately.	
	Do not shake Print Heads or ink tanks. Ink may leak out and stain clothing or the surrounding area.	
	Never touch the electrical contacts on a Print Head after printing. The metal parts may be very hot and could cause burns.	
		Do not throw ink tanks into fire.

Legal Limitations on Use of Your Product and Use of Images

It may be unlawful to make copies of, scan, print, or use reproductions of the following documents. The list provided is non-exhaustive. When in doubt, check with a legal representative in your jurisdiction.

- Paper money
- Money orders
- Certificates of deposit
- Postage stamps (canceled or uncanceled)
- Identifying badges or insignias
- Selective service or draft papers
- Checks or drafts issued by governmental agencies
- Motor vehicle licenses and certificates of title
- Traveler's checks
- Food stamps
- Passports
- Immigration papers
- Internal revenue stamps (canceled or uncanceled)
- Bonds or other certificates of indebtedness
- Stock certificates
- Copyrighted works/works of art without permission of copyright owner

Users in the U.S.A.

■ Regulatory Information

FCC Notice (U.S.A. Only)

For 120V, 60Hz model

Model Number: K10306

This device complies with Part 15 of the FCC Rules. Operation is subject to the following two conditions: (1) This device may not cause harmful interference, and (2) this device must accept any interference received, including interference that may cause undesired operation.

Note: This equipment has been tested and found to comply with the limits for a Class B digital device, pursuant to Part 15 of the FCC Rules. These limits are designed to provide reasonable protection against harmful interference in a residential installation. This equipment generates, uses and can radiate radio frequency energy and, if not installed and used in accordance with the instructions, may cause harmful interference to radio communications.

However, there is no guarantee that interference will not occur in a particular installation. If this equipment does cause harmful interference to radio or television reception, which can be determined by turning the equipment off and on, the user is encouraged to try to correct the interference by one or more of the following measures:

- Reorient or relocate the receiving antenna.
- Increase the separation between the equipment and receiver.
- Connect the equipment into an outlet on a circuit different from that to which the receiver is connected.
- Consult the dealer or an experienced radio/TV technician for help.

Use of a shielded cable is required to comply with Class B limits in Subpart B of Part 15 of the FCC Rules.

Do not make any changes or modifications to the equipment unless otherwise specified in the manual. If such changes or modifications should be made, you could be required to stop operation of the equipment.

Canon U.S.A., Inc.
One Canon Plaza
Lake Success, NY 11042
1-516-328-5600

■ Canon U.S.A., INC. LIMITED WARRANTY --- (USA Only)

The limited warranty set forth below is given by Canon U.S.A., Inc. ("Canon USA") with respect to the new or refurbished Canonbrand product ("Product") packaged with this limited warranty, when purchased and used in the United States only.

The Product is warranted against defects in materials and workmanship under normal use and service (a) for a period of one (1) year from the date of original purchase when delivered to you in new condition in its original container or (b) for 90 days from the date of original purchase for refurbished Products. Product returned to a Canon USA repair facility or a Canon USA Authorized Service Facility ("ASF"), and proven to be defective upon inspection will be (a) repaired utilizing new, remanufactured, repaired and/or recycled parts (b) exchanged for new or; (c) exchanged for a refurbished Product, as determined by the Canon USA repair facility or the ASF. Warranty repair or replacement shall not extend the original warranty period of the Product. A dated proof of purchase is required at the time of warranty service. A copy of your dated bill of sale will satisfy this requirement. This warranty does not cover any accessories, or any consumables, such as paper or ink cartridges, as to which there shall be no warranty or replacement.

This limited warranty shall only apply if the Product is used in conjunction with compatible computers, peripheral equipment and software. Canon USA shall have no responsibility for such items except for compatible Canon brand peripheral equipment covered by a separate warranty ("Separate Warranty"). Repairs of such Canon brand peripheral equipment shall be governed by the terms of the Separate Warranty. Non-Canon brand equipment and software that may be distributed with the Product are sold "as is" and without warranty of any kind by Canon USA, including any implied warranty regarding merchantability or fitness for a particular purpose, and all such warranties are disclaimed. The sole warranty, if any, with respect to such non-Canon brand items is given by the manufacturer or producer thereof.

This limited warranty covers all defects encountered in normal use of the Product and does not apply in the following cases:

- (a) Loss of or damage to the Product due to abuse, neglect, mishandling, improper packaging by you, alteration, accident, electrical current fluctuations, improper use, failure to follow operating or maintenance instructions in, or environmental conditions prescribed in, Canon USA's user's manual or other documentation, or services performed by someone other than a Canon USA repair facility or ASF. Without limiting the foregoing, dropping the Product, scratches, and abrasions will be presumed to have resulted from misuse, abuse or failure to operate the Product as set forth in the user's manual or other documentation for the Product.
- (b) Use of parts, media, software or supplies (other than those sold by Canon USA), including non-Canon ink cartridges or refilled ink cartridges, that cause damage to the Product or cause abnormally frequent service calls or service problems.
- (c) If the Product has had its serial number or dating defaced, altered or removed.

ANY SYSTEM SOFTWARE (WHETHER FACTORY LOADED ON THE PRODUCT OR CONTAINED ON THE SOFTWARE DISKETTES OR CD-ROMS ENCLOSED WITH, OR ACCOMPANYING, THE PRODUCT), AND ANY UTILITY SOFTWARE, DISTRIBUTED WITH OR FOR THE PRODUCT, IS SOLD "AS IS" AND WITHOUT WARRANTY BY CANON USA. THE SOLE WARRANTY WITH RESPECT TO SUCH SOFTWARE IS CONTAINED IN THE SOFTWARE MANUFACTURER'S LICENSE AGREEMENT DISTRIBUTED THEREWITH, INCLUDING ANY LIMITATIONS AND DISCLAIMERS THEREON. PLEASE CONTACT CANON USA IMMEDIATELY IF YOU HAVE NOT RECEIVED A COPY OF THE SOFTWARE MANUFACTURER'S LICENSE AGREEMENT.

NO IMPLIED WARRANTY, INCLUDING ANY IMPLIED WARRANTY OF MERCHANTABILITY OR FITNESS FOR A PARTICULAR PURPOSE, APPLIES TO THE PRODUCT AFTER THE APPLICABLE PERIOD OF THE EXPRESS LIMITED WARRANTY STATED ABOVE, AND NO OTHER EXPRESS WARRANTY OR GUARANTY, EXCEPT AS MENTIONED ABOVE, GIVEN BY ANY PERSON OR ENTITY WITH RESPECT TO THE PRODUCT SHALL BIND CANON USA, OR ITS ASF. (SOME STATES DO NOT ALLOW LIMITATIONS ON HOW LONG AN IMPLIED WARRANTY LASTS, SO THE ABOVE LIMITATION MAY NOT APPLY TO YOU.) CANON USA SHALL NOT BE LIABLE FOR LOSS OF REVENUES OR PROFITS, INCONVENIENCE, EXPENSE FOR SUBSTITUTE EQUIPMENT OR SERVICE, STORAGE CHARGES, LOSS OR CORRUPTION OF DATA, OR ANY OTHER SPECIAL, INCIDENTAL OR CONSEQUENTIAL DAMAGES CAUSED BY THE USE, MISUSE, OR INABILITY TO USE THE PRODUCT REGARDLESS OF THE LEGAL THEORY ON WHICH THE CLAIM IS BASED, AND EVEN IF CANON USA OR ITS ASF HAS BEEN ADVISED OF THE POSSIBILITY OF SUCH DAMAGES. NOR SHALL RECOVERY OF ANY KIND AGAINST CANON USA OR ITS ASF BE GREATER IN AMOUNT THAN THE PURCHASE PRICE OF THE PRODUCT CAUSING THE ALLEGED DAMAGE. WITHOUT LIMITING THE FOREGOING, YOU ASSUME ALL RISK AND LIABILITY FOR LOSS, DAMAGE OR INJURY TO YOU AND YOUR PROPERTY AND TO OTHERS AND THEIR PROPERTY ARISING OUT OF THE POSSESSION, USE, MISUSE, OR INABILITY TO USE THE PRODUCT SOLD BY CANON USA NOT CAUSED SOLELY AND DIRECTLY BY THE NEGLIGENCE OF CANON USA, OR ITS ASF. (SOME STATES DO NOT ALLOW THE EXCLUSION OR LIMITATION OF INCIDENTAL OR CONSEQUENTIAL DAMAGES, SO THE ABOVE EXCLUSION OR LIMITATION MAY NOT APPLY TO YOU.) THIS LIMITED WARRANTY SHALL NOT EXTEND TO ANYONE OTHER THAN THE ORIGINAL

PURCHASER OF THE PRODUCT OR THE PERSON FOR WHOM IT WAS PURCHASED AS A GIFT, AND STATES YOUR EXCLUSIVE REMEDY.

Canon USA offers a range of customer technical support* options:

- Interactive troubleshooting, e-mail technical support, the latest driver downloads and answers to frequently asked questions (www.canontechsupport.com)
- Toll-free live technical support Monday—Saturday (excluding holidays) at 1-800-828-4040
- Telephone Device for the Deaf (TDD-1-866-251-3752)
- Repair or Exchange Service Options:
In the event service is required for the Product during the limited warranty period, Canon USA offers two hardware support options:

Authorized Service Facility Carry-In / Mail-In Service

Canon USA's Carry-In/Mail-In Service provides repair or exchange, at Canon USA's option, through Canon USA's Authorized Service Facility (ASF) network. The name and telephone number of the ASF(s) near you may be obtained from Canon USA's Web site at www.canontechsupport.com or by calling the Canon USA Customer Care Center at 1-800-828-4040, or any time while speaking to a technical support person. A Product covered by this limited warranty will be repaired or exchanged, as determined by Canon USA, and returned without charge by the ASF.

InstantExchange Service **

A Canon Customer Care Center or ASF technician will attempt to diagnose the nature of the problem and, if possible, correct it over the telephone. If the problem cannot be corrected over the telephone, and you elect the InstantExchange option, a reference number will be issued to you. You will be asked for the Product serial number and other information pertaining to your Product and for a ship-to location for the replacement Product (must include street address).

The Canon USA repair facility will ship out the replacement Product prepaid by Canon USA. After receipt of the replacement Product (with instructions and a prepaid waybill), follow the enclosed instructions on how to ship your product to the Canon USA repair facility. Your Product must be returned in the shipping carton in which the replacement Product was packed and include the reference number, A COPY OF YOUR DATED PROOF OF PURCHASE (BILL OF SALE), and a complete explanation of the problem. DO NOT INCLUDE ANY OTHER ITEMS WITH THE YOUR PRODUCT IN THE RETURN SHIPPING CARTON, AND BE SURE TO RETAIN YOUR PRINTHEAD, INK CARTRIDGE(S) AND TANK(S).

InstantExchange Service exchanges your Product with a replacement Product, which will normally be shipped the same day if your request for this service is by 3 p.m. E.T. Monday through Friday, except holidays. Canon USA does not guarantee same day shipment in the event of the occurrence of factors beyond its reasonable control. The replacement Product you receive may be a refurbished or reconditioned unit and will be covered for the balance of the period remaining on your original limited warranty. NOTE THAT BY USING THIS SERVICE YOU WILL KEEP THE REPLACEMENT PRODUCT THAT IS SENT TO YOU. CANON USA WILL RETAIN THE PRODUCT THAT YOU ORIGINALLY PURCHASED, WHICH SHALL BECOME THE PROPERTY OF CANON USA. InstantExchange warranty program service is available only during the express limited-warranty period for your Product and only in the continental United States, Alaska and Hawaii during such period.

This limited warranty gives you specific legal rights, and you may also have other rights, which vary from state to state.

* Support program specifics are subject to change without notice.

** InstantExchange warranty service is subject to the availability of refurbished or new replacement units.

Canon U.S.A., Inc.
One Canon Plaza
Lake Success, NY 11042
USA

Canon is a registered trademark of Canon Inc.

©2007 Canon U.S.A., Inc. Canon is a registered trademark of Canon Inc. in the United States and may also be a registered trademark in other countries.

Index

A

Appendix 92

B

Before Using the Machine 2

C

Cleaning
 inside 65
 platen glass and document cover 63
 roller 64
Copying 24

L

Legal Limitations on Use of Your Product and Use
 of Images 100
Loading Original Documents 6
Loading Printing Paper
 Cassette 17
 Envelopes 19
 Loading Paper 15
 Rear Tray 15
 recommended paper and requirements 9

M

Media
 cannot use 10
 specialty 8
Media Type 9
Memory Card
 inserting 27
 removing 28
 supported by this machine 26

N

Nozzle Check Pattern
 examining 54
 printing 53

P

Photo Printing from Printed Photo 34
Print Head
 automatic print head alignment 58
 cleaning 56
 deep cleaning 57
 manual print head alignment 59
Printing from a Memory Card 26
 Photo Index Sheet 33
 select and print 28
Printing from Your Computer 36
 Macintosh 37
 Windows 36
Printing Photographs Directly from a Compliant
 Device 40
 PictBridge 42

R

Replacing Ink Tanks 48
Routine Maintenance 46
 replacing ink tanks 48

S

Safety Precautions 97
Scanning Images 38
Specialty Media 8
Specifications
 copy 94
 general 94
 PictBridge 95
 scan 95

T

Troubleshooting 68
Turning off the Machine 5
Turning on the Machine 5

U

Users in the U.S.A.
 Canon U.S.A., Inc. Limited Warranty - U.S. Only
 101

Ordering Information

For additional supplies, use the following descriptions and order numbers.

Description	Order #
Ink Tanks	
PGI-5 Black	0628B002
CLI-8 Black	0620B002
CLI-8 Cyan	0621B002
CLI-8 Magenta	0622B002
CLI-8 Yellow	0623B002
Canon Specialty Papers	
All Occasion Photo Cards (4" x 8"/ 50 sheets)	1029A069
Glossy Photo Paper Credit Card Size (100 sheets)	9157A023
High Resolution Paper (8.5" x 11"/ 100 sheets)	1033A011
Matte Photo Paper (4" x 6"/ 120 sheets)	7981A014
Matte Photo Paper (8.5" x 11"/ 50 sheets)	7981A004
Photo Paper Glossy (4" x 6"/ 50 sheets)	0775B021
Photo Paper Glossy (4" x 6"/ 100 sheets)	0775B022
Photo Paper Glossy (8.5" x 11"/ 50 sheets)	0775B023
Photo Paper Glossy (8.5" x 11"/ 100 sheets)	0775B024
Photo Paper Plus Double Sided (5" x 7"/ 10 sheets)	9981A006
Photo Paper Plus Double Sided (8.5" x 11"/ 10 sheets)	9981A005
Photo Paper Plus Double Sided Album Kit (5" x 7")	0041B005
Photo Paper Plus Double Sided Album Kit (8.5" x 11")	0041B006
Photo Paper Plus Glossy (4" x 6"/ 50 sheets)	7980A012
Photo Paper Plus Glossy (4" x 6"/ 120 sheets)	7980A022
Photo Paper Plus Glossy (5" x 7"/ 20 sheets)	7980A019
Photo Paper Plus Glossy (8.5" x 11"/ 20 sheets)	7980A006
Photo Paper Plus Semi-gloss (4" x 6"/ 50 sheets)	1686B014
Photo Paper Plus Semi-gloss (8" x 10" / 20 sheets)	1686B017
Photo Paper Plus Semi-gloss (8.5" x 11"/ 20 sheets)	1686B020
Photo Paper Pro (4" x 6"/ 20 sheets)	1029A014
Photo Paper Pro (4" x 6"/ 75 sheets)	1029A027
Photo Paper Pro (8" x 10"/ 20 sheets)	1029A059
Photo Paper Pro (8.5" x 11"/ 15 sheets)	1029A004
Photo Paper Pro (8.5" x 11"/ 30 sheets)	1029A028
Photo Stickers (16 stickers/sheet, 5 sheets/pack)	0001C001

Call **1-800-OK-CANON** to locate a dealer near you, or visit the Canon eStore at www.estore.usa.canon.com.

© 2007 Canon U.S.A., Inc. Canon is a registered trademark of Canon Inc. in the United States and may be a registered trademark or trademarks in other countries. All other product and brand names are trademarks of their respective owners. As an ENERGY STAR® partner, Canon U.S.A., Inc. has determined that this product meets the ENERGY STAR® guidelines for energy efficiency.

The following ink tanks are compatible with this product.



For information on product specifications, please visit our website at www.usa.canon.com