

PIXMA

iP2200/iP1600/iP1200

Quick Start Guide

Table of Contents

Introduction	1
Preparing the Printer	2
Installing the FINE Cartridges	3
Installing the Printer Driver	6
Installing the Printer Driver - Windows®	6
Installing the Printer Driver - Macintosh®	9
Basic Operations	12
Printing with Windows	12
Printing with Macintosh	13
Replacing a FINE Cartridge	14

Exif Print

This printer supports Exif Print.

Exif Print is a standard for enhancing the communication between digital cameras and printers.

Canadian Radio Interference Regulations

This digital apparatus does not exceed the Class B limits for radio noise emissions from a digital apparatus as set out in the interference-causing equipment standard entitled "Digital Apparatus," ICES-003 of the Industry Canada.

Cet appareil numérique respecte les limites de bruits radioélectriques applicables aux appareils numériques de Classe B prescrites dans la norme sur le matériel brouilleur NMB-003 d'Industrie Canada intitulée « Appareils numériques ».

International ENERGY STAR® Program

As an ENERGY STAR® Partner, Canon Inc. has determined that this product meets the ENERGY STAR guidelines for efficiency.



The International ENERGY STAR® Office Equipment Program is a global program that promotes energy saving through the use of computer and other office equipment.

The program backs the development and dissemination of products with functions that effectively reduce energy consumption. It is an open system in which business can participate voluntarily. The targeted products are office equipment such as computers, monitors, printers, faxes and copiers.

Their standards and logos are uniform among participating nations.

Power Requirements

Never use a power supply voltage other than that supplied in the country of purchase. Using the incorrect voltage could cause a fire or electric shock. The correct power supply voltages and frequencies are as follows:

AC 100-240 V, 50/60 Hz

Introduction

This *Quick Start Guide* uses the following symbols to indicate important information. Always observe the instructions indicated by these symbols.

Warning

Instructions that, if ignored, could result in death or serious personal injury caused by incorrect operation of the equipment. These must be observed for safe operation.

Caution

Instructions that, if ignored, could result in personal injury or material damage caused by incorrect operation of the equipment. These must be observed for safe operation.

Also read the Safety Precautions in the *User's Guide*. Observe the warnings and cautions to avoid personal injury or damage to the printer.

The diagrams and computer screens in this guide refer to the iP2200. The operations are exactly the same with the iP1600/iP1200, unless otherwise described.

Trademark Notices

- Windows is a trademark of Microsoft Corporation, registered in the United States and other countries.
- Macintosh and Mac are trademarks of Apple Computer, Inc., registered in the U.S. and other countries.
- All other product and brand names are trademarks of their respective owners.

Copyright ©2005 CANON INC.

All rights reserved. No part of this publication may be transmitted or copied in any form whatsoever without expressed written permission from Canon Inc.

Preparing the Printer

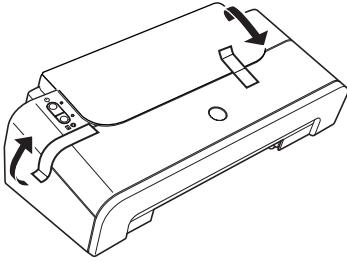

- 1 Place the printer on a flat surface.
- 2 Remove the tapes from the printer as shown.

The tape position is subject to change.

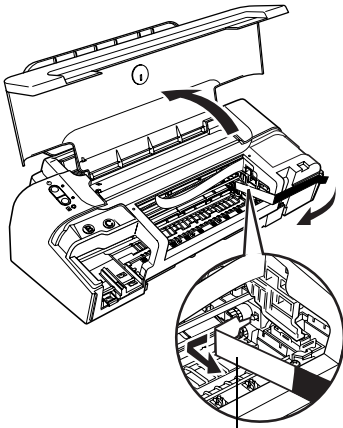

Protective Material

- 3 Open the Paper Support and the Front Cover.
- 4 Remove the Protective Material on the right side.
- 5 Close the Front Cover.

Installing the FINE Cartridges

⚠ Warning

- Never attempt to plug the power cord into the power outlet or unplug the power cord when your hands are wet.
- Never damage, modify, stretch, or excessively bend or twist the power cord. Do not place heavy objects on the power cord.
- Never use any power supply other than the standard power supply available in the country of purchase. Using the incorrect voltage and frequency could cause a fire or electric shock.
- Always push the plug all the way into the power outlet.

→ Notes

• When you use the iP2200 or iP1600

Be sure to use the iP2200 or iP1600 with both Black and Color FINE Cartridges (PG-40, CL-41). Otherwise, the printer cannot print. When either of ink runs out while printing, you can select either Color or Black ink as a printer driver setting. However you must use the printer with both Black and Color FINE Cartridges loaded regardless of the printer driver setting.

• When you use the iP1200

The iP1200 is a model that can print only with a Color FINE Cartridge (CL-41).

By installing an optionally available Black FINE Cartridge (PG-40), the iP1200 can print using both Black and Color inks just like the iP2200 and iP1600.

⚠ Caution

- For safety reasons, store FINE Cartridges out of the reach of small children.
- Do not drop or shake FINE Cartridge as this may cause the ink to leak out and stain your clothes and hands.

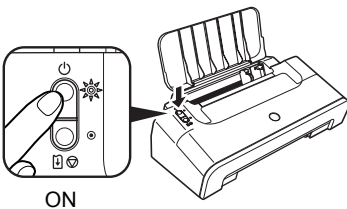

- 1 Plug the printer in.
- 2 Turn on the printer. Do NOT turn on the computer yet.

The **POWER** lamp flashes and the printer begins to operate. Wait until the **POWER** lamp remains fully lit.

- 3 Open the Front Cover.

The FINE Cartridge Holder moves to the left.

- 4 Take out the Color FINE Cartridge from its casing.

To the FINE Cartridge Holder

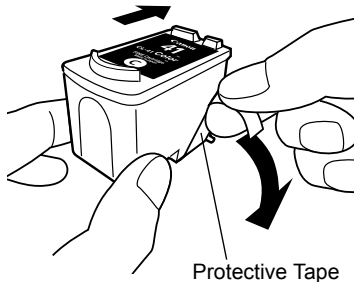

5 Remove the Protective Tape gently.

→ Notes

- Do not touch the electrical contacts or Print Head Nozzles on a FINE Cartridge.
- Handle the removed Protective Tape carefully to avoid getting your hands dirty or staining surrounding work area.
- Do not attempt to reattach the Protective Tape once you have removed it.

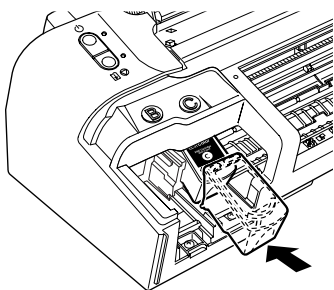
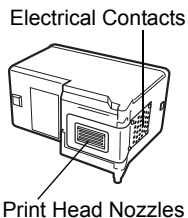

6 Insert the Color FINE Cartridge slightly slanted into the right slot (C).

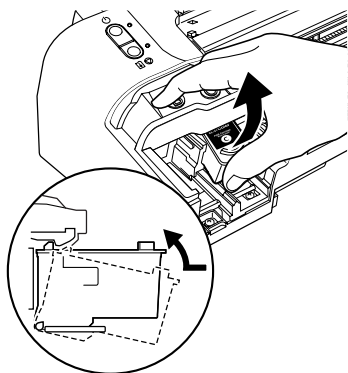

7 Push up the cartridge until it clicks into place.

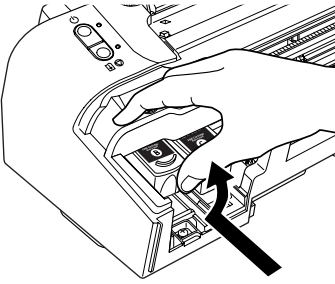

- 8 Use the same procedure to install the Black FINE Cartridge.

The Black FINE Cartridge should be installed into the left slot (B).

- 9 Close the Front Cover.

↳ **Note**

Wait until the preparatory operation is complete; it takes about one to two minutes.

Installing the Printer Driver

Installing the Printer Driver – Windows®

→ Notes

- Before installing the driver, disable all anti-virus programs and automatically loading programs.
- The screens shown in this guide are for a computer running on Windows XP with Service Pack 2 installed (hereafter called Windows XP SP2). Screens may differ depending on the operating system you are using.
- When installing the printer driver in Windows XP or Windows 2000, log on to the system as a member of the **Administrators** group.
- Do not switch users during the installation process.

If the following screen appears automatically, click **Cancel** to quit the screen and turn off the printer. Next, remove the USB cable connected to your computer. Then proceed from step 3 to install the printer driver.

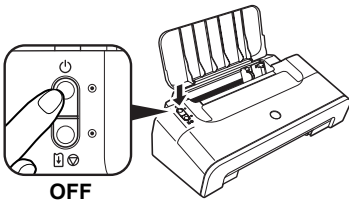

- 1 Ensure that the printer is turned off.
- 2 Turn on the computer and start Windows. If any applications automatically run, quit them.
Do NOT turn the printer on at this stage.

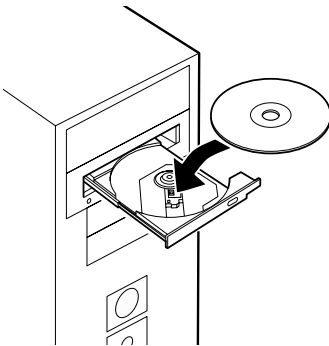

- 3 Place the *Setup Software & User's Guide CD-ROM* in the CD-ROM drive.

→ Notes

- If the **Select Language** screen appears, select a language, then click **Next**.
- If the **Select Your Place of Residence** screen appears, select your place of residence, then click **Next**.



4 Follow the instructions displayed on the screen. When the screen shown on the left is displayed, click **Easy Install**.

→ **Notes**

- When you select **Easy Install**, the items included in the CD-ROM are installed automatically. To select only particular items to be installed, click **Custom Install** and follow the instructions on the screen.
- To install **PhotoRecord**, click **Custom Install** and follow the instructions on the screen.

5 When the list of applications to install appears, verify the contents, click **Install**, and then follow the instructions on the screen.

Move the cursor over items to display explanations of each application below.

6 Read the **License Agreement** and click **Yes**.

7 When the screen shown on the left appears, connect the printer to the computer with the USB cable.

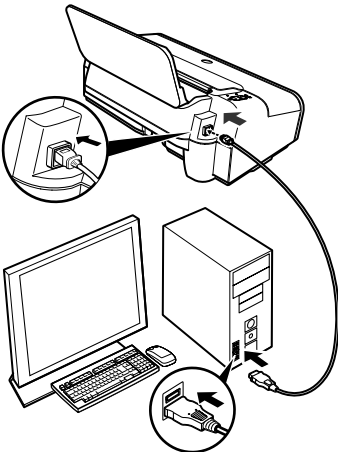
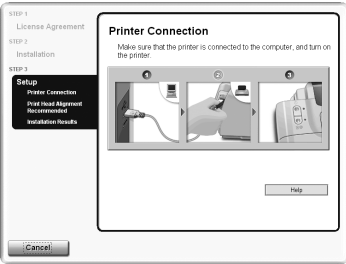

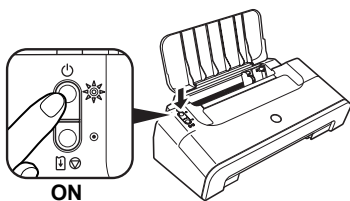

8 Turn the printer on.

If the printer is recognized, the printer driver will be automatically installed.

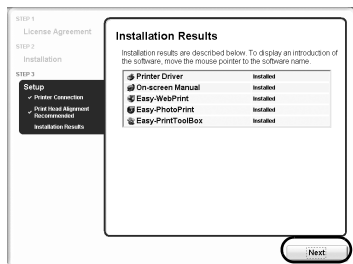

9 Click Next.

When the **Print Head Alignment Recommended** screen appears, click **Next**.



10 When the screen shown on the left appears, click **Exit**.

If the screen shows a check box for restarting your system, you can restart the system instead of just exiting the program. To restart the system, ensure that the check box is selected, and then click **Restart**.

If ruled lines are displaced or the print result is unsatisfactory, align the Print Head.

Refer to “Aligning the Print Head” in the *User's Guide*.

→ Notes

- To view the On-screen Manual, double-click the **iPXXXX On-screen Manual** shortcut icon on the desktop, or click **Start** and select **All Programs** (or **Programs**), **Canon iPXXXX Manual** and **iPXXXX On-screen Manual** (XXXX represents 2200, 1600, or 1200).
- Microsoft Internet Explorer 5.0 or later must be installed to view the On-screen Manuals.

Installing the Printer Driver - Macintosh®

→ Notes

- Do not remove or insert the USB cable during installation, as this may result in the computer or printer not operating normally.
- Before installing the driver, disable all anti-virus programs and automatically loading programs.

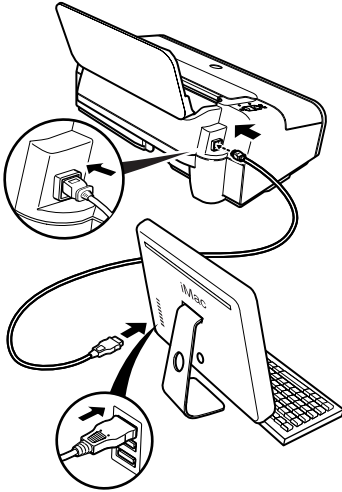

- 1 Ensure that the printer is connected to the computer.
- 2 Turn on the Mac.
- 3 Place the *Setup Software & User's Guide CD-ROM* in the CD-ROM drive.

→ Note

If the CD-ROM does not run automatically, double-click the **CD-ROM** icon on the desktop.

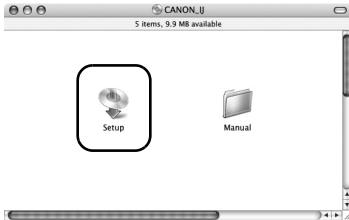

- 4 Double-click the **Setup** icon.
- 5 When the **Authenticate** screen appears, enter your administrator name and password, then click **OK**.

→ Notes

- If you do not know your administrator name or password, click **?** on the screen, then follow the on-screen instructions.
- If the **Select Language** screen appears, select a language, then click **Next**.
- If the **Select Your Place of Residence** screen appears, select your place of residence and then click **Next**.

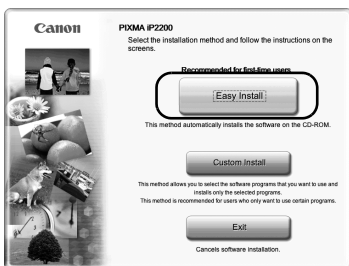

- 6 Follow the instructions displayed on the screen. When the screen shown on the left is displayed, click **Easy Install**.

➔ **Notes**

When you select **Easy Install**, all the items included in the CD-ROM are installed automatically.

To select only particular items to be installed, click **Custom Install** and follow the instructions on the screen.

- 7 When the list of applications to install appears, verify the contents, click **Install** and then follow the instructions on the screen.

Move the cursor over items to display explanations of each application below.

- 8 Read the **License Agreement** and click **Yes**.

➔ **Note**

Some screen appears after clicking **Yes**. Read the content shown on the screens and click **Next**.

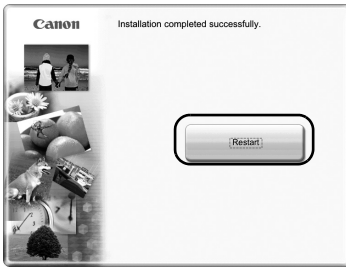

9 When the screen shown on the left appears, click **Restart**.

After restarting the computer, check that the printer name you want to use is shown in **Printer List**. If the printer name is not displayed, press **Add** to add the printer.

For details, refer to the Printer Setup Utility Help in the Mac Help.

If straight lines are misaligned or the print result is unsatisfactory, align the Print Head.

Refer to “Aligning the Print Head” in the *User's Guide*.

➔ **Notes**

- To view the On-screen Manual, double-click the **iPXXXX On-screen Manual** alias on the desktop (XXXX represents 2200, 1600, or 1200).
 - To install the *User's Guide* in other language than the installed one, double-click the **Manual** folder in *Setup Software & User's Guide CD-ROM*, **Canon** folder, and then copy a language folder to your hard disk.
-

Basic Operations

Adjusting the print settings according to your needs allows you to produce better quality prints.

⚠ Caution

- If you detect smoke, unusual smells or strange noises around the printer, immediately turn the printer off and always unplug the printer. Contact your local Canon service representative.
- To avoid injury, never put your hand or fingers inside the printer while it is printing.

Printing with Windows

- 1 From your application's **File** menu, select **Print**.
- 2 Ensure that your printer is selected, then click:
 - Windows XP → **Preferences**
 - Windows Me/Windows 98 → **Properties**
 - Windows 2000 → **Main** tab
- 3 Specify the required settings and click **OK**.

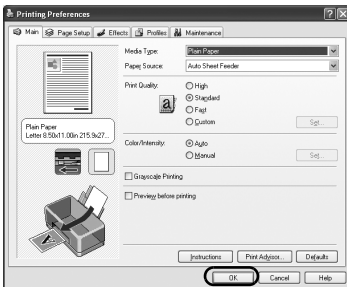

➔ Note

- For details about the printer driver, refer to the *Printer Driver Guide*.
- Click **Instructions** to view the *Printer Driver Guide*. If the On-screen Manual is not installed, **Instructions** is not displayed.

- 4 To start printing, click **Print**.

Printing will start in a few moments.

Printing with Macintosh

- 1 From your application's **File** menu, select **Page Setup**.
- 2 Select your printer model in **Format for**.
- 3 Select the paper size to be used.
- 4 Specify the page setup, then click **OK**.

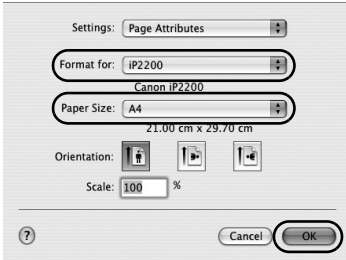

- 5 From your application's **File** menu, select **Print**.
- 6 Ensure that your printer model is selected, then select **Quality & Media** from the pop-up menu.
- 7 Specify the print settings according to your requirements.

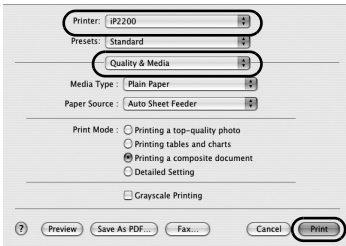

➔ Notes

- For details about the printer driver, refer to the *Printer Driver Guide*.
- Click **?** to view the *Printer Driver Guide*. If the On-screen Manual is not installed, the *Printer Driver Guide* is not displayed even if **?** is clicked.

- 8 Click **Print**.

Printing will start in a few moments.

Replacing a FINE Cartridge

When the printer runs out of ink, replace the empty FINE Cartridge with a new one. Specify the following FINE Cartridges when purchasing.

Black: PG-40



Color: CL-41



For iP2200, the FINE Cartridges PG-50 Black (High Yield) and CL-51 Color (High Yield) can be installed as an option.

→ Notes

- **When you use the iP2200 or iP1600**

Be sure to use the iP2200 or iP1600 with both Black and Color FINE Cartridges (PG-40, CL-41). Otherwise, the printer cannot print. When either of ink runs out while printing, you can select either Color or Black ink as a printer driver setting. However you must use the printer with both Black and Color FINE Cartridges loaded regardless of the printer driver setting.

- **When you use the iP1200**

The iP1200 is a model that can print only with a Color FINE Cartridge (CL-41).

By installing an optionally available Black FINE Cartridge (PG-40), the iP1200 can print using both Black and Color inks just like the iP2200 and iP1600.

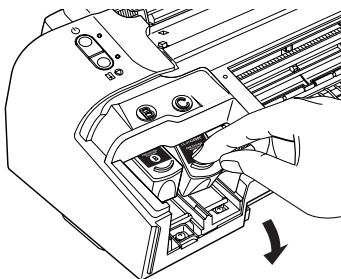

- 1 Open the Front Cover and remove the empty FINE Cartridge.

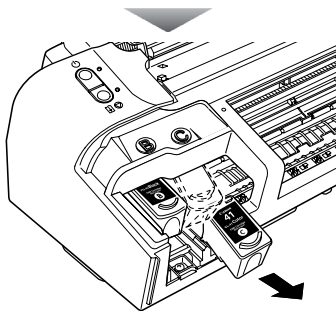

Hereafter, follow the steps from step 4 in page 3 to install the new FINE Cartridge.