



ENGLISH

ESPAÑOL

Canon

PIXMA MX470 series

# Getting Started Guía de inicio

Video Tutorials Available  
Se dispone de tutoriales en vídeo

[www.usa.canon.com/FAQVideo](http://www.usa.canon.com/FAQVideo)

## 1

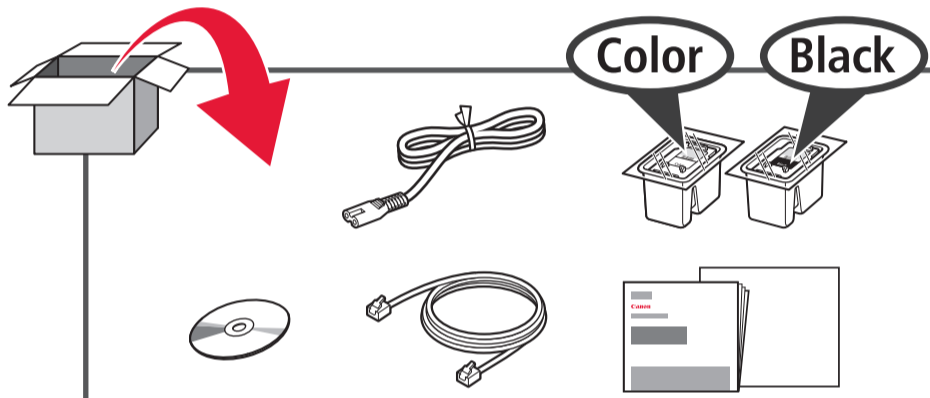

## 2

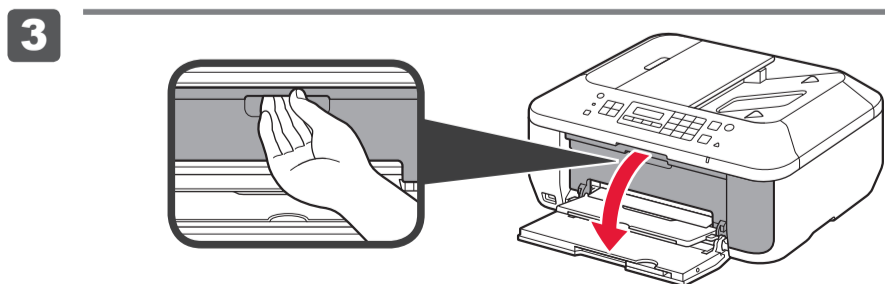
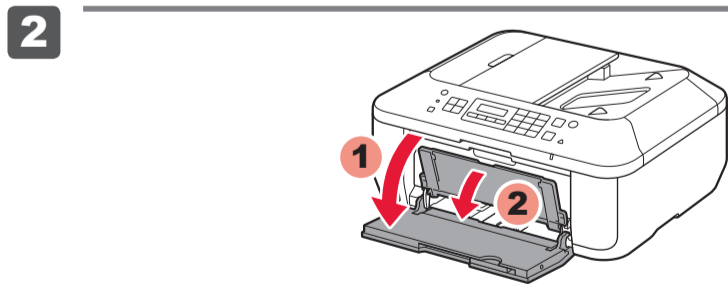
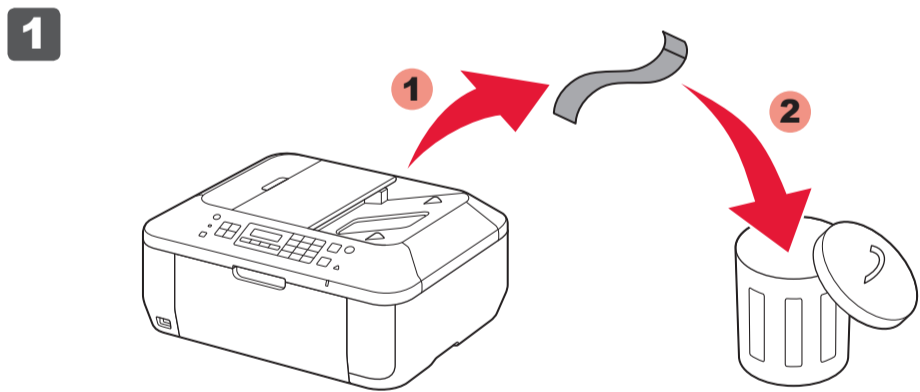

## 4

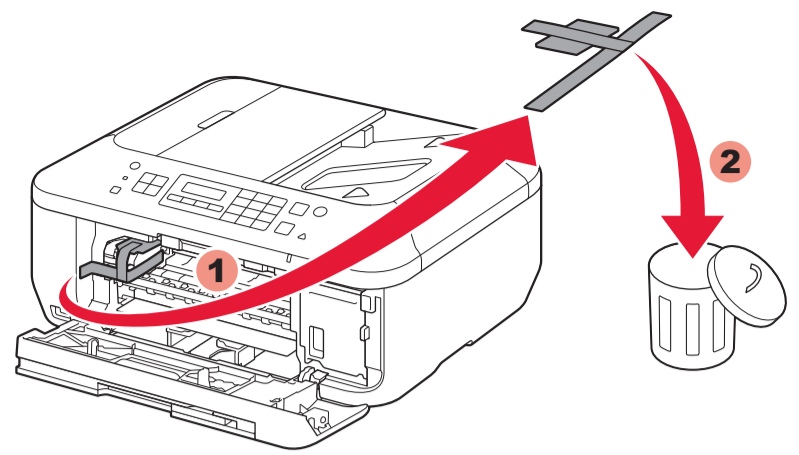

## 5

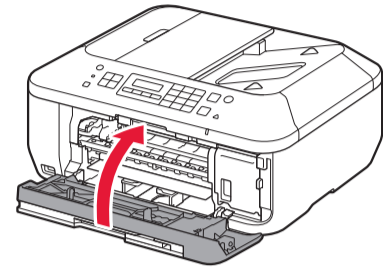

## 3

### 1

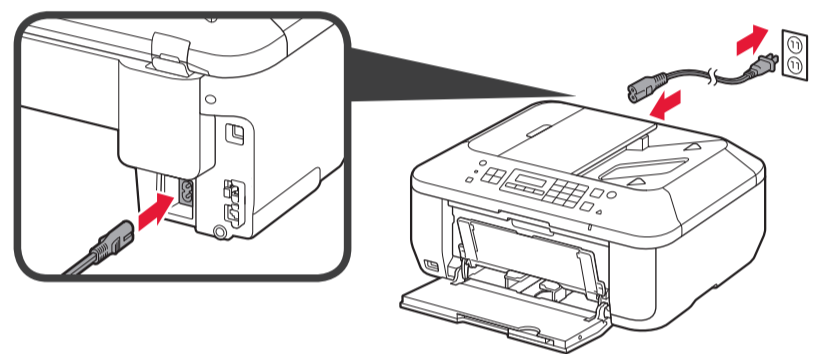

EN Do not connect the USB cable yet.

ES No conecte aún el cable USB.

### 2

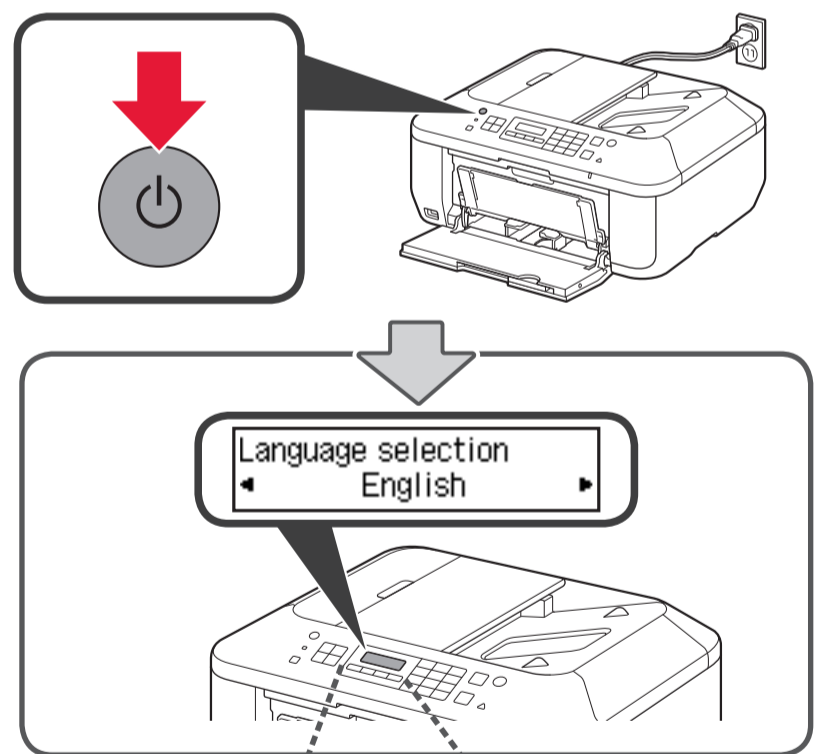

### 3

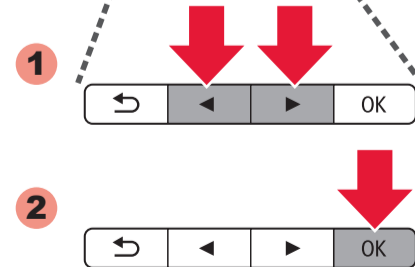

Set ink cartridge

# 4

1

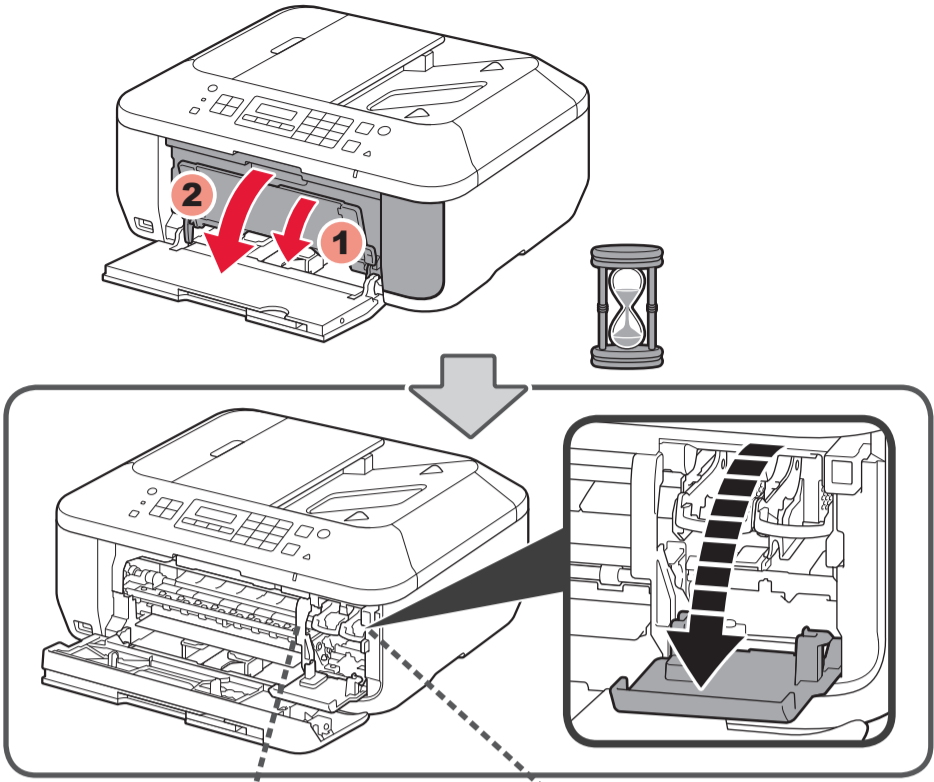

2

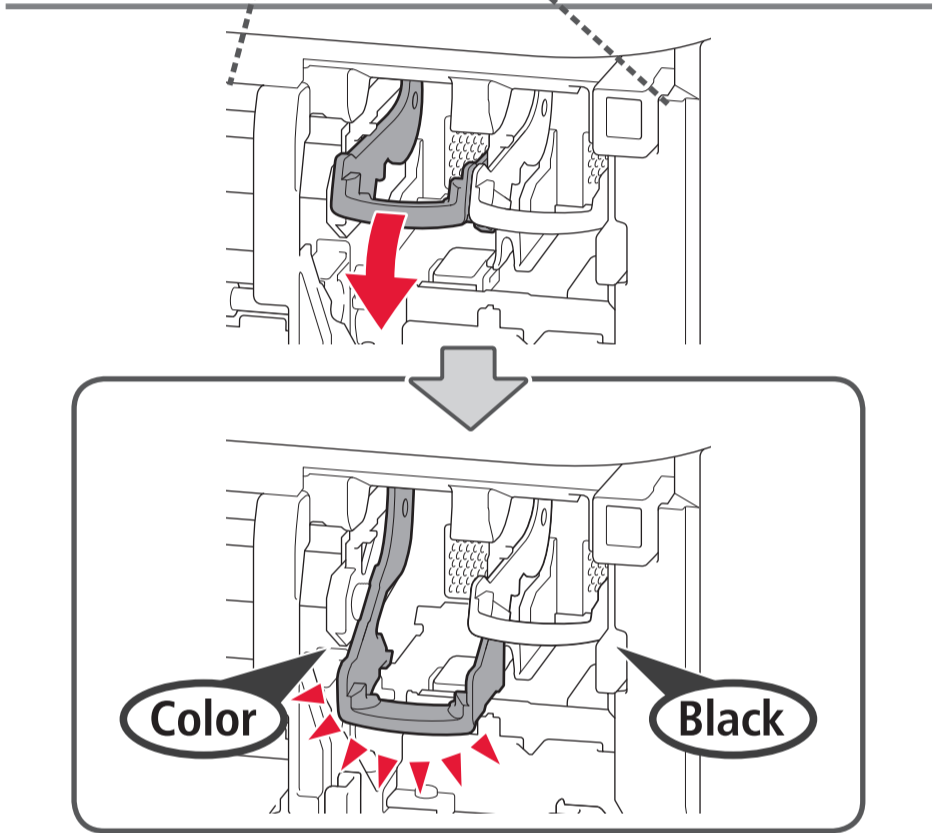

3

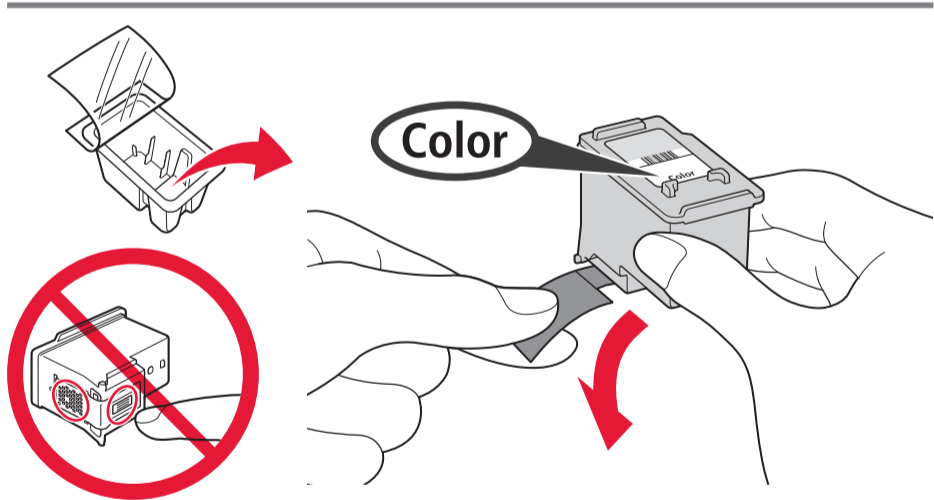

**EN** Be careful of ink on the protective tape.

**ES** Tenga cuidado con la tinta de la cinta protectora.

4

**EN** Insert the FINE Cartridge until it stops.  
**ES** Inserte el cartucho FINE (FINE Cartridge) hasta que se detenga.

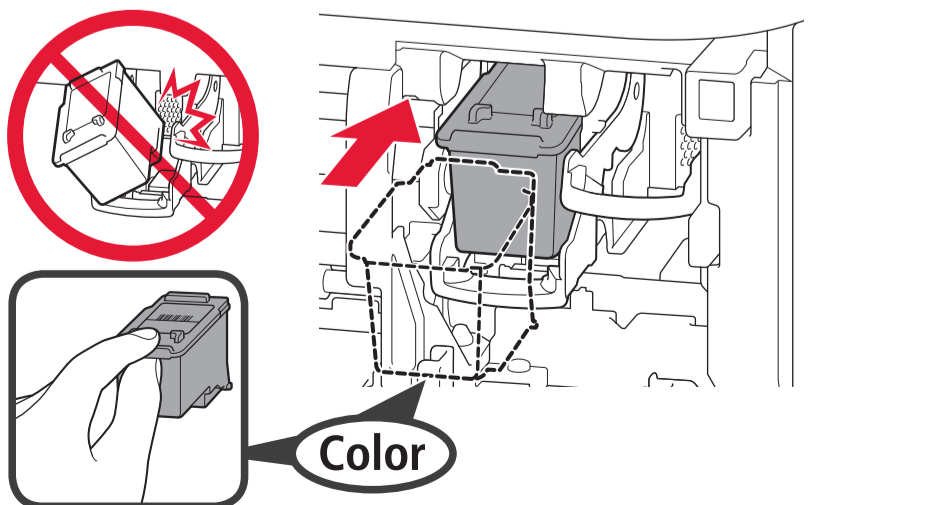

5

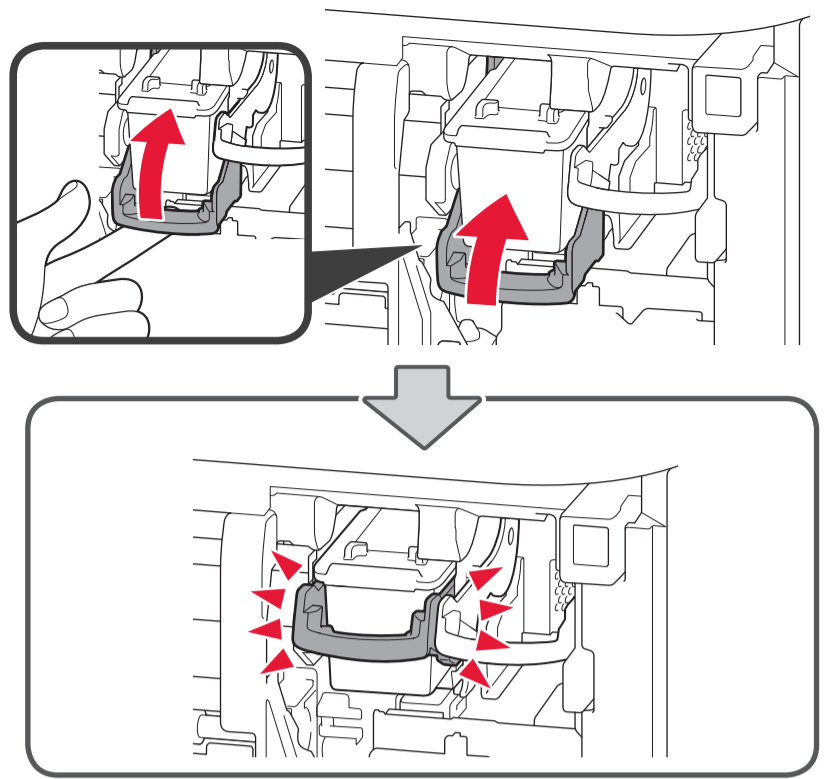

6

**EN** Install the other FINE Cartridge in the same way.  
**ES** Instale el otro cartucho FINE (FINE Cartridge) de la misma forma.

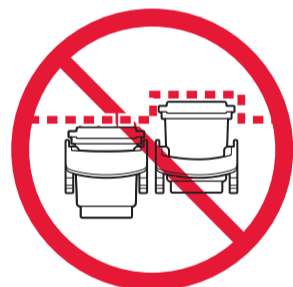
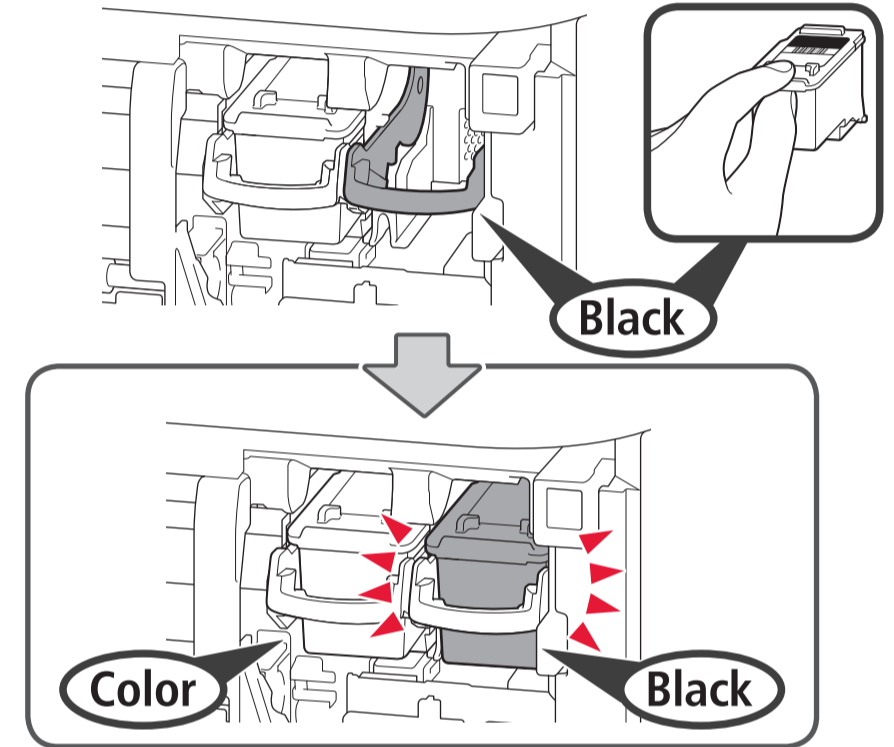

7

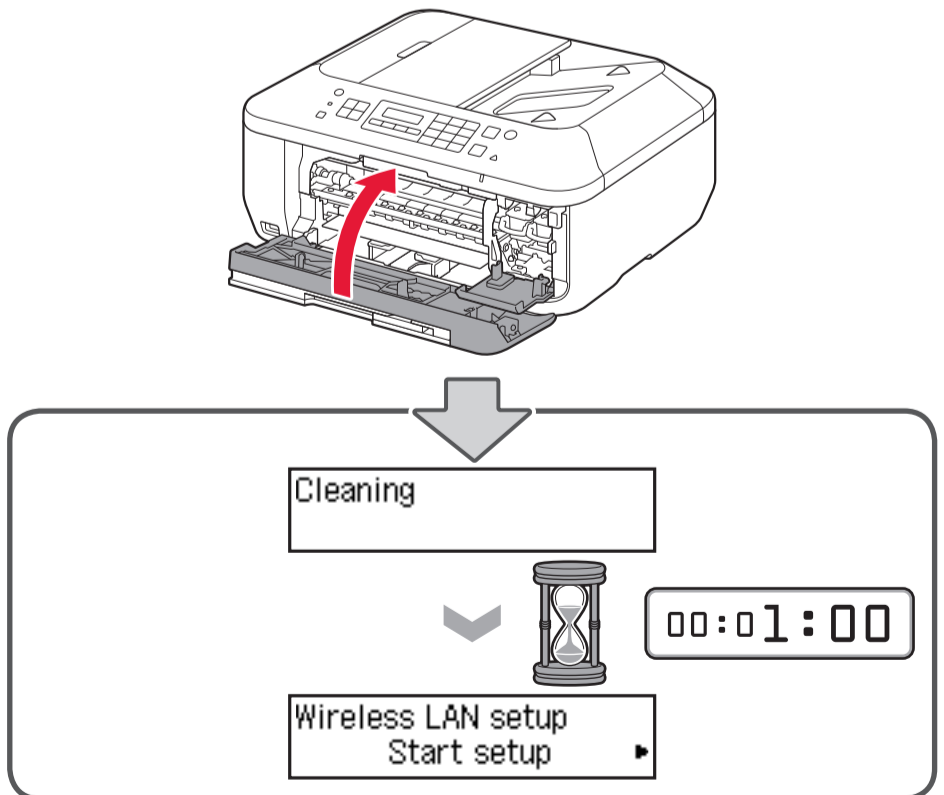

**EN** If an error message appears, check that the FINE Cartridges are installed correctly.

**ES** Si aparece un mensaje de error, compruebe que los cartuchos FINE (FINE Cartridges) están instalados correctamente.



# 5

Wireless LAN setup  
Start setup ▶

**EN** If you are using a WPS-compatible access point, select **Start setup** on the screen to connect to wireless LAN, then follow the on-screen instruction.  
If you choose other settings or have difficulty with the procedure, select **Cancel for now**, then proceed to **6**.

\* In **7**, you can follow the instruction on the computer screen to connect to wireless LAN or other kind of network.

**ES** Si utiliza un punto de acceso compatible con WPS, seleccione **Iniciar config. (Start setup)** en la pantalla para conectarse a la LAN inalámbrica y, a continuación siga las instrucciones en pantalla.  
Si elige otra configuración o tiene alguna dificultad con el procedimiento, seleccione **Cancelar por ahora (Cancel for now)** y continúe con **6**.

\* En **7**, puede seguir las instrucciones de la pantalla del ordenador para conectarse a la LAN inalámbrica o a otro tipo de red.

# 4

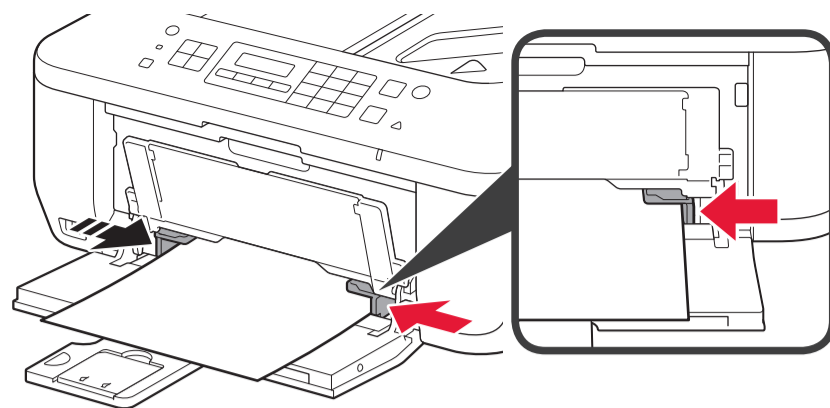

**EN** Do not press the Paper Guide too tightly against the edge of the paper. It can cause paper jams.

**ES** No presione la guía del papel demasiado contra el borde del papel. Puede ocasionar atascos de papel.

# 5

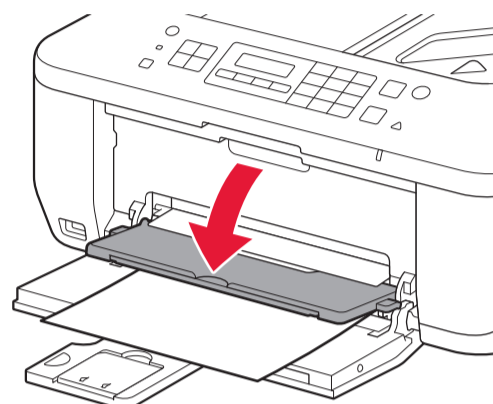

**EN** Printing without opening the Paper Output Tray causes an error.

**ES** Si imprime sin abrir la bandeja de salida del papel, provocará un error.

# 6

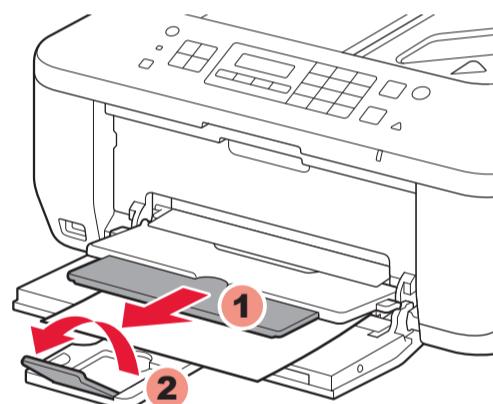

# 6

## 1

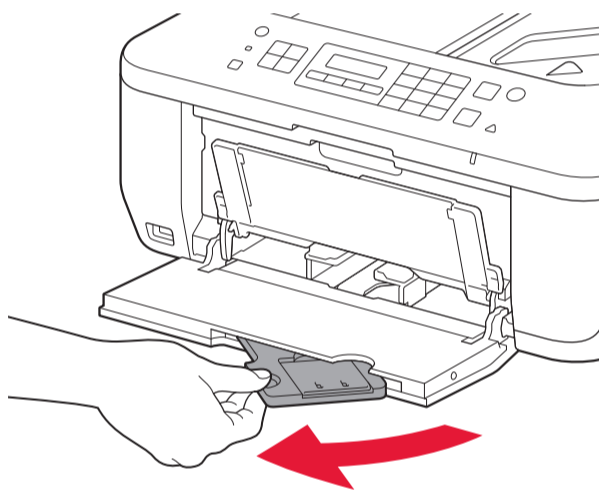

## 2

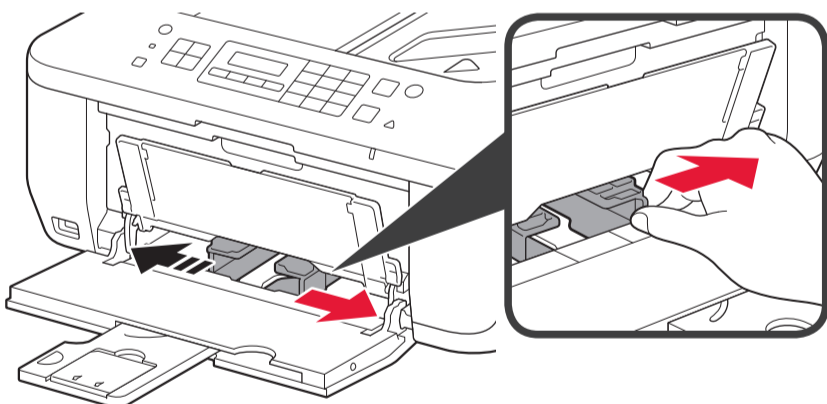

## 3

**EN** Load paper with the print side facing down.  
Letter size paper is also available.

**ES** Cargue papel con el lado de impresión hacia abajo.  
Se dispone también de papel tamaño Carta.

**A4**

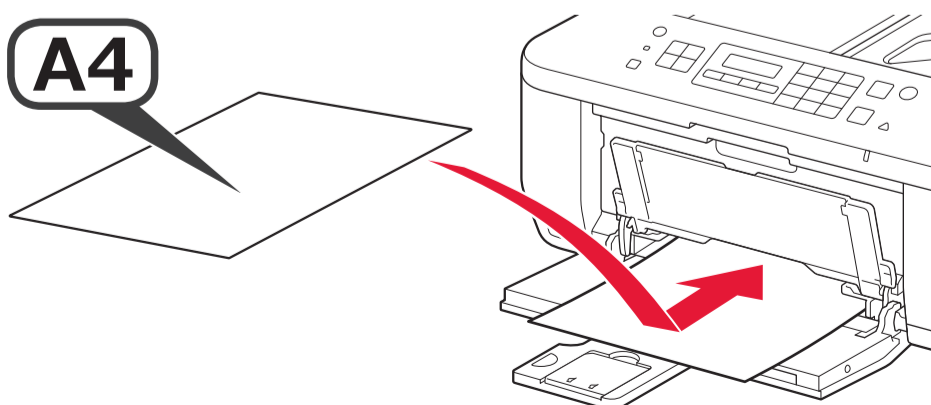

# 7

**EN** Install the software on your devices.

**ES** Instale el software en sus dispositivos.

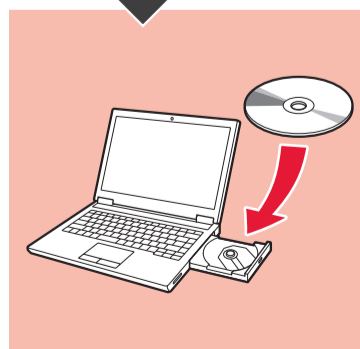
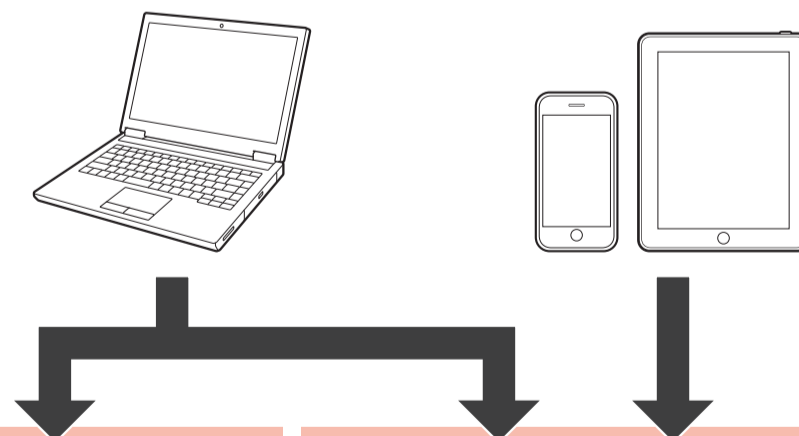

[canon.com/ijsetup](http://canon.com/ijsetup)



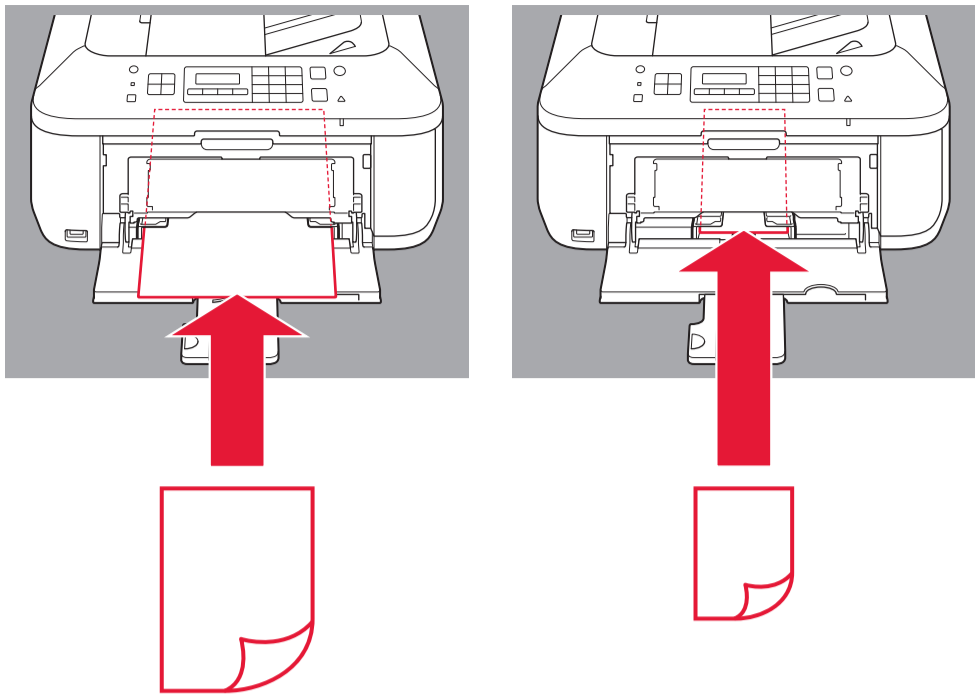

**EN** Insert paper until it stops. When using photo paper, machine settings for media type and size should be adjusted. For details, refer to the **On-screen Manual** or **Online Manual**.

**ES** Inserte el papel hasta que se detenga. Cuando use papel fotográfico, deberá ajustar la configuración del equipo al tipo y al tamaño del soporte. Para obtener más detalles, consulte el **Manual en pantalla** o el **Manual en línea**.

## Manuals Manuales

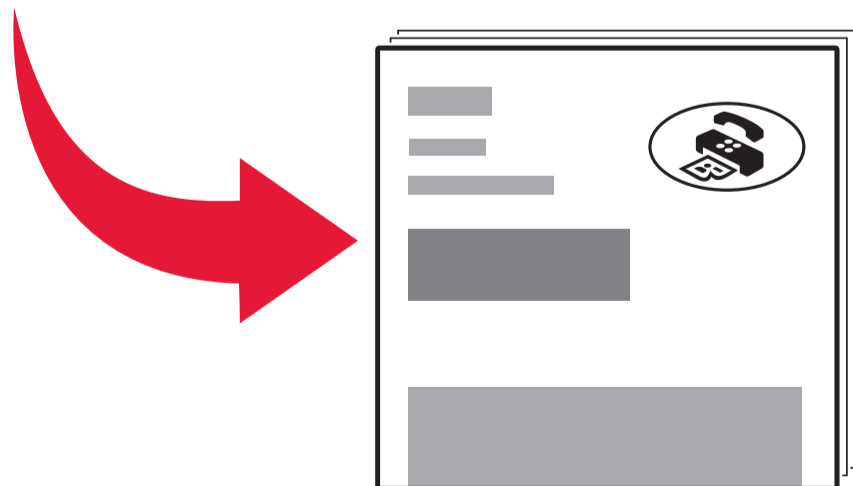
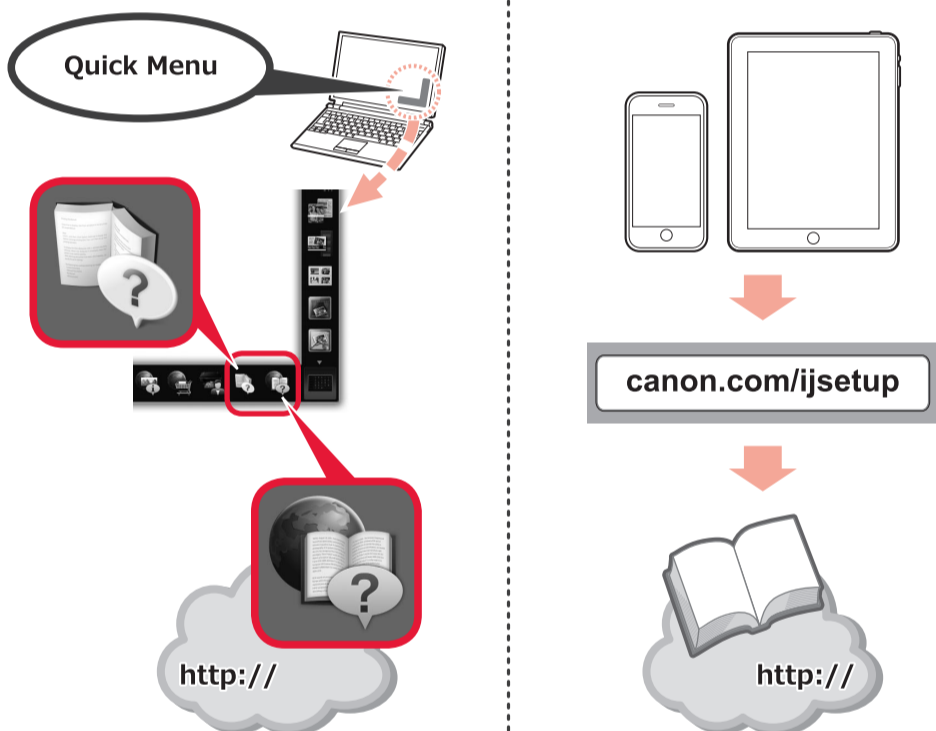

**EN** You can setup the fax features of the machine now or later. For the setup instructions, refer to **Setting Up the FAX**.

**ES** Puede configurar las funciones de fax del equipo ahora o más tarde. Para obtener instrucciones de configuración, consulte **Configuración del FAX**.