

ENGLISH



Canon DIGITAL CAMERA PowerShot G7 Advanced Camera User Guide

Canon PowerShot G7

DIGITAL CAMERA



Before Using the Camera

Shooting

Using the Mode Dial

Advanced Shooting Functions

Playback/Erasing

Print/Transfer Settings

Customizing the Camera

Troubleshooting

List of Messages

Appendix

Advanced

Camera User Guide

This guide explains camera features and procedures in detail.

Canon



Main Features

Shooting

- 6x optical zoom with shift-method image stabilizer
- Controlling camera shake or blurry subjects while shooting using a high ISO speed set with the dedicated ISO Speed Dial
- Face priority AF that detects faces in a scene
- Automatically adjusts shooting settings to match particular conditions
- Use the separately sold wide converter, tele-converter, or an externally mounted flash for EOS cameras when shooting



Playback

- Organizes Images by category
- Auto plays slideshows

Editing

- Adds effects to still images with My Colors
- Records sound memos for still images
- Edits movies
- Records sound only (sound recorder)

Printing

- Makes printing easy with the Print/Share button
- Also supports non-Canon brand *PictBridge* compliant printers

Uses of Recorded Images

- Effortlessly transfer them to a computer with the Print/Share button
- Freely customize the start-up image or start-up sound using the My Camera settings

Conventions Used in this Guide

Icons appearing below titles indicate the shooting modes in which the procedure can be used.

Mode: Shooting (📷) / Playback (▶)

Checking for Focus Right After Shooting

Shooting Mode

AUTO SCN   P Tv Av M 

* Unavailable shooting modes are shown grayed out.

See *Functions Available in Each Shooting Mode* (p. 168).

- In this guide, the *Basic Camera User Guide* is referred to as the *Basic Guide*, and the *Advanced Camera User Guide* is referred to as the *Advanced Guide*.



This mark denotes issues that may affect the camera's operation.



This mark denotes additional topics that complement the basic operating procedures.

You can use SD memory cards, SDHC memory cards and MultiMediaCards with this camera. These cards are collectively called memory cards in this guide.



Use of genuine Canon accessories is recommended.

This product is designed to achieve excellent performance when used with genuine Canon accessories. Canon shall not be liable for any damage to this product and/or accidents such as fire, etc., caused by the malfunction of non-genuine Canon accessories (e.g., a leakage and/or explosion of a battery pack). Please note that this warranty does not apply to repairs arising out of the malfunction of non-genuine Canon accessories, although you may request such repairs on a chargeable basis.





Table of Contents

Items marked with a ★ are lists or charts that summarize camera functions or procedures



Handling Precautions	5
Please Read	5
Safety Precautions	6
Preventing Malfunctions	11
Before Using the Camera – Basic Operations	12
Using the LCD Monitor	12
LCD Monitor Brightness	14
Customizing Display Information	15
Information Displayed on the LCD Monitor	18
Power Saving Function	21
Setting the World Clock	22
★ Menus and Settings	24
★ Menu List	26
Resetting Settings to Their Default Values.	32
Formatting Memory Cards	33
Shooting	34
Changing the Recording Pixels and Compression (Still Images)	34
Setting the Image Stabilizer Function.	35
Using the Digital Zoom/Digital Tele-converter	36
Adjusting the ISO Speed	38
Switching between Metering Modes.	39
☑ Adjusting the Exposure Compensation	41
Adjusting the Tone (White Balance).	42
Continuous Shooting	44
Checking for Focus Right After Shooting	46
Using the Mode Dial	48
P Program AE	48
Tv Setting the Shutter Speed	48
Av Setting the Aperture	50
M Manually Setting the Shutter Speed and Aperture	51

 Shooting Panoramic Images (Stitch Assist)	52
 Movie Shooting	54
Setting the Recording Function	58
C Saving Custom Settings	59

Advanced Shooting Functions 60

Switching between Focus Settings	60
 Selecting an AF Frame	61
Shooting Hard-to-Focus Subjects (Focus Lock, AF Lock, Manual Focus, Using the Manual Focus in Combination with the Auto Focus)	63
Focus Bracketing (Focus-BKT Mode)	67
 Locking the Exposure Setting (AE Lock)	68
 Locking the Flash Exposure Setting (FE Lock)	69
Auto Exposure Bracketing (AEB Mode)	70
Using the ND Filter	71
Switching between Flash Adjustment Settings	72
Compensating the Flash Adjustment / Flash Output	73
Switching the Timing at which the Flash Fires	74
Shooting in a My Colors Mode	75
Changing the Color	77
 Registering Settings to the Shortcut Button	82
Setting the Auto Rotate Function	84
Creating an Image Destination (Folder)	85
Resetting the File Number	87

Playback/Erasing 89

 Magnifying Images	89
 Viewing Images in Sets of Nine (Index Playback)	90
Organizing Images by Category	91
 Jumping to Images	92
Viewing Movies	94
Editing Movies	95
Rotating Images in the Display	97
Playback with Transition Effects	98
Adding My Colors Effects	98
Attaching Sound Memos to Images	101
Sound-Only Recording (Sound Recorder)	102
Automated Playback (Slide Shows)	103

Protecting Images	107
Erasing Images	109
Print Settings/Transfer Settings	111
Setting the DPOF Print Settings.	111
Setting the DPOF Transfer Settings.	115
Customizing the Camera (My Camera Settings)	117
Changing My Camera Settings	117
Registering My Camera Settings	118
Troubleshooting	120
Camera.	120
When the power is turned on	120
LCD monitor	121
Shooting	122
Shooting Movies.	126
Playback.	127
Battery/Battery Charger	128
TV monitor output.	128
Printing with a direct print compatible printer	128
List of Messages	129
Appendix	133
Viewing Images on a TV set.	133
Battery Handling.	134
Handling the Memory Card	136
Using the Power Kits (Sold Separately).	138
Using the Lenses (Sold Separately).	140
Using an Externally Mounted Flash (Sold Separately).	144
Camera Care and Maintenance	149
Specifications	150
Index.	162
Functions Available in Each Shooting Mode	168

Handling Precautions

Please Read

Test Shots

Before you try to photograph important subjects, we highly recommend that you shoot several trial images to confirm that the camera is operating and being operated correctly.

Please note that Canon Inc., its subsidiaries and affiliates, and its distributors are not liable for any consequential damages arising from any malfunction of a camera or accessory, including memory cards, that results in the failure of an image to be recorded or to be recorded in a way that is machine readable.

Warning Against Copyright Infringement

Please note that Canon digital cameras are intended for personal use and should never be used in a manner that infringes upon or contravenes international or domestic copyright laws and regulations. Please be advised that in certain cases the copying of images from performances, exhibitions, or commercial properties by means of a camera or other device may contravene copyright or other legal rights even if the image was shot for personal use.

Warranty Limitations

This camera's warranty is only effective in the country of sale. If a problem arises while the camera is in use abroad, please convey it back to the country of sale before proceeding with a warranty claim to a Canon Customer Support Help Desk.

For Canon Customer Support contacts, please see the customer support list supplied with your camera.

Camera Body Temperature

If your camera is used for prolonged periods, the camera body may become warm. Please be aware of this and take care when operating the camera for an extended period.

About the LCD Monitor

The LCD monitor is produced with extremely high-precision manufacturing techniques. More than 99.99% of the pixels operate to specification. Less than 0.01% of the pixels may occasionally misfire or appear as red or black dots. This has no effect on the recorded image and does not constitute a malfunction.

Video Format

Please set the camera's video signal format to the one used in your region before using it with a TV monitor (p. 133).

Language Setting

Please see the *Basic Guide* (p. 9) to change the language setting.

Safety Precautions

- Before using the camera, please ensure that you read the safety precautions described below and in the "Safety Precautions" section of the *Basic Camera User Guide*. Always ensure that the camera is operated correctly.
- The safety precautions noted on the following pages are intended to instruct you in the safe and correct operation of the camera and its accessories to prevent injuries or damage to yourself, other persons and equipment.
- Equipment refers to the camera, battery charger (sold separately) and car battery charger (sold separately).
- Battery refers to the battery pack.

Warnings

Equipment

- **Do not look directly into the sun or at bright light sources through the camera's viewfinder.**

Doing so can damage your eyesight.

- **Store this equipment out of the reach of children and infants. Accidental damage by a child could result in serious injury.**
 - Neck strap: Placement of the strap around the child's neck could result in asphyxiation.
 - Memory card: It may be swallowed accidentally. If this occurs, contact a doctor immediately.

- **Do not attempt to disassemble or alter any part of the equipment that is not expressly described in this guide.**
- **To avoid the risk of high-voltage electrical shock, do not touch the flash portion of the camera if it has been damaged.**
- **Stop operating the equipment immediately if it emits smoke or noxious fumes.**
- **Do not allow the equipment to come into contact with, or become immersed in, water or other liquids. If the exterior comes into contact with liquids or salt air, wipe it dry with a soft, absorbent cloth.**

Continued use of the equipment may result in fire or electrical shock. Immediately turn the camera power off and remove the camera batteries or unplug the power cord from the power outlet. Please consult your camera distributor or the closest Canon Customer Support Help Desk.

- **Do not use substances containing alcohol, benzene, thinners or other flammable substances to clean or maintain the equipment.**
- **Do not cut, damage, alter or place heavy items on the power cord.**
- **Use only recommended power accessories.**
- **Remove the power cord on a regular periodic basis and wipe away the dust and dirt that collects on the plug, the exterior of the power outlet and the surrounding area.**
- **Do not handle the power cord if your hands are wet.**

Continued use of the equipment may result in fire or electrical shock.

Battery

- Do not place the batteries near a heat source or expose it to direct flame or heat.
- The batteries should not be immersed in water or sea water.
- Do not attempt to disassemble, alter or apply heat to the batteries.
- Avoid dropping or subjecting the batteries to severe impacts that could damage the casing.
- Use only recommended batteries and accessories.

Use of batteries not expressly recommended for this equipment may cause explosions or leaks, resulting in fire, injury and damage to the surroundings. In the event that a battery leaks and the eyes, mouth, skin or clothing contact these substances, immediately flush with water and seek medical assistance.

- Disconnect the battery charger and compact power adapter from both the camera and the power outlet after recharging or when not in use to avoid fire and other hazards.
- Do not place anything, such as tablecloths, carpets, bedding or cushions, on top of the battery charger while it is charging.

Continued use over a long period may cause the units to overheat and distort, resulting in fire.

- When recharging the battery, use only a specified battery charger.
- The battery charger and compact power adapter are designed for exclusive use with this equipment. Do not use it with other products.

There is a risk of overheating and distortion which could result in fire or electrical shock.

- Before you discard a battery, cover the terminals with tape or other insulators to prevent direct contact with other objects.

Contact with the metallic components of other materials in waste containers may lead to fire or explosions.

Others

- **Do not trigger the flash in close proximity to human or animal eyes. Exposure to the intense light produced by the flash may damage eyesight.**

In particular, remain at least one meter (39 inches) away from infants when using the flash.

- **Keep objects that are sensitive to magnetic fields (such as credit cards) away from the speaker of the camera.**

Such items may lose data or stop working.

- **Exercise due caution when screwing on the separately sold wide converter, tele-converter, and conversion lens adapter.**

If they loosen, fall off and shatter, the glass shards may cause injury.

Cautions

Equipment

- **Be careful not to bang the camera or subject it to strong impacts or shocks that could lead to injury or damage the equipment when wearing or holding it by the strap.**

- **Do not store the equipment in humid or dusty areas.**

- **Do not allow metal objects (such as pins or keys) or dirt to contact the charger terminals or plug.**

Such conditions could lead to fire, electrical shock or other damage.

- **Avoid using, placing or storing the equipment in places subject to strong sunlight or high temperatures, such as the dashboard or trunk (boot) of a car.**

- **Do not use the equipment in a manner that exceeds the rated capacity of the electrical outlet or wiring accessories. Or, do not use the equipment if the cable or plug is damaged, or if the plug is not fully inserted into the power outlet.**

- **Do not use in locations with poor ventilation.**

The above-mentioned can cause leakage, overheating or explosion, resulting in fire, burns or other injuries. High temperatures may also cause deformation of the casing.

Equipment

- **When not using the camera for extended periods of time, remove the batteries from the camera or battery charger and store the equipment in a safe place.**

If the batteries are left inside the camera, damage caused by leakage may occur.

- **Do not connect compact power adapters or battery chargers to devices such as electrical transformers for foreign travel because it may lead to malfunctions, excessive heat generation, fire, electric shock or injury.**

Flash

- **Do not operate the flash with dirt, dust or other items stuck to the surface of the flash.**
- **Be careful not to cover the flash with your fingers or clothing when shooting.**

The flash may be damaged and emit smoke or noise. The resulting heat build-up could damage the flash.

- **Do not touch the surface of the flash after taking several pictures in rapid succession.**

Doing so could result in burns.

Preventing Malfunctions

Avoid Strong Magnetic Fields

- **Never place the camera in close proximity to electric motors or other equipment generating strong electromagnetic fields.**

Exposure to strong magnetic fields may cause malfunctions or corrupt image data.

Avoid Condensation Related Problems

- **When moving the equipment rapidly between hot and cold temperatures, you can avoid condensation by placing the equipment in an airtight, resealable plastic bag and letting it adjust to temperature changes slowly before removing it from the bag.**

Moving the equipment rapidly between hot and cold temperatures may cause condensation (water droplets) to form on its external and internal surfaces.

If Condensation Forms Inside the Camera

- **Stop using the camera immediately.**

Continued use may damage the equipment. Remove the memory card and batteries or compact power adapter from the camera and wait until the moisture evaporates completely before resuming use.

Using the LCD Monitor

1 Press .

DISPLAY

- The display mode changes as follows with each press.

Shooting Mode (📷)

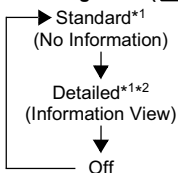

Playback Mode (▶)

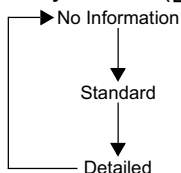

*1 Displayed information can be changed (p. 15).

*2 Shooting information, grid lines, and a histogram (**P**, **Tv**, **Av** and **M** only) are displayed with the default settings.

- When the shooting mode has been changed, the shooting information will be displayed for approximately 6 seconds, regardless of the setting for the LCD monitor.



- The LCD monitor on or off setting is retained even after the camera power is turned off.
- The LCD monitor does not shut off in the **SCN** (📷, ⚡, ⚡), **1/S**, 📺 or 🗣️ mode.
- The LCD monitor will not switch to the detailed display in the index playback mode (p. 90).

Using the Clock

You can display the current date and time for a 5-second* interval using the following two methods.

* Default setting



Method 1

Hold the **FUNC./SET** button down while turning on the power.

Method 2

In a shooting/playback mode, hold the **FUNC./SET** button down for more than one second.

- If you hold the camera horizontally, it displays the time. If you hold it vertically, the time and date display.
- You can change the display color by pressing the ◀ or ▶ button.
- The clock display will cease when the display interval is over or when a button is operated.
- The clock's display interval can be changed in the **ff** (Set up) menu (p. 29).
- The clock cannot be displayed in the index playback mode (p. 90).

LCD Monitor Brightness

LCD Monitor Brightness Settings

The brightness of the LCD monitor can be changed in the following two ways.

- Changing Settings Using the Set up Menu (p. 29)
- Changing Settings Using the **DISPLAY** Button (Quick-bright LCD Function)

You can set the LCD monitor to the brightest setting regardless of the option selected in the Set up menu by pressing the **DISPLAY** button for more than one second.*

- To restore the previous brightness setting, press the **DISPLAY** button for more than one second again.
- The next time you turn on the camera, the LCD monitor will be at the brightness setting selected in the Set up menu.

* You cannot change the brightness of the LCD monitor with this function if you have already set it to its highest setting in the Set up menu.

Night Display

When shooting in dark conditions, the camera automatically brightens the LCD monitor to suit the brightness of the subject*, making it easier to frame the subject.

* The movements of the subject will appear irregular in the LCD monitor. The recorded image will not be affected. The brightness of the image displayed in the monitor, and the brightness of the actual image recorded will be different.

Customizing Display Information



Shooting Mode

AUTO SCN *1 *2 **P Tv Av M**

*1 Only [Shooting Info] can be displayed.



*2 [3:2 Guide] cannot be displayed.

You can set the information displayed on the LCD monitor.

LCD/Viewfinder  /  / 	It is possible to set one of three display modes on the LCD monitor (Display 1/Display 2/Display Off). The 3 display modes can be switched by pressing the DISPLAY button (p. 12).
Shooting Info	Displays shooting information (p. 18).
Grid Lines	Displays grid lines to divide the screen into 9 parts. Helps confirm the vertical and horizontal positioning of the subject (p. 18).
3:2 Guide	Helps confirm the print area for a 3:2 print.* Areas outside the printable area are grayed out (p. 18). * Images are still recorded at the standard aspect ratio of 4:3
Histogram	Shooting Mode: P , Tv , Av and M only Displays histogram (p. 17).

Each press of the **DISPLAY** button changes the screen as follows (default setting):



- : No Information
- : Displays shooting information, grid lines and a histogram
- : Off

1 (Rec.) MENU ► [Custom Display].

See *Menus and Settings* (p. 25).

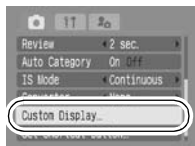

2 [LCD/Viewfinder] ► (Display 1)/ (Display 2)/ (Display Off)

- Sets LCD monitor display mode after the **DISPLAY** button is pressed.
- If you do not wish to change the display mode, use the **↑**, **↓**, **←** or **→** button and press the **FUNC./SET** button to display (//).
- You cannot add to the currently active LCD/Viewfinder icon.

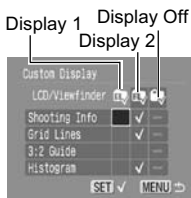

3 [Shooting Info]/[Grid Lines]/[3:2 Guide]/[Histogram].

- Using the **↑**, **↓**, **←** and **→** buttons, select the items you wish to display on the LCD monitor and press the **FUNC./SET** button to place a **✓**.
- Even though items that are grayed out can be set, they will not display in the current shooting mode.



Items with **✓** are displayed



If you press the shutter button halfway and return to the shooting screen from the custom display settings screen, the settings will not be saved.

Histogram

The histogram is a graph that allows you to check the brightness of an image. You can also display the histogram in the **P**, **Tv**, **Av** and **M** modes to check the brightness while shooting. The greater the bias toward the left in the graph, the darker the image. The greater the bias toward the right, the brighter the image. If the image is too dark, adjust the exposure compensation to a positive value. Similarly, adjust the exposure compensation to a negative value if the image is too bright (p. 41).

Sample Histograms



Dark Image



Balanced Image



Bright Image

Information Displayed on the LCD Monitor

Shooting Information (Shooting Mode)

[] * Spot AE Point Frame (p. 39)

[] * AF Frame (p. 61)

Histogram (p. 17)

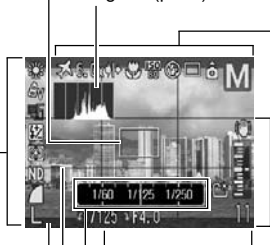

Tv Bar (p. 48)

Av Bar (p. 50)

Grid Lines (p. 15)

3 : 2 Guide (p. 15)

	White Balance (p. 42)
	My Colors (p. 75)
	Bracket (pp. 67, 70)
	Flash Exposure Compensation/ Flash Output (p. 73)
	Metering Mode (p. 39)
	ND Filter (p. 71)
	Compression (Still image) (p. 34)
	Frame Rate (Movies) (p. 57)
	Recording Pixels (pp. 34, 57)
	(Red)* Camera Shake Warning (p. 19)

●Rec* Movie Recording (p. 54)

Time Zone (p. 22)

Zoom Magnification*/

Digital Tele-Converter* (p. 36)

Macro (*Basic Guide* p. 16)

ISO Speed (p. 38)

Flash (*Basic Guide* p. 14)

Drive Mode (p. 44, *Basic Guide* p. 17)

Auto Rotate (p. 84)

Shooting Mode

(*Basic Guide* pp. 12-13)

A/S (pp. 78-81)

(p. 52)

* (p. 54)

(pp. 48-51)

* Low Battery (p. 134)

Image Stabilizer (p. 35)

Normal Exposure Index/
Exposure Level Mark (p. 51)

* Create Folder (p. 85)

MF Indicator (p. 65)

* Wind Filter* (Off) (p. 58)

• Stills: Recordable Shots

• Movies: Remaining Time/ Elapsed Time

Exposure Shift Bar (p. 57)

* AE Lock (p. 68)/

FE Lock (p. 69)

Shutter Speed* (p. 48)

Aperture Value* (p. 50)

-2 ... +2* Exposure

Compensation (p. 41)

* / * AF Lock (p. 64)/

* Manual Focus (p. 65)



If the indicator blinks orange and the camera shake warning icon () displays, this indicates that a slow shutter speed may have been selected due to insufficient illumination. Use the following methods to shoot:

- Set the IS mode to any setting other than [Off] (p. 35)
- Raise the ISO speed (p. 38)
- Select a setting other than  (flash off)
- Attach the camera to a tripod or other device

Playback Information (Playback Mode)

■ Standard

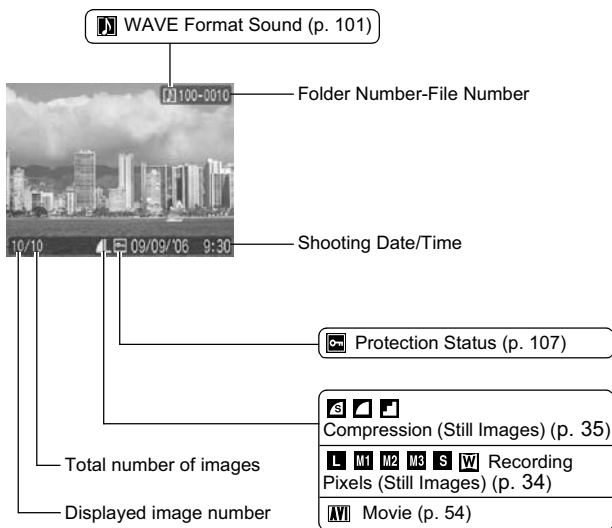

■ Detailed

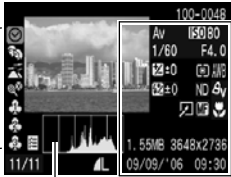

Histogram



Defined Playback (p. 92)



My Category (p. 91)

<p>Shooting Mode</p>  <p>(Basic Guide pp. 12–13)</p> <p> (p. 52) (p. 54)</p> <p> (pp. 48–51)</p>	<p> </p> <p> </p> <p>ISO Speed (p. 38)</p> <p>Aperture Value (p. 50)</p> <p> Metering Mode (p. 39)</p> <p> White Balance (p. 42)</p> <p> ND Filter (p. 71)</p> <p> My Colors (p. 75)</p> <p> My Colors (Playback) (p. 98)</p> <p> Image with a My colors effect</p> <p> AF Lock (p. 64)/Manual Focus (p. 65)</p> <p> Macro (Basic Guide p. 16)</p>
<p>Shutter Speed (p. 48)</p> <p> (p. 48)</p> <p>Recording Pixels/Frame Rate (Movies) (p. 57)</p> <p> -2 ... +2</p> <p>Exposure Compensation (p. 41)</p> <p> -2 ... +2</p> <p>Flash Exposure Compensation (p. 73)</p> <p> Flash Output (p. 73)</p>	<p>File size</p> <p>Recording Pixels (Still Image) (p. 34)</p> <p>Movie Length (Movies) (p. 54)</p>

* Appears when shooting in the color accent or color swap mode.

The following information may also be displayed with some images.

	A sound file in a format other than the WAVE format is attached or the file format is not recognized.
	JPEG image not conforming to Design rule for Camera File System Standards (p. 152)
	RAW image
	Unrecognized data type



- Information for images shot on other cameras may not display correctly.
- **Overexposure Warning**
In the following cases, overexposed portions of the image blink.
 - When reviewing an image right after shooting in the LCD monitor (information view)
 - When using the detailed display mode of the playback mode

Power Saving Function

This camera is equipped with a power saving function. The power will shut off in the following circumstances. Press the power button again to restore power.

Shooting Mode	Powers down approximately 3 minutes after the last control is accessed on the camera. The LCD monitor automatically turns off 1 minute* after the last control is accessed even if [Auto Power Down] is set to [Off]. Press any button other than the power button or change the camera orientation to turn the LCD monitor back on.
Playback Mode Connected to a Printer	Powers down approximately 5 minutes after the last control is accessed on the camera.

* This time can be changed.



- The power saving function will not activate during a slide show or while the camera is connected to a computer.
- The power saving function settings can be changed (p. 29).

Setting the World Clock

When traveling abroad, you can record images with local dates and times simply by switching the time zone setting if you pre-register the destination time zones. You can enjoy the convenience of not having to switch the Date/Time settings.

Setting the Home/World Time Zones

1 (Set up) Menu ► [Time Zone] ► .

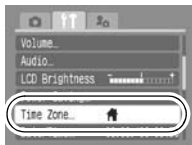

See Menus and Settings (p. 25).



2 (Home) ► .



3 Use the or button to select a home time zone ► .

- You can also select an area with the control dial.
- To set the daylight saving option, use the  or  button to  display. The time will advance by 1 hour.



4 (World) ► .



5 Use the ← or → button to select a destination time zone .

- You can also select an area with the control dial.
- As in Step 3, you can set daylight saving time.

Time difference from home time zone



6 Use the ↑ or ↓ button to select [Home/World], and the ← or → button to select .

Switching to the Destination Time Zone

1 (Set up) Menu [Time Zone] .

See Menus and Settings (p. 25).

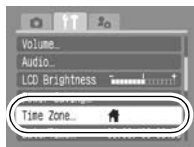

2 Use the ← or → button to select .

- To change the destination time zone, use the **FUNC./SET** button.
- When you switch to the destination time zone,  will display on the monitor.



If you change the date and time when the destination time zone is selected, the home time zone date and time will also change automatically.

Menus and Settings

Menus are used to set the shooting, playback and print settings as well as such camera settings as the date/time and electronic beep. The following menus are available.

● FUNC. Menu

● Rec., Play, Print, Set up and My Camera Menus

FUNC. Menu

Sets many of the functions commonly used during shooting.

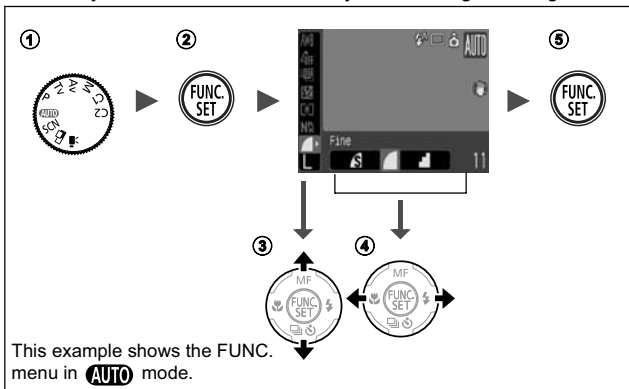

① Turn the shooting mode dial to select menu options.

② Press the FUNC./SET button.

③ Use the **↑** or **↓** button to select a menu item.

- Some items may not be selectable in some shooting modes.

④ Use the **←** or **→** button to select an option for the menu item.

- You can select further options with the **MENU** button for some options.
- After selecting an option, you can press the shutter button to shoot immediately. After shooting, this menu will appear again, allowing you to adjust the settings easily.
- You can also use the control dial to select an option for the menu item.

24 ⑤ Press the FUNC./SET button.

Rec., Play, Print, Set up and My Camera Menus

Convenient settings for shooting, playback or printing can be set with these menus.

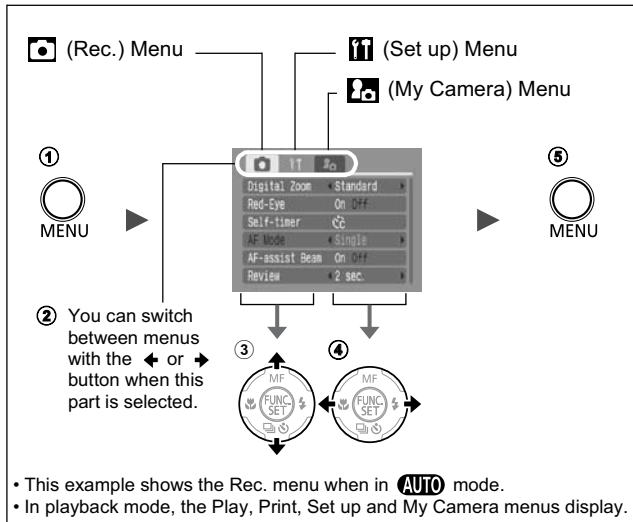











- ① Press the **MENU** button.
- ② Use the **←** or **→** button to switch between menus.
 - You can also use the zoom lever to switch between menus.
- ③ Use the **↑** or **↓** button to select a menu item.
 - Some items may not be selectable in some shooting modes.
 - You can also use the control dial to select a menu item.
- ④ Use the **←** or **→** button to select an option.
 - Menu items followed by an ellipsis (...) can only be set after pressing the **FUNC./SET** button to display the next menu. Press the **FUNC./SET** button again to confirm the setting.
- ⑤ Press the **MENU** button.

Menu List

FUNC. Menu



The icons shown below are the default settings.

Menu Item	Reference Page	Menu Item	Reference Page
 White Balance	p. 42	 ND Filter	p. 71
 My Colors	p. 75	 Compression (Still image)	p. 35
 Bracket	pp. 67, 70	 Recording Pixels (Still image)	p. 34
 +/- (Flash)/Flash Output	p. 73	 Frame Rate (Movie)	p. 57
 Metering Mode	p. 39	 Recording Pixels (Movie)	p. 57

Rec. Menu ()





*Default setting





Menu Item	Options	Reference Page
Digital Zoom	On*/Off/1.4x/2.3x (In standard movie mode: On*/Off)	p. 36
Flash Sync	1st-curtain*/2nd-curtain	p. 74
Slow Synchro	On/Off*	<i>Basic Guide</i> p. 15
Flash Adjust	Auto*/Manual	p. 72
Red-Eye	On*/Off	<i>Basic Guide</i> p. 15
Safety FE	On/Off*	p. 51
Self-timer	Delay: 0–10*, 15, 20, 30 sec. Shots: 1–10* ¹	<i>Basic Guide</i> p. 17
Spot AE Point	Center*/AF Point	p. 40
Safety Shift	On/Off*	p. 51

Menu Item	Options	Reference Page	
MF-Point Zoom	On*/Off	p. 65	
AF Mode	Continuous*/Single	p. 60	
AF-assist Beam	On*/Off	–	
Review	Off/2*–10 sec./Hold	<i>Basic Guide</i> p. 11	
Save Original	On/Off*	p. 81	
Auto Category	On*/Off	Sets whether on not images are automatically classified into categories during shooting.*2	
IS Mode	Continuous*/Shoot Only/ Panning/Off	p. 35	
Converter	None*/WC-DC58B/ TC-DC58C	Set up when shooting using the [IS Mode] by attaching the teleconverter or wide converter, sold separately (p. 140).	
Custom Display Settings	LCD/ Viewfinder	 Off*3/On*4	pp. 15, 18
	Shooting Info	Off*3/On*4	
	Grid Lines	Off*3/On*4	
	3:2 Guide	Off*3*4/On	
	Histogram	Off*3/On*4	
Set Shortcut button		p. 82	
Save Settings	C1/ C2	p. 59	

*1 Default setting is 3 shots.

*2 They are classified according to the following categories.

 (People): , ,  or images with faces detected when [Face Detect] has been selected.





 (Scenery): , , 





 (Events): , , , , , , 

*3 Default setting for .

*4 Default setting for .

Play Menu ()

Menu Item	Page
 Slide Show	p. 103
 My Category	p. 103
 Erase	p. 109
 Protect	p. 107
 My Colors	p. 98

Menu Item	Page
 Sound Recorder	p. 102
 Rotate	p. 97
 Transfer Order	p. 115
 Transition	p. 98

Print Menu ()

Menu Item	Page
Print	p. 111
Select Image & Qty.	
Select by Date	
Select by Category	

Menu Item	Page
Select by Folder	p. 111
Select All Images	
Clear All Selections	
Print Settings	



Set up Menu ()

*Default setting

Menu Item	Options	Reference Page
Mute	On/Off*	Set to [On] to silence all operation sounds except for the warning sounds (<i>Basic Guide</i> p. 10).
Volume	Off/1/2*/3/4/5	Adjusts the volume of the start-up sound, operation sound, self-timer sound, shutter sound and playback sound. The volume cannot be adjusted if [Mute] is set to [On].
Start-up Vol.		Adjusts the volume of the start-up sound when the camera is turned on.
Operation Vol.		Adjusts the volume of the operation sound that beeps when any button other than the shutter button is pressed.





Menu Item	Options	Reference Page
Selftimer Vol.		Adjusts the volume of the self-timer sound played 2 sec. before the shutter is released.
Shutter Volume		Adjusts the volume of the sound played when the shutter releases. The shutter sound does not play when a movie is recording.
Playback Vol.		Adjusts the volume of movie sounds and sound memos.
Audio		p. 58
Mic level	Auto*/Manual	Sets method of adjustment for the sound recording level.
Level	-40 to 0 dB	Sets the sound recording level.
Wind Filter	On/Off*	Reduces wind noise.
LCD Brightness	-7 to 0* to +7	Use the ◀ or ▶ button to adjust the brightness. You can check the brightness in the LCD monitor while you are adjusting the setting.
Power Saving		p. 21
Auto Power Down	On*/Off	Sets whether or not the camera automatically powers down after a set period of time elapses without the camera being operated.
Display Off	10 sec./20 sec./ 30 sec./1 min.*/ 2 min./3 min.	Sets the length of time before the LCD monitor turns off when no camera operation is performed.
Time Zone	Home*/World	p. 22
Date/Time		<i>Basic Guide</i> p. 8
Clock Display	0–5*–10 sec./ 20 sec./30 sec./ 1min./2 min./ 3 min.	p. 13
Format		You can also select a low level format (p. 33).

Menu Item	Options	Reference Page
File Numbering	Continuous*/ Auto Reset	p. 87
Create Folder		p. 85
Create New Folder	Check mark (On)/ No check mark (Off)	Creates a folder during the next shooting session.
Auto Create	Off*/Daily/ Monday-Sunday/ Monthly	You can also set an auto creation time.
Auto Rotate	On*/Off	p. 84
Distance Units	m/cm* / ft/in	Sets the units for the MF indicator distance unit (p. 65).
Lens Retract	1 minute* / 0 seconds	Sets the lens retraction timing when switching from shooting mode to playback mode.
Language		<i>Basic Guide</i> p. 9
Video System	NTSC/PAL	p. 133
Print Method	Auto*/ 	See below* ¹ .
Reset All		p. 32

*1 The connection method with the printer can be changed. Although it is normally not necessary to change the setting, select  when borderless printing an image shot in  (Widescreen) mode on wide size paper using Canon compact photo printer SELPHY CP730/CP720/CP710/CP510. As this setting will be stored to memory even when the power is turned off, to print using an image size other than , return the mode to [Auto] (however, this method cannot be changed while connected to a printer).

My Camera Menu ()

*Default setting

Menu Item	Options	Page
Theme	Selects a common theme for each My Camera settings item.	p. 117
Start-up Image	Sets the image displayed when the camera power is turned on.	
Start-up Sound	Sets the sound played when the camera power is turned on.	
Operation Sound	Sets the sound played when any button other than the shutter button is pressed.	
Selftimer Sound	Sets the sound played 2 seconds before the shutter releases in self-timer mode.	
Shutter Sound	Sets the sound played when the shutter button is pressed. There is no shutter sound for movies.	
My Camera Menu Contents	 (Off) /  * /  / 	

1 (Set up) Menu ► [Reset All].

See *Menus and Settings* (p. 25).

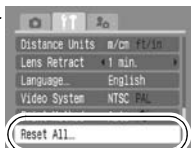

2 Select [OK] and press .



- When returning the **C1/C2** registration contents to the default setting, turn the shooting mode dial to **C1** or **C2** to operate.
- Settings cannot be reset when the camera is connected to a computer or to a printer.
- The following cannot be reset.
 - Shooting mode
 - The [Time Zone], [Date/Time], [Language] and [Video System] options in the  (Set up) menu (pp. 29, 30)
 - ISO speed (p. 38)
 - White balance data recorded with the custom white balance function (p. 43)
 - Colors specified in the [Color Accent] (p. 78) or [Color Swap] (p. 79) modes
 - Newly registered My Camera settings (p. 118)

Formatting Memory Cards



You should always format a new memory card or one from which you wish to erase all images and other data.



Please note that formatting (initializing) a memory card erases all data, including protected images and other file types.

1 (Set up) Menu ► [Format].

See *Menus and Settings* (p. 25).

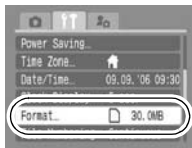

2 Select [OK] and press .

- To perform a low level format, use the button to select [Low Level Format] and the or button to add a check mark.

- You can stop formatting a card when [Low Level Format] is selected by pressing the FUNC./SET button. You can still use a card without problem when formatting is halted, but its data will be erased.



- This operation is not available in mode.
- Low Level Format

We recommend you select [Low Level Format] when you think that the recording/reading speed of a memory card has dropped. A low level format may require 2 to 3 minutes with some memory cards.

Changing the Recording Pixels and Compression (Still Images)



Shooting Mode

AUTO SCN P Tv Av M

1 FUNC. Menu * (Compression)/ * (Recording Pixels).

See Menus and Settings (p. 24).

* Default setting.





- Use the or button to select compression settings/recording pixels and press the FUNC./SET button.



Approximate Values for Recording Pixels

Recording Pixels		Purpose
L (Large)	3648 x 2736 pixels	 High Printing to about A2 size (Approx. 420 x 594 mm (16.5 x 23.4 in.)) Printing to about A3 size (Approx. 297 x 420 mm (11.7 x 16.5 in.)) Printing to about A4 size (Approx. 210 x 297 mm (8.3 x 11.7 in.)) Print postcard-size prints 148 x 100 mm (6 x 4 in.) Print L-size prints 119 x 89 mm (4.7 x 3.5 in.) Low Send images as e-mail attachments or shoot more images
M1 (Medium 1)	2816 x 2112 pixels	
M2 (Medium 2)	2272 x 1704 pixels	
M3 (Medium 3)	1600 x 1200 pixels	
S (Small)	640 x 480 pixels	
W (Widescreen)	3648 x 2048 pixels	Print on wide paper (Records at a 16:9 width-to-height aspect ratio. Portions not recorded are left black bars on LCD monitor.).

Approximate Values for Compression Settings

Compression		Purpose
 Superfine	High Quality	Shoot higher quality images
 Fine	 Normal	Shoot normal quality images
 Normal		Shoot more images





- See *Image Data Sizes (Estimated)* (p. 158).
- See *Memory Cards and Estimated Capacities* (p. 156).

Setting the Image Stabilizer Function

Shooting Mode

AUTO SCN   Tv Av M

The lens-shift type image stabilizer function allows you to minimize the camera shake effect (blurred images) when you shoot distant subjects that have been magnified or when you shoot in dark conditions without a flash.

Continuous	You can check the effect of the IS mode on image blur on the LCD monitor since the IS mode runs continually. This makes it easier to compose images and focus on subjects.
Shoot Only	IS mode is only activated when the shutter button is pressed. When set to [Continuous], some blurring may occur depending on the subjects. In Shoot Only mode, subjects can be taken without concern for any unnatural movement that may appear on the LCD monitor. This option is not available in the  mode.
Panning	This option only stabilizes the effect of up and down camera motions on the image. This option is recommended for shooting objects moving horizontally. This option is not available in the  mode.

1

 **(Rec.) Menu** ► **[IS Mode]** ► **[Continuous]* / [Shoot Only]/[Planning]/[Off].**

See *Menus and Settings* (p. 25).

* Default setting.



The following icons appear on the LCD monitor.

[Continuous]	[Shoot Only]	[Panning]	[Converter] setting in Rec. menu	Reference Page
			None	–
			WC-DC58B	p. 140
			TC-DC58C	



- If you change the shooting mode to after setting [IS Mode] to [Shooting] or [Panning] in the still image shooting mode, the setting will change to [Continuous].
- Camera shake may not be fully corrected when shooting with slow shutter speeds, such as with evening shots. Use of a tripod is recommended.
- If camera shake is too strong, it may not be fully corrected.
- Hold the camera horizontally while panning (stabilization does not work when the camera is held vertically).

Using the Digital Zoom/Digital Tele-converter

Shooting Mode

AUTO **SCN***1 *2 **P** **Tv** **Av** **M**

*1 Cannot be set in , and modes.

*2 Digital Tele-Converter cannot be set.

You can combine digital zoom with optical zoom when shooting. The available shooting characteristics and focal lengths (35mm film equivalent) are as follows.

Selection	Focal Length	Shooting Characteristics
Standard	35 – 840 mm	Enables shooting at zoom factors of up to 24x with digital and optical zoom combined. can only be set in the standard mode.
Off	35 – 210 mm	Enables shooting without digital zoom.
1.4x	49 – 294 mm	Digital zoom is fixed at the selected zoom factor, and the focal length shifts to the telephoto end. This enables a faster shutter speed and less chance of camera shake than a shot taken at the same angle of view with [Standard] or [Off].
2.3x	80.5 – 483 mm	



- The digital zoom cannot be used when the LCD monitor is turned off.
- The digital zoom cannot be used with **[W]** (Widescreen).

1

[Rec.] Menu ▶ [Digital Zoom] ▶ [Standard]* / [Off]/[1.4x]/[2.3x].

See Menus and Settings (p. 25).

* Default setting.



- When using [Standard]:
See *Shooting with the Digital Zoom* (p. 37).
- When using [1.4x], [2.3x]:
See *Shooting with the Digital Tele-Converter* (p. 38)



Shooting with the Digital Zoom

2

Press the zoom lever toward  and shoot.

- The combined digital and optical zoom setting will display in the LCD monitor.
- Based on the number of recording pixels set, the Safety Zoom feature calculates the maximum zoom factor beyond which images will begin to deteriorate. The digital zoom pauses at this zoom factor for a moment, and  appears on the LCD monitor. If you press the zoom lever toward  again, you can zoom in even closer.

In this case, the color of the zoom bar means as follows:

- White: optical zoom
 - Yellow: digital zoom (non-deteriorative)
 - Blue: digital zoom (deteriorative)
- Press the zoom lever toward  to zoom out.

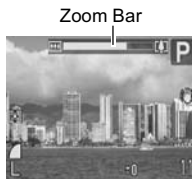

Shooting with the Digital Tele-Converter

2 Adjust the angle of view with the zoom lever and shoot.

- **T** appears on the LCD monitor.
- Depending on the number of recording pixels set, images may deteriorate (**T** and the zoom factor appear in blue).

Digital Tele-Converter



About the Digital Tele-Converter

The Digital Tele-Converter feature uses digital zoom to achieve the effects of a tele-converter (a lens used in telephoto shooting).

Adjusting the ISO Speed



Shooting Mode

AUTO SCN **P** Tv Av M

Raise the ISO speed to use a fast shutter speed when you wish to reduce the effects of camera shake or avoid blurry subjects, or to turn the flash off when shooting in a dark area.

1 Select an ISO speed using the ISO speed dial.

- When selecting a settable ISO speed, the ISO speed lamp will blink orange.
- Selecting ISO AUTO sets the optimal ISO speed according to the light level when shooting. Since the ISO speed setting will automatically be raised in dark places, the camera will select a faster shutter speed and reduce the chances of camera shake.
- Selecting ISO HI (High ISO Auto)* sets a higher sensitivity than for ISO AUTO. As the shutter speed becomes even faster, camera shake and blurred photos caused by subject movement will be reduced even more than when shooting the same scene in ISO AUTO.

* Noise may increase in the captured image compared to ISO AUTO.

ISO Speed Settings



ISO Speed \ Shooting Mode	AUTO	P	Tv	Av	M
AUTO	○	○	○	○	—*2
HI	○	○	—*1	—*1	—*2
80	—*1	○	○	○	○
100	—*1	○	○	○	○
200	—*1	○	○	○	○
400	—*1	○	○	○	○
800	—*1	○	○	○	○
1600	—*1	○	○	○	○

○ : Available

*1: The ISO speed is set to Auto.

*2: The ISO speed is set to 80.





When **SCN** (excluding ) ,  or  , the ISO speed will be fixed to Auto.

Switching between Metering Modes

Shooting Mode

AUTO **SCN**   **P Tv Av M**

	Evaluative	Appropriate for standard shooting conditions, including backlit scenes. The camera divides images into several zones for metering. It evaluates complex lighting conditions, such as the position of the subject, the brightness, the direct light, and the backlighting, and adjusts the settings to the correct exposure for the main subject.
	Center Weighted Average	Averages the light metered from the entire frame, but gives greater weight to the subject matter at the center.
	Spot	Meters the area within the spot AE point frame. Can be set when there is only one AF frame (p. 61).
	Center	Locks the spot metering frame to the center of the LCD monitor.
	AF Point	Move the spot AE point to the same position as the selected AF frame.

1 FUNC. Menu ► * (Evaluative)

See *Menus and Settings* (p. 24).

* Default setting.

- Use the ◀ or ▶ button to select the metering mode and press the **FUNC./SET** button.



Lock the spot AE point to the center of the LCD monitor/Move the spot AE point to the same position as the selected AF frame

1 (Rec.) Menu ► [Spot AE Point] ► [Center]*/[AF Point]

See *Menus and Settings* (p. 25).

* Default setting.

- When [Spot AE Point] is set to [Center], the spot AE point frame appears at the center of the LCD monitor.
- When [Spot AE Point] is set to [AF Point], it appears inside the selected AF frame.

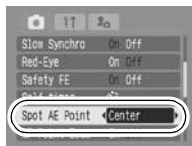

Adjusting the Exposure Compensation



Shooting Mode

AUTO SCN*

* Cannot be set in , and modes.

Adjust exposure to the + side to avoid making the subject too dark when shooting in a backlit situation or against a bright background, and adjust exposure to the - side to avoid making the subject too light when shooting at night or with a dark background.

1 Press the button several times until the exposure compensation bar is displayed.

- Use the or buttons to adjust the exposure compensation and press the button.
- Depending on the shooting mode, pressing the button will switch between the setting items as follows:



SCN	SCN mode/Exposure compensation
	Shooting direction selection/Exposure compensation
Tv	Shutter speed/Exposure compensation
Av	Aperture value/Exposure compensation

To Cancel the Exposure Compensation:



Follow procedure 1 to restore the compensation value to [0].

Adjusting the Tone (White Balance)

Shooting Mode

AUTO SCN   * P Tv Av M



* Cannot be set in  and  modes.

Normally, the  (Auto) white balance setting selects an optimal white balance. When the  (Auto) setting cannot produce natural looking colors, change the white balance using a setting appropriate for the light source.

1 FUNC. Menu * (Auto).











See Menus and Settings (p. 24).

* Default setting.



- Use the  or  button to select a white balance setting and press the FUNC./SET button.



White Balance Settings

	Auto	Settings are automatically set by the camera.
	Day Light	For recording outdoors on a bright day.
	Cloudy	For recording under overcast, shady or twilight skies.
	Tungsten	For recording under tungsten and bulb-type 3-wavelength fluorescent lighting.
	Fluorescent	For recording under warm-white, cool-white or warm-white (3-wavelength) fluorescent lighting.
	Fluorescent H	For recording under daylight fluorescent, or daylight fluorescent-type 3-wavelength fluorescent lighting.
	Flash	When using the flash (cannot be set in  mode).
	Underwater	Appropriate for shooting images with the Waterproof Case WP-DC11 (sold separately). This mode yields image data in the optimal white balance to record images with natural hues by reducing the bluish tone.
	Custom	For recording with the optimal white balance data retained in the camera from a white-colored object, such as white paper or cloth.



The white balance setting cannot be adjusted when  or  is selected for My Colors.

Using the Custom White Balance

You can set a custom white balance to obtain the optimal setting for the shooting conditions by having the camera evaluate an object, such as a piece of white paper or cloth, or a photo-quality gray card that you wish to establish as the standard white color.

In particular, take a custom white balance reading for the following situations that are difficult for the  (Auto) setting to detect correctly.

- Shooting close-ups (Macro)
- Shooting subjects of monotone color (such as sky, sea or forest)
- Shooting with a particular source of light (such as a mercury-vapor lamp)

1 **FUNC. Menu** ► * (Auto) ► (Custom).

See Menus and Settings (p. 24).

* Default setting.



2 **Aim the camera at a piece of white paper or cloth and press .**

- If you are viewing it with the LCD monitor, ensure that the center frame is completely filled with the white image. If you are using the optical viewfinder, ensure that the entire field is filled. However, the center frame will not appear when the zoom factor is 8.4x or higher or when  is displayed.



- You are recommended to set the shooting mode to **P** and the exposure compensation setting to $[\pm 0]$ before setting a custom white balance.
The correct white balance may not be obtained when the exposure setting is incorrect (image appears completely black or white).
- Shoot with the same settings as when reading the white balance data. If the settings differ, the optimal white balance may not be set.
In particular, the following should not be changed.
 - ISO Speed
 - Flash
Setting the flash to on or off is recommended. If the flash fires when reading the white balance data with the flash set to  (Auto), make sure that you also use the flash when you shoot.
- Since the white balance data cannot be read in Stitch Assist mode, preset the white balance in another shooting mode beforehand.

Continuous Shooting



Shooting Mode

AUTO SCN*¹   **P** Tv Av M



*1 Cannot be set in  and  modes.

In this mode, the camera shoots continuously while the shutter button is held down.

If you use the recommended memory card*², you can shoot continuously (smooth continuous shooting) at a set shooting interval until the memory card is full (p. 156).

*2 Recommended Memory Card:

Super high-speed SDC-512MSH memory card (sold separately) to which low-level formatting (p. 33) is conducted immediately before shooting.

	Approx. 2.0 images/sec.	Recommended when shooting continuously at a short shooting interval.
	Approx. 0.8 images/sec.	Recommended when shooting continuously while confirming the subject. Continuous shooting is possible when the shutter button is held down, and focus can be adjusted during the shooting (not applicable when in manual focus mode).

- Large/Fine mode.
- This reflects standard shooting criteria established by Canon. Actual results may vary according to the subject and shooting conditions.
- Even if continuous shooting suddenly stops, the memory card may not be full.

1 Press the  button and use the **↑** or **↓** button to display  or .



2 Shoot.

- The camera will continue to record successive images while the shutter button is held down. Recording will cease when the shutter button is released.

To Cancel Continuous Shooting:

Follow Step 1 to display 



- When in ,  will be the default setting.  cannot be set.
- Cannot be set while in the focus bracketing shooting mode or AEB shooting mode.
- The interval between shots lengthens when the built-in memory of the camera fills.
- If the flash is used, the interval between shots lengthens because the flash must charge.



You can check whether the image is in focus right after it is recorded.

1 Shoot.

- The recorded image displays for about 2 seconds (or the interval set with the Review feature (p. 27)).

2 Press (or) while the image is displayed.

- The number of times the **DISPLAY** button is pressed depends upon the display settings for the LCD monitor (See below). Press the **DISPLAY** button repeatedly until the screen at the right appears.
- Displays as follows.
 - Camera is focused: AF frame for the image that has been shot displays in white, and an orange frame appears within the focused frame.
 - Camera is not focused: image that has been shot displays, and an orange frame displays at the center of the image.
- Contents of the orange frame can be confirmed at the bottom right. Zoom can be used (p. 89).
- You can switch between AF frames and change the display position (p. 47) using the **MENU** button or the **↑**, **↓**, **←** or **→** button.

Recorded Image



Orange frame contents

To Cancel Checking the Focus:

Press the shutter button halfway.







- You can delete an image by pressing the button while the image is displayed (See *Basic Guide* p. 19).
- Pressing the **DISPLAY** button will change the display on the LCD monitor as follows.

Focus Confirmation → Detailed → Standard

Switching between AF Frames/ Changing the Display Position

1 Press .

- If you shoot with the AF frame set to [AiAF] or [Face Detect] (p. 61) and have an image with multiple AF frames selected, you can switch which AF frame to use for checking the focus each time you press the MENU button.
- Move the AF frame to the position you wish to check the focus of using the , ,  or  button.
- Pressing the MENU button restores the standard display position. If you have an image with multiple AF frames selected, each press of the MENU button will switch which AF frame to use for checking the focus.



Using the Mode Dial

P Program AE



Shooting Mode

AUTO SCN P Tv Av M

The camera automatically sets the shutter speed and aperture value to match the brightness of the subject.

- When a correct exposure cannot be obtained, the shutter speed and aperture values are shown in red on the LCD monitor when the shutter button is pressed halfway. Use the following shooting methods to obtain the correct exposure and make them show in white.
 - Using the flash
 - Changing the ISO speed
 - Changing the metering method
 - Setting the ND filter on



You can change the combinations of shutter speeds and aperture values without altering the exposure (p. 69).

Tv Setting the Shutter Speed



Shooting Mode

AUTO SCN P Tv Av M

When you set the shutter speed, the camera automatically selects an aperture value to match the brightness of the subject. Faster shutter speeds allow you to catch an instantaneous image of a moving subject, while slower speeds create a flowing effect and allow you to shoot without a flash in dark areas.

- When using the control dial, the **Tv** bar will be displayed and the shutter speed can be changed.



- If the aperture value is shown in red, the image is underexposed (insufficient light) or overexposed (too much light). Use the control dial to adjust the shutter speed until the aperture value shows in white.
- The nature of CCD image sensors is such that noise in the recorded image increases at slow shutter speeds. This camera, however, applies special processing to images shot when the shutter speed is 1.3 seconds or slower to eliminate the noise, thereby producing high-quality images. (However, a certain amount of processing time may be required before the next image can be shot.)



- The aperture value and shutter speed change according to the zoom state as follows

	Aperture Value	Shutter Speed (seconds)
Maximum Wide Angle	f/2.8	15 – 1/1600
	f/3.2 – 3.5	15 – 1/2000
	f/4.0 – 8.0	15 – 1/2500
Maximum Telephoto	f/4.8	15 – 1/1600
	f/5.6 – 6.3	15 – 1/2000
	f/7.1 – 8.0	15 – 1/2500

- The fastest shutter speed for flash synchronization is 1/500 second. The camera automatically resets the shutter speed to 1/500 second if a faster speed is selected.

Shutter Speed Display

- The following shutter speeds can be set. 1/160 indicates 1/160 second. Also, 0"3 indicates 0.3 second and 2" indicates 2 seconds.

15" 13" 10" 8" 6" 5" 4" 3" 2 2"5 2" 1"6 1"3 1" 0"8 0"6 0"5 0"4 0"3
 1/4 1/5 1/6 1/8 1/10 1/13 1/15 1/20 1/25 1/30 1/40 1/50 1/60
 1/80 1/100 1/125 1/160 1/200 1/250 1/320 1/400 1/500 1/640
 1/800 1/1000 1/1250 1/1600 1/2000 1/2500

- You can change the automatically selected combinations of shutter speeds and aperture values without altering the exposure (p. 69).

Av Setting the Aperture



Shooting Mode

AUTO SCN P Tv **Av** M

The aperture adjusts the amount of light entering through the lens. When you set the aperture value, the camera automatically selects a shutter speed to match the brightness.

Selecting a lower aperture value (opening the aperture) allows you to blur the background. A higher aperture value (closing it) brings the entire range from foreground to background into focus. The larger the aperture value, the greater the range of the image brought into clear focus.

- When using the control dial, the **Av** bar will be displayed and the aperture value can be changed.



- If the shutter speed is shown in red, the image is underexposed (insufficient light) or overexposed (too much light). Adjust the aperture value using the control dial until the shutter speed display turns to white.
- Some aperture values may not be available with certain zoom positions (p. 49).



In this mode, the shutter speed range with synchronized flash is 1/60 second to 1/500 second. The aperture value setting may therefore be changed automatically to match the synchronized flash speed even if its value was set previously.

Aperture Value Display

- The larger the aperture value, the smaller the lens aperture.

F2.8 F3.2 F3.5 F4.0 F4.5 F4.8 F5.0 F5.6 F6.3 F7.1 F8.0

- You can change the automatically selected combinations of shutter speeds and aperture values without altering the exposure (p. 69).

About Safety FE/Safety Shift

Safety Shift

If you set [Safety Shift] to [On] in the Rec. menu when the shooting mode is **Tv** or **Av** and press the shutter button halfway, the camera automatically changes the shutter speed or aperture value to obtain the correct exposure if necessary. The safety shift function does not work when the flash is on.

Safety FE

If you set [Safety FE] to [On] in the Rec. menu when shooting with the flash in the **P**, **Tv**, or **Av** shooting mode, the camera automatically changes the shutter speed or aperture value when the flash fires to avoid overexposing and blowing out the highlights in the scene.

M Manually Setting the Shutter Speed and Aperture



Shooting Mode

AUTO SCN P Tv Av **M**

You can manually set the shutter speed and aperture to shoot images.

- Select either shutter speed or aperture value with the button and turn the control dial. The **Tv** bar or **Av** bar will be displayed and values can be changed.



Selected exposure
Standard exposure

You can check the difference between the selected exposure and the standard exposure*. If the difference is more than ± 2 stops, the selected exposure appears in red on the LCD monitor. In addition, when you press the shutter button halfway, the difference between the standard exposure* and the selected exposure appears on the LCD monitor. If the difference is more than ± 2 stops, “-2” or “+2” appears in red.

* Standard exposure levels are calculated by measuring light according to the currently selected metering mode.



- If the zoom is adjusted after these values are set, the aperture value may change in accordance with the zoom position (p. 49).
- The LCD monitor's brightness matches the selected shutter speed and aperture value.

When you select a fast shutter speed or shoot a subject in a dark place, the image will always be bright if the flash is set to  (Flash on) or if an external flash is attached.

Shooting Panoramic Images (Stitch Assist)



Shooting Mode

AUTO SCN   P Tv Av M

Stitch Assist can be used to shoot overlapping images that can later be merged (stitched) to create one panoramic image on a computer.



The overlapping seams of several adjacent images can be joined into a single panoramic image.



1 Use the control dial to select a shooting direction.

- You can select from the following five shooting directions.
 - → Horizontally, left to right
 - ← Horizontally, right to left
 - ↑ Vertically, bottom to top
 - ↓ Vertically, top to bottom
 - Clockwise starting at the top left



2 Shoot the first image in the sequence.

- The exposure and white balance are set and locked with the first image.

3 Compose the second image so that it overlaps a portion of the first and shoot.

- You can press the ↑, ↓, ← or → button to return to the previously recorded image to retake the shot.
- Minor discrepancies in the overlapping portions can be corrected when the images are stitched together.

4 Repeat the procedure for additional images.

- A sequence may contain up to 26 images.
- Press the **FUNC./SET** button after the last shot.



- You cannot display the images on a TV when shooting in Stitch Assist mode.
- The settings for the first image are applied to the second image onward.



- Use PhotoStitch, a supplied software program, to merge the images on a computer.
- When the  button is pressed, you can switch between the items which you can set.
 - Exposure compensation/Shooting direction selection



The following movie modes are available.

For information on the recording pixels and frame rate in each mode, refer to “Recording Pixels and Frame Rates” (p. 57).



Standard

You can select the recording pixels and frame rate and record until the memory card is full (when a super high-speed memory card is used, such as the recommended SDC-512MSH).

The digital zoom can be used while shooting in this mode (p. 36).

- Maximum Size: 4 GB/movie*



High Resolution

Use this to display images at large sizes on computer monitors.

- Maximum Size: 4 GB*/movie



Compact

Since there are few recording pixels and also the data size is small, this mode is convenient for sending movies as e-mail attachments or when the memory card capacity is low.

- Maximum Clip Length: 3 minutes



Color Accent, Color Swap

You can have only the specified color remain and change all others into black and white, or change a specified color into a different color. (pp. 78, 79).





As with the Standard mode, you can select the recording pixels and frame rate and record until the memory card is full (when a super high-speed memory card is used, such as the recommended SDC-512MSH).

- Maximum Size: 4 GB/movie*

* The recording time will differ according to the memory card used (p. 156).

* Even if the size of the movie data has not reached 4GB, recording may stop when a shooting time of 1 hour has elapsed.

1 Select a movie mode using the control dial.

- In ,  or  mode, you can change the recording pixels and frame rate (p. 56).
- For  and  mode procedures, see “Changing the Color” (p. 77).



2 Shoot.

- Pressing the shutter button halfway automatically sets the exposure, focus and white balance settings.
- Pressing the shutter button fully starts recording video and sound simultaneously.
- During shooting, the recording time and [●Rec] appear on the LCD monitor.
- Pressing the shutter button fully again stops recording. Recording will stop automatically under the following circumstances.
 - When the maximum recording time elapses
 - When the built-in memory or memory card becomes full





- You are recommended to use a memory card that has been formatted in your camera to shoot movies (p. 33). The memory card supplied with the camera may be used without further formatting.
- Be careful of the following while recording.
 - Do not touch the microphone.
 - Do not press any buttons other than the shutter button. The sound that buttons make will be recorded in the movie.
 - The camera will automatically adjust the exposure and white balance to suit the shooting conditions during recording. Please note, however, that the sounds made by the camera automatically adjusting the exposure may also be recorded.
- The focus and optical zoom settings remain fixed for subsequent frames at the values selected for the first frame.
- Do not point the camera at the sun when shooting.



QuickTime 3.0 or later is required to play back movies (Data type: AVI/Compression method: Motion JPEG) on a computer. QuickTime (for Windows) is included on the Canon Digital Camera Solution Disk. On the Macintosh platform, this program is standard with Mac OS X or later.

Changing Recording Pixels and Frame Rates (Movies)

You can change the recording pixels and frame rate when the movie mode is set to ,  (Color Accent) or  (Color Swap).

1 FUNC. Menu ► * (Frame Rate) / *

(Recording Pixels).

See Menus and Settings (p. 24).











* Default setting.

- Use the ◀ or ▶ button to select a frame rate/recording pixels and press the **FUNC./SET** button.



Recording Pixels and Frame Rates



Frame rates indicate the number of frames recorded or played back each second. The higher the frame rate, the smoother the appearance of motion.

	Recording Pixels	Frame Rate (frames/sec.)	
			
 Standard	 640 x 480 pixels	○*1	○
 Color Accent	 320 x 240 pixels	○	○
 Color Swap			
 High Resolution *2	 1024 x 768 pixels	—	○
 Compact *2	 160 x 120 pixels	—	○

*1 Default setting.

*2 The recording pixels and frame rate are fixed.



- See *Image Data Sizes (Estimated)* (p. 158).
- See *Memory Cards and Estimated Capacities* (p. 156).
- The following operations are available before movie recording
 - AF lock: Pressing the MF button activates AF lock with the current conditions.  appears on the LCD monitor. You can cancel AF lock by pressing the MF button again.
 - Manual focus (p. 65)
 - AE lock, Exposure shift: Press the  button to enable AE lock. The exposure shift bar appears on the LCD monitor, and exposure can be changed using the control dial. You can cancel AE lock by pressing the  button again. Pressing the MENU button or changing the white balance settings, My Colors settings or the shooting mode, also cancels AF lock.

Setting the Recording Function



Shooting Mode

AUTO SCN P Tv Av M

The microphone level (sound recording level) and wind filter setting can be changed.

1 (Set up) menu ► [Audio].

See Menus and Settings (p. 25).

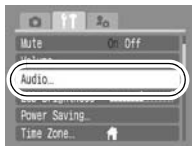

2 [Mic Level] ► [Auto]*/[Manual].

* Default setting.

- When in [Manual] mode, press the button, then set the sound recording level (recording volume) with the or button.



3 [Wind Filter] ► [On]*/[Off].

* Default setting.

- Recommended for use when the wind is strong.
- When set to [On], displays in the LCD monitor in movie mode only.



- When in [Auto] mode, if the recording volume becomes too loud, it automatically prevents distortion of sound.
- Wind filter suppresses noise when the wind is strong.

C Saving Custom Settings



Shooting Mode

AUTO SCN **P** Tv Av M

You can save frequently used shooting modes and various shooting settings to the **C** (Custom) mode. When necessary, you can then shoot images with previously saved settings by simply turning the mode dial to **C1** or **C2**. Settings that are not memorized when the shooting mode is changed or when the power is turned off (such as continuous shooting or self-timer) are also remembered.

1 Switch to the shooting mode you wish to save and set the settings.

- Functions which can be saved in **C1** or **C2**.
 - Shooting mode (**P**, **Tv**, **Av**, **M**)
 - Items which can be set in **P**, **Tv**, **Av** and **M** modes (p. 168)
 - Rec. menu settings
 - Zoom location
 - Manual focus location
- To change some of the settings saved in (other than shooting mode), select **C1** or **C2**.

2 (Rec.) Menu ► [Save Setting] ► [Destination] ► [C1]/[C2].

See Menus and Settings (p. 25).

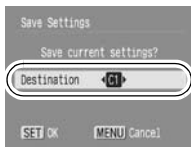

3 Press .



- The ISO speed setting cannot be saved. When shooting with **C1/C2**, set the ISO speed with the ISO speed dial.
- The settings made do not influence other shooting modes.
- Saved settings can be reset (p. 32).

Advanced Shooting Functions

Switching between Focus Settings

Shooting Mode

AUTO SCN*   Tv Av M

*In  mode only [Continuous] is available.

*In  mode only [Single] is available.

You can switch between focus settings to shoot.

Continuous	The camera is continually focusing on whatever it is aimed at even when the shutter button is not pressed, allowing you to shoot without missing opportunities. This is the default setting.
Single	The camera only focuses when the shutter button is pressed halfway, conserving battery power.

1 (Rec.) Menu ► [AF Mode] ► [Continuous]*/[Single].

See Menus and Settings (p. 25).

* Default setting.

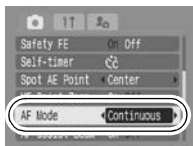

Settings can be made when the AF frame is set to [FlexiZone]. When set to [AiAF] or [Face Detect], setting is fixed to [Single] (p. 61).

Selecting an AF Frame



Shooting Mode

AUTO SCN* P Tv Av M

* Cannot be set in and modes.

The AF frame indicates the area of the composition on which the camera focuses. You can set the AF frame in the following ways.

	AiAF	The camera automatically selects between 9 AF frames to focus on according to the shooting conditions.
	FlexiZone	The camera focuses using the center AF frame. This is convenient for making sure the focus is exactly where you want it.
	Face Detect	You can have the camera automatically detect the position of a face and use this data to set the focus and exposure* while shooting. If a face is not detected, shooting will take place with [AiAF]. * Only in evaluative metering mode (p. 39).

Selecting AiAF, FlexiZone or Face Detect

- 1 Press the button.**
 - The AF frame appears in green.
- 2 Select [AiAF], [FlexiZone] or [Face Detect] using the control dial and press the button.**



- The AF frame appears as follows (when the LCD monitor is on) when the shutter button is pressed halfway.
 - Green : Shooting preparations complete
 - Yellow : Focusing difficulty*

* It will be displayed when the AF frame is set to [FlexiZone].
- The following occurs when [Face Detect] is selected.
 - Up to three AF frames display. At this point, the frame the camera judges to be the main subject appears in white while the others appear in gray. When the shutter button is pressed halfway, up to 9 green AF frames may appear.
 - If no white frame displays and all the frames appear in gray, the camera will use [AiAF] instead of [Face Detect] when shooting.
 - The camera may mistakenly identify non-human subjects as a face. If this occurs, switch to the [AiAF] or [FlexiZone] options.
 - In [Face Detect] mode, faces may not be detected.

Examples:

 - If the faces appear small, large, dark or bright relative to the overall composition.
 - If the subjects are looking sideways or lying down, or their faces are partially obscured.

Moving the AF Frame

When the shooting mode is **P**, **Tv**, **Av** or **M**, the AF frame can be moved manually to the desired area. This is convenient for focusing accurately on your chosen subject to obtain the composition you desire.

1

Press the  button.

- The AF frame appears in green.

2

Select [FlexiZone] using the control dial.

3

When moving the AF frame to the face of the subject, press the  button.

4 Move the AF frame to the position you wish to set using the ↑, ↓, ← or → button, then press the button.

- The AF frame will move back to its original position (center), if you hold down the  button.



- When the Spot AE Point is selected as the metering mode, you can use the selected Spot AE Point as the AF frame (p. 39).
- Selection cannot be made while in the manual focus mode (p. 65).
- The position of the AF frame returns to the center once the power is turned off.

Shooting Hard-to-Focus Subjects (Focus Lock, AF Lock, Manual Focus)



Shooting Mode

AUTO SCN*   **P** Tv Av M

* Cannot be set in  mode.

It may be difficult to focus on the following types of subjects.

- Subjects with extremely low contrast to the surroundings
- Scenes with a mixture of near and far subjects
- Subjects with extremely bright objects at the center of the composition
- Subjects that are moving quickly
- Subjects through glass: Try to shoot as close to the glass as possible to reduce the chances of light reflecting back off the glass.

Shooting with the Focus Lock

- 1 Aim the camera so that an object at the same focal distance as the main subject is centered in the viewfinder or in the AF frame displayed on the LCD monitor.**
- 2 Press the shutter button halfway to lock the focus.**
- 3 Keep the shutter button pressed while you recompose the image and press the shutter button all the way to shoot the image.**

Shooting with the AF Lock

- 1 Turn on the LCD monitor.**
- 2 Aim the camera so that an object at the same focal distance as the main subject is centered in the AF frame.**
- 3 Press and hold the shutter button halfway and press the MF button.**
 - The **MF** icon and the MF indicator will appear on the LCD monitor.
- 4 Re-aim the camera to compose the shot as desired and shoot.**

To Release the AF Lock: Press the **MF** button.



- The AF lock cannot be used in the **AUTO** and modes.
- The AF lock is convenient because you can let go of the shutter button to compose the image. Moreover, the AF lock is still effective after the picture is taken, allowing you to capture a second image with the same focus.
- When shooting with the focus lock or AF lock using the LCD monitor, setting [FlexiZone] (p. 61) makes shooting easier since the camera focuses using the center AF frame only.
- Because or mode does not display the AF frame, aim the camera to focus on the subject.
- AF lock can be activated simply by pressing the button when **AFL** has been assigned to it. **AFL** will appear on the monitor.

Shooting in Manual Focus Mode

The focus can be manually set.

1 Turn on the LCD monitor.

2 Press the MF button to display **MF**.

- The MF indicator is displayed.
- When the (Rec.) menu's [MF-Point Zoom] is set to [On], the portion of the image in the AF frame will appear magnified*.











* The image will not appear magnified in mode, when the digital zoom is activated or when a TV is used as the display.

* Can also be set so that the image displayed is not magnified (p. 27).



MF indicator

- Depending on the shooting mode, pressing the  button will switch between the setting items as follows:

P	Exposure compensation/ 
SCN	SCN mode/Exposure compensation*/ 
	Shooting direction selection/Exposure/ 
	 mode/ 
Tv	Shutter speed/Exposure compensation/ 
Av	Aperture value/Exposure compensation/ 
M	Shutter speed/Aperture value/ 

* Cannot be set in ,  and  modes.

3 Use the control dial and adjust the focus.

- The MF indicator shows approximate figures. Use them as a shooting guideline only.

To Cancel the Manual Focus: Press the **MF** button.



The manual focus cannot be used in the **AUTO** and  modes.

Using the Manual Focus in Combination with the Auto Focus

First, manual focus is used to roughly focus, then from that focus position the camera automatically focuses more accurately.

1 Focus the camera with the manual focus, then press the button.

- The camera focuses automatically to a more accurate focusing point.



You cannot change the AF frame setting while focusing manually. Cancel the manual focus mode, then change the AF frame setting.



Not available in **AUTO** or  mode.

Focus Bracketing (Focus-BKT Mode)

Shooting Mode

AUTO SCN   P Tv Av M

The camera automatically takes three shots: one at the manual focus position, and one each with focus positions preset farther and nearer.

The three shots are taken at the same interval as continuous shooting (p. 44).

The farther and nearer focus positions can be set in three steps: large, medium and small.



The Focus-BKT mode is not available when shooting with the flash on. Only one image at the manual focus position will be taken.

1 **FUNC. Menu** *** (BKT-Off)** **(Focus-BKT)**

See Menus and Settings (p. 24).

* Default setting.



2 **Set the amount of focus position offset with the ← or → button.**

- Press the → button to broaden or the ← button to narrow the focusing distance from the center.



3 **Press the button and shoot the image with manual focus (p. 65).**

To Cancel the Focus-BKT Mode:

Select  (BKT-Off) in Step 1.

* Locking the Exposure Setting (AE Lock)



Shooting Mode

AUTO SCN P Tv Av M

You can set the exposure and focus separately. This is effective when the contrast is too strong between the subject and background or when a subject is backlit.



You must set the flash to . The AE lock cannot be set if the flash fires.

- 1 Turn on the LCD monitor.**
- 2 Focus on the part of the subject on which you wish to lock the exposure setting.**
- 3 Press the shutter button halfway.**
- 4 Press the * button.**
 - Exposure is fixed.
- 5 Re-aim the camera to compose the shot as desired and press the shutter button fully.**

To Release the AE Lock: Operate a button other than the control dial and the ISO Speed dial.



- After locking the AE, you can change the ISO speed with exposure fixed.
- You can use the FE lock when using the flash (p. 69).

Changing shutter speed and aperture value combinations

Automatically selected combinations of shutter speeds and aperture values can be freely changed without altering the exposure (Program Shift).

1 Focus on the subject on which you wish to lock the exposure.

2 Press the shutter button halfway.

3 Press the \times button

- Exposure is fixed.



Tv Bar

Av Bar

4 Use the control dial to change shutter speed and aperture valve combinations.

5 Recompose the image and shoot.

- The setting will cancel after the shot is taken.

\times Locking the Flash Exposure Setting (FE Lock)



Shooting Mode

AUTO SCN P Tv Av M

You can lock the flash exposure so that the exposure settings are correctly set regardless of the composition of your subject.

1 Turn on the LCD monitor.

2 Press the  button and set it to  (flash on).

- If you are using an externally mounted flash, please refer to its manual for setting instructions.

3 Focus the camera on the subject on which you wish to lock the exposure setting.

4 Press the shutter button halfway.

5 Press the  button.

- The flash fires a pre-flash and the exposure is fixed.

6 Re-aim the camera to compose the shot as desired and press the shutter button fully.

To Release the FE Lock: Operate a button other than the control dial.



The FE lock function is not available when [Flash Adjust] is set to [Manual] (p. 72).

Auto Exposure Bracketing (AEB Mode)

Shooting Mode

AUTO SCN   P Tv Av M

In this mode, the camera automatically changes the exposure within a set range to take three shots as the same interval as continuous shooting (p. 44) after you press the shutter button once. The images are shot in the following order: Standard exposure, underexposure and overexposure.

1 FUNC. Menu  * (BKT-Off)  (AEB) .

See Menus and Settings (p. 24).

* Default setting.



2 Adjust the compensation range with the ← or → button.

- The compensation range can be adjusted in 1/3 increments from -2 to +2 with the exposure at the time of shooting at the center. If exposure adjustment (p. 41) is already done, setting can be done with the adjusted value as the center point.



To Cancel the AEB Mode: Select the  (BKT-Off) in Step 1.



The AEB mode cannot be used for flash photography. Only one standard exposure image gets recorded.

Using the ND Filter



Shooting Mode

AUTO SCN   P Tv Av M

The ND filter reduces light intensity to 1/8 (3 stops) of the actual level, allowing for slower shutter speeds and smaller aperture values.



Always use a tripod to prevent camera shake in this mode.

1 FUNC. Menu ► (ND Filter) ► * (ND Filter Off)/ (ND Filter On).

See Menus and Settings (p. 24).

* Default setting.



Switching between Flash Adjustment Settings



Shooting Mode

AUTO SCN P Tv Av M

Although the built-in flash and an externally mounted flash* will fire with automatic flash adjustments, it is also possible to set them so that they fire without any adjustments.

* Speedlite 220EX/430EX/580EX/

1 (Rec.) Menu ► [Flash Adjust] ► [Auto]* / [Manual].

See *Menus and Settings* (p. 25).

* Default setting.



Compensating the Flash Adjustment / Flash Output



Shooting Mode

AUTO SCN P Tv Av M

+/- (Flash) (Flash Exposure Compensation)	<ul style="list-style-type: none">● When the shooting mode is set to , P or when [Flash Adjust] is set to [Auto] (p. 72) in Tv or Av mode, settings can be adjusted in 1/3-stop increments in the range of -2 to +2 stops.● You can combine the flash exposure compensation with the camera's exposure compensation function to achieve creative effects which compensate for background exposure.
Flash Output	<ul style="list-style-type: none">● When Shooting mode is set to M or when [Flash Adjust] is set to [Manual] in Tv or Av mode (p. 72), the flash output can be controlled in three steps, starting from FULL, when shooting. When an externally mounted flash is attached, its flash output can be controlled (From 1/1 (full power) to 1/64 in 1/3 steps).

1 FUNC. Menu (+/- (Flash))/ (Flash Output).

See Menus and Settings (p. 24).

- Adjust the compensation/output using the or button and press the **FUNC./SET** button.



Example:
Flash Exposure
Compensation

Switching the Timing at which the Flash Fires



Shooting Mode

AUTO SCN P Tv Av M

1st-curtain	The flash fires right after the shutter opens, regardless of the shutter speed. Usually, the 1st-curtain is used when shooting.
2nd-curtain	The flash fires right before the shutter closes. Compared with the 1st-curtain, the flash fires later and allows you to shoot images in which, for example, a car's taillights seem to trail off behind.

1

(Rec.) Menu ► [Flash Sync] ► [1st-curtain]* / [2nd-curtain].

See *Menus and Settings* (p. 25).

* Default setting.



Image shot with the 1st-curtain setting



Image shot with the 2nd-curtain setting

Shooting in a My Colors Mode



Shooting Mode

AUTO SCN * P Tv Av M

* Cannot be set in and modes.

You can change the impression of an image when it is shot.

My Colors Settings

	My Colors Off	Records normally with this setting.
	Vivid	Emphasizes the contrast and color saturation to record bold colors.
	Neutral	Tones down the contrast and color saturation to record neutral hues.
	Sepia	Records in sepia tones.
	B/W	Records in black and white.
	Positive Film	Use this option to make red, green or blue colors more intense like the Vivid Red, Vivid Green or Vivid Blue effects. It can produce intense natural-appearing colors like those obtained with positive film.
	Lighter Skin Tone*	Use this option to make skin tones lighter.
	Darker Skin Tone*	Use this option to make skin tones darker.
	Vivid Blue	Emphasize blue tints. Use to make blue subjects, such as the sky or ocean, more vivid.
	Vivid Green	Emphasize green tints. Use to make green subjects, such as mountains, new growth, flowers and lawns, more vivid.
	Vivid Red	Emphasize red tints. Use to make red subjects, such as flowers or cars, more vivid.
	Custom Color	Use this option to adjust the balance between contrast, sharpness, saturation, reds, greens, blues and skin tones*. It can be used to make subtle adjustments, such as making blue colors more vivid or face colors brighter.



* If the image contains colors that are the same as human skin, those colors will also be changed.

* You may not obtain the expected results depending on the skin color.

1 FUNC. Menu * (My Colors Off).



See Menus and Settings (p. 24).

* Default setting.

- Use the  or  button to select a My Colors mode.



2 Shoot.

-  Mode
See Setting the Camera to a Custom Color Mode (p. 76).
- Modes other than 
Press the **FUNC./SET** button. The display will return to the shooting screen and you can shoot.

Setting the Camera to a Custom Color Mode

1 (Custom Color) .

See Menus and Settings (p. 24).



- ### 2 Use the or button to select [Contrast], [Sharpness], [Saturation], [Red], [Green], [Blue] or [Skin Tone] and the or button to adjust it.

- The altered color will display.



Select
an item

Adjust

3



- This completes the setting.

If you press the **MENU** button at this point, you will return to the screen where you can select a My Colors mode.

Changing the Color



Shooting Mode

SCN (,) (,)

Allows you to easily transform the colors in an image when shooting. This feature can be used for both still shots and movies, and offers you the enjoyment of staging image and movie effects. However, depending on the shooting conditions, there are occasions when the image may appear rough, or you may not obtain the desired color. Therefore, before you shoot important subjects, we recommend that you shoot trial images and check the results. Moreover, when shooting still images, the camera will record both the My Colors image as well as the original unaltered image when [Save Original] (p. 81) is set to [On].

	Color Accent	Use this option to have only the color specified in the LCD monitor remain and to transform all others to black and white.
	Color Swap	Use this option to transform a color specified in the LCD monitor into another. Only one different color can be selected. You cannot choose from among multiple colors.



Depending on the scene shot, ISO speed may rise and image noise may increase.

Shooting in the Color Accent Mode

1 Still image: SCN ▶ Control Dial ▶ 

Movie:  ▶ Control Dial ▶ 

See *Selecting a Shooting Mode in (Basic Guide p. 11)*.



Still image



Movie



2  .

DISPLAY

- The camera will switch to color input mode and the display will alternate between the original image and the color accent image (using the previously set color).



3 Aim the camera so that the color you wish to retain appears at the center of the LCD monitor and press the  button.

- Only one color can be specified.
- You can use the  or  button or the control dial to specify the range of colors that are retained.
 - 5: Only takes the color that you want to retain.
 - +5: Also takes colors close to the one that you want to retain.

4 Press  to complete the setting, then shoot.



- The default color accent is green.
- You may not obtain the expected results if you use the flash.
- The specified color accent is retained even if the camera's power is turned off.

Shooting in the Color Swap Mode

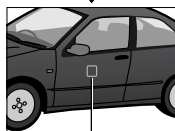

Original Color
(Before Swapping)

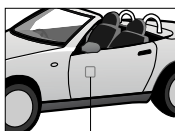

Desired Color
(After Swapping)

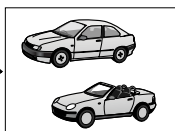

1 Still image: SCN ▶ Control Dial ▶ 

Movie:  ▶ Control Dial ▶ 

See *Selecting a Shooting Mode in (Basic Guide p. 11)*.



Still image

Movie

2  .

- The camera will switch to color input mode and the display will alternate between the original image and the color swap image (using the previously set color).



Still image

3 Aim the camera so that the original color appears at the center of the LCD monitor and press the ← button.

- Only one color can be specified.
- You can use the ↑ or ↓ button to or the control dial specify the range of colors that are swapped.
 - 5: Only takes the color that you want to swap.
 - +5: Also takes colors close to the one that you want to swap.

4 Aim the camera so that the desired color appears at the center of the LCD monitor and press the → button.

- Only one color can be specified.

5 Press  to complete the setting, then shoot.



- The default setting for color swap mode will change green into white.
- You may not obtain the expected results if you use the flash.
- The colors specified in the color swap mode are retained even if the camera's power is turned off.

Changing the Save Method for the Original Image

When shooting still images in the Color Accent or Color Swap mode, you can specify whether to record the original image (the image before altering the color) in addition to the color-altered image.

1 (Rec.) Menu ► [Save Original] ► [On]/[Off]*.

See Menus and Settings (p. 25).

* Default setting.

- If [On] is selected, the two images will be numbered consecutively with the altered image shot with the color accent on color swap setting following the original.

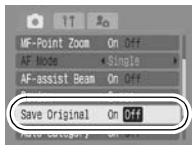

When [Save Original] is Set to [On]

- Only the color accent or color swap-altered image is shown in the LCD monitor during shooting.
- The image that appears in the LCD monitor immediately after recording is the altered image shot with the color accent or color swap setting. If you erase the image at this point, the original image is erased along with the altered image. Exercise adequate caution before deleting an image.
- Since two images are recorded with each shot, the number of shots remaining is approximately half the number displayed when this function is set to [Off].

Registering Settings to the Shortcut Button



Shooting Mode

AUTO SCN P Tv Av M

One frequently used function can be registered to the (Shortcut) button.

You can register the following functions. However, not all functions can be registered depending on the shooting mode.

Menu Item	Page	Menu Item	Page
Not Assigned*1	—	ND ND Filter	p. 71
Resolution	pp. 34, 56	Digital Tele-converter	p. 36
Compression	p. 34	IS Mode	p. 35
WB White Balance*2	p. 42	AFL AF Lock	p. 64
My Colors*3	p. 75	Create Folder	p. 85
Light Metering	p. 39	Display Off	p. 29

*1 Default setting.

*2 A custom white balance can be used once a custom white balance reading has been taken.

*3 A custom photo effect can be used once a custom effect has been set.

Registering a Function

1 (Rec.) Menu ► [Set Shortcut button].

See Menus and Settings (p. 25).

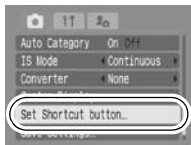

2 Use the **↑**, **↓**, **←** or **→** button to select the function you wish to register and press .

- If  appears on the lower right of the icon, you can still register this function but pressing the shortcut button will not activate the function in the current shooting mode.

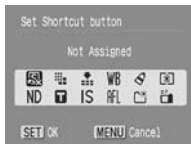

To Cancel the shortcut button: Select [Not assigned] in Step 2.

Using the Shortcut Button

1 Press the button.

- The registered function is activated and its icon appears on the LCD monitor.
- Each press of the  button cycles between setting values of the registered function.
- Functions that are not available in the current shooting mode will not appear even if they are registered.
- When [Digital Tele-converter] is used, the digital zoom setting will automatically be set to [On] (p. 26).

Setting the Auto Rotate Function

Shooting Mode



AUTO SCN   **P** Tv Av M

Your camera is equipped with an Intelligent Orientation sensor that detects the orientation of an image shot with the camera held vertically and automatically rotates it to the correct orientation when viewing it in the LCD monitor.

1 (Set up) Menu ► [Auto Rotate] ► [On]*/[Off].

See Menus and Settings (p. 25).

* Default setting.

- When the Auto Rotate function is set to [On] and the LCD monitor is set to the detailed display mode during shooting,  (normal),  (right end is down) or  (left end is down) will appear in the display.

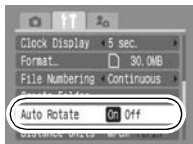

- This function may not operate correctly when the camera is pointed straight up or down. Check that the arrow  is pointing in the right direction and if it is not, then set the Auto Rotate function to [Off].
- Even if the Auto Rotate function is set to [On], the orientation of images downloaded to a computer will depend upon the software used to download the images.



When the camera is held vertically to shoot, the Intelligent Orientation sensor judges the upper end to be “up” and the lower end to be “down”. It then regulates the optimal white balance, exposure and focus for vertical photography. This function operates regardless of the on/off status of the Auto Rotate function.

Creating an Image Destination (Folder)

Shooting Mode

AUTO SCN   **P** Tv Av M

You can create a new folder at any time and the recorded images will be automatically saved to that folder.

Create New Folder	Creates a new folder the next time you shoot images. To create an additional folder, insert the check mark again.
Auto Create	You can also specify a date and time if you wish to create a new folder using a shooting time after the specified date and time.

1 (Set up) Menu **[Create Folder].**

See Menus and Settings (p. 25).

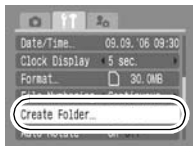

Creating a Folder the Next Time You Shoot.

2 Use the or button to check mark **[Create New Folder]** .

-  displays in the LCD monitor. The symbol will cease to display after the new folder is created.



Setting the Day or Time for Automatic Folder Creation.

2 Select a day for the [Auto Create] option and a time in the [Time] option .

-  displays when the specified time arrives. The symbol will cease to display after the new folder is created.

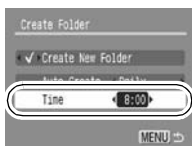

Up to 2000 images can be saved into one folder. A new folder will automatically be created when you record more than that number even if you are not creating new folders.

Resetting the File Number



Shooting Mode

AUTO SCN P Tv Av M

The images you shoot are automatically assigned file numbers. You can select how the file number is assigned.

1 **(Set up) Menu** ▶ **[File Numbering]** ▶ **[Continuous]* / [Auto Reset]**.

See Menus and Settings (p. 25).

* Default setting.

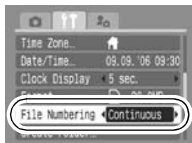

File Number Reset Function

Continuous	<p>A number one higher than the last one recorded is assigned to the next image. This is convenient for managing all your images together on a computer because you avoid file name duplication when changing folders or memory cards.*</p> <p>* When a blank memory card is used. If a memory card with recorded data is used, the 7-digit number for the last recorded folder and image is compared with the last one on the card, and the larger of the two is utilized as the basis for new images.</p>
Auto Reset	<p>The image and folder number are reset to the starting value (100-0001).* This is convenient for managing images on a folder-by-folder basis.</p> <p>* When changing to a new memory card. If a memory card with recorded data is used, the 7-digit serial number comprised of the recorded image folder number and image number will be the number for the new memory card.</p>

File and Folder Numbers

Recorded images are assigned consecutive file numbers starting with 0001 and ranging up to 9999, while folders are assigned numbers starting with 100 and ranging up to 999. Up to 2,000 images can be saved into a single folder.

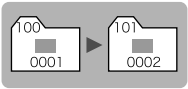
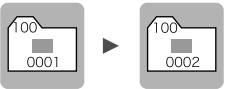
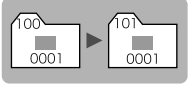
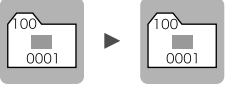
	New Folder Created	Memory Card Exchanged for Another
Continuous	Memory Card 1 	Memory Card 1 Memory Card 2 
Auto Reset	Memory Card 1 	Memory Card 1 Memory Card 2 

- Images may be saved to a new folder when there is insufficient free space even if the total number of images in a folder is less than 2,000 because the following types of images are always saved together into the same folder.
 - Images from continuous shooting
 - Self-timer images (custom)
 - Stitch Assist mode images
 - Focus Bracketing
 - AEB shooting
 - Color Accent and Color Swap still images. (When [Save Original] is set to [On])
- Images cannot be played back when the folder numbers are duplicated or image numbers are duplicated within folders.
- Please refer to the *Software Starter Guide* for information regarding folder structures or image types.

Playback/Erasing

In playback mode, you can select images with the control dial. Turning it counterclockwise selects the previous image while turning it clockwise selects the next image. Please also see the *Basic Camera User Guide* (p. 18).

Q Magnifying Images



1 Press the zoom lever toward Q.

- A magnified portion of the image will display.
- Images can be magnified up to a factor of approximately 10x.



Approximate Location of the Displayed Area

2 Use the ↑, ↓, ← or → button to move around the image.

- If you use the control dial while in the magnified display mode, the camera will switch to the previous or next image at the same level of magnification.
- You can change the magnification level with the zoom lever.

To Cancel the Magnified Display:

Press the zoom lever toward . (You can also cancel it immediately by pressing the **MENU** button.)



Movie frames and index playback images cannot be magnified.

▣ Viewing Images in Sets of Nine (Index Playback)



1 Press the zoom lever toward ▣.

- Up to nine images can be viewed at once in index playback.
- Use the **↑**, **↓**, **←** or **→** button to change the image selection.

Selected Image



Movie

To Return to Single Image Playback:

Press the zoom lever toward **Q**.

Switching between Sets of Nine Images

The jump bar will display if you press the **⏮** button while in index playback and you can switch the display between sets of nine images.

- Pressing the zoom lever toward **▣** also switches the display. Use the **←** or **→** button to move to the previous or next set of 9 images.
- Hold the **FUNC./SET** button down and press the **←** or **→** button to jump to the first or last set.



Jump Bar

To Cancel the Jump Bar:

Press the **⏮** button.

Organizing Images by Category



You can organize images into prepared categories (People, Scenery, Events, Category 1-3, To Do). At the category level, you can perform the following.

- Image searches (p. 92)
- Slide Show (p. 103)
- Protect (p. 107)
- Erase (p. 109)
- Configure print settings (p. 111)

1

(Play) Menu

See Menus and Settings (p. 25).

- In playback mode, you can press the button to display the screen in Step 2 directly.



2

Use the or button to select an image to classify and the or button to select a category and press the button.

- You can put the same image into more than one category.
- You can cancel the classification by pressing the **FUNC./SET** button a second time.









When erasing, printing or compiling a slide show, it is convenient to categorize images in the [To Do] category.

Jumping to Images



When you have many images recorded onto a memory card, it is handy to use the search keys below to jump over images to find the object of your search.

	Shot Date	Jumps to the first image of each shooting date.
	My Category	Displays the first image in each category.
	Folder	Displays the first image in each folder.
	Movie	Jumps to a movie.
	By 10 Images	Jumps over 10 images at a time.
	By 100 Images	Jumps over 100 images at a time.

1 In single image playback mode, press the button.

- The camera will switch to jump search mode.











2 Use the or button to select a search key.

- The screen sample will vary slightly according to the search key.
- You can show/hide image information using the **DISPLAY** button.

Image Information



3 Display the Images.

-  /  : press the  or  button.
-  /  /  /  : use the  or  button to select date, category, folder or movie for playback and press the **FUNC./SET** button.
 - The camera will switch to defined playback mode and play back only images corresponding to the search key.
 - Press the  button to cancel defined playback mode.

Select the search key



To Return to Single Image Playback: Press the **MENU** button.



- Defined playback mode will be canceled under the following conditions:
 - When images or movies are placed in categories
 - When images with My Colors effects or edited movies are saved as a new file.
 - When erasing an image with [Erase] in the on the  (Play) menu.



Movies cannot be played in the index playback mode.

1 Display a movie and press .



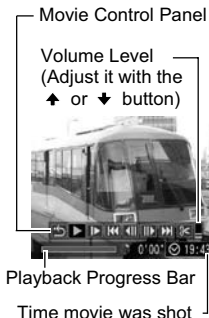







- Images with a  icon are movies.



2 Select (Play) and press .

- The movie will pause if you press the **FUNC./SET** button during playback. It will resume when you press the button again.
- When playback ends, the movie stops at the last frame displayed. Press the **FUNC./SET** button to display the movie control panel.
- You can switch between showing/hiding the playback progress bar by pressing the **DISPLAY** button while playing a movie.
- If playback was halted partway through in the prior viewing session, playback will resume from the last frame displayed.

Operating the Movie Control Panel

	Ends playback and returns to single image playback
	Print (An icon will display when a printer is connected. See the <i>Direct Print User Guide</i> for details.)
	Play
	Slow Motion (You can use the  button to slow down or the  button to speed up playback.)
	Displays the first frame
	Previous Frame (Rewinds if the FUNC./SET button is held down.)
	Next Frame (Fast Forwards if the FUNC./SET button is held down.)
	Displays the last frame
	Edit (Switches to movie editing mode.) (p. 95)



- Use the television's controls to adjust the volume when playing a movie on a TV set (p. 133).
- The sound cannot be played in slow motion playback.

Editing Movies





You can delete portions of recorded movies.



Movies that are protected or less than 1 second long cannot be edited.

1

Select  (**Edit**) in the movie control panel and press .



- The movie editing panel and the movie editing bar will display.

Movie Editing Panel



Movie Editing Bar

2 Use the **↑** or **↓** button to select (Cut Beginning) or (Cut End) and the **←** or **→** button to specify the cut point (**|**).

- To check a temporarily edited movie, select  (Play) and press the **FUNC./SET** button.
- Selecting  (Exit) cancels the edit and restores the movie control panel.

3 Select (Save) and press .

4 Select [New File] or [Overwrite] and press .

- [New File] saves the edited movie under a new file name. The pre-edit data is left unchanged.

Note, if you press the **FUNC./SET**

button while saving the movie, saving is cancelled.

- [Overwrite] saves the edited movie with its original name. The pre-edit data is lost.
- When there is not enough space left on the memory card, only [Overwrite] can be selected.



Depending on the movie's file size, it may take some time to save an edited movie. If the batteries run out partway through, edited movie clips cannot be saved. When editing movies, it is recommended to use fully charged batteries or the AC Adapter Kit ACK-DC20 (sold separately) (p. 138).

Rotating Images in the Display



Images can be rotated clockwise 90° or 270° in the display.

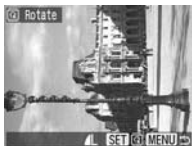

Original



90°



270°

1 (Play) Menu

See Menus and Settings (p. 25).

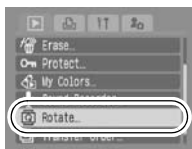

2 Use the **←** or **→** button to select an image to rotate and press to rotate it.



- Cycle through the 90°/270°/original orientations with each press of the **FUNC./SET** button.
- This also can be set in the index playback mode.



When images are downloaded to a computer, the orientation of images rotated by the camera will depend upon the software used to download the images.

Playback with Transition Effects

You can select the transition effect displayed when switching between images.

	No transition effect.
	The displayed image darkens and the next image gradually brightens until it is displayed.
	Press the ← button to have the previous image display from the left and the → button to have the next image display from the right.

1  **(Play) Menu**   /  *

See Menus and Settings (p. 25).

* Default setting.



Adding My Colors Effects

You can add effects to recorded images (stills only) using the My Colors function. The following selection of My Colors effects is available. For details, see p. 75.

	Vivid		Lighter Skin Tone
	Neutral		Darker Skin Tone
	Sepia		Vivid Blue
	B/W		Vivid Green
	Positive Film		Vivid Red

1 (Play) Menu .

See Menus and Settings (p. 25).



2 Use the or button to select an image, and press .



3 Use the or button to select the My Colors type, and press .

- The displayed image will reflect the My Colors effect.
- You can turn the zoom lever toward  to check the image at a higher magnification. While the image is zoomed, you can press the **FUNC./SET** button to switch between the image transformed with the My Colors effect and the original non-transformed image.



4 Select [OK], and press .

- The newly saved image transformed with the My Colors effect will be the last one in the list.
- To continue adding effects to other images, repeat the procedures from Step 2 onward.



5

Press  and select [Yes] or [No], then press



MENU

- Selecting [Yes] displays the image transformed with the My Colors effect, while [No] returns you to the Play menu.



- The My Colors function will not work if there is insufficient space on the memory card.
- Although My Colors effects can be added any number of times to an image, the image quality will gradually deteriorate with each application and the intended colors may not be achieved.
- Color in images taken using My Colors (p. 75) in shooting mode and images edited with the My Colors function in playback mode may differ slightly.

Attaching Sound Memos to Images

In playback mode (including single image playback, index playback, magnified playback, the review immediately after shooting in shooting mode and while confirming the focus immediately after the shooting) you can attach sound memos (up to 1 minute) to an image. The sound data is saved in WAVE format.

1 Press the button while playing back images.

- The sound memo control panel will display.







2 Use the or button to select (Record) and press .

- The elapsed time and the remaining time display.
- Pressing the **FUNC./SET** button pauses the recording. Pressing it again resumes recording.
- Up to 1 minute of recordings can be added to any one image.
- The sound mode can be changed (p. 58).



Sound Memo Panel
Elapsed Time/
Remaining Time
Volume _____
(Adjust it with the
↑ or ↓ button)

Sound Memo Panel

	Exit
	Record
	Pause
	Play
	Erase Select [Erase] in the confirmation screen and press the FUNC./SET button.
	Volume (0~5 levels)



- You cannot attach sound memos to movies.
- Sound memos for protected images cannot be erased.

Sound-Only Recording (Sound Recorder)



You can record sound only, without images, for up to two hours at one time.

1 (Play) Menu .

See Menus and Settings (p. 25).

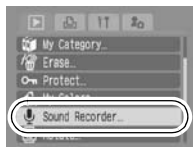

2 Select (Record) and press the button.

- Recording time will be displayed.
- Use the or button to change the sample rate. Sound quality will improve in the order of [11.025kHz], [22.050kHz], [44.100kHz]*, but the recorded file size will also increase respectively.
* Default setting.
- When pressing the **FUNC./SET** button, recording will pause. Pressing the button once again will resume recording.

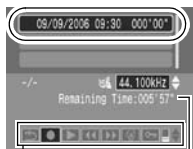

Available
Recording Time

Sound Control Panel









- The maximum recording time depends on the space available on the memory card, and the sound mode (p. 157).
- When the memory cards fills, recording will automatically stop.
- In the playback mode, the Sound Control Panel can be displayed by holding the button.

Automated Playback (Slide Shows)

Automated Playback of Memory Card Images.

* Image settings for slide shows are based on the Digital Print Order Format (DPOF) standard (p. 111).









	All Images	Plays all images on a memory card in order.
	Date	Plays images bearing a specified date in order.
	My Category	Plays the images in the selected category in order.
	Folder	Plays images in a specified folder in order.
	Movies	Plays movie files only, in order.
	Stills	Plays still images only, in order.
	Custom 1-3	Plays the images selected for each slide show, Custom 1, Custom 2 or Custom 3, in order (p. 105).

1 (Play) Menu .

See Menus and Settings (p. 25).





2 Use the , , or button to select , , , , , or .

- , , : select a date, category or folder to play back (p. 104).
- For ,  or , select the images to be played back (p. 105).
- If you want to add a transition effect to play back images, use the  button to select [Effect] and choose the type of effect with the  or  button (p. 104).



3 Select [Start] and press .





● The following functions are available during slide shows.

- Pausing/resuming the slide show: press the **FUNC./SET** button
- Fast forwarding/rewinding the slide show: press the  or  button (continue to hold the button to switch between images more rapidly)
- Stopping the slide show: press the **MENU** button.



Transition Effects

You can select the transition effect used when one image is replaced by another.

	No transition effect.
	The new image gradually brightens as it moves upward from the bottom.
	The new image first appears in a cross shape and gradually expands to display the full image.
	Portions of the new image move horizontally, then the image expands to display the full image.



In single image playback mode, you can start a slide show from the current image displayed by holding the **FUNC./SET** button while you press the  button. Please note that if you do this while the last image shot is displayed, the slide show will start from the first image using the same date.

Select a date/category/folder to play back (, ,)

1 Select , , or  and press .

2 Use the ← or → button to select a date/category/folder to play back and press the button.



Date







My Category

Folder

Selecting Images for Playback (1-3)

Select only the images that you wish to play back and save them as a slide show (Custom 1, 2 or 3). Up to 998 images can be selected. They will be played back in their order of selection.

1 Select , or and press .

- Only the  icon will display at first. When you set , the icon will change to  and  will display.  and  will change in the same way when they are set.

2 Use the ← or → button to move between images for playback and the button to select or deselect them.

- You can also select images in the index playback mode.
- Pressing the **MENU** button cancels the setting.

Check mark indicating selection

Number indicating the selection order





- **Selecting All Images**
 - 1 After selecting **1**–**3** in step 1 (p. 105), use the **▲** button to select [Mark all] and press the **FUNC./SET** button.
 - 2 Use the **▲** button to select [Mark all], press the **FUNC./SET** button.
 - 3 Use the **▶** button to select [OK] and press the **FUNC./SET** button.
- To deselect all images, select [Reset].

Adjusting the Play Time and Repeat Settings

● Play Time

Sets the duration that each image displays. Choose between 3*–10 seconds, 15 seconds and 30 seconds. Displaying time can vary slightly depending on the image.

*Default setting.

● Repeat

Sets whether the slide show stops when all the slides have been displayed or continues until stopped.

1 Select [Set up] and press  .

2 Select [Play Time] or [Repeat] and then the desired option.

- Pressing the **MENU** button cancels the setting.



Protecting Images



You can protect important images and movies from accidental erasure.

Select	You can configure the protection settings for each image singly while viewing them.
Select by Date	You can protect the images from a specified date.
Select by Category	You can protect all images in a specified category.
Select by Folder	You can protect all images in a specified folder.
All Images	You can protect all images on a memory card.

1 (Play) Menu .

See *Menus and Settings* (p. 25).



2 **Select a method and press** .

- If you select [All Images], proceed to Step 5.



3 Select the image, date, category or folder to protect and press .

● [Select]

Use the ◀ or ▶ button to select an image and press the **FUNC./SET** button.

- Pressing the **FUNC./SET** button again cancels the setting.
- You can also protect images in the index playback mode.
- Pressing the MENU button will end the setting.



● [Select by Date] [Select by Category] [Select by Folder]

Use the ▲ or ▼ button to select a date, category or folder and press the **FUNC./SET** button.

- You can select multiple dates, categories or folders.
- Pressing the **FUNC./SET** button again cancels the setting.
- Use the ◀ or ▶ button to confirm each date, category or folder image.



4 For the [All Images], [Select by Date], [Select by Category] and [Select by Folder] options, press .

5 Select [Protect] and press .

- Selecting [Unlock] cancels protection of the selected image and returns you to Step 2.
- Selecting [Stop] cancels selection of the protected image and returns you to Step 2.
- You may cancel the operation by pressing the **FUNC./SET** button during [Protect] mode.



Erasing Images



You can erase images from a memory card.

Select	Erases images after selecting them one at a time.
Select by Date	Erases images corresponding to the selected date.
Select by Category	Erases all images in the selected category.
Select by Folder	Erases all images in the selected folder.
All Images	Erases all images on a memory card.



- Note that erased images cannot be recovered. Exercise adequate caution before erasing an image.
- Protected images cannot be erased with this function.

1

(Play) Menu

See Menus and Settings (p. 25).



2

Select an option and press

- Proceed to Step 5 if you select [All Images].



3 Select images, a date, a category or a folder and press .

- [Select]

Use the ◀ or ▶ button to select an image and press the **FUNC./SET** button.

- Pressing the **FUNC./SET** button again cancels the setting.
- You can also protect images in the index playback mode.

- [Select by Date] [Select by Category] [Select by Folder]

Use the ▲ or ▼ button to select a date, category or folder and press the **FUNC./SET** button.

- Pressing the **FUNC./SET** button again cancels the setting.
- You can select multiple dates, categories or folders.
- Use the ◀ or ▶ button to confirm each date, category or folder image.



4 Press .

5 Select [OK] and press .

- Selecting [Stop] or [Cancel] cancels selection of the image you are about to erase and returns you to Step 2.
- Pressing the **FUNC./SET** button while erasing is in progress cancels the procedure.



Please format the memory card when you want to erase not only image data but also all the data contained on the card (p. 33).

Print Settings/Transfer Settings

Setting the DPOF Print Settings

You can select images on a memory card for printing and specify the number of print copies in advance using the camera. The settings used on the camera comply with the Digital Print Order Format (DPOF) standards. This is extremely convenient for printing on a direct print compatible printer, or for sending the images to a photo developing service that supports DPOF.

The  icon may display for a memory card with print settings set by a different DPOF-compliant camera. These settings will be overwritten by those set by your camera.

Select Images & Qty.	Configures print settings for single images as you view them.
Select by Date	Configures print settings for images corresponding to the selected date.
Select by Category	Configures print settings for images in the selected category.
Select by Folder	Configures print settings for images in the selected folder.
Select All Images	Configures print settings for all images.
Clear All Selections	Removes all print settings from images.



Print settings are configured for each image individually. With the [Select Images & Qty.] option, you can only set the number of copies to print when the [Print Type] option is set to [Standard] or [Both] (p. 114).

1 (Print) Menu ► Select a menu item.





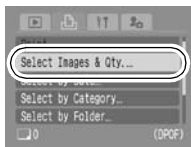

See Menus and Settings (p. 25).

- When selecting [Select All Images] go to Step 4.





2 Select the image, date, category or folder to print and press .

- [Select Images & Qty.]
Selection methods differ for the Print Type settings (p. 114).

-  (Standard)/  (Both)
Use the  or  button to select an image, press the **FUNC./SET** button and use the  or  button to select the number of print copies (up to 99).

Number of Print Copies



-  (Index)
Use the  or  button to select an image and the press **FUNC./SET** button to select or deselect it.
- You can also select images in the index playback mode.
- Pressing the **MENU** button will end the setting.

Index Print Selection



- **[Select by Date] [Select by Category] [Select by Folder]**
Use the **▲** or **▼** button to select a date, category or folder and press the **FUNC./SET** button.

- Pressing the **FUNC./SET** button again cancels the setting.
- You can select multiple dates, categories or folders.
- Pressing the **◀** or **▶** button will allow you to check the images by date, category or folder.



3 For the **[Select by Date], [Select by Category] and [Select by Folder] options, press .**



4 Select **[OK]** and press .

- Selecting [Cancel] cancels print settings of the selected image and returns you to Step 1.



- The output of some printers or photo developing services may not reflect the specified print settings.
- Print settings cannot be set for movies.



- Images are printed in order according to the file number.
- A maximum of 998 images can be selected.
- If you are connected to a printer, the  button will light blue while you are selecting images. You can start printing at this point by pressing the  button, confirming that [Print] is selected and pressing the **FUNC./SET** button.

Setting the Print Style

After setting the print style, select the images for printing. The following settings can be selected.

*Default setting

Print Type	<input checked="" type="checkbox"/> Standard*	Prints one image per page.
	<input type="checkbox"/> Index	Prints the selected images together at a reduced size in an index format.
	<input type="checkbox"/> <input type="checkbox"/> Both	Prints the images in both the standard and index formats.
<input checked="" type="checkbox"/> Date (On/Off*)	Adds the date to the print.	
<input type="checkbox"/> File No. (On/Off*)	Adds the file number to the print.	
Clear DPOF data (On*/Off)	Clears all print settings after the images print.	

1

 **(Print) Menu** ► **[Print Settings].**

See Menus and Settings (p. 25).

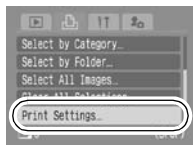

2

Select [Print Type], [Date], [File No.], or [Clear DPOF data] and then specify the settings.



- The Date and File No. settings change according to the Print Type as follows.
 - Index
[Date] and [File No.] cannot be set to [On] at the same time.
 - Standard or Both
[Date] and [File No.] can be set to [On] at the same time, however, the printable information may vary between printers.
- Dates print in the style specified in the [Date/Time] menu (*Basic Guide* p. 8).

Setting the DPOF Transfer Settings

You can use the camera to specify settings for images before downloading to a computer. Refer to the *Software Starter Guide* for instructions on how to transfer images to your computer.

The settings used on the camera comply with the Digital Print Order Format (DPOF) standards.

The  icon may display for a memory card with transfer settings set by a different DPOF-compliant camera. These settings will be overwritten by those set by your camera.

1 (Play) Menu .

See *Menus and Settings* (p. 25).

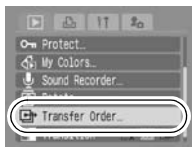

Single Images

2 Select [Order] and press .

- Selecting [Reset] cancels all transfer order settings.



3 Use the or button to select an image to transfer and press .

- Pressing the **FUNC./SET** button again deselects the setting.
- You can also select images in the index playback mode.



All the Images on a Memory Card

2 Select [Mark all] and press .

- Selecting [Reset] cancels all transfer order settings.



3 Select [OK] and press .



- Images are transferred in order according to the file number.
- A maximum of 998 images can be selected.

Customizing the Camera (My Camera Settings)

My Camera allows you to customize the start-up image and startup, operation, self-timer and shutter sounds. You can change and register these settings, enabling you to customize the camera to suit your own tastes.

Changing My Camera Settings

1 (My Camera) Menu ► Menu Item.

See Menus and Settings (p. 25).



2 Select the contents you wish to set.

- Select [Theme] to set all to the same settings.

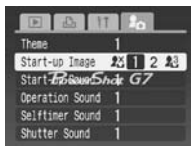

Registering My Camera Settings



Images recorded onto the memory card and newly recorded sounds can be added as My Camera settings to the menu items. You can also use the supplied software to upload your computer's images and sounds to the camera.



A computer is required to restore the My Camera settings to the defaults. Use the supplied software (ZoomBrowser EX/ImageBrowser) to restore the default settings to the camera.

1

(My Camera) Menu ► Menu Item to register.

See *Menus and Settings* (p. 25).

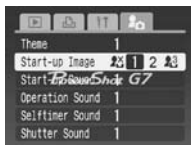

2

Select and press .

DISPLAY



3 Select an image or record a sound.

● Start-up Image

Use the ◀ or ▶ button to select the image you wish to register and press the **FUNC./SET** button.



● Start-up, Operation, Self-timer and Shutter Sounds

Select (Record) and press the **FUNC./SET** button. After recording, select (Register) and press the **FUNC./SET** button.



- Recording will automatically stop when the recording time elapses.
- To play it, select (Play).
- To exit instead of registering, press (Exit).

4 Select [OK] and press .

- To cancel registering, select [Cancel].



- The following cannot be registered as My Camera settings.
 - Movies
 - Sounds recorded with the sound memo function (p. 101) and sound recorder (p. 102)
- The prior setting is erased when a new My Camera setting is added.



See the supplied *Software Starter Guide* for more information on creating and adding to the My Camera data.

Troubleshooting

Camera

Camera will not operate.

Power is not turned on.	● Press the power button (<i>Basic Guide</i> p. 10).
Memory card slot/battery cover is open.	● Confirm that the memory card slot /battery cover is securely closed (<i>Basic Guide</i> p. 6).
Battery charge is low and the camera will not operate. (“Change the battery pack” message displays).	● Insert a fully charged battery into the camera (<i>Basic Guide</i> p. 6). ● Use the AC Adapter Kit ACK-DC20 (sold separately) (p. 138).
Poor contact between camera and battery terminals.	● Polish the terminals with a soft cotton swab before charging or using the battery (p. 134).

Sounds come from the camera interior.

The camera’s horizontal/vertical orientation was changed.	● The camera’s orientation mechanism is operating. There is no malfunction.
---	---

When the power is turned on

“Card locked!” message appears.

The SD memory card’s or SDHC memory card’s write protect tab is set to “Write protect”.	● When recording to, erasing from or formatting the memory card, slide the write protect tab upward (p. 136).
---	---

The Date/Time menu appears.

The built-in rechargeable lithium battery charge is low.	● Recharge the built-in battery immediately (<i>Basic Guide</i> p. 8).
--	---

Camera screen is black at start-up

Incompatible image has been selected as the start-up image in the My Camera Settings.

- Change the start-up image in the My Camera Settings (p. 118) or use the supplied ZoomBrowser EX or ImageBrowser program to restore the default settings. See ZoomBrowser EX/ ImageBrowser Software User Guide (PDF) for ZoomBrowser EX or ImageBrowser.

The display darkens.

The image in the LCD monitor will darken in strong sunlight or bright light.

- This is a normal occurrence in devices containing CCDs and does not constitute a malfunction. This image will not be recorded when shooting still photos, but it will be recorded when shooting movies.

Display flickers.

Display flickers when shot under fluorescent lighting.

- This is not a camera malfunction (flickering recorded in movies, but not in still images).

A bar of light (red, purple) appears on the LCD monitor.

Sometimes appears when shooting a bright subject, such as the sun or other light source.

- This is a normal occurrence in devices containing CCDs and does not constitute a malfunction. This bar of light will not be recorded when shooting still photos, but it will be recorded when shooting movies.
- Setting the ND Filter on may reduce this bar of light (p. 71).

Appears.

A slow shutter speed has likely been selected because of insufficient lighting.

- Set the IS Mode to any setting other than [Off] (p. 35).
- Raise the ISO speed (p. 38) or set the flash to any setting other than  (flash off), or secure the camera to something, such as a tripod (*Basic Guide* p. 14).

Appears.

This displays when using a memory card that has print settings or transfer settings set by other DPOF-compliant cameras.

- These settings will be overwritten by those set by your camera (p. 111).

Noise displays./Subject's movements are irregular.

Camera automatically lightened the image displayed on the LCD monitor to make it easier to see when shooting in a dark area (p. 14).

- There is no effect on the recorded image.

Shooting

Camera will not record.

Camera is in playback mode.

- Switch to Shooting mode (*Basic Guide* p. 9).

Flash is charging.

- When the flash is charged, the indicator will light orange. Shooting is now possible (*Basic Guide* p. 5).

Memory card is full.	<ul style="list-style-type: none"> ● Insert a new memory card (<i>Basic Guide</i> p. 7). ● If required, download the images to a computer and erase them from the memory card to make space.
Memory card is not formatted correctly.	<ul style="list-style-type: none"> ● Format the memory card (p. 33). ● If reformatting does not work, the memory card logic circuits may be damaged. Consult the nearest Canon Customer Support Help Desk.
SD memory card or SDHC memory card is write protected.	<ul style="list-style-type: none"> ● Slide the write protect tab upward (p. 136).

Image Seen in Viewfinder vs. Recorded Image

Usually the recorded image contains more of the scene than is seen in the viewfinder.	<ul style="list-style-type: none"> ● Confirm the actual image size with the LCD monitor. Use the LCD monitor when taking close-up shots (p. 12).
---	---

Image is blurred or out of focus.

AF-assist Beam is set to [Off].	<ul style="list-style-type: none"> ● In dark places where it is difficult for the camera to focus, the AF-assist Beam will emit to assist focusing. As the AF-assist Beam will not function when turned off, set it [On] to activate it (p. 27). Take care not to obstruct the AF-assist Beam with your hand when used.
The camera moves when the shutter button is pressed.	<ul style="list-style-type: none"> ● Set the IS Mode to any setting other than [Off] (p. 35). ● Setting the self-timer to  (2 seconds) delays the shutter release for 2 seconds after the shutter button is pressed and allows the camera to stop shaking, thus preventing a blurred image (<i>Basic Guide</i> p. 17). Even better results can be obtained by placing the camera on a stable surface or by using a tripod to shoot.













Subject is out of focal range.	<ul style="list-style-type: none"> ● Shoot with the subject at the correct shooting distance (p. 150).
The subject is hard to focus on.	<ul style="list-style-type: none"> ● Use the focus lock, AF lock or manual focus to shoot (p. 63).
Subject in recorded image is too dark.	
Insufficient light for shooting.	<ul style="list-style-type: none"> ● Set the built-in flash to  (Flash on) (<i>Basic Guide</i> p. 14). ● Use a high-output externally mounted flash. ● Set [ND Filter] to [Off] (p. 71).
The subject is underexposed because the surroundings are too bright.	<ul style="list-style-type: none"> ● Set the exposure compensation to a positive (+) setting (p. 41). ● Use the AE lock or spot metering functions (pp. 68, 39).
Subject is too far away for flash to reach.	<ul style="list-style-type: none"> ● Shoot within correct shooting distance of the subject when using the built-in flash (p. 151). ● Raise the ISO speed and then shoot (p. 38).
Subject in recorded image is too bright, or image flashes white.	
Subject is too close, making the flash too strong.	<ul style="list-style-type: none"> ● Adjust the flash output with the flash exposure compensation function (p. 73). ● Set the safety FE to [On] (p. 51).
The subject is overexposed because the surroundings are too dark.	<ul style="list-style-type: none"> ● Set the exposure compensation to a negative (-) setting (p. 41). ● Use the AE lock or spot metering functions (pp. 68, 39). ● Set [ND Filter] to [On] (p. 71).
Too much light is shining directly into the camera, or is being reflected off the subject.	<ul style="list-style-type: none"> ● Change the shooting angle.
Flash is set to on.	<ul style="list-style-type: none"> ● Set the flash to  (Flash off) (<i>Basic Guide</i> p. 14).

Image contains noise.

ISO speed is too high.

- Higher ISO speeds and  (High ISO Auto) setting may increase image noise. For higher image quality, use as low an ISO speed as possible (p. 38).
- In , , , , , , ,  and  modes in the **SCN**, the ISO speed increases and noise can appear.

White dots appear on the image.

Light from the flash has reflected off dust particles or insects in the air. This is particularly noticeable when shooting using the wide angle or when you increase the aperture value in the aperture-priority **Av** mode.

- This is a phenomenon that occurs with digital cameras and does not constitute a malfunction.

Eyes appear red.

Light is reflected back from the eyes when the flash is used in dark areas.

- Set [Red-Eye] to [On] in the shooting menu (*Basic Guide* p. 15). For this mode to be effective, the subject must be looking right at the red-eye reduction lamp. Try asking them to look directly at the lamp.
- Even better results can be obtained by increasing the lighting in indoor settings or approaching closer to the subject.

Continuous shooting slows down.

The memory card's performance has dropped.

- To enhance the continuous shooting performance, you are recommended to format the memory card in the camera after you save all its images to your computer (p. 33).

Recording images to memory card takes a long time.

Memory card was formatted in another device.

- Use a memory card formatted in your camera (p. 33).

Lens will not retract.

Memory card slot/battery cover was opened with power on.

- After closing the memory card slot/battery cover, turn the power on then back off (*Basic Guide* p. 7).

Shooting Movies

The recording time may not display properly or filming may stop unexpectedly.

The following types of memory cards are used.

- Slow recording cards.
- Cards formatted on a different camera or a computer.
- Cards which have had images recorded and erased repeatedly.

- Although the recording time may not display properly during shooting, the movie will be recorded correctly on the memory card. Recording time will display properly if you format the memory card in this camera (excluding slow recording memory cards) (p. 33).

“!” displayed on the LCD monitor in red and shooting automatically stopped.

There is insufficient free space in the camera's built-in memory.

- Try the following procedures.
 - Format the card with a low level format before filming (p. 33)
 - Lower the recording pixels or the frame rate (p. 56)
 - Use a high-speed memory card (SDC-512MSH, etc.)

Zoom does not operate.

Zoom lever was pressed while shooting in movie mode.

- Operate the zoom before shooting in movie mode (*Basic Guide* p. 14). Note the digital zoom is available while shooting, but only in Standard movie mode.

Playback

Cannot play back.

You attempted to play back images shot with another camera or images edited with a computer.

- Computer images that cannot be played back will play back if they are added to the camera using the supplied software program ZoomBrowser EX or ImageBrowser. See *ZoomBrowser EX/ ImageBrowser Software User Guide* (PDF).

File name was changed with a computer or file location was changed.

- Set the file name or location on the file format/structure of the camera. (Refer to the *Software Starter Guide* for details).

Movies cannot be edited.

Some movies shot with another camera cannot be edited.

Movies do not play back correctly.

Movies recorded with high recording pixels and frame rates may momentarily stop playing if played on slow reading memory cards.

You may experience frame dropping and audio breakup when playing back a movie on a computer with insufficient system resources.

Reading images from memory card is slow.

Memory card was formatted in another device.

- Use a memory card formatted in your camera (p. 33).

Battery/Battery Charger

Battery consumed quickly.

Battery life exceeded if battery loses its charge quickly at normal temperature (23 °C/73 °F).

- Replace the battery with a new one (*Basic Guide* p. 6).

Battery will not charge.

Battery life exceeded.

- Replace the battery with a new one (*Basic Guide* p. 6).

TV monitor output

Image not showing on TV monitor/Distorted image.

Incorrect video system setting.

- Set the video system to the appropriate setting, NTSC or PAL, for your TV (p. 30).

Shooting in Stitch Assist mode.

- The output will not appear on a TV in Stitch Assist mode. Shoot in a different shooting mode (*Basic Guide* p. 11).

Printing with a direct print compatible printer

Cannot print

The camera and printer are not properly connected.

- Securely connect the camera and printer with the specified cable.

The printer power is not turned on.

- Turn on the printer power.

The print connection method is not correct.

- In the  (Set up) menu, select [Print Method] and select [Auto] (p. 30).

List of Messages

The following messages may appear on the LCD monitor during shooting or playback. Please refer to the *Direct Print User Guide* for the messages that display during a printer connection.

Busy...

Image is being recorded to, or read from, memory card. The playback mode is starting up.

No memory card

You turned on the camera without a memory card installed, or with a memory card installed in the wrong orientation (*Basic Guide* p. 7).

Card locked!

The SD memory card or SDHC memory card is write-protected.

Cannot record!

You attempted to shoot an image without a memory card installed, with a memory card installed in the wrong orientation, or attempted to attach a sound memo to a movie.

Memory card error

There may be something wrong with the memory card. By formatting the malfunctioning memory card with the camera, you may be able to continue using it. However, if this error message appears even when using the supplied memory card, contact your Canon Customer Support Help Desk as there may be a problem with the camera.

Memory card full

Memory card is full of images and no more can be recorded or saved. Or no more image settings, sound memos or sound recorder can be recorded.

Naming error!

The image could not be created because there is an image with the same name as the folder that the camera is attempting to create, or the highest possible file number has already been reached. In the Set up menu, set [File Numbering] to [Auto Reset]. Or, after saving all the images you wish to retain onto a computer. Save all the images you wish to retain onto a computer, then reformat the memory card. Please note that formatting will erase all the existing images and other data.

Change the battery pack.

Battery charge is insufficient to operate the camera. Replace it at once with a charged one or recharge the battery.

No image

No images recorded on memory card.

Image too large

You attempted to play back an image larger than 4992 x 3328 pixels or with a large data size.

Incompatible JPEG format

You attempted to play back an incompatible JPEG image (edited with a computer, etc.).

RAW

You attempted to play back a RAW image.

Unidentified Image

You attempted to play back an image with corrupted data, an image with a recording type specific to another manufacturer's camera, or an image that has been downloaded to a computer and altered.

Cannot magnify!

You attempted to magnify an image recorded in a different camera or data type, an image edited with a computer, or a movie.

Cannot rotate

You attempted to rotate an image recorded in a different camera or data type, an image edited with a computer.

Incompatible WAVE format.

A sound memo cannot be added to this image since the data type of the existing sound memo is incorrect.

Cannot register this image!

You attempted to register an image recorded in a different camera or a movie as a start-up image.

Cannot modify image

You attempted to apply a My Colors effect to a movie or an image recorded in a different camera.

Cannot assign to category

You attempted to categorize an image recorded in a different camera.

Cannot transfer!

When transferring images to your computer using the Direct Transfer menu, you attempted to select an image with corrupted data or an image taken with another camera. You may have also attempted to select a movie when [Wallpaper] was selected in the Direct Transfer menu.

Protected!

You attempted to erase or edit a protected image, movie or sound memo.

Too many marks

Too many images have been marked with print settings, transfer settings or slide show settings. Cannot process any more.

Cannot complete!

Could not save the print, transfer or slide show settings.

Unselectable image

You attempted to set the print settings for a non-JPEG image.

Communication error

The computer was unable to download the image due to the large amount of images (approx. 1000) stored on the memory card.

Lens error, restart camera

An error was detected while the lens was in motion, and the power has been automatically turned off. This error can occur if you hold the lens while it is in motion or you operate it in a location with excessive dust or sand in the air. Try turning the power back on, and resume shooting or playback. If this message continues to display, contact your Canon Customer Support Help Desk as there may be a problem with the lens.

Exx

(xx: number) Camera detected error. Turn the power off and then back on, then shoot or play back. A problem exists if the error code reappears. Note the number and contact your Canon Customer Support Help Desk. If an error code displays directly after taking a picture, the shot may not have been recorded. Check image in playback mode.

Viewing Images on a TV set

You can shoot or play back images on a television with the supplied AV cable.

1 Turn off the Camera and the TV.

2 Connect the AV cable to the camera's AV OUT terminal.

- Open the terminal cover by slipping a fingernail under the right edge and plug the AV cable in all the way.

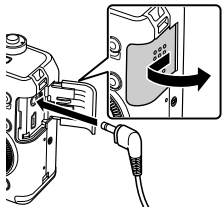

3 Plug the other ends of the AV cable to the VIDEO IN and AUDIO IN jacks on the TV.

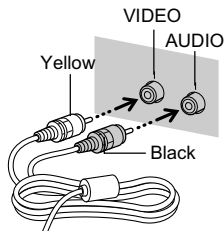

4 Turn on the TV and switch it to Video mode.

5 Turn on the camera.



The video output signal can be switched (NTSC or PAL) to accommodate different regional standards (p. 30). The default setting varies between regions

- NTSC: Japan, U.S.A., Canada, Taiwan and others
- PAL: Europe, Asia (excluding Taiwan), Oceania and others

If the video system is set incorrectly, the camera output may not display properly.

Battery Handling

Battery Charge

The following icon and message will display.



Battery charge is low.
Recharge it as soon as possible it will be used for an extended period.

Change the batteries

Battery charge is insufficient to operate the camera.
Replace the battery immediately.

Battery Handling Precautions

- **Keep the battery terminals clean at all times.**
Dirty terminals may cause poor contact between the battery and camera. Polish the terminals with a soft cotton swab before charging or using the battery.
- **At low temperatures, battery performance may be reduced and the low battery icon () may appear earlier than usual.**
Under these conditions, revive the battery by warming it in a pocket immediately before use.
- **However, ensure that there are no metallic items in the pocket that could cause a short circuit, such as a key ring, etc.**
The battery may short circuit.
- **Do not allow any metal objects such as key rings to touch the (+) and (-) terminals (Fig. A). To carry the battery or store it during periods of disuse, always replace the terminal cover (Fig.B).**
These conditions can damage the battery. You may be able to check the charge state depending upon how the terminal cover is attached (Fig. C, D).



U.S.A. and Canada only:

The Lithium ion/polymer battery that powers the product is recyclable.

Please call 1-800-8-BATTERY for information on how to recycle this battery.

Fig. A

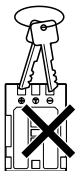

Fig. B

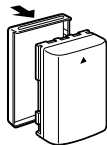
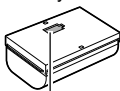

Fig. C

Fully Charged
Battery



Insert the battery
pack so the blue
area is visible.

Fig. D

Used Battery

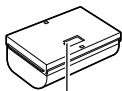

Attach in the
opposite way
of Fig. C.

- **You are recommended to use it in the camera until it is completely discharged and to store it in an indoor location with low relative humidity and between the temperatures of 0 – 30 °C (32 – 86 °F).**

Storing a fully charged battery for long periods of time (about one year) may shorten its life cycle or affect its performance. If you do not use the battery for long periods of time, charge it fully and discharge it fully in the camera about once a year before returning it to storage.

- **Do not mix batteries of different types or from different manufacturers.**

Charging the Battery

- **Since this is a lithium-ion battery, you need not completely discharge it before recharging.**
- **It takes approximately 1 hour 30 minutes to fully charge the battery from a depleted state (based on Canon's testing standards).**
 - Charging it within a temperature range of 5 – 40 °C (41 – 104 °F) is recommended.
 - Charge times may vary according to the ambient temperature and the battery's charge state.
- **You are advised to charge the battery on the day of use, or one day before, to ensure a full charge.**
Even charged batteries continue to discharge naturally.
- **If the performance of the battery diminishes substantially even when it is fully charged, its life has been exceeded and it should be replaced.**

Handling the Memory Card

SD memory card or SDHC memory card Write Protect Tab

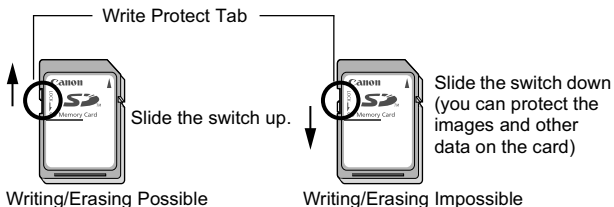

Cautions When Handling

- **Memory cards are high-precision electronic devices. Do not bend them, apply force to them, or subject them to shocks or vibration.**
- **Do not attempt to disassemble or alter the memory card.**
- **Do not allow dirt, water or foreign objects to contact the terminals on the back of the card. Do not touch the terminals with your hands or metal objects.**
- **Do not peel away the original label on the memory card or cover it with another label or sticker.**
- **When writing on the memory card, do not use a pencil or ball-point pen. Only use a soft point pen (e.g. felt-tip pen).**
- **Do not use or store memory cards in the following locations.**
 - Locations subject to dust or sand
 - Locations subject to high humidity and high temperatures
- **Since some or all of the data recorded on the memory card may be corrupted or erased by electrical noise, static electricity or card malfunction, making a backup copy of important data is recommended.**

Formatting

- **Please note that formatting (initializing) an memory card erases all data, including protected images.**
- **You are recommended to use memory cards that have been formatted in your camera.**
 - The card supplied with the camera may be used without further formatting.
 - When the camera is malfunctioning, a corrupted memory card might be the cause. Reformatting the memory card may solve the problem.
 - When a non-Canon brand memory card is malfunctioning, reformatting it may solve the problem.
 - Memory cards formatted in other cameras, computers, or peripheral devices may not operate correctly in this camera. When that happens, reformat the memory card with this camera.
- **If formatting in the camera does not work properly, turn the camera off and re-insert the memory card. Then turn the camera back on and format again.**
- **Be careful when transferring or disposing of a memory card. Formatting or erasing the data on a memory card merely changes the file management information on the card and does not ensure that its contents are completely deleted.**

When disposing of a memory card, take precautions, such as physically destroying the card, to prevent personal information leaks.

Using the Power Kits (Sold Separately)

Using the AC Adapter Kit ACK-DC20

It is best to power the camera with AC Adapter Kit ACK-DC20 (sold separately) when you are using it for long periods of time or connecting it to a computer.



Turn the camera power off before connecting or disconnecting the AC adapter.

- 1 Attach the power cord to the compact power adapter and plug it into a power outlet.**

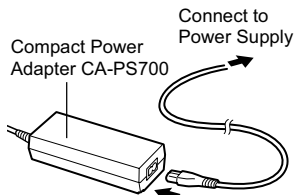

- 2 Connect the DC plug of the compact power adapter cable to the DC Coupler DR-20 terminal.**

DC Coupler DR-20

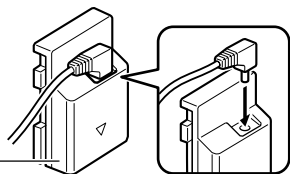

- 3 Open the memory card slot/battery cover, then insert the DC Coupler until it is locked.**

Battery lock

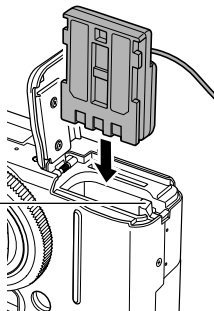

4 Press and hold the DC Coupler cable cover using the cable, then close the memory card slot/battery cover.

- Always disconnect the compact power adapter from the power supply after use.

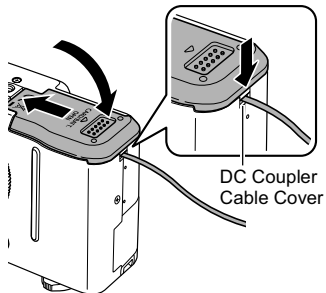

Using the Car Battery Charger CBC-NB2

Car Battery Charger CBC-NB2 (sold separately) can be used to charge battery packs from an automobile's cigarette lighter socket. Always ensure that the automobile's engine is running when you use the car battery charger. Use of it with the engine off may flatten the battery. Always unplug the car battery charger before turning off the engine.



- The battery will stop charging whenever you turn the engine off, so be sure to unplug the car battery cable from the cigarette lighter socket.
- Wait until the engine is running again to plug the car battery cable into the cigarette lighter socket.
- The car battery charger can only be used in a negative ground car. It cannot be used in a positive ground car.

1 With the engine running, plug the car battery cable into the cigarette lighter socket.

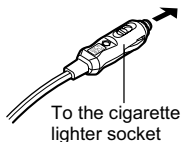

2 Insert the battery pack all the way into the battery charger as shown.

- Align the arrow on the battery pack and the arrow on the battery charger to correctly insert the battery pack in the charger.
- The charge indicator will light red while the battery pack is charging. It will change to green when the charge is complete.
- After charging, remove the battery pack and unplug the car battery cable from the cigarette lighter socket.

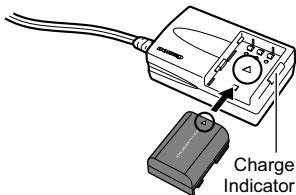

Using the Lenses (Sold Separately)

The camera supports use of the separately sold Wide Converter WC-DC58B and Tele-converter TC-DC58C. In order to attach these lenses, you also need to use the separately sold Conversion Lens Adapter LA-DC58H.



- When attaching the wide converter or tele-converter be sure to screw it on securely. If they come loose, they may fall from the lens adapter, posing risk of injury from shattered glass.
- Never look into the sun or into strong light through the wide converter or tele-converter as this can result in blindness or impairment of vision.



- If you use the built-in flash when shooting with these attachments, the outer area of the recorded image (especially lower right corner) will come out relatively dark.
- When using the tele-converter, please set the focal length to the telephoto end. At other zoom settings, the image will appear as if its corners have been cut off.
- When using the wide converter, please set the camera to the wide angle end.
- If you use the viewfinder for shooting, a portion of the view will be blocked by these attachments. Please use the LCD monitor.

■ **Wide Converter WC-DC58B**

Use this converter for taking wide-angle shots. The wide converter changes the focal length of the camera body's lens by a factor of 0.75x (the thread diameter is 58 mm).

■ **Tele-converter TC-DC58C**

This lens is used for taking telephoto shots. The lens changes the focal length of the camera body's lens by a factor of 2x. (the thread diameter is 58 mm).



It is not possible to attach a lens hood or filter to the wide converter or tele-converter.

■ **Conversion Lens Adapter LA-DC58H**

This is a lens adapter required for attaching the wide converter or tele-converter.

Attaching a Lens

- 1 Be sure that the camera is turned off.**
- 2 Press the ring release button and hold it down, and turn the ring in the direction of the arrow.**

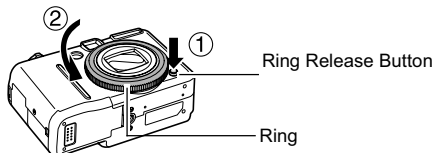

- 3 When the ○ mark on the camera and the ● mark on the ring are aligned, lift off the ring.**

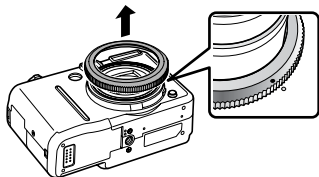

- 4 Align the ● mark on the conversion lens adapter with the ○ mark on the camera, and turn the adapter in the direction of the arrows until locked.**

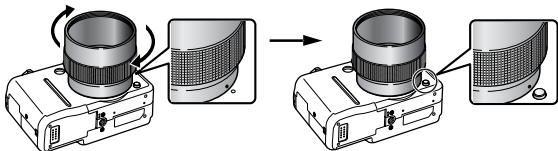

- To remove the conversion lens adapter, turn the adapter in the opposite direction with holding down the ring release button.

5 Set the lens on the adapter, and turn it in the indicated direction to attach it securely.



- Completely remove all dust and dirt from conversion lenses with a lens blower brush before use. The camera may focus on any dirt that remains.
- Be careful when handling the lenses since it is easy to get finger prints on them.
- Be careful not to drop the camera or adapter when removing the ring.
- When using these lens attachments, you should not shoot images in  mode. It will not be possible to use the PhotoStitch software from your computer to accurately stitch the images together.

Converter Settings

Set up when shooting using the [IS Mode] (p. 35) by attaching the Wide Converter WC-DC58B or Tele-converter TC-DC58C, sold separately.

1

 (Rec.) Menu ► [Converter] ► [Off]* / [WC-DC58B]/[TC-DC58C].

See Menus and Settings (p. 25).

* Default setting.

- Select the attached converter.



When you remove the converter from the camera, return the converter setting to [Off].

Using an Externally Mounted Flash (Sold Separately)

Shooting Mode

AUTO SCN*   **P** Tv Av M

* Cannot be set in , ,  and  modes.

Speedlites

You can make your flash photography even clearer and more natural appearing with the use of a separately sold externally mounted flash.

The camera's auto exposure function will operate with a Canon Speedlite 220EX, 430EX or 580EX. (Except with the **M** mode or when [Flash Adjust] is set to [Manual].) Other flashes may fire manually or not fire at all.

Please check the manual for your flash.

* Certain functions noted in the manuals for the Canon Speedlite 220EX, 430EX and 580EX cannot be performed when mounted on this camera. Please read this guide before using one of these flashes on the camera.

1 Attach the flash to the camera's hot shoe.

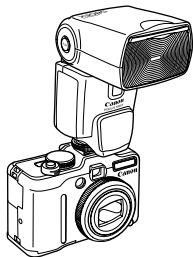

2 Turn the external flash on and press the camera power button.

-  (red) appears on the LCD monitor.

3 Turn the shooting mode dial to the desired mode.

Speedlite 220EX, 430EX or 580EX

- The maximum flash synchro shutter speed is 1/250 second.
- The flash will automatically adjust its output when [Flash Adjust] is set to [Auto].
- In **M** mode or when [Flash Adjust] is set to [Manual], the flash will fire with manual adjustments. Refer to the guide number noted in the instructions manual for the flash you are using for aperture value and ISO speed, and set the appropriate value for the distance from the subject.
- When [Flash Adjust] is set to [Manual], the flash output can be adjusted. When [Flash Adjust] is set to [Auto] the flash exposure compensation can be adjusted (p. 73).
- In **M** mode or when [Flash Adjust] is set to [Manual], the output of an externally mounted flash can be adjusted in the flash output adjustment screen (p. 73). When a Speedlite 430EX or 580EX is mounted on the camera, you can adjust the flash output from either the flash or the camera. (The flash setting overrides the camera setting when both are set.) To set it from the flash, you are recommended to use the flash's manual mode. When using Speed Light 220 EX, adjustment can be made on the camera only. You can also adjust the flash output even when the camera is set to the E-TTL automatic flash exposure compensation mode by changing the flash exposure compensation setting. To shoot with the flash, you are recommended to set the white balance to the  (Flash) setting.

Other Canon Flashes

- Since other flashes fire at full strength, set the shutter speed and aperture accordingly. You are recommended to set the white balance to  (Flash) to shoot.

4 Press the shutter button halfway.

- The flash is charged when its pilot lamp lights up.

5 Press the shutter button all the way to shoot the image.



- For continuous shooting, the flash can be in quick flash mode (pilot lamp flashing in green). In this case, light emission may be smaller than with full flash (pilot lamp flashing in red).
- The focus bracketing mode and the AEB mode cannot be used for flash photography. If the flash fires, only one image gets recorded.
- Flashes (especially high-voltage flashes) or flash accessories made by other manufacturers may override certain camera functions or cause a camera malfunction.



- The following functions can be used with a Speedlite 220EX, 430EX or 580EX.
 - Auto Exposure (Use the E-TTL mode with a 430EX or 580EX)
 - FE Lock (Not available in **M** mode or when [Flash Adjust] is [Manual])
 - Flash Sync (1st-curtain/2nd-curtain) (2nd-curtain priority with Speedlite 430EX or 580EX)
 - Slow Synchro
 - Flash Exposure Compensation (When Speedlite 430EX or 580EX is used, if flash exposure adjustments are made both from the camera and the flash, the 430EX's (or 580EX's) flash exposure compensation setting takes precedence when the flash is set to E-TTL mode. The camera's flash exposure compensation setting will not activate.)
 - Auto Zoom (Not available with the 220EX)
 - Manual flash

High-Power Flash HF-DC1

This flash is used to supplement the camera's built-in flash when the subject is too far away for proper illumination. Use the following procedures to affix the camera and High-Power Flash to the supporting bracket.

Please read the instructions accompanying the flash along with this explanation.

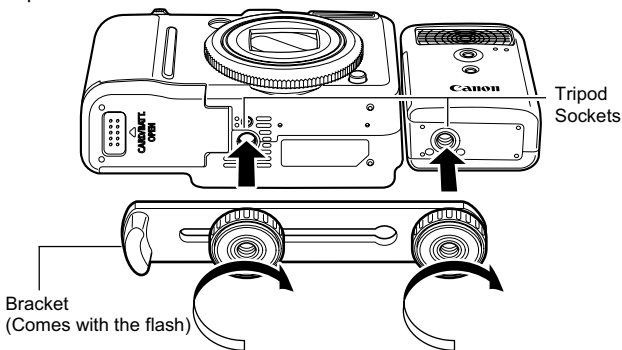

- The High-Power Flash will not fire under the following circumstances.
 - When shooting in **M** mode
 - When [Flash Sync] is on [2nd-curtain]
 - When [Flash Adjust] is on [Manual]
- The flash charge time will lengthen as the battery charge gets weaker. Always set the power/mode switch to [OFF] when you finish using the flash.
- Be careful not to touch the flash window or sensor windows with your fingers while the flash is in use.
- The flash may fire if another flash is being used in close proximity.
- The High-Power Flash may not fire outdoors in daylight or when there are no reflective items.

- For continuous shooting, although the flash fires for the first shot, it does not fire for subsequent shots.
- Fasten the attachment screws securely so that they do not loosen. Failure to do so may lead to the dropping of the camera and flash resulting in damage to both.



- Before attaching the bracket to the flash, check that the lithium battery (CR123A or DL123) is installed.
- Fix the high power flash parallel to the front panel of the camera, so that the flash will illuminate the subjects properly.
- A tripod can be used even when the flash is attached.

■ Batteries

● Charge becomes Severely Limited

If the battery usage time has considerably diminished, wipe the battery terminals well with a dry cloth. The terminals may be dirty from fingerprints.

● Usage in Cold Temperatures

Get a spare generic lithium battery (CR123A or DL123). You are recommended to place the spare battery in your pocket to warm it up before switching it for the battery in the flash.

● Non-Use over Extended Periods

Leaving batteries in the High-Power Flash could allow the battery fluid to leak, damaging the product. Remove the batteries from the High-Power Flash and store them in a cool, dry place.

Camera Care and Maintenance

Never use thinners, benzine, synthetic cleansers or water to clean the camera. These substances may distort or damage the equipment.

Camera Body

Gently wipe dirt off the camera body with a soft cloth or eyeglass lens wiper.

Lens

First use a lens blower brush to remove dust and dirt, then remove any remaining dirt by wiping the lens lightly with a soft cloth.



Never use synthetic cleansers on the camera body or lens. If dirt remains, contact the closest Canon Customer Support Help Desk as listed on the customer support list supplied with your camera.

Viewfinder and LCD Monitor

Use a lens blower brush to remove dust and dirt. If necessary, gently wipe with a soft cloth or an eyeglass lens wiper to remove stubborn dirt.



Never rub or press strongly on the LCD monitor. These actions may damage it or lead to other problems.

Soft Case SC-DC50 (Sold Separately)

Handle with care. Leather material may discolor.

Specifications

All data is based on Canon's standard testing methods. Subject to change without notice.

PowerShot G7

(W): Max. wide angle (T): Max. telephoto

Camera Effective Pixels	: Approx. 10.0 million
Image Sensor	: 1/1.8-inch type CCD (Total number of pixels: Approx. 10.4 million)
Lens	: 7.4 (W) – 44.4 (T) mm (35mm film equivalent: 35 (W) – 210 (T) mm) f/2.8 (W) – f/4.8 (T)
Digital Zoom	: Approx. 4.0x (Up to approx. 24x in combination with the optical zoom)
Optical Viewfinder	: Real-image zoom viewfinder Picture coverage approx. 80% (representative value) Eyepoint: 15 mm (0.59 in.) Dioptric adjustment –3.0 to + 1.0 1/m (dpt)
LCD Monitor	: 2.5-inch type, low-temperature polycrystalline silicon TFT color LCD, approx. 207,000 pixels (Picture coverage 100%)
AF System	: TTL autofocus AF lock and Manual focus are available AiAF (Face Detect/9-point) / AF (1-point*) * Fixed to center or FlexiZone
Shooting Distance (From the front of the lens)	: Normal: 50 cm (1.6 ft.) – infinity Macro: 1 – 50 cm (W) (0.39 in. – 1.6 ft. (W)) Manual focus: 1 cm (0.39 in.) – infinity (W)/ 50 cm (1.6 ft.) – infinity (T) Sports mode: 1 m (3.3 ft.) – infinity (W)/ 3 m (9.8 ft.) – infinity (T)
Shutter	: Mechanical shutter + electronic shutter

Shutter Speeds	: 15 – 1/2500 sec. <ul style="list-style-type: none"> • The shutter speed varies depending on the shooting mode. • Slow shutter speeds of 1.3 sec. or slower operate with noise reduction.
Image Stabilization	: Lens-shift type Continuous/Shoot Only*/Panning*/Off * Still images only
Metering System	: Evaluative, Center-weighted average or Spot* *Fixed to center or linked to the AF frame
Exposure Compensation	: ± 2.0 stops in 1/3-stop increments
ISO Speed* ¹	: Auto* ² , High ISO Auto* ² , ISO 80/100/200/400/800/1600 * ¹ Standard Output Sensitivity, Recommended Exposure Index. * ² Camera automatically sets the optimal speed.
ND Filter (built-in)	: Light intensity reduction: 3 stops (Intensity becomes 1/8 of actual level)
White Balance	: Auto, Day Light, Cloudy, Tungsten, Fluorescent, Fluorescent H, Flash, Underwater or Custom
Built-in Flash	: Auto, on, off Flash output compensation (±2.0 stops in 1/3-stop increments), flash output settings (3 steps), FE Lock, Slow Synchro, 2nd-curtain Synchro, Safety FE and Red-Eye Reduction are available.
Built-in Flash Range	: Normal: 50 cm – 4.0 m (1.6 – 13.1 ft.) (W), 50 cm – 2.5 m (1.6 – 8.2 ft.) (T) Macro: 30 – 50 cm (12 in. – 1.6 ft.) (W) (ISO speed : Auto)
External Flash	: Flash output compensation (±2.0 stops in 1/3-stop increments), flash output settings (19 steps), FE Lock, Slow Synchro, 2nd-curtain Synchro and Safety FE are available.
Terminals for External Flash	: Hot shoe flash-sync contacts Use of the following external flashes is recommended: Canon Speedlite 220EX, 430EX and 580EX.

Shooting Modes	: Auto Creative zone: Program, Shutter-speed priority, Aperture priority, Manual, Custom 1, Custom 2 Image zone: Special Scene ¹ , Stitch Assist and Movie ² ¹ Portrait, Landscape, Night Scene, Sports, Night Snapshot, Kids&Pets, Indoor, Foliage, Snow, Beach, Fireworks, Aquarium, Underwater, ISO3200, Color Accent and Color Swap. ² Standard, High Resolution, Compact, Color Accent and Color Swap.	
Continuous Shooting	: Approx. 2.0 shots/sec. (Large/Fine mode) Approx. 0.8 shots/sec. (Continuous Shooting AF, Large/Fine mode)	
Self-timer	: Activates shutter after an approx. 10-sec./ approx. 2-sec., Custom Timer	
Computer-controlled shooting	: Shooting possible when connected to a computer using supplied software.	
Recording Media	: SD memory card/SDHC memory card/ MultiMediaCard	
File Format	: Design rule for camera file system and DPOF compliant	
Data Type (Still images)	: Exif 2.2 (JPEG)*	
(Movies)	: AVI (Image data: Motion JPEG; Audio data: WAVE (monaural)) * This digital camera supports Exif 2.2 (also called "Exif Print"). Exif Print is a standard for enhancing the communication between digital cameras and printers. By connecting to an Exif Print-compliant printer, the camera's image data at the time of shooting is used and optimized, yielding extremely high quality prints.	
Compression	: Superfine, Fine, Normal	
Number of (Still images)	Large:	3648 x 2736 pixels
Recording Pixels	Medium 1:	2816 x 2112 pixels
	Medium 2:	2272 x 1704 pixels
	Medium 3:	1600 x 1200 pixels
	Small:	640 x 480 pixels
	Widescreen:	3648 x 2048 pixels

- (Movies) : Standard, Color Accent and Color Swap:
640 x 480 pixels (30 frames/sec., 15 frames/sec.)
320 x 240 pixels (30 frames/sec., 15 frames/sec.)
Recording can continue until the memory card is full* (can record up to a maximum of 4GB at one time)**
High Resolution:
1024 x 768 pixels (15 frames/sec.)
Recording can continue until the memory card is full* (can record up to a maximum of 4GB at one time)**
Compact:
160 x 120 pixels (15 frames/sec.)
Maximum recording length per clip: 3 min.
* Using super high-speed memory cards (SDC-512 MSH recommended).
** Even if the clip size has not reached 4GB, recording will stop at the moment the clip length reaches 1 hour. Depending on the volume and data writing speed of the memory card, recording will stop after one hour of continuous recording even if the recorded data volume has not reached 4GB.

-
- Audio : Quantization Bit Rate: 16 bit
Sampling Rate
Sound Memos, Movies (Compact):
11.025 kHz
Movies (except Compact): 44.100 kHz
Sound Recorder: 11.025 kHz, 22.050 kHz,
44.100 kHz

-
- Playback Modes : Single (histogram displayable), Index (9 thumbnail images), Magnified (approx. 10x (max.) in LCD monitor, advance or reverse through magnified images possible), Jump (it is possible to jump to every tenth or hundredth image, to the first image of each shooting date, to movies or to the first image in each folder. In index playback mode, it displays 9 images at once.), Auto Play, My Color, Sound memos (up to 1 min.), Movie (edit/slow motion play back possible), or Sound recorder (up to 2 hours).

Direct Print	: <i>PictBridge</i> compliant, and <i>Canon Direct Print</i> and <i>Bubble Jet Direct</i> compatible
My Camera Settings	: Start-up image, start-up sound, operation sound, self-timer sound, and shutter sound.
Interface	: USB 2.0 Hi-Speed (mini-B), PTP (Picture Transfer Protocol) Audio/Video output (NTSC or PAL selectable, monaural audio)
Power Source	: Battery Pack NB-2LH (Rechargeable lithium-ion battery) AC Adapter Kit ACK-DC20
Operating Temperatures	: 0 – 40 °C (32 – 104 °F)
Operating Humidity	: 10 – 90%
Dimensions (excluding protrusions)	: 106.4 x 71.9 x 42.5 mm (4.19 x 2.83 x 1.67 in.)
Weight (camera body only)	: Approx. 320 g (11.3 oz.)

Battery Capacity (Battery Pack NB-2LH (Fully charged))

Number of Images Shot		Playback Time
LCD Monitor On (Based on the CIPA standard)	LCD Monitor Off	
Approx. 220 images	Approx. 500 images	Approx. 5 hours

- The actual figures will vary according to the shooting conditions and settings.
- Movie data is excluded.
- At low temperatures, the battery performance may diminish and the low battery icon may appear very rapidly. In these circumstances, the performance can be improved by warming the battery in a pocket before use.

Test Conditions

Shooting: Normal temperature ($23^{\circ}\text{C} \pm 2^{\circ}\text{C}/73^{\circ}\text{F} \pm 3.6^{\circ}\text{F}$), normal relative humidity ($50\% \pm 20\%$), alternating wide angle end and telephoto end shots at 30 second intervals with the flash fired once every two shots and the camera power turned off after every tenth shot. Power is left off for a sufficient amount of time*, then the power is turned back on and the testing procedure is repeated.

- A Canon-brand memory card is used.

* Until the battery returns to normal temperature



















Playback: Normal temperature ($23^{\circ}\text{C} \pm 2^{\circ}\text{C}/73^{\circ}\text{F} \pm 3.6^{\circ}\text{F}$), normal relative humidity ($50\% \pm 20\%$), continuous playback at 3 seconds per image.



See *Battery Handling Precautions* (p. 134).

Memory Cards and Estimated Capacities















: Card included with the camera

Recording Pixels	Compression	32MB	SDC-128M	SDC-512MSH
L (Large) 3648 x 2736 pixels		6	29	116
		11	50	194
		24	103	402
M1 (Medium 1) 2816 x 2112 pixels		10	45	176
		17	75	292
		36	156	603
M2 (Medium 2) 2272 x 1704 pixels		14	61	237
		25	109	425
		51	217	839
M3 (Medium 3) 1600 x 1200 pixels		28	121	471
		51	217	839
		97	411	1590
S (Small) 640 x 480 pixels		109	460	1777
		168	711	2747
		265	1118	4317
W (Widescreen) 3648 x 2048 pixels		9	40	157
		15	66	257
		32	139	539

-  Capable of smooth continuous shooting (p. 44) (Only available when card has been formatted with a low level format).
- This reflects standard shooting criteria established by Canon. Actual results may vary according to the subject and shooting conditions.

Movie

☐: Card included with the camera

	Recording Pixels	Frame Rate	32MB	SDC-128M	SDC-512MSH
 Standard	 640 x 480 pixels		14 sec.	1 min. 1 sec.	3 min. 57 sec.
			27 sec.	1 min. 56 sec.	7 min. 30 sec.
 Color Accent	 320 x 240 pixels		38 sec.	2 min. 42 sec.	10 min. 29 sec.
 Color Swap			1 min. 6 sec.	4 min. 39 sec.	17 min. 58 sec.
 High Resolution	 1024 x 768 pixels		14 sec.	1 min. 1 sec.	3 min. 57 sec.
 * Compact	 160 x 120 pixels		3 min. 5 sec.	13 min. 2 sec.	50 min. 21 sec.



* Maximum movie clip length at : 3 min. The figures indicate the maximum continuous recording time.















Estimated Sound Recorder File Sizes and Recording Times

☐: Card included with the camera

	Sound Size	32MB	SDC-128M	SDC-512M
11.025 kHz	22 KB/sec.	23 min. 4 sec.	1 hr. 36 min. 59 sec.	6 hrs. 14 min. 16 sec.
22.050 kHz	44 KB/sec.	11 min. 32 sec.	48 min. 30 sec.	3 hrs. 7 min. 8 sec.
44.100 kHz	88 KB/sec.	5 min. 46 sec.	24 min. 15 sec.	1 hr. 33 min. 34 sec.

Image Data Sizes (Estimated)

Recording Pixels	Compression		
			
L 3648 x 2736 pixels	4100 KB	2460 KB	1170 KB
M1 2816 x 2112 pixels	2720 KB	1620 KB	780 KB
M2 2272 x 1704 pixels	2002 KB	1116 KB	556 KB
M3 1600 x 1200 pixels	1002 KB	558 KB	278 KB
S 640 x 480 pixels	249 KB	150 KB	84 KB
W 3648 x 2048 pixels	3040 KB	1847 KB	874 KB

	Recording Pixels	Frame Rate	File size
 Standard	 640 x 480 pixels	 30	2006 KB/sec.
		 15	1046 KB/sec.
 Color Accent	 320 x 240 pixels	 30	746 KB/sec.
 Color Swap		 15	416 KB/sec.
 High Resolution	 1024 x 768 pixels	 15	2066 KB/sec.
 Compact	 160 x 120 pixels	 15	142 KB/sec.

MultiMediaCard

Interface	Compatible with MultiMediaCard standards
Dimensions	32.0 x 24.0 x 1.4 mm (1.3 x 0.9 x 0.06 in.)
Weight	Approx. 1.5 g (0.05 oz.)

SD Memory Card

Interface	Compatible with SD memory card standards
Dimensions	32.0 x 24.0 x 2.1 mm (1.3 x 0.9 x 0.1 in.)
Weight	Approx. 2 g (0.07 oz.)

Battery Pack NB-2LH

Type	Rechargeable lithium-ion battery
Nominal Voltage	7.4 V DC
Typical Capacity	720 mAh
Cycle Life	Approx. 300 times
Operating Temperatures	0 – 40°C (32 – 104°F)
Dimensions	33.3 x 45.2 x 16.2 mm (1.31 x 1.78 x 0.64 in.)
Weight	Approx. 43 g (1.52 oz.)

Battery Charger CB-2LW/CB-2LWE

Rated Input	100 – 240 V AC (50/60 Hz) 0.12 A (100 V) – 0.065 A (240 V)
Rated Output	8.4 V DC, 0.55 A
Charging Time	Approx. 1 hr. 30 min. (when charging NB-2LH)
Operating Temperatures	0 – 40 °C (32 – 104 °F)
Dimensions	56.0 x 91.0 x 22.5 mm (2.2 x 3.6 x 0.9 in.)
Weight	Approx. 68 g (2.4 oz.) (CB-2LW) Approx. 61 g (2.2 oz.) (CB-2LWE) (excluding power cord)

Compact Power Adapter CA-PS700

(Included with the separately sold AC Adapter Kit ACK-DC20)

Rated Input	100 – 240 V AC (50/ 60 Hz)
Rated Output	7.4 V DC, 2.0 A
Operating Temperatures	0 – 40°C (32 – 104°F)
Dimensions	45.0 x 112.0 x 29.0 mm (1.77 x 4.41 x 1.14 in.) (body only)
Weight	Approx. 185 g (6.53 oz.) (excluding power cord)

Car Battery Charger CBC-NB2 (Sold Separately)

Rated Input	12 V/ 24 V DC
Rated Output	8.4 V DC, 0.55 A
Charging Time	Approx. 1 hr. 30 min. (when charging NB-2LH)
Operating temperatures	0 – 40 °C (32 – 104 °F)
Dimensions	91.0 x 29.5 x 56.0 mm (3.58 x 1.16 x 2.20 in.)
Weight	Approx. 145 g (5.11 oz.) (excluding power cord)

Wide Converter WC-DC58B (Sold Separately)

Magnification	0.75x
Focal Length* ¹	26.3 mm (35mm film equivalent)
Focusing Range* ¹	Approx. 30 cm (12 in.) – infinity (W)* ²
Thread Diameter	58 mm standard filter thread* ³
Dimensions	Diameter: 97.0 mm (3.82 in.) Length: 49.5 mm (1.95 in.)
Weight	Approx. 365 g (12.9 oz.)

Tele-converter TC-DC58C (Sold Separately)

Magnification	2x
Focal Length*4	420 mm (35mm film equivalent)
Focusing Range*4	Approx. 1.8 m (5.9 ft.) – infinity (T)*2
Thread Diameter	58 mm standard filter thread*3
Dimensions	Diameter: 80.0 mm (3.15 in.) Length: 81.3 mm (3.20 in.)
Weight	Approx. 335 g (11.8 oz.)

*1 When mounted on PowerShot G7 (Max. wide angle)

*2 From front of the mounted tele-converter during normal shooting.

*3 Conversion Lens Adapter LA-DC58H is required when mounted on PowerShot G7

*4When mounted on PowerShot G7 (Max. telephoto)

Conversion Lens Adapter LA-DC58H (Sold Separately)

Thread Diameter	58 mm standard filter thread
Dimensions	Diameter: 63.5 mm (2.50 in.) Length: 50.6 mm (1.99 in.)
Weight	Approx. 25 g (0.88 oz.)

(W) : Max. wide angle (T) : Max. telephoto

Index

Numerics

1st-curtain	74
2nd-curtain	74
3:2 Guide	15

A

AC Adapter Kit ACK-DC20	138
AE Lock	68
AEB Mode	70
AF Frame	61
AF Lock	63, 64
AF Mode	60
AF-assist Beam	27, 123
AiAF	61
Aperture Value	48, 50, 51
Audio	58
Auto Rotate Function	84

B

Battery	
Battery Capacity	155
Charging	<i>Basic</i> 6
Handling	134
Installing	<i>Basic</i> 6

C

Car Battery Chager	139
Category	
Auto Category	27
My Category (Playback)	92
Clock Display	13
Color Accent Mode	78
Color Swap Mode	79
Compression	35
Continuous Shooting	44
Control Dial	<i>Basic</i> 4
Create Folder	85
Creative Zone	<i>Basic</i> 13

Custom Settings	59
-----------------------	----

D

Date/Time	<i>Basic</i> 8
Digital Tele-converter	36
DIGITAL Terminal	<i>Basic</i> 27
Digital Zoom	36
Direct Transfer	<i>Basic</i> 30
Distance Units	30
Downloading Images to a Computer	
<i>Basic</i> 24	
DPOF	
Print Settings	111
Transfer Order	115

E

Erasing	109, <i>Basic</i> 19
Exposure	41

F

Face Detect	61
FE Lock	69
File Number	19, 87, 114
Flash	<i>Basic</i> 14
Focus	46, 61
Focus Bracketing	
(Focus-BKT Mode)	67
Focus Lock	64
Frame Rate	57
FUNC./SET	24, <i>Basic</i> 3

G

Grid Lines	15
------------------	----

H

High-Power Flash	147
Histogram	17

I		Print Menu	25, 28
Image Data Sizes (Estimated)	158	Rec. Menu	25, 26
Image Zone	<i>Basic</i> 12	Set up Menu.....	25, 28
Index Playback	90	MENU Button	25, <i>Basic</i> 3
Indicator	<i>Basic</i> 5	Messages	129
Interface Cable	<i>Basic</i> 22, <i>Basic</i> 27	Metering Modes	39
ISO Speed	38	MF-Point Zoom	27, 65
J		Mic Level.....	58
Jump (Image Search).....	92	Movie	
L		Editing	95
Landscape	<i>Basic</i> 12	Playback	94
Language	<i>Basic</i> 9	Shooting	54
LCD Monitor		Mute	28
Brightness	14	My Camera Settings	
Night Display	14	Changing	117
Playback Information.....	19	Registering.....	118
Shooting Information	19	My Category.....	92
Using the LCD Monitor.....	12	My Colors.....	75
Lens		My Colors Effects	98
Conversion Lens Adapter ...	140	N	
Tele-converter	140	ND Filter.....	71
Wide Converter.....	140	P	
M		Playback	<i>Basic</i> 18
Macro	<i>Basic</i> 16	Power Button ..	<i>Basic</i> 3, <i>Basic</i> 10
Magnifying	89	Power Saving	21
Manual Focus	65	Power Souce	
Memory Card		Compact Power Adapter.....	138
Estimated Capacities	156	Print/Share Button	
Formatting	33	<i>Basic</i> 3, <i>Basic</i> 22, <i>Basic</i> 30
Handling	136	Printing	111, <i>Basic</i> 22
Inserting	<i>Basic</i> 7	Program Shift	69
Menu		Protect	107
FUNC. Menu.....	24, 26	Q	
Menus and Settings	24, 25	Quick-bright LCD.....	14
My Camera Menu	25, 31	R	
Play Menu	25, 28	Recording Pixels	34, 57
		Red-Eye Reduction	<i>Basic</i> 15

Reset All	32
Review	<i>Basic</i> 11
Rotate	97

S

Safety FE	51
Safety Shift	51
Safety Zoom.....	37
Save Original	81
Self-Timer	<i>Basic</i> 17
Shooting Mode	<i>Basic</i> 12
Av	<i>Basic</i> 13
Creative Zone	<i>Basic</i> 13
Functions Available	168
Image Zone.....	<i>Basic</i> 12
M.....	<i>Basic</i> 13
P.....	<i>Basic</i> 13
Special Scene	<i>Basic</i> 12
Tv	<i>Basic</i> 13
Shortcut Button	82
Shutter Button	
Fully.....	<i>Basic</i> 11
Halfway.....	<i>Basic</i> 10
Shutter Speed	48, 50
Slide Show	103
Slow Synchro	<i>Basic</i> 15
Smooth Continuous Shooting ...	44
Soft Case	149
Sound Memo.....	101
Sound Recorder	102
Speedlite.....	144
Spot AE Point Frame.....	39
Stitch Assist	52
System Requirements	<i>Basic</i> 25

T

Telephoto.....	<i>Basic</i> 14
Time Zone.....	22
Transition	98

V

Video Output System	133
---------------------------	-----

W

White Balance	42
Wide Angle	<i>Basic</i> 14
Wind Filter.....	58
World Clock	22

Z

Zoom.....	36, <i>Basic</i> 14
-----------	---------------------

MEMO

Disclaimer

- While every effort has been made to ensure that the information contained in this guide is accurate and complete, no liability can be accepted for any errors or omissions.
- Canon reserves the right to change the specifications of the hardware and software described herein at anytime without prior notice.
- No part of this guide may be reproduced, transmitted, transcribed, stored in a retrieval system, or translated into any language in any form, by any means, without the prior written permission of Canon.
- Canon makes no warranties for damages resulting from corrupted or lost data due to a mistaken operation or malfunction of the camera, the software, memory cards, personal computers, peripheral devices, or use of non-Canon memory cards.

Trademark Acknowledgments

- Macintosh, Mac OS and QuickTime are trademarks of Apple Computer Inc., registered in the United States and/or other countries.
- Microsoft® and Windows® are either registered trademarks or trademarks of Microsoft Corporation in the United States and/or other countries.
- The SDHC logo is a trademark.

IMPORTANT SAFETY INSTRUCTIONS-SAVE THESE INSTRUCTIONS. DANGER-TO REDUCE THE RISK OF FIRE OR ELECTRIC SHOCK, CAREFULLY FOLLOW THESE INSTRUCTIONS.

For connection to a supply not in the U.S.A., use an attachment plug adapter of the proper configuration for the power outlet.

This battery charger is for exclusive use with Battery Pack NB-2LH (0.72Ah). There is a danger of explosion if other battery packs are used. Be sure to dispose of the battery pack according to the laws and regulations of your area.

This power unit is intended to be correctly orientated in a vertical or floor mount position.

FCC Notice

(Digital Camera, Model PC1210)

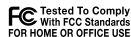

This device complies with Part 15 of the FCC Rules. Operation is subject to the following two conditions;

- (1) this device may not cause harmful interference, and
- (2) this device must accept any interference received, including interference that may cause undesired operation.

Note: This equipment has been tested and found to comply with the limits for Class B digital devices, pursuant to Part 15 of the FCC rules. These limits are designed to provide reasonable protection against harmful interference in a residential installation. This equipment generates, uses and can radiate radio frequency energy and, if not installed and used in accordance with the instructions, may cause harmful interference to radio communications. However, there is no guarantee that interference will not occur in a particular installation. If this equipment does cause harmful interference to radio or television reception, which can be determined by turning the equipment off and on, the user is encouraged to try to correct the interference by one or more of the following measures:

- Reorient or relocate the receiving antenna.
- Increase the separation between the equipment and receiver.
- Connect the equipment into an outlet on a circuit different from that to which the receiver is connected.
- Consult the dealer or an experienced radio/TV technician for help.

The cable with the ferrite core provided with the digital camera must be used with this equipment in order to comply with Class B limits in Subpart B of Part 15 of the FCC rules.

Do not make any changes or modifications to the equipment unless otherwise specified in the manual. If such changes or modifications should be made, you could be required to stop operation of the equipment.

Canon U.S.A., Inc.

One Canon Plaza, Lake Success, NY 11042, U.S.A.

Tel No. (516) 328-5600

Canadian Radio Interference Regulations

This Class B digital apparatus complies with Canadian ICES-003.

Réglementation canadienne sur les interférences radio

Cet appareil numérique de la classe B est conforme à la norme NMB-003 du Canada.

Functions Available in Each Shooting Mode

The following chart shows the functions and settings available in each shooting mode.

Function		AUTO	SCN					P	Tv	Av	M		
							Others ¹⁾						
Recording Pixels (pp. 34, 57)	Large	●	●	●	●	—	●	▲	—	●	●	●	●
	Medium 1	○	○	○	○	—	○	△	—	○	○	○	○
	Medium 2	○	○	○	○	—	○	△	—	○	○	○	○
	Medium 3	○	○	○	○	●	○	△	—	○	○	○	○
	Small	○	○	○	○	—	○	△	—	○	○	○	○
	Widescreen	○	○	○	○	—	○	△	—	○	○	○	○
	Movie	—	—	—	—	—	—	○ ²⁾	—	—	—	—	—
Compression (p. 35)	Super Fine	○	○	○	○	○	○	△	—	○	○	○	○
	Fine	●	●	●	●	●	●	▲	—	●	●	●	●
	Normal	○	○	○	○	○	○	△	—	○	○	○	○
Frame Rate (p. 57)	—	—	—	—	—	—	—	○ ²⁾	—	—	—	—	
Flash (Basic p. 14)	Auto	●	—	—	—	—	○ ³⁾	△	—	○	○	○	○
	On	—	—	—	—	—	○ ³⁾	△	—	○	○	○	○
	Off	○	●	●	●	●	—	▲	—	●	●	●	●
Red-Eye Reduction (Basic p. 15)	○	—	—	—	○	○	△	—	○	○	○	○	
AF-assist Beam (p. 27)	○	—	—	—	○	○	△	○	○	○	○	○	
Slow Synchro (Basic p. 15)	—	—	—	—	—	—	△ ⁴⁾	—	○	—	○	—	
Flash Adjust (p. 72)	—	—	—	—	—	—	—	—	—	○	○	○	
+/- (Flash) (p. 73)		—	—	—	—	—	—	△	—	○	○	○	—
Flash Output (p. 73)		—	—	—	—	—	—	—	—	○	○	○	○
Flash Sync (p. 74)	1st-curtain	●	—	—	—	○	—	▲	—	●	●	●	●
	2nd-curtain	—	—	—	—	—	—	—	—	○	○	○	○
Drive Mode (p. 44) (Basic p. 17)	Single Shot	●	○	●	●	●	●	▲	●	●	●	●	●
	Continuous Shooting	—	—	○	○	○	○ ⁶⁾	—	—	○	○	○	○
	Continuous Shooting AF	—	●	○	○	○	○ ⁶⁾	—	—	○	○	○	○
	10 sec., 2 sec. Self Timer	○	—	○	○	○	○	△	○	○	○	○	○
	Custom	○	—	○	○	○	○ ⁶⁾	—	—	○	○	○	○
AF Frame (p. 61)	FlexiZone	○	●	●	○	○	○	—	—	●	●	●	●
	Active	—	—	—	—	—	—	—	—	○	○	○	○
	AiAF	○	—	—	○	○	○	●	●	○	○	○	○
	Face Detect	●	—	—	●	●	●	—	—	○	○	○	○
AF Lock (p. 64)		—	—	—	○	○	○	○	○	○	○	○	
Manual Focus (p. 65)		—	—	—	○	○	○	○	○	○	○	○	
Bracket (p. 67)	AEB	—	—	—	—	—	—	—	—	○	○	○	—
	Focus-BKT	—	—	—	—	—	—	—	—	○ ⁷⁾	○ ⁷⁾	○ ⁷⁾	○ ⁷⁾

Function	AUTO	SCN								P	Tv	Av	M
							Others ¹⁾						
Macro Mode (Basic p. 16)		○	—	—	○	○	○ ⁵⁾	○	○	○	○	○	○
Digital Zoom (p. 36)		○	○	○	○	—	○ ⁶⁾	—	○ ⁸⁾	○	○	○	○
Digital Teleconverter (p. 36)		○	○	○	○	—	○ ⁶⁾	—	—	○	○	○	○
Exposure Compensation (p. 41)		—	○	○	○	—	○ ⁶⁾	△	—	○	○	○	—
Safety Shift (p. 51)		—	—	—	—	—	—	—	—	—	○	○	—
Safety FE (p. 51)		—	—	—	—	—	—	—	—	○	○	○	—
Exposure Shift (p. 57)		—	—	—	—	—	—	—	○ ⁹⁾	—	—	—	—
ND Filter (p. 71)	ND	—	—	—	—	—	—	—	○	○	○	○	○
Metering System (p. 39)	Evaluative									●	●	●	●
	Center Weighted Avg.	—	—	—	—	—	—	—	—	○	○	○	○
	Spot	—	—	—	—	—	—	—	—	○	○	○	○
AE Lock/FE Lock (pp. 68, 69)		—	—	—	—	—	—	—	—	○	○	○	—
White Balance ¹¹⁾ (p. 42)								△	○ ¹²⁾	○	○	○	○
My Colors (p. 75)		—	—	—	—	—	—	△	○ ¹³⁾	○	○	○	○
ISO Speed (p. 38)		○								○	○	○	○
Auto Rotate (p. 84)		○	○	○	○	○	○	△	○	○	○	○	○
Custom Display (p. 15)		○						—	○ ¹⁴⁾	○	○	○	○
IS Mode (p. 35)		○	○	○	○	○	○	△	○ ¹⁵⁾	○	○	○	○

- Setting available (● Default setting) △ Setting can only be selected for the first image (▲: Default setting).
 • (Shaded Area): Setting is retained even when the camera power is shut off.
 • The default for the settings changed by the menu and button operations can be restored all at once except for [Date/Time], [Language] and [Video System] (p. 32).

-
- The recording pixels and frame rates for the Movie mode (p. 54)
- The default flash setting will be [Auto] in the , , , , , , , , , , , modes, and [Flash off] in the , , , modes.
- Slow Synchro will be fixed to [On] in the , , modes.
- The macro mode cannot be set in the , mode.
- The following functions cannot be set in the , mode.
 - Continuous Shooting/Continuous Shooting AF
 - Custom Self-timer
 - Digital Zoom
 - Digital Teleconverter
 - Exposure Compensation
- Selectable only in manual focus.
- Operation is possible during shooting (only during standard).
- Can be set after AE lock is set.
- Automatically set by the camera.
- Settings cannot be made when My Colors is set to or mode.
- [Flash] cannot be set.
- Settings cannot be set in the , modes.
- [3:2 Guide] cannot be set.
- [Shoot Only] and [Panning] cannot be set in the mode.