

iPF9400S

User's Guide

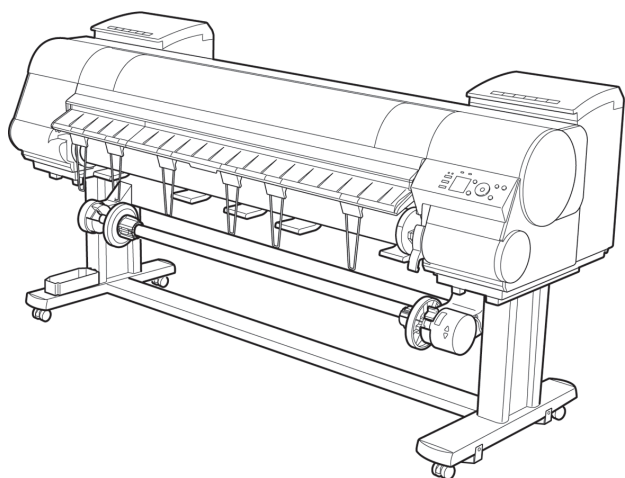

- Manuals for this printer
- Setup Guide
 - Basic Guide
 - User's Guide** Electronic manual
 - Paper Reference Guide Electronic manual

Read this manual before attempting to operate the printer.
Keep this manual in a handy location for future referencing.

Basic Printing Workflow	19
Enhanced Printing Options	35
Printing CAD Drawings	54
Printing enlargements or reductions	74
Printing at full size	90
Borderless Printing	101
Printing banners or at other non-standard sizes	114
Tiling and multiple pages per sheet	127
Centering originals	144
and so on	
Windows Software	177
Printer Driver	178
Preview	213
Free Layout	223
Color imageRUNNER Enlargement Copy	246
Print Plug-In for Photoshop / Digital Photo Professional	257
Layout Plug-In for Photoshop	317
Print Plug-In for Office	322
and so on	
Mac OS X Software	363
Printer Driver	364
Preview	389
Free Layout	417
Color imageRUNNER Enlargement Copy	448
Print Plug-In for Photoshop / Digital Photo Professional	465
Layout Plug-In for Photoshop	523
and so on	
Handling and Use of Paper	529
Control Panel	655
Printer Parts	691
Network Setting	707
Print Job Management	741
Adjustments for Better Print Quality	803
Color Management	821
Maintenance and Consumables	833
Troubleshooting	883
Error Message	915
Specifications	941
Appendix	945

Note

In order to be printed easily, this PDF-format manual is converted from the HTML-format instruction manual included on the "User Manuals CD-ROM" supplied with the printer. Thus, there are descriptions that are applied only in HTML format, and functions (video display function, etc.) that cannot be used. We appreciate your understanding.

Contents

Basic Printing Workflow 19

Printing procedure 20

Printing Options Using Rolls and Sheets	20
Turning the Printer On and Off	21
Loading and Printing on Rolls	22
Loading and Printing on Sheets	25
Printing in Windows	26
Printing from Mac OS X	27

Canceling print jobs 29

Canceling Print Jobs from the Control Panel	29
Canceling Print Jobs from Windows	30
Canceling Print Jobs from Mac OS X	30

Pausing Printing 33

Pausing Printing	33
------------------------	----

Enhanced Printing Options 35

Choosing Paper for Printing 36

Choosing a Paper for Printing	36
Specifying Paper in the Printer Driver	36

Printing Photos and Office Documents 37

Printing Photos and Images	37
Printing Photos and Images (Windows)	38
Printing Photos and Images (Mac OS X)	39
Printing from Photoshop	42
Printing Adobe RGB Images (Windows)	43
Printing Adobe RGB Images (Mac OS X)	46
Printing Office Documents	48
Printing Office Documents (Windows)	48
Printing Office Documents (Mac OS X)	50
Using PosterArtist to Compose Originals	52

Printing CAD Drawings 54

Printing Line Drawings and Text	54
Printing Line Drawings and Text (Windows)	54
Printing Line Drawings and Text (Mac OS X)	56
Printing from AutoCAD	58

Adjusting Images 60

Adjusting the Color in the Printer Driver	60
Fine-Tuning Colors of Photos and Images (Windows)	62
Fine-Tuning Colors of Photos and Images (Mac OS X)	64
Giving Priority to Particular Graphic Elements and Colors for Printing	67
Choosing the Document Type and Printing Conditions (Windows)	69
Choosing the Document Type and Printing Conditions (Mac OS X)	71

Printing enlargements or reductions 74

Resizing Originals to Match the Paper Size	74
Resizing Originals to Match the Paper Size (Windows)	74
Resizing Originals to Match the Paper Size (Mac OS X)	76
Resizing Originals to Fit the Roll Width	78
Resizing Originals to Fit the Roll Width (Windows)	79
Resizing Originals to Fit the Roll Width (Mac OS X)	81

Resizing Originals by Entering a Scaling Value	84
Resizing Originals by Entering a Scaling Value (Windows)	84
Resizing Originals by Entering a Scaling Value (Mac OS X)	86
Printing at full size	90
Printing on Oversize Paper	90
Printing at Full Size (Windows)	91
Printing at Full Size (Mac OS X)	92
Borderless Printing at Actual Size	95
Borderless Printing at Actual Size (Windows)	96
Borderless Printing at Actual Size (Mac OS X)	98
Borderless Printing	101
Borderless Printing on Paper of Equivalent Size	101
Borderless Printing by Resizing Originals to Match the Paper Size (Windows)	102
Borderless Printing by Resizing Originals to Match the Paper Size (Mac OS X)	104
Borderless Printing by Resizing Originals to Fit the Roll Width	107
Borderless Printing by Resizing Originals to Fit the Roll Width (Windows)	108
Borderless Printing by Resizing Originals to Fit the Roll Width (Mac OS X)	110
Printing banners or at other non-standard sizes	114
Printing Vertical or Horizontal Banners (Large-Format Printing)	114
Printing Vertical or Horizontal Banners (Large-Format Printing; Windows)	115
Printing Vertical or Horizontal Banners (Large-Format Printing; Mac OS X)	119
Printing on Non-Standard Paper Sizes	122
Printing on Non-Standard Paper Sizes (Windows)	122
Printing on Non-Standard Paper Sizes (Mac OS X)	124
Tiling and multiple pages per sheet	127
Printing Multiple Originals Next to Each Other	127
Printing Multiple Originals Next to Each Other (Windows)	128
Printing Multiple Originals Next to Each Other (Mac OS X)	130
Printing Multiple Pages Continuously	131
Printing Multiple Pages Continuously (Windows)	131
Printing Multiple Pages Continuously (Mac OS X)	133
Printing Multiple Pages Per Sheet	135
Printing Multiple Pages Per Sheet (Windows)	135
Printing Multiple Pages Per Sheet (Mac OS X)	137
Printing Posters in Sections	140
Printing Large Posters (Windows)	141
Centering originals	144
Printing Originals Centered on Rolls	144
Printing Originals Centered on Rolls (Windows)	144
Printing Originals Centered on Rolls (Mac OS X)	146
Printing Originals Centered on Sheets	149
Printing Originals Centered on Sheets (Windows)	149
Printing Originals Centered on Sheets (Mac OS X)	151
Conserving roll paper	154
Conserving Roll Paper by Rotating Originals 90 Degrees	154
Conserving Roll Paper by Rotating Originals 90 Degrees (Windows)	154
Conserving Roll Paper by Rotating Originals 90 Degrees (Mac OS X)	156
Conserving Roll Paper by Printing Originals Without Top and Bottom Margins	158
Conserving Roll Paper by Printing Originals Without Top and Bottom Margins (Windows)	159
Conserving Roll Paper by Printing Originals Without Top and Bottom Margins (Mac OS X)	160
Checking Images Before Printing	164
Checking the Layout in a Preview Before Printing	164

Other useful settings 165

Printing With Watermarks	165
Printing with Watermarks— COPY, FILE COPY, and so on (Windows)	166
Making the Original Orientation Match the Paper Orientation	168
Making the Original Orientation Match the Paper Orientation (Windows)	168
Making the Original Orientation Match the Paper Orientation (Mac OS X)	170
Using Favorites	172
Cutting Roll Paper After Printing	173
Cutting Roll Paper After Printing (Windows)	173
Cutting Roll Paper After Printing (Mac OS X)	174

Windows Software 177**Printer Driver** 178

Printer Driver Settings	178
Specifying Paper in the Printer Driver	180
Confirming Print Settings	182
Checking the Layout in a Preview Before Printing	182
Using Favorites	184
Accessing the Printer Driver Dialog Box from Applications	185
Accessing the Printer Driver Dialog Box from the Operating System Menu	187
Main Sheet	188
Paper Information on Printer Dialog Box	191
Paper Detailed Settings Dialog Box	192
View Settings Dialog Box for the Printing Application	193
Color Adjustment Sheet: Color	194
Object Adjustment Dialog box: Color	195
Matching Sheet	196
Color Adjustment Sheet: Monochrome	198
Object Adjustment Dialog box: Monochrome	199
Gray Adjustment Sheet	200
Page Setup Sheet	201
Output Method Dialog box	204
Paper Size Options Dialog Box	205
Layout Sheet	206
Page Options Dialog Box	207
Special Settings Dialog Box	208
Favorites Sheet	209
Utility Sheet	210
Support Sheet	211
Settings Summaries Dialog Box	212
Device Settings Sheet	212

Preview 213

The Features of Preview	213
Starting Preview	213
Preview Main Window	214
Dialog Area	216
Enlarge/Reduce the screen display	217
Moving a Page	217
Using the ruler	217
Priority setting for rotating 90 degrees	218
Printing with Selecting the Layout	219
Print on the Center	221
Not Print Spaces at the Top/Bottom	222

Free Layout 223

The Features of Free Layout	223
Starting Free Layout	223

Free Layout Main Window	225
Detailed Settings	226
Preferences Dialog Box	227
Page Options Dialog Box	228
Zoom Dialog Box	229
Format Dialog Box	229
Laying out a Multiple-File Document on One Page	231
Laying out a Document Created with Multiple Application Programs on One Page	233
Selecting an Object	236
Changing the Object Size	237
Moving an Object	238
Rotating an Object	238
Laying out Objects Automatically	238
Aligning Objects	239
Changing the Object Overlapping Order	240
Pasting a Copied or Cut Object	242
Folded Duplex Window	242
Finished Size Settings Dialog Box	243
Binding Settings Dialog Box	244
Prints using Folded Duplex	245

Color imageRUNNER Enlargement Copy **246**

The Features of Color imageRUNNER Enlargement Copy	246
Starting Color imageRUNNER Enlargement Copy	246
Color imageRUNNER Enlargement Copy Dialog Box	247
Hot Folder	248
Creating a New Hot Folder	249
Specifying an Existing Shared Folder as a Hot Folder	252
Setting the Print Parameters	255
Printing Enlargements of Scanned Originals from a Color imageRUNNER	255

Print Plug-In for Photoshop / Digital Photo Professional **257**

Features of the Print Plug-In for Photoshop/Digital Photo Professional	258
Installation Procedures	258
Uninstall Procedures	261
Starting from Photoshop	261
Starting from Digital Photo Professional	262
Print Plug-In for Photoshop/Digital Photo Professional Main Window	263
Preview Area	265
Main Sheet	267
Page Setup Sheet	270
Color Settings Sheet (Color)	272
Color Settings Sheet (Monochrome)	273
Print History Sheet	274
Support Sheet	275
Adjustment pattern setting dialog box	276
Paper Detailed Settings Dialog Box	280
Set Configuration Dialog Box	282
ICC Conversion Options dialog box	283
Roll Paper Options Dialog Box	284
Size Options Dialog Box	284
Curves Dialog Box	285
Print History Details Dialog Box	286
Utilize Three Types of Previews	287
Check Image with Print Area Layout	287
Check the original image with Image	288
Check Image with Roll Paper Preview	288
Print with a Desired Picture Quality	289
Adjust the Colors and Print	290
Adjust the Colors while Checking the Preview (for Color)	290

Adjust the Colors while Checking the Preview (for Monochrome)	291
Adjust the Colors by Color Matching	293
Print High-Quality Adobe RGB16bit Images	294
Prints monochrome photographs with high quality	295
Using Adobe CMM	296
Printing an Adjustment Pattern and Selecting Adjustment Values	297
Perform Black Point Compensation	299
Perform Printing Press Simulation Print	300
Enlarge/Reduce and Print	300
Enlarge/Reduce and Print Matching Output Media Size	301
Enlarge/Reduce and Print Matching Width of Roll Paper	302
Specify Scaling, Enlarge/Reduce and Print	303
Print with No Borders	304
Customize Media Settings	305
Utilize Print History	305
Confirm Print History Details	306
Apply Print History to an Image	307
Store Print History to Print Preferences	307
Delete Print History	309
Export Print History from Print Preferences	311
Import Print History to Print Preferences	312
Delete Print History from Print Preferences	314
Set Information to Print with Image	315
Layout Plug-In for Photoshop	317
About the Layout Plug-In	317
Layout Plug-In Main Window	317
Add Canvas Size dialog box	319
Creating and Printing a Layout Image for Mounting on a Frame	320
Print Plug-In for Office	322
Print Plug-In for Office features	322
Steps to install	323
Steps to uninstall	325
When Print Plug-In for Office is not displayed	326
To start from Microsoft Word	330
Print Matching Roll Width (Word)	331
Borderless Printing (Word)	333
Multi-Page Printing (Word)	336
Register the settings (Word)	337
Print Using Registered Settings (Word)	338
Portrait Orientation / Landscape Orientation (Word)	340
To start from Microsoft PowerPoint	341
Print Matching Roll Width (PowerPoint)	343
Borderless Printing (PowerPoint)	345
Multi-Page Printing (PowerPoint)	348
Register the settings (PowerPoint)	349
Print Using Registered Settings (PowerPoint)	350
Portrait Orientation / Landscape Orientation (PowerPoint)	352
To start from Microsoft Excel	353
Print Entire Sheet (Excel)	355
Print Selected Area (Excel)	357
Configuring Binding (Excel)	360
Configuring Special Settings	361

Printer Driver	364
Printer Driver Settings	364
Specifying Paper in the Printer Driver	366
Confirming Print Settings	368
Checking the Layout in a Preview Before Printing	368
Using Favorites	369
Accessing the Printer Driver Dialog Box from Applications	370
Main Pane	370
Paper Information on Printer Dialog Box	374
Paper Detailed Settings Dialog Box	374
View settings Dialog Box for the Printing Application	377
Matching pane	377
Color Settings Pane: Color	380
Object Adjustment dialog box: Color	381
Color Settings Pane: Monochrome	382
Object Adjustment dialog box: Monochrome	383
Gray Adjustment Pane	383
Page Setup Pane	385
Utility Pane	386
Additional Settings Pane	387
Support Pane	387
Preview	389
The Features of Preview	389
Starting Preview	389
Preview Main Window	391
Paper Settings Panel	394
Easy Settings	396
Advanced Settings	398
Output Settings Panel	399
Color Settings Panel	401
Color Adjustment	402
Gray Adjustment	405
Matching	406
Driver Matching Mode	409
ICC Matching Mode	410
ColorSync	411
Preferences Dialog Box	411
Zoom Dialog Box	412
Go to Page Dialog Box	412
Print with No Borders	412
Print on the Center	413
Not Print Spaces at the Top/Bottom	413
Print Page Rotated 90 Degrees	414
Display with Fitting to the Width of the Paper	415
Display with All	415
Display with Actual Size	415
Moving a Page	416
Free Layout	417
The Features of Free Layout	417
Starting Free Layout	417
Free Layout Main Window	419
Paper Settings Panel	422
Easy Settings	424
Advanced Settings	426
Color Settings Panel	427

Color Adjustment	428
Gray Adjustment	431
Matching	432
Driver Matching Mode	435
ICC Matching Mode	436
ColorSync	437
Preferences Dialog Box	438
Page Setup Dialog Box	439
Zoom Dialog Box	440
Format Dialog Box	440
Laying out a Multiple-File Document on One Page	441
Laying out a Document Created with Multiple Application Programs on One Page	441
Selecting an Object	442
Changing the Object Size	442
Moving an Object	443
Rotating an Object	443
Laying out Objects Automatically	444
Aligning Objects	444
Changing the Object Overlapping Order	446
Pasting a Copied or Cut Object	447
Color imageRUNNER Enlargement Copy	448
The Features of Color imageRUNNER Enlargement Copy	448
Starting Color imageRUNNER Enlargement Copy	449
Color imageRUNNER Enlargement Copy Dialog Box	450
Hot Folder	450
Creating a New Hot Folder	451
Editing a Hot Folder (Setting Print Conditions)	452
Deleting a Hot Folder	454
Setting the Print Parameters	455
Paper Settings Panel	455
Easy Settings	457
Advanced Settings	458
Output Settings Panel	459
Color Settings Panel	461
Driver Matching Mode	462
ICC Matching Mode	463
Printing Enlargements of Scanned Originals from a Color imageRUNNER	463
Print Plug-In for Photoshop / Digital Photo Professional	465
Features of the Print Plug-In for Photoshop/Digital Photo Professional	466
Installation Procedures	466
Uninstall Procedures	468
Starting from Photoshop	470
Starting from Digital Photo Professional	470
Print Plug-In for Photoshop/Digital Photo Professional Main Window	471
Preview Area	473
Main Sheet	474
Page Setup Sheet	477
Color Settings Sheet (Color)	479
Color Settings Sheet (Monochrome)	480
Print History Sheet	481
Support Sheet	482
Adjustment pattern setting dialog box	483
Paper Detailed Settings Dialog Box	487
Set Configuration Dialog Box	488
ICC Conversion Options dialog box	489
Roll Paper Options Dialog Box	490
Size Options Dialog Box	491
Curves Dialog Box	492

Print History Details Dialog Box	493
Utilize Three Types of Previews	494
Check Image with Print Area Layout	494
Check the original image with Image	495
Check Image with Roll Paper Preview	495
Print with a Desired Picture Quality	496
Adjust the Colors and Print	497
Adjust the Colors while Checking the Preview (for Color)	497
Adjust the Colors while Checking the Preview (for Monochrome)	498
Adjust the Colors by Color Matching	501
Print High-Quality Adobe RGB16bit Images	502
Prints monochrome photographs with high quality	503
Using Adobe CMM	503
Printing an Adjustment Pattern and Selecting Adjustment Values	505
Perform Black Point Compensation	506
Perform Printing Press Simulation Print	507
Enlarge/Reduce and Print	508
Enlarge/Reduce and Print Matching Output Media Size	508
Enlarge/Reduce and Print Matching Width of Roll Paper	509
Specify Scaling, Enlarge/Reduce and Print	510
Print with No Borders	511
Customize Media Settings	512
Utilize Print History	512
Confirm Print History Details	513
Apply Print History to an Image	514
Store Print History to Print Preferences	514
Delete Print History	516
Export Print History from Print Preferences	517
Import Print History to Print Preferences	518
Delete Print History from Print Preferences	520
Set Information to Print with Image	521

Layout Plug-In for Photoshop 523

About the Layout Plug-In	523
Layout Plug-In Main Window	523
Add Canvas Size dialog box	525
Creating and Printing a Layout Image for Mounting on a Frame	526

Handling and Use of Paper 529

Paper 530

Types of Paper	530
Paper Sizes	530
Using Paper Other Than Genuine Paper and feed confirmed Paper	533
Printing on Paper Other Than Genuine Paper and feed confirmed Paper Using Existing Settings	533
Printing on Paper Other Than Genuine Paper and feed confirmed Paper by Adding a Media Type	534
Displaying the Paper Reference Guide	535
Updating paper information	536

Handling rolls 538

Attaching the Roll Holder to Rolls	538
Loading Rolls in the Printer	541
Changing the Type of Paper	545
Specifying the Paper Length	547
Removing the Roll from the Printer	547
Removing the Roll Holder from Rolls	550
Feeding Roll Paper Manually	551
Keeping Track of the Amount of Roll Paper Left	552
Specifying the Ink Drying Time for Rolls	552
Specifying the Cutting Method for Rolls	554

Cutting the Leading Edge of Roll Paper Automatically	560
Reducing Dust from Cutting Rolls	562
Handling sheets	563
Loading Sheets in the Printer	563
Printing From a Desired Starting Point	566
Removing Sheets	568
Output Stacker	570
Output Stacker	570
Parts of the Output Stacker	571
Using the Output Stacker	572
Storing the Output Stacker	576
Media take-up unit	578
Media Take-up Unit	578
Using the Media Take-up Unit	578
Enabling Roll Take-Up	579
Disabling Roll Take-Up	579
Loading the Rewind Spool on the Media Take-up Unit	580
Removing Printed Documents from the Media Take-up Unit	587
Media Configuration Tool (Windows)	590
The Features of Media Configuration Tool	590
Installation Procedures	591
Starting Method	593
Media Configuration Tool Main Window	593
Editing Media Type Information for Genuine Paper and Feed Confirmed Paper	594
Adding Media Types	596
Changing Media Names	598
Deleting Media Types You Have Added	600
Switching Media Types Display Show/Hide	602
Changing the Display Order of Media Types	603
Using Paper Other than Genuine Paper and Feed Confirmed Paper	605
Compatible Paper	606
Add Custom Paper	607
Delete Custom Paper	613
Edit Custom Paper	614
Export Custom Media Information	615
Import Custom Media Information	615
Warnings	617
Media Configuration Tool (Mac OS X)	619
The Features of Media Configuration Tool	619
Procedures for Installing	620
Procedures for Uninstalling	622
Starting Method	625
Media Configuration Tool Main Window	626
Editing Media Type Information for Genuine Paper and Feed Confirmed Paper	627
Adding Media Types	628
Changing Media Names	631
Deleting Media Types You Have Added	633
Switching Media Types Display Show/Hide	635
Changing the Display Order of Media Types	637
Using Paper Other than Genuine Paper and Feed Confirmed Paper	638
Compatible Paper	640
Add Custom Paper	641
Delete Custom Paper	648
Edit Custom Paper	648
Export Custom Media Information	649

Import Custom Media Information	650
Warnings	652

Control Panel 655

Operations and Display Screen 656

Control Panel	656
Control Panel Display	658
How to View Instructions With Navigate	661
Checking Instructions During Printer Operations	663

Printer Menu 665

Printer Menu Operations	665
Menu Operations	666
Menu Structure	669
Menu Settings	675
Status Print	684
Printing Interface Setting Reports	687

Printer Parts 691

Printer parts 692

Front	692
Back	694
Top Cover (Inside)	695
Carriage	696
Ink Tank Cover (Inside)	697
Stand	698
Media Take-up Unit	699

Hard Disk 701

Printer Hard Disk Operations	701
Checking the Free Hard Disk Space	702
Erasing Data on the Printer's Hard Disk	703

Optional accessories 705

Roll Holder Set	705
-----------------------	-----

Network Setting 707

Network Environment 708

Network Environment	708
---------------------------	-----

Using RemoteUI 711

Using RemoteUI	711
----------------------	-----

Initial Settings 713

Configuring the IP Address on the Printer	713
Configuring the IP Address Using the Printer Control Panel	713
Configuring the IP Address Using ARP and PING Commands	714
Configuring TCP/IPV6 Network Settings	716
Configuring the Printer Driver Destination (Windows)	716

Configuring the Printer Driver Destination (Mac OS X)	717
Configuring the Printer's TCP/IP Network Settings With RemoteUI	717
NetWare Settings	720
Configuring NetWare Network Settings	720
Specifying the Printer's Frame Type	720
Specifying NetWare Print Services	723
Configuring the Printer's NetWare Network Settings With RemoteUI	725
Mac OS X Settings	728
Configuring the Destination in TCP/IP Networks	728
Configuring the Destination for Bonjour Network	729
Configuring the Destination for AppleTalk Networks	731
Configuring the Printer's AppleTalk Network Settings	732
Other Settings	734
Specifying Printer-Related Information	734
Configuring the Communication Mode Manually	735
Email Notification When Printing is Finished or Errors Occur	736
Initializing the Network Settings	736
Device Setup Utility (Windows)	738
imagePROGRAF Device Setup Utility	738
Installing imagePROGRAF Device Setup Utility	738
Configuring the IP Address Using imagePROGRAF Device Setup Utility	738

Print Job Management	741
Status Monitor (Windows)	742
The Features of imagePROGRAF Status Monitor	742
Job Management Using imagePROGRAF Status Monitor	743
Printmonitor (Mac OS X)	745
The Features of imagePROGRAF Printmonitor	745
Job Management Using imagePROGRAF Printmonitor	746
Accounting (Windows)	748
Accounting Manager	748
Launching the Accounting Manager	748
Accounting Manager Main Window	749
Job List Area	751
Accounting Manager Basic Procedures	752
Configuring Unit Costs in Accounting Manager	753
Setting the Unit Cost for Ink	753
Setting the Unit Cost for Paper	754
Setting the Unit Cost for Items Other Than Ink and Paper	756
Configuring Units and Display Settings in Accounting Manager	757
Automatically Acquiring Print Job Logs at Regular Intervals	757
Canceling Regular Print Job Log Acquisition	758
Switching Between Displaying Jobs on Printer and Regularly Acquired Jobs	758
Exporting Print Job Data as a CSV File	758
Displaying Job Properties or Period Properties	759
Showing, Saving and Loading Selected Unit Cost Data	760
Showing the Total Amount of Ink and Paper Consumed	760
Basic Print Job Operations	762
Using the Printer Hard Disk	762
Saving Print Jobs on the Printer Hard Disk	764
Managing the Job Queue (Deleting or Preempting Other Jobs)	767
Managing Pending Jobs (Printing or Deleting Jobs on Hold)	769
Printing Saved Jobs	771

Deleting Saved Jobs	776
Moving Saved Jobs	780
Advanced Print Job Operations	784
Saving Print Jobs Sent from Sources Other than the Printer Driver	784
Printing Without Saving Jobs in the Common Box	785
Setting Passwords for Personal Boxes	786
Naming Personal Boxes	789
Displaying a List of Saved Jobs	792
Printing a List of Saved Jobs	795
Displaying Details of Saved Jobs	796
Renaming Saved Jobs	799

Adjustments for Better Print Quality **803**

Adjustment for high-precision printing **804**

Enhancing Printing Quality	804
----------------------------------	-----

Adjusting the Printhead **806**

Adjusting the Printhead	806
Automatic Adjustment to Straighten Lines and Colors	806
Manual Adjustment to Straighten Lines and Colors	808
Adjustment When Installing the Printhead	810
Troubleshooting Paper Abrasion and Blurry Images	811

Adjusting the feed amount **813**

Adjusting the Feed Amount	813
Selecting a Feed Amount Adjustment Method	813
Automatic Banding Adjustment	814
Manual Banding Adjustment	815
Fine-Tuning the Paper Feed Amount	817
Adjusting Line Length	818
Adjusting the Vacuum Strength	819

Color Management **821**

Monitor Matching **822**

Printing Images to Match Monitor Colors	822
Printing Images to Match Monitor Colors (Windows)	823
Printing Images to Match Monitor Colors (Mac OS X)	825

Color Calibration **828**

Corrects slight differences in how colors appear (color calibration)	828
Paper that can be used in Color Calibration	830

Maintenance and Consumables **833**

Ink Tanks **834**

Ink Tanks	834
Replacing Ink Tanks	834
Checking Ink Tank Levels	844
When to Replace Ink Tanks	845

Printheads **846**

Printhead	846
Checking for Nozzle Clogging	846
Cleaning the Printhead	847
Replacing the Printhead	848

Cutter Unit **856**

Cutter Unit	856
-------------------	-----

Replacing the Cutter Unit	856
---------------------------------	-----

Maintenance Cartridge 860

Maintenance Cartridge	860
Replacing the Maintenance Cartridge	860
Checking the Remaining Maintenance Cartridge Capacity	867
When to Replace the Maintenance Cartridge	867

Cleaning the Printer 869

Cleaning the Printer Exterior	869
Cleaning Inside the Top Cover	869

Other Maintenance 873

Preparing to Transfer the Printer	873
Updating the Firmware	879

Consumables 881

Troubleshooting 883

Frequently Asked Questions 884

Frequently Asked Questions	884
----------------------------------	-----

Problems Regarding Paper 886

Clearing Jammed Roll Paper	886
Clearing a Jammed Sheet	889
Roll paper cannot be inserted into the paper feed slot	891
Cannot load sheets	892
Paper is not cut straight	892
Paper is not cut	892
The media take-up unit continues rotating	892
The size of clear film cannot be detected	893
Margins are wide	893
When printing on thin roll paper, the printed surface becomes scratched	893

Printing does not start 894

The Data lamp on the Control Panel does not light up	894
The printer does not respond even if print jobs are sent	894
Ink Filling.. is displayed	894
The display screen indicates Agitating... ..	894

The printer stops during a print job 895

An error message is shown on the Display Screen	895
The printer ejects blank, unprinted paper	895

Problems with the printing quality 896

Printing is faint	896
Paper rubs against the printhead	897
The edges of the paper are dirty	897
The surface of the paper is dirty	898
The back side of the paper is dirty	898
Immediately after borderless printing, the trailing edge margin is soiled during regular printing	899
Printed colors are inaccurate	899
Banding in different colors occurs	899
Colors in printed images are uneven	900
Image edges are blurred or white banding occurs	901
Setting the Blue Switch on the Platen	901
The contrast becomes uneven during printing	904
The length of printed images is inaccurate in the feeding direction	904
Images are printed crooked	905
Documents are printed in monochrome	905

Line thickness is not uniform	905
Lines or colors are misaligned	906
Borders appear in borderless printing	906

Cannot print over a network 907

Cannot connect the printer to the network	907
Cannot print over a TCP/IP network	907
Cannot print over a NetWare network	907
Cannot print over AppleTalk or Bonjour networks	908

Installation problems 909

Removing Installed Printer Drivers	909
--	-----

Other problems 911

The printer does not go on	911
The printer takes time to start up	911
If the Printer Makes a Strange Sound	911
Messages advising to check the maintenance cartridge are not cleared	911
The printer consumes a lot of ink	912
Ink Level Detection	912

Error Message 915

Error Messages 916

Messages regarding paper 918

Paper mismatch	918
MediaType Mismatch	918
The paper is too small.	919
The paper is too small.	919
PaprWidth Mismatch	920
Paper size not detected.	920
Insufficient paper for job	921
This paper cannot be used as size is not supported.	921
Roll printing is selected.	922
Roll printing is selected, but sheets are loaded.	922
The roll is empty.	922
No sheets.	923
Sheet printing is selected.	923
Regular printing is selected, but a roll is loaded.	923
Paper jam.	923
Paper loaded askew.	924
Cannot detect paper	924
Cannot feed paper.	924
Cannot cut this paper.	924
End of paper feed.	925
Rel lever is in wrong position.	925
Rewinding error.	925
Media take-up unit ready.	926
Turn on the media take-up unit.	926
Borderless printing not possible.	926
Paper position not suitable for borderless printing.	926

Messages regarding ink 928

Ink insufficient.	928
No ink left.	928
Remaining level of the ink cannot be correctly detected.	928
Close Ink Tank Cover	928
Ink tank is empty.	929
Not much ink is left.	929
No ink tank loaded.	929

The following ink tanks cannot be recognized. 929

Messages regarding printing or adjustment 930

Cannot execute this command. Use other paper. 930
 Cannot calibrate. 930
 Excessive temperature or humidity. 930
 Please execute common calibration. 931
 Please commn calibr using above paper. 931
 Please calibrate using above paper. 931
 Borderless printing not possible. Paper stretched or shrank. 931
 Before borderless printing, move the blue platen switch. 931
 Blue platen switch is dirty. 932
 Move the blue platen switch No.xx to the right. (xx represents a number) 932
 Cannot adjust paper feed. 932
 Check printed document. 932

Messages regarding printheads 933

Cannot adjust printhead. 933
 PHeads: wrong pos. 933
 Wrong x printhead. (x is L, R, or not displayed) 933
 x printhead error (x is L, R, or not displayed) 933
 Cannot recognize print head x. (x is L, R, or not displayed) 934
 Execute printhead cleaning. 934

Messages regarding the maintenance cartridge 935

No maintenance cartridge. 935
 Wrong maintenance cartridge. 935
 Maint. cart. The level is low 935
 No Maintenance Cartridge capacity. 935
 Maintenance cartridge full. 935
 Maintenance cartridge problem. 935

Messages regarding the hard disk 936

Hard disk error. 936
 File read error. 936
 The mail box is full. 936
 Mail box full. Now printing without saving data. 936
 Mail box nearly full. 936
 Maximum jobs stored. 936
 Mail box full. Delete unwanted data 936

Other Messages 938

GARO Wxxxx (x represents a number) 938
 ERROR Exxx-xxxx (x represents a letter or number) 938
 Hardware error. xxxxxxxx-xxxx (x represents a letter or number) 938
 Top cover is open. 938
 Prepare for parts replacement. 939
 Parts replacement time has passed. 939
 Unknown file. 939
 Calibration There is a problem with the multi-sensor. 939
 Multi-sensor error 939

Specifications 941

Printer Specifications 942

Specifications 942
 Print Area 943

Appendix 945**Safety Precautions 946**

Safety Precautions	946
Legal Notices	948

Manuals for this printer 950

Manuals for this printer	950
About This User Manual	950

How to use this manual 952

Searching Topics	952
HTML Version of the Manual for Printing	953

Disposal of the product 959

WEEE Directive	959
----------------------	-----

Basic Printing Workflow

Printing procedure	20
Canceling print jobs	29
Pausing Printing	33

Enhanced Printing Options	35
---------------------------	----

Windows Software	177
------------------	-----

Mac OS X Software	363
-------------------	-----

Handling and Use of Paper	529
---------------------------	-----

Control Panel	655
---------------	-----

Printer Parts	691
---------------	-----

Network Setting	707
-----------------	-----

Print Job Management	741
----------------------	-----

Adjustments for Better Print Quality	803
--------------------------------------	-----

Color Management	821
------------------	-----

Maintenance and Consumables	833
-----------------------------	-----

Troubleshooting	883
-----------------	-----

Error Message	915
---------------	-----

Specifications	941
----------------	-----

Appendix	945
----------	-----

Printing procedure

- Printing Options Using Rolls and Sheets 20
- Turning the Printer On and Off 21
- Loading and Printing on Rolls 22
- Loading and Printing on Sheets 25
 - Specifying Paper in the Printer Driver (Windows) 180
 - Specifying Paper in the Printer Driver (Mac OS X) 366
- Printing in Windows 26
- Printing from Mac OS X 27

Printing Options Using Rolls and Sheets

The printer supports both rolls and sheets. This section introduces the main features of each, as well as the main printing methods available. Select rolls or sheets to suit your particular printing application.



- For information on the types of paper the printer supports, see "Types of Paper." →P.530
- Note** • A variety of other ways to print are available besides those introduced here. For details, see "Enhanced Printing Options." →P.35

Roll printing

Media in spooled rolls is generally called Roll Media. Rolls are loaded on the Roll Holder, which are in turn loaded in the printer.

Rolls can be used to print large photos or create posters or banners that cannot be printed on regular sheets.

- **Large-format printing**
Easily print vertical or horizontal banners from familiar applications such as Microsoft Office applications. (See "Printing Vertical or Horizontal Banners (Large-Format Printing).") →P.114
- **Borderless printing**
Print without a margin (border) around posters or photos.
(See "Borderless Printing on Paper of Equivalent Size.") →P.101
(See "Borderless Printing by Resizing Originals to Fit the Roll Width.") →P.107
(See "Borderless Printing at Actual Size.") →P.95
- **Banner printing**
You can print multiple pages as a single continuous image, without margins between pages. (See "Printing Multiple Pages Continuously.") →P.131
- **90-degree rotation before printing**
Originals in portrait orientation are rotated 90 degrees when possible to use paper more efficiently. (See "Conserving Roll Paper by Rotating Originals 90 Degrees.") →P.154
- **Enlarged/reduced printing**
You can freely adjust the size of originals by enlarging or reducing originals before printing.
(See "Resizing Originals to Match the Paper Size.") →P.74
(See "Resizing Originals to Fit the Roll Width.") →P.78
(See "Resizing Originals by Entering a Scaling Value.") →P.84
- **Free Layout (Windows) and imagePROGRAF Free Layout (Macintosh)**
Print multiple documents from multiple applications (such as word-processing programs, spreadsheet programs, and so on) next to each other. (See "Printing Multiple Originals Next to Each Other.") →P.127

Sheet printing

Sheets refer to individual sheets of paper.

Insert the sheet between the Platen and the Paper Retainer.

- **Enlarged/reduced printing**
You can freely adjust the size of originals by enlarging or reducing originals before printing.
(See "Resizing Originals to Match the Paper Size." →P.74)
(See "Resizing Originals by Entering a Scaling Value." →P.84)
- **Free Layout (Windows) and imagePROGRAF Free Layout (Macintosh)**
Print multiple documents from multiple applications (such as word-processing programs, spreadsheet programs, and so on) next to each other.
(See "Printing Multiple Originals Next to Each Other." →P.127)

Turning the Printer On and Off

Turning the printer on

- 1 Press the **Power** button to turn on the printer.
The printer will now start up.
After the Display Screen shows the Canon logo, "**Starting up... Please wait.**" is displayed.



- 2 The **Power Lamp** is lit when the printer finishes starting up, and the printer is now in **Standby**.

The printer will not go into **Standby** in the following situations. Take the appropriate action.



- The Top Cover is open
Close the Top Cover.
- The Ink Tank Cover is open
Close the Ink Tank Cover.
- The Printhead is not installed
see "Replacing the Printhead." →P.848
- An Ink Tank is not installed
see "Replacing Ink Tanks." →P.834
- If **ERROR** is shown on the Display Screen
see "Error Messages." →P.916

- The **Power Lamp** and **Message Lamp** are not lit (even once), and nothing appears on the Display Screen
Make sure the printer is plugged in correctly. Check the connection at the plug and electrical outlet.
- No paper is loaded
Load paper. (See "Loading and Printing on Rolls.") →P.22 (See "Loading and Printing on Sheets.")
→P.25



- Starting the printer when it is connected via the USB cable to a Macintosh computer that is off may cause the computer to start up at the same time. To prevent this, disconnect the USB cable before starting the printer. Connecting the printer to the computer via a USB hub may solve this issue.

Turning the printer off



- Never disconnect the printer's power supply or unplug it during a print job. This may damage the printer.

- 1 Make sure no print jobs are in progress.
If the **Message Lamp** is flashing, check the message on the Display Screen and take action as necessary.
(See "Error Messages.") →P.916



If the **Data Lamp** is flashing, the printer is receiving a print job. Turn off the printer only after printing is finished.



- 2 Hold down the **Power** button for more than a second.

After "**Shut Down.. Please Wait..**" is shown on the Display Screen, the printer shuts off.



Loading and Printing on Rolls

These are the basic steps for loading and printing on rolls.
Follow these steps to load and print on rolls.

- For details on using the Output Stacker, see "Using the Output Stacker." →P.572
- For details on using the Media Take-up Unit, see "Media Take-up Unit." →P.578



- If you are not using the Media Take-up Unit when printing long documents such as banners, spread a clean cloth or paper on the floor. Use the Output Stacker to prevent long printed documents from being soiled by the floor after they are printed. (See "Using the Output Stacker.") →P.572



Note

- For details on supported sizes and types of rolls, see **Paper Sizes** or the Paper Reference Guide. (See "Paper Sizes.") →P.530 (See "Types of Paper.") →P.530
- To wait until the ink dries after printing before cutting the roll, set **Drying Time** in the printer driver. (See "Specifying the Ink Drying Time for Rolls.") →P.552
- Once you have used all the paper on a roll, clean the platen. If the Platen inside the Top Cover becomes dirty, it may soil the underside of paper. (See "Cleaning Inside the Top Cover.") →P.869

- 1 Turn the printer on. (See "Turning the Printer On and Off.") →P.21



- 2 Load the roll on the Roll Holder. (See "Attaching the Roll Holder to Rolls.") →P.538

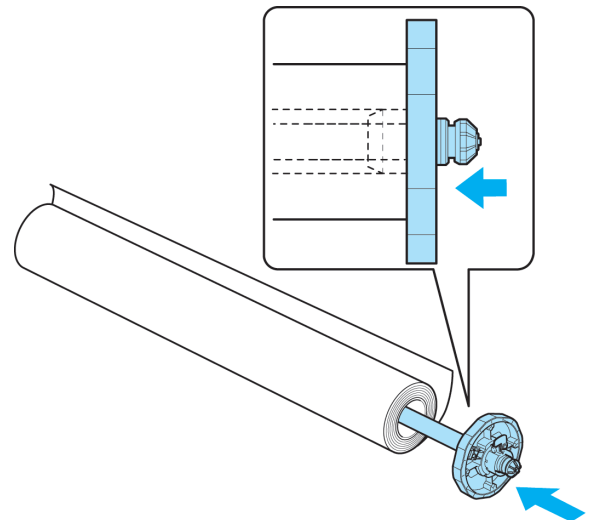

3 Load the roll in the printer. (See "Loading Rolls in the Printer.") →P.541

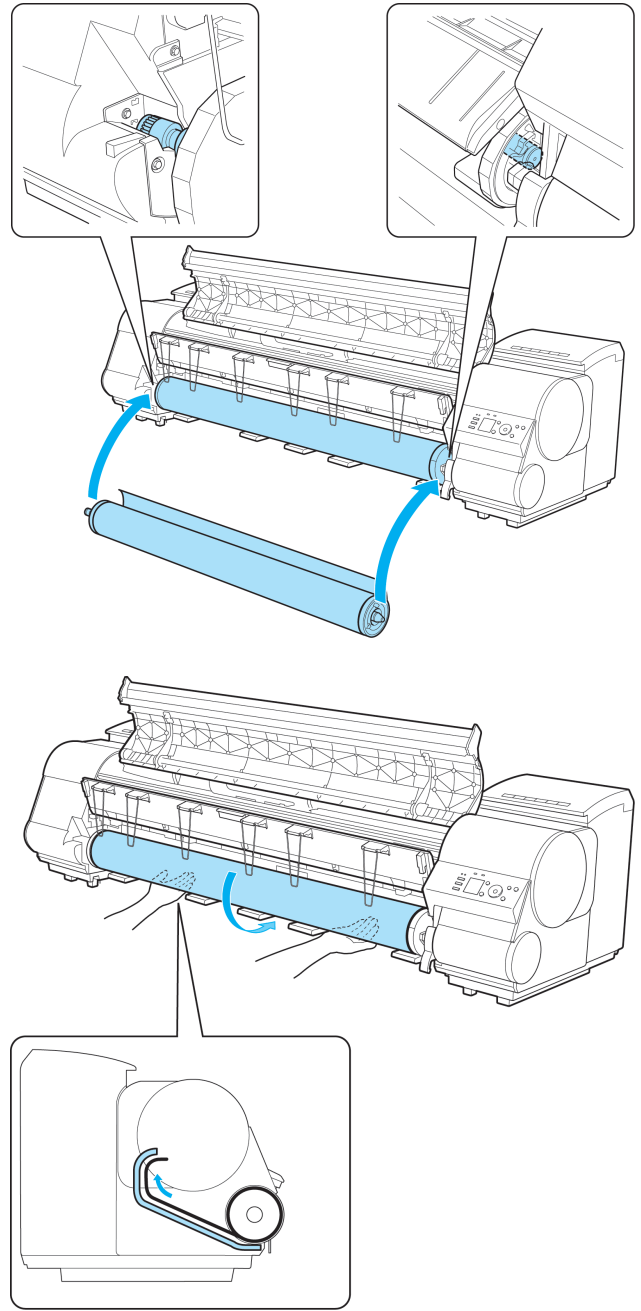

Important • When printing without borders, definitely set the blue Switch on the platen to the ● side. If the switch is set incorrectly, print quality may deteriorate. (See "Setting the Blue Switch on the Platen.") →P.901

4 Select the type of paper. (See "Changing the Type of Paper.") →P.545





- If no barcode has been printed on the roll and you have set **ManageRemainRoll** to **On**, specify the roll length after the type of paper. (See "Specifying the Paper Length.") →P.547

5 Complete settings in the printer driver for the type of paper and other details.

- Specifying Paper in the Printer Driver (Windows) →P.180
- Specifying Paper in the Printer Driver (Mac OS X) →P.366

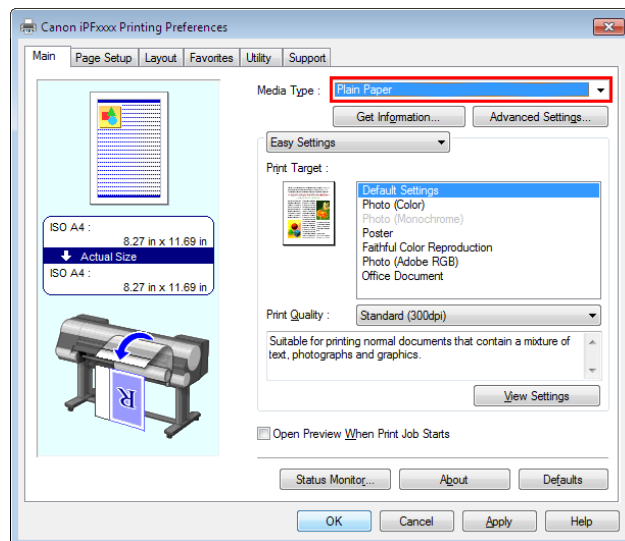

6 Send the print job.

- Printing in Windows →P.26
- Printing from Mac OS X →P.27

The printer now starts printing the print job.

Loading and Printing on Sheets

These are the basic steps for loading sheets and then printing. Follow the steps below to load and print on sheets.



- For details on supported types and sizes of paper, see **Paper Sizes** or the Paper Reference Guide. (See "Paper Sizes.") →P.530 (See "Types of Paper.") →P.530
- Borderless printing is not supported on sheets. For the features and the main printing methods available for sheet printing, see "Printing Options Using Rolls and Sheets." →P.20

1 Turn the printer on. (See "Turning the Printer On and Off.") →P.21



2 Complete settings in the printer driver for the type of paper and other details.

- Specifying Paper in the Printer Driver (Windows) →P.180
- Specifying Paper in the Printer Driver (Mac OS X) →P.366

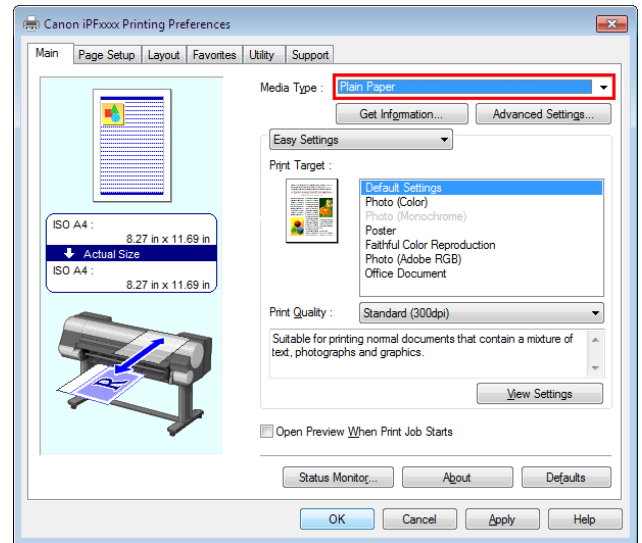

3 Send the print job.

- Printing in Windows →P.26
- Printing from Mac OS X →P.27

4 Load the sheet. (See "Loading Sheets in the Printer.")

→P.563

Start printing.

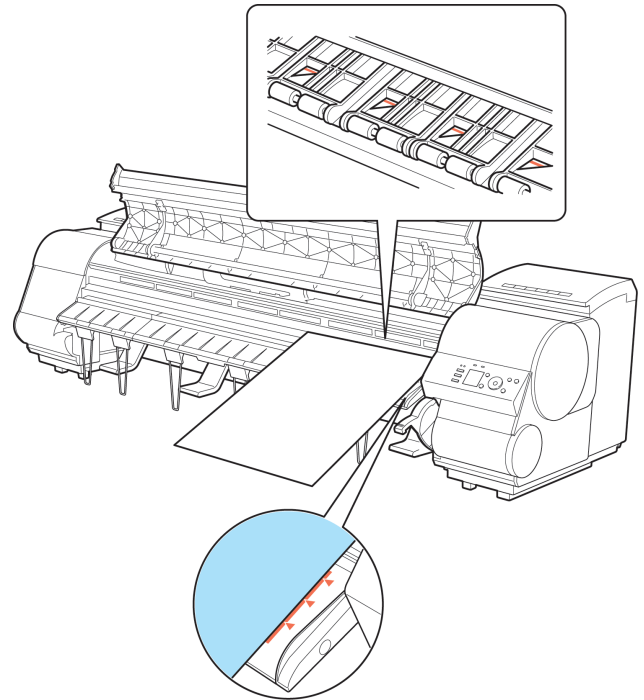

Printing in Windows

Print from the application menu.



- We recommend exiting unnecessary applications before printing. Running several applications while printing may interrupt the transfer of print data and affect printing quality.

1 In the source application, select **Print** from the **File** menu to display the dialog box for printing conditions.

2 After confirming that the printer is selected in the dialog box, click **Print** or **OK** to start printing.



Note

- The appearance of the dialog box varies depending on the software application. In most cases, the dialog box includes basic printing options and enables you to choose the printer, specify the range of pages, number of copies, and so on.

Example: Print dialog box displayed by the application

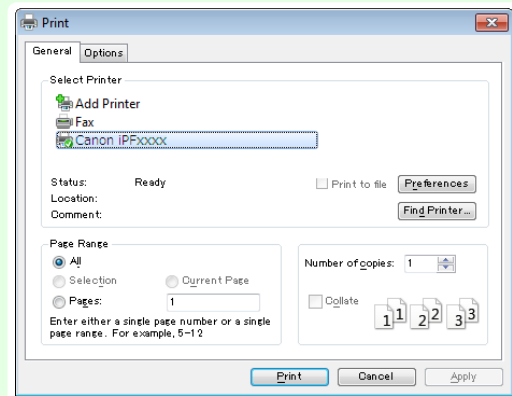

- If another printer is selected, select the printer you want to use under **Select Printer** or in the dialog box displayed after clicking **Printer**.

Settings for many printing methods (including enlarged or reduced printing, borderless printing, and so on) are displayed in the printer driver dialog box. There are two ways to access the printer driver dialog box, as follows.

- From the application
(See "Accessing the Printer Driver Dialog Box from Applications.") →P.185
- From the operating system menu
(See "Accessing the Printer Driver Dialog Box from the Operating System Menu.") →P.187

Printing from Mac OS X

Print from the application menu after registering the printer.



Important

- We recommend exiting unnecessary applications before printing. Running several applications while printing may interrupt the transfer of print data and affect printing quality.

Registering the printer

Before printing, you must register the printer in **imagePROGRAF PrinterSetup.app**.

For instructions on registering the printer, see "Configuring the Printer Driver Destination." →P.717



Important

- During this setup process, the printer will not be listed among available printers if it is off or disconnected.

Printing from the application software

1 In the application software, select **Print** from the **File** menu to display the dialog box for printing conditions.



Note

- This dialog box includes basic printing options and enables you to choose the printer, specify the range of pages, number of copies, and so on.

2 Select the printer in the **Printer** list.

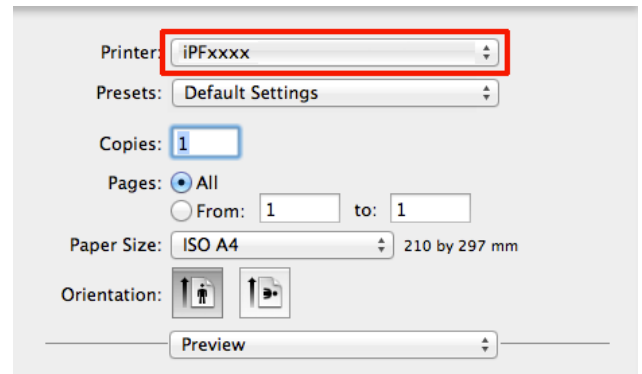

3 Click **Print** to start printing.
As shown in the following illustration, you can switch to other panes in this dialog box to complete settings for various methods of printing, including enlarged and reduced printing, borderless printing, and so on.

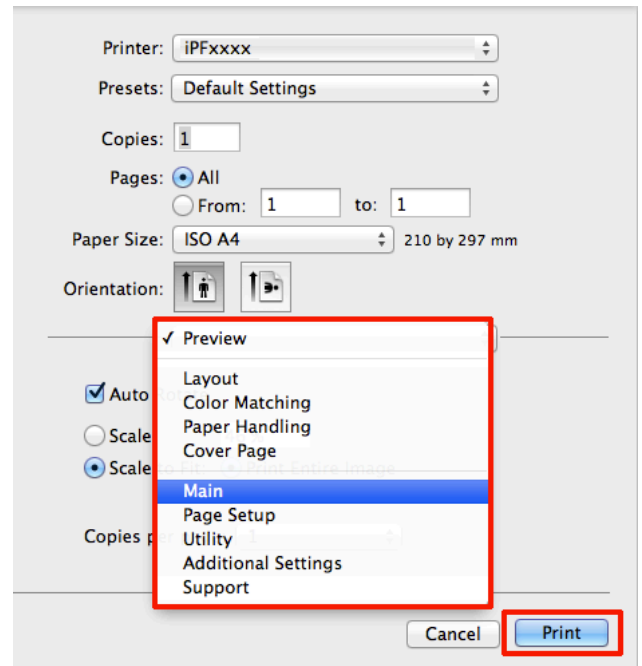

Canceling print jobs

Canceling Print Jobs from the Control Panel	29
Canceling Print Jobs from Windows	30
Canceling Print Jobs from Mac OS X	30

Canceling Print Jobs from the Control Panel

To cancel printing or reception of print jobs, press the **Stop** button on the Control Panel.



When you press the **Stop** button during printing, printer operation varies depending on the current status.

- If you press the **Stop** button before printing starts

Pressing the **Stop** button before printing starts will display a confirmation message. To cancel the print job, select "Yes".

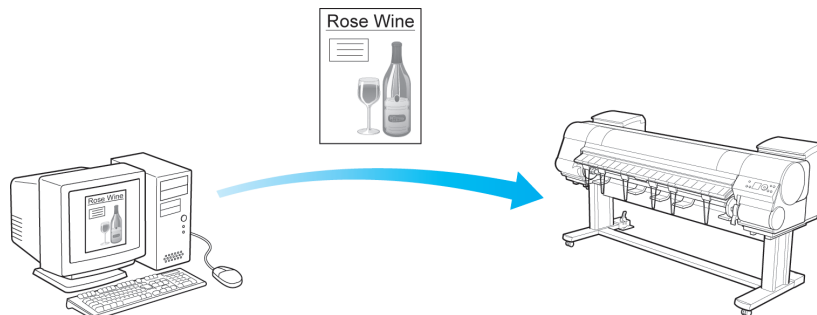

The Printer does not print.

- If you press the **Stop** button during printing

Pressing the **Stop** button during printing will display a confirmation message. To cancel the print job immediately, select "Yes".

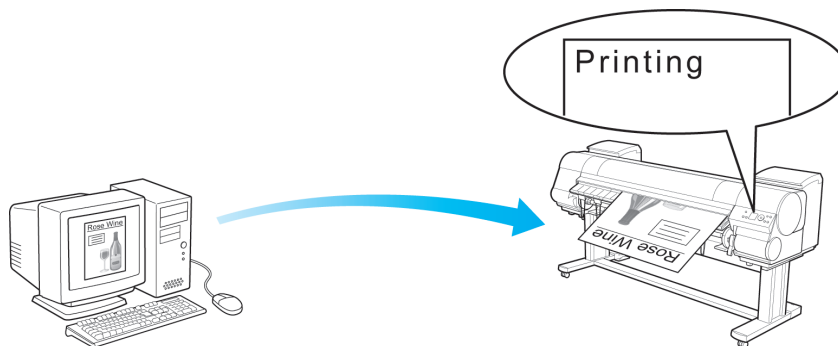

The printer stops immediately.

Canceling Print Jobs from Windows

In the printer window, you can cancel jobs that are being sent to the printer. Using imagePROGRAF Status Monitor, you can cancel print jobs that have already been received by the printer or that are currently being printed.

1 Click the printer icon in the taskbar to display the printer window.



Note

- You can also display this window by double-clicking the printer icon in the **Printers and Faxes** (or **Printer**) folder, accessible through the Windows **start** menu.

2 Right-click the job to cancel and select **Cancel**.

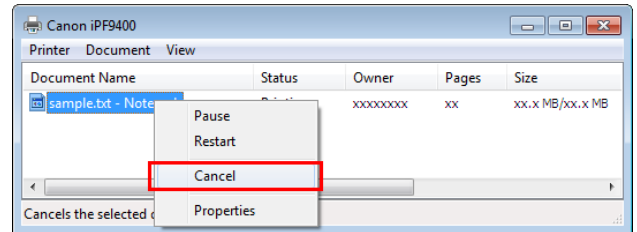

3 If the job to cancel is not shown in the printer window (that is, if the print data has already been received by the printer), double-click the taskbar icon to display imagePROGRAF Status Monitor.

4 On the **Printer Status** sheet, click **Cancel Job**.

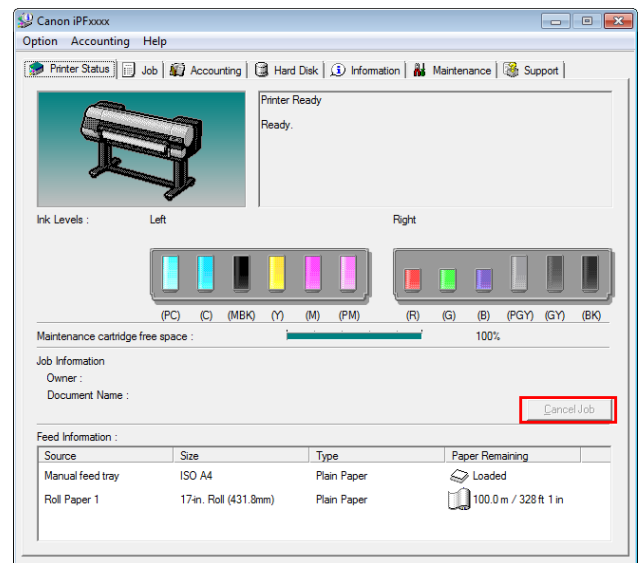

Note

- The screen may differ slightly depending on the model you are using.

Canceling Print Jobs from Mac OS X

In the printer window, you can cancel jobs that are being sent to the printer. Otherwise, you can cancel jobs from imagePROGRAF Printmonitor if they have been received by the printer or are currently being printed.



Note

- Print jobs are shown in the printer window while they are being sent from the computer. After transmission, jobs are not displayed even during printing.
- Print jobs are displayed in the imagePROGRAF Printmonitor window from the moment the printer starts receiving the print data until the moment printing is finished. They are not displayed before print data is sent to the printer, even if the computer has started preparing the print data.

1 Click the printer icon in the **Dock** to display the printer window.

2 Click **Pause Printer** to stop printing.

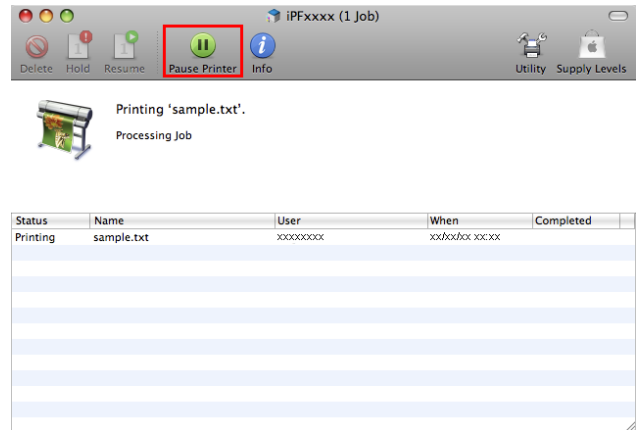

3 If there are no jobs in the printer window that can be canceled, (that is, if the print data has already been sent to the printer), click **Utility** to display imagePROGRAF Printmonitor.

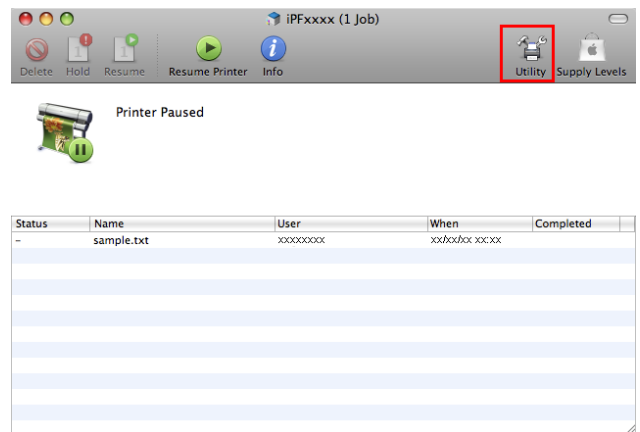

4 Select the print job to cancel and click  to delete the print job.

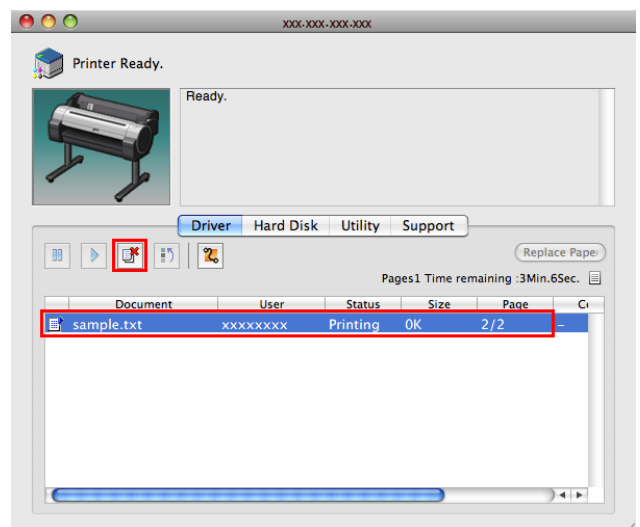

• The screen may differ slightly depending on the model you are using.

Note

The job sent to the printer is canceled.

5 Exit imagePROGRAF Printmonitor. In the printer window, click **Resume Printer**.



- Always follow these steps if you cancel print jobs from imagePROGRAF Printmonitor. If you do not restart job processing, the next job cannot be printed.

Pausing Printing

Pausing Printing

During printing, if you set **Pause Print** in the Control Panel menu to **On**, printing is stopped at that point and the printer enters a state in which printing is paused. (See "Control Panel Display.") →P.658

Printing from the job queue is not possible in this state.

To restore normal operation after this state, set **Pause Print** to **Off**.



Note

- In the following cases, the status is cleared even if you do not set **Pause Print** to **Off**, and printing from the job queue resumes.
 - When paper is advanced
 - When you execute **Chg. Paper Type** in the **Paper Menu**

1

During printing, on the **Tab Selection screen** of the Control Panel, press

◀ or ▶ to select the Job tab ().



Note

- If the **Tab Selection screen** is not displayed, press the **Menu** button.

2

Press the **OK** button.

The **Job Menu** is displayed.

3

Press ▲ or ▼ to select **Pause Print**, and then press the **OK** button.

4

Press ▲ or ▼ to select **On** or **Off**, and then press the **OK** button.

Memo

Basic Printing Workflow	19
-------------------------	----

Enhanced Printing Options

Choosing Paper for Printing	36
Printing Photos and Office Documents	37
Printing CAD Drawings	54
Adjusting Images	60
Printing enlargements or reductions	74
Printing at full size	90
Borderless Printing	101
Printing banners or at other non-standard sizes	114
Tiling and multiple pages per sheet	127
Centering originals	144
Conserving roll paper	154
Checking Images Before Printing	164
Other useful settings	165

Windows Software	177
Mac OS X Software	363
Handling and Use of Paper	529
Control Panel	655
Printer Parts	691
Network Setting	707
Print Job Management	741
Adjustments for Better Print Quality	803
Color Management	821
Maintenance and Consumables	833
Troubleshooting	883
Error Message	915
Specifications	941
Appendix	945

Choosing Paper for Printing

Choosing a Paper for Printing	36
Changing the Type of Paper	545
Specifying Paper in the Printer Driver	36
Specifying Paper in the Printer Driver (Windows)	180
Specifying Paper in the Printer Driver (Mac OS X)	366

Choosing a Paper for Printing

Select the appropriate media type from the printer control panel or printer driver to match the paper loaded in the printer. The appropriate media type differs between the case of genuine Canon paper or Canon feed confirmed paper and the case of paper other than Canon feed confirmed paper. Select the media type by following the description below. For information on how to select the media type in the printer control panel, see "Changing the Type of Paper" [→P.545](#) , and for information on how to select the media type in the printer driver, "Specifying Paper in the Printer Driver (Windows)" [→P.180](#) or see "Specifying Paper in the Printer Driver (Mac OS X)." [→P.366](#)



Important • If you use paper other than Canon feed confirmed paper, Canon provides absolutely no guarantees regarding print quality or paper feed properties.



Note • Genuine Canon paper and Canon feed confirmed paper are detailed in " Paper Reference Guide".
 • An error message is displayed on the printer Control Panel if the media type specified in the printer driver does not match the media type specified in the printer. Although you can print under these conditions, the printing results may not be suitable.

• Genuine Canon paper or Canon feed confirmed paper

For genuine Canon paper or Canon feed confirmed paper, select the settings that are optimized for that type of paper. For more information on the settings for genuine Canon paper or Canon feed confirmed paper, see " Paper Reference Guide."

• Paper other than Canon feed confirmed paper

For paper other than Canon feed confirmed paper, one method is to select from existing settings and another method is to create a new media type and add it to the printer control panel and printer driver. For details, see "Using Paper Other Than Genuine Paper and feed confirmed Paper." [→P.533](#)

Specifying Paper in the Printer Driver

If you replace the paper, complete the printer driver settings for the paper type and size. For instructions on configuring paper settings in the printer driver, refer to the following topics, as appropriate for your computer and operating system.





- Specifying Paper in the Printer Driver (Windows) [→P.180](#)
- Specifying Paper in the Printer Driver (Mac OS X) [→P.366](#)

Printing Photos and Office Documents

Printing Photos and Images	37
Printing Photos and Images (Windows)	38
Printing Photos and Images (Mac OS X)	39
Printing from Photoshop	42
Printing Adobe RGB Images (Windows)	43
Printing Adobe RGB Images (Mac OS X)	46
Printing Office Documents	48
Printing Office Documents (Windows)	48
Printing Office Documents (Mac OS X)	50
Using PosterArtist to Compose Originals	52

Printing Photos and Images

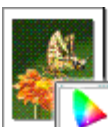
By selecting the following **Print Target** from **Easy Settings** of the printer driver, you can easily configure the printing of illustrations and photos.

	Print Target	Description
	Photo (Color)	Print photographic images from digital cameras with an optimal setting.
	Photo (Monochrome)	Print monochrome photos with an optimal setting.
	Poster	An optimal setting for posters. Print in vivid colors with impact and high saturation.
	Faithful Color Reproduction	Print with minimum color difference. Suitable for printing scanner images and when print results are too vivid.
	Photo (Adobe RGB)	Setting suitable for printing images created using the color space of Adobe RGB in optimal color.



Important

- Depending on the **Media Type** setting, some **Print Target** options may not be available.



Note

- You can check the settings values for each print target by clicking **View Settings**.

You can also fine-tune these values as needed. (**Advanced Settings**)

For details on **Advanced Settings**, refer to "Giving Priority to Particular Graphic Elements and Colors for Printing →P.67".

For instructions on printing photos and images, refer to the following topics, as appropriate for your computer and operating system.

- Printing Photos and Images (Windows) →P.38

- Printing Photos and Images (Mac OS X) →P.39

Printing Photos and Images (Windows)

This topic describes how to print photos based on the following example.

- Document: Photo image from a digital camera
- Page size: 10×12 inches (254.0×304.8 mm)
- Paper: Roll
- Paper type: **Canon Premium Glossy Paper 2 280**
- Roll paper width: 10 inches (254.0 mm)

1 Choose **Print** in the application menu.

2 Select the printer in the dialog box, and then display the printer driver dialog box. (See "Accessing the Printer Driver Dialog Box from Applications →P.185")

3 Make sure the **Main** sheet is displayed.

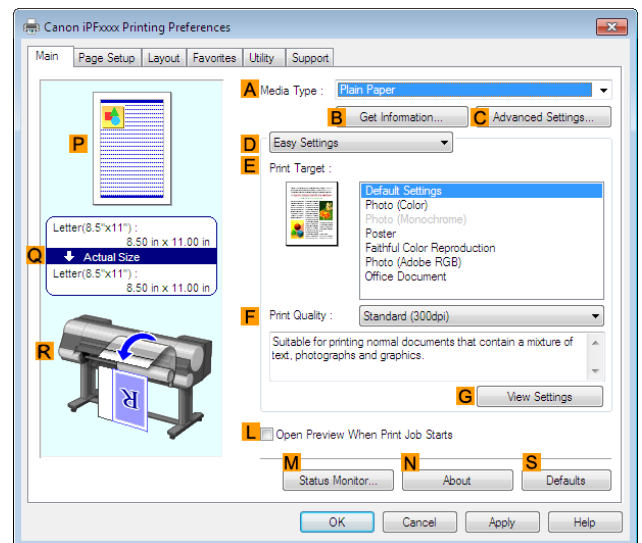

4 In the **A Media Type** list, select the type of paper that is loaded. In this case, click **Canon Premium Glossy Paper 2 280**.

In the **A Media Type**, choose the type of paper used for printing, such as Glossy Paper, **Canon Coated Paper**, and so on. Make sure the paper you select is loaded in the printer.



Note

- The paper type setting in the printer driver and related software (as well as on the Control Panel) is updated when you install the Media Configuration Tool from the User Software CD-ROM or if you change paper information by using the Media Configuration Tool. For details, see Media Configuration Tool →P.590 .

5 After confirming that **D Easy Settings** is selected, click **Photo (Color)** in the **E Print Target** list.



Note

- You can check the settings values selected in the **E Print Target** list by clicking **G View Settings**.

- 6** Click the **Page Setup** tab to display the **Page Setup** sheet.

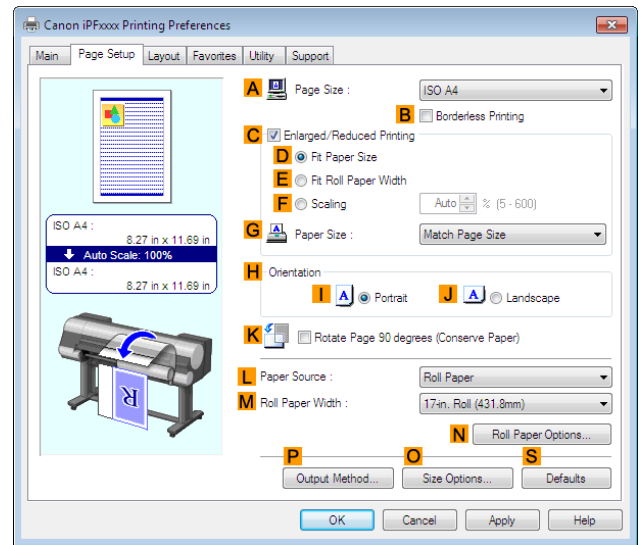

- 7** In the **A Page Size** list, click the size of the original as specified in the application. In this case, click **10"x12"**.

- 8** Select and click a roll paper in the **L Paper Source** list.

- 9** Select the width of the loaded roll in the **M Roll Paper Width** list—in this case, **10-in. Roll (254.0mm)**.

- 10** Specify additional printing conditions.
For details on available printing conditions, see "Printer Driver Settings" →P.178 "

- 11** Confirm the print settings and print as desired.



Note

- For instructions on confirming print settings, see "Confirming Print Settings." →P.182

Printing Photos and Images (Mac OS X)

This topic describes how to print photos based on the following example.

- Document: Photo image from a digital camera
- Page size: 10×12 inches (254.0×304.8 mm)
- Paper: Roll paper
- Paper type: **Canon Premium Glossy Paper 2 280**
- Roll paper width: 10 inches (254.0 mm)

1 This sets the **B Format for** and **C Paper Size**.



- The configuration method varies depending on the OS and application software you are using. If **Page Setup** is displayed in the application menu, the settings are configured by opening the **Page Attributes** dialog box from **Page Setup**.

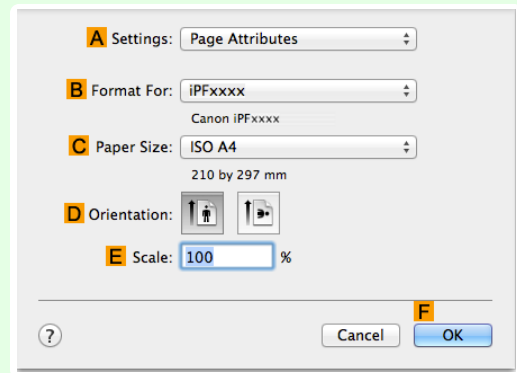

If it is not displayed, the settings are configured in the upper part of the printer driver displayed when you select **Print** from the application software menu.

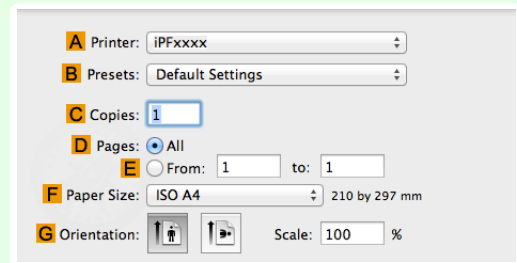

2 Select the printer in the **A Printer** list.

3 In the **F Paper Size** list, click the size of the original. In this case, click **10"x12"**.

4 If you configured the settings using the **Page Attributes** dialog box, click **F OK** to close the dialog box, and then select **Print** from the application software menu.

5 Access the **Main** pane.

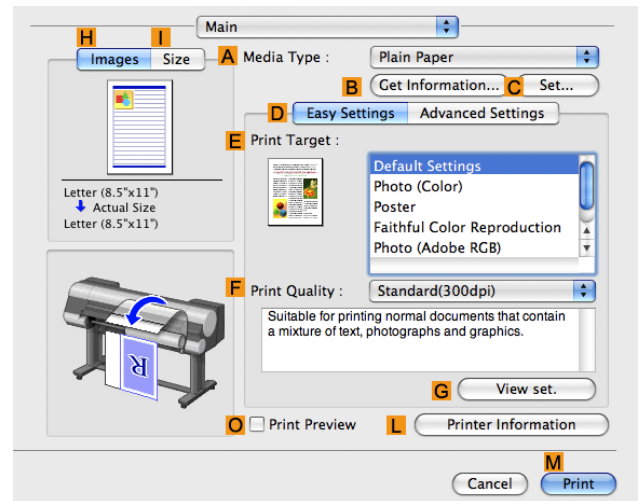

- 6** In the **A Media Type** list, select the type of paper that is loaded. In this case, click **Canon Premium Glossy Paper 2 280**.

Make sure the paper you select is loaded in the printer.



Note

- The types of paper indicated in the printer driver and related software (as well as on the Control Panel) are updated when you install the Media Configuration Tool from the User Software CD-ROM or if you change paper information by using the Media Configuration Tool. For details, see Media Configuration Tool →P.619.

- 7** After confirming that **D Easy Settings** is selected, click **Photo (Color)** in the **E Print Target** list.



Note

- For information on settings optimized for printing photos and images, see "Printing Photos and Images" →P.37.
- You can check the settings values selected in the **E Print Target** list by clicking **G View set..**

- 8** Make your selection in the **F Print Quality** list.

- 9** Access the **Page Setup** pane.

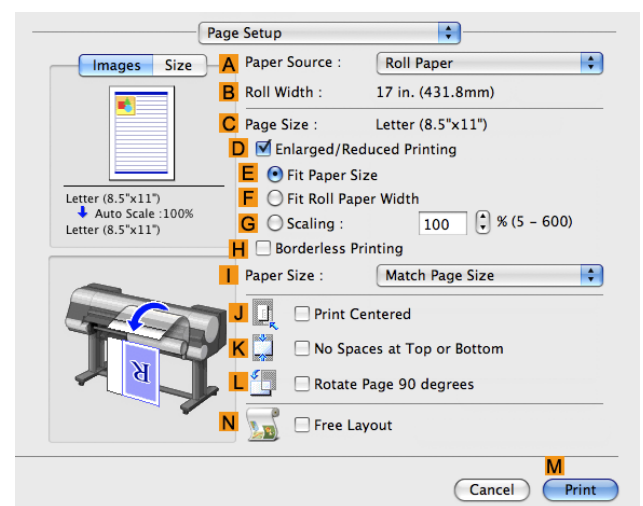

- 10** Select and click a roll paper in the **A Paper Source** list.

- 11** Make sure the width of the loaded roll is displayed in the **B Roll Width** list—in this case, **10 in. (254.0mm)**.



Note

- If the width of the roll loaded in the printer is not shown in **B Roll Width**, click **L Printer Information** on the **Main** pane to update the printer information.

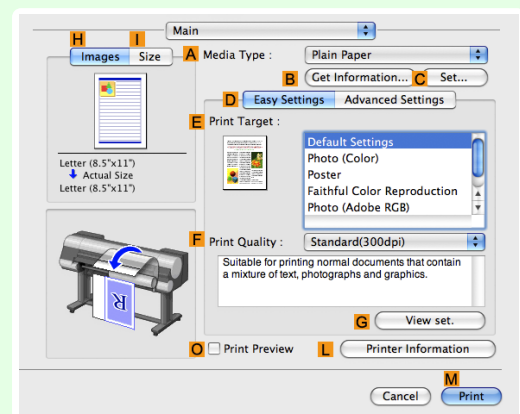

12 Make sure **C Page Size** on the **Page Setup** pane shows the original size as specified in **C Paper Size** in the **Page Attributes** dialog box—in this case, **10"x12"**.

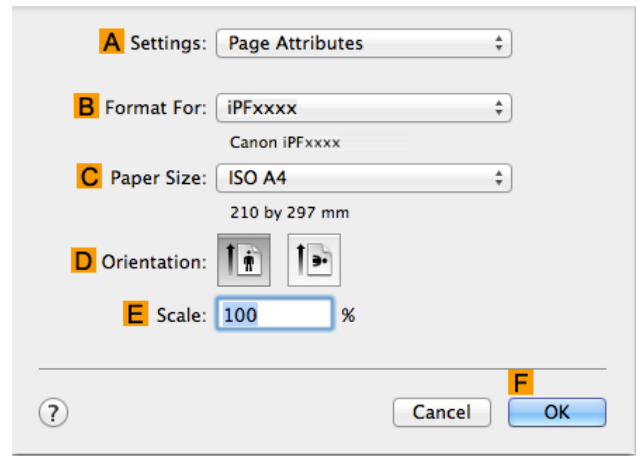

13 Specify additional printing conditions. For details on available printing conditions, see "Printer Driver Settings →P.364 "

14 Confirm the print settings, and then click **M Print** to start printing.

 For tips on confirming print settings, see "Confirming Print Settings →P.368 "

Note

Printing from Photoshop

You can print images in the Adobe RGB color space that you have created in Photoshop, the Adobe Systems photo retouching application. Using the dedicated Photoshop printer driver plug-in (provided with the printer) makes it easy to print Adobe RGB images more attractively.

- Using the Plug-in to Print
The imagePROGRAF Print Plug-In for Photoshop is a dedicated plug-in provided with the printer that you can load in Photoshop and customize for your printing needs. By using the plug-in, you can print while preserving the 16-bit RGB data from Photoshop without losing the exceptional color gradations of original image. Some of the settings and customizations available in the plug-in are as follows.
 - Automatic detection of the color space (sRGB or Adobe RGB) for automatic selection of the optimal profile. This feature eliminates the need to complete intricate settings when printing Adobe RGB images.
 - Advanced gray adjustment, including adjustment of tone curves, in addition to an array of standard adjustments for color balance, brightness, contrast, highlight, and shadow.
 - Fine-tune color tones in Photoshop while viewing a preview that accurately reproduces printing results.
 - With print log management, you can save and load setting parameters from past print jobs.

 imagePROGRAF Print Plug-In for Photoshop for Windows and Macintosh are provided with the printer.

Note

For instructions and details on which versions of Photoshop are compatible with the imagePROGRAF Print Plug-In for Photoshop, refer to the following topics, as appropriate for your computer and operating system.

- Print Plug-In (Windows) →P.257
- Print Plug-In (Macintosh) →P.465

- Using the Printer Driver to Print
The printer driver offers the following settings and adjustments.
 - Choose the standard sRGB color space or Adobe RGB as desired.

- Adjust the color balance, brightness, contrast, saturation, and gray levels.

For instructions on using the printer driver to print Adobe RGB images created in Photoshop, refer to the following topics, as appropriate for your computer and operating system.

- Printing Adobe RGB Images (Windows) →P.43
- Printing Adobe RGB Images (Mac OS X) →P.46

Printing Adobe RGB Images (Windows)

This topic describes how to print Adobe RGB images based on the following example.

- Document: Adobe RGB image created in Photoshop
- Page Size: 10×12 inches (254.0×304.8 mm)
- Paper: Roll
- Paper type: **Canon Premium Glossy Paper 2 280**
- Roll Paper Width: 10 inches (254.0 mm)



- In Photoshop, select no color-matching.

Important • In the printer driver settings, select **Driver Matching Mode** and choose **Adobe RGB** in **Color Space**.

- 1 In Photoshop, create an image in the Adobe RGB color space.



- The following procedures are based on the example of Photoshop CS3/CS4/CS5.

Note • For instructions on creating Adobe RGB images, refer to the Photoshop documentation.

- 2 Choose **Print with Preview** from the **File** menu to display the **Print** dialog box.

- 3 Make sure the setting mode is **Color Management**.

- 4 In the **Color Handling** list in **Options**, click **Printer Manages Colors**.

- 5 Click **Print** to display the **Print** dialog box.

- 6 Select the printer and click **Properties** to display the printer driver dialog box.

- 7 Make sure the **Main** sheet is displayed.

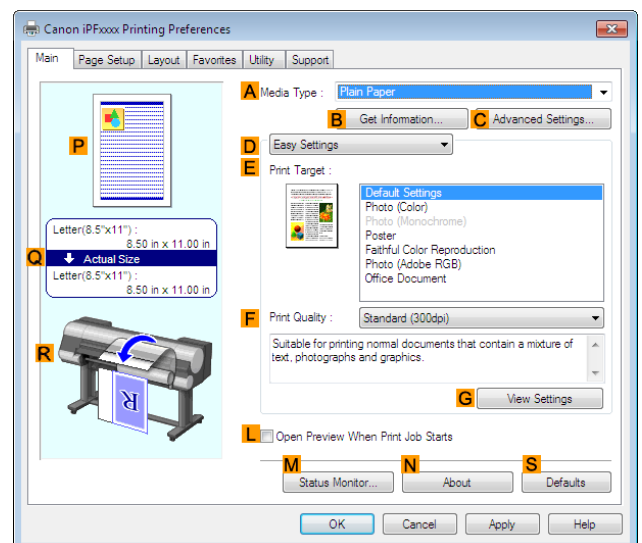

8 In the **A Media Type** list, select the type of paper that is loaded. In this case, click **Canon Premium Glossy Paper 2 280**.

9 Click **D Advanced Settings** to switch the print mode.

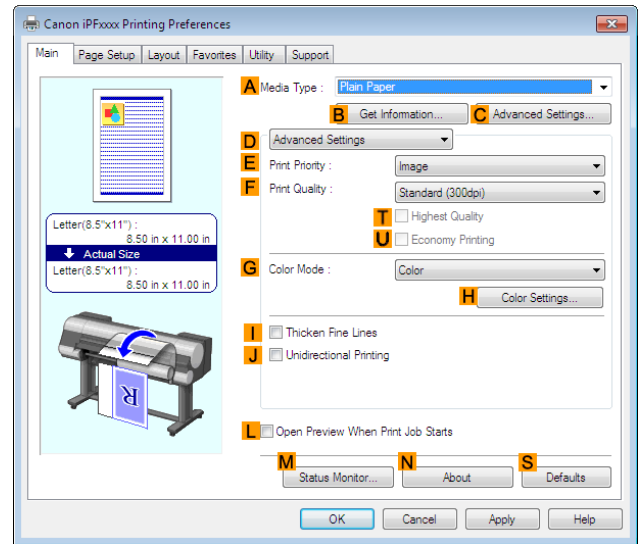

10 Click **Image** in the **E Print Priority** list.

11 Select the print quality in the **F Print Quality** list.

 • Options displayed in the **F Print Quality** list vary depending on the paper type.

Note

12 Click **Color** in the **G Color Mode** list.

13 Click **H Color Settings** to display the **Color Settings** dialog box.

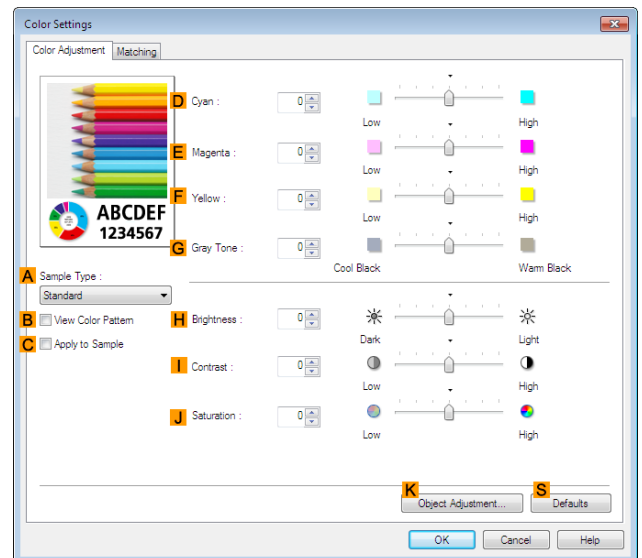

- 14** Click the **Matching** tab to display the **Matching** sheet.

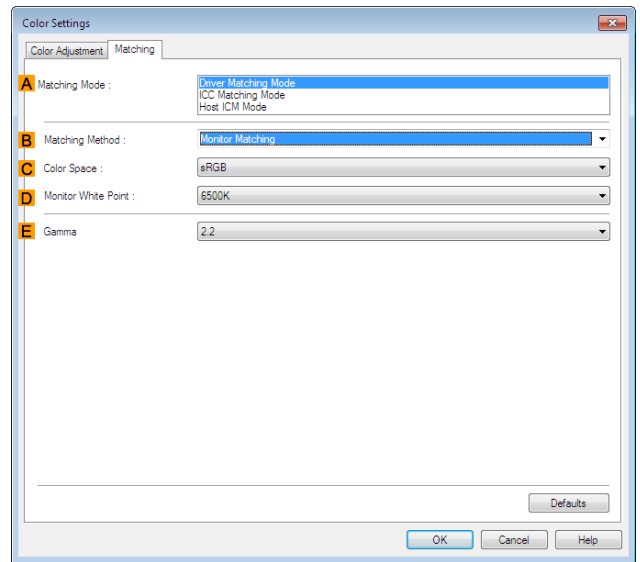

- 15** In **A Matching Mode**, click **Driver Matching Mode**.

- 16** In **C Color Space**, click **Adobe RGB**.

- 17** Click **OK** to close the **Color Settings** dialog box.

- 18** Click the **Page Setup** tab to display the **Page Setup** sheet.

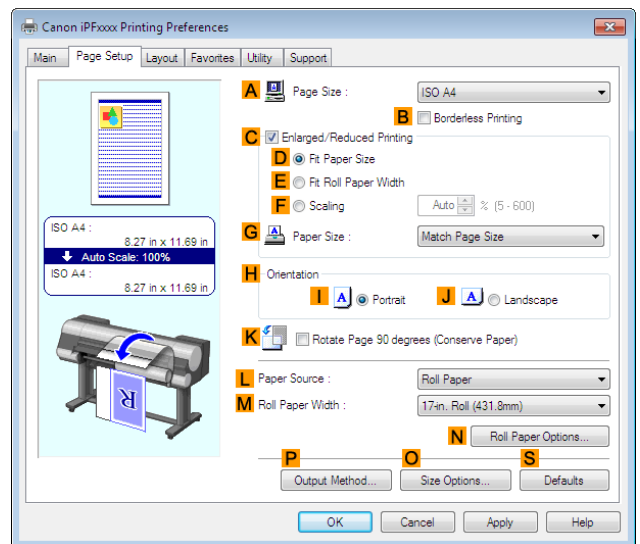

- 19** In the **A Page Size** list, click the size of the original as specified in the source application. In this case, click **10"x12"**.

- 20** Select and click a roll paper in the **L Paper Source** list.

- 21** Select the width of the loaded roll in the **M Roll Paper Width** list. In this case, click **10-in. Roll (254.0mm)**, and then click **OK**.

22 Confirm the print settings and print as desired.



• For tips on confirming print settings, see "Confirming Print Settings →P.182 "

Printing Adobe RGB Images (Mac OS X)

This topic describes how to print Adobe RGB images based on the following example.

- Document: Adobe RGB image created in Photoshop
- Page size: 10×12 inches (254.0×304.8 mm)
- Paper: Roll
- Paper type: **Canon Premium Glossy Paper 2 280**
- Roll paper width: 10 inches (254.0 mm)



• In Photoshop, select no color-matching.
Important • In the printer driver settings, select **Driver Matching Mode** and choose **Adobe RGB in Color Space**.

1 In Photoshop, create an image in the Adobe RGB color space.



• The following procedures are based on the example of Photoshop CS3/CS4/CS5.
 • For instructions on creating Adobe RGB images, refer to the Photoshop documentation.

2 Choose **Print with Preview** from the Photoshop menu to display the **Print** dialog box.

3 Make sure the setting mode is **Color Management**.

4 In the **Color Handling** list, click **Printer Manages Colors**.

5 Click **Print**.

6 Access the **Main** pane.

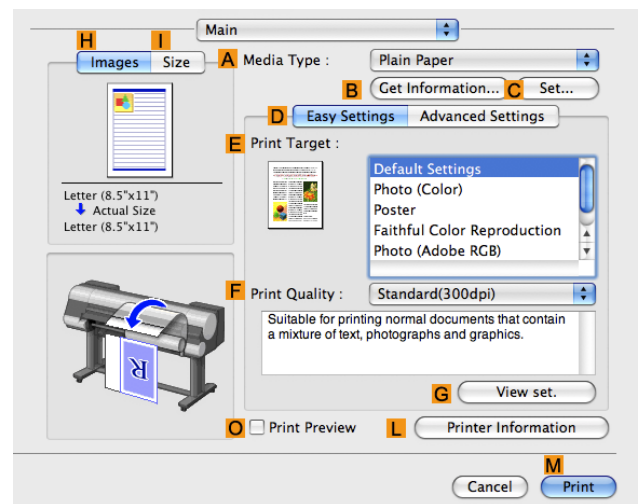

7 In the **A Media Type** list, select the type of paper that is loaded. In this case, click **Canon Premium Glossy Paper 2 280**.

- 8** Click **D Advanced Settings** to switch the print mode.

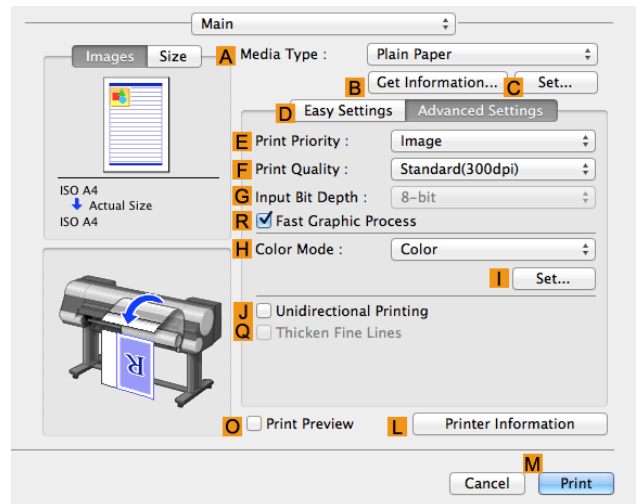

- 9** Click **Image** in the **E Print Priority** list.

- 10** Select the print quality in the **F Print Quality** list.



Note

- Options displayed in the **F Print Quality** list vary depending on the type of paper.

- 11** Click **Color** in the **H Color Mode** list.

- 12** Click **I Set** to display the **Color Settings** dialog box.

- 13** Click **Matching** to display the **Matching** pane.

- 14** In **Matching Mode**, click **Driver Matching Mode**.

- 15** In **Color Space**, click **Adobe RGB**.

- 16** Click **OK** to close the **Color Settings** dialog box.

- 17** Access the **Page Setup** pane.

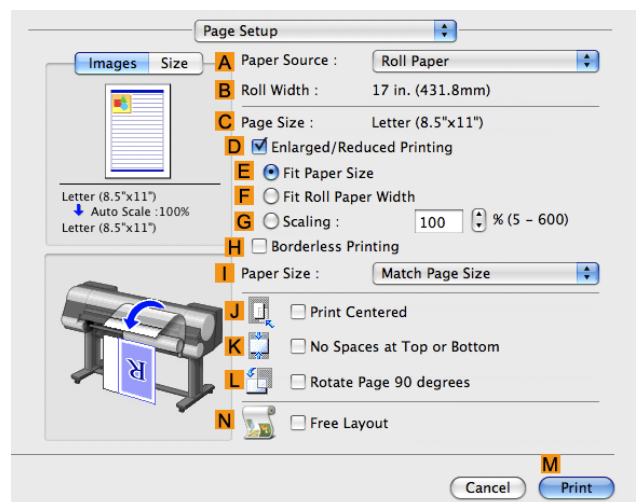

18 Select and click a roll paper in the **A Paper Source** list.

19 Make sure the width of the loaded roll paper is displayed in the **B Roll Width** list—here, **10-in. Roll (254.0mm)**.

 **Note** • If the width of the roll loaded in the printer is not shown in **B Roll Width**, click **L Printer Information** on the **Main** pane to update the printer information.

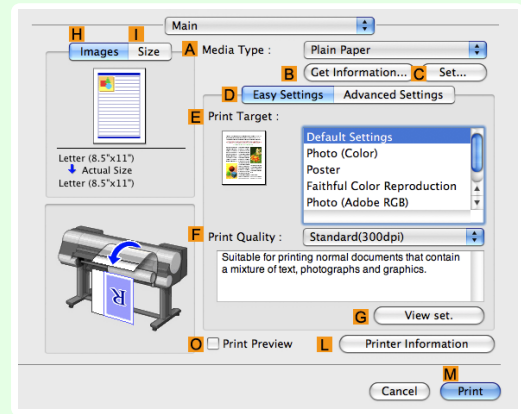

20 Make sure **C Page Size** in the **Page Setup** pane matches the size of the original as specified in Photoshop—in this case, **10"x12"**.

21 Confirm the print settings, and then click **M Print** to start printing.

 **Note** • For tips on confirming print settings, see "Confirming Print Settings." →P.368

Printing Office Documents

By selecting **Office Document** from **Easy Settings** of the printer driver, you can easily configure settings for printing office documents.

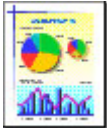
	Print Target	Description
	Office Document	Setting optimized for printing general office documents such as materials for distribution so that they can be viewed easily.

 **Note** • You can check the settings values for each print target by clicking **View Settings**.
 • You can also fine-tune these values as needed. (Advanced Settings)
 For details on Advanced Settings, refer to "Giving Priority to Particular Graphic Elements and Colors for Printing" →P.67 "

For instructions on printing office documents, refer to the following topics, as appropriate for your computer and operating system.

- Printing Office Documents (Windows) →P.48
- Printing Office Documents (Mac OS X) →P.50

Printing Office Documents (Windows)

48 This topic describes how to print office documents based on the following example.

- Document: Office document created using word-processing or spreadsheet programs
- Page size: A4 (210.0 × 297.0 mm [8.3 × 11.7 in])
- Paper: Sheets

- Paper type: **Plain Paper**
- Paper size: A4 (210.0 × 297.0 mm [8.3 × 11.7 in])

- 1 Choose **Print** in the application menu.
- 2 Select the printer in the dialog box, and then display the printer driver dialog box. (See "Accessing the Printer Driver Dialog Box from Applications →P.185 ")
- 3 Make sure the **Main** sheet is displayed.

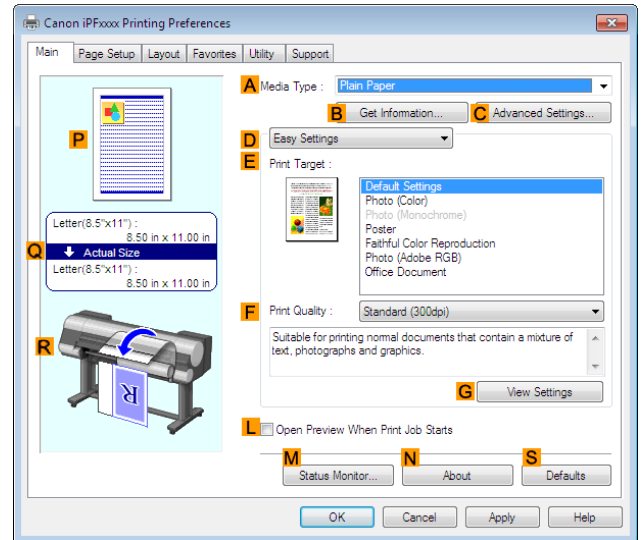

- 4 In the **A Media Type** list, select the type of paper that is loaded. In this case, click **Plain Paper**.
- 5 After confirming that **D Easy Settings** is selected, click **Office Document** in the **E Print Target** list.



Note

- You can check the settings values selected in the **E Print Target** list by clicking **G View Settings**.

- 6 Click the **Page Setup** tab to display the **Page Setup** sheet.

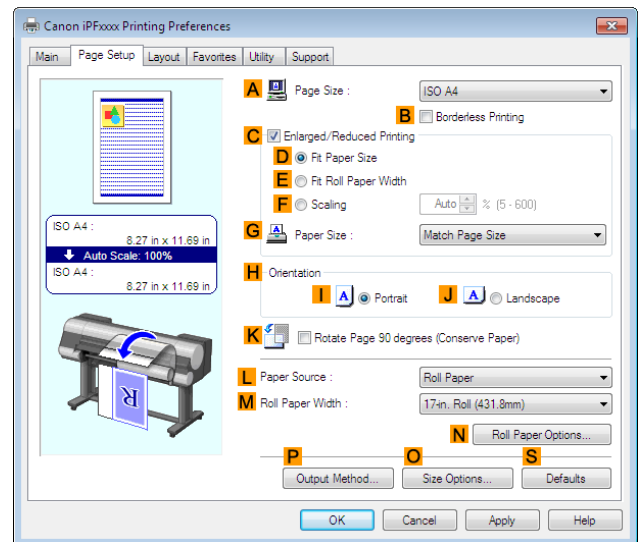

- 7 In the **A Page Size** list, click the size of the original as specified in the application. In this case, click **ISO A4**.
- 8 Click **Cut Sheet** in the **L Paper Source** list.

9 Specify additional printing conditions.
For details on available printing conditions, see "Printer Driver Settings →P.178 "

10 Confirm the print settings and print as desired.

 **Note** • For tips on confirming print settings, see "Confirming Print Settings →P.182 "

Printing Office Documents (Mac OS X)

This topic describes how to print office documents based on the following example.

- Document: Office document created using word-processing or spreadsheet programs
- Page size: A4 (210.0 × 297.0 mm [8.3 × 11.7 in])
- Paper: Sheets
- Paper type: **Plain Paper**
- Paper size: A4 (210.0 × 297.0 mm [8.3 × 11.7 in])

1 This sets the **B Format for** and **C Paper Size**.

 **Note** • The configuration method varies depending on the OS and application software you are using. If **Page Setup** is displayed in the application menu, the settings are configured by opening the **Page Attributes** dialog box from **Page Setup**.

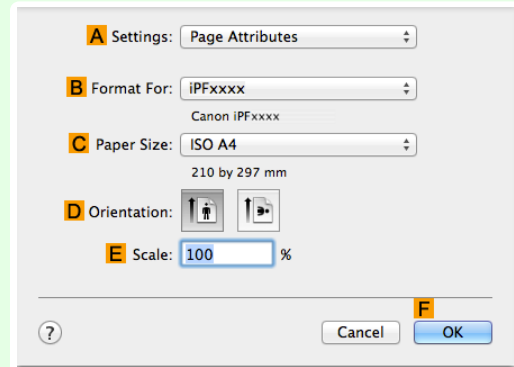

If it is not displayed, the settings are configured in the upper part of the printer driver displayed when you select **Print** from the application software menu.

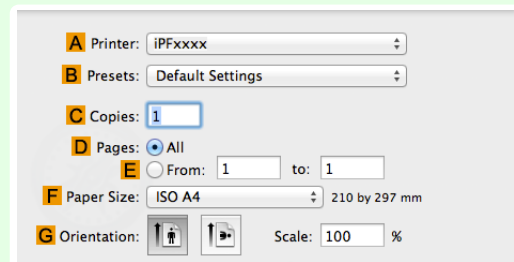

2 Select the printer in the **A Printer** list.

3 In the **F Paper Size** list, click the size of the original. In this case, click **ISO A4 - for Paper Tray (Large Margins)**.

4 If you configured the settings using the **Page Attributes** dialog box, click **F OK** to close the dialog box, and then select **Print** from the application software menu.

5 Access the **Main** pane.

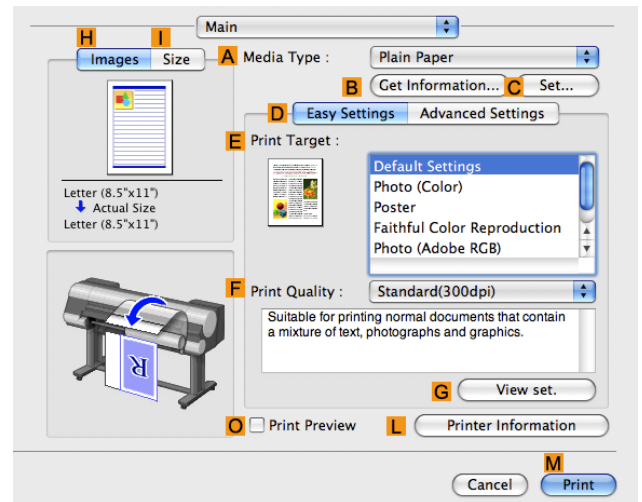

6 In the **A Media Type** list, select the type of paper that is loaded. In this case, click **Plain Paper**.

7 After confirming that **D Easy Settings** is selected, click **Office Document** in the **E Print Target** list.



Note

- You can check the settings values selected in the **E Print Target** list by clicking **G View set..**

8 Make your selection in the **F Print Quality** list.

9 Access the **Page Setup** pane.

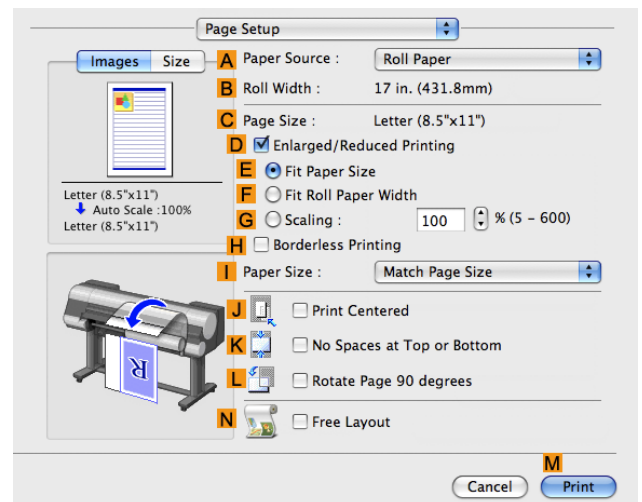

10 Click **Cut Sheet** in the **A Paper Source** list.

- 11** Make sure the **C Page Size** setting matches the original size as selected in **C Paper Size** in the **Page Attributes** dialog box—in this case, **ISO A4 - for Paper Tray (Large Margins)**.

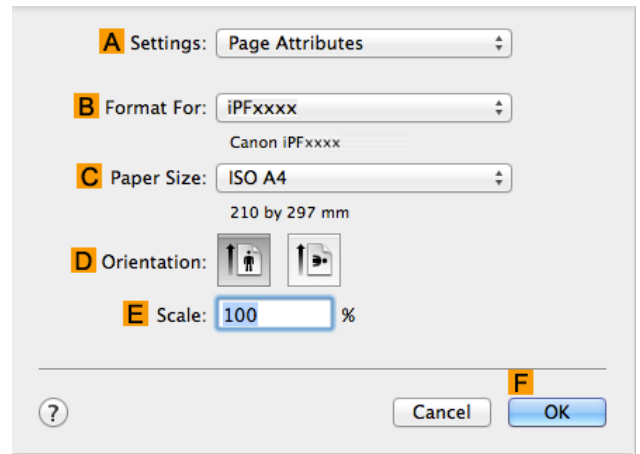

- 12** Specify additional printing conditions. For details on available printing conditions, see "Printer Driver Settings →P.364 "

- 13** Confirm the print settings, and then click **M Print** to start printing.



Note

- For tips on confirming print settings, see "Confirming Print Settings →P.368 "

Using PosterArtist to Compose Originals

You can print a variety of source documents from word-processing or spreadsheet programs or screen shots from web browsers after composing an original with them using PosterArtist.

This topic describes how to use PosterArtist to compose originals from multiple applications, creating a poster layout for printing.

- 1 Choose **Print** in the application menu.
- 2 Select the printer in the dialog box, and then open the printer driver dialog box. (See "Accessing the Printer Driver Dialog Box from Applications (Windows)." →P.185)
- 3 Make sure the **Main** sheet is displayed.

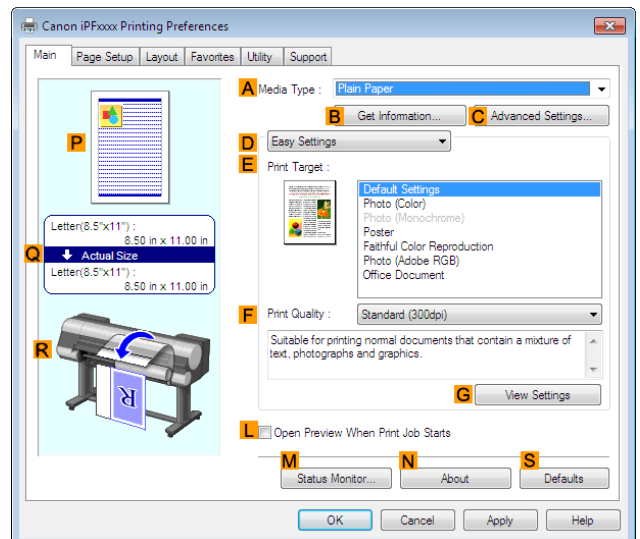

- 4** Click the **Layout** tab to display the **Layout** sheet.

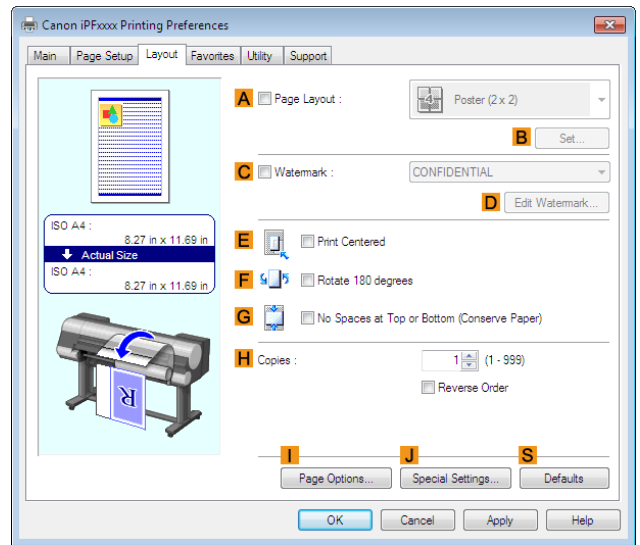

- 5** Select the **A Page Layout** check box.

- 6** Click in the **Edit Using PosterArtist** in the **A Page Layout** list.



Note

- This function cannot be used with a 64-bit version OS.

- 7** When you attempt to print, PosterArtist starts up and the PageCapture window is displayed. (At this point, the document will not be printed yet.)

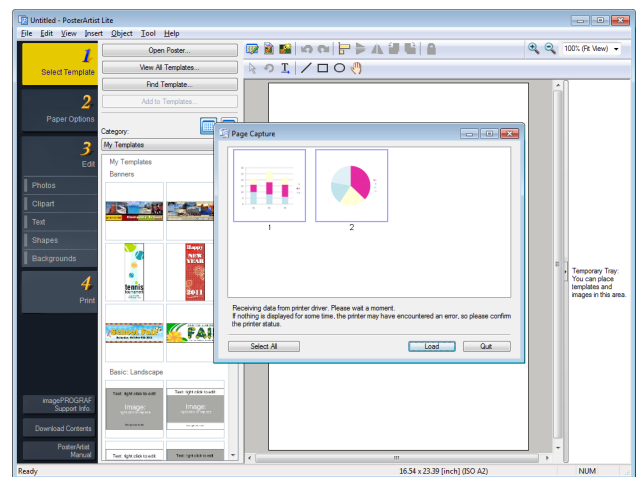

- 8** Choose the page to load in PosterArtist.

- 9** Edit and rearrange the image in the PosterArtist window as desired. Without closing the PosterArtist window, repeat steps 1-8 to arrange originals from multiple applications on the same page.



Note

- For details on how to edit and sort images, refer to the PosterArtist Manual.



- 10** Print from the PosterArtist menu.

Printing CAD Drawings

- Printing Line Drawings and Text 54
 - Printing Line Drawings and Text (Windows) 54
 - Printing Line Drawings and Text (Mac OS X) 56
- Printing from AutoCAD 58

Printing Line Drawings and Text

By selecting the following **Print Target** from **Easy Settings** of the printer driver, you can easily configure setting for printing line drawings and characters.

	Print Target	Description
	Perspective, GIS	Settings optimized for printing 3D CAD drawings, perspective drawings, and maps, including GIS maps.
	CAD (Color Line Drawing)	Settings optimized to print intricate lines in CAD drawings clearly.



- You can check the settings values for each print target by clicking **View Settings**.
- Note** • You can also fine-tune these values as needed. (**Advanced Settings**)
 For details on **Advanced Settings**, refer to "Giving Priority to Particular Graphic Elements and Colors for Printing →P.67 "

Printing Line Drawings and Text (Windows)

This topic describes how to print line drawings based on the following example.

- Document: CAD drawing
- Page size: A3 (297.0 × 420.0 mm [11.7 × 16.5 in])
- Paper: Roll paper
- Paper type: **Plain Paper**
- Roll paper width: A2/A3 roll (420.0 mm [16.5 in])

- 1** Choose **Print** in the application menu.
- 2** Select the printer in the dialog box, and then display the printer driver dialog box.(See "Accessing the Printer Driver Dialog Box from Applications →P.185 ")

- 3** Make sure the **Main** sheet is displayed.

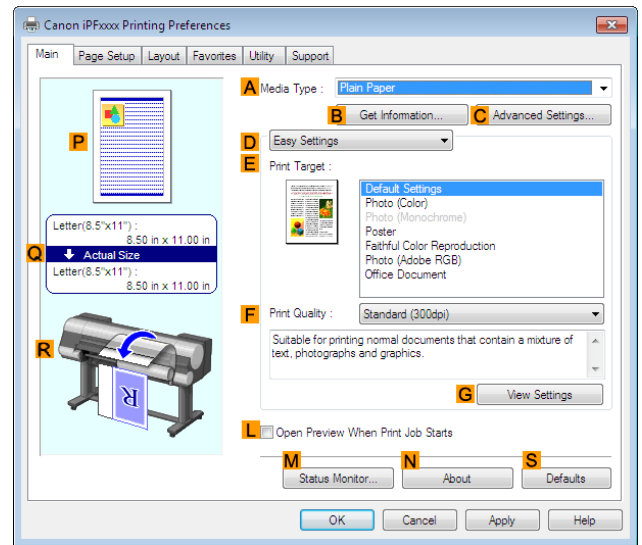

- 4** In the **A Media Type** list, select the type of paper that is loaded. In this case, click **Plain Paper**.

- 5** After confirming that **D Easy Settings** is selected, click **CAD (Color Line Drawing)** or **CAD (Monochrome Line Drawing)** in the **E Print Target** list.



Note

- You can check the settings values selected in the **E Print Target** list by clicking **G View Settings**.

- 6** Click the **Page Setup** tab to display the **Page Setup** sheet.

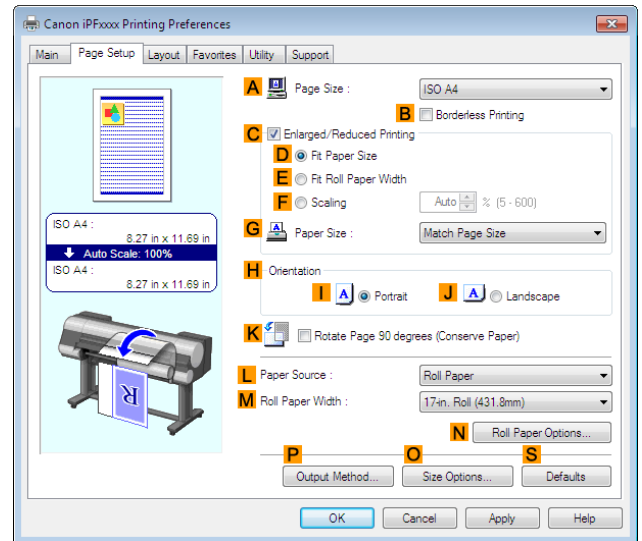

- 7** In **A Page Size**, click the size of the original as specified in the application. In this case, click **ISO A3**.

- 8** Select and click a roll paper in the **L Paper Source** list.

- 9** Select the width of the loaded roll in the **M Roll Paper Width** list—in this case, **ISO A2/A3 Roll (420.0mm)**.

- 10** Specify additional printing conditions.
For details on available printing conditions, see "Printer Driver Settings →P.178 "

11 Confirm the print settings and print as desired.

- For tips on confirming print settings, see "Confirming Print Settings →P.182 "
- Note** • You can conserve roll paper by configuring settings suitable for the document. For details on how to conserve paper and print, refer to "Conserving Roll Paper by Rotating Originals 90 Degrees →P.154 "

Printing Line Drawings and Text (Mac OS X)

This topic describes how to print line drawings based on the following example.

- Document: CAD drawing
- Page size: A3 (297.0 × 420.0 mm [11.7 × 16.5 in])
- Paper: Roll
- Paper type: **Plain Paper**
- Roll paper width: A2/A3 roll (420.0 mm [16.5 in])

1 This sets the **B Format for** and **C Paper Size**.

- Note** • The configuration method varies depending on the OS and application software you are using. If **Page Setup** is displayed in the application menu, the settings are configured by opening the **Page Attributes** dialog box from **Page Setup**.

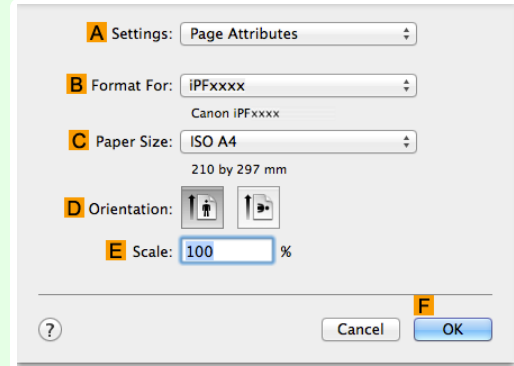

If it is not displayed, the settings are configured in the upper part of the printer driver displayed when you select **Print** from the application software menu.

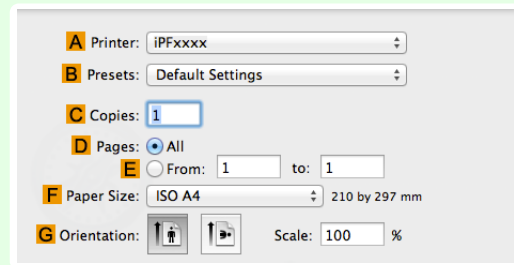

2 Select the printer in the **A Printer** list.

3 In the **F Paper Size** list, click the size of the original. In this case, click **ISO A3**.

4 If you configured the settings using the **Page Attributes** dialog box, click **F OK** to close the dialog box, and then select **Print** from the application software menu.

5 Access the **Main** pane.

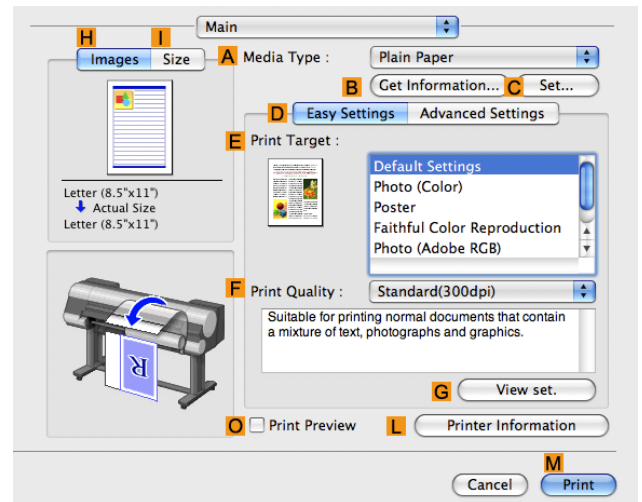

6 In the **A Media Type** list, select the type of paper that is loaded. In this case, click **Plain Paper**.

7 After confirming that **D Easy Settings** is selected, click **CAD (Color Line Drawing)** in the **E Print Target** list.

 • You can check the settings values selected in the **E Print Target** list by clicking **G View set..**

Note

8 Make your selection in the **F Print Quality** list.

9 Access the **Page Setup** pane.

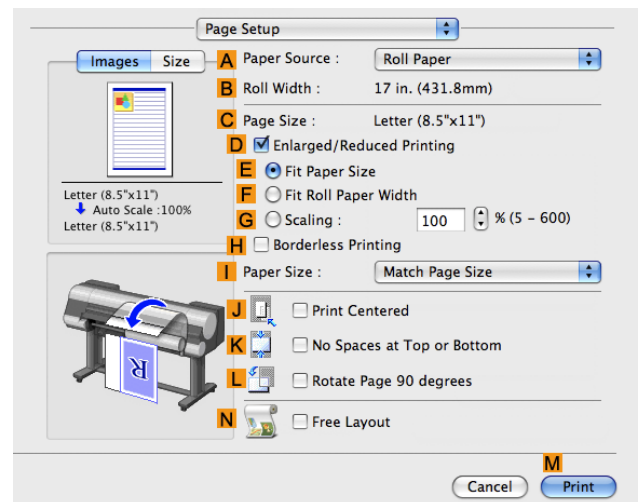

10 Select and click a roll paper in the **A Paper Source** list.

11 Make sure the width of the loaded roll is displayed in the **B Roll Width** list—in this case, **ISO A2/A3 (420.0mm)**.



Note

- If the width of the roll loaded in the printer is not shown in **B Roll Width**, click **L Printer Information** on the **Main** pane to update the printer information.

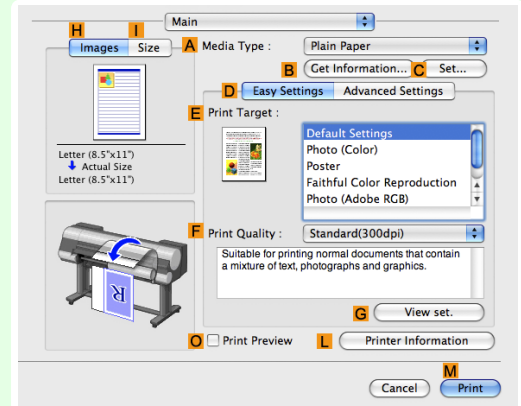

12 Make sure **C Page Size** on the **Page Setup** pane shows the original size as specified in **C Paper Size** in the **Page Attributes** dialog box—in this case, **ISO A3**.

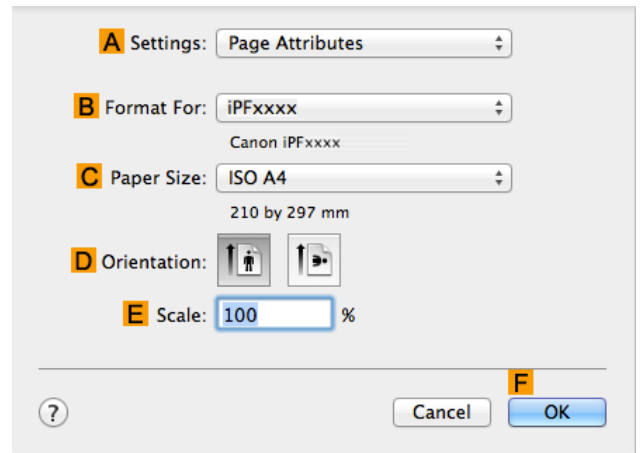

13 Specify additional printing conditions.
For details on available printing conditions, see "Printer Driver Settings →P.364 "

14 Confirm the print settings, and then click **M Print** to start printing.



Note

- For tips on confirming print settings, see "Confirming Print Settings →P.368 "
- You can conserve roll paper by configuring settings suitable for the document. For details on how to conserve paper and print, refer to "Conserving Roll Paper by Rotating Originals 90 Degrees →P.156 .

Printing from AutoCAD

Printer Driver Optimization Module for AutoCAD is software for printing optimally from AutoCAD with the printer driver. By optimally controlling the processing resolution of raster data and the memory to be used in image processing of AutoCAD, printing superior in reliability and productivity is realized.

If you install Printer Driver Optimization Module for AutoCAD on a computer on which supported AutoCAD is installed, it will be installed automatically.



Note

- Printer Driver Optimization Module for AutoCAD is applied automatically when you print from AutoCAD, and optimal printing is performed.

Confirming the Installation of Printer Driver Optimization Module for AutoCAD

You can confirm whether Printer Driver Optimization Module for AutoCAD is installed by the following method.

- 1 From the **File** menu of AutoCAD, select **Print**.
- 2 The **Printing** dialog box is displayed. Printer Driver Optimization Module for AutoCAD is installed if in **Plotter** of **Printer/plotter** this is displayed: **iPFxxxx - Optimized driver - by Canon Inc..**

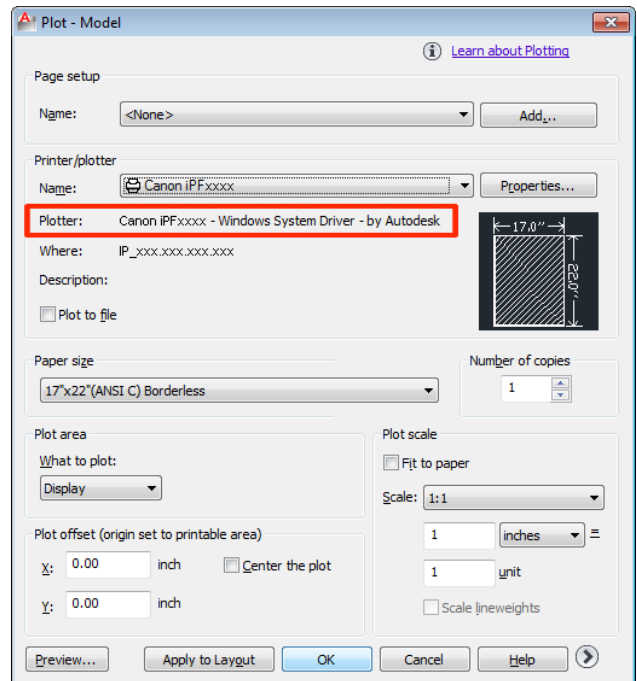

Installation of Printer Driver Optimization Module for AutoCAD

If Printer Driver Optimization Module for AutoCAD is not installed, install it by the following method.

- 1 Insert User Software CD-ROM in the CD-ROM drive and start the installer.
- 2 In the **Setup Menu** window, click **Install Individual Software**.
- 3 Click **Install** of Printer Driver Optimization Module for AutoCAD.
- 4 Follow the instructions on the screen.

Adjusting Images

Adjusting the Color in the Printer Driver	60
Fine-Tuning Colors of Photos and Images (Windows)	62
Fine-Tuning Colors of Photos and Images (Mac OS X)	64
Giving Priority to Particular Graphic Elements and Colors for Printing	67
Choosing the Document Type and Printing Conditions (Windows)	69
Choosing the Document Type and Printing Conditions (Mac OS X)	71

Adjusting the Color in the Printer Driver

Color settings specified in the application for your documents are essentially given priority over other settings for each print job, but further color adjustment is possible in the printer driver.

• Color Mode

Choose how the printer driver processes color, as desired.

The available options vary depending on the color mode.

Color Mode	Description	Color Adjustment
Color	Print in color.	You can select the color balance and color matching functions.
Monochrome (Photo)	Grayscale printing optimized for monochrome photos.	You can adjust the color balance in ways tailored to monochrome photos.
Monochrome	Print in grayscale.	You can adjust the color balance.
No color correction (*1)	Prints without performing color-matching in the printer driver.	You can adjust the color balance.

*1: If **No color correction** is selected, the **Matching** sheet / **Matching** pane is not displayed.

• Color Adjustment

You can adjust colors separately for images, graphics, and text documents.

Adjustment Item	Description
Cyan	Fine-tune color tones by adjusting the levels of Cyan , Magenta , and Yellow .
Magenta	
Yellow	
Gray Tone	Adjust the grayscale, in a range from cool, blue tones to warm, red tones.
Brightness	Adjust the brightness of printed images while keeping the darkest and lightest portions intact.
Contrast	Adjust the contrast of the darkest and lightest portions relative to each other. For soft gradation, decrease the contrast. For hard gradation, increase the contrast.
Saturation	Adjust the level of color saturation, in a range from subdued to vivid.



- Click **Object Adjustment** to open the **Object Adjustment** dialog box, which allows you to select the color adjustment target from **Image**, **Graphics**, and **Text**.

Note

• Matching

You can choose the color-matching mode and method.

By adjusting the color-matching mode and method, you can make printed colors match the colors of on-screen images more closely.



Important

- If **No color correction** is selected under **Color Mode**, the **Matching** cannot be changed.

Matching Mode	Description	Remarks
Driver Matching Mode	Enables printing of optimal color tones using a driver specific color profile.	You should normally select this mode.
ICC Matching Mode	Enables color matching using ICC profiles. Select this if you want to print by specifying the input profile, printer profile, and matching method in detail.	This allows you to use ICC profiles for digital cameras and scanners, ICC profiles created using the profile creation tool, etc.
Host ICM Mode	Enables color matching by the host computer using the ICM function of Windows. Select this if you want to print from an application that supports the ICM function.	Available when using Windows.
ColorSync	Enables color matching by using the ColorSync function of Mac OS. Select this if you want to perform soft proofing using ColorSync before printing.	Available when using Mac OS. To select ColorSync , choose ColorSync on the Color Matching panel.

Matching Method	Description	Remarks
Auto	Color-matching optimized for images, graphics, or text.	The available options and their display order vary depending on your selected color-matching mode, as well as the operating system.
Perceptual	Color-matching optimized for printing typical photos attractively. Smooth gradation is a feature. This is also an easy-to-use mode when performing color adjustment using application software.	
Colorimetric	Color-matching optimized for printing image data with accurate colors in input color space. This is the easiest-to-use mode when you want to adjust the color and print. However, gradation may be lost for colors of wider range than the color reproduction range of the printer. Generally, this is also called relative colorimetric.	
Colorimetric (No Wht-pnt Corr)	Color-matching, which uses the same processing method as Colorimetric processing, is useful when you want to reproduce colors down to the color of the paper. Color-matching is often called "absolute colorimetric."	
Saturation	Color-matching optimized for printing posters, etc., vividly.	
Monitor Matching	Suitable for optimized printing to match the appearance on the monitor. Color-matching optimized for accurately reproducing colors on the calibrated sRGB or AdobeRGB monitor.	

For instructions on color adjustment, refer to the following topics, as appropriate for your computer and operating system.

- Fine-Tuning Colors of Photos and Images (Windows) →P.62
- Fine-Tuning Colors of Photos and Images (Mac OS X) →P.64

Fine-Tuning Colors of Photos and Images (Windows)

You can specify your own print settings instead of using the **Print Target** presets. This topic describes how to fine-tune the color tone of photos before printing.

- 1** Choose **Print** in the application menu.
- 2** Select the printer in the dialog box, and then display the printer driver dialog box. (See "Accessing the Printer Driver Dialog Box from Applications →P.185 ")
- 3** Make sure the **Main** sheet is displayed.

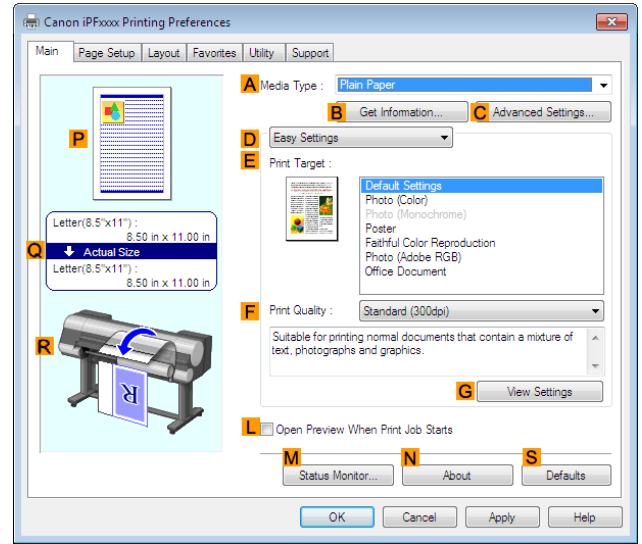

- 4** In the **A Media Type** list, select the type of paper that is loaded.
- 5** Click **D Advanced Settings** to switch the print mode.

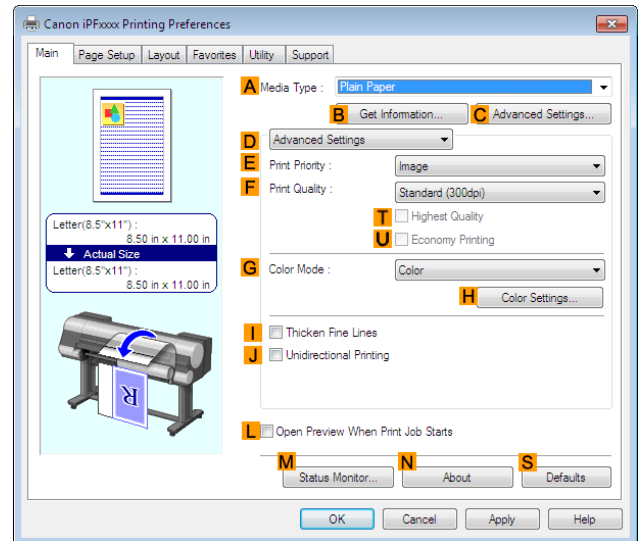

- 6** Click **Color** in the **G Color Mode** list.

- 7** Click **H Color Settings** to display the **Color Settings** dialog box.

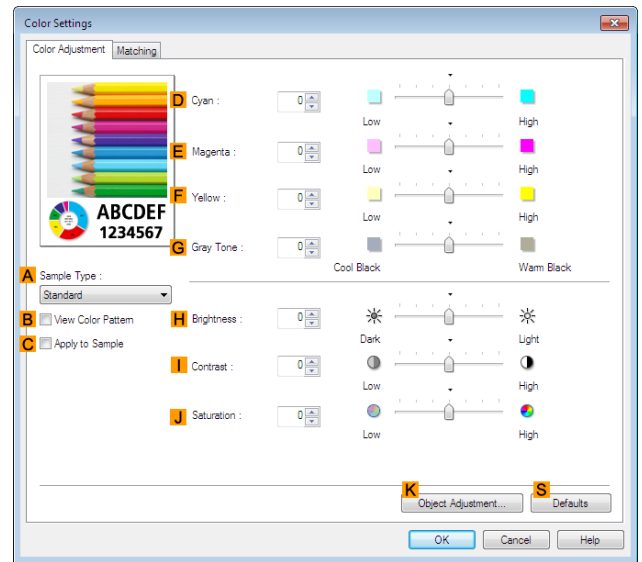

- 8** On the **Color Adjustment** sheet, adjust the color tones, brightness, and so on as desired.

Adjustment Item	Description
D Cyan	Fine-tune color tones by adjusting the levels of Cyan, Magenta, and Yellow.
E Magenta	
F Yellow	
G Gray Tone	Adjust the gray tone to suit the images of monochrome photos. Choose cool black (tinged with blue), pure black (neutral), warm black (tinged with red), and so on. Select the color tone in the color region or from the list.
H Brightness	Adjust the brightness of printed images while keeping the darkest and lightest portions intact.
I Contrast	Adjust the contrast of the darkest and lightest portions relative to each other. For soft gradation, decrease the contrast. For hard gradation, increase the contrast.
J Saturation	Adjust the level of color saturation, in a range from subdued to vivid.



Note

- Click **Object Adjustment** to open the **Object Adjustment** dialog box, which allows you to select the color adjustment target from **Image**, **Graphics**, and **Text**.

- 9** Close the **Color Settings** dialog box.

10 Click the **Page Setup** tab to display the **Page Setup** sheet.

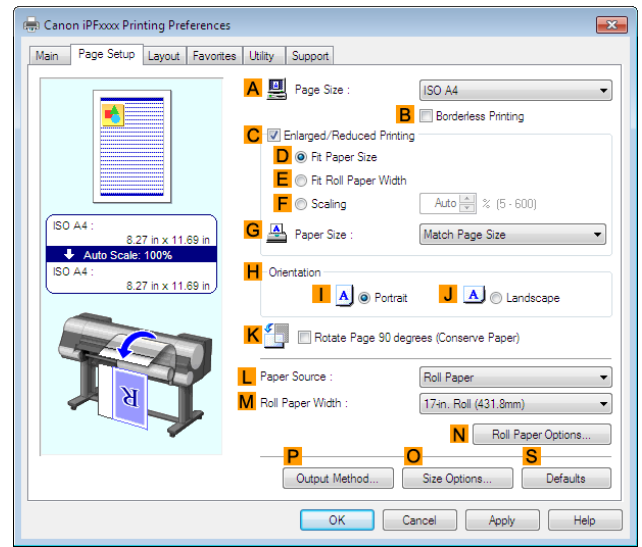

11 Confirm the settings of **A Page Size**, **L Paper Source**, and so on.

12 Confirm the print settings and print as desired.



• For tips on confirming print settings, see "Confirming Print Settings →P.182 "

Note

Fine-Tuning Colors of Photos and Images (Mac OS X)

You can specify your own print settings instead of using the **Print Target** presets. This topic describes how to fine-tune the color tone of photos before printing.

1 This sets the **B Format for** and **C Paper Size**.



• The configuration method varies depending on the OS and application software you are using. If **Page Setup** is displayed in the application menu, the settings are configured by opening the **Page Attributes** dialog box from **Page Setup**.

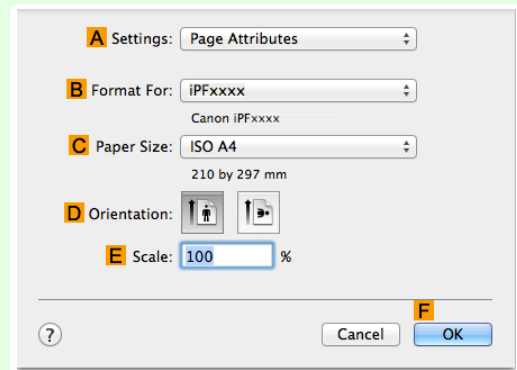

If it is not displayed, the settings are configured in the upper part of the printer driver displayed when you select **Print** from the application software menu.

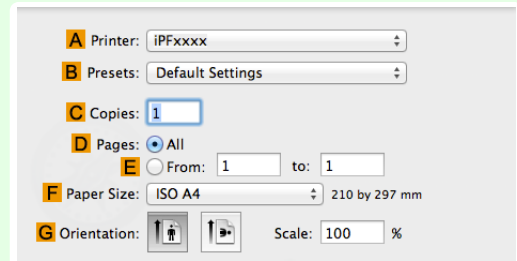

- 2 Select the printer in the **A Printer** list.
- 3 Choose the original size in the **F Paper Size** list.
- 4 If you configured the settings using the **Page Attributes** dialog box, click **F OK** to close the dialog box, and then select **Print** from the application software menu.
- 5 Access the **Main** pane.

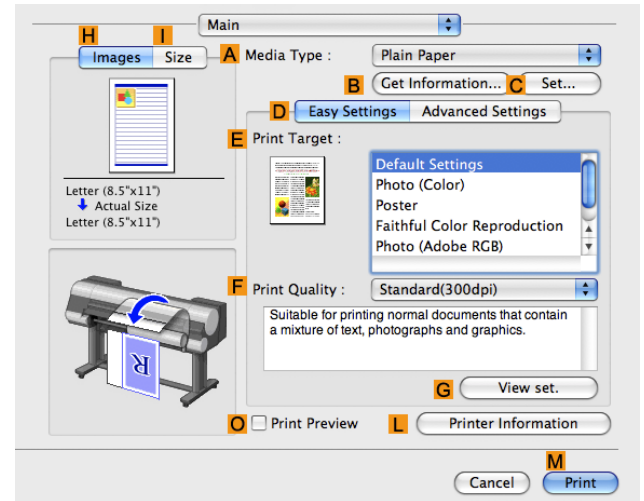

- 6 In the **A Media Type** list, select the type of paper that is loaded.
- 7 Click **D Advanced Settings** to switch the print mode.

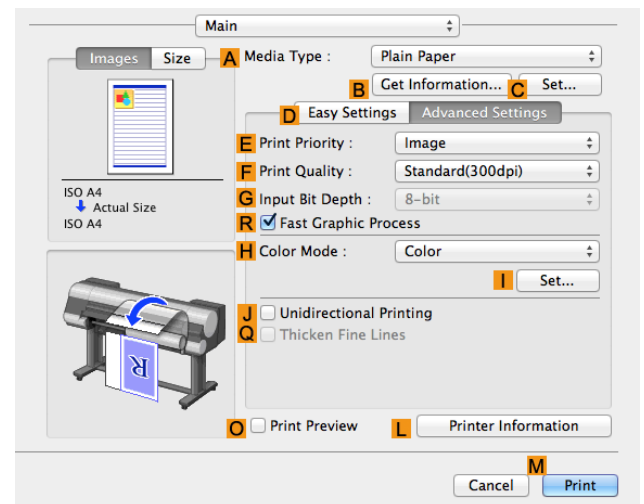

- 8 Click **Color** in the **H Color Mode** list.

9 Click **I**Set to display the **Color Settings** dialog box.

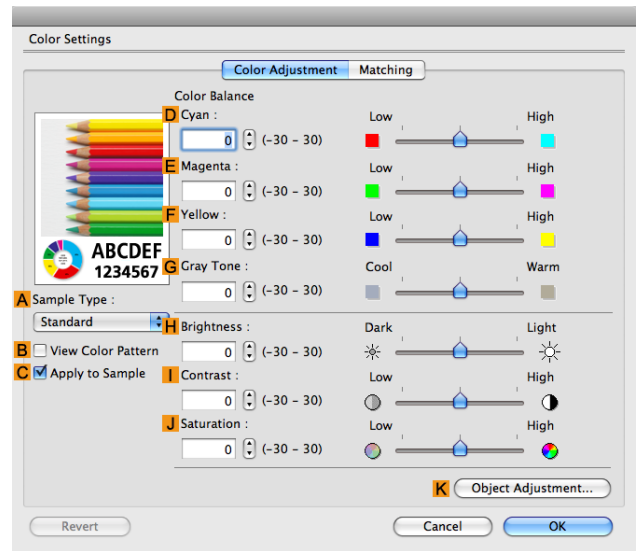

10 On the **Color Adjustment** pane, adjust the color tones, brightness, and so on as desired.

Adjustment Item	Description
D Cyan	Fine-tune color tones by adjusting the levels of Cyan, Magenta, and Yellow.
E Magenta	
F Yellow	
G Gray Tone	Adjust the gray tone to suit the images of monochrome photos. Choose cool black (tinged with blue), pure black (neutral), warm black (tinged with red), and so on. Select the color tone in the color region or from the list.
H Brightness	Adjust the brightness of printed images while keeping the darkest and lightest portions intact.
I Contrast	Adjust the contrast of the darkest and lightest portions relative to each other. For soft gradation, decrease the contrast. For hard gradation, increase the contrast.
J Saturation	Adjust the level of color saturation, in a range from subdued to vivid.

 **Note** • Click **Object Adjustment** to open the **Object Adjustment** dialog box, which allows you to select the color adjustment target from **Images**, **Graphics**, and **Text**.

11 Click **OK** to close the **Color Settings** dialog box.

12 Access the **Page Setup** pane.

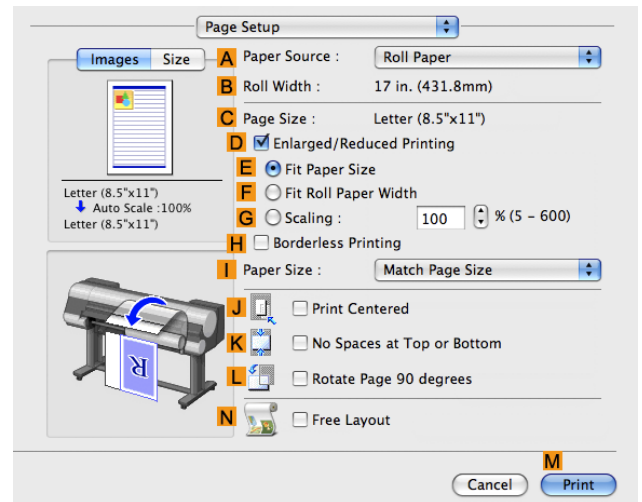

13 Confirm the settings of **A Paper Source** and **C Page Size**.

14 Confirm the print settings, and then click **M Print** to start printing.



Note

- For tips on confirming print settings, see "Confirming Print Settings →P.368 "

Giving Priority to Particular Graphic Elements and Colors for Printing

You can specify detailed print settings as desired for the quality level, colors, and other criteria.

• Print Priority

Choose the graphic elements that you want to emphasize for printing.

Print Priority (*1)	Description
Image	A setting for posters or other documents made up mainly of photos or images, or for emphasizing photos or images in printed documents.
Line Drawing/Text	Choose this setting for CAD drawings made up mainly of intricate lines, or to enhance the finishing of fine text. However, the quality may not be sufficient when printing photos or images that require a lot of color coverage. In this case, choose Image instead.
Office Document	Choose this setting for better legibility of documents combining text and graphics, such as documents and presentation material created with typical office applications.
Proof	This is a setting for enhancing the reproduction of text, illustrations, and photos on print proofs. However, this takes more time than regular printing.

*1: Options suitable for the selected type of paper are listed under Print Priority.

• Print Quality

Choose the print quality.

The printing mode is determined by a combination of the print quality and resolution.

Print Quality (*1)	Description	Print Priority
High	Choose this setting to print at high resolution when quality is most important. Printing takes longer and consumes more ink than in Standard or Fast modes, but this mode offers exceptional printing quality.	Image Line Drawing/Text Proof

Print Quality (*1)	Description	Print Priority
Standard	Choose this setting to print at standard resolution when quality and speed are both important. Printing takes less time than in High mode.	Image Line Drawing/Text Office Document Proof
Fast	Choose this setting to print faster. Printing in fast mode can help you work more efficiently when checking layouts.	Image Line Drawing/Text Proof

*1: Options suitable for the selected Print Priority are listed under Print Quality.

• Color Settings

Setting Item	Options	Description
Color Mode (*1)	Color Monochrome (Photo) Monochrome No color correction	Choose whether to print in color or monochrome. (Refer to "Adjusting the Color in the Printer Driver →P.60 ")
Color Adjustment (Images)	Cyan Magenta Yellow Gray Tone Brightness Contrast Saturation	You can adjust the levels of cyan, magenta, and yellow as well as the brightness, contrast, saturation, and gray tone separately for images, graphics, and text documents. If you choose Monochrome in Color Mode only Brightness and Contrast can be adjusted.
Color Adjustment (Graphics)		
Color Adjustment (Text)		
Gray Adjustment	Color Balance Brightness Contrast Highlight Shadow	Choose the gray tone color balance (Cool Black or Warm Black) and adjust levels of brightness, contrast, highlight, and shadow as desired. These levels can be adjusted when Monochrome (Photo) is selected in Color Mode .
Color-Matching Modes	Driver Matching Mode ICC Matching Mode	Choose the color-matching mode. Other color-matching modes may be provided by the computer operating system, such as ICM and ColorSync.
Color-Matching Method (*2)	Auto Perceptual Saturation Monitor Matching Colorimetric other	Choose the color-matching method. The available options vary depending on your selection in Color-Matching Mode .
Color Space (*3)	sRGB Adobe RGB	Choose a standard color space (sRGB) or an expanded color space (Adobe RGB).

*1: Options suitable for the selected **Print Priority** and **Media Type** are listed under **Color Mode**.

*2: The order of options displayed varies depending on the operating system.

*3: **Adobe RGB** is not available if an incompatible combination of the paper type and print quality is selected.

• Enhancing printing quality

Setting Item	Description
Highest quality	This prints at the highest resolution. Printing takes longer and consumes more ink than in other modes, but this mode offers superior printing quality.
Thicken Fine Lines	Prints making fine lines appear thicker.
Unidirectional Printing	Prints by suppressing color variations and misaligned ruled lines. However, this takes more time than regular printing.

Setting Item	Description
Economy Printing	When this mode is selected, the quality is diminished from that of regular printing, however less ink is consumed. Select this mode if you want to conserve ink when printing to check drawings, for example. Depending on the Media Type and Print Quality settings, this mode may not be available.



Note

- To print at a higher level of quality, in the printer driver, choose **High** in **Print Quality**, and select **Highest quality** and print.

For instructions on specifying the print quality and color settings before printing, refer to the following topics, as appropriate for your computer and operating system.

- Choosing the Document Type and Printing Conditions (Windows) →P.69
- Choosing the Document Type and Printing Conditions (Mac OS X) →P.71

Choosing the Document Type and Printing Conditions (Windows)

You can specify your own print settings instead of using the **Print Target** presets. This topic describes how print photographic images in monochrome.

- Choose **Print** in the application menu.
- Select the printer in the dialog box, and then display the printer driver dialog box.(Refer to "Accessing the Printer Driver Dialog Box from Applications →P.185 ")
- Make sure the **Main** sheet is displayed.

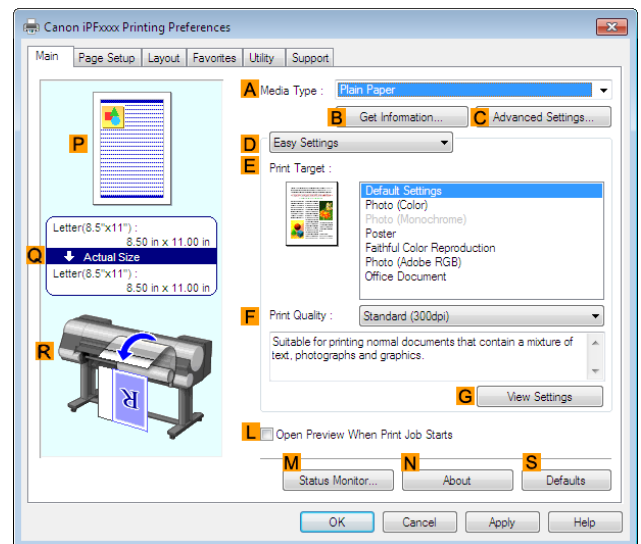

- In the **A Media Type** list, select the type of paper that is loaded.

5 Click **D Advanced Settings** to switch the print mode.

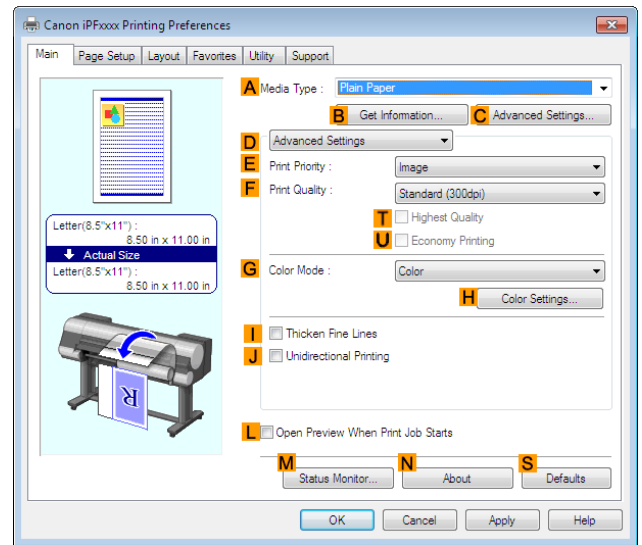

6 Click **Image** in the **E Print Priority** list.

7 Click **High (600dpi)** in the **F Print Quality** list.

 • Options displayed in the **F Print Quality** list vary depending on the type of paper.
Note

8 Click **Monochrome** in the **G Color Mode** list.

9 To adjust the brightness and contrast, click **H Color Settings**.

 • For instructions on adjusting brightness and contrast, see "Adjusting the Color in the Printer Driver." →P.60
Note

10 Click the **Page Setup** tab to display the **Page Setup** sheet.

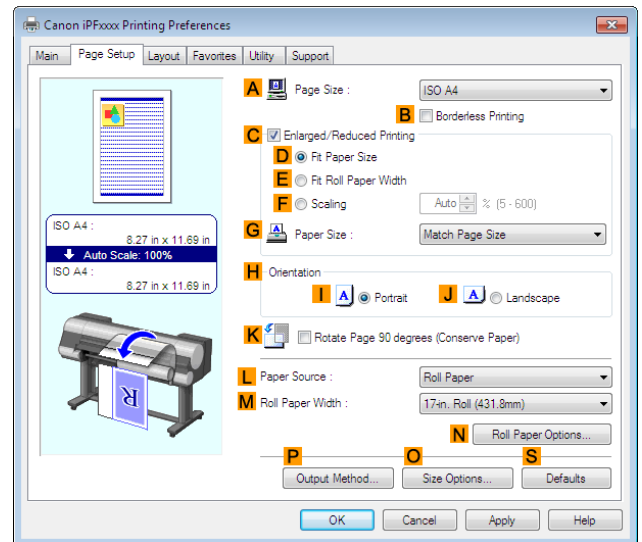

11 Confirm the settings of **A Page Size**, **L Paper Source**, and so on.

- 12** Confirm the print settings and print as desired.



Note

- For details on how to check the printing settings, refer to "Confirming Print Settings →P.182".

Choosing the Document Type and Printing Conditions (Mac OS X)

You can specify your own print settings instead of using the **Print Target** presets. This topic describes how print photographic images in monochrome.

- 1** Choose **Page Setup** from the application menu to display the **Page Attributes** dialog box.

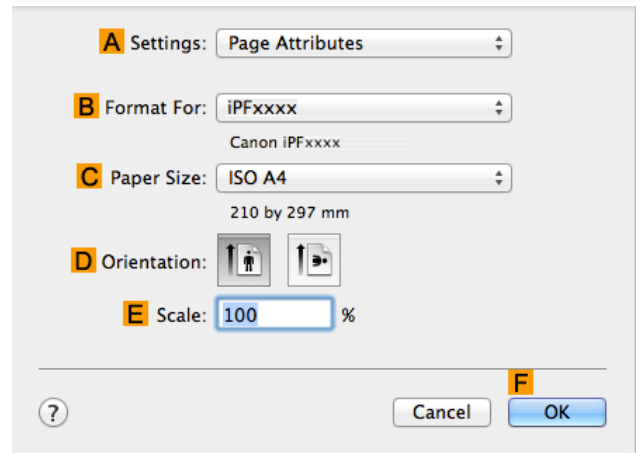

- 2** Select the printer in the **B Format for** list.
- 3** Choose the original size in the **C Paper Size** list.
- 4** Click **F OK** to close the dialog box.
- 5** In the application menu, choose **Print**.
- 6** Access the **Main** pane.

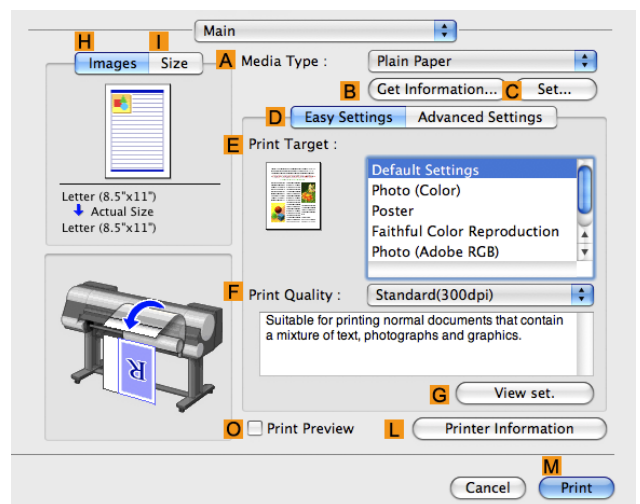

- 7** In the **A Media Type** list, select the type of paper that is loaded.

8 Click **D Advanced Settings** to switch the print mode.

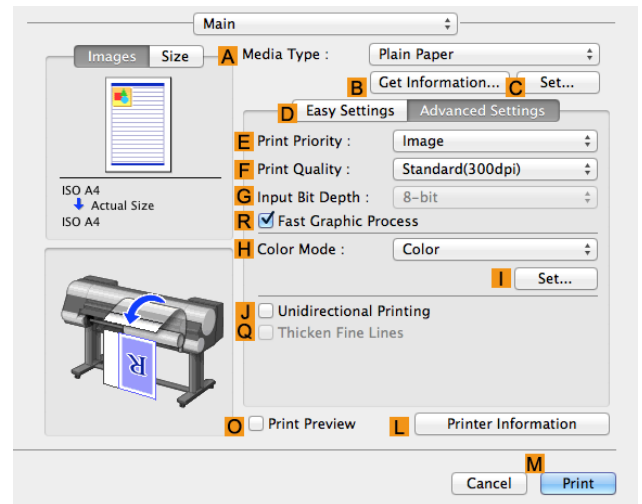

9 Click **Image** in the **E Print Priority** list.

10 Click **High (600dpi)** in the **F Print Quality** list.

• Options displayed in the **F Print Quality** list vary depending on the paper type.
Note

11 Click **Monochrome** in the **H Color Mode** list.

12 To adjust the brightness and contrast, click **I Set**.

• For instructions on adjusting brightness and contrast, see "Adjusting the Color in the Printer Driver →P.60 "

13 Access the **Page Setup** pane.

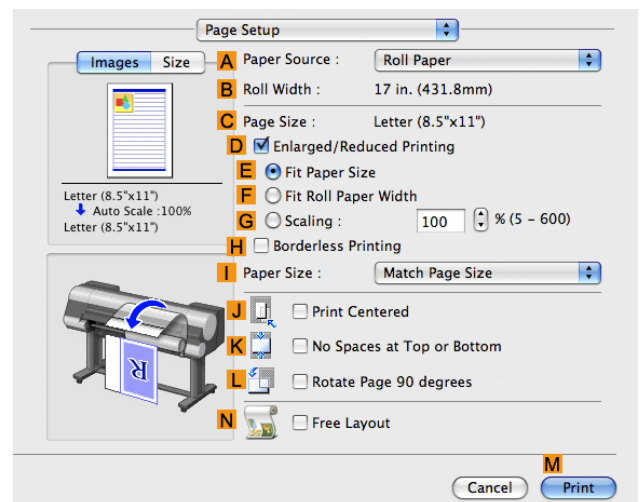

14 Confirm the settings of **A Paper Source** and **C Page Size**.

15 Confirm the print settings, and then click **Print** to start printing.



Note

- For tips on confirming print settings, see "Confirming Print Settings [→P.368](#) "

Printing enlargements or reductions

Resizing Originals to Match the Paper Size	74
Resizing Originals to Match the Paper Size (Windows)	74
Resizing Originals to Match the Paper Size (Mac OS X)	76
Resizing Originals to Fit the Roll Width	78
Resizing Originals to Fit the Roll Width (Windows)	79
Resizing Originals to Fit the Roll Width (Mac OS X)	81
Resizing Originals by Entering a Scaling Value	84
Resizing Originals by Entering a Scaling Value (Windows)	84
Resizing Originals by Entering a Scaling Value (Mac OS X)	86

Resizing Originals to Match the Paper Size

You can freely adjust the size of originals by enlarging or reducing them as desired.

- **Enlarged/Reduced Printing**

Enlarge or reduce the original in the printer driver, as desired.

- **Fit Paper Size**

Enlarge or reduce the original to match the size of the paper you are using.

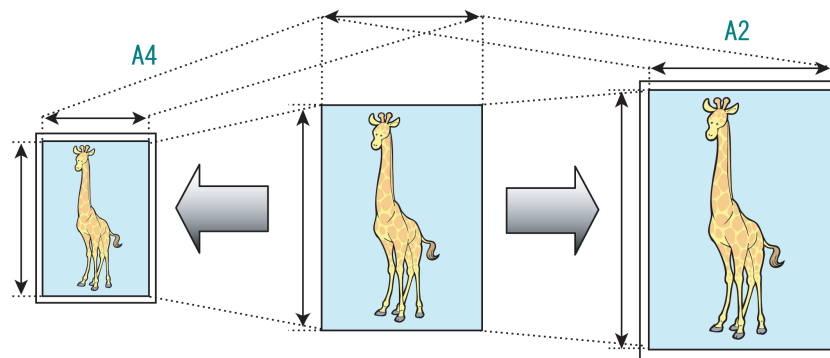

For instructions on resizing originals to match the paper size, refer to the following topics, as appropriate for your computer and operating system.

- Resizing Originals to Match the Paper Size (Windows) →P.74
- Resizing Originals to Match the Paper Size (Mac OS X) →P.76



Note

- For better printing results when enlarging photos from a digital camera in TIFF or JPEG format, use an image-editing application software such as Adobe Photoshop to specify an image resolution of 150 dpi or more at actual size.

Resizing Originals to Match the Paper Size (Windows)

This topic describes how to enlarge originals before printing to match the paper size, based on the following example.

- Document: Any Type
- Page size: A4 (210.0×297.0mm)/Letter (8.3 × 11.7 in)
- Paper: Roll
- Paper type: **Plain Paper**
- Roll paper width: A2/A3 roll (420.0 mm [16.5 in])

74

1 Choose **Print** in the application menu.

2 Select the printer in the dialog box, and then open the printer driver dialog box. (See "Accessing the Printer Driver Dialog Box from Applications →P.185 ")

- 3** Make sure the **Main** sheet is displayed.

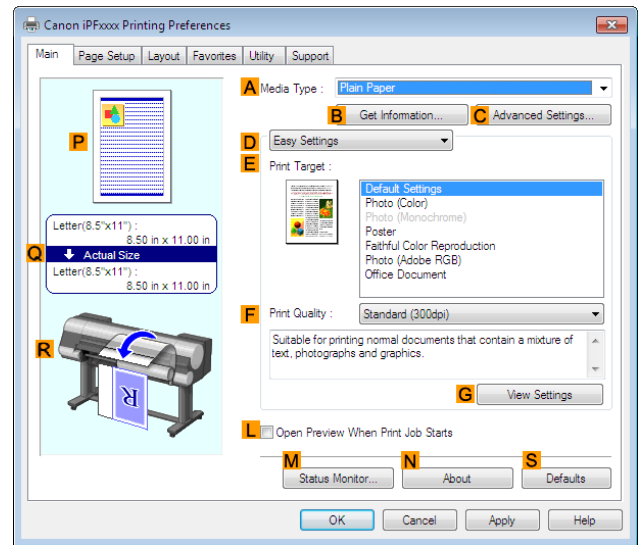

- 4** In the **A Media Type** list, select the type of paper that is loaded. In this case, click **Plain Paper**.

- 5** Select the printing application in the **E Print Target** list.

- 6** Click the **Page Setup** tab to display the **Page Setup** sheet.

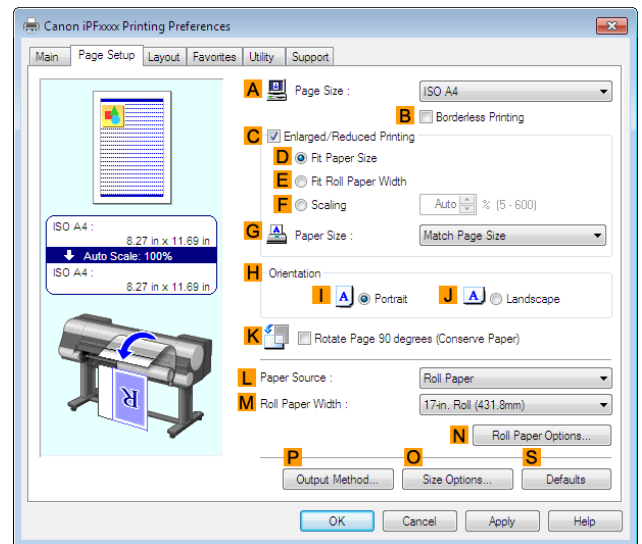

- 7** Select and click a roll paper in the **L Paper Source** list.

- 8** Select the width of the loaded roll in the **M Roll Paper Width** list—in this case, **ISO A2/A3 Roll (420.0mm)**.

- 9** In the **A Page Size** list, click the size of the original as specified in the application. In this case, click **ISO A4**.

- 10** Select the **C Enlarged/Reduced Printing** check box.

- 11** Select the **D Fit Paper Size** check box.

- 12** Click **ISO A3** in the **G Paper Size** list.

13 Confirm the print settings and print as desired.



Note

- For tips on confirming print settings, see "Confirming Print Settings →P.182 "

Resizing Originals to Match the Paper Size (Mac OS X)

This topic describes how to enlarge originals before printing to match the paper size, based on the following example.

- Document: Any Type
- Page size: A4 (210.0 × 297.0 mm [8.3 × 11.7 in])
- Paper: Roll paper
- Paper type: **Plain Paper**
- Roll paper width: A2/A3 roll (420.0 mm [16.5 in])

1 This sets the **B Format for** and **C Paper Size**.



Note

- The configuration method varies depending on the OS and application software you are using. If **Page Setup** is displayed in the application menu, the settings are configured by opening the **Page Attributes** dialog box from **Page Setup**.

If it is not displayed, the settings are configured in the upper part of the printer driver displayed when you select **Print** from the application software menu.

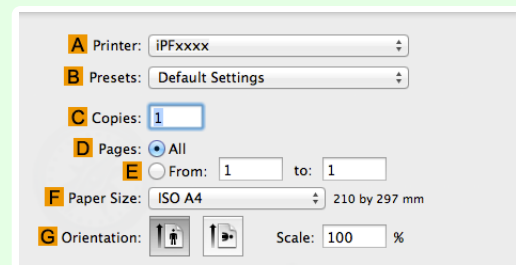
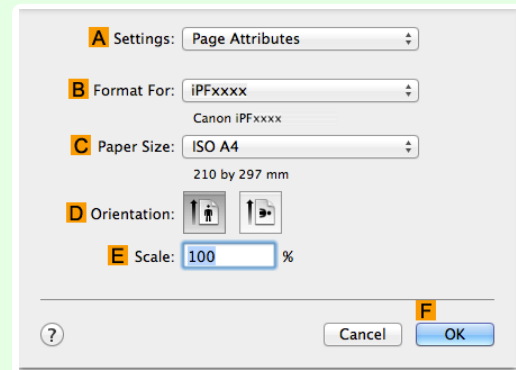

2 Select the printer in the **A Printer** list.

3 In the **F Paper Size** list, click the size of the original. In this case, click **ISO A4**.

4 If you configured the settings using the **Page Attributes** dialog box, click **F OK** to close the dialog box, and then select **Print** from the application software menu.

5 Access the **Main** pane.

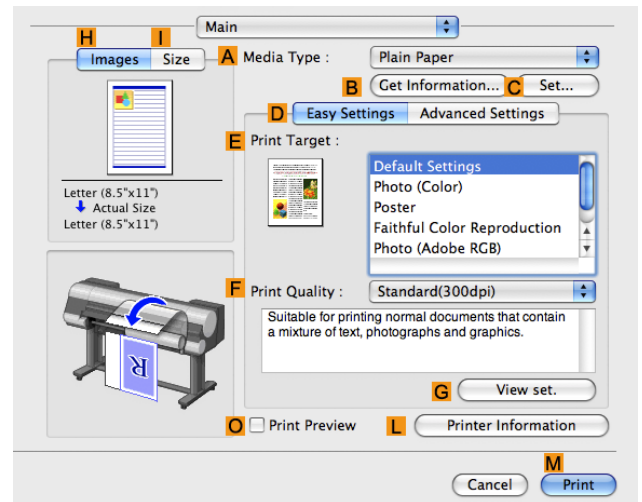

6 In the **A Media Type** list, select the type of paper that is loaded. In this case, click **Plain Paper**.

7 Make your selection in the **E Print Target** list.

8 Make your selection in the **F Print Quality** list.

9 Access the **Page Setup** pane.

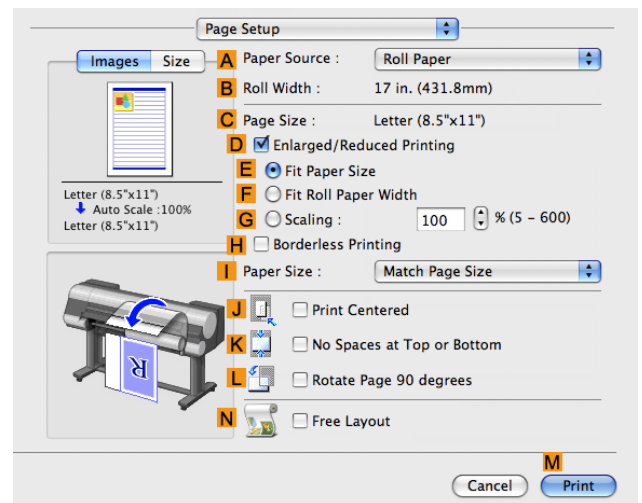

10 Select and click a roll paper in the **A Paper Source** list.

- 11** Make sure the width of the loaded roll is displayed in the **B Roll Width** list—in this case, **ISO A2/A3 (420.0mm)**.



Note

- If the width of the roll loaded in the printer is not shown in **B Roll Width**, click **L Printer Information** on the **Main** pane to update the printer information.

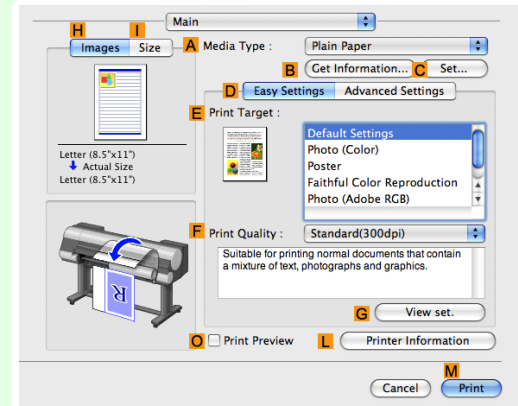

- 12** Make sure **C Page Size** on the **Page Setup** pane shows the original size as specified in **C Paper Size** in the **Page Attributes** dialog box—in this case, **ISO A4**.

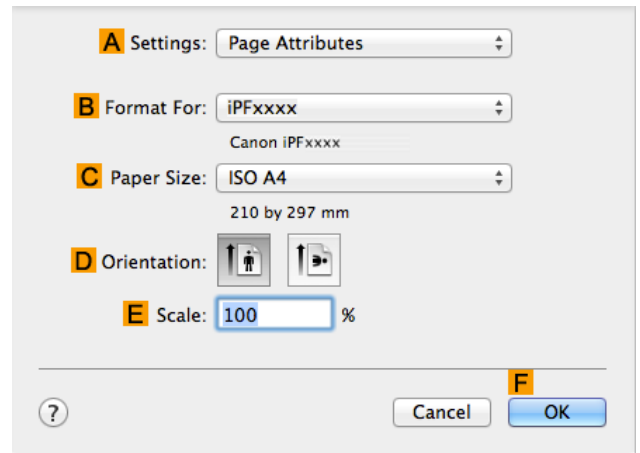

- 13** Select the **D Enlarged/Reduced Printing** check box.

- 14** Make sure **E Fit Paper Size** is selected.

- 15** Click **ISO A3** in the **I Paper Size** list.

- 16** Confirm the print settings, and then click **M Print** to start printing.



Note

- For tips on confirming print settings, see "Confirming Print Settings" →P.368 "

Resizing Originals to Fit the Roll Width

You can freely adjust the size of originals by enlarging or reducing them as desired.

• Enlarged/Reduced Printing

Enlarge or reduce the original in the printer driver, as desired.

- **Fit Roll Paper Width**

Enlarge or reduce the original as a whole to match the roll paper width, as desired.

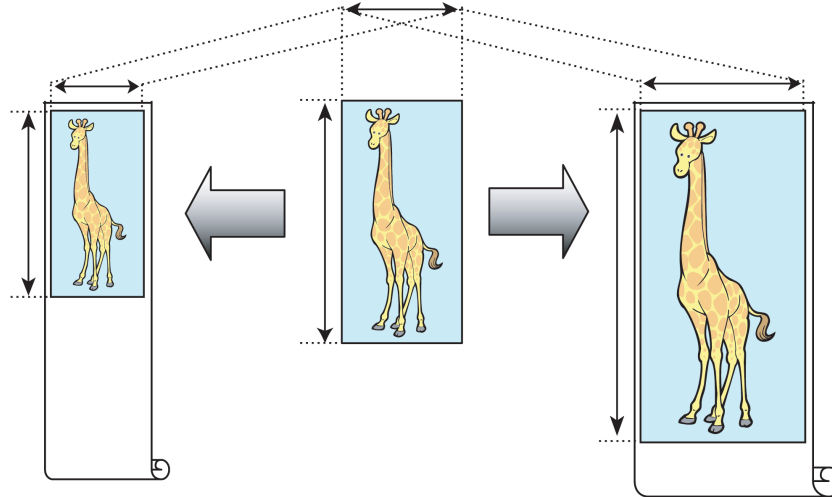

For instructions on resizing originals to match the roll paper width, refer to the following topics, as appropriate for your computer and operating system.

- Resizing Originals to Fit the Roll Width (Windows) →P.79
- Resizing Originals to Fit the Roll Width (Mac OS X) →P.81



Note

- For better printing results when enlarging photos from a digital camera in TIFF or JPEG format, use an image-editing application software such as Adobe Photoshop to specify an image resolution of 150 dpi or more at actual size.

Resizing Originals to Fit the Roll Width (Windows)

This topic describes how to enlarge originals before printing to match the roll width, based on the following example.

- Document: Any type
- Page size: A4 (210.0×297.0 mm)/Letter (8.3 × 11.7 in)
- Paper: Roll
- Paper type: **Plain Paper**
- Roll paper width: 16 inches (406.4 mm)

1 Choose **Print** in the application menu.

2 Select the printer in the dialog box, and then display the printer driver dialog box. (See "Accessing the Printer Driver Dialog Box from Applications" →P.185 ")

- 3** Make sure the **Main** sheet is displayed.

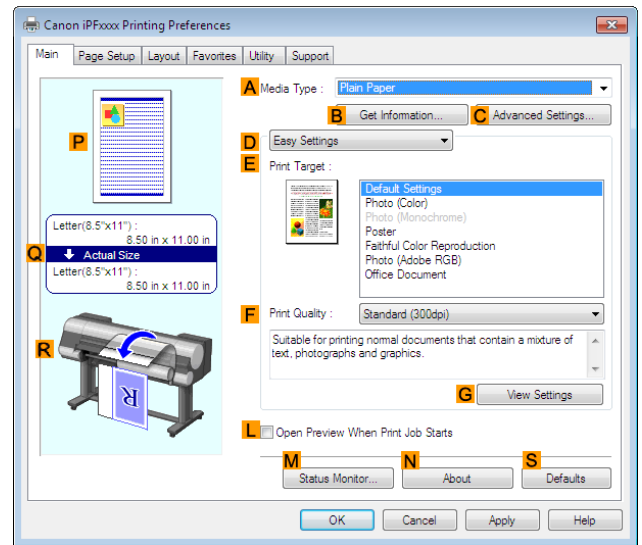

- 4** In the **A Media Type** list, select the type of paper that is loaded. In this case, click **Plain Paper**.

- 5** Select the printing application in the **E Print Target** list.

- 6** Click the **Page Setup** tab to display the **Page Setup** sheet.

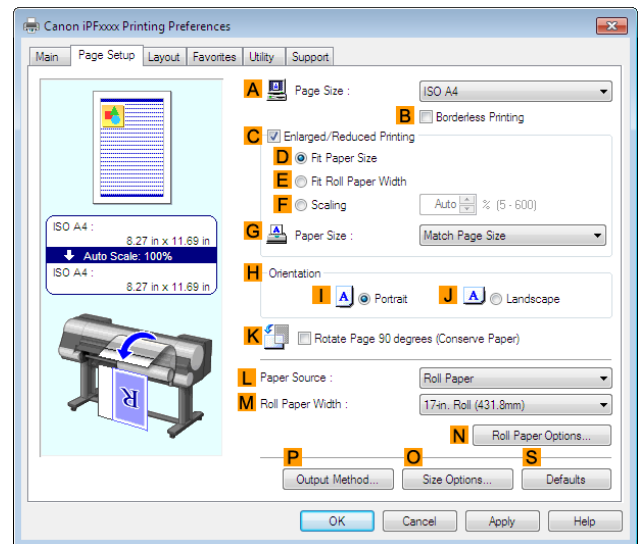

- 7** Select and click a roll paper in the **L Paper Source** list.

- 8** In the **A Page Size** list, click the size of the original as specified in the application. In this case, click **ISO A4** or **Letter (8.5"x11")**.

9 Select the **C Enlarged/Reduced Printing** check box.



Note

- If the **C Enlarged/Reduced Printing** check box is not displayed on the **Page Setup** sheet, clear the **B Borderless Printing** check box.

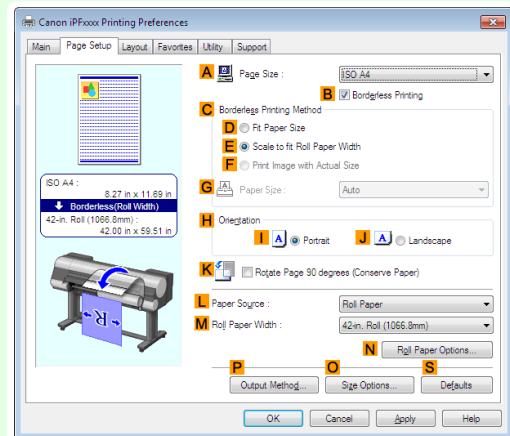

10 Click **E Fit Roll Paper Width**.



Note

- After you click **E Fit Roll Paper Width**, the **Information** dialog box is displayed. Select the width of the loaded roll in the **Roll Paper Width** list and click **OK**.
- Make sure the roll paper width you specify matches the width of the loaded roll.

11 Confirm the print settings and print as desired.



Note

- For tips on confirming print settings, see "Confirming Print Settings →P.182 "

Resizing Originals to Fit the Roll Width (Mac OS X)

This topic describes how to enlarge originals before printing to match the roll width, based on the following example.

- Document: Any Type
- Page size: A4 (210.0 × 297.0 mm [8.3 × 11.7 in])
- Paper: Roll paper
- Paper type: **Plain Paper**
- Roll paper width: 16 inches (406.4 mm)

1 This sets the **B Format for** and **C Paper Size**.



Note

- The configuration method varies depending on the OS and application software you are using. If **Page Setup** is displayed in the application menu, the settings are configured by opening the **Page Attributes** dialog box from **Page Setup**.

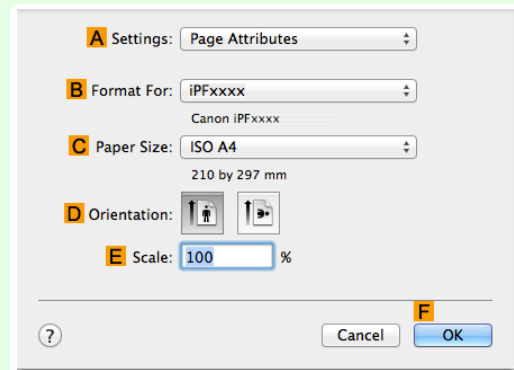

If it is not displayed, the settings are configured in the upper part of the printer driver displayed when you select **Print** from the application software menu.

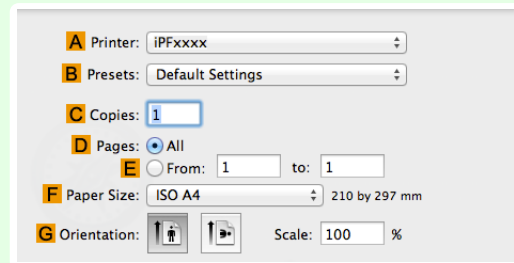

2 Select the printer in the **A Printer** list.

3 In the **F Paper Size** list, click the size of the original. In this case, click **ISO A4**.

4 If you configured the settings using the **Page Attributes** dialog box, click **F OK** to close the dialog box, and then select **Print** from the application software menu.

5 Access the **Main** pane.

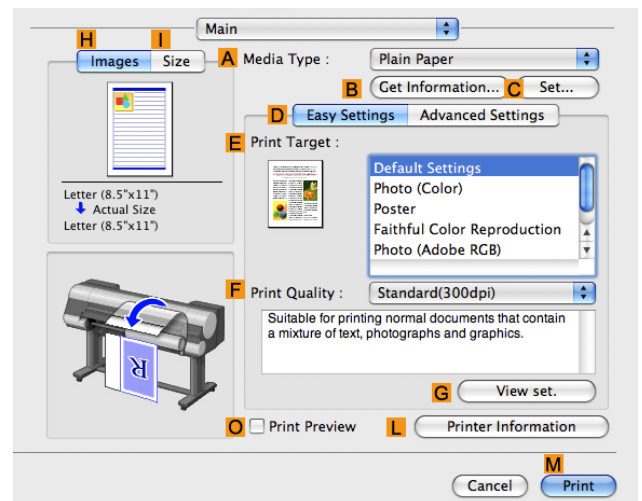

6 In the **A Media Type** list, select the type of paper that is loaded. In this case, click **Plain Paper**.

7 Make your selection in the **E Print Target** list.

8 Make your selection in the **F Print Quality** list.

9 Access the **Page Setup** pane.

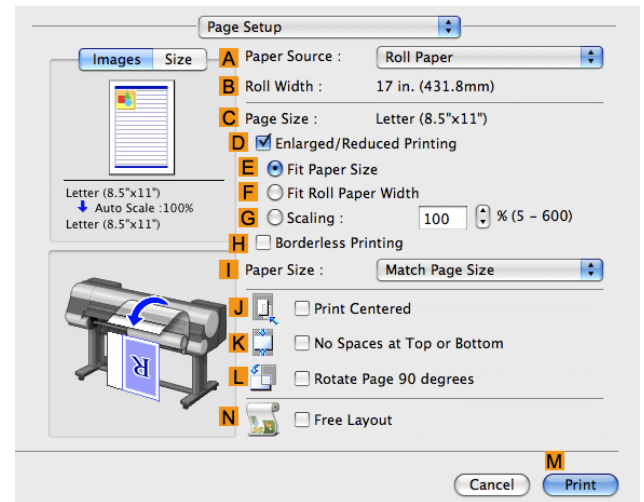

10 Select and click a roll paper in the **A Paper Source** list.

11 Make sure the width of the loaded roll is displayed in the **B Roll Width** list—in this case, **16 in. (406.4mm)**.



Note

- If the width of the roll loaded in the printer is not shown in **B Roll Width**, click **L Printer Information** on the **Main** pane to update the printer information.

12 Make sure the **C Page Size** setting matches the original size as selected in **C Paper Size** in the **Page Attributes** dialog box—in this case, **ISO A4**.

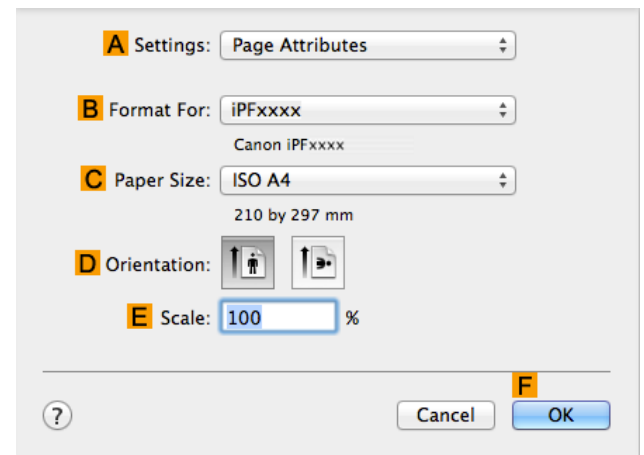

13 Select the **D Enlarged/Reduced Printing** check box.

14 Click **F Fit Roll Paper Width**.

15 Confirm the print settings, and then click **M Print** to start printing.



Note

- For tips on confirming print settings, see "Confirming Print Settings" →P.368 "

Resizing Originals by Entering a Scaling Value

You can freely adjust the size of originals by enlarging or reducing them as desired.

- **Enlarged/Reduced Printing**

Enlarge or reduce the original in the printer driver, as desired.

- **Scaling**

Enlarge or reduce originals by a particular amount, as desired.

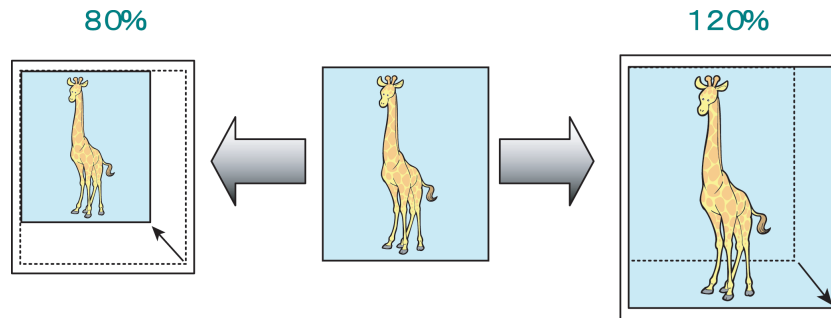

For instructions on entering a scaling value to resize originals, refer to the following topics, as appropriate for your computer and operating system.

- Resizing Originals by Entering a Scaling Value (Windows) →P.84
- Resizing Originals by Entering a Scaling Value (Mac OS X) →P.86



Note

- For better printing results when enlarging photos from a digital camera in TIFF or JPEG format, use an image-editing application software such as Adobe Photoshop to specify an image resolution of 150 dpi or more at actual size.

Resizing Originals by Entering a Scaling Value (Windows)

This topic describes how to enlarge originals before printing by entering a scaling value, based on the following example.

- Document: Any Type
- Page size: A4 (210.0 × 297.0 mm [8.3 × 11.7 in])
- Paper: Roll paper
- Paper type: **Plain Paper**
- Roll paper width: A2/A3 roll (420.0 mm [16.5 in])



Important

- In borderless printing, you cannot resize originals by entering a scaling value.

- 1 Choose **Print** in the application menu.
- 2 Select the printer in the dialog box, and then display the printer driver dialog box. (See "Accessing the Printer Driver Dialog Box from Applications →P.185 ")

- 3** Make sure the **Main** sheet is displayed.

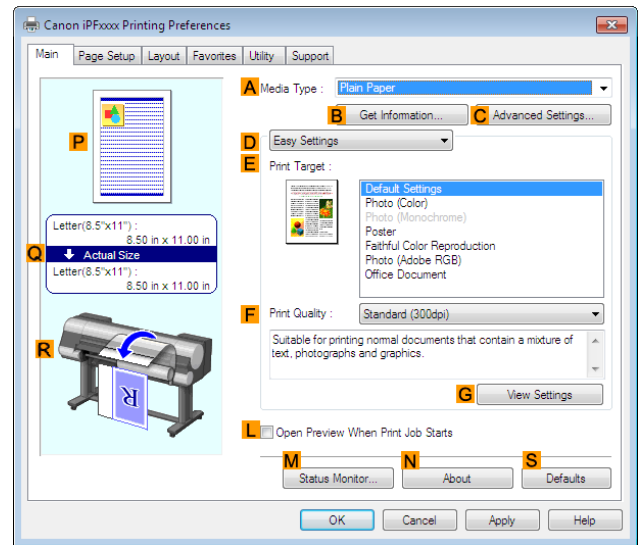

- 4** In the **A Media Type** list, select the type of paper that is loaded. In this case, click **Plain Paper**.

- 5** Select the printing application in the **E Print Target** list.

- 6** Click the **Page Setup** tab to display the **Page Setup** sheet.

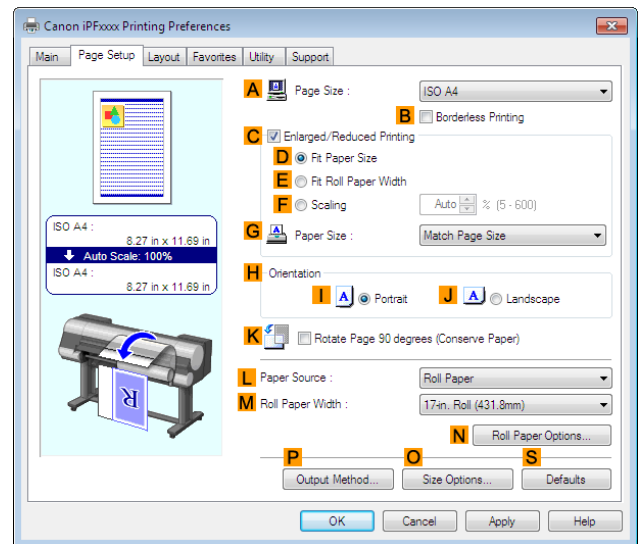

- 7** Select and click a roll paper in the **L Paper Source** list.

- 8** Select the width of the loaded roll in the **M Roll Paper Width** list—in this case, **ISO A2/A3 Roll (420.0mm)**.

- 9** In the **A Page Size** list, click the size of the original as specified in the application. In this case, click **ISO A4**.

- 10** Select the **C Enlarged/Reduced Printing** check box.

- 11** Click **ISO A4** in the **G Paper Size** list.

12 Click **F Scaling** and enter **120**.**Note**

- You can specify enlargement that exceeds the paper size, but in this case, the portions off the bottom and right edges of the paper will not be printed.
- If the original size after enlargement or reduction is smaller than the paper size, the original is printed in the upper-left corner. In this case, you can center originals by selecting **E Print Centered** on the **Layout** sheet.

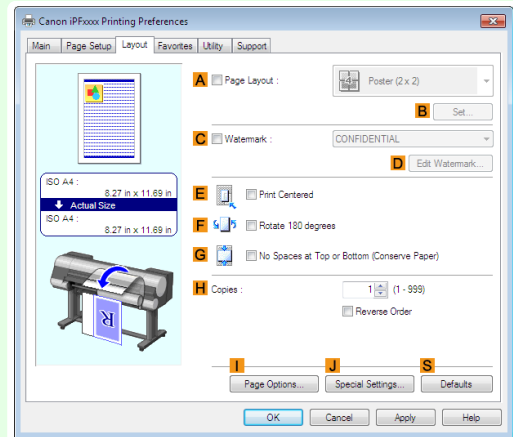
**13** Confirm the print settings and print as desired.**Note**

- For tips on confirming print settings, see "Confirming Print Settings →P.182 "

Resizing Originals by Entering a Scaling Value (Mac OS X)

This topic describes how to enlarge originals before printing by entering a scaling value, based on the following example.

- Document: Any Type
- Page size: A4 (210.0 × 297.0 mm [8.3 × 11.7 in])
- Paper: Roll paper
- Paper type: **Plain Paper**
- Roll paper width: A2/A3 roll (420.0 mm [16.5 in])

1 This sets the **B Format for** and **C Paper Size**.



Note

- The configuration method varies depending on the OS and application software you are using. If **Page Setup** is displayed in the application menu, the settings are configured by opening the **Page Attributes** dialog box from **Page Setup**.

If it is not displayed, the settings are configured in the upper part of the printer driver displayed when you select **Print** from the application software menu.

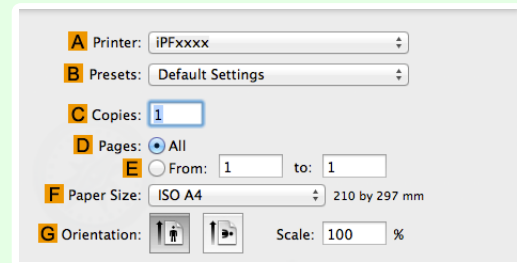
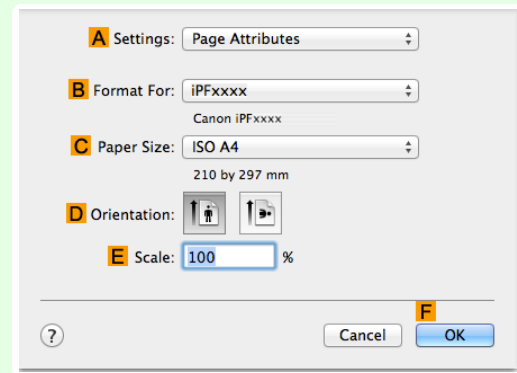

2 Select the printer in the **A Printer** list.

3 In the **F Paper Size** list, click the size of the original. In this case, click **ISO A4**.

4 If you configured the settings using the **Page Attributes** dialog box, click **F OK** to close the dialog box, and then select **Print** from the application software menu.

5 Access the **Main** pane.

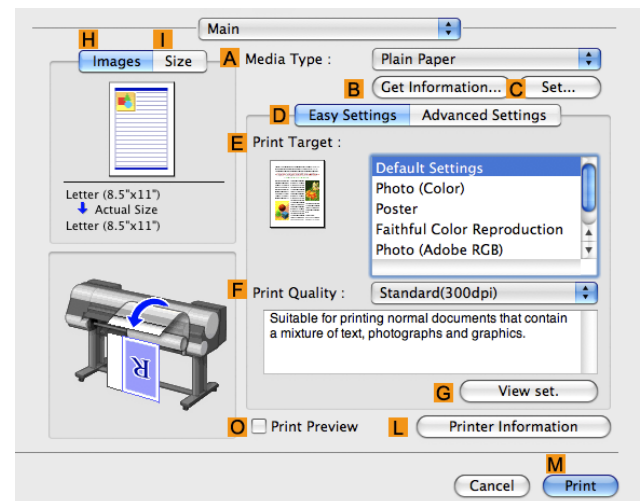

6 In the **A Media Type** list, select the type of paper that is loaded. In this case, click **Plain Paper**.

7 Make your selection in the **E Print Target** list.

8 Make your selection in the **F Print Quality** list.

9 Access the **Page Setup** pane.

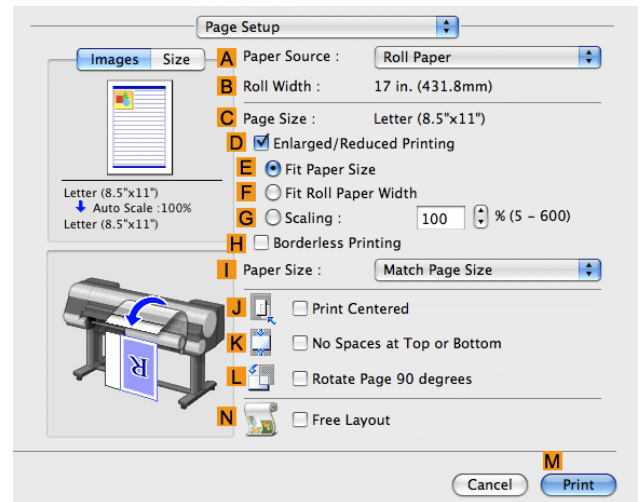

10 Select and click a roll paper in the **A Paper Source** list.

11 Make sure the width of the loaded roll is displayed in the **B Roll Width** list—in this case, **ISO A2/A3 (420.0mm)**.



Note

- If the width of the roll loaded in the printer is not shown in **B Roll Width**, click **L Printer Information** on the **Main** pane to update the printer information.

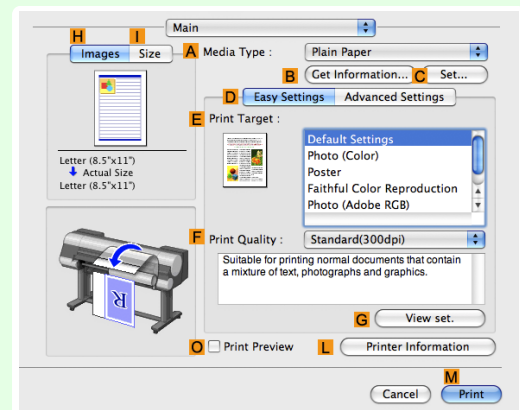

12 Make sure the **C Page Size** setting matches the original size as selected in **C Paper Size** in the **Page Attributes** dialog box—in this case, **ISO A4**.

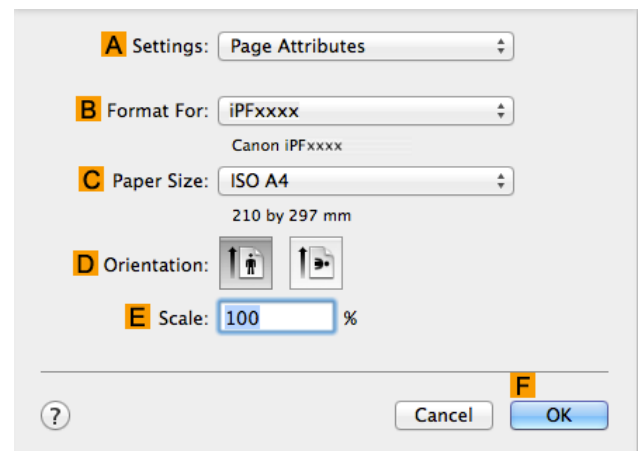

13 Select the **D Enlarged/Reduced Printing** check box.

14 Click **G Scaling** and enter **120**.



Note

- You can specify enlargement that exceeds the paper size, but in this case, the portion off the edge of the paper will not be printed.
- If the original size after enlargement or reduction is smaller than the paper size, the original is printed in the upper-left corner. In this case, you can center originals by selecting the **J Print Centered** check box.

15 Confirm the print settings, and then click **M Print** to start printing.



Note

- For tips on confirming print settings, see "Confirming Print Settings [→P.368](#) "

Printing at full size

Printing on Oversize Paper	90
Printing at Full Size (Windows)	91
Printing at Full Size (Mac OS X)	92
Borderless Printing at Actual Size	95
Borderless Printing at Actual Size (Windows)	96
Borderless Printing at Actual Size (Mac OS X)	98

Printing on Oversize Paper

You can print all areas of the original at full scale by selecting the paper size from **Oversize** (sizes where the margins needed for printer operation have been added to the page size).

We recommend when printing with a focus on image.



- If you prepare an original for printing without a margin and print it on paper of regular size, the image near the edge will not be printed.

• Oversize

When printing on standard paper sizes, printing is performed by taking the margins necessary for printer operations inside the region of the original. (See "Print Area.") [→P.943](#) For example, printing the A4 size (210 x 297 mm) original shown in Figure (b) gives the result as shown in Figure (a).

However, if **Oversize** paper is selected, printing is performed by taking the margins necessary for printer operations outside of the region of the original to give the result as shown in Figure (c).

The A4 size print as shown in Figure (b) can then be obtained by trimming the margins from the periphery after printing.

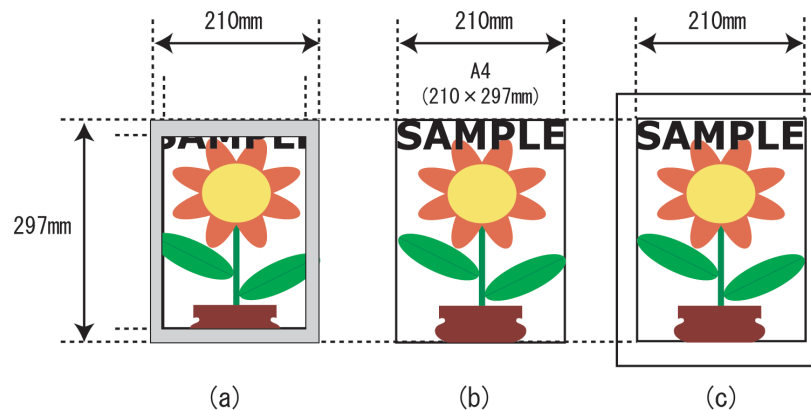

- When printing on **Oversize** paper, load paper larger than the page size—a size that includes the margin required by the printer.

- Sheets: Load paper that is at least 10 mm (0.39 in) wider and 28 mm (1.10 in) higher than the page size
- Rolls: Load paper that is at least 10 mm (0.39 in) wider and 10 mm (0.39 in) higher than the page size



- Paper larger than the maximum size supported by the printer cannot be used as paper for oversized printing. (See "Paper Sizes.") [→P.530](#)

- Oversized printing (selecting **Oversize** in **Page Size**) is only available in Windows.
- To perform oversized printing on a Macintosh computer, you must specify a non-standard page size and print on it.
- To specify a non-standard paper size in oversized printing, register the paper size as a Custom Paper Size. Oversized printing is not available with **Custom Size**. (See "Printing on Non-Standard Paper Sizes.") [→P.122](#)

For instructions on oversized printing, refer to the following topics, as appropriate for your computer and operating system.

- Printing at Full Size (Windows) →P.91
- Printing at Full Size (Mac OS X) →P.92

Printing at Full Size (Windows)

This topic describes how to print at full size based on the following example. (Oversized Printing)

- Document: Any Type
- Page Size: A4 (210.0×297.0 mm)/Letter (8.3 × 11.7 in)
- Paper: Roll
- Paper type: **Plain Paper**
- Roll paper width: A2/A3 roll (420.0 mm [16.5 in])

1 Choose **Print** in the application menu.

2 Select the printer in the dialog box, and then display the printer driver dialog box. (See "Accessing the Printer Driver Dialog Box from Applications →P.185 ")

3 Make sure the **Main** sheet is displayed.

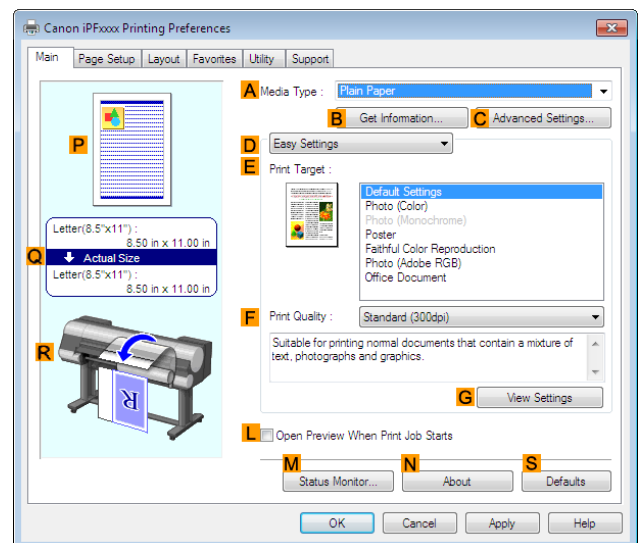

4 In the **A Media Type** list, select the type of paper that is loaded. In this case, click **Plain Paper**.

- 5** Click the **Page Setup** tab to display the **Page Setup** sheet.

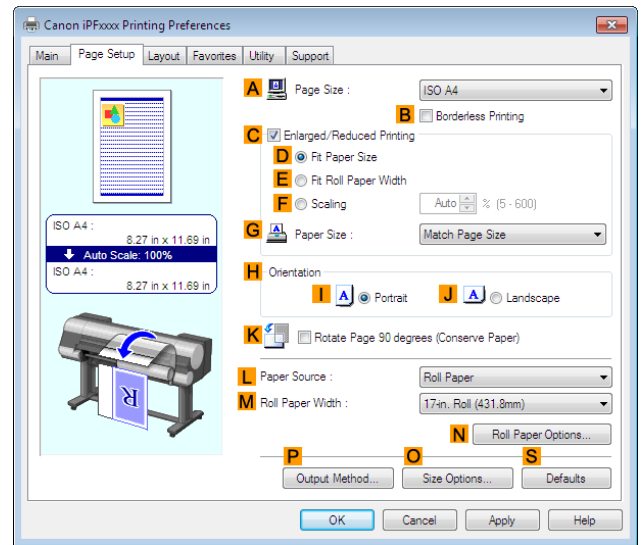

- 6** Click **O Size Options** to display the **Paper Size Options** dialog box.
- 7** In the **Paper Size Options** dialog box, select the **Oversize** check box in **Display Series**.
- 8** Click **OK** to close the **Paper Size Options** dialog box.
- 9** Click **Oversize - ISO A4** in the **A Page Size** list.
- 10** Select and click a roll paper in the **L Paper Source** list.
- 11** Select the width of the loaded roll in the **M Roll Paper Width** list—in this case, **ISO A2/A3 Roll (420.0mm)**.
- 12** Confirm the print settings and print as desired.



Note

- For tips on confirming print settings, see "Confirming Print Settings" →P.182 "

Printing at Full Size (Mac OS X)

This topic describes how to print at full size based on the following example. (Oversized Printing)

- Document: Any Type
- Page size: A4 (210.0 × 297.0 mm [8.3 × 11.7 in])
- Paper: Roll paper
- Paper type: **Plain Paper**
- Roll paper width: A2/A3 roll (420.0 mm [16.5 in])

1 This sets the **B Format for** and **C Paper Size**.



Note

- The configuration method varies depending on the OS and application software you are using. If **Page Setup** is displayed in the application menu, the settings are configured by opening the **Page Attributes** dialog box from **Page Setup**.

If it is not displayed, the settings are configured in the upper part of the printer driver displayed when you select **Print** from the application software menu.

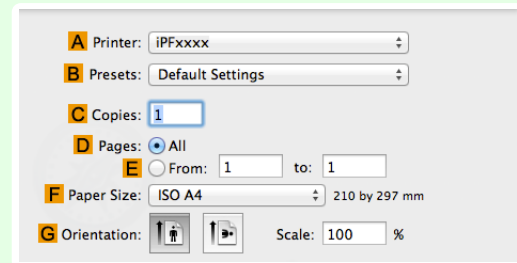
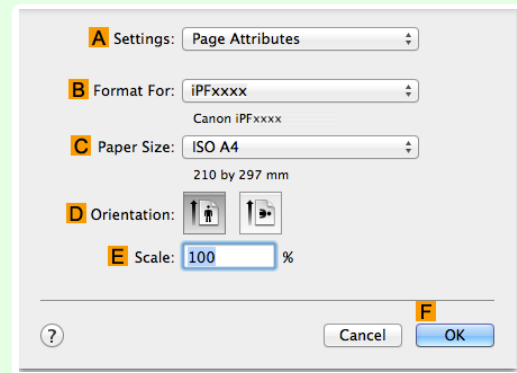

2 Select the printer in the **A Printer** list.

3 In **F Paper Size**, click the size of the original. In this case, click **ISO A4 - Oversize**.

4 If you configured the settings using the **Page Attributes** dialog box, click **F OK** to close the dialog box, and then select **Print** from the application software menu.

5 Access the **Main** pane.

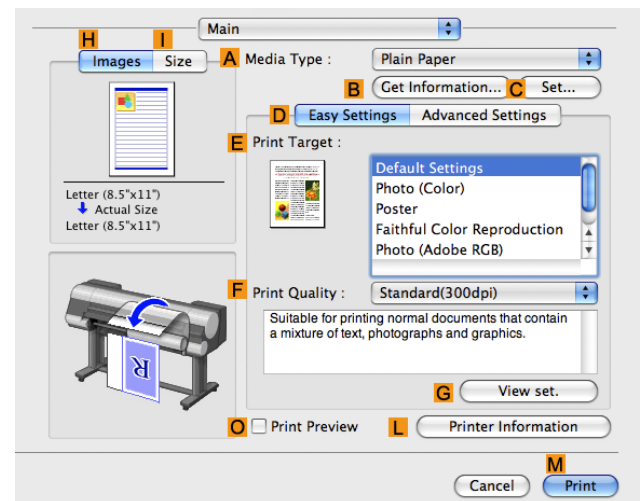

6 In the **A Media Type** list, select the type of paper that is loaded. In this case, click **Plain Paper**.

7 Make your selection in the **E Print Target** list.

8 Make your selection in the **F Print Quality** list.

9 Access the **Page Setup** pane.

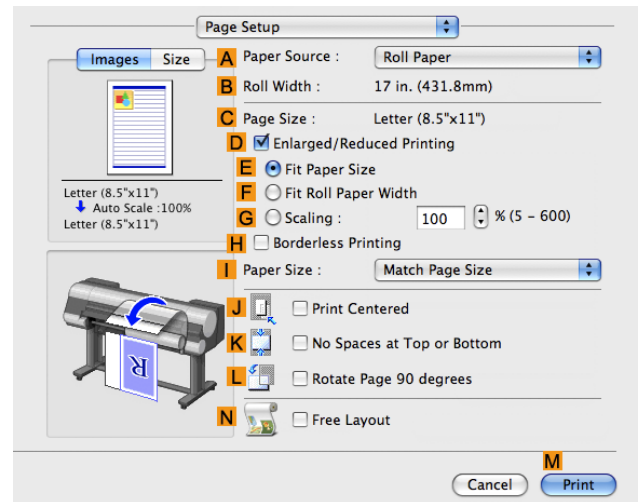

10 Select and click a roll paper in the **A Paper Source** list.

11 Make sure the width of the loaded roll is displayed in the **B Roll Width** list—in this case, **ISO A2/A3 (420.0mm)**.



Note

- If the width of the roll loaded in the printer is not shown in **B Roll Width**, click **L Printer Information** on the **Main** pane to update the printer information.

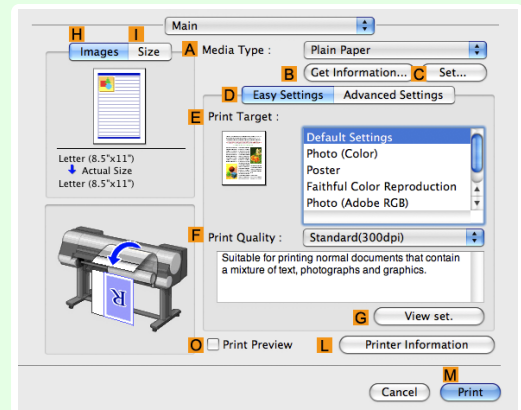

12 Make sure **C Paper Size** shows the original size as specified in **C Paper Size** in the **Page Attributes** dialog box—in this case, **ISO A4 - Oversize**.

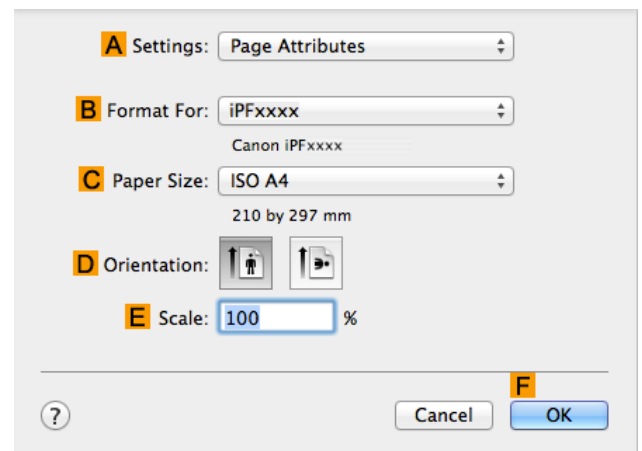

13 Confirm the print settings, and then click **M Print** to start printing.



Note

- For tips on confirming print settings, see "Confirming Print Settings →P.368 "

Borderless Printing at Actual Size

Take advantage of borderless printing to print documents such as posters (made up mainly of photos or images) without a surrounding margin, or border.

Borderless printing is only available with rolls.

• Borderless Printing

In regular printing, a margin required by the printer is added around the original. With borderless printing, you can print documents without the margin, so that the printed image covers the entire surface of the paper.

Paper incompatible with the printer's auto cut function can be printed without borders on the left and right sides only.

Printing without borders on the left and right sides only is available when **CutDustReduct.** is set to **On**.



Important

- When printing without borders, be certain to set the blue switch on the platen to the ● side. If the switch is set incorrectly, print quality may deteriorate. (See "Setting the Blue Switch on the Platen.") →P.901
- There are limits on the media type and roll paper width of paper that can be used for borderless printing. For information on the media types that can be used for borderless printing, see "Paper Reference Guide."
- Borderless printing is not possible if details such as crop marks and margins are included as data on the periphery of the original.
- These features cannot be used in combination with borderless printing: special page layouts, centering originals, and printing cut lines on rolls.
- If **Fit Paper Size** or **Print Image with Actual Size** (Windows only) is selected while performing borderless printing, **Rotate Page 90 degrees (Conserve Paper)** cannot be selected. Note that if borderless printing is possible, then even if the original is rotated 90 degrees, it will be printed by automatically rotating the page by 90 degrees.

• Borderless Printing Method

Choose the method of borderless printing that suits the original, as desired.

• Print Image with Actual Size

Prints originals at actual size, without enlarging or reducing them. We recommend when focusing on image quality. You should create the original at a size larger by 3 mm on each side than the paper size.

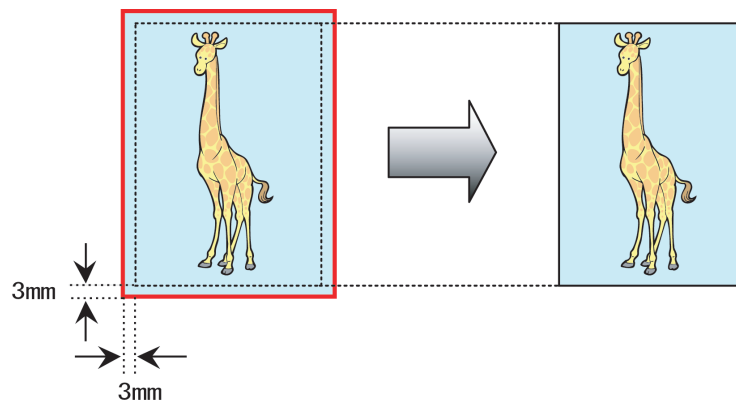



- Not all page sizes are available.

Note • When performing borderless printing without using **Print Image with Actual Size**, the image deteriorates slightly because the image is automatically enlarged.

For instructions on borderless printing of photos and images at actual size, refer to the following topics, as appropriate for your computer and operating system.

- Borderless Printing at Actual Size (Windows) →P.96
- Borderless Printing at Actual Size (Mac OS X) →P.98

Borderless Printing at Actual Size (Windows)

This topic describes how to print borderlessly at actual size based on the following example.



Important • When borderless printing is used, the edge of the paper is cut during printing. Thus, ink density may be uneven at the edges. If you require higher image quality, select **No** from the **Automatic Cutting** list in the **Roll Paper Options** dialog box. In this case, the paper can be printed without borders on the left and right sides only. Once printed and cut, please cut the upper and lower bands with scissors.

- Document: Any type
- Page size: 10×12 inches (254.0×304.8 mm)
- Paper: Roll
- Paper type: **Canon Heavyweight Coated Paper**
- Roll paper width: 10 inches (254.0 mm)

- 1 Create the original in the source application 3 mm (0.12 in) larger on each side than 254.0×304.8 mm (10 × 12 in) —that is, 260.0×310.8 mm (10.2 × 12.2 in)



- Note**
- If you can specify the margin, as in Microsoft Word, set the margin at 0 mm. For instructions on specifying the margin, refer to the software documentation.
 - The extra 3 mm (0.12 in) on each side will not be printed. Create the original so that it fits inside the paper area to be printed on.

- 2 Choose **Print** in the application menu.

- 3 Select the printer in the dialog box, and then display the printer driver dialog box. (See "Accessing the Printer Driver Dialog Box from Applications.") →P.185

- 4 Make sure the **Main** sheet is displayed.

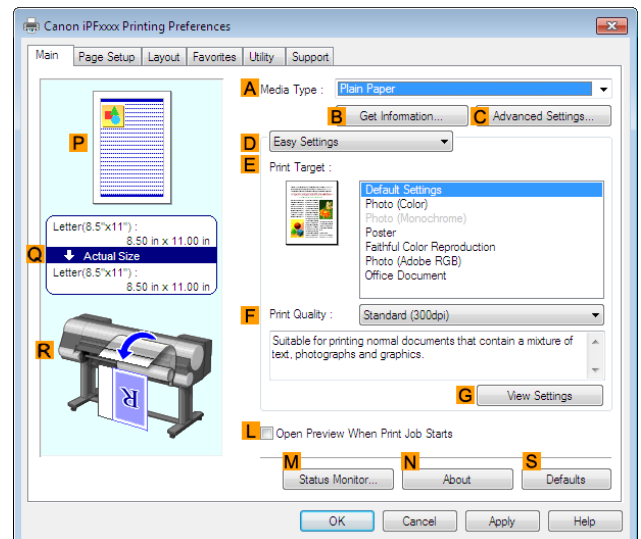

5 In the **A Media Type** list, select the type of paper that is loaded. In this case, click **Canon Heavyweight Coated Paper**.

6 Select the print target in the **E Print Target** list.



• When you are using paper that takes longer for ink to adhere for borderless printing and the Cutter Unit touches printing surfaces that are not dry yet, it may damage the paper or the edge of the document that is cut, depending on frequency of use. In this kind of situation, change the ink drying time using the following procedure.

- Click **Advanced Settings** in **Media Type**.
- Select an ink drying time in the list for the **Between Pages** setting of **Drying Time**.

7 Click the **Page Setup** tab to display the **Page Setup** sheet.

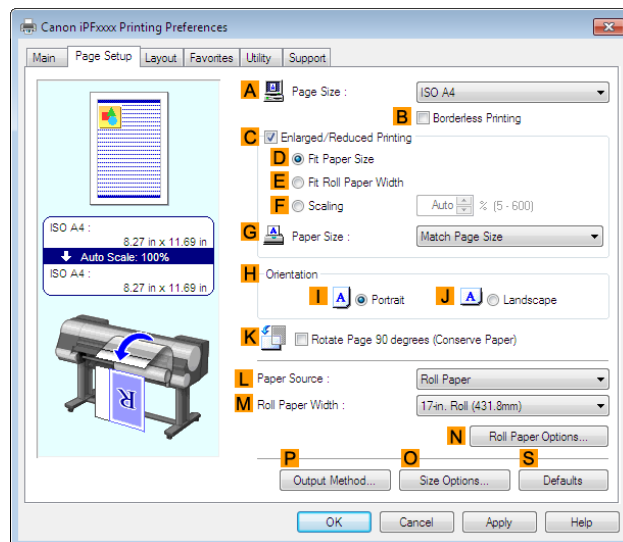

8 In the **A Page Size** list, click the size of the original as specified in the source application. In this case, click **10"x12"**.

9 Select and click a roll paper in the **L Paper Source** list.

10 Select the **B Borderless Printing** check box to display the **Information** dialog box.

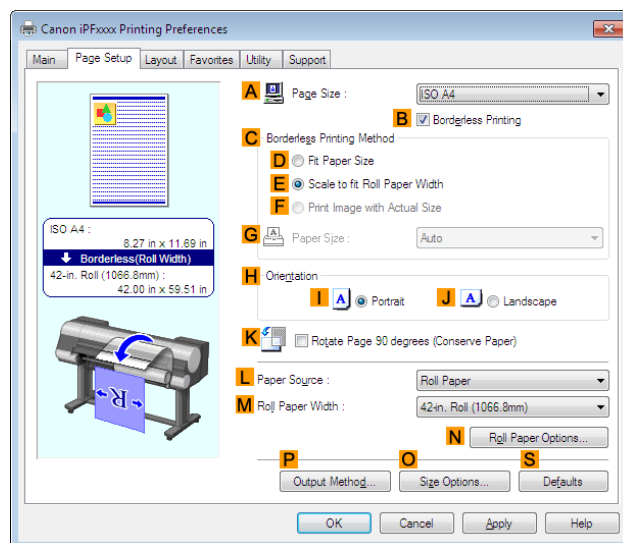

11 Select the width of the loaded roll in the **Roll Paper Width** list—in this case, click **10-in. Roll (254.0mm)**.

12 Click **OK** to close the **Information** dialog box.

13 In **C Borderless Printing Method**, click **F Print Image with Actual Size**.

14 Confirm the print settings and print as desired.



Note

- For tips on confirming print settings, see "Confirming Print Settings." →P.182

Borderless Printing at Actual Size (Mac OS X)

This topic describes how to print borderlessly at actual size based on the following example.



Important

- When borderless printing is used, the edge of the paper is cut during printing. Thus, ink density may be uneven at the edges. If you require higher image quality, select **No** from the **Automatic Cutting** list in the **Paper Detailed Settings** dialog box. In this case, the paper can be printed without borders on the left and right sides only. Once printed and cut, please cut the upper and lower bands with scissors.

- Document: Any type
- Page size: 10 × 12 inches (254.0×304.8 mm)—Borderless
- Paper: Roll
- Paper type: **Canon Heavyweight Coated Paper**
- Roll paper width: 10 inches (254.0 mm)

1 Choose **Page Setup** from the application menu to display the **Page Attributes** dialog box.

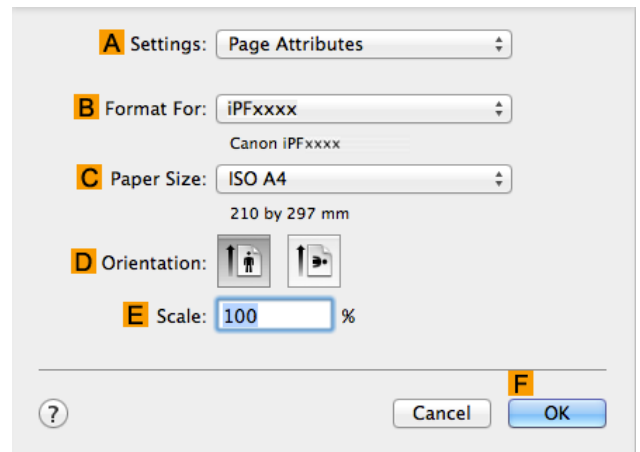

2 Select the printer in the **B Format for** list.

3 In the **C Paper Size** list, choose a paper size supported for borderless printing. Here, click **10"x12" - Borderless**.



Note

- Paper sizes supported for borderless printing are indicated by **-Borderless**.

4 Click **F OK** to close the dialog box.

5 In the application, create an original that takes up the entire space of the paper size.

6 Choose **Print** in the application menu.

7 Access the **Main** pane.

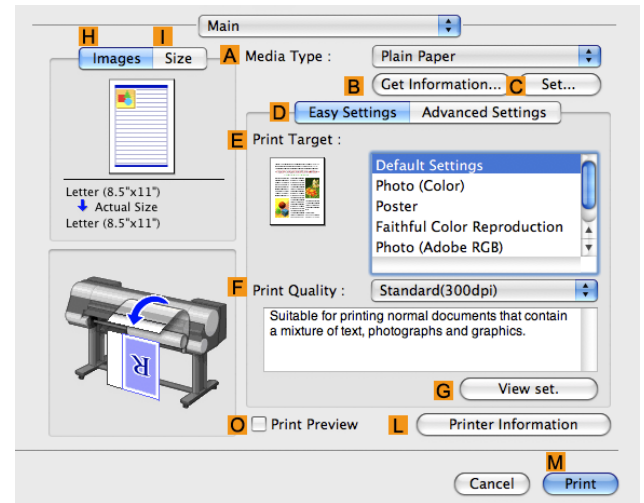

8 In the **A Media Type** list, select the type of paper that is loaded. In this case, click **Canon Heavyweight Coated Paper**.

9 Select the print target in the **E Print Target** list.



- When you are using paper that takes longer for ink to adhere for borderless printing and the Cutter Unit touches printing surfaces that are not dry yet, it may damage the paper or the edge of the document that is cut, depending on frequency of use. In this kind of situation, change the ink drying time in **Between Pages** in the **Paper Detailed Settings** dialog box.

10 Access the **Page Setup** pane.

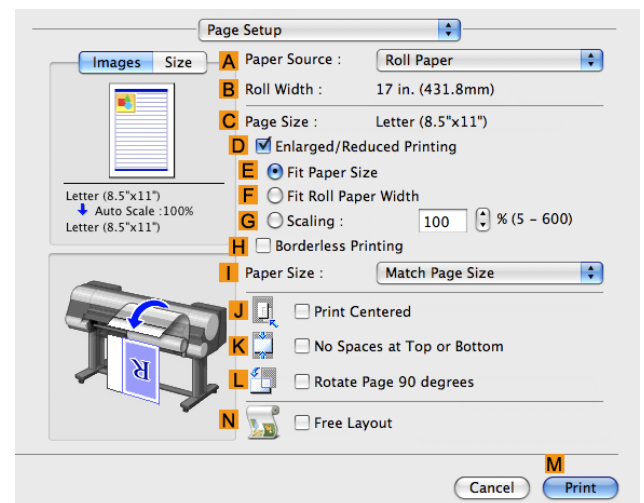

11 Select and click a roll paper in the **A Paper Source** list.

- 12** Confirm that the roll paper width matches the paper size. Make sure the width of the loaded roll is displayed in the **B Roll Width** list—in this case, **10 in. (254.0mm)**.

Note • If the width of the loaded roll is not displayed in **B Roll Width**, click **L Printer Information** on the **Main** pane and update the printer information.

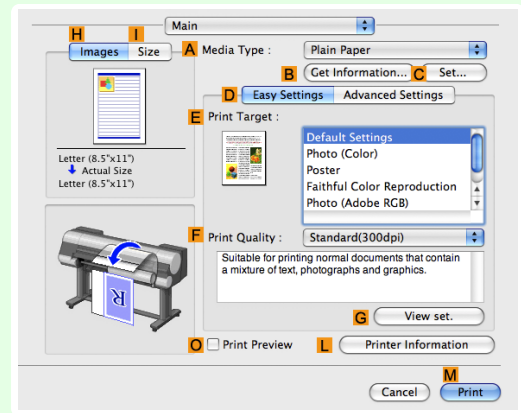

- 13** Make sure the **C Page Size** setting matches the original size as selected in **C Paper Size** in the **Page Attributes** dialog box—in this case, **10"x12" - Borderless**.

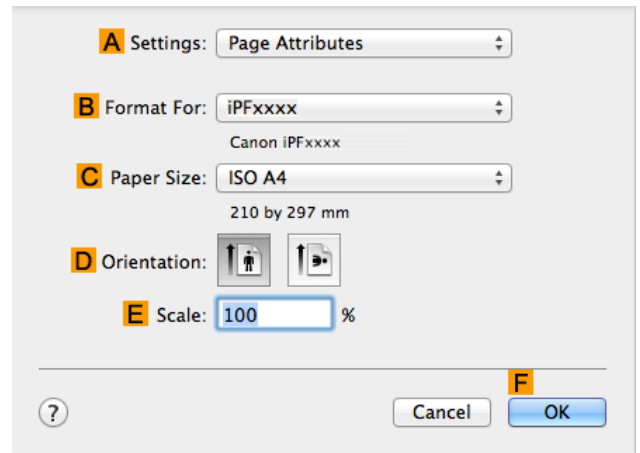

- 14** Confirm the print settings, and then click **M Print** to start printing.

Note • For tips on confirming print settings, see "Confirming Print Settings →P.368 "

Borderless Printing

Borderless Printing on Paper of Equivalent Size	101
Borderless Printing by Resizing Originals to Match the Paper Size (Windows)	102
Borderless Printing by Resizing Originals to Match the Paper Size (Mac OS X)	104
Borderless Printing by Resizing Originals to Fit the Roll Width	107
Borderless Printing by Resizing Originals to Fit the Roll Width (Windows)	108
Borderless Printing by Resizing Originals to Fit the Roll Width (Mac OS X)	110
Borderless Printing at Actual Size	95
Borderless Printing at Actual Size (Windows)	96
Borderless Printing at Actual Size (Mac OS X)	98

Borderless Printing on Paper of Equivalent Size

Take advantage of borderless printing to print documents such as posters (made up mainly of photos or images) without a surrounding margin, or border.

Borderless printing is only available with rolls.

• Borderless Printing

In regular printing, a margin required by the printer is added around the original. With borderless printing, you can print documents without the margin, so that the printed image covers the entire surface of the paper.

Paper incompatible with the printer's auto cut function can be printed without borders on the left and right sides only.

Printing without borders on the left and right sides only is available when **CutDustReduct.** is set to **On**.



Important

- When printing without borders, be certain to set the blue switch on the platen to the ● side. If the switch is set incorrectly, print quality may deteriorate. (See "Setting the Blue Switch on the Platen.") →P.901
- There are limits on the media type and roll paper width of paper that can be used for borderless printing. For information on the media types that can be used for borderless printing, see "Paper Reference Guide."
- Borderless printing is not possible if details such as crop marks and margins are included as data on the periphery of the original.
- These features cannot be used in combination with borderless printing: special page layouts, centering originals, and printing cut lines on rolls.
- If **Fit Paper Size** or **Print Image with Actual Size** (Windows only) is selected while performing borderless printing, **Rotate Page 90 degrees (Conserve Paper)** cannot be selected. Note that if borderless printing is possible, then even if the original is rotated 90 degrees, it will be printed by automatically rotating the page by 90 degrees.

• Borderless Printing Method

Choose the method of borderless printing that suits the original, as desired.

• Fit Paper Size

Enlarge or reduce the original to match the size of the paper you are using.

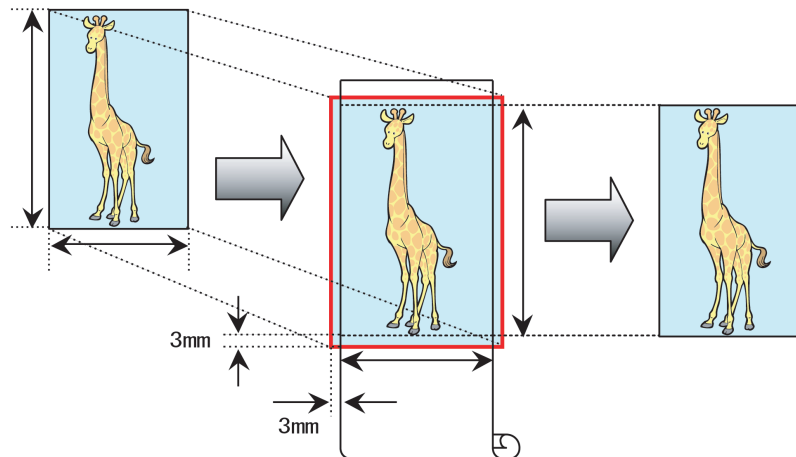

Note

- The printer driver automatically enlarges originals 3 mm (0.12 in) past the dimensions of the paper on each side. The 3 mm portion beyond the edge on each side is not printed.

For instructions on borderless printing of photos, images, and other documents to match the paper size, refer to the following topics, as appropriate for your computer and operating system.

- Borderless Printing by Resizing Originals to Match the Paper Size (Windows) →P.102
- Borderless Printing by Resizing Originals to Match the Paper Size (Mac OS X) →P.104

Borderless Printing by Resizing Originals to Match the Paper Size (Windows)

This topic describes how to enlarge originals before borderless printing to match the paper size, based on the following example.



Important

- When borderless printing is used, the edge of the paper is cut during printing. Thus, ink density may be uneven at the edges. If you require higher image quality, select **No** from the **Automatic Cutting** list in the **Roll Paper Options** dialog box. In this case, the paper can be printed without borders on the left and right sides only. Once printed and cut, please cut the upper and lower bands with scissors.

- Document: Any type
- Page size: 10×12 inches (254.0×304.8 mm)
- Paper: Roll
- Paper type: **Canon Heavyweight Coated Paper**
- Roll paper width: 10 inches (254.0 mm)

1 In the application, create an original that takes up the entire space of the paper size.



Note

- If you can specify the margin, as in Microsoft Word, set the margin at 0 mm. For instructions on specifying the margin, refer to the software documentation.

2 Choose **Print** in the application menu.

3 Select the printer in the dialog box, and then display the printer driver dialog box. (See "Accessing the Printer Driver Dialog Box from Applications.") →P.185

- 4** Make sure the **Main** sheet is displayed.

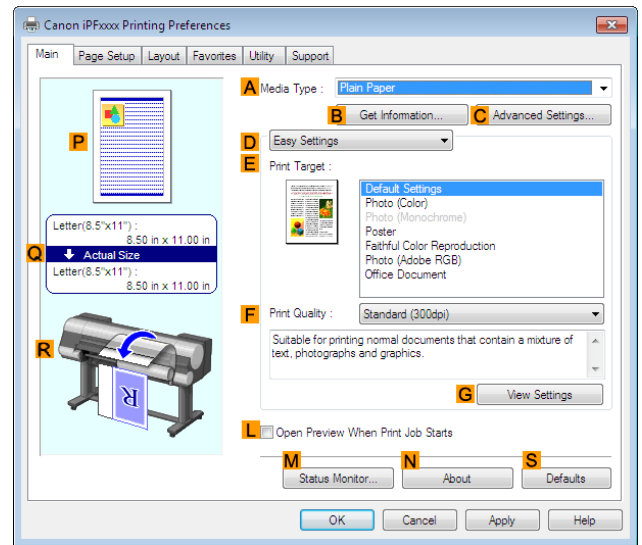

- 5** In the **A Media Type** list, select the type of paper that is loaded. In this case, click **Canon Heavyweight Coated Paper**.

- 6** Select the print target in the **E Print Target** list.



Important

- When you are using paper that takes longer for ink to adhere for borderless printing and the Cutter Unit touches printing surfaces that are not dry yet, it may damage the paper or the edge of the document that is cut, depending on frequency of use. In this kind of situation, change the ink drying time using the following procedure.
 - Click **Advanced Settings** in **Media Type**.
 - Select an ink drying time in the list for the **Between Pages** setting of **Drying Time**.

- 7** Click the **Page Setup** tab to display the **Page Setup** sheet.

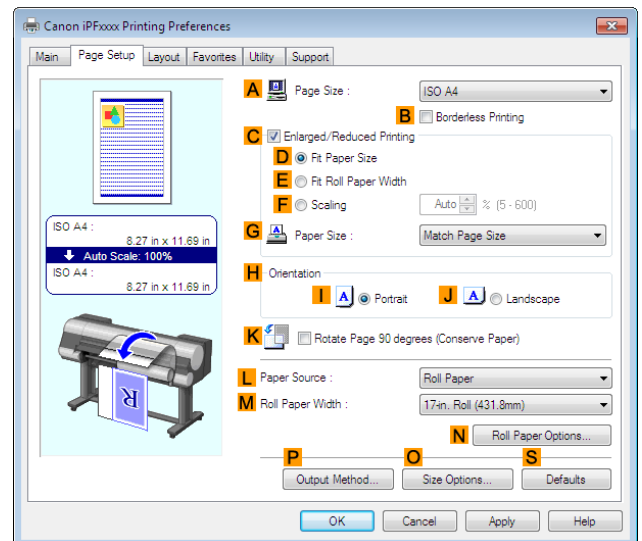

- 8** In the **A Page Size** list, click the size of the original as specified in the application. In this case, click **10"x12"**.

- 9** Select and click a roll paper in the **L Paper Source** list.

- 10** Select the **B Borderless Printing** check box to display the **Information** dialog box.

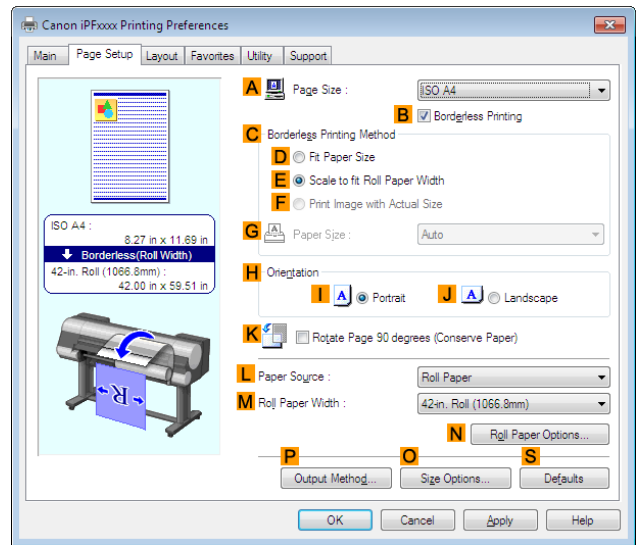

- 11** Select the width of the loaded roll in the **Roll Paper Width** list—in this case, click **10-in. Roll (254.0mm)**.

- 12** Click **OK** to close the **Information** dialog box.

- 13** In **C Borderless Printing Method**, click **D Fit Paper Size**.

- 14** Click **Match Page Size** in the **G Paper Size** list.

- 15** Confirm the print settings and print as desired.



- For tips on confirming print settings, see "Confirming Print Settings." →P.182

Note

Borderless Printing by Resizing Originals to Match the Paper Size (Mac OS X)

This topic describes how to enlarge originals before borderless printing to match the paper size, based on the following example.



Important

- When borderless printing is used, the edge of the paper is cut during printing. Thus, ink density may be uneven at the edges. If you require higher image quality, select **No** from the **Automatic Cutting** list in the **Paper Detailed Settings** dialog box. In this case, the paper can be printed without borders on the left and right sides only. Once printed and cut, please cut the upper and lower bands with scissors.

- Document: Any type
- Page size: 10×12 inches (254.0×304.8 mm)
- Paper: Roll
- Paper type: **Canon Heavyweight Coated Paper**
- Roll paper width: 10 inches (254.0 mm)

- 1 Choose **Page Setup** from the application menu to display the **Page Attributes** dialog box.

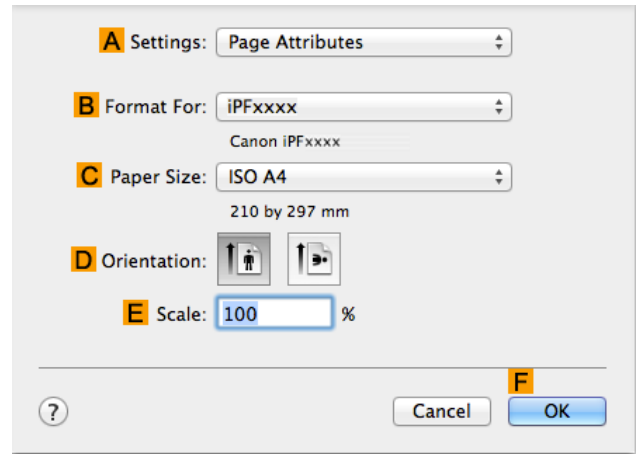

- 2 Select the printer in the **B Format for** list.

- 3 In the **C Paper Size** list, click the size of the original. In this case, click **10"x12"**.



Note

- All sizes are available in borderless printing if you resize originals to match the paper size.

- 4 Click **OK** to close the dialog box.

- 5 In the application, create an original that takes up the entire space of the paper size.

- 6 Choose **Print** in the application menu.

- 7 Access the **Main** pane.

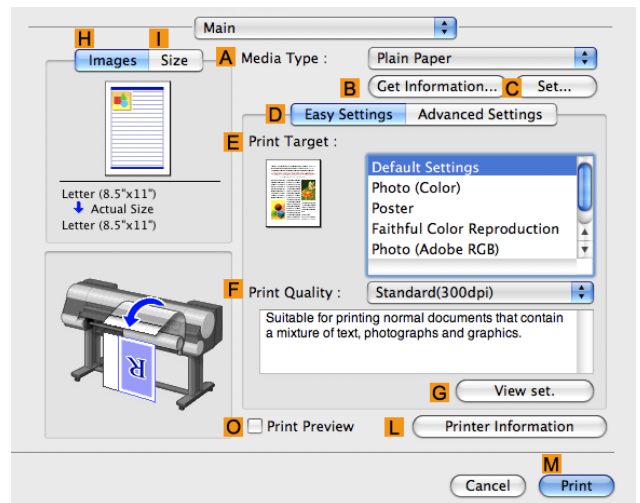

- 8 In the **A Media Type** list, select the type of paper that is loaded. In this case, click **Canon Heavyweight Coated Paper**.

9 Select the print target in the **E Print Target** list.



- When you are using paper that takes longer for ink to adhere for borderless printing and the Cutter Unit touches printing surfaces that are not dry yet, it may damage the paper or the edge of the document that is cut, depending on frequency of use. In this kind of situation, change the ink drying time in **Between Pages** in the **Paper Detailed Settings** dialog box.

10 Access the **Page Setup** pane.

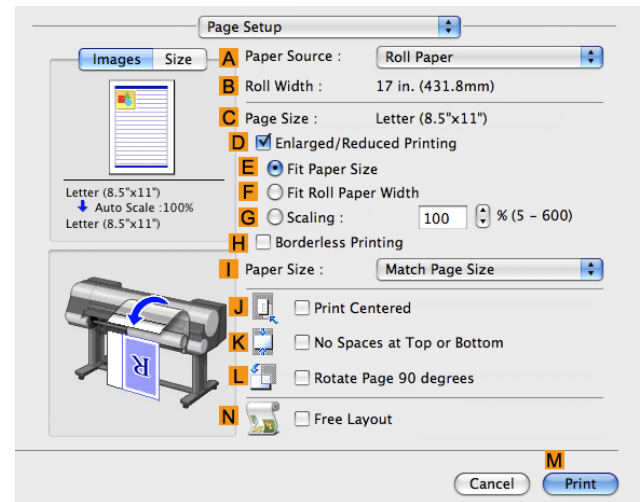

11 Select and click a roll paper in the **A Paper Source** list.

12 Make sure the width of the loaded roll is displayed in the **B Roll Width** list—in this case, **10 in. (254.0mm)**.



- If the width of the loaded roll is not displayed in **B Roll Width**, click **L Printer Information** on the **Main** pane and update the printer information.

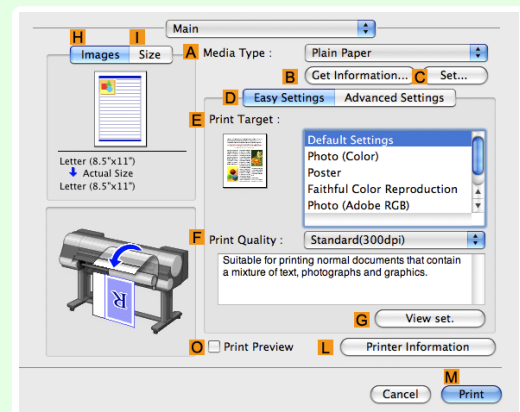

- 13** Make sure the **C Page Size** setting matches the original size as selected in **C Paper Size** in the **Page Attributes** dialog box—in this case, **10"x12"**.

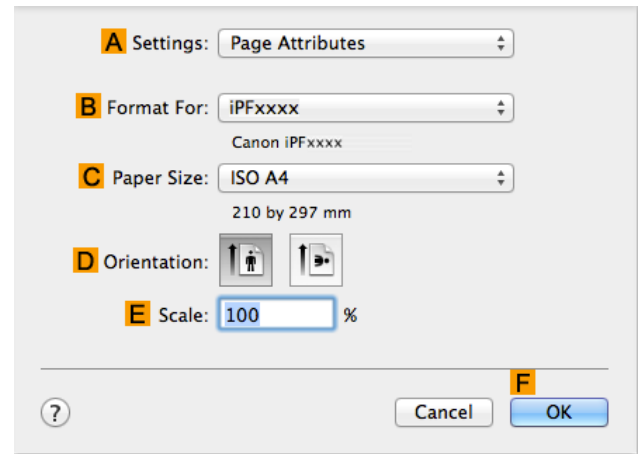

- 14** Select the **D Enlarged/Reduced Printing** check box.
- 15** Select the **H Borderless Printing** check box.
- 16** Click **E Fit Paper Size** under **D Enlarged/Reduced Printing**.
- 17** In **I Paper Size**, click the paper size. In this case, click **10"x12" - Borderless**.
- 18** Confirm the print settings, and then click **M Print** to start printing.



Note

- For tips on confirming print settings, see "Confirming Print Settings" →P.368 "

Borderless Printing by Resizing Originals to Fit the Roll Width

Take advantage of borderless printing to print documents such as posters (made up mainly of photos or images) without a surrounding margin, or border.

Borderless printing is only available with rolls.

• Borderless Printing

In regular printing, a margin required by the printer is added around the original. With borderless printing, you can print documents without the margin, so that the printed image covers the entire surface of the paper.

Paper incompatible with the printer's auto cut function can be printed without borders on the left and right sides only.

Printing without borders on the left and right sides only is available when **CutDustReduct.** is set to **On**.



Important

- When printing without borders, be certain to set the blue switch on the platen to the ● side. If the switch is set incorrectly, print quality may deteriorate. (See "Setting the Blue Switch on the Platen.") →P.901
- There are limits on the media type and roll paper width of paper that can be used for borderless printing. For information on the media types that can be used for borderless printing, see "Paper Reference Guide."
- Borderless printing is not possible if details such as crop marks and margins are included as data on the periphery of the original.
- These features cannot be used in combination with borderless printing: special page layouts, centering originals, and printing cut lines on rolls.
- If **Fit Paper Size** or **Print Image with Actual Size** (Windows only) is selected while performing borderless printing, **Rotate Page 90 degrees (Conserve Paper)** cannot be selected. Note that if borderless printing is possible, then even if the original is rotated 90 degrees, it will be printed by automatically rotating the page by 90 degrees.

- **Borderless Printing Method**

Choose the method of borderless printing that suits the original, as desired.

- **Scale to fit Roll Paper Width**

Enlarge or reduce the original as a whole to match the roll paper width.

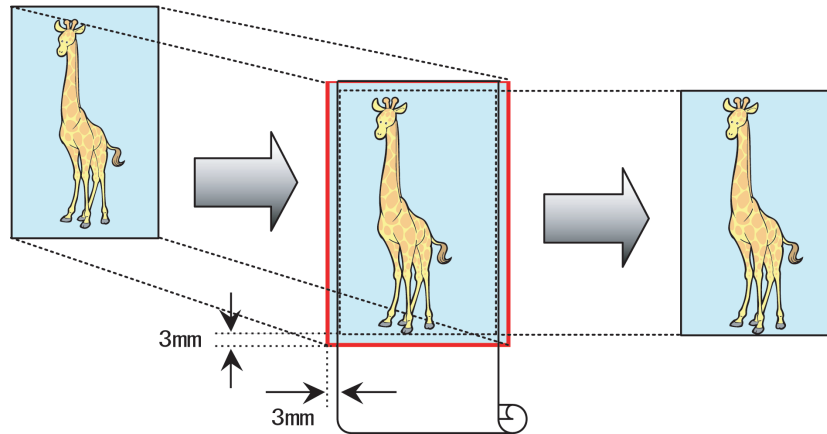

Note

- You can combine this function with rotating pages 90 degrees before printing so that the original width (relative to portrait orientation) matches the roll paper width in borderless printing.

For instructions on borderless printing of photos, images, and other documents to match the roll paper width, refer to the following topics, as appropriate for your computer and operating system.

- Borderless Printing by Resizing Originals to Fit the Roll Width (Windows) →P.108
- Borderless Printing by Resizing Originals to Fit the Roll Width (Mac OS X) →P.110

Borderless Printing by Resizing Originals to Fit the Roll Width (Windows)

This topic describes how to enlarge originals before borderless printing to match the roll width, based on the following example.



Important

- When borderless printing is used, the edge of the paper is cut during printing. Thus, ink density may be uneven at the edges. If you require higher image quality, select **No** from the **Automatic Cutting** list in the **Roll Paper Options** dialog box. In this case, the paper can be printed without borders on the left and right sides only. Once printed and cut, please cut the upper and lower bands with scissors.

- Document: Any type
- Page size: A4 (210.0×297.0 mm)/Letter (8.3 × 11.7 in)
- Paper: Roll
- Paper type: **Canon Heavyweight Coated Paper**
- Roll paper width: 10 inches (254.0 mm)

1 In the application, create an original that takes up the entire space of the paper size.



Note

- If you can specify the margin, as in Microsoft Word, set the margin at 0 mm. For instructions on specifying the margin, refer to the software documentation.

2 Choose **Print** in the application menu.

3 Select the printer in the dialog box, and then display the printer driver dialog box. (See "Accessing the Printer Driver Dialog Box from Applications.") →P.185

- 4** Make sure the **Main** sheet is displayed.

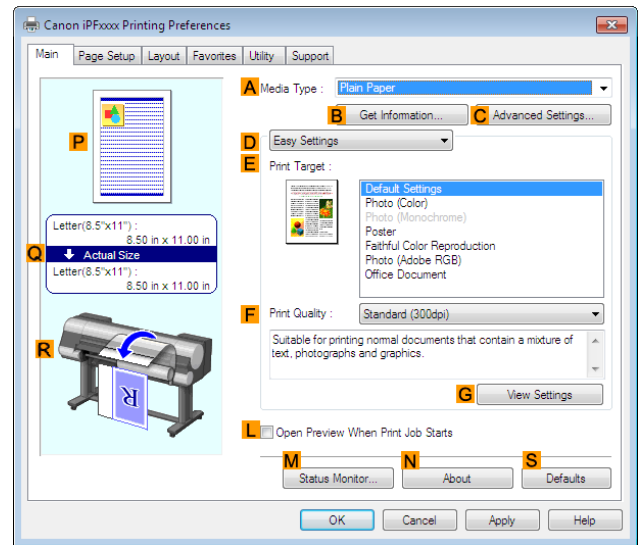

- 5** In the **A Media Type** list, select the type of paper that is loaded. In this case, click **Canon Heavyweight Coated Paper**.

- 6** Select the print target in the **E Print Target** list.



Important

- When you are using paper that takes longer for ink to adhere for borderless printing and the Cutter Unit touches printing surfaces that are not dry yet, it may damage the paper or the edge of the document that is cut, depending on frequency of use. In this kind of situation, change the ink drying time using the following procedure.
 - Click **Advanced Settings** in **Media Type**.
 - Select an ink drying time in the list for the **Between Pages** setting of **Drying Time**.

- 7** Click the **Page Setup** tab to display the **Page Setup** sheet.

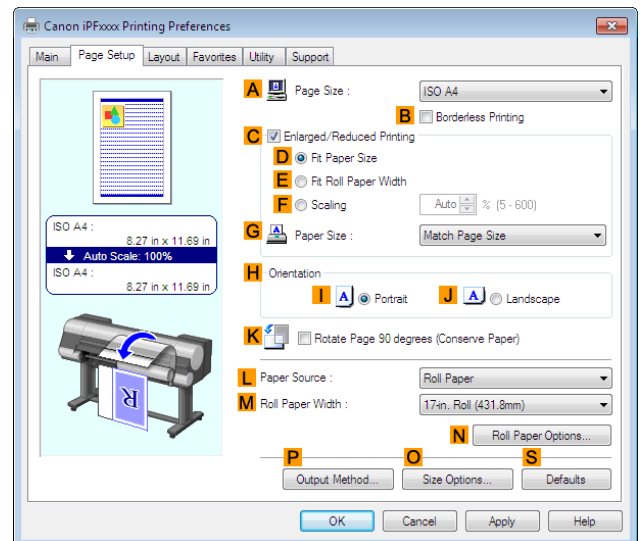

- 8** In the **A Page Size** list, click the size of the original as specified in the application. In this case, click **ISO A4**.

- 9** Select and click a roll paper in the **L Paper Source** list.

- 10** Select the **B Borderless Printing** check box to display the **Information** dialog box.

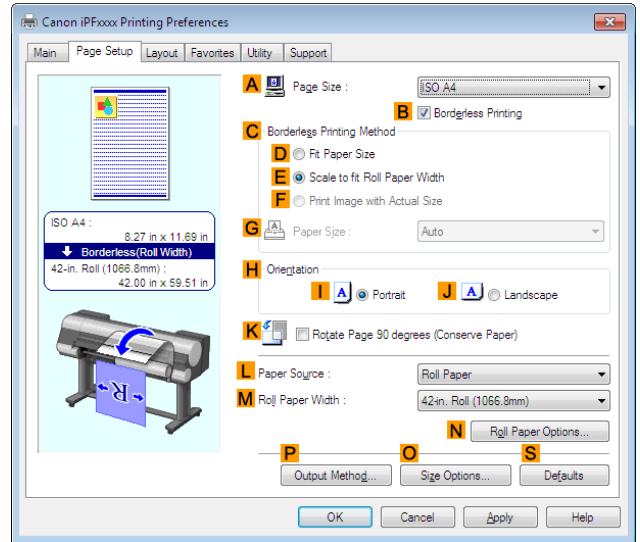

- 11** Select the width of the loaded roll in the **Roll Paper Width** list—in this case, click **10-in. Roll (254.0mm)**.
- 12** Click **OK** to close the **Information** dialog box.
- 13** In **C Borderless Printing Method**, make sure **E Scale to fit Roll Paper Width** is selected.
- 14** Confirm the print settings and print as desired.



Note

- For tips on confirming print settings, see "Confirming Print Settings." →P.182

Borderless Printing by Resizing Originals to Fit the Roll Width (Mac OS X)

This topic describes how to enlarge originals before borderless printing to match the roll width, based on the following example.



Important

- When borderless printing is used, the edge of the paper is cut during printing. Thus, ink density may be uneven at the edges. If you require higher image quality, select **No** from the **Automatic Cutting** list in the **Paper Detailed Settings** dialog box. In this case, the paper can be printed without borders on the left and right sides only. Once printed and cut, please cut the upper and lower bands with scissors.

- Document: Any type
- Page size: A4 (210.0×297.0 mm)/Letter (8.3 × 11.7 in)
- Paper: Roll
- Paper type: **Canon Heavyweight Coated Paper**
- Roll paper width: 10 inches (254.0 mm)

- 1 Choose **Page Setup** from the application menu to display the **Page Attributes** dialog box.

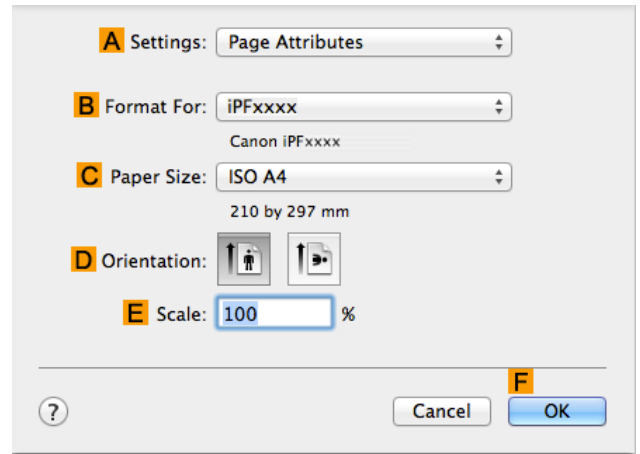

- 2 Select the printer in the **B Format for** list.
- 3 In **C Paper Size**, click the size of the original. In this case, click **ISO A4**.



Note

- All sizes are available in borderless printing if you resize originals to fit the roll width.

- 4 Click **OK** to close the dialog box.
- 5 In the application, create an original that takes up the entire space of the paper size.
- 6 Choose **Print** in the application menu.
- 7 Access the **Main** pane.

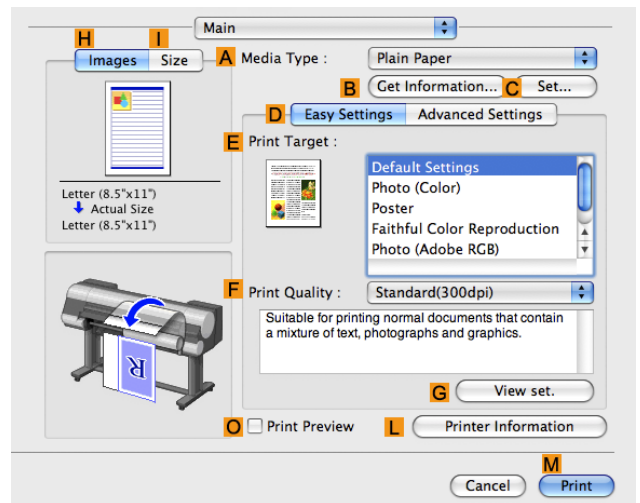

- 8 In the **A Media Type** list, select the type of paper that is loaded. In this case, click **Canon Heavyweight Coated Paper**.

9 Select the print target in the **E Print Target** list.



- When you are using paper that takes longer for ink to adhere for borderless printing and the Cutter Unit touches printing surfaces that are not dry yet, it may damage the paper or the edge of the document that is cut, depending on frequency of use. In this kind of situation, change the ink drying time in **Between Pages** in the **Paper Detailed Settings** dialog box.

10 Access the **Page Setup** pane.

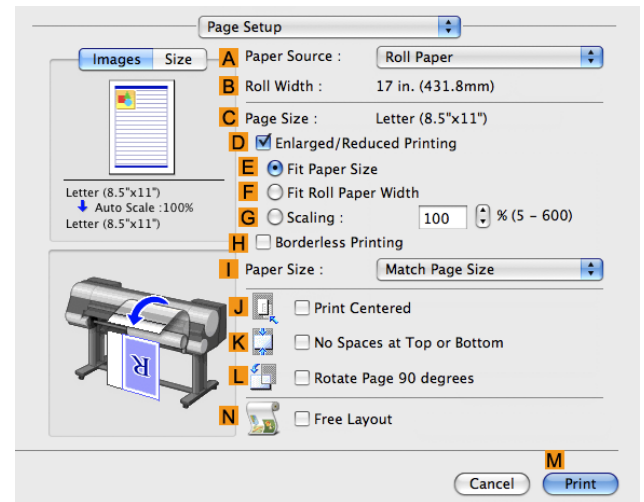

11 Select and click a roll paper in the **A Paper Source** list.

12 Make sure the width of the loaded roll is displayed in the **B Roll Width** list—here, **10 in. (254.0mm)**.



- If the width of the loaded roll is not displayed in **B Roll Width**, click **L Printer Information** on the **Main** pane and update the printer information.

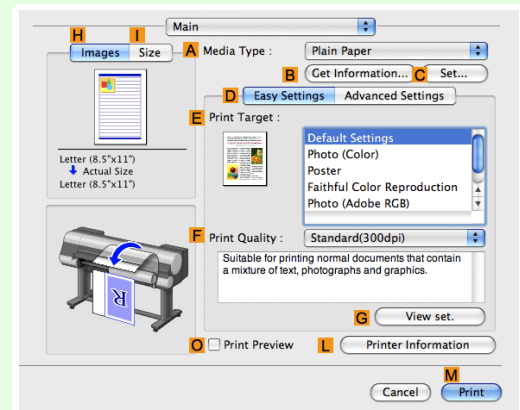

- 13** Make sure the **C Page Size** setting matches the original size as selected in **C Paper Size** in the **Page Attributes** dialog box—in this case, **ISO A4**.

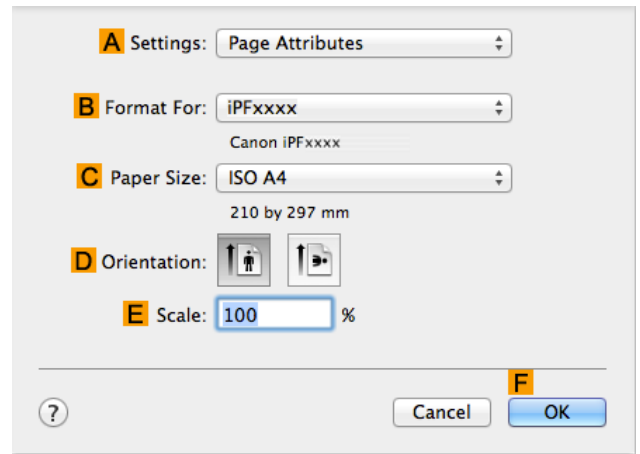

- 14** Select the **D Enlarged/Reduced Printing** check box.

- 15** Select the **H Borderless Printing** check box.
This ensures that **F Fit Roll Paper Width** is automatically selected in **D Enlarged/Reduced Printing**.

- 16** Confirm the print settings, and then click **M Print** to start printing.



Note

- For tips on confirming print settings, see "Confirming Print Settings →P.368 "

Printing banners or at other non-standard sizes

Printing Vertical or Horizontal Banners (Large-Format Printing)	114
Printing Vertical or Horizontal Banners (Large-Format Printing; Windows)	115
Printing Vertical or Horizontal Banners (Large-Format Printing; Mac OS X)	119
Printing on Non-Standard Paper Sizes	122
Printing on Non-Standard Paper Sizes (Windows)	122
Printing on Non-Standard Paper Sizes (Mac OS X)	124

Printing Vertical or Horizontal Banners (Large-Format Printing)

On this printer, large-format printing of up to 18.0 m is available using rolls.

If you use Print Plug-In for Office or PosterArtist, you can easily print maximum 18.0 m vertical or horizontal banners. (Refer to "Print Plug-In for Office features (Windows) →P.322 " and "Using PosterArtist to Compose Originals →P.52 ".) However, you may not be able to print 18.0 m due to restrictions in the settable document size according to the application software.

Fit Roll Paper Width

To match the width of vertical and horizontal banners with the width of rolls, use the printer driver function for automatically enlarging/reducing and printing.

For example, if you automatically enlarge a document created with application software such as Microsoft Word, you can print the full width of the roll easily.

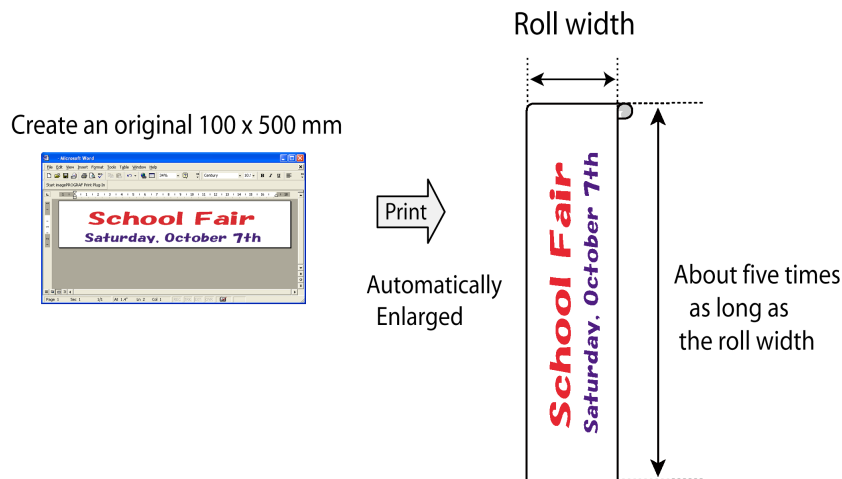

For instructions on printing vertical or horizontal banners, refer to the following topics, as appropriate for your computer and operating system.

- Printing Vertical or Horizontal Banners (Large-Format Printing; Windows) →P.115
- Printing Vertical or Horizontal Banners (Large-Format Printing; Mac OS X) →P.119



Important

- Before printing, check how much of the roll paper is left. If you have activated automatic detection of the remaining roll paper, a warning message is displayed when there is not enough roll paper left.
- If not much ink is left, prepare replacement ink tanks.
- To print at a higher level of quality, in the printer driver, choose **High** in Print Quality, and choose **Unidirectional Printing** as the direction of printing.

Printing Vertical or Horizontal Banners (Large-Format Printing; Windows)

By automatic enlargement of a document created with an application software by the printer driver, you can print maximum 18.0 m vertical or horizontal banners.

However, you may not be able to print 18.0 m due to restrictions in the settable document size according to the application software.

This topic describes how to print a banner about five times as long as the roll width based on the following example.

- Document: A horizontal banner created in Microsoft Word
- Page size: Non-standard (100×500 mm [3.9×19.7 in])
- Paper: Roll
- Paper type: **Plain Paper**
- Roll paper width: 16 in (406.4 mm)

The print procedure is as follows.

1. Register a Custom Paper Size in the printer driver.
Call a non-standard paper size registered in the printer driver with Custom Paper Size.
Once you register Custom Paper Size, you then can select it repeatedly from the paper size list.
Custom Paper Size can be set up to 18.0 m.
2. In the application, create an original in the size you registered.
3. Print the banner, using the settings that correspond to banners.

Registering a Custom Paper Size

This example describes how to register a paper size that is horizontally elongated and suitable for banners in either horizontal or vertical format.

- 1 Display the printer driver dialog box. (See "Accessing the Printer Driver Dialog Box from the Operating System Menu →P.187 ")
- 2 Click the **Page Setup** tab to display the **Page Setup** sheet.

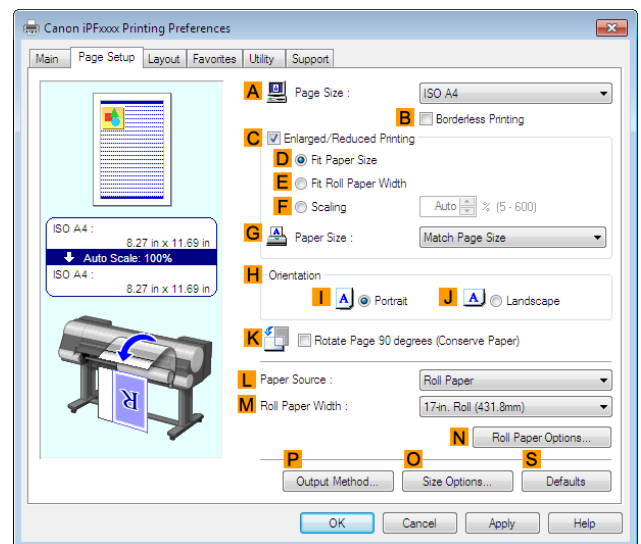

- 3 Select and click a roll paper in the **L Paper Source** list.
- 4 Click **O Size Options** to display the **Paper Size Options** dialog box.
- 5 Enter a desired paper name in **Custom Paper Size Name**. **My Horizontal Banner** is used in this example.
- 6 In **Units**, click **mm**.

7 Under **Paper Size**, enter **100** in **Width** and **500** in **Height**.

8 Click **Add** to add the paper size of **My Horizontal Banner**.

9 Click **OK** to close the **Paper Size Options** dialog box.

10 Close the printer driver dialog box.



Note

- Although you can even set **Custom Size** for the paper size, the maximum settable size is 3.2 m. The setting of **Custom Size** is disabled when you exit the application software. For more information, see "Printing on Non-Standard Paper Sizes [→P.122](#) "

Creating the banner in the application

Follow the steps below to create the banner in Microsoft Word using the Custom Paper Size you registered.

1 Start Microsoft Word.

2 Choose **Page Setup** from the **File** menu to display the **Page Setup** dialog box.

3 Under **Paper Size**, click the Custom Paper Size you registered—**My Horizontal Banner** in this example.



Important

- If **My Horizontal Banner** is not listed, make sure this printer is selected as the printer to use.
- In applications such as Microsoft PowerPoint that do not enable you to choose registered paper sizes, use the custom paper size setting in **Custom** and specify 100×500 mm (3.9×19.7 in)

4 Set the printing orientation to horizontal.

5 Create the banner.

Printing the banner

Follow these steps to print the banner using the corresponding banner settings.

1 Choose **Print** in the Microsoft Word menu.

2 Select the printer in the dialog box, and then display the printer driver dialog box. (See "Accessing the Printer Driver Dialog Box from Applications [→P.185](#) ")

- 3** Make sure the **Main** sheet is displayed.

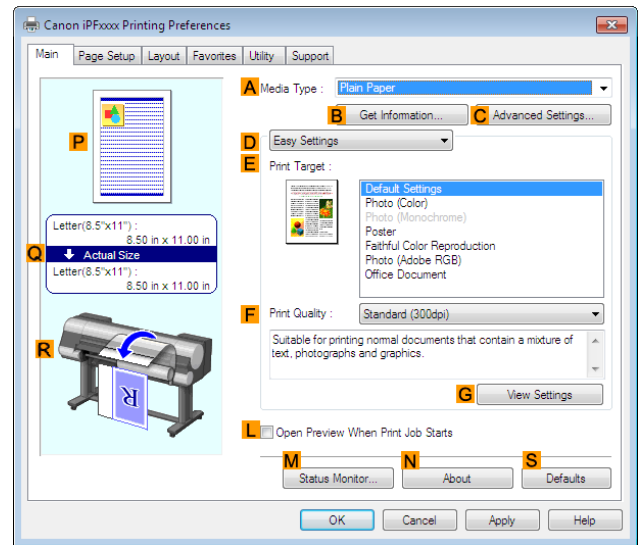

- 4** In the **A Media Type** list, select the type of paper that is loaded. In this case, click **Plain Paper**.

- 5** After confirming that **D Easy Settings** is selected, click **Poster** in the **E Print Target** list.

- 6** Click the **Page Setup** tab to display the **Page Setup** sheet.

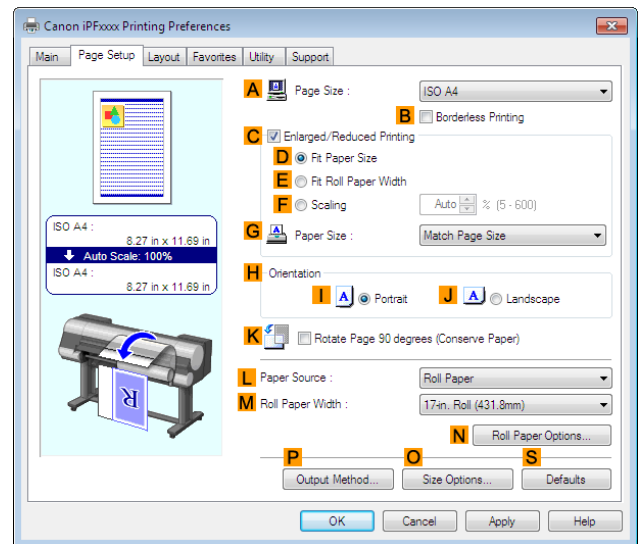

- 7** In the **A Page Size** list, click the size you registered, **My Horizontal Banner**.

8 Select the **C Enlarged/Reduced Printing** check box.



Note

- If the **C Enlarged/Reduced Printing** check box is not displayed on the **Page Setup** sheet, clear the **B Borderless Printing** check box.

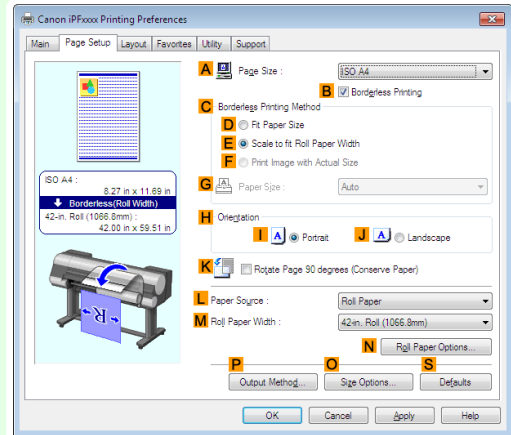

9 Select and click a roll paper in the **L Paper Source** list.

10 After you click **E Fit Roll Paper Width**, the **Information** dialog box is displayed.

11 Select the width of the loaded roll in the **Roll Paper Width** list. In this case, click **16-in. Roll (406.4mm)**, and then click **OK**.

12 Confirm the print settings and print as desired.



Note

- For tips on confirming print settings, see "Confirming Print Settings" →P.182 "

If printing is unsuccessful, you may be able to print after completing the following setting.

1 On the **Layout** sheet, click **J Special Settings** to display the **Special Settings** dialog box.

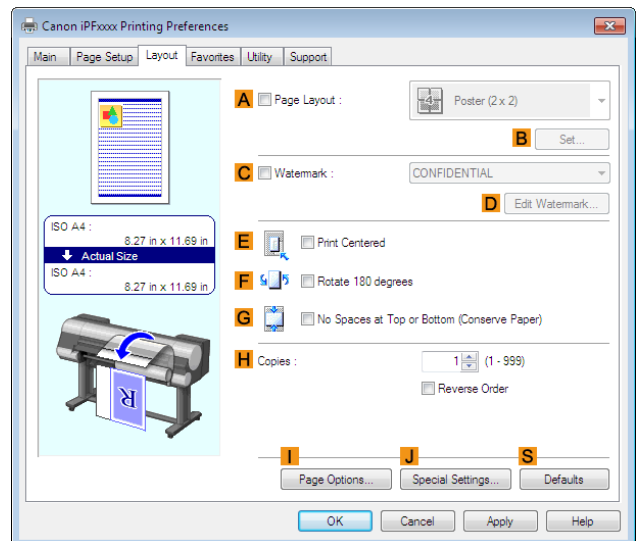

- 2** In the **FineZoom Settings** list, click **Yes**.

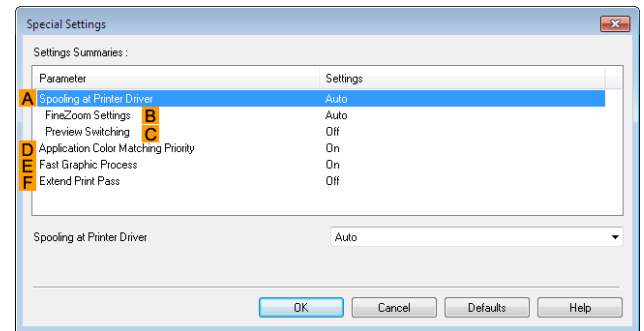

Printing Vertical or Horizontal Banners (Large-Format Printing; Mac OS X)

By automatic enlargement of a document created with an application software by the printer driver, you can print maximum 18.0 m vertical or horizontal banners.

This topic describes how to print a banner about five times as long as the roll width based on the following example.

- Document: An original designed for a horizontal banner
- Page Size: Non-standard (100×500 mm [3.9×19.7 in])
- Paper: Roll
- Paper type: **Plain Paper**
- Roll paper width: 16 inches (406.4 mm)

The print procedure is as follows.

1. In the application, create an original in the format of a horizontal or vertical banner.
2. In **Page Setup**, register **Custom Page Sizes** (Mac OS X v10.5) / **Custom Paper Sizes** (Mac OS X v10.6 or later). Once you register **Custom Page Sizes** / **Custom Paper Sizes**, you then can select it repeatedly from the paper size list. **Custom Page Sizes** / **Custom Paper Sizes** can be set up to 18.0 m.
3. Print the banner, using the settings that correspond to banners.



Note

- The following procedures are based on Mac OS X v10.5. The method of setting up non-standard paper sizes varies depending on the version of Mac OS X.

Register a Custom Page Sizes

This example describes how to register and print using a page size that is horizontally elongated and suitable for banners in either horizontal or vertical format.

- 1 Create the document in the application.
- 2 Choose **Print** in the application menu.

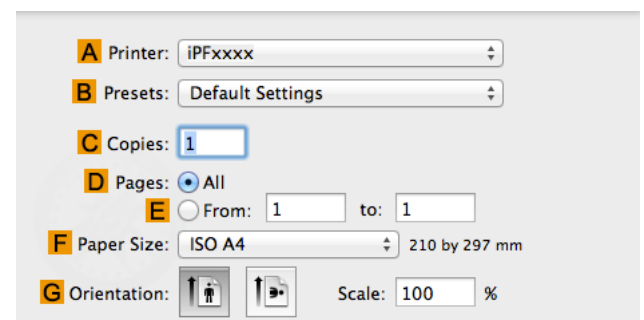

- 3** Select the printer in the **A Printer** list.
- 4** Click **Manage Custom Sizes** in the **F Paper Size** list to display the **Custom Page Sizes** dialog box.

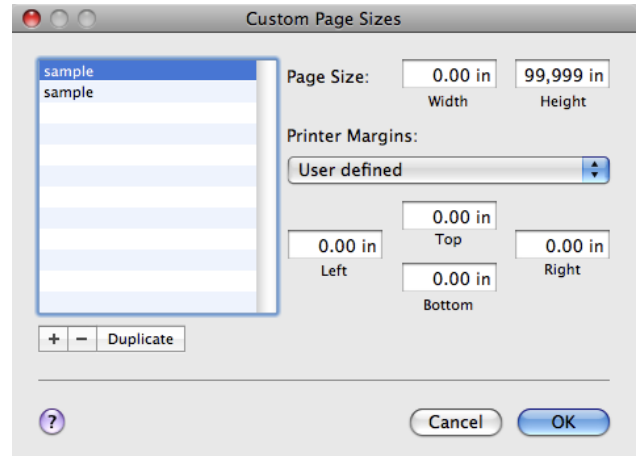

- 5** Double-click **Untitled** in the list at left, and then enter a name for the page size you want to register. Here, enter **100*500**.
If the **Untitled** size is not listed at left, click **+** below the list.
- 6** Under **Page Size**, enter **10** in **Width** and **50** in **Height**. Here, measurements are entered in centimeters.
- 7** Specify the margins by entering **0.3** in **Printer Margins**. Here, too, measurements are entered in centimeters.
- 8** Click **OK** to close the **Custom Page Sizes** dialog box.
- 9** In the **F Paper Size** list, click the size of the original. In this case, click **100*500**, the size you registered.
- 10** In **G Orientation**, click the icon of the document in landscape orientation.
- 11** Click **OK** to close the dialog box.

Print the banner

Follow the steps below to print the banner using the corresponding banner settings.

- 1** Choose **Print** in the application menu.

2 Access the **Main** pane.

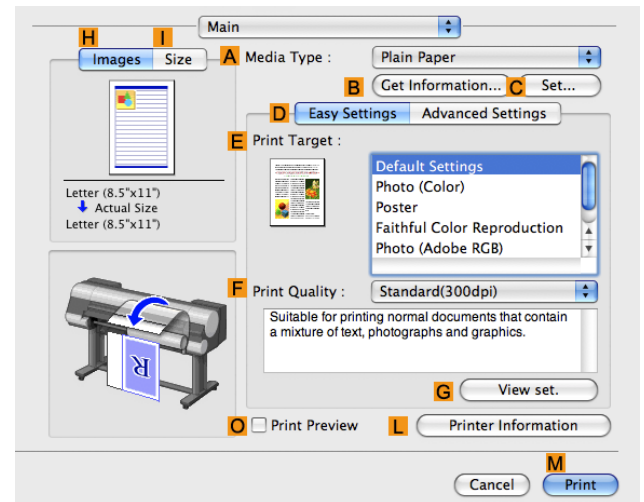

3 In the **A Media Type** list, select the type of paper that is loaded. In this case, click **Plain Paper**.

4 Make your selection in the **E Print Target** list.

5 Make your selection in the **F Print Quality** list.

6 Access the **Page Setup** pane.

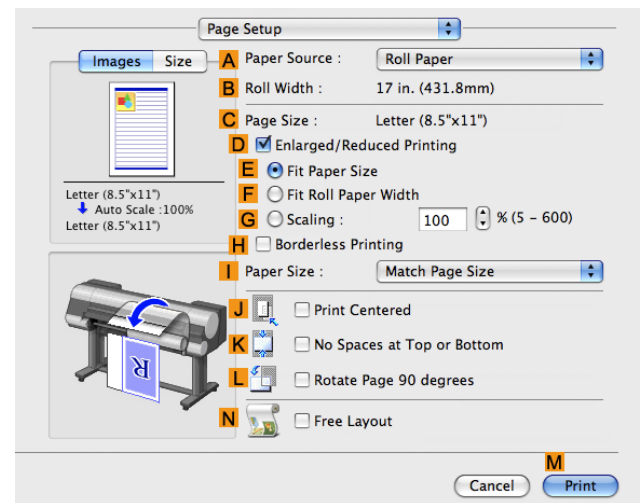

7 Select and click a roll paper in the **A Paper Source** list.

8 Make sure the width of the loaded roll is displayed in the **B Roll Width** list—in this case, **16 in. (406.4mm)**.

-  **Note** • If the width of the loaded roll is not displayed in **B Roll Width**, click **L Printer Information** on the **Main** pane and update the printer information.

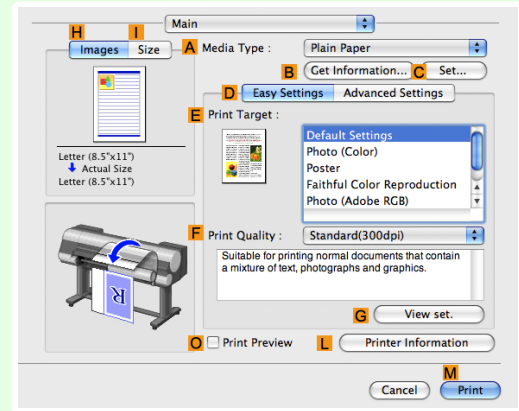

9 In **C Page Size**, make sure **100*500** is displayed, as registered in **Page Setup**.

10 Select the **D Enlarged/Reduced Printing** check box.

11 Click **F Fit Roll Paper Width**.

12 Confirm the print settings, and click **M Print** to start printing.

-  **Note** • For tips on confirming print settings, see "Confirming Print Settings →P.368 "

Printing on Non-Standard Paper Sizes

For printing on non-standard size paper, first register the paper size in the printer driver. Once you register a paper size, you then can select it repeatedly from the paper size list. The paper size can be set up to 18.0 m.

-  **Note** • In Windows, although you can even set **Custom Size** for the paper size, the maximum settable size is 3.2 m. The setting of **Custom Size** is disabled when you exit the application software.

For instructions on specifying non-standard paper sizes for printing, refer to the following topics, as appropriate for your computer and operating system.

- Printing on Non-Standard Paper Sizes (Windows) →P.122
- Printing on Non-Standard Paper Sizes (Mac OS X) →P.124

Printing on Non-Standard Paper Sizes (Windows)

For printing on non-standard size paper, first register the paper size in the printer driver. Call a non-standard paper size registered in the printer driver with Custom Paper Size. Once you register Custom Paper Size, you then can select it repeatedly from the paper size list. Custom Paper Size can be set up to 18.0 m.

-  **Note** • Although you also can set **Custom Size** for the paper size temporarily, the maximum settable size is 3.2 m. Also, the setting of **Custom Size** is disabled when you exit the application software.

Registering and Printing With a Custom Paper Size

This topic describes how to register a non-standard paper size by the name of **430 mm Square** and print based on the following example.

- Document: Any Type
- Page Size: A square sheet (430 × 430 mm [16.9 × 16.9 in])
- Paper: Sheets
- Media Type: Any type
- Paper Size: A square sheet (430 × 430 mm [16.9 × 16.9 in])

- 1 Load the square paper (430 × 430 mm [16.9 × 16.9 in]) in the printer.
- 2 Choose **Print** in the application menu.
- 3 Select the printer in the dialog box, and then display the printer driver dialog box. (See "Accessing the Printer Driver Dialog Box from Applications → P.185 ")
- 4 Make sure the **Main** sheet is displayed.

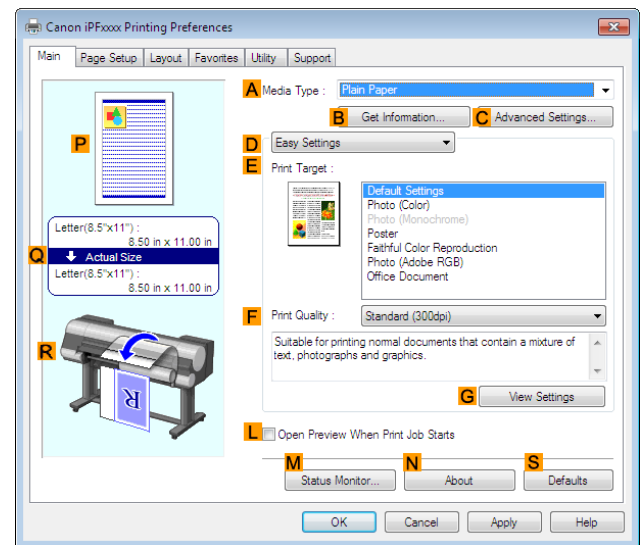

- 5 In the **A Media Type** list, select the type of paper that is loaded.
- 6 After confirming that **D Easy Settings** is selected, select from the **E Print Target** list.

7 Click the **Page Setup** tab to display the **Page Setup** sheet.

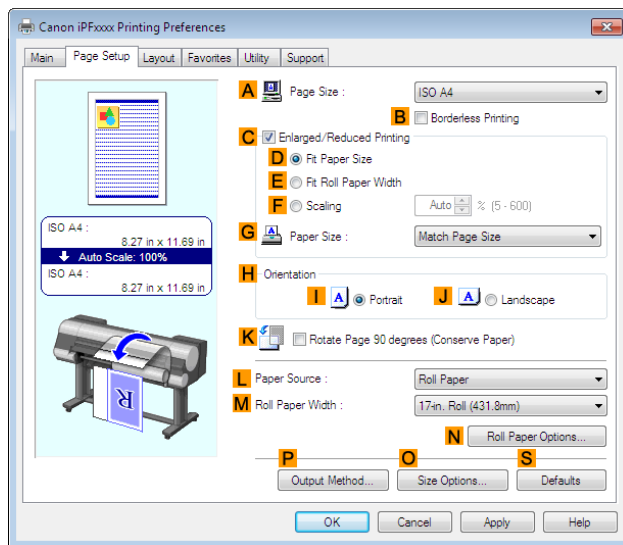

8 Click **O Size Options** to display the **Paper Size Options** dialog box.

9 Enter a desired paper name in **Custom Paper Size Name**. **430 mm Square** is used in this example.

10 Select **mm** in **Units**.

11 Enter **430** (16.9 in) in both **Width** and **Height**.

 **Note** • If you select the **Fix the Ratio of the Width to Height** check box, after you enter a value in either **Width** or **Height**, the other value will be automatically applied based on the original aspect ratio.

12 Click **Add** to register **430 mm Square**.

13 Click **OK** to close the **Paper Size Options** dialog box.

14 Click **Cut Sheet** in the **L Paper Source** list.

15 In the **A Page Size** list, click the size you added, **430 mm Square**.

16 Confirm the print settings and print as desired.

 **Note** • For tips on confirming print settings, see "Confirming Print Settings →P.182 "

Printing on Non-Standard Paper Sizes (Mac OS X)

For printing on non-standard size paper, first register the paper size in the printer driver.

Call a non-standard paper size registered in the printer driver with **Custom Page Sizes** (Mac OS X v10.5)/ **Custom Paper Sizes** (Mac OS X v10.6 or later).

Once you register **Custom Page Sizes** / **Custom Paper Sizes**, you then can select it repeatedly from the paper size list.

Custom Page Sizes / **Custom Paper Sizes** can be set up to 18.0 m.

This topic describes how to register a non-standard paper size by the name of **430*430** and print based on the following example.

- Document: Any Type
- Page Size: A square sheet (430 × 430 mm [16.9 × 16.9 in])
- Paper: Sheets
- Media Type: Any type
- Paper Size: A square sheet (430 × 430 mm [16.9 × 16.9 in])



The following procedures are based on Mac OS X v10.5. The method of setting up non-standard paper sizes varies depending on the version of Mac OS X.

- 1 Create the document in the application.
- 2 Load the square paper (430 × 430 mm [16.9 × 16.9 in]) in the printer.
- 3 Choose **Print** in the application menu.

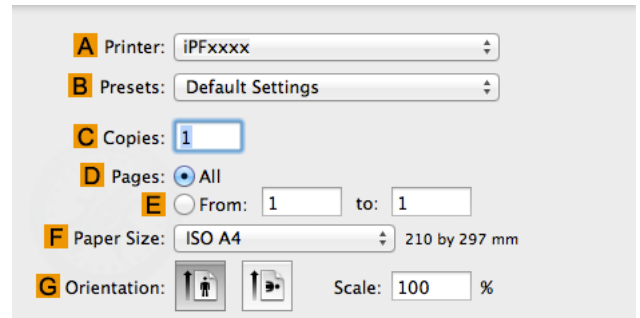

- 4 Select the printer in the **A Printer** list.
- 5 Click **Manage Custom Sizes** in the **F Paper Size** list to display the **Custom Page Sizes** dialog box.

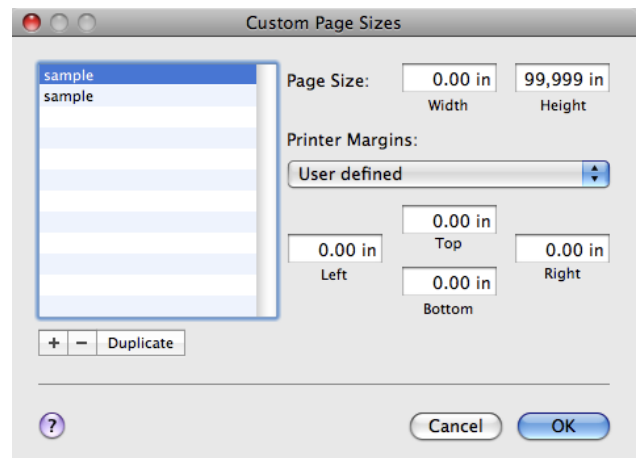

- 6 In **Page Size**, enter the height and width of the original. Here, enter **43.00 cm** in **Height** and **Width**.
- 7 In **Printer Margins**, enter **0.5** for the top and side margins and **2.3** for the bottom margin. Here, measurements are entered in centimeters.
- 8 Double-click **Untitled** in the list at left in the **Custom Page Sizes** dialog box and enter the paper name—in this case, **430*430**.
- 9 Click **OK** to close the **Custom Page Sizes** dialog box.
- 10 In the **F Paper Size** list, click the size of the original. In this case, click **430*430**, the size you registered.

11 If you configured the settings using the **Page Attributes** dialog box, click **OK** to close the dialog box, and then select **Print** from the application software menu.

12 Access the **Main** pane.

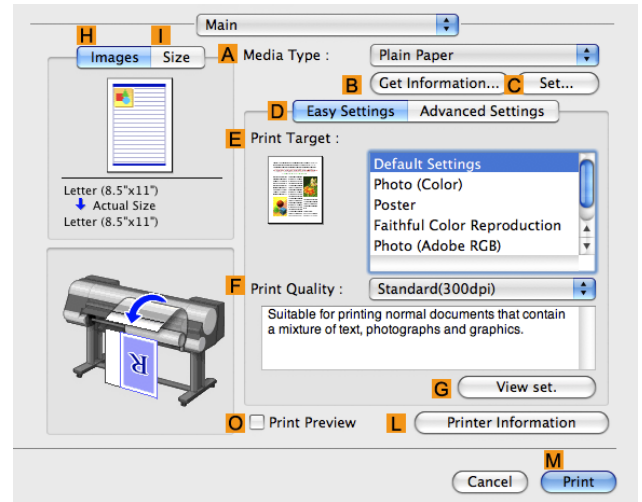

13 In the **A Media Type** list, select the type of paper that is loaded.

14 After confirming that **D Easy Settings** is selected, select from the **E Print Target** list.

15 Make your selection in the **F Print Quality** list.

16 Access the **Page Setup** pane.

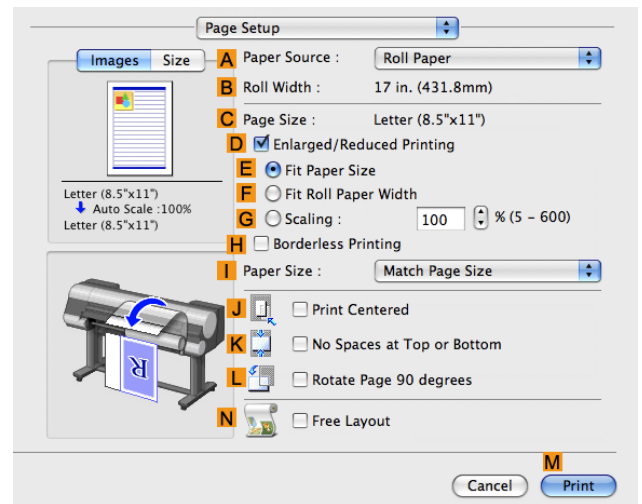

17 Click **Cut Sheet** in the **A Paper Source** list.

18 In **C Page Size**, make sure **430*430** is displayed, as registered in **Page Setup**.

19 Confirm the print settings, and then click **M Print** to start printing.



• For tips on confirming print settings, see "Confirming Print Settings →P.368 "

Note

Tiling and multiple pages per sheet

Printing Multiple Originals Next to Each Other	127
Printing Multiple Originals Next to Each Other (Windows)	128
Printing Multiple Originals Next to Each Other (Mac OS X)	130
Printing Multiple Pages Continuously	131
Printing Multiple Pages Continuously (Windows)	131
Printing Multiple Pages Continuously (Mac OS X)	133
Printing Multiple Pages Per Sheet	135
Printing Multiple Pages Per Sheet (Windows)	135
Printing Multiple Pages Per Sheet (Mac OS X)	137
Printing Posters in Sections	140
Printing Large Posters (Windows)	141

Printing Multiple Originals Next to Each Other

By arranging originals from word-processing or spreadsheet programs or web browser screen shots next to each other on single sheets, you can create highly expressive presentation materials, easy-to-understand meeting materials, and a variety of other printed documents.

- **Free Layout (Windows)**

Besides combining multiple pages in a single-page layout, you can combine originals from multiple files—even multiple source applications—in a single-page layout.

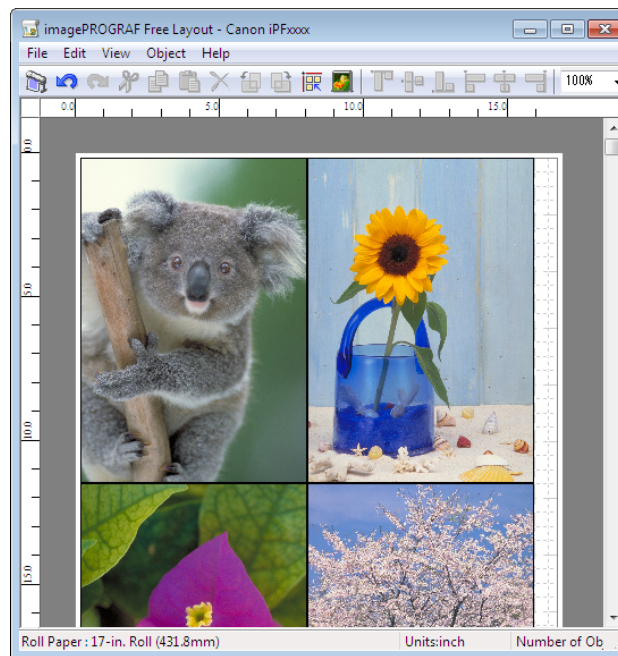

• **imagePROGRAF Free Layout (Macintosh)**

Besides combining multiple pages in a single-page layout, you can combine originals from multiple files—even multiple source applications—in a single-page layout.

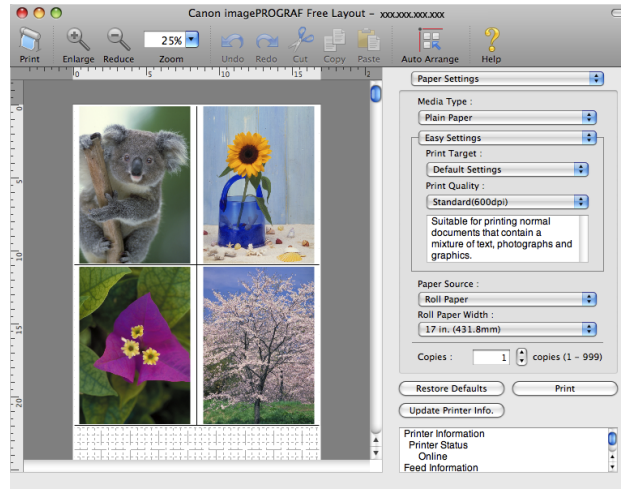

For instructions on arranging originals from multiple applications, refer to the following topics.

- Printing Multiple Originals Next to Each Other (Windows) →P.128
- Printing Multiple Originals Next to Each Other (Mac OS X) →P.130

Printing Multiple Originals Next to Each Other (Windows)

This topic describes how to arrange multiple originals using the Free Layout function.

- 1 Choose **Print** in the application menu.
- 2 Select the printer in the dialog box, and then display the printer driver dialog box.(See "Accessing the Printer Driver Dialog Box from Applications →P.185 ")
- 3 Make sure the **Main** sheet is displayed.

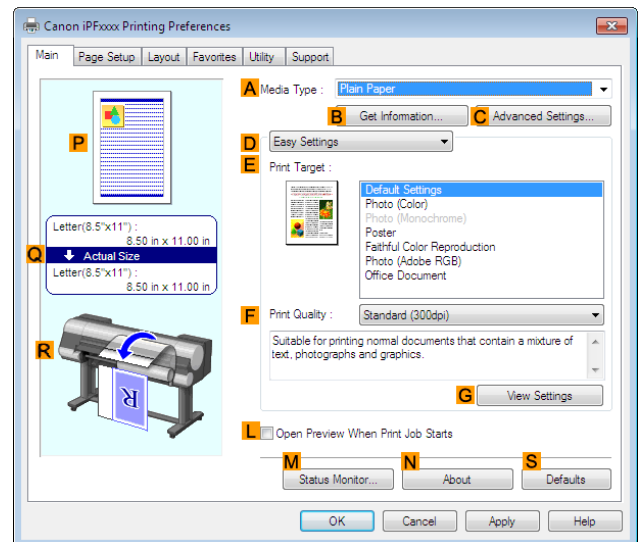

- 4** Click the **Layout** tab to display the **Layout** sheet.

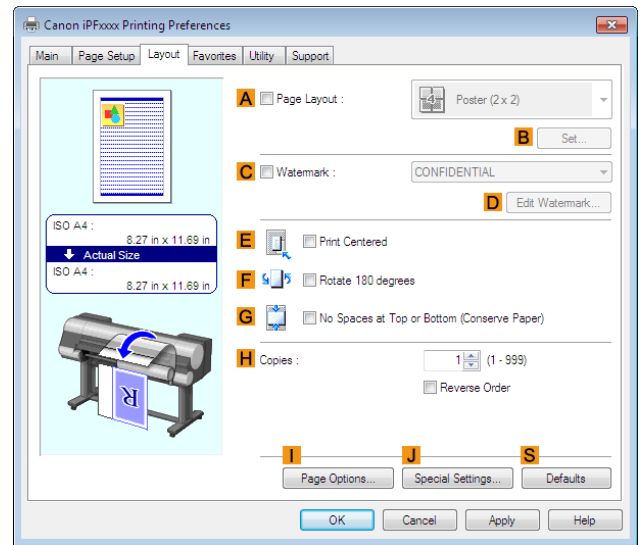

- 5** Select the **A Page Layout** check box.

- 6** Click **Free Layout** in the **A Page Layout** list.

- 7** When you attempt to print, the imagePROGRAF Free Layout window is displayed. (At this point, the document will not be printed yet.)

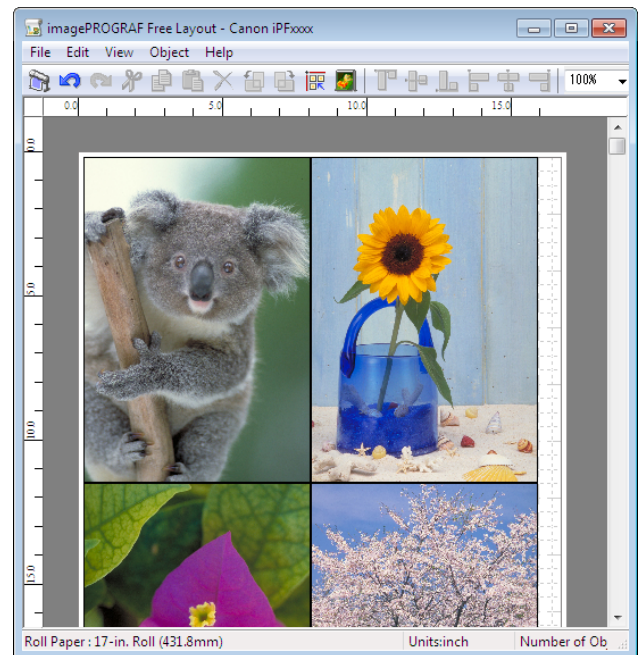

- 8** Edit and rearrange the image in the imagePROGRAF Free Layout window as desired.



Note

- Without closing the imagePROGRAF Free Layout window, repeat steps 1–7 to arrange originals from multiple applications on the same page.
- For instructions on editing and rearranging images, refer to the imagePROGRAF Free Layout help topic.

- 9** Print from the imagePROGRAF Free Layout menu.



• For details on imagePROGRAF Free Layout functions, refer to Free Layout →P.223 .

Note

Printing Multiple Originals Next to Each Other (Mac OS X)

This topic describes how to use the **Free Layout** function to arrange multiple originals next to each other before printing.

1 Choose **Print** in the application menu.

2 Access the **Page Setup** pane.

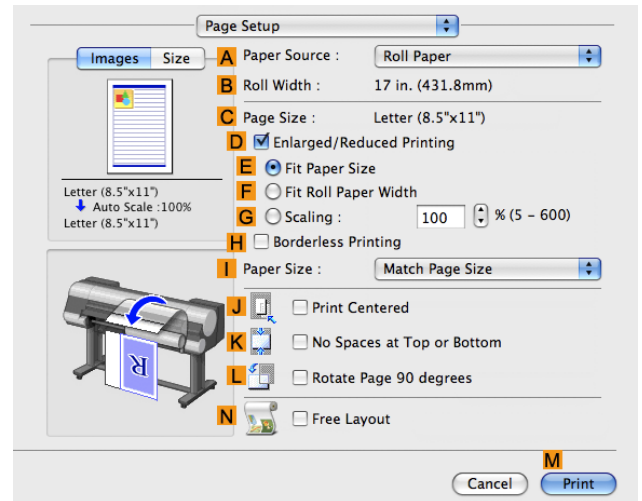

3 Select the **N Free Layout** check box.

4 Click **M Print**.

5 The **Canon imagePROGRAF Free Layout** window is displayed.

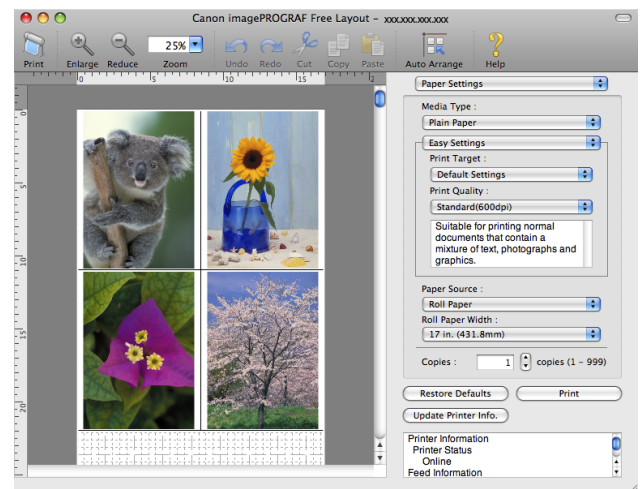

6 Edit and rearrange the image in the **Canon imagePROGRAF Free Layout** window as desired.



Note

- Without closing the **Canon imagePROGRAF Free Layout** window, repeat steps 1 to 4 to arrange originals from multiple applications on the same page.
- For instructions on editing and rearranging images, refer to the **Canon imagePROGRAF Free Layout** help topic.

7 Print from the **Canon imagePROGRAF Free Layout** menu.



Note

- For details on **Canon imagePROGRAF Free Layout** functions, refer to Free Layout [→P.417](#) .

Printing Multiple Pages Continuously

You can print multiple pages as a single continuous image, without margins between pages.

• **Banner Printing**

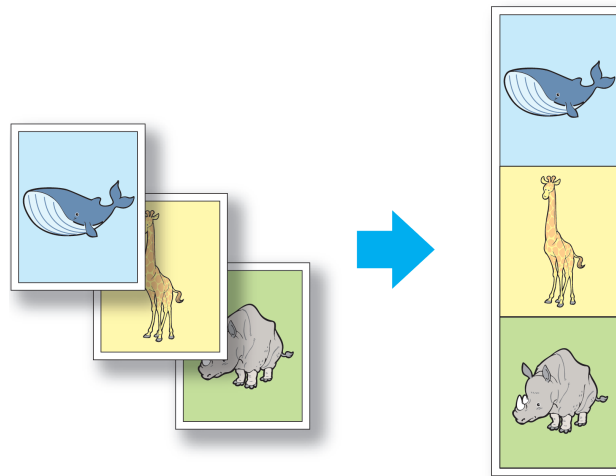

Important

- This feature is only available with rolls. It cannot be used when printing on sheets.
- During banner printing, settings for conserving paper, number of copies, borderless printing, enlargement or reduction, and other layout-related settings are disregarded.

For instructions on borderless printing of photos and images at actual size, refer to the following topics, as appropriate for your computer and operating system.

- Printing Multiple Pages Continuously (Windows) [→P.131](#)
- Printing Multiple Pages Continuously (Mac OS X) [→P.133](#)

Printing Multiple Pages Continuously (Windows)

This topic describes how to print multiple pages as a single continuous image, without margins between pages.



Important

- This feature is only available with rolls. It cannot be used when printing on sheets.
- During banner printing, settings for conserving paper, number of copies, borderless printing, enlargement or reduction, and other layout-related settings are disregarded.

1 Choose **Print** in the application menu.

2 Select the printer in the dialog box, and then display the printer driver dialog box. (See "Accessing the Printer Driver Dialog Box from Applications" [→P.185](#) ")

3 Make sure the **Main** sheet is displayed.

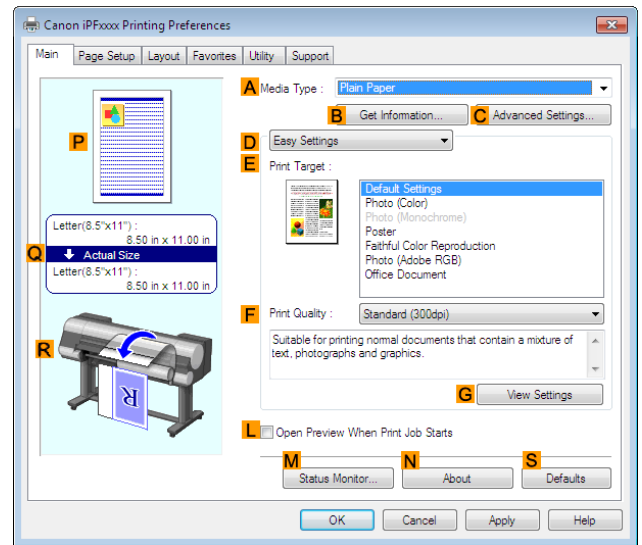

4 In the **A Media Type** list, click the type of paper that is loaded.

5 Click the **Page Setup** tab to display the **Page Setup** sheet.

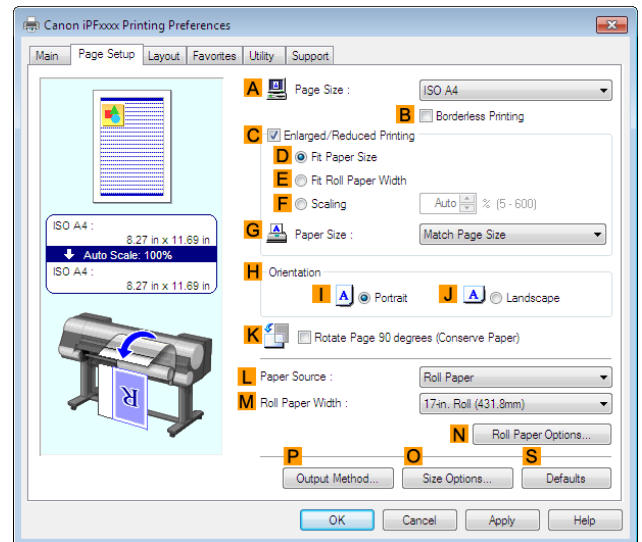

6 Select and click a roll paper in the **L Paper Source** list.

7 Click **N Roll Paper Options** to display the **Roll Paper Options** dialog box.

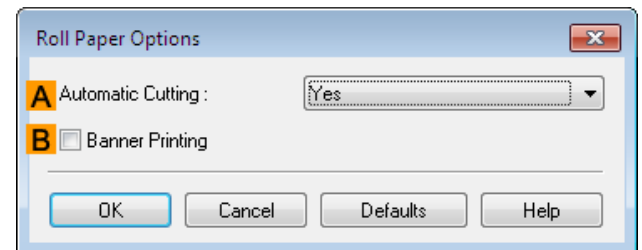

132 **8** Select the **B Banner Printing** check box.

9 Click **OK**.

10 Confirm the print settings and print as desired.



Note

- For tips on confirming print settings, see "Confirming Print Settings →P.182 "

Printing Multiple Pages Continuously (Mac OS X)

This topic describes how to print multiple pages as a single continuous image, without margins between pages.



Important

- This feature is only available with rolls. It cannot be used when printing on sheets.
- During banner printing, settings for conserving paper, number of copies, borderless printing, enlargement or reduction, and other layout-related settings are disregarded.

1 This sets the **B Format for** and **C Paper Size**.



Note

- The configuration method varies depending on the OS and application software you are using. If **Page Setup** is displayed in the application menu, the settings are configured by opening the **Page Attributes** dialog box from **Page Setup**.

If it is not displayed, the settings are configured in the upper part of the printer driver displayed when you select **Print** from the application software menu.

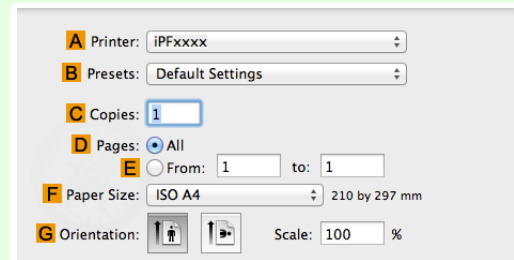
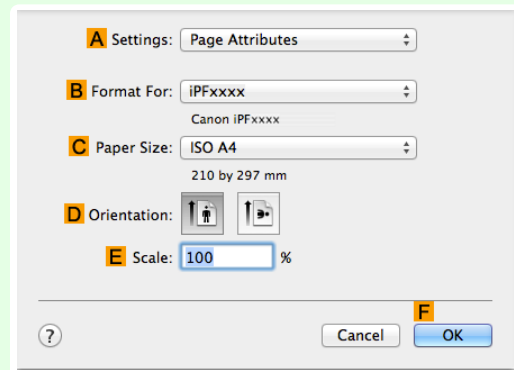

2 Select the printer in the **A Printer** list.

3 Click the original size in the **F Paper Size** list.

4 If you configured the settings using the **Page Attributes** dialog box, click **F OK** to close the dialog box, and then select **Print** from the application software menu.

5 Access the **Main** pane.

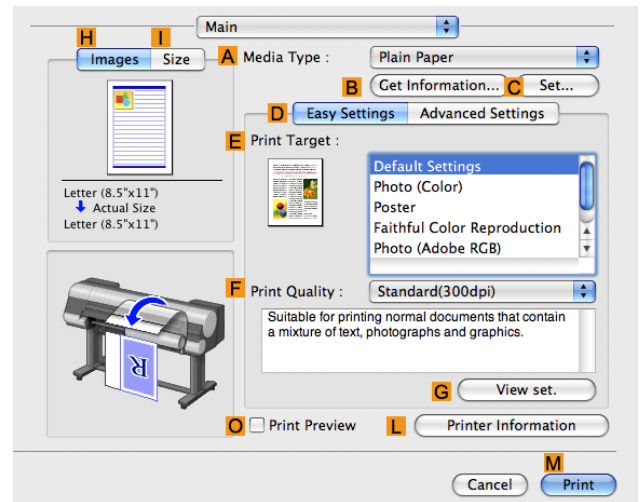

6 In the **A Media Type** list, click the type of paper that is loaded.

7 Make your selection in the **E Print Target** list.

8 Make your selection in the **F Print Quality** list.

9 Access the **Page Setup** pane.

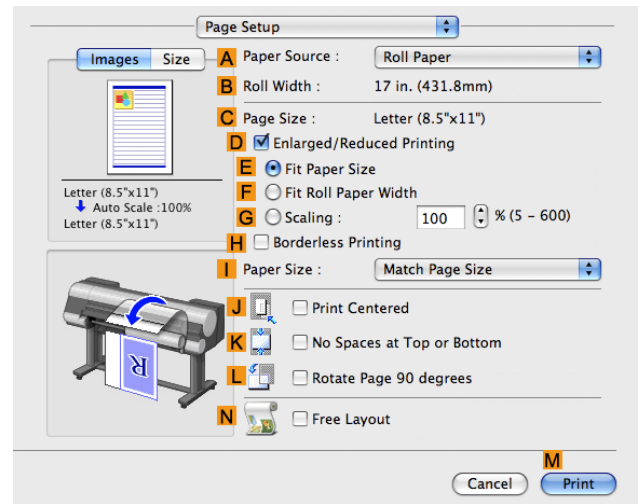

10 Click **Roll Paper (Banner)** in the **A Paper Source** list.

11 Confirm the print settings, and then click **M Print** to start printing.



• For tips on confirming print settings, see "Confirming Print Settings →P.368 "

Note

Printing Multiple Pages Per Sheet

To conserve paper, you can print several pages of the original on a single sheet by reducing the original and dividing the sheet into areas for each page.

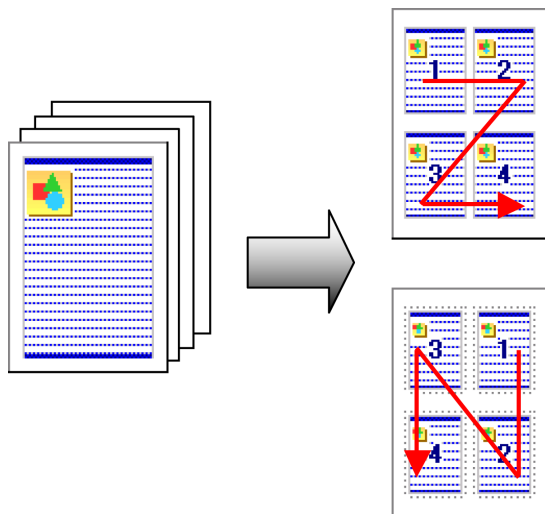

• Page Layout

Specify a number of pages of the original to print on a single sheet, in a layout of multiple pages per sheet.



Important

- This function cannot be combined with the following options.
 - Borderless Printing
 - Scaling Originals (Windows)
 - Banner Printing (Windows)
- When printing using this function, the **Print Centered** setting is disabled.



Note

- You can print up to 16 pages of the original on a single sheet.
- You can also change the page layout order and print page boundary lines, as desired.

For instructions on printing multiple pages per sheet, refer to the following topics, as appropriate for your computer and operating system.

- Printing Multiple Pages Per Sheet (Windows) →P.135
- Printing Multiple Pages Per Sheet (Mac OS X) →P.137

Printing Multiple Pages Per Sheet (Windows)

This topic describes how to print four pages of originals together on a single sheet based on the following example.

- Document: Any Type
- Page size: A3 (297.0×420.0 mm [11.7×16.5 in])
- Paper: Roll
- Paper type: **Plain Paper**
- Roll paper width: A2/A3 roll (420.0 mm [16.5 in])

1

Choose **Print** in the application menu.

2

Select the printer in the dialog box, and then open the printer driver dialog box. (See "Accessing the Printer Driver Dialog Box from Applications →P.185 ")

3 Make sure the **Main** sheet is displayed.

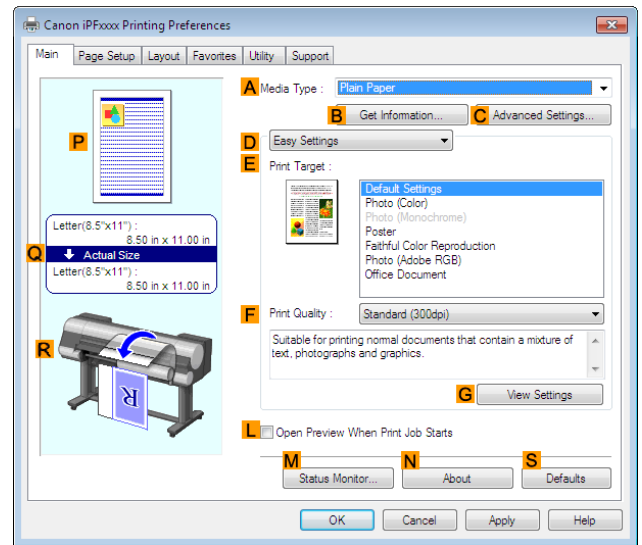

4 In the **A Media Type** list, select the type of paper that is loaded. In this case, click **Plain Paper**.

5 Make your selection in the **E Print Target** list.

6 Make your selection in the **F Print Quality** list.

7 Click the **Page Setup** tab to display the **Page Setup** sheet.

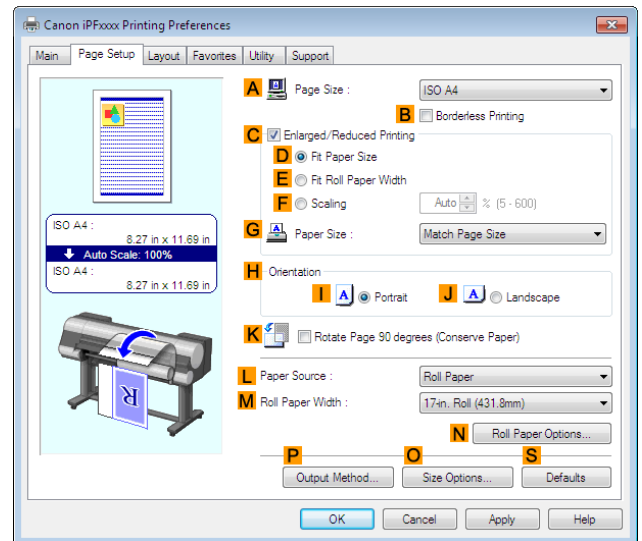

8 In **A Page Size**, click the size of the original as specified in the application software. In this case, click **ISO A3**.

9 Select and click a roll paper in the **L Paper Source** list.

10 Select the width of the loaded roll in the **M Roll Paper Width** list—in this case, **ISO A2/A3 Roll (420.0mm)**.

11 Click the **Layout** tab to display the **Layout** sheet.

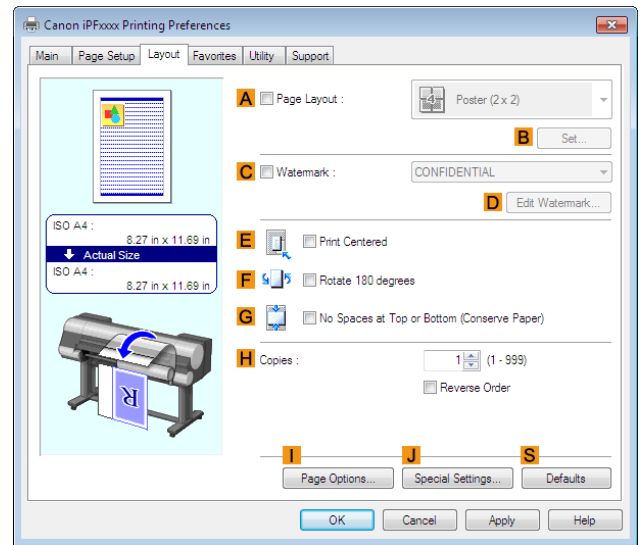

12 Select the **A Page Layout** check box.

13 Click **4 Pages/Sheet** in the **A Page Layout** list.



Note

- You can select the layout order for placing four pages on a sheet and a frame border in the **Page Layout Printing** dialog box by clicking **B Set**.

14 Confirm the print settings and print as desired.



Note

- For tips on confirming print settings, see "Confirming Print Settings" →P.182 "

Printing Multiple Pages Per Sheet (Mac OS X)

This topic describes how to print four pages of an original on a single sheet, based on the following example.

- Document: Any Type
- Page size: A3 (297.0 × 420.0 mm [11.7 × 16.5 in])
- Paper: Roll paper
- Paper type: **Plain Paper**
- Roll paper width: A2/A3 roll (420.0 mm [16.5 in])

1 This sets the **B Format for** and **C Paper Size**.



- The configuration method varies depending on the OS and application software you are using. If **Page Setup** is displayed in the application menu, the settings are configured by opening the **Page Attributes** dialog box from **Page Setup**.

If it is not displayed, the settings are configured in the upper part of the printer driver displayed when you select **Print** from the application software menu.

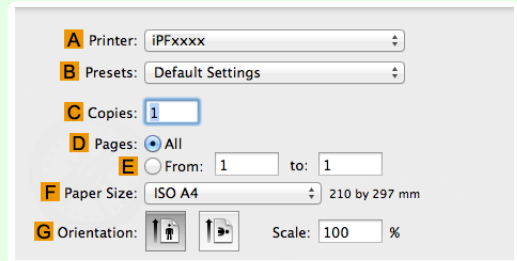
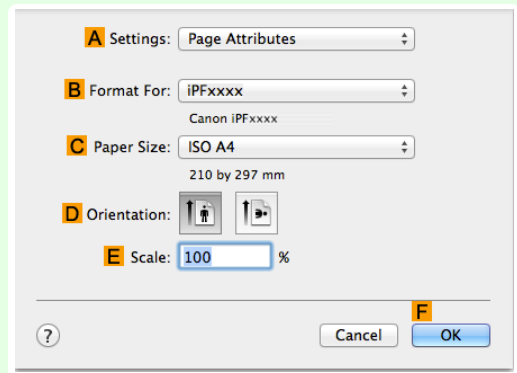

2 Select the printer in the **A Printer** list.

3 In the **F Paper Size** list, click the size of the original. In this case, click **ISO A3**.

4 If you configured the settings using the **Page Attributes** dialog box, click **F OK** to close the dialog box, and then select **Print** from the application software menu.

5 Access the **Layout** pane.

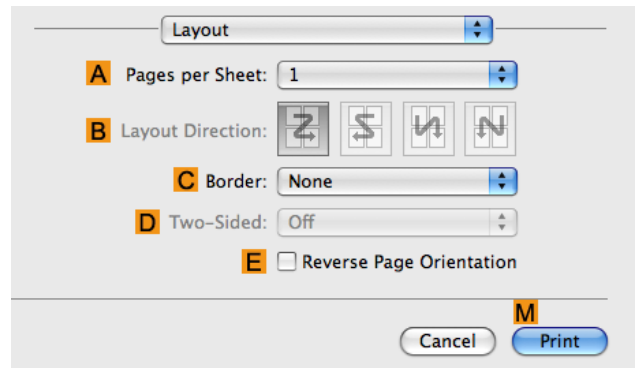

6 Click **4** in the **A Pages per Sheet** list.

7 Access the **Main** pane.

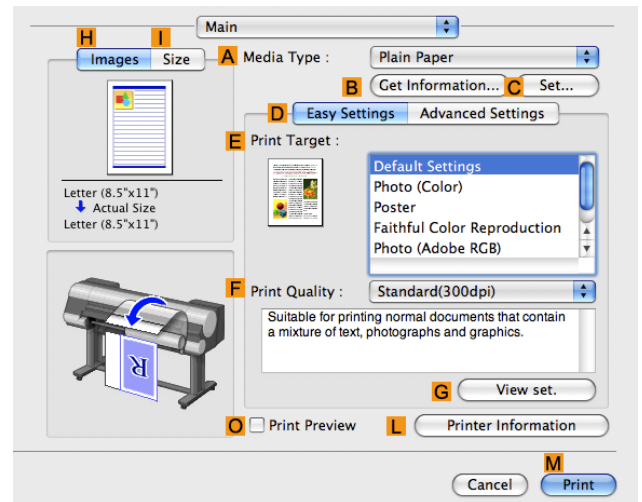

8 In the **A Media Type** list, select the type of paper that is loaded. In this case, click **Plain Paper**.

9 Make your selection in the **E Print Target** list.

10 Make your selection in the **F Print Quality** list.

11 Access the **Page Setup** pane.

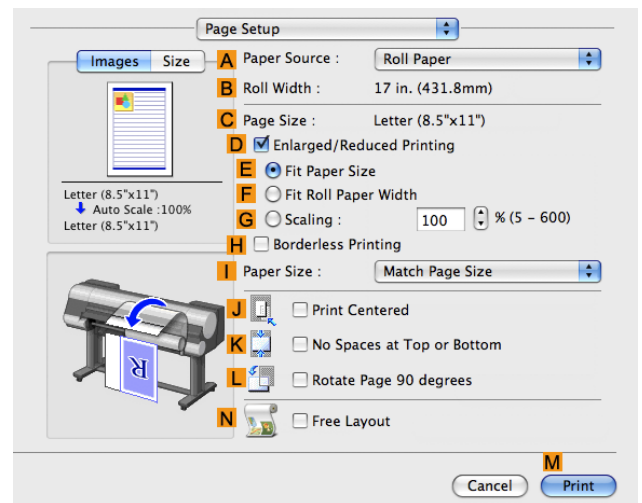

12 Select and click a roll paper in the **A Paper Source** list.

13 Make sure the width of the loaded roll is displayed in the **B Roll Width** list—in this case, **ISO A2/A3 (420.0mm)**.



- If the width of the roll loaded in the printer is not shown in **B Roll Width**, click **L Printer Information** on the **Main** pane to update the printer information.

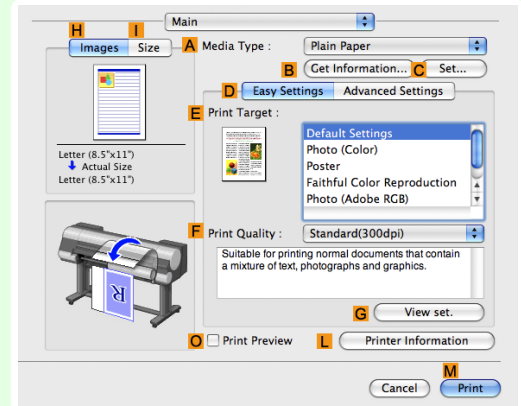

14 Make sure **C Page Size** shows the original size as specified in **C Paper Size** in the **Page Attributes** dialog box—in this case, **ISO A3**.

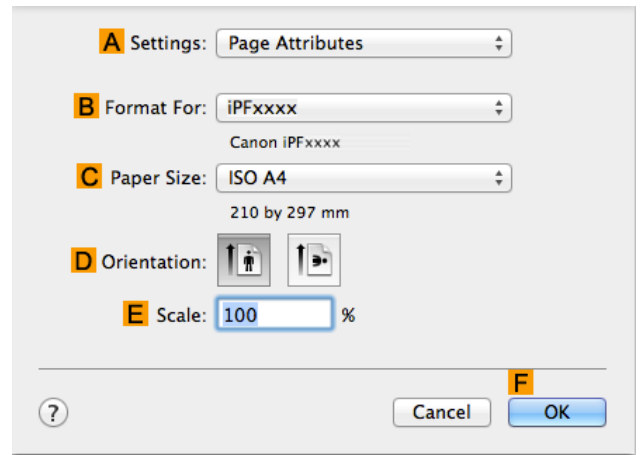

15 Confirm the print settings, and then click **M Print** to start printing.



- For tips on confirming print settings, see "Confirming Print Settings →P.368 "

Printing Posters in Sections

You can enlarge an original to print it in sections on several sheets. By assembling the printed sheets, you can create a poster larger than the maximum supported paper size of the printer.

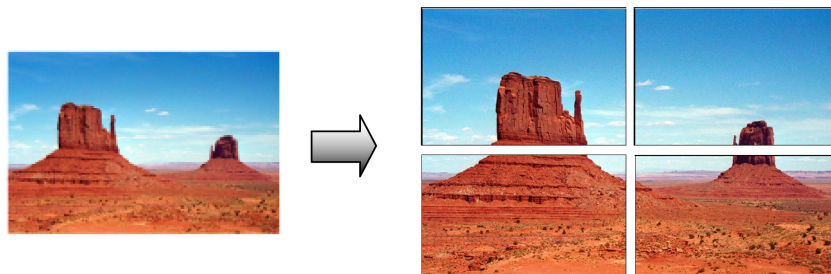

• Page Layout

Choose poster printing.



- When printing using this function, the **Print Centered**, **Watermark**, **No Spaces at Top or Bottom (Conserve Paper)**, and **Page Options** settings are disabled.

For instructions on printing large posters, refer to the following topics, as appropriate for your computer and operating system.

- Printing Large Posters (Windows) →P.141



- This method of poster printing is supported in Windows.

Printing Large Posters (Windows)

You can enlarge an original to print it in sections on several sheets. By assembling the printed sheets, you can create a poster larger than the maximum supported paper size of the printer. This topic describes how to enlarge an A2 original for printing it in sections on four sheets, based on the following example.

- Document: Poster
- Page size: A2 (420.0×594.0 mm [16.5 × 23.4 in])
- Paper: Sheets
- Paper Size: A2 (420.0 × 594.0 mm [16.5 × 23.4 in])

- 1 Choose **Print** in the application menu.
- 2 Select the printer in the dialog box, and then display the printer driver dialog box. (See "Accessing the Printer Driver Dialog Box from Applications →P.185 ")
- 3 Make sure the **Main** sheet is displayed.

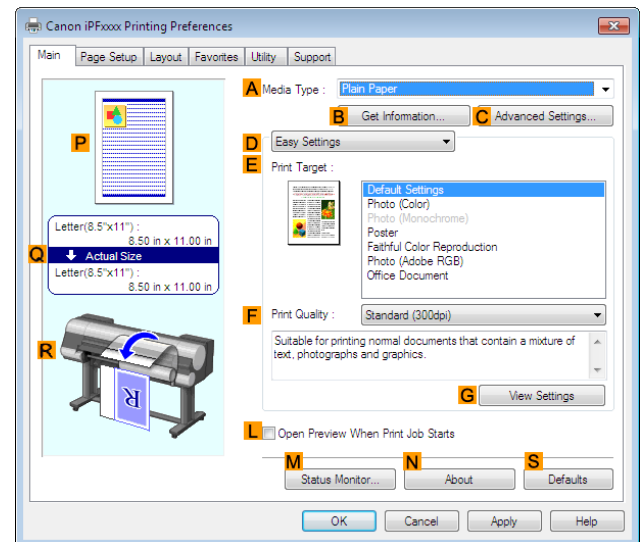

- 4 In the **A Media Type** list, select the type of paper that is loaded.
- 5 Click **Poster** in the **E Print Target** list.

6 Click the **Page Setup** tab to display the **Page Setup** sheet.

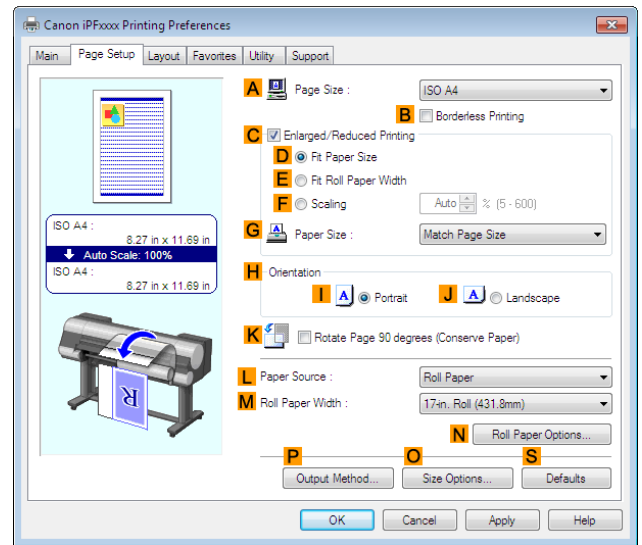

7 In **A Page Size**, click the size of the original as specified in the application. In this case, click **ISO A2**.

8 Click **Cut Sheet** in the **L Paper Source** list.

9 Click the **Layout** tab to display the **Layout** sheet.

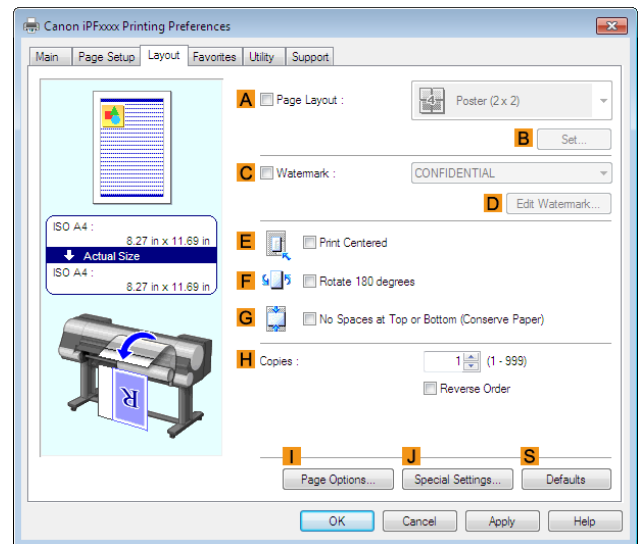

10 Select the **A Page Layout** check box.

11 Click **Poster (2 x 2)** in the **A Page Layout** list.



Note

- Follow the steps below to print only a portion of the poster as divided for printing.
- Click **B Set** under **A Page Layout** to display the **Pages to Print** dialog box.
- On the **Pages to Print** dialog box, clear the check boxes of the portion you do not want to print.
- Click **OK** to close the **Pages to Print** dialog box.

12 Confirm the print settings and print as desired.

Note

- For tips on confirming print settings, see "Confirming Print Settings [→P.182](#) "

Centering originals

Printing Originals Centered on Rolls	144
Printing Originals Centered on Rolls (Windows)	144
Printing Originals Centered on Rolls (Mac OS X)	146
Printing Originals Centered on Sheets	149
Printing Originals Centered on Sheets (Windows)	149
Printing Originals Centered on Sheets (Mac OS X)	151

Printing Originals Centered on Rolls

You can print originals centered on a page—for example, if the paper is larger than the original, or if you are reducing the original.

- **Print Centered**

If you use originals smaller than the roll paper width, you can center them relative to the width when printing.

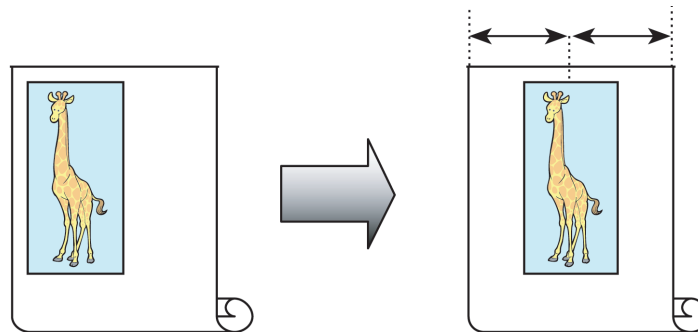

For instructions on centering originals when printing on rolls, refer to the following topics, as appropriate for your computer and operating system.

- Printing Originals Centered on Rolls (Windows) →P.144
- Printing Originals Centered on Rolls (Mac OS X) →P.146

Printing Originals Centered on Rolls (Windows)

This topic describes how to center originals before printing on rolls based on the following example.

- Document: Any type
- Page size: A4 (210.0×297.0 mm)/Letter (8.3 × 11.7 in)
- Paper: Roll
- Paper type: **Plain Paper**
- Roll width: A3/A4 roll (297.0 mm [11.7 in])

- 1 Choose **Print** in the application menu.
- 2 Select the printer in the dialog box, and then display the printer driver dialog box. (See "Accessing the Printer Driver Dialog Box from Applications" →P.185 ")

- 3** Make sure the **Main** sheet is displayed.

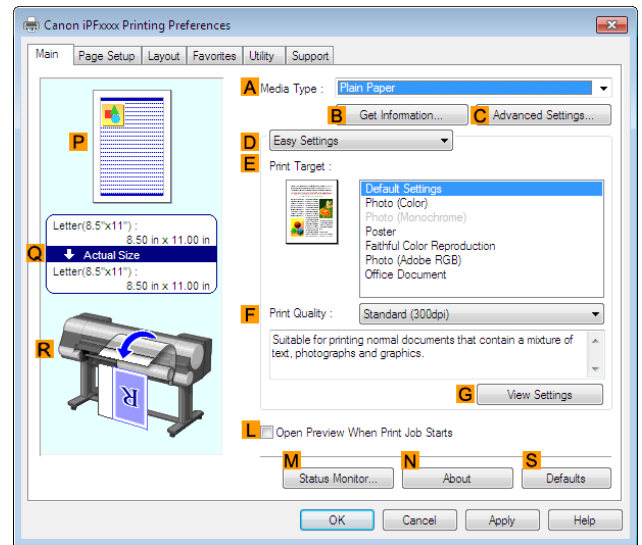

- 4** In the **A Media Type** list, select the type of paper that is loaded. In this case, click **Plain Paper**.

- 5** Select the print target in the **E Print Target** list.

- 6** Click the **Page Setup** tab to display the **Page Setup** sheet.

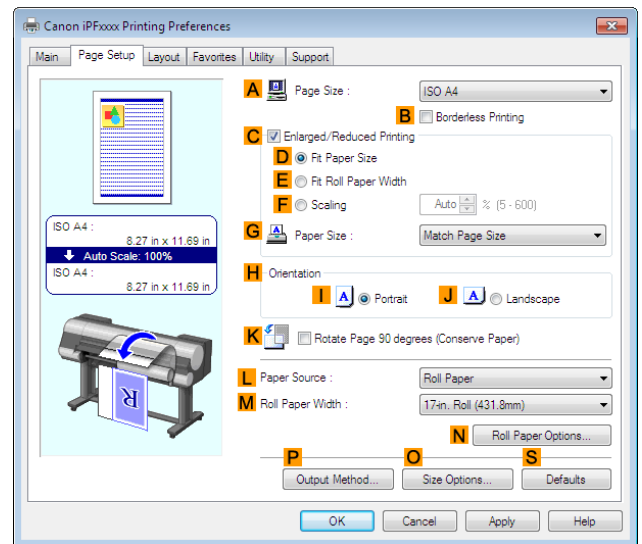

- 7** In the **A Page Size** list, click the size of the original as specified in the application. In this case, click **ISO A4** or **Letter (8.5"x11")**.

- 8** Select and click a roll paper in the **L Paper Source** list.

- 9** Select the width of the loaded roll in the **M Roll Paper Width** list—in this case, **ISO A3/A4 Roll (297.0mm)**.

10 Click the **Layout** tab to display the **Layout** sheet.

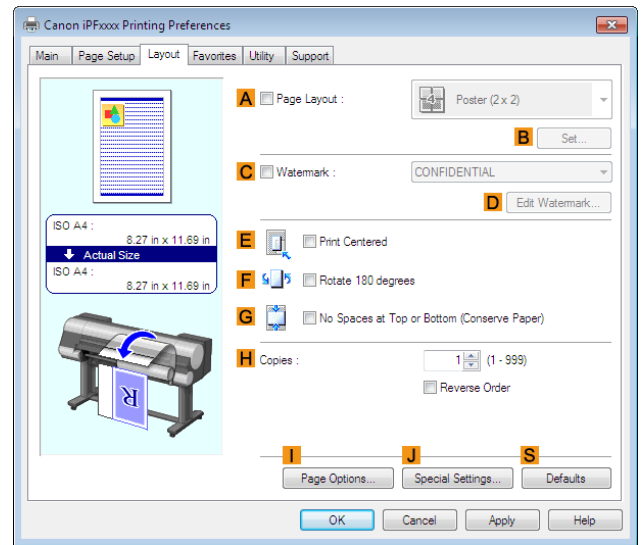

11 Select the **E Print Centered** check box.

12 Confirm the print settings and print as desired.



Note

• For tips on confirming print settings, see "Confirming Print Settings →P.182 "

Printing Originals Centered on Rolls (Mac OS X)

This topic describes how to center originals before printing on rolls based on the following example.

- Document: Any Type
- Page size: A4 (210.0 × 297.0 mm [8.3 × 11.7 in])
- Paper: Roll paper
- Paper type: **Plain Paper**
- Roll paper width: A3/A4 roll (297.0 mm [11.7 in])

1 This sets the **B Format for** and **C Paper Size**.



Note

- The configuration method varies depending on the OS and application software you are using. If **Page Setup** is displayed in the application menu, the settings are configured by opening the **Page Attributes** dialog box from **Page Setup**.

If it is not displayed, the settings are configured in the upper part of the printer driver displayed when you select **Print** from the application software menu.

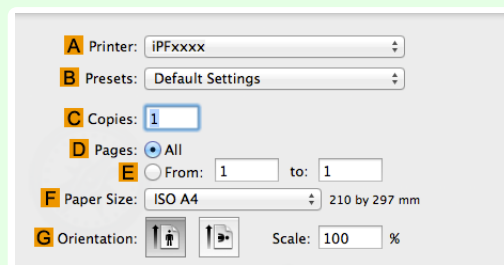
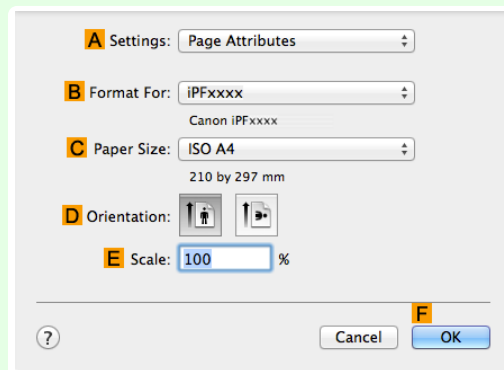

2 Select the printer in the **A Printer** list.

3 In the **F Paper Size** list, click the size of the original. In this case, click **ISO A4**.

4 If you configured the settings using the **Page Attributes** dialog box, click **F OK** to close the dialog box, and then select **Print** from the application software menu.

5 Access the **Main** pane.

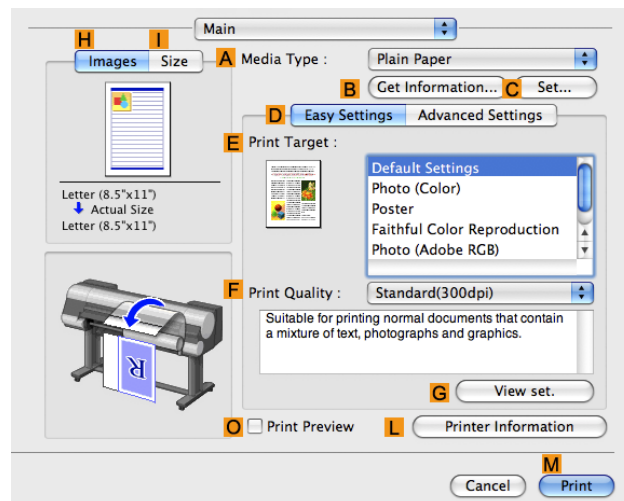

6 In the **A Media Type** list, select the type of paper that is loaded. In this case, click **Plain Paper**.

7 Make your selection in the **E Print Target** list.

8 Make your selection in the **F Print Quality** list.

9 Access the **Page Setup** pane.

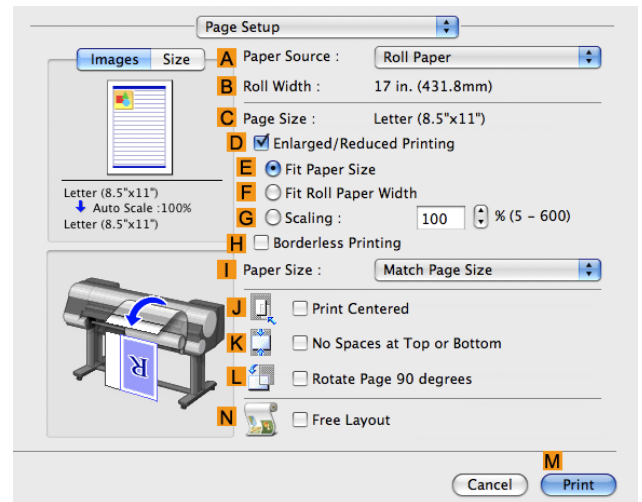

10 Select and click a roll paper in the **A Paper Source** list.

11 Make sure the width of the loaded roll is displayed in **B Roll Width**—in this case, **ISO A3/A4 (297.0mm)**.

Note • If the width of the roll loaded in the printer is not shown in **B Roll Width**, click **L Printer Information** on the **Main** pane to update the printer information.

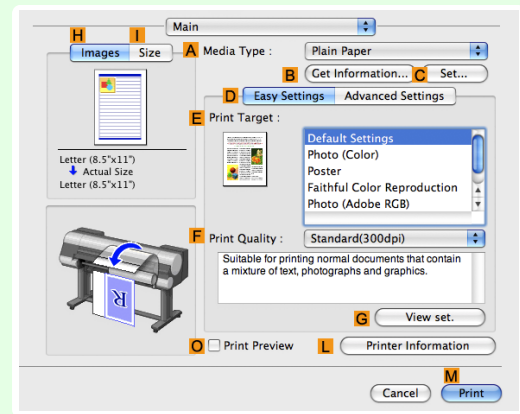

12 Make sure the **C Page Size** setting matches the original size as selected in **C Paper Size** in the **Page Attributes** dialog box—in this case, **ISO A4**.

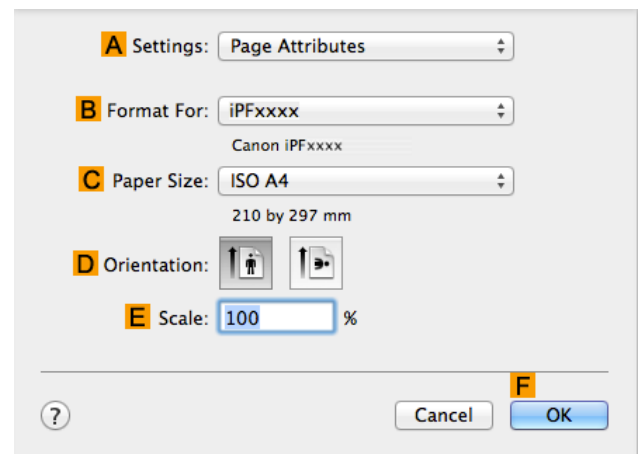

13 Select the **J Print Centered** check box.

14 Confirm the print settings, and then click **Print** to start printing.



Note

- For tips on confirming print settings, see "Confirming Print Settings →P.368 "

Printing Originals Centered on Sheets

You can print originals centered on a page—for example, if the paper is larger than the original, or if you are reducing the original.

• Print Centered

If you use paper larger than the original size or print originals after reduction, the printed images may be aligned in the upper-left corner of the paper. In this case, you can center originals on sheets when printing.

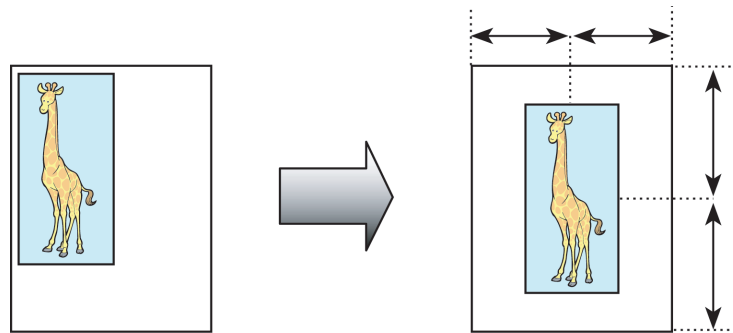

For instructions on centering originals when printing on sheets, refer to the following topics, as appropriate for your computer and operating system.

- Printing Originals Centered on Sheets (Windows) →P.149
- Printing Originals Centered on Sheets (Mac OS X) →P.151

Printing Originals Centered on Sheets (Windows)

This topic describes how to reduce an original 50% for printing centered on a sheet.

- Document: Any Type
- Page size: A4 (210.0 × 297.0 mm [8.3 × 11.7 in])
- Paper: Sheets
- Paper type: **Plain Paper**
- Paper size: A4 (210.0 × 297.0 mm [8.3 × 11.7 in])

1 Choose **Print** in the application menu.

2 Select the printer in the dialog box, and then display the printer driver dialog box. (See "Accessing the Printer Driver Dialog Box from Applications →P.185 ")

3 Make sure the **Main** sheet is displayed.

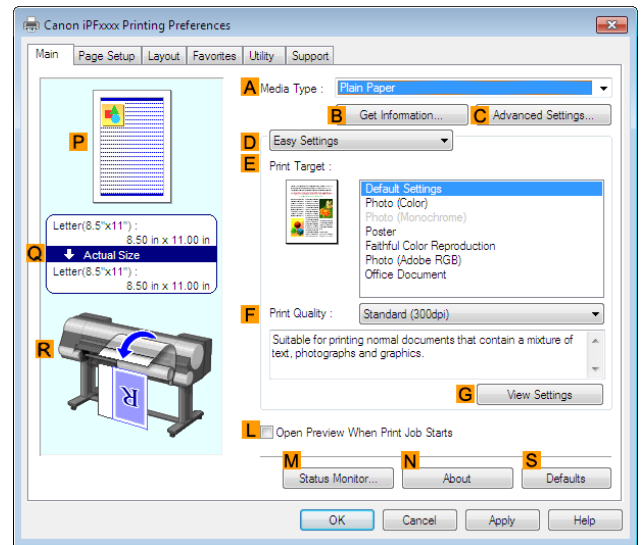

4 In the **A Media Type** list, select the type of paper that is loaded. In this case, click **Plain Paper**.

5 Make your selection in the **E Print Target** list.

6 Click the **Page Setup** tab to display the **Page Setup** sheet.

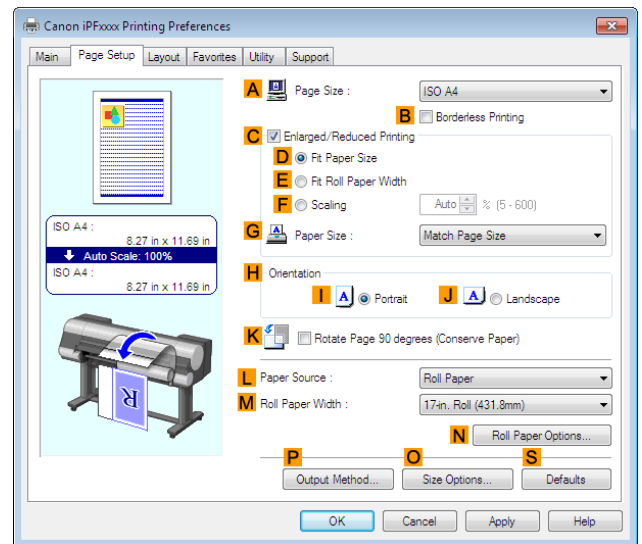

7 In the **A Page Size** list, click the size of the original as specified in the application. In this case, click **ISO A4**.

8 Select the **C Enlarged/Reduced Printing** check box.

9 Click **Match Page Size** in the **G Paper Size** list.

10 Click **F Scaling** and enter **50**.

11 Click **Cut Sheet** in the **L Paper Source** list.

12 Click the **Layout** tab to display the **Layout** sheet.

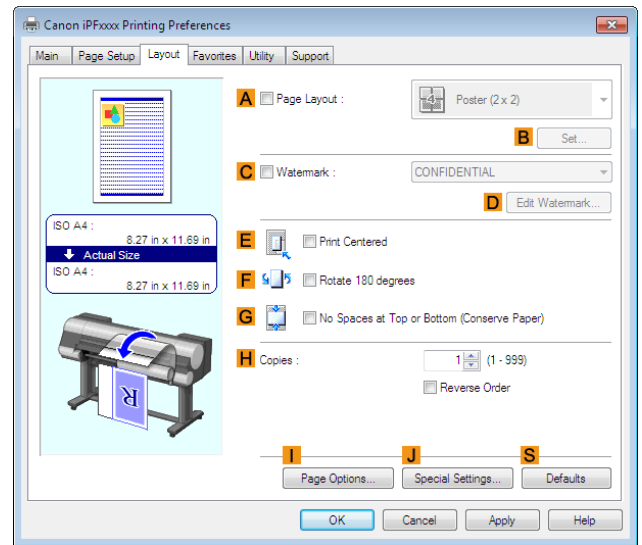

13 Select the **E Print Centered** check box.

14 Confirm the print settings and print as desired.



Important

- If you have selected **Cut Sheet** as the paper source, follow the instructions on the printer control panel to enter the paper size.



Note

- For tips on confirming print settings, see "Confirming Print Settings →P.182 "

Printing Originals Centered on Sheets (Mac OS X)

This topic describes how to center originals for printing on sheets, based on the following example.

- Document: Any Type
- Page size: A4
- Paper: Sheets
- Paper type: **Plain Paper**
- Paper size: Non-standard

1 This sets the **B Format for** and **C Paper Size**.



- The configuration method varies depending on the OS and application software you are using. If **Page Setup** is displayed in the application menu, the settings are configured by opening the **Page Attributes** dialog box from **Page Setup**.

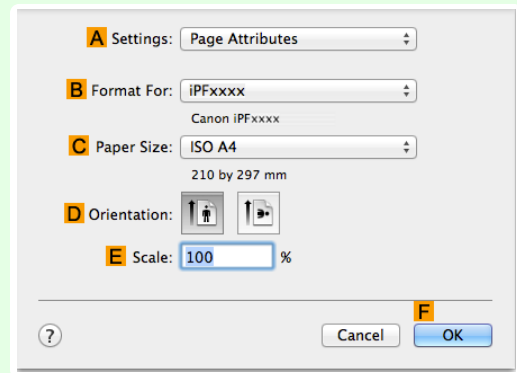

If it is not displayed, the settings are configured in the upper part of the printer driver displayed when you select **Print** from the application software menu.

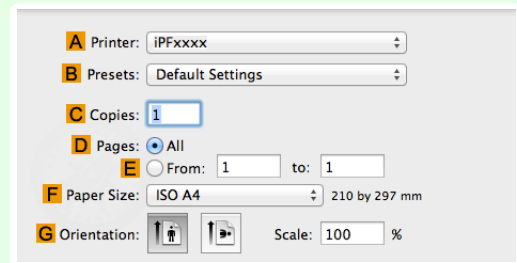

2 Select the printer in the **A Printer** list.

3 In the **F Paper Size** list, click the size of the original. In this case, click **ISO A4 - Cut Sheet**.

4 If you configured the settings using the **Page Attributes** dialog box, click **F OK** to close the dialog box, and then select **Print** from the application software menu.

5 Access the **Main** pane.

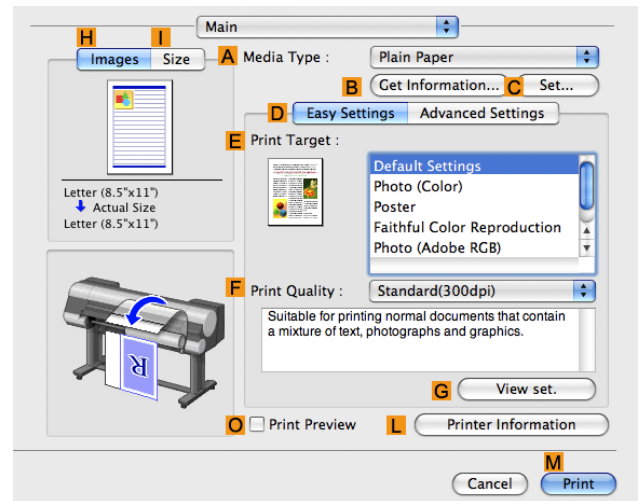

6 In the **A Media Type** list, select the type of paper that is loaded. In this case, click **Plain Paper**.

7 Make your selection in the **E Print Target** list.

8 Make your selection in the **F Print Quality** list.

9 Access the **Page Setup** pane.

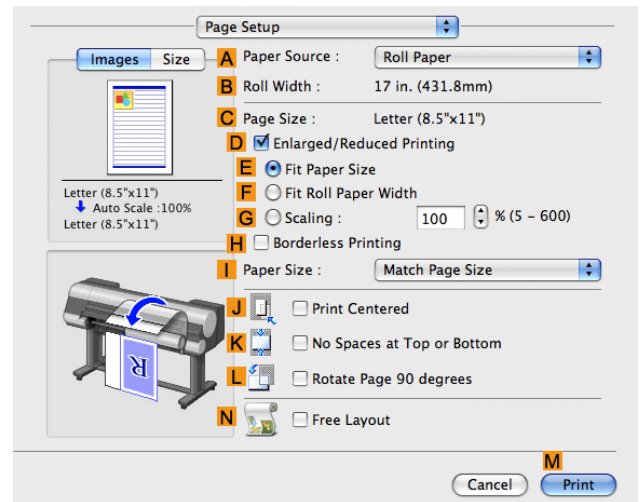

10 Click **Cut Sheet** in the **A Paper Source** list.

11 Make sure the **C Page Size** setting matches the original size as selected in **C Paper Size** in the **Page Attributes** dialog box—in this case, **ISO A4 - Cut Sheet**.

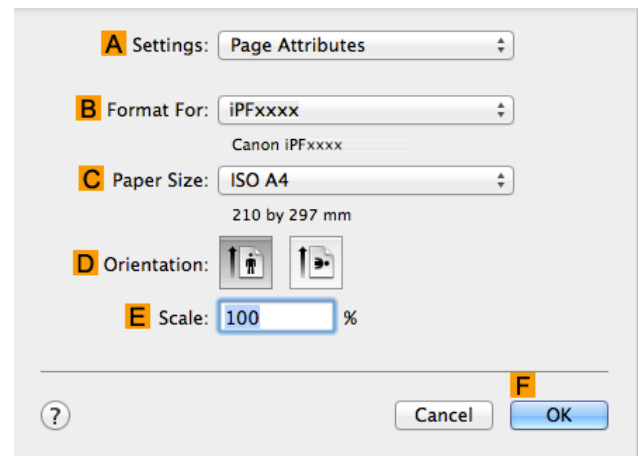

12 Select the **J Print Centered** check box.

13 Confirm the print settings, and then click **M Print** to start printing.



Note

- For tips on confirming print settings, see "Confirming Print Settings →P.368 "



Important

- If you have selected **Cut Sheet** as the paper source, follow the instructions on the printer control panel to enter the paper size.

Conserving roll paper

Conserving Roll Paper by Rotating Originals 90 Degrees	154
Conserving Roll Paper by Rotating Originals 90 Degrees (Windows)	154
Conserving Roll Paper by Rotating Originals 90 Degrees (Mac OS X)	156
Conserving Roll Paper by Printing Originals Without Top and Bottom Margins	158
Conserving Roll Paper by Printing Originals Without Top and Bottom Margins (Windows)	159
Conserving Roll Paper by Printing Originals Without Top and Bottom Margins (Mac OS X)	160

Conserving Roll Paper by Rotating Originals 90 Degrees

You can conserve roll paper by specifying particular settings as suitable for your original.

- **Rotate Page 90 degrees (Conserve Paper)**

When originals are printed in portrait orientation, the original is rotated 90 degrees before printing if it fits within the roll width. This enables you to conserve paper.

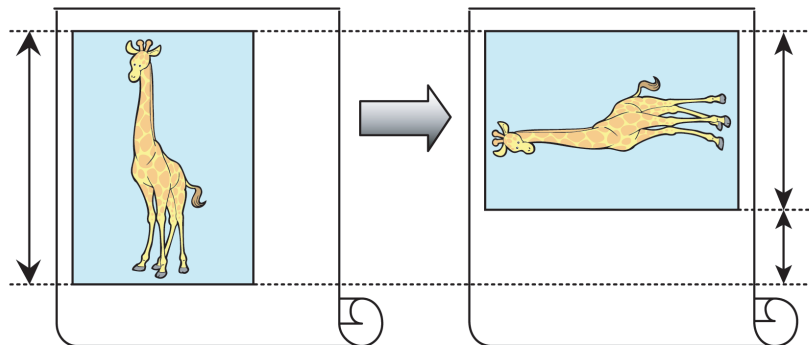

• If the page would exceed the roll paper width after rotation, use this function with Scale to fit Roll Paper Width to print rotated pages.

For tips on conserving roll paper, refer to the following topics, as appropriate for your computer and operating system.

- Conserving Roll Paper by Rotating Originals 90 Degrees (Windows) →P.154
- Conserving Roll Paper by Rotating Originals 90 Degrees (Mac OS X) →P.156

Conserving Roll Paper by Rotating Originals 90 Degrees (Windows)

This topic describes how to conserve paper by rotating originals 90 degrees before printing, based on the following example.

- Document: Any type
- Page size: A4 (210.0×297.0 mm)/Letter (8.3×11.7 in)
- Paper: Roll
- Paper type: **Plain Paper**
- Roll paper width: A3/A4 roll (297.0 mm [11.7 in])

This example illustrates how to rotate an A4 (210.0×297.0 mm)/Letter (8.3×11.7 in) original in portrait orientation 90 degrees to fit within the width of A3/A4 roll paper (297.0 mm [11.7 in]), which enables you to conserve paper.

1 Choose **Print** in the application menu.

2 Select the printer in the dialog box, and then open the printer driver dialog box.(See "Accessing the Printer Driver Dialog Box from Applications →P.185 ")

- 3** Make sure the **Main** sheet is displayed.

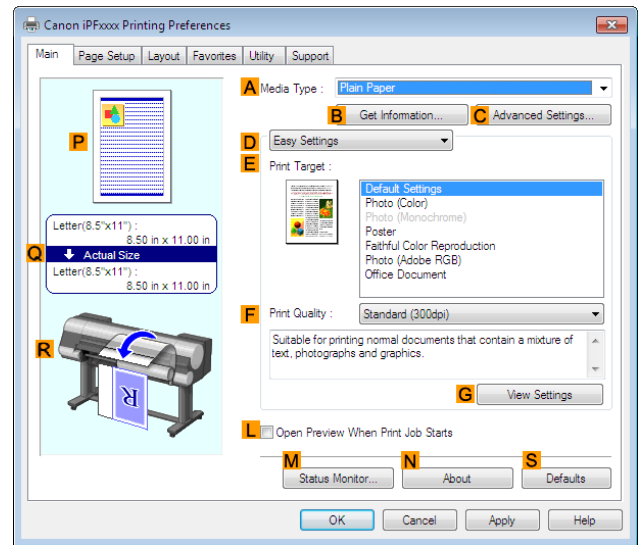

- 4** In the **A Media Type** list, select the type of paper that is loaded. In this case, click **Plain Paper**.

- 5** Click the **Page Setup** tab to display the **Page Setup** sheet.

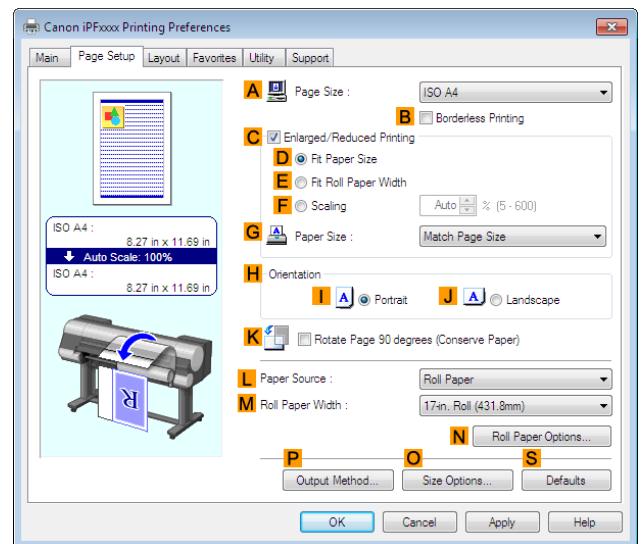

- 6** In the **A Page Size** list, click the size of the original as specified in the application. In this case, click **ISO A4** or **Letter (8.5"x11")**.

- 7** Select and click a roll paper in the **L Paper Source** list.

- 8** Select the width of the loaded roll in the **M Roll Paper Width** list—in this case, **ISO A3/A4 Roll (297.0mm)**.

- 9** Select the **K Rotate Page 90 degrees (Conserve Paper)** check box.

- 10** Confirm the print settings and print as desired.



• For tips on confirming print settings, see "Confirming Print Settings →P.182 "

Note

Conserving Roll Paper by Rotating Originals 90 Degrees (Mac OS X)

This topic describes how to conserve roll paper by rotating originals 90 degrees before printing, based on the following example.

- Document: Any Type
- Page size: A4 (210.0 × 297.0 mm [8.3 × 11.7 in])
- Paper: Roll paper
- Paper type: **Plain Paper**
- Roll paper width: A3/A4 roll (297.0 mm [11.7 in])

This example illustrates how to rotate an A4 (210.0×297.0 mm)/Letter (8.3 × 11.7 in) original in portrait orientation 90 degrees to fit within the width of A3/A4 roll (297.0 mm [11.7 in]), which enables you to conserve paper.

1 This sets the **B Format for** and **C Paper Size**.



Note

- The configuration method varies depending on the OS and application software you are using. If **Page Setup** is displayed in the application menu, the settings are configured by opening the **Page Attributes** dialog box from **Page Setup**.

If it is not displayed, the settings are configured in the upper part of the printer driver displayed when you select **Print** from the application software menu.

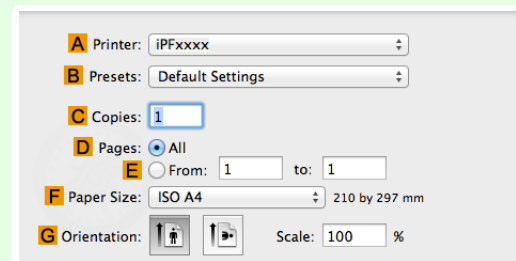
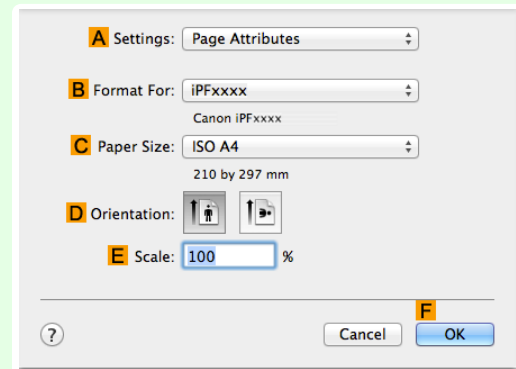

2 Select the printer in the **A Printer** list.

3 In the **F Paper Size** list, click the size of the original. In this case, click **ISO A4**.

4 If you configured the settings using the **Page Attributes** dialog box, click **F OK** to close the dialog box, and then select **Print** from the application software menu.

5 Access the **Main** pane.

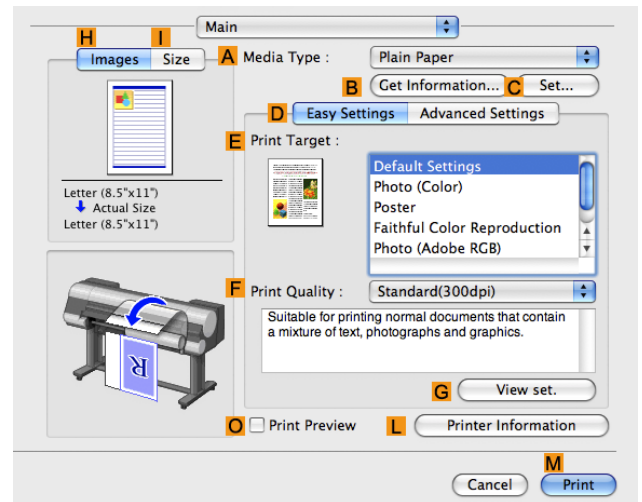

6 In the **A Media Type** list, select the type of paper that is loaded. In this case, click **Plain Paper**.

7 Access the **Page Setup** pane.

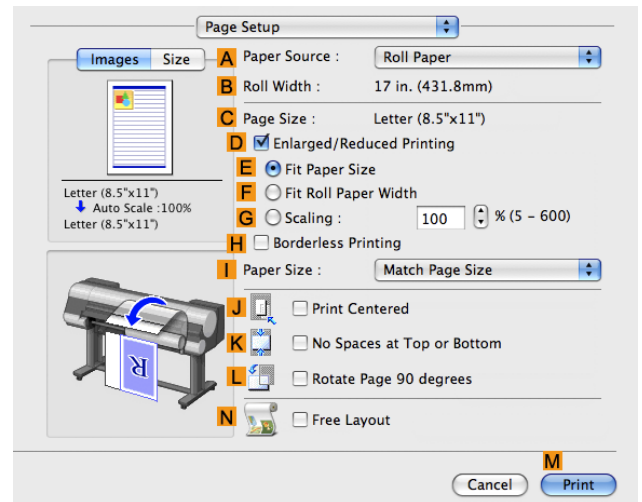

8 Select and click a roll paper in the **A Paper Source** list.

9 Make sure the width of the loaded roll is displayed in **B Roll Width** —in this case, **ISO A3/A4 (297.0mm)**.



Note

- If the width of the roll loaded in the printer is not shown in **B Roll Width**, click **L Printer Information** on the **Main** pane to update the printer information.

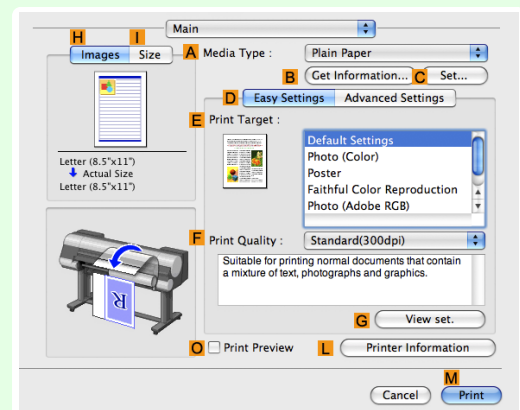

10 Make sure the **C Page Size** setting matches the original size as selected in **C Paper Size** in the **Page Attributes** dialog box—in this case, **ISO A4**.

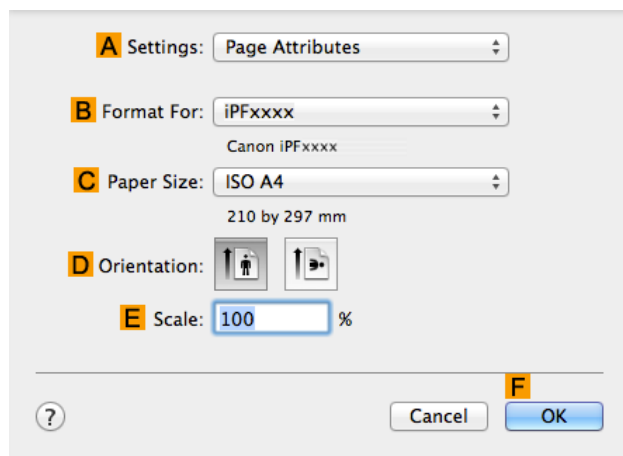

11 Select the **L Rotate Page 90 degrees** check box.

12 Confirm the print settings, and then click **M Print** to start printing.



Note

- For tips on confirming print settings, see "Confirming Print Settings" →P.368 "

Conserving Roll Paper by Printing Originals Without Top and Bottom Margins

You can conserve roll paper by specifying particular settings as suitable for your original.

• No Spaces at Top or Bottom (Conserve Paper)

You can print without feeding the paper for blank portions of originals if there are top and bottom margins in originals. This enables you to conserve as much paper as the size of the margins.

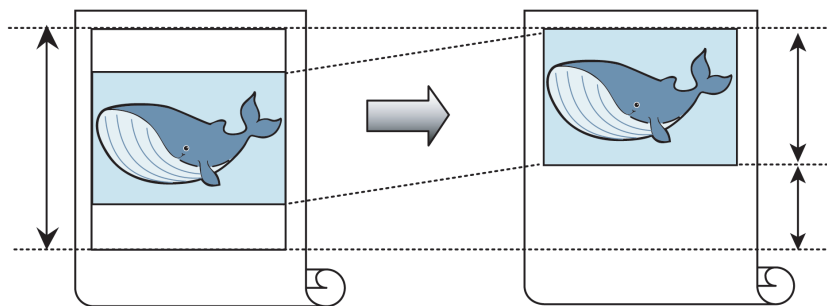

Important

- Printing without the top and bottom margins is not supported in the following cases.
 - Banner printing
 - If you have chosen poster as the type of page layout



Note

- Even during borderless printing, you can print without the top and bottom margins.
- Printing without the top and bottom margins may cause inconsistency in the size of printed documents, depending on the layout of images or text in your originals.

For tips on conserving roll paper, refer to the following topics, as appropriate for your computer and operating system.

- Conserving Roll Paper by Printing Originals Without Top and Bottom Margins (Windows) →P.159
- Conserving Roll Paper by Printing Originals Without Top and Bottom Margins (Mac OS X) →P.160

Conserving Roll Paper by Printing Originals Without Top and Bottom Margins (Windows)

This topic describes how to conserve roll paper when printing originals that have a top and bottom margin, based on the following example.

- Document: Any type
- Page size: A4 (210.0×297.0mm)/Letter (8.3 × 11.7 in)
- Paper: Roll
- Paper type: **Plain Paper**
- Roll paper width: A3/A4 roll (297.0 mm [11.7 in])

1 Choose **Print** in the application menu.

2 Select the printer in the dialog box, and then display the printer driver dialog box. (See "Accessing the Printer Driver Dialog Box from Applications →P.185")

3 Make sure the **Main** sheet is displayed.

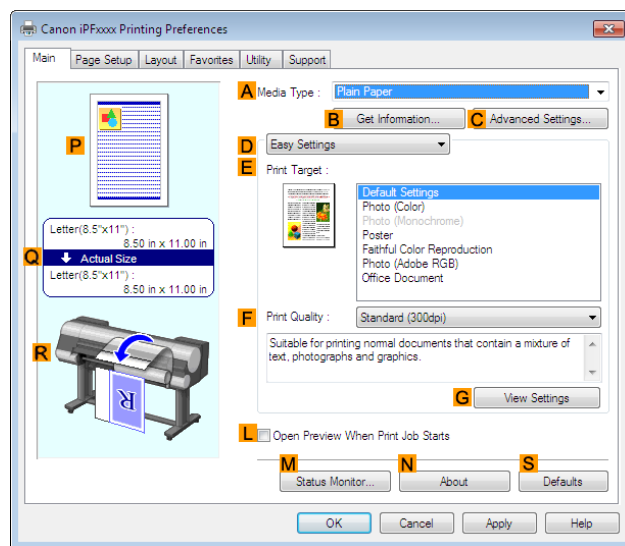

4 In the **A Media Type** list, select the type of paper that is loaded. In this case, click **Plain Paper**.

5 Click the **Page Setup** tab to display the **Page Setup** sheet.

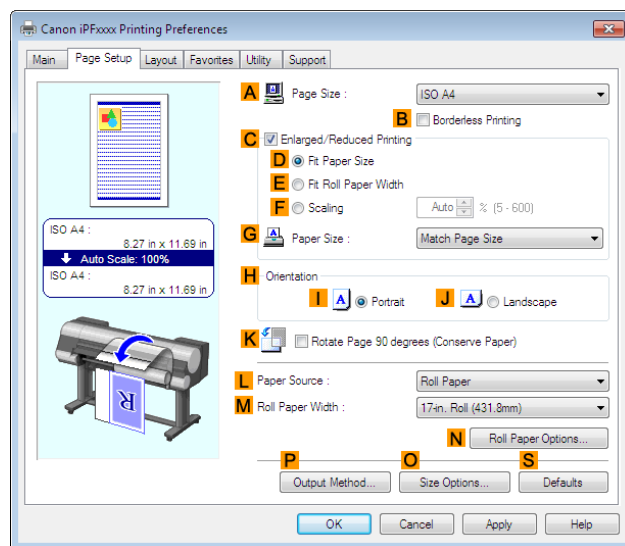

- 6 In the **A Page Size** list, click the size of the original as specified in the application. In this case, click **ISO A4** or **Letter (8.5"x11")**.
- 7 Select and click a roll paper in the **L Paper Source** list.
- 8 Select the width of the loaded roll in the **M Roll Paper Width** list—in this case, **ISO A3/A4 Roll (297.0mm)**.
- 9 Click the **Layout** tab to display the **Layout** sheet.

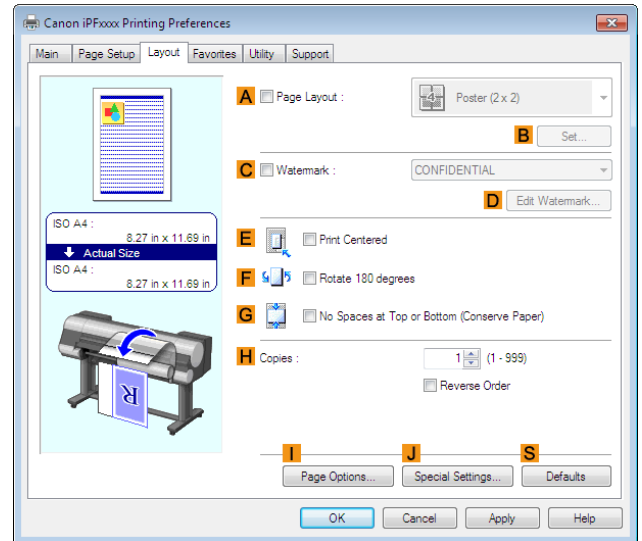

- 10 Select the **G No Spaces at Top or Bottom (Conserve Paper)** check box.
- 11 Confirm the print settings and print as desired.



Note

- For tips on confirming print settings, see "Confirming Print Settings →P.182 "

Conserving Roll Paper by Printing Originals Without Top and Bottom Margins (Mac OS X)

This topic describes how to conserve roll paper when printing originals that have a top and bottom margin, based on the following example.

- Document: Any Type
- Page size: A4 (210.0 × 297.0 mm [8.3 × 11.7 in])
- Paper: Roll paper
- Paper type: **Plain Paper**
- Roll paper width: A3/A4 roll (297.0 mm [11.7 in])

1 This sets the **B Format for** and **C Paper Size**.



Note

- The configuration method varies depending on the OS and application software you are using. If **Page Setup** is displayed in the application menu, the settings are configured by opening the **Page Attributes** dialog box from **Page Setup**.

If it is not displayed, the settings are configured in the upper part of the printer driver displayed when you select **Print** from the application software menu.

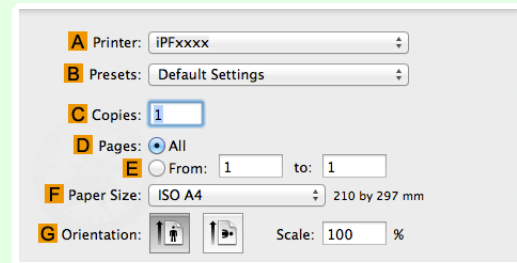
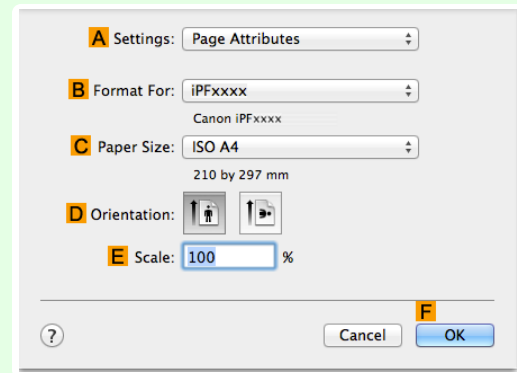

2 Select the printer in the **A Printer** list.

3 In the **F Paper Size** list, click the size of the original. In this case, click **ISO A4**.

4 If you configured the settings using the **Page Attributes** dialog box, click **F OK** to close the dialog box, and then select **Print** from the application software menu.

5 Access the **Main** pane.

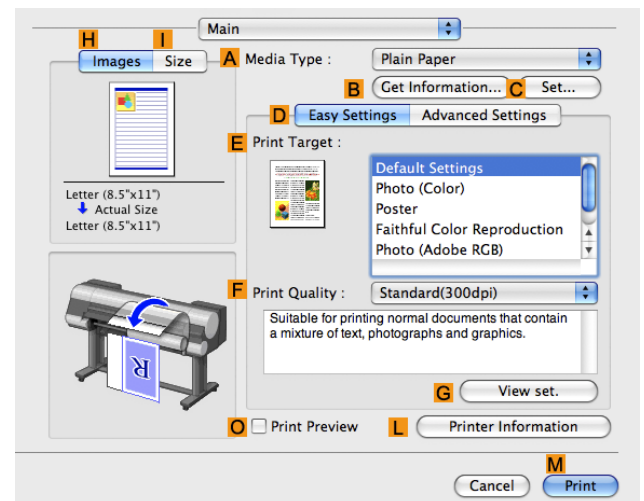

6 In the **A Media Type** list, select the type of paper that is loaded. In this case, click **Plain Paper**.

7 Access the **Page Setup** pane.

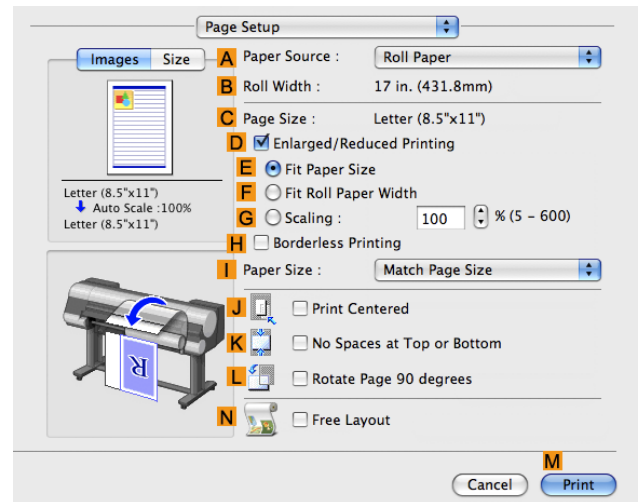

8 Select and click a roll paper in the **A Paper Source** list.

9 Make sure the width of the loaded roll is displayed in **B Roll Width**—in this case, **ISO A3/A4 (297.0mm)**.

Note • If the width of the roll loaded in the printer is not shown in **B Roll Width**, click **L Printer Information** on the **Main** pane to update the printer information.

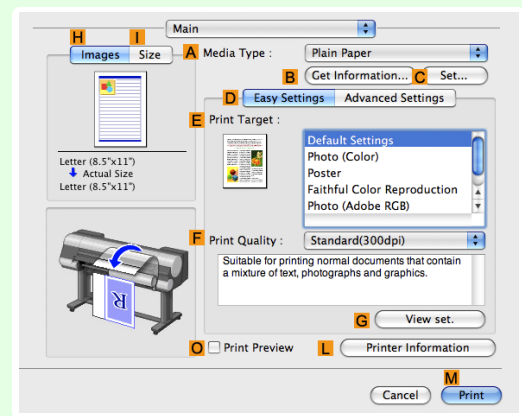

10 Make sure the **C Page Size** setting matches the original size as selected in **C Paper Size** in the **Page Attributes** dialog box—in this case, **ISO A4**.

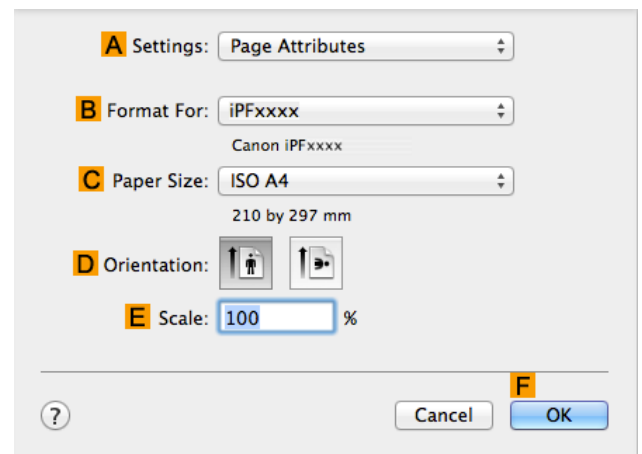

11 Select the **K No Spaces at Top or Bottom** check box.

12 Confirm the print settings, and then click **Print** to start printing.



Note

- For tips on confirming print settings, see "Confirming Print Settings [→P.368](#) "

Checking Images Before Printing

Checking the Layout in a Preview Before Printing

You can check the print layout on the preview screen.

- **Open Preview When Print Job Starts (Windows)**

While viewing the preview screen, you can also adjust orientation or other settings, and your changes will be instantly applied on the preview screen.

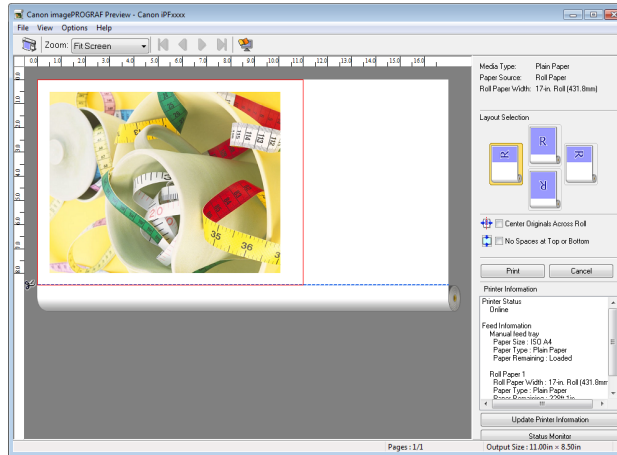

• Under some settings and in some environments, PageComposer may be started.

Note

- **Preview (Macintosh)**

While viewing the preview screen, you can also adjust layout or size settings, and your changes will be instantly applied on the preview screen.

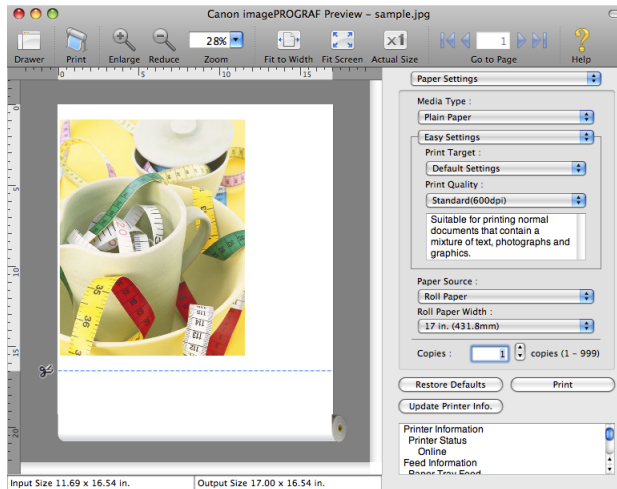

For instructions on how to check the layout before printing, refer to the following topics:

- [Checking the Layout in a Preview Before Printing \(Windows\)](#) →P.182
- [Checking the Layout in a Preview Before Printing \(Mac OS X\)](#) →P.368

Other useful settings

Printing With Watermarks	165
Printing with Watermarks— COPY, FILE COPY, and so on (Windows)	166
Making the Original Orientation Match the Paper Orientation	168
Making the Original Orientation Match the Paper Orientation (Windows)	168
Making the Original Orientation Match the Paper Orientation (Mac OS X)	170
Using Favorites	172
Using Favorites (Windows)	184
Using Favorites (Mac OS X)	369
Cutting Roll Paper After Printing	173
Cutting Roll Paper After Printing (Windows)	173
Cutting Roll Paper After Printing (Mac OS X)	174

Printing With Watermarks

You can add watermarks (background images) to documents that require special handling.

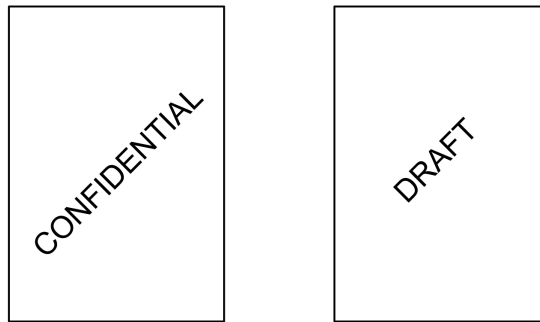

• Watermark

Watermarks are applied to all pages of your document.



Important

- Watermarks are not printed if you select poster as the type of page layout.

The following watermarks are provided:

- CONFIDENTIAL
- COPY
- DRAFT
- FILE COPY
- FINAL
- PRELIMINARY
- PROOF
- TOP SECRET

You can also create your own watermarks. Specify the following options to customize your watermark.

- Watermark string: Specify the font, size, color, and so on. Surround the watermark with a frame, if desired.
- Watermark position: Specify the position on the page, the angle, and so on.
- Watermark printing method: Specify whether to print the watermark superimposed or under the document image. You can also print the watermark only on the first page, if desired.



- Watermarks are supported in Windows.

Note • In addition to the provided watermarks, you can create up to 50 original watermarks.

For detailed instructions on printing with watermarks, refer to the following topics:

- Printing with Watermarks— COPY, FILE COPY, and so on (Windows) →P.166

Printing with Watermarks— COPY, FILE COPY, and so on (Windows)

This topic describes how to print with watermarks, based on the following example of printing with a **FILE COPY** watermark.

- Document: Any type
- Page size: A2 (420.0×594.0 mm [16.5 × 23.4 in])
- Paper: Roll paper
- Paper type: **Plain Paper**
- Roll paper width: A2/A3 roll (420.0 mm [16.5 in])

1 Choose **Print** in the application menu.

2 Select the printer in the dialog box, and then display the printer driver dialog box. (See "Accessing the Printer Driver Dialog Box from Applications →P.185 ")

3 Make sure the **Main** sheet is displayed.

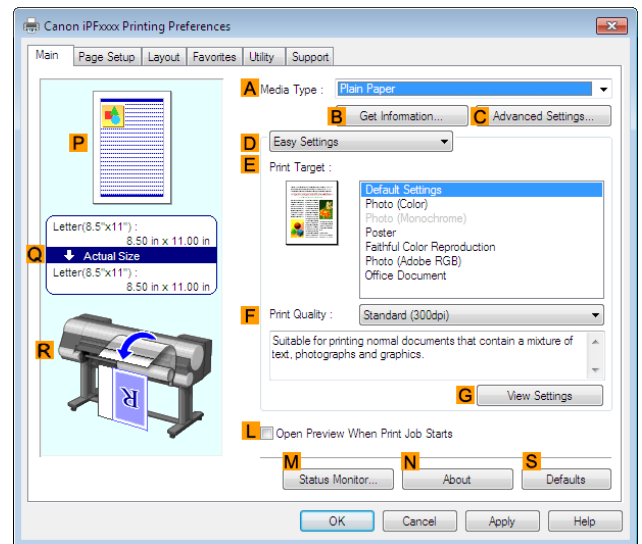

4 In the **A Media Type** list, select the type of paper that is loaded. In this case, click **Plain Paper**.

5 Make your selection in the **E Print Target** list.



- You can check the settings values selected in the **E Print Target** list by clicking **G View Settings**.

Note

- 6** Click the **Page Setup** tab to display the **Page Setup** sheet.

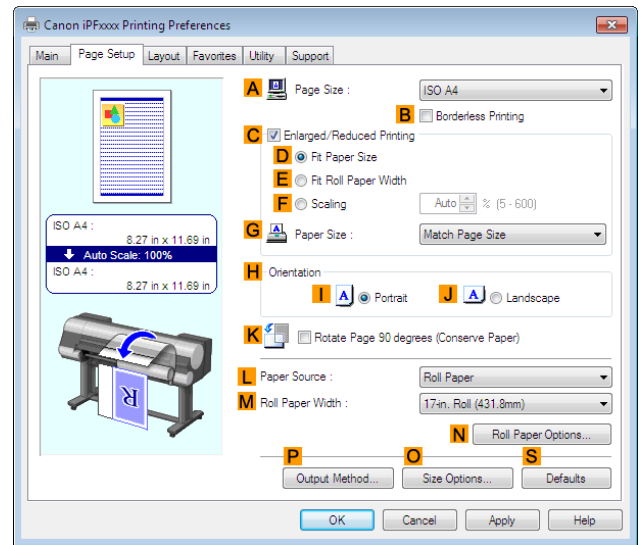

- 7** In **A Page Size**, click the size of the original as specified in the application software. In this case, click **ISO A2**.
- 8** Select and click a roll paper in the **L Paper Source** list.
- 9** Select the width of the loaded roll in the **M Roll Paper Width** list—in this case, **ISO A2/A3 Roll (420.0mm)**.
- 10** Click the **Layout** tab to display the **Layout** sheet.

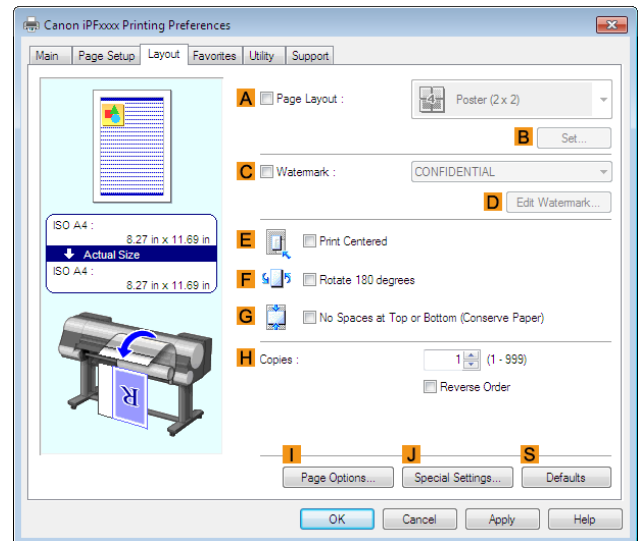

- 11** Select the **C Watermark** check box.
- 12** Click **FILE COPY** in the **Watermarks** list.



- Click **D Edit Watermark** to open the **Edit Watermark** dialog box. In the **Edit Watermark** dialog box, you can create custom watermarks and change the position and angle of watermarks.

- 13** Confirm the print settings and print as desired.



- For tips on confirming print settings, see "Confirming Print Settings →P.182 "

Making the Original Orientation Match the Paper Orientation

You can specify the original orientation to match the orientation of the paper for printing.

• Orientation

Paper is usually loaded in the printer in portrait orientation. When you have an original in landscape orientation, you can specify the printing orientation so that the original is printed in landscape orientation.

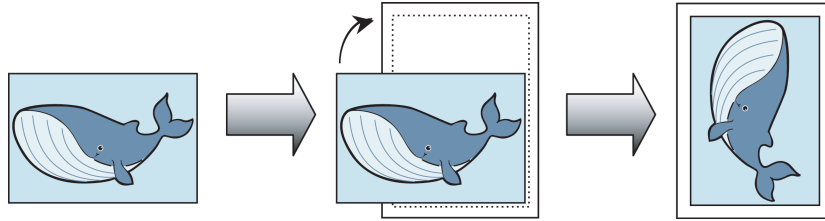

• Rotate 180 degrees

The original is rotated 180 degrees to print it upside down.

• Mirror

A mirror image of the original is printed.

For instructions on specifying the original orientation before printing, refer to the following topics, as appropriate for your computer and operating system.

- Making the Original Orientation Match the Paper Orientation (Windows) →P.168
- Making the Original Orientation Match the Paper Orientation (Mac OS X) →P.170

Making the Original Orientation Match the Paper Orientation (Windows)

This topic describes how to print an original in landscape orientation after matching the paper orientation, based on the following example.

- Document: An original in landscape orientation
- Page size: A4 (210.0 × 297.0 mm)/Letter (8.3 × 11.7 in)
- Paper: Roll
- Paper type: **Plain Paper**
- Roll paper width: A2/A3 roll (420.0 mm [16.5 in])

1 Choose **Print** in the application menu.

2 Select the printer in the dialog box, and then open the printer driver dialog box. (See "Accessing the Printer Driver Dialog Box from Applications →P.185 ")

- 3** Make sure the **Main** sheet is displayed.

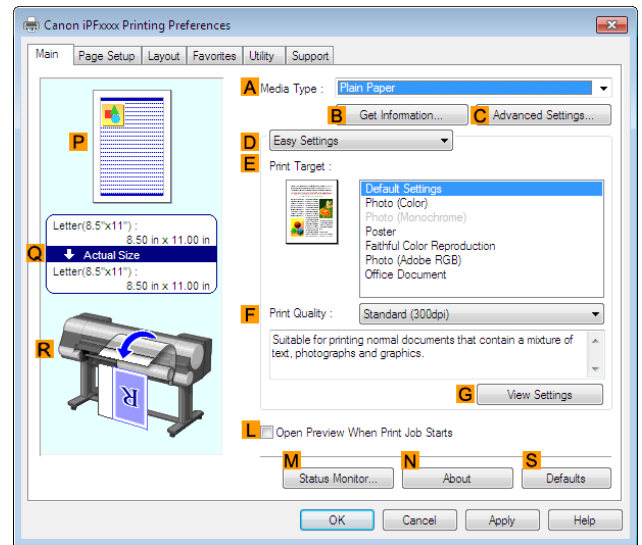

- 4** In the **A Media Type** list, select the type of paper that is loaded. In this case, click **Plain Paper**.

- 5** Make your selection in the **E Print Target** list.

- 6** Make your selection in the **F Print Quality** list.

- 7** Click the **Page Setup** tab to display the **Page Setup** sheet.

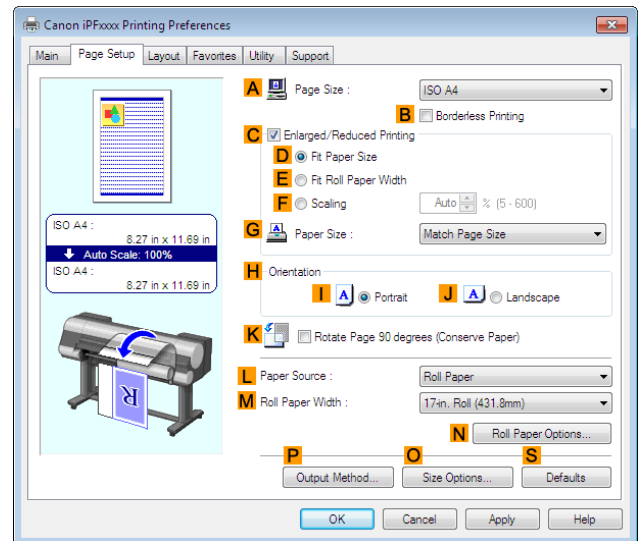

- 8** In the **A Page Size** list, click the size of the original as specified in the application. In this case, click **ISO A4** or **Letter (8.5"x11")**.

- 9** In **H Orientation**, click **J Landscape**.

- 10** Select and click a roll paper in the **L Paper Source** list.

- 11** Select the width of the loaded roll in the **M Roll Paper Width** list—in this case, **ISO A2/A3 Roll (420.0mm)**.

12 Confirm the print settings and print as desired.



• For tips on confirming print settings, see "Confirming Print Settings →P.182 "

Note

Making the Original Orientation Match the Paper Orientation (Mac OS X)

This topic describes how to print an original in landscape orientation after matching the paper orientation, based on the following example.

- Document: An original in landscape orientation
- Page size: A4 (210.0 × 297.0 mm [8.3 × 11.7 in])
- Paper: Roll paper
- Paper type: **Plain Paper**
- Roll paper width: A2/A3 roll (420.0 mm [16.5 in])

1 This sets the **B Format for** and **C Paper Size**.



Note

• The configuration method varies depending on the OS and application software you are using. If **Page Setup** is displayed in the application menu, the settings are configured by opening the **Page Attributes** dialog box from **Page Setup**.

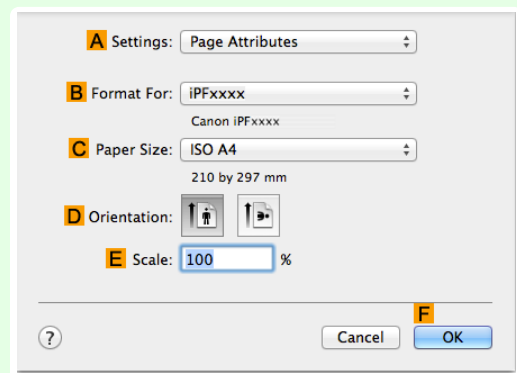

If it is not displayed, the settings are configured in the upper part of the printer driver displayed when you select **Print** from the application software menu.

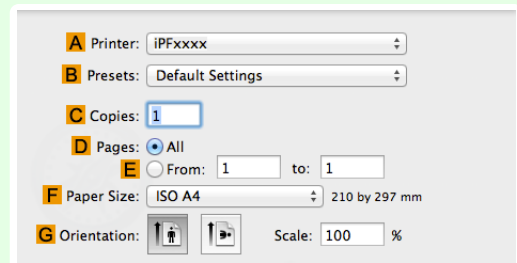

2 Select the printer in the **A Printer** list.

3 In the **F Paper Size** list, click the size of the original. In this case, click **ISO A4**.

4 In **G Orientation**, click the icon of the document in landscape orientation.

5 If you configured the settings using the **Page Attributes** dialog box, click **F OK** to close the dialog box, and then select **Print** from the application software menu.

6 Access the **Main** pane.

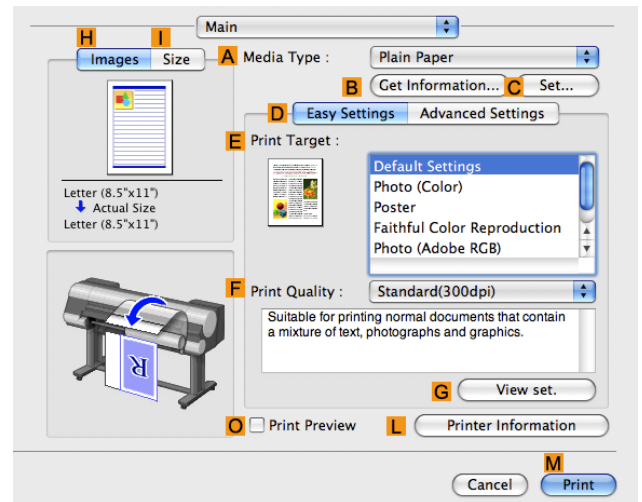

7 In the **A Media Type** list, select the type of paper that is loaded. In this case, click **Plain Paper**.

8 Make your selection in the **E Print Target** list.

9 Make your selection in the **F Print Quality** list.

10 Access the **Page Setup** pane.

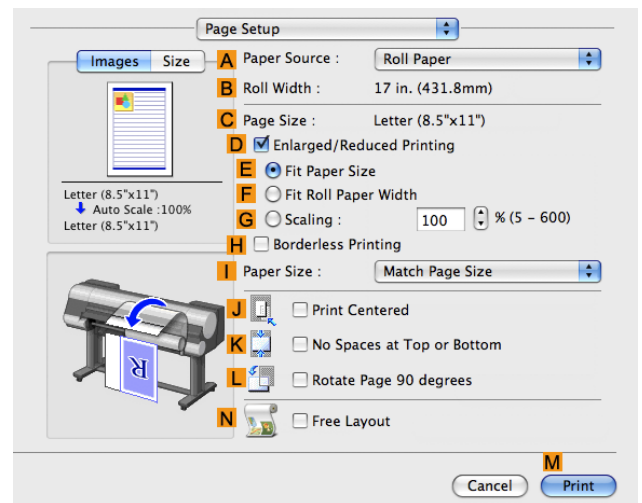

11 Select and click a roll paper in the **A Paper Source** list.

- 12** Make sure the width of the loaded roll is displayed in the **B Roll Width** list—in this case, **ISO A2/A3 (420.0mm)**.



Note

- If the width of the roll loaded in the printer is not shown in **B Roll Width**, click **L Printer Information** on the **Main** pane to update the printer information.

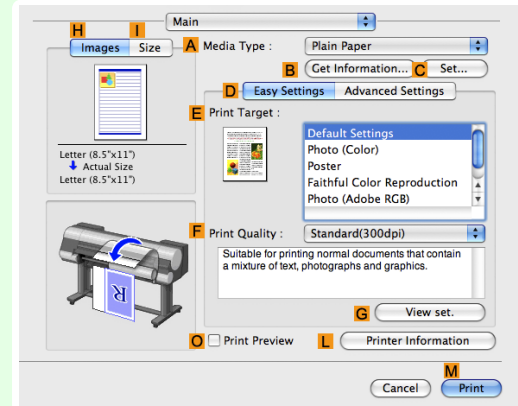

- 13** Make sure the **C Page Size** setting matches the original size as selected in **C Paper Size** in the **Page Attributes** dialog box—in this case, **ISO A4**.

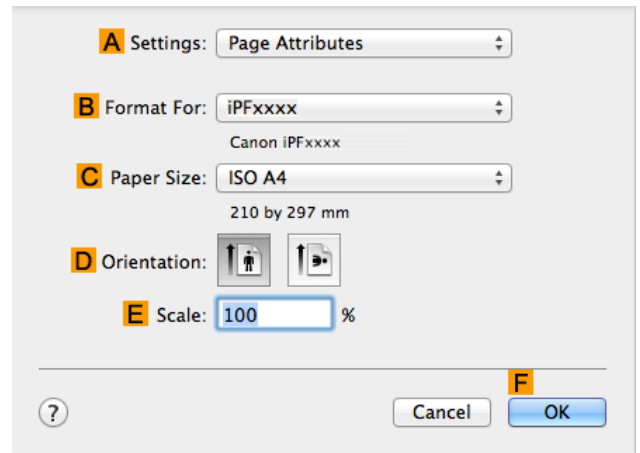

- 14** Confirm the print settings, and then click **M Print** to start printing.



Note

- For tips on confirming print settings, see "Confirming Print Settings" →P.368 "

Using Favorites

You can register print settings as **Favorites** to reuse settings from a particular job that met your expectations, or settings for a particular page size that you will use repeatedly.

• Favorites

Registering a favorite for later use. You can choose the settings you have registered from a list before printing, and you can check the settings details.



Note

- You can also save the favorite settings as files. Using these files is a convenient way to print under the same conditions on another computer. (In Windows.)

For instructions on using favorites to print, refer to the following topics, as appropriate for your computer and operating system.

- Using Favorites (Windows) →P.184
- Using Favorites (Mac OS X) →P.369

Cutting Roll Paper After Printing

Roll paper can be automatically cut after printing.



Note

- It may not be possible to cut certain types of paper, such as adhesive paper. For details on types of paper that cannot be used with the auto cut feature, see the Paper Reference Guide. (See "Types of Paper →P.530 ")

Automatic Cutting

Roll paper is cut automatically after printing. If you prefer, you can print continuously without cutting the roll, or you can print a cut line.

For instructions on cutting roll paper after printing, refer to the following topics, as appropriate for your computer and operating system.

- Cutting Roll Paper After Printing (Windows) →P.173
- Cutting Roll Paper After Printing (Mac OS X) →P.174

Cutting Roll Paper After Printing (Windows)

This topic describes how to cut roll paper automatically after printing (using the auto cut function), as well as how to print a cut line for manual cutting.



Note

- The auto cut function is activated on the printer by default and when the printer driver is installed. Follow the steps below to reactivate the function if it is disabled, or to select the setting for printing a cut line instead.

- Choose **Print** in the application menu.
- Select the printer in the dialog box, and then display the printer driver dialog box. (See "Accessing the Printer Driver Dialog Box from Applications →P.185 ")
- Click the **Page Setup** tab to display the **Page Setup** sheet.

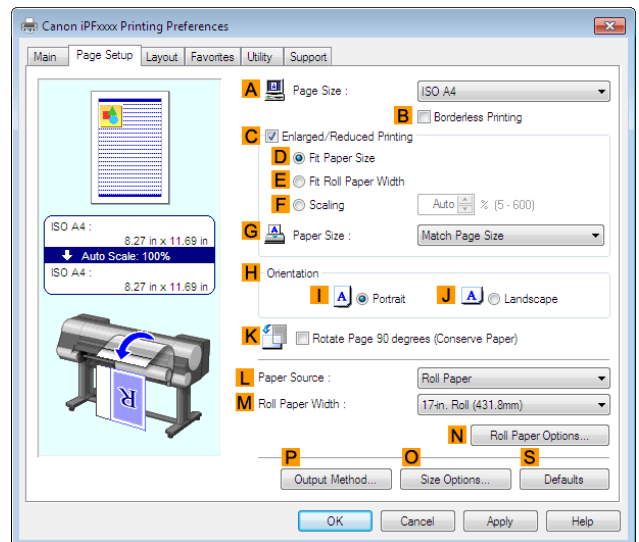

- Select and click a roll paper in the **L Paper Source** list.

- 5** Click **N Roll Paper Options** to display the **Roll Paper Options** dialog box.

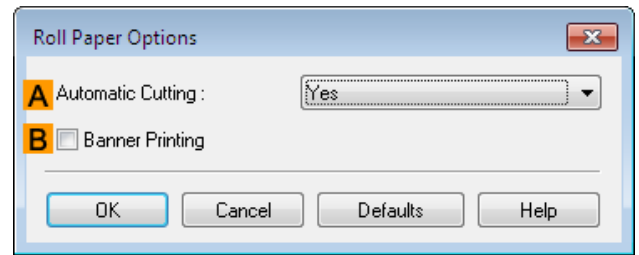

- 6** To enable automatic cutting, click **Yes** in the **A Automatic Cutting** list. If you prefer to cut the paper later yourself, click **Print Cut Guideline**.

- 7** Click **OK** to close the **Roll Paper Options** dialog box.

- 8** Confirm the print settings and print as desired.



Note

- For tips on confirming print settings, see "Confirming Print Settings →P.182 "

Roll paper will be automatically cut after printing.

Cutting Roll Paper After Printing (Mac OS X)

This topic describes how to cut roll paper automatically after printing (using the auto cut function), as well as how to print a cut line for manual cutting.



Note

- The auto cut function is activated on the printer by default and when the printer driver is installed. Follow the steps below to reactivate the function if it is disabled, or to select the setting for printing a cut line instead.

- 1** This sets the **B Format for** and **C Paper Size**.



Note

- The configuration method varies depending on the OS and application software you are using. If **Page Setup** is displayed in the application menu, the settings are configured by opening the **Page Attributes** dialog box from **Page Setup**.

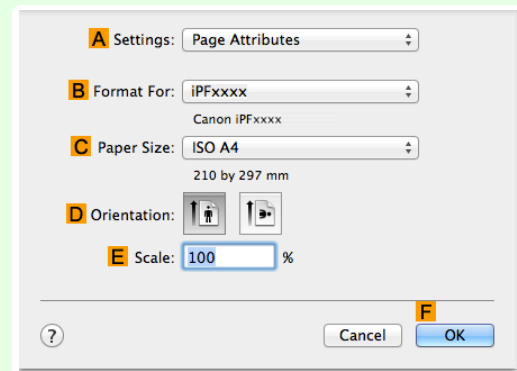

If it is not displayed, the settings are configured in the upper part of the printer driver displayed when you select **Print** from the application software menu.

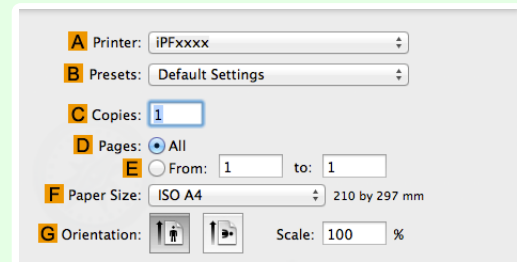

- 2 Select the printer in the **A Printer** list.
- 3 Choose the original size in the **F Paper Size** list.
- 4 If you configured the settings using the **Page Attributes** dialog box, click **F OK** to close the dialog box, and then select **Print** from the application software menu.
- 5 Access the **Page Setup** pane.

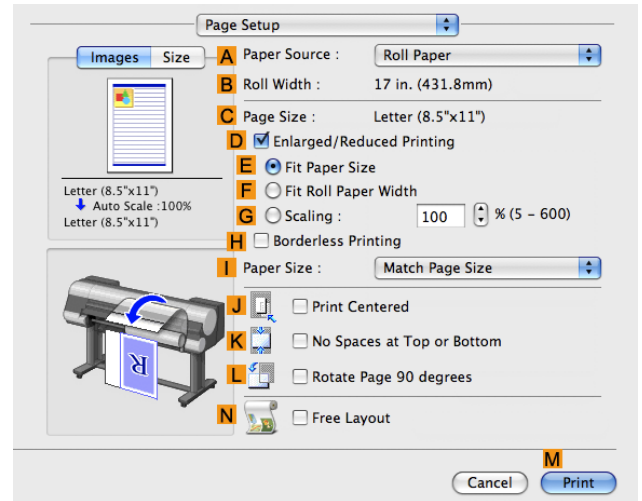

- 6 Select and click a roll paper in the **A Paper Source** list.
- 7 Access the **Main** pane.

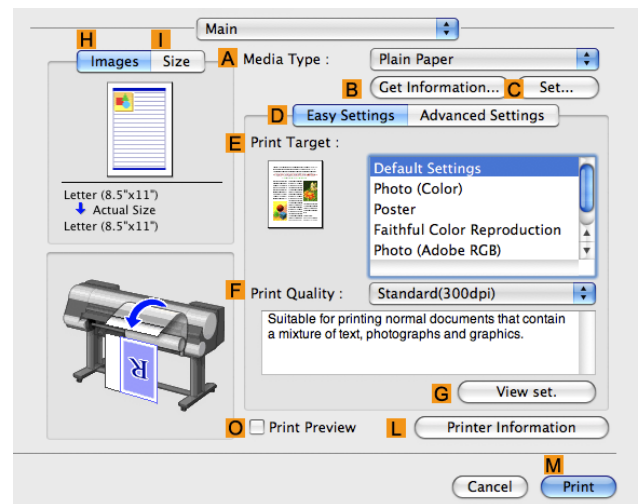

- 8 In the **A Media Type** list, select the type of paper that is loaded.

- 9** Click **C Set** to display the **Paper Detailed Settings** dialog box.

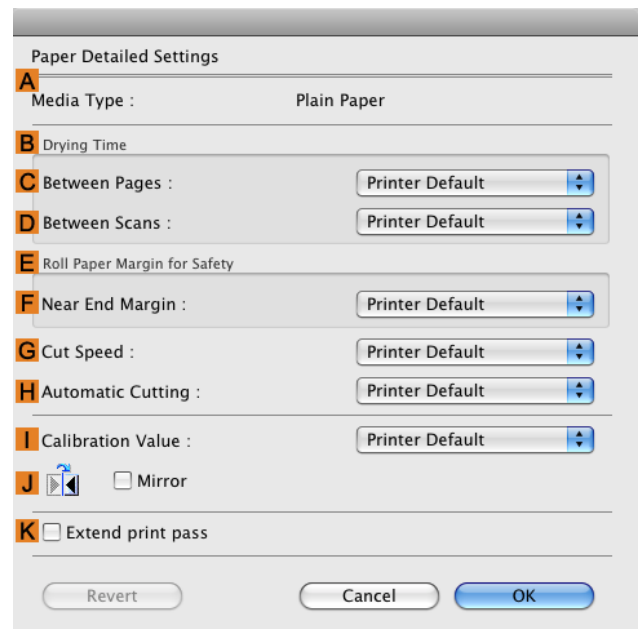

- 10** To enable automatic cutting, click **Printer Default** in the **H Automatic Cutting** list. If you prefer to cut the paper later yourself, click **Print Cut Guideline**.



Important

- If the automatic cut function has been deactivated on the printer, change the auto cut setting on the printer Control Panel.

- 11** Click **OK** to close the **Paper Detailed Settings** dialog box.

- 12** Confirm the print settings, and then click **M Print** to start printing.



Note

- For tips on confirming print settings, see "Confirming Print Settings →P.368 "

Basic Printing Workflow	19
-------------------------	----

Enhanced Printing Options	35
---------------------------	----

Windows Software

Printer Driver	178
Preview	213
Free Layout	223
Color imageRUNNER Enlargement Copy	246
Print Plug-In for Photoshop / Digital Photo Professional	257
Layout Plug-In for Photoshop	317
Print Plug-In for Office	322
→ Status Monitor	742
→ Accounting	748
→ Device Setup Utility	738
→ Media Configuration Tool	590

Mac OS X Software	363
-------------------	-----

Handling and Use of Paper	529
---------------------------	-----

Control Panel	655
---------------	-----

Printer Parts	691
---------------	-----

Network Setting	707
-----------------	-----

Print Job Management	741
----------------------	-----

Adjustments for Better Print Quality	803
--------------------------------------	-----

Color Management	821
------------------	-----

Maintenance and Consumables	833
-----------------------------	-----

Troubleshooting	883
-----------------	-----

Error Message	915
---------------	-----

Specifications	941
----------------	-----

Appendix	945
----------	-----

Printer Driver

Printer Driver Settings	178
Specifying Paper in the Printer Driver	180
Confirming Print Settings	182
Checking the Layout in a Preview Before Printing	182
Using Favorites	184
Accessing the Printer Driver Dialog Box from Applications	185
Accessing the Printer Driver Dialog Box from the Operating System Menu	187
Main Sheet	188
Paper Information on Printer Dialog Box	191
Paper Detailed Settings Dialog Box	192
View Settings Dialog Box for the Printing Application	193
Color Adjustment Sheet: Color	194
Object Adjustment Dialog box: Color	195
Matching Sheet	196
Color Adjustment Sheet: Monochrome	198
Object Adjustment Dialog box: Monochrome	199
Gray Adjustment Sheet	200
Page Setup Sheet	201
Output Method Dialog box	204
Paper Size Options Dialog Box	205
Layout Sheet	206
Page Options Dialog Box	207
Special Settings Dialog Box	208
Favorites Sheet	209
Utility Sheet	210
Support Sheet	211
Settings Summaries Dialog Box	212
Device Settings Sheet	212

Printer Driver Settings

For instructions on accessing the Windows printer driver, refer to the following topics.

- Accessing the Printer Driver Dialog Box from Applications →P.185
- Accessing the Printer Driver Dialog Box from the Operating System Menu →P.187

For information on the Windows printer driver settings, refer to the following topics.

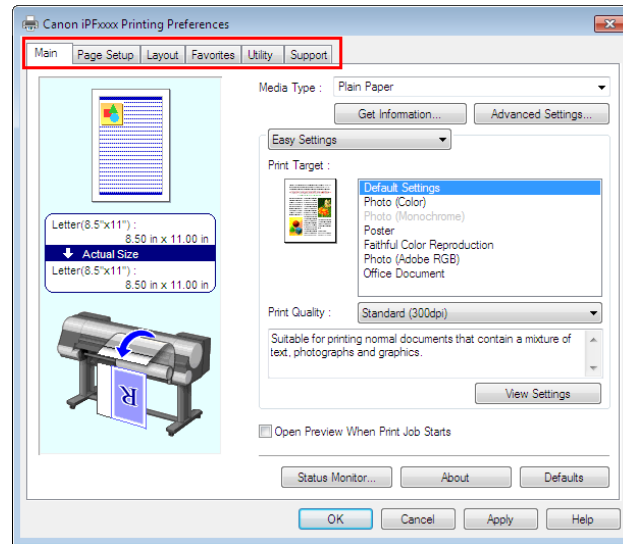

- **Main Sheet** →P.188
You can specify the type of paper, color processing, print quality, print preview, and other settings. Choose **Easy Settings** to specify basic print settings based on the printing application or **Advanced Settings** to complete more detailed settings as desired.
 - Paper Detailed Settings Dialog Box →P.192
 - View Settings Dialog Box for the Printing Application →P.193
 - Color Adjustment Sheet: Color →P.194
 - Object Adjustment Dialog box: Color →P.195
 - Matching Sheet →P.196
 - Color Adjustment Sheet: Monochrome →P.198
 - Object Adjustment Dialog box: Monochrome →P.199
 - Gray Adjustment Sheet →P.200
- **Page Setup Sheet** →P.201
You can specify the page size of the original, borderless printing, enlargement or reduction, the orientation, the paper size and feed source, and automatic cutting.
 - Output Method Dialog box →P.204
 - Paper Size Options Dialog Box →P.205
- **Layout Sheet** →P.206
You can specify the page layout, watermarks, the orientation, the number of copies, and print processing options.
 - Page Options Dialog Box →P.207
 - Special Settings Dialog Box →P.208
- **Favorites Sheet** →P.209
Groups of print settings you select on each sheet can be saved as a favorite. Favorites you have added can be edited or used at the time of printing as desired.
- **Utility Sheet** →P.210
You can specify settings related to maintenance for the Printhead and feed amount, as well as settings for **Color imageRUNNER Enlargement Copy**.
- **Support Sheet** →P.211

You can view support information and the user manual.

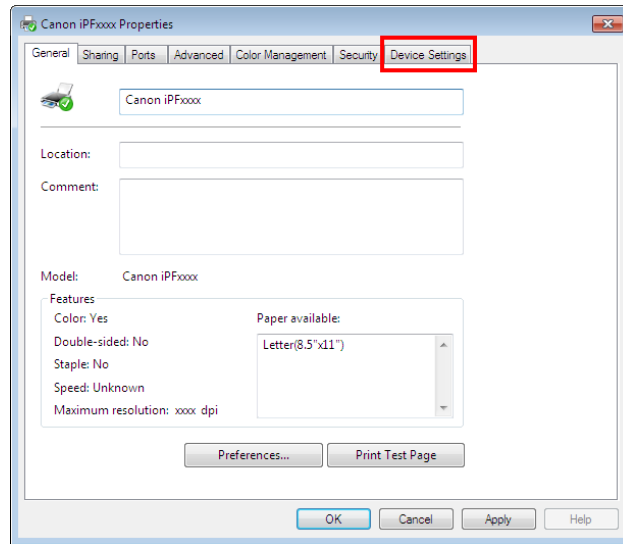

- Device Settings Sheet →P.212

You can display settings for optional equipment installed on the printer and see the version information for the printer driver.

imagePROGRAF Free Layout is a feature for freely arranging originals from various source applications on a single page as desired before printing. For details, see Free Layout →P.223 .

Color imageRUNNER Enlargement Copy is a feature for automatic enlargement and printing of scanned originals from a **Color imageRUNNER**. For details, see Color imageRUNNER Enlargement Copy →P.246 .

Specifying Paper in the Printer Driver

If you have replaced the paper, you must complete the following settings in the printer driver.



Important

- Always specify the same type and size of paper in the printer menu and printer driver.

1 Choose **Print** in the application menu.

2 Select the printer in the dialog box, and then display the printer driver dialog box.(See "Accessing the Printer Driver Dialog Box from Applications →P.185 ")

- 3** Make sure the **Main** sheet is displayed.

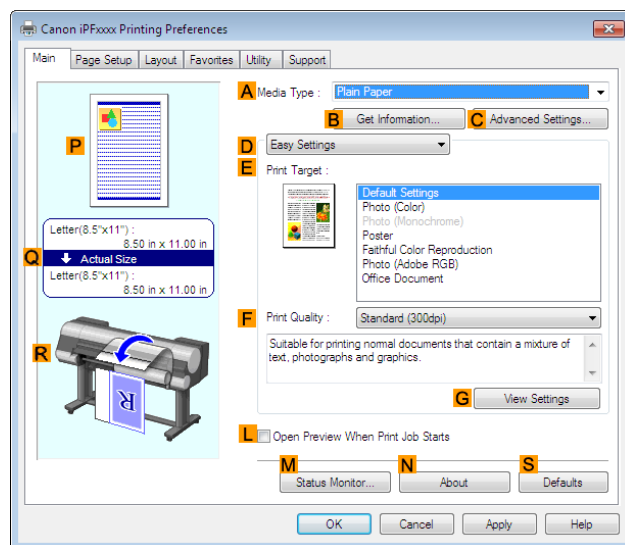

- 4** In the **A Media Type** list, select the type of paper that is loaded.



Note

- Click the **B Get Information** button to display the **Paper Information on Printer** dialog box. On the **Paper Information on Printer** dialog box, you can obtain information on the paper in the printer and configure printer driver settings for the feed source and type of paper. This function requires that the **Status Monitor** be installed.

- 5** Click the **Page Setup** tab to display the **Page Setup** sheet.

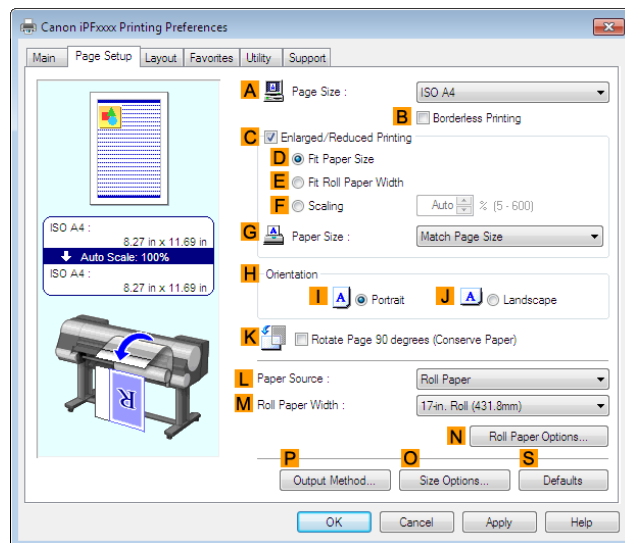

- 6** In the **A Page Size** list, select the size of the original as specified in the application.

- 7** In the **L Paper Source** list, select how paper is supplied.

- 8** If you have selected roll paper in **L Paper Source**, select the width of the loaded roll in **M Roll Paper Width**.



Note

- A variety of settings are available in the printer driver to suit different printing applications. For details on available printing conditions, see "Printer Driver Settings →P.178 "

Confirming Print Settings

There are two ways to confirm the print settings, as follows.

- **Checking a preview of the settings**

A preview of the settings is displayed on the left side of the **Main**, **Page Setup**, and **Layout** sheets. By checking illustrations and numerical values in the preview, you can confirm current settings for the page size, orientation, paper source, layout, and so on.

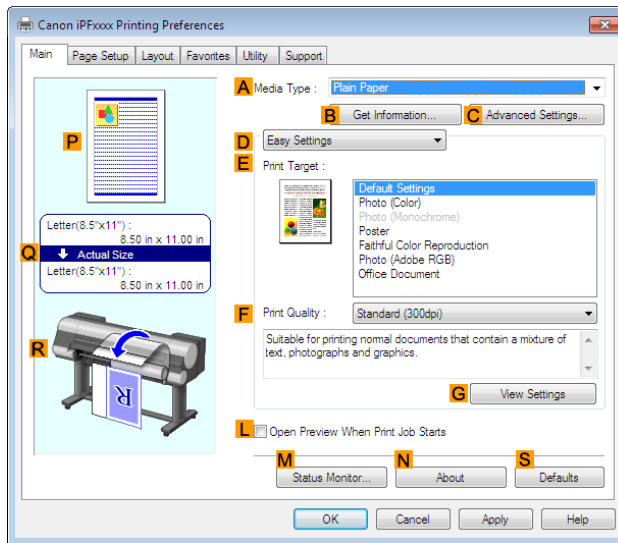

Display Area	Information Displayed
P Top illustrations	Illustrations indicate the orientation, page layout, borderless printing selection, color mode, and other settings information.
Q Middle, bordered area	The page size, paper size, and method and percentage of enlargement or reduction are indicated.
R Bottom illustrations	Illustrations indicate the feed source, orientation, borderless printing selection, and other settings information.



Note

• To confirm the **Print Target** specified in **Easy Settings**, click **G View Settings** on the **Main** sheet to display the **View Settings** dialog box.

- **Checking a print preview**

You can check an image of the original just as it will be printed.

When you activate this feature, imagePROGRAF Preview or PageComposer is started before printing. Confirming how documents will be printed this way helps prevent printing errors.

For details on print previews, see "Checking the Layout in a Preview Before Printing →P.164 "

Checking the Layout in a Preview Before Printing

This topic describes how to preview images of print jobs before actually printing them.

- 1 Choose **Print** in the application menu.
- 2 Select the printer in the dialog box, and then display the printer driver dialog box. (See "Accessing the Printer Driver Dialog Box from Applications →P.185 ")

3 Make sure the **Main** sheet is displayed.

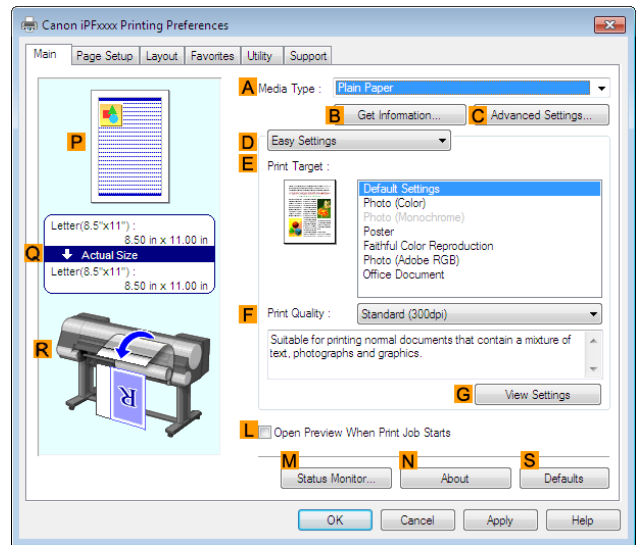

4 Select the **L Open Preview When Print Job Starts** check box.

5 After you click **OK**, when you print a job, the **image-PROGRAF Preview** window will be displayed.

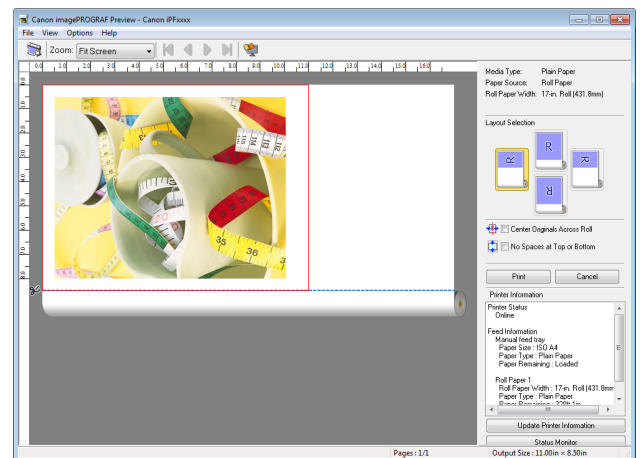

Note

- If PageComposer is running, access the **Special Settings** dialog box from the **Layout** sheet and clear **Enable Preview Switching**.

6 On the main window, you can check the layout and change settings as needed.

7 To print, click **Print** in the **File** menu.



Note

- For details on **imagePROGRAF Preview** functions, see Preview [→P.213](#).

Using Favorites

This topic describes how to register favorites and print using favorite settings.

Registering a favorite

This section describes the procedure for registering printing settings that have been changed in the driver as **Favorites**.

- 1 Choose **Print** in the application menu.
- 2 Select the printer in the dialog box, and then display the printer driver dialog box. (Refer to "Accessing the Printer Driver Dialog Box from Applications →P.185 ")
- 3 Perform normal printing settings.
The favorite is registered from here.
- 4 Click the **Favorites** tab to display the **Favorites** sheet.

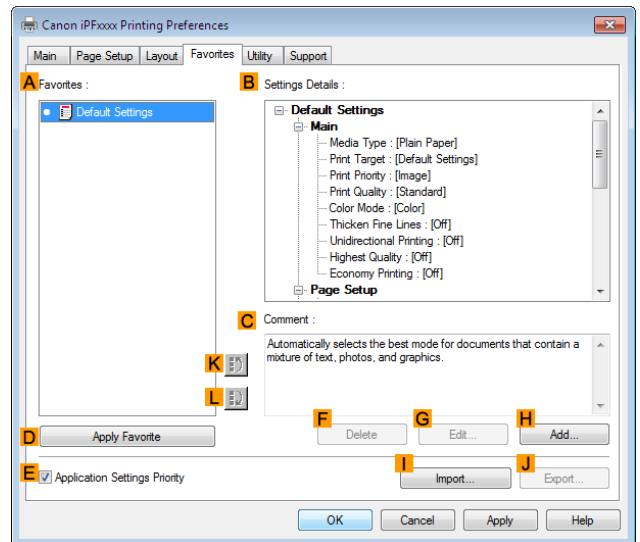

- 5 Click **H Add** to display the **Add** dialog box.

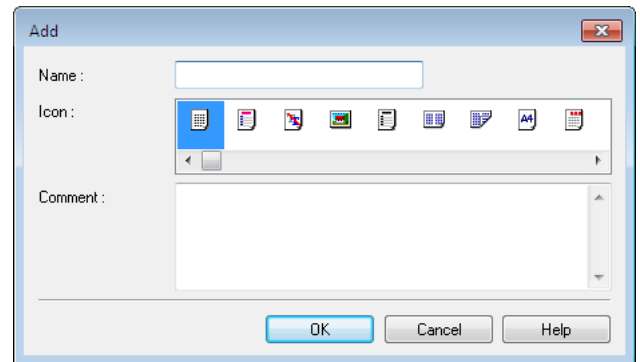

- 6 Enter a desired name in **Name**, such as **Photos for Presentations** or **Monthly Report**.
- 7 Choose a fitting icon for these print settings in the **Icon** list.
- 8 In **Comment**, enter a description of the favorite to be added, as desired.

- 9** Click **OK** to close the **Add** dialog box.
The favorite you have added is now displayed in **A Favorites**.



Note

- To save a favorite as a file, click **J Export** and specify the file to save.

Printing using the favorite

Follow the steps below to print using the favorite you have registered.

- 1** Choose **Print** in the application menu.
- 2** Select the printer in the dialog box, and then display the printer driver dialog box. (See "Accessing the Printer Driver Dialog Box from Applications →P.185 ")
- 3** Click the **Favorites** tab to display the **Favorites** sheet.

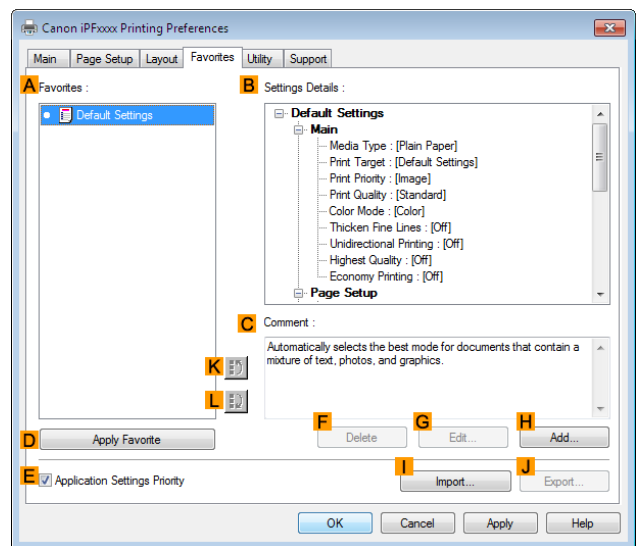

- 4** In the **A Favorites**, choose the favorite you registered.



Note

- To import a favorite, click **I Import** and specify the favorite file.

- 5** Click **D Apply Favorite** to replace the favorite settings with the current print settings.

- 6** Confirm the print settings and print as desired.



Note

- For instructions on confirming print settings, see "Confirming Print Settings →P.182 "

Accessing the Printer Driver Dialog Box from Applications

- 1** Choose **Print** from the **File** menu to display the dialog box for printing conditions.

2 Select the printer, and then display the printer driver dialog box.



Note

- The dialog box for specifying printing conditions varies depending on the source application. In some cases, when you select the printer, a sheet for configuring the printer driver is added to the dialog box. In the following case, click **Preferences**.

- Example: **Print** dialog box displayed by the application software

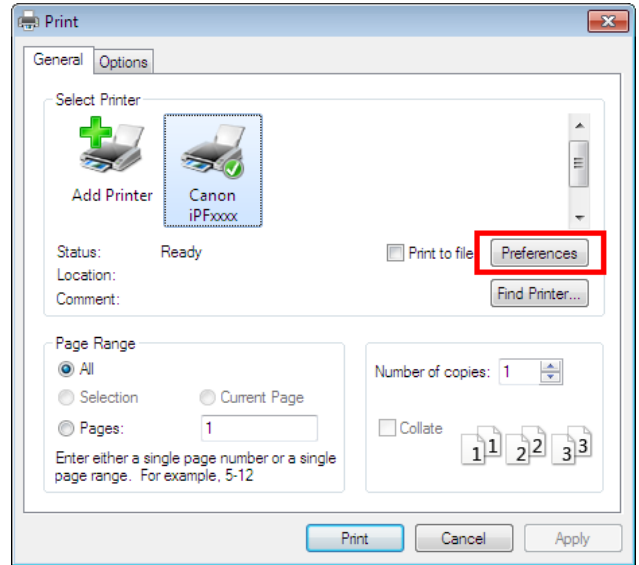

Six sheets of print settings are displayed by the printer driver: **Main**, **Page Setup**, **Layout**, **Favorites**, **Utility**, and **Support**.

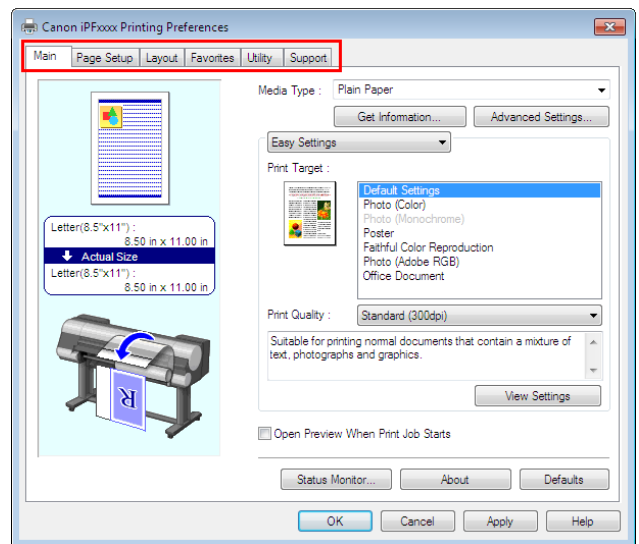

Note

- The titles of dialog boxes may vary depending on the application, and sheets other than these six sheets may be displayed.



Important

- If you access the printer driver dialog box from the source application, changes you make to the settings will only apply temporarily to that application. Because these are sizes you specify temporarily in the printer driver, the sizes will not be available after you exit the application.
- You can also access the printer driver dialog box from the Windows system menu. To use the settings continuously in all applications, open the printer driver from the system menu to make the settings. See "Accessing the Printer Driver Dialog Box from the Operating System Menu →P.187".

Accessing the Printer Driver Dialog Box from the Operating System Menu

- 1 Click **start > Printers and Faxes** (or **Printers**).
- 2 Select the printer, and then display the printer properties dialog box.

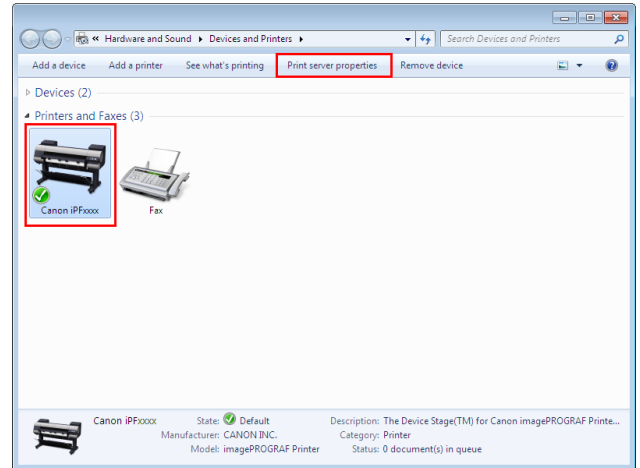

- 3 Click **Printing Preferences** to display the **Main** (or **Printing Preferences**) dialog box, titled with the name of this printer.

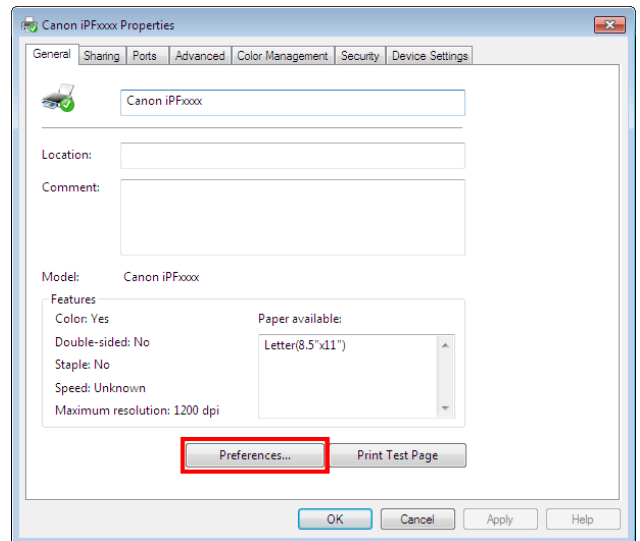

Note

- The **Device Settings** sheet is also an extension of the printer driver. (See "Device Settings Sheet →P.212 ")

Six sheets of print settings are displayed by the printer driver: **Main**, **Page Setup**, **Layout**, **Favorites**, **Utility**, and **Support**.

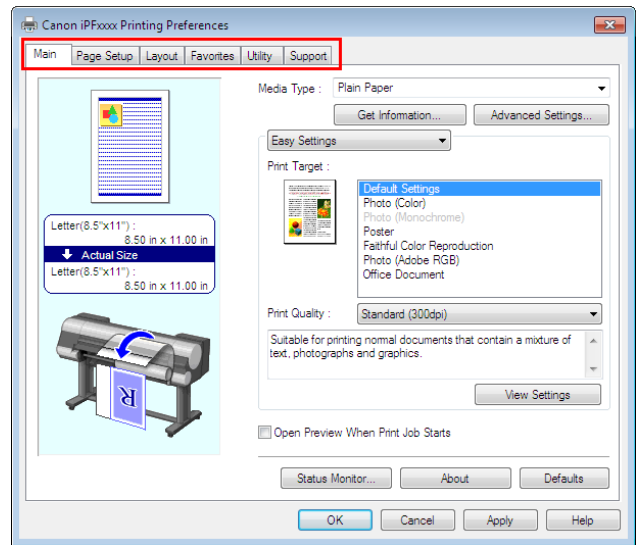

Important

- If you access the printer driver dialog box from the operating system menu, changes you make to the settings will apply to all applications you use for printing.
- You can also access the printer driver dialog box from applications. See "Accessing the Printer Driver Dialog Box from Applications →P.185".

Main Sheet

The following settings are available on the **Main** sheet. For details on settings items, refer to the printer driver help file.



Note

- On the **Main** sheet, choose **Easy Settings** to specify basic print settings based on the particular printing application, or switch to **Advanced Settings** to complete more detailed settings as desired.

Common Items

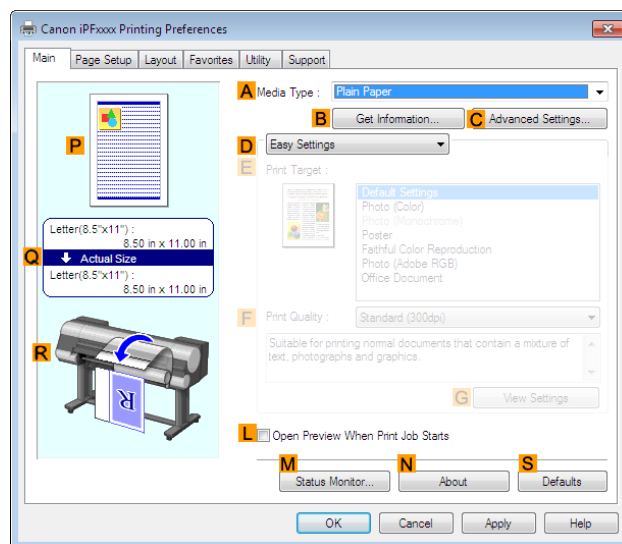

• A Media Type

Select the type of paper.

For information on the types of paper the printer supports, refer to the Paper Reference Guide. (See " Paper Reference Guide".)

• **B** Get Information

Displays **Paper Information on Printer**. You can update the printer driver settings for the feed source, media type, and roll width by selecting the feed source.

- Paper Information on Printer Dialog Box →P.191

• **C** Advanced Settings

Displays **Paper Detailed Settings**. You can configure the printing settings to match the type of media, such as the ink drying time.

- Paper Detailed Settings Dialog Box →P.192

• **L** Open Preview When Print Job Starts

If you turn this on, **imagePROGRAF Preview** starts before printing. This allows you to check on-screen previews of documents before printing.

- Checking the Layout in a Preview Before Printing →P.164

• **M** Status Monitor

Starts imagePROGRAF Status Monitor.

You can check the printer status, job status, and other conditions.

You can also set up email notification if printer errors occur by completing the **Email Notice** settings.

For details, refer to the **Status Monitor** help file.

• **N** About

Displays version information for the printer driver.

• **S** Defaults

Restores all settings on the sheet to the default values.

Configuration using **Easy Settings**

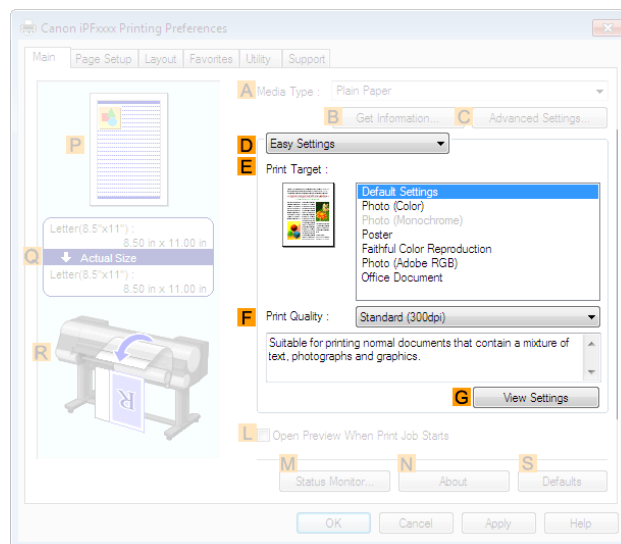

• **E** Print Target

Choose presets that match the type of document to be printed.

- Printing Photos and Images →P.37
- Printing Line Drawings and Text →P.54
- Printing Office Documents →P.48

Depending on the **A Media Type** setting, some **E Print Target** options may not be available.

- **F Print Quality**

Choose the level of print quality.

- Giving Priority to Particular Graphic Elements and Colors for Printing →P.67

- **G View Settings**

Displays the **E Print Target** setting values.

You can view and change the order of **E Print Target** setting values.

- View Settings Dialog Box for the Printing Application →P.193

Configuration using **Advanced Settings**

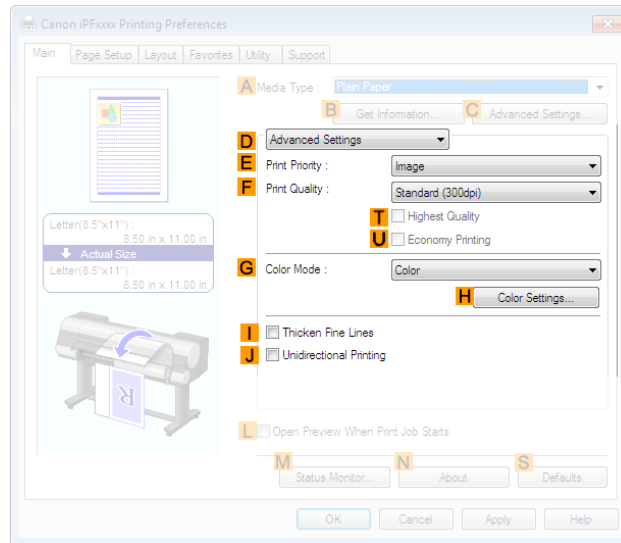

- **E Print Priority**

Choose the graphic elements that you want to emphasize for printing.

- Giving Priority to Particular Graphic Elements and Colors for Printing →P.67

- **F Print Quality**

Choose the level of print quality.

- Giving Priority to Particular Graphic Elements and Colors for Printing →P.67

- **T Highest quality**

If you select this option, the document will be printed with enhanced quality at the highest resolution. Compared to the other options, more time and ink are consumed in printing, however you will attain print results with the highest quality.



Note

- If you set **F Print Quality** to **High**, you can select **T Highest quality**. However, depending on **A Media Type** and **E Print Priority**, you may not be able to select **T Highest quality**.

- **U Economy Printing**

If you select this option, you can print with less ink consumed. However, print quality is lower than in regular printing.

Select this option to save ink, such as when printing to check drawings. Depending on the settings of **A Media Type** and **F Print Quality**, you may not be able to select this option.



Note

- If you set **F Print Quality** to **Fast**, you can select **U Economy Printing**. However, depending on **A Media Type** and **E Print Priority**, you may not be able to select **U Economy Printing**.

• **G Color Mode**

Choose the color mode.

- Giving Priority to Particular Graphic Elements and Colors for Printing →P.67



Note

- Depending on the **A Media Type** setting, some **G Color Mode** options may not be available.

• **H Color Settings**

Click to display the **Color Settings** dialog box for more advanced color settings.

- Adjusting the Color in the Printer Driver →P.60

• **I Thicken Fine Lines**

Activate this option to print fine lines more distinctly.

• **J Unidirectional Printing**

Select this checkbox to prevent problems such as misaligned lines and improve the print quality. However, the printing speed becomes slower.

Paper Information on Printer Dialog Box

On the **Paper Information on Printer** dialog box, you can obtain information on the paper in the printer and configure printer driver settings for the paper source and media type.

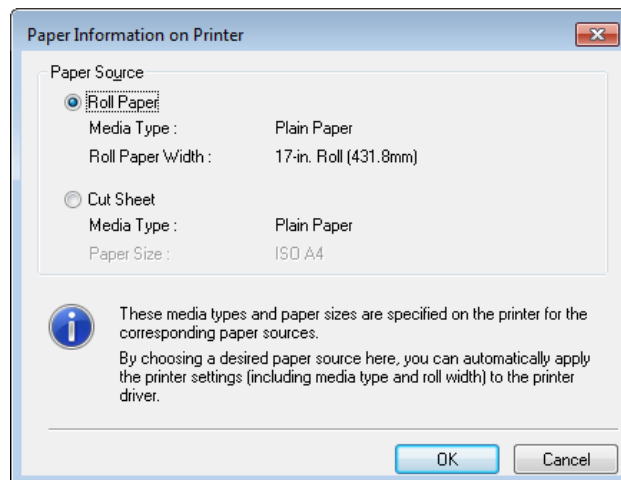

Note

- To display the **Paper Information on Printer** dialog box, on the **Main** sheet, click **Get Information by Media Type**. (See "Main Sheet" →P.188)

• **A Paper Source**

Shows the paper source supported by the printer, as well as information about the loaded paper. To update the paper source and media type settings in the printer driver, select the desired **Paper Source** option and click **OK**.

Paper Detailed Settings Dialog Box

In the **Paper Detailed Settings** dialog box, you can set **Drying Time** for the paper selected with **Media Type** of the **Main** sheet, etc.

You can display this dialog box by clicking **Settings of Media Type** on the **Main** sheet. (Refer to "Main Sheet →P.188".)

As for the items for which you can select **Printer Default** in this dialog box, you also can set them from the control panel of the printer. (Refer to "Menu Settings →P.675".)

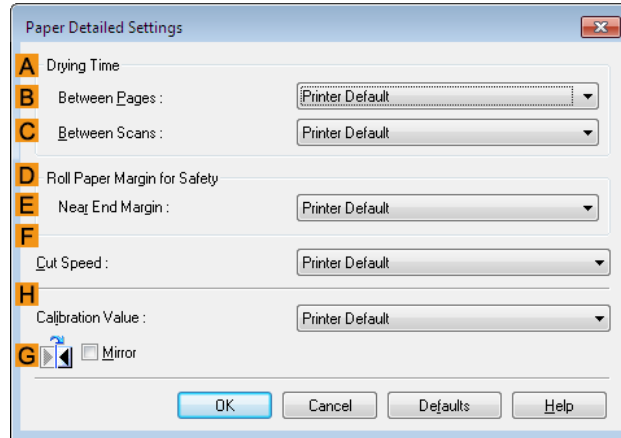

A Drying Time

Specify the time that the printer waits for ink to dry, as needed. The **Drying Time** setting is only valid for rolls.

- B Between Pages**

You can set the time to wait after printing 1 document page until ejecting the paper. Since waiting time is required for ink to dry before a roll is cut, you can deliver paper in the Output Stacker with the ink dried even if **Cutting Mode** is set to **Automatic**.

Setting Item	Details
Printer Default	The setting of the control panel of the printer is applied.
Off	Paper is ejected immediately after printing completes.
30 sec. / 1 min. / 3 min. / 5 min. / 10 min. / 30 min. / 60 min.	Paper is ejected when the set time elapses after printing completes.

- C Between Scans**

You can set the time to wait after printing 1 line on a page until printing the next line. Set this to avoid bleeding or color unevenness such as when bleeding occurs on a page or when color unevenness occurs during borderless printing.

Setting Item	Details
Printer Default	The setting of the control panel of the printer is applied.
Off	The next line is printed immediately after a line is printed.
1 sec. / 3 sec. / 5 sec. / 7 sec. / 9 sec.	The next line is printed when the set time elapses after a line is printed. * Increase the time according to the occurrence condition of bleeding or unevenness.

D Roll Paper Margin for Safety

You can specify the length of a margin on the leading edge of paper to ensure that paper susceptible to curling is held firmly against the Platen.

- E Near End Margin**

Specify the length of the **Near End Margin** (the leading edge margin) of the roll, as needed.

Setting Item	Details
Printer Default	The setting of the control panel of the printer is applied.
5 mm (0.2 in)	The document is printed in the standard size. * Select this when you do not have any problems in printing.
20 mm (0.8 in)	Select this when rubbing against the printhead occurs such as when using paper that tends to curl.

F Cut Speed

Select the speed of automatic cutting, as needed. You can adjust this setting if paper is not cut well when automatic cutting is used.

Setting Item	Details
Printer Default	The setting of the control panel of the printer is applied.
High Speed	When the Standard setting does not result in cutting the surface cleanly, select this.
Standard	Select this when you do not have any problems in automatic cutting.
Low Speed	This helps prevent adhesive from sticking to the cutter and keeps the cutter sharp if you select it when using adhesive paper.

H Calibration Value

You can specify whether to apply the results of calibration performed on the printer to image processing.

Setting Item	Details
Printer Default	The setting of the control panel of the printer is applied.
Enabled	Print using the calibration results.
Disabled	Print without using the calibration results. Select this to avoid the changing of the color of images during printing by color calibration.

G Mirror

Specify whether to print a mirror image, as needed. Select this option to print a version of the document or image with the left and right sides inverted.

View Settings Dialog Box for the Printing Application

In the **View Settings** dialog box, you can check details of the selected printing application.

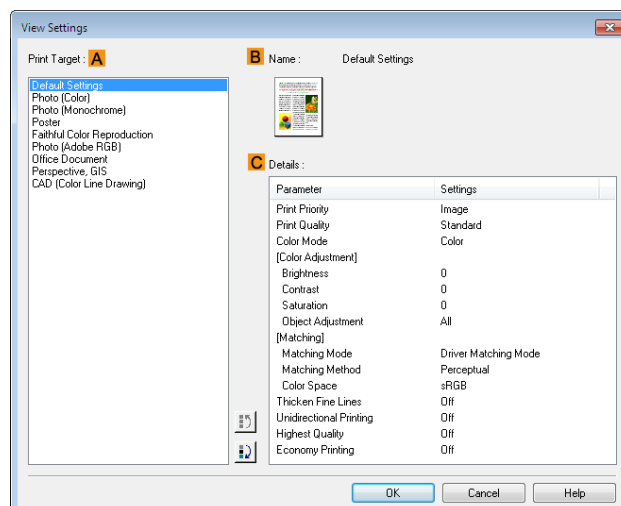



Note

- To display the **View Settings** dialog box, on the **Main** sheet, click **View Settings** by **Print Target**.(See "Main Sheet →P.188 ")

- A Print Target**

Shows all **Print Target** options (settings items for the printing application).

- B Name**

Identifies the item selected in **Print Target** by its name and an icon.

- C Details**

Here, you can confirm detailed settings values for each listed item for the selected **Print Target**.

Color Adjustment Sheet: Color

If the color tone as printed is not as you expected, you can adjust it on the **Color Adjustment** sheet.

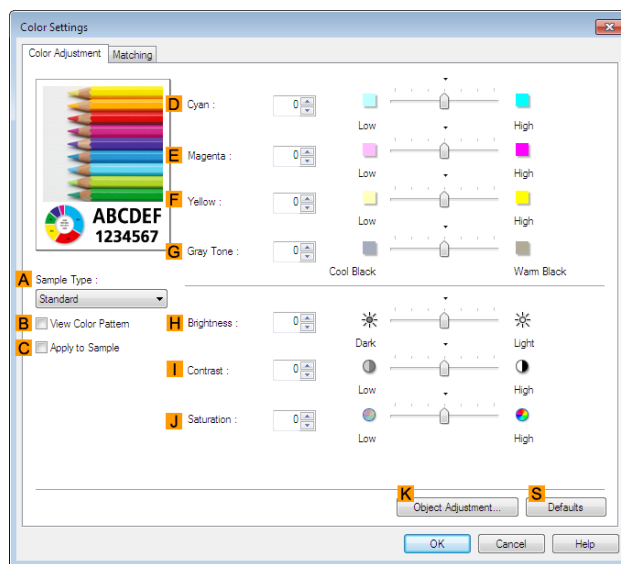

Note

- To display the **Color Adjustment** sheet, on the **Main** sheet, click **Color Settings** by **Color Mode** in **Advanced Settings**.(See "Main Sheet →P.188 ")

- A Sample Type**

Choose a sample image from **Standard**, **Portrait**, **Landscape**, or **Graphics**.

- B View Color Pattern**

Select this checkbox to display the color pattern.

- C Apply to Sample**

Select this checkbox to apply the changed settings to the sample image.

- D Cyan / E Magenta / F Yellow**

Fine-tune color tones by adjusting the levels of each color.

- G Gray Tone**

Adjust the color tone of grays as desired. Choose **Cool Black** (tinged with blue) or **Warm Black** (tinged with red).

- **H Brightness**

Adjust the overall image brightness as desired. You can adjust the brightness if the printed document is lighter or darker than the original image (that is, the original photo that was scanned or the original graphic as it appears on the computer screen).

- **I Contrast**

Adjust the contrast of the darkest and lightest portions relative to each other, as desired. Increasing the **Contrast** makes images sharper, and reducing the **Contrast** softens images.

- **J Saturation**

Adjust the color intensity as desired. Increasing the **Saturation** setting makes colors more vivid, and reducing the **Saturation** makes colors more subdued.

- **K Object Adjustment**

Select this option to display the **Object Adjustment** dialog box, in which you can specify objects subject to color adjustment.

- Object Adjustment Dialog box: Color →P.195

- **S Defaults**

Click to restore all settings on the sheet to the default values.



Note

- For details on settings items, see "Adjusting the Color in the Printer Driver →P.60 "

Object Adjustment Dialog box: Color

In the **Object Adjustment** dialog box, you can specify what type of print jobs to apply color adjustment to. If an original comprises images, graphics, and text, you can specify which portion to apply color adjustment to.

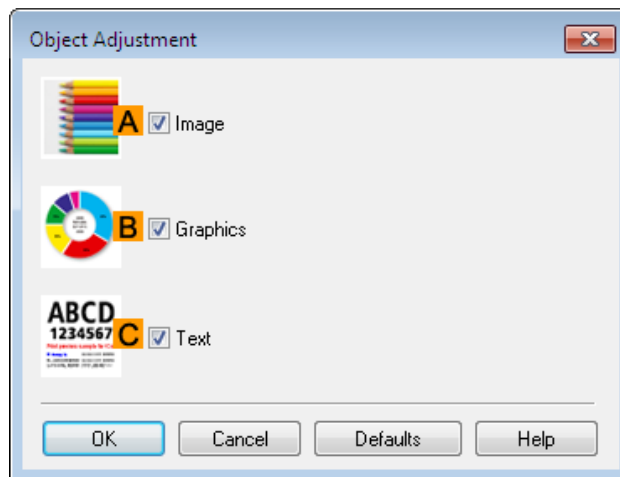

Note

- To display the **Object Adjustment** dialog box, click **Object Adjustment** on the **Color Adjustment** sheet.

- **A Image**

Select this option to apply color adjustment to image areas, such as photos.

- **B Graphics**

Select this option to apply color adjustment to graphics, such as lines and circles.

- **C Text**

Select this option to apply color adjustment to text.

Matching Sheet

On the **Matching** sheet, you can specify color matching to compensate for differences in the appearance of colors on various devices.



Important

- If **No color correction** is selected under **Color Mode**, the **Matching** sheet is not displayed.



Note

- To display the **Matching** sheet, on the **Main** sheet, click **Color Settings** in **Color Mode** in **Advanced Settings**, and then click the **Matching** sheet. (Refer to "Main Sheet →P.188 ")

Driver Matching Mode

The following options are available when you select **Driver Matching Mode** in the **A Matching Mode** list.

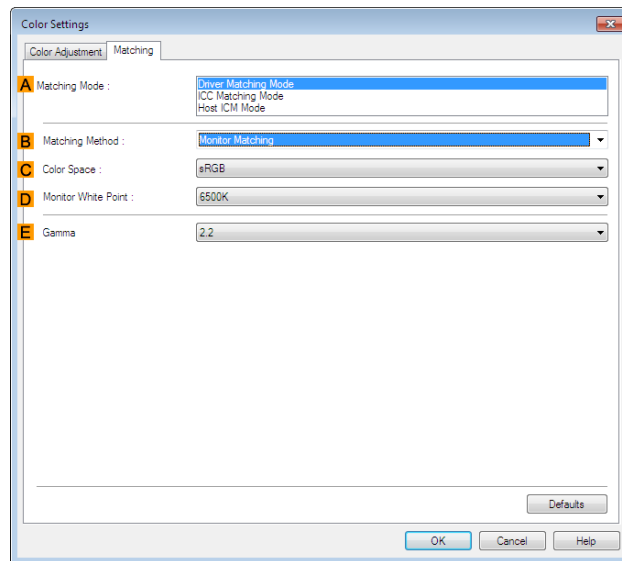

• A Matching Mode

Select the color matching mode to use, as desired.

Normally, select **Driver Matching Mode**. For color matching based on ICC profiles, select **ICC Matching Mode** or **Host ICM Mode**, depending on your color matching system.

• B Matching Method

Select the color matching method that suits the document to be printed. Various **Matching Method** options are available depending on your selection in **Matching Mode**.

• C Color Space

Select the applicable color space as desired.

• D Monitor White Point

Enter the color temperature set on the monitor.

Displayed when the **B Matching Method** is set to **Monitor Matching**.

• E Gamma

You can adjust the gradation of intermediate tones in an image.

2.2 is normally selected. If you want a softer impression than **2.2**, select **1.8**.

ICC Matching Mode and Host ICM Mode

The following options are available when you select **ICC Matching Mode** or **Host ICM Mode** in the **A Matching Mode** list.

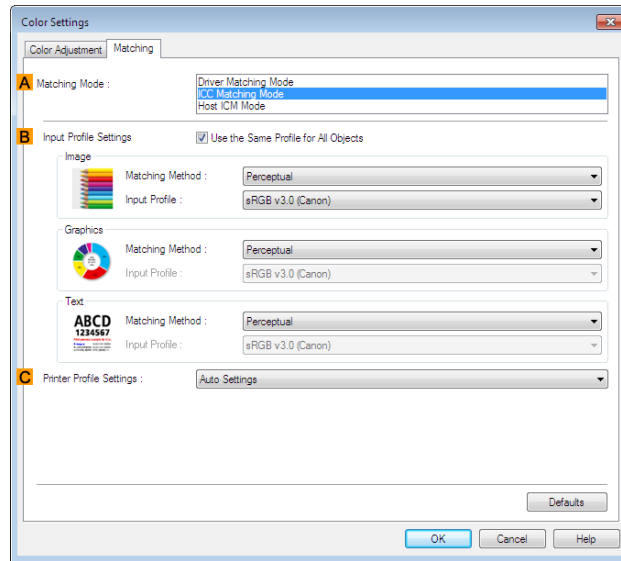

- **A Matching Mode**

Select the color matching mode to use, as desired.

- **B Input Profile Settings**

You can select **Image**, **Graphics**, or **Text**. You can choose **Matching Method** and **Input Profile**. Various options are available depending on your selected **Matching Mode**.

To apply the same input profile automatically for **Graphics** and **Text**, select **Use the Same Profile for All Objects**. To apply separate input profiles to **Graphics** and **Text**, clear **Use the Same Profile for All Objects** and specify the individual settings.

- **C Printer Profile Settings**

Specify the printer profile as desired. Normally, select **Auto Settings**.

We recommend that you select an ICC profile created using commercially available profile creation software in order to perform color management accurately on paper other than genuine Canon paper and feed confirmed paper. The created ICC profile needs to be saved in the following folder on the computer you are using.

C:\Windows\system32\spool\drivers\color folder



Note

- C: may vary according to the user environment.



Note

- For details on settings items, see "Adjusting the Color in the Printer Driver." →P.60

Color Adjustment Sheet: Monochrome

On the **Color Adjustment** sheet for monochrome printing, you can adjust the brightness and contrast.

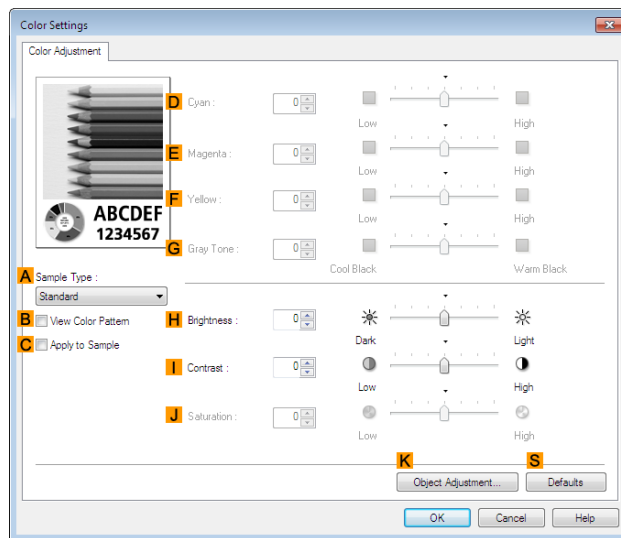

- To display the **Color Adjustment** sheet, on the **Main** sheet, click **Color Settings** by **Color Mode** in **Advanced Settings**. (See "Main Sheet" →P.188")

• A Sample Type

Choose a sample image from **Standard**, **Portrait**, **Landscape**, or **Graphics**.

• B View Color Pattern

Select this checkbox to display the color pattern.

• C Apply to Sample

Select this checkbox to apply the changed settings to the sample image.

• D Cyan / E Magenta / F Yellow

Not available.

• G Gray Tone

Not available.

• H Brightness

Adjust the overall image brightness as desired. You can adjust the brightness if the printed document is lighter or darker than the original image (that is, the original photo that was scanned or the original graphic as it appears on the computer screen).

• I Contrast

Adjust the contrast of the darkest and lightest portions relative to each other, as desired. Increasing the **Contrast** makes images sharper, and reducing the **Contrast** softens images.

• J Saturation

Not available.

• K Object Adjustment

Select this option to display the **Object Adjustment** dialog box, in which you can specify objects subject to color adjustment.

- Object Adjustment Dialog box: Monochrome →P.199

- **S Defaults**

Click to restore all settings on the sheet to the default values.



Note

- For details on settings items, see "Adjusting the Color in the Printer Driver →P.60 "

Object Adjustment Dialog box: Monochrome

In the **Object Adjustment** dialog box, you can specify what type of print jobs to apply color adjustment to. If an original comprises images, graphics, and text, you can specify which portion to apply color adjustment to.

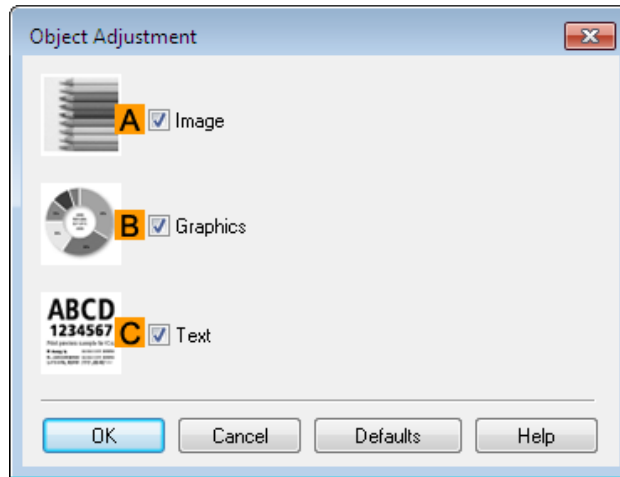

Note

- To display the **Object Adjustment** dialog box, click **Object Adjustment** on the **Color Adjustment** sheet.

- **A Image**

Select this option to apply color adjustment to image areas, such as photos.

- **B Graphics**

Select this option to apply color adjustment to graphics, such as lines and circles.

- **C Text**

Select this option to apply color adjustment to text.

Gray Adjustment Sheet

On the **Gray Adjustment** sheet, you can adjust the color balance, brightness, contrast, and other image qualities.

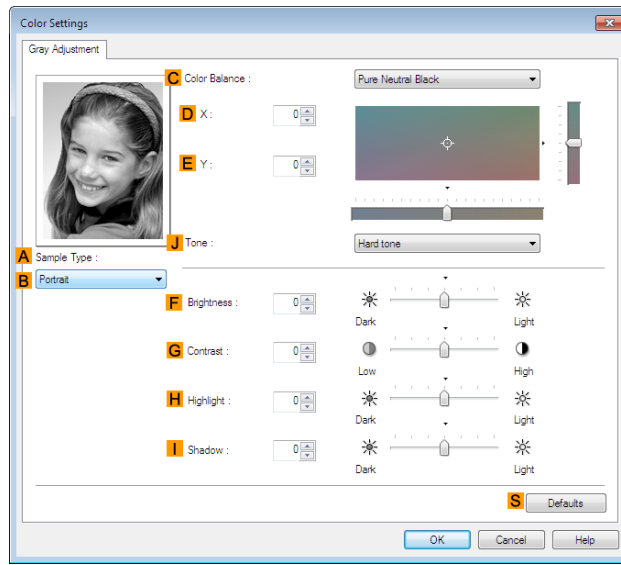

Note

- To display the **Gray Adjustment** sheet, on the Main Sheet →P.188, select **Monochrome (Photo)** by **Color Mode** in **Advanced Settings**, and then click **Color Settings**.
- Monochrome (Photo)** is not available for all types of paper.

• A Sample Type

The image at left is updated to reflect any changes you make to setting items on the sheet, enabling you to check the results of adjustment.

• B Sample List

Select a sample image, as desired.

• C Color Balance

Click the list to select a color balance that suits the printing application.

• DX / EY

Adjust the color balance as you check the color tone in the adjustment area.

You can adjust the square area in the center by clicking or dragging it.

Drag the vertical or horizontal scroll bars for adjustment, as desired.

You can click the arrows by the **DX** (horizontal) and **EY** (vertical) boxes or enter the values directly.

• J Tone

You can adjust the brightness of intermediate tones in an image. Selecting **Hard tone** gives a hard impression with more definition. Selecting **Soft tone** gives a soft impression.

• F Brightness

Adjust the overall image brightness as desired. You can adjust the brightness if the printed document is lighter or darker than the original image (that is, the original photo that was scanned or the original graphic as it appears on the computer screen).

• G Contrast

Adjust the contrast of the darkest and lightest portions relative to each other, as desired. Increasing the **Contrast** makes images sharper, and reducing the **Contrast** softens images.

- **H Highlight**

Adjust the brightness of the lightest portion.

- **I Shadow**

Adjust the brightness of the darkest portion.

- **S Defaults**

Click to restore all settings on the sheet to the default values.

Page Setup Sheet

The following settings are available on the **Page Setup** sheet. For details on settings items, refer to the printer driver help file.

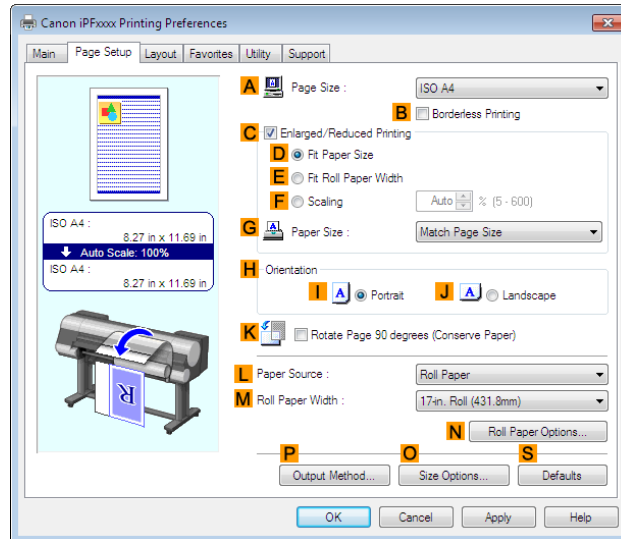

- **A Page Size**

Select the page size as specified in the source application.

For details on available page sizes, see "Paper Sizes →P.530 "

- **B Borderless Printing**

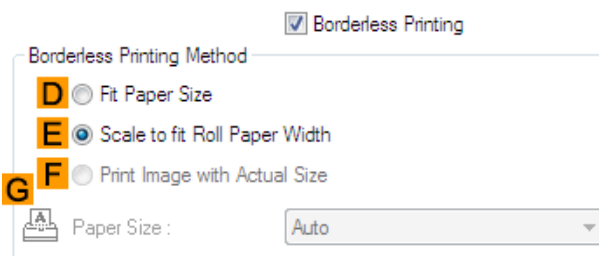

Borderless printing is available if roll paper is selected in the **L Paper Source** list. Choose from the following options when this setting is activated.

- Borderless Printing on Paper of Equivalent Size →P.101
- Borderless Printing by Resizing Originals to Fit the Roll Width →P.107
- Borderless Printing at Actual Size →P.95

- **D Fit Paper Size**

Scales the document image to match the paper size.

- **E Scale to fit Roll Paper Width**

Scales the document image to match the roll width.

- **F Print Image with Actual Size**

Prints documents at their actual size. This function is available when you have selected the size same as the width of **Roll Paper** for either the length or width of the document from the **A Page Size** list.

- **G Paper Size**

Available when **D Fit Paper Size** is selected.

Choose the size of the paper you will print on.

For details on available paper sizes, see "Paper Sizes →P.530 "

Paper sizes compatible with borderless printing are shown in the list.

- **C Enlarged/Reduced Printing**

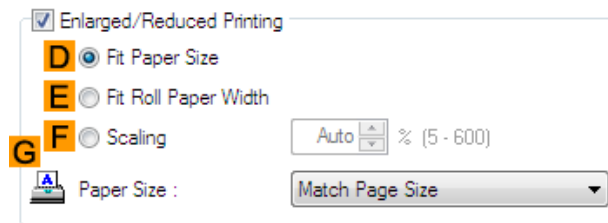

Choose from the following options when this setting is activated.

- Resizing Originals to Match the Paper Size →P.74
- Resizing Originals to Fit the Roll Width →P.78
- Resizing Originals by Entering a Scaling Value →P.84

- **D Fit Paper Size**

Scales the document image to match the paper size.

- **E Fit Roll Paper Width**

Scales the document image to match the roll width.

- **F Scaling**

Resizes the document image based on a specified scaling value. Enter a value in a range of **5–600**.

- **G Paper Size**

Choose the size of the paper you will print on.

For details on available paper sizes, see "Paper Sizes →P.530 "

- **H Orientation**

Choose the printing orientation.

- Making the Original Orientation Match the Paper Orientation →P.168

- **K Rotate Page 90 degrees (Conserve Paper)**

Activate this setting to rotate the document image by 90 degrees before printing.

- Conserving Roll Paper by Rotating Originals 90 Degrees →P.154

- **L Paper Source**

Choose the feed source, as desired.

Options displayed in the list vary depending on the selection in **Media Type** on the **Main** sheet.

- **M Roll Paper Width**

Choose the roll width.

For details on available roll widths, see "Paper Sizes [→P.530](#) "

• **N Roll Paper Options**

Complete optional roll paper settings. Click to display the **Roll Paper Options** dialog box.

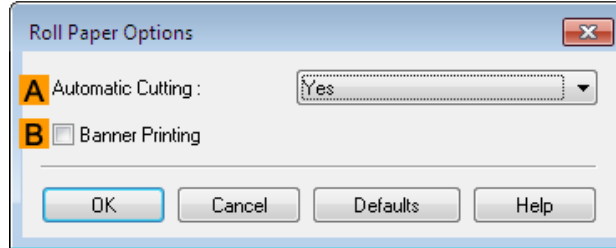

Under **A Automatic Cutting**, you can specify **Yes** or **No** and **Print Cut Guideline**.

- Cutting Roll Paper After Printing [→P.173](#)

Select **B Banner Printing** when printing multiple pages continuously.

- Printing Multiple Pages Continuously [→P.131](#)

• **P Output Method**

Click to display the **Output Method** dialog box, which enables you to complete the **Output Method** and **Name of data to be saved** settings.

- Output Method Dialog box [→P.204](#)

• **O Size Options**

Click to display the **Paper Size Options** dialog box, which enables you to register additional paper sizes or select the size system for use.

- Paper Size Options Dialog Box [→P.205](#)

• **S Defaults**

Restores all settings on the sheet to the default values.

Output Method Dialog box

The **Output Method** dialog box allows you to select the **Output Method** and set the save settings when saving to the box.

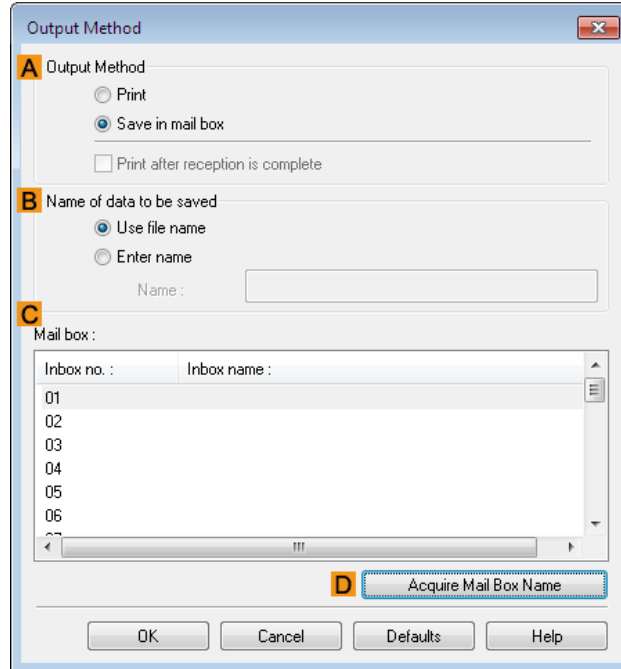

- To display the **Output Method** dialog box, on the **Page Setup** sheet, click **Output Method**. (Refer to "Page Setup Sheet →P.201")

• **A Output Method**

If **Print** is selected, the print job is saved to the printer hard disk after printing has finished.

If **Save in mail box** is selected, the print job is saved to the printer hard disk. If you choose **Save in mail box**, also specify the destination personal box in the **Mail box** list.

If **Print after reception is complete** is checked, you can prevent degradation of print quality that occurs when receiving a print job is interrupted and printing is aborted in the middle.

These can be selected as **Print** options.

• **B Name of data to be saved**

To use the file name, choose **Use file name**.

Otherwise choose **Enter name** and enter a name in **Name**.

• **C Mail box**

Displays a list of mail boxes. If you choose **Save in mail box**, also specify the destination personal box from the list.

• **D Acquire Mail Box Name**

When this is clicked, the box name acquired from the printer main unit is displayed in **Mail box**.

Paper Size Options Dialog Box

In the **Paper Size Options** dialog box, you can create and register your own Custom Paper Size. The sizes you define are listed with standard paper sizes for selection later as needed.

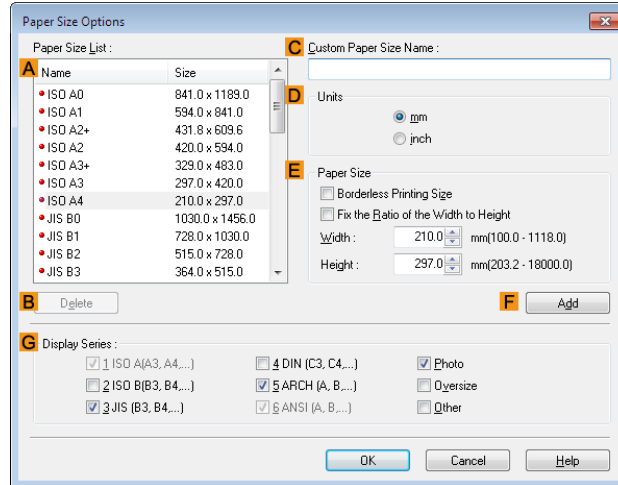

Important

- You cannot create any arbitrary roll paper width as a Custom Paper Size.
- If you select a **Paper Size** from **Paper Size Options**, load paper of a size equal to or larger than the **Paper Size Options** into the printer. If the size of the loaded paper is smaller than the **Paper Size Options**, an incomplete output image may be printed.



Note

- To display the **Paper Size Options** dialog box, on the **Page Setup** sheet, click **Paper Size Options**. (See "Page Setup Sheet.") →P.201

• **A Paper Size List**

Shows the names and sizes of paper that can be used with the printer driver.

• **B Delete**

Custom paper sizes created by users can be deleted from the **A Paper Size List**, as needed. However, they cannot be deleted in the following situations.

- If a standard paper size of the printer driver is selected.
- If an oversized paper size is selected.
- If a paper size marked with a red circle is selected.

• **C Custom Paper Size Name**

You can name Custom Paper Size as desired.

• **D Units**

Specify the desired unit of measure for the Custom Paper Size height and width.

• **E Paper Size**

Specify the desired **Width** and **Height**. You can make your selection from sizes that are compatible with **Borderless Printing** by selecting **Borderless Printing Size**. To maintain the aspect ratio of the **Width** and **Height** as you resize the paper, select **Fix the Ratio of the Width to Height**.

• **F Add**

Enables you to register the custom paper size you have specified or overwrite an existing custom paper size.

• **G Display Series**

You can limit the number of options shown in **Page Size**, **Paper Size**, and **Paper Size List**.

Layout Sheet

The following settings are available on the **Layout** sheet. For details on settings items, refer to the printer driver help.

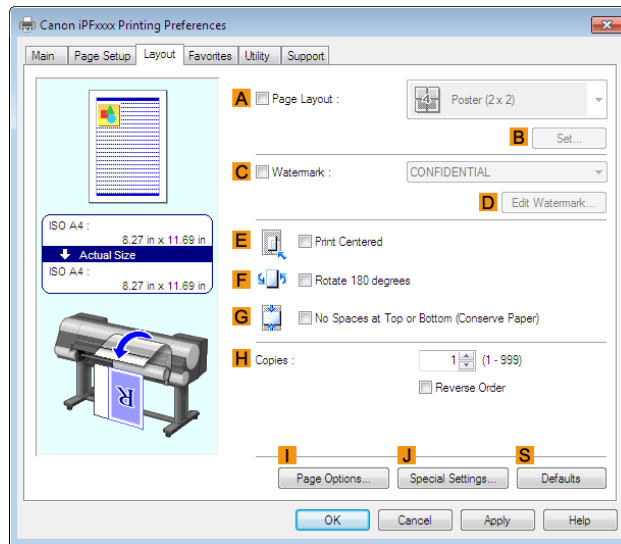

• **A Page Layout**

Activate this setting to select a particular page layout.

- Printing Multiple Pages Per Sheet →P.135
- Printing Posters in Sections →P.140
- Printing Multiple Originals Next to Each Other →P.127
- Using PosterArtist to Compose Originals →P.52

• **B Set**

Click to display one of the following dialog boxes depending on the selection in **A Page Layout**. In these dialog boxes, you can specify layout details and which pages to print, as well as other settings.

- **Page Layout Printing**
- **Pages to Print**
- **Free Layout Settings**

• **C Watermark**

Activating this option makes two settings available, **Watermarks** and **D Edit Watermark**.

- Printing With Watermarks →P.165
- **Watermarks**
Lists the provided watermarks. Choose the watermark to print.

• **D Edit Watermark**

Click to display the **Edit Watermark** dialog box for creating your own, original watermark.

• **E Print Centered**

Activate this setting to print document images in the center of the paper.

- Printing Originals Centered on Rolls →P.144
- Printing Originals Centered on Sheets →P.149

• **F Rotate 180 degrees**

Activate this option to rotate document images by 180 degrees before printing.

• **G No Spaces at Top or Bottom (Conserve Paper)**

Activate this setting to print the next image skipping blank areas above and below printable data in documents, which enables you to conserve the paper.

- Conserving Roll Paper by Printing Originals Without Top and Bottom Margins →P.158

• H Copies

Enter the number of copies to print, in a range of **1–999**.

- **Reverse Order**

Activate this option to print pages in reverse order.

• I Page Options

Click to display the **Page Options** dialog box, which enables you to complete settings for printing the user name, date, or page number in the header or footer.

- Page Options Dialog Box →P.207

• J Special Settings

If the printing results are not as you expected, click this option to change how printing is processed.

- Special Settings Dialog Box →P.208

• S Defaults

Click to restore all settings on the sheet to the default values.

Page Options Dialog Box

The **Page Options** dialog box offers the following settings.

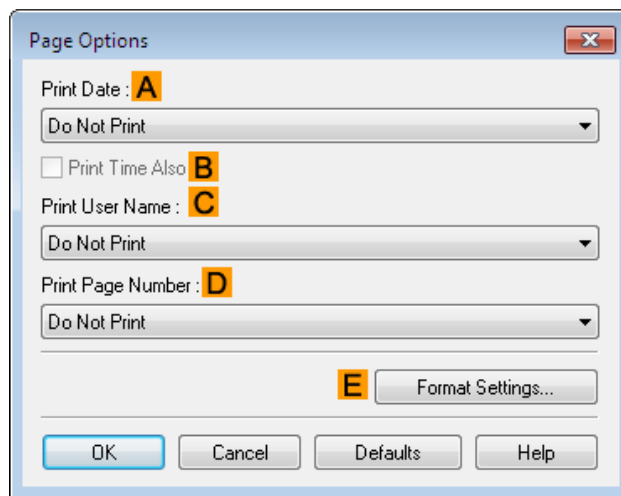

Note

- To display the **Page Options** dialog box, on the **Layout** sheet, click **Page Options**. (See "Layout Sheet →P.206 ")

• A Print Date

Select where the date is printed, as desired. To print the time as well, select **B Print Time Also**.

• C Print User Name

Select where the user name is printed, as desired.

• D Print Page Number

Select where the page number is printed, as desired.

• E Format Settings

Click to display the **Format Settings** dialog box, which enables you to complete format-related settings.

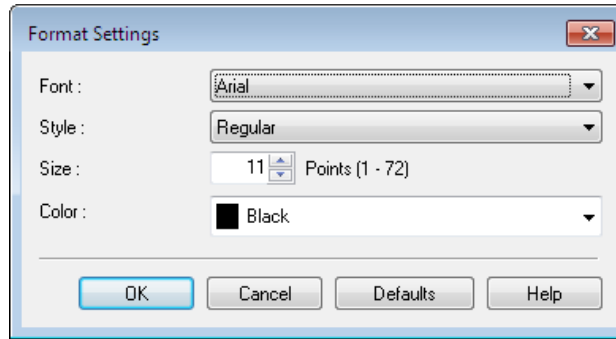

Note

- If you specify the same position for multiple items, the items are printed from left to right in this order: date, user name, and page number.
- When you print multiple pages per sheet using **Page Layout Printing** or similar functions, these items will be printed for each page.

Special Settings Dialog Box

If the printing results are not as you expected, you can change how printing is processed in the **Special Settings** dialog box.

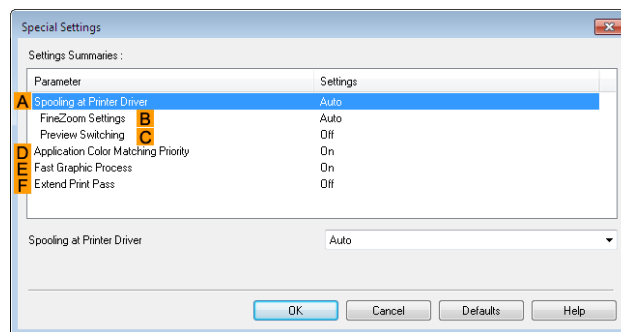

Note

- To display the **Special Settings** dialog box, on the **Layout** sheet, click **Special Settings**. (See "Layout Sheet.") →P.206
- Click the processing method for **Parameter** within the **Settings Summaries** frame to display a list of the setting details under the frame.

• A Spooling at Printer Driver

Sets whether or not print jobs are spooled in the printer driver and processed by PageComposer. Printing results may be improved in some cases by setting this to **No** or **No (EMF Spooling)**.



Note

- When set to **No** or **No (EMF Spooling)**, functions such as **Page Layout**, **Watermark**, **Reverse Order**, **Page Options**, **FineZoom Settings**, and **Preview Switching** can no longer be used.

• B FineZoom Settings

This function is used in large-format printing.

If it is set to **Yes**, problems in the printing may be improved.

If it is set to **No**, image distortions such as fine lines disappearing may be improved.

• C Preview Switching

When this setting is turned on, PageComposer starts when printing is performed with the **Open Preview When Print Job Starts** check box selected in the **Main** sheet.

- **D Application Color Matching Priority**

When this is on, you can give applications priority in color management.

- **E Fast Graphic Process**

Turning this setting on may help produce the expected results if image colors are inconsistent in printed documents or if lines are printed in varying thicknesses.



Note

- This function cannot be used on 64-bit version of Windows.

- **F Extend print pass**

Uneven printing that occurs when printing with the **Highest quality** check box selected in **Print Quality** may be improved by turning this setting on. However, this also reduces the printing speed.

Favorites Sheet

The following settings are available on the **Favorites** sheet. For details on settings items, refer to the printer driver help.

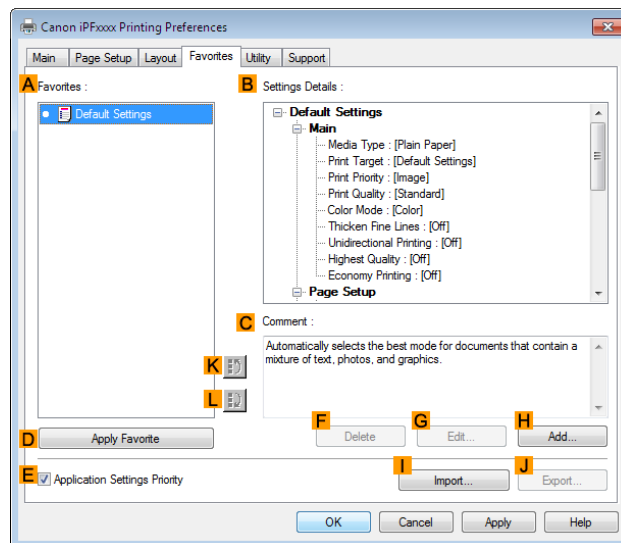

- **A Favorites**

Printing favorites you have created are listed with **Default Settings** favorites.

- Using Favorites →P.172

- **B Settings Details**

Displays details of the favorite selected in the **A Favorites**.

- **C Comment**

Displays notes registered in the favorite.

- **D Apply Favorite**

Click to change the current print settings to those of the favorite selected in the **A Favorites**.

- **E Application Settings Priority**

Activate this setting to use settings values specified in the source application in preference to favorite settings selected in the **A Favorites**, when clicking **D Apply Favorite**. For details on the settings items used in preference, refer to the printer driver help.

- **F Delete**

Click to delete the selected favorite from the **A Favorites** list.

- **G Edit**

Click to display the **Edit** dialog box, which enables you to change the name and icon for the favorite selected in the **A Favorites** list.

- **H Add**

Click to display the **Add** dialog box, which enables you to add the current print settings as a favorite.

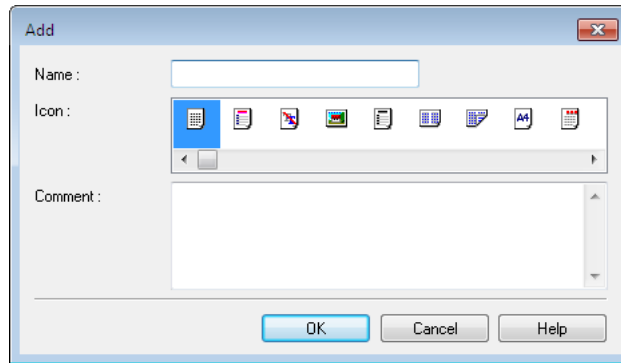

- **I Import**

Click to display the **Open** dialog box, which enables you to import favorite settings saved as a file.

- **J Export**

Click to display the **Save As** dialog box, which enables you to save the favorite settings as a file.

- **K Up**

Click to move the selected favorite up in the **A Favorites** list.

- **L Down**

Click to move the selected favorite down in the **A Favorites** list.

Utility Sheet

The following items can be executed on the **Utility** sheet. For details on the utilities, refer to the relevant utility help.

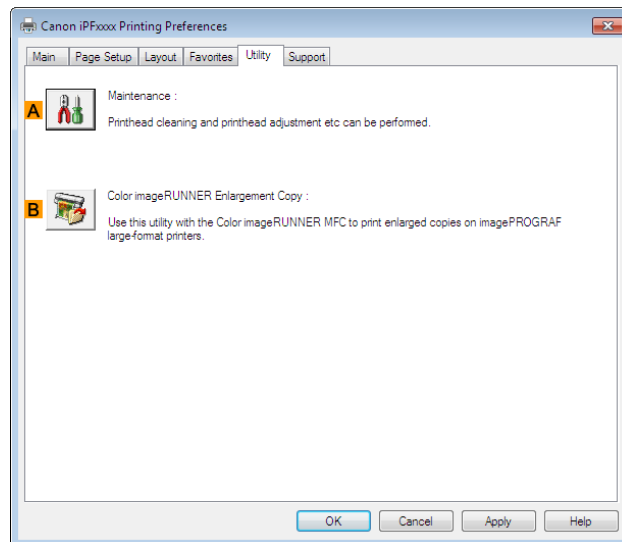

• **A Maintenance**

Click to start the imagePROGRAF Status Monitor, which offers the following maintenance for the printer.

- Nozzle (ink ejecting outlet) check
- Nozzle (ink ejecting outlet) cleaning
- Head alignment adjustment
- Feed amount adjustment

• **B Color imageRUNNER Enlargement Copy**

Click to launch Color imageRUNNER Enlargement Copy (iR enlargement copy), which enables you to create hot folders used for Color imageRUNNER Enlargement Copy and assign print settings to hot folders.

- Printing Enlargements of Scanned Originals from a Color imageRUNNER →P.255

For details, see Color imageRUNNER Enlargement Copy →P.246 .

Support Sheet

On the **Support** sheet, you can view support information and the user's manual.

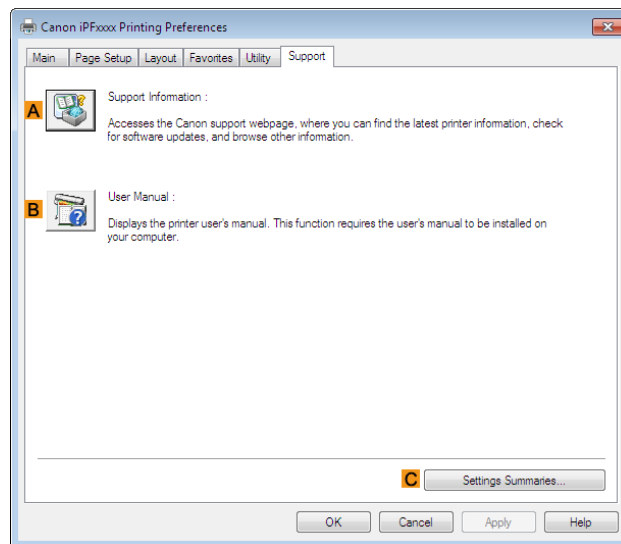

• **A Support Information**

Click to access the Canon support webpage, where you can find the latest information on the printer and consumables, check for printer driver updates, and browse other information.

• **B User Manual**

Click to view the printer user's manual. This function requires the user's manual to be installed on your computer.

• **C Settings Summaries**

Click to display the **View Settings** dialog box, which enables you to confirm the settings for the **Main**, **Page Setup**, **Layout**, and **Favorites** sheets.

Settings Summaries Dialog Box

The **Settings Summaries** dialog box enables you to confirm the settings for the **Main**, **Page Setup**, **Layout**, and **Favorites** sheets.

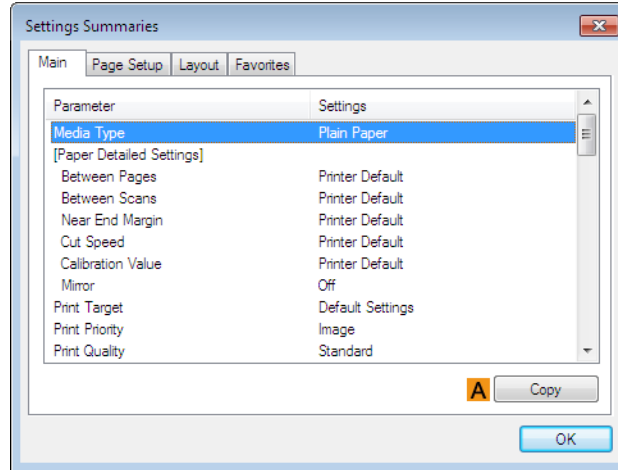

- **A Copy**

Click to copy the settings information to the clipboard. You can paste the settings information into a file created with a text editor or similar application.

Device Settings Sheet

Many settings items on the printer properties sheets are controlled by Windows applications. However, the **Device Settings** sheet is for configuring the printer, and it is an extension of the printer driver.

The following settings are available on the **Device Settings** sheet.

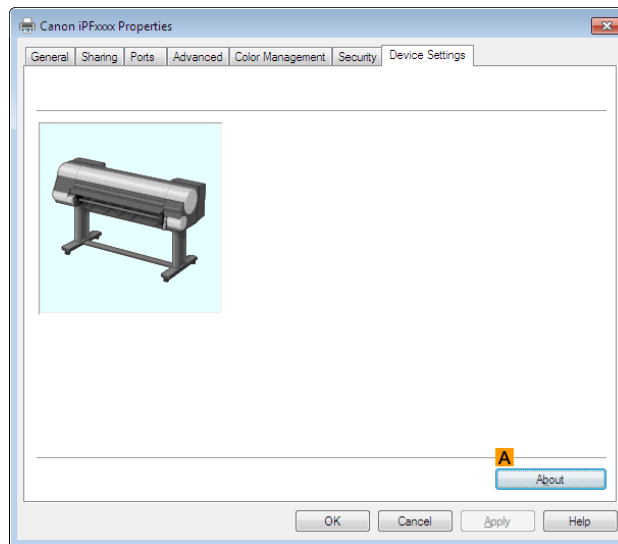

- **A About**

You can display version information for the printer driver.

Preview

- The Features of Preview 213
- Starting Preview 213
- Preview Main Window 214
- Dialog Area 216
- Enlarge/Reduce the screen display 217
- Moving a Page 217
- Using the ruler 217
- Priority setting for rotating 90 degrees 218
- Printing with Selecting the Layout 219
- Print on the Center 221
- Not Print Spaces at the Top/Bottom 222

The Features of Preview

The main features of Preview are as follows.

- While viewing this screen, you can adjust layout settings of a document created with application software.
- You can not only adjust layout settings but also your changes will be instantly applied on the preview screen, and you can print the preview screen as it is seen.

 • The media type, image size, detailed media settings, and the printer settings can cause the actual print output to differ from the Preview settings.

Starting Preview

Follow the procedure below to start the Preview.

- 1** Start the application software which you use.
- 2** From the application software's **File** menu, select the printer setup menu to open the **Print** dialog box.

 • Normally, select **Print** from the **File** menu.

- 3** On the **Main** sheet, click on the **Open Preview When Print Job Starts** check box.
Click the **OK** button to save the settings.

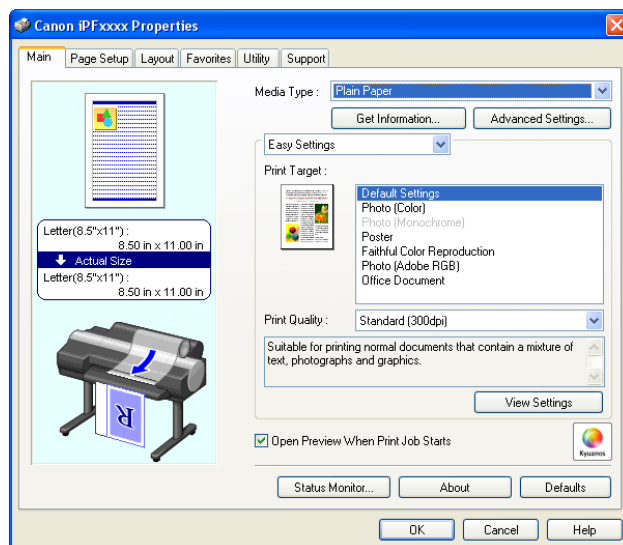



- Your printer is depicted in the lower-left area of this screen.

Note

4 On the **Print** dialog box in the application software, click the **Print** button.

5 Preview main window is displayed.

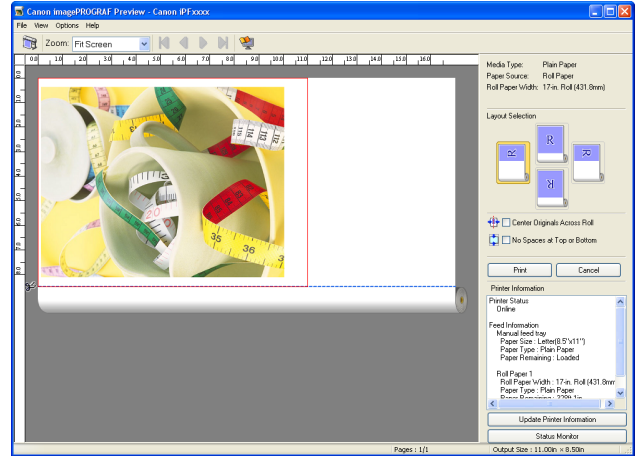

Preview Main Window

The Preview main window consists of the menu and tool bars, preview and dialog area and status bar.

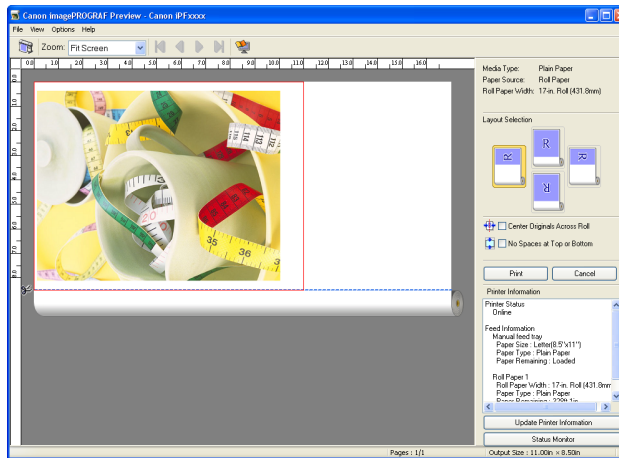

- You can use the **View** menu to show or hide the tool bar.

Note

• Menu Bar

This allows you to select menus required for operations.

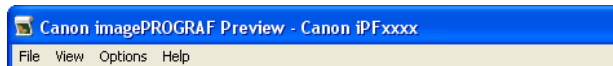

• Tool Bar

This allows you to select tool buttons required for major operations.



• Preview Area

You can check the settings you made in this area.

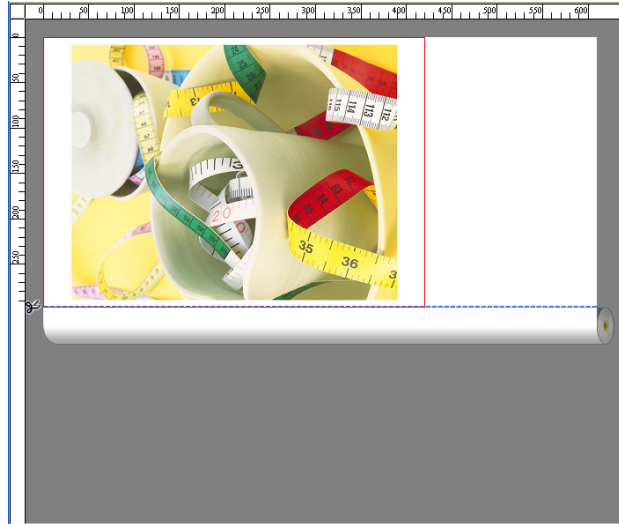

• Dialog Area

This allows you to set the print conditions and perform a print job.

For more information about Dialog Area, see "Dialog Area." →P.216

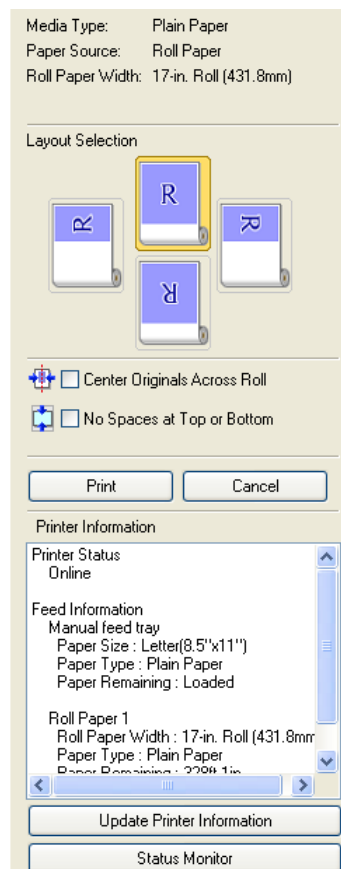

• Status Bar

This shows the message, Pages and Output Size.

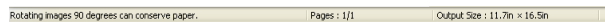

Dialog Area

You can select the layout and print on the center.

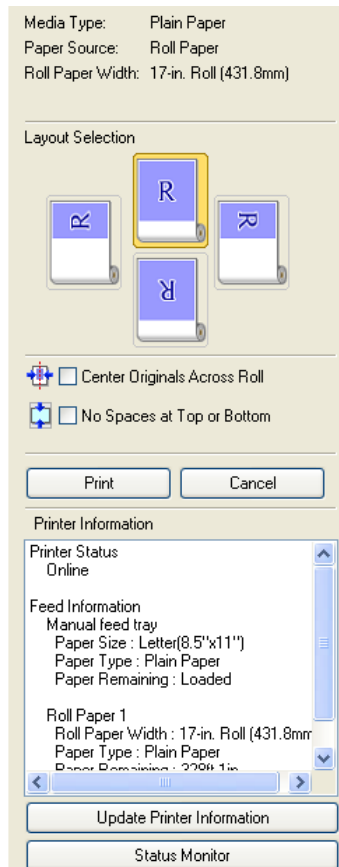

- **Media Type / Paper Source /Paper Size**

You can confirm the information that is set.

- **Layout Selection**

You can print which conserves paper by selecting the layout.

For more information about **Layout Selection**, see "Printing with Selecting the Layout." →P.219

- **Center Originals Across Roll**

You can print on the center of the media loaded in the printer.

For more information about **Center Originals Across Roll**, see "Print on the Center." →P.221



Note

- Available only if rolls are selected in **Paper Source**.

- **No Spaces at Top or Bottom**

You can save paper on not to feed roll paper for the empty spaces when the print data contains spaces at the top or bottom.

For more information about **No Spaces at Top or Bottom**, see "Not Print Spaces at the Top/Bottom." →P.222



Note

- Available only if rolls are selected in **Paper Source**.

- **Print Button**

Click the button to start printing.

- **Cancel Button**

Click the button to stop printing.

- **Printer Information**

You can confirm the information acquired from the printer.

- **Update Printer Information Button**

Click the button to update the printer information with connecting to the printer.

- **Status Monitor Button**

Click the button to start **Status Monitor**.

Enlarge/Reduce the screen display

You can enlarge or reduce the screen display when you select **Zoom** from the **View** menu.

Setting	Details
Fit Screen	Display all.
Fit to Width	Display to the width of the paper.
Reduce	Display at half of the standard size.
Standard	Display at the standard size.
Enlarge	Display with the double of the standard size.
Enlarge More	Display with the triple of the standard size.



Note

- This item can be selected even if you have clicked the ▼ button in the toolbar **Zoom**.

Moving a Page

You can move a page to display when you select **Go to Page** from the **View** menu.

Setting	Details
First Page	Go to the first page.
Previous Page	Go to the previous page.
Next Page	Go to the next page.
Last Page	Go to the last page.
Go To Page	Go to the specified page.



Note

- You can also move a page by clicking  on the tool bar.

Using the ruler

You can confirm the layout with using the ruler.

- **Switching the ruler Show/Hide**
In the **View** menu, select **Ruler** to switch the ruler Show/Hide.
- **Changing the ruler unit**
You can set the ruler unit when you select **Units** from the **View** menu.

Setting	Details
mm	Use mm as the ruler unit.

Setting	Details
inch	Use inches as the ruler unit.

Priority setting for rotating 90 degrees

You can select **Rotate 90 Degrees If Possible** or **Use Driver Settings** from the **Options** menu.

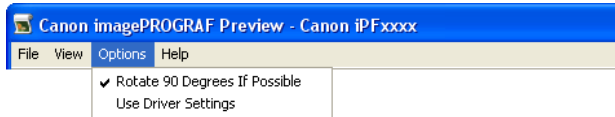

Setting	Details
Rotate 90 Degrees If Possible	Rotates pages in portrait orientation 90 degrees before printing. Pages are only rotated if they can fit lengthwise across the roll.
Use Driver Settings	Follows printer driver settings when determining whether to rotate pages.

Selecting **Rotate 90 Degrees If Possible** or Placing a checkmark for **Rotate Page 90 degrees (Conserve Paper)** on the printer driver

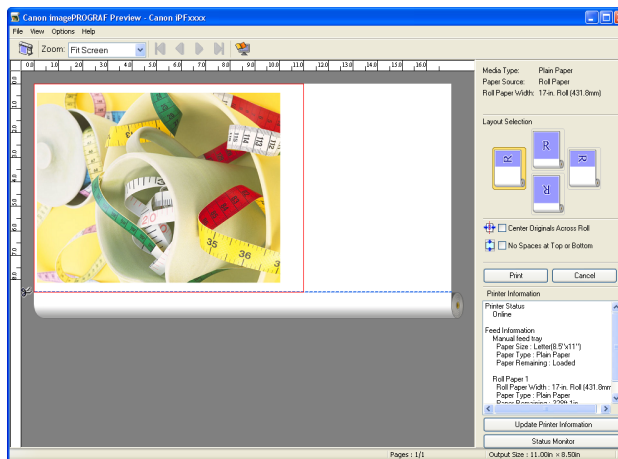

Selecting **Use Driver Settings**

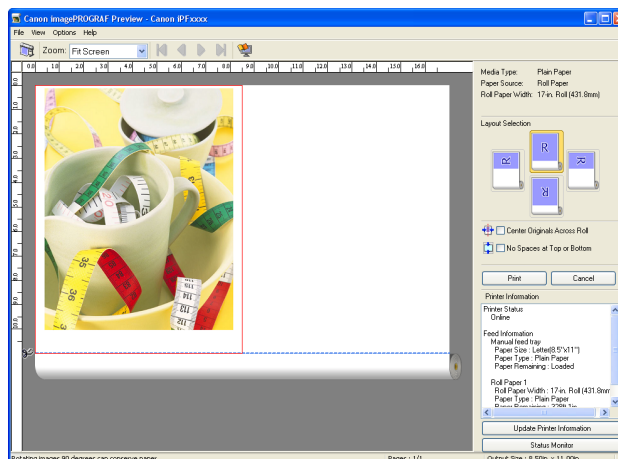





Printing with Selecting the Layout

You can print which conserves paper by selecting the layout.

1 In **Layout Selection**, click the layout button to use.





Button	Details
Upper Button	Turn at the position of 
Right Button	Turn at the position of 
Left Button	Turn at the position of 
Lower Button	Turn at the position of 

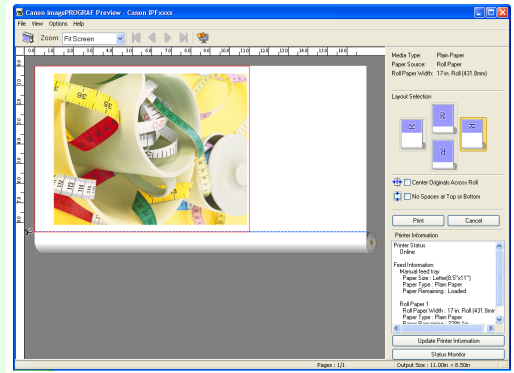

- **Right Button** or **Left Button** can be selected only when the rotated pages can fit lengthwise across the roll.
- Note** • By clicking **Right Button** or **Left Button**, you can save paper by printing in landscape orientation on roll paper.
- You can select only **Upper Button** or **Lower Button** if **Cut Sheet** is selected.



Button	Details
	The button is selected currently.
	The button can be selected.
	The button can not be selected.

2

Click the **Print** Button.

Printing on the selected layout begins.

Print on the Center

You can print on the center of the media loaded in the printer.

- 1 Click the **Center Originals Across Roll** check box on.

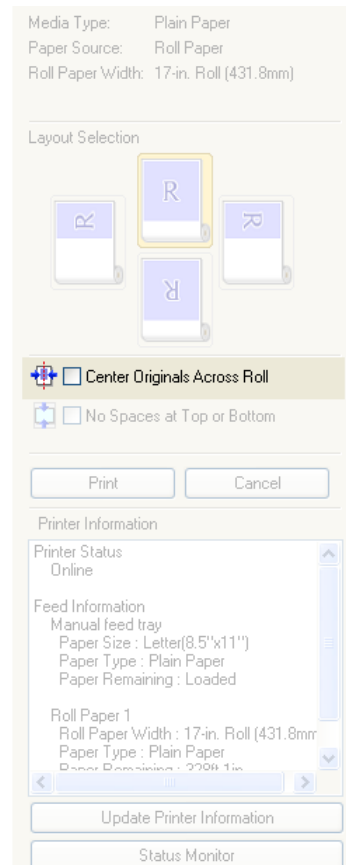

- 2 Click the **Print** button

Printing on the center begins.



Note

- Available only if rolls are selected in **Paper Source**.

Not Print Spaces at the Top/Bottom

You can save paper on not to feed roll paper for the empty spaces when the print data contains spaces at the top or bottom.

- 1 Click the **No Spaces at Top or Bottom** check box on.

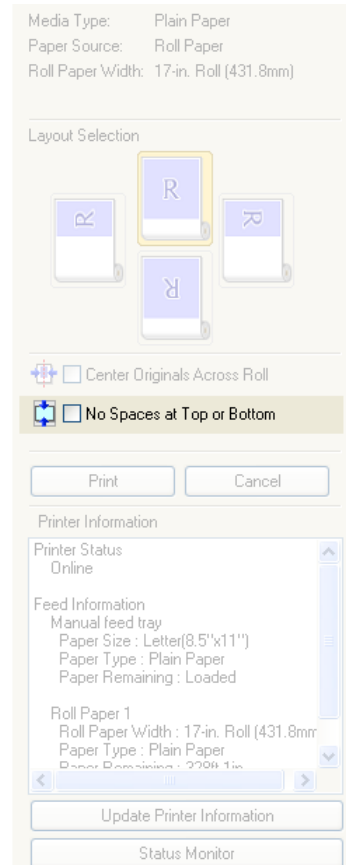

- 2 Click the **Print** button.

Printing on the settings with no spaces at top or bottom begins.

Free Layout

The Features of Free Layout	223
Starting Free Layout	223
Free Layout Main Window	225
Detailed Settings	226
Preferences Dialog Box	227
Page Options Dialog Box	228
Zoom Dialog Box	229
Format Dialog Box	229
Laying out a Multiple-File Document on One Page	231
Laying out a Document Created with Multiple Application Programs on One Page	233
Selecting an Object	236
Changing the Object Size	237
Moving an Object	238
Rotating an Object	238
Laying out Objects Automatically	238
Aligning Objects	239
Changing the Object Overlapping Order	240
Pasting a Copied or Cut Object	242
Folded Duplex Window	242
Finished Size Settings Dialog Box	243
Binding Settings Dialog Box	244
Prints using Folded Duplex	245

The Features of Free Layout

The main features of Free Layout are as follows.

- Allows you to lay out at will and print a document created with application software.
- You can not only lay out multiple pages on one page but also lay out and print a multiple-file document on one page, or lay out and print a document created with multiple application programs on one page.
- Any two pages can be arranged and printed in a layout that becomes duplex on folding.
This can be used such as for advertising posters that are suspended from the ceiling.

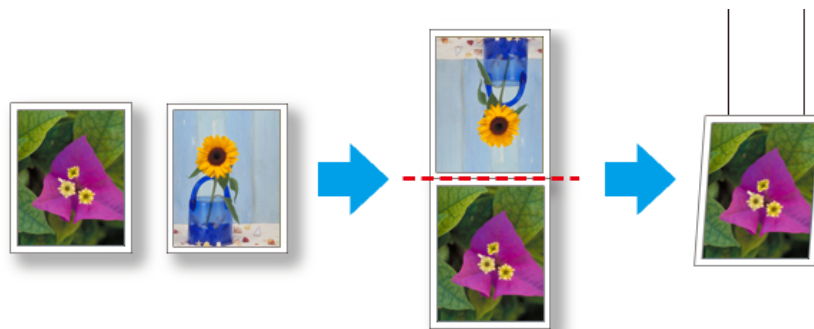

- The media type, image size, detailed media settings, and the printer settings can cause the actual print output to differ from the Free Layout settings.

Starting Free Layout

Follow the procedure below to start the Free Layout.

- 1 Start the application software which you use.

- 2** From the application software's **File** menu, select the printer setup menu to open the **Print** dialog box.



Note

- Normally, select **Print** from the **File** menu.

- 3** From the list, select the printer and select the **Layout** sheet.

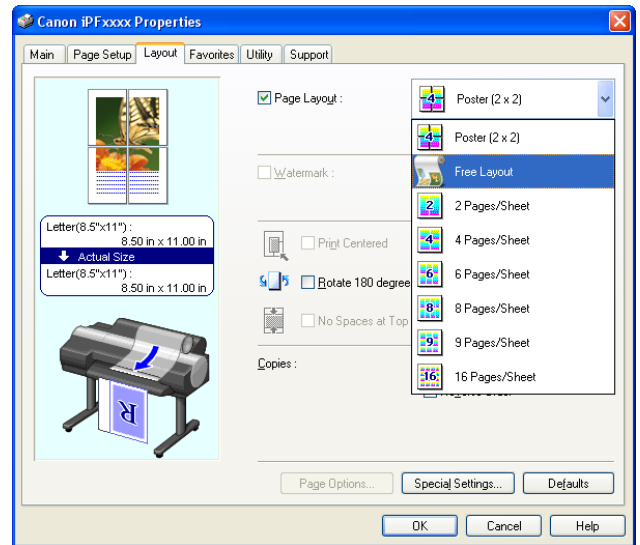

Note

- Your printer is depicted in the lower-left area of this screen.

- 4** In the **Layout** sheet, click on the **Page Layout** check box and select **Free Layout** from the list. Click the **OK** button to save the settings.



Note

- When you select **Free Layout**, all other setting items will be disabled.

- 5** On the **Print** dialog box in the application software, click the **Print** button. **Free Layout** main window is displayed.

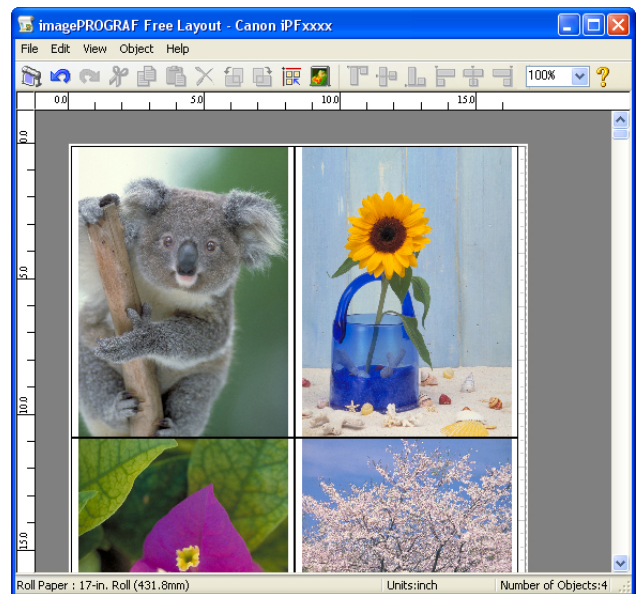

Free Layout Main Window

The Free Layout main window consists of the menu and tool bars, layout area and status bar.

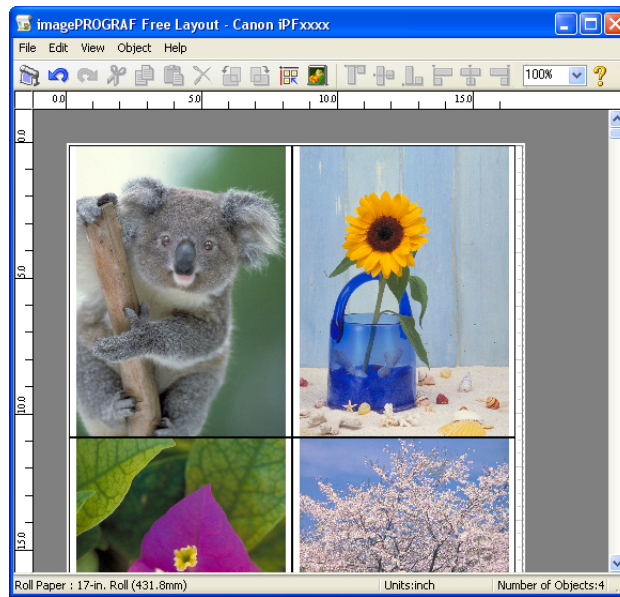

- You can use the **View** menu to show or hide the tool and status bar.

Note

• Menu Bar

This allows you to select menus required for operations.

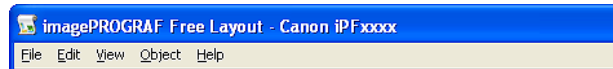

• Tool Bar

This allows you to select tool buttons required for major operations.



- **Layout Area**

This allows you to lay out objects and edit the object size and orientation.



- **Status Bar**

This shows the paper size, unit of length, and number of objects.

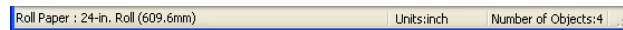

Detailed Settings

The printer driver opens when you select **Detailed Settings** from the **File** menu. The printer driver is used to configure basic settings to match the type of media loaded in the printer.

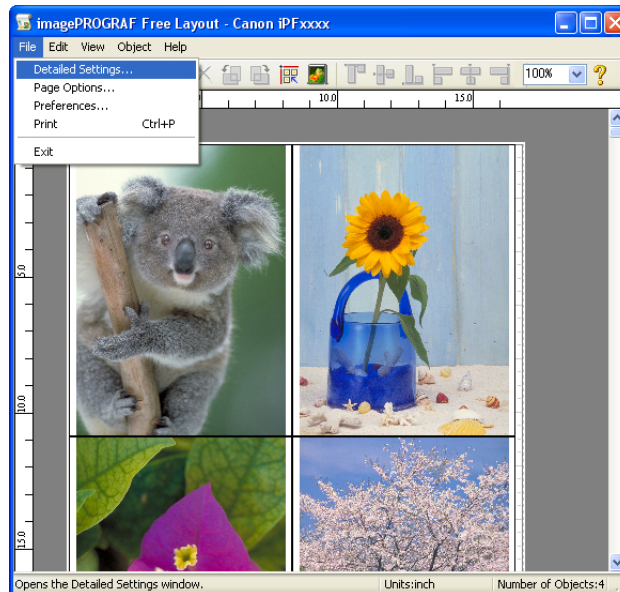

Refer to Printer Driver [→P.178](#) for details on the printer driver.



Note

- When you select the **Detailed Settings**, the only three sheets displayed are the **Main** sheet, the **Page Setup** sheet, and the **Layout** sheet. Some of the printer driver settings may be disabled.

Preferences Dialog Box

This dialog box appears when you select **Preferences** from the **File** menu. This allows you to configure the preferences of Free Layout.

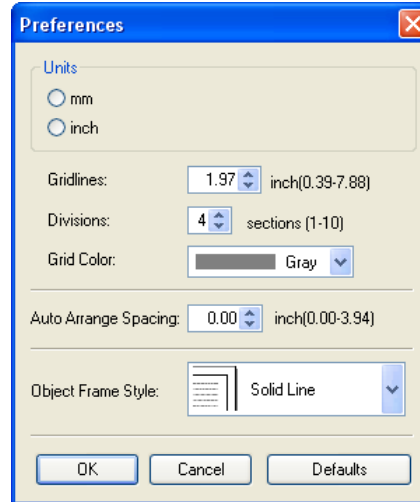

• Units

Set the unit for paper length, margins, and so on.

• Gridlines

You can input a grid line width value in numerical characters so that they serve as a guide to laying out objects.



Note

- You can input between 10.0 and 200.0(mm) (between 0.39 and 7.88(inch)).
- You can change the numbers by clicking either ▲ button or ▼ button.

• Divisions

You can change the number of divisions of grid lines so that they serve as a guide to laying out objects.



Note

- You can input between 1 and 10.
- You can change the numbers by clicking either ▲ button or ▼ button.

• Grid Color

Select the grid line color.

• Auto Arrange Spacing

Change the object-to-object spacing to be applied in the operation of laying out objects automatically.



Note

- You can input between 0.0 and 100.0(mm) (between 0.00 and 3.94(inch)).
- You can change the numbers by clicking either ▲ button or ▼ button.

• Object Frame Style

You can select the object frame style for printing.

The following settings are available for the object frame style.

Setting	Details
None	You can print with no frame style.
Solid Line	You can print the solid line as the frame style.
Dotted Line	You can print the dotted line as the frame style.
Dashed Line	You can print the dashed line as the frame style.

Setting	Details
Crop Marks	You can print with the crop marks.

Page Options Dialog Box

This dialog box appears when you select **Page Options** from the **File** menu. This allows you to configure the roll paper length, object layout order, and margins of Free Layout.

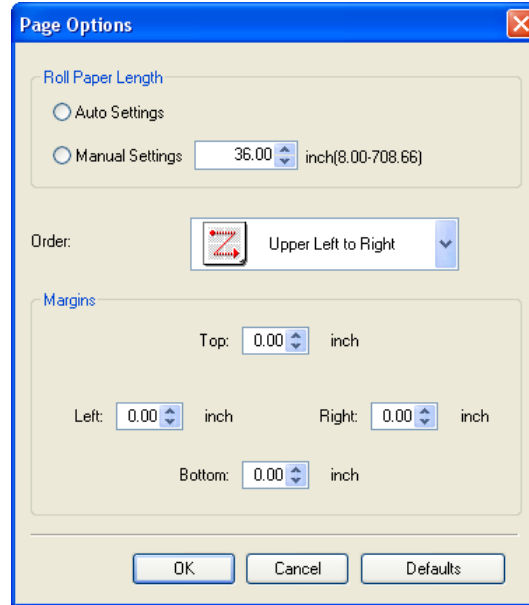

• Roll Paper Length

Set the length of one page to print on roll paper.

The following settings are available for roll paper length.

Setting	Details
Auto Settings	The one-page length to be printed on roll paper is automatically set so that the laid-out objects are printed on one page.
Manual Settings	You can input the length of one page to print on roll paper in numerical characters.



Note

- Available only if rolls are selected in **Paper Source**.
- You can input between 203.2 and 18000.0(mm) (between 8.00 and 708.66(inch)).
- You can change the numbers by clicking either ▲ button or ▼ button.

• Order

Set the object layout order.

The following settings are available for order.

Setting	Details
Upper Left to Right	The objects are laid out from upper left to right.
Upper Left to Bottom	The objects are laid out from upper left to bottom.
Upper Right to Left	The objects are laid out from upper right to left.
Lower Left to Top	The objects are laid out from lower left to top.



Note

- When you have selected **Roll Paper Length > Auto Settings** and **Paper Orientation > Vertical**, you can choose **Upper Left to Right** or **Upper Right to Left**.
- When you have selected **Roll Paper Length > Auto Settings** and **Paper Orientation > Horizontal**, you can choose **Upper Left to Bottom** or **Lower Left to Top**.

• Margins

You can input the paper margins in numerical characters.



Note

- You can input between 0.0 and 50.0(mm) (between 0.00 and 1.97(inch)).
- You can change the numbers by clicking either ▲ button or ▼ button.

Zoom Dialog Box

This dialog box appears when you select **Zoom** from the **View** menu. You can enlarge or reduce the screen display.

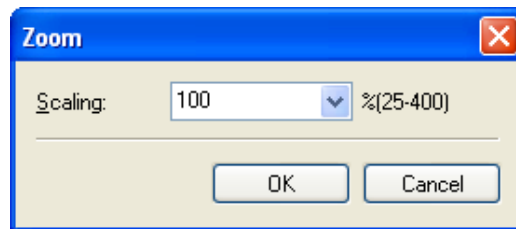

• Scaling

Set the magnification for enlargement or reduction of the screen display.



Note

- You can input between 25 and 400.
- You can change the numbers by clicking ▼ button.

Format Dialog Box

This dialog box appears when you select **Format** from the **Object** menu after you select an object.

Size Sheet

You can rotate, enlarge, or reduce an object.

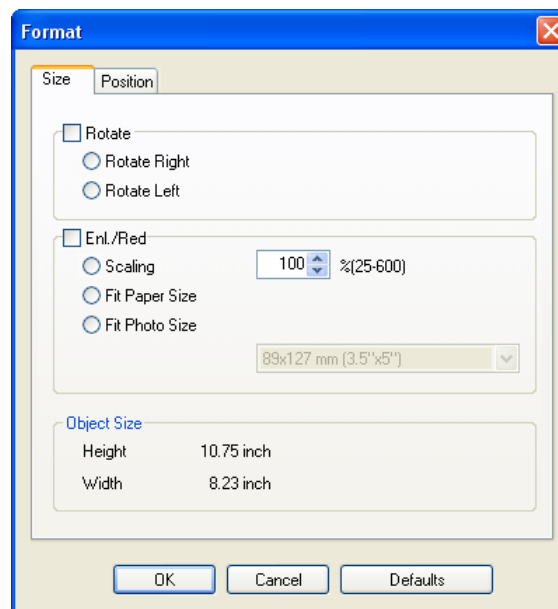



Note

- When the objects are not selected, you can not select **Format**.

• **Rotate**

When you place a checkmark here, you can select **Rotate Right** or **Rotate Left**.

Setting	Details
Rotate Right	Rotates the object 90 degrees clockwise.
Rotate Left	Rotates the object 90 degrees counterclockwise.



Note

- When several objects are selected, you cannot select **Rotate**.

• **Enl./Red.**

When you place a checkmark here, you can select **Scaling**, **Fit Paper Size**, or **Fit Photo Size**.

Setting	Details
Scaling	Allows you to input the value of the enlargement or reduction ratio of an object.
Fit Paper Size	Prints by enlarging or reducing each object to match the paper size. If you are using roll paper, objects are enlarged or reduced so that the width of each object matches the width of the roll paper.
Fit Photo Size	Prints all of the objects at the specified photo size.



Note

- You can input between 25 and 600.
- You can change the numbers by clicking either ▲ button or ▼ button.

Position Sheet

You can rotate, enlarge, or reduce an object.

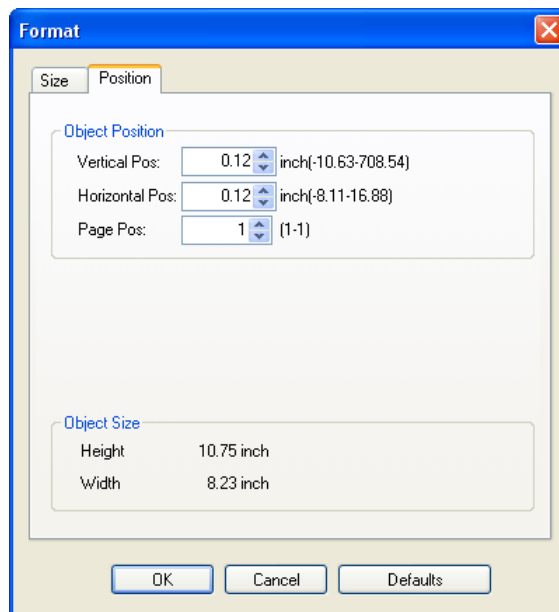

Note

- When the objects are not selected, you can not select **Format**.

• Object Position

You can move the object position by changing the values.

Setting	Details
Vertical Pos	You can input the number of the vertical position in numerical characters.
Horizontal Pos	You can input the number of the horizontal position in numerical characters.
Page Pos	You can input the number of the page position in numerical characters.

• Object Size

You can confirm the object size.



Note

- When several objects are selected, you cannot display **Object Size**.

Laying out a Multiple-File Document on One Page

You can lay out and print a multiple-file document on one page.

- 1 From the application software's **File** menu, select the printer setup menu to open the **Print** dialog box.



Note

- Normally, select **Print** from the **File** menu.

- 2 Click **Properties** to open the **Properties** dialog box.

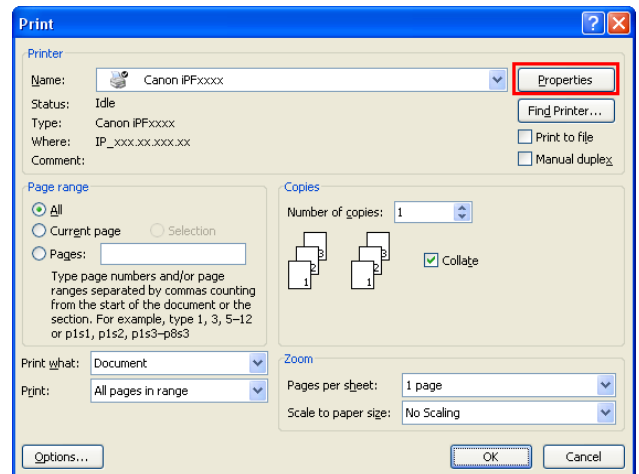

3 In the **Page Setup** sheet, select **Paper Source**.

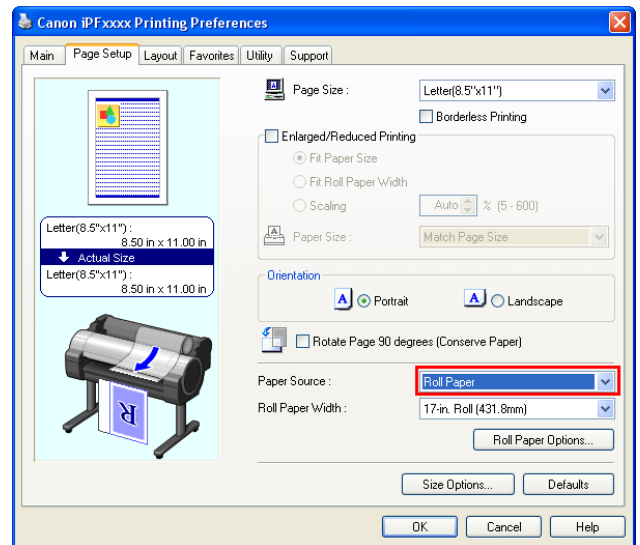



 • Your printer is depicted in the lower-left area of this screen.

Note

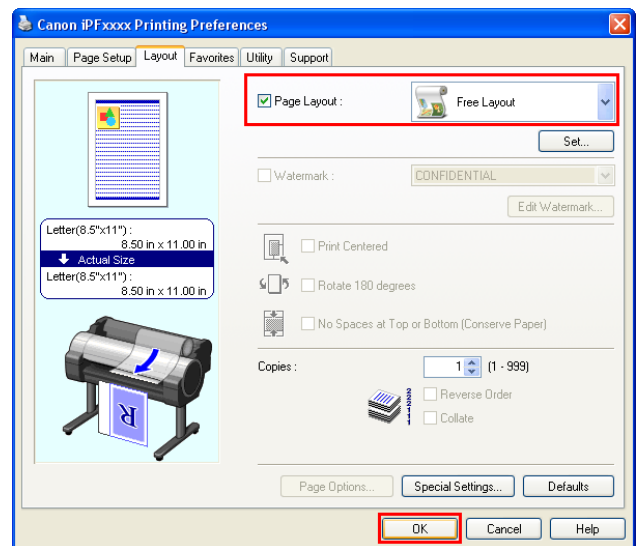
4 In the **Layout** sheet, click on the **Page Layout** check box and select Free Layout from the list.



 • Your printer is depicted in the lower-left area of this screen.

 • When you select Free Layout, all other setting items will be disabled.

Note

5 Click the **OK** button to save the settings.

- 6** In the **Print** dialog box, select the pages to print and the number of copies, and click the **OK** button.

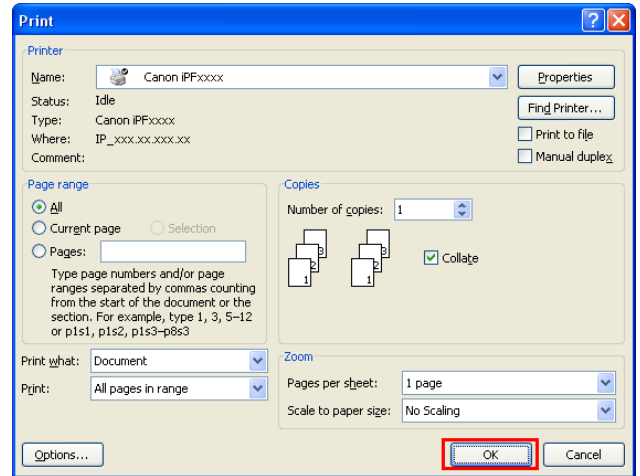

Free Layout starts, laying out the document created with application software in the layout area as an object.

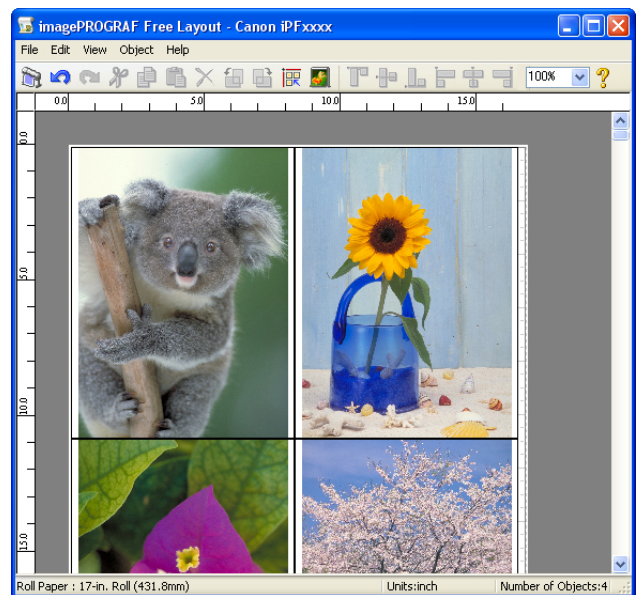

- 7** Leaving Free Layout running, open other files with the application software and repeat the above steps.

Laying out a Document Created with Multiple Application Programs on One Page

You can lay out and print a document created with multiple application programs on one page.

- 1** From the application software's **File** menu, select the printer setup menu to open the **Print** dialog box.



Note

- Normally, select **Print** from the **File** menu.

2 Click **Properties** to open the **Properties** dialog box.

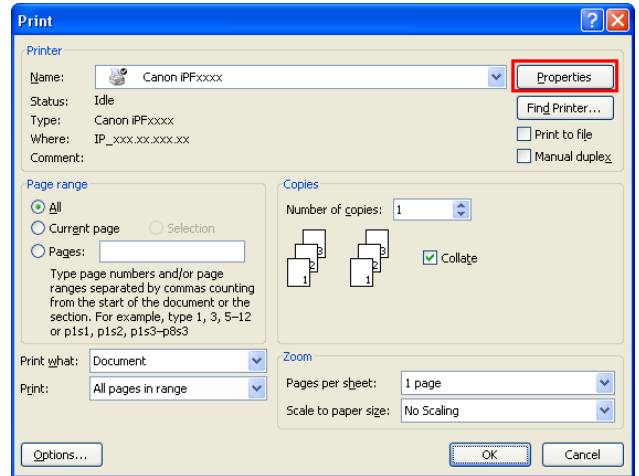

3 In the **Page Setup** sheet, select **Paper Source**.

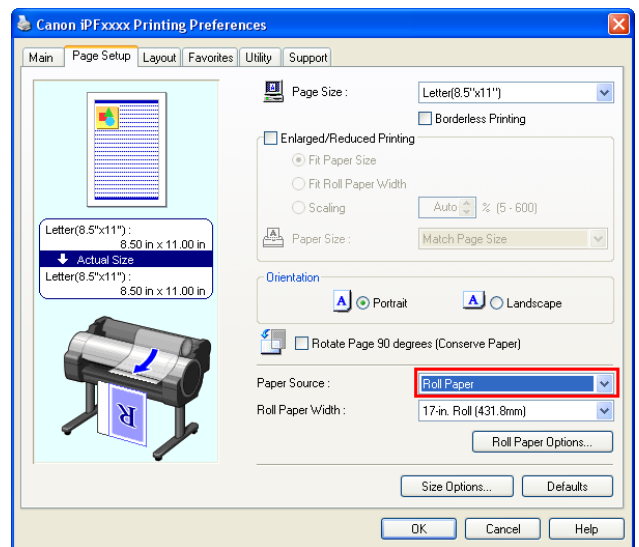

Note

- Your printer is depicted in the lower-left area of this screen.

- 4** In the **Layout** sheet, click on the **Page Layout** check box and select **Free Layout** from the list.

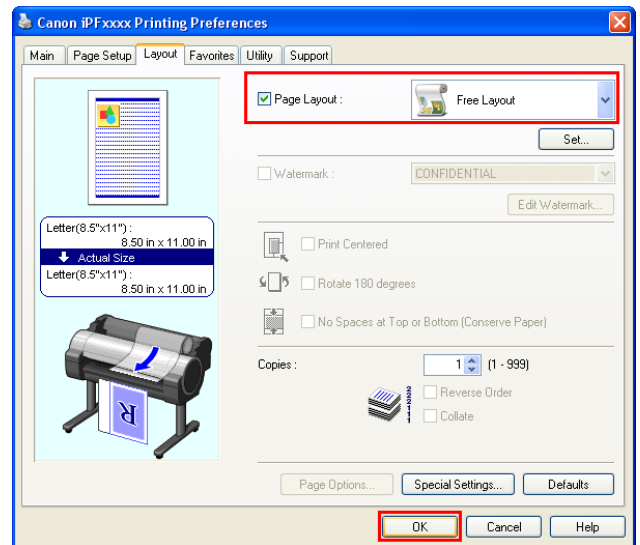

Note

- Your printer is depicted in the lower-left area of this screen.
- When you select Free Layout, all other setting items will be disabled.

- 5** Click the **OK** button to save the settings.

- 6** In the **Print** dialog box, select the pages to print and the number of copies, and click the **OK** button.

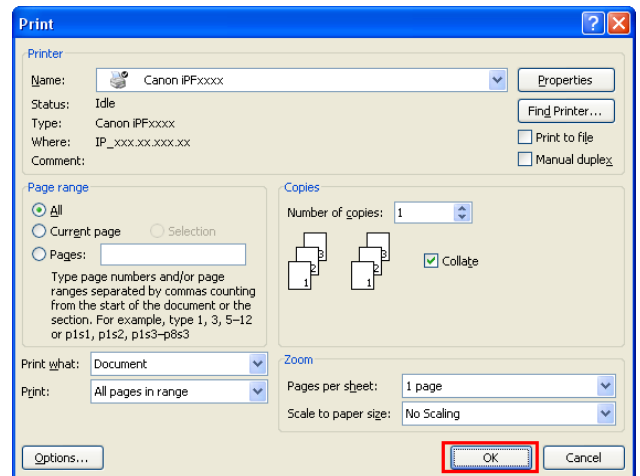

Free Layout starts, laying out the document created with application software in the layout area as an object.

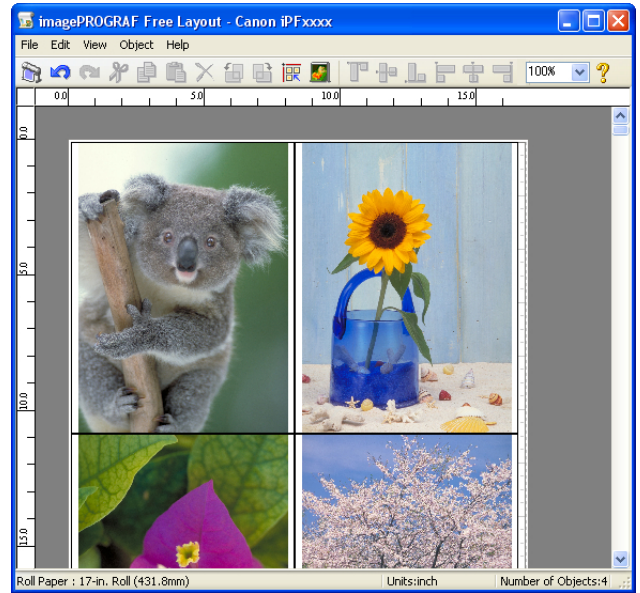

7 Leaving Free Layout running, open other files with other application software and repeat the above steps.

Selecting an Object

When an object is selected, a select box (blue border) appears around the object.





Note

- To select an object, click that object.
- To select multiple successive objects, click them while holding down the Shift key.
- To select multiple arbitrary objects, click them while holding down the Ctrl key.
- To select all objects, select **Select All** from the **Edit** menu.
- When you specify the area with dragging the mouse, the object in the area is selected.

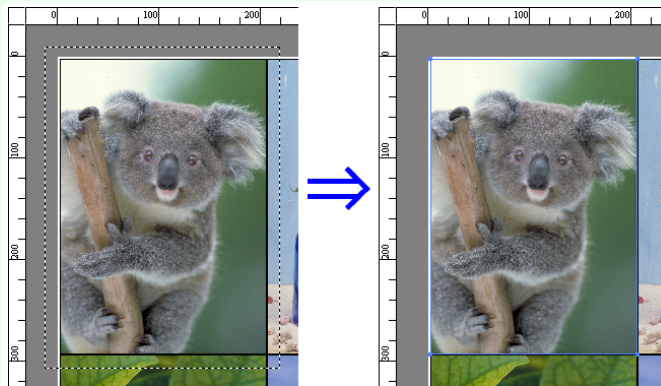

Changing the Object Size

You can change the object size by means of mouse operation or by specifying a scaling value.



Note

- The vertical-to-horizontal ratio remains unchanged when the object is enlarged or reduced.

Resizing by means of mouse operation

- 1 Select an object.
- 2 Place the pointer at a corner of the selection box around the object to show the arrow handle, and drag this handle to change the object size.

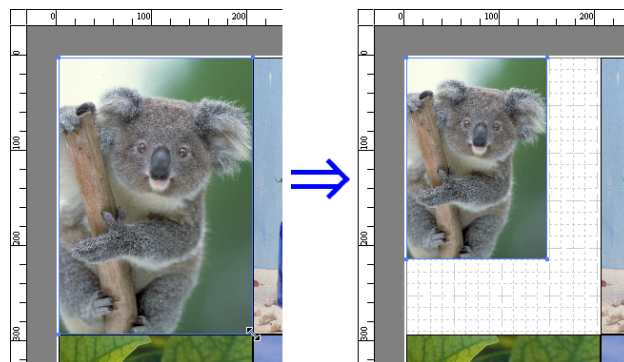

Resizing by specifying a scaling value

- 1 Select an object.
Click on the **Enl./Red.** checkbox in the Format Dialog Box **→P.229** and select **Scaling**.
- 2 You either enter numbers directly.



Note

- You can input between 25 and 600.
- You can change the numbers by clicking either ▲ button or ▼ button.

- 3 Click the **OK** button.

Moving an Object

You can move the object position.

- 1 Select an object.
- 2 Place the pointer inside the selection box of the object to show the crosshair handle, and drag it to move the object.
Alternatively, you can move the **Object Position** by changing the values in **Vertical Pos**, **Horizontal Pos** and **Page Pos** in the Format Dialog Box [→P.229](#) .

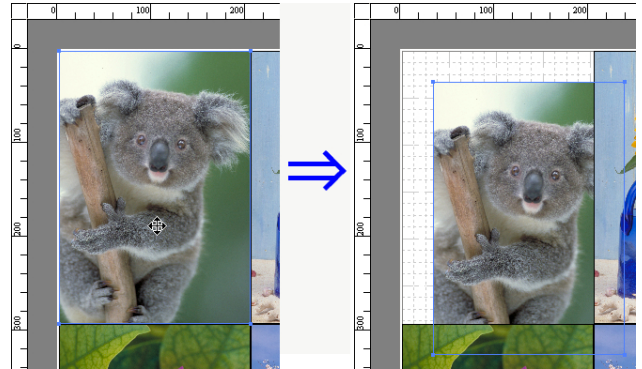

Rotating an Object

You can rotate the object.

- 1 Select an object.
- 2 Select **Rotate Left 90 Degrees** or **Rotate Right 90 Degrees** from the toolbar.
Alternatively, you may click on the **Rotate** check box in the Format Dialog Box [→P.229](#) then select **Rotate Right** or **Rotate Left**, and click the **OK** button.

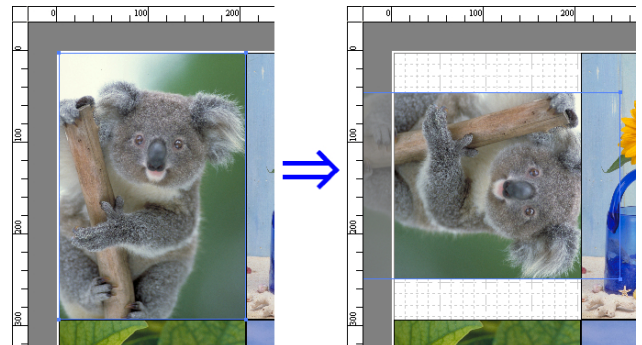

Laying out Objects Automatically

Click **Auto Arrange Object** in the tool bar. This automatically lays out objects. Alternatively, you may select **Auto Arrange Object** from the **Object** menu.

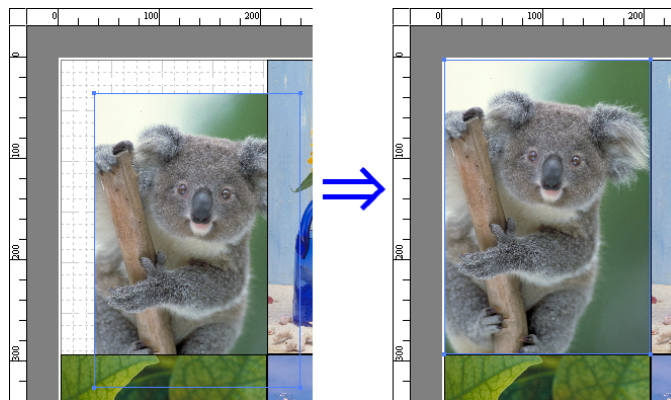



- The object layout order varies depending on the **Order** setting in the Page Options Dialog Box →P.228 dialog box.

Note

Aligning Objects

You can align objects systematically.

- Select multiple objects.
- Click the align button from the toolbar.
Alternatively, you may select the align menu from the **Object** menu.

• Align Top

Lays out the objects, justifying them to the top.

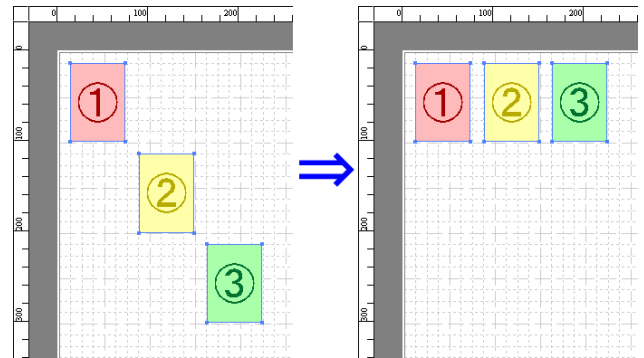

• Center Vertically

Lays out the objects, justifying them to the vertical center.

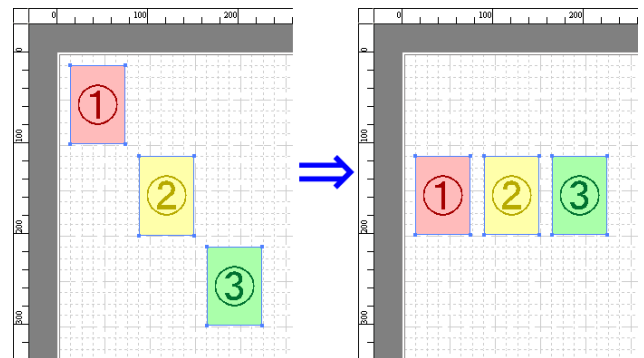

• Align Bottom

Lays out the objects, justifying them to the bottom.

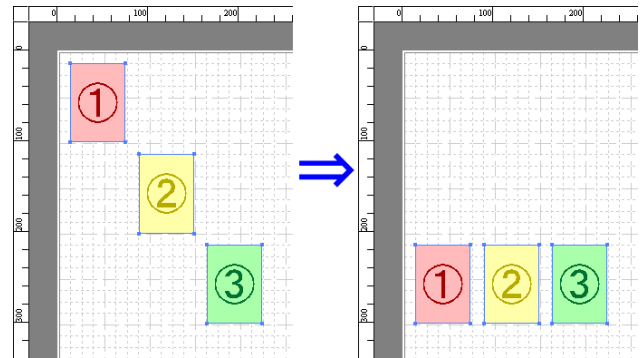

- **Align Left**

Lays out the objects, justifying them to the left.

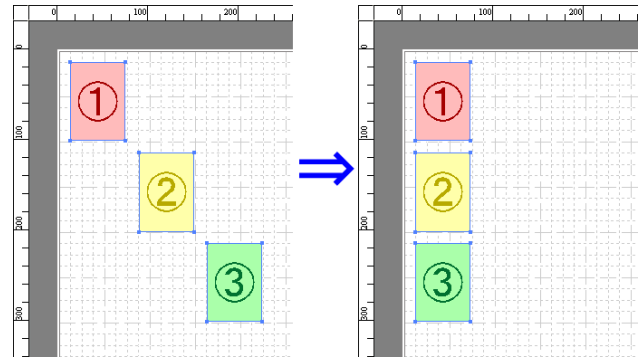

- **Center Horizontally**

Lays out the objects, justifying them to the horizontal center.

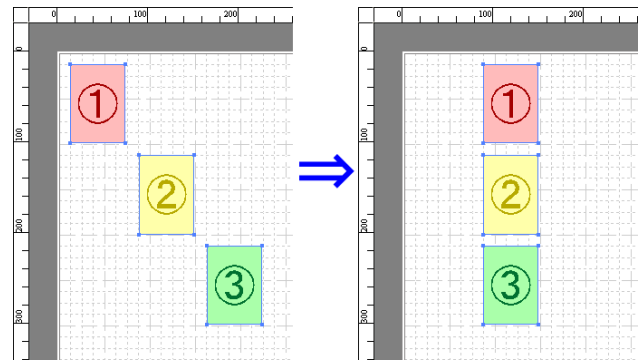

- **Align Right**

Lays out the objects, justifying them to the right.

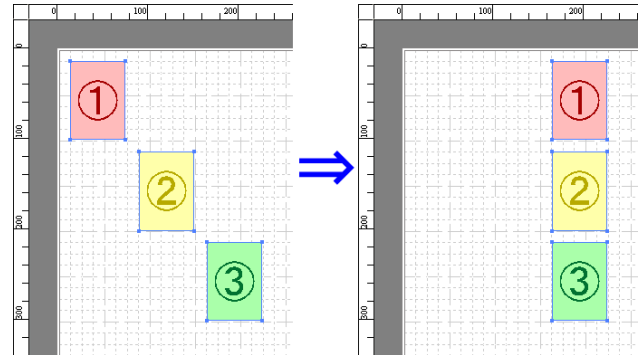

Changing the Object Overlapping Order

You can change the object overlapping order.

- 1 Select an object.
- 2 Select the Overlapping Order menu from the **Object** menu.



- The order of overlapping affects the order of objects automatically laid out.
- You can also select by clicking the right button of the mouse on an object.

- **Bring to Front**

Moves the object to the frontmost position.

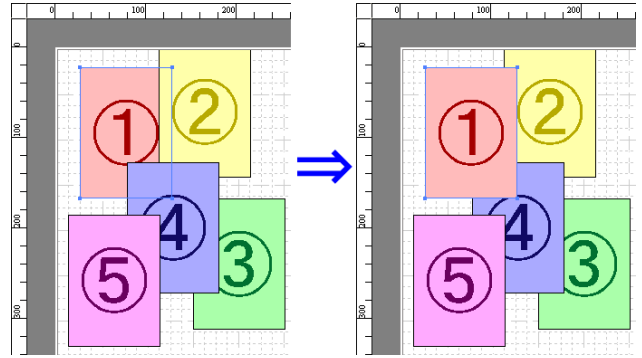

- **Send to Back**

Moves the object to the backmost position.

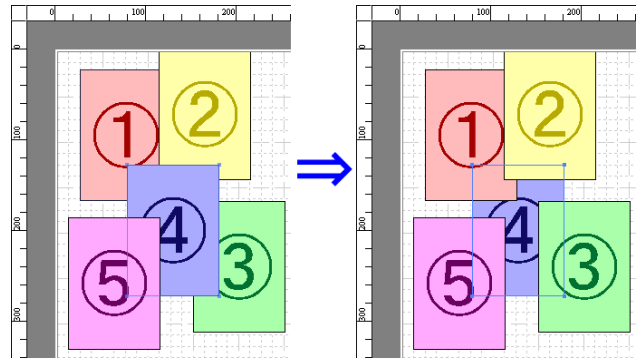

- **Bring Forward**

Moves the object one position to the front.

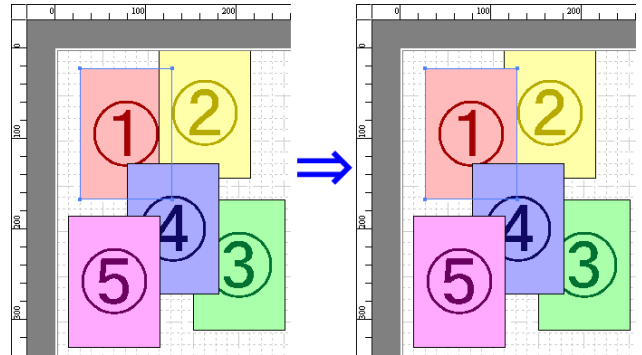

- **Send Backward**

Moves the object one position to the back.

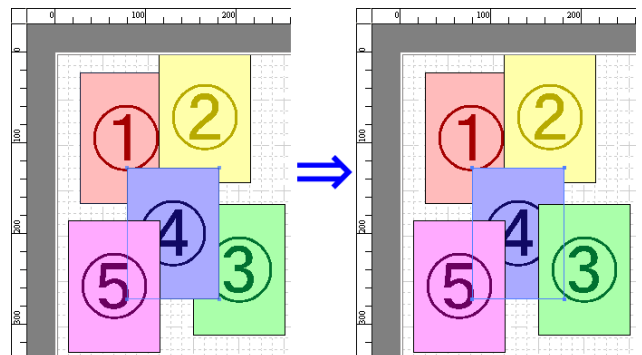

Pasting a Copied or Cut Object

- 1 Click **Copy** or **Cut** from the toolbar.
Alternatively, you may select **Copy** or **Cut** from the **Edit** menu.
- 2 Click **Paste** from the toolbar.
Alternatively, you may select **Paste** from the **Edit** menu.



Note

- The copied or cut object is laid out at the end of the page.
- You can also select by clicking the right button of the mouse on an object.
- In order to paste an object on any position that you like, you can paste the object with **Pointed Paste** by clicking the right button of the mouse on any position that you want.

Folded Duplex Window

This window is displayed if you select **Folded Duplex** from the **Edit** menu after selecting an object. Using the **Folded Duplex** function allows you to print with fold lines added.

The **Folded Duplex** window consists of the menu and tool bars, layout area and status bar.

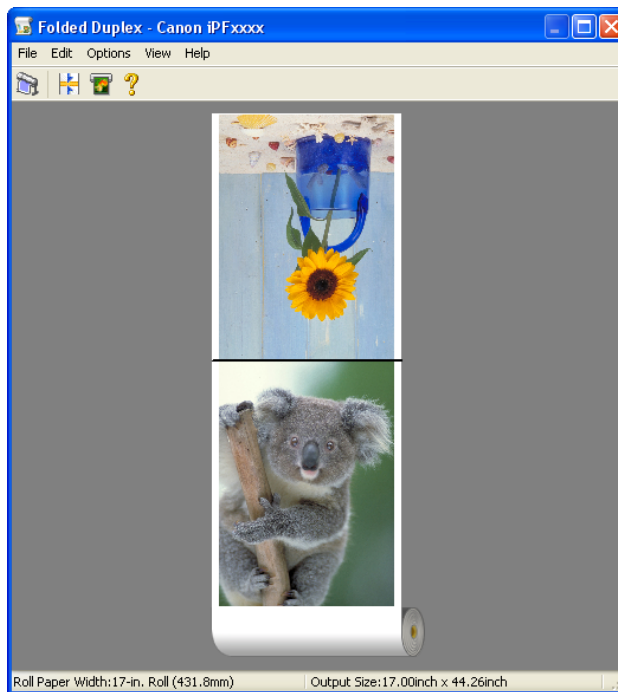

Note

- The toolbar and status bar can be toggled between hidden and displayed from the **View** menu.

• Menu Bar

This allows you to select menus required for operations.



• Tool Bar

This allows you to select tool buttons required for major operations.



- **Layout Area**

This allows you to check the arrangement and orientation of objects.

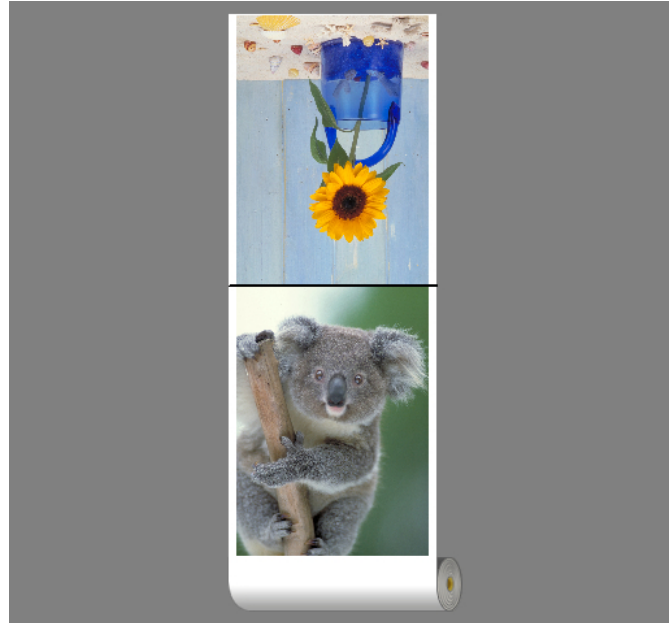

- **Status Bar**

This shows the paper source, roll paper width, and output size.

Roll Paper Width: 17-in. Roll (431.8mm) Output Size: 17.00inch x 44.26inch

Finished Size Settings Dialog Box

This dialog box is displayed when you select **Finished Size Settings** from the **Edit** menu. This allows you to configure finished size settings.

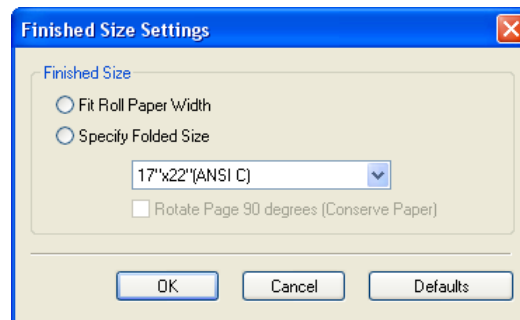

- **Finished Size**

Selects the method for setting the finished size.

The following settings are available for the finished size.

Setting	Details
Fit Roll Paper Width	Prints by automatically enlarging or reducing the entire document so that the width of the document matches the roll paper width.
Specify Folded Size	Prints by automatically enlarging or reducing the entire document to match the size of the paper. Select the actual size of the paper you want to print on in Fit Paper Size .
Rotate Page 90 degrees (Conserve Paper)	Prints by rotating pages by 90 degrees. Pages are automatically rotated if they will fit within the roll paper width when rotated, and are not rotated if they will not fit within the roll paper width.

Binding Settings Dialog Box

This is displayed when you select **Binding Settings** from the **Edit** menu. This allows you to configure the binding edge settings.

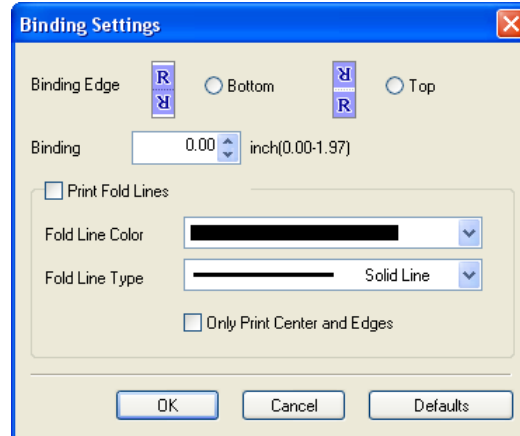

• Binding Edge

Configures the binding edge when folding paper.

The following settings are available for the binding edge.

Setting	Details
Bottom	Prints by placing the binding margin (gutter) at the bottom of the document.
Top	Prints by placing the binding margin (gutter) at the top of the document.

• Binding

Configures the binding margin (gutter).

Prints by creating a binding margin (gutter) of the specified size. Enter the margin size as a number.



Note

- The values that can be entered are 0 to 50 (mm).

• Print Fold Lines

Configures the color and type of fold lines.



Note

- To not print fold lines, clear the **Print Fold Lines** checkbox.

• Fold Line Color

You can select the fold lines.

• Fold Line Type

You can select the fold lines.

The following settings are available for the fold line type.

Setting	Details
Solid Line	You can print the solid line as the frame style.
Dotted Line	You can print the dotted line as the frame style.
Dashed Line	You can print the dashed line as the frame style.

• Only Print Center and Edges

To print fold lines at the center and both edges, select the **Only Print Center and Edges** checkbox.

Prints using Folded Duplex

This prints 2 pages consecutively. Folding back the paper at the fold lines of the center substitutes for duplex printing.

- 1 Select two objects from the layout area of Free Layout.
- 2 Select **Folded Duplex** from the **Edit** menu of Free Layout. Open the **Folded Duplex** window and arrange the selected objects in the layout area.
- 3 Open the **Finished Size Settings** dialog box from the **Edit** menu.
- 4 Select **Fit Roll Paper Width** or **Specify Folded Size** in **Finished Size**.



Note

- **Rotate Page 90 degrees (Conserve Paper)** is also available when **Specify Folded Size** is selected.

- 5 Click **OK** to save the settings.
- 6 Open the **Binding Settings** dialog box from the **Edit** menu.
- 7 Select **Bottom** or **Top** in **Binding Edge**.
- 8 Specify the **Binding** width in **Binding**.
- 9 Configure the **Fold Line Color** and **Fold Line Type** from **Print Fold Lines**.



Note

- When the **Only Print Center and Edges** checkbox is selected, fold lines are only printed at the three locations of the center and both edges.

- 10 Click **OK** to save the settings.
- 11 Confirm the print setting and begin printing.

Color imageRUNNER Enlargement Copy

The Features of Color imageRUNNER Enlargement Copy	246
Starting Color imageRUNNER Enlargement Copy	246
Color imageRUNNER Enlargement Copy Dialog Box	247
Hot Folder	248
Creating a New Hot Folder	249
Specifying an Existing Shared Folder as a Hot Folder	252
Setting the Print Parameters	255
Printing Enlargements of Scanned Originals from a Color imageRUNNER	255

The Features of Color imageRUNNER Enlargement Copy

The main features of Color imageRUNNER Enlargement Copy are as follows.

- Allows the document scanned with the Color imageRUNNER to be automatically enlarged and printed.
- You can perform basic printer settings such as printer selection, media type and output profile selection, and matching methods, in addition to borderless printing and enlargement/reduction process without growing through the printer driver.



• The media type, image size, detailed media settings, and the printer settings can cause the actual print output to differ from the Color imageRUNNER Enlargement Copy settings.

Starting Color imageRUNNER Enlargement Copy

Follow the procedure below to start the Color imageRUNNER Enlargement Copy.

To start by selecting **Printers and Faxes** from the **start** button

- 1 Open the folder of the OS you are using for configuring printers.
For example, on Windows XP click the **start** button on the desktop, and then select **Printers and Faxes**.
- 2 Right-click the Printers icon and select **Printing Preferences** to open the **Printing Preferences** dialog box. In the **Utility** sheet, click the **Color imageRUNNER Enlargement Copy** button.

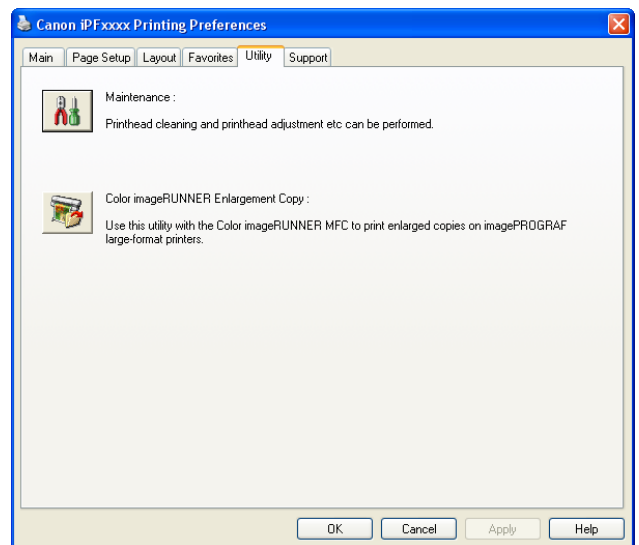

- 3** The **Color imageRUNNER Enlargement Copy** dialog box displays.

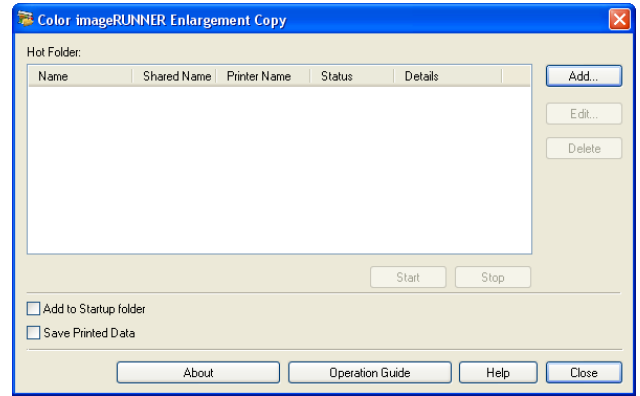

Note

- If you click on the **Add to Startup folder** check box in the **Color imageRUNNER Enlargement Copy** dialog box, the icon of Color imageRUNNER Enlargement Copy utility will appear on the task bar when starting Windows thereafter.

To start by selecting **Color imageRUNNER Enlargement Copy** from the **start** button

- 1** From the Windows **start** button, select **Color imageRUNNER Enlargement Copy**.

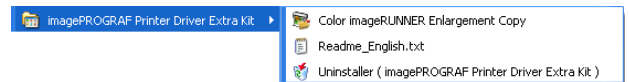

- 2** The **Color imageRUNNER Enlargement Copy** dialog box displays.

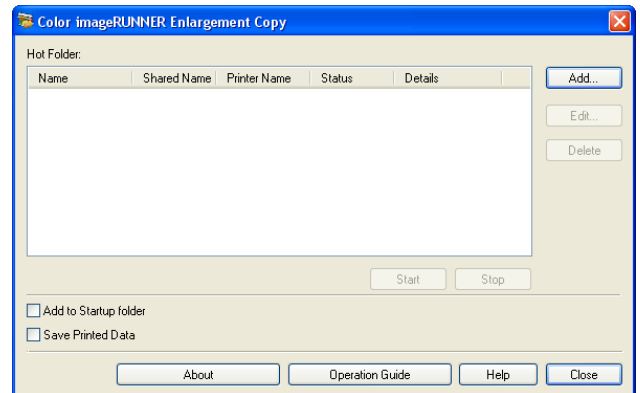

Color imageRUNNER Enlargement Copy Dialog Box

The explanation below is on the **Color imageRUNNER Enlargement Copy** dialog box.

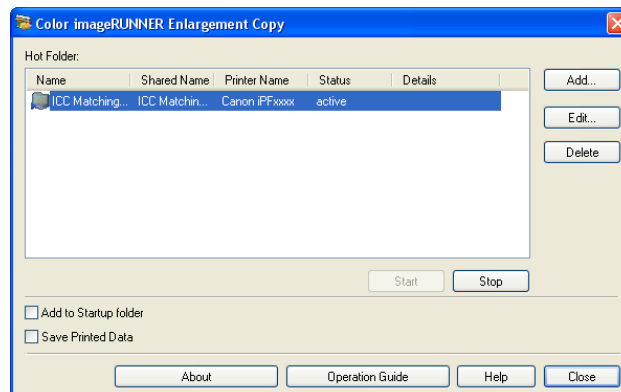



Note

- For the step to open the **Color imageRUNNER Enlargement Copy** dialog box, see "Starting Color imageRUNNER Enlargement Copy." →P.246

- **Hot Folder**

The hot folder list appears.

- **Add Button**

Click the button to open the **Easy Setup Wizard** dialog box so that you can add a hot folder.

- **Edit Button**

From the **Hot Folder** list, select a hot folder and click the button to open the **Add/Edit Hot Folder** dialog box that allows you to edit the hot folder.

- **Delete Button**

From the **Hot Folder** list, select a hot folder and click the button to delete the hot folder.

- **Start Button**

Clicking the button changes the status of the selected **inactive** Hot Folder to **active**.

- **Stop Button**

Clicking the button changes the status of the selected **active** Hot Folder to **inactive**.

- **Add to Startup folder**

Register the application in the Windows startup menu.

- **Save Printed Data**

Automatically saves printed data.

- **About Button**

Click the button to display the name and the version number of the utility.

- **Operation Guide Button**

Click the button to display the **Color imageRUNNER Enlargement Copy Setup Manual**.

Hot Folder

Hot folder refers to a folder used for Color imageRUNNER Enlargement Copy.

- When transferred to the PC's hot folder, the document data scanned with the Color imageRUNNER is printed in enlarged size from the printer according to the print conditions set in the hot folder.
- You can create a new hot folder, edit or delete an existing one, and set print conditions at will.



Note

- You can create up to 20 hot folders.

Creating a New Hot Folder

- 1 Open the **Color imageRUNNER Enlargement Copy** dialog box, and then click the **Add** button.

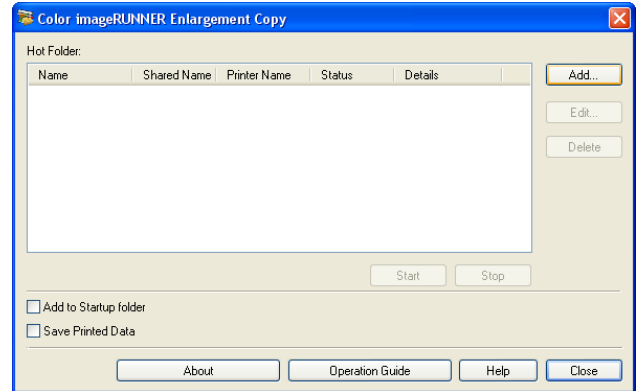

Note

- For the step to open the **Color imageRUNNER Enlargement Copy** dialog box, see "Starting Color imageRUNNER Enlargement Copy." →P.246

- 2 The **Easy Setup Wizard** dialog box displays. Click the **Next** button.

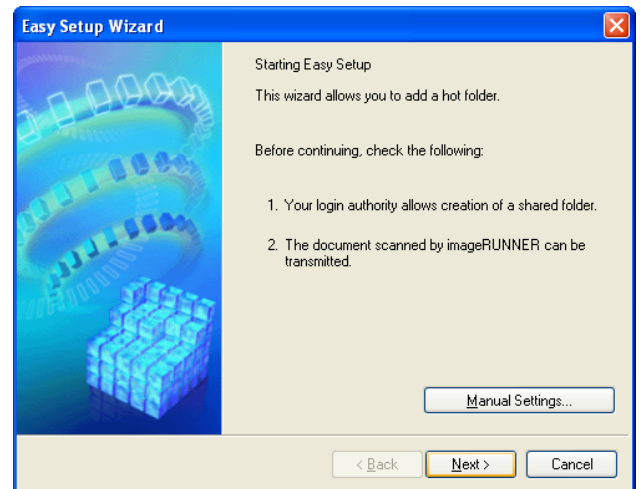

- 3 Select the type of printer to use. Click the **Next** button.

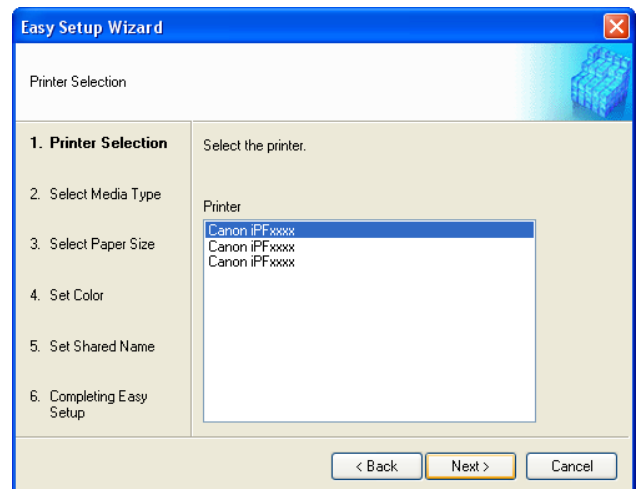

4 Select the media type to print.



- If the **Borderless Printing** checkbox is checked, only media types that can be used for borderless printing are displayed in the list.

Click the **Next** button.

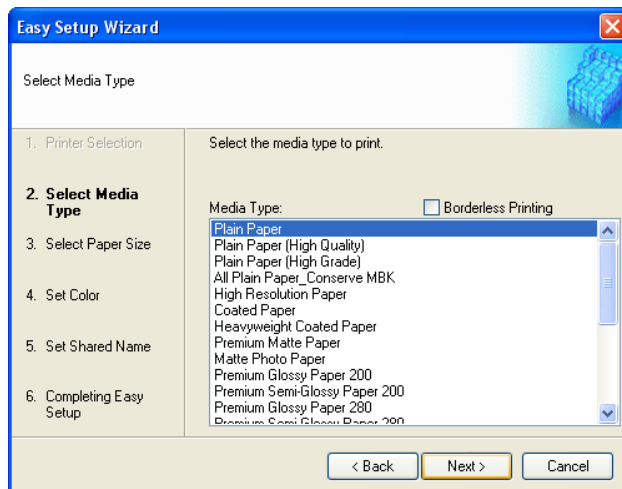

5 Select roll paper or cut sheet to print. Also, select the media size to print. Click the **Next** button.

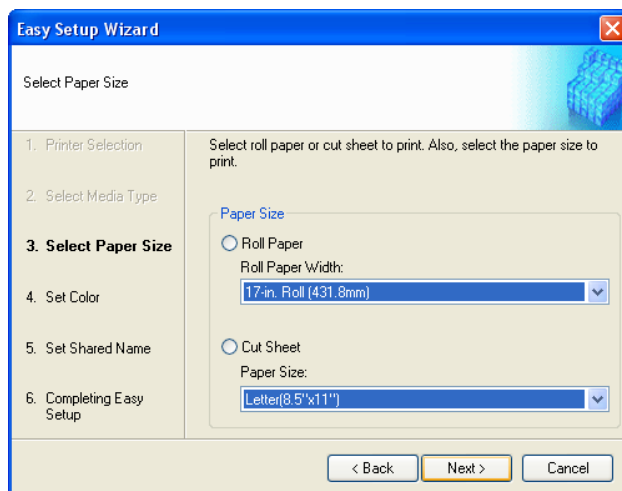

6 Select the color matching method. Click the **Next** button.

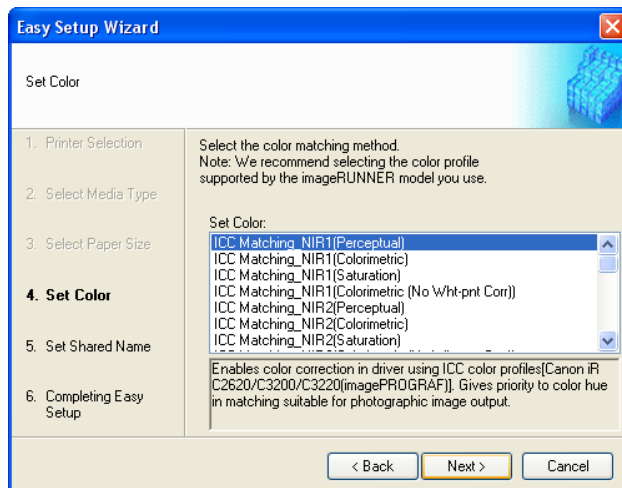

- 7** To receive a document scanned with the Color imageRUNNER, you need to share a folder. Enter the folder shared name in **Shared Name**.
Click the **Next** button.



Note

- This shared name is used as the name of the hot folder.
- You cannot use the **Back** button, after clicking the **Next** button here.

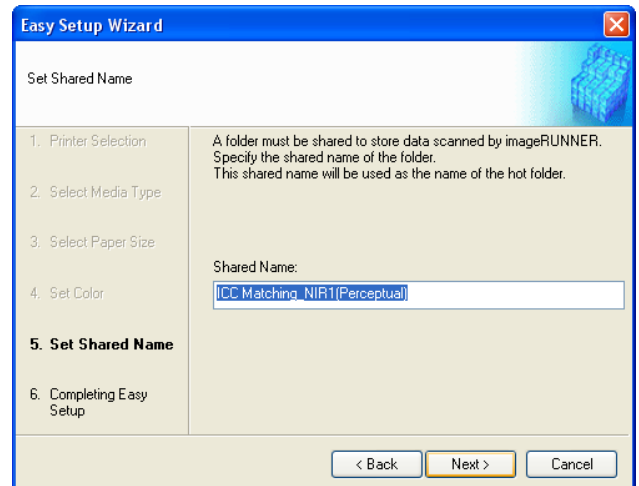

- 8** Click **Finish** button to close the **Easy Setup Wizard** dialog box.

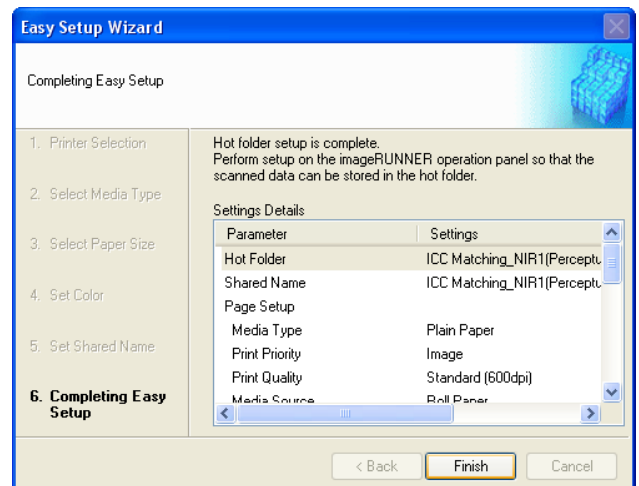

The hot folder you have created appears in the **Hot Folder** list in the **Color imageRUNNER Enlargement Copy** dialog box.

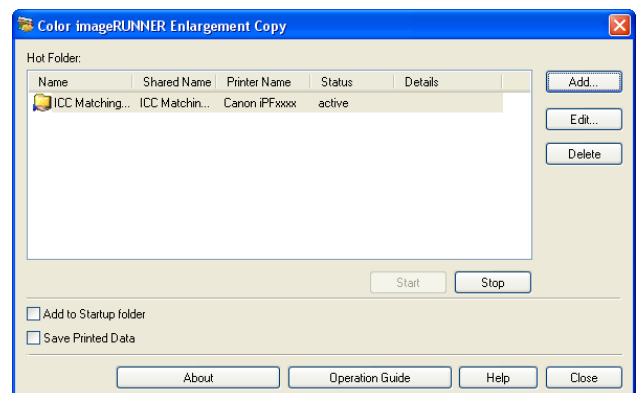

Specifying an Existing Shared Folder as a Hot Folder

- 1 Share the folder you want to specify as a hot folder.
- 2 Open the **Color imageRUNNER Enlargement Copy** dialog box, and then click the **Add** button.

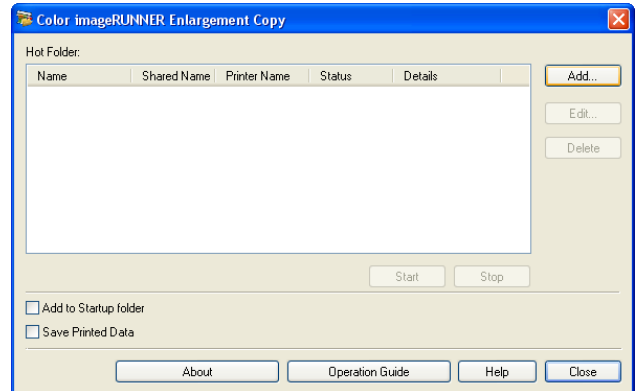

Note

- For the step to open the **Color imageRUNNER Enlargement Copy** dialog box, see "Starting Color imageRUNNER Enlargement Copy." →P.246

- 3 The **Easy Setup Wizard** dialog box displays. Click the **Manual Settings** button.

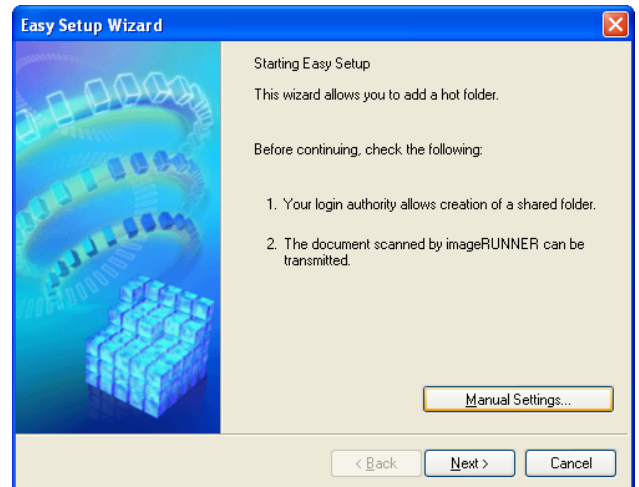

- 4** The **Add/Edit Hot Folder** dialog box displays. Enter the hot folder name in **Name**. Click the **Browse** button, with selecting **Specify a folder**, to set the existing shared folder.

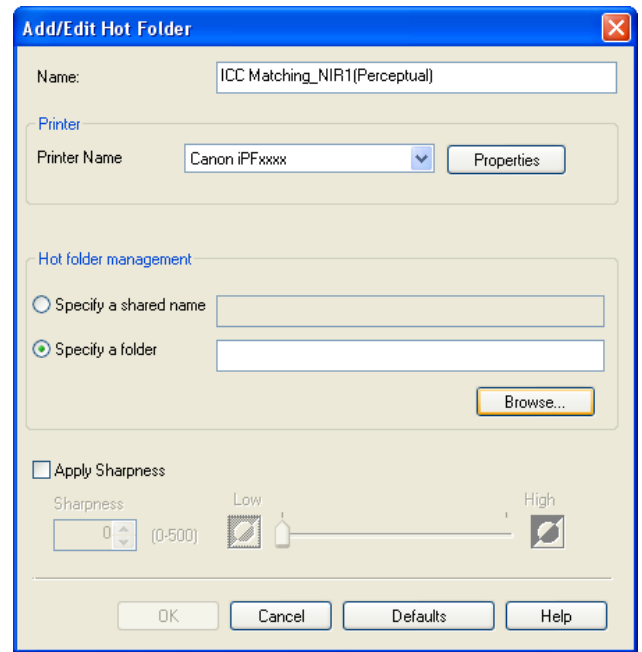

- 5** The location of the folders will appear. Select the folder to specify a hot folder, and click the **OK** button.

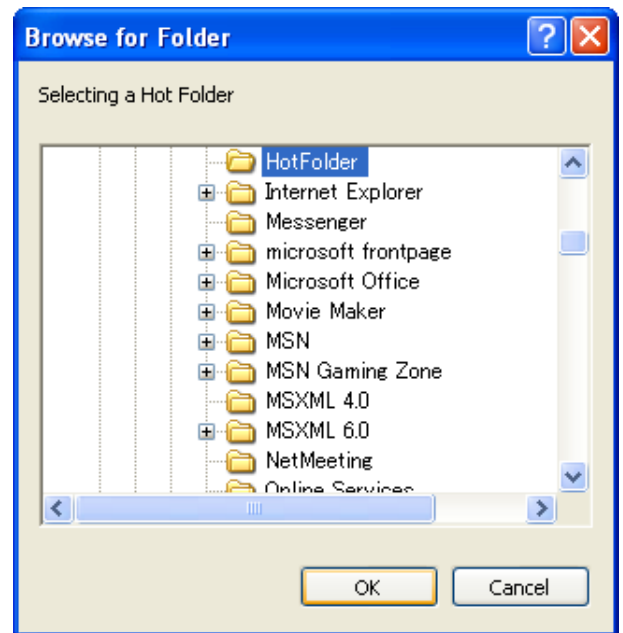

6 As necessary, set the print conditions in the hot folder. (See "Setting the Print Parameters.") →P.255
 Click the **OK** button to close the **Add/Edit Hot Folder** dialog box.

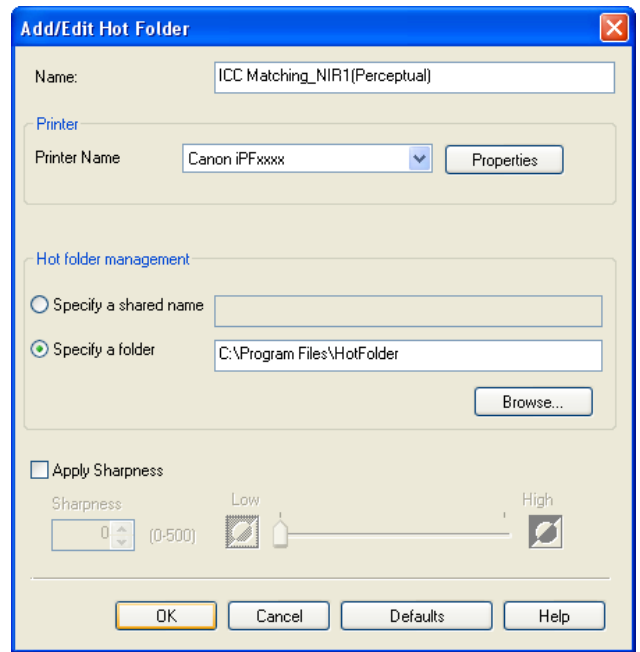

The hot folder you have created appears in the **Hot Folder** list in the **Color imageRUNNER Enlargement Copy** dialog box.

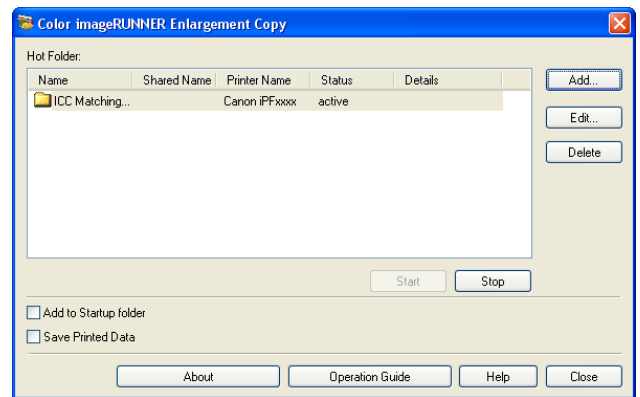

Setting the Print Parameters

The printer driver opens when you click the **Properties** button in the **Add/Edit Hot Folder** dialog box. The printer driver is used to configure basic settings to match the type of media loaded in the printer.

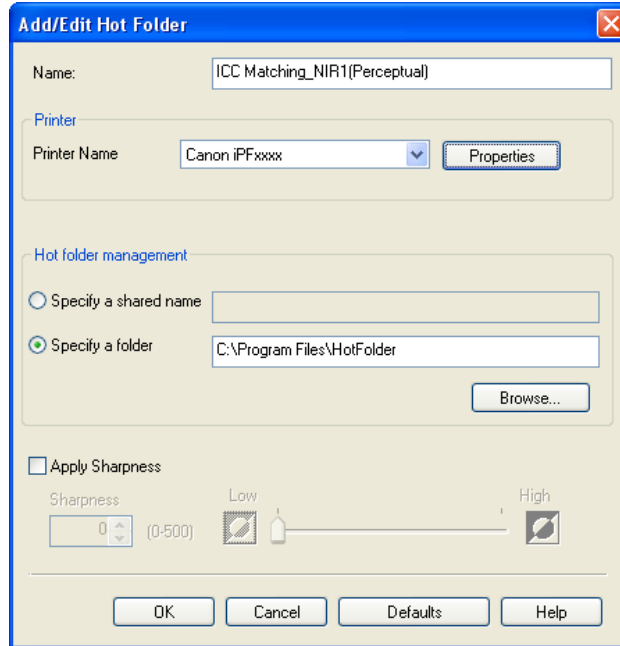

Refer to Printer Driver [→P.178](#) for details on the printer driver.



- The only three sheets displayed are the **Main** sheet, the **Page Setup** sheet, and the **Layout** sheet. Some of the printer driver settings may be disabled.

• Apply Sharpness

Place a checkmark here to set the sharpness.

Drag the slider bar to the left or right to adjust. You can also adjust by directly entering a number in the numeric input field.



- You can input between 0 and 500.
- You can change the numbers by clicking either ▲ button or ▼ button.
- You cannot be applied to PDF files.

Printing Enlargements of Scanned Originals from a Color imageRUNNER

Scanned originals from a Color imageRUNNER can be enlarged and printed automatically. Originals you create by scanning with a Color imageRUNNER are transferred to a "hot folder" and printed automatically after enlargement according to printing conditions you specify for that folder.

This processing sequence is called the Color imageRUNNER Enlargement Copy function.

To use Color imageRUNNER Enlargement Copy, first complete these settings in the following order.

- Register a hot folder on your computer.
Register a hot folder on your computer for storing scanned originals from the Color imageRUNNER and complete the settings for enlargement copy. For details, see "Creating a New Hot Folder." [→P.249](#)
- Complete the scanning settings on the Color imageRUNNER.
Configure the Color imageRUNNER to send scanned originals to the hot folder.

After these settings are complete, you can print enlarged copies of scanned originals from the Color imageRUNNER.

Completing the scanning settings on the Color imageRUNNER.

Configure the Color imageRUNNER to send scanned originals to the hot folder. It is easy to send scanned originals to the hot folder if you assign the scanning settings and destination to a **Favorites** button on the Color imageRUNNER. For instructions on assigning scanning settings and destinations to a **Favorites** button, refer to the setting manual, displayed by clicking **Color imageRUNNER Enlargement Copy Setup Manual** button of Color imageRUNNER Enlargement Copy utility, or refer to the Color imageRUNNER manual.

Scanning the original and print an enlargement

Follow the steps below to scan an original on the Color imageRUNNER for enlarged printing on the printer. For detailed instructions, refer to the Color imageRUNNER manual.

- 1** Load the original on the platen glass or document feeder of the Color imageRUNNER.
- 2** Press **Send** to display the screen for transmission.
- 3** Press **Favorites**, and then press the **Favorites** button assigned to the hot folder.
- 4** Press **Start** on the control panel. If you scan originals on the platen glass, after scanning all originals, press **Done** on the touch-panel display.
Scanned originals are sent to the hot folder and automatically enlarged and printed following the conditions you specified for the folder.

Print Plug-In for Photoshop / Digital Photo Professional

Features of the Print Plug-In for Photoshop/Digital Photo Professional	258
Installation Procedures	258
Uninstall Procedures	261
Starting from Photoshop	261
Starting from Digital Photo Professional	262
Print Plug-In for Photoshop/Digital Photo Professional Main Window	263
Preview Area	265
Main Sheet	267
Page Setup Sheet	270
Color Settings Sheet (Color)	272
Color Settings Sheet (Monochrome)	273
Print History Sheet	274
Support Sheet	275
Adjustment pattern setting dialog box	276
Paper Detailed Settings Dialog Box	280
Set Configuration Dialog Box	282
ICC Conversion Options dialog box	283
Roll Paper Options Dialog Box	284
Size Options Dialog Box	284
Curves Dialog Box	285
Print History Details Dialog Box	286
Utilize Three Types of Previews	287
Check Image with Print Area Layout	287
Check the original image with Image	288
Check Image with Roll Paper Preview	288
Print with a Desired Picture Quality	289
Adjust the Colors and Print	290
Adjust the Colors while Checking the Preview (for Color)	290
Adjust the Colors while Checking the Preview (for Monochrome)	291
Adjust the Colors by Color Matching	293
Print High-Quality Adobe RGB16bit Images	294
Prints monochrome photographs with high quality	295
Using Adobe CMM	296
Printing an Adjustment Pattern and Selecting Adjustment Values	297
Perform Black Point Compensation	299
Perform Printing Press Simulation Print	300
Enlarge/Reduce and Print	300
Enlarge/Reduce and Print Matching Output Media Size	301
Enlarge/Reduce and Print Matching Width of Roll Paper	302
Specify Scaling, Enlarge/Reduce and Print	303
Print with No Borders	304
Customize Media Settings	305
Utilize Print History	305
Confirm Print History Details	306
Apply Print History to an Image	307
Store Print History to Print Preferences	307
Delete Print History	309
Export Print History from Print Preferences	311
Import Print History to Print Preferences	312
Delete Print History from Print Preferences	314
Set Information to Print with Image	315

Features of the Print Plug-In for Photoshop/Digital Photo Professional

The main features of the Print Plug-In for Photoshop/Digital Photo Professional are as follows.

- You can automatically detect the color space of Adobe RGB or sRGB-use images, etc., and automatically set optimal profiles. Thus, you can print without the trouble of configuring settings.
- You can modify image data directly in Photoshop and send the image data to the printer. This allows you to process not only 8-bit, but also 16-bit image data.
- By using the preview function for images based on real images, and the preview function for layouts based on image positioning by media size, you can use this software to make color adjustments and confirm print layout.
- You can perform basic printer settings such as printer selection, media type and output profile selection, and matching methods, in addition to borderless printing and enlargement/reduction process without growing through the printer driver.
- You can print an image with adjustment values such as the color balance, brightness, and contrast varying in steps and select your preferred adjustment values. (See "Adjustment pattern setting dialog box.") →P.276
- You can create and print a layout image for finishing by mounting in a frame with the image extended to the sides of the frame by using the Layout Plug-In that is installed at the same time as the Print Plug-In for Photoshop. (See "About the Layout Plug-In.") →P.317
- By using the print history management function, you can import past print settings parameters. Additionally, you can save preferences as a file.



Note

- The actual output may differ from the settings in Print Plug-In for Photoshop/Digital Photo Professional (the arrangement of the image in the layout preview, print start position, and paper size) depending on the media type, image size, paper detailed settings, and printer main unit settings.

- Loss of gradation in dark areas can be reduced by performing black point compensation.



Note

- Adobe CMM is required in order to use the black point compensation function.

- You can perform a printer simulation print by specifying the printer profile.

Installation Procedures

The procedure for installing the Print Plug-In for Photoshop/Digital Photo Professional is as follows.



Note

- The Layout Plug-In is also installed when the Print Plug-In for Photoshop is installed.

- 1 Insert the User Software CD-ROM into the CD-ROM drive to start the installer.



Note

- If the installer screen does not appear, open the CD-ROM icon in **My Computer** and click on **setup.exe** to open the icon.

2 Click **imagePROGRAF Print Plug-in** button.



3 Click the **Install** button corresponding to the Print Plug-In for Photoshop/Digital Photo Professional you are using.

- For 32-bit Windows

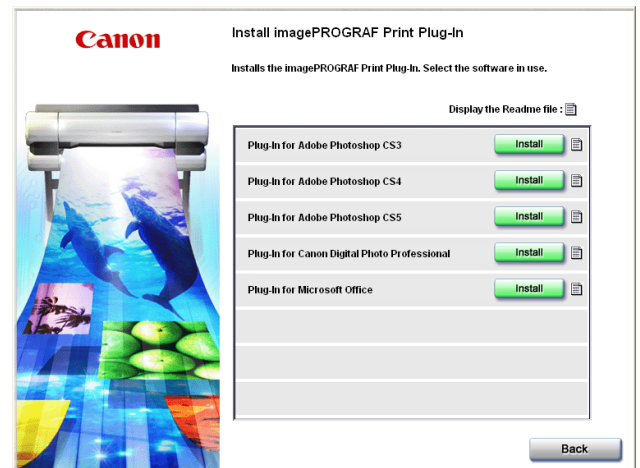

- For 64-bit Windows

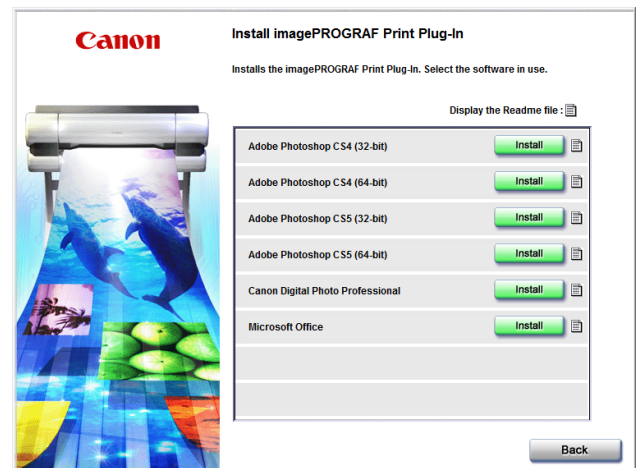



Note

- If a version of Photoshop supported by Print Plug-In for Photoshop is not installed, **The application is not installed.** is displayed. Install the Print Plug-In on a computer that has a supported version of Photoshop installed.
- If the folder for the Photoshop Plug-In to install Print Plug-In cannot be found, **Specify the destination for installation of the plug-in?** will appear. In this case, refer to the Photoshop manual then specify a folder for the Plug-In.
- The Print Plug-In for Photoshop cannot be installed on systems where the installed Photoshop has not been started even once. In this situation, start and then exit Photoshop once before installing the Print Plug-In for Photoshop.

4 Click **Next** button.

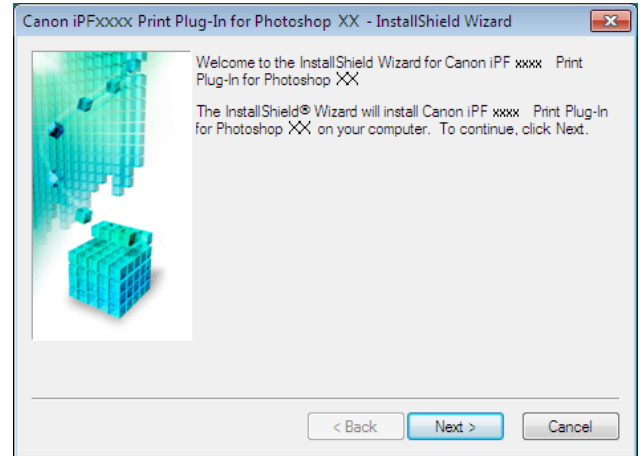

5 After you have read the Licensing Agreement, select **I accept the terms of the license agreement** and click the **Next** button.

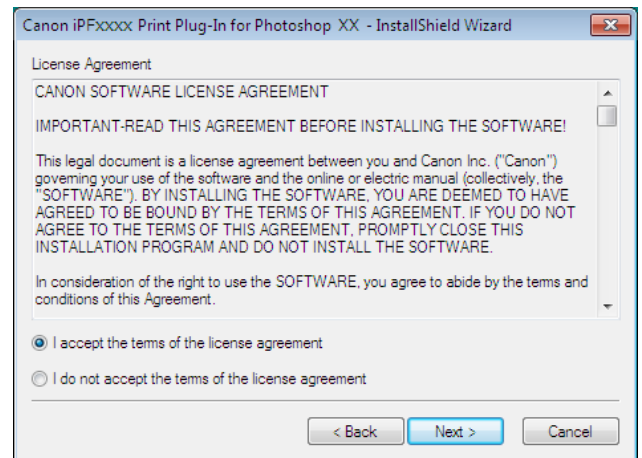

6 Click **Install** button.

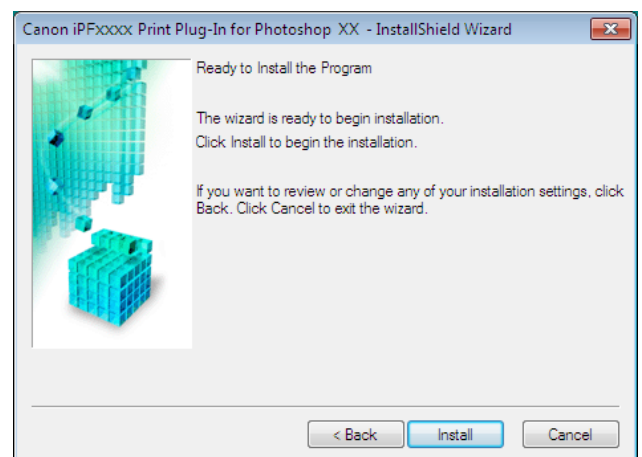

7 Click **Finish** button.

Installing the Print Plug-In for Photoshop/Digital Photo Professional finishes.

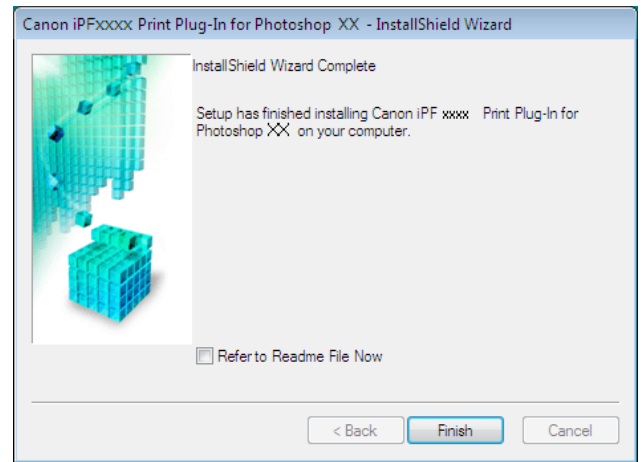

Uninstall Procedures

The procedure for uninstalling the Print Plug-In for Photoshop/Digital Photo Professional and Layout Plug-In is as follows.



Note

- This section describes the procedure in Windows 7.

• Uninstall the Print Plug-In for Photoshop

1. Select **start** in **Control Panel** menu.
2. Select **Programs and Features**.
3. Select **Canon iPFxxxx Print Plug-In for Photoshop xx**, then click **Change/Remove**.

• Uninstall the Print Plug-In for Digital Photo Professional

1. Select **start** in **Control Panel** menu.
2. Select **Programs and Features**.
3. Select **Canon iPFxxxx Print Plug-In for Digital Photo Professional**, then click **Change/Remove**.



Note

- iPFxxxx is the name of your printer.

• Uninstalling the Layout Plug-In

1. Select **Control Panel** from the **start** menu.
2. Select **Programs and Features**.
3. Select **imagePROGRAF Layout Plug-In**, and then click the **Change/Remove** button.

Starting from Photoshop

Follow the procedure below to start the Print Plug-In for Photoshop from Photoshop.

1 Start Photoshop.

2 Open the image that you wish to print.

3 If required, select the print range.



Note

- Images for use with Print Plug-In for Photoshop are less than 60,000 pixels in width and height. Reduce the selection range or reduce the image with processing for images more than 60,000 pixels in width and height, and then attempt step 3.

4 Select **Export**(or **Data Export**) from the **File** menu and then select the output plug-in that matches your printer. The imagePROGRAF Print Plug-In for Photoshop window (known below as the Print Plug-In window) is displayed.

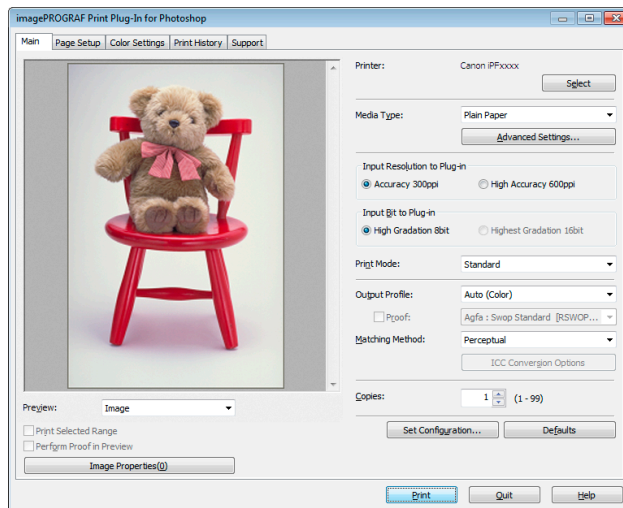

Important

- When a profile is created with a commercially available profile creation tool, it may be created in ICCv4 format. When an image source profile is ICCv4, you must install AdobeCMM or use Print Plug-In in a Windows Vista or later environment. When Adobe CMM is not installed in a Windows XP environment, a message is displayed, and the source profile changes to Adobe RGB. To use an ICCv4 profile in a Windows XP environment, exit Plug-In and then install Adobe CMM. For details on installing Adobe CMM →P.296 .



Note

- When the color space of the entry screen is CMYK, it changes to AdobeRGB due to processing with Print Plug-In. Also, **Relative Colorimetric** is used for the matching method.
- If the message below is displayed but the Print Plug-In window is not displayed, install the newest imagePROGRAF printer driver and then attempt step 3.
The imagePROGRAF Printer Driver for iPFxxxx is either not installed correctly or not installed at all. Please install.
(The iPFxxxx portion of the above message will reflect your printer name.)
- If the message below is displayed but the Print Plug-In window is not displayed, convert the color space of the image to either RGB color, grayscale, or CMYK color and then attempt step 3.
Set the color space of the image to either RGB color, grayscale, or CMYK color.

Starting from Digital Photo Professional

Follow the procedure below to start the Print Plug-In for Digital Photo Professional from Digital Photo Professional.

1 Start Digital Photo Professional.

2 Open the RGB color image that you want to print.

3 If required, select the print range.



- Images for use with Print Plug-In for Digital Photo Professional are less than 6,000 pixels in width and height. Reduce the selection range or reduce the image with processing for images more than 6,000 pixels in width and height, and then attempt step 3.

4 Select **File** from the **Plug-in printing** menu and then select the output plug-in that matches your printer. The imagePROGRAF Print Plug-In for Digital Photo Professional window (hereinafter referred to as the Print Plug-In window) is displayed.

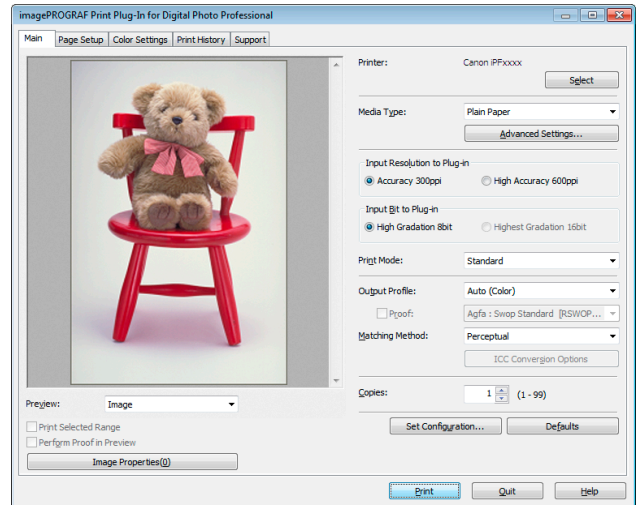

- When a profile is created with a commercially available profile creation tool, it may be created in ICCv4 format. When an image source profile is ICCv4, you must install Adobe CMM or use Print Plug-In in a Windows Vista or later environment. When Adobe CMM is not installed in a Windows XP environment, a message is displayed, and the source profile changes to Adobe RGB. To use an ICCv4 profile in a Windows XP environment, exit Plug-In and then install Adobe CMM. For details on installing Adobe CMM, refer to Using Adobe CMM →P.296.

Print Plug-In for Photoshop/Digital Photo Professional Main Window

The Print Plug-In for Photoshop/Digital Photo Professional main window consists of the sheet selection area, and the preview and button area.

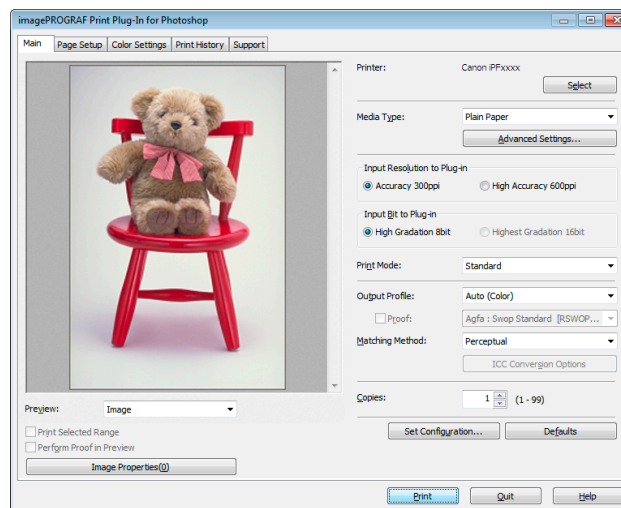

- **Sheet Selection Area**

The tabs used to switch between each sheet on the Print Plug-In for Photoshop/Digital Photo Professional window are displayed.

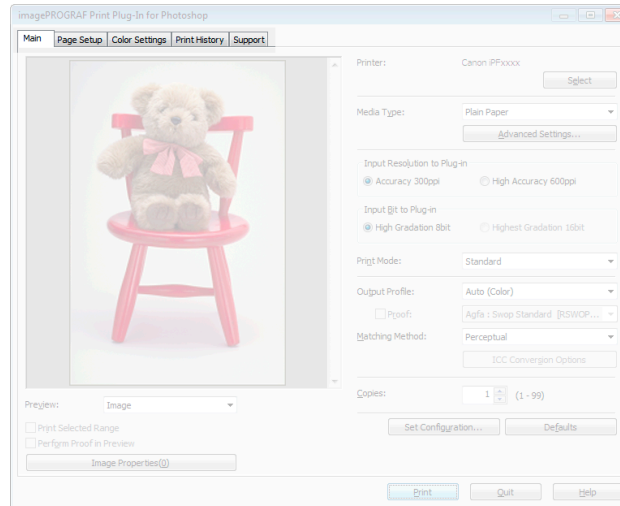

When you select a tab, a sheet is displayed. The settings available on each sheet are as follows.

- Main Sheet →P.267
- Page Setup Sheet →P.270
- Color Settings Sheet (Color) →P.272
- Print History Sheet →P.274
- Support Sheet →P.275

- **Preview Area**

You can check the settings you made on the image in this area.

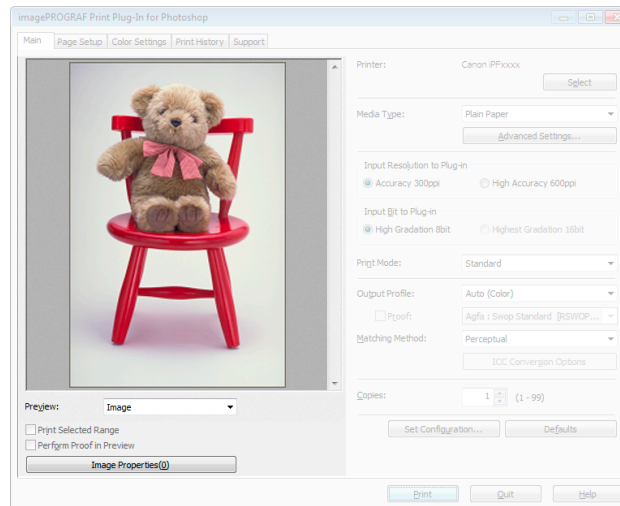

About the settings available on the preview area, see "Preview Area." →P.265

- **Button Area**

This contains the buttons **Print**, **Quit** and **Help**

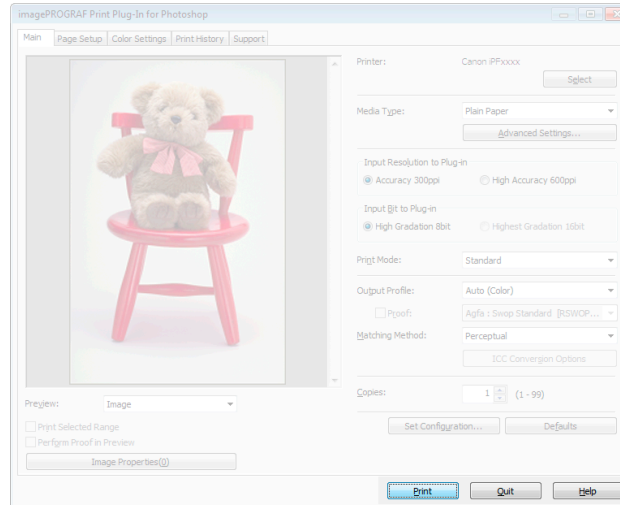

- **PrintButton**
Click this button to begin printing.
- **QuitButton**
Click this button to close the Print Plug-In for Photoshop/Digital Photo Professional Main window and return to application software.
- **HelpButton**
Click this button to display the Print Plug-In for Photoshop/Digital Photo Professional Help file.

Preview Area

You can check the settings you made on the image in this area.

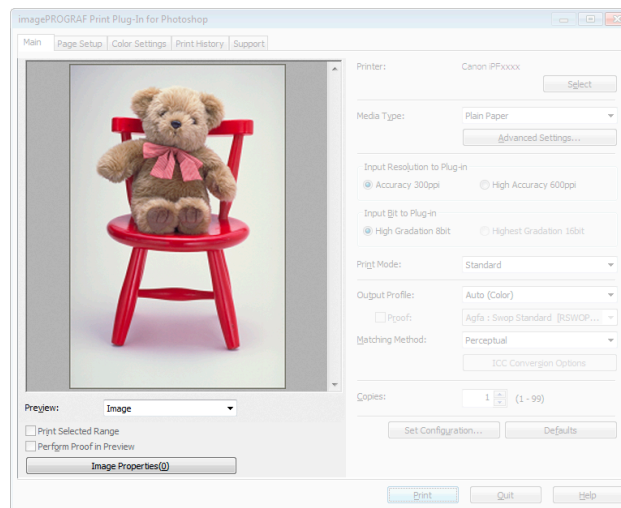



- **Preview**

Select the preview display method.

For more information about preview, see "Utilize Three Types of Previews." →P.287

Setting	Details
Print Area Layout	Displays the print range and the area out of the print range in the layout matching the Paper Size set.

Setting	Details
Print Area Layout	*You can change the image print position when you drag the image while the cursor is displayed as  .
Image	The entire image is displayed. *You can select the print range when you drag the image while the cursor is displayed as  *When you click the image while the cursor is displayed as  , the selected area is deselected.
Roll Paper Preview	Display the media size and roll paper information on the top in the layout printing on roll paper. *To select Roll Paper Preview , select Roll Paper in Paper Source .

• **Print Selected Range**

Place a checkmark here to only print the selected range.



Note

- When you select **Preview** in the **Image**, then select a portion of the image on the preview display, this becomes valid.

• **Perform Proof in Preview**

Place a checkmark here to simulate the colors of the output product in the preview.



Note

- If **Auto (Color)** is selected under **Output Profile**, some media types are enabled.
- If ICC profile is selected under **Output Profile**, this is always enabled.
- The actual color balance of the print product and the simulation product may differ with some environments and conditions. In addition, when you have selected an ICC Profile with **Output Profile** and it is not compatible with the printer or media that you are using, the color balance of the actual print product will differ.

• **Image Properties** button

When you click the button to open the **Image Properties** dialog box, where **Image Size**, **Resolution**, **Bit** and **Color Space** information of the image imported to Print Plug-In are displayed.

Click the **Close** button to return to Print Plug-In for Photoshop/Digital Photo Professional.

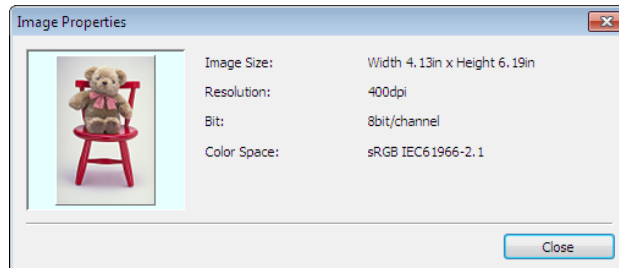

Main Sheet

You can use this sheet to perform basic settings such as selecting a printer, setting the media type, or adjusting image quality.

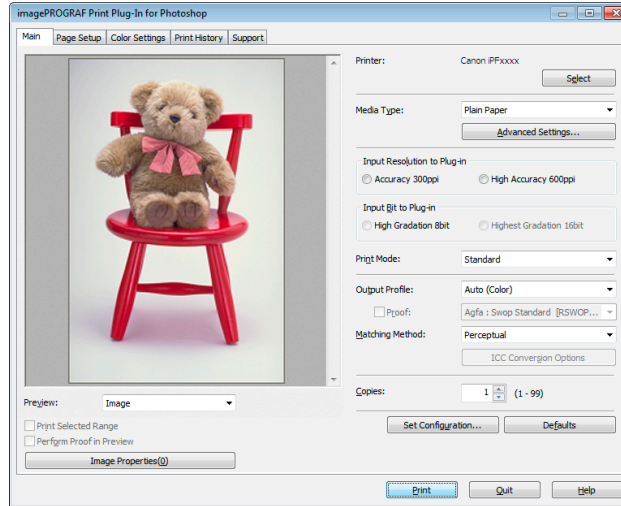

• Printer

The printer types are displayed.

• Select button

Click this button to display the **Select Printer** dialog box.

When you click the **OK** button after selecting the printer in the **Select Printer** dialog box, you can change the printer that corresponds with Print Plug-In for Photoshop/Digital Photo Professional.

• Media Type

This allows you to select the media type.

For more information about Media Type, see "Customize Media Settings." →P.305



Note

- Always select media type that is actually set in the printer. When the media you chose is different from the media set in the printer, you may not receive the desired print results.

• Advanced Settings button

Click the button to display the **Paper Detailed Settings** dialog box.

For more information about the media detailed settings, see "Paper Detailed Settings Dialog Box." →P.280

• Input Resolution to Plug-in

You can select the resolution to process the image with Print Plug-In.

The following settings are available for resolution.

Setting	Details
Accuracy 300ppi	This processes images at an accurate resolution. This can control print speed and memory capacity.
High Accuracy 600ppi	This processes images at a more accurate resolution. This setting results in the best print quality, but this takes more time to print than Accuracy 300ppi while also requiring more memory capacity. *This may not be displayed depending on how you set Media Type

• Input Bit to Plug-in

You can select the bit number to process with Print Plug-In for Photoshop/Digital Photo Professional.

The following settings are available for the input bit number.

Setting	Details
High Gradation 8bit	This processes images with at 8bit/channel (24 bit).
Highest Gradation 16bit	This processes images with at 16bit/channel (48 bit). *This may not be displayed depending on how you set Media Type and Input Resolution to Plug-in .

• Print Mode

Selecting the printing mode strikes the balance between the quality of the printed image and printing speed. The following settings are available for the print mode.

Setting	Details
Highest	A setting for printing at the highest resolution when quality is most important. Printing takes longer and consumes more ink than in other modes, but this mode offers superior printing quality.
High	Choose this setting to print at high resolution when quality is most important. Printing takes longer and consumes more ink than in Standard or Fast modes, but this mode offers exceptional printing quality.
Standard	Choose this setting to print at standard resolution when quality and speed are both important. Printing takes less time than in Highest or High mode.
Fast	Choose this setting to print faster. Printing in fast mode can help you work more efficiently when checking layouts.
Highest (Max. No. of Passes)	If you are concerned about uneven colors in the print result of Highest quality , selecting this option may improve printing results. However, printing may take longer.



Note

- The selectable fields may vary according to the **Media Type**, **Input Resolution to Plug-in** and **Input Bit to Plug-in** settings.

• Output Profile

You can select the output profile.

The following settings are available for the output profile.

Setting	Details
Auto (Color)	Performs the optimum color conversion from the input image data color space information (sRGB, Adobe RGB), media settings etc. You should normally select these settings.
Auto (Monochrome Photo)	Performs the best color conversion to monochrome from the input image data color space information (sRGB, Adobe RGB), media settings etc.
None (No Color Correction)	You cannot perform color conversion with a plug-in. This is useful for creating an original ICC profile.
External ICC Profiles	This selects printer ICC profiles to be output to ICC profiles saved in the OS standard folder. Use the color space of the input data as well as the select ICC profile to perform color conversion.



Important

- To use an ICCv4 profile, you must install AdobeCMM or use Print Plug-In in a Windows Vista or later environment. For details on installing Adobe CMM, refer to Using Adobe CMM →P.296 .



Note

- **Auto (Monochrome Photo)** can only be selected for the corresponding media types.

• Proof

This is displayed when an ICC profile is selected as the **Output Profile**.

When this is checked, you can perform printing press simulation prints.

Refer to Perform Printing Press Simulation Print →P.300 for details on printing press simulation prints.

• Matching Method

You can select the processing method when performing color conversion.

The following settings are available for the matching method.

Setting	Details
Perceptual	This converts the image to an image with natural color balance and gradation. This is useful for pictures.
Saturation	This converts the image to an image with heightened color saturation. The color balance of pictures and drawings may change.
Relative Colorimetric	This converts the image with emphasis on color balance before the conversion or on visual color balance. This is useful for pictures and drawings.



Note

- When the **Output Profile** you have set is **Auto (Monochrome Photo)** or **None (No Color Correction)**, you cannot select a matching method.

• ICC Conversion Options button

This is displayed when an ICC profile is selected as the **Output Profile**.

When this button is clicked, the **ICC Conversion Options** dialog box is displayed allowing you to configure color conversion related settings.

Refer to ICC Conversion Options dialog box [→P.283](#) for details on ICC Conversion Options.

• Copies

You can input the number of print copies in numerical characters.



Note

- The maximum value is 99.
- You can change the numbers by clicking either ▲ or ▼.

• Set Configuration button

Clicking the button opens the **Set Configuration** dialog box that provides settings for the adjustment of image sharpness and image enlargement method.

For more information about **Set Configuration**, see "Set Configuration Dialog Box." [→P.282](#)

• Defaults button

Click the button to return all of the settings on the **Main** sheet to their defaults.

Page Setup Sheet

You can use this sheet to set the size of the image to be printed, the media size, and whether to enlarge/reduce the image.

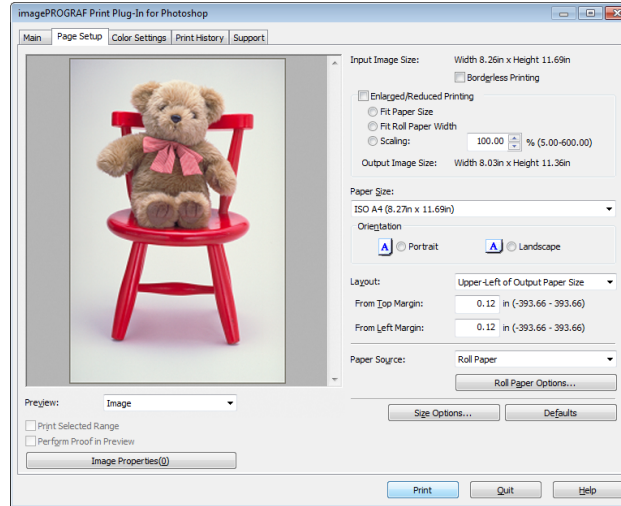

• Input Image Size

The size of the image imported to Print Plug-In for Photoshop/Digital Photo Professional is displayed.

• Borderless Printing

When you place a checkmark here, the **Specify Roll Paper Width** dialog box is displayed and you can print an image without borders.

For more information about **Borderless Printing**, see "Print with No Borders." →P.304



Note

- Available only if rolls are selected in **Paper Source**.

• Enlarged/Reduced Printing

When you place a checkmark here, you can print enlarged/reduced images.

When printing an enlarged/reduced image, select the method for enlargement/reduction. The image size sent to the printer is displayed matching the selected method in **Output Image Size**.

The following settings are available for enlarged/reduced printing.

Setting	Details
Fit Paper Size	This automatically enlarges/reduces the entire image imported to Print Plug-In to match the export media size when printing.
Fit Roll Paper Width	This automatically enlarges/reduces the entire image imported to Print Plug-In to match the width of the roll paper with the width of the image when printing. *Displayed only if rolls are selected in Paper Source .
Scaling	This enlarges/reduces the entire image by the specified scaling value. Input the scaling value in numerical characters. You can specify a range between 5-600%. *You can change the numbers by clicking either ▲ or ▼.



Note

- This is not displayed when a checkmark is placed in **Borderless Printing**.

• Output Image Size

The output image size is displayed up to one place after the decimal point in millimeters.



- When **Paper Size** is smaller than **Output Image Size**, part of the image may not print.

Note

• Paper Size

You can select the size of the print media.



- This is not displayed when a checkmark is placed in **Borderless Printing**.
- This is not displayed when **Fit Roll Paper Width** is set in **Enlarged/Reduced Printing**.

Note

• Orientation

This selects the print orientation.

The following settings are available for orientation.

Setting	Details
Portrait	Prints the image on the media as it appears on the screen.
Landscape	Prints the image on the media rotated 90 degrees.

• Layout

You can select the print position of an image on the media.

The following settings are available for layout.

Layout

Setting	Details
Upper-Left of Output Paper Size	Prints the image with fitting the top left of the active print area for Paper Size .
Center of Output Paper Size	Prints the center of the image on the center of the selected Paper Size .
Specify Print Start Position	You can print with specifying the top and left printing start positions in From Top Margin and From Left Margin for Paper Size .
From Top Margin	Input the margin from the top of the media in numbers. *You can input between -9999 and 9999 mm.
From Left Margin	Input the margin from the left of the media in numbers. *You can input between -9999 and 9999 mm.



- Select **Print Area Layout** or **Image** in **Preview** when you select **Layout**.

Note

Roll Paper Layout

Setting	Details
Upper-Left of Roll Paper	Prints the top left of Media Size on the top left of the selected roll paper.
Center of Roll Paper	Prints the center of Media Size on the center of the selected roll paper.



- Select **Roll Paper Preview** in **Preview** when you select **Roll Paper Layout**.

Note

• Paper Source

You can select the media source.

The following settings are available for media source.

Setting	Details
Roll Paper	Select to print on roll paper.

Setting	Details
Cut Sheet	Select to print on the cut sheet.

- **Roll Paper Options** button

Click this button to open the **Roll Paper Options** dialog box, where you can set roll paper width and perform auto cut settings.

For more information about the roll paper options, see "Roll Paper Options Dialog Box." →P.284

- **Size Options**

Click the Size Options button to open the **Size Options** dialog box and you can select a media name, size and other settings.

For more information about the size options, see "Size Options Dialog Box." →P.284

- **Defaults** button

Click the button to return all of the settings on the **Page Setup** sheet to their defaults.

Color Settings Sheet (Color)

You can use this sheet to adjust image Color, **Brightness**, **Contrast**, **Saturation**, and you can set the color balance of print product more to your liking.

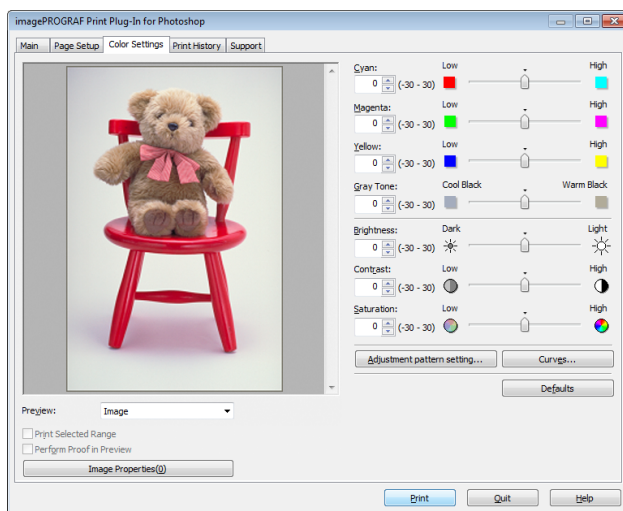

- You can check a preview of the adjusted state for the following items.
Cyan / Magenta / Yellow, Gray Tone, Brightness, Contrast, Saturation, and Gray Tone Adjustment

- **Cyan / Magenta / Yellow**

You can adjust the strength or weakness of a color by either inputting a numerical value or dragging the slide bar.

- **Gray Tone**

You can adjust gray tone from cool black (cool tones) to warm black (red tones) by either inputting a numerical value or dragging the slide bar.

- **Brightness**

You can adjust the brightness of the printed image without losing the brightest and darkest areas by either inputting a numerical value or dragging the slide bar.

- **Contrast**

You can relatively adjust the brightness of the brightest and darkness areas by either inputting a numerical value or dragging the slide bar.

- **Saturation**

You can adjust the saturation of vivid color balance to dark color balance by either inputting a numerical value or dragging the slide bar.

- **Adjustment pattern setting** button

When this button is clicked, the **Adjustment pattern setting** dialog box is displayed. The **Adjustment pattern setting** dialog box allows you to print an adjustment pattern with adjustment values that vary in steps up and down, and to select your preferred adjustment values.

For details on **Adjustment pattern setting**, see "Adjustment pattern setting dialog box." →P.276

- **Curve** button

Click the button to open the **Curve** dialog box then set the **Channel** and other settings.

For more information about **Curve**, see "Curves Dialog Box." →P.285

- **Defaults** button

Click the button to return all of the settings on the **Color Settings** sheet to their defaults.

Color Settings Sheet (Monochrome)

This screen allows you to adjust settings such as the **Color Balance**, **Tone**, **Brightness**, and **Contrast** to configure the printing result to be closer to your expected tone and gradation.

This is displayed when **Auto (Monochrome Photo)** is selected in the **Output Profile** on the Main Sheet →P.267 .

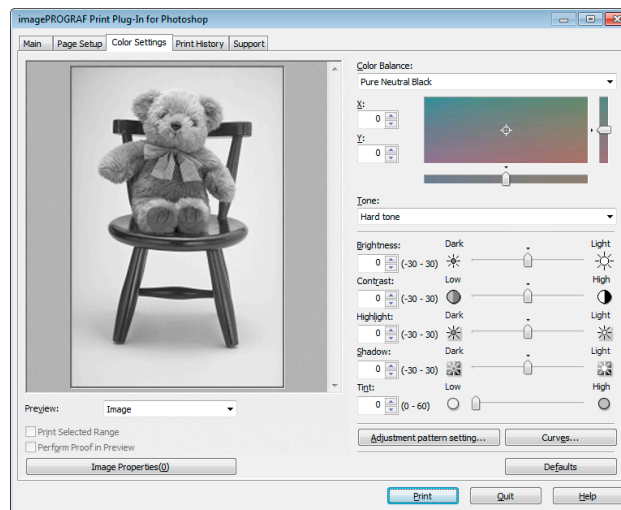

- You can check a preview of the adjusted state for the following items.
Color Balance, Tone, Brightness, Contrast, Highlight, Shadow, and Tint

- **Color Balance**

Allow you to select the color balance to suit your application.

- **X / Y**

Adjust the color balance as you check the color tone in the adjustment area.

You can adjust the square area in the center by clicking or dragging it.

Drag the vertical or horizontal scroll bars for adjustment, as desired.

You can click the arrows by the **X** (horizontal) and **Y** (vertical) boxes or enter the values directly.

- **Tone**

You can adjust the brightness of intermediate tones in an image. Selecting **Hard tone** gives a hard impression with more definition. Selecting **Soft tone** gives a soft impression.

- **Brightness**

You can adjust the brightness of the printed image without losing the brightest and darkest areas by either inputting a numerical value or dragging the slide bar.

- **Contrast**

You can relatively adjust the brightness of the brightest and darkness areas by either inputting a numerical value or dragging the slide bar.

- **Highlight**

Adjust the brightness of the lightest portion.

- **Shadow**

Adjust the brightness of the darkest portion.

- **Tint**

Fills in the white parts of the paper with a small amount of ink in order to reduce the difference in texture between highlights in the image and the white parts of the paper.

- **Adjustment pattern setting button**

When this button is clicked, the **Adjustment pattern setting** dialog box is displayed. The **Adjustment pattern setting** dialog box allows you to print an adjustment pattern with adjustment values that vary in steps up and down, and to select your preferred adjustment values.

For details on **Adjustment pattern setting**, see "Adjustment pattern setting dialog box." →P.276

- **Curve button**

Click the button to open the **Curve** dialog box then set the **Channel** and other settings.

For more information about **Curve**, see "Curves Dialog Box." →P.285

- **Defaults button**

Click the button to return all of the settings on the **Color Settings** sheet to their defaults.

Print History Sheet

You can use this sheet to apply settings history used in printing, and to print information, such as the image file name, with the image.

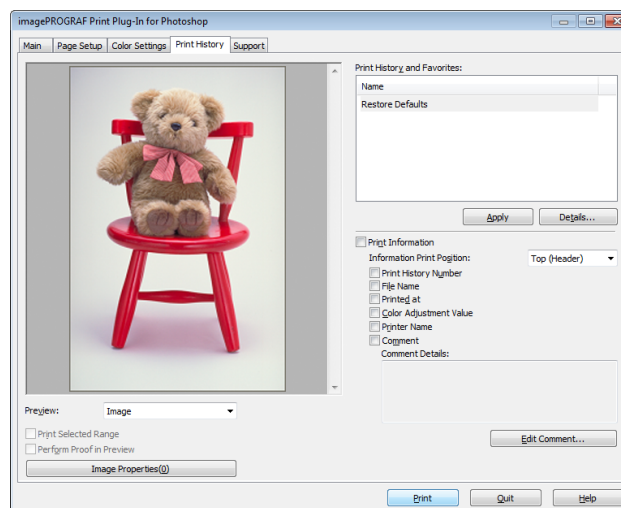

- **Print History and Favorites**

This displays a list of print preferences.

Select **Restore Defaults** and click the **Apply** button to restore all settings to their initial settings.



Note

- You can check the 3 print preferences in the preview display.

- Apply** button

When you click the button, the print setting content applies to the current image selected with **Print History and Favorites**.

- Details** button

Click the Details button to open the **Print History Details** dialog box, where you can manage print history.

For more information about the print history details, see "Print History Details Dialog Box." →P.286

- Print Information**

When you place a checkmark here, you can print the file name and print time and date on the image. The following settings are available for the print position and content.

For more information about **Print Information**, see "Set Information to Print with Image." →P.315

Setting	Details	
Information Print Position	Selects the information print position.	
	Top (Header)	Information is printed on the top of the image.
	Bottom (Footer)	Information is printed on the bottom of the image.
Print History Number	Place a checkmark here to print the print history number.	
File Name	Place a checkmark here to print the file name.	
Printed at	Place a checkmark here to print the time and date.	
Color Adjustment Value	Place a checkmark here to print the color adjustment value.	
Printer Name	Place a checkmark here to print the printer name.	
Comment	Place a checkmark here to print the comment details.	
Comment Details	Place a checkmark here to display the comment details.	

- Edit Comment** button

Click the button to display the **Edit Comment** dialog box, where you can edit the comment.

Support Sheet

You can display product support information and the electronic manual.

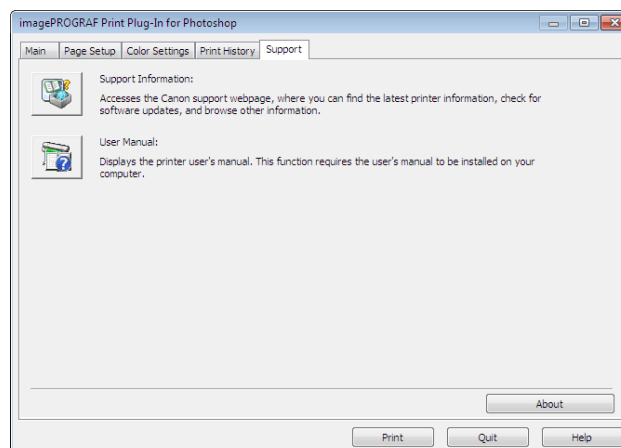

- **Support Information button**

Click the button to display websites that contain the latest product information.



- An Internet connection is needed to view the websites.

Note

- **User Manual button**

Click the button to display the printer manuals installed on the computer.



- You must have User Manual installed on your computer.

Note

Adjustment pattern setting dialog box

Displays the adjustment pattern by taking images with the adjustment values varying up and down in steps from the baseline adjustment values in the **Color Settings** sheet (color or monochrome). This allows you to print the adjustment pattern and select your preferred adjustment values while comparing the images.

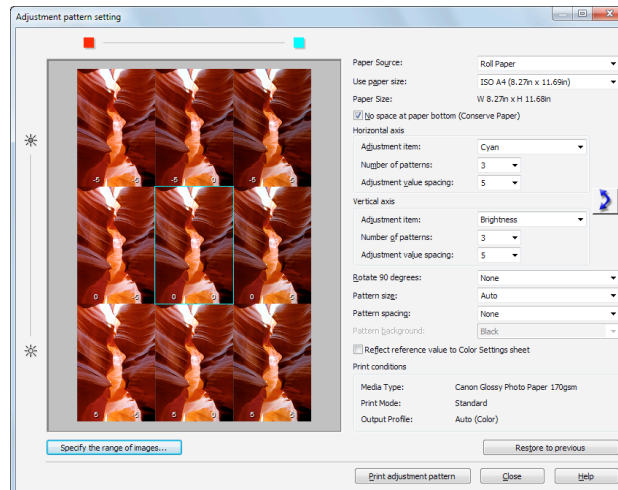

- **Preview Area**

This area allows you to view adjustment pattern images side-by-side to check the state when changes to adjustment values are applied.

The adjustment values of the image enclosed in the blue frame in the center are used as the base values, with images arranged around this with the adjustment values varying in steps up and down from these base values. If you click any of the images, the adjustment pattern is redisplayed with the adjustment values from that image as the base values.

The adjustment values are displayed at the top of each image. If both the **Horizontal Axis** and **Vertical Axis** are configured, the adjustment value for the **Horizontal Axis** is displayed on the right and the adjustment value for the **Vertical Axis** is displayed on the left. If the image is so small that the adjustment values cannot be displayed, you can check the adjustment values by displaying the tool tip.



- For images where the adjustment values are out of range, an adjustment pattern is not displayed and the message **Out of Range** is displayed instead.

Note

- **Paper Source**

Selects the paper feed method for the paper to print the adjustment pattern on. You can split the usage between printing adjustment patterns on cut paper (manual feed) and printing work pieces on roll paper.

• Use Paper Size

Selects the paper size to print the adjustment pattern on.

The adjustment pattern is printed so that it fits into the selected paper size.



Note

- If the image size is large and **Dimensions** is selected in **Pattern Size**, the pattern display might not fit within the vertical direction of the paper size. In this case, select **Auto** in **Pattern Size**.
- The printed paper size is displayed in **Paper Size**.

• Paper Size

Since the length in the vertical direction may differ between the **Use Paper Size** and actual printed material, this displays the actual output paper size.

• No Space at Paper Bottom (Conserve Paper)

If a margin appears at the bottom of the paper with the paper size selected in **Use Paper Size**, you can conserve paper by selecting this check box to print excluding the margin area. The state of the length in the vertical direction being shortened to conserve the margin area is reflected in the displayed **Paper Size**.

• Horizontal Axis / Vertical Axis

Configures settings such as the items that change in steps and the number of patterns when multiple adjustment patterns are arranged horizontally or vertically.

• Adjustment Item

Selects the items to change in steps.

For color, you can select **Cyan, Magenta, Yellow, Gray Tone, Brightness, Contrast, or Saturation**.

For monochrome, you can select **X Color Balance, Y Color Balance, Tone, Brightness, Contrast, Highlight, Shadow, or Tint**.

The icons for **Horizontal Axis Adjustment Item** are displayed above the preview area and the icons for **Vertical Axis Adjustment Item** are displayed on the left of the preview area.



Note

- **None** can only be selected for **Vertical Axis** in both color and monochrome.

• Number of Patterns

You can select the number of images to display in the pattern in the horizontal or vertical direction from 3, 5, and 7. If the adjustment item is **Tone**, you can select 3 or 5. When **Tone** is selected as the adjustment value, -1 is **Soft tone**, 0 is **Middle tone**, 2 is **Medium-hard tone**, 3 is **Hard tone**, and 5 is **Strong-hard tone**.

• Adjustment Value Spacing

You can select the interval of the variation in adjustment values between neighboring adjustment pattern images from the range of 1 to 10. The larger the value, the greater the differences between the states of the adjustment pattern images. Note that if the adjustment item is **Tone**, the **Adjustment Value Spacing** cannot be selected.



- (Swap) button

Rearranges the adjustment pattern with the **Horizontal Axis** and **Vertical Axis** adjustment items swapped.

• Rotate 90 degrees

Rotating the image may make it easier to conserve paper and compare images.

Select **Per Image** to rotate each of the images in the adjustment pattern by 90 degrees.

Select **Entire Image after layout** to rotate the entire adjustment pattern by 90 degrees.

When **None** is selected, the image is not rotated.

- **Pattern Size**

You can specify the size of the image when printing the adjustment pattern.

When **Auto** is selected, the image is enlarged or reduced to fit the adjustment pattern into the **Use Paper Size**.

When **Dimensions** is selected, the image is printed at the input image size without enlarging or reducing. **Dimensions** cannot be selected when the paper feed method is **Manual**.



Note

- If the input image size is large, check the **Paper Size** before starting printing because it may be larger than the actual printed material size.
- Select **Dimensions** in **Pattern Size** to print at the input image size without enlarging or reducing the images.
- Patterns that extend past the horizontal width of the paper are printed wrapped onto the next line.

- **Pattern Spacing**

You can select **None** or **Available**. If **Available** is selected, you can insert a background between each image. The background color can be specified in **Pattern Background**.

- **Pattern Background**

You can select the background color from **White**, **Black**, and Gray.

If it is difficult to compare the differences between neighboring adjustment pattern images, changing the background color may make it easier to compare. The **Pattern Spacing** can be selected if **Pattern Background** is **Available**.

- **Update Base Values in the Color Settings Sheet**

Select this check box and click the **Close** button to apply the setting values (standard values) of the image enclosed in the blue frame in the center of the preview area in the **Color Settings** sheet (color or monochrome).

- **Print Conditions**

Displays the paper type, print mode, and output profile configured in the main window. This makes it possible to check the details of each of the settings when printing the adjustment pattern without returning to the main window.

- **Specify the Range of Images** button

When this button is clicked, the **Specify the Range of Images** dialog box is displayed for specifying the range of images.

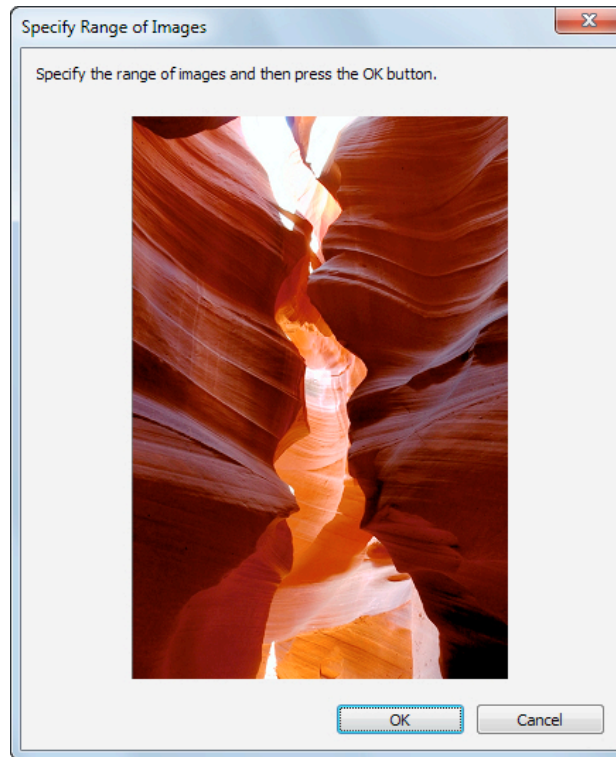

When you specify the range by using the mouse or other means and then click the **OK** button, the **Specify the Range of Images** dialog box closes and the specified image range is redisplayed as the adjustment pattern. If you click the **Cancel** button, the **Specify the Range of Images** dialog box closes even if a range is selected.



Note

- The selected range is cleared by clicking the image with a range selected.

- **Restore to Previous** button

When this button is clicked, the settings are restored to the defaults when the **Adjustment pattern setting** dialog box was first displayed.

- **Close** button

When this button is clicked, the setting values in the **Adjustment pattern setting** dialog box are saved and the dialog box is closed. These setting values are applied the next time the Print Plug-In for Photoshop/Digital Photo Professional is started. Furthermore, if you select the **Update Base Values in the Color Settings Sheet** check box and click the **Close** button, the setting values for the image enclosed in the blue frame in the preview area (central image) are applied to the settings in the **Color Settings** sheet (color or monochrome).

- **Print Adjustment Pattern** button

When this button is clicked, printing the adjustment pattern is executed. The **Adjustment pattern setting** dialog box does not close even after executing the printing.

The adjustment values are printed at the top of each image. If both the **Horizontal Axis** and **Vertical Axis** are configured, the adjustment value for the **Horizontal Axis** is displayed on the right and the adjustment value for the **Vertical Axis** is displayed on the left.

Each of the setting values for the paper type, print mode, and output profile as well as the adjustment values configured in the **Color Settings** sheet (color or monochrome) are printed at the bottom of the paper. However, the adjustment values for the **Curve** are not printed.



- The job name when printing the adjustment pattern is "Original Image Name + Pattern-Print". For example, the print job name for the image "ABC.jpg" is "ABC_Pattern-Print.jpg".

Paper Detailed Settings Dialog Box

This dialog box appears when you click the **Advanced Settings** button on the **Main Sheet**. You can set **Drying Time** and **Roll Paper Margin for Safety** by media type.

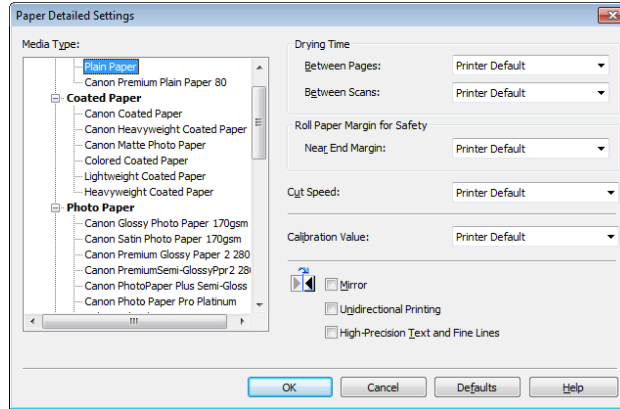

• Drying Time Between Pages

This sets the wait time for the ink to dry between each completely printed sheet and the output of the sheet.

Setting	Details
Printer Default	The settings of the printer operating panel are applied.
None	The paper is ejected immediately after printing.
30sec. / 1min. / 3min. / 5min. / 10min. / 30min. / 60min.	The sheet is ejected when the specified time after printing has elapsed.

Between Scans

This sets the wait time between line scans during printing.

Setting	Details
Printer Default	The settings of the printer operating panel are applied.
None	The printing continues to the next line immediately after the last line.
1sec. / 3sec. / 5sec. / 7sec. / 9sec.	The printing continues to the next line after the set time. *For the media type that has problems, such as ink smears on the page or colors that seem uneven during borderless printing etc., increase the value for this setting.

• Roll Paper Margin for Safety Near End Margin

This sets the length of the near end margin of the roll paper.

Setting	Details
Printer Default	The settings of the printer operating panel are applied.
5mm	Print at a standard size. *Select for Media Type that has no problem when printing with a standard size margin.
20mm	Select this when rubbing against the printhead occurs such as when using paper that tends to curl.

• Cut Speed

This selects the auto cut speed.

Setting	Details
Printer Default	The settings of the printer operating panel are applied.
Fast	Select this setting if cutting with the Standard setting is not clean.
Standard	Select this setting when you are not experiencing problems.
Slow	This helps prevent adhesive from sticking to the cutter and keeps the cutter sharp if you select it when using adhesive paper.

- **Calibration Value**

When calibration has been carried out on the printer, use this setting to choose whether or not to use the results.

Setting	Details
Printer Default	The settings of the printer operating panel are applied.
Use Value	The calibration results are used for printing.
Disregard Value	The calibration results are not used for printing. Select this option to avoid changes to image color tones during printing due to color calibration.

- **Mirror**

Specify whether to print a mirror image, as needed. Select this option to print a version of the document or image with the left and right sides inverted.

- **Unidirectional Printing**

Select this checkbox to prevent problems such as misaligned lines and improve the print quality. However, the printing speed becomes slower.

- **High-Precision Text and Fine Lines**

Print increasing ink impact accuracy, particularly for sharper text and fine lines. However, this takes more time than regular printing.



Note

- When **Highest (Max. No. of Passes)** is selected as the print mode, **High-Precision Text and Fine Lines** cannot be selected.

Set Configuration Dialog Box

This dialog box appears when you click the **Set Configuration** button on the **Main Sheet**. You can set the adjustment of image sharpness and image enlargement method.

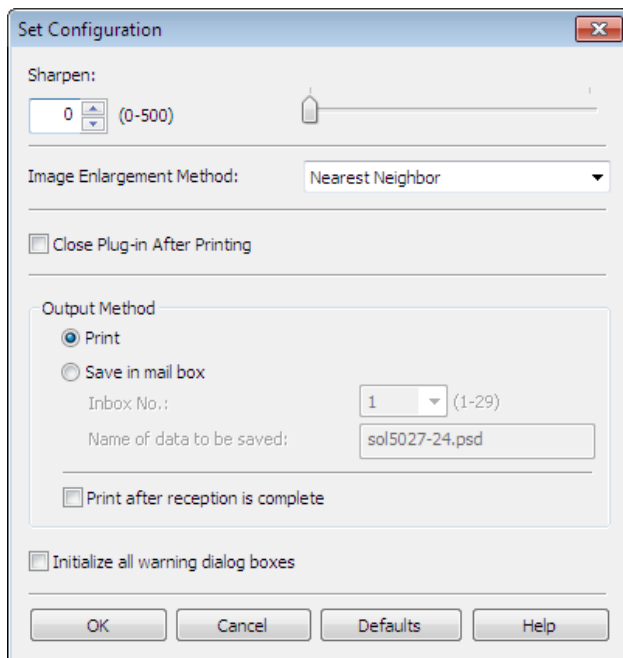

• Sharpen

Performs adjustment of the sharpness (outline) settings.

• Image Enlargement Method

You can select the image enlargement method.

The following settings are available for the image enlargement method.

Setting	Details
Nearest Neighbor	Performs simple enlargement.
Bilinear	Performs line vector enlargement.
Bicubic	Adjust pixels with calculation of elements such as a color or brightness of neighboring pixels.

• Close Plug-in After Printing

When you place a checkmark here, the plug-in closes after printing finishes.



Note

- If printing does not finish correctly because it was canceled or an error occurred, the plug-in does not close.

• Output Method

You can select the output method.

The following settings are available for the output method.

Setting	Details
Print	Normal printing. The print job data is stored temporarily in the box as the job prints.
Save in mail box	Saves the print data in the mail box. If you select Save in mail box , you must specify Name of data to be saved .
Print after reception is complete	When you place a checkmark here, you can print after saving jobs in the temporary storage space. This cannot be used when Save in mail box is selected.

- **Initialize all warning dialog boxes**

When this is checked, all of the warning dialog boxes that have been set to "Do not show this screen again" become displayed.

ICC Conversion Options dialog box

This is displayed when an ICC profile is selected in the **Output Profile** list in the **Main** sheet and the **ICC Conversion Options** button is clicked. This allows you to configure detailed color matching related settings.

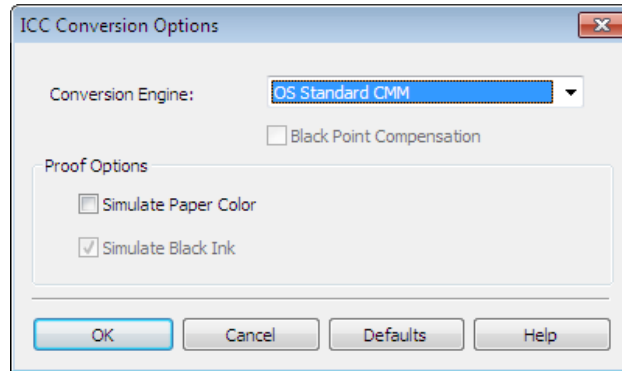

- **Conversion Engine**

Selects the conversion engine to use when converting colors.



Note

- Adobe CMM needs to be installed in order to use **Adobe CMM**. Refer to Using Adobe CMM [→P.296](#) for details on how to install Adobe CMM.

- **Black Point Compensation**

Check this check box to perform black point compensation. Loss of gradation in dark areas can be improved by performing black point compensation.



Note

- This can be used if **Adobe CMM** is selected as the **Conversion Engine**.

- **Proof Options**

Configures settings related to printing press simulation.

The proof options consist of the following settings.

Setting	Details
Simulate Paper Color	Select this when performing paper color simulation. When this is on, Simulate Black Ink is automatically turned on and becomes grayed out.
Simulate Black Ink	Select this when performing simulation of black ink. In order to enable this setting, Adobe CMM needs to be selected under Conversion Engine .

Roll Paper Options Dialog Box

This dialog box appears when you click the **Roll Paper Options** button on the **Page Setup** Sheet. You can set the roll paper width and perform the auto cut settings.

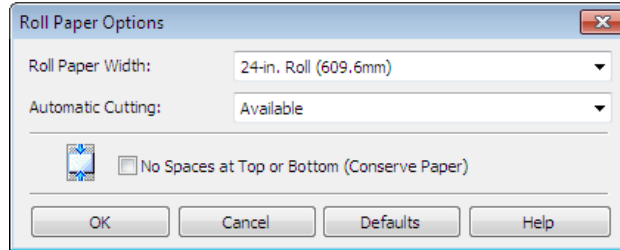

- **Roll Paper Width**

This selects the width of the roll media set to the printer.

- **Automatic Cutting**

You can set the printer to cut roll paper automatically or print a guideline for cutting. The following settings are available for automatic cutting.

Setting	Details
Available	Each page is automatically cut after it is printed.
None	Each page is not cut after it is printed and printing continues without interruption.
Print Cut Guideline	A print cut guideline is printed after each page and printing continues without interruption.

- **No Spaces at Top or Bottom (Conserve Paper)**

When you place a checkmark here, the print data is printed without margins.

Size Options Dialog Box

This dialog box appears when you click the **Size Options** button on the **Page Setup** Sheet. You can select a media name, size and other settings.

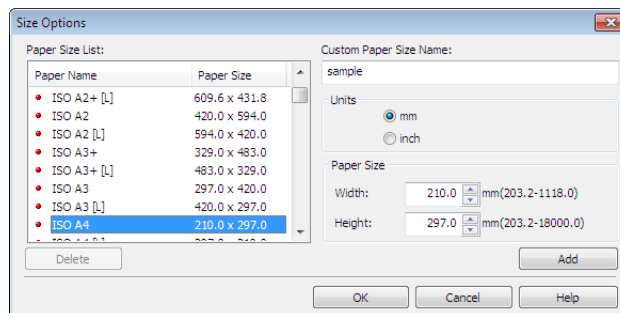

- **Paper Size List**

Displays all the standard sizes and custom media sizes.

- **Custom Paper Size Name**

You can enter any name up to 63 characters.

- **Units**

You can select the units of measure to use when you define custom media size. Switching this setting resets the units of measure for the entire Plug-In.

- **Paper Size Width**

Enter the width of the media size.

Height

Enter the height of the media size.

- **Add button**

Click the button to register the contents of the settings.

Curves Dialog Box

This dialog box appears when you click the **Curves** button on the **Color Settings** Sheet. You can set **Channel** and other settings.

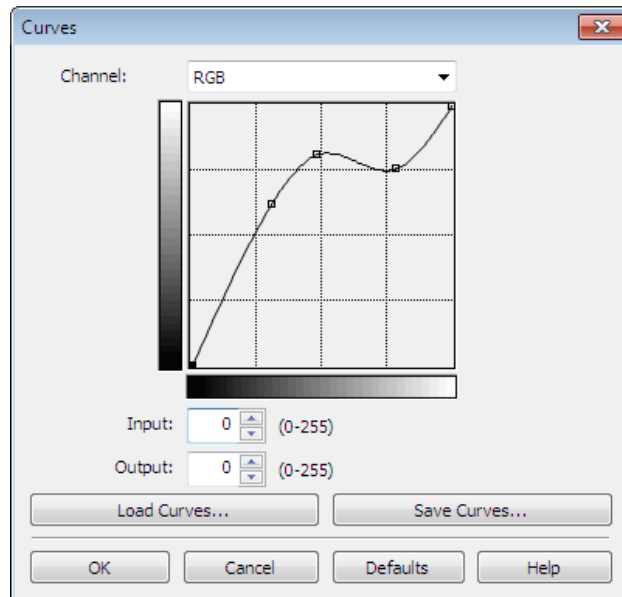

- **Channel**

Select from among **RGB**, **Red**, **Green**, or **Blue**.



Note

- **Gray** is displayed for monochrome printing and this selection cannot be changed.

- **Input**

Enter an input value.



Note

- The allowed entry range is 0 to 255.
- You can change the numbers by clicking either ▲ button or ▼ button.

- **Output**

Enter an output value.



Note

- The allowed entry range is 0 to 255.
- You can change the numbers by clicking either ▲ button or ▼ button.

- **Load Curves** button

Click the button to load stored data for a tone curve.

• **Save Curves** button

Click the button to stores the current tone curve settings.

Print History Details Dialog Box

This dialog box appears when you click the **Details** button on the **Print History** Sheet. This controls print history. For more information about **Print History Details**, see "Utilize Print History." →P.305

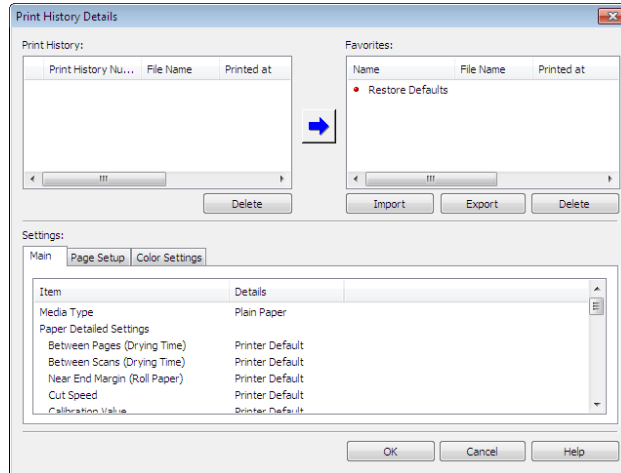

• **Print History**

Print History appears in list format.

Display Items	Details
Print History Number	Displays the print history number.
File Name	Displays image file name.
Printed at	Displays time and date of printing.
Comment	Displays comment details.



Note

- Up to 200 print history items can be displayed. All items above 200 are deleted.
- When you cannot print properly because you canceled the printing or an error occurred, appears **X** to the left of the print history number.

• **Delete** button

Click the button to delete the selected print history.

• **Add** button



Click the button to add the selected print history to preferences.



Note

- Up to 200 print preference items can be added.

• **Favorites**

The print history stored in print preferences displays in list format.



Note

- You can change the order by selecting an item and dragging it to another place.

- **Import button**

Click the button to import print history saved as a file.

- **Export button**

Click the button to save print history as a file that is stored in print preferences.

- **Delete button**

Click the button to delete print history stored in print preferences.

- **Settings**

Displays the print history settings selected from the **Print History** or **Favorites**.

Setting	Details
Main	When you select this the Main sheet settings are displayed.
Page Setup	When you select this the Page Setup sheet settings are displayed.
Color Settings	When you select this the Color Settings sheet settings are displayed.

Utilize Three Types of Previews

You can use Print Plug-In for Photoshop/Digital Photo Professional to check an image in three types of previews. The preview types are as follows.



- Check Image with Print Area Layout →P.287
- Check the original image with Image →P.288
- Check Image with Roll Paper Preview →P.288

Check Image with Print Area Layout

Displays the print range and the area out of the print range in the layout matching the media size set in the print area layout.

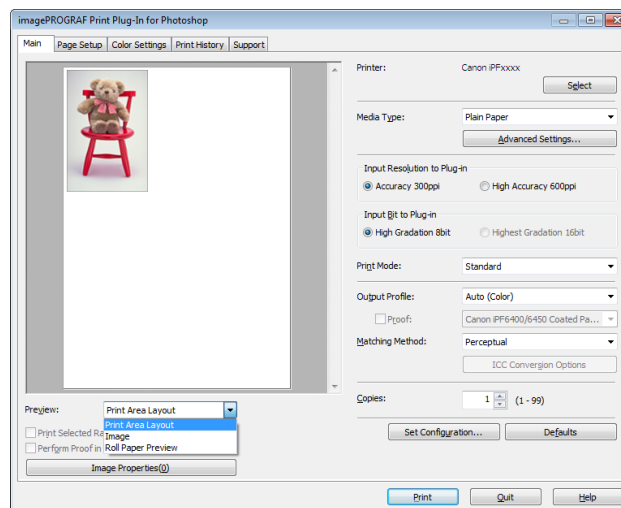
Select **Print Area Layout** in **Preview**.





- When the cursor on the preview is displayed as  on the preview, you can specify the print position by dragging the image.
- **Note** When the cursor is displayed as  on the preview, the below conditions on the **Page Setup** sheet have all been met.
 - There is no checkmark in **Borderless Printing**.
 - There is no checkmark in **Enlarged/Reduced Printing** or **Scaling** has been selected.

Check the original image with Image

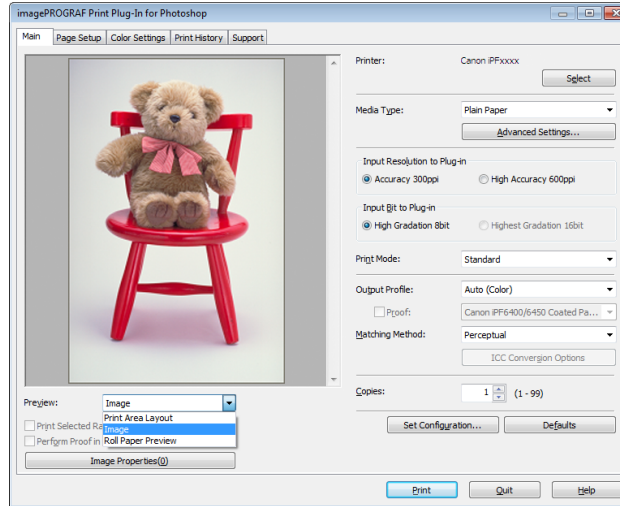
In the image preview you can check the entire image that you have input.
Select **Image** in **Preview**.



- When the cursor appears as a small magnifying glass  while there is an **Image** in the **Preview** area, the **Selected Range** feature is enabled and you can drag the cursor on the image and select an area for printing.
- When you click the image while the cursor is displayed as  on the preview, the selected area is deselected.

Check Image with Roll Paper Preview

Display the media size and roll paper information on the top in the layout printing on roll paper in Roll Paper Preview.
Select **Roll Paper Preview** in **Preview**.

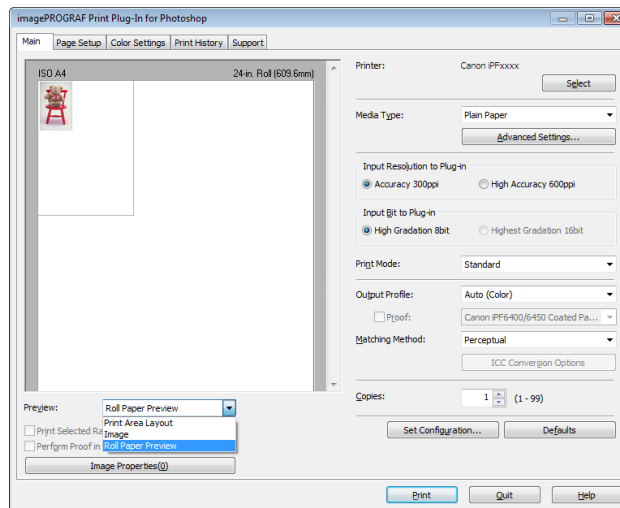

- To select **Roll Paper Preview** in **Preview**, select **Roll Paper** in **Paper Source**.

Print with a Desired Picture Quality

You can specify and print at the resolution you desire.

1 Display the **Main** sheet.

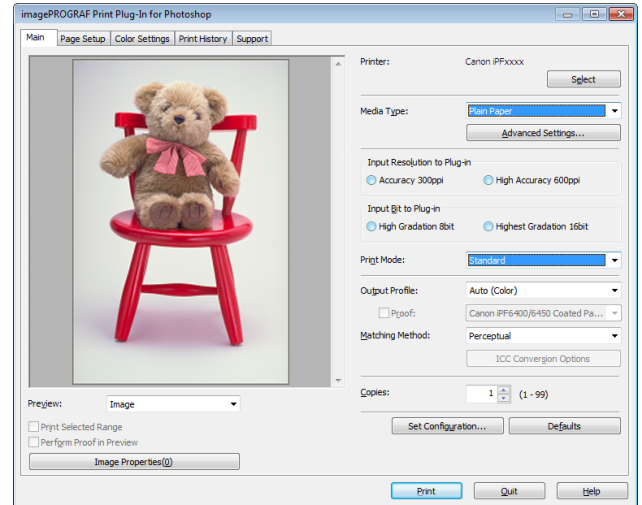

2 Select the media set to the printer in **Media Type**.



Note

- Always select media type that is actually set in the printer. When the media you chose is different from the media set in the printer, you may not receive the desired print results.

3 Choose either **Accuracy 300ppi** or **High Accuracy 600ppi** for the resolution to process images in **Input Resolution to Plug-in**.



Note

- When you select **Accuracy 300ppi** images are processed at an accurate resolution. This can control print speed and memory capacity.
- When you select **High Accuracy 600ppi** images are processed at a more accurate resolution. This setting results in the best print quality, but this takes more time to print than **Accuracy 300ppi** while also requiring more memory capacity.
- **High Accuracy 600ppi** will not display with some **Media Type** settings.

4 Choose either **High Gradation 8bit** or **Highest Gradation 16bit** for the bit number when processing images in **Input Bit to Plug-in**.



Note

- When you select **High Gradation 8bit**, images are processed at 8 bit/channel (24 bit).
- When you select **Highest Gradation 16bit**, images are processed at 16bit/channel (48 bit).
- **Highest Gradation 16bit** will not display with some **Media Type** or **Input Resolution to Plug-in** settings.

5 Select the mode to be printed when processing images in **Print Mode**.



Note

- The settings that can be selected differ by **Media Type**, **Input Resolution to Plug-in**, and **Input Bit to Plug-in** selected.

6 Click the **Print** button. Printing begins.

Adjust the Colors and Print

You can adjust the colors to your liking and print images.

The explanation below is on 6 ways to adjust the colors using Print Plug-In for Photoshop/Digital Photo Professional.

- Adjust the Colors while Checking the Preview (for Color) →P.290
- Adjust the Colors while Checking the Preview (for Monochrome) →P.291
- Adjust the Colors by Color Matching →P.293
- Print High-Quality Adobe RGB16bit Images →P.294
- Prints monochrome photographs with high quality →P.295
- Using Adobe CMM →P.296

Adjust the Colors while Checking the Preview (for Color)

You can adjust the colors while checking the adjustments in the preview.

The following explanation is on the procedures for adjusting example image below.

- **Low** for **Cyan**
- **High** for **Yellow**
- **Low** for **Saturation**
- **Warm Black** for **Gray Tone**
- Enhance brightness for the curves

The above image adjustments are reflected in the before and after images below.

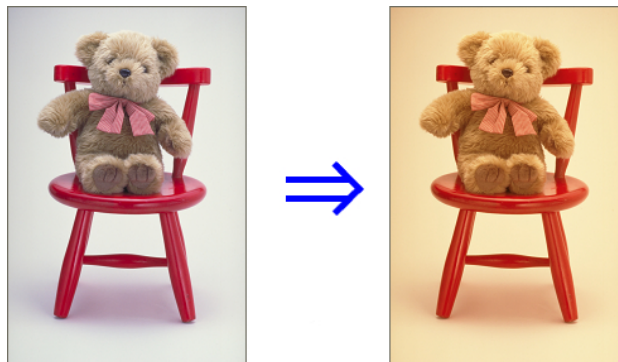

1 Display the **Color Settings** sheet.

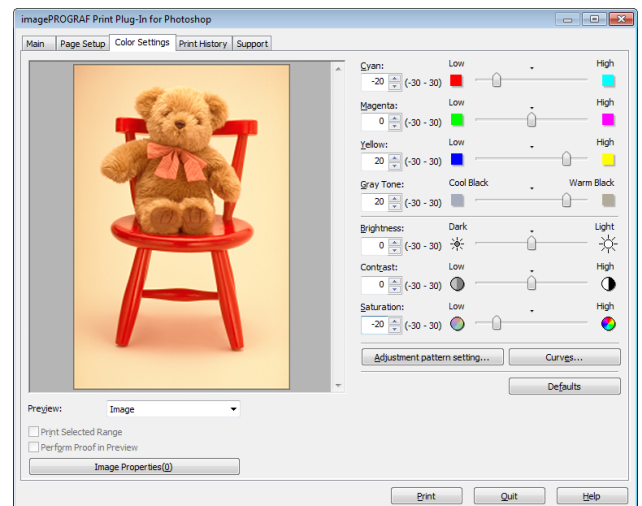

2 Drag the slide bar in the direction of **Low** in **Cyan**.

3 Drag the slide bar in the direction of **High** in **Yellow**.

4 Drag the slide bar in the direction of **Low** in **Saturation**.

5 Drag the slide bar in the direction of **Warm Black** in **Gray Tone**.



Note

- You can change the numbers by inputting in numerical characters.
- You can change the numbers by clicking either ▲ button or ▼ button.

6 Click the **Curves** button then click near the center of the curve.

7 Enter 120 in **Input** and 135 in **Output** then click the **OK** button.

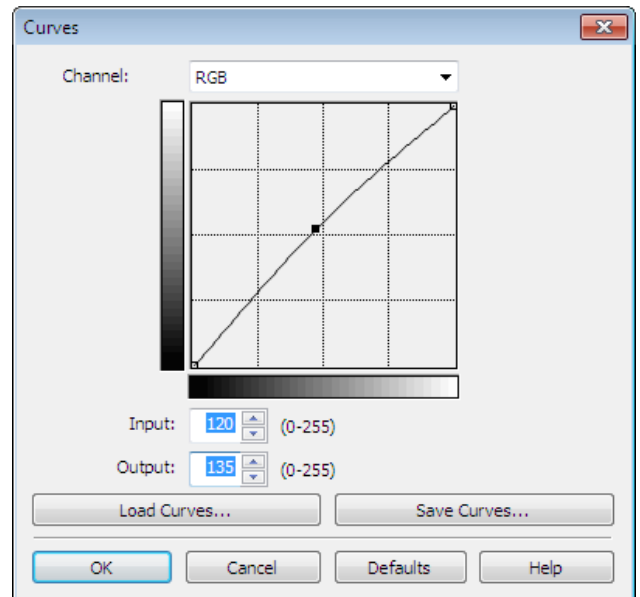

8 Click the **Print** button.

The adjustments are reflected in the image and printing begins.

Adjust the Colors while Checking the Preview (for Monochrome)

You can adjust the colors while checking the adjustments in the preview. The following explanation is about the procedures for adjusting example image below.

- **Low** for **Contrast**
- **Light** for **Highlight**
- **Light** for **Shadow**
- Enhance brightness for the curves

The unapplied and the applied images of the above image adjustments are as below.

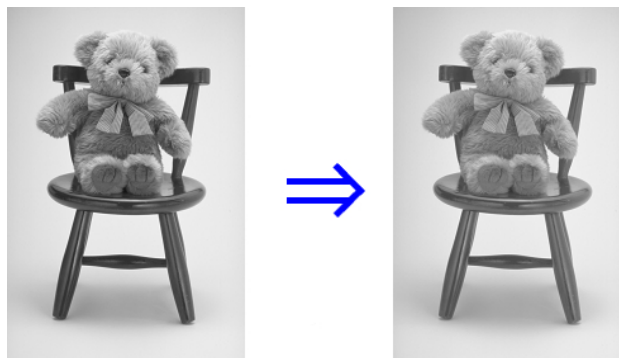

- 1 Open the **Main** sheet.
- 2 Select **Auto (Monochrome Photo)** in **Output Profile**.

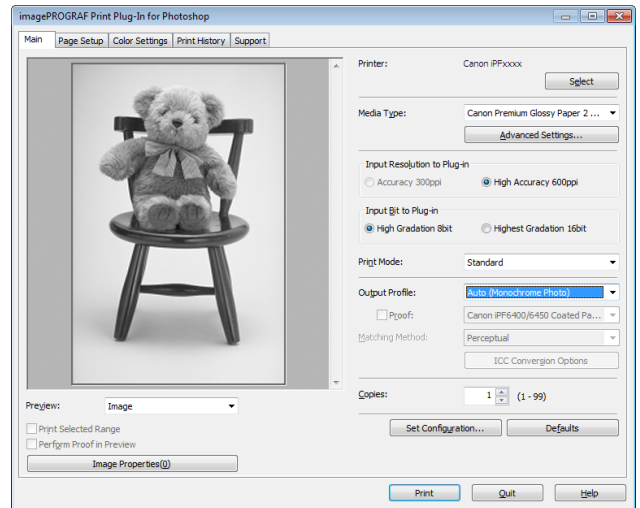

- 3 Open the **Color Settings** sheet.

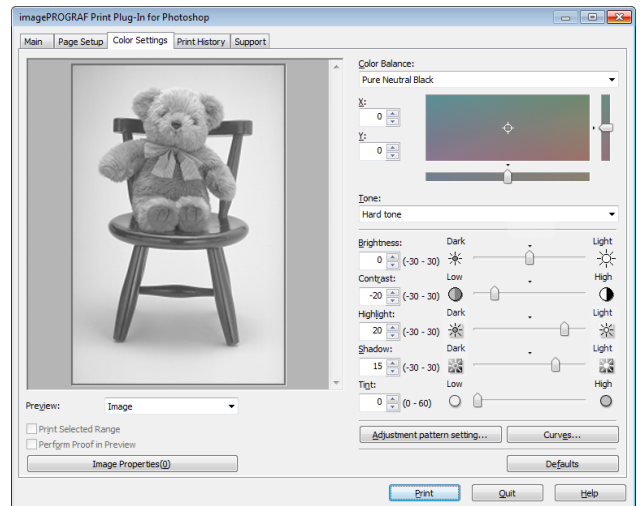

- 4 In **Contrast**, drag the slide bar toward **Low**.
- 5 In **Highlight**, drag the slide bar toward **Light**.
- 6 In **Shadow**, drag the slide bar toward **Light**.



Note

- You can change the numbers by inputting in numerical characters.
- You can change the numbers by clicking either ▲ button or ▼ button.

- 7 Click the **Curves** button then click near the center of the curve.

- 8** Enter 120 in **Input** and 135 in **Output** then click the **OK** button.

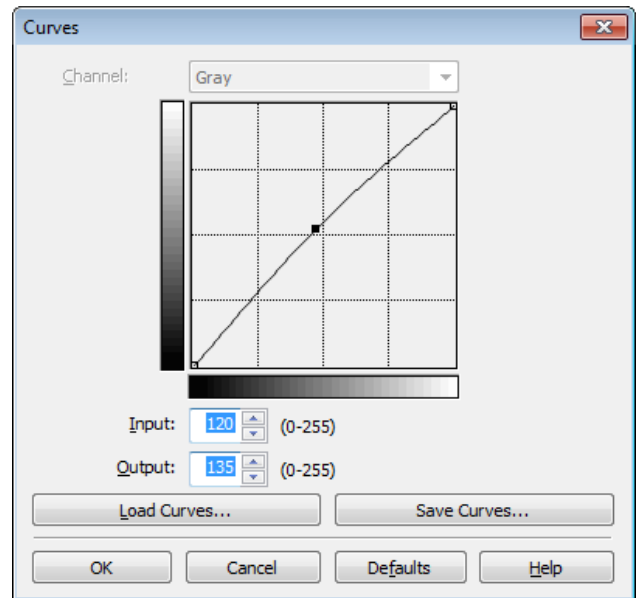

- 9** Click the **Print** button.

This applies the image adjustments and starts the print job.

Adjust the Colors by Color Matching

When you print a color image imported from a scanner or a digital camera, the image may appear different from the image on the screen. That is due to the differences in color on the screen and in the printer. In Print Plug-In for Photoshop/Digital Photo Professional, you can get the color balance of the print product closer to the color balance displayed on the screen through performing ICC (International Color Consortium) color profile settings, matching method settings, and settings for the internal profile, which performs optimum color conversion in response to media and resolution settings.

- 1** Display the **Main** sheet.

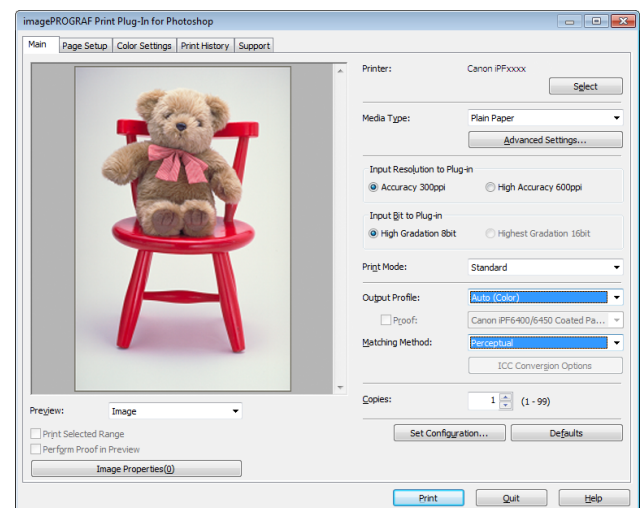

2 Select the profile in **Output Profile**.



Note

- When you place a checkmark in **Perform Proof in Preview**, you can check the color matching in the preview. This may not be displayed depending on how you set **Media Type**.
- The details of **Output Profile** you have set is saved even when you close the Print Plug-In for Photoshop/Digital Photo Professional, but when the specified profile cannot be located it is set to **Auto (Color)**.
- If an ICC profile is selected as the **Output Profile**, Adobe CMM can be selected as the color conversion engine. Refer to Using Adobe CMM →P.296 for details.

3 Select the profile matching method in **Matching Method**.

4 Click the **Print** button.

Printing begins with the output profile and matching method that you have set.

Print High-Quality Adobe RGB16bit Images

This prints a high-quality Adobe RGB16bit image taken with a high-end digital camera. Print Plug-In for Photoshop/Digital Photo Professional allows you to print high color gamut and high tone images, when the Adobe RGB16bit image data has been retouched in Photoshop, without compromising the level of tone in the image.

1 Select the Adobe RGB16bit image data in Photoshop and start Print Plug-In for Photoshop/Digital Photo Professional. (See "Starting from Photoshop.") →P.261

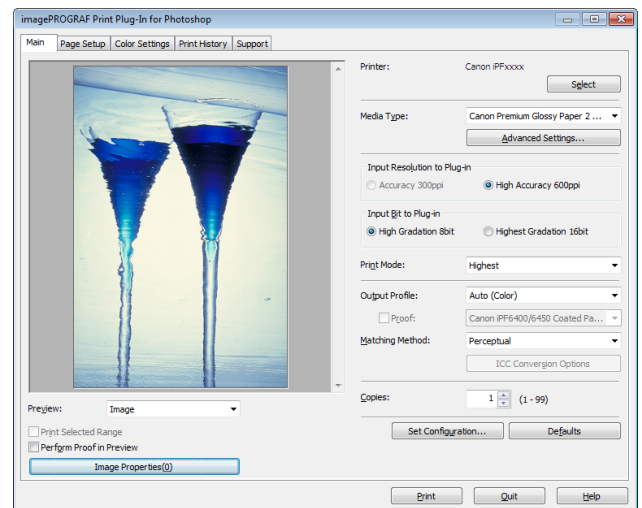

2 Click **Image Properties** button.

3 Check that **Adobe RGB** is displayed in **Color Space**, and **16bit/channel** is displayed in **Bit** in the **Image Properties** dialog box, and click the **Close** button.

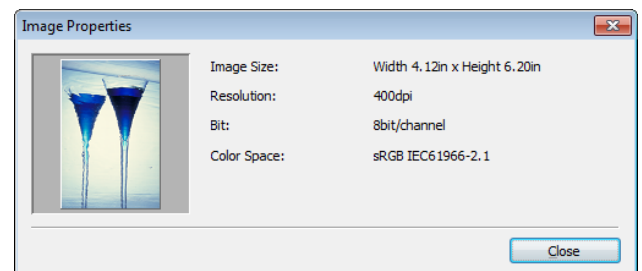

4 Display the **Main** sheet.

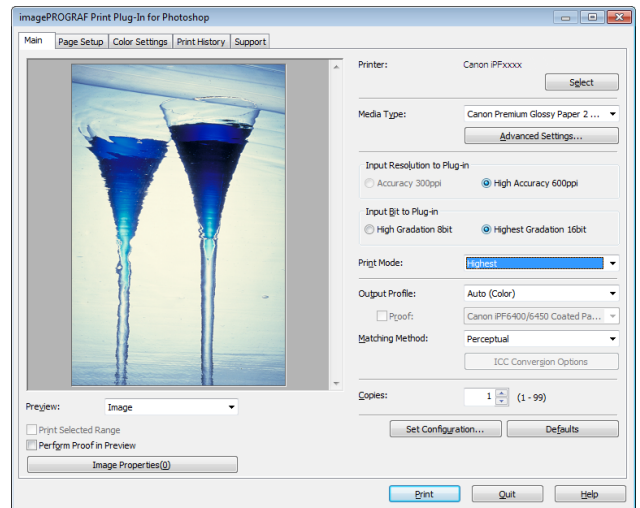

5 Select **High Accuracy 600ppi** in **Input Resolution to Plug-in**.

6 Select **Highest Gradation 16bit** in **Input Bit to Plug-in**.

7 Select the highest quality possible in **Print Mode**.

8 If required, adjust the colors using color matching.



Note

- For more information about the color matching, see "Adjust the Colors by Color Matching." →P.293

9 Click the **Print** button.

Printing of the Adobe RGB16bit image begins.

Prints monochrome photographs with high quality

Prints images captured with a scanner or digital camera in monochrome with high quality. Provides stable monochrome photo images without color casts and minimizes the influences of the difference of the light source.

1 Display the **Main** sheet.

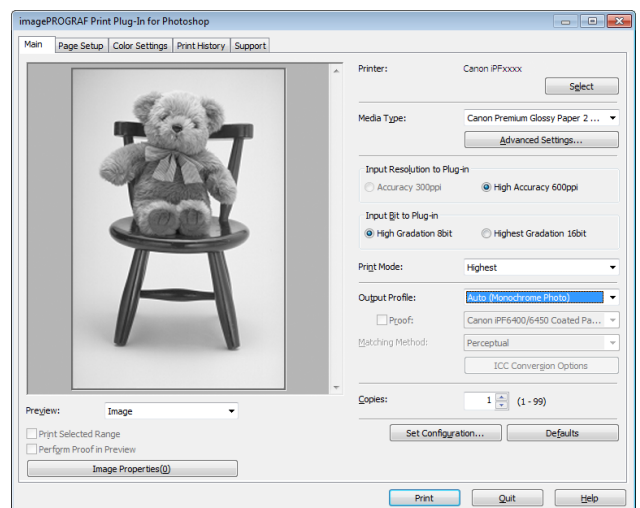

2 Select **Auto (Monochrome Photo)** in **Output Profile**.



Note

- **Auto (Monochrome Photo)** can be selected only after a compatible **Media Type** has been selected.

3 Click the **Print** button.

Performs conversion to the most suitable monochrome and printing begins.

Using Adobe CMM

Adobe CMM is a color conversion engine made by Adobe. Using Adobe CMM makes it possible to obtain uniform color conversion results and to use the black point compensation function.

• How to Obtain Adobe CMM

Adobe CMM can be obtained using the following procedure.

1 Open the Adobe website (<http://www.adobe.com>).

2 Enter "Adobe CMM" in the search input box on the screen.

3 Search for the "Adobe Color Management Module (CMM)" item and select the Windows version.

4 Download the file by following the on-screen directions.

5 Start the installer in the downloaded file to perform the installation.



Important

- Use version 1.1 or higher of Adobe CMM.

• Adobe CMM System Requirements

The system requirements for Adobe CMM are as follows.

- Supported OS
Windows XP SP2, Windows Vista
- Supported CPU
Intel Xeon, Xeon Dual, Intel Centrino, Pentium 4 processor



Note

- Check with Adobe for details.

• How to Use Adobe CMM

The procedure for using Adobe CMM is as follows.

1 Display the **Main** sheet.

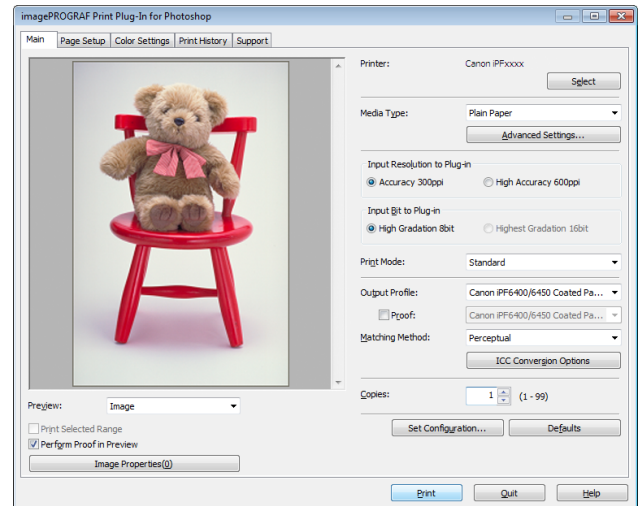

2 Select one of the ICC profiles as the **Output Profile**.

3 Click the **ICC Conversion Options** button.

4 In the **ICC Conversion Options** dialog box, select **Adobe CMM** from **Conversion Engine**.

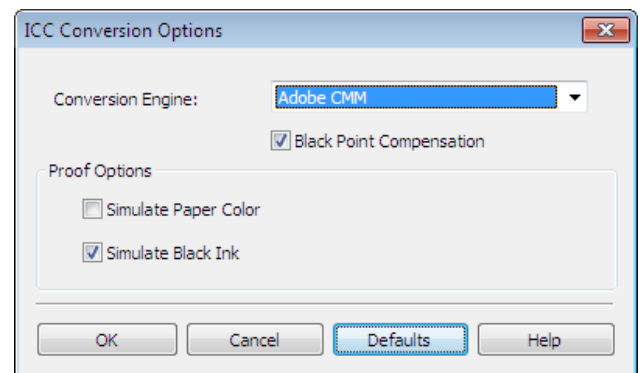

5 Click the **OK** button to close the **ICC Conversion Options** dialog box.

Printing an Adjustment Pattern and Selecting Adjustment Values

Since you can print an adjustment pattern and select your preferred adjustment values while comparing the images, this allows you to conserve ink and paper, and save the time it takes to repeatedly check adjustment results. The procedure for displaying and printing an adjustment pattern is as follows.

1 Display the **Color Settings** sheet (color or monochrome) and set the adjustment values to use as the baseline values.

- Click the **Adjustment pattern setting** button to display the **Adjustment pattern setting** dialog box.

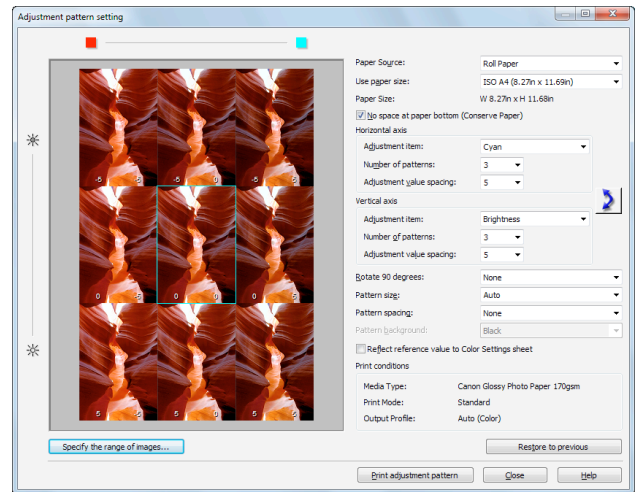

- Set the **Adjustment Item**, **Number of Patterns**, and **Adjustment Value Spacing** for the **Horizontal Axis** and **Vertical Axis**.
If you want to check part of an image as the adjustment pattern, click the **Specify the Range of Images** button, select the range you want to check in the **Specify the Range of Images** dialog box, and then click the **OK** button.

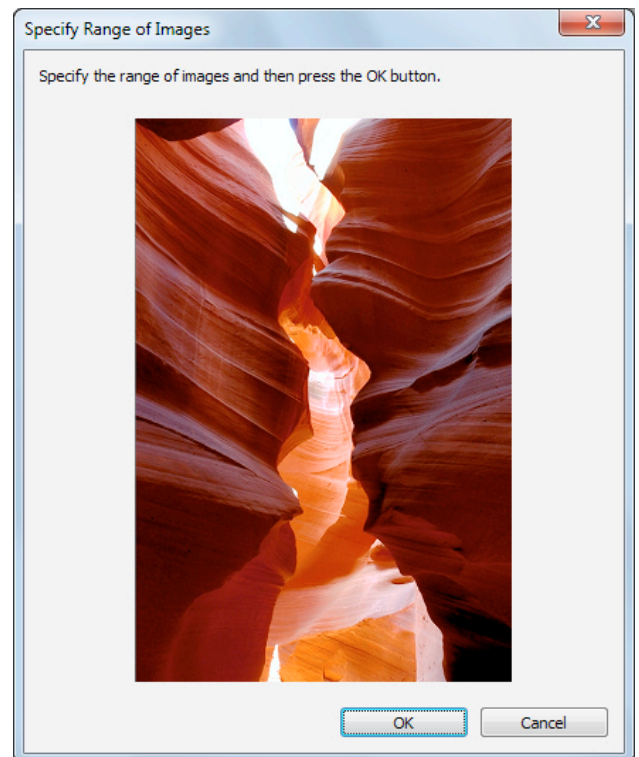

- Set **Rotate 90 degrees**, **Pattern Size**, **Pattern Spacing**, and **Pattern Background** as needed.
- For the **Paper Source** setting, select how the paper to print on is to be supplied.
- For the **Use Paper Size** setting, select the paper size to print on.
- Click the **Print Adjustment Pattern** button.
The adjustment pattern starts printing.

- Check the image in the adjustment pattern that is closest to the customer image and click the corresponding image in the preview area.

- 9 If there are any other items that you want to adjust, select **Adjustment Item** and perform steps 7 and 8.
- 10 Once you have made the necessary adjustments, select the **Update Base Values in the Color Settings Sheet** check box and click the **Close** button.
The previous adjustment values in the **Color Settings** sheet (color or monochrome) are updated.

Perform Black Point Compensation

Black point compensation that is equivalent to Photoshop can be performed using the following procedure. Use this to avoid saturation in the black areas of images.



- Adobe CMM needs to be installed in order to use black point compensation. Refer to Using Adobe CMM →P.296 for details on how to install Adobe CMM.

- 1 Display the **Main** sheet.

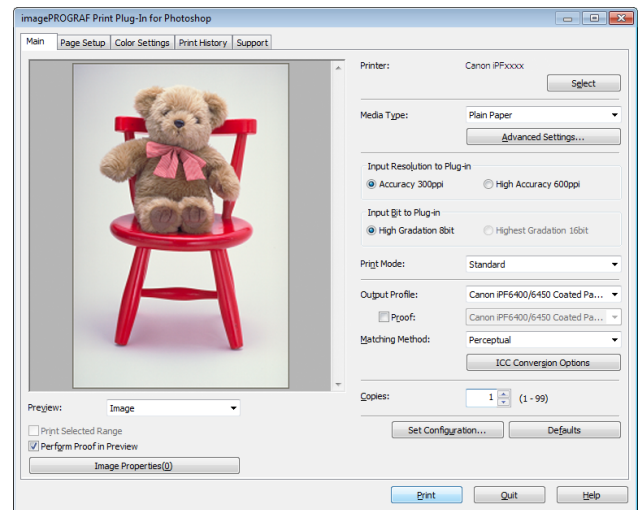

- 2 Select one of the ICC profiles as the **Output Profile**.
- 3 Click the **ICC Conversion Options** button to open the **ICC Conversion Options** dialog box.
- 4 Select **Adobe CMM** as the **Conversion Engine**.
- 5 Check the **Black Point Compensation** check box.

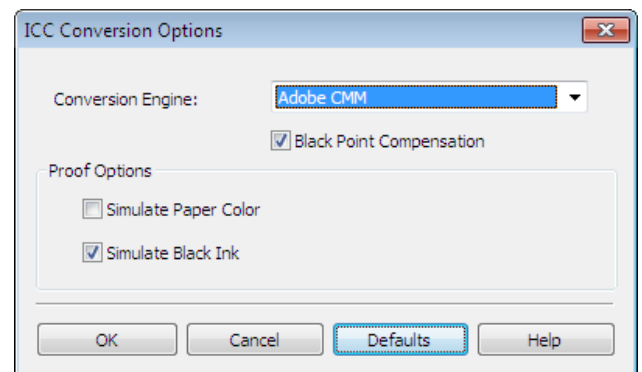

- 6 Click the **OK** button to close the **ICC Conversion Options** dialog box.

Perform Printing Press Simulation Print

You can perform printing press simulation prints by specifying ICC profiles such as Japan Color or SWOP, and specifying an ICC profile for the printing press.

- 1 Display the **Main** sheet.

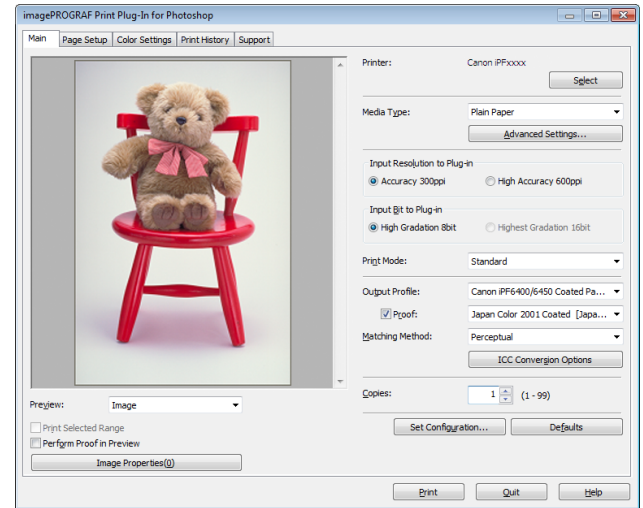

- 2 Select one of the ICC profiles as the **Output Profile**.
- 3 Check the **Proof** check box and select the profile for the printing press you want to target from the list on the right.
- 4 Click the **ICC Conversion Options** button to open the **ICC Conversion Options** dialog box.

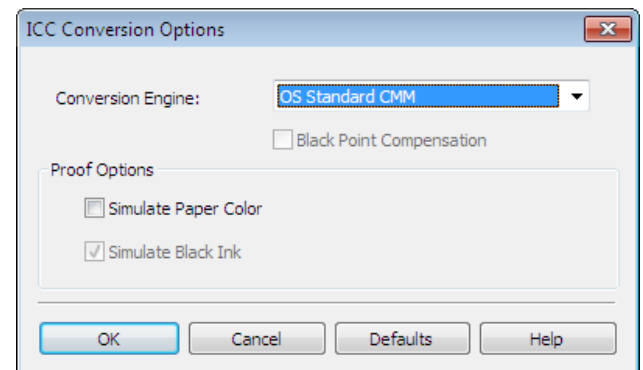

- 5 Configure the **Proof Options** as needed.



Note

- The proof options are **Simulate Paper Color** and **Simulate Black Ink**. The settings that can be selected vary depending on the **Conversion Engine** settings.

- 6 Click the **OK** button to close the **ICC Conversion Options** dialog box.
- 7 Click the **Print** button.
Printing begins.

Enlarge/Reduce and Print

You can enlarge or reduce an image in Print Plug-In. Three methods to enlarge/reduce and print are as follows.

- Enlarge/Reduce and Print Matching Output Media Size →P.301

- Enlarge/Reduce and Print Matching Width of Roll Paper →P.302
- Specify Scaling, Enlarge/Reduce and Print →P.303

Enlarge/Reduce and Print Matching Output Media Size

By specifying the media type loaded in the printer, the image can be enlarged or reduced to fit the size of the image area of the media. This feature is useful when you need to print on the full width of Media that you have selected.



Note

- When you need to print on the full width of roll media, see "Enlarge/Reduce and Print Matching Width of Roll Paper." →P.302
- When you do the procedure below to print on roll media, the print job will match the size of the output with the media selected with the **Paper Size** setting.

1 Display the **Page Setup** sheet.

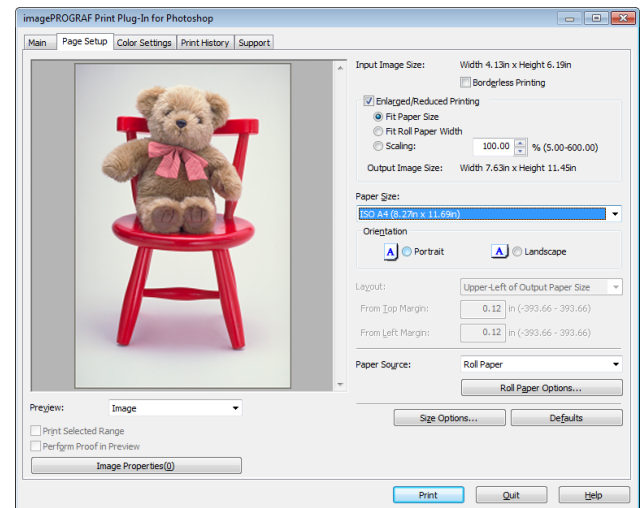

2 Select the size of the media that you want to print in **Paper Size**.



Note

- This is not displayed when a checkmark is placed in **Borderless Printing**.
- This is not displayed when **Fit Roll Paper Width** is set in **Enlarged/Reduced Printing**.

3 Select either **Portrait** or **Landscape** as the media orientation for the image in **Orientation**.



Note

- When you select **Portrait**, the image on the media prints as it appears on the screen.
- When you select **Landscape**, the image on the media prints rotated 90 degrees.

4 Click the **Enlarged/Reduced Printing** check box on.



Note

- This is not displayed when a checkmark is placed in **Borderless Printing**.

5 Select **Fit Paper Size**.

6 Click the **Print** button.

The image prints filling the entire output media surface.

Enlarge/Reduce and Print Matching Width of Roll Paper

You can enlarge/reduce and print an image matching the width of the roll paper set in the printer. This is useful when you wish to print an image that covers the entire width of the roll paper.



Note

- Printing will not occur properly when a print roll is not set to the printer.

1 Display the **Page Setup** sheet.

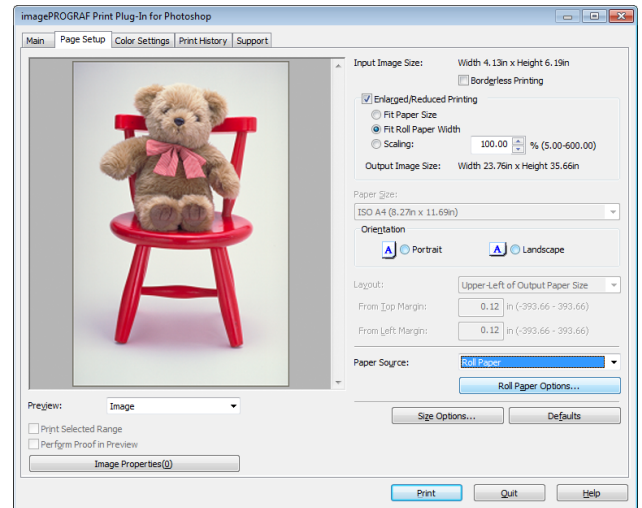

2 Select **Roll Paper** in **Paper Source**.

3 Click the **Roll Paper Options** button.

4 Set the roll paper options and click the **OK** button.



- For more information about the **Roll Paper Options** dialog box, see "Roll Paper Options Dialog Box." →P.284

Note • Click the **Defaults** button to return all of the roll paper option settings to their defaults.

5 Select either **Portrait** or **Landscape** as the media orientation for the image in **Orientation**.



- When you select **Portrait**, the image on the media prints as it appears on the screen.

Note • When you select **Landscape**, the image on the media prints rotated 90 degrees.

6 Click the **Enlarged/Reduced Printing** check box on.



- This is not displayed when a checkmark is placed in **Borderless Printing**.

Note

7 Select **Fit Roll Paper Width**.

8 Click the **Print** button.

The image prints covering the entire width of the roll paper.

Specify Scaling, Enlarge/Reduce and Print

You can specify scaling to enlarge/reduce an image and print. This is useful when you wish to print an image at a specific size.

1 Display the **Page Setup** sheet.

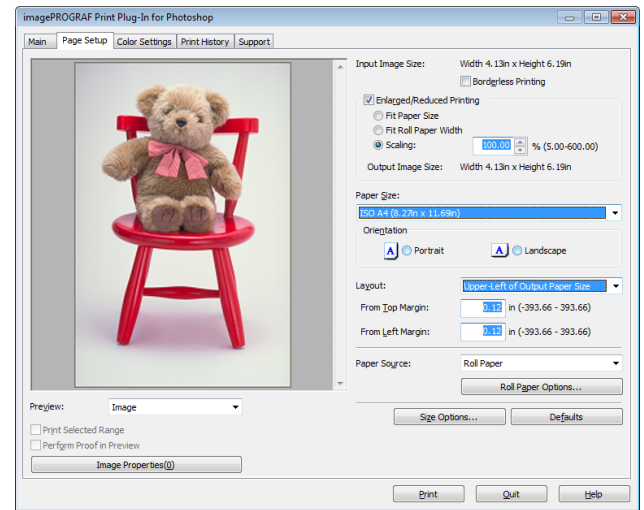

2 Select the size of the media that you want to print in **Paper Size**.



Note

- This is not displayed when a checkmark is placed in **Borderless Printing**.
- **Fit Roll Paper Width** is set in **Enlarged/Reduced Printing**.

3 Select either **Portrait** or **Landscape** as the media orientation for the image in **Orientation**.



Note

- When you select **Portrait**, the image on the media prints as it appears on the screen.
- When you select **Landscape**, the image on the media prints rotated 90 degrees.

4 Click the **Enlarged/Reduced Printing** check box on.



Note

- This is not displayed when a checkmark is placed in **Borderless Printing**.

5 Select **Scaling** and input the scaling factor or drag the four corners of the image in the Preview display.



Note

- You can specify scaling rate in intervals of 0.01%.
- You can specify a range between 5.00-600.00%.
- The size of the width and height proportionally grow when the image is enlarged/reduced.

6 Either drag the image on the **Print Area Layout** preview, or set the print position **Layout**.

7 Click the **Print** button.

Printing begins at the set scaling rate.

Print with No Borders

You can use the borderless printing function to print without margins surrounding the image.



- With some media borderless printing can be performed only between two edges.

Note • To use the borderless printing function, the specified media must be set to the printer.

1 Display the **Page Setup** sheet.

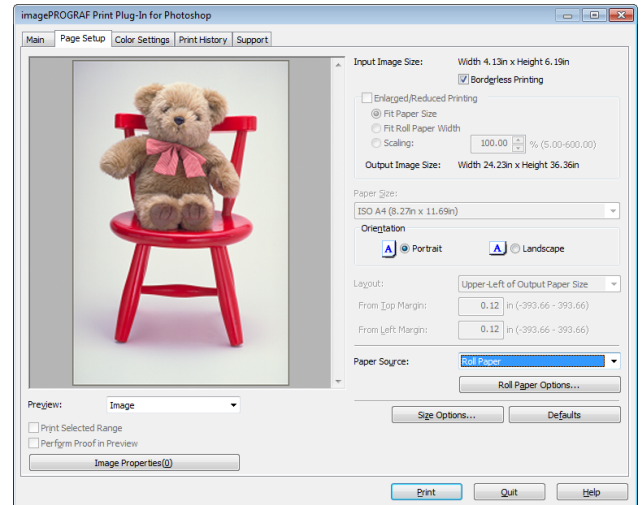

2 Select **Roll Paper** in **Paper Source**.

3 Click the **Borderless Printing** check box on.



Note

- Select the width for roll paper set in the printer in **Roll Paper Width** in the **Specify Roll Paper Width** dialog box, and click **OK**.

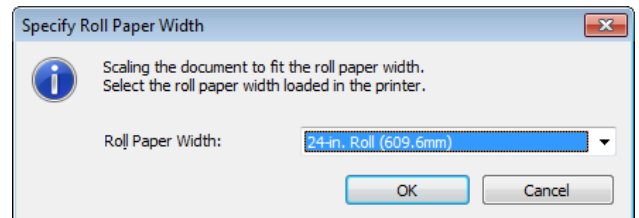

4 Click the **Print** button.

Borderless printing begins.

Customize Media Settings

You can customize media settings.

- 1 Display the **Main** sheet.

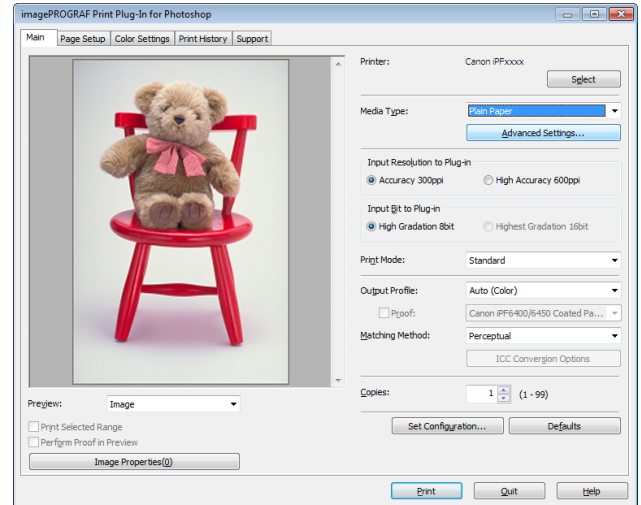

- 2 Select the media type that you wish to customize in **Media Type**.



Note

- Always select media type that is actually set in the printer. When the media you chose is different from the media set in the printer, you may not receive the desired print results.

- 3 Click the **Advanced Settings** button.

- 4 Perform the settings in the Paper Detailed Settings Dialog Box [→P.280](#) and click the **OK** button.

Utilize Print History

When you perform various settings and print in Print Plug-In for Photoshop/Digital Photo Professional, those settings are saved as print history. Also, you can export and import as files. You can store often-used print history under a specified name in print preferences.



Note

- You can save up to 200 print history items. All items over 200 are deleted in chronological order.

You can do the following things using print history.

- Confirm Print History Details [→P.306](#)
- Apply Print History to an Image [→P.307](#)
- Store Print History to Print Preferences [→P.307](#)
- Delete Print History [→P.309](#)
- Export Print History from Print Preferences [→P.311](#)
- Import Print History to Print Preferences [→P.312](#)
- Delete Print History from Print Preferences [→P.314](#)
- Set Information to Print with Image [→P.315](#)

Confirm Print History Details

You can confirm the print history details.

1 Display **Print History** sheet.

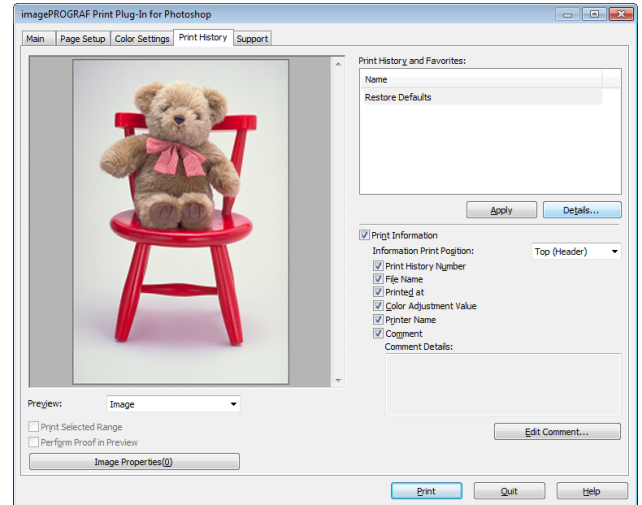

2 Click the **Details** button.



Note

- Select the print history you wish to check the details of, from either **Print History** or **Favorites** in the **Print History Details** dialog box.

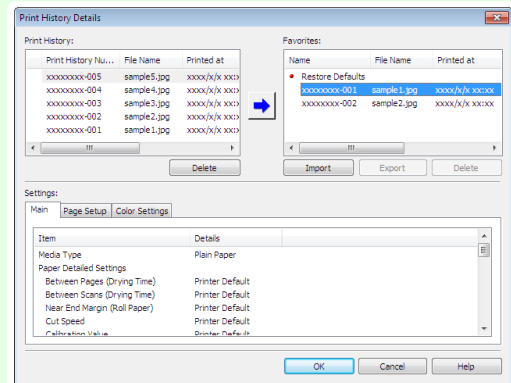

3 Check the print history details in **Settings**, and click the **OK** button.



Note

- You can display the print history details by switching the sheets.

Apply Print History to an Image

You can use previous print history, and apply it to an image.

- 1 Display the **Print History** sheet.

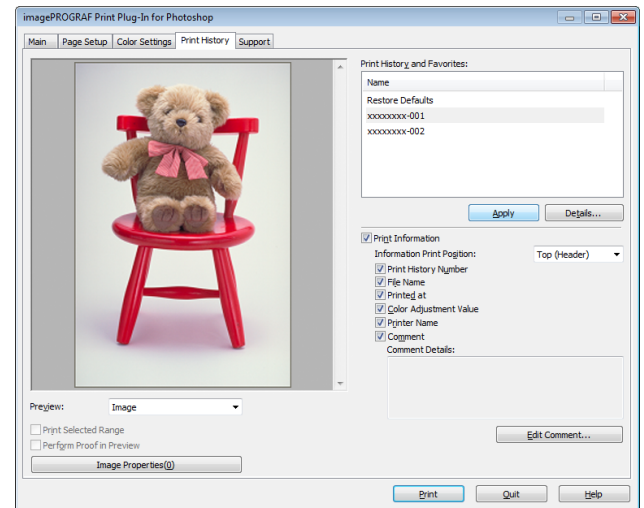

- 2 If required, check the print history details. (See "Confirm Print History Details.") →P.306

- 3 Select the print history you wish to apply from **Print History and Favorites**, and click the **Apply** button.

Store Print History to Print Preferences

You can store often-used print history to print preferences. Not only can you store the print history stored under a different name in print preferences, you can also find it with ease.



Note

- You can store up to 200 print history items to print preferences.

- 1 Display the **Print History** sheet.

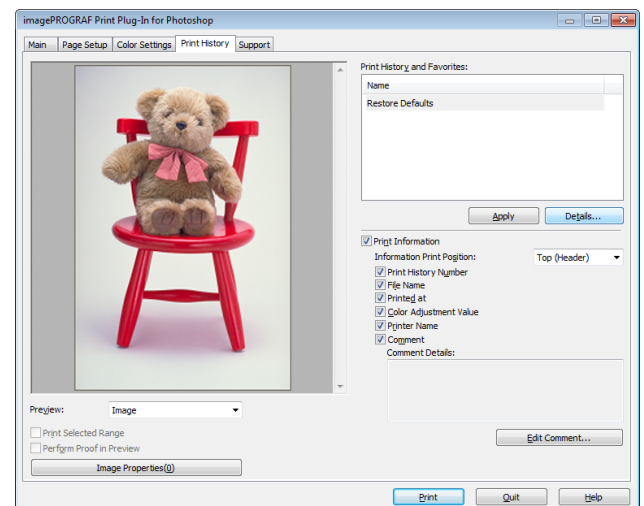

- 2 Click the **Details** button.

- 3** Select the print history you wish to store in print preferences from **Print History** in the **Print History Details** dialog box, and check the print history details in **Settings**.

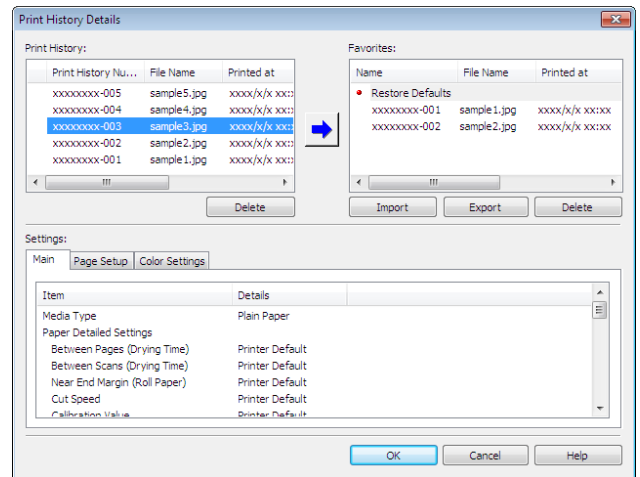

- 4** Select the print history you wish to store in print preferences from **Print History** and click the  button.

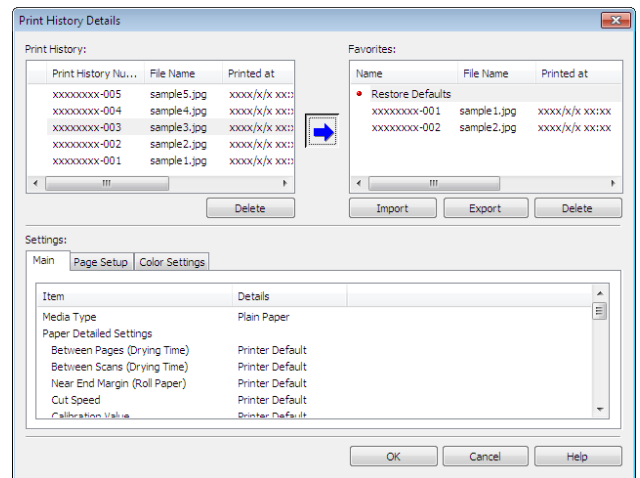

- 5** In the **Add Favorites** dialog box input the name of the print history in **Name**, input a comment in **Comment**, and click the **OK** button.

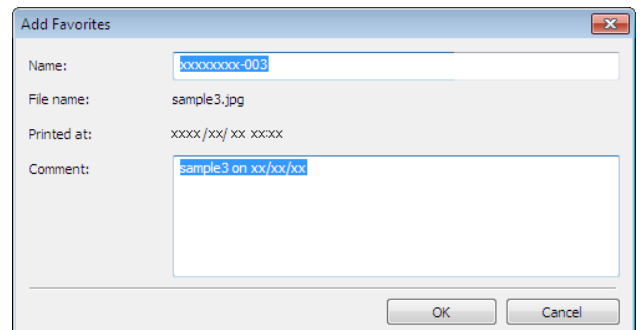

- 6 Click the **OK** button to close the **Print History Details** dialog box.

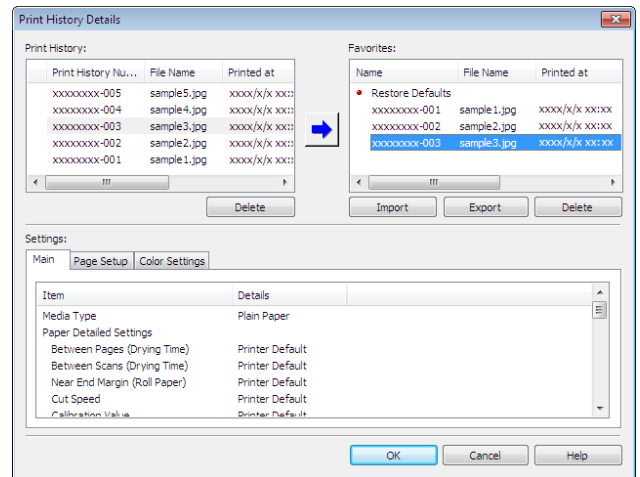

Delete Print History

You can delete print history.



Important

- Be aware that you cannot undo deletions of print history.

- 1 Display the **Print History** sheet.

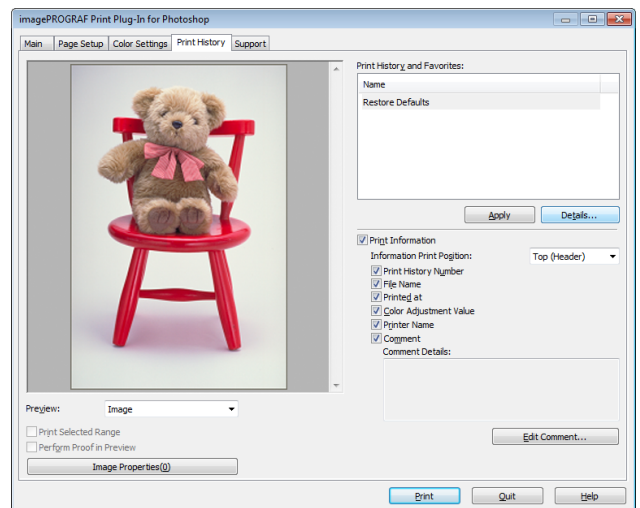

- 2 Click the **Details** button.

- 3** Select the print history you wish to delete from **Print History** in the **Print History Details** dialog box, and click the **Delete** button.

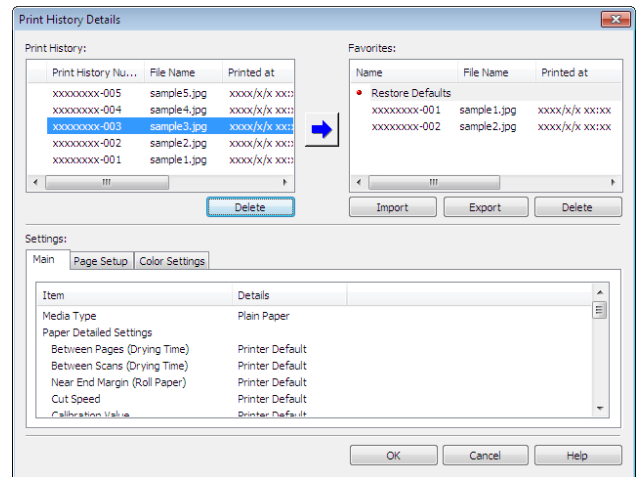

- 4** Click the **OK** button.

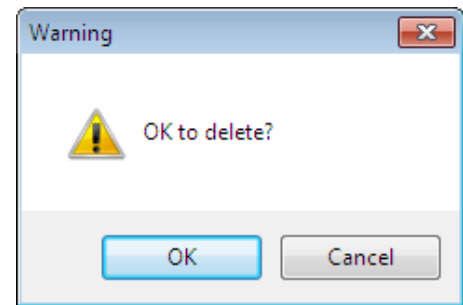

- 5** Click the **OK** button to close the **Print History Details** dialog box.

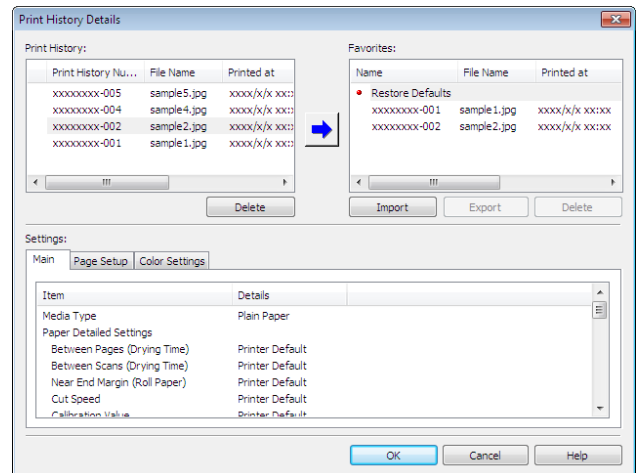

Export Print History from Print Preferences

You can export print history stored in print preferences as a file.

- 1 Display the **Print History** sheet.

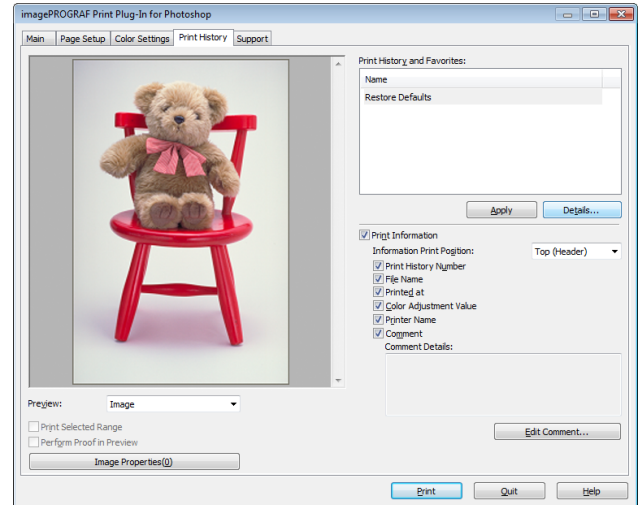

- 2 Click the **Details** button.

- 3 Select the print history you wish to export from **Favorites** in the **Print History Details** dialog box, and click the **Export** button.

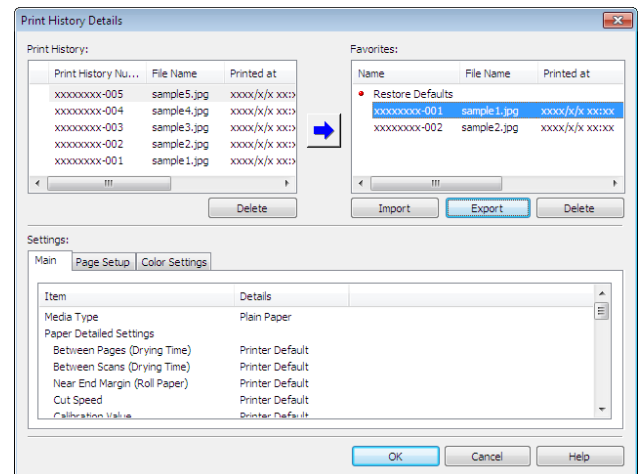

- 4 Input the name of the print history in **File Name** in the **Save As** dialog box, and click the **Save** button.

The print history is exported under the specified file name.

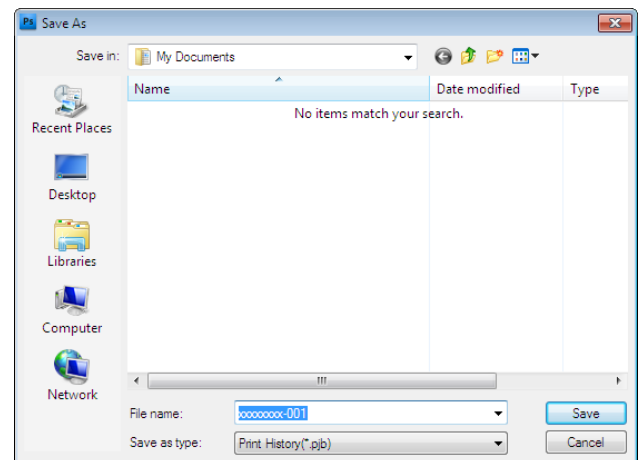

5 Click the **OK** button to close the **Print History Details** dialog box.

Import Print History to Print Preferences

You can import print history in file format and store it to print preferences.

1 Display the **Print History** sheet.

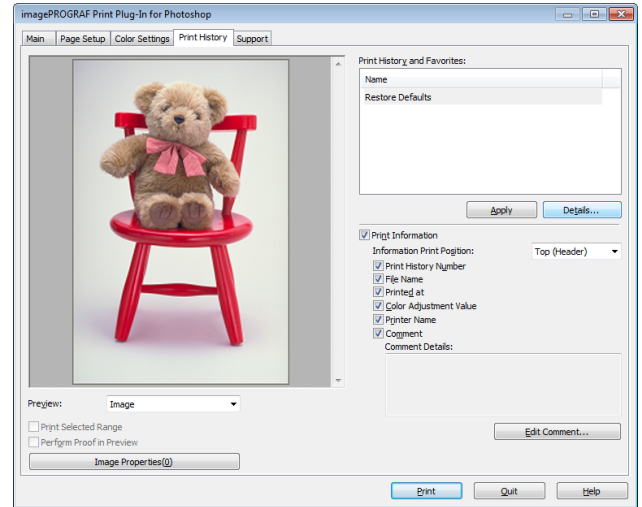

2 Click the **Details** button.

3 Click the **Import** button of the **Favorites** in the **Print History Details** dialog box.

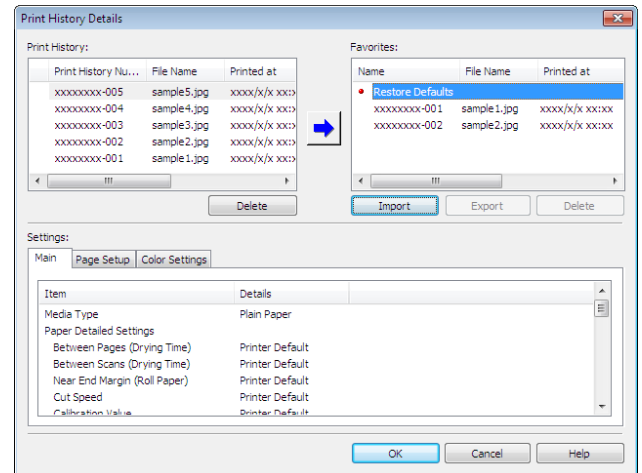

- 4** Select the print history you wish to import in the **Open** dialog box, and click the **Open** button.

The print history is imported.

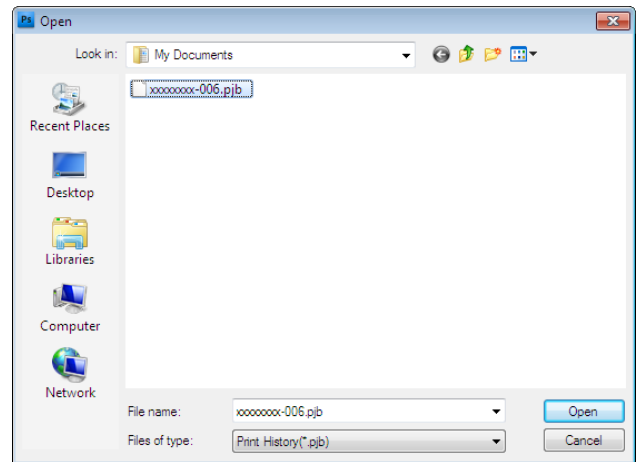

- The print history file name suffix is *.pjb.
- Note** You cannot import a print history file exported from a different OS in Print Plug-In for Photoshop/Digital Photo Professional.
- You cannot import a print history file exported from a different printer in Print Plug-In for Photoshop/Digital Photo Professional.

- 5** Click the **OK** button to close the **Print History Details** dialog box.

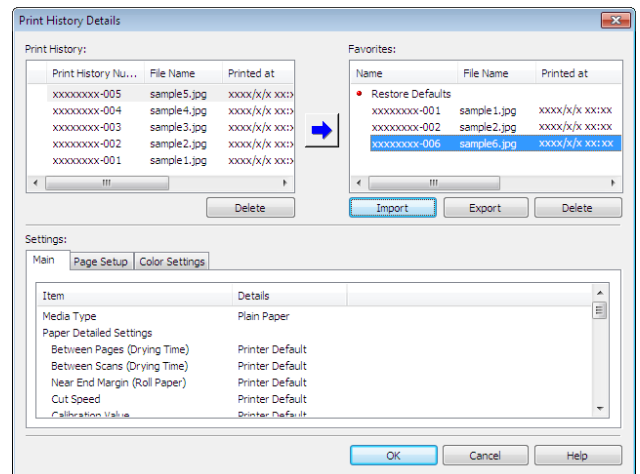

Delete Print History from Print Preferences

You can delete print history store to print preferences. You cannot store more than 200 print history items in print preferences.

1 Display the **Print History** sheet.

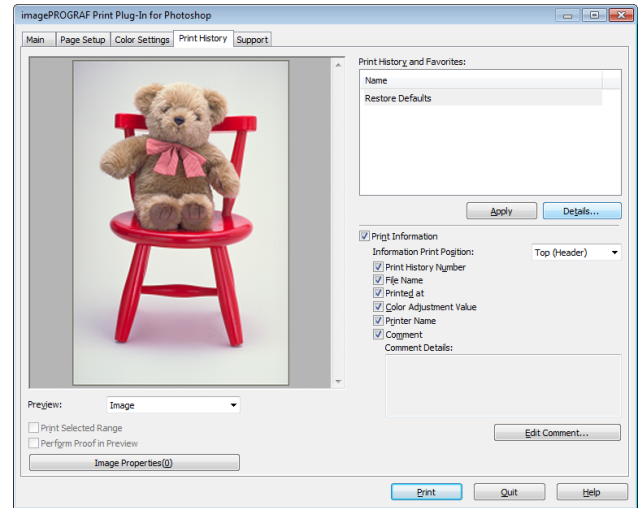

2 Click the **Details** button.

3 Select the print history you wish to delete from **Favorites** in the **Print History Details** dialog box, and click the **Delete** button.

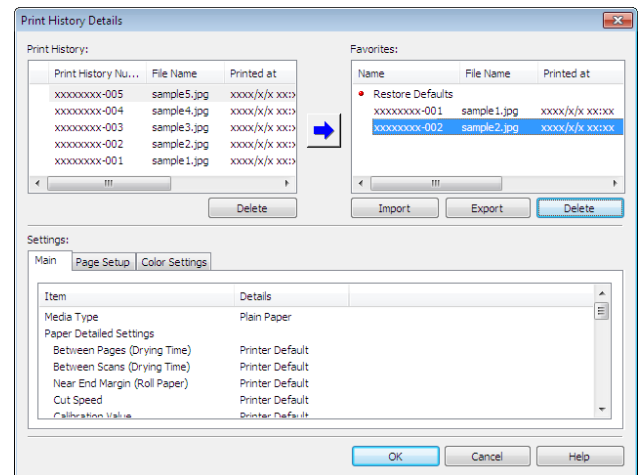

4 Click the **OK** button.

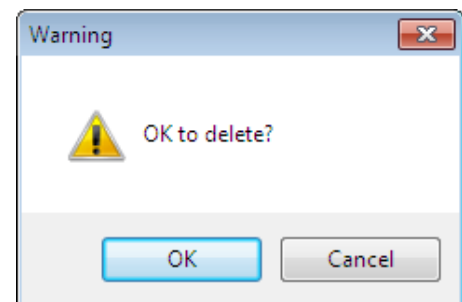

- 5** Click the **OK** button to close the **Print History Details** dialog box.

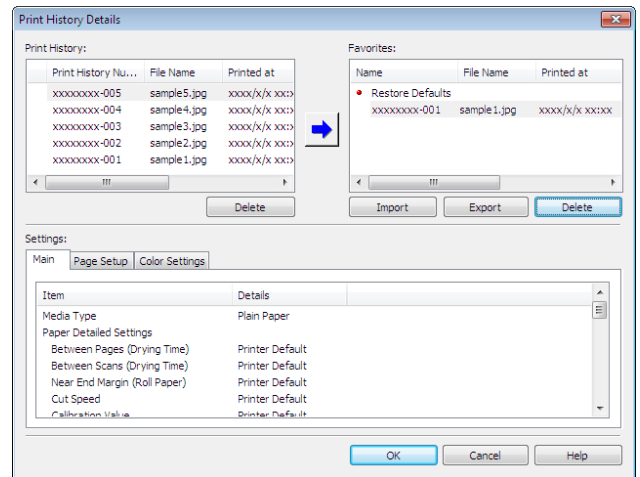

Set Information to Print with Image

You can print information with an image that is related, such as the file name and the time and date.



Note

- When you use the borderless printing function to print, the information will not be printed. (See "Print with No Borders.")
- →P.304
- When the printed information is too long as does not fit on the media, a break will appear in the printed information.
- The information may print on the image data with some media sizes, enlargement rates and print position values.
- When **Keep Media Size** is set to **On** on the printer, a portion of bottom of the print data is not printed.

- 1** Display the **Print History** sheet.

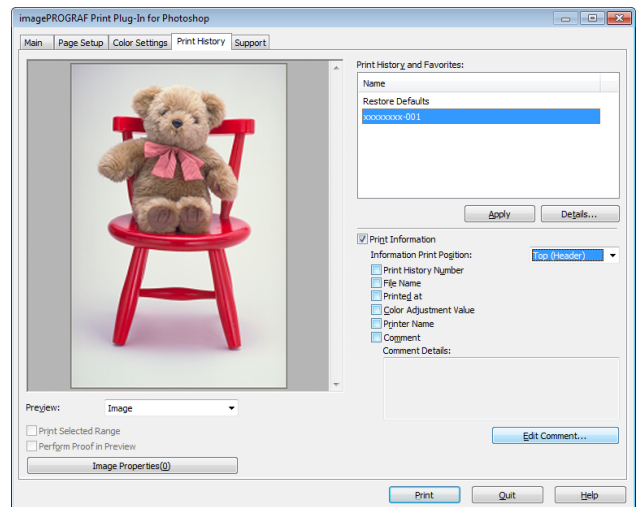

- 2** Click the **Print Information** check box on.
- 3** Select the position where you wish to print the information in **Information Print Position**.
- 4** Click the information check box you wish to print on.

5 When you wish to edit the comment, click the **Edit Comment** button.



Note

- When you do not wish to edit the comment, move to step 7.

6 Input the comment in the **Edit Comment** dialog box, and click **OK** button.

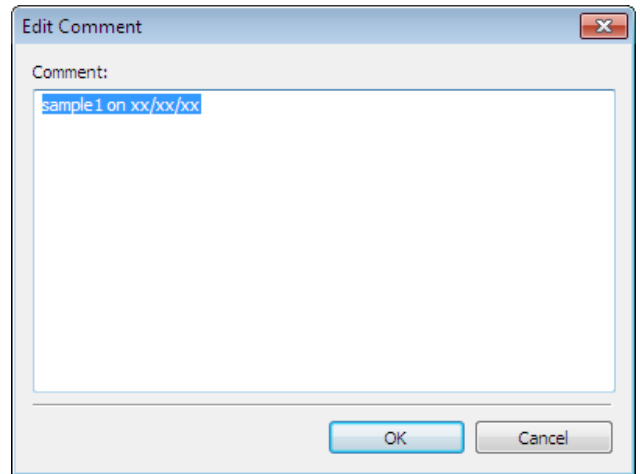

7 Click the **Print** button.

Comments are printed with images.

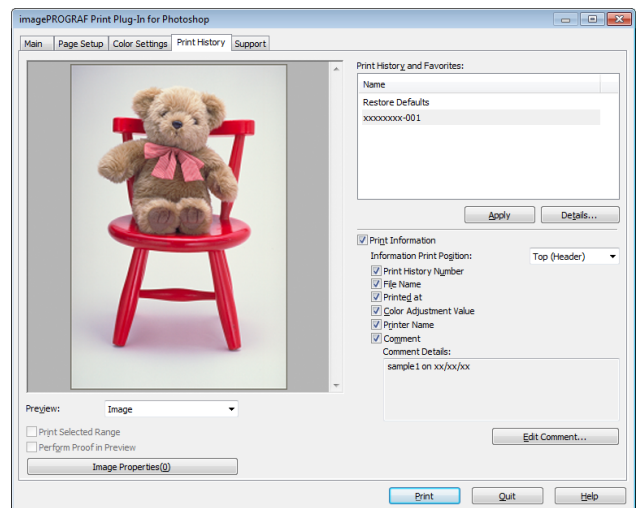

Layout Plug-In for Photoshop

- About the Layout Plug-In 317
- Layout Plug-In Main Window 317
- Add Canvas Size dialog box 319
- Creating and Printing a Layout Image for Mounting on a Frame 320

About the Layout Plug-In

When printing a photo to mount on a frame, you can start the Layout Plug-In from Photoshop and create a layout image where the image extends to the sides of the frame.



-  • The Layout Plug-In can be used with Photoshop CS5, Photoshop CS4, and Photoshop CS3.
- Note** • Layout images created in the Layout Plug-In can be printed as-is from the Print Plug-In for Photoshop.

For details on the functionality of the Layout Plug-In, see "Layout Plug-In Main Window." →P.317

For details on how to start and how to use the Layout Plug-In, see "Creating and Printing a Layout Image for Mounting on a Frame." →P.320

Layout Plug-In Main Window

This window is for creating a layout image for finishing an image extended around the sides of the frame when printing a photo for mounting on a frame.

You can check the details of the settings in the preview area on the left side of the Layout Plug-In Main Window.

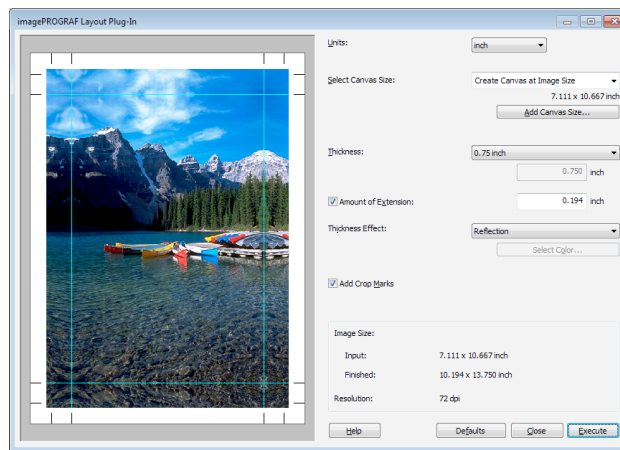

• Units

You can select the units from mm, inches, and pixels.



- Since values entered in mm or inches are first converted temporarily to pixels and then reconverted to mm or inches, values may be displayed that differ from the entered values.

• Select Canvas Size

Selects the canvas size. If **Create the Canvas at the Image Size** is selected, the image size is treated as the canvas size. It is recommended that you provide a canvas that matches the image size.

• Add Canvas Size button

Click this button to display the **Add Canvas Size** dialog box and register a **Custom Canvas Size**. (See "Add Canvas Size dialog box.") [→P.319](#)

• Thickness

Specifies the thickness of the canvas (the width of the canvas sides). Although you can select from 0.75 inches (approx. 19 mm) and 1.5 inches (approx. 38 mm), you can also specify any arbitrary thickness.



- Since values entered in mm or inches are first converted temporarily to pixels and then reconverted to mm or inches, values may be displayed that differ from the entered values.

• Amount of Extension

Selecting this check box allows you to configure the amount of extension that protrudes past the canvas sides. This allows you to prevent white paper from appearing on the canvas sides when mounted. The larger the amount of extension, the larger the area hidden behind the back surface.



- Since values entered in mm or inches are first converted temporarily to pixels and then reconverted to mm or inches, values may be displayed that differ from the entered values.

• Thickness Effect

You can select from the following canvas effects.

- **Image**
Wraps the image to the canvas sides.
- **Soft Image**
Performs Gaussian filtering on the image on the canvas sides.
- **Reflection**
Reflects the image on the canvas sides.
- **Soft Reflection**
Reflects the image on the canvas sides and performs Gaussian filtering.
- **White**
Makes the canvas sides white.
- **Black**
Makes the canvas sides black.
- **Custom Color**
Makes the canvas sizes the specified color. The color is specified by clicking the **Select Color** button.

• Add Crop Marks

When this check box is selected, crop marks are printed at the outer edges of the image as guides to the positions to fold the paper when mounting on a canvas.

• Display Information

Displays the following information.

- **Input**

Displays the original image size before creating the layout image.

- **Finished**

Displays the image size of the entire layout image with the canvas sides, crop marks, and the amount of extension added to the input image size.

- **Resolution**

Displays the resolution of the image. This is not changed from the resolution of the original image. If the image size is changed in the Layout Plug-In, the resolution is maintained the same as the original image, and resampling is performed using the Bicubic method.

If you do not want the number of pixels in the image to change (resample), select **Create the Canvas at the Image Size** in **Select Canvas Size** and select an option other than **Image** and **Soft Image** in **Thickness Effect**.

- **Defaults** button

Click this button to reset the setting values.

- **Close** button

When this button is clicked, the Layout Plug-In exits and the current setting values are saved. When the Layout Plug-In is started the next time, the setting values from the previous time are used.

- **Execute** button

When this button is clicked, the Print Plug-In for Photoshop starts. To print the created layout image, click the **Print** button in the Print Plug-In for Photoshop main window.



Important

- When you close the Print Plug-In, the created layout image is discarded.



Note

- If the Print Plug-In for Photoshop for multiple different models is installed, a screen for selecting the model is displayed when you click the **Execute** button.
- When you close Print Plug-In for Photoshop main window after printing, the Layout Plug-In main window is displayed again.
- If the size of the layout image is larger than the paper size that can be printed by the printer, you should reduce the size of the layout image to the output paper size in advance before printing.

Add Canvas Size dialog box

This dialog box is displayed when you click the **Add Canvas Size** button in the Layout Plug-In main window. It allows you to register and delete arbitrary canvas sizes (custom canvas sizes).

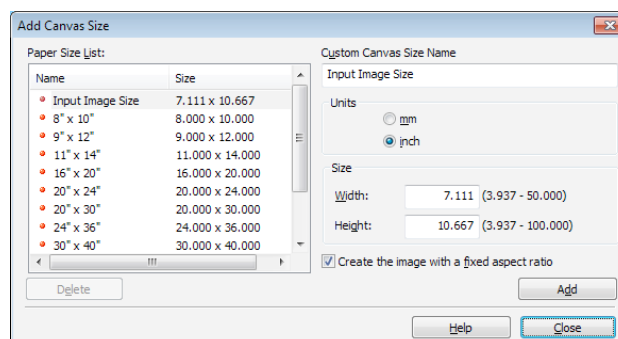

Click the **Close** button to close the **Add Canvas Size** dialog box.

Adding a Canvas Size

- 1 Specify the units for the width and height of the canvas size you are adding in **Units**.

- 2 Enter the width and height of the canvas size you are adding in **Size**.
When you select a size displayed in the **Paper Size List**, the values are displayed in the **Width** and **Height** in the **Size** field. When **Input Image Size** is selected, the size of the input image is used as-is for the width and height of the canvas.
Selecting the **Create the Image with a Fixed Aspect Ratio** check box allows you to create a custom size at the same aspect ratio as the input image. For example, if you change the width, then the height also changes according to the aspect ratio of the input image.

- 3 Enter the name of the canvas size to add in **Custom Canvas Size Name**.

- 4 Click the **Add** button.

Deleting a Canvas Size

- 1 Select the **Custom Canvas Size Name** you want to delete from the **Paper Size List**.

- 2 Click the **Delete** button.



Note

- Sizes that have a red circle in the **Name** cannot be deleted.

Creating and Printing a Layout Image for Mounting on a Frame

The procedure for creating and printing a layout image for mounting on a frame is as follows.

- 1 Start Photoshop.
- 2 Open the image to lay out and edit the image in Photoshop as needed.
- 3 Select **imagePROGRAF Layout Plug-In** from **Automate** in the Photoshop **File** menu.
Run the Layout Plug-In to display the Layout Plug-In Main Window.

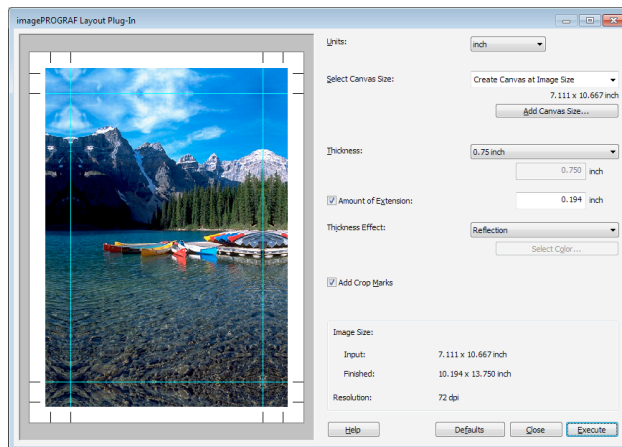

Note

- The Layout Plug-In can handle images with a width and height of less than 60,000 pixels. For images with a width or height of 60,000 pixels or more, either reduce the selection range or reduce the image through image processing before performing step 3.

- 4** Select the canvas size that matches the frame for mounting the image and create a layout image by adding effects such as frame side effects.

For details, see "Layout Plug-In Main Window." →P.317



Important

- The created layout image cannot be modified in Photoshop.

- 5** Once you have finished creating the layout image, run the Print Plug-In for Photoshop and print on paper that is larger than the size of the layout image.



Important

- When you click the **Close** button to close the Layout Plug-In, the created layout image is discarded.

- 6** Mount the printed layout image on the frame.



Important

- Fully dry the printed paper before mounting it on the frame.
- Take care when mounting on the frame. The ink may peel off if you touch the printed surface.



Note

- As you fold the printed paper along the frame, the folded areas may crack and reveal the paper underneath, depending on the media type. You can prevent the folded areas from splitting to some degree by using commercially available inkjet protection spray or liquid laminating agent for inkjets before folding.

Print Plug-In for Office

Print Plug-In for Office features	322
Steps to install	323
Steps to uninstall	325
When Print Plug-In for Office is not displayed	326
To start from Microsoft Word	330
Print Matching Roll Width (Word)	331
Borderless Printing (Word)	333
Multi-Page Printing (Word)	336
Register the settings (Word)	337
Print Using Registered Settings (Word)	338
Portrait Orientation / Landscape Orientation (Word)	340
To start from Microsoft PowerPoint	341
Print Matching Roll Width (PowerPoint)	343
Borderless Printing (PowerPoint)	345
Multi-Page Printing (PowerPoint)	348
Register the settings (PowerPoint)	349
Print Using Registered Settings (PowerPoint)	350
Portrait Orientation / Landscape Orientation (PowerPoint)	352
To start from Microsoft Excel	353
Print Entire Sheet (Excel)	355
Print Selected Area (Excel)	357
Configuring Binding (Excel)	360
Configuring Special Settings	361

Print Plug-In for Office features

Print Plug-In for Office is a Plug-In that enables easy printing from **Microsoft Office**.

- It is displayed on the toolbar/ribbon, so it is easily accessible.
- It can be set by just selecting from the Wizard.
- **Large-Format Printing** custom size can also be set in the Wizard from **Microsoft Word** or **Microsoft PowerPoint**.
- Custom size can be set automatically from **Microsoft Excel**.
- The layout can be checked before printing by starting the preview screen.



Note

- 64 bit edition Windows OS operates only on WOW64 (32 bit emulator).



Important

- The **Print Plug-In for Office** toolbar/ribbon might not be displayed in **Microsoft Office** after installing **imagePROGRAF Print Plug-In for Office**. For details, refer to When Print Plug-In for Office is not displayed [→P.326](#) .
- If you opened the Office document from **Internet Explorer**, the software will not run correctly.
- If you are editing an embedded object or link object, the software will not run correctly.
- If you added the **imagePROGRAF Print Plug-In** ribbon to the **Microsoft Office 2007/2010** Quick Access toolbar, the software will not run correctly.

Steps to install

Below are the steps to install **Print Plug-In for Office**.



Note

- You must log into Windows as an Administrator before the installation.

1

Insert "User Software CD-ROM" into the CD-ROM drive and start the installer.



Note

- If the installer screen does not display, open the CD-ROM icon from **My Computer**, click **setup.exe**, and open the icon.

2

Click the **Install Individual Software** button.

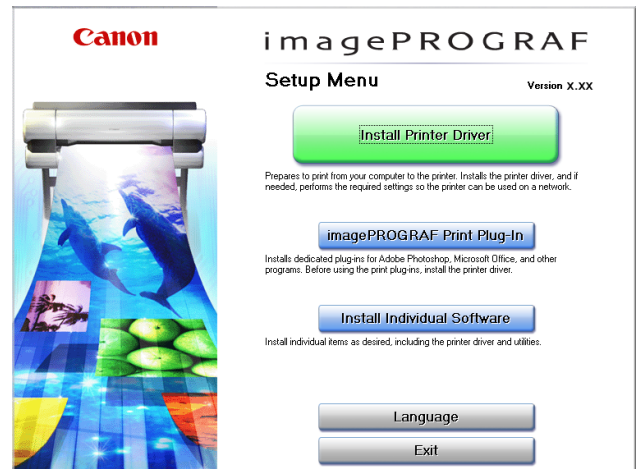

3

Click **Install** in **imagePROGRAF Print Plug-In for Office**.

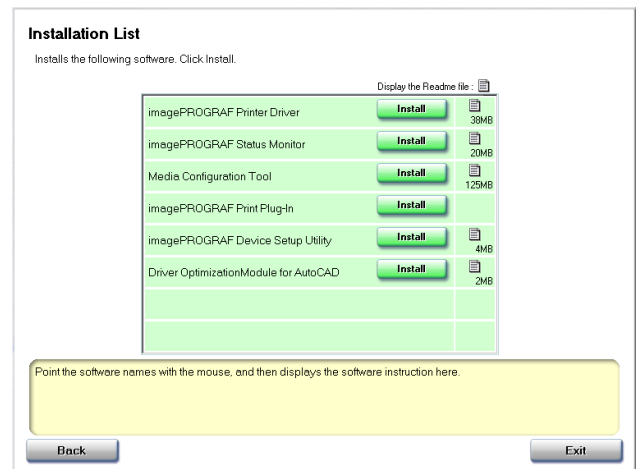

4 Click the **Next** button.

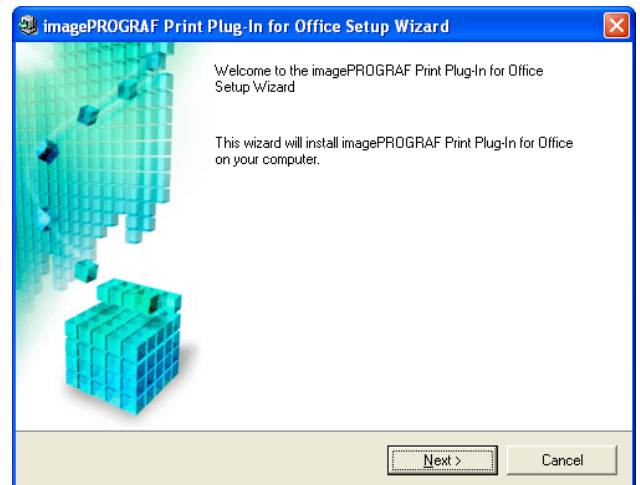

5 Read the **License Agreement**, and click the **Yes** button.

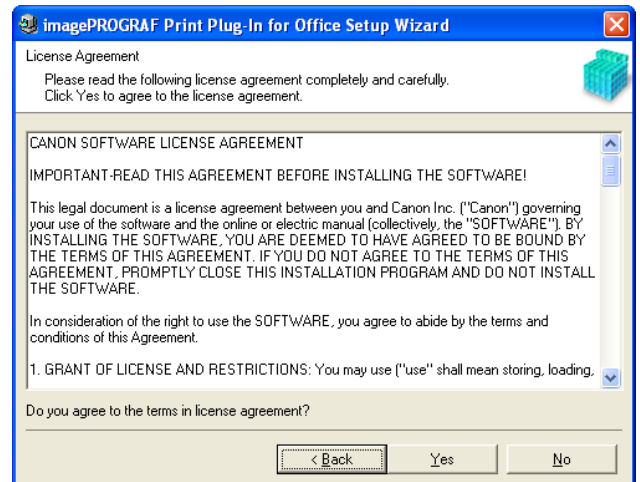

6 Click the **Start** button.

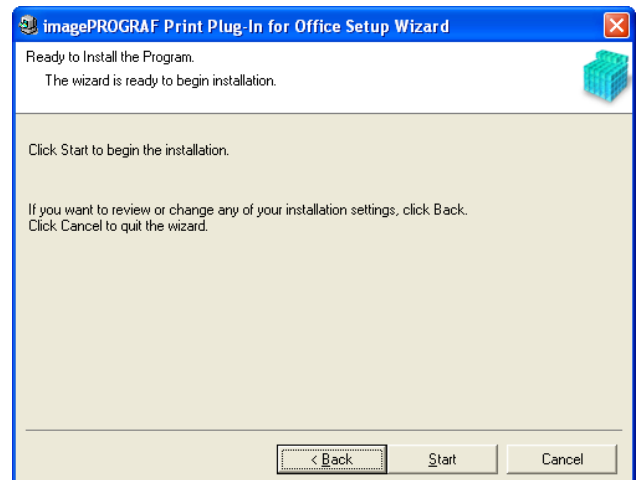

7 Click the **Yes** button.

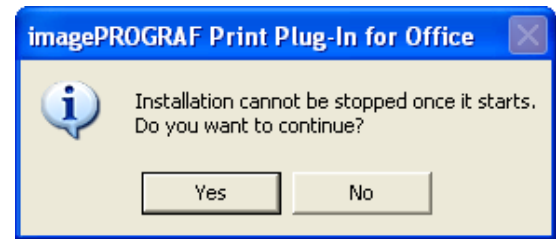

8 Click the **Exit** button.

The installation for **Print Plug-In for Office** is complete.

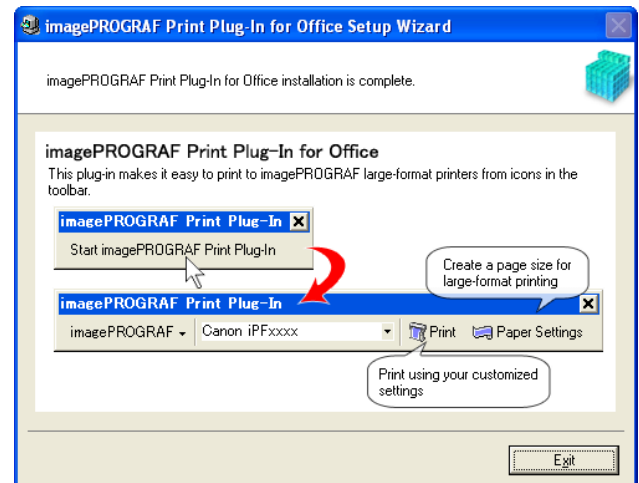

Important

- When you install this software, the virtual printer **Canon imagePROGRAF PrintPlugIn** may be installed. If you want to use this software, do not uninstall the virtual printer **Canon imagePROGRAF PrintPlugIn**.
- The **Print Plug-In for Office** toolbar/ribbon might not be displayed in **Microsoft Office** after installing **imagePROGRAF Print Plug-In for Office**. Refer to the following topic for details on how to display the **imagePROGRAF Print Plug-In for Office** toolbar/ribbon.
 - When Print Plug-In for Office is not displayed →P.326

Steps to uninstall

Below are the steps to uninstall **Print Plug-In for Office**.

- 1** If **Microsoft Office** is open, close it.
- 2** Select **Control Panel** from the **start** menu.
- 3** Open **Add or Remove Programs**.

- 4** Select **imagePROGRAF Print Plug-In**, and click the **Remove** button.

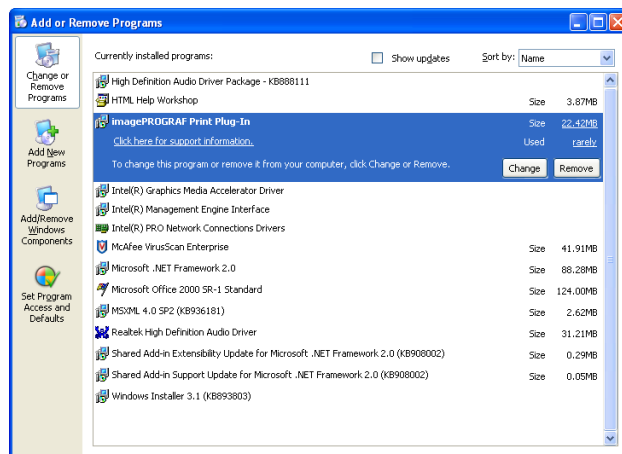

- You cannot uninstall **Print Plug-In for Office** if an Office application is running. When a message appears, select **Cancel** and close all Office applications that are running.

When Print Plug-In for Office is not displayed

Buttons such as **Start imagePROGRAF Print Plug-In** sometimes do not appear in the **Word**, **PowerPoint** and **Excel** Office applications, and the **Print Plug-In for Office** functions are not available.

In this event, re-install **Print Plug-In for Office**.

If you are using **Microsoft Office 2003** or later, you can also enable add-ins to display **Print Plug-In for Office**.

See below for the procedure for re-installing the plug-in or enabling add-ins.

Re-installing Print Plug-In for Office

If a problem occurs, such as the system or an application terminating abnormally, the **Microsoft Office** application disables add-ins as a safety precaution.

In this event, you will need to re-install **Print Plug-In for Office** to display the **imagePROGRAF Print Plug-In** toolbar/ribbon.



- You cannot re-install **Print Plug-In for Office** once an Office application is running. When the message appears, select **Cancel** and close the active Office application.

Re-install **Print Plug-In for Office** as follows:

- Close **Microsoft Office** if it is open.
- Install **Print Plug-In for Office**.
For information about installing, see "Steps to install." →P.323

Enabling Print Plug-In for Office for items disabled in Office applications

If a problem occurs, such as the system or an application terminating abnormally, the **Microsoft Office** application disables add-ins as a safety precaution.

In this event, you will need to restore the disabled add-ins in order to display the **imagePROGRAF Print Plug-In** toolbar/ribbon.

Use the procedure below to restore the add-ins disabled by **Microsoft Office**.

- For **Microsoft Office 2010**

1 Select **Options** from the **File** menu.

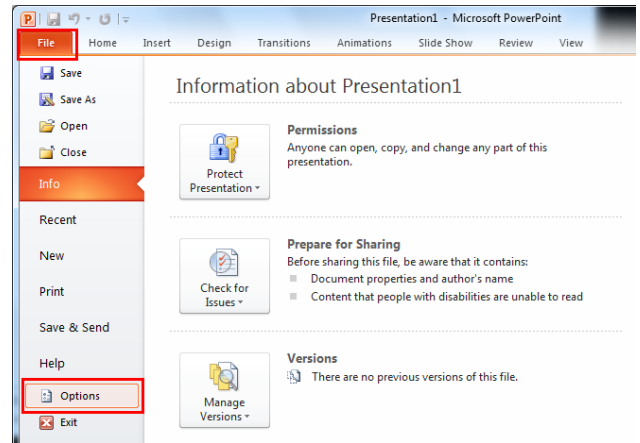

2 From the list on the left side of the **<application name> options** dialog box, select **Add-ins**.

3 Select **Disabled Items** in the **Manage** combo box and click the **Go** button.

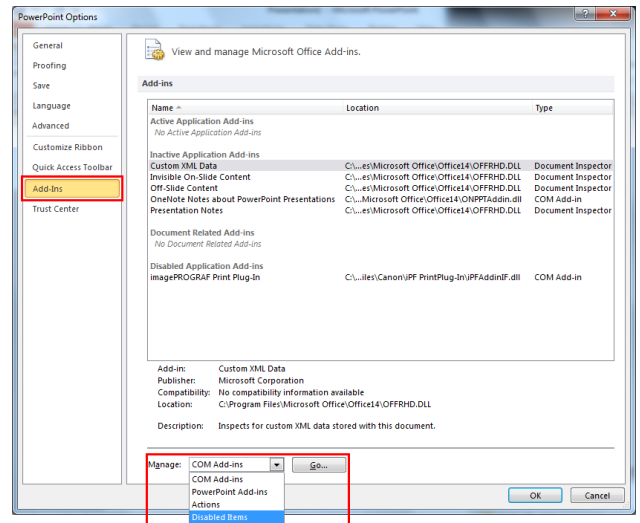

4 If **Addin imageprograf print plug-in (ipfaddinif.dll)** is displayed in the **Disabled Items** dialog box, select it and click the **Enable** button.

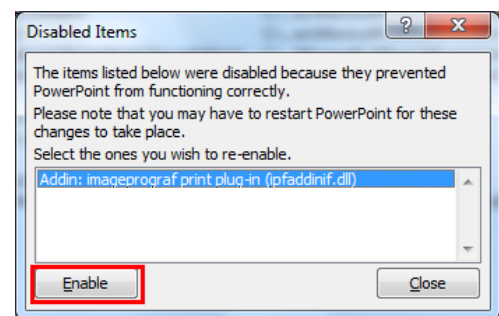

5 Close all the dialog boxes and restart the Office application.

- For **Microsoft Office 2007**

- 1 Click the **Office** button and then click the **<application name> options** button.

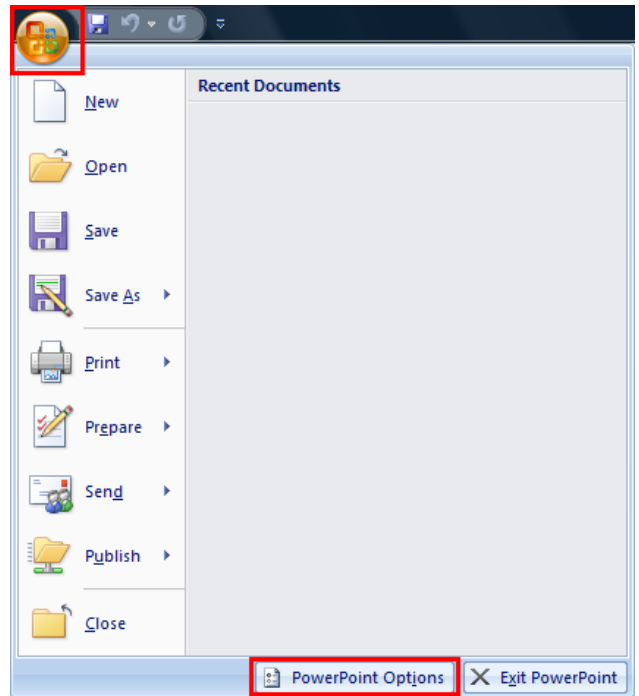

- 2 From the list on the left side of the **<application name> options** dialog box, select **Add-ins**.

- 3 Select **Disabled Items** in the **Manage** combo box and click the **Go** button.

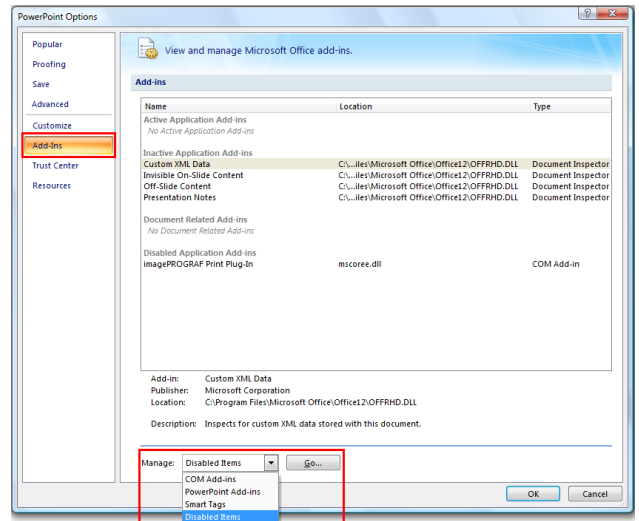

- 4** If **Addin imageprograf print plug-in (ipfaddinif.dll)** is displayed in the **Disabled Items** dialog box, select it and click the **Enable** button.

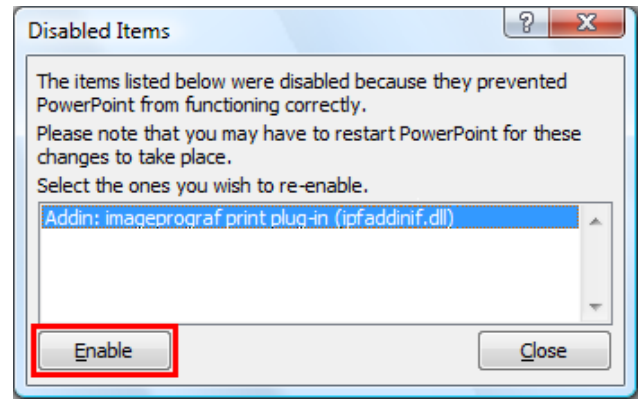

- 5** Close all the dialog boxes and restart the Office application.

- For **Microsoft Office 2003**

- 1** Click **About <application name>** in the **Help** menu of application.



- 2** Click the **Disabled Items** button in the **About <application name>** dialog box.

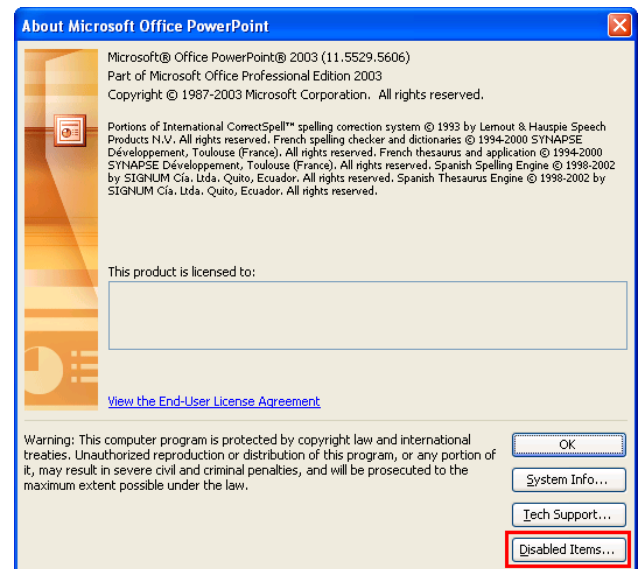

- 3 If **Addin imageprograf print plug-in (ipfaddinif.dll)** is displayed in the **Disabled Items** dialog box, select it and click the **Enable** button.

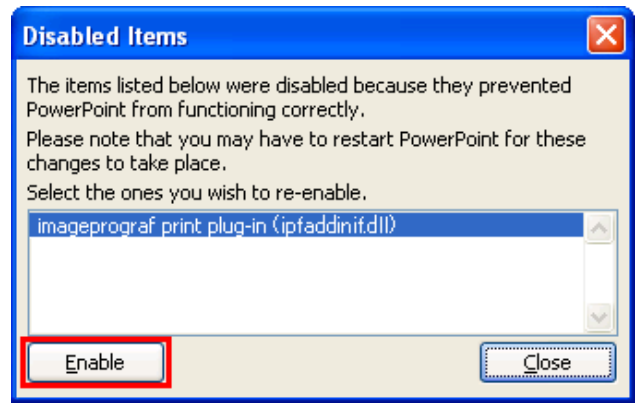

- 4 Close all the dialog boxes and restart the Office application.

To start from Microsoft Word

Below are the steps to start **Print Plug-In for Office** from **Microsoft Word**.

- 1 Start **Microsoft Word**.
- 2 If **Start imagePROGRAF Print Plug-In** is displayed on the toolbar/ribbon, click it.

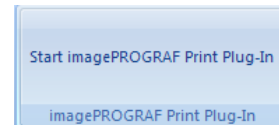

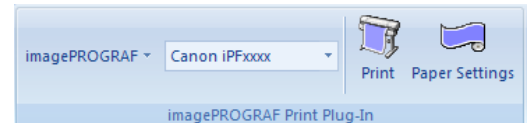

Important • If the **imagePROGRAF Print Plug-In** toolbar/ribbon is not displayed, refer to the following.
 • When Print Plug-In for Office is not displayed →P.326

- 3 Check that the **imagePROGRAF Print Plug-In** toolbar/ribbon is displayed.

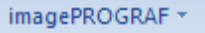
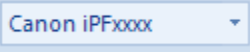

- 4 Click the buttons on the toolbar/ribbon according to the items you want to set.

Icon	Contents
 Menu	Displays the About , Help , and Special Settings dialog boxes. You can change the settings using the Special Settings dialog box. Refer to Configuring Special Settings →P.361 for details.
 Printer list	Select Printer. If you select Show All Printers , the imagePROGRAF printers will be displayed again. Select this when you want to display all printer drivers or update the display.
 Print Button	The print Wizard is displayed. The settings Print Matching Roll Width , Borderless Printing , Multi-Page Printing , and Print Using Registered Settings can be set.
 Paper Settings Button	Large-Format Wizard is displayed. Settings for Portrait or Landscape Orientation can be set.

Printing Wizard dialog box

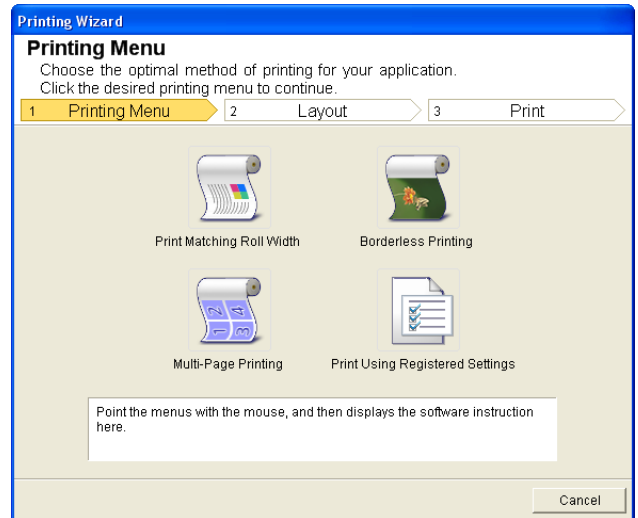

Important

- If you want to change the display to another file or application while the **Printing Wizard** is open, close the **Printing Wizard** dialog box. Otherwise, you may not be able to change displays or operate the toolbar.

Large-Format Printing Wizard dialog box

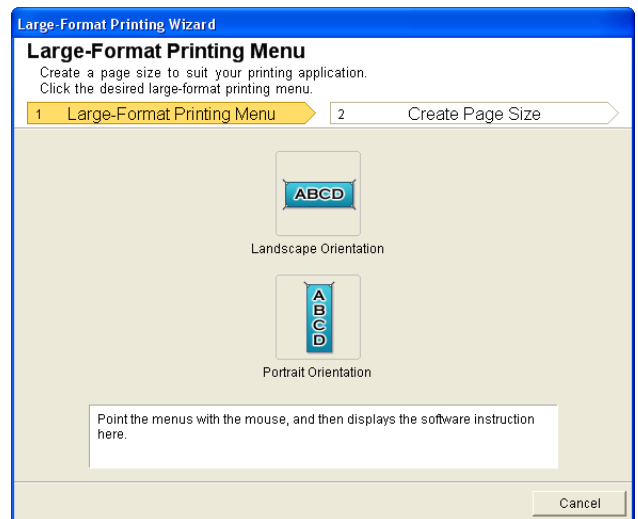

Important

- If you want to change the display to another file or application while the **Large-Format Printing Wizard** is open, close the **Large-Format Printing Wizard** dialog box. Otherwise, you may not be able to change displays or operate the toolbar/ribbon.
- The layout may collapse if you create a form using existing data. If that is the case, modify the data again.

Print Matching Roll Width (Word)

Prints to the edge of the roll width. You can print large exhibits and posters, and also print Portrait and Landscape orientations made in **Large-Format Printing Wizard**.

- 1 Start **Microsoft Word**.

2 If **Start imagePROGRAF Print Plug-In** is displayed, click it.

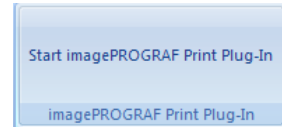

3 Click **Print** from the **imagePROGRAF Print Plug-In** toolbar/ribbon. The **Printing Wizard** dialog box is displayed.

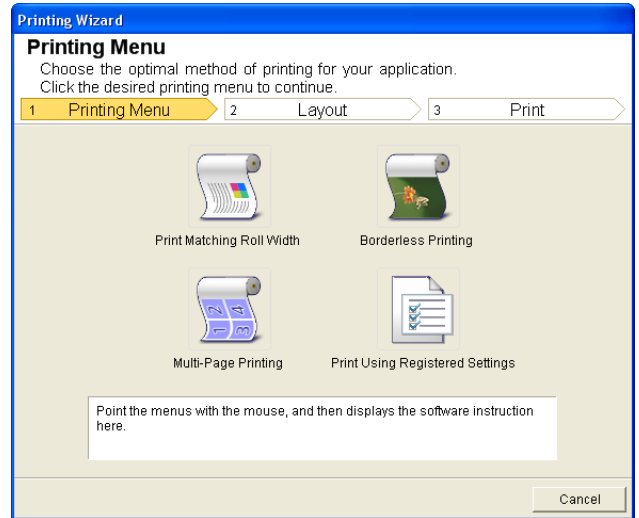

• If you want to change the display to another file or application while the **Printing Wizard** is open, close the **Printing Wizard** dialog box. Otherwise, you may not be able to change displays or operate the toolbar/ribbon.

4 Click **Print Matching Roll Width**.

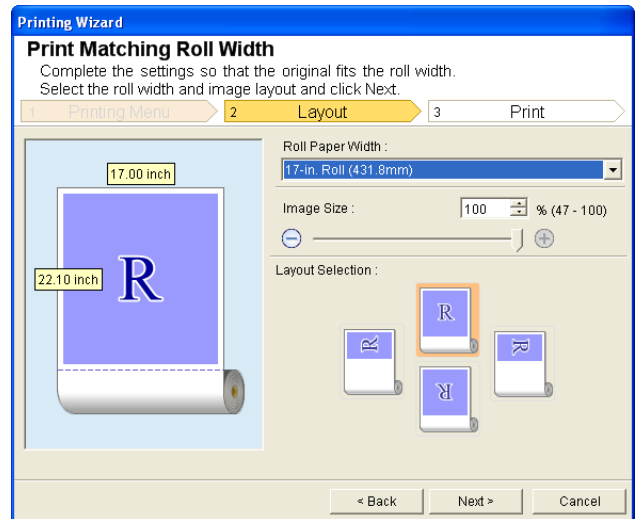

5 Select **Roll Paper Width** that is set in the printer.

6 Select image size.

7 Select layout.

8 Select **Next**.

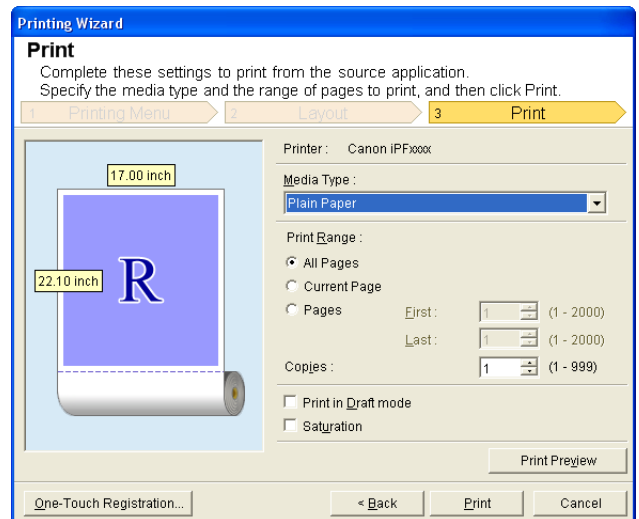

9 Select **Media Type**.

10 Select **Print Range** from **All Pages**, **Current Page**, and **Pages**. If **Pages** is selected, enter the number of pages.

11 Enter **Copies**.



- When **Print in Draft mode** is selected, printing is fast but the print quality is poor.
- When **Saturation** is selected, you can print posters, etc., vividly.
- The settings are registered when the **One-Touch Registration** is pressed. This is convenient if you need to print multiple times using the same setting.
- Press the **Print Preview** button to display the preview screen. You can check and make changes to the layout in the preview screen.
- When you print to the edge of the roll width, the maximum length will be the lesser of 5.587 times the roll paper width, or 18.0m.

12 Press **Print** to start printing.

Borderless Printing (Word)

Prints up to the border of the media. Photos and posters can be printed without worrying about margins.

1 Start **Microsoft Word**.

2 If **Start imagePROGRAF Print Plug-In** is displayed, click it.

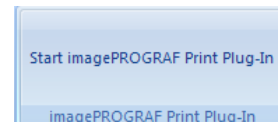

- 3** Click **Print** from the **imagePROGRAF Print Plug-In** toolbar/ribbon.
The **Printing Wizard** dialog box is displayed.

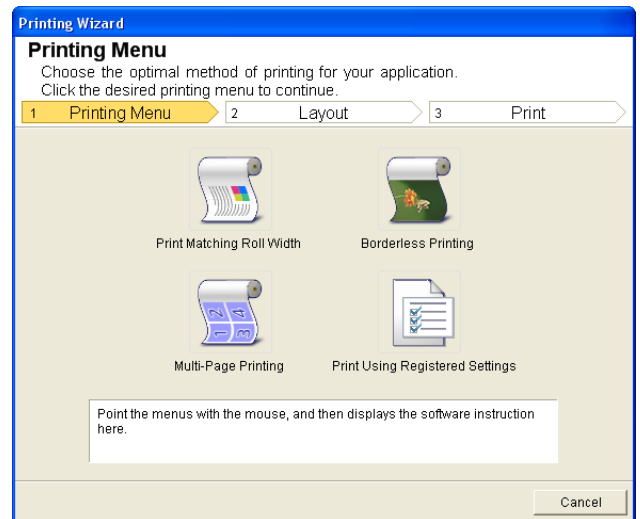

Important

- If you want to change the display to another file or application while the **Printing Wizard** is open, close the **Printing Wizard** dialog box. Otherwise, you may not be able to change displays or operate the toolbar/ribbon.

- 4** Click **Borderless Printing**.

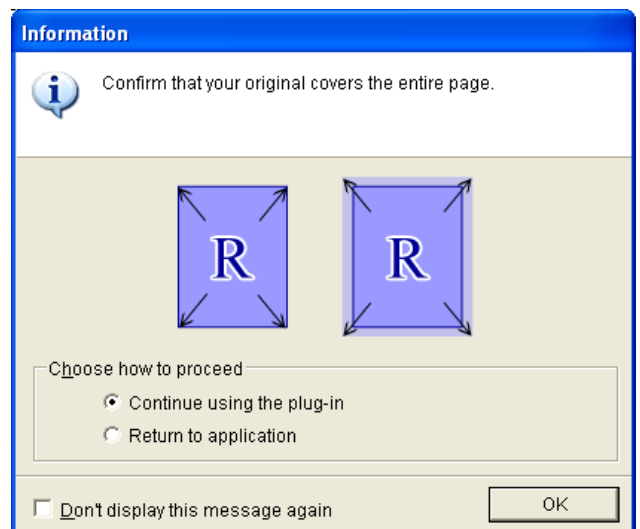

- 5** A confirmation dialog box is displayed. If the data fills up the page, confirm that **Continue using the plug-in** is selected in **Choose how to proceed** and press **OK**.



Note

- To adjust the data, select **Return to application** and press **OK**. Exit **Print Plug-In for Office** and return to the application.

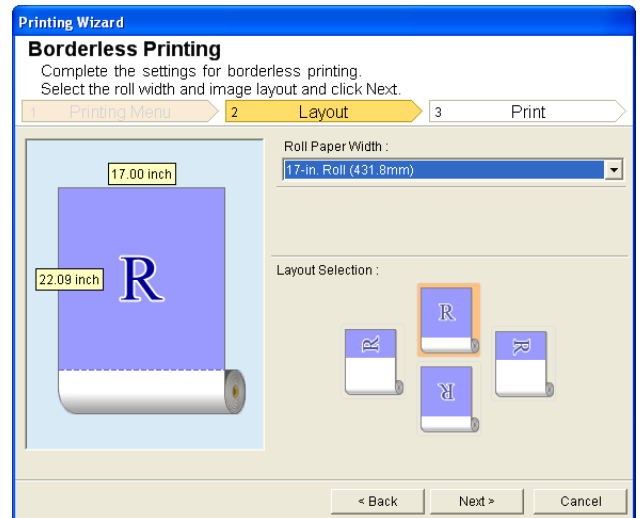

6 Select **Roll Paper Width** that is set in the printer.

7 Select **Layout**.

8 Select **Next**.

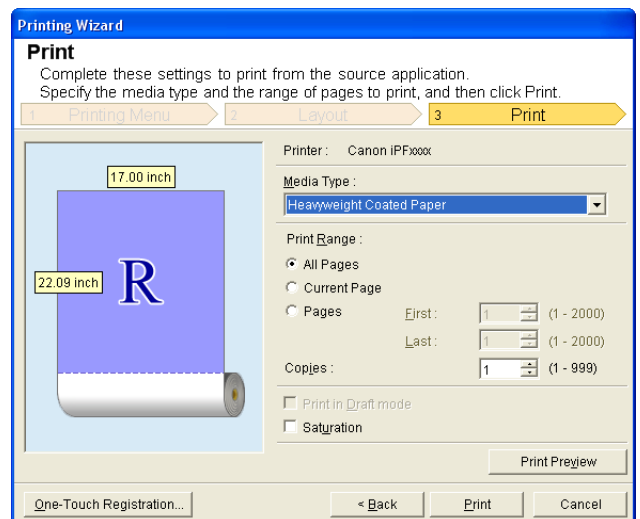

9 Select **Media Type**.

10 Select **Print Range** from **All Pages**, **Current Page**, and **Pages**.
For **Pages**, insert the page number.

11 Enter **Copies**.



- When **Print in Draft mode** is selected, printing is fast but the print quality is poor.
- When **Saturation** is selected, you can print posters, etc., vividly.
- Press the **One-Touch Registration** button to register the settings. This is useful for multiple printing using the same settings.
- Press the **Print Preview** button to display the preview screen. You can confirm and make changes to the layout in the preview screen.
- The maximum length for Borderless Printing is the lesser of 5.587 times the roll paper width, or 18.0m.

12 Press **Print** to start printing.

Multi-Page Printing (Word)

Prints multiple pages as one page. You can print handouts into a single page, or print matter with many pages.

1 Start **Microsoft Word**.

2 If **Start imagePROGRAF Print Plug-In** is displayed, click it.

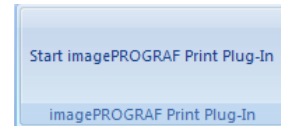

3 Click **Print** from the **imagePROGRAF Print Plug-In** toolbar/ribbon. The **Printing Wizard** dialog box is displayed.

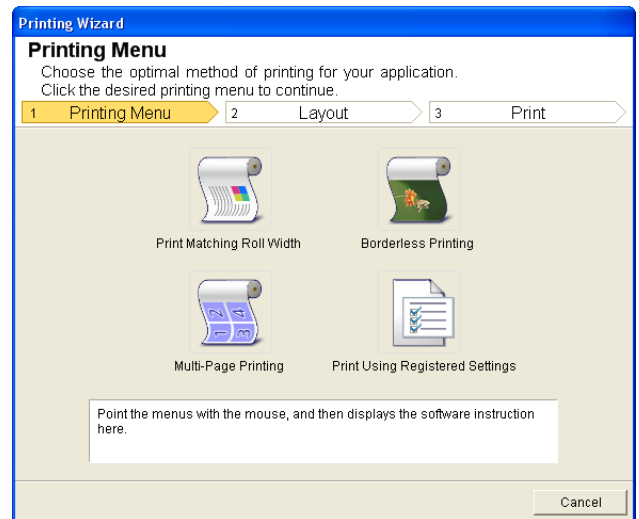

- If you want to change the display to another file or application while the **Printing Wizard** is open, close the **Printing Wizard** dialog box. Otherwise, you may not be able to change displays or operate the toolbar/ribbon.

4 Click **Multi-Page Printing**.

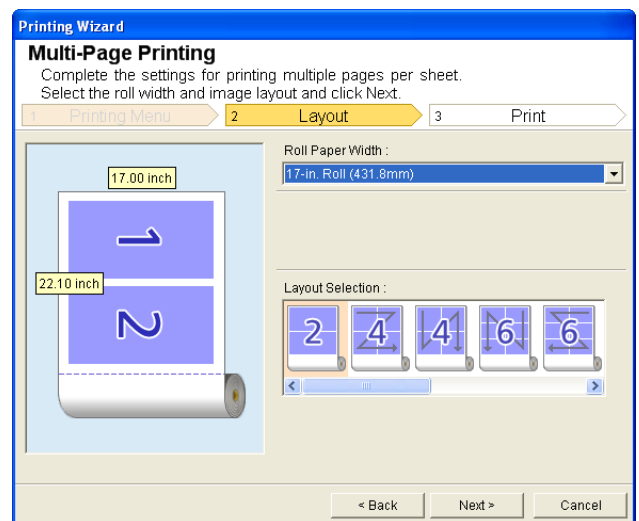

5 Select the **Roll Paper Width** that is set in the printer.

6 Select layout from **Layout Selection**.

7 Select **Next**.

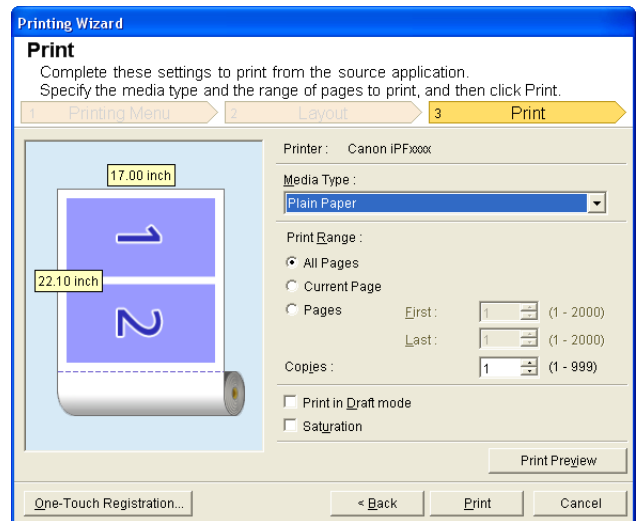

8 Select **Media Type**.

9 Select **Print Range** from **All Pages**, **Current Page**, and **Pages**. If **Pages** is selected, enter the number of pages.

10 Enter **Copies**.



- When **Print in Draft mode** is selected, printing is fast but the print quality is poor.
- Note** • When **Saturation** is selected, you can print posters, etc., vividly.
- The settings are registered when the **One-Touch Registration** is pressed. This is convenient if you need to print multiple times using the same setting.
- Press the **Print Preview** button to display the preview screen. You can check and make changes to the layout in the preview screen.
- The maximum length for Multi-Page Printing is the lesser of 5.587 times the roll paper width, or 18.0m.

11 Press **Print** to start printing.

Register the settings (Word)

If you are going to print multiple times using the same setting, you can select **One-Touch Registration**. Registered settings can be recalled from **Print Using Registered Settings**.

1 Set up to the **Print** screen from **Print Matching Roll Width**, **Borderless Printing** or **Multi-Page Printing** of **Printing Menu**.



- Up to 20 items can be registered.
- Note** • The available settings are as follows.
 - Print Matching Roll Width (Word) →P.331
 - Borderless Printing (Word) →P.333
 - Multi-Page Printing (Word) →P.336

2 Click the **One-Touch Registration** button.

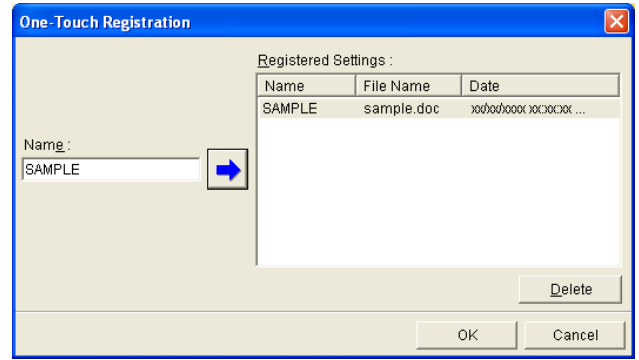

3 Enter name in **Name**.
Up to 31 characters can be entered.

4 Click . The name you entered is displayed in **Registered Settings**.

5 Click **OK**, and return to the **Print** screen.

6 Click **Print** to print, and click **Cancel** to cancel the print.

 **Note** • Clicking **Cancel** in the **Print** screen will not delete the registered settings.

Print Using Registered Settings (Word)

Prints using the registered settings.

1 Start **Microsoft Word**.

2 If **Start imagePROGRAF Print Plug-In** is displayed, click it.

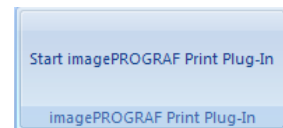

3 Click **Print** from the **imagePROGRAF Print Plug-In** toolbar/ribbon.
The **Printing Wizard** dialog box is displayed.

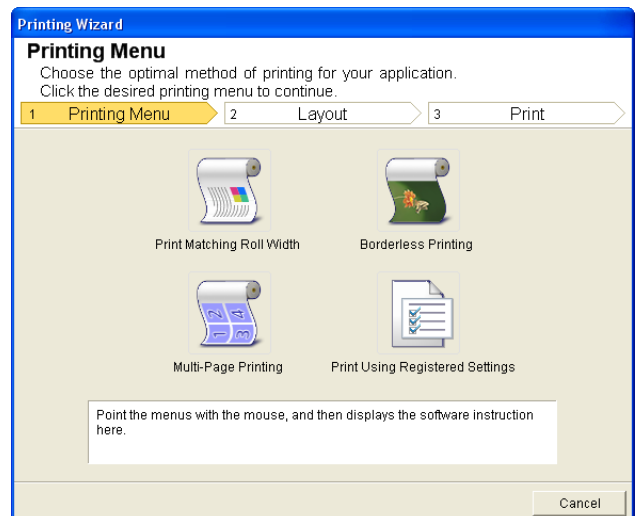



- If you want to change the display to another file or application while the **Printing Wizard** is open, close the **Printing Wizard** dialog box. Otherwise, you may not be able to change displays or operate the toolbar/ribbon.

4 Click **Print Using Registered Settings**.

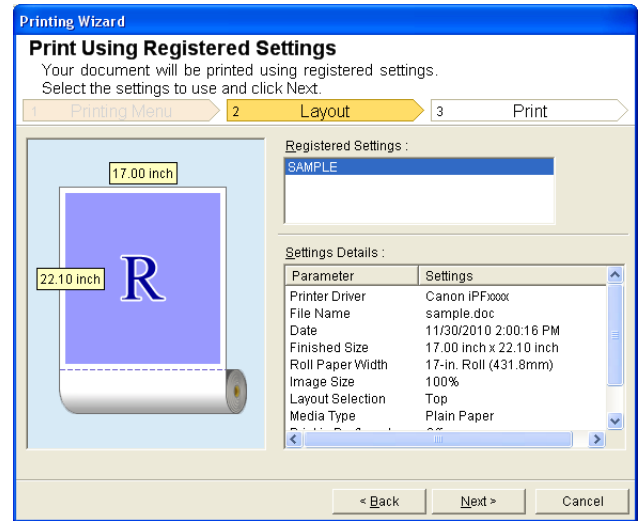

5 Click the **Next** button.

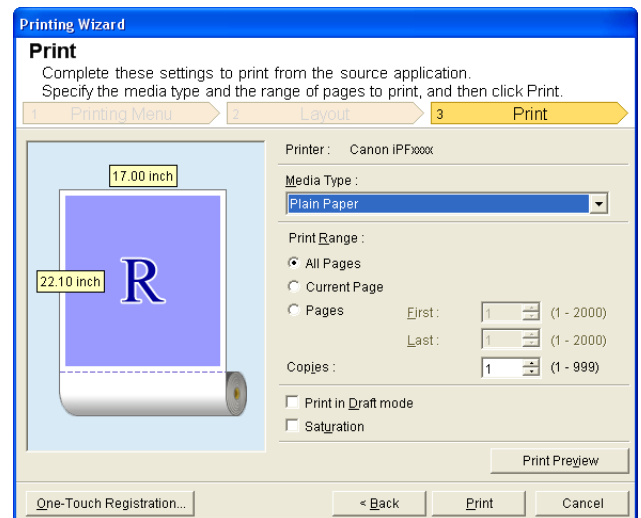

6 Select **Media Type**.

7 Select **Print Range** from **All Pages**, **Current Page**, or **Pages**. If **Pages** is selected, enter the number of pages.

8 Enter **Copies**.



- When **Print in Draft mode** is selected, printing is fast but the print quality is poor.
- When **Saturation** is selected, you can print posters, etc., vividly.
- Press the **Print Preview** button to display the preview screen. You can check and make changes to the layout in the preview screen.
- The maximum print length when printing with the registered settings is the lesser of 5.587 times the roll paper width, or 18.0m.

9 Press **Print** to start printing.

Portrait Orientation / Landscape Orientation (Word)

Print to the edge of the roll width. You can print large exhibits and posters, or print the Landscape or Portrait Orientation Page Sizes made in the **Large-Format Printing Wizard**.

Create Page Size in Portrait or Landscape Orientation.

Use the **Large-Format Printing Wizard** to create portrait page sizes for Potrait Orientation, and landscape page sizes for Landscape Orientation.

1 Start **Microsoft Word**.

2 If **Start imagePROGRAF Print Plug-In** is displayed, click it.

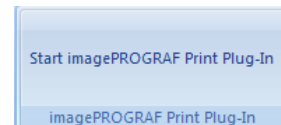

3 Click **Paper Settings** from the **imagePROGRAF Print Plug-In** toolbar/ribbon. The **Large-Format Printing Wizard** dialog box is displayed.



Note

- If you want to change the display to another file or application while the **Large-Format Printing Wizard** is open, close the **Large-Format Printing Wizard** dialog box. Otherwise, you may not be able to change displays or operate the toolbar/ribbon.

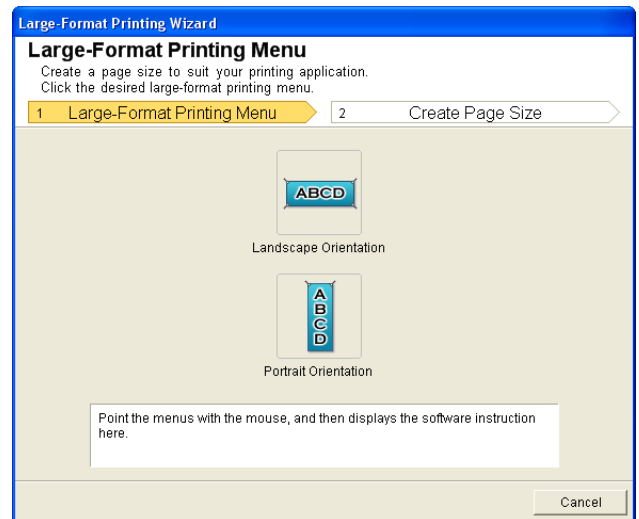

4 Click **Portrait Orientation** or **Landscape Orientation**.



Note

- The steps taken to create a Portrait Page Size will be used as an example to explain the procedure.

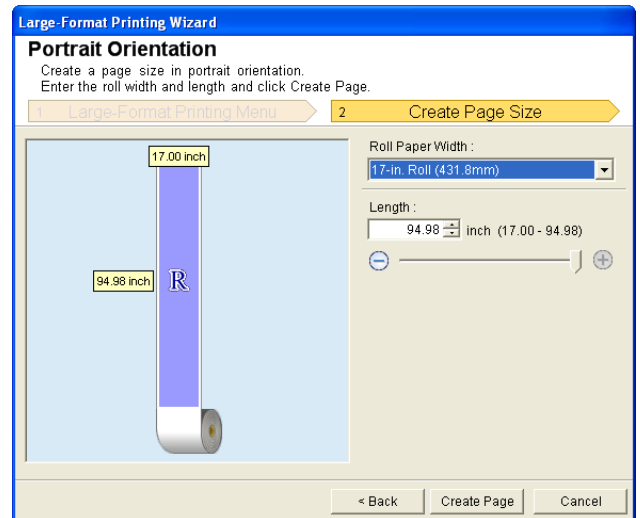

5 Adjust **Length** from the list-box or slide-bar.

6 Click the **Create Page** button.

7 Click **OK** if the message is displayed.

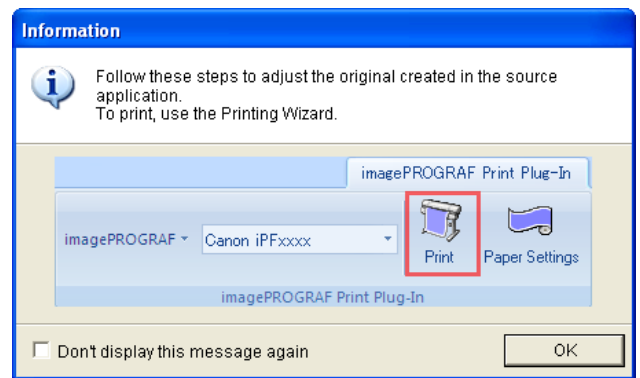

8 Edit and create the document.



Note

- Printing is done in **Print Matching Roll Width** of the **Printing Wizard**. For details on **Print Matching Roll Width**, see "Print Matching Roll Width (Word)." →P.331



Important

- The layout may collapse if you create a form using existing data. If that is the case, modify the data again.

To start from Microsoft PowerPoint

Below are the steps to start **Print Plug-In for Office** from **Microsoft PowerPoint**.

1 Start **Microsoft PowerPoint**.

2 If **Start imagePROGRAF Print Plug-In** is displayed on the toolbar/ribbon, click it.

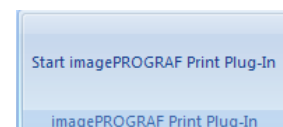

Important • If the **imagePROGRAF Print Plug-In** toolbar/ribbon is not displayed, refer to the following.
 • When Print Plug-In for Office is not displayed →P.326

3 Check that the **imagePROGRAF Print Plug-In** toolbar/ribbon is displayed.

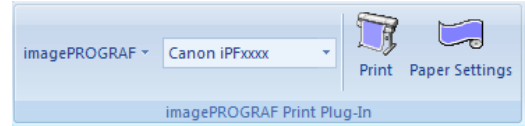

4 Click the buttons on the toolbar/ribbon according to the items you want to set.

Icon	Contents
Menu	Displays the About , Help , and Special Settings dialog boxes. (See "Configuring Special Settings.") →P.361
Printer list	Select Printer. If you select Show All Printers , the imagePROGRAF printers will be displayed again. Select this when you want to display all printer drivers or update the display.
Print Button	The print Wizard is displayed. The settings Print Matching Roll Width , Borderless Printing , Multi-Page Printing , and Print Using Registered Settings can be set.
Paper Settings Button	Large-Format Wizard is displayed. Settings for Portrait or Landscape Orientation can be set.

Printing Wizard dialog box

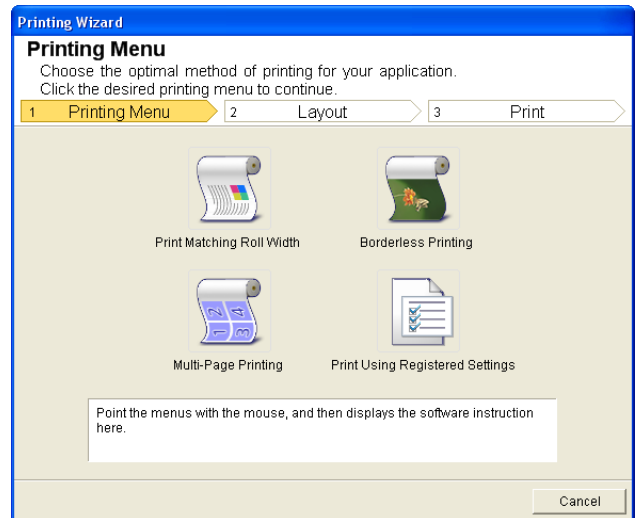

Important • If you want to change the display to another file or application while the **Printing Wizard** is open, close the **Printing Wizard** dialog box. Otherwise, you may not be able to change displays or operate the toolbar/ribbon.

Note • If you open a password protected document as read-only, the **Printing Wizard** cannot be run.

Large-Format Printing Wizard dialog box

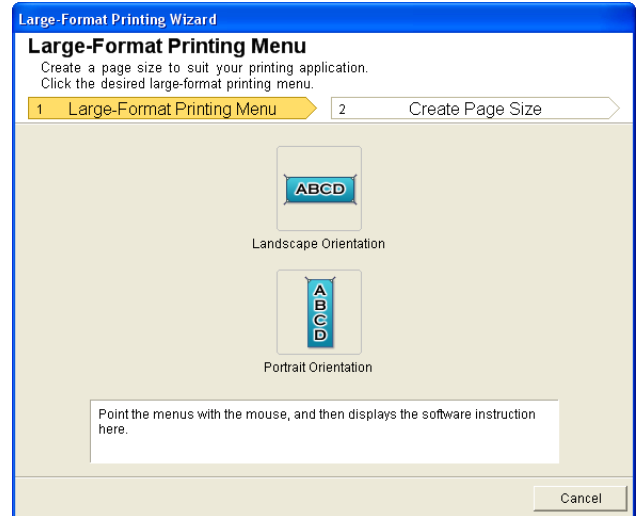

Important

- If you want to change the display to another file or application while the **Large-Format Printing Wizard** is open, close the **Large-Format Printing Wizard** dialog box. Otherwise, you may not be able to change displays or operate the toolbar/ribbon.
- The layout may collapse if you create a form using existing data. If that is the case, modify the data again.



Note

- If you open a password protected document as read-only, the **Large-Format Printing Wizard** cannot be run. Remove the password protection.

Print Matching Roll Width (PowerPoint)

Prints to the edge of the roll width. You can print large exhibits and posters, and also print Portrait and Landscape orientations made in **Large-Format Printing Wizard**.

- 1 Start **Microsoft PowerPoint**.
- 2 If **Start imagePROGRAF Print Plug-In** is displayed, click it.

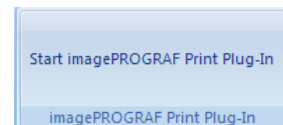

- 3** Click **Print** from the **imagePROGRAF Print Plug-In** toolbar/ribbon.
The **Printing Wizard** dialog box is displayed.

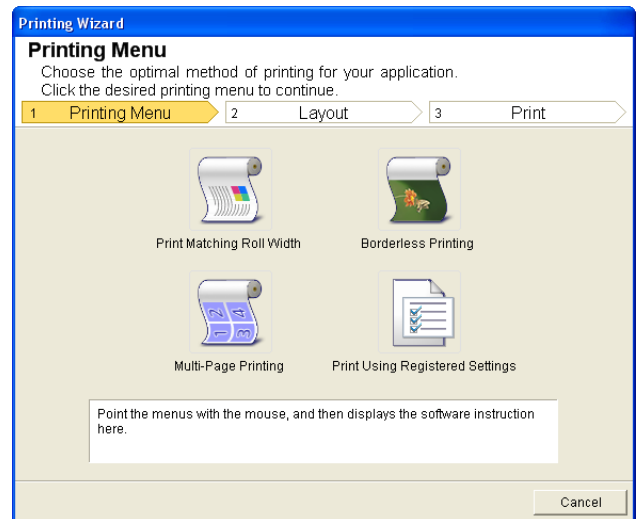

Important

- If you want to change the display to another file or application while the **Printing Wizard** is open, close the **Printing Wizard** dialog box. Otherwise, you may not be able to change displays or operate the toolbar/ribbon.

- 4** Click **Print Matching Roll Width**.

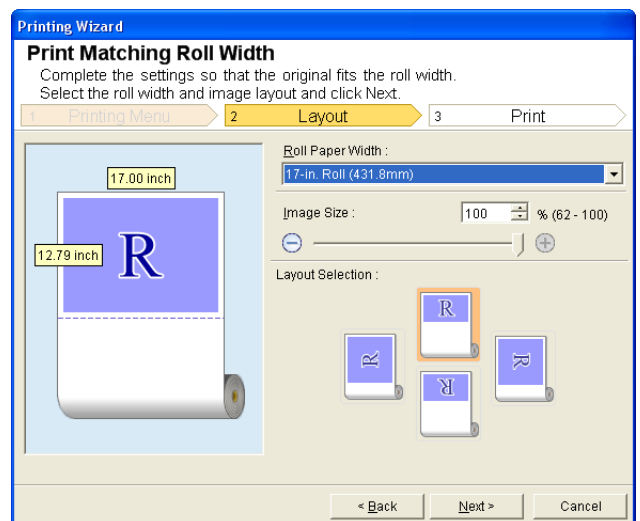

- 5** Select **Roll Paper Width** that is set in the printer.

- 6** Select image size.

- 7** Select layout.

8 Select Next.

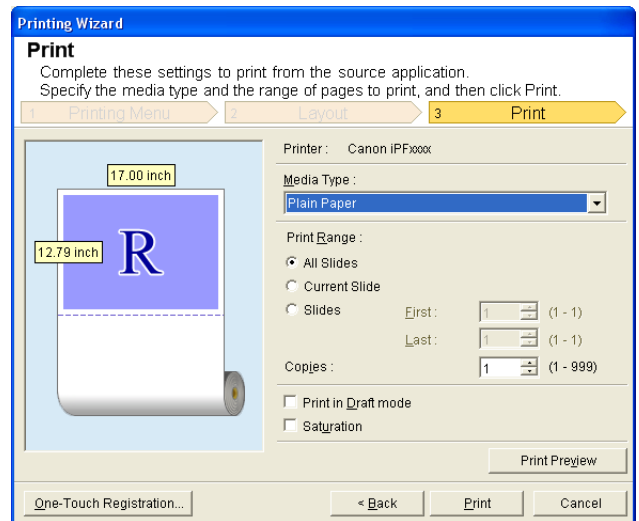

9 Select Media Type.

10 Select Print Range from All Slides, Current Slide, and Slides. If Slides is selected, enter the slide number.

11 Enter Copies.



- When **Print in Draft mode** is selected, printing is fast but the print quality is poor.
- When **Saturation** is selected, you can print posters, etc., vividly.
- The settings are registered when the **One-Touch Registration** is pressed. This is convenient if you to need print multiple times using the same setting.
- Press the **Print Preview** button to display the preview screen. You can check and make changes to the layout in the preview screen.
- When you print to the edge of the roll width, the maximum length will be the lesser of 14.22 times the roll paper width, or 18.0m.

12 Press Print to start printing.

Borderless Printing (PowerPoint)

Prints up to the border of the media. Photos and posters can be printed without worrying about margins.

1 Start Microsoft PowerPoint.

2 If Start imagePROGRAF Print Plug-In is displayed, click it.

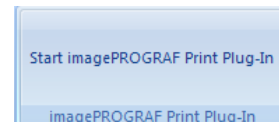

- 3** Click **Print** from the **imagePROGRAF Print Plug-In** toolbar/ribbon.
The **Printing Wizard** dialog box is displayed.

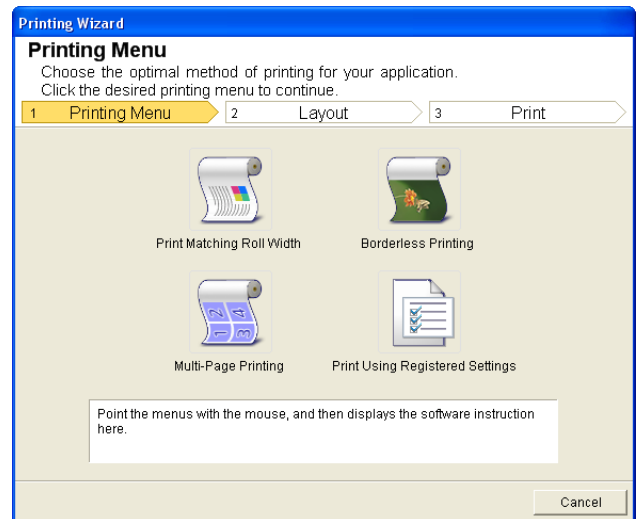

Important

- If you want to change the display to another file or application while the **Printing Wizard** is open, close the **Printing Wizard** dialog box. Otherwise, you may not be able to change displays or operate the toolbar/ribbon.

- 4** Click **Borderless Printing**.

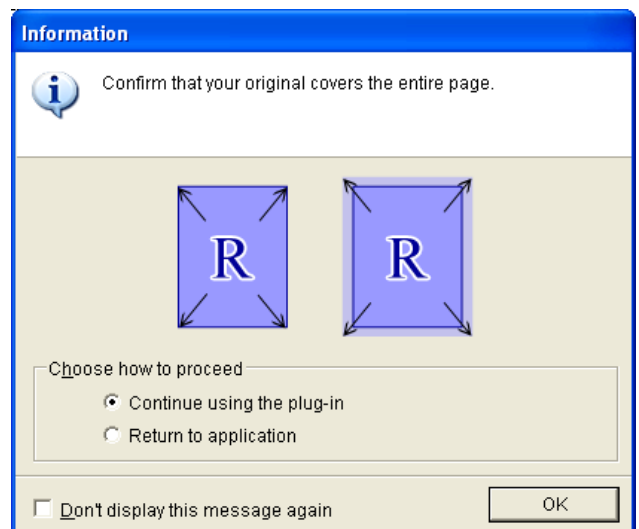

- 5** A confirmation dialog box is displayed. If the data fills up the page, confirm that **Continue using the plug-in** is selected in **Choose how to proceed** and press **OK**.



Note

- To adjust the data, select **Return to application** and press **OK**. Exit **Print Plug-In for Office** and return to the application.

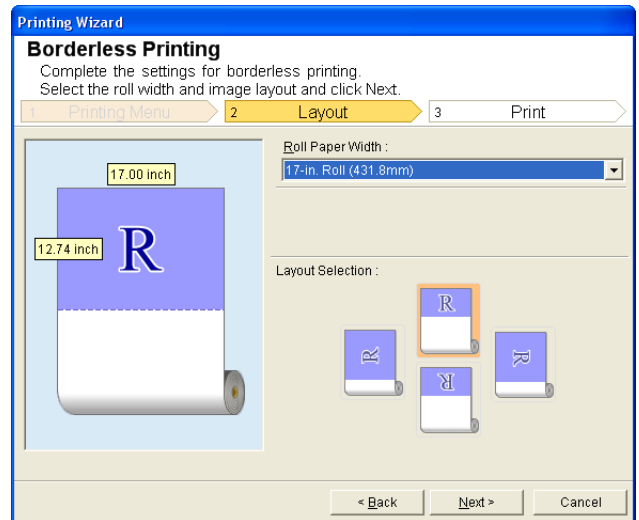

6 Select **Roll Paper Width** that is set in the printer.

7 Select **Layout**.

8 Select **Next**.

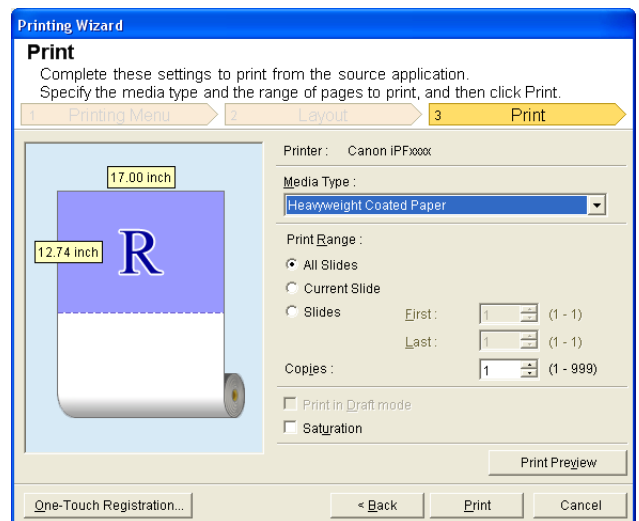

9 Select **Media Type**.

10 Select **Print Range** from **All Slides**, **Current Slide**, and **Slides**.
If **Slides** is selected, enter the slide number.

11 Enter **Copies**.



- When **Print in Draft mode** is selected, printing is fast but the print quality is poor.
- When **Saturation** is selected, you can print posters, etc., vividly.
- Press the **One-Touch Registration** button to register the settings. This is useful for multiple printing using the same settings.
- Press the **Print Preview** button to display the preview screen. You can confirm and make changes to the layout in the preview screen.
- The maximum length for Borderless Printing is the lesser of 14.22 times the roll paper width, or 18.0m.

12 Press **Print** to start printing.

Multi-Page Printing (PowerPoint)

Prints multiple pages as one page. You can print handouts into a single page, or print matter with many pages.

1 Start **Microsoft PowerPoint**.

2 If **Start imagePROGRAF Print Plug-In** is displayed, click it.

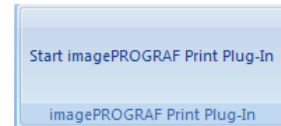

3 Click **Print** from the **imagePROGRAF Print Plug-In** toolbar/ribbon. The **Printing Wizard** dialog box is displayed.

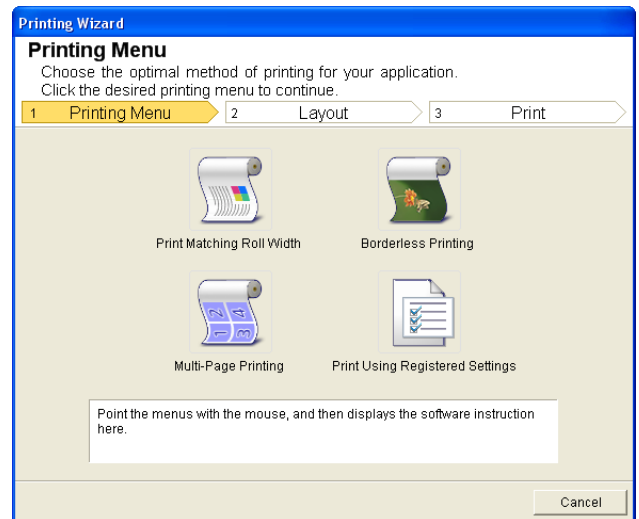

- If you want to change the display to another file or application while the **Printing Wizard** is open, close the **Printing Wizard** dialog box. Otherwise, you may not be able to change displays or operate the toolbar/ribbon.

4 Click **Multi-Page Printing**.

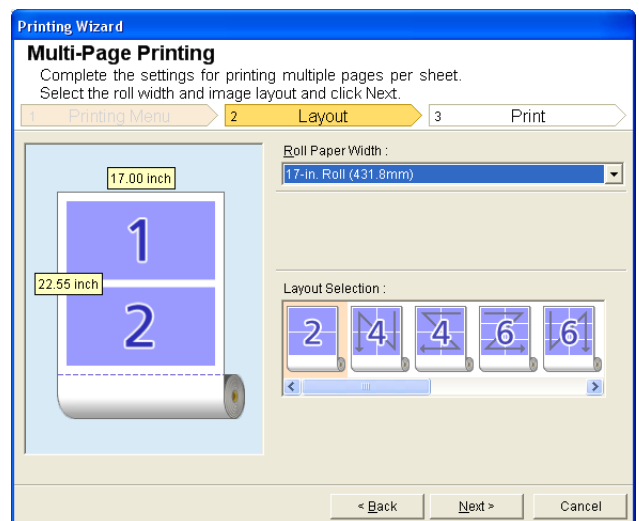

5 Select the **Roll Paper Width** that is set in the printer.

6 Select layout from **Layout Selection**.

7 Select **Next**.

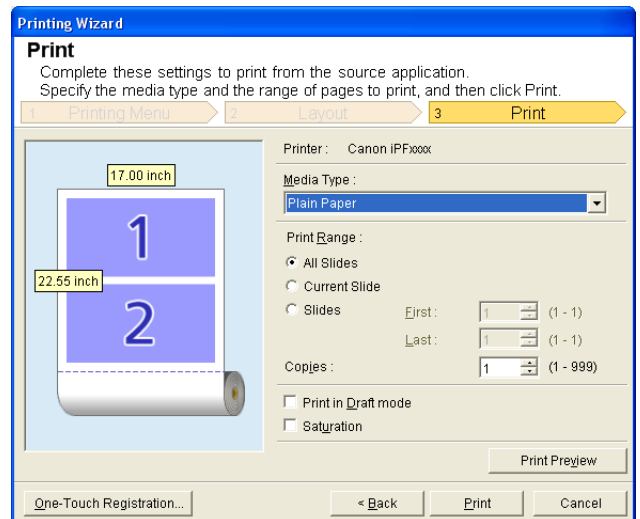

8 Select **Media Type**.

9 Select **Print Range** from **All Slides**, **Current Slide**, and **Slides**. If **Slides** is selected, enter the slide number.

10 Enter **Copies**.

- When **Print in Draft mode** is selected, printing is fast but the print quality is poor.
- When **Saturation** is selected, you can print posters, etc., vividly.
- The settings are registered when the **One-Touch Registration** is pressed. This is convenient if you need to print multiple times using the same setting.
- Press the **Print Preview** button to display the preview screen. You can check and make changes to the layout in the preview screen.
- The maximum length for Multi-Page Printing is the lesser of 14.22 times the roll paper width, or 18.0m.

11 Press **Print** to start printing.

Register the settings (PowerPoint)

If you are going to print multiple times using the same setting, you can select **One-Touch Registration**. Registered settings can be recalled from **Print Using Registered Settings**.

1 Set up to the **Print** screen from **Print Matching Roll Width**, **Borderless Printing** or **Multi-Page Printing** of **Printing Menu**.

- Up to 20 items can be registered.
- The available settings are as follows.
 - Print Matching Roll Width (PowerPoint) →P.343
 - Borderless Printing (PowerPoint) →P.345
 - Multi-Page Printing (PowerPoint) →P.348

2 Click the **One-Touch Registration** button.

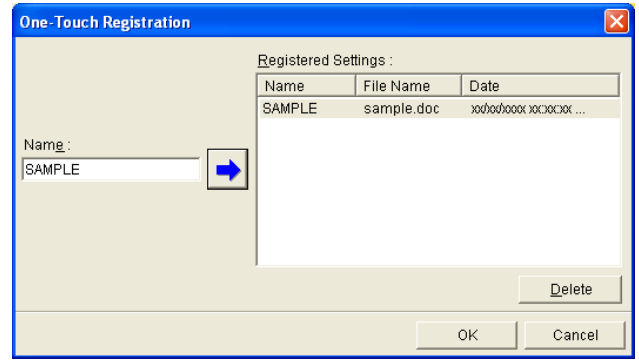

3 Enter name in **Name**.
Up to 31 characters can be entered.

4 Click . The name you entered is displayed in **Registered Settings**.

5 Click **OK**, and return to the **Print** screen.

6 Click **Print** to print, and click **Cancel** to cancel the print.

 • Clicking **Cancel** in the **Print** screen will not delete the registered settings.

Note

Print Using Registered Settings (PowerPoint)

Prints using the registered settings.

1 Start **Microsoft PowerPoint**.

2 If **Start imagePROGRAF Print Plug-In** is displayed, click it.

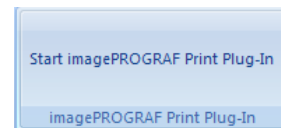

3 Click **Print** from the **imagePROGRAF Print Plug-In** toolbar/ribbon.
The **Printing Wizard** dialog box is displayed.

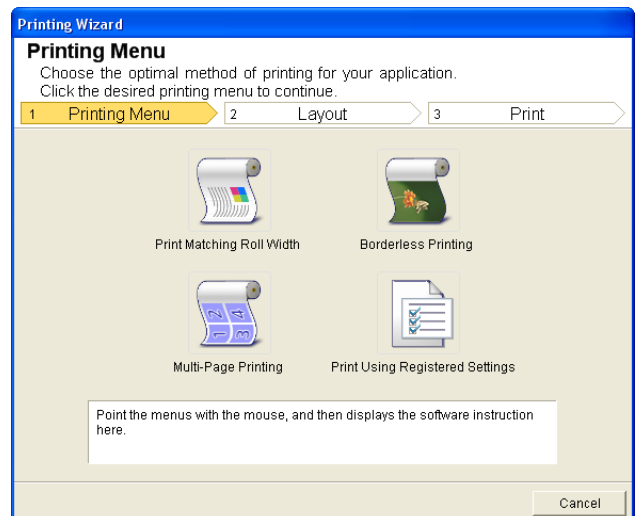



- If you want to change the display to another file or application while the **Printing Wizard** is open, close the **Printing Wizard** dialog box. Otherwise, you may not be able to change displays or operate the toolbar/ribbon.

4 Click **Print Using Registered Settings**.

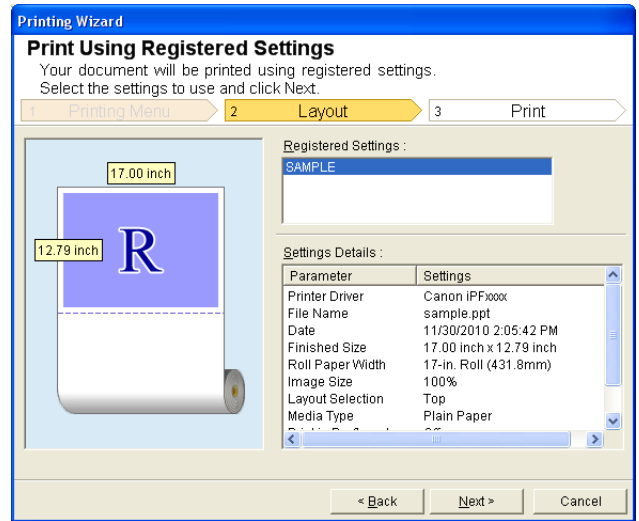

5 Click the **Next** button.

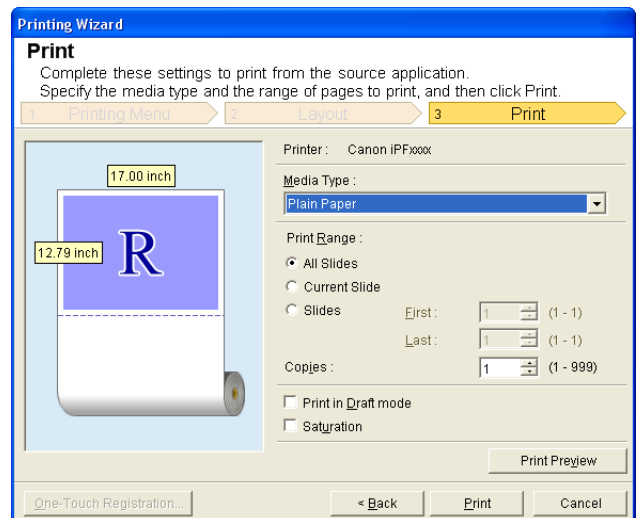

6 Select **Media Type**.

7 Select **Print Range** from **All Slides**, **Current Slide**, and **Slides**. If **Slides** is selected, enter the slide number.

8 Enter **Copies**.



- When **Print in Draft mode** is selected, printing is fast but the print quality is poor.
- When **Saturation** is selected, you can print posters, etc., vividly.
- Press the **Print Preview** button to display the preview screen. You can check and make changes to the layout in the preview screen.
- The maximum print length when printing with the registered settings is the lesser of 14.22 times the roll paper width, or 18.0m.

9 Press **Print** to start printing.

Portrait Orientation / Landscape Orientation (PowerPoint)

Print to the edge of the roll width. You can print large exhibits and posters, or print the Landscape or Portrait Orientation Page Sizes made in the **Large-Format Printing Wizard**.

Create Page Size in Portrait or Landscape Orientation.

Use the **Large-Format Printing Wizard** to create portrait page sizes for Potrait Orientation, and landscape page sizes for Landscape Orientation.

1 Start **Microsoft PowerPoint**.

2 If **Start imagePROGRAF Print Plug-In** is displayed, click it.

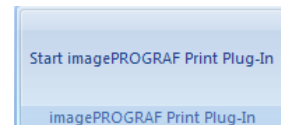

3 Click **Paper Settings** from the **imagePROGRAF Print Plug-In** toolbar/ribbon. The **Large-Format Printing Wizard** dialog box is displayed.

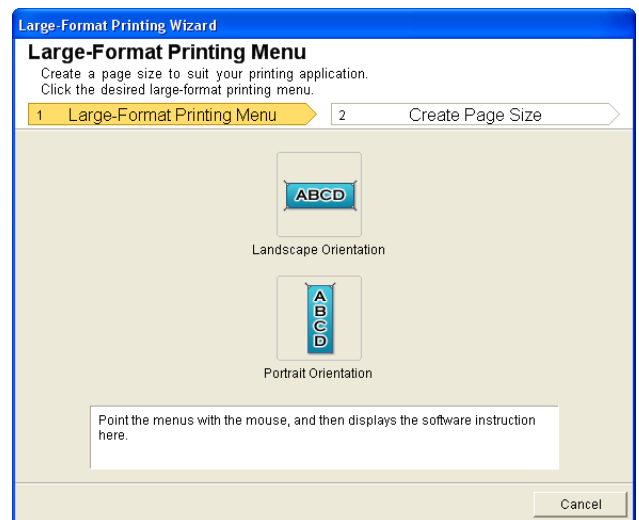

- If you want to change the display to another file or application while the **Large-Format Printing Wizard** is open, close the **Large-Format Printing Wizard** dialog box. Otherwise, you may not be able to change displays or operate the toolbar/ribbon.

4 Click **Portrait Orientation** or **Landscape Orientation**.



- The steps taken to create a Portrait Page Size will be used as an example to explain the procedure.

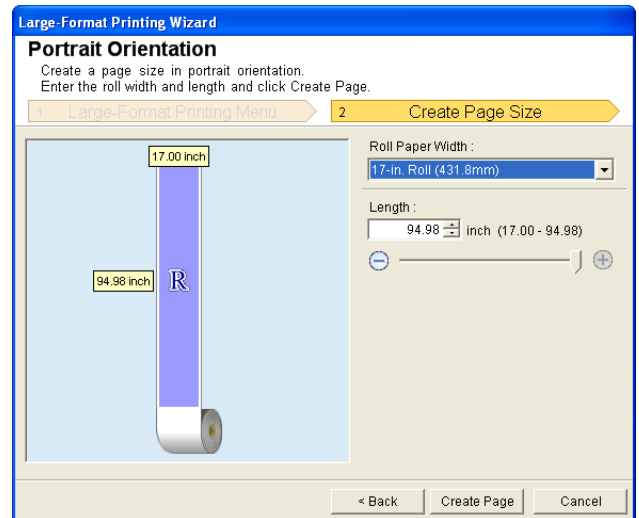

5 Adjust **Length** from the list-box or slide-bar.

6 Click the **Create Page** button.

7 Click **OK** if the message is displayed.

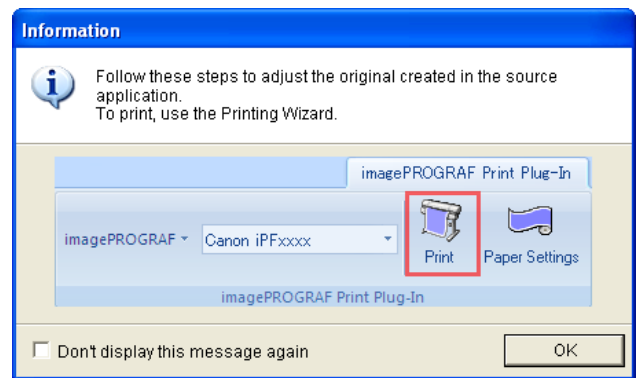

8 Edit and create the document.

Important • The layout may collapse if you create a form using existing data. If that is the case, modify the data again.

Note • Printing is done in **Print Matching Roll Width** of the **Printing Wizard**. For details on **Print Matching Roll Width**, see "Print Matching Roll Width (PowerPoint)." →P.343

To start from Microsoft Excel

Below are the steps to start **Print Plug-In for Office** from **Microsoft Excel**.

1 Start **Microsoft Excel**.

2 If **Start imagePROGRAF Print Plug-In** is displayed on the toolbar/ribbon, click it.

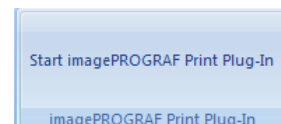

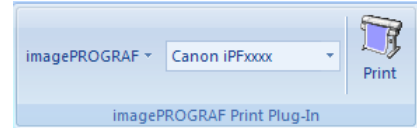

Important • If the **imagePROGRAF Print Plug-In** toolbar/ribbon is not displayed, refer to the following.
 • When Print Plug-In for Office is not displayed →P.326

3 Check that the **imagePROGRAF Print Plug-In** toolbar/ribbon is displayed.

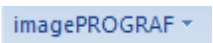
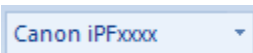

4 Click the buttons on the toolbar/ribbon according to the items you want to set.

Icon	Contents
 Menu	Displays the About , Help , and Special Settings dialog boxes. (See "Configuring Special Settings.") →P.361
 Printer list	Select Printer. If you select Show All Printers , the imagePROGRAF printers will be displayed again. Select this when you want to display all printer drivers or update the display.
 Print Button	The print Wizard is displayed. The settings Print Entire Sheet and Print Selected Area can be set.

Printing Wizard dialog box

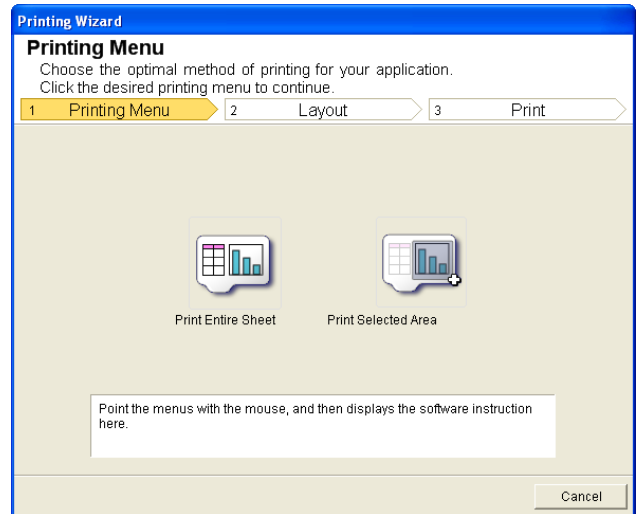

Important

- If you want to change the display to another file or application while the **Printing Wizard** is open, close the **Printing Wizard** dialog box. Otherwise, you may not be able to change displays or operate the toolbar/ribbon.
- The **Printing Wizard** will not start if you click the **Print** button on the toolbar/ribbon while editing a cell.
- When more than one worksheet is selected, the **Printing Wizard** cannot be run. Select only one worksheet and click **Print** again.
- When an object is selected, the **Printing Wizard** is not started if you click the **Print** button on the toolbar/ribbon.
- If the paper size in Excel is blank, the **Printing Wizard** cannot be run. From the **File** menu in Excel, select **Page Setup** and check **Paper size**.

Windows Software
Print Plug-In for Office



Note

- If you click the **Print** button with a graph selected, a message dialog box will appear asking if you want to continue printing. If you click **No**, you will return to the application.
- If you click the **Print** button with a page break set, a message dialog box will appear asking if you want to continue printing. If you click **No**, you will return to the application. If you do not use the set page break, check the page break preview and change the setting.
- If you click the **Print** button with a page range set, a message dialog box will appear asking if you want to continue printing. If you click **No**, you will return to the application. If you do not use the set page range, check the page break preview and change the setting.
- If you click the **Print** button with a worksheet or cell protected, a message dialog box will appear asking if you want to continue printing. If you click **No**, you will return to the application. If you want to change the setting, remove the protection from the worksheet or cell.

Print Entire Sheet (Excel)

For resizing the entire sheet to fit the roll width. Choose this option to enlarge the currently displayed sheet before printing.

1 Start **Microsoft Excel**.

2 If **Start imagePROGRAF Print Plug-In** is displayed, click it.

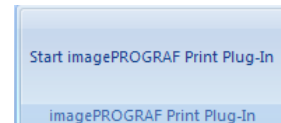

3 Click **Print** from the **imagePROGRAF Print Plug-In** toolbar/ribbon.



Important

- When more than one worksheet is selected, the **Printing Wizard** cannot be run. Select only one worksheet and click **Print** again.

If a print area is set, a confirmation message dialog box will appear.

To print the entire sheet, cancel the setting of the print area.

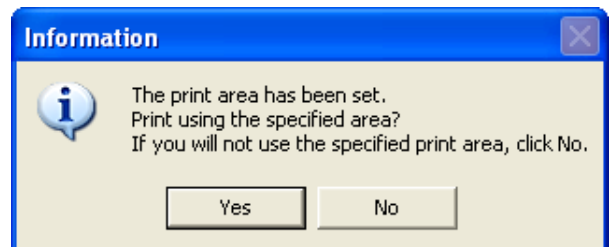

The **Printing Wizard** dialog box is displayed.

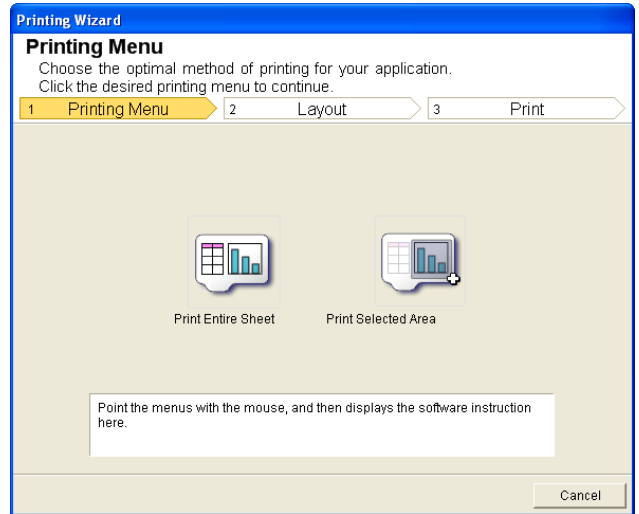

- 4 Click **Print Entire Sheet**.
A message will appear informing you that analysis is in progress.

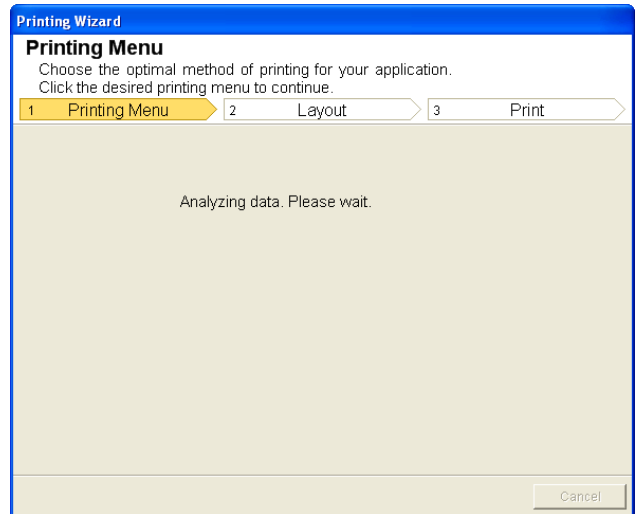

The **Layout** menu will appear automatically.

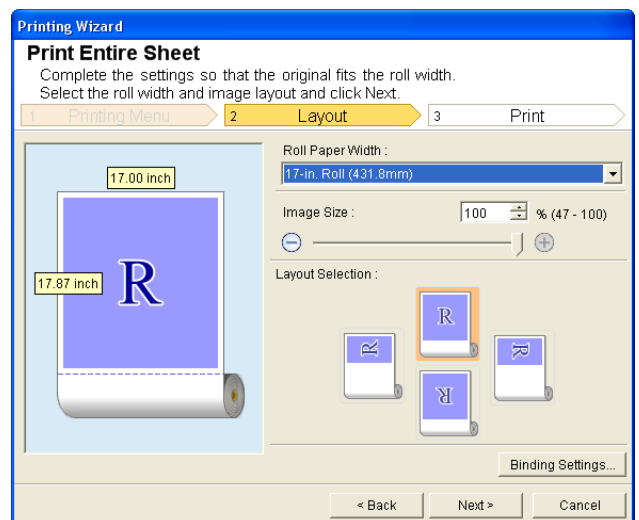

• If data analysis requires time, a message dialog will appear. If you select **No**, you will return to the application.

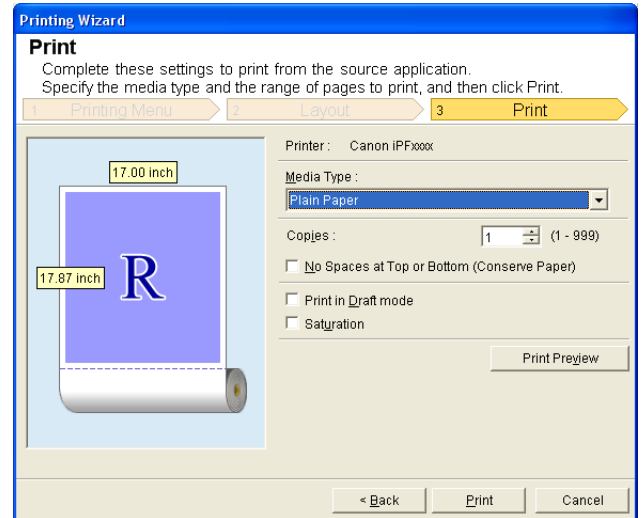

Note

- 5 Select **Roll Paper Width** that is set in the printer.
- 6 Select image size.
- 7 Select layout.
- 8 To configure **Binding**, click the **Binding Settings** button.
Refer to [Configuring Binding \(Excel\)](#) →P.360 for details on the procedure for configuring **Binding**.
- 9 Select **Next**.





- 10 Select **Media Type**.

- 11 Enter **Copies**.

-  When **Print in Draft mode** is selected, printing is fast but the print quality is poor.
- Note**  When **Saturation** is selected, you can print posters, etc., vividly.
- Press the **Print Preview** button to display the preview screen. You can check and make changes to the layout in the preview screen.
- When you print to the edge of the roll width, the maximum print length is 18.0m.

- 12 If the upper and lower margins are too wide, check **No Spaces at Top or Bottom (Conserve Paper)**.
The upper and lower margins can be checked in **Print Preview**.

- 13 Press **Print** to start printing.

-  If divided into plural pages, try reducing the data size or the range you select.
- Important**  You cannot run **Print** or **Print Preview** if you select it for a worksheet with no data displayed.

Print Selected Area (Excel)

For resizing the selected range of cells to fit the roll width. Choose this option to enlarge a particular part of the sheet before printing.

- 1 Start **Microsoft Excel**.

2 If **Start imagePROGRAF Print Plug-In** is displayed, click it.

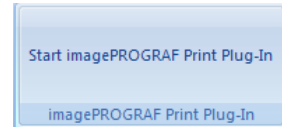

3 Click **Print** from the **imagePROGRAF Print Plug-In** toolbar/ribbon.



- When more than one worksheet is selected, the **Printing Wizard** cannot be run. Select only one worksheet and click **Print** again.

If a print area is set, a confirmation message dialog box will appear.
To print the selected area, cancel the setting of the print area.

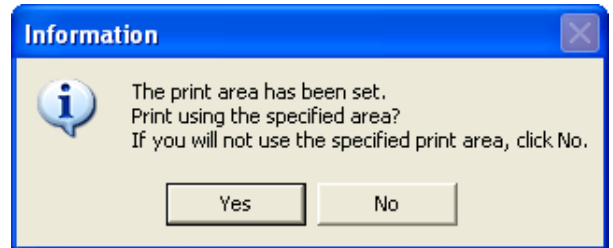

The **Printing Wizard** dialog box is displayed.

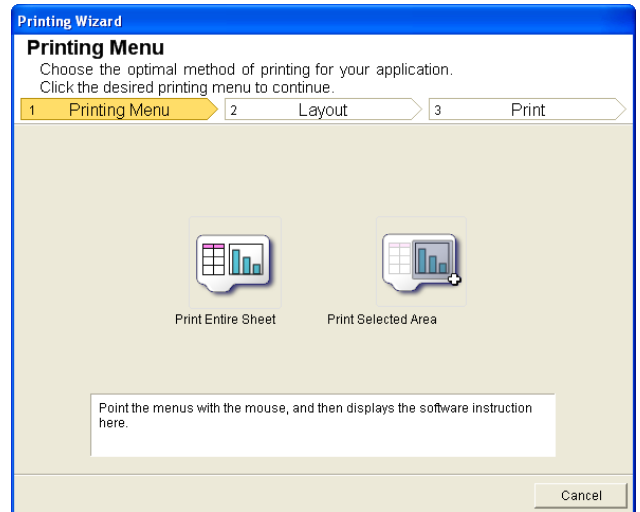

4 Click **Print Selected Area**.



- If only one cell is selected, **Print Selected Area** cannot be selected.

A message will appear informing you that analysis is in progress.

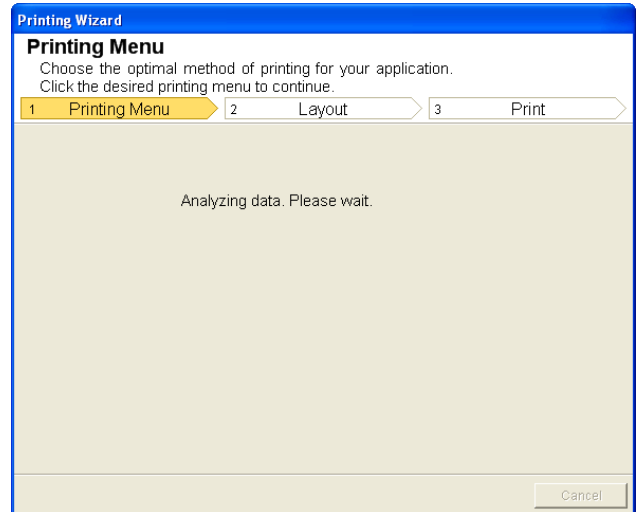

The Layout menu will appear automatically.

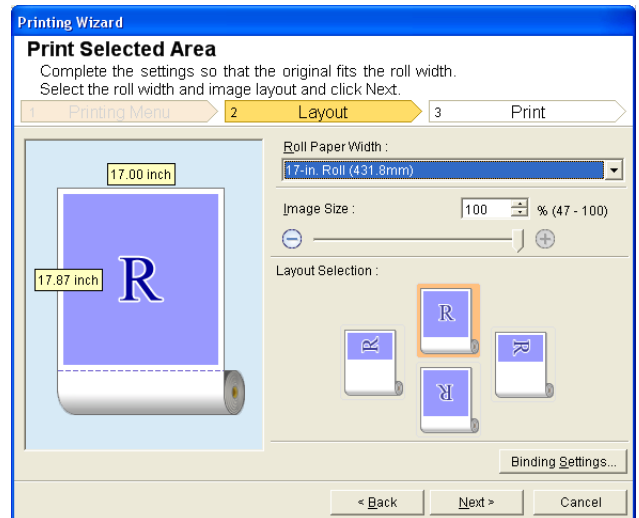

Important

- If the range selected in **Excel 2007/2010** is too large, it will not be possible to analyze the data. Select a smaller range and then run the analysis.



Note

- If data analysis requires time, a message dialog will appear. If you select **No**, you will return to the application.

5 Select **Roll Paper Width** that is set in the printer.

6 Select image size.

7 Select layout.

8 To configure **Binding**, click the **Binding Settings** button.
Refer to [Configuring Binding \(Excel\)](#) (→P.360) for details on the procedure for configuring **Binding**.

9 Select Next.

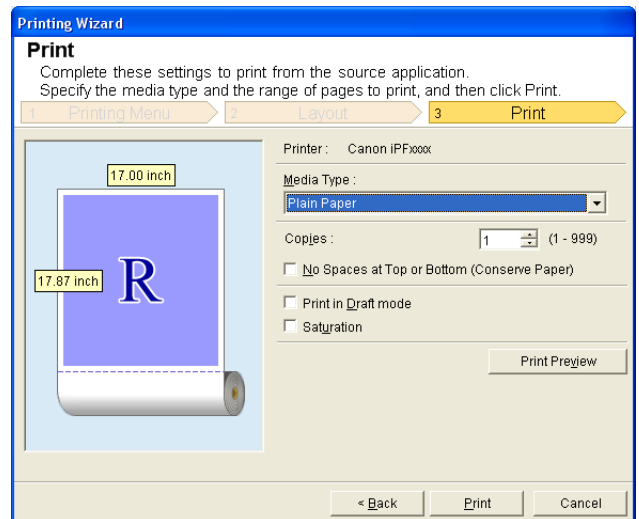

10 Select Media Type.

11 Enter Copies.



- When **Print in Draft mode** is selected, printing is fast but the print quality is poor.
- Note** • When **Saturation** is selected, you can print posters, etc., vividly.
- Press the **Print Preview** button to display the preview screen. You can check and make changes to the layout in the preview screen.
- When you print to the edge of the roll width, the maximum print length is 18.0m.

12 If the upper and lower margins are too wide, check **No Spaces at Top or Bottom (Conserve Paper)**. The upper and lower margins can be checked in **Print Preview**.

13 Press **Print** to start printing.



- If divided into plural pages, try reducing the data size or the range you select.
- Important** • You cannot run **Print** or **Print Preview** if you select it for a worksheet with no data displayed.

Configuring Binding (Excel)

You can configure **Binding** margins for binding printouts.

1 Configure the settings up to **Layout Selection** in the **Layout** screen in **Print Entire Sheet** or **Print Selected Area**.

Refer to Print Entire Sheet (Excel) →P.355 and Print Selected Area (Excel) →P.357 for the configuration methods.

2 Click the **Binding Settings** button.



- You cannot click the **Binding Settings** button in the following situations.
- Important** • When the **Image Size** is set to **100%**
- When a graph is selected
- When page breaks have been set
- When a sheet or cell is protected

Open the **Binding Settings** dialog box.

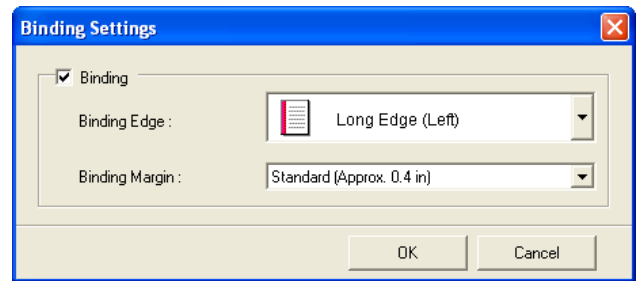

3 If the **Binding** checkbox is not checked, select it to turn binding on.

4 Select **Binding Edge**.

5 Select **Binding Margin**.

6 Click the **OK** button.
Return to the **Layout** screen.

Check that the **Binding** settings are applied in the preview screen.

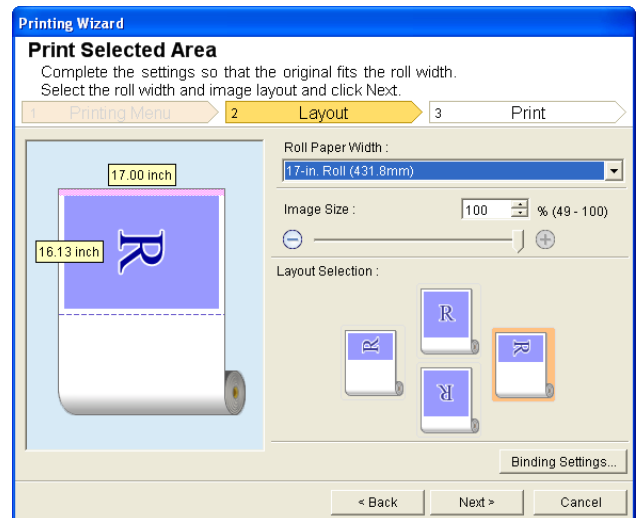

7 Configure the settings in the **Printing Wizard** dialog box.

Configuring Special Settings

You can configure **Special Settings** from the **imagePROGRAF Print Plug-In** toolbar.

1 Click **imagePROGRAF** in the toolbar, and select **Special Settings**.

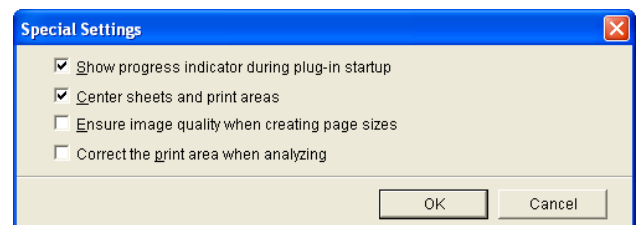

2 Turn the checkbox for the item you want to change on or off.

Item	Details
Show progress indicator during plug-in startup	When this setting is off, hides the progress indicator that appears while the plug-in is starting up.

Item	Details
Center sheets and print areas	When this setting is off, printing is performed without changing the position. When this setting is on, printing is performed with the top, bottom, left, and right margins layed out equally. When this setting is off, printing is performed without changing the position. This function is only valid in Microsoft Excel .
Ensure image quality when creating page sizes	When this setting is on, documents are created at the maximum size. This reduces the enlargement ratio during actual printing, which minimizes degradation of the quality of photos, etc. This function is only valid in [Microsoft PowerPoint .
Correct the print area when analyzing	For data that cannot be processed with usual data analysis, the print area is corrected and then the data is processed. When data analysis fails, you may be able to print by turning on this checkbox. This function is only valid in Microsoft Excel .

- 3 Click **OK** to close the **Special Settings** dialog box.

Basic Printing Workflow	19
Enhanced Printing Options	35
Windows Software	177

Mac OS X Software

Printer Driver	364
Preview	389
Free Layout	417
Color imageRUNNER Enlargement Copy	448
Print Plug-In for Photoshop / Digital Photo Professional	465
Layout Plug-In for Photoshop	523
→ Printmonitor	745
→ Media Configuration Tool	619

Handling and Use of Paper	529
Control Panel	655
Printer Parts	691
Network Setting	707
Print Job Management	741
Adjustments for Better Print Quality	803
Color Management	821
Maintenance and Consumables	833
Troubleshooting	883
Error Message	915
Specifications	941
Appendix	945

Printer Driver

- Printer Driver Settings 364
- Specifying Paper in the Printer Driver 366
- Confirming Print Settings 368
- Checking the Layout in a Preview Before Printing 368
- Using Favorites 369
- Accessing the Printer Driver Dialog Box from Applications 370
- Main Pane 370
 - Paper Information on Printer Dialog Box 374
 - Paper Detailed Settings Dialog Box 374
 - View settings Dialog Box for the Printing Application 377
 - Matching pane 377
 - Color Settings Pane: Color 380
 - Object Adjustment dialog box: Color 381
 - Color Settings Pane: Monochrome 382
 - Object Adjustment dialog box: Monochrome 383
 - Gray Adjustment Pane 383
- Page Setup Pane 385
- Utility Pane 386
- Additional Settings Pane 387
- Support Pane 387

Mac OS X Software

Printer Driver

Printer Driver Settings

For instructions on accessing the Mac OS X printer driver, refer to the following topics.

- Accessing the Printer Driver Dialog Box from Applications →P.370

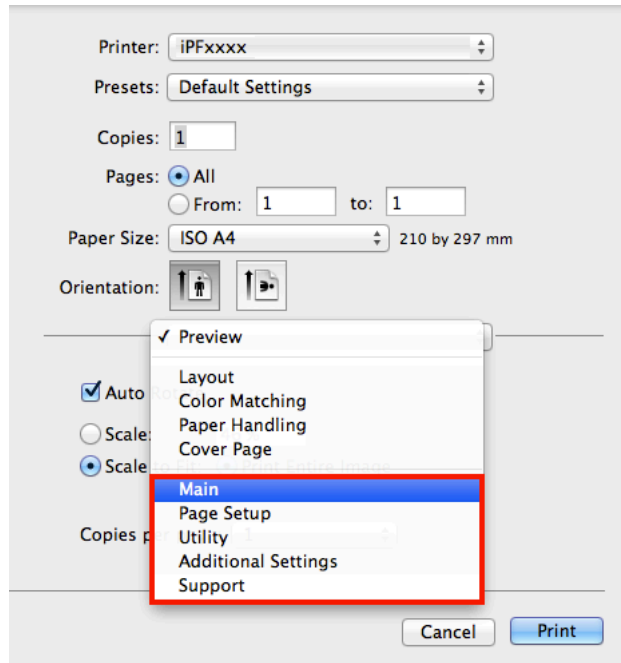

For information on the Mac OS X printer driver settings, refer to the following topics.

- Main Pane →P.370

You can specify the media type, color processing, print quality, print preview, and other settings. Choose **Easy Settings** to specify basic print settings based on the printing application or **Advanced Settings** to complete more detailed settings as desired.

- Paper Detailed Settings Dialog Box →P.374
- View settings Dialog Box for the Printing Application →P.377
- Color Settings Pane: Color →P.380
- Object Adjustment dialog box: Color →P.381
- Matching pane →P.377
- Color Settings Pane: Monochrome →P.382
- Object Adjustment dialog box: Monochrome →P.383
- Gray Adjustment Pane →P.383
- Page Setup Pane →P.385
You can specify the page size of the original, borderless printing, enlargement or reduction, the orientation, the paper size and source, and automatic cutting.
- Utility Pane →P.386
You can specify settings related to maintenance for the Printhead and feed amount, as well as settings for **Color imageRUNNER Enlargement Copy**.
- Additional Settings Pane →P.387
You can specify settings for how print jobs are sent to the printer.
- Support Pane →P.387
You can view support information and the user's manual.

With the **imagePROGRAF Free Layout** feature, you can arrange originals from various source applications on a single page before printing. For details, see Free Layout →P.417 .

With the **imagePROGRAF Preview** feature, you can check the layout before printing and adjust layout or size settings while viewing a preview screen. For details, see Preview →P.389 .

With the **Color imageRUNNER Enlargement Copy** feature, you can automatically enlarge and print scanned originals from a **Color imageRUNNER**. For details, see Color imageRUNNER Enlargement Copy →P.448 .

Specifying Paper in the Printer Driver

If you have replaced the paper, you must complete the following settings in the printer driver.

1 This sets the **B Format for** and **C Paper Size**.



Note

- The configuration method varies depending on the OS and application software you are using. If **Page Setup** is displayed in the application menu, the settings are configured by opening the **Page Attributes** dialog box from **Page Setup**.

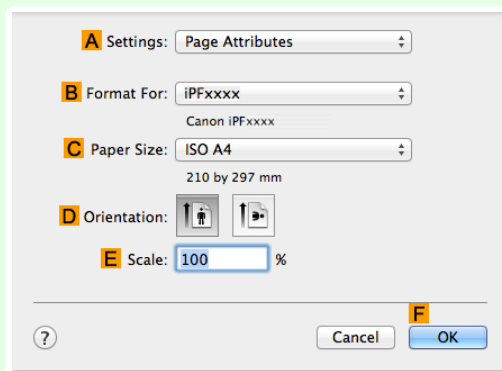

If it is not displayed, the settings are configured in the upper part of the printer driver displayed when you select **Print** from the application software menu.

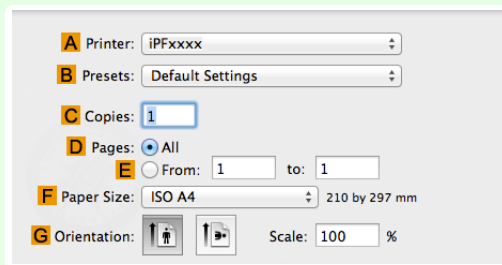

2 Select the printer in the **A Printer** list.

3 Choose the original size in the **F Paper Size** list.

4 If you configured the settings using the **Page Attributes** dialog box, click **F OK** to close the dialog box, and then select **Print** from the application software menu.

5 Access the **Main** pane.

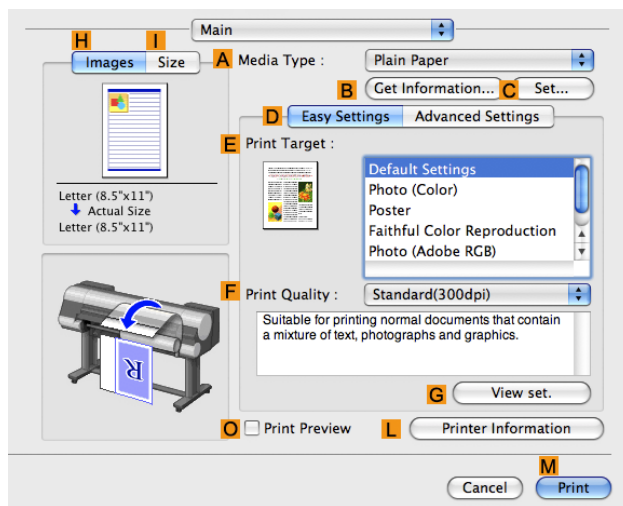

6 In the **A Media Type** list, select the type of paper that is loaded.

7 Access the **Page Setup** pane.

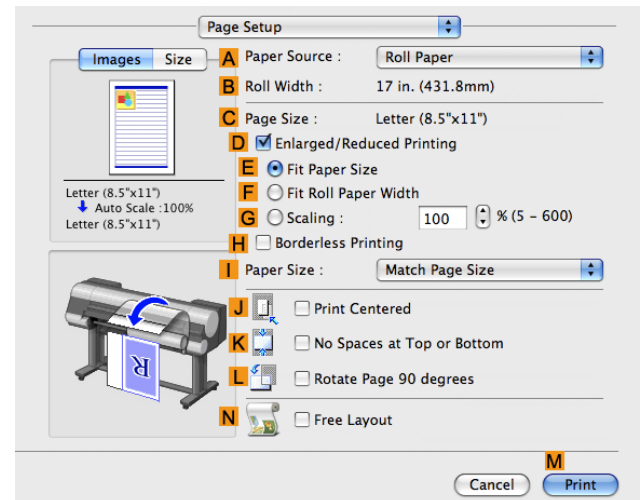

8 In the **A Paper Source** list, select how paper is supplied.

9 If you have selected **Cut Sheet** in **A Paper Source**, make sure the size as selected in **Page Setup** is displayed in **C Page Size**. If you have selected roll paper in **A Paper Source**, make sure the width of the loaded roll is displayed in **B Roll Width**.



Note

- If the width of the roll loaded in the printer is not shown in **B Roll Width**, click **L Printer Information** on the **Main** pane to update the printer information.

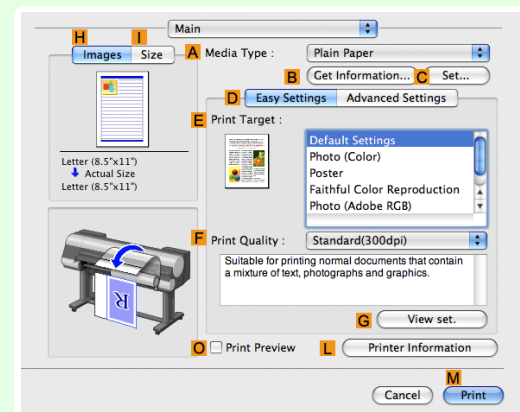

Note

- A variety of settings are available in the printer driver to suit different printing applications. For details on available printing conditions, see "Printer Driver Settings →P.364 "

Confirming Print Settings

There are two ways to confirm what printing conditions have been specified, as follows.

Checking a preview of the settings

A preview of the settings is displayed on the left side of the **Main**, **Page Setup**, **Utility**, and **Additional Settings** panes. By checking images and numerical values in the preview, you can confirm current settings for the page size, orientation, paper source, and so on.

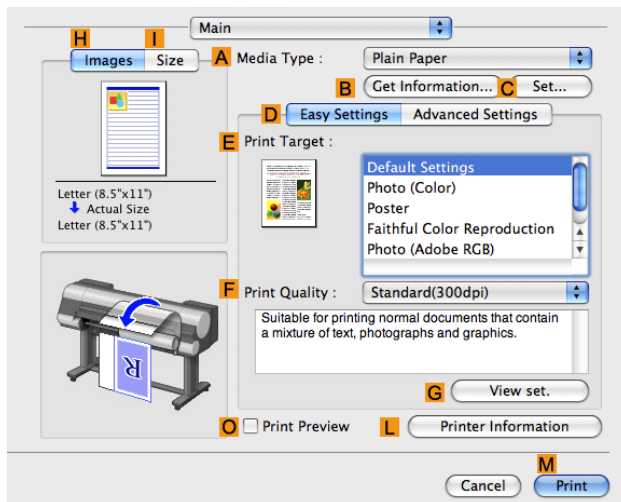

Display Area	Information Displayed
Pane displayed when the H Images tab is clicked	On top, illustrations indicate the page size of the original, the paper size, orientation, layout, borderless printing selection, color mode, and other settings information. Under this, the page size, paper size, and method and percentage of enlargement or reduction is displayed.
Pane displayed when the I Size tab is clicked	Paper size details are indicated numerically.
Pane with printer and paper illustrations	Illustrations indicate the paper source, orientation, borderless printing selection, and other settings information.



- To confirm the **Print Target** specified in **Easy Settings**, click **G View set.** on the **Main** pane to display the **View settings** dialog box.

Checking a print preview

You can check an image of the original just as it will be printed.

Confirming the image of print jobs beforehand helps prevent printing errors.

For details on print previews, see "Checking the Layout in a Preview Before Printing" →P.164 "

Checking the Layout in a Preview Before Printing

This topic describes how to check the layout before printing using the **Canon imagePROGRAF Preview** function.

- 1 Choose **Print** in the application menu.

2 Access the **Main** pane.

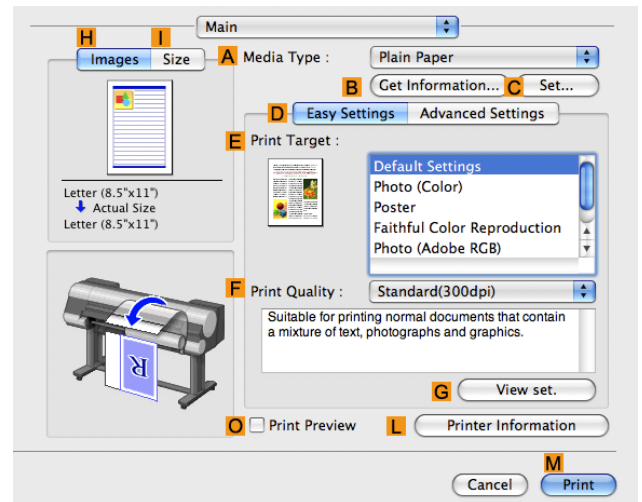

3 Select the **Print Preview** check box.

4 Click **Print**.

5 The **Canon imagePROGRAF Preview** window is displayed.

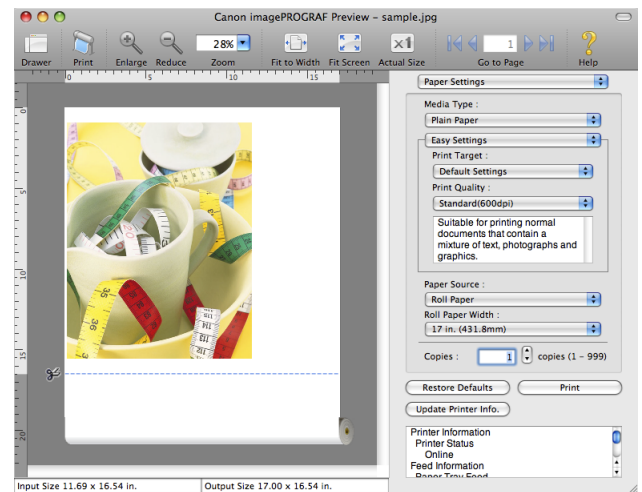

6 Check the layout and adjust settings in the **Canon imagePROGRAF Preview** window as desired.

7 Print from the **Canon imagePROGRAF Preview** menu.



Note

- For details on **imagePROGRAF Preview** functions, refer to **Preview** → P.389 .

Using Favorites

You can use the **Presets** function in Mac OS X for favorite-based printing.



Note

- In the printing dialog box, click **Save As** in the **Presets** list to save the current print settings. This is a standard feature of the operating system. For details, refer to the Mac OS documentation.

Accessing the Printer Driver Dialog Box from Applications

1 In the application software, select **Print** from the **File** menu to display the dialog box for printing conditions.



Note • This dialog box includes basic printing options and enables you to choose the printer, specify the range of pages, number of copies, and so on.

2 Select the printer in the **Printer** list.

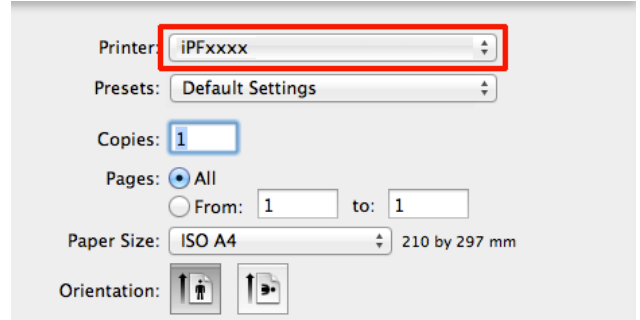

3 Click **Print** to start printing.
As shown in the following illustration, you can switch to other panes in this dialog box to complete settings for various methods of printing, including enlarged and reduced printing, borderless printing, and so on.

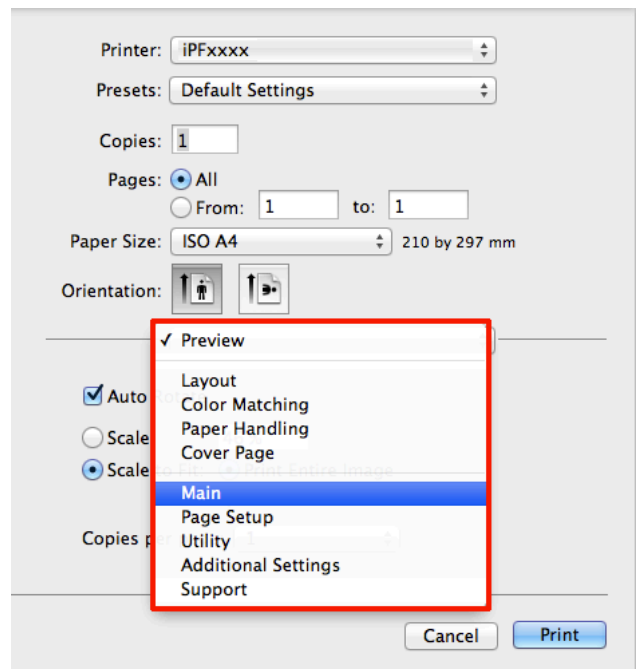

Main Pane

The following settings are available on the **Main** pane. For details on settings items, refer to the printer driver help.



Note • On the **Main** pane, choose **Easy Settings** to specify basic print settings based on the print target, or switch to **Advanced Settings** to complete more detailed settings as desired.

Common Items

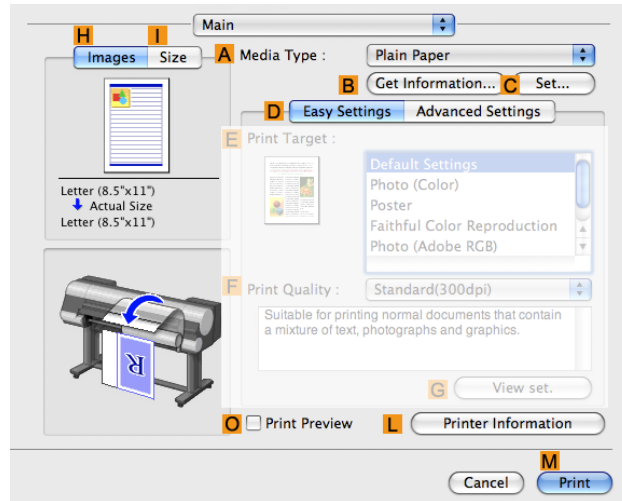

- **A Media Type**

Select the paper type.

For information on the types of paper the printer supports, refer to the Paper Reference Guide. (See " Paper Reference Guide".)

- **B Get Information**

Displays **Paper Information on Printer**. You can update the printer driver settings for the feed source, media type, and roll width by selecting the feed source.

- Paper Information on Printer Dialog Box →P.374

- **C Set**

Displays **Paper Detailed Settings**. You can configure the printing settings to match the type of media, such as the ink drying time.

- Paper Detailed Settings Dialog Box →P.374

- **O Print Preview**

If you turn this on, **imagePROGRAF Preview** starts before printing.

This allows you to check on-screen previews of documents before printing.



Important

- When **Free Layout** is selected on the **Page Setup** panel, **Free Layout** is disabled.

- Checking the Layout in a Preview Before Printing →P.164

- **L Printer Information**

Displays the **Printer Information** dialog box, which shows printer information such as ink levels and the calibration history.



Note

- Each of the **B Get Information**, **C Set**, and **L Printer Information** buttons may not be usable depending on the application type and OS version.

Configuration using **Easy Settings**

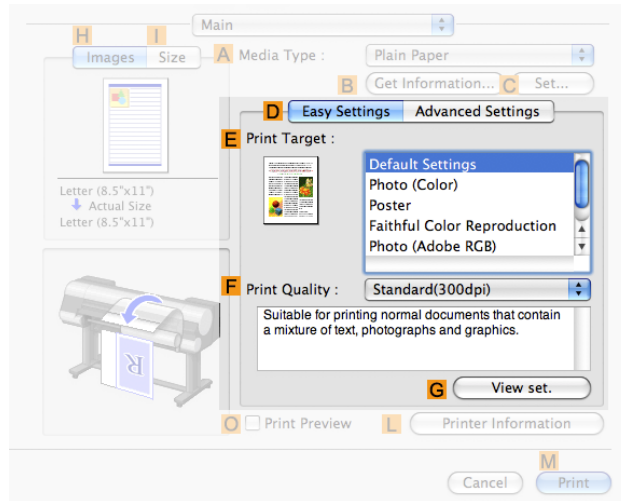

- **E Print Target**

Choose presets that match the type of document to be printed.

- Printing Photos and Images →P.37
- Printing Office Documents →P.48
- Printing Line Drawings and Text →P.54

- **F Print Quality**

Choose the level of print quality.

- **G View set.**

Click to display the **View settings** dialog box, which enables you to confirm the settings for the selected item from the **E Print Target** list or change the order of items listed in **E Print Target**.

- View settings Dialog Box for the Printing Application →P.377

Configuration using **Advanced Settings**

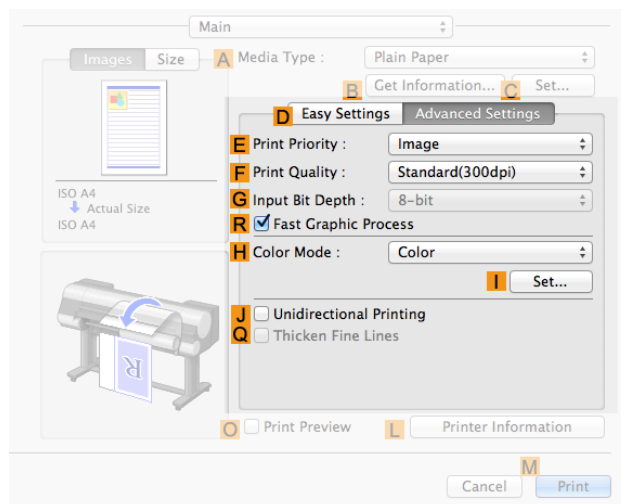

- **E Print Priority**

Choose the graphic elements that you want to emphasize for printing.

- Giving Priority to Particular Graphic Elements and Colors for Printing →P.67

- **F Print Quality**

Choose the level of print quality.

- Giving Priority to Particular Graphic Elements and Colors for Printing →P.67

- **N Highest quality**

If you select this option, the document will be printed with enhanced quality at the highest resolution. Compared to the other options, more time and ink are consumed in printing, however you will attain print results with the highest quality.



Note

- If you set **F Print Quality** to **High**, you can select **N Highest quality**. However, depending on **A Media Type**, you may not be able to select **N Highest quality**.

- **K Economy Printing**

When this mode is selected, you can print with less ink consumed. However, print quality is lower than in regular printing. Select this option to save ink, such as when printing to check drawings. Depending on the **A Media Type** and **F Print Quality** settings, this mode may not be available.



Note

- If you set **F Print Quality** to **Fast**, you can select **K Economy Printing**. However, depending on **A Media Type**, you may not be able to select **K Economy Printing**.

- **G Input Bit Depth**

Choose the levels of gradation in print data, either **8-bit** or **16-bit**. Optimal results when printing data with rich gradation are possible by choosing **16-bit**. For example, this option is particularly suited to printing images created after specifying 16 bits per channel in Photoshop.

- **R Fast Graphic Process**

Select this option to print faster than usual, when possible.

- **H Color Mode**

Choose the color mode.

- Giving Priority to Particular Graphic Elements and Colors for Printing →P.67

- **I Set**

Click to display the **Color Settings** dialog box for more advanced color settings.

- Adjusting the Color in the Printer Driver →P.60

- **J Unidirectional Printing**

Select this checkbox to prevent problems such as misaligned lines and improve the print quality. However, the printing speed becomes slower.

- **Q Thicken Fine Lines**

Activate this option to print fine lines more distinctly.

Paper Information on Printer Dialog Box

On the **Paper Information on Printer** dialog box, you can obtain information on the paper in the printer and configure printer driver media type setting.

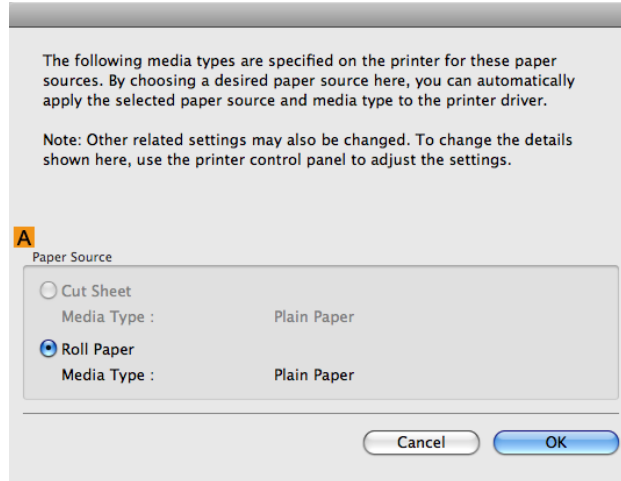

Note

- To display the **Paper Information on Printer** dialog box, on the **Main** pane, click **Get Information by Media Type**. (See "Main Pane →P.370")

• **A** Paper Source

Shows the **Paper Source** supported by the printer, as well as the type of paper loaded. To update the media type setting in the printer driver, select the desired **Paper Source** option and click **OK**.

Paper Detailed Settings Dialog Box

In the **Paper Detailed Settings** dialog box, you can set **Drying Time** for the paper selected with **Media Type** of the **Main** panel, etc.

You can display this dialog box by clicking **Set of Media Type** on the **Main** panel. (Refer to "Main Pane →P.370".)

You also can select from the control panel of the printer the items for which you can select **Printer Default** in this dialog box. (Refer to "Menu Settings →P.675".)

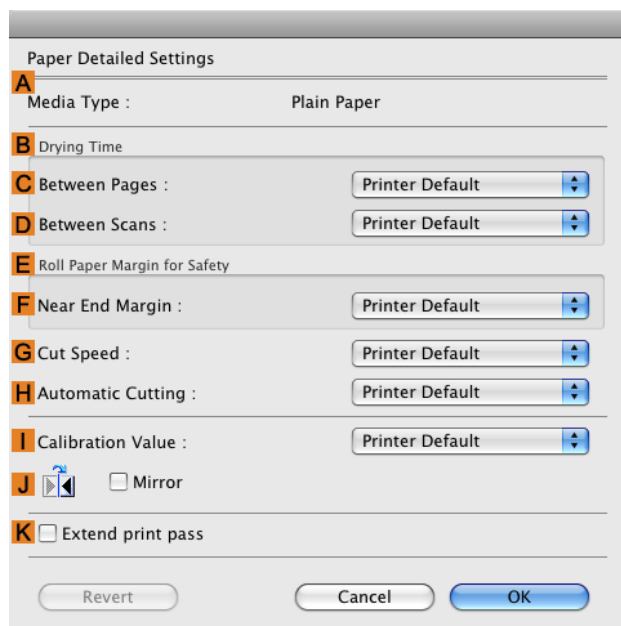

A Media Type

The paper selected with **Media Type** of the **Main** panel is displayed.

For information on the types of paper the printer supports, refer to the Paper Reference Guide. (See " Paper Reference Guide".)

B Drying Time

Specify the time that the printer waits for ink to dry, as needed. The **Drying Time** setting is only valid for rolls.

• C Between Pages

You can set the time to wait after printing 1 document page until ejecting the paper. Since waiting time is required for ink to dry before a roll is cut, you can deliver paper in the Output Stacker with the ink dried even if **Cutting Mode** is set to **Automatic**.

Setting Item	Details
Printer Default	The setting of the control panel of the printer is applied.
None	Paper is ejected immediately after printing completes.
30 sec. / 1 min. / 3 min. / 5 min. / 10 min. / 30 min. / 60 min.	Paper is ejected when the set time elapses after printing completes.

• D Between Scans

You can set the time to wait after printing 1 line on a page until printing the next line. Set this to avoid bleeding or color unevenness such as when bleeding occurs on a page or when color unevenness occurs during borderless printing.

Setting Item	Details
Printer Default	The setting of the control panel of the printer is applied.
None	The next line is printed immediately after a line is printed.
1 sec. / 3 sec. / 5 sec. / 7 sec. / 9 sec.	The next line is printed when the set time elapses after a line is printed. * Increase the time according to the occurrence condition of bleeding or unevenness.

E Roll Paper Margin for Safety

You can specify the length of a margin on the leading edge of paper to ensure that paper susceptible to curling is held firmly against the Platen.

• F Near End Margin

Specify the length of the **Near End Margin** (the leading edge margin) of the roll, as needed.

Setting Item	Details
Printer Default	The setting of the control panel of the printer is applied.
5 mm (0.2 in)	The document is printed in the standard size. * Select this when you do not have any problems in printing.
20 mm (0.8 in)	Select this when rubbing against the printhead occurs such as when using paper that tends to curl.

G Cut Speed

Select the speed of automatic cutting, as needed. You can adjust this setting if paper is not cut well when automatic cutting is used.

Setting Item	Details
Printer Default	The setting of the control panel of the printer is applied.
High Speed	When the Standard setting does not result in a clean cut surface, select this.
Standard	Select this when you do not have any problems in automatic cutting.

Setting Item	Details
Low Speed	This helps prevent adhesive from sticking to the cutter and keeps the cutter sharp if you select it when using adhesive paper.

H Automatic Cutting

Set whether to perform roll cutting automatically or print a cut line.

The following settings are available for automatic cutting.

Setting Item	Details
Printer Default	The setting of the control panel of the printer is applied.
None	After printing completes, the roll is not cut per page, and the next page of data is printed successively.
Print Cut Guideline	After printing completes, a line is printed per page, and the next page of data is printed successively.

I Calibration Value

You can specify whether to apply the results of calibration performed on the printer to image processing.

Setting Item	Details
Printer Default	The setting of the control panel of the printer is applied.
Enabled	Print using the calibration results.
Disabled	Print without using the calibration results. Select this to avoid the changing of the color of images during printing by color calibration.

J Mirror

Specify whether to print a mirror image, as needed. Select this option to print a version of the document or image with the left and right sides inverted.

K Extend print pass

Uneven printing that occurs when printing with the **Highest quality** check box selected in **Print Quality** may be improved by selecting this check box. However, this also reduces the printing speed.

View settings Dialog Box for the Printing Application

In the **View settings** dialog box, you can check details of the selected printing application.

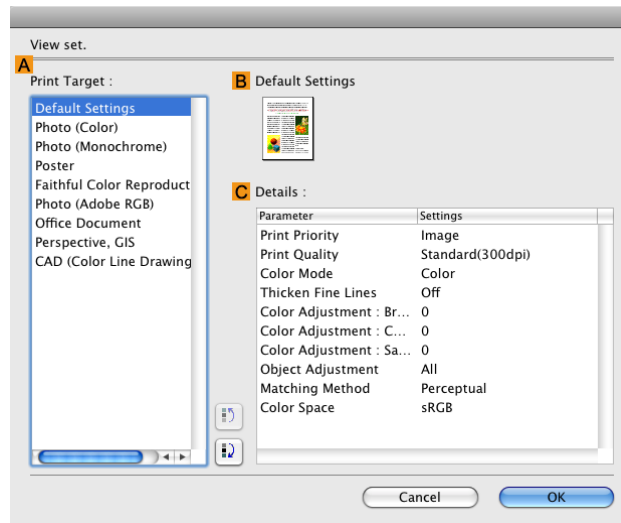

Note

- To display the **View settings** dialog box, on the **Main** pane, click **View settings by Print Target**. (See "Main Pane →P.370 ")

• **A Print Target**

Shows all **Print Target** options (settings items for the printing application).

• **B Name**

Identifies the item selected in **Print Target** by its name and an icon.

• **C Details**

Here, you can confirm detailed settings values for each item selected in the **Print Target** list.

Matching pane

On the **Matching** pane, you can specify color matching to compensate for differences in the appearance of colors on various devices.



Important

- The **Matching** pane is not displayed when **No color correction** or **Monochrome** is selected in **Color Mode**.



Note

- To display the **Matching** pane, on the **Main** pane click **Color Settings by Color Mode** in **Advanced Settings**, and then click the **Matching** tab. (See "Main Pane.") →P.370

Driver Matching Mode

The following options are available when you select **Driver Matching Mode** in the **A Matching Mode** list.

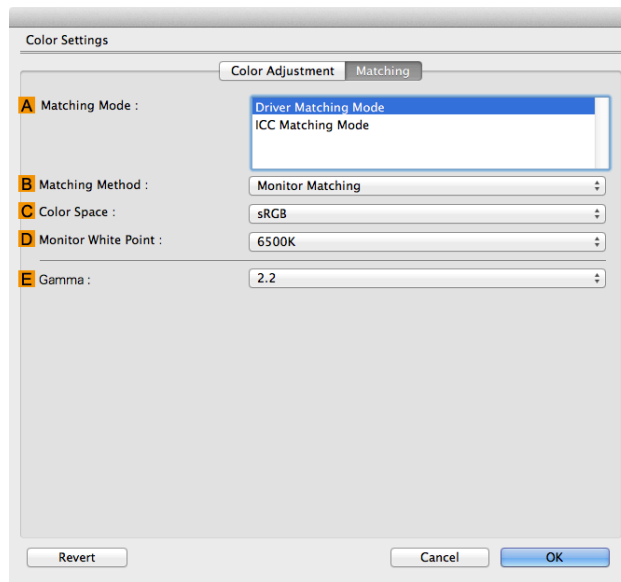

- **A Matching Mode**

Select the color matching mode to use, as desired.

Normally, select **Driver Matching Mode**. For color matching based on ICC profiles, select **ICC Matching Mode** depending on your color matching system.

- **B Matching Method**

Select the color matching method that suits the document to be printed. Various **B Matching Method** options are available depending on your selection in **A Matching Mode**.

- **C Color Space**

Select the applicable color space as desired.

- **D Monitor White Point**

Enter the color temperature set on the monitor.

Displayed when the **B Matching Method** is set to **Monitor Matching**.

- **E Gamma**

You can adjust the gradation of intermediate tones in an image.

2.2 is normally selected. If you want a softer impression than **2.2**, select **1.8**.

ICC Matching Mode

The following options are available when you select **ICC Matching Mode**, in the **A Matching Mode** list.

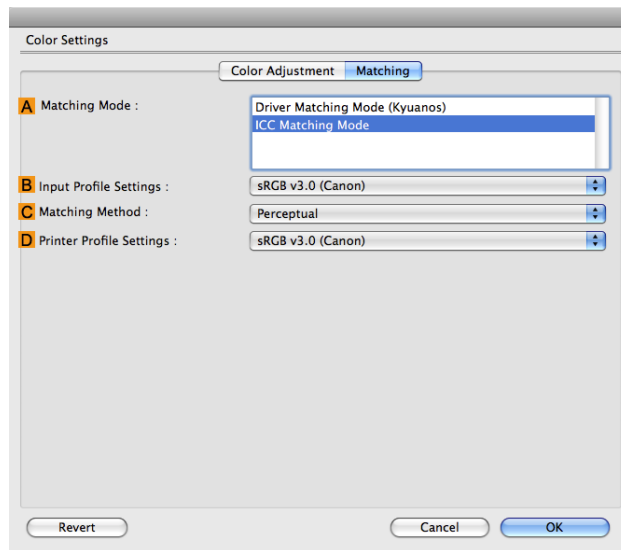

Note

- To display the **Matching** pane, on the **Main** pane, click **Color Settings** by **Color Mode** in **Advanced Settings**, and then click the **Matching** tab. (See "Main Pane" →P.370 ")

- **A Matching Mode**

Select the color matching mode to use, as desired.

- **B Input Profile Settings**

You can choose **Input Profile**.

Various options are available depending on your selected **A Matching Mode**.

- **C Matching Method**

You can choose **C Matching Method**.

Various options are available depending on your selected **A Matching Mode**.

- **D Printer Profile Settings**

Specify the printer profile as desired.

We recommend that you select an ICC profile created using commercially available profile creation software in order to perform color management accurately on paper other than genuine Canon paper and feed confirmed paper. The created ICC profile needs to be saved in the following folder on the computer you are using.

/user/(user name)/library/ColorSync/Profiles folder



Note

- For details on settings items, see "Adjusting the Color in the Printer Driver." →P.60

Color Settings Pane: Color

In general, make any needed adjustments to the color of documents in the application used to create them. However, if the color tone as printed is not as you expected, you can also adjust the color in the printer driver.

If the color tone as printed is not as you expected, you can adjust it on the **Color Adjustment** pane.

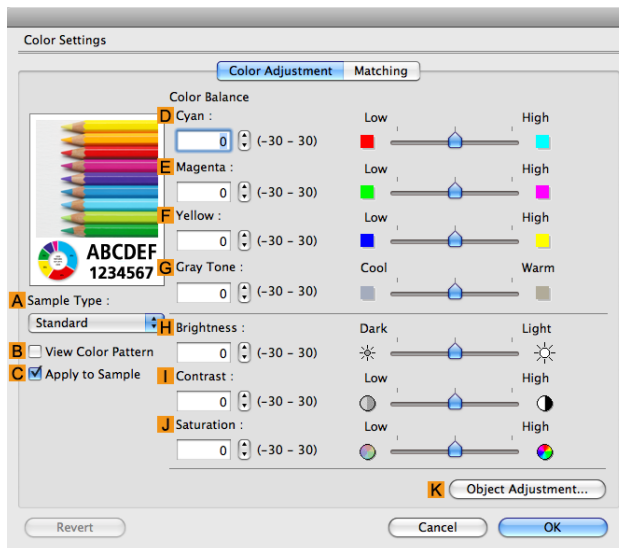

Note

- To display the **Color Adjustment** pane, on the **Main** pane click **Color Settings by Color Mode** in **Advanced Settings**. (See "Main Pane →P.370 ")
- For details on settings items, see "Adjusting the Color in the Printer Driver →P.60 "

• **A Sample Type**

Choose a sample image from **Standard**, **Portrait**, **Landscape**, or **Graphics**.

• **B View Color Pattern**

Select this checkbox to display the color pattern.

• **C Apply to Sample**

Select this checkbox to apply the changed settings to the sample image.

• **D Cyan / E Magenta / F Yellow**

Correct color tones by adjusting the levels of each color.

• **G Gray Tone**

Adjust the color tone of grays as desired. Choose **Cool** (tinged with blue) or **Warm** (tinged with red).

• **H Brightness**

Adjust the overall image brightness as desired. You can adjust the brightness if the printed document is lighter or darker than the original image (that is, the original photo that was scanned or the original graphic as it appears on the computer screen).

• **I Contrast**

Adjust the contrast of the darkest and lightest portions relative to each other, as desired. Increasing the **Contrast** makes images sharper, and reducing the **Contrast** softens images.

• **J Saturation**

Adjust the color intensity as desired. Increasing the **Saturation** setting makes colors more vivid, and reducing the **Saturation** makes colors more subdued.

- **K Object Adjustment**

Select this option to display the **Object Adjustment** dialog box, in which you can specify objects subject to color adjustment.

- Object Adjustment dialog box: Color →P.381

Object Adjustment dialog box: Color

In the **Object Adjustment** dialog box, you can specify what type of print jobs to apply color adjustment to. If an original comprises images, graphics, and text, you can specify which portion to apply color adjustment to.

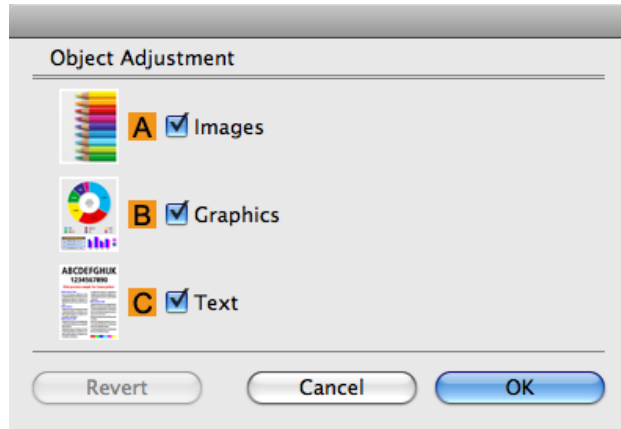

Note

- To display the **Object Adjustment** dialog box, click **Object Adjustment** on the **Color Adjustment** panel.

- **A Images**

Select this option to apply color adjustment to image areas, such as photos.

- **B Graphics**

Select this option to apply color adjustment to graphics, such as lines and circles.

- **C Text**

Select this option to apply color adjustment to text.

Color Settings Pane: Monochrome

On the **Color Adjustment** pane for monochrome printing, you can adjust the brightness and contrast.

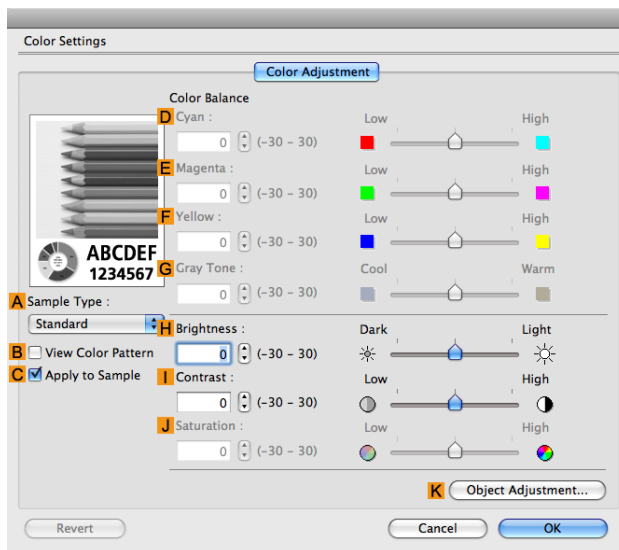

Note

- To display the **Color Adjustment** pane, on the **Main** pane, click **Color Settings** in **Advanced Settings**. (See "Main Pane →P.370 ")
- For details on settings items, see "Adjusting the Color in the Printer Driver →P.60 "

- **A Sample Type**

Choose a sample image from **Standard**, **Portrait**, **Landscape**, or **Graphics**.

- **B View Color Pattern**

Select this checkbox to display the color pattern.

- **C Apply to Sample**

Select this checkbox to apply the changed settings to the sample image.

- **D Cyan / E Magenta / F Yellow**

Not available.

- **G Gray Tone**

Not available.

- **H Brightness**

Adjust the overall image brightness as desired. You can adjust the brightness if the printed document is lighter or darker than the original image (that is, the original photo that was scanned or the original graphic as it appears on the computer screen).

- **I Contrast**

Adjust the contrast of the darkest and lightest portions relative to each other, as desired. Increasing the **I Contrast** makes images sharper, and reducing the **I Contrast** softens images.

- **J Saturation**

Not available.

- **K Object Adjustment**

Select this option to display the **Object Adjustment** dialog box, in which you can specify objects subject to color adjustment.

- Object Adjustment dialog box: Monochrome →P.383

Object Adjustment dialog box: Monochrome

In the **Object Adjustment** dialog box, you can specify what type of print jobs to apply color adjustment to. If an original comprises images, graphics, and text, you can specify which portion to apply color adjustment to.

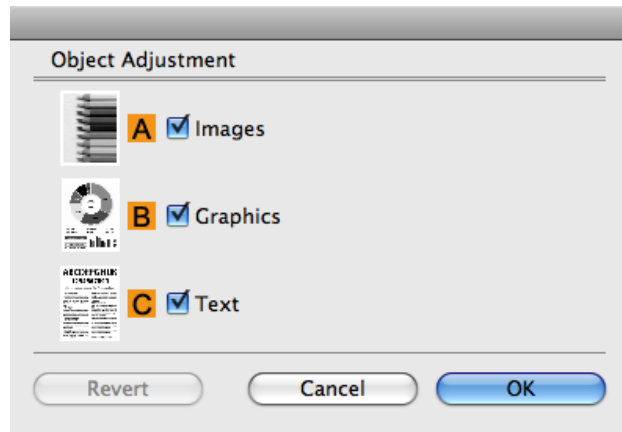

Note

- To display the **Object Adjustment** dialog box, click **Object Adjustment** on the **Color Adjustment** panel.

• A Images

Select this option to apply color adjustment to image areas, such as photos.

• B Graphics

Select this option to apply color adjustment to graphics, such as lines and circles.

• C Text

Select this option to apply color adjustment to text.

Gray Adjustment Pane

On the **Gray Adjustment** pane, you can adjust the color balance, brightness, contrast, and other image qualities.

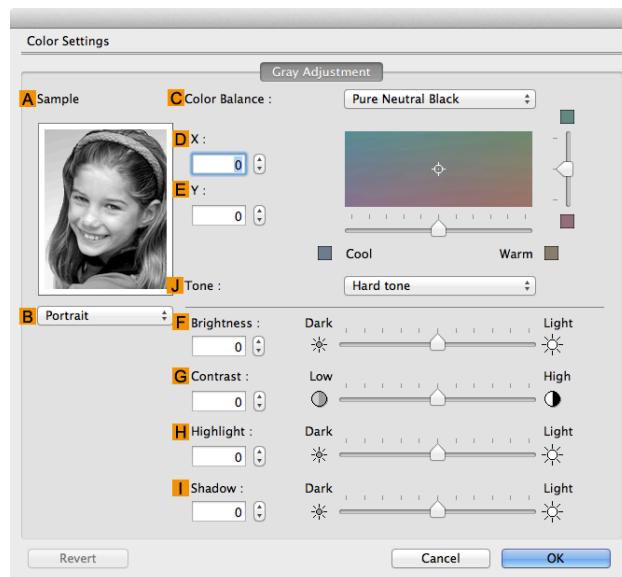



Note

- To display the **Gray Adjustment** pane, on the Main Pane [→P.370](#) , select **Monochrome (Photo)** by **Color Mode** in **Advanced Settings**, and then click **Color Settings**.
- **Monochrome (Photo)** is not available for all types of paper.

• **A Sample**

The image at left is updated to reflect any changes you make to setting items on the sheet, enabling you to check the results of adjustment.

• **B Sample List**

Select a sample image, as desired.

• **C Color Balance**

Click the list to select a color balance that suits the printing application.

• **DX / EY**

Adjust the color balance as you check the color tone in the adjustment area.

You can adjust the square area in the center by clicking or dragging it.

Drag the vertical or horizontal scroll bars for adjustment, as desired.

You can click the arrows by the **DX** (horizontal) and **EY** (vertical) boxes or enter the values directly.

• **J Tone**

You can adjust the brightness of intermediate tones in an image. Selecting **Hard tone** gives a hard impression with more definition. Selecting **Soft tone** gives a soft impression.

• **F Brightness**

Adjust the overall image brightness as desired. You can adjust the brightness if the printed document is lighter or darker than the original image (that is, the original photo that was scanned or the original graphic as it appears on the computer screen).

• **G Contrast**

Adjust the contrast of the darkest and lightest portions relative to each other, as desired. Increasing the **Contrast** makes images sharper, and reducing the **Contrast** softens images.

• **H Highlight**

Adjust the brightness of the lightest portion.

• **I Shadow**

Adjust the brightness of the darkest portion.

Page Setup Pane

The following settings are available on the **Page Setup** pane. For details on settings items, refer to the printer driver help.

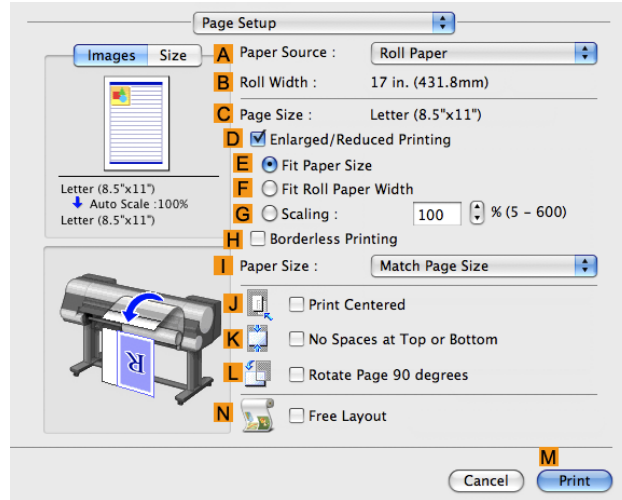

• **A Paper Source**

Choose how paper is supplied.

Options displayed in the list vary depending on the selection in **A Media Type** in the **Main** pane.

• **B Roll Width**

Displays the paper width of the roll loaded in the printer. **Unknown** is displayed if the printer cannot detect the roll paper width.

• **C Page Size**

Displays the size of the original, as specified in the page settings of the application.

For details on page sizes available in the application, see "Paper Sizes" [→P.530](#) "

• **D Enlarged/Reduced Printing**

Select this checkbox to choose the following options.

- Resizing Originals to Match the Paper Size [→P.74](#)
- Resizing Originals to Fit the Roll Width [→P.78](#)
- Resizing Originals by Entering a Scaling Value [→P.84](#)

• **E Fit Paper Size**

Resizes the document image to match the paper size.

• **F Fit Roll Paper Width**

Resizes the document image to match the roll width.

• **G Scaling**

Resizes the document image based on a specified scaling value. Enter a value in a range of **5–600**.

• **H Borderless Printing**

Borderless printing is available if roll paper is selected in the **A Paper Source** list.

Activate this setting for borderless printing to match the size and width of the paper.

- Borderless Printing on Paper of Equivalent Size [→P.101](#)
- Borderless Printing by Resizing Originals to Fit the Roll Width [→P.107](#)
- Borderless Printing at Actual Size [→P.95](#)

• **I Paper Size**

Choose the size of the paper you will print on.

Click **Display all selections for Paper Size** to list available sizes.

For details on available paper sizes, see "Paper Sizes →P.530 "

• **J Print Centered**

Select this checkbox to print document images in the center of the paper.

- Printing Originals Centered on Rolls →P.144
- Printing Originals Centered on Sheets →P.149

• **K No Spaces at Top or Bottom**

Select this checkbox to print the next image skipping blank areas above and below printable data in documents, which enables you to conserve the paper.

- Conserving Roll Paper by Printing Originals Without Top and Bottom Margins →P.158

• **L Rotate Page 90 degrees**

Select this checkbox to rotate the document image by 90 degrees before printing.

- Conserving Roll Paper by Rotating Originals 90 Degrees →P.154

• **N Free Layout**

Select this checkbox to start **imagePROGRAF Free Layout** before printing.

This allows you to print multiple documents next to each other.



Important

- When **Print Preview** is selected on the **Main** panel, **Print Preview** is disabled.

- Printing Multiple Originals Next to Each Other →P.127

Utility Pane

The following settings are available on the **Utility** pane.

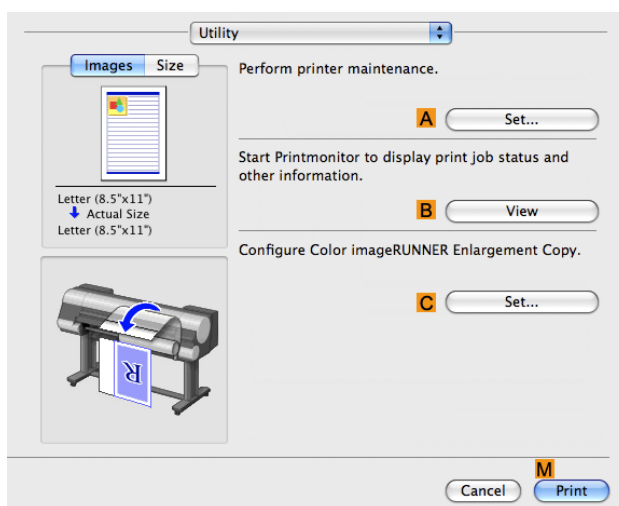

• **A Set**

Click to display the **Printer Information** dialog box, which offers the following maintenance for the printer.

- Nozzle (ink ejecting outlet) cleaning
- Head alignment adjustment
- Feed amount adjustment

- **B View**

Click to start **imagePROGRAF Printmonitor**, which enables you to view the status of print jobs.

- **C Set**

Click to complete the settings for Color imageRUNNER Enlargement Copy (iR enlargement copy).

For details, see Color imageRUNNER Enlargement Copy →P.448 .

Additional Settings Pane

The following settings are available on the **Additional Settings** pane.

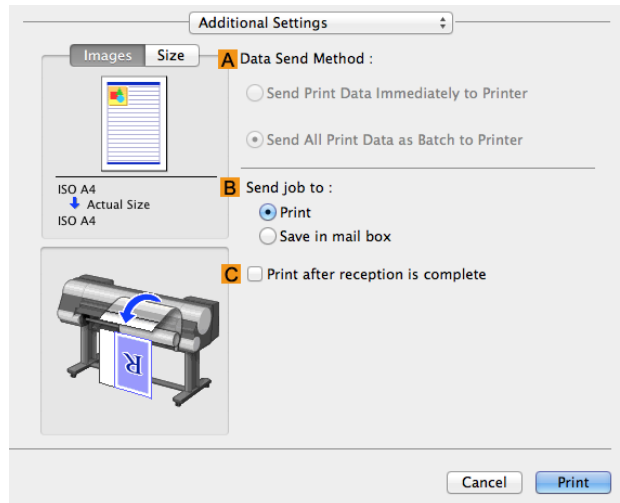

- **A Data Send Method**

Display the method of sending print jobs to the printer.

- **B Send job to**

You can configure the method for saving print jobs to the printer hard disk.

- **C Print after reception is complete**

You can prevent degradation of print quality that occurs when receiving a print job is interrupted and printing is aborted in the middle.

Support Pane

On the **Support** pane, you can view support information and the user's manual.

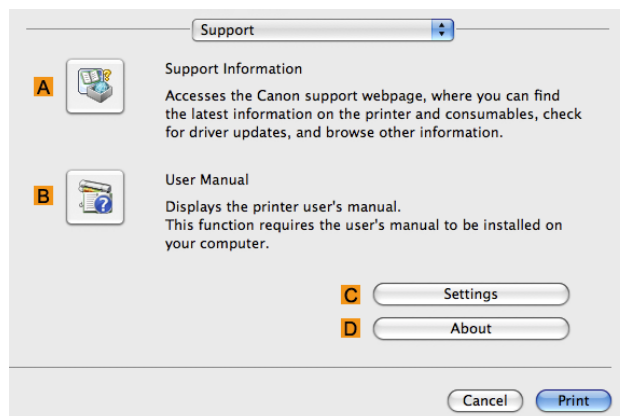

- **A Support Information**

Click to access the Canon support webpage, where you can find the latest information on the printer and consumables, check for printer driver updates, and browse other information.

- **B User Manual**

Click to view the printer user's manual. This function requires the user's manual to be installed on your computer.

- **C Settings**

The settings can be saved as a file. Click to display the **Export** dialog box, which enables you to specify where to save the file.

- **D About**

You can display version information for the printer driver.

Preview

The Features of Preview	389
Starting Preview	389
Preview Main Window	391
Paper Settings Panel	394
Easy Settings	396
Advanced Settings	398
Output Settings Panel	399
Color Settings Panel	401
Color Adjustment	402
Gray Adjustment	405
Matching	406
Driver Matching Mode	409
ICC Matching Mode	410
ColorSync	411
Preferences Dialog Box	411
Zoom Dialog Box	412
Go to Page Dialog Box	412
Print with No Borders	412
Print on the Center	413
Not Print Spaces at the Top/Bottom	413
Print Page Rotated 90 Degrees	414
Display with Fitting to the Width of the Paper	415
Display with All	415
Display with Actual Size	415
Moving a Page	416

The Features of Preview

The main features of Preview are as follows.

- While viewing this screen, you can adjust layout settings of a document created with application software.
- You can not only adjust layout settings but also your changes will be instantly applied on the preview screen, and you can print the preview screen as it is seen.



Note

- The media type, image size, detailed media settings, and the printer settings can cause the actual print output to differ from the Preview settings.

Starting Preview

Follow the procedure below to start the Preview.

- 1 Start the application software which you use.
- 2 From the application software's **File** menu, select the printer setup menu to open the **Print** dialog box.



Note

- Normally, select **Print** from the **File** menu.

- 3 Click **Print Preview** in the **Main** panel to attach a checkmark.

4 Click the **Print** button in the **Print** dialog box.

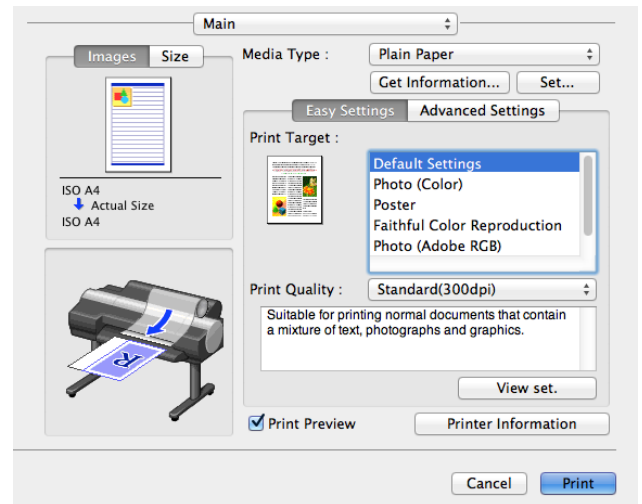

Note

- Your printer is depicted in the lower-left area of this screen.

5 Preview main window is displayed.

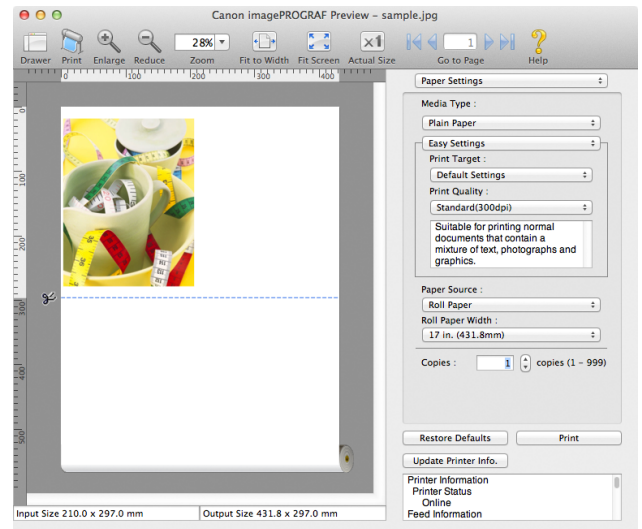

Preview Main Window

The Preview main window consists of the menu and tool bars, and preview, dialog, drawer and status area.

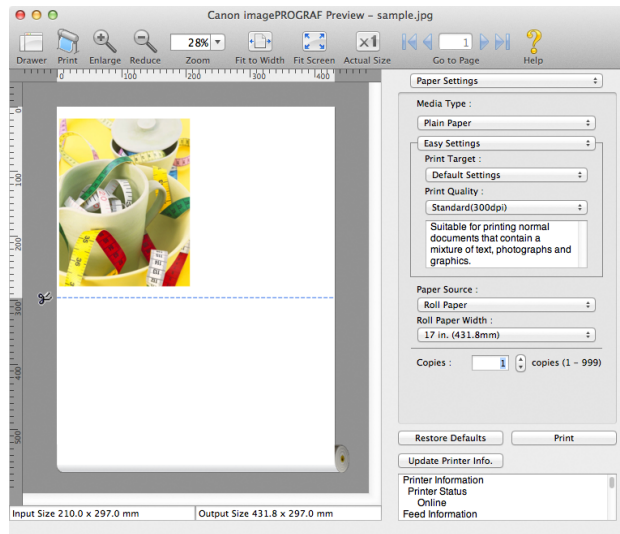

Note

- You can use the **View** menu to show or hide the tool bar.

• Menu Bar

This allows you to select menus required for operations.



• Tool Bar

This allows you to select tool buttons required for major operations.



- **Preview Area**

You can check the settings you made in this area.

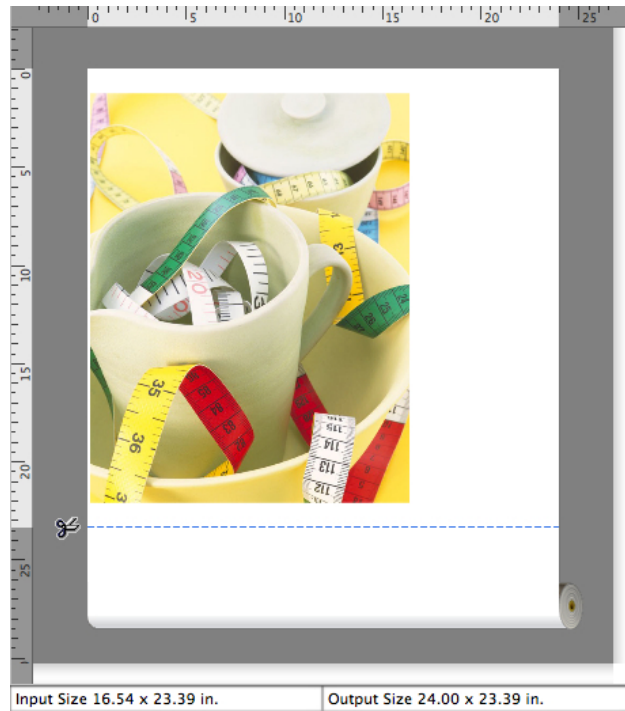

- **Dialog Area**

This allows you to set the print conditions and perform a print job.

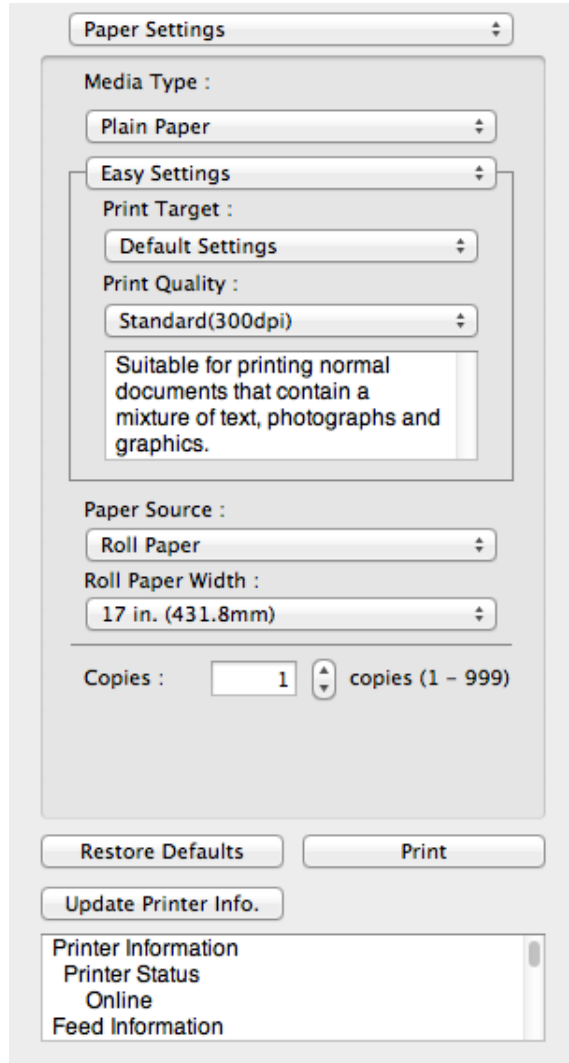

- **Drawer Area**

This allows you to display the thumbnails of a document.

This area appears when you click  **Drawer** from the tool bar.

Alternatively, you may select **Drawer** from the **View** menu.

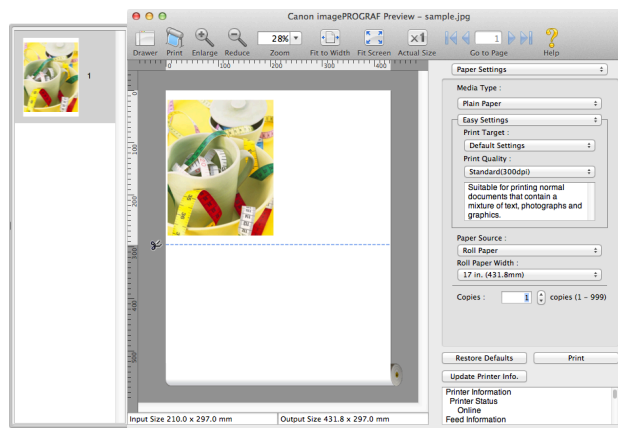

- **Status Area**

This shows **Input Size** and **Output Size**.

Input Size 16.54 x 23.39 in. Output Size 24.00 x 23.39 in.

Paper Settings Panel

This panel appears when you select **Paper Settings** in the dialog area.

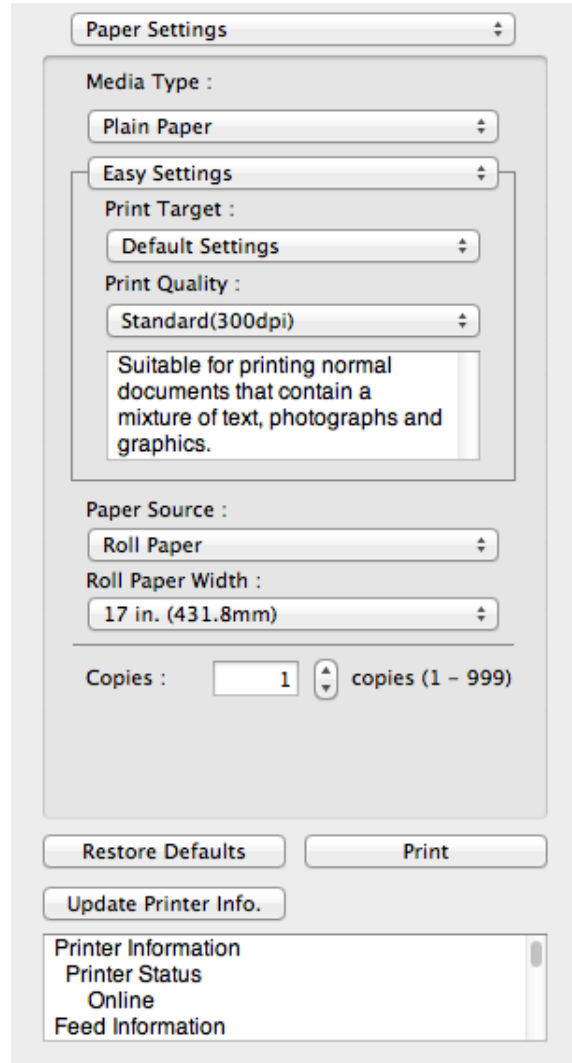

- **Media Type**

This allows you to select the media type.



Note

- Always select media type that is actually set in the printer. When the media you chose is different from the media set in the printer, you may not receive the desired print results.

- **Easy Settings / Advanced Settings**

Two modes are available to provide the optimum print settings for jobs.

The settings available on each mode are as follows.

- Easy Settings →P.396
- Advanced Settings →P.398

- **Paper Source**

You can select the paper source.

The following settings are available for paper source.

Setting	Details
Cut Sheet	Select to print on the cut sheet.
Roll Paper	Select to print on roll paper.

- **Roll Paper Width**

This selects the width of the roll media set to the printer.



Note

- Available only if rolls are selected in **Paper Source**.

- **Copies**

You can input the number of print copies in numerical characters.



Note

- The maximum value is 999.
- You can change the numbers by clicking either ▲ button or ▼ button.

- **Restore Defaults** Button

Click the button to reset to the setting when starting Preview.

- **Print** Button

Click the button to begin printing.

- **Update Printer Info.** Button

Click the button to acquire printer information.

Easy Settings

You can easily select the best settings for the print job by just selecting an item from the print target list that matches the content of the document.

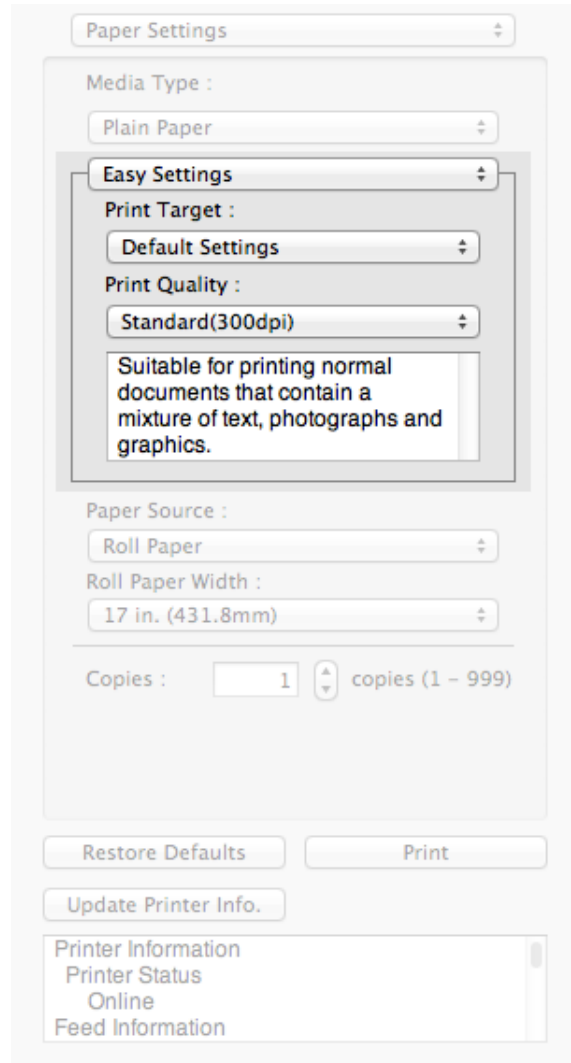

• Print Target

You can easily select the best settings for the print job simply.

If you select each **Print Target** item the corresponding comment for that item is displayed below the list.

Setting	Details
Default Settings	Suitable for printing normal documents that contain a mixture of text, photographs, and graphics.
Photo (Color)	Suitable for printing photographic images captured with a digital camera.
Photo (Monochrome)	Suitable for optimized printing of monochrome photos.
Poster	The best setting for posters. Prints using vivid and high impact colors.
Faithful Color Reproduction	Prints by faithfully reproducing the colors of the original image.
Photo (Adobe RGB)	Achieves the best color when printing an image created with the Adobe RGB color space feature.
CAD (Color Line Drawing)	Prints the fine lines of CAD drawings and other such documents sharp and clear.
Perspective, GIS	Suitable for attractive printing of 3D-CAD drawings, perspective drawings, and GIS drawings including maps.
Office Document	Suitable for printing handouts as well as general office documents for which print clarity is key.

Setting	Details
Custom Settings	Suitable for printing documents for which Advanced Settings have been specified.



Note

- The number of settings available for selection depends on the media type.

• Print Quality

Selecting print quality strikes a balance between the quality of the printed image and printing speed.

The level of the print quality and resolution settings are displayed in the following combinations.

Setting	Details
Print Quality	Highest quality / High / Standard / Fast
Resolution	600dpi / 300dpi



Note

- The availability of settings is determined by the media type and print priority selections.
- Printing time is longer and more ink is consumed with **High** than with **Fast**, however, print quality is higher.
- Printing time is shorter and less ink is consumed with **Fast** than with **High**, however, print quality is lower.
- For **Highest quality**, the resolution is not displayed.

Advanced Settings

Presents detailed settings for the print quality, the color mode, and other items so you can select the values for these settings yourself.

• Print Priority

Select a print quality mode that is appropriate for the print job.

Setting	Details
Image	This mode achieves the best results for printing photographic images and illustrations.
Line Drawing	This mode is best for printing CAD drawings with fine lines or wall newsheet or other documents that contain large amounts of text. However, you may not achieve the quality you expect with printing photographs or other images with many filled areas. For these types of jobs, select Image .
Proof	This is a setting for enhancing the reproducibility of characters, illustrations, and photos with print proofing. However, this takes more time than regular printing.
Office Document	Prints common office documents, such as proposals, memos for distribution, etc., so they are easy to read.



Note

- The number of settings available for selection depends on the media type.

• Print Quality

Selecting print quality strikes a balance between the quality of the printed image and printing speed.

The level of the print quality and resolution settings are displayed in the following combinations.

Setting	Details
Print Quality	Highest quality / High / Standard / Fast
Resolution	600dpi / 300dpi



- The availability of settings is determined by the media type and print priority selections.
- Note** • Printing time is longer and more ink is consumed with **High** than with **Fast**, however, print quality is higher.
- Printing time is shorter and less ink is consumed with **Fast** than with **High**, however, print quality is lower.
- For **Highest quality**, the resolution is not displayed.

Output Settings Panel

This panel appears when you select **Output Settings** in the dialog area.

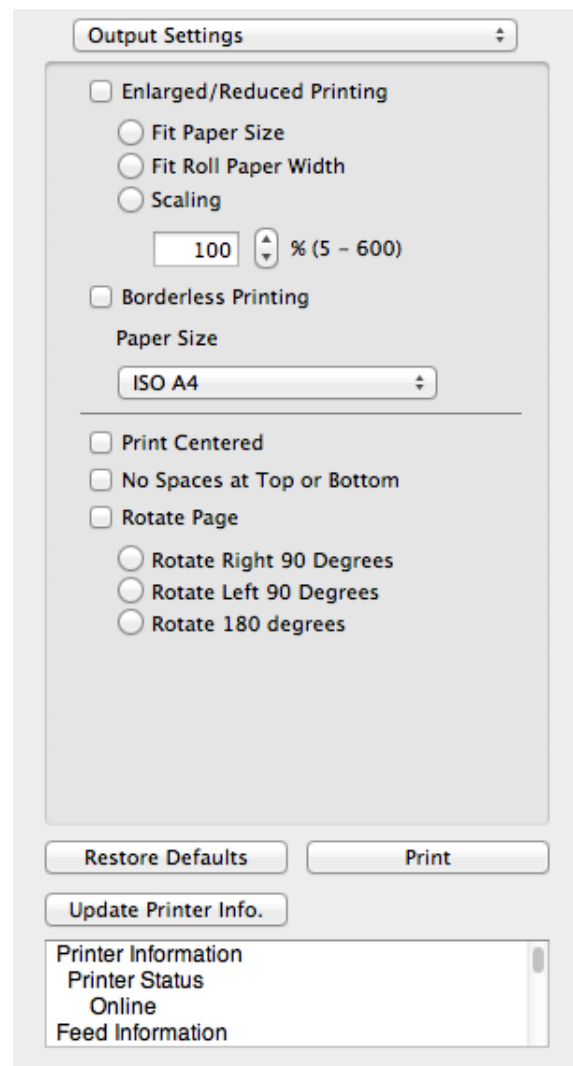

• Enlarged/Reduced Printing

Select the method for enlarged/reduced printing.

The following settings are available for enlarged/reduced printing.

Setting	Details
Fit Paper Size	Enlarges/reduces the whole page automatically to fit the media size selected for output. Select the media size to print from Paper Size .
Fit Roll Paper Width	Enlarges/reduces the whole page automatically to fit the width of the roll paper with the page width. *Make sure that the width of the roll paper in the printer is set correctly for Roll Paper Width in the Paper Settings panel. *Displayed only if rolls are selected in Paper Source .
Scaling	Enlarges/reduces the whole page by the scaling rate as specified. Input the scaling value in numerical characters. You can specify a range between 5 and 600%. *You can change the numbers by clicking either ▲ button or ▼ button. *Although Scaling can be set to make the image larger than the media size, the part that does not fit in the media cannot be printed. *This is not displayed when a checkmark is placed in Borderless Printing .

• **Borderless Printing**

You can print the media without margins on all sides when the roll paper with the specific width and the specific media type is used.

For more information about **Borderless Printing**, see "Print with No Borders." →P.412



Note

- Available only if rolls are selected in **Paper Source**.
- This is not displayed when a checkmark is placed in **Print Centered**.

• **Paper Size**

You can select the size of the print media.



Note

- This is not displayed when **Fit Roll Paper Width** is set in **Enlarged/Reduced Printing**.

• **Print Centered**

You can print on the center of the media loaded in the printer.

For more information about **Print Centered**, see "Print on the Center." →P.413



Note

- This is not displayed when a checkmark is placed in **Borderless Printing**.

• **No Spaces at Top or Bottom**

You can save paper on not to feed roll paper for the empty spaces when the print data contains spaces at the top or bottom.

For more information about **No Spaces at Top or Bottom**, see "Not Print Spaces at the Top/Bottom." →P.413



Note

- Available only if rolls are selected in **Paper Source**.

• **Rotate Page**

Select the method for rotating page.

The following settings are available for rotating page.

Setting	Details
Rotate Right 90 Degrees	Rotates the portrait page right 90 degrees and print in landscape orientation. When the rotated page can fit in the width of roll paper, the page is rotated automatically, and when it can not fit in the width of roll paper, the page is not rotated.

Setting	Details
Rotate Left 90 Degrees	Rotates the portrait page left 90 degrees and print in landscape orientation. When the rotated page can fit in the width of roll paper, the page is rotated automatically, and when it can not fit in the width of roll paper, the page is not rotated.
Rotate 180 degrees	Allows you to rotate the image 180 degrees from the vertical to the right.

- **Restore Defaults Button**

Click the button to reset to the setting when starting Preview.

- **Print Button**

Click the button to begin printing.

- **Update Printer Info. Button**

Click the button to acquire printer information.

Color Settings Panel

This panel appears when you select **Color Settings** in the dialog area.

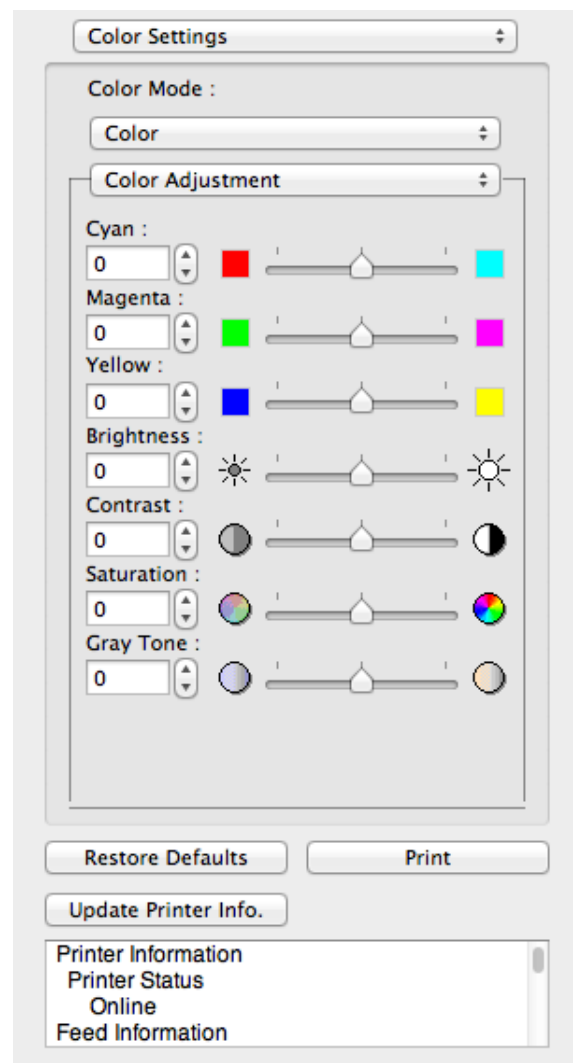

- **Color Mode**

You can select a color mode to suit the print job.

Setting	Details
Color	Enables color printing.
Monochrome (Photo)	Prints monochrome photo image data in a gray scale that is free of color casting (phenomenon of grays that appear tinted).
Monochrome	Disables color printing and converts image from continuous color to grayscaled monochrome.
No color correction	Prints without performing color matching in the printer driver. Select this when color matching is performed by the application such as Adobe Photoshop or when you want to print color charts using the profile creation tool.



Note

- The availability of settings depends on the print priority and media type selections.

• Color Adjustment / Gray Adjustment / Matching

You can set the color adjustment and matching.

- Color Adjustment →P.402
- Gray Adjustment →P.405
- Matching →P.406



Note

- You can select **Gray Adjustment** only after **Monochrome (Photo)** has been selected in **Color Mode**.

- Matching** is not displayed if **No color correction** has been selected in **Color Mode**.

• Restore Defaults Button

Click the button to reset to the setting when starting Preview.

• Print Button

Click the button to begin printing.

• Update Printer Info. Button

Click the button to acquire printer information.

Color Adjustment

You can set the color adjustment.

Adjusting Color

Normally colors should be adjusted in the software application, but if you see colors in the printout that do not match colors on the screen, you can perform color adjustments.

- Select **Color** on **Color Mode** in the **Color Settings** panel.

2 Select Color Adjustment.

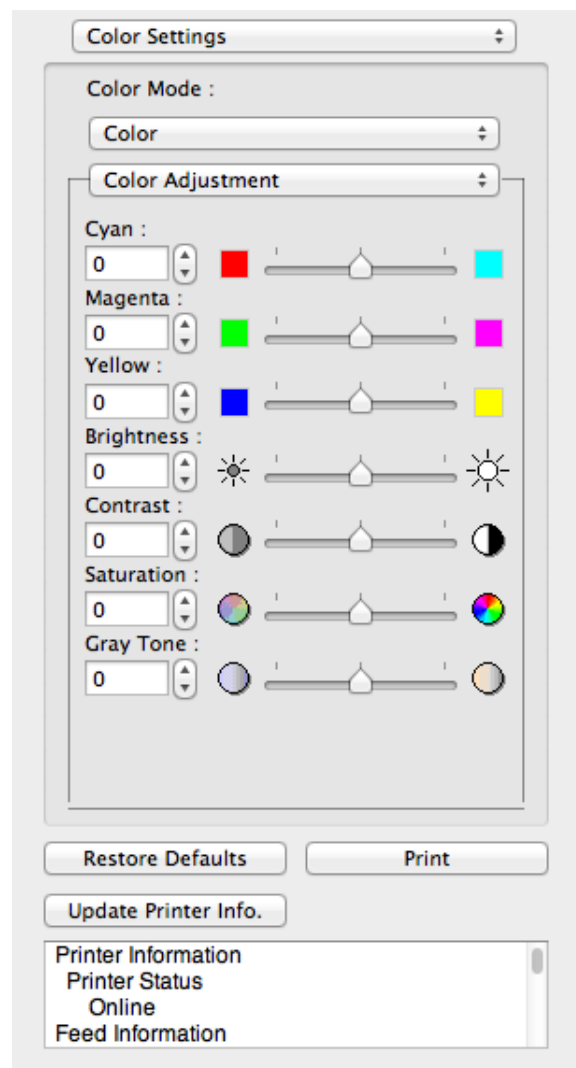

3 Drag each slider to the left or right to adjust.

Setting	Details
Cyan	Adjusts the strength of colors to compensate the hues.
Magenta	Adjusts the strength of colors to compensate the hues.
Yellow	Adjusts the strength of colors to compensate the hues.
Brightness	Adjusts the brightness of the entire image. When the results of the printout are brighter than the original images such as the original photo before scanning and graphics created on the display, or when you want to print in different degrees of brightness, use this feature.
Contrast	Adjusts the relative brightness between the brightest and darkest portions of the image. *For soft gradation, decrease the contrast. For hard gradation, increase the contrast.
Saturation	Adjusts the hues for vivid color or dark color.
Gray Tone	Adjusts gray from cool black (bluish tones) to warm black (reddish tones).



- You can also click the up or down arrow, or enter the number directly to increase or decrease the value.

Note

Adjusting Monochrome

Use the monochrome setting to print monochrome images of color photographs captured with a scanner or digital camera or other color images.

1 Select **Monochrome** on **Color Mode** in the **Color Settings** panel.

2 Select **Color Adjustment**.

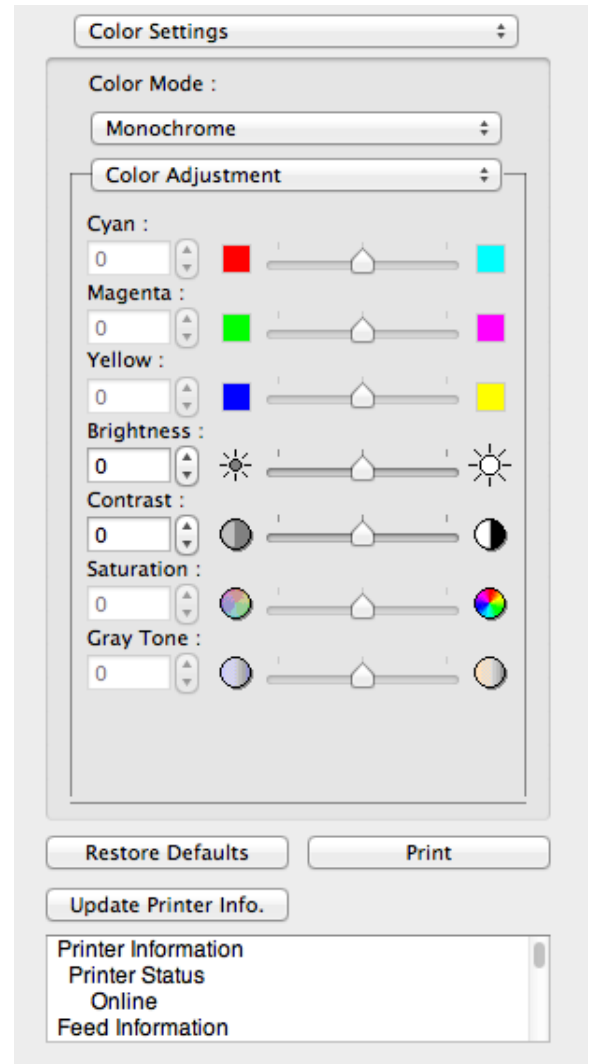

3 Drag each slider to the left or right to adjust.

Setting	Details
Brightness	Adjusts the brightness of the entire image. When the results of the printout are brighter than the original images such as the original photo before scanning and graphics created on the display, or when you want to print in different degrees of brightness, use this feature.
Contrast	Adjusts the relative brightness between the brightest and darkest portions of the image. *For soft gradation, decrease the contrast. For hard gradation, increase the contrast.



Note

- You can also click the up or down arrow, or enter the number directly to increase or decrease the value.

Gray Adjustment

You can set the gray adjustment.

Adjusting Monochrome (Photo)

Sets monochrome printing for black-and-white photo image data captured with a scanner or digital camera.

- 1 Select **Monochrome (Photo)** on **Color Mode** in the **Color Settings** panel.
- 2 Select **Gray Adjustment**.

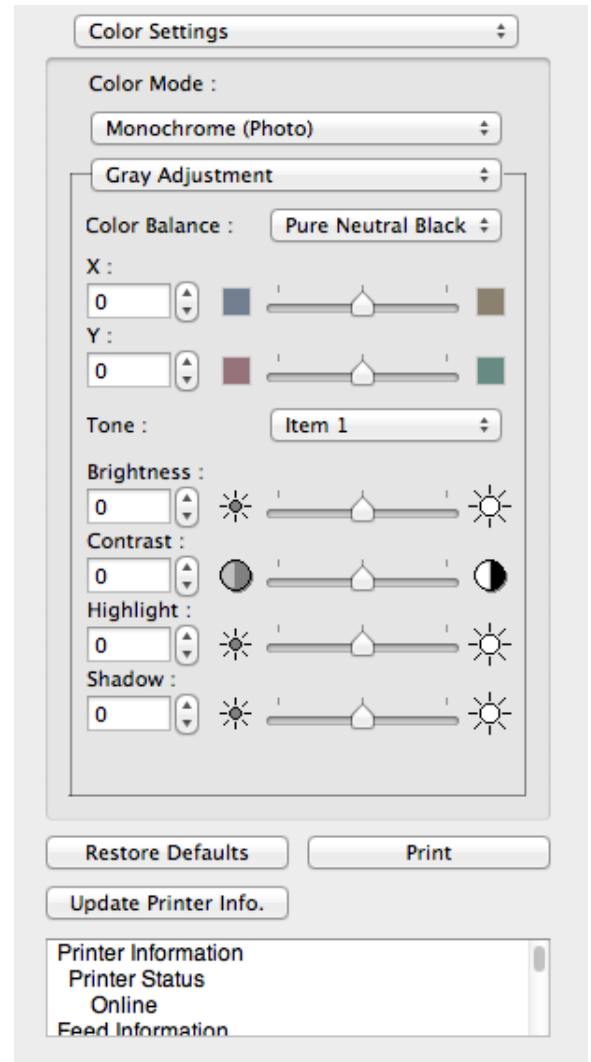

- 3 Click the **Color Balance** list and select the color settings.

Setting	Details
Cool Black	Adjusts cool black (blue tones) to gray.
Pure Neutral Black	Adjusts to neutral gray.
Warm Black	Adjusts warm black (red tones) to gray.

-  To perform the adjustments, drag the X or Y slide bar left and right.
- Note** • You can also click the up or down arrow, or enter the number directly to increase or decrease the value by X and Y.

4 Drag each slider to the left or right to adjust.

Setting	Details
Tone	You can adjust the brightness of intermediate tones in an image. Selecting Hard tone gives a hard impression with more definition. Selecting Soft tone gives a soft impression.
Brightness	Adjusts the brightness of the entire image. When the results of the printout are brighter than the original images such as the original photo before scanning and graphics created on the display, or when you want to print in different degrees of brightness, use this feature.
Contrast	Adjusts the relative brightness between the brightest and darkest portions of the image. *For soft gradation, decrease the contrast. For hard gradation, increase the contrast.
Highlight	Adjusts the brightness of the brightest areas.
Shadow	Adjusts the brightness of the darkest areas.



- You can also click the up or down arrow, or enter the number directly to increase or decrease the value.

Note

- The availability of settings depends on the selected the media type.

Matching

You can set the matching.



Important

- If **No color correction** is selected under **Color Mode**, the **Matching** is not displayed.

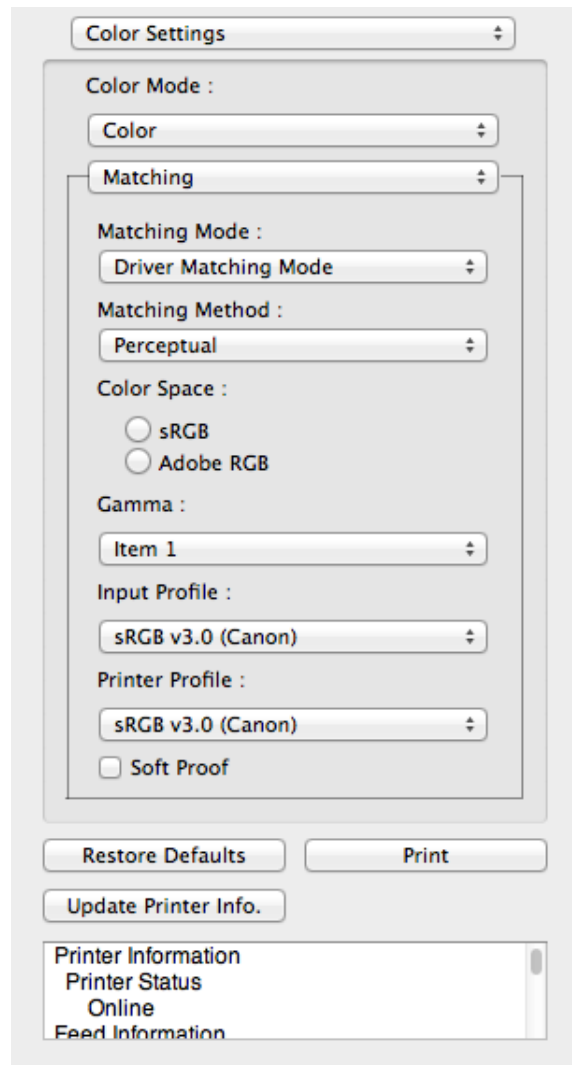

• Matching Mode

You can select a matching mode to suit the print job.

Setting	Details
Driver Matching Mode →P.409	Enables printing of optimal color tones using a driver specific color profile. You should normally select this mode.
ICC Matching Mode →P.410	Enables color matching using ICC profiles. Select this if you want to print by specifying the input profile, printer profile, and matching method in detail. This allows you to use ICC profiles for digital cameras and scanners, ICC profiles created using the profile creation tool, etc.
ColorSync →P.411	Enables color matching by using the ColorSync function of Mac OS. Select this if you want to perform soft proofing using ColorSync before printing.



• You need to set each correction on the printer driver.

Note • **ColorSync** needs to be selected in the **Color Matching** panel of the driver in order to select **ColorSync**.

• Matching Method

You can select a matching method to suit the print job.

• Color Space

Select the color space.



Note

- You can select only after **Driver Matching Mode** has been selected in **Matching Mode**.

• **Gamma**

You can adjust the gradation of intermediate tones in an image. **2.2** is normally selected. If you want a softer impression than **2.2**, select **1.8**.

• **Input Profile**

Select the input profile.



Note

- You can select only after **ICC Matching Mode** has been selected in **Matching Mode**.

• **Printer Profile**

Select the printer profile.



Note

- You can select only after **ICC Matching Mode** has been selected in **Matching Mode**.

• **Soft Proof**

When you place a checkmark here, **ColorSync** applies to the preview area.



Note

- You can select only after **ColorSync** has been selected in **Matching Mode**.

Driver Matching Mode

1 Under **Matching Mode**, select **Driver Matching Mode**.

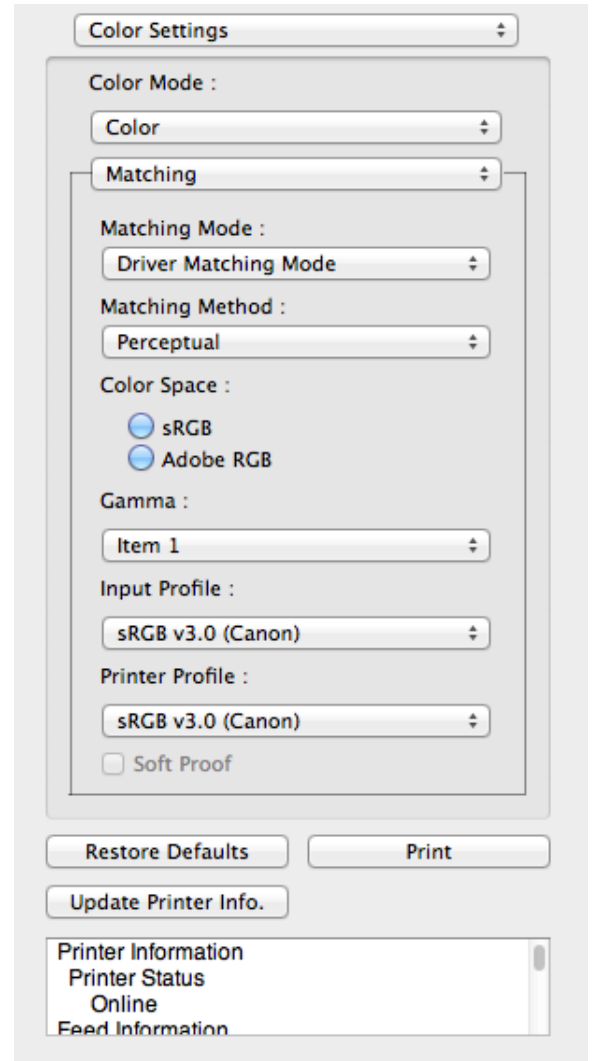

2 Click the **Matching Method** list, and then select a setting.

Setting	Details
Auto	Automatically selects the best color matching method for each Image, Graphics, Text.
Perceptual	Color-matching optimized for printing typical photos attractively. Smooth gradation is a feature. This is also an easy-to-use mode when performing color adjustment using application software.
Saturation	Color-matching optimized for printing posters, etc., vividly.
Colorimetric	Color-matching optimized for printing image data with accurate colors in input color space. This is the easiest-to-use mode when you want to adjust the color and print. However, gradation may be lost for colors of wider range than the color reproduction range of the printer. Generally, this is also called relative colorimetric.

3 Select **Color Space** for the print output.

Setting	Details
sRGB	Uses color space for a standard monitor. This selection is ideal for most software applications.
Adobe RGB	Uses wide color space. Use this setting to print images created with Adobe RGB color space.

ICC Matching Mode

1 Under **Matching Mode**, select **ICC Matching Mode**.

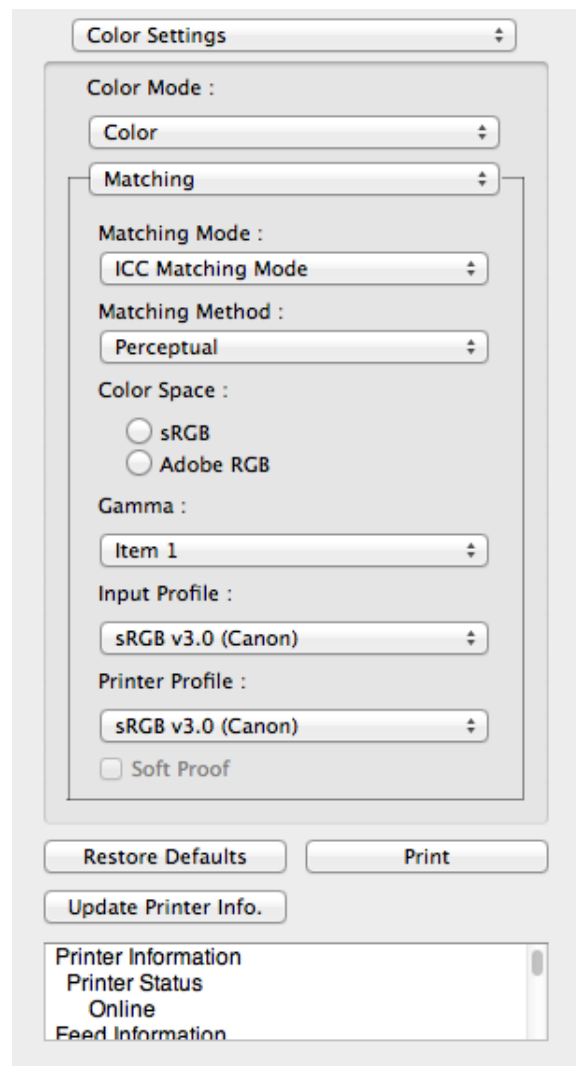

2 Click the **Matching Method** list, and then select a setting.

Setting	Details
Perceptual	Color-matching optimized for printing typical photos attractively. Smooth gradation is a feature. This is also an easy-to-use mode when performing color adjustment using application software.
Saturation	Color-matching optimized for printing posters, etc., vividly.
Colorimetric	Color-matching optimized for printing image data with accurate colors in input color space. This is the easiest-to-use mode when you want to adjust the color and print. However, gradation may be lost for colors of wider range than the color reproduction range of the printer. Generally, this is also called relative colorimetric.
Colorimetric (No White-Point Correction)	The processing method of color-matching is identical to Colorimetric . Use this when you want to further reproduce the target paper material color of the image data. Generally, this also is called absolute colorimetric.

3 Click the **Input Profile** list and select an input profile.

4 Click the **Printer Profile** list and select a printer profile.

ColorSync

- 1 Check that **ColorSync** is selected in **Matching Mode**.

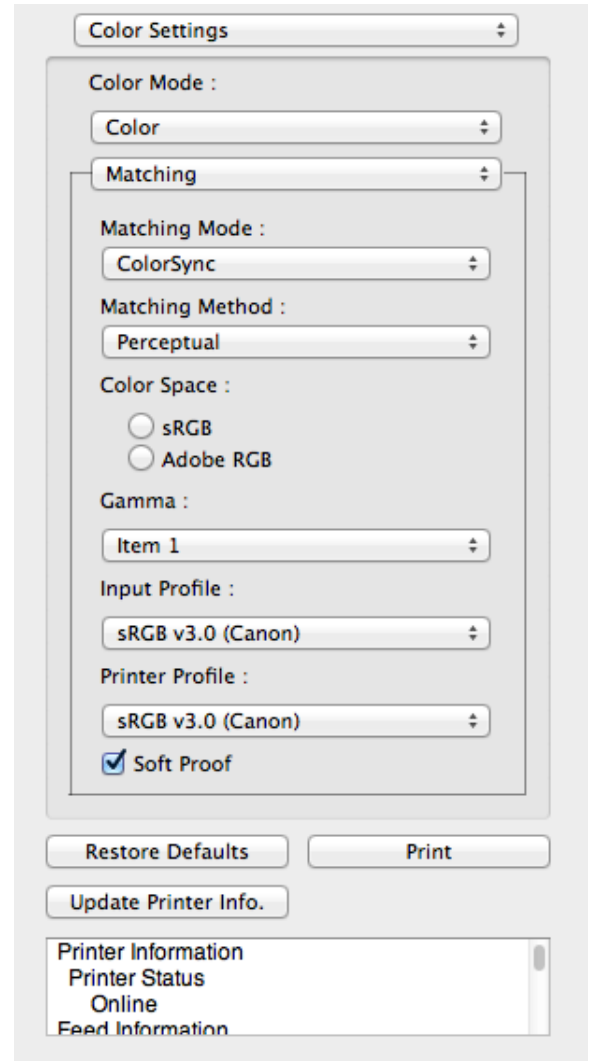

- 2 To apply **ColorSync** to previews, check the **Soft Proof** check box.

Preferences Dialog Box

This dialog box appears when you select **Preferences** from the **imagePROGRAF Advanced Preview** menu. You can set the preferences for Preview.

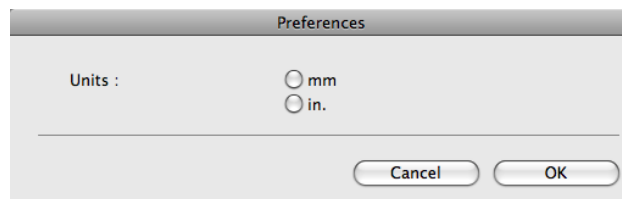

- **Units**

Set the unit for paper length, margins, and so on.

Zoom Dialog Box

This dialog box appears when you select **Zoom** from the **View** menu. You can enlarge or reduce the screen display.

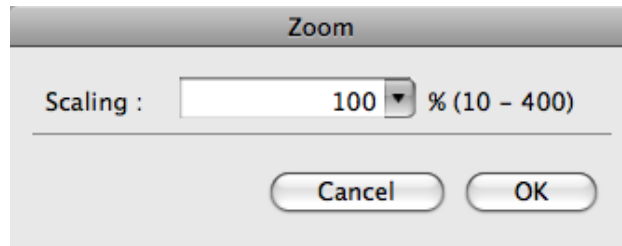

• Scaling

Set the magnification for enlargement or reduction of the screen display.



Note

- You can input between 10 and 400.
- You can change the numbers by clicking ▼ button.

Go to Page Dialog Box

This dialog box appears when you select **Go to Page** from the **View** menu.

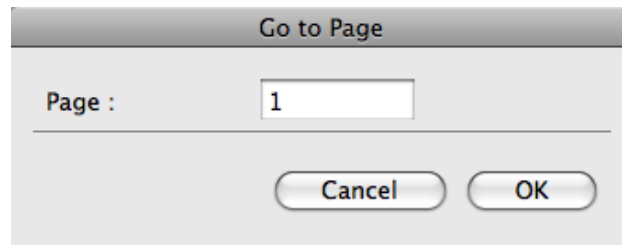

Note

- You can not select **Go to Page** if the document is only one page.

• Page

Input the page number in numerical characters to display in the preview area.



Note

- You can change the numbers in the range of the page of the documents.

Print with No Borders

You can use the borderless printing function to print without margins surrounding the image.



Note

- With some media borderless printing can be performed only between two edges.
- To use the borderless printing function, the specified media must be set to the printer.

1

On the Paper Settings Panel [→P.394](#) , select **Roll Paper** in **Paper Source**.

2

On the Output Settings Panel [→P.399](#) , click the **Enlarged/Reduced Printing** check box on.

3

Select **Fit Roll Paper Width**.

- 4** Click the **Borderless Printing** check box on.

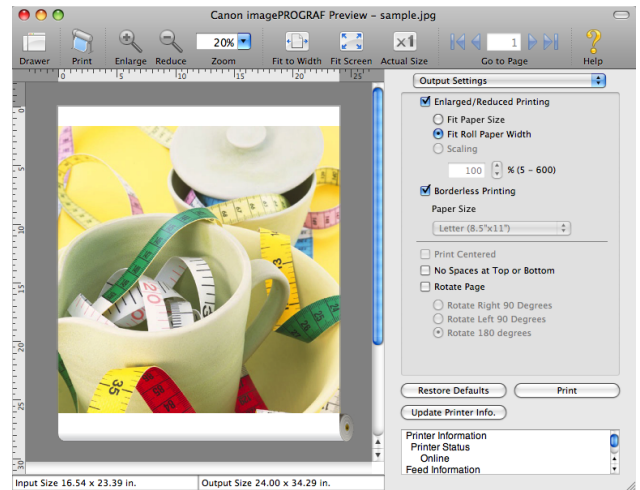

- 5** Click the **Print** button.
Borderless printing begins.

Print on the Center

You can print on the center of the media loaded in the printer.



- This is not displayed when a checkmark is placed in **Borderless Printing**.

Note

- 1** On the Output Settings Panel (→P.399), click the **Print Centered** check box on.

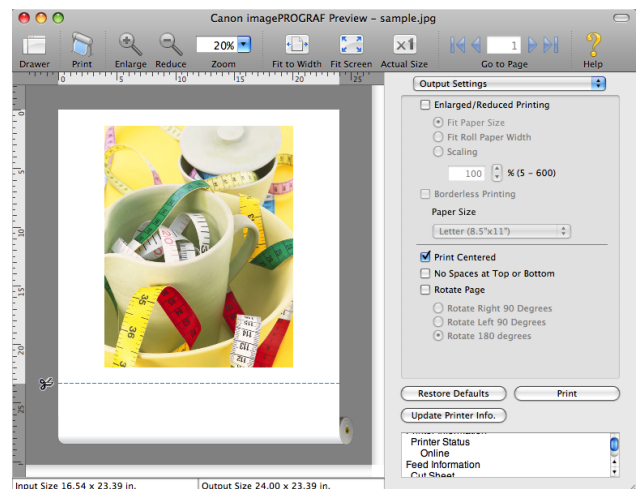

- 2** Click the **Print** button.
Printing on the center begins.

Not Print Spaces at the Top/Bottom

You can save paper on not to feed roll paper for the empty spaces when the print data contains spaces at the top or bottom.



- This is not displayed when a checkmark is placed in **Borderless Printing**.

Note

- 1 On the Paper Settings Panel →P.394 , select **Roll Paper** in **Paper Source**.
- 2 On the Output Settings Panel →P.399 , click the **No Spaces at Top or Bottom** check box on.

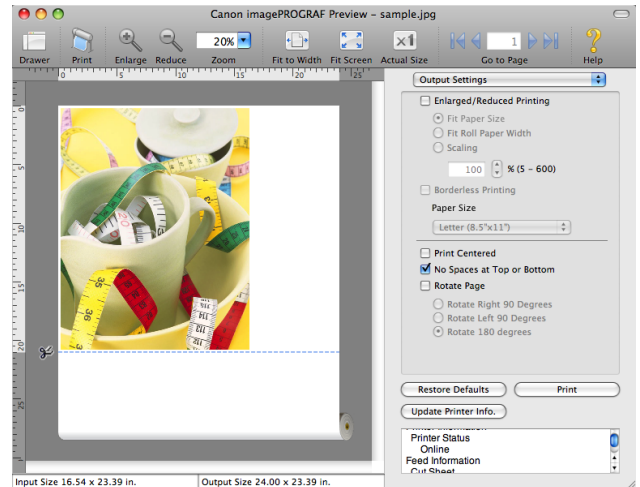

- 3 Click the **Print** button.
Printing on the settings with no spaces at top or bottom begins.

Print Page Rotated 90 Degrees

You can save paper by printing in landscape orientation on roll paper.

- 1 On the Paper Settings Panel →P.394 , select **Roll Paper** in **Paper Source**.
- 2 On the Output Settings Panel →P.399 , click the **Rotate Page** check box on.
- 3 Select **Rotate Right 90 Degrees** or **Rotate Left 90 Degrees**.

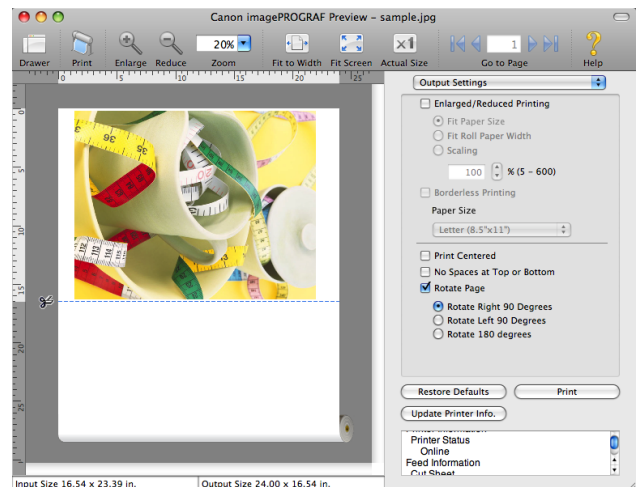

- 4 Click the **Print** button.
Printing on rotating 90 degrees begins.

Display with Fitting to the Width of the Paper

In the preview area, you can display to the width of the paper.

1 Select  **Fit to Width** from the tool bar.

2 Fitting to the width of the paper, it is displayed.

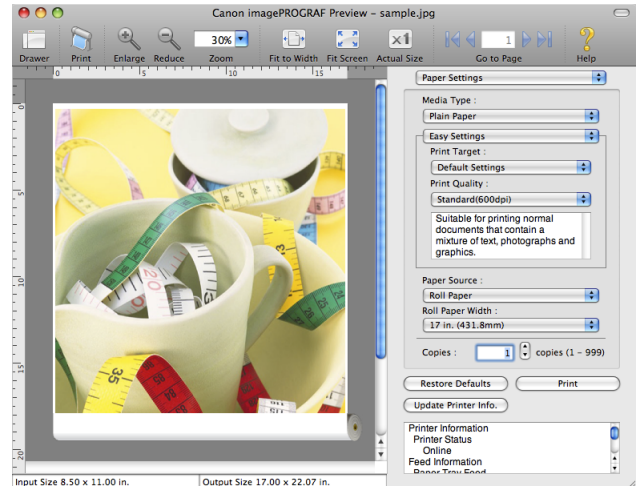

Display with All

In the preview area, you can display all.

1 Select  **Fit Screen** from the tool bar.

2 All is displayed.

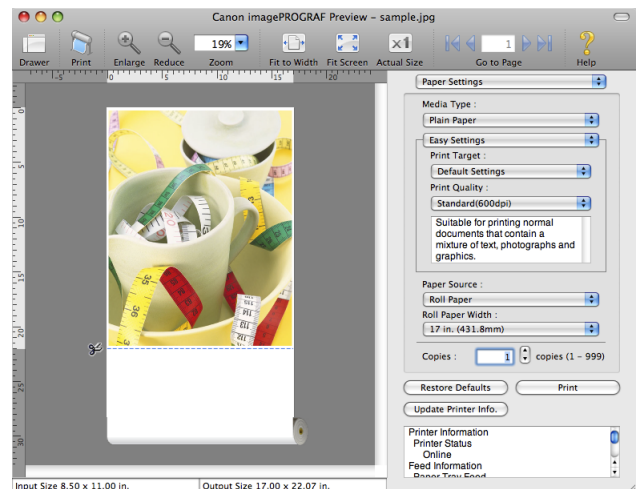

Display with Actual Size

In the preview area, you can display the actual size.

1 Select  **Actual Size** from the tool bar.



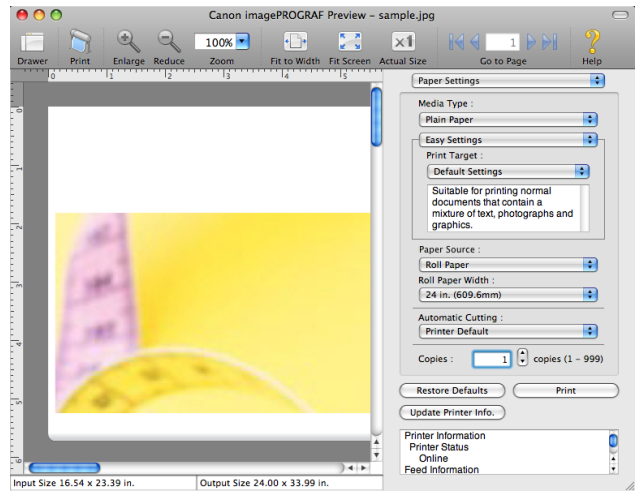

2 Actual size is displayed.



Moving a Page

You can move a page to display in the preview area.

1 Select each button in **Go to Page** on the tool bar.

Setting	Details
	Go to the first page.
	Go to the previous page.
	Go to the next page.
	Go to the last page.

2 The target page appears.

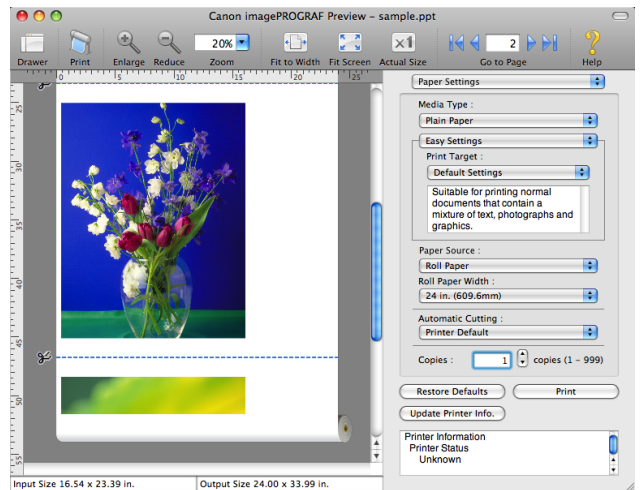

416 • You can also move a page by clicking the page on the thumbnails.



Note

Free Layout

The Features of Free Layout	417
Starting Free Layout	417
Free Layout Main Window	419
Paper Settings Panel	422
Easy Settings	424
Advanced Settings	426
Color Settings Panel	427
Color Adjustment	428
Gray Adjustment	431
Matching	432
Driver Matching Mode	435
ICC Matching Mode	436
ColorSync	437
Preferences Dialog Box	438
Page Setup Dialog Box	439
Zoom Dialog Box	440
Format Dialog Box	440
Laying out a Multiple-File Document on One Page	441
Laying out a Document Created with Multiple Application Programs on One Page	441
Selecting an Object	442
Changing the Object Size	442
Moving an Object	443
Rotating an Object	443
Laying out Objects Automatically	444
Aligning Objects	444
Changing the Object Overlapping Order	446
Pasting a Copied or Cut Object	447

The Features of Free Layout

The main features of Free Layout are as follows.

- Allows you to lay out at will and print a document created with application software.
- You can not only lay out multiple pages on one page but also lay out and print a multiple-file document on one page, or lay out and print a document created with multiple application programs on one page.



Note

- The media type, image size, detailed media settings, and the printer settings can cause the actual print output to differ from the Free Layout settings.

Starting Free Layout

Follow the procedure below to start the Free Layout.

- 1 Start the application software which you use.
- 2 From the application software's **File** menu, select the printer setup menu to open the **Print** dialog box.



Note

- Normally, select **Print** from the **File** menu.

- 3 Click on **Free Layout** in the **Page Setup** panel to attach a checkmark.

4 Click the **Print** button in the **Print** dialog box.

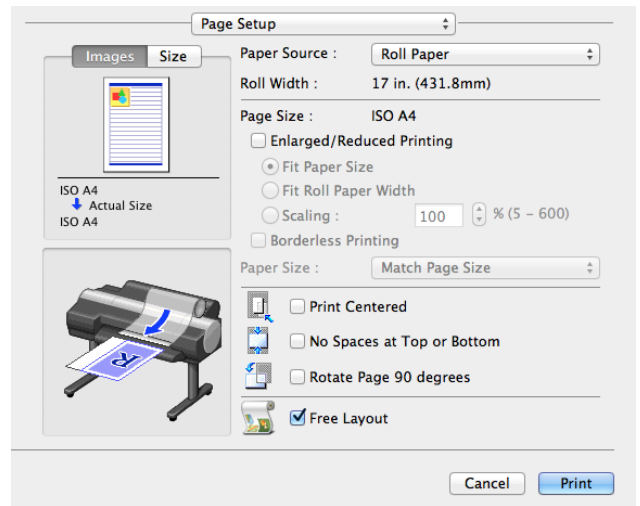

Note

Your printer is depicted in the lower-left area of this screen.

5 Free Layout main window is displayed.

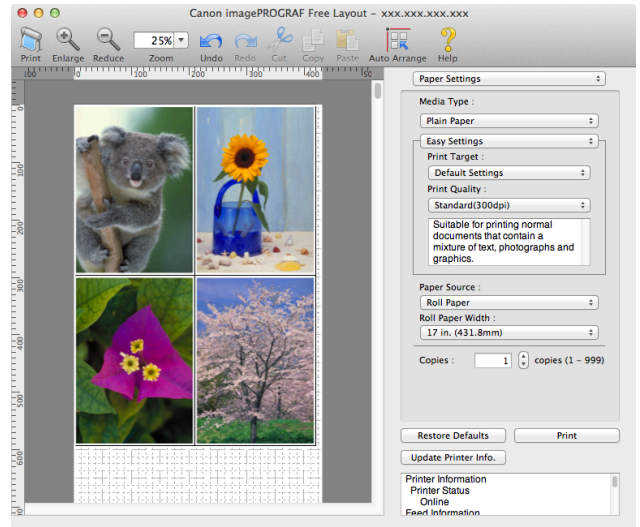

Free Layout Main Window

The Free Layout main window consists of the menu and tool bars, layout area and dialog areas.

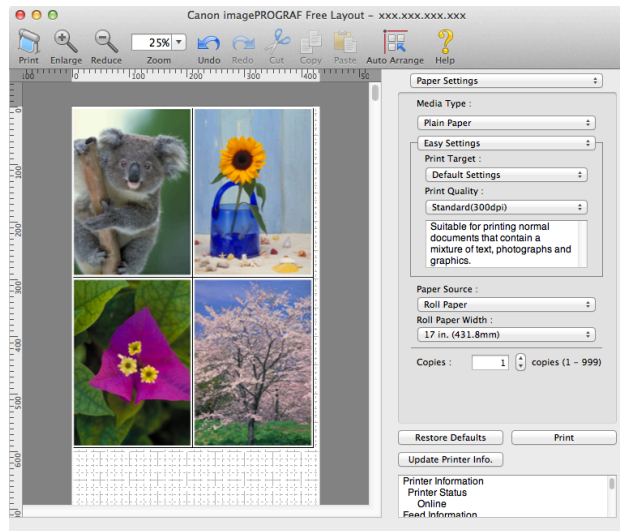

- You can use the **View** menu to show or hide the tool.

Note

• Menu Bar

This allows you to select menus required for operations.



• Tool Bar

This allows you to select tool buttons required for major operations.



- **Layout Area**

This allows you to lay out objects and edit the object size and orientation.

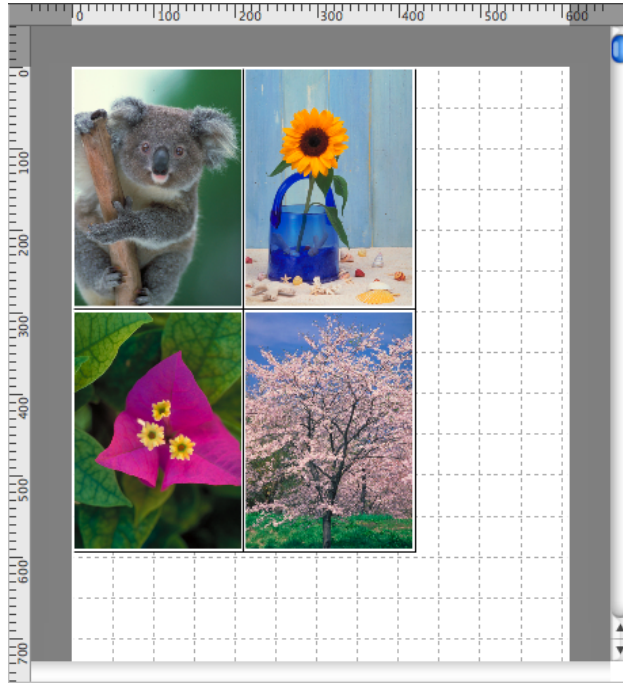

- Dialog Area

This allows you to set the print conditions and perform a print job.

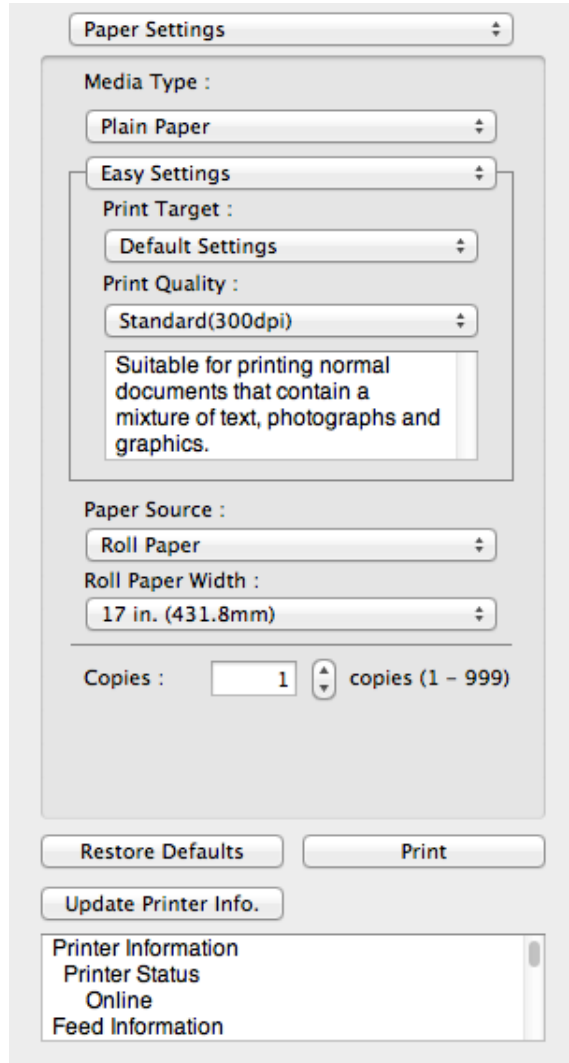

Paper Settings Panel

This panel appears when you select **Paper Settings** in the dialog area.

• Media Type

This allows you to select the media type.



Note

- Always select media type that is actually set in the printer. When the media you chose is different from the media set in the printer, you may not receive the desired print results.

• Easy Settings / Advanced Settings

Two modes are available to provide the optimum print settings for jobs. The settings available on each mode are as follows.

- Easy Settings →P.424
- Advanced Settings →P.426

• Paper Source

You can select the paper source.

The following settings are available for paper source.

Setting	Details
Cut Sheet	Select to print on the cut sheet.

Setting	Details
Roll Paper	Select to print on roll paper.

- **Roll Paper Width**

This selects the width of the roll media set to the printer.



Note

- Available only if rolls are selected in **Paper Source**.

- **Copies**

You can input the number of print copies in numerical characters.



Note

- The maximum value is 999.
- You can change the numbers by clicking either ▲ button or ▼ button.

- **Restore Defaults Button**

Click the button to reset to the setting when starting Free Layout.

- **Print Button**

Click the button to begin printing.

- **Update Printer Info. Button**

Click the button to acquire printer information.

Easy Settings

You can easily select the best settings for the print job by just selecting an item from the print target list that matches the content of the document.

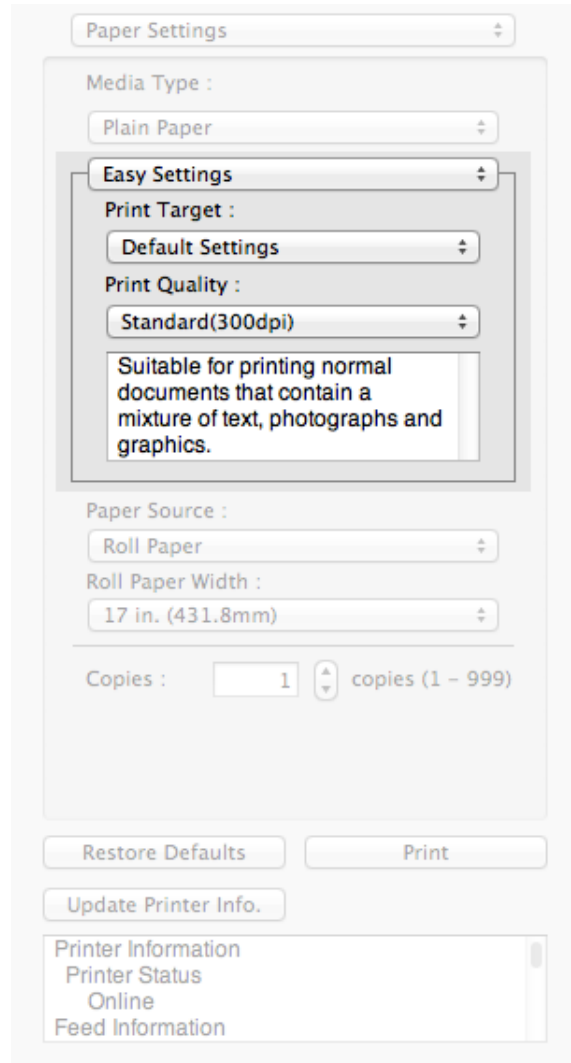

• Print Target

You can easily select the best settings for the print job simply.

If you select each **Print Target** item the corresponding comment for that item is displayed below the list.

Setting	Details
Default Settings	Suitable for printing normal documents that contain a mixture of text, photographs, and graphics.
Photo (Color)	Suitable for printing photographic images captured with a digital camera.
Photo (Monochrome)	Suitable for optimized printing of monochrome photos.
Poster	The best setting for posters. Prints using vivid and high impact colors.
Faithful Color Reproduction	Prints by faithfully reproducing the colors of the original image.
Photo (Adobe RGB)	Achieves the best color when printing an image created with the Adobe RGB color space feature.
CAD (Color Line Drawing)	Prints the fine lines of CAD drawings and other such documents sharp and clear.
Perspective, GIS	Suitable for attractive printing of 3D-CAD drawings, perspective drawings, and GIS drawings including maps.
Office Document	Suitable for printing handouts as well as general office documents for which print clarity is key.

Setting	Details
Custom Settings	Suitable for printing documents for which Advanced Settings have been specified.



Note

- The number of settings available for selection depends on the media type.

• Print Quality

Selecting print quality strikes a balance between the quality of the printed image and printing speed.

The level of the print quality and resolution settings are displayed in the following combinations.

Setting	Details
Print Quality	Highest quality / High / Standard / Fast
Resolution	600dpi / 300dpi



Note

- The availability of settings is determined by the media type and print priority selections.
- Printing time is longer and more ink is consumed with **High** than with **Fast**, however, print quality is higher.
- Printing time is shorter and less ink is consumed with **Fast** than with **High**, however, print quality is lower.
- For **Highest quality**, the resolution is not displayed.

Advanced Settings

Presents detailed settings for the print priority, the print quality, and other items so you can select the values for these settings yourself.

• Print Priority

Select a print quality mode that is appropriate for the print job.

Setting	Details
Image	This mode achieves the best results for printing photographic images and illustrations.
Line Drawing	This mode is best for printing CAD drawings with fine lines or wall newsheet or other documents that contain large amounts of text. However, you may not achieve the quality you expect with printing photographs or other images with many filled areas. For these types of jobs, select Image .
Proof	This is a setting for enhancing the reproducibility of characters, illustrations, and photos with print proofing. However, this takes more time than regular printing.
Office Document	Prints common office documents, such as proposals, memos for distribution, etc., so they are easy to read.



Note

- The number of settings available for selection depends on the media type.

• Print Quality

Selecting print quality strikes a balance between the quality of the printed image and printing speed.

The level of the print quality and resolution settings are displayed in the following combinations.

Setting	Details
Print Quality	Highest quality / High / Standard / Fast
Resolution	600dpi / 300dpi



- The availability of settings is determined by the media type and print priority selections.
- Note** • Printing time is longer and more ink is consumed with **High** than with **Fast**, however, print quality is higher.
- Printing time is shorter and less ink is consumed with **Fast** than with **High**, however, print quality is lower.
- For **Highest quality**, the resolution is not displayed.

Color Settings Panel

This panel appears when you select **Color Settings** in the dialog area.

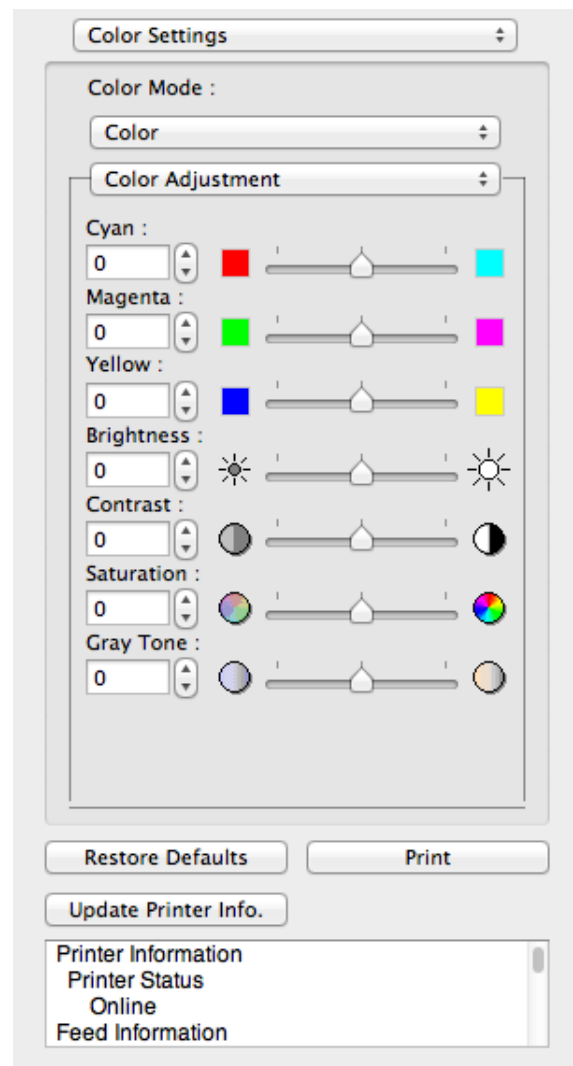

• Color Mode

You can select a color mode to suit the print job.

Setting	Details
Color	Enables color printing.
Monochrome (Photo)	Prints monochrome photo image data in a gray scale that is free of color casting (phenomenon of grays that appear tinted).
Monochrome	Disables color printing and converts image from continuous color to grayscaled monochrome.
No color correction	Prints without performing color matching in the printer driver. Select this when color matching is performed by the application such as Adobe Photoshop or when you want to print color charts using the profile creation tool.



Note

- The availability of settings depends on the print priority and media type selections.

• Color Adjustment / Gray Adjustment / Matching

You can set the color adjustment and matching.

- Color Adjustment →P.428
- Gray Adjustment →P.431
- Matching →P.432



Note

- You can select **Gray Adjustment** only after **Monochrome (Photo)** has been selected in **Color Mode**.

- Matching** is not displayed if **No color correction** has been selected in **Color Mode**.

• Restore Defaults Button

Click the button to reset to the setting when starting Free Layout.

• Print Button

Click the button to begin printing.

• Update Printer Info. Button

Click the button to acquire printer information.

Color Adjustment

You can set the color adjustment.

Adjusting Color

Normally colors should be adjusted in the software application, but if you see colors in the printout that do not match colors on the screen, you can perform color adjustments.

1

Select **Color** on **Color Mode** in the **Color Settings** panel.

2 Select Color Adjustment.

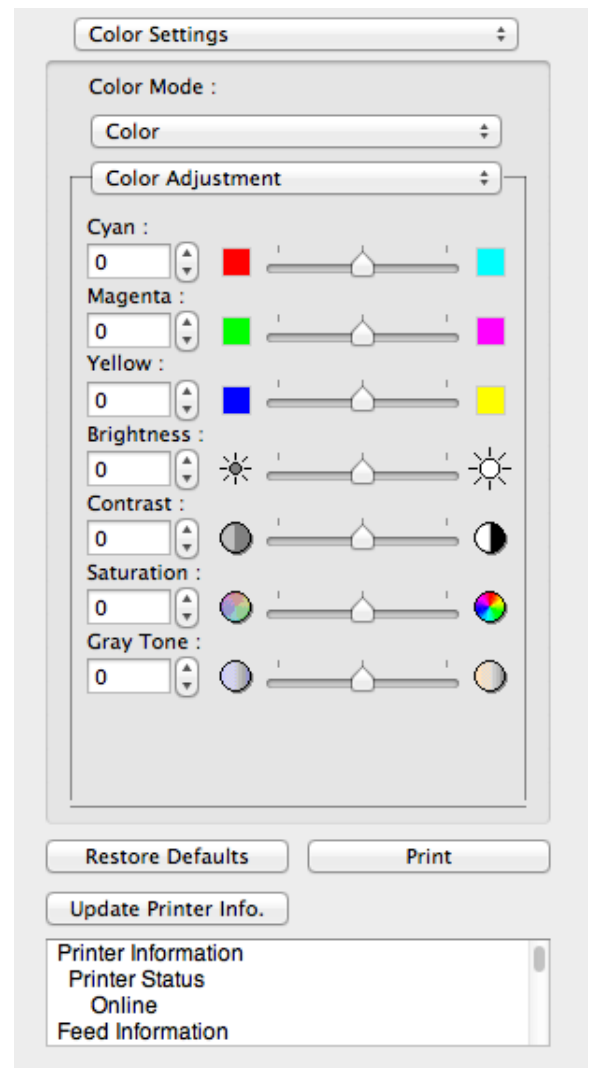

3 Drag each slider to the left or right to adjust.

Setting	Details
Cyan	Adjusts the strength of colors to compensate the hues.
Magenta	Adjusts the strength of colors to compensate the hues.
Yellow	Adjusts the strength of colors to compensate the hues.
Brightness	Adjusts the brightness of the entire image. When the results of the printout are brighter than the original images such as the original photo before scanning and graphics created on the display, or when you want to print in different degrees of brightness, use this feature.
Contrast	Adjusts the relative brightness between the brightest and darkest portions of the image. *For soft gradation, decrease the contrast. For hard gradation, increase the contrast.
Saturation	Adjusts the hues for vivid color or dark color.
Gray Tone	Adjusts gray from cool black (bluish tones) to warm black (reddish tones).



Note

- You can also click the up or down arrow, or enter the number directly to increase or decrease the value.

Adjusting Monochrome

Use the monochrome setting to print monochrome images of color photographs captured with a scanner or digital camera or other color images.

1 Select **Monochrome** on **Color Mode** in the **Color Settings** panel.

2 Select **Color Adjustment**.

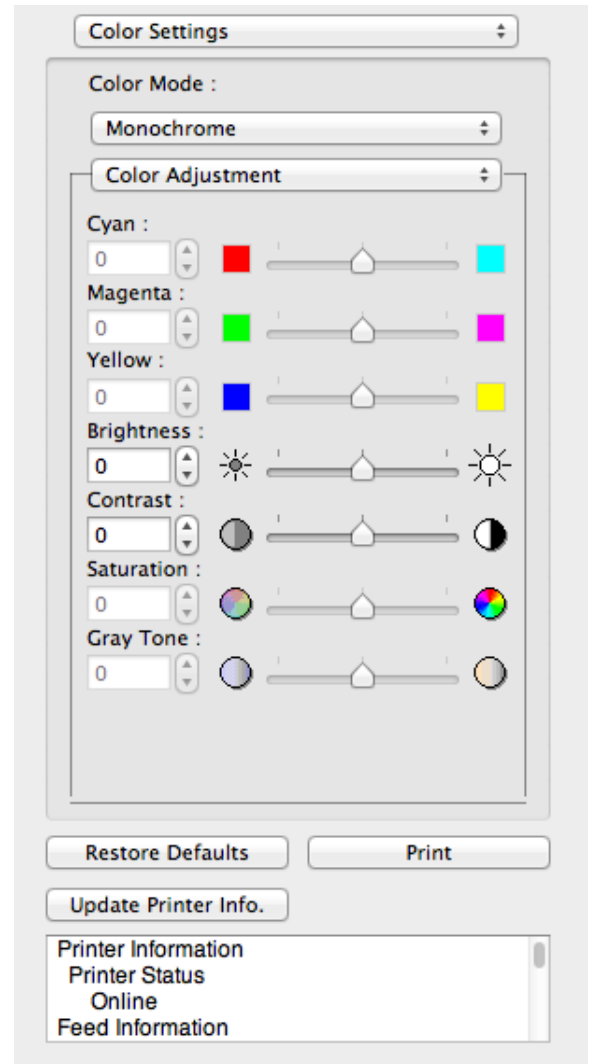

3 Drag each slider to the left or right to adjust.

Setting	Details
Brightness	Adjusts the brightness of the entire image. When the results of the printout are brighter than the original images such as the original photo before scanning and graphics created on the display, or when you want to print in different degrees of brightness, use this feature.
Contrast	Adjusts the relative brightness between the brightest and darkest portions of the image. *For soft gradation, decrease the contrast. For hard gradation, increase the contrast.



Note

- You can also click the up or down arrow, or enter the number directly to increase or decrease the value.

Gray Adjustment

You can set the gray adjustment.

Adjusting Monochrome (Photo)

Sets monochrome printing for black-and-white photo image data captured with a scanner or digital camera.

- 1 Select **Monochrome (Photo)** on **Color Mode** in the **Color Settings** panel.
- 2 Select **Gray Adjustment**.

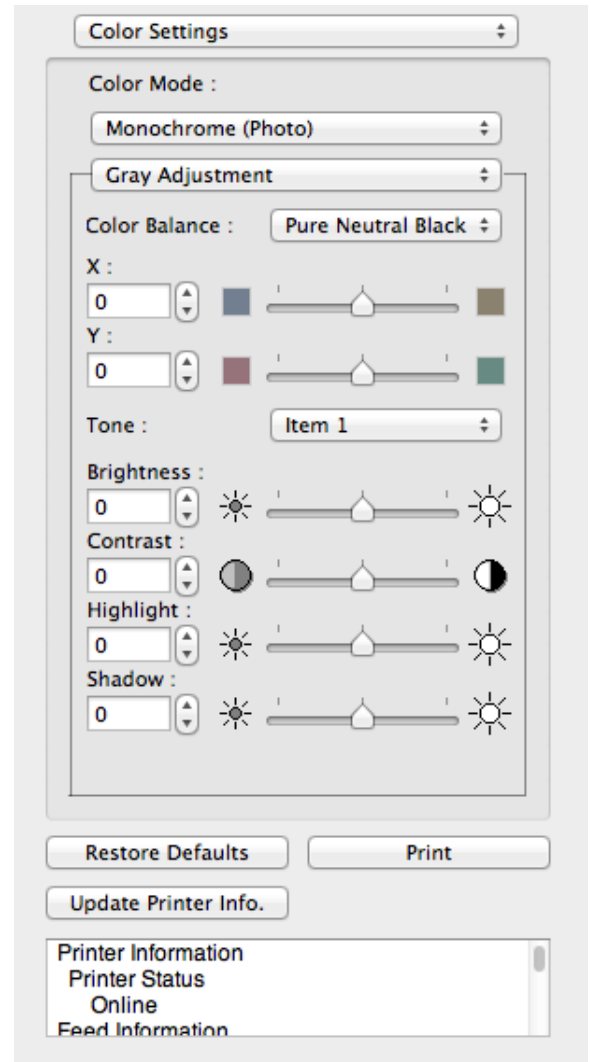

- 3 Click the **Color Balance** list and select the color settings.

Setting	Details
Cool Black	Adjusts cool black (blue tones) to gray.
Pure Neutral Black	Adjusts to neutral gray.
Warm Black	Adjusts warm black (red tones) to gray.

-  To perform the adjustments, drag the X or Y slide bar left and right.
- Note** • You can also click the up or down arrow, or enter the number directly to increase or decrease the value by X and Y.

4 Drag each slider to the left or right to adjust.

Setting	Details
Tone	You can adjust the brightness of intermediate tones in an image. Selecting Hard tone gives a hard impression with more definition. Selecting Soft tone gives a soft impression.
Brightness	Adjusts the brightness of the entire image. When the results of the printout are brighter than the original images such as the original photo before scanning and graphics created on the display, or when you want to print in different degrees of brightness, use this feature.
Contrast	Adjusts the relative brightness between the brightest and darkest portions of the image. *For soft gradation, decrease the contrast. For hard gradation, increase the contrast.
Highlight	Adjusts the brightness of the brightest areas.
Shadow	Adjusts the brightness of the darkest areas.



- You can also click the up or down arrow, or enter the number directly to increase or decrease the value.

Note

- The availability of settings depends on the selected the media type.

Matching

You can set the matching.



Important

- If **No color correction** is selected under **Color Mode**, the **Matching** is not displayed.

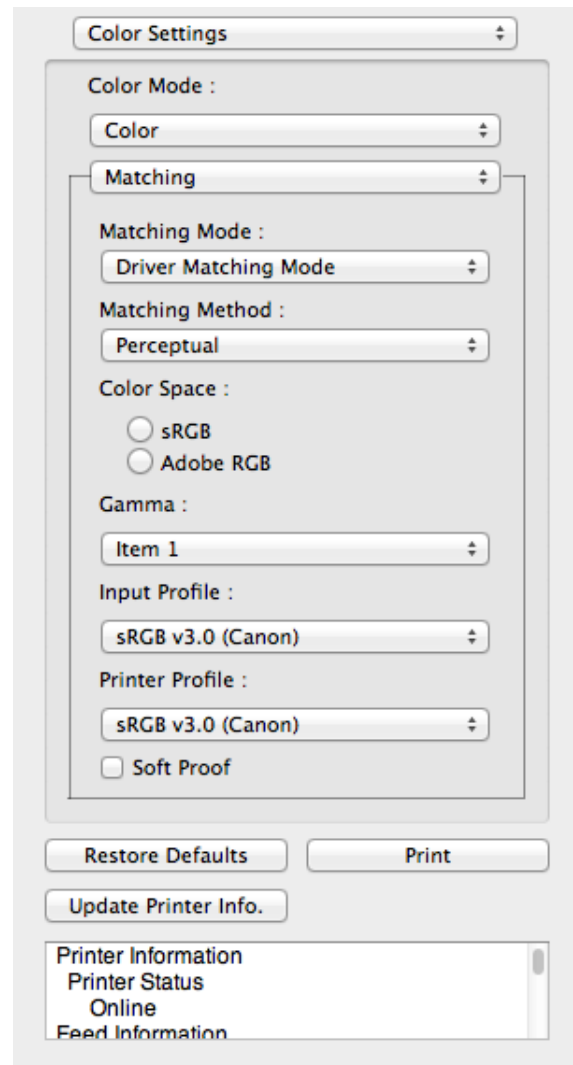

• Matching Mode

You can select a matching mode to suit the print job.

Setting	Details
Driver Matching Mode →P.435	Enables printing of optimal color tones using a driver specific color profile. You should normally select this mode.
ICC Matching Mode →P.436	Enables color matching using ICC profiles. Select this if you want to print by specifying the input profile, printer profile, and matching method in detail. This allows you to use ICC profiles for digital cameras and scanners, ICC profiles created using the profile creation tool, etc.
ColorSync →P.437	Enables color matching by using the ColorSync function of Mac OS. Select this if you want to perform soft proofing using ColorSync before printing.



• You need to set each correction on the printer driver.

Note • **ColorSync** needs to be selected in the **Color Matching** panel of the driver in order to select **ColorSync**.

• Matching Method

You can select a matching method to suit the print job.

• Color Space

Select the color space.



Note

- You can select only after **Driver Matching Mode** has been selected in **Matching Mode**.

• Gamma

You can adjust the gradation of intermediate tones in an image. **2.2** is normally selected. If you want a softer impression than **2.2**, select **1.8**.

• Input Profile

Select the input profile.



Note

- You can select only after **ICC Matching Mode** has been selected in **Matching Mode**.

• Printer Profile

Select the printer profile.



Note

- You can select only after **ICC Matching Mode** has been selected in **Matching Mode**.

• Soft Proof

When you place a checkmark here, **ColorSync** applies to the layout area.



Note

- You can select only after **ColorSync** has been selected in **Matching Mode**.

Driver Matching Mode

1 Under **Matching Mode**, select **Driver Matching Mode**.

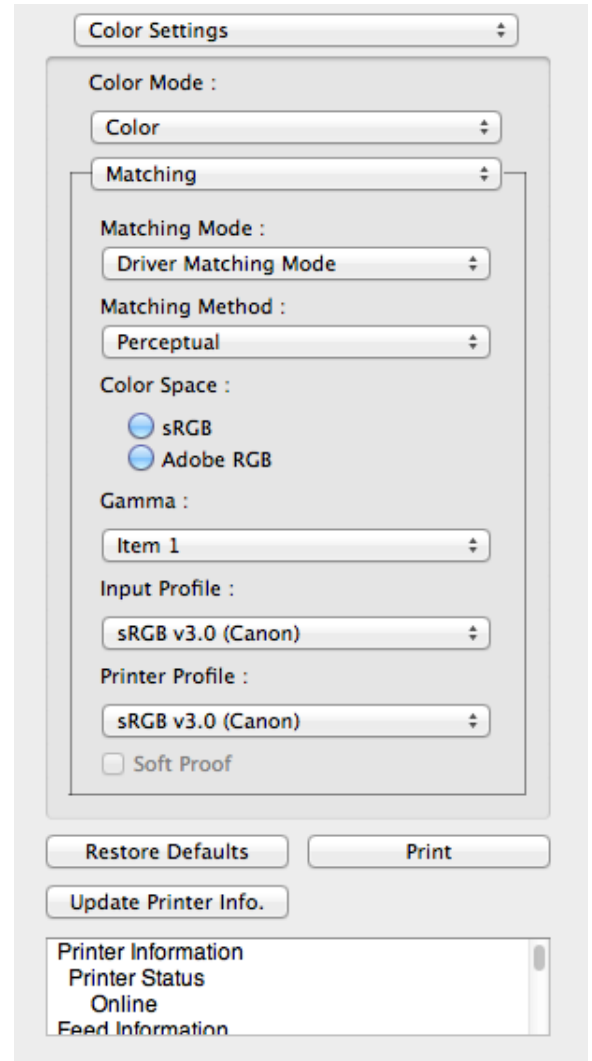

2 Click the **Matching Method** list, and then select a setting.

Setting	Details
Auto	Automatically selects the best color matching method for each Image, Graphics, Text.
Perceptual	Color-matching optimized for printing typical photos attractively. Smooth gradation is a feature. This is also an easy-to-use mode when performing color adjustment using application software.
Saturation	Color-matching optimized for printing posters, etc., vividly.
Colorimetric	Color-matching optimized for printing image data with accurate colors in input color space. This is the easiest-to-use mode when you want to adjust the color and print. However, gradation may be lost for colors of wider range than the color reproduction range of the printer. Generally, this is also called relative colorimetric.

3 Select **Color Space** for the print output.

Setting	Details
sRGB	Uses color space for a standard monitor. This selection is ideal for most software applications.
Adobe RGB	Uses wide color space. Use this setting to print images created with Adobe RGB color space.

ICC Matching Mode

- Under **Matching Mode**, select **ICC Matching Mode**.

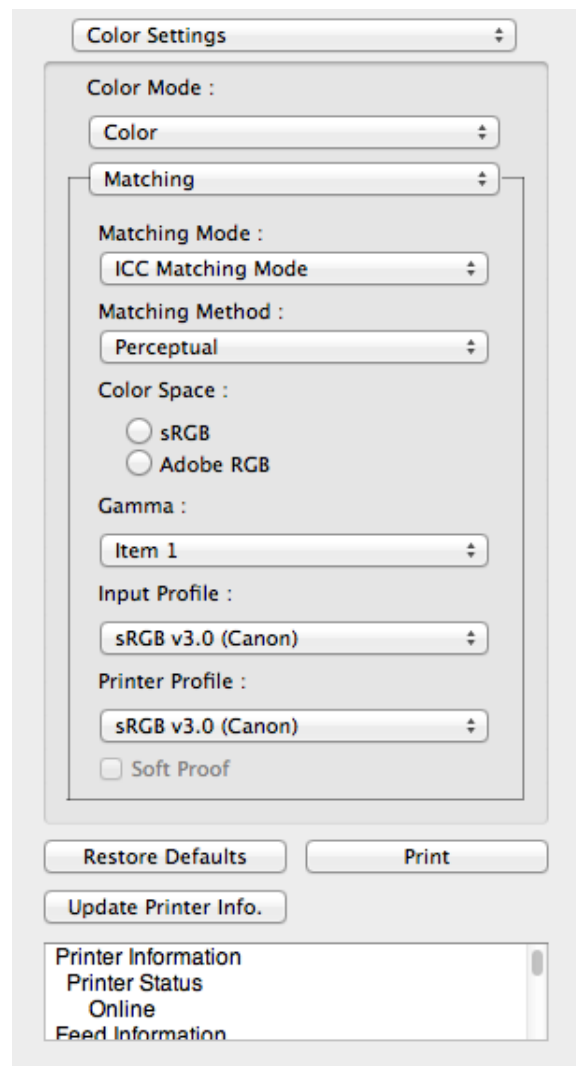

- Click the **Matching Method** list, and then select a setting.

Setting	Details
Perceptual	Color-matching optimized for printing typical photos attractively. Smooth gradation is a feature. This is also an easy-to-use mode when performing color adjustment using application software.
Saturation	Color-matching optimized for printing posters, etc., vividly.
Colorimetric	Color-matching optimized for printing image data with accurate colors in input color space. This is the easiest-to-use mode when you want to adjust the color and print. However, gradation may be lost for colors of wider range than the color reproduction range of the printer. Generally, this is also called relative colorimetric.
Colorimetric (No White-Point Correction)	The processing method of color-matching is identical to Colorimetric . Use this when you want to further reproduce the target paper material color of the image data. Generally, this also is called absolute colorimetric.

- Click the **Input Profile** list and select an input profile.

- Click the **Printer Profile** list and select a printer profile.

ColorSync

1 Check that **ColorSync** is selected in **Matching Mode**.

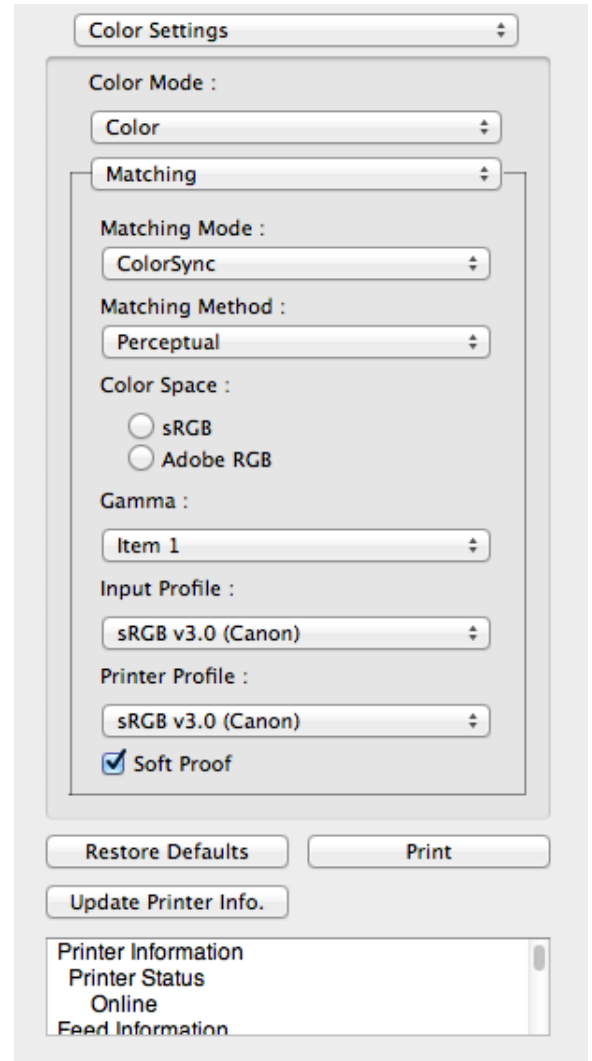

2 Place a checkmark on **Soft Proof** to simulate the output product in Layout Area.

Preferences Dialog Box

This dialog box appears when you select **Preferences** from the imagePROGRAF Advanced Preview menu. You can set the preferences for Free Layout.

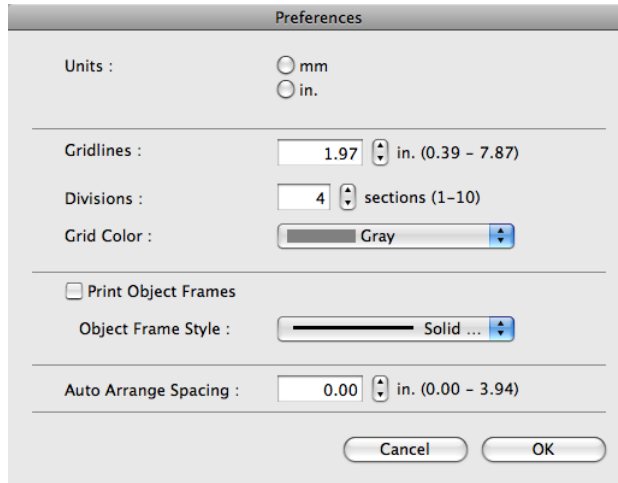

• Units

Set the unit for paper length, margins, and so on.

• Gridlines

You can input a grid line width value in numerical characters so that they serve as a guide to laying out objects.



Note

- You can input between 10.0 and 200.0(mm) (between 0.39 and 7.87(inch)).
- You can change the numbers by clicking either ▲ button or ▼ button.

• Divisions

You can change the number of divisions of grid lines so that they serve as a guide to laying out objects.



Note

- You can input between 1 and 10.
- You can change the numbers by clicking either ▲ button or ▼ button.

• Grid Color

Select the grid line color.

• Print Object Frames

You can print the object border.



Note

- If you do not want to print the object border, deselect the **Print Object Frames** check box.

• Object Frame Style

You can select the object frame style for printing.

The following settings are available for the object frame style.

Setting	Details
Solid Line	You can print the solid line as the frame style.
Dotted Line	You can print the dotted line as the frame style.
Dashed Line	You can print the dashed line as the frame style.

• Auto Arrange Spacing

Change the object-to-object spacing to be applied in the operation of laying out objects automatically.



Note

- You can input between 0.0 and 100.0(mm) (between 0.00 and 3.94(inch)).
- You can change the numbers by clicking either ▲ button or ▼ button.

Page Setup Dialog Box

This dialog box appears when you select **Page Setup** from the **File** menu. This dialog box provides selections for setting the media size, orientation and other important features.

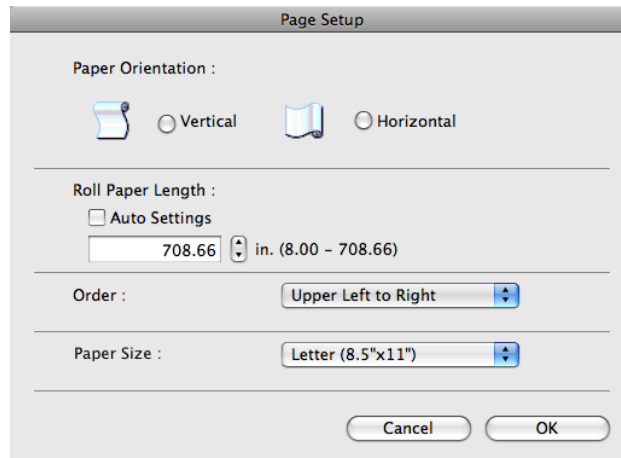

• Paper Orientation

This selects the paper orientation.

The following settings are available for orientation.

Setting	Details
Vertical	Prints the image and text created with the application software in the orientation as it is.
Horizontal	Prints the image and text by rotating sideways 90 degrees from the orientation as specified in the application.

• Roll Paper Length

Set the length of one page to print on roll paper.

When you place a checkmark on **Auto Settings**, the one-page length to be printed on roll paper is automatically set so that the laid-out objects are printed on one page.



Note

- Available only if rolls are selected in **Paper Source**.
- You can input between 203.2 and 18000.0(mm) (between 8.00 and 708.66(inch)).
- You can change the numbers by clicking either ▲ button or ▼ button.

• Order

Set the object layout order.

The following settings are available for order.

Setting	Details
Upper Left to Right	The objects are laid out from upper left to right.
Upper Left to Bottom	The objects are laid out from upper left to bottom.



Note

- When you have selected **Roll Paper Length > Auto Settings** and **Paper Orientation > Vertical**, you can choose only **Upper Left to Right**.
- When you have selected **Roll Paper Length > Auto Settings** and **Paper Orientation > Horizontal**, you can choose only **Upper Left to Bottom**.

• Paper Size

You can select the size of the print media.



Note

- You cannot display this if **Roll Paper** is selected in **Paper Source**.

Zoom Dialog Box

This dialog box appears when you select **Zoom** from the **View** menu. You can enlarge or reduce the screen display.

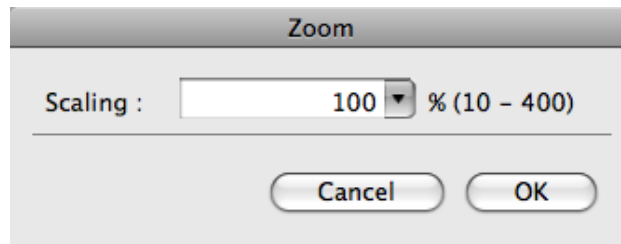

• Scaling

Set the magnification for enlargement or reduction of the screen display.



Note

- You can input between 10 and 400.
- You can change the numbers by clicking ▼ button.

Format Dialog Box

This dialog box appears when you select **Format** from the **Object** menu after you select an object. You can rotate, enlarge, or reduce an object.

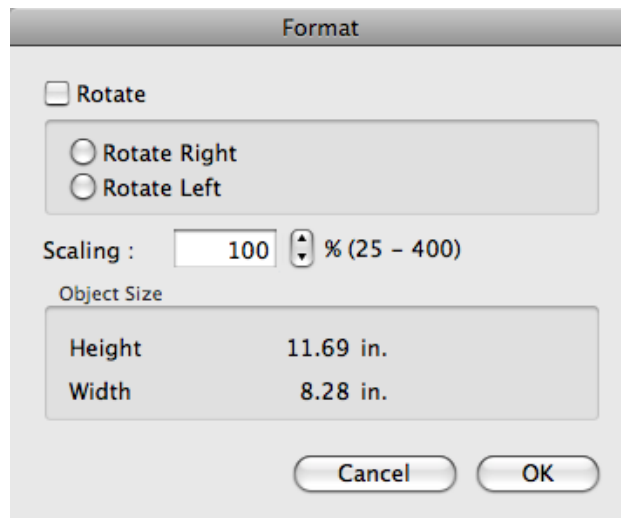

Note

- When the objects are not selected, you can not select **Format**.

• Rotate

When you place a checkmark here, you can select **Rotate Right** or **Rotate Left**.

Setting	Details
Rotate Right	Rotates the object 90 degrees clockwise.
Rotate Left	Rotates the object 90 degrees counterclockwise.



Note

- When several objects are selected, you cannot select **Rotate**.

• Scaling

You can input the value for enlargement or reduction of the object in numerical characters.



Note

- You can input between 25 and 400.
- You can change the numbers by clicking either ▲ button or ▼ button.

• Object Size

You can confirm the object size.



Note

- When several objects are selected, you cannot display **Object Size**.

Laying out a Multiple-File Document on One Page

You can lay out and print a multiple-file document on one page.

- 1 From the application software's **File** menu, select the printer setup menu to open the **Print** dialog box.



Note

- Normally, select **Print** from the **File** menu.

- 2 Click on **Free Layout** in the **Page Setup** panel to attach a checkmark.

- 3 In the **Print** dialog box, select the pages to print and the number of copies, and click the **Print** button. Free Layout starts, laying out the document created with application software in the layout area as an object.

- 4 Leaving Free Layout running, open other files with the application software and repeat the above steps.

Laying out a Document Created with Multiple Application Programs on One Page

You can lay out and print a document created with multiple application programs on one page.

- 1 From the application software's **File** menu, select the printer setup menu to open the **Print** dialog box.



Note

- Normally, select **Print** from the **File** menu.

- 2 Click on **Free Layout** in the **Page Setup** panel to attach a checkmark.

- 3 In the **Print** dialog box, select the pages to print and the number of copies, and click the **Print** button. Free Layout starts, laying out the document created with application software in the layout area as an object.

- 4 Leaving Free Layout running, open the files with other application software and repeat the above steps.

Selecting an Object

When an object is selected, a select box (blue border) appears around the object.

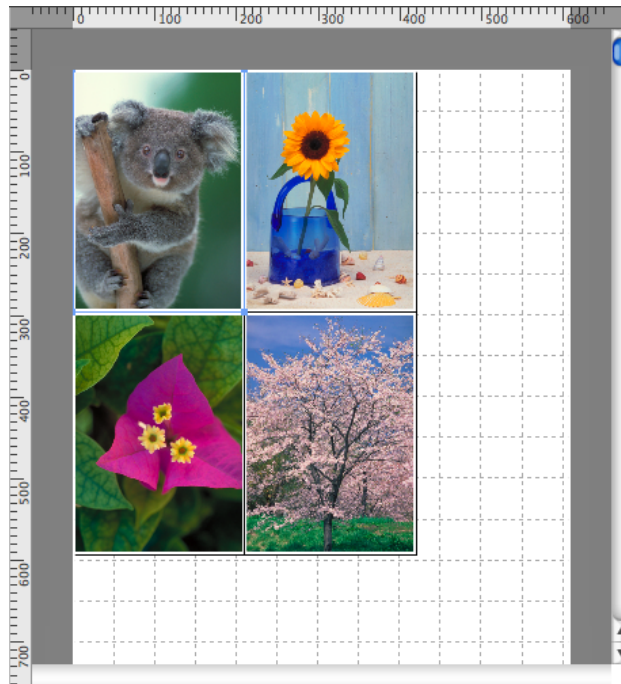

Note

- To select an object, click that object.
- To select multiple successive objects, click them while holding down the shift key.
- To select multiple arbitrary objects, click them while holding down the command key.
- To select all objects, select **Select All** from the **Edit** menu.

Changing the Object Size

You can change the object size by means of mouse operation or by specifying a scaling value.



Note

- The vertical-to-horizontal ratio remains unchanged when the object is enlarged or reduced.

Resizing by means of mouse operation

- 1 Select an object.
- 2 Place the pointer at a corner of the selection box around the object to show the arrow handle, and drag this handle to change the object size.

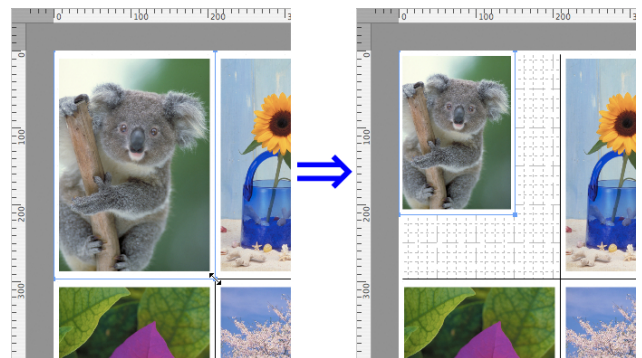

Resizing by specifying a scaling value

- 1 Select an object.
- 2 Open the Format Dialog Box →P.440 .
- 3 Use **Scaling** to set the magnification for enlargement or reduction. You either enter numbers directly.



Note

- You can input between 25 and 400.
- You can change the numbers by clicking either ▲ button or ▼ button.

- 4 Click the **OK** button.

Moving an Object

You can move the object position.

- 1 Select an object.
- 2 Place the pointer inside the selection box of the object to show the crosshair handle, and drag it to move the object.

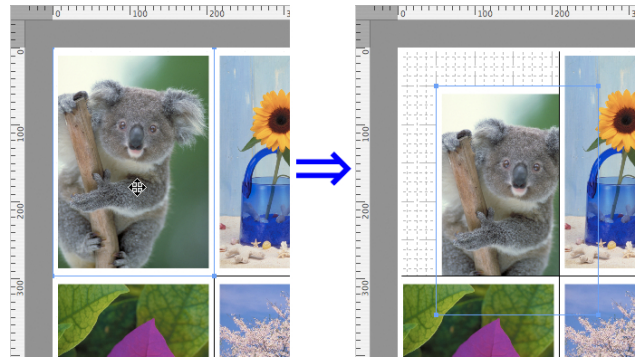

Rotating an Object

You can rotate the object.

- 1 Select an object.
- 2 Select **Rotate Left** or **Rotate Right** from the toolbar. Alternatively, you may click on the **Rotate** check box in the Format Dialog Box →P.440 then select **Rotate Right** or **Rotate Left**, and click the **OK** button.

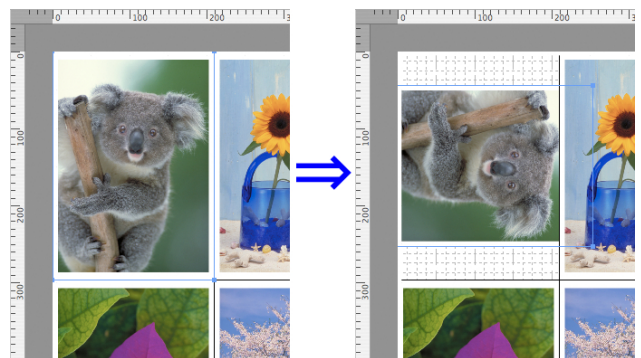

Note

- When several objects are selected, you cannot select **Rotate**.

Laying out Objects Automatically

Click **Auto Arrange** in the tool bar. This automatically lays out objects. Alternatively, you may select **Auto Arrange Object** from the **Object** menu.

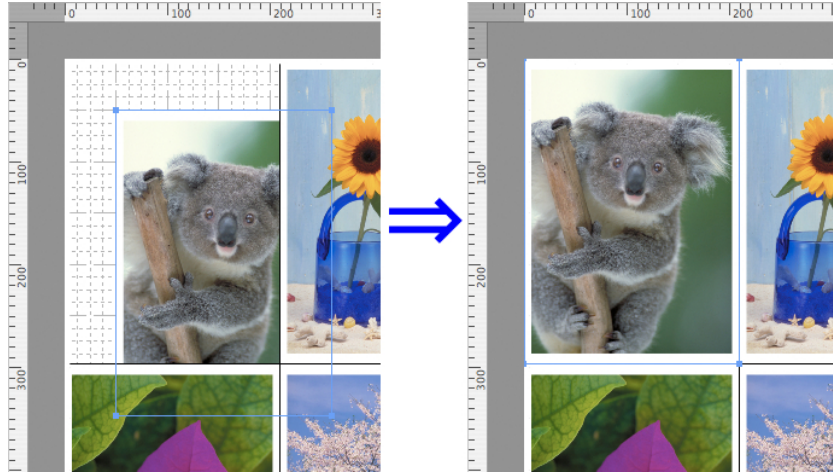

Note

- The object layout order varies depending on the **Order** setting on the Page Setup Dialog Box →P.439 .

Aligning Objects

You can align objects systematically.

- 1 Select multiple objects.
- 2 Select the align menu from the **Object** menu.

- **Align Top**

Lays out the objects, justifying them to the top.

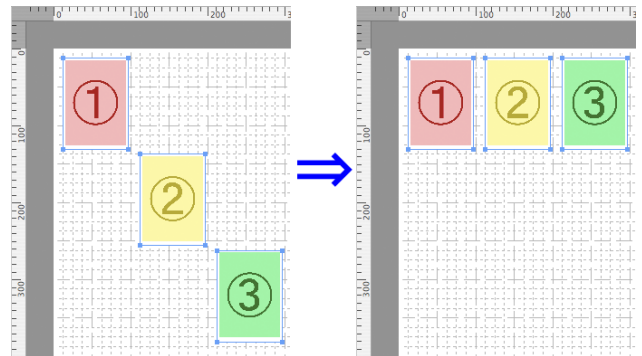

- **Center Vertically**

Lays out the objects, justifying them to the vertical center.

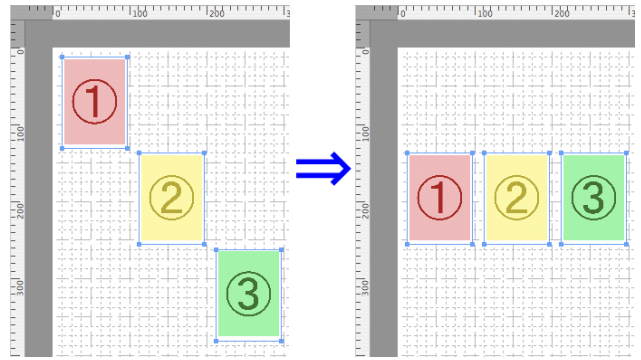

- **Align Bottom**

Lays out the objects, justifying them to the bottom.

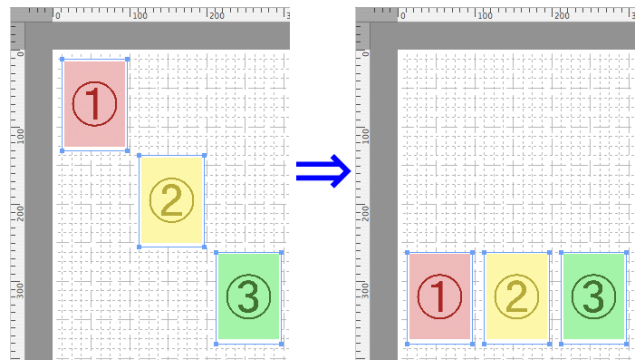

- **Align Left**

Lays out the objects, justifying them to the left.

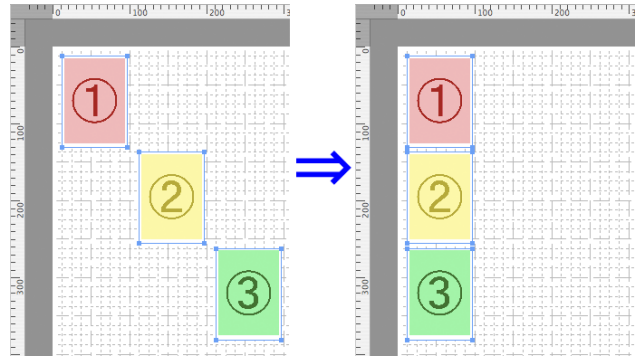

- **Center Horizontally**

Lays out the objects, justifying them to the horizontal center.

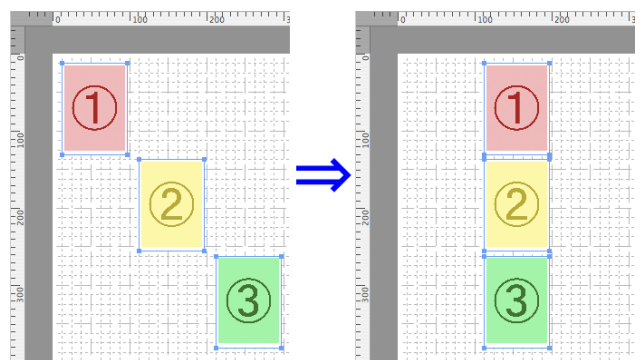

- **Align Right**

Lays out the objects, justifying them to the right.

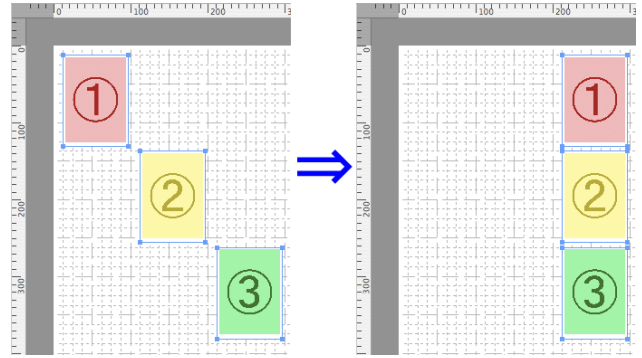

Changing the Object Overlapping Order

You can change the object overlapping order.

- 1 Select an object.
- 2 Select the overlapping order menu from the **Object** menu.

- **Bring to Front**

Moves the object to the frontmost position.

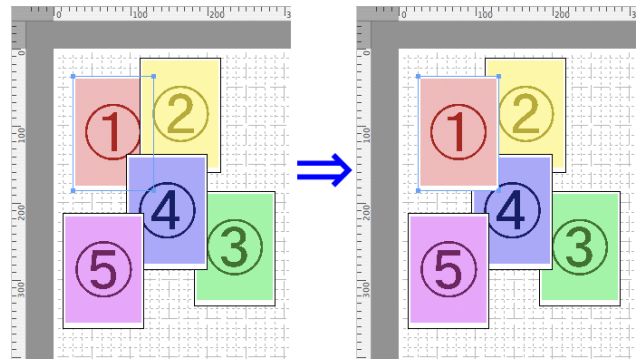

- **Send to Back**

Moves the object to the backmost position.

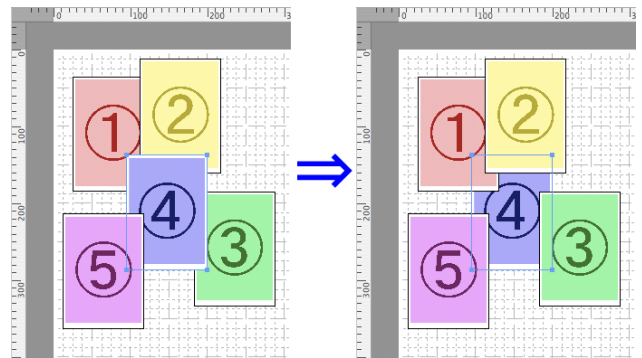

- **Bring Forward**

Moves the object one position to the front.

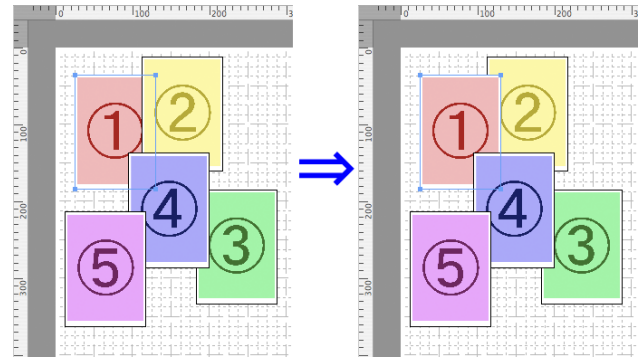

- **Send Backward**

Moves the object one position to the back.

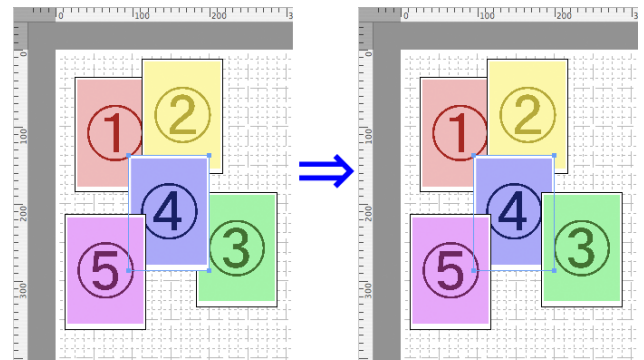

Pasting a Copied or Cut Object

- 1 Click **Copy** or **Cut** from the toolbar.
Alternatively, you may select **Copy** or **Cut** from the **Edit** menu.
- 2 Click **Paste** from the toolbar.
Alternatively, you may select **Paste** from the **Edit** menu.



Note

- The copied or cut object is laid out at the end of the page.

Color imageRUNNER Enlargement Copy

- The Features of Color imageRUNNER Enlargement Copy 448
- Starting Color imageRUNNER Enlargement Copy 449
- Color imageRUNNER Enlargement Copy Dialog Box 450
- Hot Folder 450
- Creating a New Hot Folder 451
- Editing a Hot Folder (Setting Print Conditions) 452
- Deleting a Hot Folder 454
- Setting the Print Parameters 455
- Paper Settings Panel 455
- Easy Settings 457
- Advanced Settings 458
- Output Settings Panel 459
- Color Settings Panel 461
- Driver Matching Mode 462
- ICC Matching Mode 463
- Printing Enlargements of Scanned Originals from a Color imageRUNNER 463

The Features of Color imageRUNNER Enlargement Copy

The main features of Color imageRUNNER Enlargement Copy are as follows.

- Allows the document scanned with the Color imageRUNNER to be automatically enlarged and printed.
- You can perform basic printer settings such as printer selection, media type and output profile selection, and matching methods, in addition to borderless printing and enlargement/reduction process without growing through the printer driver.





- The media type, image size, detailed media settings, and the printer settings can cause the actual print output to differ from the Color imageRUNNER Enlargement Copy settings.

Starting Color imageRUNNER Enlargement Copy

Follow the procedure below to start the Color imageRUNNER Enlargement Copy.

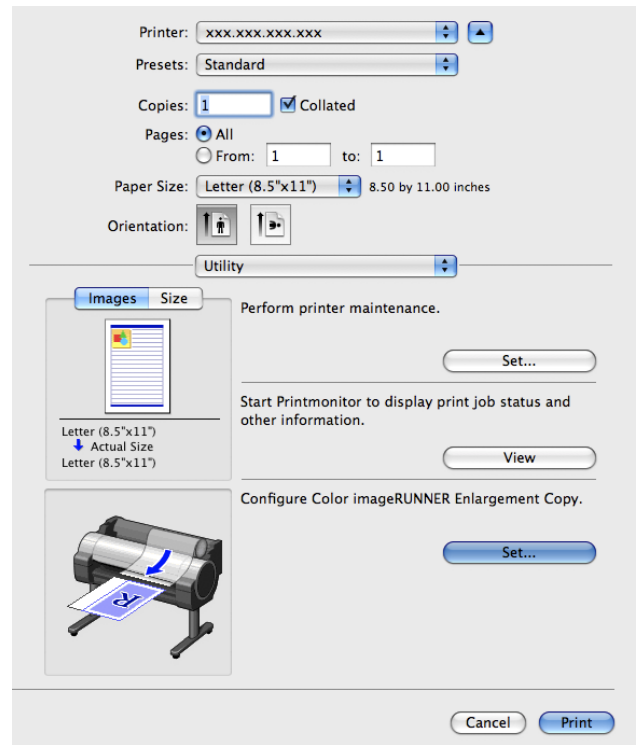
- 1 Open the **Utility** panel of the **Print** dialog box.



-  • Your printer is depicted in the lower-left area of this screen.
- Note

- 2 Click the **Set** button in **Configure Color imageRUNNER Enlargement Copy**, to open the **Color imageRUNNER Enlargement Copy** dialog box.

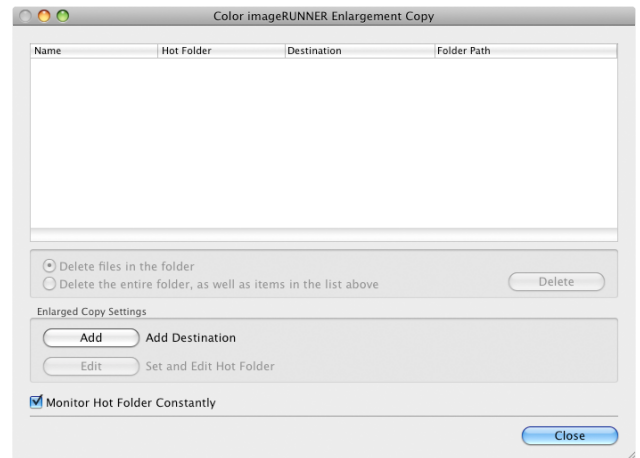

-  • You can also start the utility directly by clicking on the **Color imageRUNNER Enlargement Copy.app** icon in **Applications > Canon Utilities > iR Enlargement Copy**.
- Note
- If you are using Mac OS X v10.7 and later, start it from Launchpad.

Color imageRUNNER Enlargement Copy Dialog Box

The explanation below is on the **Color imageRUNNER Enlargement Copy** dialog box.

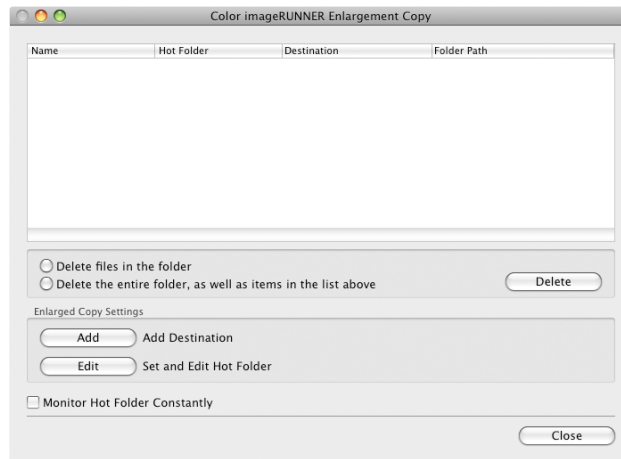

Note

- For the step to open the **Color imageRUNNER Enlargement Copy** dialog box, see "Starting Color imageRUNNER Enlargement Copy." →P.449

• Delete files in the folder

From the Hot Folder list, select a hot folder and click the **Delete** button to delete only files in the hot folder.

• Delete the entire folder, as well as items in the list above

From the Hot Folder list, select a hot folder and click the **Delete** button to delete the hot folder.

• Delete Button

Select **Delete files in the folder** or **Delete the entire folder, as well as items in the list above** and click this button to delete the hot folder or only files in the hot folder.

• Add Button

Click the button to open the **Destination Selection** dialog box so that you can add a hot folder.

• Edit Button

From the Hot Folder list, select a hot folder and click this button to open the **Add/Edit Hot Folder** dialog box that allows you to edit the hot folder.

• Monitor Hot Folder Constantly

If the check box is selected, the Hot Folder is monitored from after the next login.

Hot Folder

Hot folder refers to a folder used for Color imageRUNNER Enlargement Copy.

- When transferred to the PC's hot folder, the document data scanned with the Color imageRUNNER is printed in enlarged size from the printer according to the print conditions set in the hot folder.
- You can create a new hot folder, edit or delete an existing one, and set print conditions at will.



Note

- You can create up to 10 hot folders.

Creating a New Hot Folder

- 1 Open the **Color imageRUNNER Enlargement Copy** dialog box.

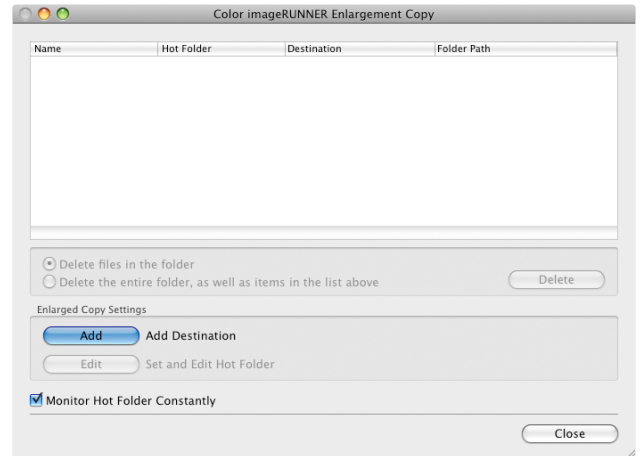

Note

- For the step to open the **Color imageRUNNER Enlargement Copy** dialog box, see "Starting Color imageRUNNER Enlargement Copy." →P.449

- 2 Click the **Add** button in **Enlarged Copy Settings** to open the **Destination Selection** dialog box.

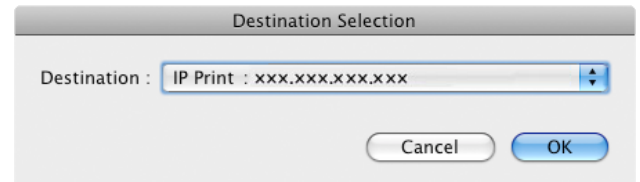

- 3 From the printer list in **Destination**, select the printer of destination.

- 4 Click the **OK** button to open the **Add/Edit Hot Folder** dialog box.

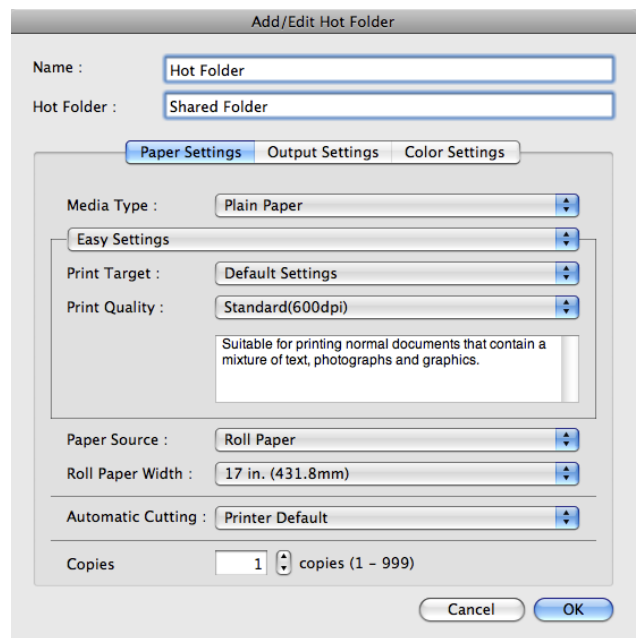

- 5 In **Name**, enter the name to display in the Hot Folder list.

- 6 In **Hot Folder**, enter the Hot Folder name.

- 7** Click the **OK** button. The created Hot Folder is listed in the **Color imageRUNNER Enlargement Copy** dialog box.

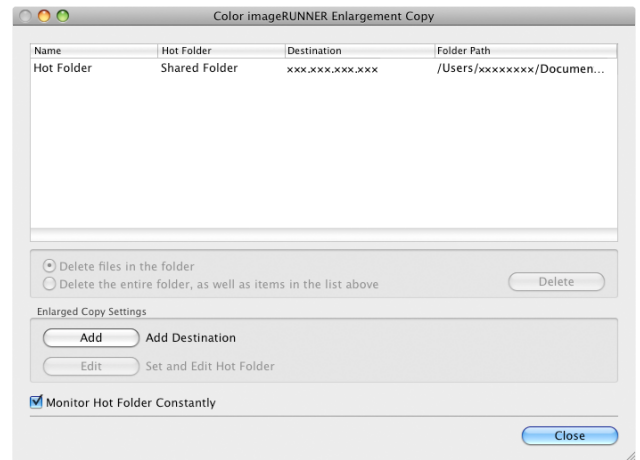

- 8** Click the **Close** button to close the **Color imageRUNNER Enlargement Copy** dialog box.

- 9** From the **Apple** Menu, open the **Sharing** dialog box for **System Preferences**.

- 10** For Mac OS X v10.5-v10.6:
Check the **File Sharing** checkbox and click the **Options** button.
Check the **Share files and folders using FTP** and **Share files and folders using SMB** checkboxes to configure the sharing.
For Mac OS X v10.7 and later:
Check the **File Sharing** checkbox and click the **Options** button.
Check the **Share files and folders using SMB** checkbox to configure the sharing.

 • You can create up to 10 hot folders.
Note

Editing a Hot Folder (Setting Print Conditions)

- 1** Open the **Color imageRUNNER Enlargement Copy** dialog box.

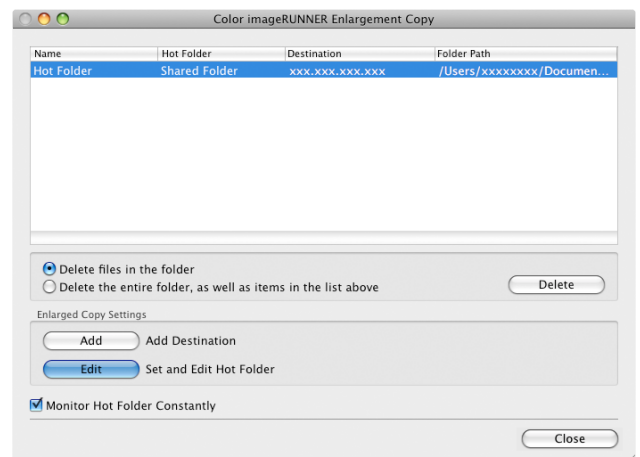

- 2** Select the Hot Folder from the Hot Folder list.

- 3** From **Enlarged Copy Settings**, click **Edit** button to open the **Add/Edit Hot Folder** dialog box.

- 4** Make the necessary settings in the Paper Settings Panel →P.455 .

The screenshot shows the 'Add/Edit Hot Folder' dialog box with the 'Paper Settings' tab selected. The 'Name' field is 'Hot Folder' and the 'Hot Folder' field is 'Shared Folder'. The 'Paper Settings' tab is active, showing the following options:

- Media Type: Plain Paper
- Easy Settings: (Expanded)
 - Print Target: Default Settings
 - Print Quality: Standard(600dpi)
 - Suitable for printing normal documents that contain a mixture of text, photographs and graphics.
- Paper Source: Roll Paper
- Roll Paper Width: 17 in. (431.8mm)
- Automatic Cutting: Printer Default
- Copies: 1 copies (1 - 999)

Buttons: Cancel, OK

- 5** Make the necessary settings in the Output Settings Panel →P.459 .

The screenshot shows the 'Add/Edit Hot Folder' dialog box with the 'Output Settings' tab selected. The 'Name' field is 'Hot Folder' and the 'Hot Folder' field is 'Shared Folder'. The 'Output Settings' tab is active, showing the following options:

- Enlarged/Reduced Printing
 - Fit Media Size
 - Fit Roll Paper Width
 - Scaling: 100 % (5 - 600)
 - Borderless Printing
- Paper Size: ISO A4
- Print Centered
- No Spaces at Top or Bottom
- Rotate Page
 - Rotate Right 90 Degrees
 - Rotate Left 90 Degrees
 - Rotate 180 degrees

Buttons: Cancel, OK

6 Make the necessary settings in the Color Settings Panel →P.461 .

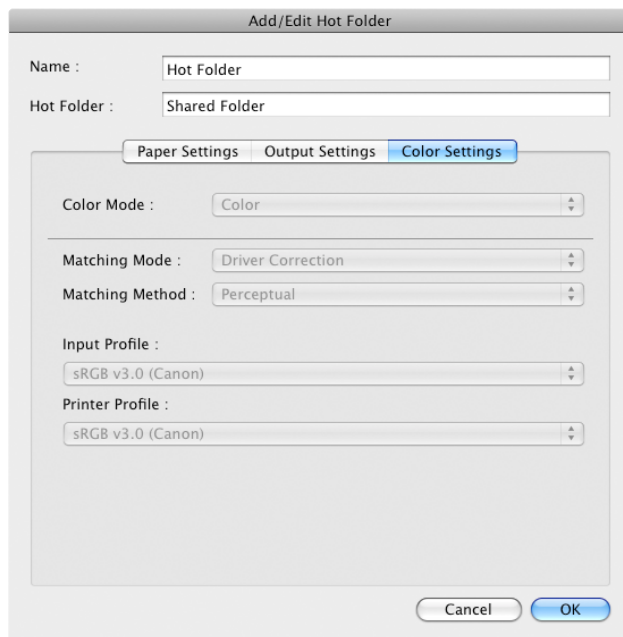

7 Click the **OK** button to close the **Add/Edit Hot Folder** dialog box.

8 From the **Apple** Menu, open the **Sharing** dialog box for **System Preferences**.

9 For Mac OS X v10.5-v10.6:
 Check the **File Sharing** checkbox and click the **Options** button.
 Check the **Share files and folders using FTP** and **Share files and folders using SMB** checkboxes to configure the sharing.
 For Mac OS X v10.7 and later:
 Check the **File Sharing** checkbox and click the **Options** button.
 Check the **Share files and folders using SMB** checkbox to configure the sharing.



• If you've made shared settings when you created a new Hot Folder, you do not need to execute steps 8 to 9.

Note

Deleting a Hot Folder

1 Open the **Color imageRUNNER Enlargement Copy** dialog box.

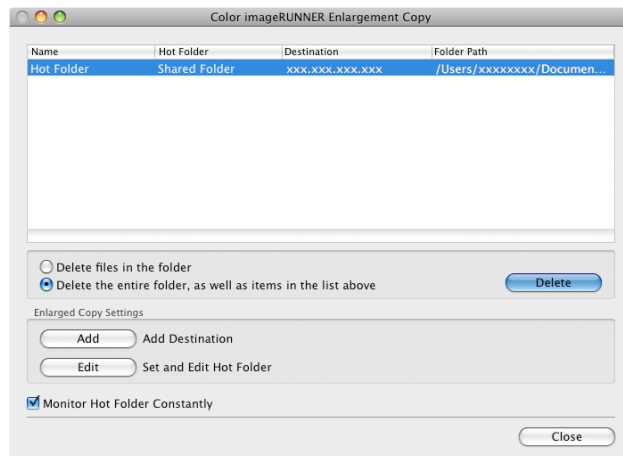

2 Select the Hot Folder you want to delete from the Hot Folder list.

3 Select **Delete the entire folder, as well as items in the list above**, and then click the **Delete** button.

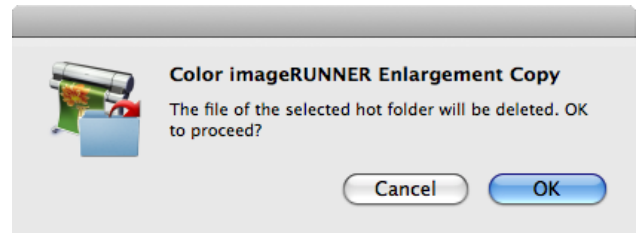

4 Read the message and then click the **OK** button.



Note

- Select **Delete files in the folder** to delete only files in the hot folder.

Setting the Print Parameters

You can set the print conditions in the setting panels within the **Add/Edit Hot Folder** dialog box. The settings available on each panel are as follows.

- Paper Settings Panel →P.455
- Output Settings Panel →P.459
- Color Settings Panel →P.461

Paper Settings Panel

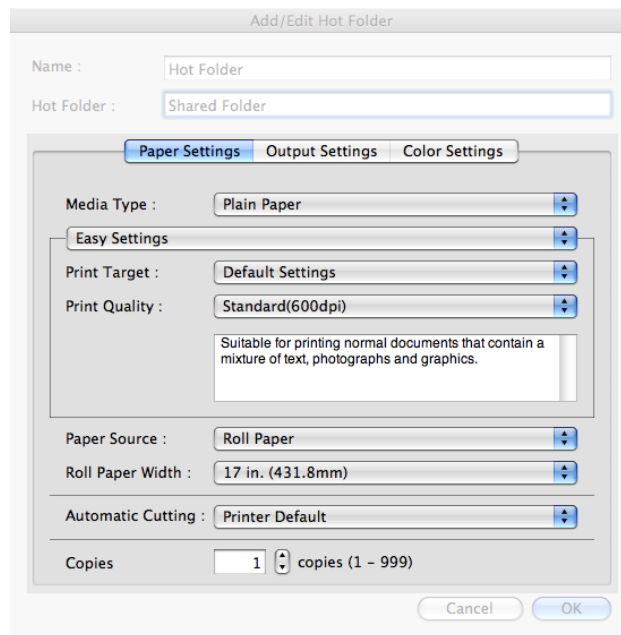

• Easy Settings / Advanced Settings

Two modes are available to provide the optimum print settings for jobs. The settings available on each mode are as follows.

- Easy Settings →P.457
- Advanced Settings →P.458

• Media Type

This allows you to select the media type.



- Always select media type that is actually set in the printer. When the media you chose is different from the media set in the printer, you may not receive the desired print results.

• Paper Source

You can select the paper source.

The following settings are available for paper source.

Setting	Details
Cut Sheet	Select to print on the cut sheet.
Roll Paper	Select to print on roll paper.

• Roll Paper Width

This selects the width of the roll media set to the printer.



- Available only if rolls are selected in **Paper Source**.

• Automatic Cutting

You can set the printer to cut roll paper automatically or print a guideline for cutting.

The following settings are available for automatic cutting.

Setting	Details
Printer Default	The value set on the printer operation panel takes priority.
None	Each page is not cut after it is printed and printing continues without interruption.
Print Cut Guideline	A print cut guideline is printed after each page and printing continues without interruption.



- Available only if rolls are selected in **Paper Source**.

• Copies

You can input the number of print copies in numerical characters.



- The maximum value is 999.
- You can change the numbers by clicking either ▲ button or ▼ button.

Easy Settings

You can easily select the best settings for the print job by just selecting an item from the print target list that matches the content of the document.

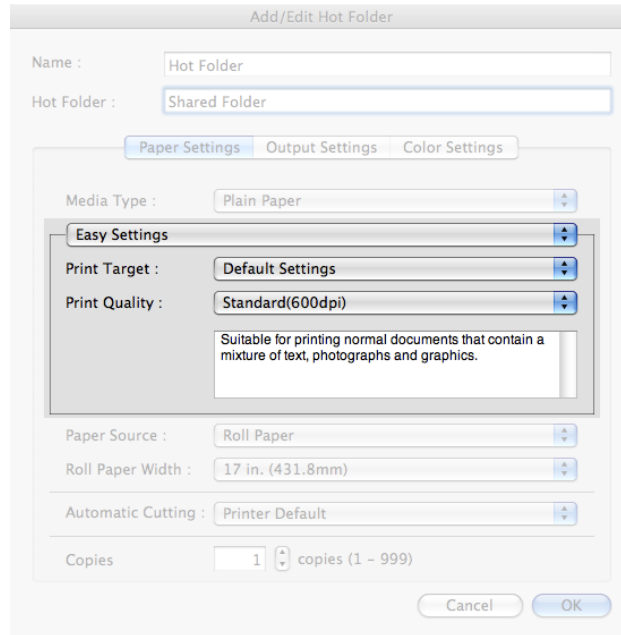

• Print Target

You can easily select the best settings for the print job simply.

If you select each **Print Target** item the corresponding comment for that item is displayed below the list.

Setting	Details
Default Settings	Suitable for printing normal documents that contain a mixture of text, photographs, and graphics.
Photo (Color)	Suitable for printing photographic images captured with a digital camera.
Photo (Monochrome)	Suitable for optimized printing of monochrome photos.
Poster	The best setting for posters. Prints using vivid and high impact colors.
Faithful Color Reproduction	Prints by faithfully reproducing the colors of the original image.
CAD (Color Line Drawing)	Prints the fine lines of CAD drawings and other such documents sharp and clear.
Perspective, GIS	Suitable for attractive printing of 3D-CAD drawings, perspective drawings, and GIS drawings including maps.
Office Document	Suitable for printing handouts as well as general office documents for which print clarity is key.
Custom Settings	Suitable for printing documents for which Advanced Settings have been specified.



Note

- The number of settings available for selection depends on the media type.

• Print Quality

Selecting print quality strikes a balance between the quality of the printed image and printing speed.

The level of the print quality and resolution settings are displayed in the following combinations.

Setting	Details
Print Quality	High / Standard / Fast
Resolution	600dpi / 300dpi



Note

- The availability of settings is determined by the media type and print priority selections.
- Printing time is longer and more ink is consumed with **High** than with **Fast**, however, print quality is higher.
- Printing time is shorter and less ink is consumed with **Fast** than with **High**, however, print quality is lower.

Advanced Settings

Presents detailed settings for the print priority, the print quality, and other items so you can select the values for these settings yourself.

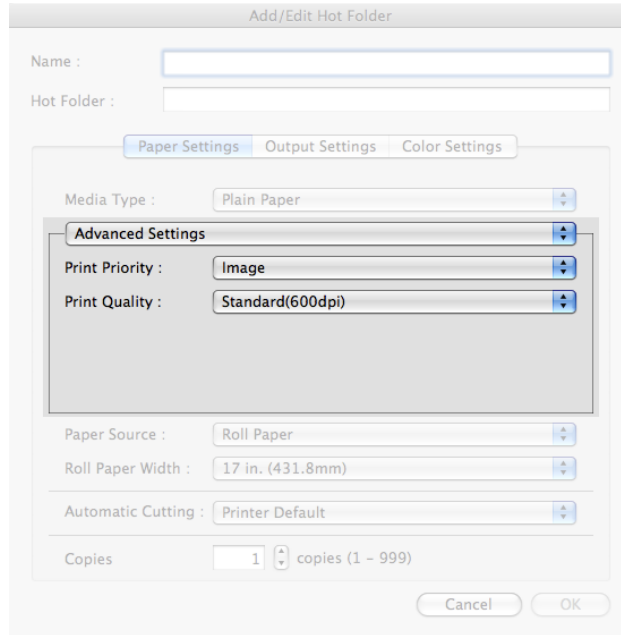

• Print Priority

Select a print quality mode that is appropriate for the print job.

Setting	Details
Image	This mode achieves the best results for printing photographic images and illustrations.
Line Drawing	This mode is best for printing CAD drawings with fine lines or wall newsheet or other documents that contain large amounts of text. However, you may not achieve the quality you expect with printing photographs or other images with many filled areas. For these types of jobs, select Image .
Proof	This is a setting for enhancing the reproducibility of characters, illustrations, and photos with print proofing. However, this takes more time than regular printing.
Office Document	Prints common office documents, such as proposals, memos for distribution, etc., so they are easy to read.



Note

- The number of settings available for selection depends on the media type.

• Print Quality

Selecting print quality strikes a balance between the quality of the printed image and printing speed.

The level of the print quality and resolution settings are displayed in the following combinations.

Setting	Details
Print Quality	High / Standard / Fast
Resolution	600dpi / 300dpi



- The availability of settings is determined by the media type and print priority selections.
- Note** • Printing time is longer and more ink is consumed with **High** than with **Fast**, however, print quality is higher.
- Printing time is shorter and less ink is consumed with **Fast** than with **High**, however, print quality is lower.

Output Settings Panel

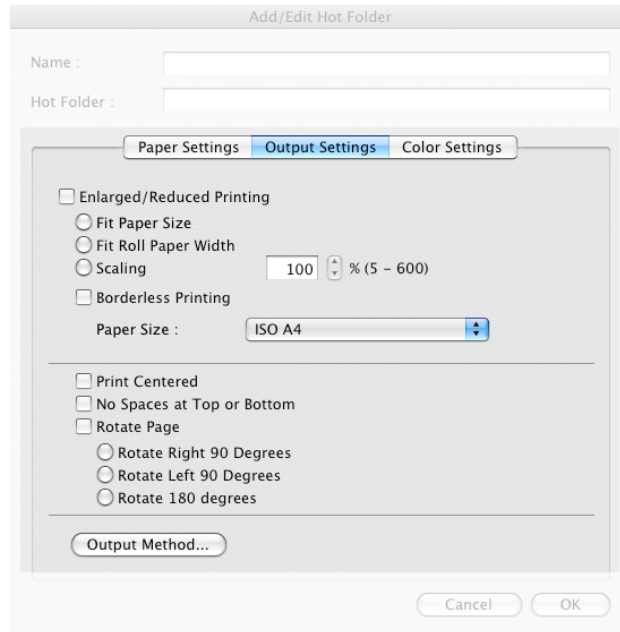

• Enlarged/Reduced Printing

Select the method for enlarged/reduced printing.

The following settings are available for enlarged/reduced printing.

Setting	Details
Fit Paper Size	Enlarges/reduces the whole page automatically to fit the media size selected for output. Select the media size to print from Paper Size .
Fit Roll Paper Width	Enlarges/reduces the whole page automatically to fit the width of the roll paper with the page width. *Make sure that the width of the roll paper in the printer is set correctly for Roll Paper Width in the Paper Settings panel. *Displayed only if rolls are selected in Paper Source .
Scaling	Enlarges/reduces the whole page by the scaling rate as specified. Input the scaling value in numerical characters. You can specify a range between 5 and 600%. *You can change the numbers by clicking either ▲ button or ▼ button. *Although Scaling can be set to make the image larger than the media size, the part that does not fit in the media cannot be printed. *This is not displayed when a checkmark is placed in Borderless Printing .

• Borderless Printing

You can print the media without margins on all sides when the roll paper with the specific width and the specific media type is used.



- Available only if rolls are selected in **Paper Source**.
- Note**

• Paper Size

You can select the size of the print media.



Note

- This is not displayed when **Fit Roll Paper Width** is set in **Enlarged/Reduced Printing**.

• Print Centered

Select this feature to print the image in the center of a cut sheet or to print left and right margins evenly from the edges of roll paper.



Note

- This feature is useful when you print the document enlarged or reduced with **Scaling** as well. When an image is scaled, it is always enlarged or reduced in reference to a starting point in the upper left corner of the page. If the image is reduced, the bottom and right margins are enlarged and the top and left margins remain unchanged. At that point, you can set all margins evenly with this feature.

• No Spaces at Top or Bottom

You can set the printer to print without any empty area when the print data contains empty area at the top or bottom. Since the printer does not feed paper over the empty area, you can save paper.



Note

- Available only if rolls are selected in **Paper Source**.

• Rotate Page

Select the method for rotating page.

The following settings are available for rotating page.

Setting	Details
Rotate Right 90 Degrees	Rotates the portrait page right 90 degrees and print in landscape orientation. When the rotated page can fit in the width of roll paper, the page is rotated automatically, and when it can not fit in the width of roll paper, the page is not rotated. *When Fit Roll Paper Width is selected under Enlarged/Reduced Printing , then the image is enlarged or reduced after rotating to fit the width of the roll paper.
Rotate Left 90 Degrees	Rotates the portrait page left 90 degrees and print in landscape orientation. When the rotated page can fit in the width of roll paper, the page is rotated automatically, and when it can not fit in the width of roll paper, the page is not rotated. *When Fit Roll Paper Width is selected under Enlarged/Reduced Printing , then the image is enlarged or reduced after rotating to fit the width of the roll paper.
Rotate 180 degrees	Allows you to rotate the image 180 degrees from the vertical to the right.



Note

- Available only if rolls are selected in **Paper Source**.

• Output Method Button

Click the button to open the **Output Method** dialog box.

In this dialog box, you can specify the object output method.

Color Settings Panel

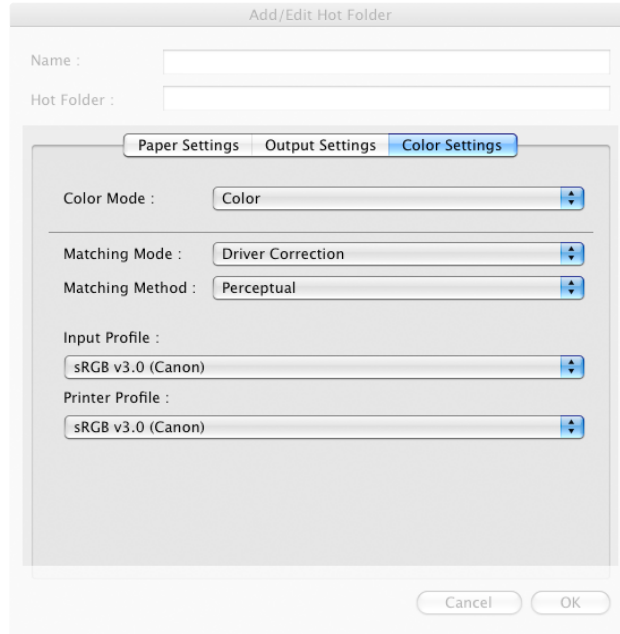

• Color Mode

You can select a color mode to suit the print job.

Setting	Details
Color	Enables color printing.
Monochrome (Photo)	Prints monochrome photo image data in a gray scale that is free of color casting (phenomenon of grays that appear tinted).
Monochrome	Disables color printing and converts image from continuous color to grayscaled monochrome.



Note

- The availability of settings depends on the print priority and media type selections.

• Matching Mode

Under **Matching Mode**, select the matching mode.

Setting	Details
Driver Matching Mode →P.462	Enables printing of optimal color tones using a driver specific color profile. You should normally select this mode.
ICC Matching Mode →P.463	Enables color matching using ICC profiles. Select this if you want to print by specifying the input profile, printer profile, and matching method in detail. This allows you to use ICC profiles for digital cameras and scanners, ICC profiles created using the profile creation tool, etc.
No Correction	No color matching is performed. Select this option when you want to perform color matching in the software application.

Driver Matching Mode

- Under **Matching Mode**, select **Driver Matching Mode**.

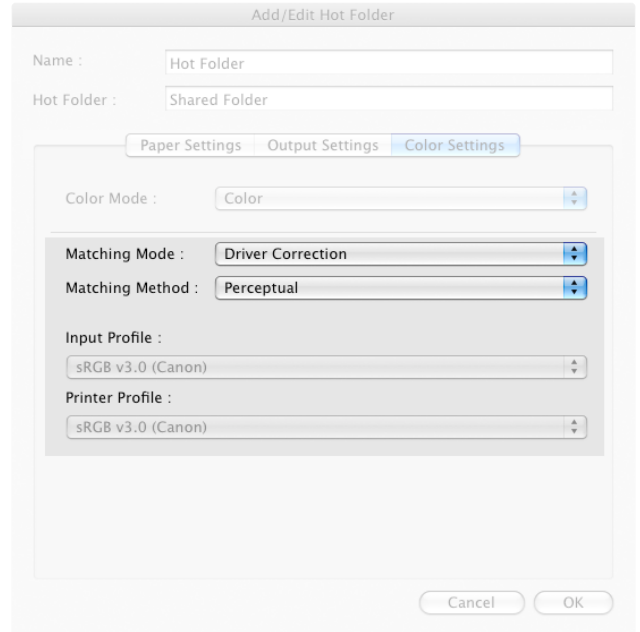

- Click **Matching Method** list, and then select a setting.

Setting	Details
Auto	Automatically selects the best color matching method for each Image, Graphics, Text.
Perceptual	Color-matching optimized for printing typical photos attractively. Smooth gradation is a feature. This is also an easy-to-use mode when performing color adjustment using application software.
Saturation	Color-matching optimized for printing posters, etc., vividly.
Colorimetric	Color-matching optimized for printing image data with accurate colors in input color space. This is the easiest-to-use mode when you want to adjust the color and print. However, gradation may be lost for colors of wider range than the color reproduction range of the printer. Generally, this is also called relative colorimetric.

ICC Matching Mode

- Under **Matching Mode**, select **ICC Matching Mode**.

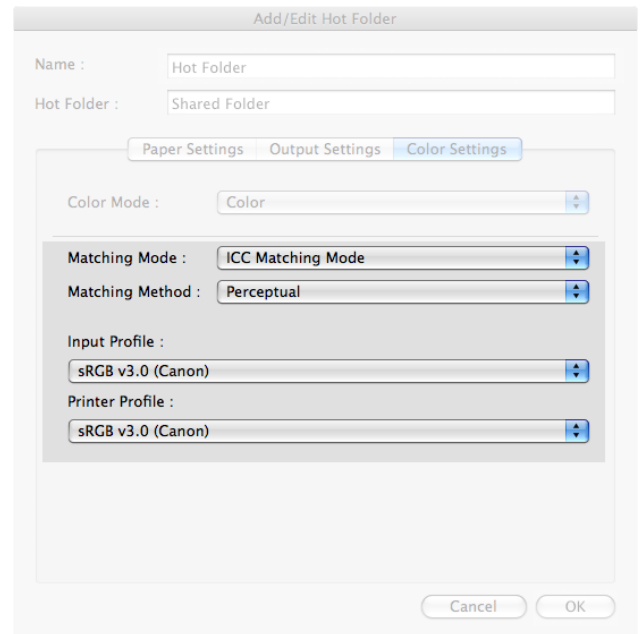

- Click **Matching Method** list, and then select a setting.

Setting	Details
Perceptual	Color-matching optimized for printing typical photos attractively. Smooth gradation is a feature. This is also an easy-to-use mode when performing color adjustment using application software.
Saturation	Color-matching optimized for printing posters, etc., vividly.
Colorimetric	Color-matching optimized for printing image data with accurate colors in input color space. This is the easiest-to-use mode when you want to adjust the color and print. However, gradation may be lost for colors of wider range than the color reproduction range of the printer. Generally, this is also called relative colorimetric.
Colorimetric (No White-Point Correction)	The processing method of color-matching is identical to Colorimetric . Use this when you want to further reproduce the target paper material color of the image data. Generally, this also is called absolute colorimetric.

- Click the **Input Profile** list, and then select an input profile.



Note

- To match the color on the printing, select the input profile for Color imageRUNNER Enlargement Copy of the Color imageRUNNER type in use.

- Click the **Printer Profile** list, and then select a printer profile.

Printing Enlargements of Scanned Originals from a Color imageRUNNER

Scanned originals from a Color imageRUNNER can be enlarged and printed automatically. Originals you create by scanning with a Color imageRUNNER are transferred to a "hot folder" and printed automatically after enlargement according to printing conditions you specify for that folder. This processing sequence is called the Color imageRUNNER Enlargement Copy function. To use Color imageRUNNER Enlargement Copy, first complete these settings in the following order.

- Register a hot folder on your computer.
Register a hot folder on your computer for storing scanned originals from the Color imageRUNNER and complete the settings for enlargement copy. For details, see "Creating a New Hot Folder." →P.451

2. Complete the scanning settings on the Color imageRUNNER.
Configure the Color imageRUNNER to send scanned originals to the hot folder.

After these settings are complete, you can print enlarged copies of scanned originals from the Color imageRUNNER.

Completing the scanning settings on the Color imageRUNNER.

Configure the Color imageRUNNER to send scanned originals to the hot folder. It is easy to send scanned originals to the hot folder if you assign the scanning settings and destination to a **Favorites** button on the Color imageRUNNER. For instructions on assigning scanning and sending settings to the **Favorites** button, refer to the Color imageRUNNER manual.

Scanning the original and print an enlargement

Follow the steps below to scan an original on the Color imageRUNNER for enlarged printing on the printer. For detailed instructions, refer to the Color imageRUNNER manual.

- 1 Load the original on the platen glass or document feeder of the Color imageRUNNER.
- 2 Press **Send** to display the screen for transmission.
- 3 Press **Favorites**, and then press the **Favorites** button assigned to the hot folder.
- 4 Press **Start** on the control panel. If you scan originals on the platen glass, after scanning all originals, press **Done** on the touch-panel display.
Scanned originals are sent to the hot folder and automatically enlarged and printed following the conditions you specified for the folder.

Print Plug-In for Photoshop / Digital Photo Professional

Features of the Print Plug-In for Photoshop/Digital Photo Professional	466
Installation Procedures	466
Uninstall Procedures	468
Starting from Photoshop	470
Starting from Digital Photo Professional	470
Print Plug-In for Photoshop/Digital Photo Professional Main Window	471
Preview Area	473
Main Sheet	474
Page Setup Sheet	477
Color Settings Sheet (Color)	479
Color Settings Sheet (Monochrome)	480
Print History Sheet	481
Support Sheet	482
Adjustment pattern setting dialog box	483
Paper Detailed Settings Dialog Box	487
Set Configuration Dialog Box	488
ICC Conversion Options dialog box	489
Roll Paper Options Dialog Box	490
Size Options Dialog Box	491
Curves Dialog Box	492
Print History Details Dialog Box	493
Utilize Three Types of Previews	494
Check Image with Print Area Layout	494
Check the original image with Image	495
Check Image with Roll Paper Preview	495
Print with a Desired Picture Quality	496
Adjust the Colors and Print	497
Adjust the Colors while Checking the Preview (for Color)	497
Adjust the Colors while Checking the Preview (for Monochrome)	498
Adjust the Colors by Color Matching	501
Print High-Quality Adobe RGB16bit Images	502
Prints monochrome photographs with high quality	503
Using Adobe CMM	503
Printing an Adjustment Pattern and Selecting Adjustment Values	505
Perform Black Point Compensation	506
Perform Printing Press Simulation Print	507
Enlarge/Reduce and Print	508
Enlarge/Reduce and Print Matching Output Media Size	508
Enlarge/Reduce and Print Matching Width of Roll Paper	509
Specify Scaling, Enlarge/Reduce and Print	510
Print with No Borders	511
Customize Media Settings	512
Utilize Print History	512
Confirm Print History Details	513
Apply Print History to an Image	514
Store Print History to Print Preferences	514
Delete Print History	516
Export Print History from Print Preferences	517
Import Print History to Print Preferences	518
Delete Print History from Print Preferences	520
Set Information to Print with Image	521

Features of the Print Plug-In for Photoshop/Digital Photo Professional

The main features of the Print Plug-In for Photoshop/Digital Photo Professional are as follows.

- You can automatically detect the color space of Adobe RGB or sRGB-use images, etc., and automatically set optimal profiles. Thus, you can print without the trouble of configuring settings.
- You can modify image data directly in Photoshop and send the image data to the printer. This allows you to process not only 8-bit, but also 16-bit image data.
- By using the preview function for images based on real images, and the preview function for layouts based on image positioning by media size, you can use this software to make color adjustments and confirm print layout.
- You can perform basic printer settings such as printer selection, media type and output profile selection, and matching methods, in addition to borderless printing and enlargement/reduction process without growing through the printer driver.
- You can print an image with adjustment values such as the color balance, brightness, and contrast varying in steps and select your preferred adjustment values. (See "Adjustment pattern setting dialog box.") →P.483
- You can create and print a layout image for finishing by mounting in a frame with the image extended to the sides of the frame by using the Layout Plug-In that is installed at the same time as the Print Plug-In for Photoshop. (See "About the Layout Plug-In.") →P.523
- By using the print history management function, you can import past print settings parameters. Additionally, you can save preferences as a file.



Note

- The actual output may differ from the settings in Print Plug-In for Photoshop/Digital Photo Professional (the arrangement of the image in the layout preview, print start position, and paper size) depending on the media type, image size, paper detailed settings, and printer main unit settings.

- Loss of gradation in dark areas can be reduced by performing black point compensation.



Note

- Adobe CMM is required in order to use the black point compensation function.

- You can perform a printer simulation print by specifying the printer profile.

Installation Procedures

The procedures to install Print Plug-In for Photoshop/Digital Photo Professional are as follows.



Note

- Always install the printer driver before installing the Print Plug-In for Photoshop/Digital Photo Professional.
- The Layout Plug-In is also installed when the Print Plug-In for Photoshop is installed.

1 Insert the User Software CD-ROM into the CD-ROM drive to start the installer.

2 Click on the **iPFxxxx PlugIn InstallerX** icon in the **Plug-in** folder in the User Software CD-ROM.



Note

- The iPFxxxx icon is the name of the printer you are using.

- 3** Input the Administrator name and password and click the **OK** button.



- 4** After you have read the software User's Licensing Agreement, click the **Continue** button.

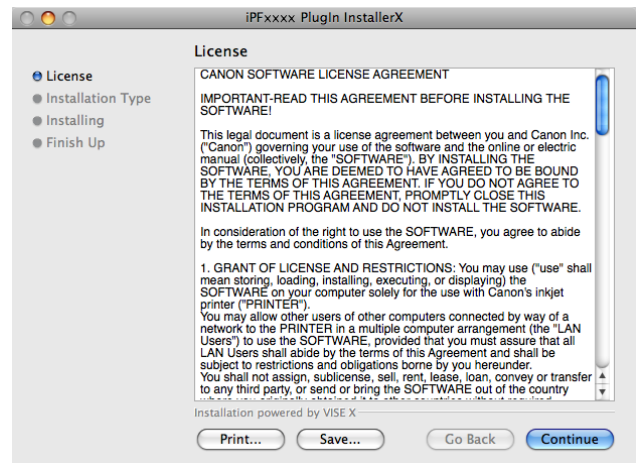

- 5** Click the **Agree** button.

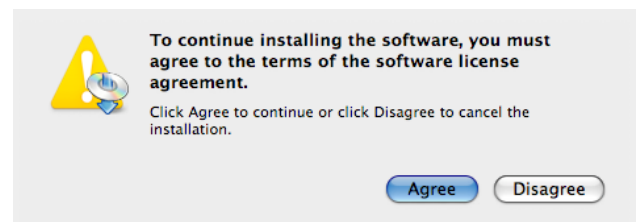

- 6** Select **Custom Install** to put a checkmark on your Print Plug-In, then click the **Install** button.

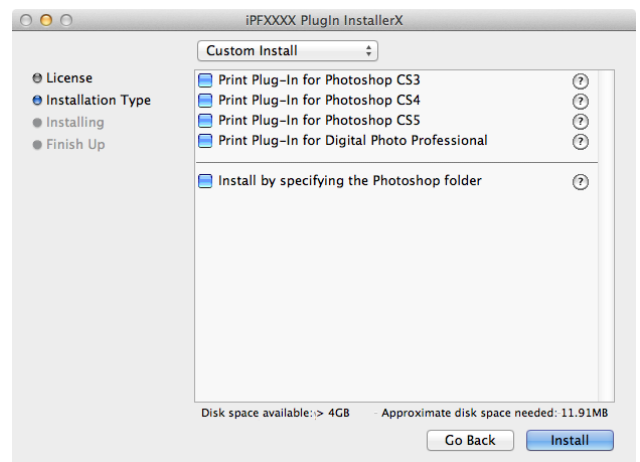

7 To quit another application, click the **Continue** button.

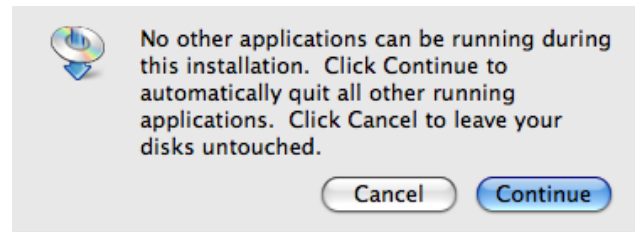

8 Click the **Quit** button.

The Print Plug-In for Photoshop/Digital Photo Professional installation is complete.

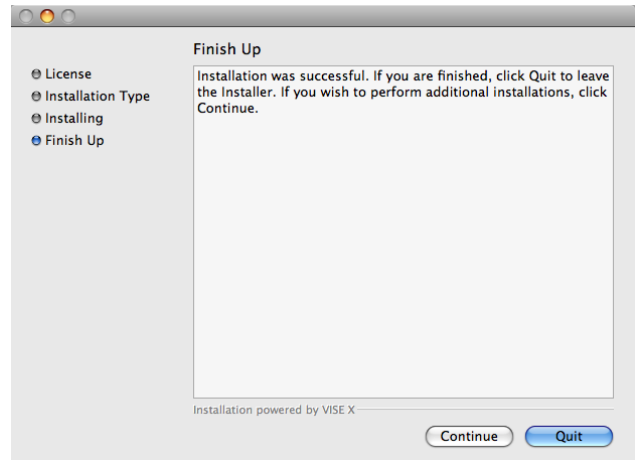

Uninstall Procedures

The procedures for uninstalling the Print Plug-In for Photoshop/Digital Photo Professional are as follows.

- Uninstall Print Plug-In for Photoshop
 - 1.** Close Photoshop.
 - 2.** In Finder, display the **Print Plugin for iPFxxxx** folder.
 - 3.** Delete the **Print Plugin for iPFxxxx** folder.



Note

- iPFxxxx is the name of your printer.

- Uninstall Print Plug-In for Digital Photo Professional
 - 1.** Perform the installation procedures 1 through 5.

2. Select **Uninstall**.

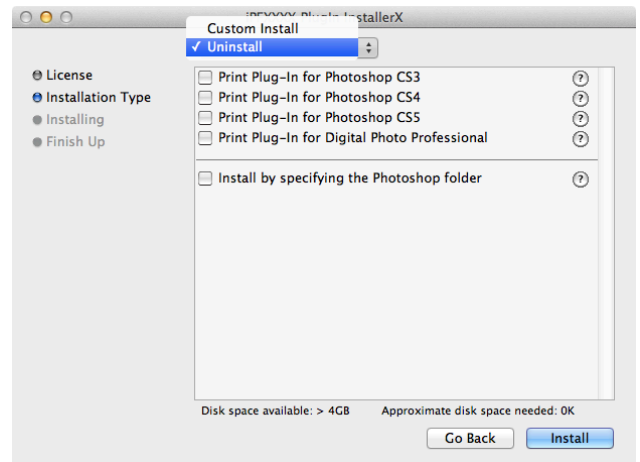

3. Click the **Uninstall** button.

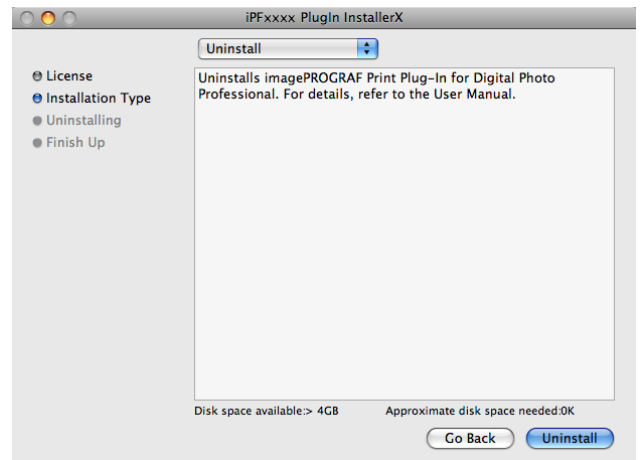

4. To quit another application, click on the **Continue** button.

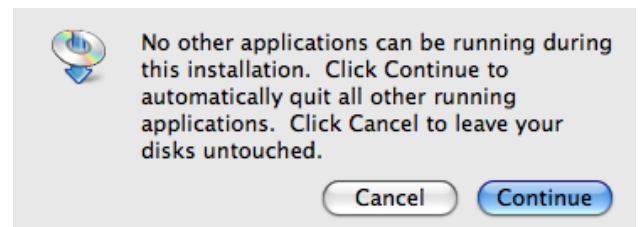

5. Click the **Quit** button.

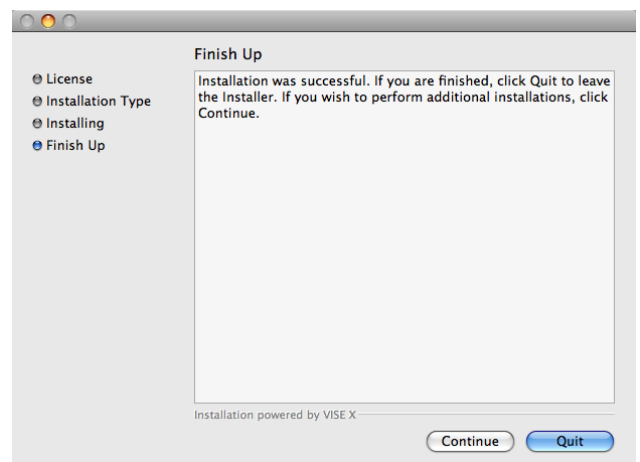

Starting from Photoshop

Follow the procedure below to start the Print Plug-In for Photoshop from Photoshop.

- 1 Start Photoshop.
- 2 Open the image that you wish to print.
- 3 If required, select the print range.



Note

- Images for use with Print Plug-In for Photoshop are less than 60,000 pixels in width and height. Reduce the selection range or reduce the image with processing for images more than 60,000 pixels in width and height, and then attempt step 3.

- 4 Select **Export** (or **Data Export**) from the **File** menu and then select the output plug-in that matches your printer. The imagePROGRAF Print Plug-In for Photoshop window (known below as the Print Plug-In window) is displayed.

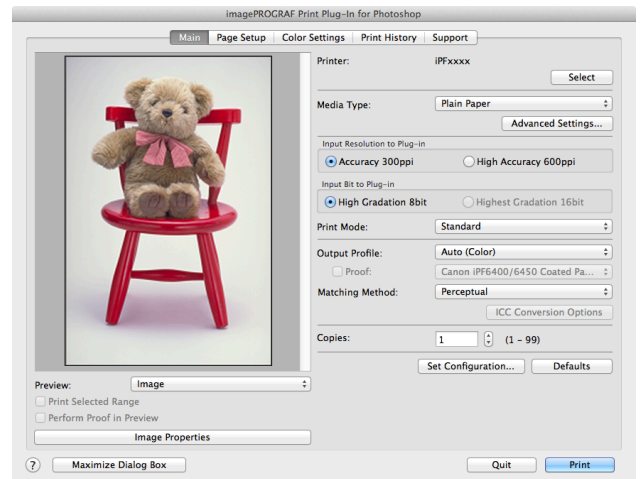

Note

- When the color space of the input image is CMYK, it is changed to AdobeRGB for processing with Print Plug-In for Photoshop. Also, **Relative Colorimetric** is used for the matching method.
- If the message below is displayed but the Print Plug-In window is not displayed, install the newest imagePROGRAF printer driver and then attempt step 3.
To install imagePROGRAF Print Plug-In, the latest version of the imagePROGRAF printer driver must be installed.
- If the following message is displayed, but the Print Plug-In window is not displayed, open only one Photoshop.
When Photoshop is running in multiple windows, the plug-in may not start.
- If the message below is displayed but the Print Plug-In window is not displayed, convert the color space of the image to either RGB color, grayscale, or CMYK color and then attempt step 3.
Set the color space of the image to either RGB color, grayscale, or CMYK color.

Starting from Digital Photo Professional

Follow the procedure below to start the Print Plug-In for Digital Photo Professional from Digital Photo Professional.

- 1 Start Digital Photo Professional.
- 2 Open the RGB color image that you want to print.
- 3 If required, select the print range.



Note

- Images for use with Print Plug-In for Digital Photo Professional are less than 6,000 pixels in width and height. Reduce the selection range or reduce the image with processing for images more than 6,000 pixels in width and height, and then attempt step 3.

- 4** Select **File** from the **Plug-in printing** menu and then select the output plug-in that matches your printer. The imagePROGRAF Print Plug-In for Digital Photo Professional window (hereinafter referred to as the Print Plug-In window) is displayed.

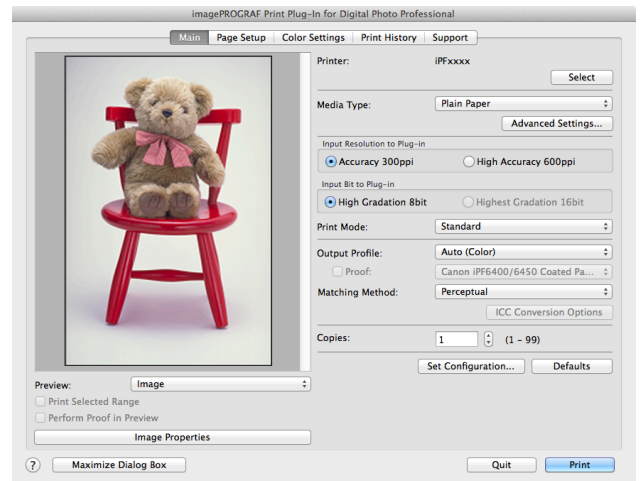

Print Plug-In for Photoshop/Digital Photo Professional Main Window

The Print Plug-In main window consists of the sheet selection area, and the preview and button area.

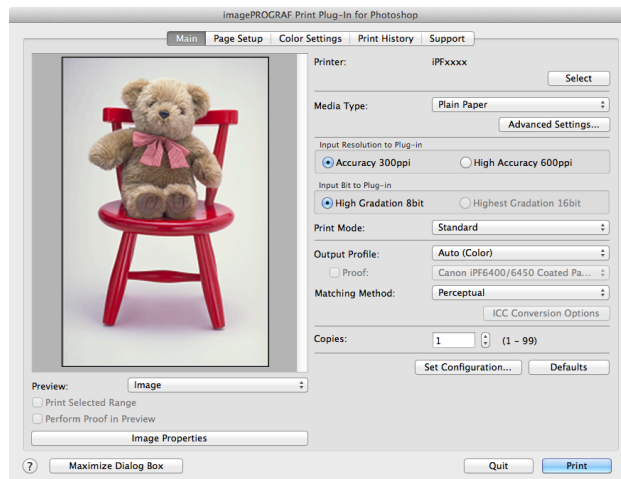

- **Sheet Selection Area**

The tabs used to switch between each sheet on the Print Plug-In window are displayed.

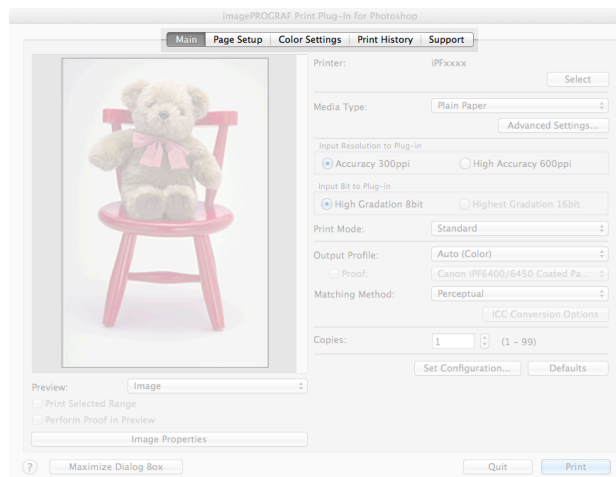

When you select a tab, a sheet is displayed. The settings available on each sheet are as follows.

- Main Sheet →P.474
- Page Setup Sheet →P.477
- Color Settings Sheet (Color) →P.479
- Print History Sheet →P.481
- Support Sheet →P.482

- Preview Area

You can check the settings you made on the image in this area.

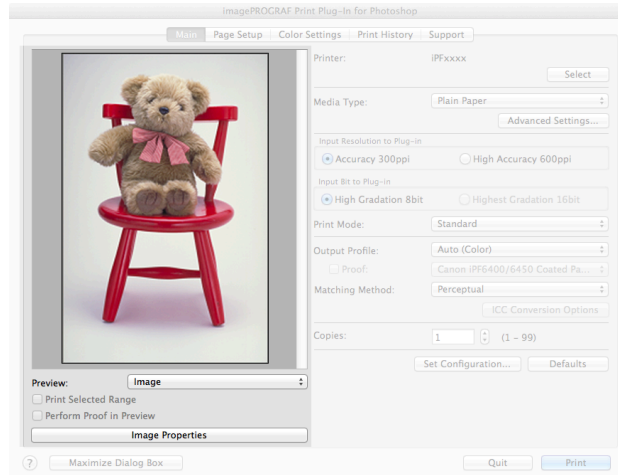

About the settings available on the preview area, see "Preview Area." →P.473

- Button Area

This contains the buttons **Print**, **Quit**, **Help** and **Maximize Dialog Box**

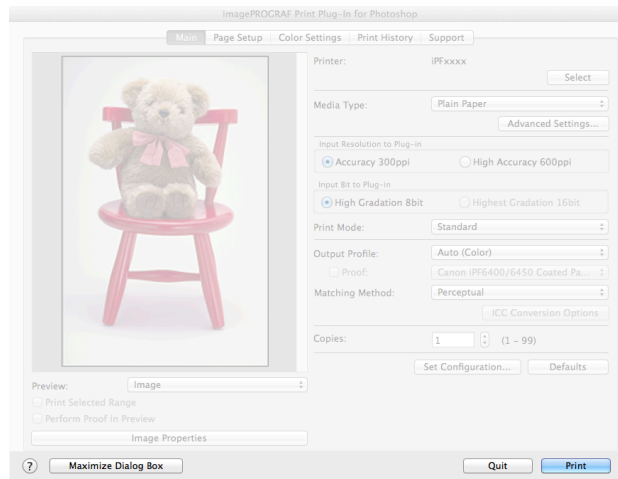

- **Print** Button
Click this button to begin printing.
- **Quit** Button
Click this button to close the Print Plug-In window and return to application software.
-  Button
Click this button to display the Print Plug-In for Photoshop/Digital Photo Professional Help file.
- **Maximize Dialog Box** button
When this button is clicked, the Print Plug-In main window is displayed enlarged to cover the entire display screen.

Preview Area

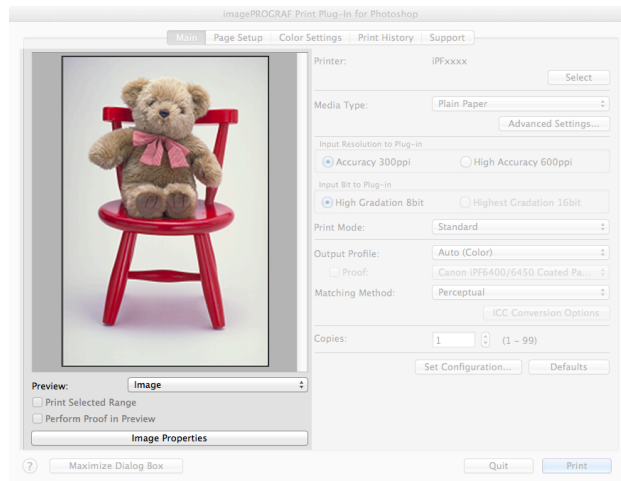

You can check the settings you made on the image in this area.



• Preview

Select the preview display method.

For more information about preview, see "Utilize Three Types of Previews." →P.494

Setting	Details
Print Area Layout	Displays the print range and the area out of the print range in the layout matching the Paper Size set. *You can change the image print position when you drag the image while the cursor is displayed as  .
Image	The entire image is displayed. *You can select the print range when you drag the image while the cursor is displayed as  .
Roll Paper Preview	Display the media size and roll paper information on the top in the layout printing on roll paper. *To select Roll Paper Preview , select Roll Paper in Paper Source .

• Print Selected Range

Place a checkmark here to only print the selected range.



Note

- When you select **Preview** in the **Image**, then select a portion of the image on the preview display, this becomes valid.

• Perform Proof in Preview

Place a checkmark here to simulate the colors of the output product in the preview.



Note

- If **Auto (Color)** is selected under **Output Profile**, some media types are enabled.
- If ICC profile is selected under **Output Profile**, this is always enabled.
- The actual color balance of the print product and the simulation product may differ with some environments and conditions. In addition, when you have selected an ICC Profile with **Output Profile** and it is not compatible with the printer or media that you are using, the color balance of the actual print product will differ.

• Image Properties button

When you click the button to open the **Image Properties** dialog box, where **Image Size**, **Resolution**, **Bit** and **Color Space** information of the image imported to Print Plug-In are displayed.

Click the **Close** button to return to Print Plug-In.

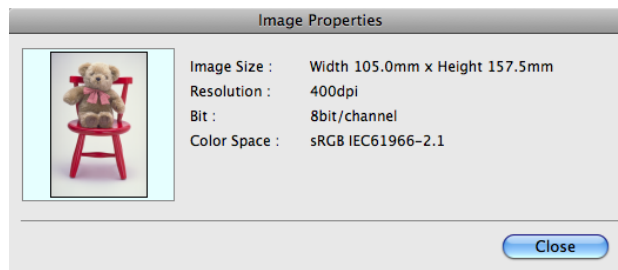

Main Sheet

You can use this sheet to perform basic settings such as selecting a printer, setting the media type, or adjusting image quality.

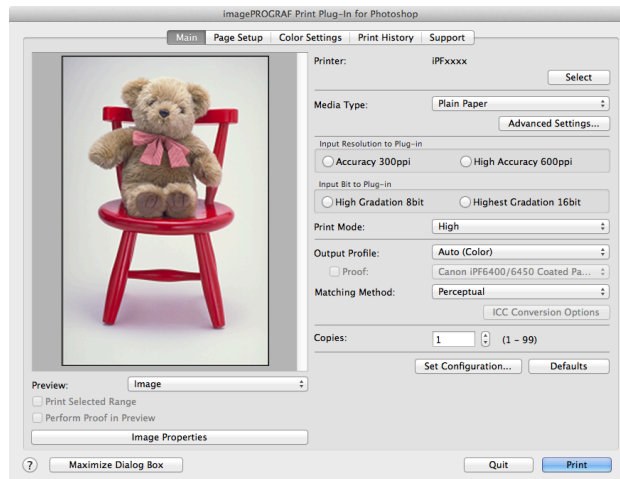

- **Printer**

The printer types are displayed.

- **Select button**

Click this button to display the **Select Printer** dialog box.

When you click the **OK** button after selecting the printer in the **Select Printer** dialog box, you can change the printer that corresponds with Print Plug-In.

- **Media Type**

This allows you to select the media type.

For more information about, see "Customize Media Settings." →P.512



Note

- Always select media type that is actually set in the printer. When the media you chose is different from the media set in the printer, you may not receive the desired print results.

- **Advanced Settings button**

Click the button to display the **Paper Detailed Settings** dialog box.

For more information about the media detailed settings, see "Paper Detailed Settings Dialog Box." →P.487

- **Input Resolution to Plug-in**

You can select the resolution to process the image with Print Plug-In.

The following settings are available for resolution.

Setting	Details
Accuracy 300ppi	This processes images at an accurate resolution. This can control print speed and memory capacity.
High Accuracy 600ppi	This processes images at a more accurate resolution. This setting results in the best print quality, but this takes more time to print than Accuracy 300ppi while also requiring more memory capacity. *This may not be displayed depending on how you set Media Type

• Input Bit to Plug-in

You can select the bit number to process with Print Plug-In.
The following settings are available for the input bit number.

Setting	Details
High Gradation 8bit	This processes images with at 8bit/channel (24 bit).
Highest Gradation 16bit	This processes images with at 16bit/channel (48 bit). *This may not be displayed depending on how you set Media Type and Input Resolution to Plug-in .

• Print Mode

Selecting the printing mode strikes the balance between the quality of the printed image and printing speed.
The following settings are available for the print mode.

Setting	Details
Highest	A setting for printing at the highest resolution when quality is most important. Printing takes longer and consumes more ink than in other modes, but this mode offers superior printing quality.
High	Choose this setting to print at high resolution when quality is most important. Printing takes longer and consumes more ink than in Standard or Fast modes, but this mode offers exceptional printing quality.
Standard	Choose this setting to print at standard resolution when quality and speed are both important. Printing takes less time than in Highest or High mode.
Fast	Choose this setting to print faster. Printing in fast mode can help you work more efficiently when checking layouts.
Highest (Max. No. of Passes)	If you are concerned about uneven colors in the print result of Highest quality , selecting this option may improve printing results. However, printing may take longer.



- The selectable fields may vary according to the **Media Type**, **Input Resolution to Plug-in** and **Input Bit to Plug-in** settings.

Note

• Output Profile

You can select the output profile.
The following settings are available for the output profile.

Setting	Details
Auto (Color)	Performs the optimum color conversion from the input image data color space information (sRGB, Adobe RGB), media settings etc. You should normally select these settings.
Auto (Monochrome Photo)	Performs the best color conversion to monochrome from the input image data color space information (sRGB, Adobe RGB), media settings etc.
None (No Color Correction)	You cannot perform color conversion with a plug-in. This is useful for creating an original ICC profile.
External ICC Profiles	This selects printer ICC profiles to be output to ICC profiles saved in the OS standard folder. Use the color space of the input data as well as the select ICC profile to perform color conversion.



- **Auto (Monochrome Photo)** can only be selected for the corresponding media types.

Note

• **Proof**

This is displayed when an ICC profile is selected as the **Output Profile**.

When this is checked, you can perform printing press simulation prints.

Refer to Perform Printing Press Simulation Print →P.507 for details on printing press simulation prints.

• **Matching Method**

You can select the processing method when performing color conversion.

The following settings are available for the matching method.

Setting	Details
Perceptual	This converts the image to an image with natural color balance and gradation. This is useful for pictures.
Saturation	This converts the image to an image with heightened color saturation. The color balance of pictures and drawings may change.
Relative Colorimetric	This converts the image with emphasis on color balance before the conversion or on visual color balance. This is useful for pictures and drawings.



- When the **Output Profile** you have set is **Auto (Monochrome Photo)** or **None (No Color Correction)**, you cannot select a matching method.

Note

• **ICC Conversion Options** button

This is displayed when an ICC profile is selected as the **Output Profile**.

When this button is clicked, the **ICC Conversion Options** dialog box is displayed allowing you to configure color conversion related settings.

Refer to ICC Conversion Options dialog box →P.489 for details on ICC Conversion Options.

• **Copies**

You can input the number of print copies in numerical characters.



- The maximum value is 99.
- You can change the numbers by clicking either ▲ or ▼.

Note

• **Set Configuration** button

Clicking the button opens the **Set Configuration** dialog box that provides settings for the adjustment of image sharpness and image enlargement method.

For more information about **Set Configuration**, see "Set Configuration Dialog Box." →P.488

• **Defaults** button

Click the button to return all of the settings on the **Main** sheet to their defaults.

Page Setup Sheet

You can use this sheet to set the size of the image to be printed, the media size, and whether to enlarge/reduce the image.

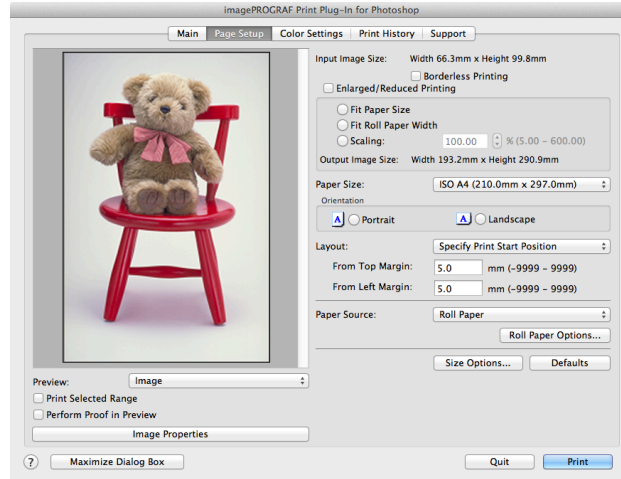

• Input Image Size

The size of the image imported to Print Plug-In is displayed.

• Borderless Printing

When you place a checkmark here, the **Specify Roll Paper Width** dialog box is displayed and you can print an image without borders.

For more information about **Borderless Printing**, see "Print with No Borders." →P.511



Note

- Available only if rolls are selected in **Paper Source**.

• Enlarged/Reduced Printing

When you place a checkmark here, you can print enlarged/reduced images.

When printing an enlarged/reduced image, select the method for enlargement/reduction. The image size sent to the printer is displayed matching the selected method in **Output Image Size**.

The following settings are available for enlarged/reduced printing.

Setting	Details
Fit Paper Size	This automatically enlarges/reduces the entire image imported to Print Plug-In to match the export media size when printing.
Fit Roll Paper Width	This automatically enlarges/reduces the entire image imported to Print Plug-In to match the width of the roll paper with the width of the image when printing. *Displayed only if rolls are selected in Paper Source .
Scaling	This enlarges/reduces the entire image by the specified scaling value. Input the scaling value in numerical characters. You can specify a range between 5-600%. *You can change the numbers by clicking either ▲ or ▼.



Note

- This is not displayed when a checkmark is placed in **Borderless Printing**.

• Output Image Size

The output image size is displayed up to one place after the decimal point in millimeters.



- When **Paper Size** is smaller than **Output Image Size**, part of the image may not print.

Note

• Paper Size

You can select the size of the print media.



- This is not displayed when a checkmark is placed in **Borderless Printing**.
- This is not displayed when **Fit Roll Paper Width** is set in **Enlarged/Reduced Printing**.

Note

• Orientation

This selects the print orientation.

The following settings are available for orientation.

Setting	Details
Portrait	Prints the image on the media as it appears on the screen.
Landscape	Prints the image on the media rotated 90 degrees.

• Layout

You can select the print position of an image on the media.

The following settings are available for layout.

Layout

Setting	Details
Upper-Left of Output Paper Size	Prints the image with fitting the top left of the active print area for Paper Size .
Center of Output Paper Size	Prints the center of the image on the center of the selected Paper Size .
Specify Print Start Position	You can print with specifying the top and left printing start positions in From Top Margin and From Left Margin for Paper Size .
From Top Margin	Input the margin from the top of the media in numbers. *You can input between -9999 and 9999 mm.
From Left Margin	Input the margin from the left of the media in numbers. *You can input between -9999 and 9999 mm.



- Select **Print Area Layout** or **Image** in **Preview** when you select **Layout**.

Note

Roll Paper Layout

Setting	Details
Upper-Left of Roll Paper	Prints the top left of Media Size on the top left of the selected roll paper.
Center of Roll Paper	Prints the center of Media Size on the center of the selected roll paper.



- Select **Roll Paper Preview** in **Preview** when you select **Roll Paper Layout**.

Note

• Paper Source

You can select the media source.

The following settings are available for media source.

Setting	Details
Roll Paper	Select to print on roll paper.

Setting	Details
Cut Sheet	Select to print on the cut sheet.

- **Roll Paper Options** button

Click this button to open the **Roll Paper Options** dialog box, where you can set roll paper width and perform auto cut settings.

For more information about the roll paper options, see "Roll Paper Options Dialog Box." →P.490

- **Size Options**

Click the Size Options button to open the **Size Options** dialog box and you can select a media name, size and other settings.

For more information about the size options, see "Size Options Dialog Box." →P.491

- **Defaults** button

Click the button to return all of the settings on the **Page Setup** sheet to their defaults.

Color Settings Sheet (Color)

You can use this sheet to adjust image Color, **Brightness**, **Contrast**, **Saturation**, and you can set the color balance of print product more to your liking.

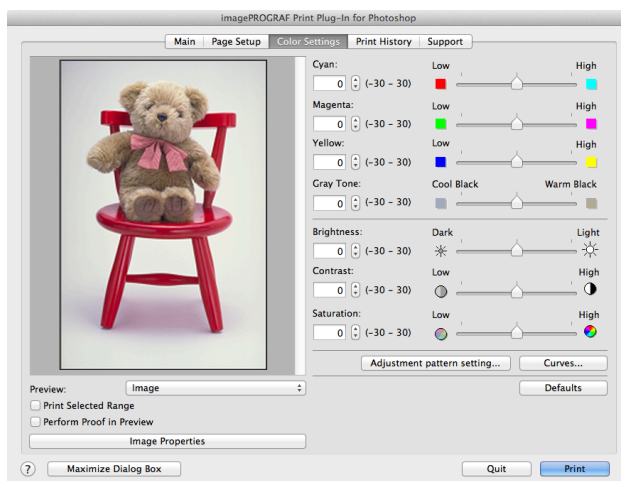

- You can check a preview of the adjusted state for the following items.

Cyan / Magenta / Yellow, Gray Tone, Brightness, Contrast, Saturation, and Gray Tone Adjustment

- **Cyan / Magenta / Yellow**

You can adjust the strength or weakness of a color by either inputting a numerical value or dragging the slide bar.

- **Gray Tone**

You can adjust gray tone from cool black (cool tones) to warm black (red tones) by either inputting a numerical value or dragging the slide bar.

- **Brightness**

You can adjust the brightness of the printed image without losing the brightest and darkest areas by either inputting a numerical value or dragging the slide bar.

- **Contrast**

You can relatively adjust the brightness of the brightest and darkness areas by either inputting a numerical value or dragging the slide bar.

- **Saturation**

You can adjust the saturation of vivid color balance to dark color balance by either inputting a numerical value or dragging the slide bar.

- **Adjustment pattern setting** button

When this button is clicked, the **Adjustment pattern setting** dialog box is displayed. The **Adjustment pattern setting** dialog box allows you to print an adjustment pattern with adjustment values that vary in steps up and down, and to select your preferred adjustment values.

For details on **Adjustment pattern setting**, see "Adjustment pattern setting dialog box." →P.483

- **Curve** button

Click the button to open the **Curve** dialog box then set the **Channel** and other settings.

For more information about **Curve**, see "Curves Dialog Box." →P.492

- **Defaults** button

Click the button to return all of the settings on the **Color Settings** sheet to their defaults.

Color Settings Sheet (Monochrome)

This screen allows you to adjust settings such as the **Color Balance**, **Tone**, **Brightness**, and **Contrast** to configure the printing result to be closer to your expected tone and gradation.

This is displayed when **Auto (Monochrome Photo)** is selected in the **Output Profile** on the Main Sheet →P.474 .

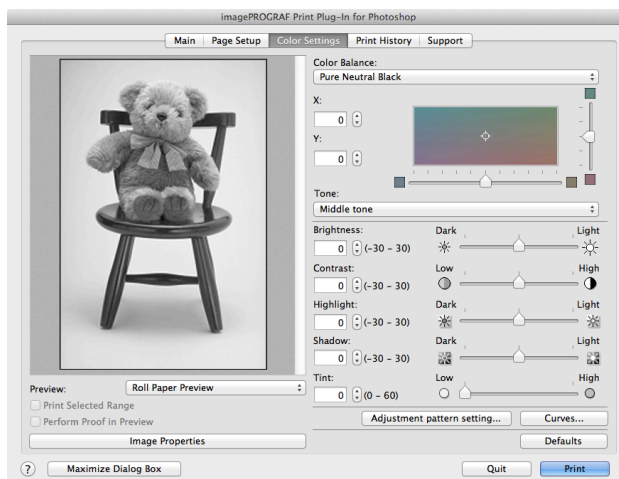

- You can check a preview of the adjusted state for the following items.
Color Balance, Tone, Brightness, Contrast, Highlight, Shadow, and Tint

- **Color Balance**

Allow you to select the color balance to suit your application.

- **X / Y**

Adjust the color balance as you check the color tone in the adjustment area.

You can adjust the square area in the center by clicking or dragging it.

Drag the vertical or horizontal scroll bars for adjustment, as desired.

You can click the arrows by the **X** (horizontal) and **Y** (vertical) boxes or enter the values directly.

- **Tone**

You can adjust the brightness of intermediate tones in an image. Selecting **Hard tone** gives a hard impression with more definition. Selecting **Soft tone** gives a soft impression.

- **Brightness**

You can adjust the brightness of the printed image without losing the brightest and darkest areas by either inputting a numerical value or dragging the slide bar.

- **Contrast**

You can relatively adjust the brightness of the brightest and darkness areas by either inputting a numerical value or dragging the slide bar.

- **Highlight**

Adjust the brightness of the lightest portion.

- **Shadow**

Adjust the brightness of the darkest portion.

- **Tint**

Fills in the white parts of the paper with a small amount of ink in order to reduce the difference in texture between highlights in the image and the white parts of the paper.

- **Adjustment pattern setting button**

When this button is clicked, the **Adjustment pattern setting** dialog box is displayed. The **Adjustment pattern setting** dialog box allows you to print an adjustment pattern with adjustment values that vary in steps up and down, and to select your preferred adjustment values.

For details on **Adjustment pattern setting**, see "Adjustment pattern setting dialog box." →P.483

- **Curve button**

Click the button to open the **Curve** dialog box then set the **Channel** and other settings.

For more information about **Curve**, see "Curves Dialog Box." →P.492

- **Defaults button**

Click the button to return all of the settings on the **Color Settings** sheet to their defaults.

Print History Sheet

You can use this sheet to apply settings history used in printing, and to print information, such as the image file name, with the image.

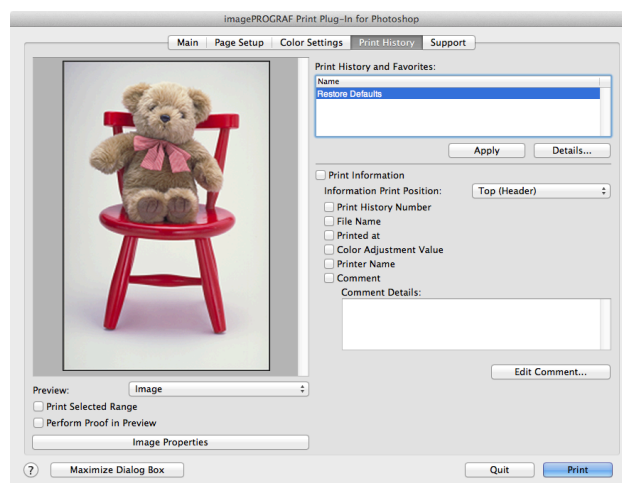

- **Print History and Favorites**

This displays a list of print preferences.

Select **Restore Defaults** and click the **Apply** button to restore all settings to their initial settings.



Note

- You can check the 3 print preferences in the preview display.

- **Apply** button

When you click the button, the print setting content applies to the current image selected with **Print History and Favorites**.

- **Details** button

Click the Details button to open the **Print History Details** dialog box, where you can manage print history. For more information about the print history details, see "Print History Details Dialog Box." →P.493

- **Print Information**

When you place a checkmark here, you can print the file name and print time and date on the image. The following settings are available for the print position and content.

For more information about **Print Information**, see "Set Information to Print with Image." →P.521

Setting	Details	
Information Print Position	Selects the information print position.	
	Top (Header)	Information is printed on the top of the image.
	Bottom (Footer)	Information is printed on the bottom of the image.
Print History Number	Place a checkmark here to print the print history number.	
File Name	Place a checkmark here to print the file name.	
Printed at	Place a checkmark here to print the time and date.	
Color Adjustment Value	Place a checkmark here to print the color adjustment value.	
Printer Name	Place a checkmark here to print the printer name.	
Comment	Place a checkmark here to print the comment details.	
Comment Details	Place a checkmark here to display the comment details.	

- **Edit Comment** button

Click the button to display the **Edit Comment** dialog box, where you can edit the comment.

Support Sheet

You can display product support information and the electronic manual.

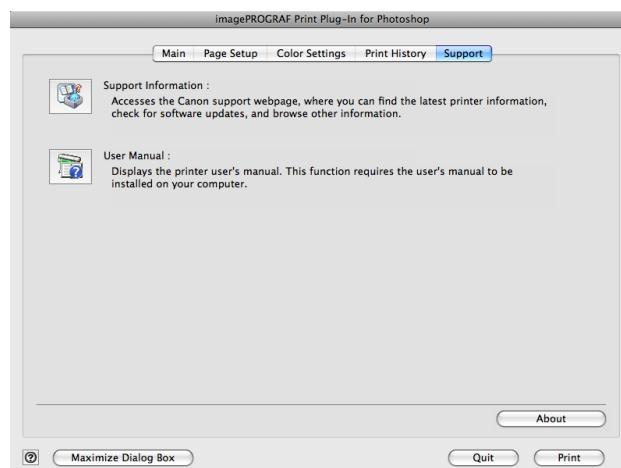

- **Support Information** button

Click the button to display websites that contain the latest product information.



- An Internet connection is needed to view the websites.

Note

• User Manual button

Click the button to display the printer manuals installed on the computer.



- You must have User Manual installed on your computer.

Note

• About button

Click the button to open the version information window of the Print Plug-In. Click the **OK** button in the version information window to return to the Print Plug-In window.

Adjustment pattern setting dialog box

Displays the adjustment pattern by taking images with the adjustment values varying up and down in steps from the baseline adjustment values in the **Color Settings** sheet (color or monochrome). This allows you to print the adjustment pattern and select your preferred adjustment values while comparing the images.

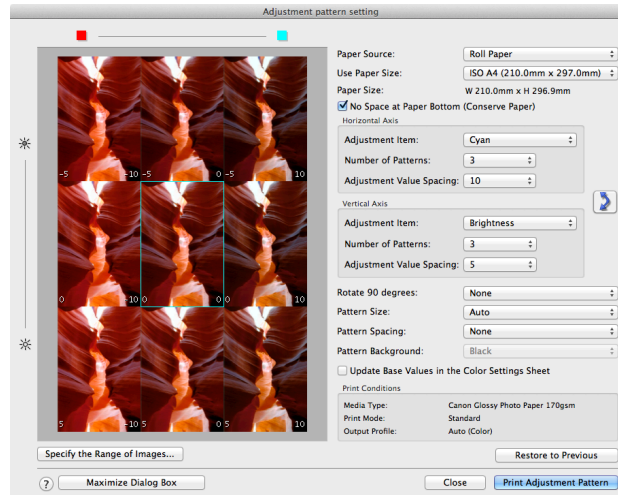

• Preview Area

This area allows you to view adjustment pattern images side-by-side to check the state when changes to adjustment values are applied.

The adjustment values of the image enclosed in the blue frame in the center are used as the base values, with images arranged around this with the adjustment values varying in steps up and down from these base values. If you click any of the images, the adjustment pattern is redisplayed with the adjustment values from that image as the base values.

The adjustment values are displayed at the top of each image. If both the **Horizontal Axis** and **Vertical Axis** are configured, the adjustment value for the **Horizontal Axis** is displayed on the right and the adjustment value for the **Vertical Axis** is displayed on the left. If the image is so small that the adjustment values cannot be displayed, you can check the adjustment values by displaying the tool tip.



- For images where the adjustment values are out of range, an adjustment pattern is not displayed and the message **Out of Range** is displayed instead.

Note

• Paper Source

Selects the paper feed method for the paper to print the adjustment pattern on. You can split the usage between printing adjustment patterns on cut paper (manual feed) and printing work pieces on roll paper.

- **Use Paper Size**

Selects the paper size to print the adjustment pattern on.

The adjustment pattern is printed so that it fits into the selected paper size.



Note

- If the image size is large and **Dimensions** is selected in **Pattern Size**, the pattern display might not fit within the vertical direction of the paper size. In this case, select **Auto** in **Pattern Size**.
- The printed paper size is displayed in **Paper Size**.

- **Paper Size**

Since the length in the vertical direction may differ between the **Use Paper Size** and actual printed material, this displays the actual output paper size.

- **No Space at Paper Bottom (Conserve Paper)**

If a margin appears at the bottom of the paper with the paper size selected in **Use Paper Size**, you can conserve paper by selecting this check box to print excluding the margin area. The state of the length in the vertical direction being shortened to conserve the margin area is reflected in the displayed **Paper Size**.

- **Horizontal Axis / Vertical Axis**

Configures settings such as the items that change in steps and the number of patterns when multiple adjustment patterns are arranged horizontally or vertically.

- **Adjustment Item**

Selects the items to change in steps.

For color, you can select **Cyan, Magenta, Yellow, Gray Tone, Brightness, Contrast, or Saturation**.

For monochrome, you can select **X Color Balance, Y Color Balance, Tone, Brightness, Contrast, Highlight, Shadow, or Tint**.

The icons for **Horizontal Axis Adjustment Item** are displayed above the preview area and the icons for **Vertical Axis Adjustment Item** are displayed on the left of the preview area.



Note

- **None** can only be selected for **Vertical Axis** in both color and monochrome.

- **Number of Patterns**

You can select the number of images to display in the pattern in the horizontal or vertical direction from 3, 5, and 7. If the adjustment item is **Tone**, you can select 3 or 5. When **Tone** is selected as the adjustment value, -1 is **Soft tone**, 0 is **Middle tone**, 2 is **Medium-hard tone**, 3 is **Hard tone**, and 5 is **Strong-hard tone**.

- **Adjustment Value Spacing**

You can select the interval of the variation in adjustment values between neighboring adjustment pattern images from the range of 1 to 10. The larger the value, the greater the differences between the states of the adjustment pattern images. Note that if the adjustment item is **Tone**, the **Adjustment Value Spacing** cannot be selected.



- (Swap) button

Rearranges the adjustment pattern with the **Horizontal Axis** and **Vertical Axis** adjustment items swapped.

- **Rotate 90 degrees**

Rotating the image may make it easier to conserve paper and compare images.

Select **Per Image** to rotate each of the images in the adjustment pattern by 90 degrees.

Select **Entire Image after layout** to rotate the entire adjustment pattern by 90 degrees.

When **None** is selected, the image is not rotated.

• Pattern Size

You can specify the size of the image when printing the adjustment pattern.

When **Auto** is selected, the image is enlarged or reduced to fit the adjustment pattern into the **Use Paper Size**. When **Dimensions** is selected, the image is printed at the input image size without enlarging or reducing. **Dimensions** cannot be selected when the paper feed method is **Manual**.



Note

- If the input image size is large, check the **Paper Size** before starting printing because it may be larger than the actual printed material size.
- Select **Dimensions** in **Pattern Size** to print at the input image size without enlarging or reducing the images.
- Patterns that extend past the horizontal width of the paper are printed wrapped onto the next line.

• Pattern Spacing

You can select **None** or **Available**. If **Available** is selected, you can insert a background between each image. The background color can be specified in **Pattern Background**.

• Pattern Background

You can select the background color from **White**, **Black**, and **Gray**.

If it is difficult to compare the differences between neighboring adjustment pattern images, changing the background color may make it easier to compare. The **Pattern Spacing** can be selected if **Pattern Background** is **Available**.

• Update Base Values in the Color Settings Sheet

Select this check box and click the **Close** button to apply the setting values (standard values) of the image enclosed in the blue frame in the center of the preview area in the **Color Settings** panel (color or monochrome).

• Print Conditions

Displays the paper type, print mode, and output profile configured in the main window. This makes it possible to check the details of each of the settings when printing the adjustment pattern without returning to the main window.

- **Specify the Range of Images** button

When this button is clicked, the **Specify the Range of Images** dialog box is displayed for specifying the range of images.

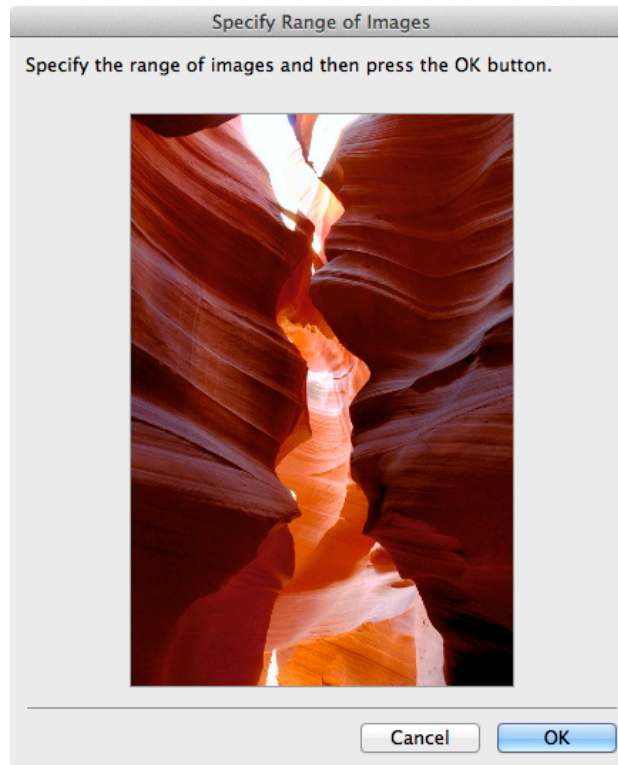

When you specify the range by using the mouse or other means and then click the **OK** button, the **Specify the Range of Images** dialog box closes and the specified image range is redisplayed as the adjustment pattern. If you click the **Cancel** button, the **Specify the Range of Images** dialog box closes even if a range is selected.



Note

- The selected range is cleared by clicking the image with a range selected.

- **Restore to Previous** button

When this button is clicked, the settings are restored to the defaults when the **Adjustment pattern setting** dialog box was first displayed.

- **Close** button

When this button is clicked, the setting values in the **Adjustment pattern setting** dialog box are saved and the dialog box is closed. These setting values are applied the next time the Print Plug-In for Photoshop/Digital Photo Professional is started. Furthermore, if you select the **Update Base Values in the Color Settings Sheet** check box and click the **Close** button, the setting values for the image enclosed in the blue frame in the preview area (central image) are applied to the settings in the **Color Settings** sheet (color or monochrome).

- **Print Adjustment Pattern** button

When this button is clicked, printing the adjustment pattern is executed. The **Adjustment pattern setting** dialog box does not close even after executing the printing.

The adjustment values are printed at the top of each image. If both the **Horizontal Axis** and **Vertical Axis** are configured, the adjustment value for the **Horizontal Axis** is displayed on the right and the adjustment value for the **Vertical Axis** is displayed on the left.

Each of the setting values for the paper type, print mode, and output profile as well as the adjustment values configured in the **Color Settings** sheet (color or monochrome) are printed at the bottom of the paper. However, the adjustment values for the **Curve** are not printed.



Note

- The job name when printing the adjustment pattern is "Original Image Name + Pattern-Print". For example, the print job name for the image "ABC.jpg" is "ABC_Pattern-Print.jpg".

- Maximize Dialog Box** button

When this button is clicked, the **Adjustment pattern setting** dialog box is displayed enlarged to cover the entire display screen.

Paper Detailed Settings Dialog Box

This dialog box appears when you click the **Advanced Settings** button on the **Main Sheet**. You can set **Drying Time** and **Roll Paper Margin for Safety** by media type.

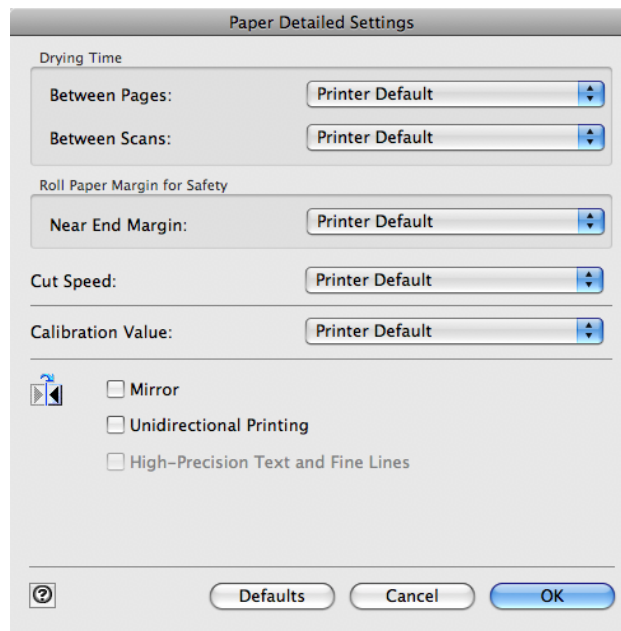

- Roll Paper Margin for Safety**

Near End Margin

This sets the length of the near end margin of the roll paper.

Setting	Details
Printer Default	The settings of the printer operating panel are applied.
5mm	Print at a standard size. *Select for Media Type that has no problem when printing with a standard size margin.
20mm	Select this when rubbing against the printhead occurs such as when using paper that tends to curl.

- Cut Speed**

This selects the auto cut speed.

Setting	Details
Printer Default	The settings of the printer operating panel are applied.
Fast	Select this setting if cutting with the Standard setting is not clean.
Standard	Select this setting when you are not experiencing problems.

Setting	Details
Slow	This helps prevent adhesive from sticking to the cutter and keeps the cutter sharp if you select it when using adhesive paper.

- **Calibration Value**

When calibration has been carried out on the printer, use this setting to choose whether or not to use the results.

Setting	Details
Printer Default	The settings of the printer operating panel are applied.
Use Value	The calibration results are used for printing.
Disregard Value	The calibration results are not used for printing. Select this option to avoid changes to image color tones during printing due to color calibration.

- **Mirror**

Specify whether to print a mirror image, as needed. Select this option to print a version of the document or image with the left and right sides inverted.

- **Unidirectional Printing**

Select this checkbox to prevent problems such as misaligned lines and improve the print quality. However, the printing speed becomes slower.

- **High-Precision Text and Fine Lines**

Print increasing ink impact accuracy, particularly for sharper text and fine lines. However, this takes more time than regular printing.



Note

- When **Highest (Max. No. of Passes)** is selected as the print mode, **High-Precision Text and Fine Lines** cannot be selected.

Set Configuration Dialog Box

This dialog box appears when you click the **Set Configuration** button on the **Main Sheet**. You can set the adjustment of image sharpness and image enlargement method.

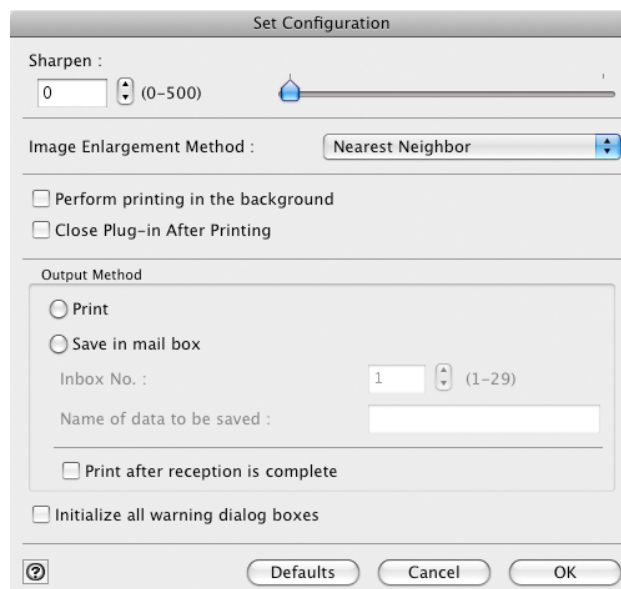

- **Sharpen**

Performs adjustment of the sharpness (outline) settings.

• Image Enlargement Method

You can select the image enlargement method.

The following settings are available for the image enlargement method.

Setting	Details
Nearest Neighbor	Performs simple enlargement.
Bilinear	Performs line vector enlargement.
Bicubic	Adjust pixels with calculation of elements such as a color or brightness of neighboring pixels.

• Perform printing in the background

When you place a checkmark here, the plug-in performs printing with the Plug-In in the background.

• Close Plug-in After Printing

When you place a checkmark here, the plug-in closes after printing finishes.



Note

- If printing does not finish correctly because it was canceled or an error occurred, the plug-in does not close.

• Output Method

You can select the output method.

The following settings are available for the output method.

Setting	Details
Print	Normal printing. The print job data is stored temporarily in the box as the job prints.
Save in mail box	Saves the print data in the mail box. If you select Save in mail box , you must specify Name of data to be saved .
Print after reception is complete	When you place a checkmark here, you can print after saving jobs in the temporary storage space. This cannot be used when Save in mail box is selected.

• Initialize all warning dialog boxes

When this is checked, all of the warning dialog boxes that have been set to "Do not show this screen again" become displayed.

ICC Conversion Options dialog box

This is displayed when an ICC profile is selected in the **Output Profile** list in the **Main** sheet and the **ICC Conversion Options** button is clicked. This allows you to configure detailed color matching related settings.

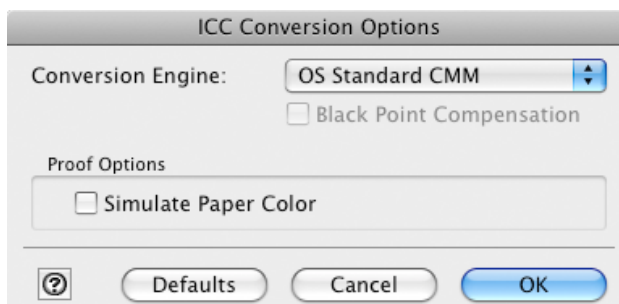

• Conversion Engine

Selects the conversion engine to use when converting colors.



Note

- Adobe CMM needs to be installed in order to use **Adobe CMM**. Refer to Using Adobe CMM [→P.503](#) for details on how to install Adobe CMM.

- **Black Point Compensation**

Check this check box to perform black point compensation. Loss of gradation in dark areas can be improved by performing black point compensation.



Note

- This can be used if **Adobe CMM** is selected as the **Conversion Engine**.

- **Proof Options**

Configures settings related to printing press simulation. The proof options consist of the following settings.

Setting	Details
Simulate Paper Color	Select this when performing paper color simulation.

Roll Paper Options Dialog Box

This dialog box appears when you click the **Roll Paper Options** button on the **Page Setup** Sheet. You can set the roll paper width and perform the auto cut settings.

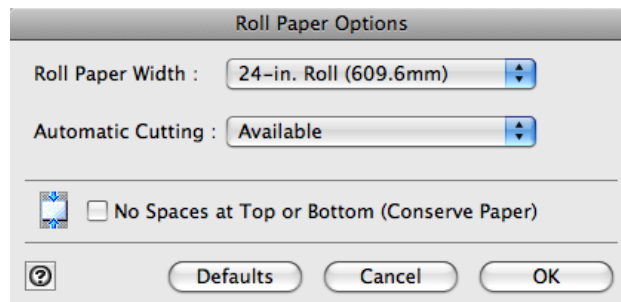

- **Roll Paper Width**

This selects the width of the roll media set to the printer.

- **Automatic Cutting**

You can set the printer to cut roll paper automatically or print a guideline for cutting. The following settings are available for automatic cutting.

Setting	Details
Available	Each page is automatically cut after it is printed.
None	Each page is not cut after it is printed and printing continues without interruption.
Print Cut Guideline	A print cut guideline is printed after each page and printing continues without interruption.

- **No Spaces at Top or Bottom (Conserve Paper)**

When you place a checkmark here, the print data is printed without margins.

Size Options Dialog Box

This dialog box appears when you click the **Size Options** button on the **Page Setup Sheet**. You can select a media name, size and other settings.

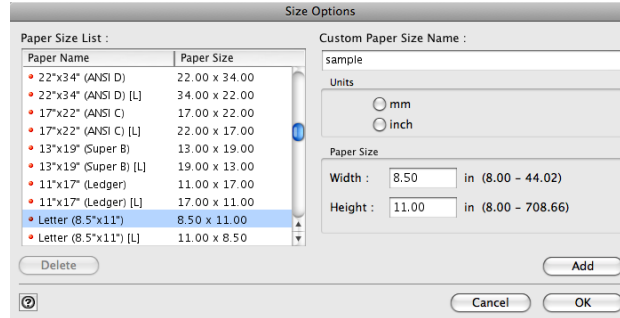

- **Paper Size List**

Displays all the standard sizes and custom media sizes.

- **Custom Paper Size Name**

You can enter any name up to 63 characters.

- **Units**

You can select the units of measure to use when you define custom media size. Switching this setting resets the units of measure for the entire Plug-In.

- **Paper Size**

Width

Enter the width of the media size.

Height

Enter the height of the media size.

- **Add button**

Click the button to register the contents of the settings.

Curves Dialog Box

This dialog box appears when you click the **Curves** button on the **Color Settings** Sheet. You can set **Channel** and other settings.

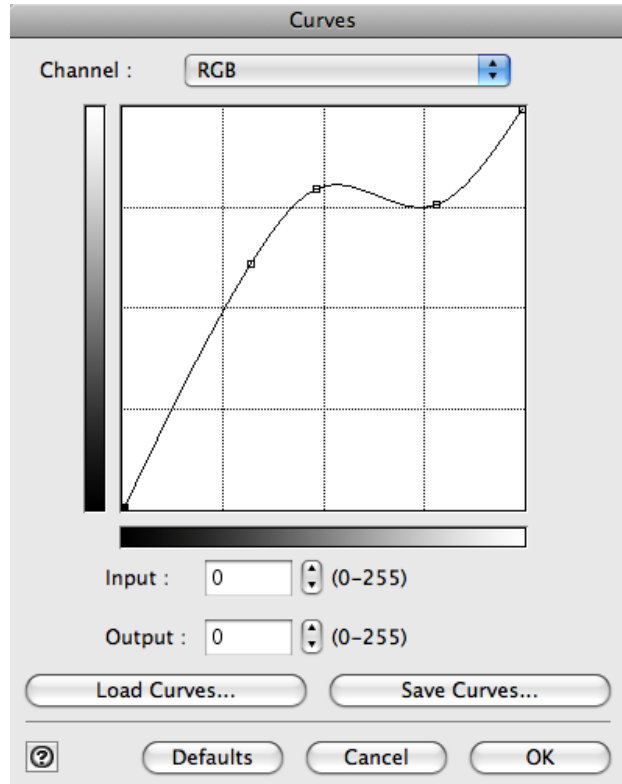

- **Channel**

Select from among **RGB**, **Red**, **Green**, or **Blue**.



Note

- **Gray** is displayed for monochrome printing and this selection cannot be changed.

- **Input**

Enter an input value.



Note

- The allowed entry range is 0 to 255.
- You can change the numbers by clicking either ▲ button or ▼ button.

- **Output**

Enter an output value.



Note

- The allowed entry range is 0 to 255.

- **Load Curves** button

Click the button to load stored data for a tone curve.

- **Save Curves** button

Click the button to stores the current tone curve settings.

Print History Details Dialog Box

This dialog box appears when you click the **Details** button on the **Print History** Sheet. This controls print history. For more information about **Print History Details**, see "Utilize Print History." →P.512

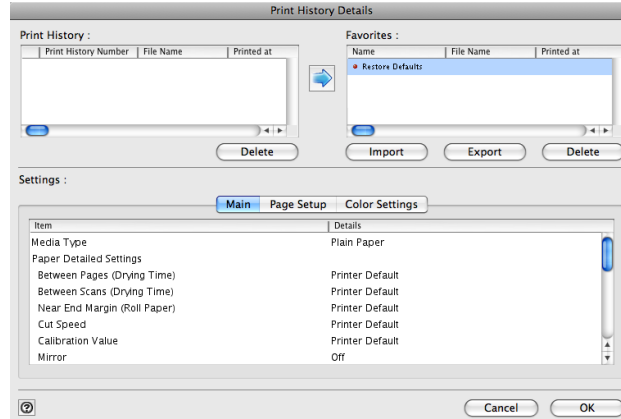

• Print History

Print History appears in list format.

Display Items	Details
Print History Number	Displays the print history number.
File Name	Displays image file name.
Printed at	Displays time and date of printing.
Comment	Displays comment details.



- Up to 200 print history items can be displayed. All items above 200 are deleted.

Note • When you cannot print properly because you canceled the printing or an error occurred, appears **X** to the left of the print history number.

• Delete button

Click the button to delete the selected print history.

• Add button

Click the  button to add the selected print history to preferences.



- Up to 200 print preference items can be added.

Note

• Favorites

The print history stored in print preferences displays in list format.



- You can change the order by selecting an item and dragging it to another place.

Note

• Import button

Click the button to import print history saved as a file.

- **Export button**

Click the button to save print history as a file that is stored in print preferences.

- **Delete button**

Click the button to delete print history stored in print preferences.

- **Settings**

Displays the print history settings selected from the **Print History** or **Favorites**.

Setting	Details
Main	When you select this the Main sheet settings are displayed.
Page Setup	When you select this the Page Setup sheet settings are displayed.
Color Settings	When you select this the Color Settings sheet settings are displayed.

Utilize Three Types of Previews

You can use Print Plug-In to check an image in three types of previews. The preview types are as follows.

- Check Image with Print Area Layout →P.494
- Check the original image with Image →P.495
- Check Image with Roll Paper Preview →P.495



Check Image with Print Area Layout

Displays the print range and the area out of the print range in the layout matching the media size set in the print area layout.

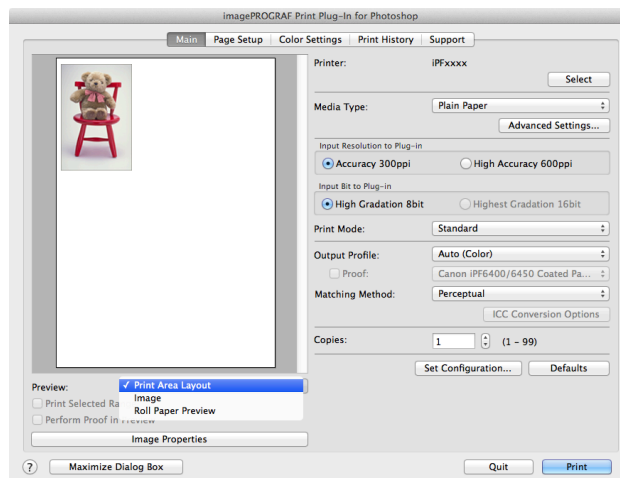
Select **Print Area Layout** in **Preview**.



Note



- When the cursor on the preview is displayed as  on the preview, you can specify the print position by dragging the image.
- When the cursor is displayed as  on the preview, the below conditions on the **Page Setup** sheet have all been met.
 - There is no checkmark in **Borderless Printing**.
 - There is no checkmark in **Enlarged/Reduced Printing** or **Scaling** has been selected.

Check the original image with Image

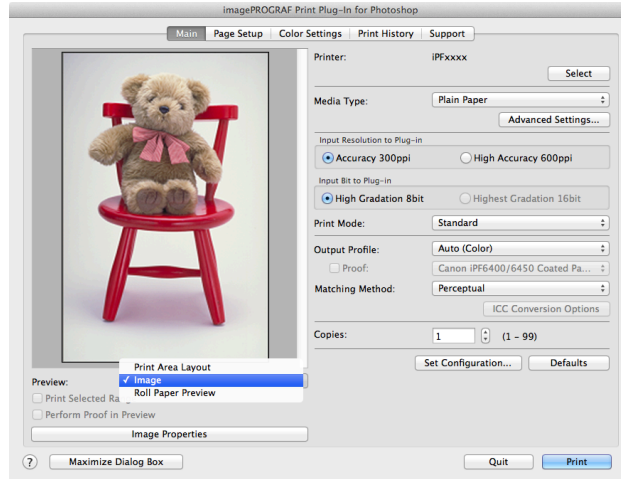
In the image preview you can check the entire image that you have input.
Select **Image** in **Preview**.



Note

- When the cursor appears as a small magnifying glass  while there is an **Image** in the **Preview** area, the **Selected Range** feature is enabled and you can drag the cursor on the image and select an area for printing.
- When you click the image while the cursor is displayed as  on the preview, the selected area is deselected.

Check Image with Roll Paper Preview

Display the media size and roll paper information on the top in the layout printing on roll paper in Roll Paper Preview.
Select **Roll Paper Preview** in **Preview**.

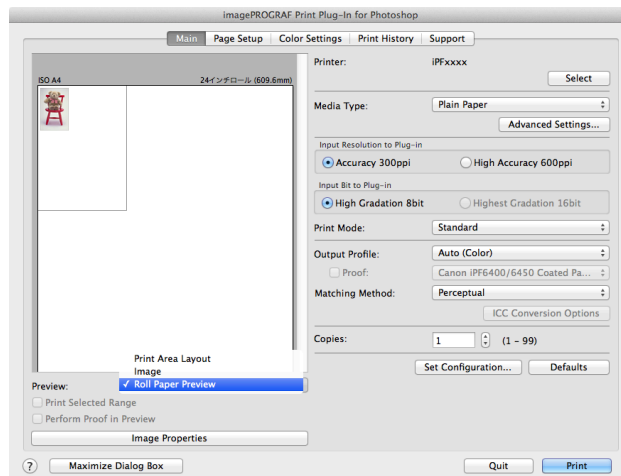

Note

- To select **Roll Paper Preview** in **Preview**, select **Roll Paper** in **Paper Source**.

Print with a Desired Picture Quality

You can specify and print at the resolution you desire.

1 Display the **Main** sheet.

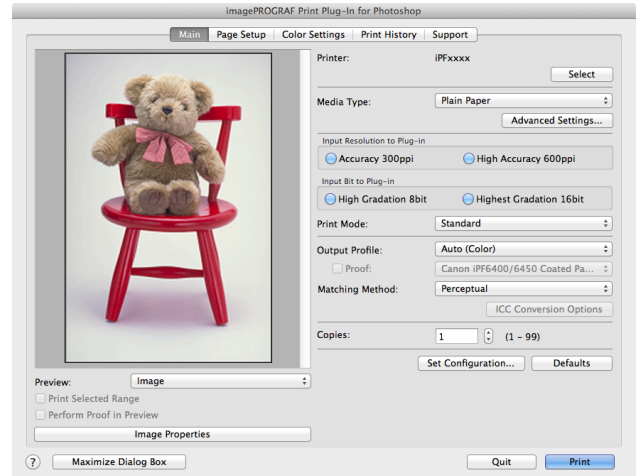

2 Select the media set to the printer in **Media Type**.



Note

- Always select media type that is actually set in the printer. When the media you chose is different from the media set in the printer, you may not receive the desired print results.

3 Choose either **Accuracy 300ppi** or **High Accuracy 600ppi** for the resolution to process images in **Input Resolution to Plug-in**.



Note

- When you select **Accuracy 300ppi** images are processed at an accurate resolution. This can control print speed and memory capacity.
- When you select **High Accuracy 600ppi** images are processed at a more accurate resolution. This setting results in the best print quality, but this takes more time to print than **Accuracy 300ppi** while also requiring more memory capacity.
- **High Accuracy 600ppi** will not display with some **Media Type** settings.

4 Choose either **High Gradation 8bit** or **Highest Gradation 16bit** for the bit number when processing images in **Input Bit to Plug-in**.



Note

- When you select **High Gradation 8bit**, images are processed at 8 bit/channel (24 bit).
- When you select **Highest Gradation 16bit**, images are processed at 16bit/channel (48 bit).
- **Highest Gradation 16bit** will not display with some **Media Type** or **Input Resolution to Plug-in** settings.

5 Select the mode to be printed when processing images in **Print Mode**.



Note

- The settings that can be selected differ by **Media Type**, **Input Resolution to Plug-in**, and **Input Bit to Plug-in** selected.

6 Click the **Print** button.

Printing begins.

Adjust the Colors and Print

You can adjust the colors to your liking and print images.

The explanation below is on 5 ways to adjust the colors using Print Plug-In.

- Adjust the Colors while Checking the Preview (for Color) →P.497
- Adjust the Colors while Checking the Preview (for Monochrome) →P.498
- Adjust the Colors by Color Matching →P.501
- Print High-Quality Adobe RGB16bit Images →P.502
- Prints monochrome photographs with high quality →P.503
- Using Adobe CMM →P.503

Adjust the Colors while Checking the Preview (for Color)

You can adjust the colors while checking the adjustments in the preview.

The following explanation is on the procedures for adjusting example image below.

- **Low** for **Cyan**
- **High** for **Yellow**
- **Low** for **Saturation**
- **Warm Black** for **Gray Tone**
- Enhance brightness for the curves

The above image adjustments are reflected in the before and after images below.

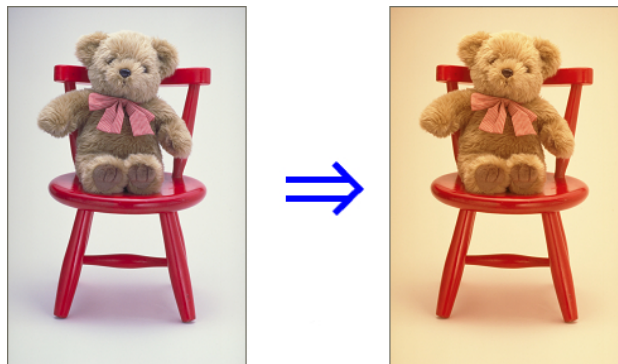

- 1 Display the **Color Settings** sheet.

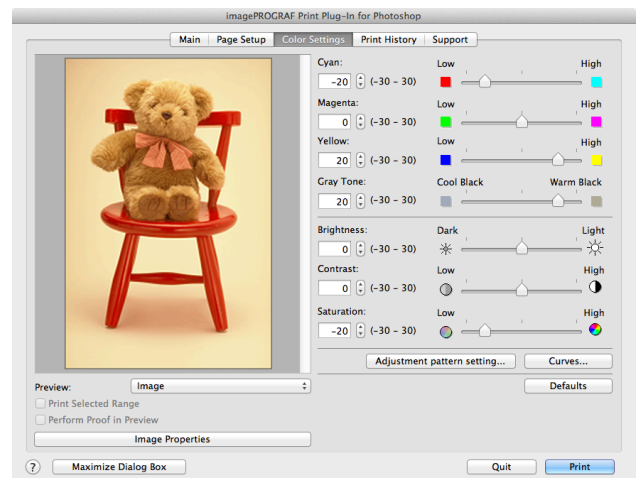

- 2 Drag the slide bar in the direction of **Low** in **Cyan**.

- 3 Drag the slide bar in the direction of **High** in **Yellow**.

4 Drag the slide bar in the direction of **Low** in **Saturation**.

5 Drag the slide bar in the direction of **Warm Black** in **Gray Tone**.



Note

- You can change the numbers by inputting in numerical characters.
- You can change the numbers by clicking either ▲ button or ▼ button.

6 Click the **Curves** button then click near the center of the curve.

7 Enter 120 in **Input** and 135 in **Output** then click the **OK** button.

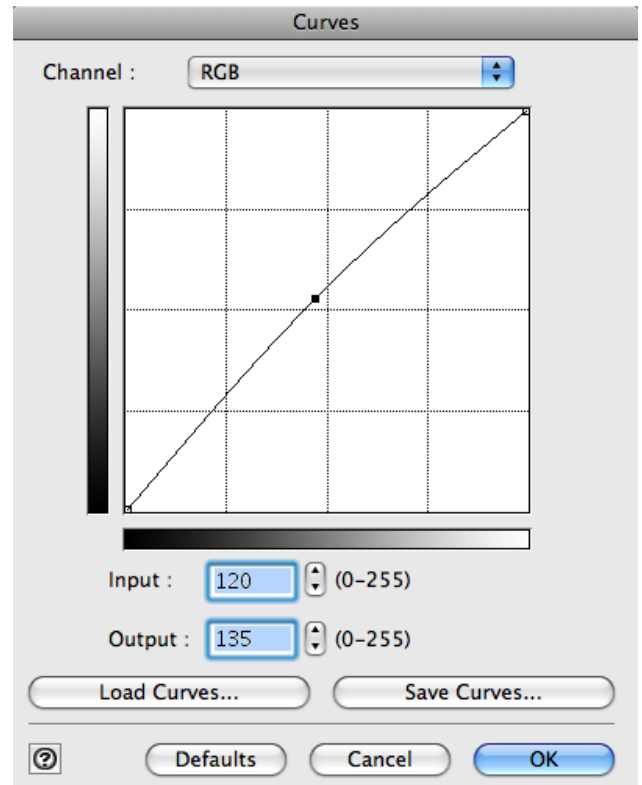

8 Click the **Print** button.

The adjustments are reflected in the image and printing begins.

Adjust the Colors while Checking the Preview (for Monochrome)

You can adjust the colors while checking the adjustments in the preview.

The following explanation is about the procedures for adjusting example image below.

- **Low** for **Contrast**
- **Light** for **Highlight**
- **Light** for **Shadow**
- Enhance brightness for the curves

The unapplied and the applied images of the above image adjustments are as below.

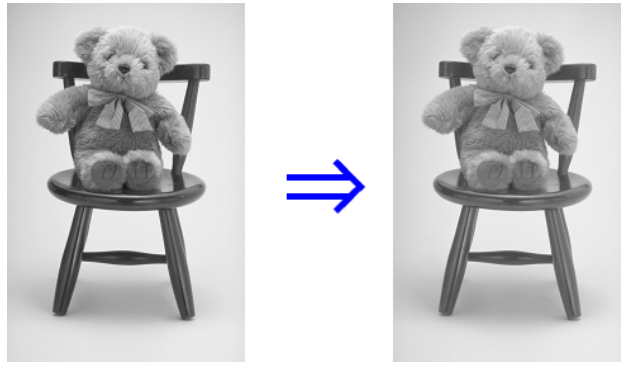

- 1 Open the **Main** sheet.
- 2 Select **Auto (Monochrome Photo)** in **Output Profile**.

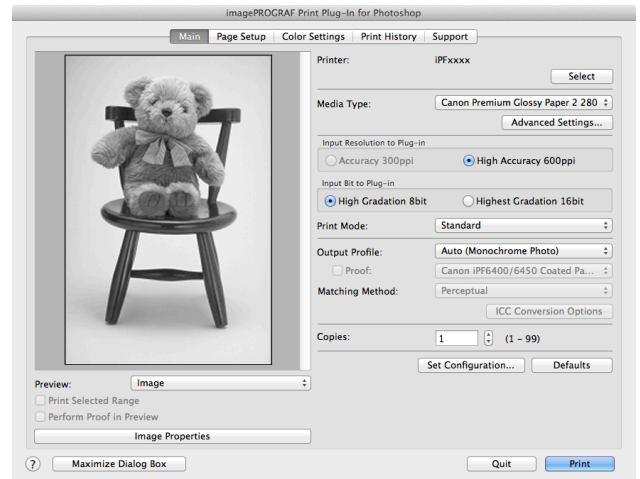

- 3 Open the **Color Settings** sheet.

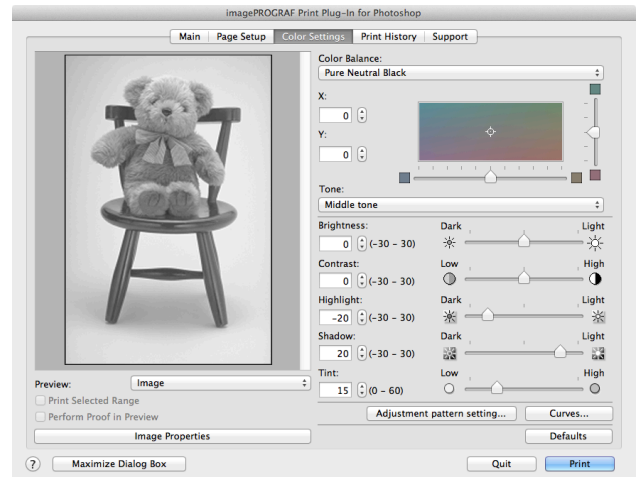

- 4 In **Contrast**, drag the slide bar toward **Low**.
- 5 In **Highlight**, drag the slide bar toward **Light**.

6 In **Shadow**, drag the slide bar toward **Light**.



Note

- You can change the numbers by inputting in numerical characters.
- You can change the numbers by clicking either ▲ button or ▼ button.

7 Click the **Curves** button then click near the center of the curve.

8 Enter 120 in **Input** and 135 in **Output** then click the **OK** button.

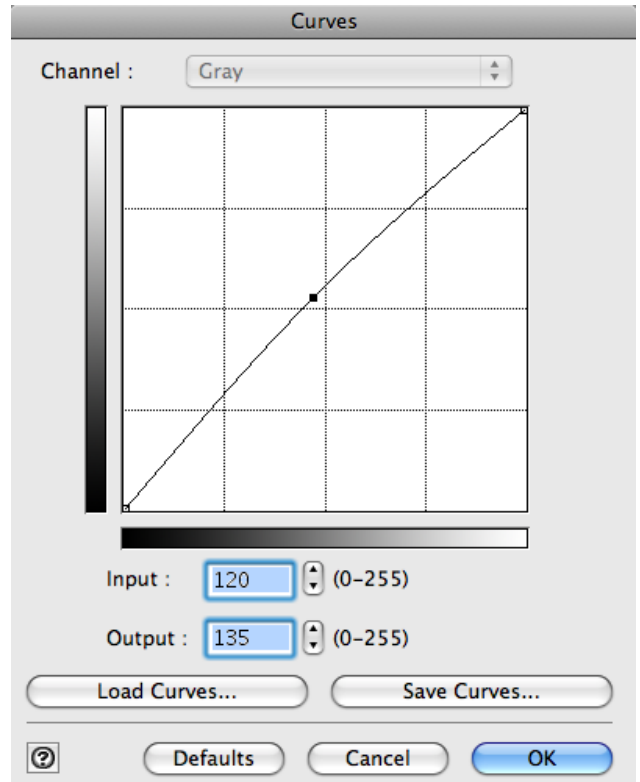

9 Click the **Print** button.

This applies the image adjustments and starts the print job.

Adjust the Colors by Color Matching

When you print a color image imported from a scanner or a digital camera, the image may appear different from the image on the screen. That is due to the differences in color on the screen and in the printer. In Print Plug-In, you can get the color balance of the print product closer to the color balance displayed on the screen through performing ICC (International Color Consortium) color profile settings, matching method settings, and settings for the internal profile, which performs optimum color conversion in response to media and resolution settings.

1 Display the **Main** sheet.

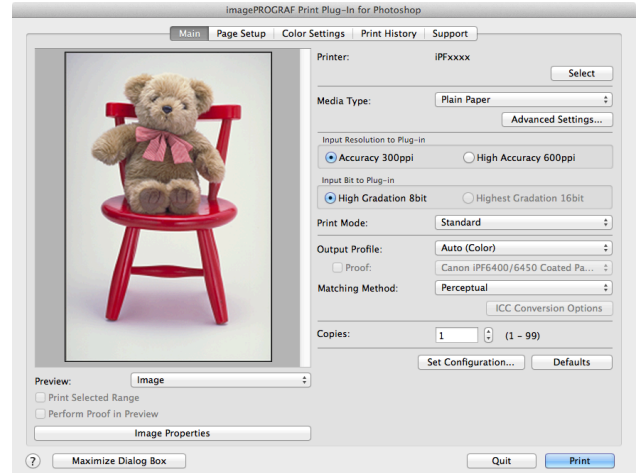

2 Select the profile in **Output Profile**.



Note

- When you place a checkmark in **Perform Proof in Preview**, you can check the color matching in the preview. This may not be displayed depending on how you set **Media Type**.
- The details of **Output Profile** you have set is saved even when you close the Print Plug-In, but when the specified profile cannot be located it is set to **Auto (Color)**.
- If an ICC profile is selected as the **Output Profile**, Adobe CMM can be selected as the color conversion engine. Refer to Using Adobe CMM →P.503 for details.

3 Select the profile matching method in **Matching Method**.

4 Click the **Print** button.

Printing begins with the output profile and matching method that you have set.

Print High-Quality Adobe RGB16bit Images

This prints a high-quality Adobe RGB16bit image taken with a high-end digital camera. Print Plug-In allows you to print high color gamut and high tone images, when the Adobe RGB16bit image data has been retouched in Photoshop, without compromising the level of tone in the image.

- 1 Select the Adobe RGB16bit image data in Photoshop and start Print Plug-In. (See "Starting from Photoshop.")
→P.470

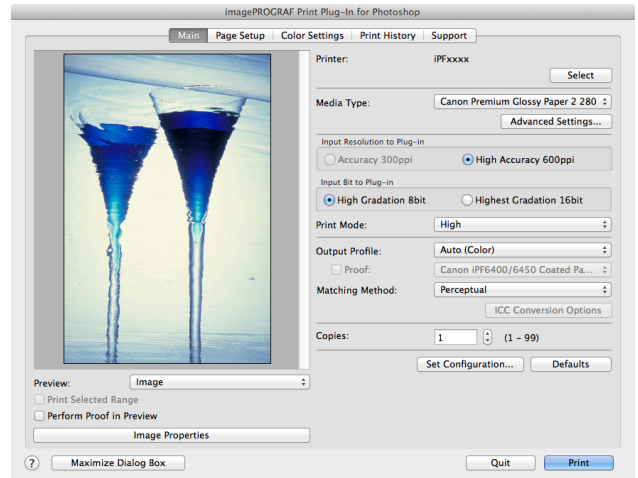

- 2 Click **Image Properties** button.

- 3 Check that **Adobe RGB** is displayed in **Color Space**, and **16bit/channel** is displayed in **Bit** in the **Image Properties** dialog box, and click the **Close** button.

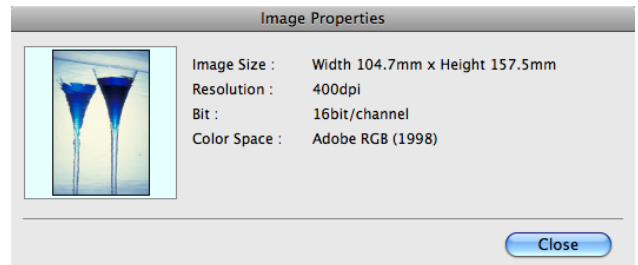

- 4 Display the **Main** sheet.

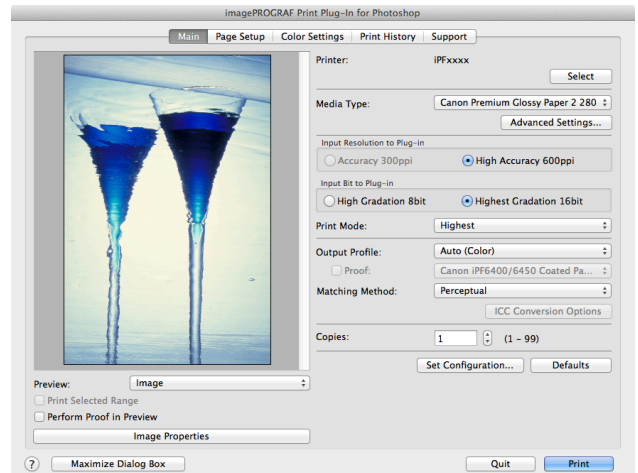

- 5 Select **High Accuracy 600ppi** in **Input Resolution to Plug-in**.

- 6 Select **Highest Gradation 16bit** in **Input Bit to Plug-in**.

- 7 Select the highest quality possible in **Print Mode**.

- 8** If required, adjust the colors using color matching.



Note

- For more information about the color matching, see "Adjust the Colors by Color Matching." →P.501

- 9** Click the **Print** button.

Printing of the Adobe RGB16bit image begins.

Prints monochrome photographs with high quality

Prints images captured with a scanner or digital camera in monochrome with high quality. Provides stable monochrome photo images without color casts and minimizes the influences of the difference of the light source.

- 1** Display the **Main** sheet.

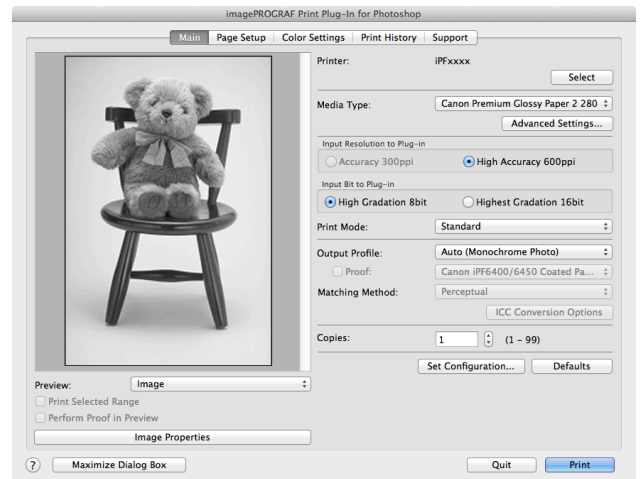

- 2** Select **Auto (Monochrome Photo)** in **Output Profile**.



Note

- **Auto (Monochrome Photo)** can be selected only after a compatible **Media Type** has been selected.

- 3** Click the **Print** button.

Performs conversion to the most suitable monochrome and printing begins.

Using Adobe CMM

Adobe CMM is a color conversion engine made by Adobe. Using Adobe CMM makes it possible to obtain uniform color conversion results and to use the black point compensation function.



Important

- Use version 1.1 or higher of Adobe CMM.

- How to Obtain Adobe CMM

Adobe CMM can be obtained using the following procedure.

- 1** Open the Adobe website (<http://www.adobe.com>).

- 2** Enter "Adobe CMM" in the search input box on the screen.

- 3 Search for the "Adobe Color Management Module (CMM)" item and select the Macintosh version.
- 4 Download the file by following the on-screen directions.
- 5 Start the installer in the downloaded file to perform the installation.

- **Adobe CMM System Requirements**

The system requirements for Adobe CMM are as follows.

- Supported OS
Mac OS X 10.4.8 or later
- Supported CPU
PowerPC G4 or G5
Intel Core Duo, Intel Core 2 Duo, Intel Xeon processor



- Check with Adobe for details.

Note

- **How to Use Adobe CMM**

The procedure for using Adobe CMM is as follows.

- 1 Display the **Main** sheet.

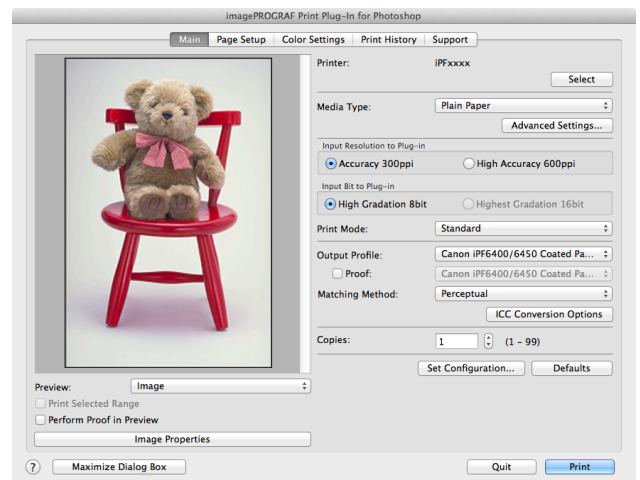

- 2 Select one of the ICC profiles as the **Output Profile**.

- 3 Click the **ICC Conversion Options** button.

- 4 In the **ICC Conversion Options** dialog box, select **Adobe CMM** from **Conversion Engine**.

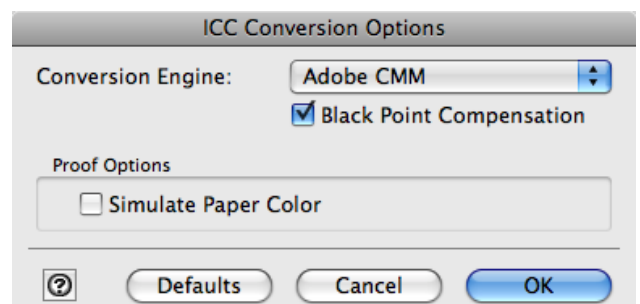

- 5 Click the **OK** button to close the **ICC Conversion Options** dialog box.

Printing an Adjustment Pattern and Selecting Adjustment Values

Since you can print an adjustment pattern and select your preferred adjustment values while comparing the images, this allows you to conserve ink and paper, and save the time it takes to repeatedly check adjustment results. The procedure for displaying and printing an adjustment pattern is as follows.

- 1 Display the **Color Settings** sheet (color or monochrome) and set the adjustment values to use as the baseline values.
- 2 Click the **Adjustment pattern setting** button to display the **Adjustment pattern setting** dialog box.

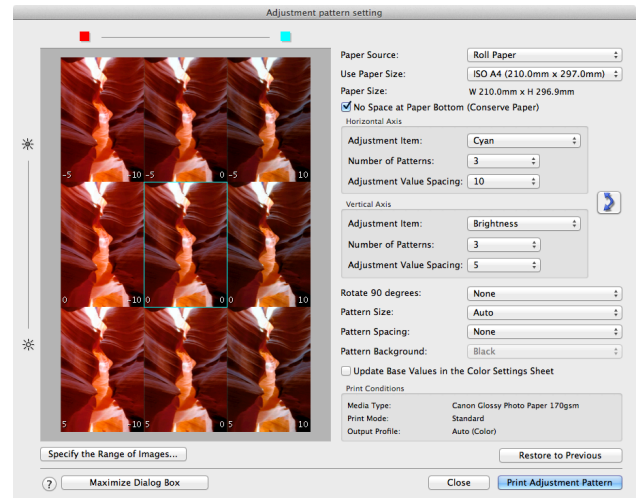

- 3 Set the **Adjustment Item**, **Number of Patterns**, and **Adjustment Value Spacing** for the **Horizontal Axis** and **Vertical Axis**.
If you want to check part of an image as the adjustment pattern, click the **Specify the Range of Images** button, select the range you want to check in the **Specify the Range of Images** dialog box, and then click the **OK** button.

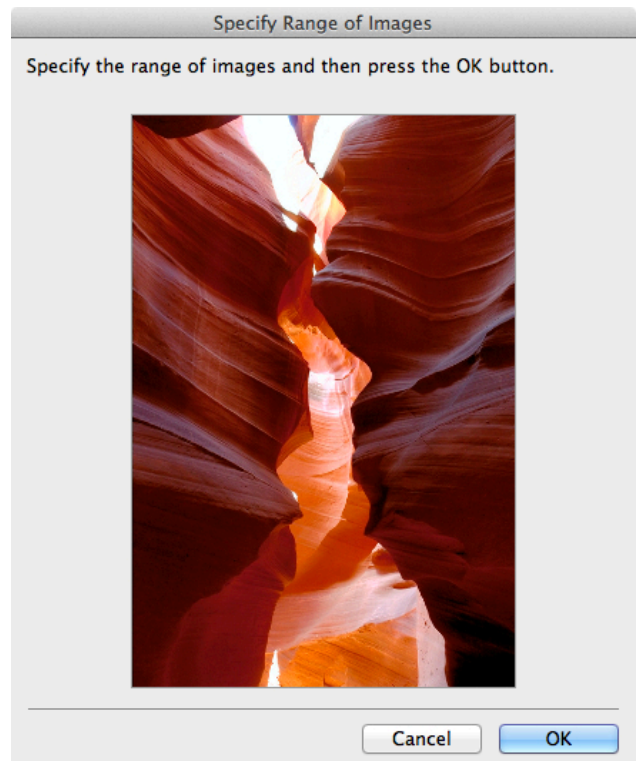

- 4 Set **Rotate 90 degrees**, **Pattern Size**, **Pattern Spacing**, and **Pattern Background** as needed.
- 5 For the **Paper Source** setting, select how the paper to print on is to be supplied.

- 6 For the **Use Paper Size** setting, select the paper size to print on.
- 7 Click the **Print Adjustment Pattern** button.
The adjustment pattern starts printing.
- 8 Check the image in the adjustment pattern that is closest to the customer image and click the corresponding image in the preview area.
- 9 If there are any other items that you want to adjust, select **Adjustment Item** and perform steps 7 and 8.
- 10 Once you have made the necessary adjustments, select the **Update Base Values in the Color Settings Sheet** check box and click the **Close** button.
The previous adjustment values in the **Color Settings** sheet (color or monochrome) are updated.

Perform Black Point Compensation

Black point compensation that is equivalent to Photoshop can be performed using the following procedure. Use this to avoid saturation in the black areas of images.



Important

- In order to make the black point compensation settings effective, close down and restart Photoshop or Digital Photo Professional.
- Adobe CMM needs to be installed in order to use black point compensation. Refer to Using Adobe CMM →P.503 for details on how to install Adobe CMM.

- 1 Display the **Main** sheet.

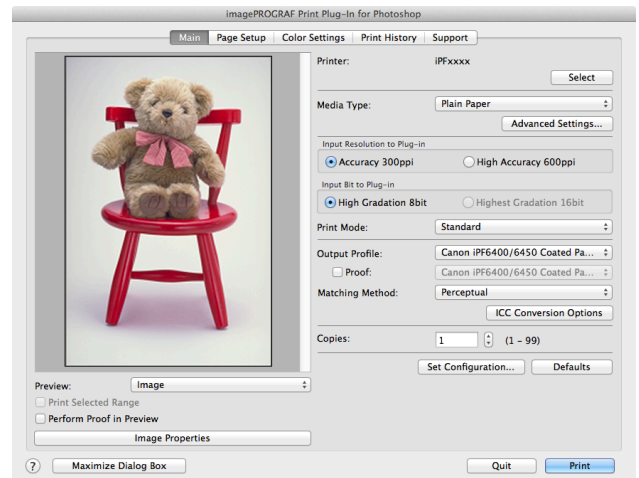

- 2 Select one of the ICC profiles as the **Output Profile**.
- 3 Click the **ICC Conversion Options** button to open the **ICC Conversion Options** dialog box.
- 4 Select **Adobe CMM** as the **Conversion Engine**.

- 5** Check the **Black Point Compensation** check box.

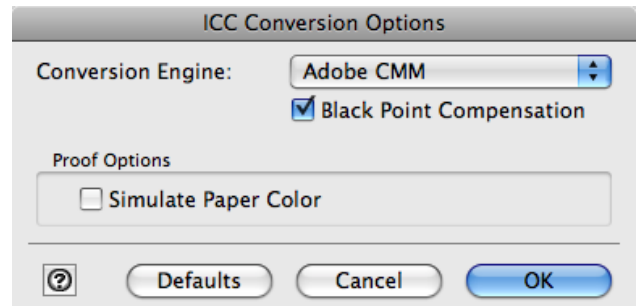

- 6** Click the **OK** button to close the **ICC Conversion Options** dialog box.

Perform Printing Press Simulation Print

You can perform printing press simulation prints by specifying ICC profiles such as Japan Color or SWOP, and specifying an ICC profile for the printing press.

- 1** Display the **Main** sheet.

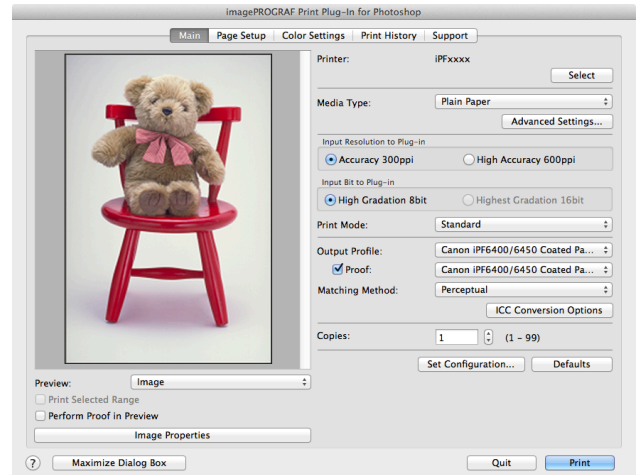

- 2** Select one of the ICC profiles as the **Output Profile**.

- 3** Check the **Proof** check box and select the profile for the printing press you want to target from the list on the right.

- 4** Click the **ICC Conversion Options** button to open the **ICC Conversion Options** dialog box.

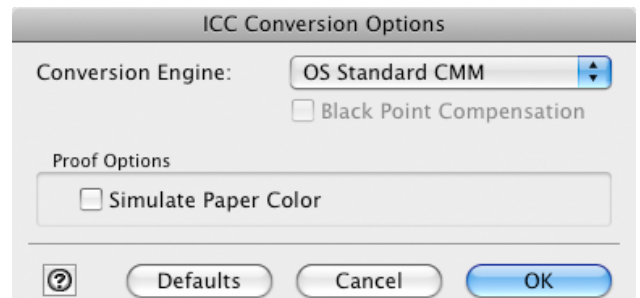

- 5** Configure the **Proof Options** as needed.



Note

- The proof option is **Simulate Paper Color**.

6 Click the **OK** button to close the **ICC Conversion Options** dialog box.

7 Click the **Print** button.
Printing begins.

Enlarge/Reduce and Print

You can enlarge or reduce an image in Print Plug-In.
Three methods to enlarge/reduce and print are as follows.

- Enlarge/Reduce and Print Matching Output Media Size →P.508
- Enlarge/Reduce and Print Matching Width of Roll Paper →P.509
- Specify Scaling, Enlarge/Reduce and Print →P.510

Enlarge/Reduce and Print Matching Output Media Size

By specifying the media type loaded in the printer, the image can be enlarged or reduced to fit the size of the image area of the media. This feature is useful when you need to print on the full width of Media that you have selected.

- When you need to print on the full width of roll media, see "Enlarge/Reduce and Print Matching Width of Roll Paper." →P.509
- Note** • When you do the procedure below to print on roll media, the print job will match the size of the output with the media selected with the **Paper Size** setting.

1 Display the **Page Setup** sheet.

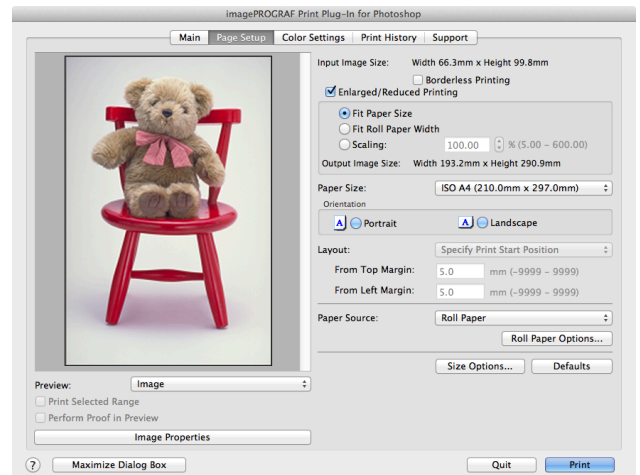

2 Select the size of the media that you want to print in **Paper Size**.

- This is not displayed when a checkmark is placed in **Borderless Printing**.
- Note** • This is not displayed when **Fit Roll Paper Width** is set in **Enlarged/Reduced Printing**.

3 Select either **Portrait** or **Landscape** as the media orientation for the image in **Orientation**.

- When you select **Portrait**, the image on the media prints as it appears on the screen.
- Note** • When you select **Landscape**, the image on the media prints rotated 90 degrees.

4 Click the **Enlarged/Reduced Printing** check box on.

- This is not displayed when a checkmark is placed in **Borderless Printing**.
- Note**

5 Select **Fit Paper Size**.

6 Click the **Print** button.

The image prints filling the entire output media surface.

Enlarge/Reduce and Print Matching Width of Roll Paper

You can enlarge/reduce and print an image matching the width of the roll paper set in the printer. This is useful when you wish to print an image that covers the entire width of the roll paper.



Note

- Printing will not occur properly when a print roll is not set to the printer.

1 Display the **Page Setup** sheet.

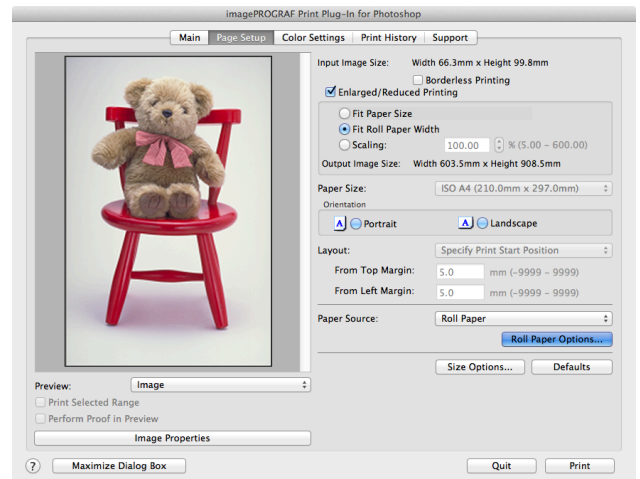

2 Select **Roll Paper** in **Paper Source**.

3 Click the **Roll Paper Options** button.

4 Set the roll paper options and click the **OK** button.



Note

- For more information about the **Roll Paper Options** dialog box, see "Roll Paper Options Dialog Box." →P.490

- Click the **Defaults** button to return all of the roll paper option settings to their defaults.

5 Select either **Portrait** or **Landscape** as the media orientation for the image in **Orientation**.



Note

- When you select **Portrait**, the image on the media prints as it appears on the screen.

- When you select **Landscape**, the image on the media prints rotated 90 degrees.

6 Click the **Enlarged/Reduced Printing** check box on.



Note

- This is not displayed when a checkmark is placed in **Borderless Printing**.

7 Select **Fit Roll Paper Width**.

8 Click the **Print** button.

The image prints covering the entire width of the roll paper.

Specify Scaling, Enlarge/Reduce and Print

You can specify scaling to enlarge/reduce an image and print. This is useful when you wish to print an image at a specific size.

1 Display the **Page Setup** sheet.

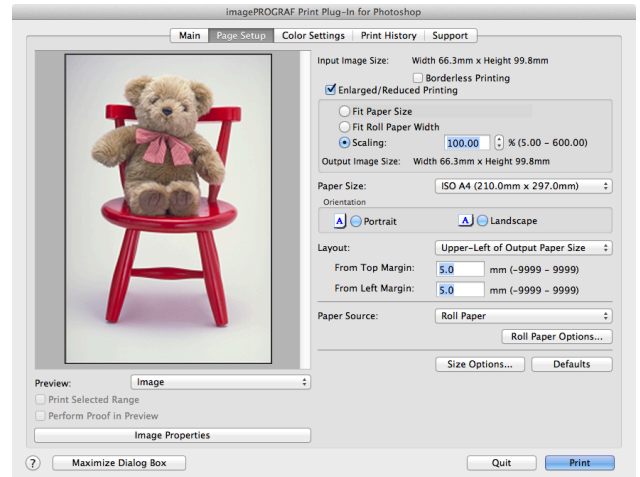

2 Select the size of the media that you want to print in **Paper Size**.

-  This is not displayed when a checkmark is placed in **Borderless Printing**.
- Note** • **Fit Roll Paper Width** is set in **Enlarged/Reduced Printing**.

3 Select either **Portrait** or **Landscape** as the media orientation for the image in **Orientation**.

-  When you select **Portrait**, the image on the media prints as it appears on the screen.
- Note** • When you select **Landscape**, the image on the media prints rotated 90 degrees.

4 Click the **Enlarged/Reduced Printing** check box on.

-  This is not displayed when a checkmark is placed in **Borderless Printing**.
- Note**

5 Select **Scaling** and input the scaling factor or drag the four corners of the image in the Preview display.

-  You can specify scaling rate in intervals of 0.01%.
- Note** • You can specify a range between 5.00-600.00%.
- The size of the width and height proportionally grow when the image is enlarged/reduced.

6 Either drag the image on the **Print Area Layout** preview, or set the print position **Layout**.

7 Click the **Print** button.

Printing begins at the set scaling rate.

Print with No Borders

You can use the borderless printing function to print without margins surrounding the image.



- With some media borderless printing can be performed only between two edges.

Note • To use the borderless printing function, the specified media must be set to the printer.

- 1 Display the **Page Setup** sheet.

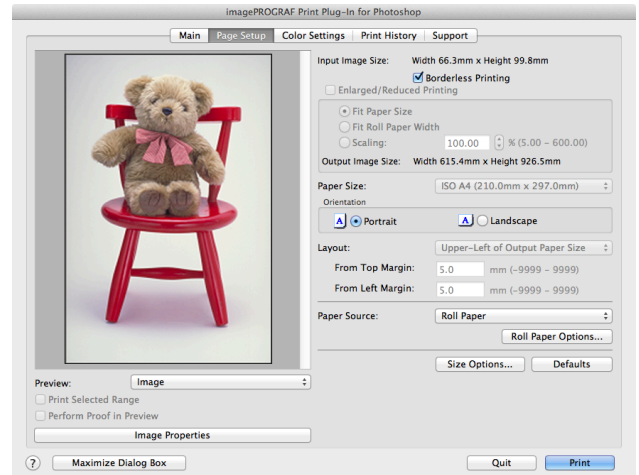

- 2 Select **Roll Paper** in **Paper Source**.

- 3 Click the **Borderless Printing** check box on.



Note

- Select the width for roll paper set in the printer in **Roll Paper Width** in the **Specify Roll Paper Width** dialog box, and click **OK**.

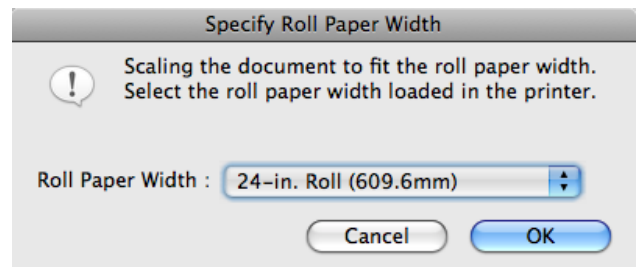

- 4 Click the **Print** button.

Borderless printing begins.

Customize Media Settings

You can customize media settings.

- 1 Display the **Main** sheet.

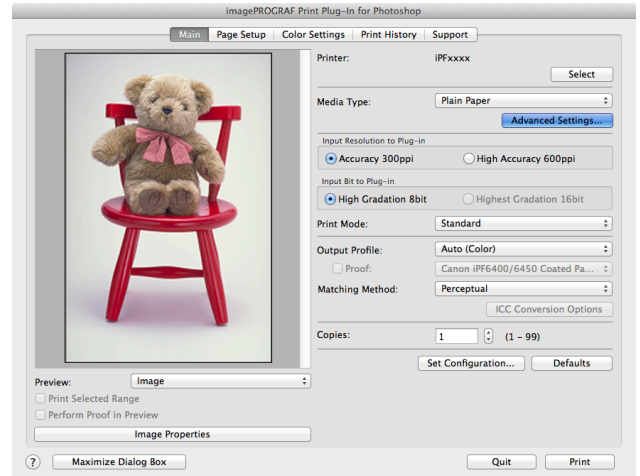

- 2 Select the media type that you wish to customize in **Media Type**.



Note

- Always select media type that is actually set in the printer. When the media you chose is different from the media set in the printer, you may not receive the desired print results.

- 3 Click the **Advanced Settings** button.

- 4 Perform the settings in the Paper Detailed Settings Dialog Box →P.487 and click the **OK** button.

Utilize Print History

When you perform various settings and print in Print Plug-In, those settings are saved as print history. Also, you can export and import as files. You can store often-used print history under a specified name in print preferences.



Note

- You can save up to 200 print history items. All items over 200 are deleted in chronological order.

You can do the following things using print history.

- Confirm Print History Details →P.513
- Apply Print History to an Image →P.514
- Store Print History to Print Preferences →P.514
- Delete Print History →P.516
- Export Print History from Print Preferences →P.517
- Import Print History to Print Preferences →P.518
- Delete Print History from Print Preferences →P.520
- Set Information to Print with Image →P.521

Confirm Print History Details

You can confirm the print history details.

1 Display **Print History** sheet.

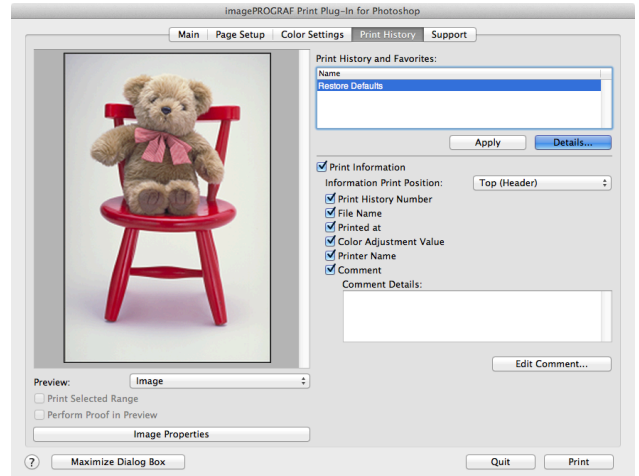

2 Click the **Details** button.



Note

- Select the print history you wish to check the details of, from either **Print History** or **Favorites** in the **Print History Details** dialog box.

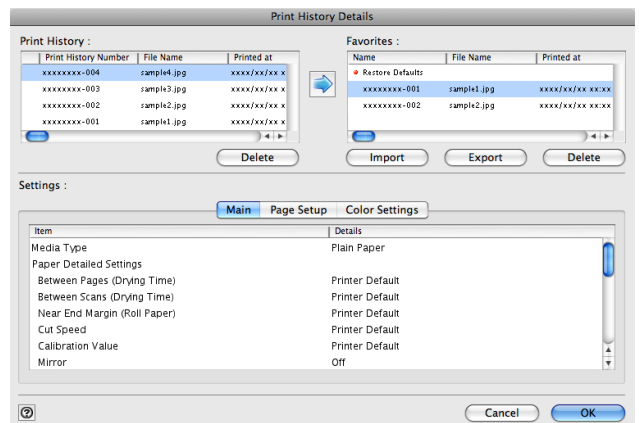

3 Check the print history details in **Settings**, and click the **OK** button.



Note

- You can display the print history details by switching the sheets.

Apply Print History to an Image

You can use previous print history, and apply it to an image.

- 1 Display the **Print History** sheet.

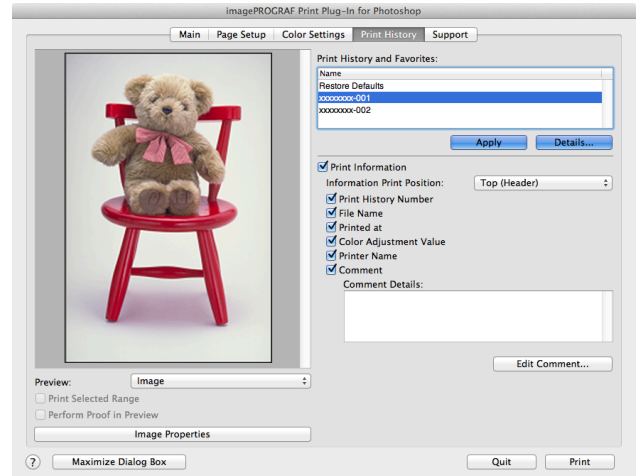

- 2 If required, check the print history details. (See "Confirm Print History Details." →P.513)

- 3 Select the print history you wish to apply from **Print History and Favorites**, and click the **Apply** button.

Store Print History to Print Preferences

You can store often-used print history to print preferences. Not only can you store the print history stored under a different name in print preferences, you can also find it with ease.



Note

- You can store up to 200 print history items to print preferences.

- 1 Display the **Print History** sheet.

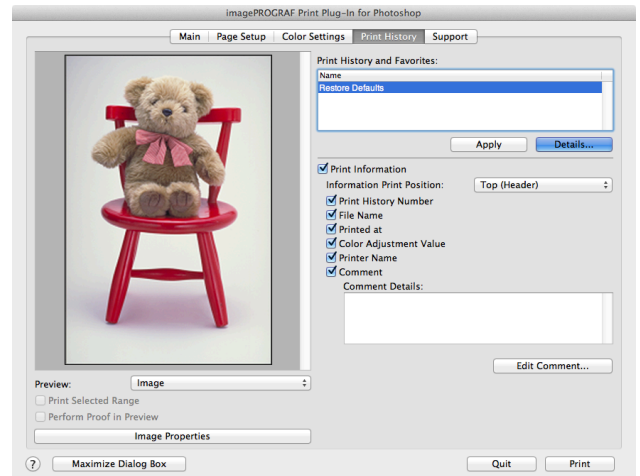

- 2 Click the **Details** button.

3 Select the print history you wish to store in print preferences from **Print History** in the **Print History Details** dialog box, and check the print history details in **Settings**.

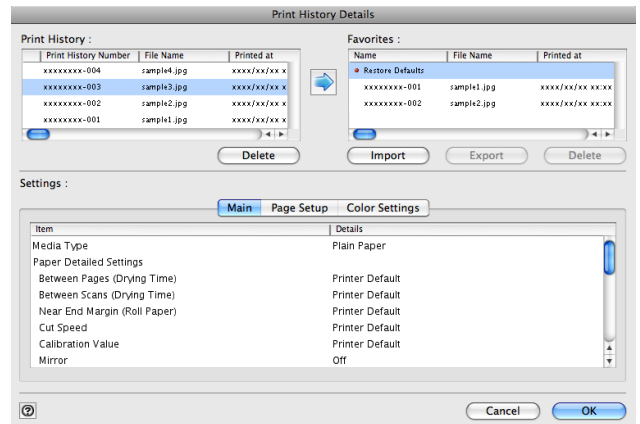

4 Select the print history you wish to store in print preferences from **Print History** and click the  button.

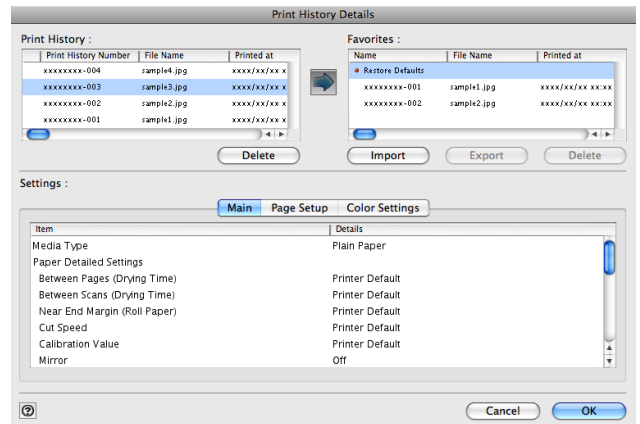

5 In the **Add Favorites** dialog box input the name of the print history in **Name**, input a comment in **Comment**, and click the **OK** button.

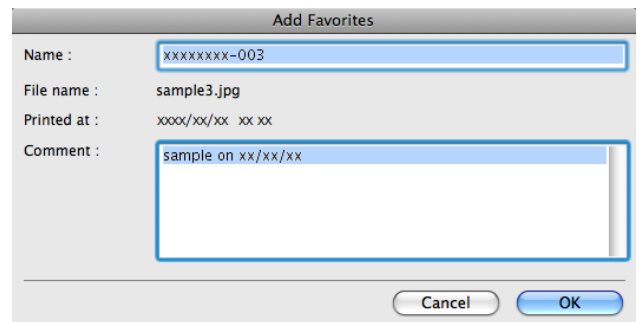

6 Click the **OK** button to close the **Print History Details** dialog box.

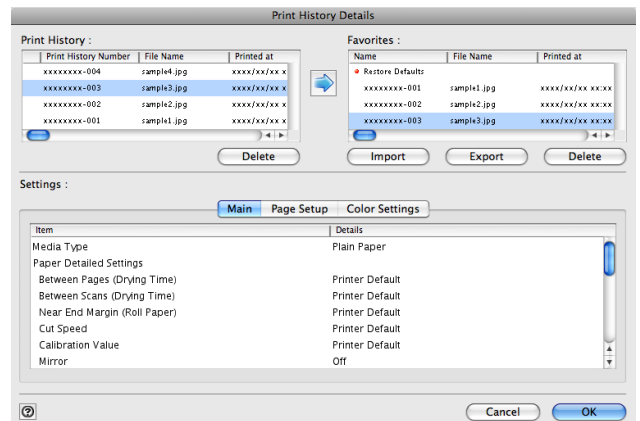

Delete Print History

You can delete print history.



Important

- Be aware that you cannot undo deletions of print history.

1 Display the **Print History** sheet.

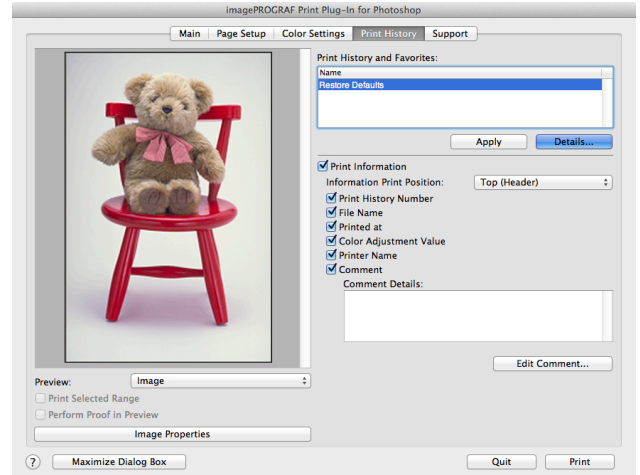

2 Click the **Details** button.

3 Select the print history you wish to delete from **Print History** in the **Print History Details** dialog box, and click the **Delete** button.

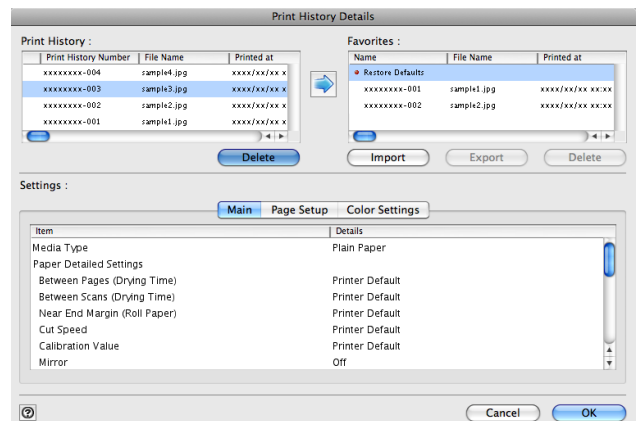

4 Click the **OK** button.

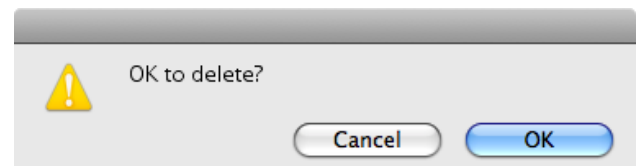

- 5** Click the **OK** button to close the **Print History Details** dialog box.

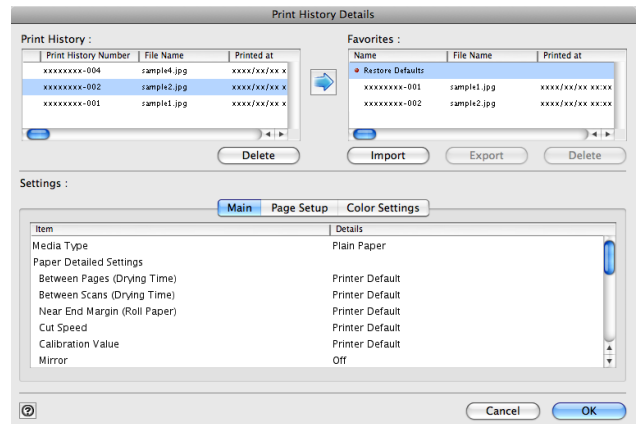

Export Print History from Print Preferences

You can export print history stored in print preferences as a file.

- 1** Display the **Print History** sheet.

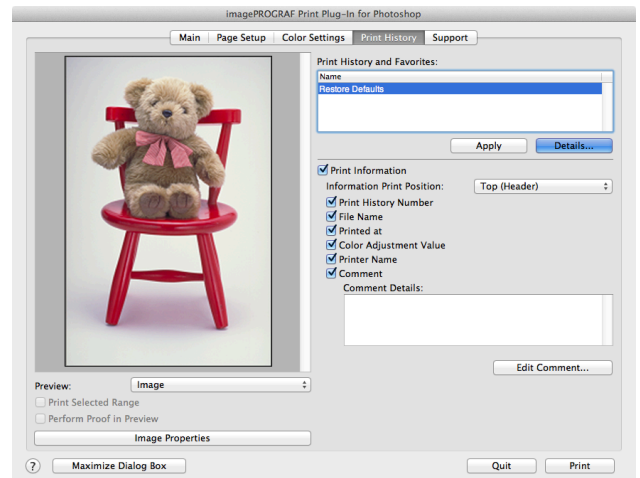

- 2** Click the **Details** button.

- 3** Select the print history you wish to export from **Favorites** in the **Print History Details** dialog box, and click the **Export** button.

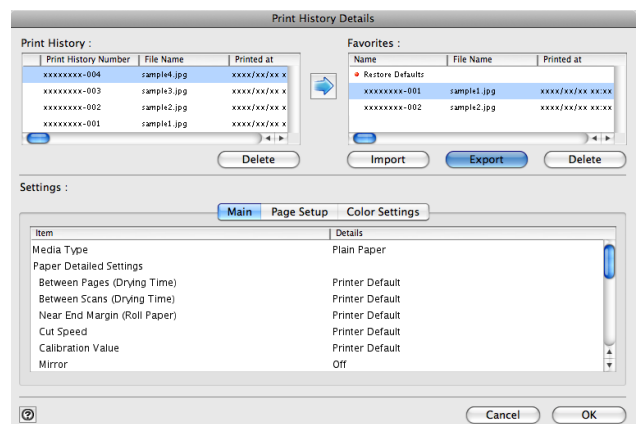

- Input the name of the print history in **Save As** in the **Save** dialog box, and click the **Save** button.

The print history is exported under the specified file name.

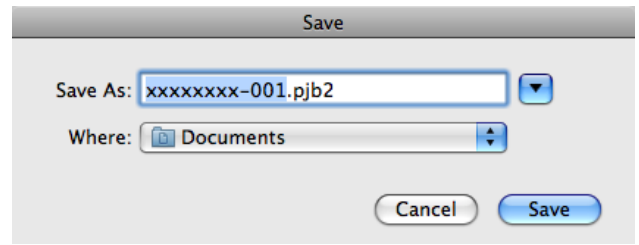

- Click the **OK** button to close the **Print History Details** dialog box.

Import Print History to Print Preferences

You can import print history in file format and store it to print preferences.

- Display the **Print History** sheet.

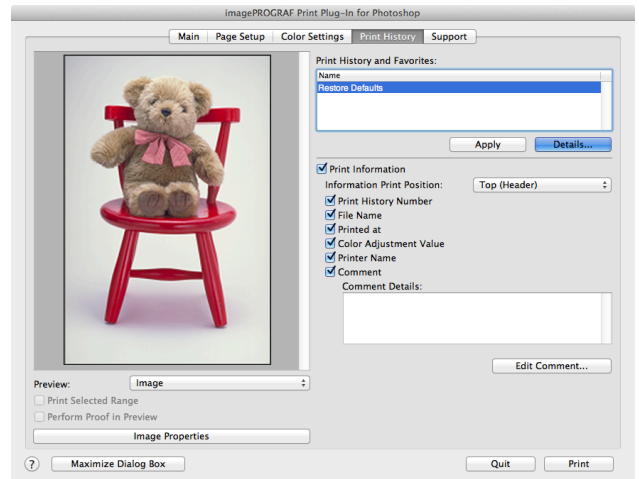

- Click the **Details** button.

- Click the **Import** button of the **Favorites** in the **Print History Details** dialog box.

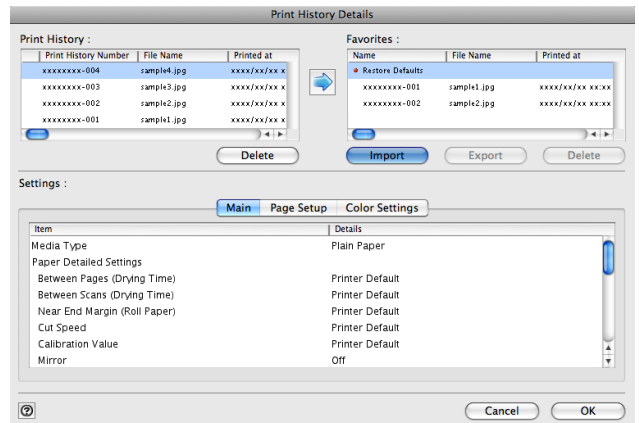

- 4** Select the print history you wish to import in the **Open** dialog box, and click the **Open** button.

The print history is imported.

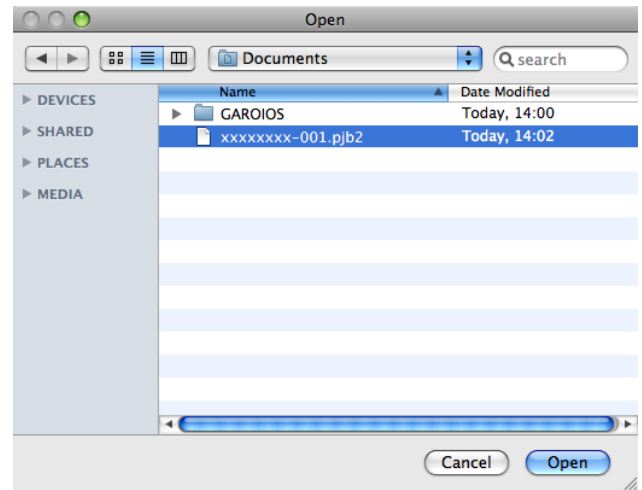

- The print history file name suffix is *.pjb/*.pjb2.
- Note** • You cannot import a print history file exported from a different OS in Print Plug-In.
- You cannot import a print history file exported from a different printer in Print Plug-In.

- 5** Click the **OK** button to close the **Print History Details** dialog box.

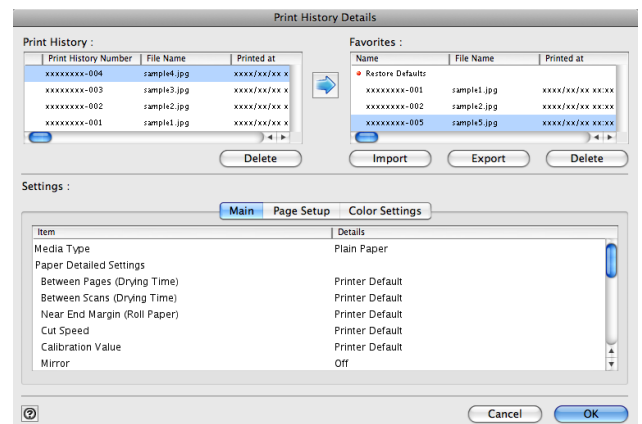

Delete Print History from Print Preferences

You can delete print history store to print preferences. You cannot store more than 200 print history items in print preferences.

1 Display the **Print History** sheet.

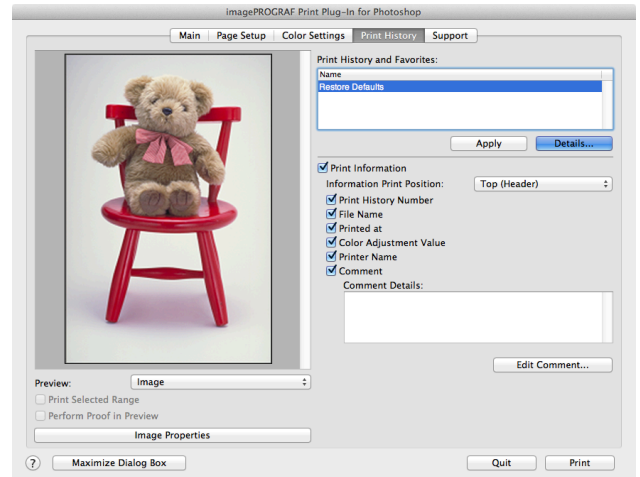

2 Click the **Details** button.

3 Select the print history you wish to delete from **Favorites** in the **Print History Details** dialog box, and click the **Delete** button.

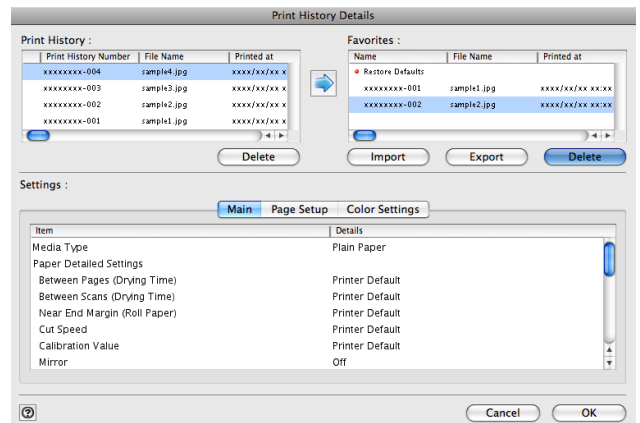

4 Click the **OK** button.

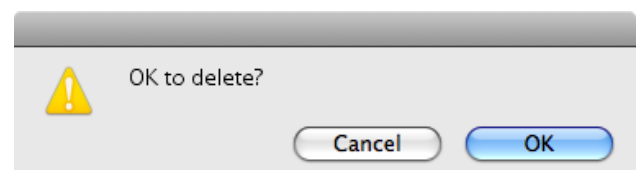

- 5** Click the **OK** button to close the **Print History Details** dialog box.

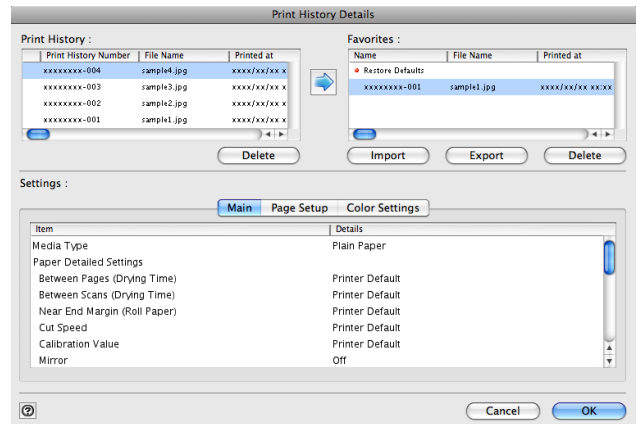

Set Information to Print with Image

You can print information with an image that is related, such as the file name and the time and date.



Note

- When you use the borderless printing function to print, the information will not be printed. (See "Print with No Borders.")
- When the printed information is too long as does not fit on the media, a break will appear in the printed information.
- The information may print on the image data with some media sizes, enlargement rates and print position values.
- When **Keep Media Size** is set to **On** on the printer, a portion of bottom of the print data is not printed.

- 1** Display the **Print History** sheet.

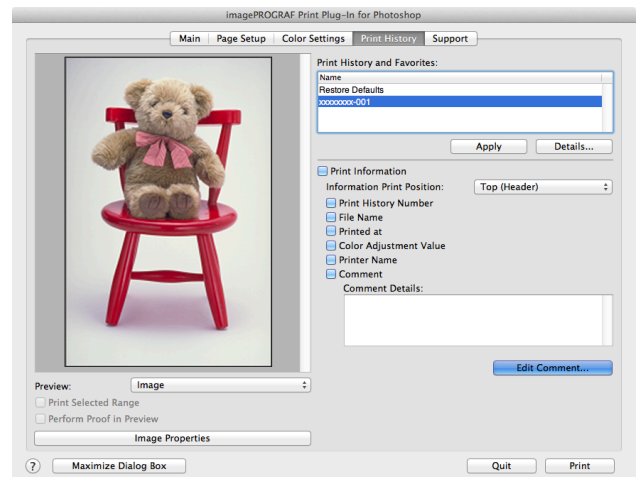

- 2** Click the **Print Information** check box on.
- 3** Select the position where you wish to print the information in **Information Print Position**.
- 4** Click the information check box you wish to print on.
- 5** When you wish to edit the comment, click the **Edit Comment** button.



Note

- When you do not wish to edit the comment, move to step 7.

- 6** Input the comment in the **Edit Comment** dialog box, and click **OK** button.

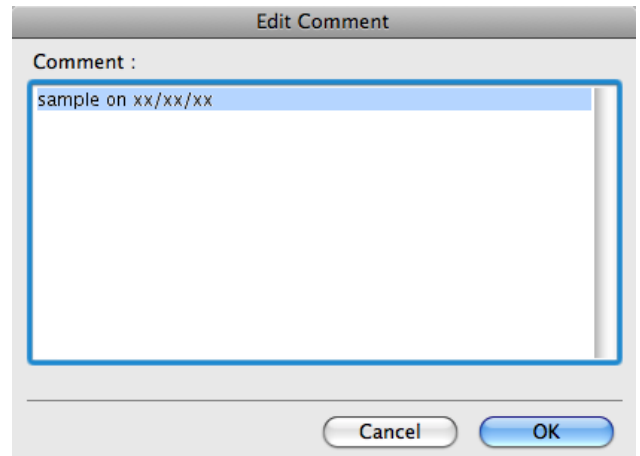

- 7** Click the **Print** button.
Comments are printed with images.

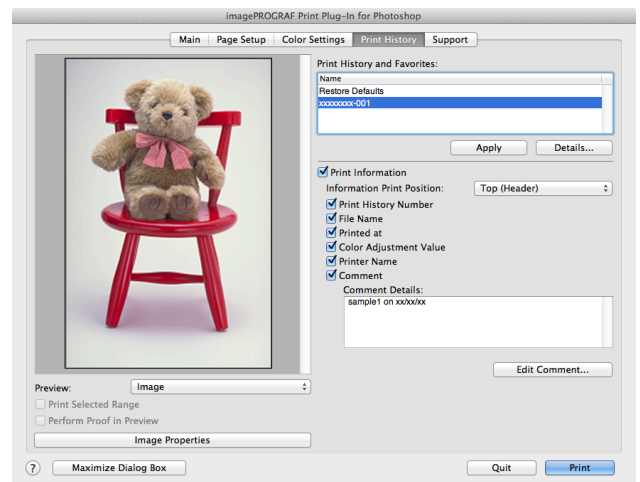

Layout Plug-In for Photoshop

About the Layout Plug-In	523
Layout Plug-In Main Window	523
Add Canvas Size dialog box	525
Creating and Printing a Layout Image for Mounting on a Frame	526

About the Layout Plug-In

When printing a photo to mount on a frame, you can start the Layout Plug-In from Photoshop and create a layout image where the image extends to the sides of the frame.



- The Layout Plug-In can be used with Photoshop CS5, Photoshop CS4, and Photoshop CS3.
- Note** • Layout images created in the Layout Plug-In can be printed as-is from the Print Plug-In for Photoshop.

For details on the functionality of the Layout Plug-In, see "Layout Plug-In Main Window." →P.523

For details on how to start and how to use the Layout Plug-In, see "Creating and Printing a Layout Image for Mounting on a Frame." →P.526

Layout Plug-In Main Window

This window is for creating a layout image for finishing an image extended around the sides of the frame when printing a photo for mounting on a frame.

You can check the details of the settings in the preview area on the left side of the Layout Plug-In Main Window.

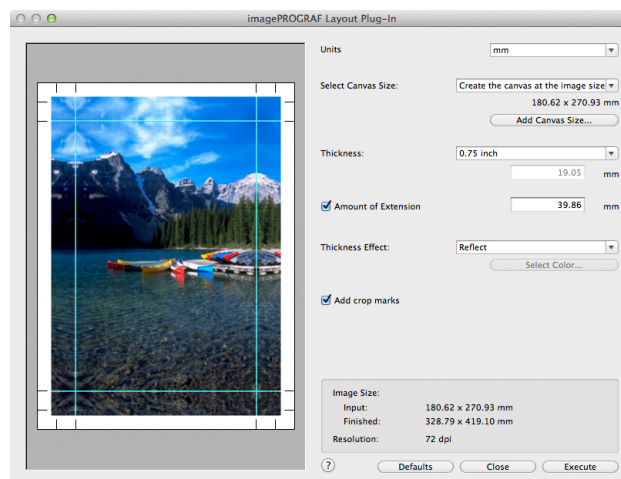

• Units

You can select the units from mm, inches, and pixels.



- Since values entered in mm or inches are first converted temporarily to pixels and then reconverted to mm or inches, values may be displayed that differ from the entered values.

• Select Canvas Size

Selects the canvas size. If **Create the Canvas at the Image Size** is selected, the image size is treated as the canvas size. It is recommended that you provide a canvas that matches the image size.

• Add Canvas Size button

Click this button to display the **Add Canvas Size** dialog box and register a **Custom Canvas Size**. (See "Add Canvas Size dialog box.") [→P.525](#)

• Thickness

Specifies the thickness of the canvas (the width of the canvas sides). Although you can select from 0.75 inches (approx. 19 mm) and 1.5 inches (approx. 38 mm), you can also specify any arbitrary thickness.



- Since values entered in mm or inches are first converted temporarily to pixels and then reconverted to mm or inches, values may be displayed that differ from the entered values.

• Amount of Extension

Selecting this check box allows you to configure the amount of extension that protrudes past the canvas sides. This allows you to prevent white paper from appearing on the canvas sides when mounted. The larger the amount of extension, the larger the area hidden behind the back surface.



- Since values entered in mm or inches are first converted temporarily to pixels and then reconverted to mm or inches, values may be displayed that differ from the entered values.

• Thickness Effect

You can select from the following canvas effects.

- **Image**
Wraps the image to the canvas sides.
- **Soft Image**
Performs Gaussian filtering on the image on the canvas sides.
- **Reflection**
Reflects the image on the canvas sides.
- **Soft Reflection**
Reflects the image on the canvas sides and performs Gaussian filtering.
- **White**
Makes the canvas sides white.
- **Black**
Makes the canvas sides black.
- **Custom Color**
Makes the canvas sizes the specified color. The color is specified by clicking the **Select Color** button.

• Add Crop Marks

When this check box is selected, crop marks are printed at the outer edges of the image as guides to the positions to fold the paper when mounting on a canvas.

• Display Information

Displays the following information.

- **Input**

Displays the original image size before creating the layout image.

- **Finished**

Displays the image size of the entire layout image with the canvas sides, crop marks, and the amount of extension added to the input image size.

- **Resolution**

Displays the resolution of the image. This is not changed from the resolution of the original image. If the image size is changed in the Layout Plug-In, the resolution is maintained the same as the original image, and resampling is performed using the Bicubic method.

If you do not want the number of pixels in the image to change (resample), select **Create the Canvas at the Image Size** in **Select Canvas Size** and select an option other than **Image** and **Soft Image** in **Thickness Effect**.

- **Defaults** button

Click this button to reset the setting values.

- **Close** button

When this button is clicked, the Layout Plug-In exits and the current setting values are saved. When the Layout Plug-In is started the next time, the setting values from the previous time are used.

- **Execute** button

When this button is clicked, the Print Plug-In for Photoshop starts. To print the created layout image, click the **Print** button in the Print Plug-In for Photoshop main window.



Important

- When you close the Print Plug-In, the created layout image is discarded.



Note

- If the Print Plug-In for Photoshop for multiple different models is installed, a screen for selecting the model is displayed when you click the **Execute** button.
- When you close Print Plug-In for Photoshop main window after printing, the Layout Plug-In main window is displayed again.
- If the size of the layout image is larger than the paper size that can be printed by the printer, you should reduce the size of the layout image to the output paper size in advance before printing.

Add Canvas Size dialog box

This dialog box is displayed when you click the **Add Canvas Size** button in the Layout Plug-In main window. It allows you to register and delete arbitrary canvas sizes (custom canvas sizes).

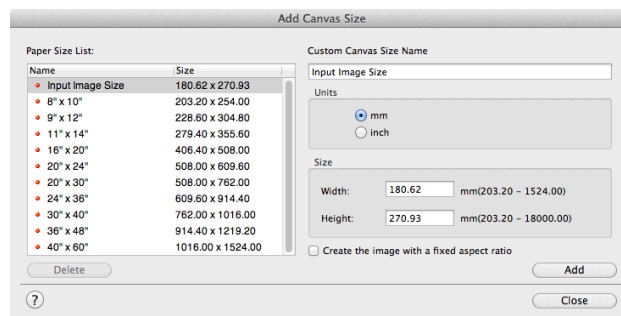

Click the **Close** button to close the **Add Canvas Size** dialog box.

Adding a Canvas Size

- 1 Specify the units for the width and height of the canvas size you are adding in **Units**.

- 2 Enter the width and height of the canvas size you are adding in **Size**.
When you select a size displayed in the **Paper Size List**, the values are displayed in the **Width** and **Height** in the **Size** field. When **Input Image Size** is selected, the size of the input image is used as-is for the width and height of the canvas.
Selecting the **Create the Image with a Fixed Aspect Ratio** check box allows you to create a custom size at the same aspect ratio as the input image. For example, if you change the width, then the height also changes according to the aspect ratio of the input image.

- 3 Enter the name of the canvas size to add in **Custom Canvas Size Name**.

- 4 Click the **Add** button.

Deleting a Canvas Size

- 1 Select the **Custom Canvas Size Name** you want to delete from the **Paper Size List**.

- 2 Click the **Delete** button.

 • Sizes that have a red circle in the **Name** cannot be deleted.

Note

Creating and Printing a Layout Image for Mounting on a Frame

The procedure for creating and printing a layout image for mounting on a frame is as follows.

- 1 Start Photoshop.
- 2 Open the image to lay out and edit the image in Photoshop as needed.
- 3 Select **imagePROGRAF Layout Plug-In** from **Automate** in the Photoshop **File** menu.
Run the Layout Plug-In to display the Layout Plug-In Main Window.

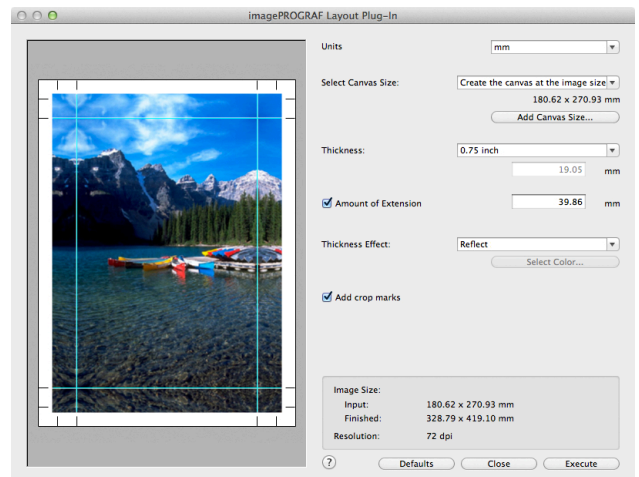

 • The Layout Plug-In can handle images with a width and height of less than 60,000 pixels. For images with a width or height of 60,000 pixels or more, either reduce the selection range or reduce the image through image processing before performing step 3.

- 4 Select the canvas size that matches the frame for mounting the image and create a layout image by adding effects such as frame side effects.

For details, see "Layout Plug-In Main Window." →P.523



Important

- The created layout image cannot be modified in Photoshop.

- 5 Once you have finished creating the layout image, run the Print Plug-In for Photoshop and print on paper that is larger than the size of the layout image.



Important

- When you click the **Close** button to close the Layout Plug-In, the created layout image is discarded.

- 6 Mount the printed layout image on the frame.



Important

- Fully dry the printed paper before mounting it on the frame.
- Take care when mounting on the frame. The ink may peel off if you touch the printed surface.



Note

- As you fold the printed paper along the frame, the folded areas may crack and reveal the paper underneath, depending on the media type. You can prevent the folded areas from splitting to some degree by using commercially available inkjet protection spray or liquid laminating agent for inkjets before folding.

Memo

Basic Printing Workflow	19
Enhanced Printing Options	35
Windows Software	177
Mac OS X Software	363

Handling and Use of Paper

Paper	530
Handling rolls	538
Handling sheets	563
Output Stacker	570
Media take-up unit	578
Media Configuration Tool (Windows)	590
Media Configuration Tool (Mac OS X)	619

Control Panel	655
Printer Parts	691
Network Setting	707
Print Job Management	741
Adjustments for Better Print Quality	803
Color Management	821
Maintenance and Consumables	833
Troubleshooting	883
Error Message	915
Specifications	941
Appendix	945

Paper

Types of Paper	530
Paper Sizes	530
Using Paper Other Than Genuine Paper and feed confirmed Paper	533
Printing on Paper Other Than Genuine Paper and feed confirmed Paper Using Existing Settings	533
Printing on Paper Other Than Genuine Paper and feed confirmed Paper by Adding a Media Type	534
Displaying the Paper Reference Guide	535
Updating paper information	536

Types of Paper

The following types of paper are supported by the printer. For details on the paper supported by the printer, refer to the Paper Reference Guide. (See Paper Reference Guide.)

- Plain Paper
- Coated Paper
- Photo Paper
- Glossy Paper
- Proofing Paper
- CAD-dedicated Paper Etc.

The following content is described in the Paper Reference Guide.

- Types of paper
- Paper handling
- Paper product specifications
- Use precautions
- Setting of printer driver, control panel etc.



- For more information on how to use paper that is not listed in the Paper Reference Guide, see "Using Paper Other Than Genuine Paper and feed confirmed Paper." →P.533

- Paper Reference Guide display method

You can display the Paper Reference Guide from [imagePROGRAF Support Information]. (See "Displaying the Paper Reference Guide." →P.535)

- Method of Updating Supported Paper

Paper supported by the printer may be newly released on the imagePROGRAF website.

To use newly released paper, register the latest paper information on the printer with the Media Configuration Tool. (See "Updating paper information." →P.536)



Important

- To install the Paper Reference Guide and register paper types applicable to your region on your printer even when not using the printer driver, install the Media Configuration Tool. For information about the Media Configuration Tool, see Media Configuration Tool (Windows) →P.590 or Media Configuration Tool (Macintosh) →P.619 .

Paper Sizes

Rolls

Rolls that meet the following conditions are supported.

- Outer diameter: up to 150 mm (6.0 in)
- Inner diameter of paper core: 2 or 3 inches
- Printing side out

Roll width	Roll Paper Width Settings in Printer Driver	Borderless Printing (*1)
1524.0 mm (60.00 in)	60-in. Roll (1524.0mm)	Yes
1371.6 mm (54.00 in)	54-in. Roll (1371.6mm)	No
1270.0 mm (50.00 in)	50-in. Roll (1270.0mm)	Yes
1117.6 mm (44.00 in)	44-in. Roll (1117.6mm)	Yes
1066.8 mm (42.00 in)	42-in. Roll (1066.8mm)	Yes
1030.0 mm (40.55 in)	JIS B0/B1 Roll (1030.0mm)	Yes
914.4 mm (36.00 in)	36-in. Roll (914.4mm)	Yes
841.0 mm (33.11 in)	ISO A0/A1 Roll (841.0mm)	Yes
762.0 mm (30.00 in)	30-in. Roll (762.0mm)	No
728.0 mm (28.66 in)	JIS B1/B2 Roll (728.0mm)	No
609.6 mm (24.00 in)	24-in. Roll (609.6mm)	Yes
594.0 mm (23.39 in)	ISO A1/A2 Roll (594.0mm)	Yes
515.0 mm (20.28 in)	JIS B2/B3 Roll (515.0mm)	Yes
431.8 mm (17.00 in)	17-in. Roll (431.8mm)	Yes
420.0 mm (16.54 in)	ISO A2/A3 Roll (420.0mm)	No
406.4 mm (16.00 in)	16-in. Roll (406.4mm)	No
355.6 mm (14.00 in)	14-in. Roll (355.6mm)	Yes
297.0 mm (11.69 in)	ISO A3/A4 Roll (297.0mm)	No
254.0 mm (10.00 in)	10-in. Roll (254.0mm)	Yes

*1: For information on types of paper compatible with borderless printing, refer to the Paper Reference Guide. (See "Types of Paper.")

→P.530

Sheets

Sheets of the following sizes are supported.

Paper size	Dimensions
ISO A0	841.0 × 1189.0 mm (33.11 × 46.81 in)
ISO A1	594.0 × 841.0 mm (23.39 × 33.11 in)
ISO A2	420.0 × 594.0 mm (16.54 × 23.39 in)
ISO A2+	431.8 × 609.6 mm (17.00 × 24.00 in)
ISO A3	297.0 × 420.0 mm (11.69 × 16.54 in)
ISO A3+	329.0 × 483.0 mm (12.95 × 19.02 in)
ISO A4	210.0 × 297.0 mm (8.27 × 11.69 in)
ISO B0	1000.0 × 1414.0 mm (39.37 × 55.67 in)
ISO B1	707.0 × 1000.0 mm (27.83 × 39.37 in)
ISO B2	500.0 × 707.0 mm (19.69 × 27.83 in)
ISO B3	353.0 × 500.0 mm (13.90 × 19.69 in)
ISO B4	250.0 × 353.0 mm (9.84 × 13.90 in)
JIS B0	1030.0 × 1456.0 mm (40.55 × 57.32 in)
JIS B1	728.0 × 1030.0 mm (28.66 × 40.55 in)
JIS B2	515.0 × 728.0 mm (20.28 × 28.66 in)
JIS B3	364.0 × 515.0 mm (14.33 × 20.28 in)
JIS B4	257.0 × 364.0 mm (10.12 × 14.33 in)

Paper size	Dimensions
34"x44"(ANSI E)	863.6 × 1117.6 mm (34.00 × 44.00 in)
28"x40"(ANSI F)	711.2 × 1016.0 mm (28.00 × 40.00 in)
22"x34"(ANSI D)	558.8 × 863.6 mm (22.00 × 34.00 in)
17"x22"(ANSI C)	431.8 × 558.8 mm (17.00 × 22.00 in)
11"x17"(Ledger)	279.4 × 431.8 mm (11.00 × 17.00 in)
13"x19"(Super B)	330.2 × 482.6 mm (13.00 × 19.00 in)
Letter(8.5"x11")	215.9 × 279.4 mm (8.50 × 11.00 in)
Legal(8.5"x14")	215.9 × 355.6 mm (8.50 × 14.00 in)
36"x48"(ARCH E)	914.4 × 1219.2 mm (36.00 × 48.00 in)
30"x42"(ARCH E1)	762.0 × 1066.8 mm (30.00 × 42.00 in)
26"x38"(ARCH E2)	660.4 × 965.2 mm (26.00 × 38.00 in)
27"x39"(ARCH E3)	685.8 × 990.6 mm (27.00 × 39.00 in)
24"x36"(ARCH D)	609.6 × 914.4 mm (24.00 × 36.00 in)
18"x24"(ARCH C)	457.2 × 609.6 mm (18.00 × 24.00 in)
12"x18"(ARCH B)	304.8 × 457.2 mm (12.00 × 18.00 in)
9"x12"(ARCH A)	228.6 × 304.8 mm (9.00 × 12.00 in)
DIN C0	917.0 × 1296.0 mm (36.10 × 51.02 in)
DIN C1	648.0 × 917.0 mm (25.51 × 36.10 in)
DIN C2	458.0 × 648.0 mm (18.03 × 25.51 in)
DIN C3	324.0 × 458.0 mm (12.76 × 18.03 in)
DIN C4	229.0 × 324.0 mm (9.02 × 12.76 in)
20"x24"	508.0 × 609.6 mm (20.00 × 24.00 in)
18"x22"	457.2 × 558.8 mm (18.00 × 22.00 in)
14"x17"	355.6 × 431.8 mm (14.00 × 17.00 in)
12"x16"	304.8 × 406.4 mm (12.00 × 16.00 in)
10"x12"	254.0 × 304.8 mm (10.00 × 12.00 in)
10"x15"	254.0 × 381.0 mm (10.00 × 15.00 in)
8"x10"	203.2 × 254.0 mm (8.00 × 10.00 in)
US Photo 16"x20"	406.4 × 508.0 mm (16.00 × 20.00 in)
Poster 20"x30"	508.0 × 762.0 mm (20.00 × 30.00 in)
Poster 30"x40"	762.0 × 1016.0 mm (30.00 × 40.00 in)
Poster 42"x60"	1066.8 × 1524.0 mm (42.00 × 60.00 in)
Poster 44"x62"	1117.6 × 1574.8 mm (44.00 × 62.00 in)
Poster 50"x70"	1270.0 × 1778.0 mm (50.00 × 70.00 in)
Poster 54"x76"	1371.6 × 1930.4 mm (54.00 × 76.00 in)
Poster 60"x84"	1524.0 × 2133.6 mm (60.00 × 84.00 in)
13"x22"	329.0 × 558.0 mm (12.95 × 21.97 in)
Poster 300x900mm	300.0 × 900.0 mm (11.81 × 35.43 in)
Custom Paper Size	203.2 × 203.2 mm (8.00 × 8.00 in) – 1524.0 × 1600.0 mm (60.00 × 62.99in)



Note

- For details on non-standard paper sizes, see "Printing on Non-Standard Paper Sizes." →P.122
- Borderless printing is not supported on sheets.

Using Paper Other Than Genuine Paper and feed confirmed Paper

When using this printer to print on paper other than genuine Canon paper and feed confirmed paper, use paper that meets the following conditions.



Note

- Refer to Paper Reference Guide for details on genuine Canon paper and feed confirmed paper. (Refer to " Paper Reference Guide")

- Paper where the size is described in "Paper Sizes" (See "Paper Sizes." →P.530)
- Paper where the thickness is described in "Paper Thickness" in "Specifications" (See "Specifications." →P.942)
- Paper where bleeding and ink overflow does not occur when printing
- Paper that does not warp severely when loading the paper or printing



Important

- If you use paper other than genuine Canon paper and feed confirmed paper, Canon provides absolutely no guarantees regarding print quality or paper feed properties. Refer to Paper Reference Guide for details on genuine Canon paper and feed confirmed paper. (Refer to " Paper Reference Guide")

After loading the paper in the printer, select the media type in the control panel and printer driver and then perform the printing. For the media type, you can select easily from existing settings or you can create and use settings for the paper you are using.

Printing Using Existing Settings

You can print easily by selecting from existing settings provided in the printer control panel and printer driver. (See "Printing on Paper Other Than Genuine Paper and feed confirmed Paper Using Existing Settings." →P.533)

Printing Using Additional Settings

You can print by using the **Add Custom Paper** function in the Media Configuration Tool to create settings suitable for the paper other than genuine paper and feed confirmed paper you are using and adding these settings as a new media type to the printer control panel and printer driver. (See "Printing on Paper Other Than Genuine Paper and feed confirmed Paper by Adding a Media Type." →P.534)

Printing on Paper Other Than Genuine Paper and feed confirmed Paper Using Existing Settings

You can easily print on paper other than genuine Canon paper and feed confirmed paper without making complicated settings by selecting existing settings provided in the printer control panel and printer driver depending on the media type you are using. The existing settings consist of general-purpose paper settings provided for each media type and special settings that allow you to select the amount of ink to use.



Important

- The genuine Canon paper settings provided in the printer control panel and printer driver are optimized for genuine Canon paper. If these settings are selected for printing on paper other than genuine Canon paper, the ink may bleed or the print-head may rub against the paper. In order to easily print on paper other than genuine Canon paper and feed confirmed paper, we recommend that you select one of the following general-purpose paper settings or special settings.



Note

- For an overview of the media types, see "Types of Paper." →P.530
- For details on how to select the media type in the control panel and printer driver, see "Types of Paper." →P.530

Choosing General-Purpose Paper Settings

Since these settings anticipate a wide variety of paper other than genuine Canon paper and feed confirmed paper, these settings will make it difficult for bleeding ink and the printhead rubbing to occur. Refer to the following table for the relationships between the conditions of the paper other than genuine Canon paper and feed confirmed paper and the media type to select.

Type	Approximate weight	Approximate thickness	Printer control panel	Printer driver
Plain Paper	70 g/m ²	0.09 mm (0.0035 in.)	Plain Paper	Plain Paper
Coated Paper	90 g/m ²	0.13 mm (0.0051 in.)	LW. Coated Paper	Lightweight Coated Paper
Coated Paper	170 g/m ²	0.22 mm (0.0087 in.)	HW. Coated Paper	Heavyweight Coated Paper
Photo Paper	180 g/m ²	0.18 mm (0.0071 in.)	LW. Photo Paper	Lightweight Photo Paper
Photo Paper	260 g/m ²	0.26 mm (0.010 in.)	HW. Photo Paper	Heavyweight Photo Paper
Proof	80 g/m ²	0.10 mm (0.0039 in.)	News Proof	Newsprint for Proofing
Art Paper	65 g/m ²	0.15 mm (0.0059 in.)	JPN Paper Washi	Japanese Paper Washi
Art Paper	200 g/m ²	0.35 mm (0.014 in.)	HW. Art Paper	Heavyweight Art Paper
Art Paper	300 g/m ²	0.44 mm (0.017 in.)	Ex HW. Art Paper	Extra Heavyweight Art Paper
Sign/CAD Paper	470 g/m ²	0.35 mm (0.014 in.)	Bannr Vinyl	Banner Vinyl
Sign/CAD Paper	300 g/m ²	0.28 mm (0.011 in.)	Adhesive Vinyl	Adhesive Vinyl
Sign/CAD Paper	240 g/m ²	0.18 mm (0.0071 in.)	Glossy Film	Glossy Film
Sign/CAD Paper	150 g/m ²	0.11 mm (0.0043 in.)	CAD Clear Film	CAD Clear Film

Selecting Special Settings

Special settings are provided that allow you to select the amount of ink used in steps. You can fix lackluster colors or bleeding ink by selecting special settings where the amount of ink used is suitable for the paper you are using. The special settings are organized as follows so that they can be used as follows depending on the type of black ink and the media type.

Type of special settings	Type of black ink	Example of applicable paper
"Special 1" to "Special 5"	BK (photo black)	Glossy paper, proofing paper
"Special 6" to "Special 10"	MBK (matte black)	Coated Paper, Matte Paper, Art Paper

"Special 1" and "Special 6" use the least amount of ink, with the amount of ink used increasing through 5 steps as the number increases up to "Special 5" and "Special 10" which use the greatest amount of ink. Although colors become more vivid as the amount of ink used increases, bleeding also occurs more easily. We recommend that you try in order starting from "Special 1" or "Special 6" while checking the state of the printing.



- If you cannot obtain sufficiently good image quality by selecting the general-purpose settings or special settings, you can create settings as suitable for the paper you are using by using the "Add Custom Paper" function in the Media Configuration Tool. For details, see "Printing on Paper Other Than Genuine Paper and feed confirmed Paper by Adding a Media Type." →P.534

Printing on Paper Other Than Genuine Paper and feed confirmed Paper by Adding a Media Type

The **Add Custom Paper** function in the Media Configuration Tool is provided as a method for improving print quality and feed properties over printing paper other than genuine Canon paper and feed confirmed paper using the general-purpose settings. This can be expected to improve properties such as print quality because it allows you to configure settings such as the maximum amount of ink to use and the height of the printhead depending on the characteristics of the paper you are using. Furthermore, printing can be performed by adding the settings created using this function to the printer control panel and printer driver as a new media type.

For details on Media Configuration Tool, refer as follows.

- Media Configuration Tool (Windows) →P.590
- Media Configuration Tool (Macintosh) →P.619



Important

- For details on how to select the added media type in the control panel, see "Changing the Type of Paper." →P.545
- For details on how to select the media type in the printer driver, refer to the following topics.
 Specifying Paper in the Printer Driver (Windows) →P.180
 Specifying Paper in the Printer Driver (Mac OS X) →P.366
- We recommend that you use an ICC profile created using commercially available profile creation software in order to perform color management accurately on paper other than genuine Canon paper and feed confirmed paper. The created ICC profile can be registered to the printer driver and printed. For details, see "Matching Sheet (Windows)." →P.196

Displaying the Paper Reference Guide

The Paper Reference Guide can be accessed from **imagePROGRAF Support Information**. Follow these instructions, as appropriate for your operating system.

Windows

1. Double-click the **iPFxxxx Support** desktop icon. (iPFxxxx indicates the printer model.)

The **imagePROGRAF Support Information** window is displayed.



iPFxxxx
Support

2. Click the **Paper Reference Guide** button.

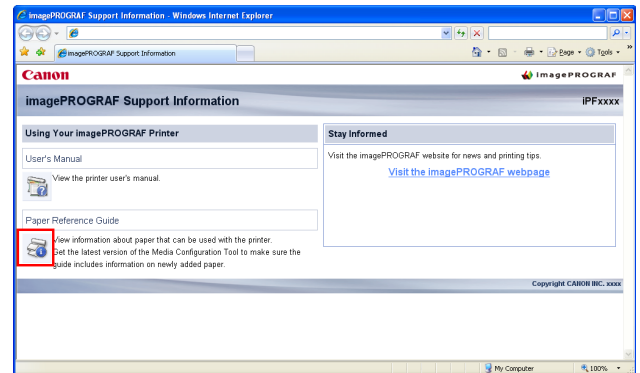

The Paper Reference Guide is displayed.

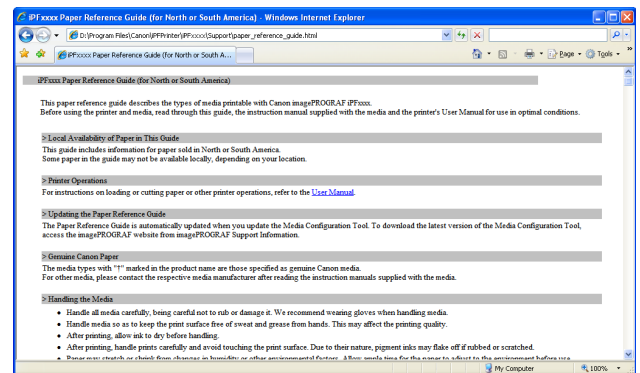

Mac OS X

1. Click the **iPF Support** icon in the **Dock** (**Launchpad** in OS10.7).

The **imagePROGRAF Support Information** window is displayed.



2. Click the **Paper Reference Guide** button.

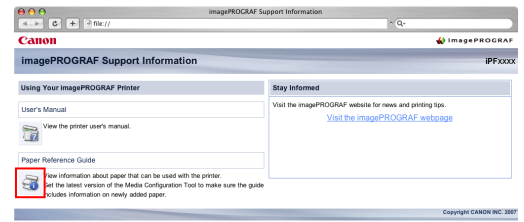

The Paper Reference Guide is displayed.

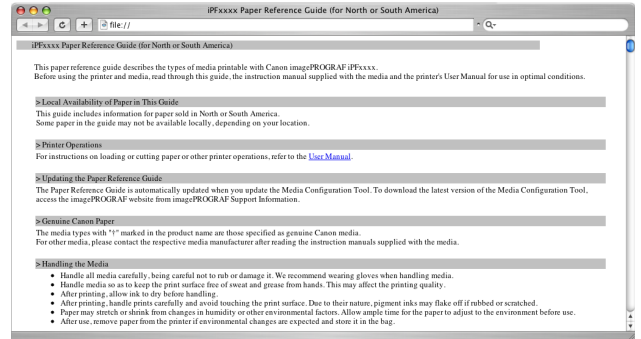

Updating paper information

As for paper information of the Paper Reference Guide, printer Control Panel, and printer driver, you can update it to the latest information by downloading and installing the latest version of **Media Information File** (Media Information File) from the imagePROGRAF website.

Download the latest **Media Information File** (Media Information File) after accessing the imagePROGRAF-dedicated site from **imagePROGRAF Support Information**. If you cannot download it, contact your Canon dealer. For details on **Media Information File** (Media Information File), refer as follows.

- Media Configuration Tool →P.590 (Windows)
- Media Configuration Tool →P.619 (Macintosh)



- When your version of Media Configuration Tool is older than the version released on the imagePROGRAF website, download and install the latest version of Media Configuration Tool before installing **Media Information File**. If you do not install the latest version of Media Configuration Tool before installing **Media Information File**, the latest paper information cannot be updated.

• Windows

1. Double-click the **iPFxxxx Support** desktop icon. (iPFxxxx indicates the printer model.)

The **imagePROGRAF Support Information** window is displayed.



2. Click **Visit the imagePROGRAF webpage.**

The default browser on your computer is started and the imagePROGRAF webpage is displayed.

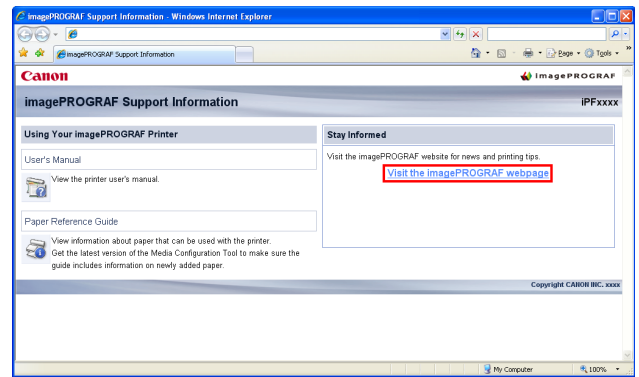

• Mac OS X

1. Click the **iPF Support** icon in the **Dock** (**Launchpad** in OS10.7).

The **imagePROGRAF Support Information** window is displayed.



2. Click **Visit the imagePROGRAF webpage.**

The default browser on your computer is started and the imagePROGRAF webpage is displayed.

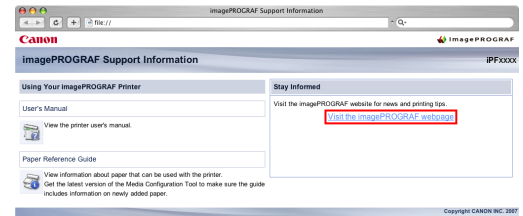

Handling rolls

- Attaching the Roll Holder to Rolls 538
- Loading Rolls in the Printer 541
- Changing the Type of Paper 545
- Specifying the Paper Length 547
- Removing the Roll from the Printer 547
- Removing the Roll Holder from Rolls 550
- Clearing Jammed Roll Paper 886
- Feeding Roll Paper Manually 551
- Keeping Track of the Amount of Roll Paper Left 552
- Specifying the Ink Drying Time for Rolls 552
- Specifying the Cutting Method for Rolls 554
- Cutting the Leading Edge of Roll Paper Automatically 560
- Reducing Dust from Cutting Rolls 562
- Roll Holder Set 705

Handling and Use of Paper

Handling rolls

Attaching the Roll Holder to Rolls

When printing on rolls, attach the Roll Holder to the roll.

Rolls have a two- or three-inch paper core. Use the correct attachment for the paper core. The printer comes equipped with the 2-Inch Paper Core Attachment installed.

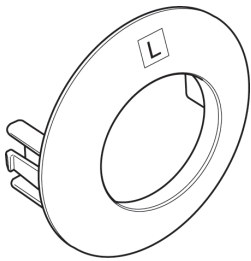
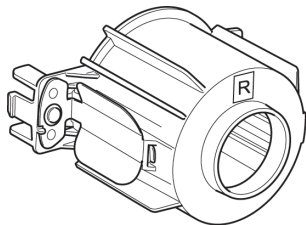
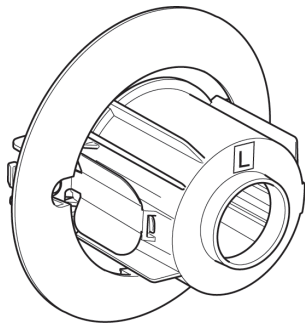
Using Rolls with a 2-inch Paper Core		Using Rolls with a 3-inch Paper Core	
Roll Holder Side	Holder Stopper Side	Roll Holder Side	Holder Stopper Side
No Attachment Needed	2-Inch Paper Core Attachment	3-Inch Paper Core Attachment #1	3-Inch Paper Core Attachment #2
			

 • Set the roll on a table or other flat surface so that it does not roll or fall. Rolls are heavy, and dropping a roll may cause injury.

Caution



- When handling the roll, be careful not to soil the printing surface. This may affect the printing quality. We recommend wearing clean cloth gloves when handling rolls to protect the printing surface.
- Use scissors or a cutting tool to cut the edge of the roll paper if it is uneven, dirty, or has tape residue. Otherwise, it may cause feeding problems and affect the printing quality. Be careful not to cut through any barcodes printed on the roll.
- Align the edges of the paper on both ends of the roll. Misalignment may cause feeding problems.

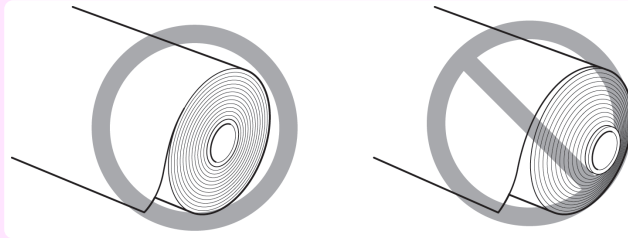

- For details on supported sizes and types of rolls, see **Paper Sizes** or the Paper Reference Guide. (See "Paper Sizes.")
 →P.530 (See "Types of Paper.") →P.530
- To view instructions as you attach the Roll Holder, press the **Navigate** button. (See "How to View Instructions With Navigate.")
 →P.661

1

Lift the Holder Stopper lever (a) from the shaft side to unlock it. Holding the Holder Stopper at the position indicated (b), remove it from the Roll Holder.

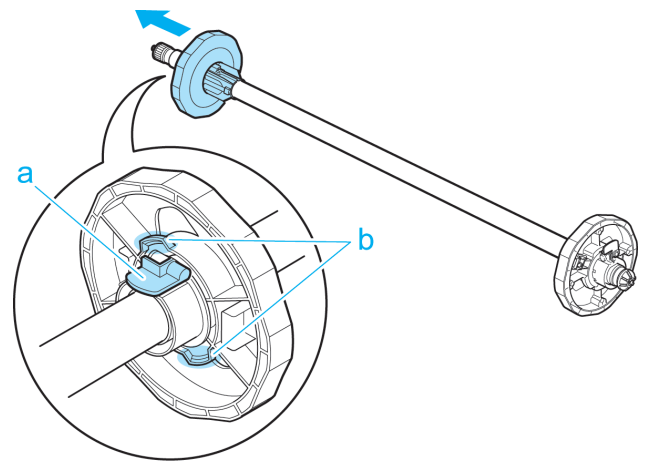

2

Insert the respective attachments for the roll paper core on the Roll Holder and Holder Stopper.

- Using rolls with a 2-inch paper core

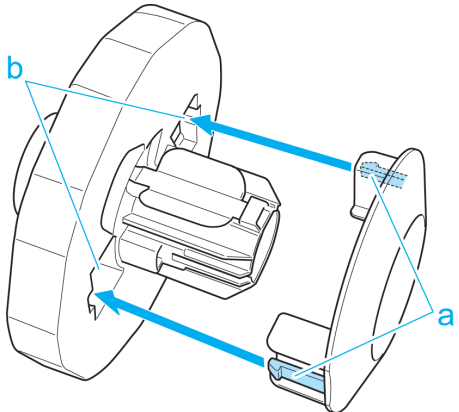
Holder Stopper Side	Roll Holder Side
<p>Align the tips (a) of the 2-Inch Paper Core Attachment with the holes (b) of the Holder Stopper and insert it firmly.</p> 	<p>No attachment is needed.</p>

• Using rolls with a 3-inch paper core

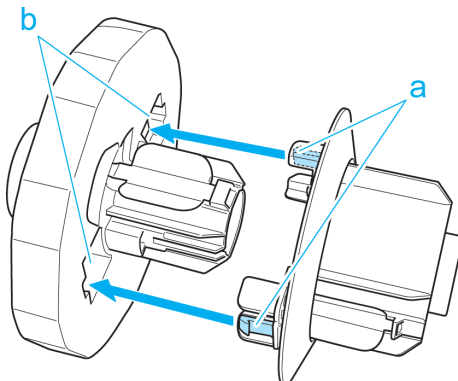
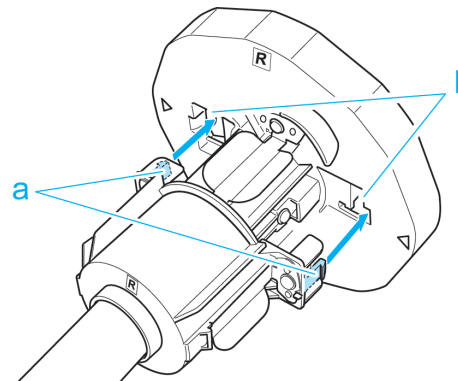
Holder Stopper Side	Roll Holder Side
<p>Align the tips (a) of 3-Inch Paper Core Attachment #2 with the holes (b) of the Holder Stopper and insert it firmly.</p> 	<p>Align the tips (a) of 3-Inch Paper Core Attachment #1 with the holes (b) of the Roll Holder and insert it firmly.</p> 

- 3 With the edge of the roll paper facing forward as shown, insert the Roll Holder from the right of the roll. Insert it firmly until the roll touches the flange (a) of the Roll Holder, leaving no gap.

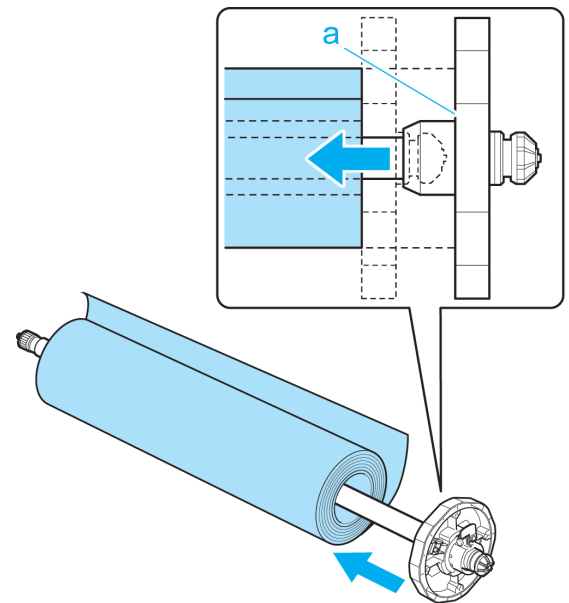

- 4** Insert the Holder Stopper from the left in the Roll Holder as shown. Holding it at the position shown (b), push it firmly in until the flange (a) of the Holder Stopper touches the roll. Lock the Holder Stopper lever (c) by pushing it down toward the shaft side.

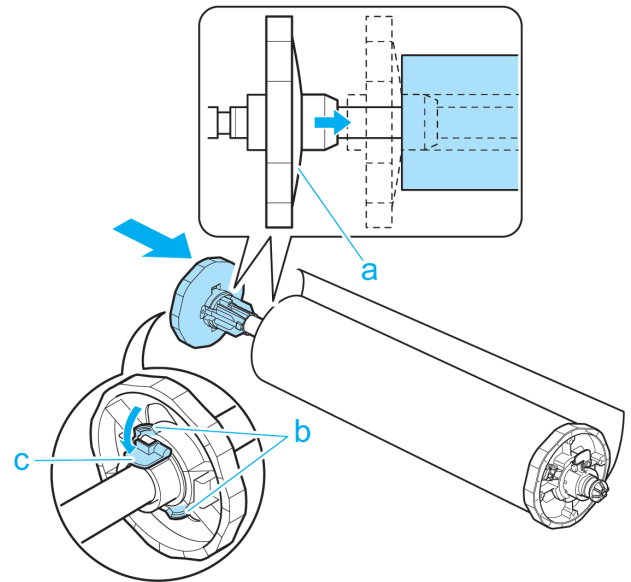

Loading Rolls in the Printer

Follow these steps to load rolls in the printer.



Important

- Always load rolls when the printer is on. If the printer is off when you load a roll, the paper may not be advanced correctly when you turn the printer on.
- Before loading a roll, confirm whether the inside of the Top Cover or the Ejection Guide is soiled. If soiled, we recommend cleaning in advance. (See "Cleaning Inside the Top Cover.") →P.869

- 1** Press the **Load** button.



- 2** Press **▲** or **▼** to select **Load Roll Paper**, and then press the **OK** button.



Note

- If any paper has been advanced that will not be used, a message is shown requesting you to remove it. Press **▲** or **▼** to select "**Yes**", and then press the **OK** button. Remove the paper and go to the next step.

3 Open the Top Cover and lift the Ejection Guide.

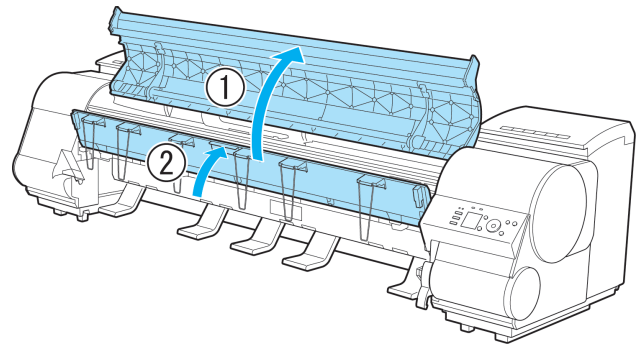

4 Holding the Roll Holder so that the side with the white gear faces the side of the Roll Holder Slot with a white gear, load the Roll Holder shaft (a) into the grooves (b) on both ends of the Roll Holder Slot, fully into the slot.

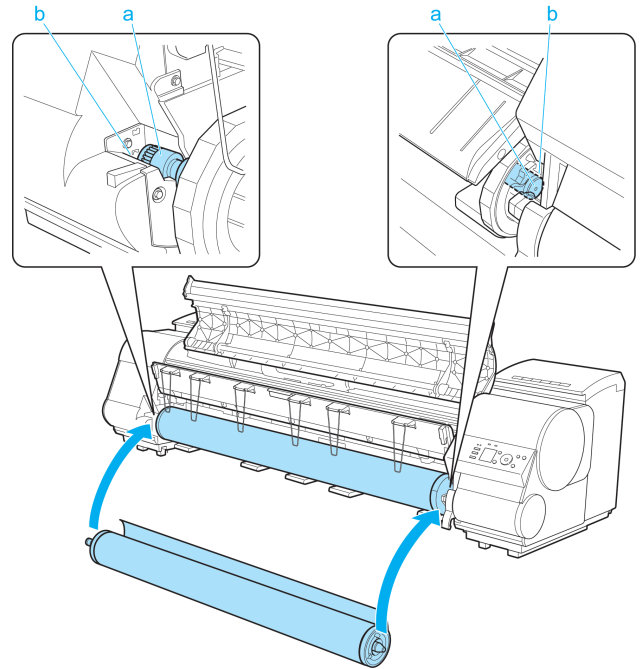

- Be careful not to drop the roll and hurt yourself when loading it.
- Caution**
- Be careful not to pinch your fingers between the Roll Holder shaft (a) and the guide grooves (b) when loading rolls.

- 5** Pull out the roll evenly on both ends and insert it in the Paper Feed Slot (a). Advance the roll until it touches the Paper Retainer (b).

Once the roll reaches the Paper Retainer, it is automatically advanced over the Platen.

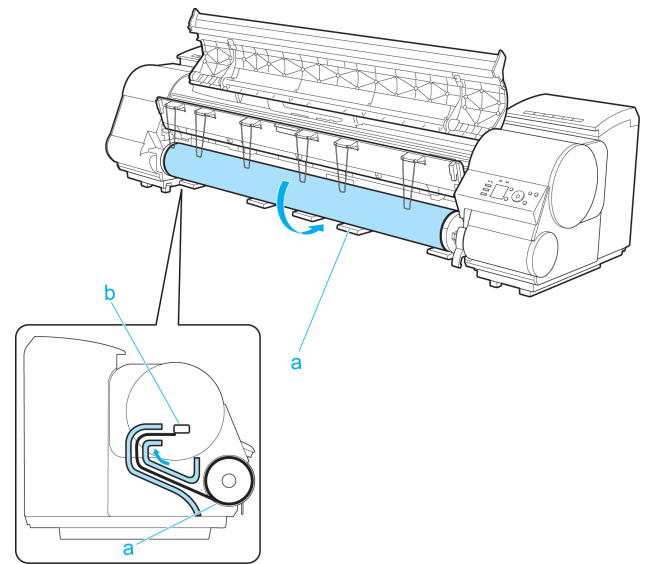

Important

- When handling the roll, be careful not to soil the printing surface. Otherwise, it may affect printing quality. We recommend wearing clean cloth gloves when handling rolls to protect the printing surface.
- If the paper is wrinkled or warped, straighten it out before loading it.
- For paper that tends to curl, lift the Release Lever and manually pull the roll paper over the Platen.
- Load paper straight so it is not fed askew.

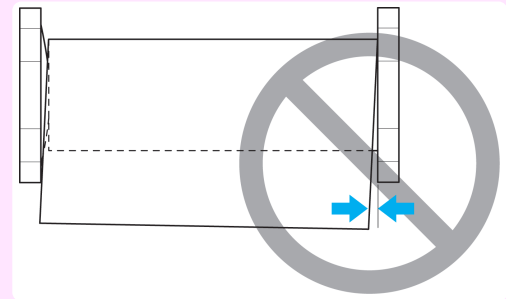

- 6** Lower the Ejection Guide.

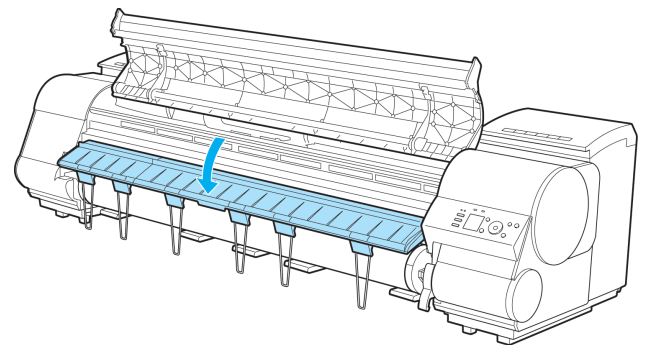

- 7** Holding the edge of the roll paper, lift the Release Lever.

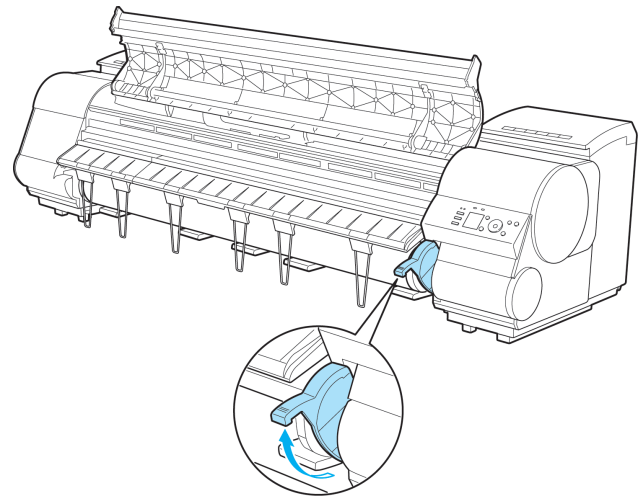

- 8** Hold the edge of the roll paper as you gently pull it evenly with both hands to the position of the Ejection Guide (a). Align the right side of the roll paper with the Paper Alignment Line (b), keeping this side parallel to the line, and then lower the Release Lever.

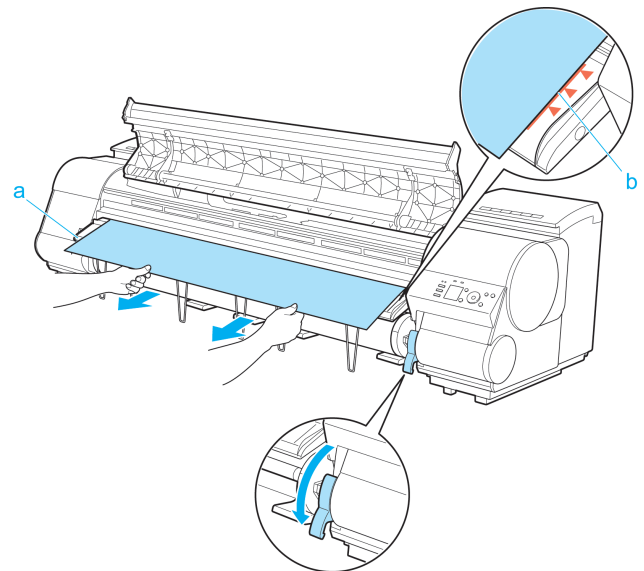

Important

- Do not omit steps 7 and 8. If paper cannot be advanced straight or if it wrinkles, it may jam or rub against the Printhead.
- Do not force the roll paper into alignment with the paper alignment line (b). This may prevent the paper from being advanced straight.



Note

- You can adjust the strength of suction holding paper against the Platen when the Release Lever is released. If it is difficult to load paper, press the ▲ or ▼ button on the Control Panel to adjust the strength. Set suction stronger by pressing the ▲ button or weaker with the ▼ button. Three settings are available.

9 Close the Top Cover.

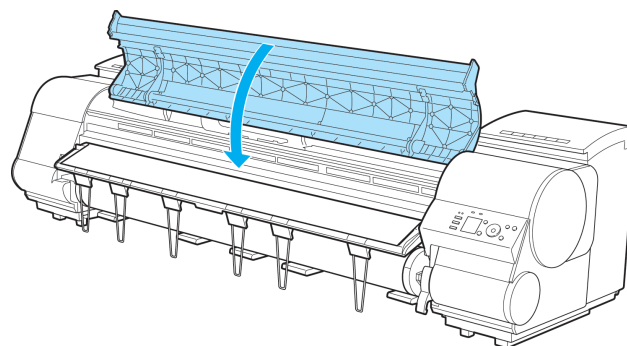

10 Once paper feeding starts, you will need to do the following, based on the **ManageRemainRoll** setting and the barcode printed on rolls. (See "Keeping Track of the Amount of Roll Paper Left.") →P.552

ManageRemainRoll	Barcodes	Printer Operation After the Paper is Fed
Off	Printed	A menu for selection of the type of paper is shown on the Display Screen. Press ▲ or ▼ to select the type of paper, and then press the OK button.
	Not printed	
On	Printed	The type and amount of paper left is automatically detected based on the barcode printed on the roll. There is no need to specify the type and length of the paper.
	Not printed	A menu for selection of the type and length of paper is shown on the Display Screen. Press ▲ or ▼ to select the type and length of paper loaded, and then press the OK button.



- Cut the edge of the roll using the **Paper Cutting** function if the edge is creased or soiled. (See "Specifying the Cutting Method for Rolls.") →P.554



- For details on types of paper to select, see the Paper Reference Guide. (See "Types of Paper.") →P.530
- Adjusting the printhead alignment with the type of paper to be used in printing may enhance printing quality. (See "Automatic Adjustment to Straighten Lines and Colors.") →P.806
- When paper leading edge detection is set to **Off** for Manual, printing will start at the position at which the roll was set in procedure 8. Thus, the margin of the paper leading edge will enlarge. (See "Specifying the Cutting Method for Rolls.") →P.554

Changing the Type of Paper

Follow these steps to change the type of paper specified on the printer after you have loaded paper.

If you will continue using this type of paper later, selecting **Keep Paper Type > On** will save the time and effort of configuring the media type setting when you load the paper again. The current media type settings before you select **On** will be automatically selected at that time. (See "Using the Same Type of Paper Regularly.") →P.546



- For best printing results, the printer fine-tunes the print head height and the feed amount for each type of paper. Be sure to select the type of paper to use correctly before printing.
- Because the printer fine-tunes the feed amount for each type of paper, the margins and the size of printed images may vary depending on the type of paper used. If margins and the size of images are not as you expected, adjust the paper feed amount. (See "Adjusting the Feed Amount.") →P.813
- Rolls and sheets have different printing areas, and sheets having a larger bottom margin than rolls. (See "Print Area.") →P.943

Changing the Type of Paper



Note

- When you load a roll, a menu for selection of the type of paper is shown on the Display Screen. Select the type of paper, and then press the **OK** button.
If no barcode has been printed on the roll and you have set **ManageRemainRoll** to **On**, specify the roll length after the type of paper. (See "Specifying the Paper Length." →P.547)

- On the **Tab Selection screen** of the Control Panel, press ◀ or ▶ to select the Paper tab ().

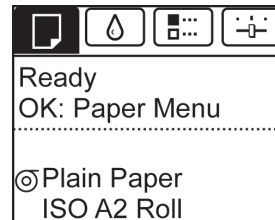

Note

- If the **Tab Selection screen** is not displayed, press the **Menu** button.

- Press the **OK** button.
The **Paper Menu** is displayed.

- Press ▲ or ▼ to select **Chg. Paper Type**, and then press the **OK** button.

- Press ▲ or ▼ to select the type of paper loaded (**Roll Paper** or **Cut Sheet**), and then press the **OK** button.

- Press ▲ or ▼ to select the type of paper loaded in the printer, and then press the **OK** button.



Important

- Be sure to select the correct paper type. If this setting does not match the loaded paper, it may cause feed errors and affect printing quality.



Note

- For details on types of paper, see the Paper Reference Guide. (See "Types of Paper." →P.530) By default, **Plain Paper** is selected.
- If you move the Release Lever, the setting automatically reverts to the previously selected paper.

Using the Same Type of Paper Regularly

Configure this setting so that current media type settings will be automatically selected when you load the same type of paper later.

- On the **Tab Selection screen** of the Control Panel, press ◀ or ▶ to select the Paper tab ().

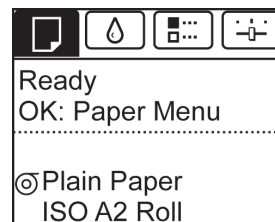

Note

- If the **Tab Selection screen** is not displayed, press the **Menu** button.

- Press the **OK** button.
The **Paper Menu** is displayed.

3 Press ▲ or ▼ to select **Keep Paper Type**, and then press the **OK** button.

4 Press ▲ or ▼ to select **On**, and then press the **OK** button.



Note

- The specified media type setting is updated in the following situations.
 - When using sheets, if you send a print job before loading a sheet, the media type setting is updated to match the type of paper specified by the print job.
 - When you have selected **ManageRemainRoll** > **On** on the Control Panel and a barcode is printed on the roll, the media type setting is updated to match the type of paper specified by the barcode.
 - To change the media type setting, see "Changing the Type of Paper." →P.546

Specifying the Paper Length

When changing the length of paper after the paper has been advanced, specify the length as follows.



Note

- Specify the paper length when you have set **ManageRemainRoll** to **On**. (See "Keeping Track of the Amount of Roll Paper Left.") →P.552

1 On the **Tab Selection screen** of the Control Panel, press ◀ or ▶ to select the Paper tab ().



Note

- If the **Tab Selection screen** is not displayed, press the **Menu** button.

2 Press the **OK** button.
The **Paper Menu** is displayed.

3 Press ▲ or ▼ to select **Chg. Paper Size**, and then press the **OK** button.

4 Press ▲ or ▼ to select **Roll Length**, and then press the **OK** button.

5 Press ▲ or ▼ to select the length of paper loaded in the printer, and then press the **OK** button.
Specify the roll length as follows.

- Press the ◀ or ▶ button to move to the next field for input.
- Press the ▲ or ▼ button to enter the value.
- Repeat steps 1 and 2 to finish entering the value, and then press the **OK** button.

Removing the Roll from the Printer

Remove rolls from the printer as follows.



Note

- If you need to cut the roll, see "Specifying the Cutting Method for Rolls." →P.554

- 1 On the **Tab Selection screen** of the Control Panel, press ◀ or ▶ to select the Paper tab ().

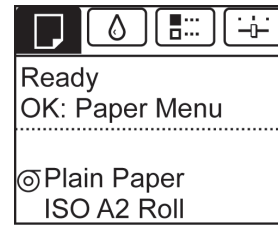

 • If the **Tab Selection screen** is not displayed, press the **Menu** button.
Note

- 2 Press the **OK** button.
The **Paper Menu** is displayed.
- 3 Press ▲ or ▼ to select **Eject Paper**, and then press the **OK** button.
- 4 Press ▲ or ▼ to select **"Yes"**, and then press the **OK** button.
The roll is rewound.

 **Important**

- If you have selected **ManageRemainRoll > On** in the Control Panel menu, a barcode is printed on the leading edge of the roll. Do not remove the roll before the barcode is printed. You will be unable to keep track of the amount of roll paper left. (See "Keeping Track of the Amount of Roll Paper Left.") →P.552

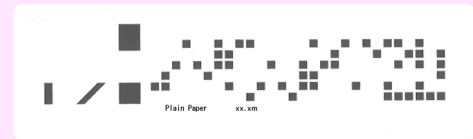

- 5 Open the Top Cover and lift the Ejection Guide.

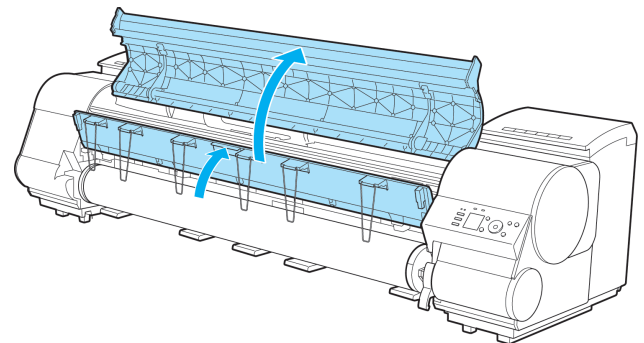

- 6 Using both hands, rotate the Roll Holder in the direction of the arrow to rewind the roll.

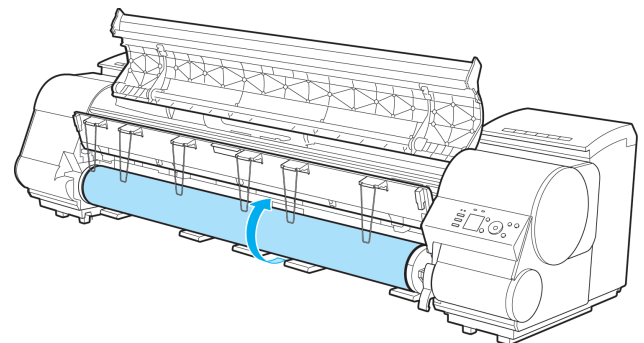

- 7** Holding the Roll Holder flange (a), remove the holder from the Roll Holder Slot.

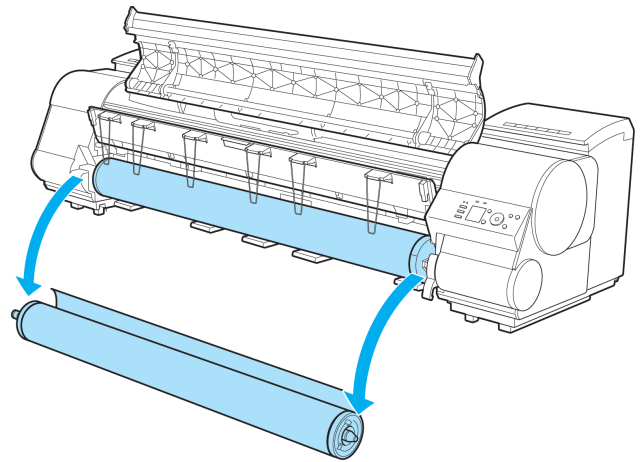

Note

- For instructions on removing the Roll Holder from rolls, see "Removing the Roll Holder from Rolls." →P.550

- 8** Lower the Ejection Guide and close the Top Cover.

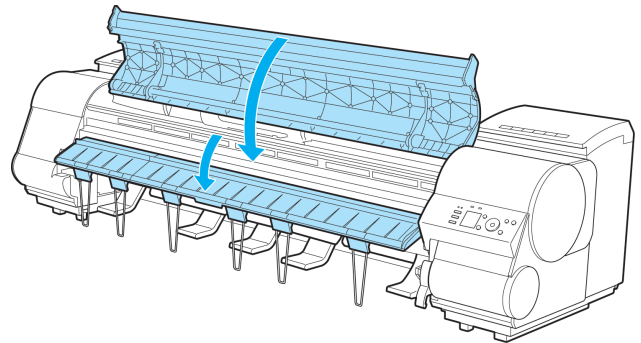

Note

- To load new paper in the printer at this point, see "Loading Rolls in the Printer." →P.541
- Clean inside the top cover before loading paper. (See "Cleaning Inside the Top Cover.") →P.869

Removing the Roll Holder from Rolls

- 1 Lift the Holder Stopper lever (a) from the shaft side to unlock it. Holding the Holder Stopper at the position indicated (b), remove it from the Roll Holder.

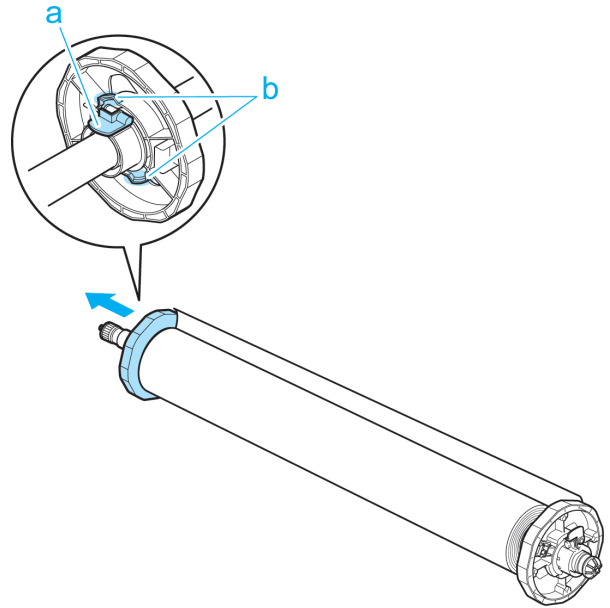

- 2 Remove the Roll Holder from the roll.

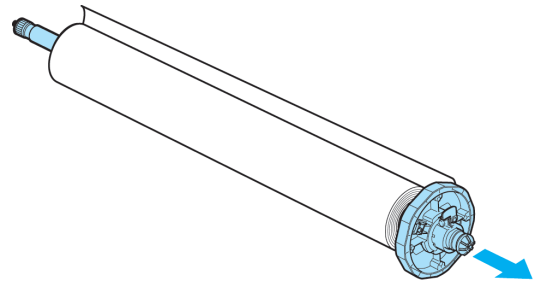

- 3 When removing attachments, push the tips (a) in as you remove the attachment.

- 3-Inch Paper Core Attachment #1 (Roll Holder side)

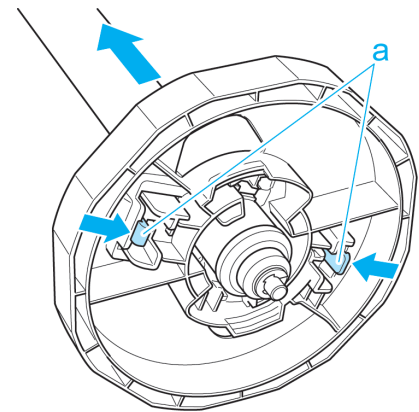

- 3-Inch Paper Core Attachment #2 (Holder Stopper side)

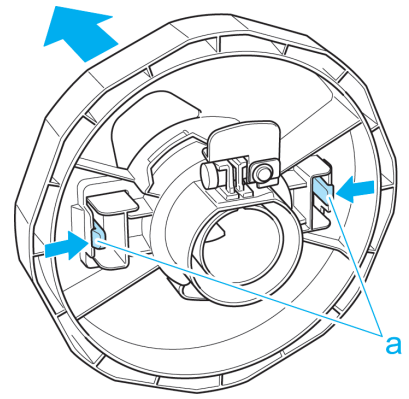

- 2-Inch Paper Core Attachment

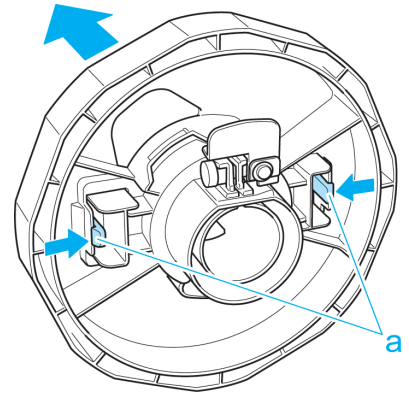

Important

- Store the roll in the original bag or box, away from high temperature, humidity, and direct sunlight. If paper is not stored properly, the printing surface may become scratched, which may affect the printing quality when you use it again.

Feeding Roll Paper Manually

After a roll has been advanced, you can press the **Feed** button to feed or retract the roll with the **▲** and **▼** buttons.

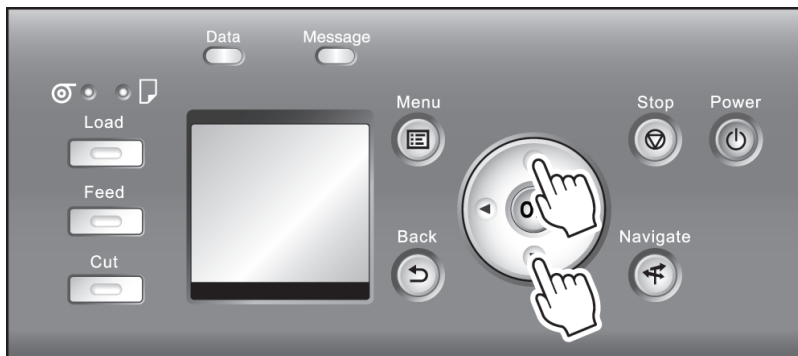

- 1 Press the **Feed** button.
- 2 Press the **▲** or **▼** button to advance or retract the roll.
Press **▲** to retract the roll manually.
Press **▼** to advance the roll manually.



- If you hold down ▲ or ▼ for less than a second, the roll will move about 1 mm (0.04 in).
If you hold down ▲ or ▼ for more than a second, the roll will move until you release the button. Release the button when the Display Screen indicates "End of paper feed. Cannot feed paper more."

Keeping Track of the Amount of Roll Paper Left

Setting **ManageRemainRoll** to **On** in the **Paper Menu** of the Control Panel will print a barcode with text on the roll when the roll is removed that identifies the type of paper and amount left. When **ManageRemainRoll** is **On** and you load rolls with printed barcodes, the type of paper and amount left are automatically detected after rolls are loaded. The barcode will be cut off after it has been read.

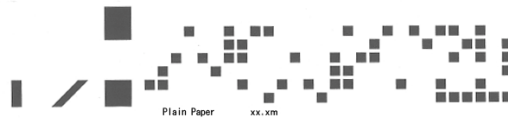

- If the barcode on the roll is not detected, enter the type and length of paper on the Control Panel.

Follow these steps to set **ManageRemainRoll** to **On** as follows.

- 1 On the **Tab Selection screen** of the Control Panel, press ◀ or ▶ to select the Paper tab ().

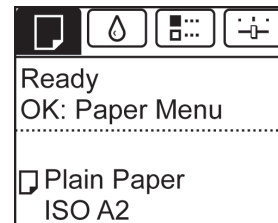

- If the **Tab Selection screen** is not displayed, press the **Menu** button.

- 2 Press the **OK** button.
The **Paper Menu** is displayed.
- 3 Press ▲ or ▼ to select **ManageRemainRoll**, and then press the **OK** button.
- 4 Press ▲ or ▼ to select **On**, and then press the **OK** button.

Specifying the Ink Drying Time for Rolls

When you are using paper that takes longer for ink to adhere, ink may be transferred onto the paper surface during ejection, soiling it. In that case, you may be able to improve the condition by setting the time to wait for the ink to dry after printing.



- If the Cutter touches the print surface on which the ink is not dry, the paper surface may become scratched or soiled, or the paper surface may rub when the paper falls and the surface may become soiled.
To wait for the ink to dry without allowing printed documents to fall after printing, set **Cutting Mode** on the menu of the printer to **Eject**. (See "Specifying the Cutting Method for Rolls.") [→P.554](#)

Windows

- 1 Display the printer driver dialog box.
(See "Accessing the Printer Driver Dialog Box from the Operating System Menu (Windows).") [→P.187](#)

- 2** Select the **Main** sheet and click **C Advanced Settings** in **A Media Type**.

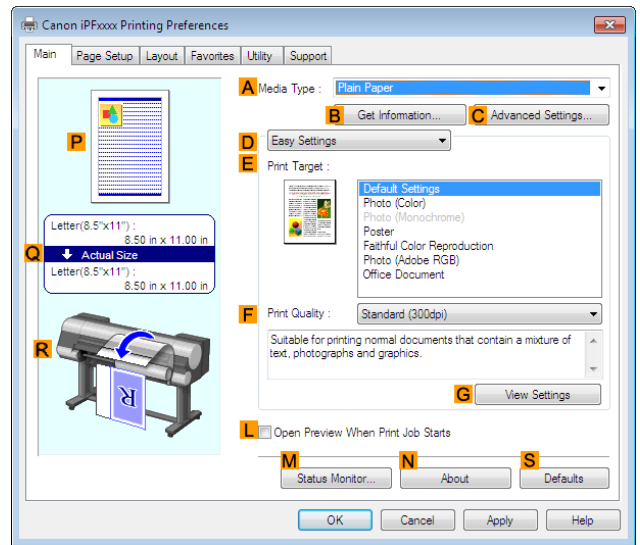

- 3** In the **Paper Detailed Settings** dialog box displayed next, select the desired settings values in **B Between Pages** and **C Between Scans** in **A Drying Time**, and then click **OK**.
(See "Paper Detailed Settings Dialog Box (Windows).")
→P.192

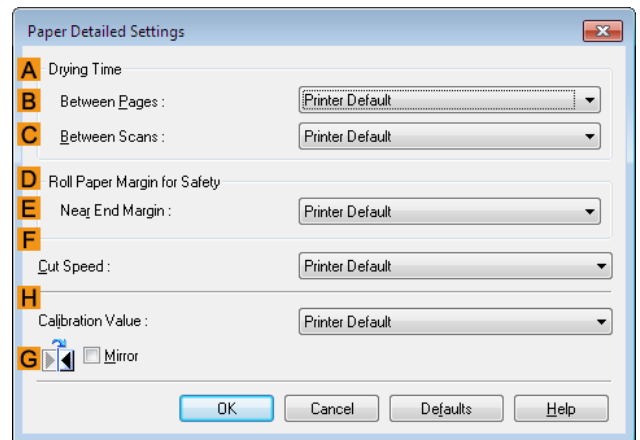

Mac OS X

- 1** Choose **Print** in the application menu.
- 2** Select the **Main** pane and click **C Settings** in **A Media Type**.

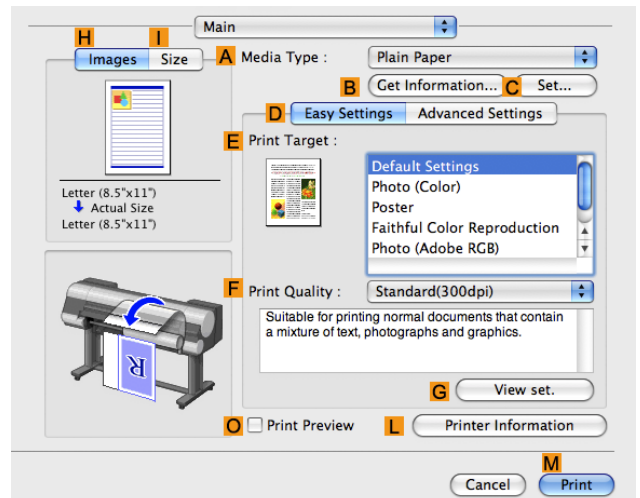

3 In the **Paper Detailed Settings** dialog box displayed next, select the desired settings values in **C Between Pages** and **D Between Scans** in **B Drying Time**, and then click **OK**.
 (See "Paper Detailed Settings Dialog Box (Mac OS X).")
 →P.374

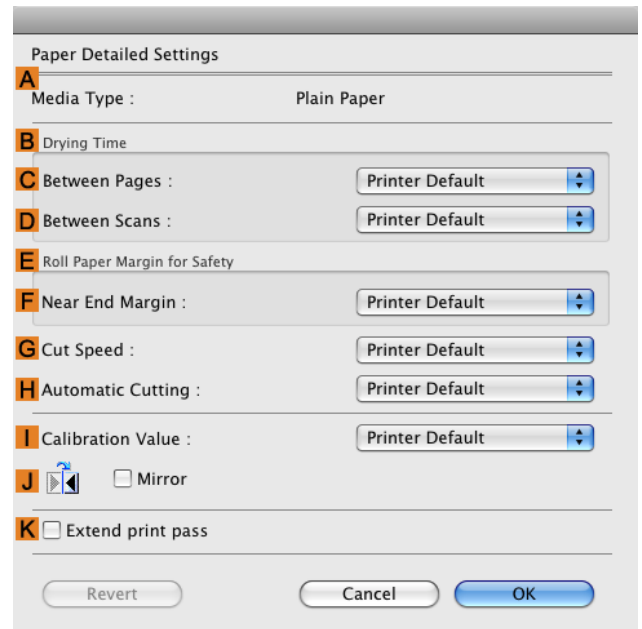

Specifying the Cutting Method for Rolls

How rolls are cut after ejection varies depending on printer settings.

Cutting Method		Printer Setting		Driver Setting	
Automatic	The roll is automatically cut by the Cutter Unit following printer driver settings.	Media Menu > Paper Details > (Various Types of Paper) > Cutting Mode	Automatic	Auto Cut (See "Cutting Roll Paper After Printing.") →P.173	Yes
Eject	Select this to move the cutter by key operation and cut paper. Although there are cases with Automatic in which the paper falls and the paper surface is scratched when the paper rubs the Output Stacker, you can avoid damaging the paper with this method since you can cut by holding the paper with your hand so that the paper does not fall when cutting. Also, since you can cut while visually confirming the drying of the ink, you can avoid ejecting paper before the ink has dried. To cut the roll with the Cutter Unit, press the Cut button.		Eject		Yes
Manual	Select this for paper that cannot be cut with the Cutter Unit and for paper of which the leading edge curls strongly and rubs the printhead. Use scissors to cut each document from the roll after printing. For continuous printing (if you will cut each page later), select Auto Cut > Yes or select Print Cut Guideline .		Manual	No Yes Print Cut Guideline	
Paper Cutting	Choose this option if you want to cut pages by pressing Cutter Unit buttons for manual cutting after printing when Auto Cut > No is selected or Print Cut Guideline is selected in the printer driver. Otherwise choose this option if you want to cut the roll edge after loading a roll.		Cut button pressed	Yes	No Print Cut Guideline



- Automatic and Eject are valid only when you have selected **Auto Cut > Yes** in the printer driver.

Note

- With Eject, printing does not resume after a series of jobs have been printed continuously until the roll is cut.
- **Eject** is the preset selection in **Cutting Mode** for some types of paper. For this paper, we recommend keeping the preset cutting mode.
- If documents printed using Automatic, Eject, or manual cutting are short, rolls are advanced a specific amount before cutting to prevent problems with cutting and paper ejection. This may create a wider bottom margin, in some cases.

Cut rolls manually in the following cases:

Eject (when the paper surface is being scratched / to wait for ink to dry)

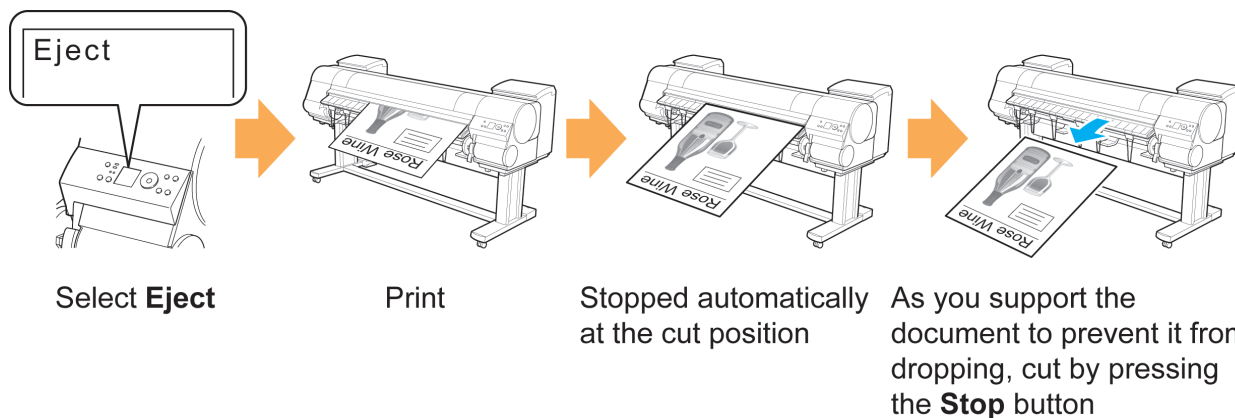

Important

- When cutting wide printed documents after ejection, have two people support the documents. If the paper drops, printed documents may be damaged.
- Do not lift the paper when holding printed documents before cutting. If the paper rises, it may affect the printing quality or cause rough cut edges.

- 1 On the **Tab Selection screen** of the Control Panel, press ◀ or ▶ to select the Paper tab ().

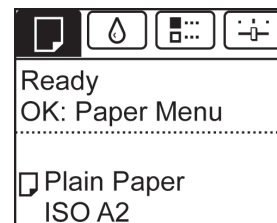

Note

- If the **Tab Selection screen** is not displayed, press the **Menu** button.

- 2 Press the **OK** button. The **Paper Menu** is displayed.
- 3 Press ▲ or ▼ to select **Paper Details**, and then press the **OK** button.
- 4 Press ▲ or ▼ to select the type of paper, and then press the **OK** button.
- 5 Press ▲ or ▼ to select **Cutting Mode**, and then press the **OK** button.
- 6 Press ▲ or ▼ to select **Eject**, and then press the **OK** button.
- 7 Print the job.
When printing is finished, the printer will stop without cutting.

- 8** Holding the printed document to prevent it from dropping, press the **Cut** button to cut the roll.



Manual (when using media that cannot be cut with the Cutter Unit)

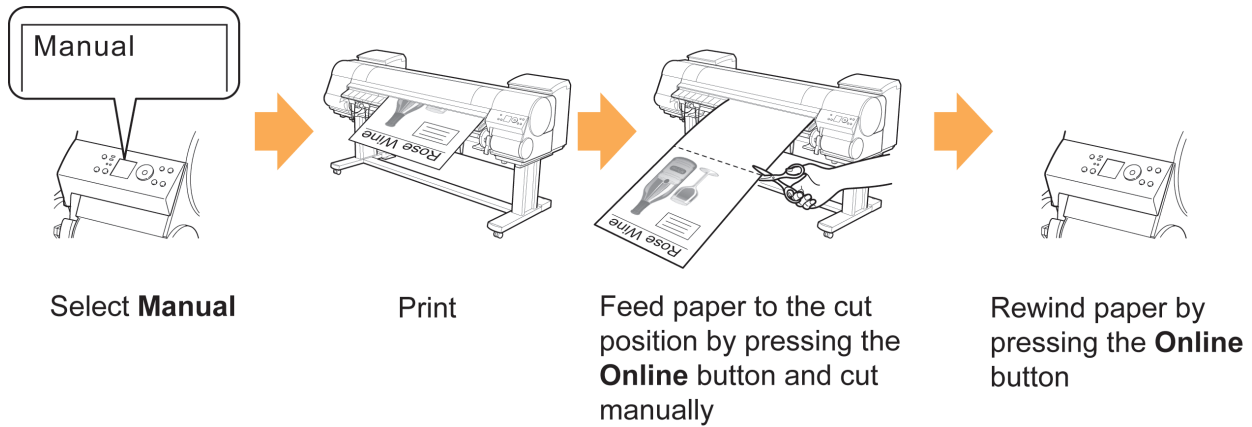

- 1** On the **Tab Selection screen** of the Control Panel, press ◀ or ▶ to select the Paper tab ().

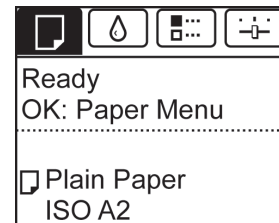

 **Note** • If the **Tab Selection screen** is not displayed, press the **Menu** button.

- 2** Press the **OK** button. The **Paper Menu** is displayed.
- 3** Press ▲ or ▼ to select **Paper Details**, and then press the **OK** button.
- 4** Press ▲ or ▼ to select the type of paper, and then press the **OK** button.
- 5** Press ▲ or ▼ to select **Cutting Mode**, and then press the **OK** button.
- 6** Press ▲ or ▼ to select **Manual**, and then press the **OK** button.
- 7** When **Perform the detection of paper leading edge?** is displayed, select **Perform(recommend)**.
- 8** Print the job.
The printer stops advancing the paper after printing.

9 Press the **Feed** button.

Roll paper is fed to the specified cut position and then automatically stopped.



10 Cut the roll paper manually with scissors or the like.

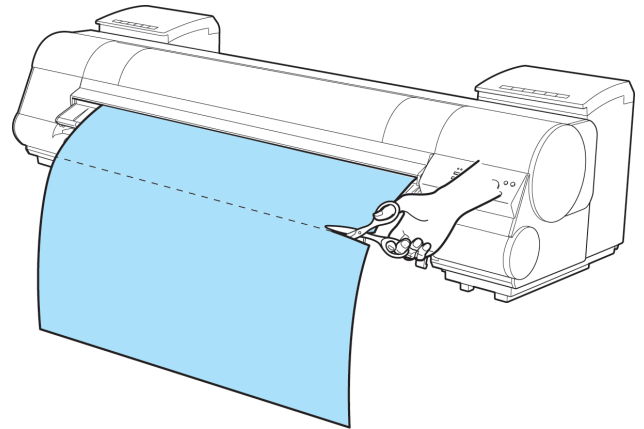



11 Press the **OK** button.

After the roll is rewound, it stops automatically.

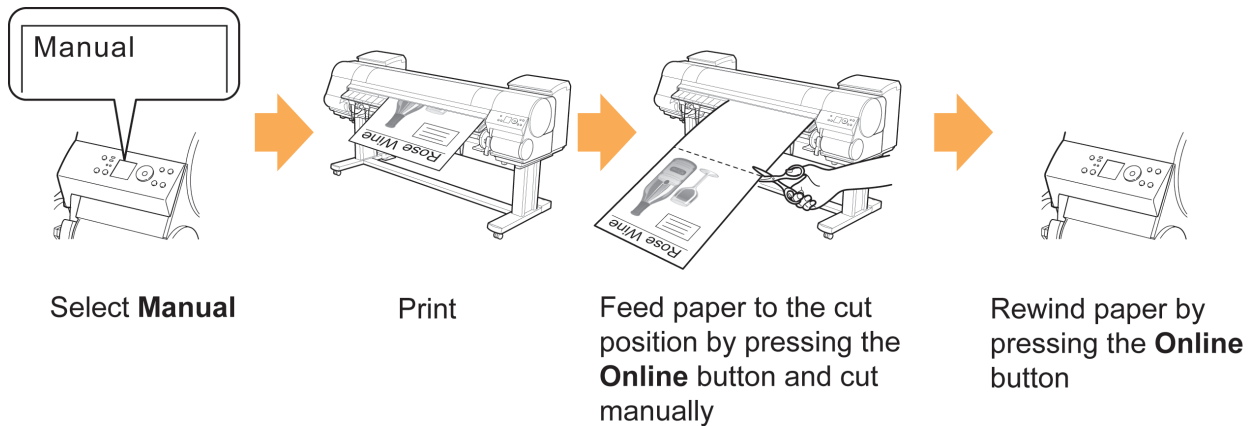

Manual (for paper of which the leading edge rubs the printhead)



- 1 On the **Tab Selection screen** of the Control Panel, press ◀ or ▶ to select the Paper tab ().

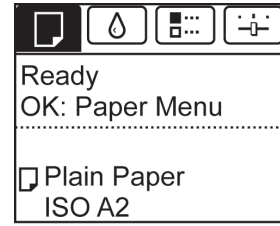

 **Note** • If the **Tab Selection screen** is not displayed, press the **Menu** button.

- 2 Press the **OK** button. The **Paper Menu** is displayed.
- 3 Press ▲ or ▼ to select **Paper Details**, and then press the **OK** button.
- 4 Press ▲ or ▼ to select the type of paper, and then press the **OK** button.
- 5 Press ▲ or ▼ to select **Cutting Mode**, and then press the **OK** button.
- 6 Press ▲ or ▼ to select **Manual**, and then press the **OK** button.
- 7 When **Perform the detection of paper leading edge?** is displayed, select **Do not perform**.

 **Note**

- If you set the detection of paper leading edge to **Do not perform**, a margin of about 10 cm is created at the paper leading edge when printing starts.
- When the detection of paper leading edge is set to **Do not perform**, printing will start at the position at which the roll was set for the first printing after replacing a roll. Thus, the margin of the paper leading edge will enlarge. (See "Loading Rolls in the Printer." →P.541)

- 8 Press the **Feed** button.



- 9 Press ▲ or ▼ to align the paper leading edge with the (a) position.

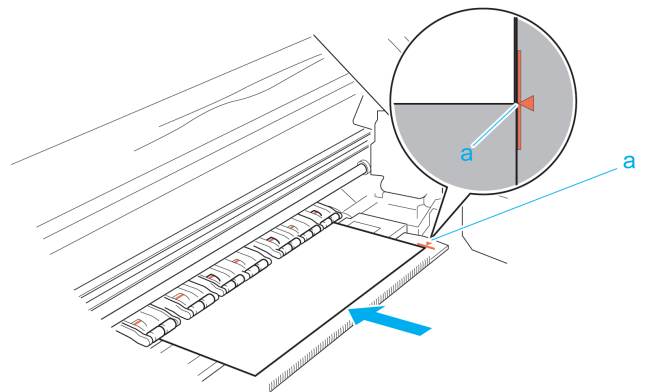

- 10** Print the job.
The printer stops advancing the paper after printing.



Note

- The printer can continue to receive print jobs from computers. If a print job is received and printed here, it can be printed without the margin of about 10 cm being created at the paper leading edge.

- 11** Press the **Feed** button.

Roll paper is fed to the specified cut position and then automatically stopped.



- 12** Cut the roll paper manually with scissors or the like.

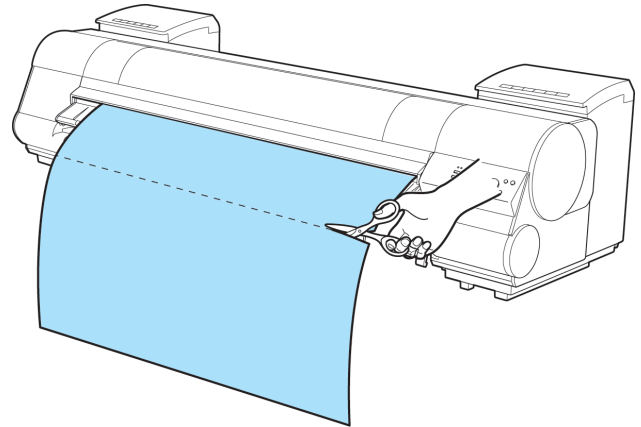

Important

- Cut at the dotted line printed on the paper. If you cut on the printer side of the dotted line, the paper leading edge may rub against the printhead and may deviate from the paper retainer.

- 13** Press the **OK** button.

After the roll is rewound, it stops automatically.



Paper cutting (to have the roll cut at your specified position)

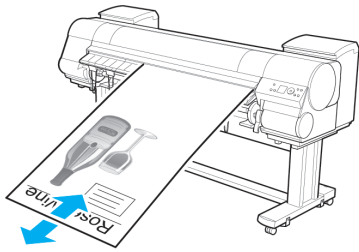

Feed paper the cutting position by pressing ▲ or ▼

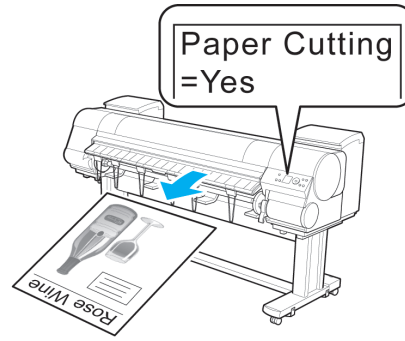

Paper Cutting

- 1 Press the **Feed** button.
- 2 Press the ▼ button to advance the roll to the position for cutting.



- 3 Press the **Cut** button.



- 4 Press ▲ or ▼ to select **Yes**, and then press the **OK** button. After the roll paper is cut, it is rewound automatically.

Cutting the Leading Edge of Roll Paper Automatically

If the leading edge of the paper is cut crooked or is not cut straight when roll paper is loaded, it will not print correctly. If this happens, you can cut the leading edge of the paper straight when loading a paper roll by using **Trim Edge First** in the Control Panel menu.

Trim Edge First offers the following options.

- **Automatic**

If the leading edge of the paper is cut crooked and is not cut straight when loading roll paper, cut the leading edge straight and eject the fragment of paper to prevent printing on the platen and soiling the printer.

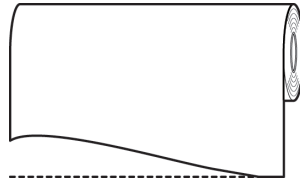

• On (Preset Len)

The amount to cut from the leading edge of the paper varies depending on the media type, and is cut to a prescribed length. For more information on the prescribed length, see the leading edge precut length in the Paper Reference Guide. (See "Paper Reference Guide")

• On(Input Length)

The amount to cut from the leading edge of paper is specified in the control panel. The amount to cut from the leading edge can be specified in the range of lengths displayed in the control panel. The range of lengths differs from each media type.



- The amount to cut from the leading edge of paper cannot be set shorter than the length displayed in the control panel.

Note

• Manual

The amount to cut from the leading edge of the paper can be adjusted by pressing the ▲ and ▼ buttons. After making the adjustment, you can cut the paper by pressing the **Paper Cutting** button and selecting **Cut paper**.

After the paper has been cut, press **Finish paper set**.



- If you do not press **Finish paper set** after cutting the paper, you will not be able to print again.

Note

• Off

The edge is not cut and scraps are not removed.

Follow these steps to change the **Trim Edge First** setting.

- 1 On the **Tab Selection screen** of the Control Panel, press ◀ or ▶ to select the Paper tab ().

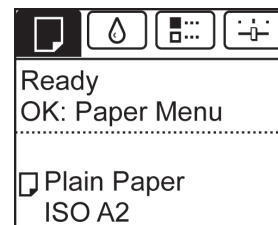

- If the **Tab Selection screen** is not displayed, press the **Menu** button.

Note

- 2 Press the **OK** button.
The **Paper Menu** is displayed.
- 3 Press ▲ or ▼ to select **Paper Details**, and then press the **OK** button.
- 4 Press ▲ or ▼ to select the type of paper, and then press the **OK** button.
- 5 Press ▲ or ▼ to select **Trim Edge First**, and then press the **OK** button.

- 6 Press ▲ or ▼ to select the desired setting option, and then press the **OK** button. This setting takes effect the next time you load a roll.

Reducing Dust from Cutting Rolls

For media such as Backlit Film that are more likely to generate debris when cut, select **CutDustReduce. > On** in the **Paper Menu** of the Control Panel. This option reduces debris from cutting by printing black lines at the leading and trailing edges of documents. It may help prevent Printhead damage. You can specify for **CutDustReduce.** to be activated for particular types of paper.

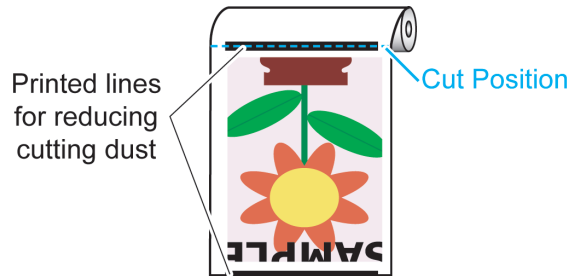

Important

- Do not set **CutDustReduce.** to **On** for paper that wrinkles easily, such as **Plain Paper** or lightweight paper. This may impair cutting and cause paper jams.
- Borderless printing is not available when **CutDustReduce.** is set to **On**. To use borderless printing, select **CutDustReduce. > Off**.

Set **CutDustReduce.** to **On** as follows.

- 1 On the **Tab Selection screen** of the Control Panel, press ◀ or ▶ to select the Paper tab ().

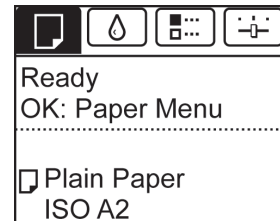

Note

- If the **Tab Selection screen** is not displayed, press the **Menu** button.

- 2 Press the **OK** button. The **Paper Menu** is displayed.
- 3 Press ▲ or ▼ to select **Paper Details**, and then press the **OK** button.
- 4 Press ▲ or ▼ to select the type of paper loaded in the printer, and then press the **OK** button.
- 5 Press ▲ or ▼ to select **CutDustReduce.**, and then press the **OK** button.
- 6 Press ▲ or ▼ to select **On**, and then press the **OK** button.

Handling sheets

Loading Sheets in the Printer	563
Changing the Type of Paper	545
Printing From a Desired Starting Point	566
Removing Sheets	568
Clearing a Jammed Sheet	889

Loading Sheets in the Printer

Follow these steps to load sheets in the printer.



Important

- Paper that is wrinkled or warped may jam. If necessary, straighten the paper and reload it.
- Load the paper straight. Loading paper askew will cause an error.



Note

- Loading sheets when a roll is already loaded in the printer may cause jams. We recommend removing rolls before loading sheets. (See "Removing the Roll from the Printer.") →P.547
- To prevent the roll from unwinding if you leave it loaded, wrap a sheet of paper around the roll and tape it.

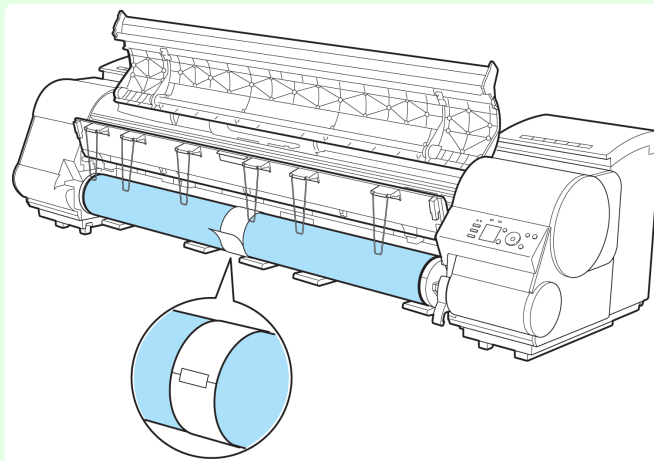

- Before loading sheets, make sure the printer is clean inside the Top Cover and around the Ejection Guide. If these areas are dirty, we recommend cleaning them in advance. (See "Cleaning Inside the Top Cover.") →P.869
- Store unused paper in the original package, away from high temperature, humidity, and direct sunlight.

1

Select sheets as the paper source.

- If a print job was received

Sheets are automatically selected, and the media type and size specified by the print job are shown on the Display Screen.

Press ▲ or ▼ to select **Load Paper**, and then press the **OK** button.

- If no print job was received

1. Press the **Load** button.



2. Press ▲ or ▼ to select **Load Cut Sheet**, and then press the **OK** button.



Note

- If any paper has been advanced that will not be used, a message is shown requesting you to remove it. Press ▲ or ▼ to select "Yes", and then press the **OK** button. Remove the paper and go to the next step.

2 Lift the Release Lever and open the Top Cover.

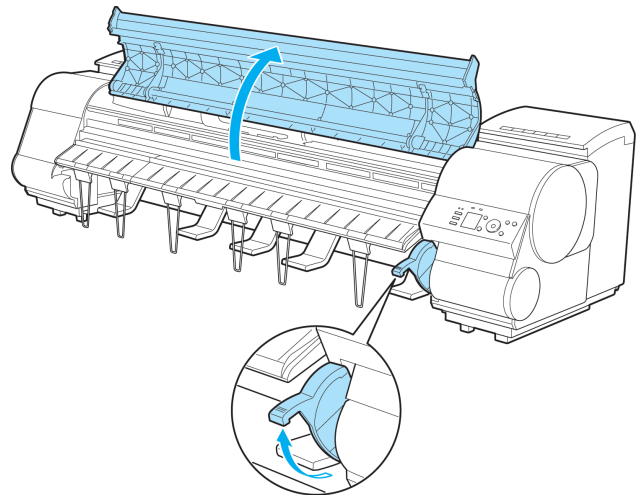

Important

- Do not touch the Linear Scale (a), Carriage Shaft (b), or Fixed Blade (c). This may stain your hands and damage the printer.

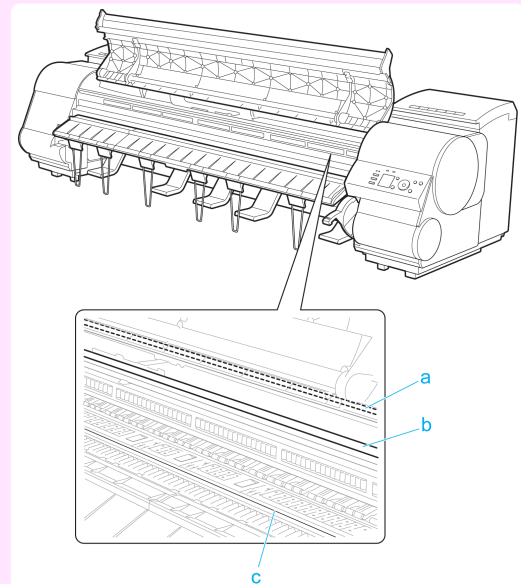

3 With a sheet lengthwise and printing-side up, insert it between the Platen (a) and the Paper Retainer (b). Align the edges of the sheet as follows.

- 1.** Align the sheet with the Paper Alignment Line (c) at right.
- 2.** Align the inserted edge of the sheet with the leading edge of the Paper Alignment Line (d), as shown.

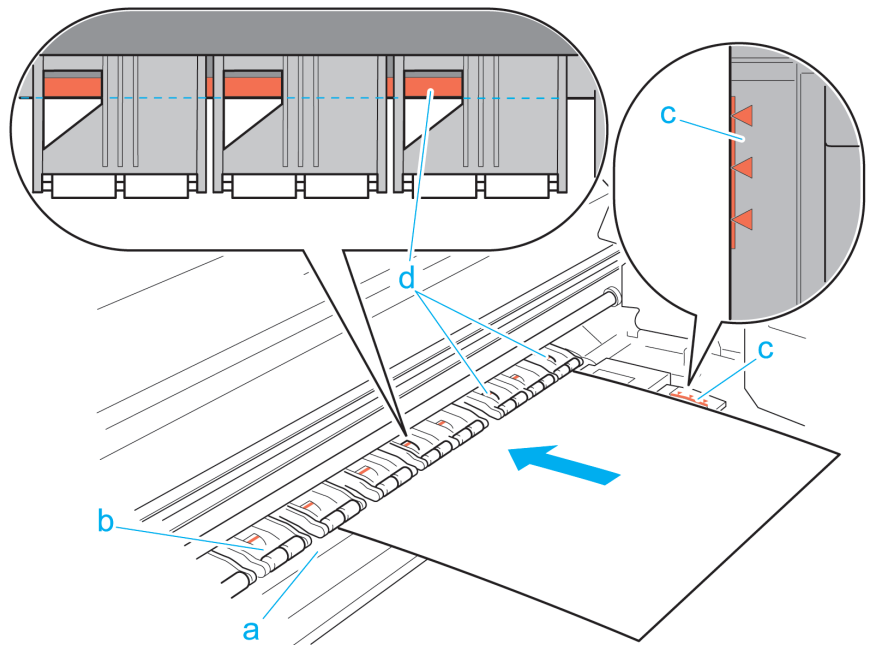

When inserted, sheets are automatically held by suction against the Platen.

- Important**
- Load a sheet so that it is parallel to the Paper Alignment Line at right (c). Loading paper askew will cause an error.
 - Warped paper may rub against the Printhead. Straighten paper if it is warped before loading it.

- Note**
- You can adjust the strength of suction holding paper against the Platen when the Release Lever is up. If it is difficult to load paper, press the ▲ or ▼ button on the Control Panel to adjust the strength. Set suction stronger by pressing the ▲ button or weaker with the ▼ button. Three settings are available. However, even if you increase the suction, it may not be sufficient to hold some types of paper against the Platen well. In this case, use your hand to load the paper.
 - Sheets are held in place by suction through holes on the Platen. Although the suction may produce a noise when paper is loaded in some positions, it does not indicate a problem. If the noise is distracting, try moving the paper over slightly to the left or right (up to 1 mm [0.039 in]) while keeping it parallel to the Paper Alignment Line.
 - The suction remains on for about 30 seconds during loading. If you cannot finish loading a sheet during this time, pull the sheet away and reinsert it to start the suction again.

4 Lower the Release Lever and close the Top Cover.

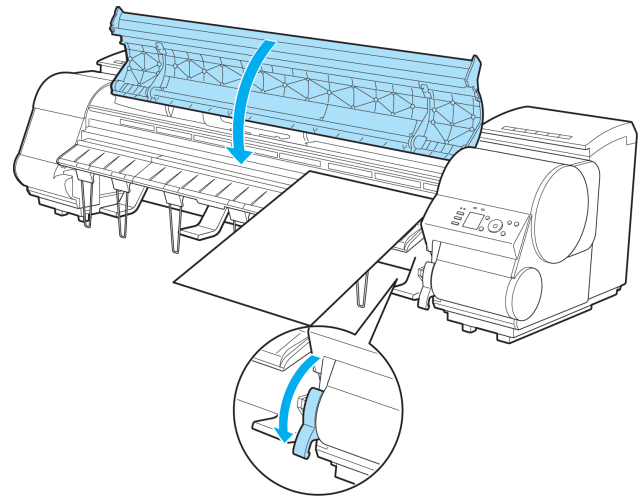

- If a print job was received
Pressing the **OK** button will advance the paper, and then printing will begin.
- If no print job was received
A menu for selection of the type of paper is shown on the Display Screen.
Press **▲** or **▼** to select the type of paper, and then press the **OK** button.
The printer now starts feeding the paper.

- For details on types of paper to select, see the Paper Reference Guide. (See "Types of Paper.") →P.530
- Note** • When using the Output Stacker, if you will print on large, stiff sheets, we recommend adjusting the Output Stacker into the lowest position to prevent printed sheets from being bent. (See "Using the Output Stacker.") →P.572

Printing From a Desired Starting Point

Print on sheets from a desired starting point as follows.

Set Width Detection to Off

1 On the **Tab Selection screen** of the Control Panel, press **◀** or **▶** to select the Paper tab ().



- If the **Tab Selection screen** is not displayed, press the **Menu** button.
- Note**

- 2** Press the **OK** button.
The **Paper Menu** is displayed.
- 3** Press **▲** or **▼** to select **Paper Details**, and then press the **OK** button.
- 4** Press **▲** or **▼** to select the type of paper, and then press the **OK** button.
- 5** Press **▲** or **▼** to select **Width Detection**, and then press the **OK** button.

- 6** Press ▲ or ▼ to select **Off**, and then press the **OK** button.

Load paper in the desired position to start printing from

Follow these instructions to load paper at the desired starting position for printing when **Width Detection** is **Off**.

- 1** If you did not send a print job in advance, a menu for selection of the type of paper is displayed. Press ▲ or ▼ to select the type of paper, and then press the **OK** button.



Note

- If a print job was received before paper was advanced, the media type and size specified by the job are shown on the Display Screen. Thus, this screen is not displayed. Go to step 2.

- 2** "**Width Detection OFF. OK to continue?**" is now shown on the Display Screen. Press ▲ or ▼ to select "**Leave OFF**", and then press the **OK** button.

- 3** After a menu for selection of the paper size is displayed, press ▲ or ▼ to select the paper size, and then press the **OK** button.

- 4** Open the Top Cover and check the position where paper is loaded.

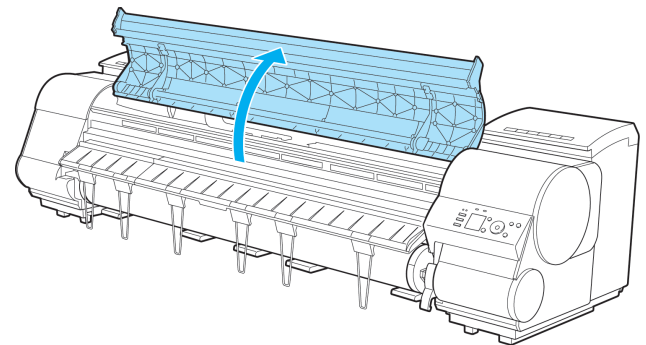

To start printing from the current position, close the Top Cover.

To reposition the paper, lift the Release Lever.

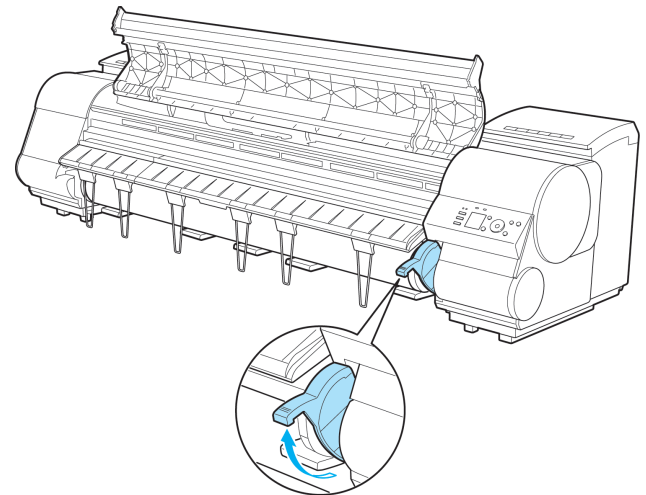

- 5 Keeping the right edge of the paper aligned with the extended line of the paper alignment line (a) on the right side of the printer and the position from which to start printing aligned with the groove (b) at the far end of the platen, load the paper.

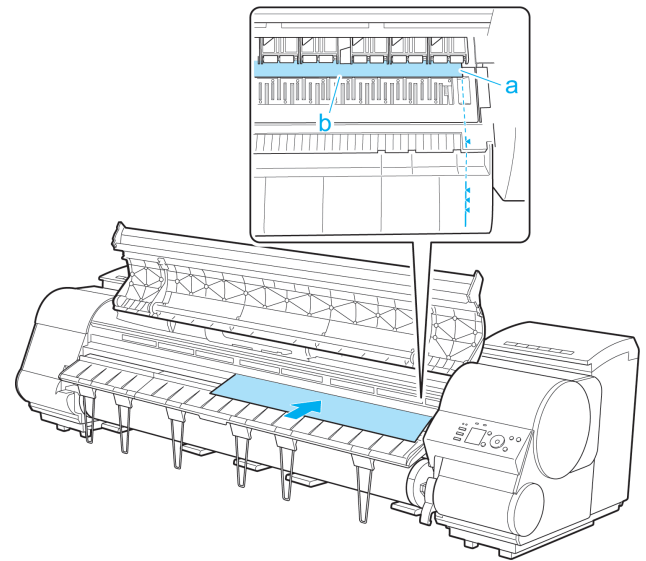

- 6 Lower the Release Lever and close the Top Cover.

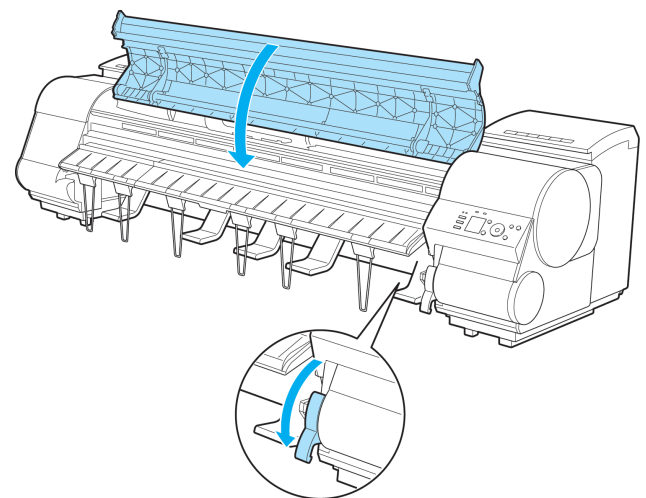

Removing Sheets

Remove sheets from the printer as follows.

- 1 On the **Tab Selection screen** of the Control Panel, press ◀ or ▶ to select the Paper tab ().

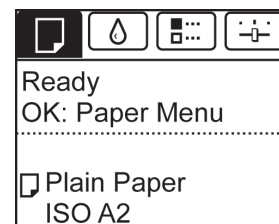

 • If the **Tab Selection screen** is not displayed, press the **Menu** button.
Note

- 2 Press the **OK** button.
The **Paper Menu** is displayed.

3 Press ▲ or ▼ to select **Eject Paper**, and then press the **OK** button.

4 Press ▲ or ▼ to select **"Yes"**, and then press the **OK** button.
The paper is ejected from the front of the printer.

5 Open the Top Cover, lift the Release Lever, and remove the sheet.

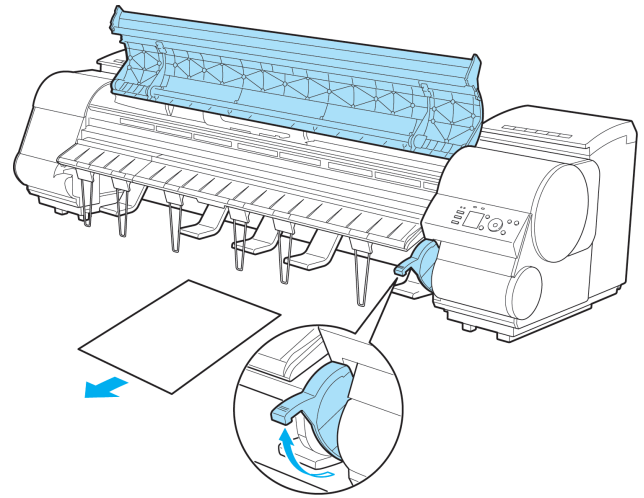

6 Lower the Release Lever and close the Top Cover.

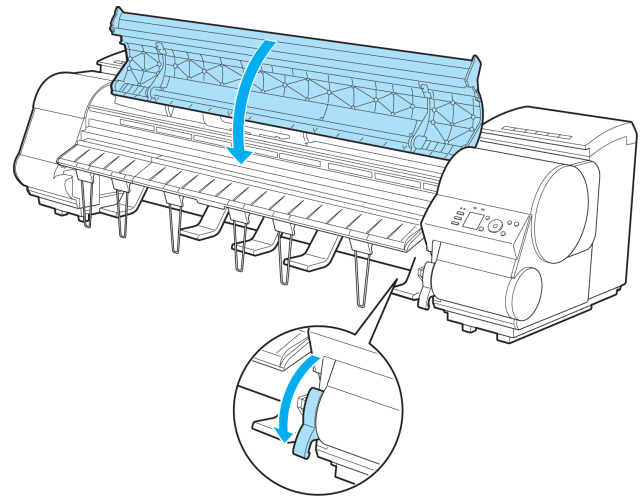

Output Stacker

Output Stacker	570
Parts of the Output Stacker	571
Using the Output Stacker	572
Storing the Output Stacker	576

Output Stacker

A cloth tray that catches ejected documents. (Optional)

- Output Stacker BU-01

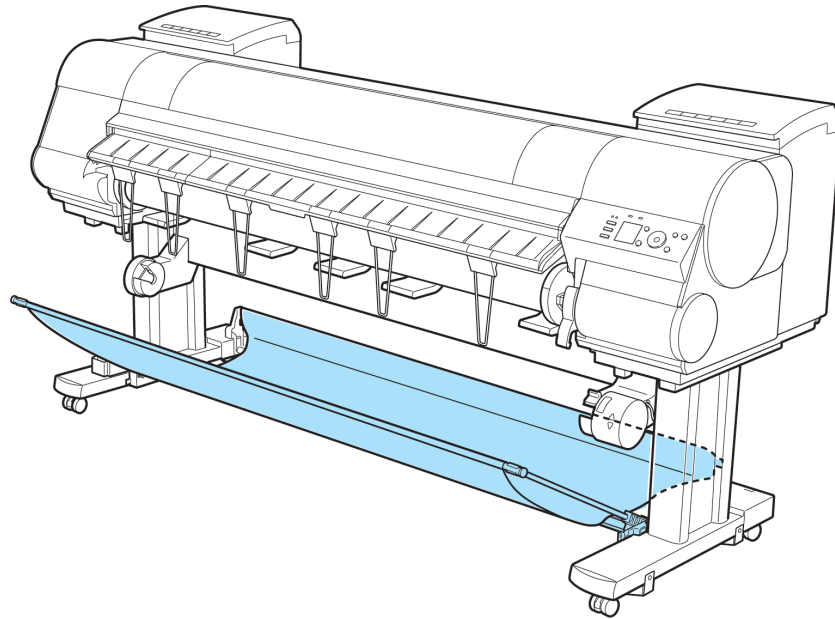

Note

- For more information on how to attach the Output Stacker, refer to the Setup Guide.

Parts of the Output Stacker

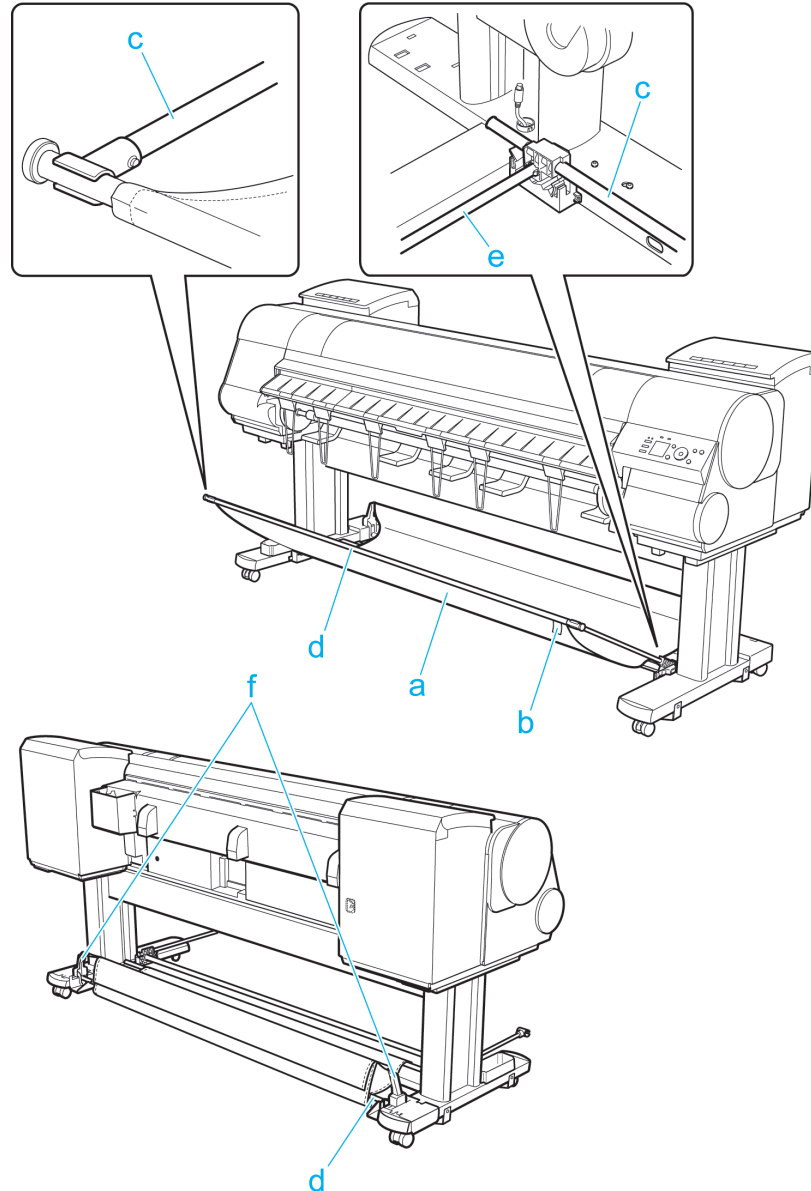

a Output Stacker

A cloth tray that catches ejected documents.

b White tag

A point of reference for attaching the Output Stacker in the right direction.

c Basket Arm R and Basket Arm L

Holds the Basket Rod (tag side) attached to the Output Stacker. When the Output Stacker is not used, push it down and store it next to the Stand Leg.

d Basket Rod (tag side) and Basket Rod (cord side)

Holds the cloth Output Stacker securely in specific positions.

e Basket Rod

Keeps Basket Arm R and Basket Arm L at the same angle.

f Rod Holder

Holds the middle of the Basket Rod (cord side).

(See "Using the Output Stacker.") →P.572

Using the Output Stacker

The Output Stacker can be held at four positions, as shown.

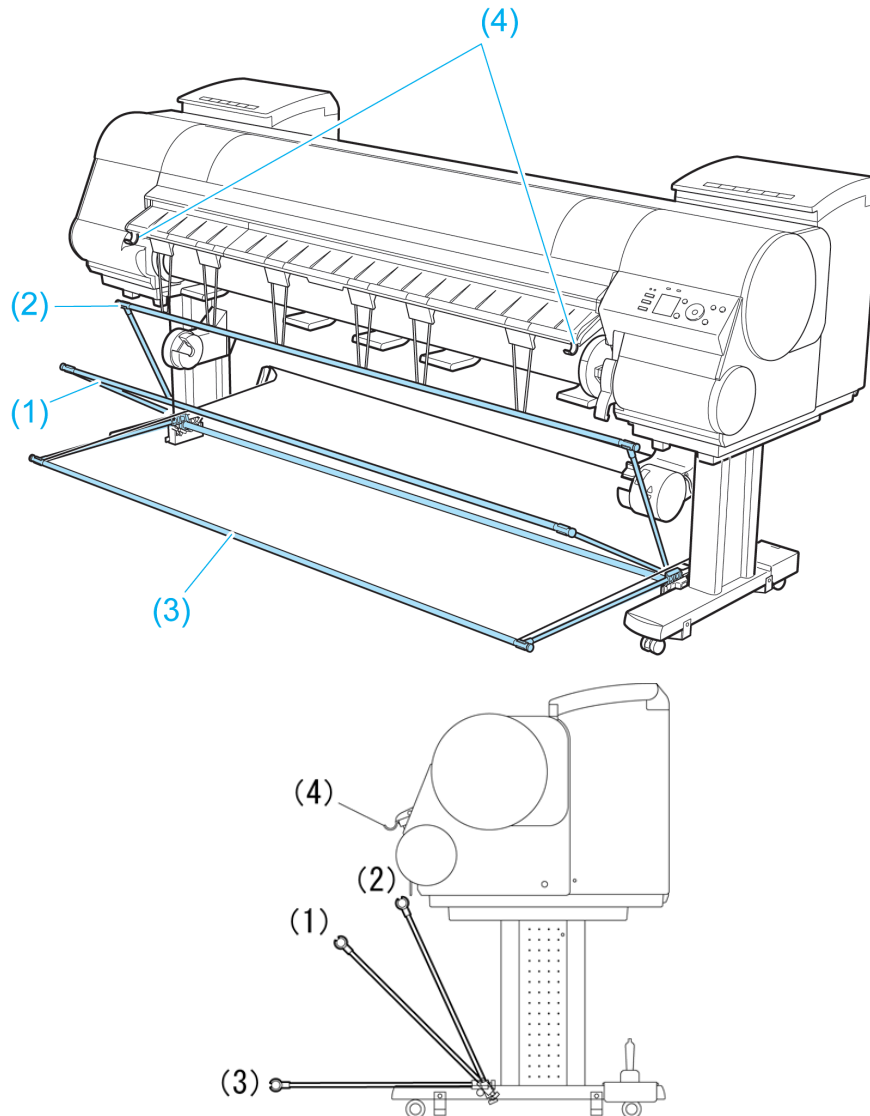

- When storing printed documents on the Output Stacker
Use position (1).
- When the Output Stacker is not used
Use position (2).
- When the Media Take-up Unit is used, or when the Output Stacker is stored for long periods
Lower it to position (3) for storage. (See "Storing the Output Stacker.") →P.576
When using the Output Stacker again after storage, reattach the Basket Rod on the front of the Output Stacker to the tips of the left and right basket arms and pull it out completely .
- When printing on large, stiff sheets
Use position (3).
Set it to position (4) when printing banners or when printing on delicate paper. (See "Using the output stacker for ejection in front.") →P.573



- When storing printed documents on the Output Stacker, always use it in position (1). If you do not, printed documents may not be dropped into the Output Stacker, and the printed surface may become soiled.
- The Output Stacker can hold one sheet. When printing multiple pages, remove each sheet after it is printed.
- Before using the Output Stacker, remove the Rewind Spool. If you do not, it may prevent printed documents from being held correctly, and they may be scratched.
- The Output Stacker can hold roll paper up to 84 inches (2133.6 mm) long. When printing longer documents, adjust the stacker for ejection in front or use the Media Take-up Unit (option).

The Output Stacker locks into position if you lift it to position (1) or (2). To lower the Output Stacker, lift the front Basket Rod lightly to release the lock, and then lower the stacker.

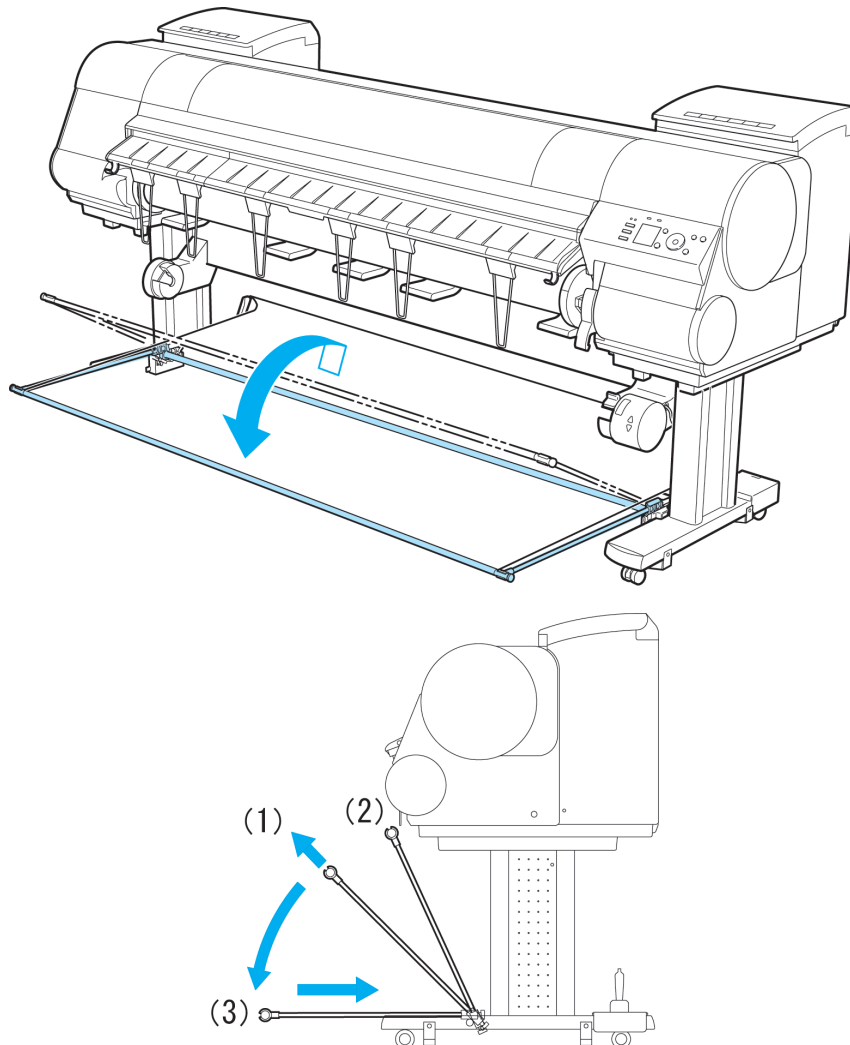

Using the output stacker for ejection in front

You can also set the stacker to the following position when printing banners or when printing on delicate paper.



Important

- When using the stacker for ejection in front, always select **Cutting Mode > Eject**. Selecting **Automatic** may damage printed documents. (See "Specifying the Cutting Method for Rolls.") →P.554
- During ejection in the front of the printer, be especially careful when using delicate paper or paper that curls easily.
- Depending on the type of paper, the edge may curl or bend during ejection. In this case, straighten out the paper. If the paper is curled or bent, it may damage printed documents.
- Some types of paper may get caught between the Ejection Guide and Output Stacker during ejection. In this case, free the paper from where it is caught. If the paper is caught, it may damage printed documents.

- 1 Lift the Basket Rod gently to release the lock, lower the stacker toward the front, and push it back.

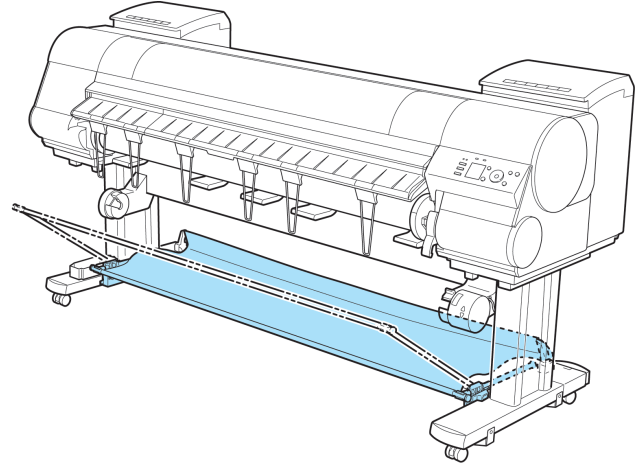

- 2 Remove the Output Stacker from the printer. Remove the front Basket Rod from the left and right basket arms, and remove the back Basket Rod and black cord from the Rod Holder.

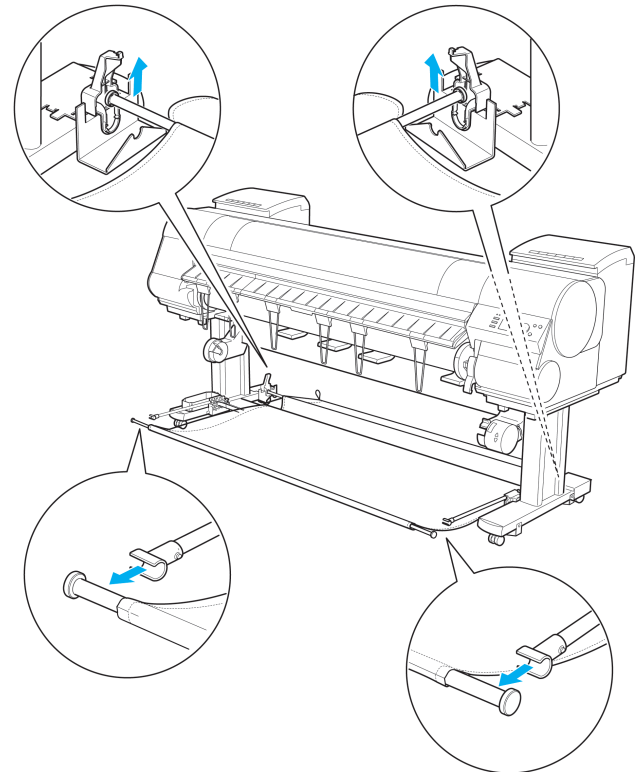

- 3** Stow the left and right basket arms. Next, with the Rod Holder still attached, remove the Rod Holder Adapter and put it in front of the printer.

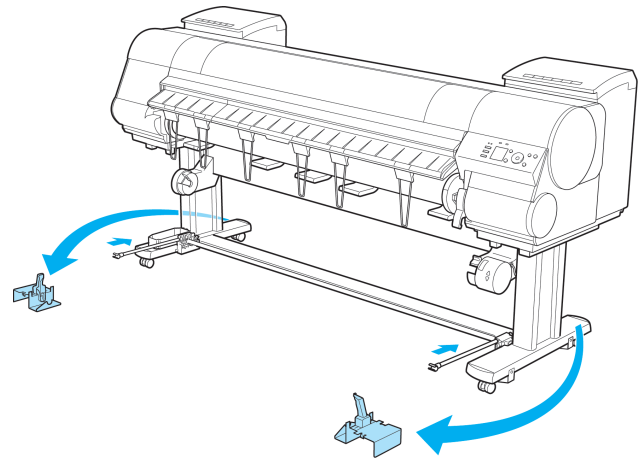

- 4** Pull out the left and right Basket Hooks from the Ejection Guide.

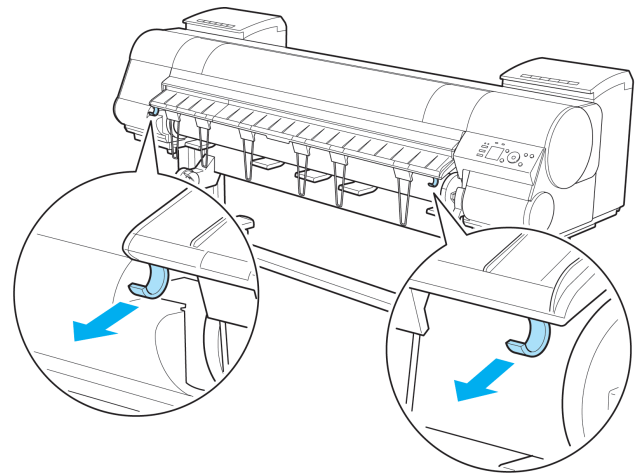

- 5** Attach the Basket Rod to the Basket Hooks so that the white tag of the Basket Cloth is on the left.

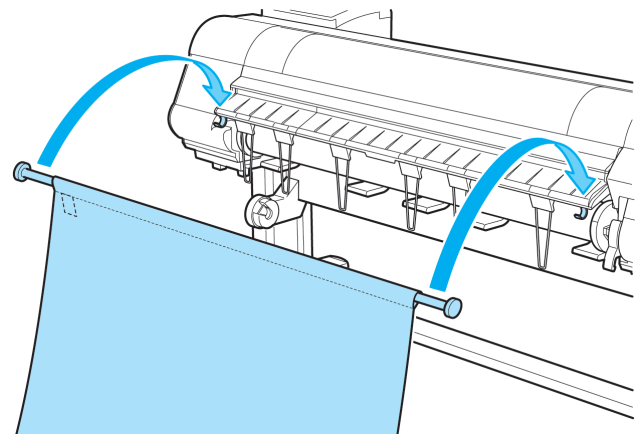

- 6** Form the Basket Cloth into a sloping shape to make it taut, and attach the middle Basket Rod to the Rod Holder.

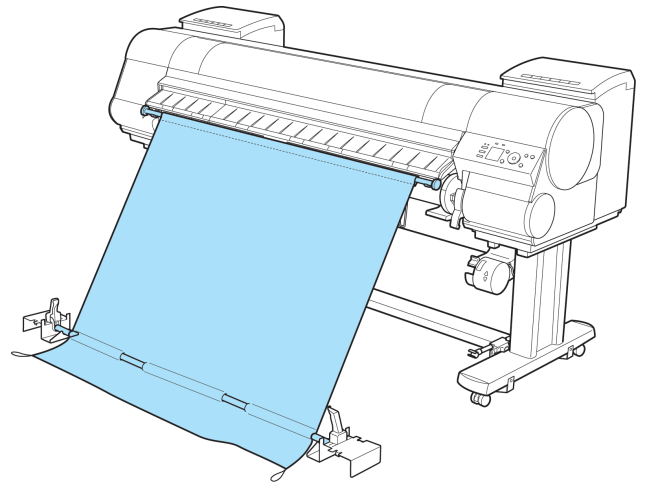

Storing the Output Stacker

Stow the Output Stacker if you will use the Media Take-up Unit or if you will not use the Output Stacker for an extended period.

- 1** When the Output Stacker is in the position used when storing printed documents (a), lift the front Basket Rod gently to release the lock, lower the stacker toward the front (b), and push it all the way back.

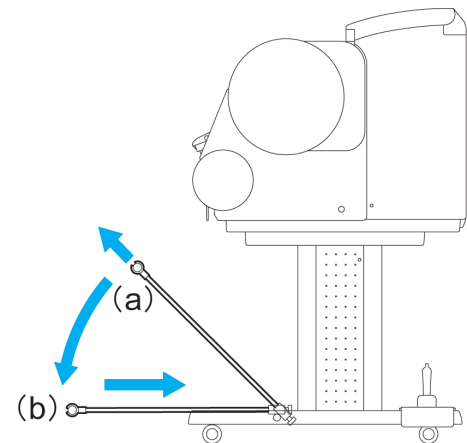

- 2** Remove the front Basket Rod from the left and right basket arms. Roll up the Basket Cloth and put it at the back of the Bottom Stand Stay.

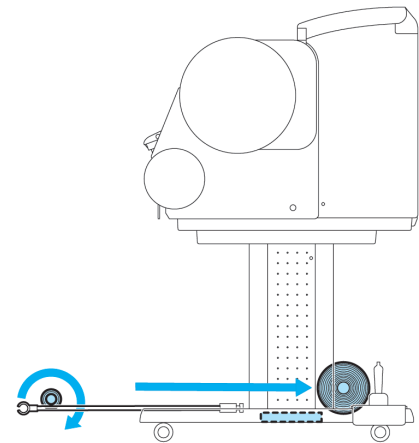



Important

- When using the Media Take-up Unit, position the Basket Cloth and Basket Rod so they do not interfere with the Media Take-up Sensor (wave portion). This may impair operation.

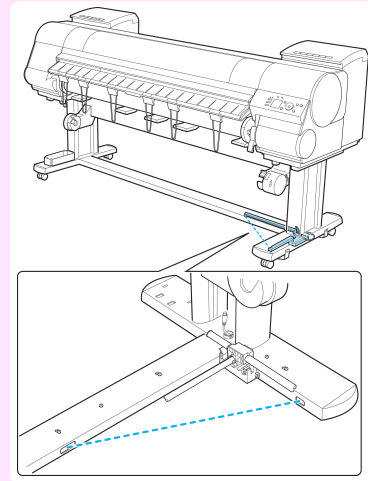

3

Push in the left and right basket arms toward the back all the way, until they stop.

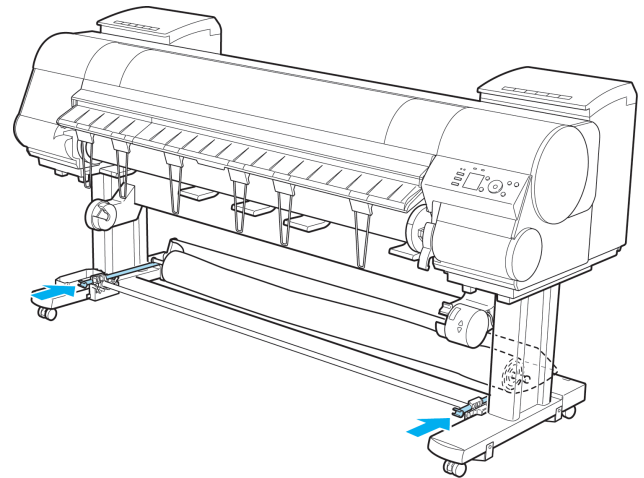

Media take-up unit

Media Take-up Unit	578
Using the Media Take-up Unit	578
Enabling Roll Take-Up	579
Disabling Roll Take-Up	579
Loading the Rewind Spool on the Media Take-up Unit	580
Removing Printed Documents from the Media Take-up Unit	587

Media Take-up Unit

Use the Media Take-up Unit to have documents that are printed on rolls rewound automatically after printing. This is convenient for large-format printing, or when printing large-volume jobs continuously.

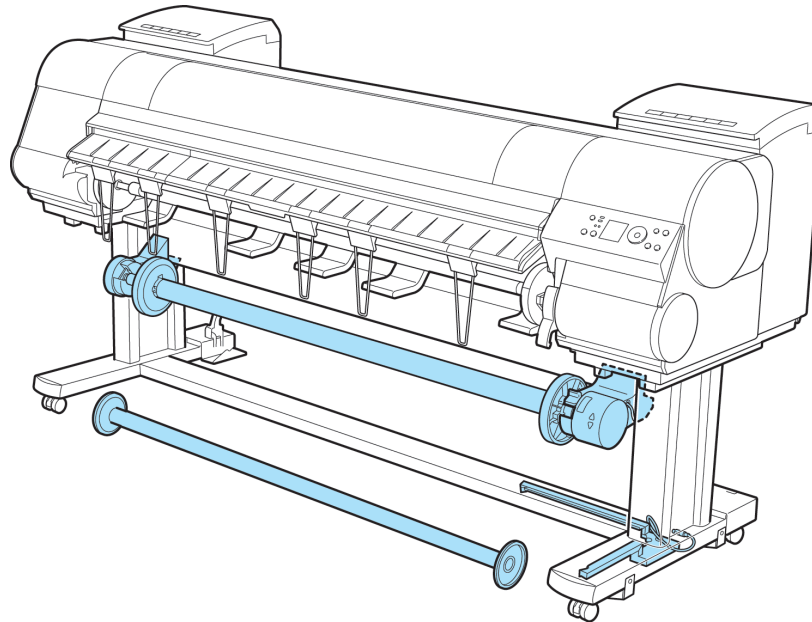

- For more information on how to attach the Media Take-up Unit, refer to the Setup Guide.

Note • For information on the types of paper compatible with the Media Take-up Unit, refer to the Paper Reference Guide. (See "Types of Paper.") →P.530

- For Media Take-up Unit instructions, see "Using the Media Take-up Unit." →P.578

Using the Media Take-up Unit

- 1 Turn the printer on. (See "Turning the Printer On and Off.") →P.21
- 2 Enable roll take-up. (See "Enabling Roll Take-Up.") →P.579
- 3 Load the rewind spool on the media take-up unit. (See "Loading the Rewind Spool on the Media Take-up Unit.") →P.580
- 4 Turn on the Media Take-up Unit.
- 5 Print on the roll.
- 6 Turn off the Media Take-up Unit.

7 Remove the printed document from the media take-up unit. (See "Removing Printed Documents from the Media Take-up Unit.") →P.587

8 Disable roll take-up. (See "Disabling Roll Take-Up.") →P.579



- The Media Take-up Unit cannot be used with sheets.
- Important** • If you have attached the Output Stacker, always stow it before using the Media Take-up Unit. (See "Storing the Output Stacker.") →P.576
- Position the Basket Cloth and Basket Rod so they do not interfere with the Media Take-up Sensor. This may impair operation. (See "Storing the Output Stacker.") →P.576
- Rolls are not cut automatically when the Media Take-up Unit is used, regardless of the **Cutting Mode** setting in the printer menu or the **Automatic Cutting** setting in the printer driver. However, you can cut paper by pressing the **Cut** button.
- Color tones after printing may change during the ink drying period for some types of paper. Allow ample drying time before the final check of colors, and do not remove printed documents from the Media Take-up Unit too soon.
- In humid environments, documents printed using plenty of ink on relatively insubstantial media such as lightweight **Canon Coated Paper** may not be retracted evenly by the unit. In this case, take steps to control humidity in the operating environment, or adjust the **Roll DryingTime** setting so that printed documents are retracted after the ink has fully dried.
- In humid environments, documents printed on **Fabric Banner** or **Adhesive Synthetic Paper** may not be retracted evenly by the unit. In this case, take steps to control humidity in the operating environment, or adjust the **Roll DryingTime** setting so that printed documents are retracted after the ink has fully dried.

Enabling Roll Take-Up

1 On the **Tab Selection screen** of the Control Panel, press ◀ or ▶ to select the Settings/Adj. tab ().

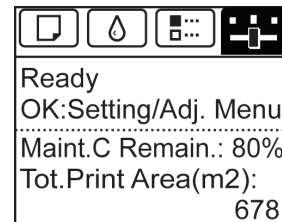

Note

- If the **Tab Selection screen** is not displayed, press the **Menu** button.

2 Press the **OK** button.
The **Set./Adj. Menu** is displayed.

3 Press ▲ or ▼ to select **Take-up Reel**, and then press the **OK** button.

4 Press ▲ or ▼ to select **Use Take-up Reel**, and then press the **OK** button.

5 Press ▲ or ▼ to select **Enable**, and then press the **OK** button.

Disabling Roll Take-Up

1 Press the **Cut** button.

- 2** Press ▲ or ▼ to select **Yes**, and then press the **OK** button.
The mode now switches from take-up mode to regular mode.



Note

- The printer will also switch from take-up mode to regular mode if you lift the Release Lever and cut the roll with scissors instead of pressing the **Cut** button.

- 3** On the **Tab Selection screen** of the Control Panel, press ◀ or ▶ to select the **Settings/Adj. tab** ().

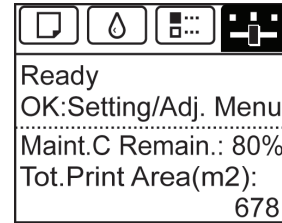

Note

- If the **Tab Selection screen** is not displayed, press the **Menu** button.

- 4** Press the **OK** button.
The **Set./Adj. Menu** is displayed.

- 5** Press ▲ or ▼ to select **Take-up Reel**, and then press the **OK** button.

- 6** Press ▲ or ▼ to select **Use Take-up Reel**, and then press the **OK** button.

- 7** Press ▲ or ▼ to select **Disable**, and then press the **OK** button.

Loading the Rewind Spool on the Media Take-up Unit

- 1** When using the Output Stacker, stow the Output Stacker before this procedure. (See "Storing the Output Stacker.") →P.576



Important

- Position the Basket Cloth and Basket Rod so they do not interfere with the Media Take-up Sensor (wave portion). This may impair operation.

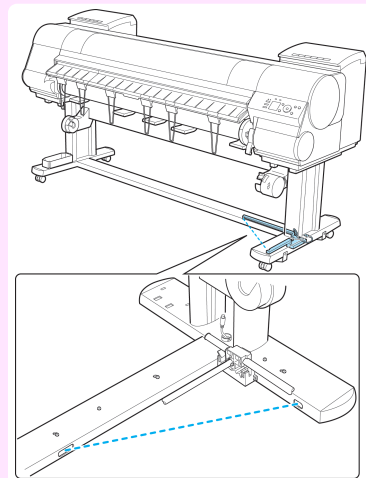

- 2** Unlock the flange on the left side of the Rewind Spool by lifting the lever (a) from the shaft side. Remove the flange.

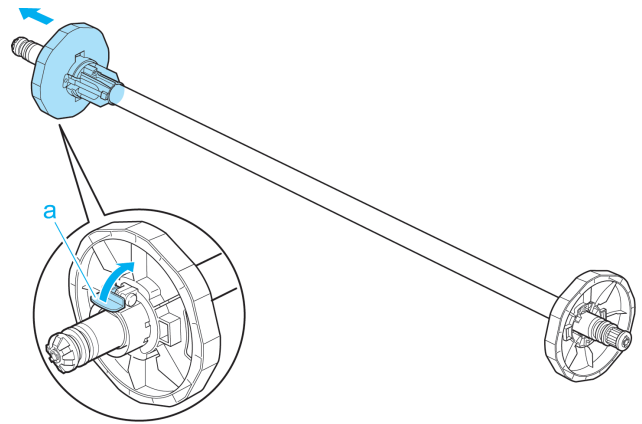

- 3** When rewinding rolls with 3-inch paper cores, insert the 3-inch Adapter on the flanges at both ends.

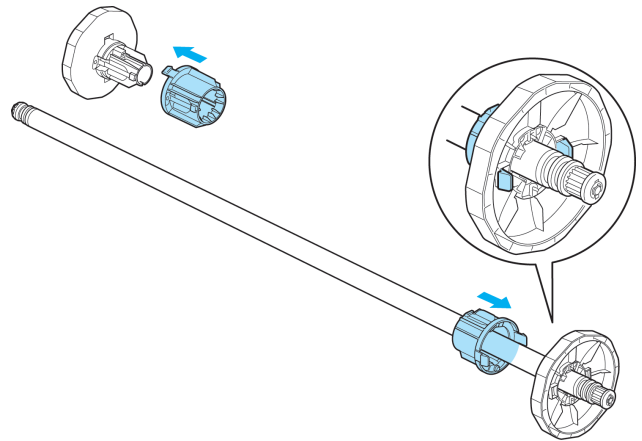

- 4** Insert the paper core, which serves as the spindle for rewinding a roll, on the Rewind Spool.

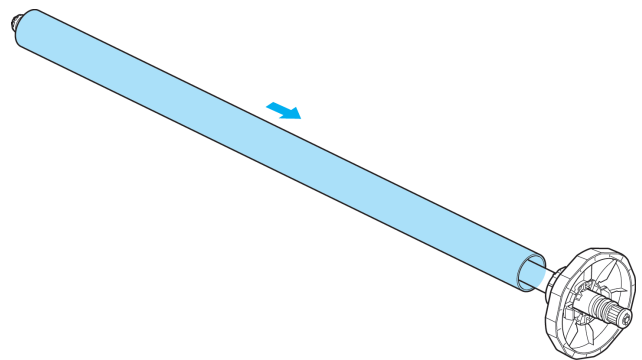

Important

- Definitely load the same size of paper core in the Rewind Spool as that of the roll to be rewound. Using a paper core of a different size may cause rewinding problems.

- 5** Push the flanges in firmly until the paper core is secured in place and push down the lever (a) toward the shaft.

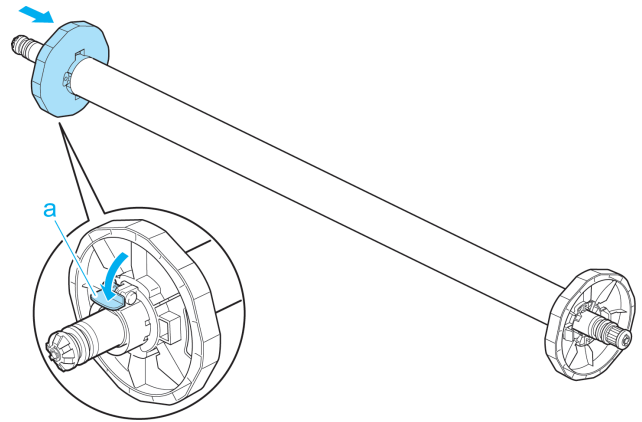

- After the flange is pressed strongly, confirm that the paper core does not move. If you can hold and move the paper core leftward and rightward and there is clearance between the flange and paper core, repeat procedures 2 to 4. If there is clearance, a rewinding problem may result.

- 6** Load the Rewind Spool on the Media Take-up Unit so that the gear of the Rewind Spool (a) meshes with the gear of the Right Media Take-up Unit (b).

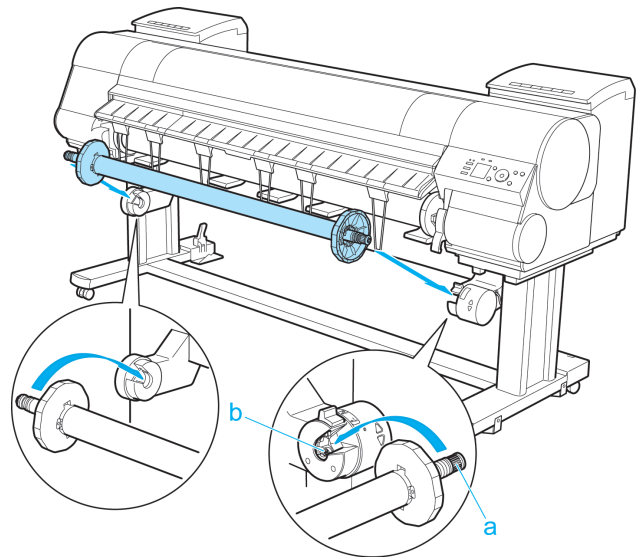

- If the gear of the Rewind Spool (a) does not mesh with the gear of the Right Media Take-up Unit (b), the Media Take-up Unit cannot be turned on.

- 7** On the **Tab Selection screen** of the Control Panel, press ◀ or ▶ to select the Settings/Adj. tab ().

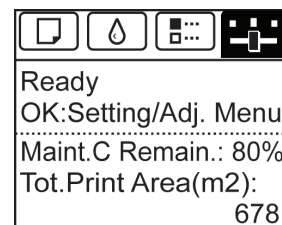

- If the **Tab Selection screen** is not displayed, press the **Menu** button.

- 8** Press the **OK** button.
The **Set./Adj. Menu** is displayed.

9 Press ▲ or ▼ to select **Take-up Reel**, and then press the **OK** button.

10 Press ▲ or ▼ to select **Auto Feed**, and then press the **OK** button.
The roll is now advanced to the Media Take-up Unit.

11 Hold the roll paper by the middle of the leading edge and align the right edge with the right edge of the paper core of the Rewind Spool. With the left and right edges of the roll paper evenly taut, tape the middle to the paper core to fasten it.

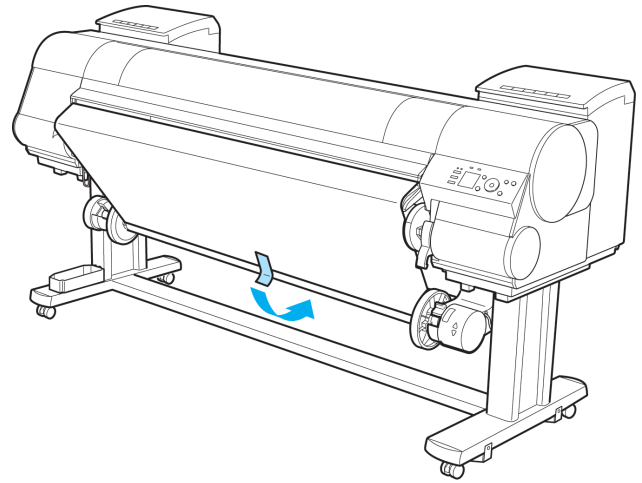

12 Making sure the roll paper is not slack, tape the left and right side of the leading edge to the paper core.

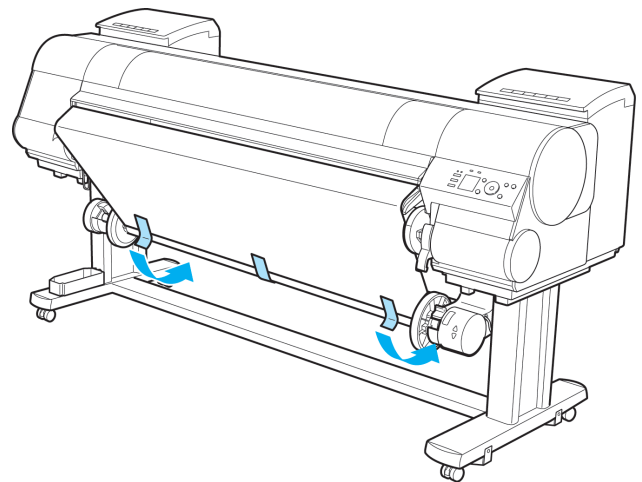

Note

- When rewinding heavyweight paper, use strong adhesive tape to fasten it. Otherwise, a rewinding problem may result.

13 Press the ▼ button to make the roll a little slack.

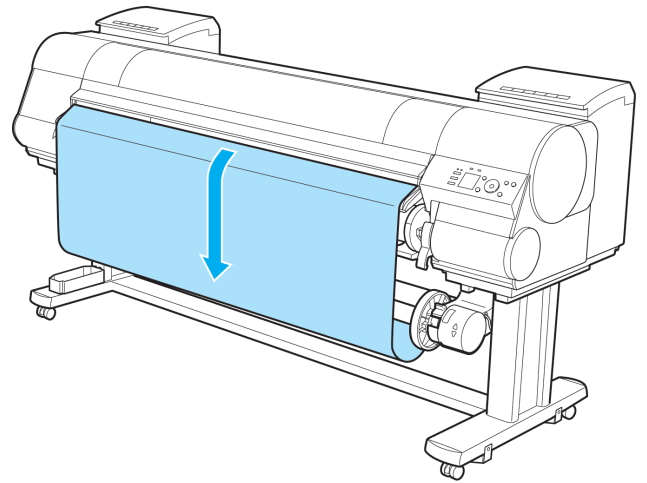

14 On the Right Media Take-up Unit, pull the Rewind Mode Switch forward to turn it on. Press the ▼ button to rewind the roll so that it is nearly taut.

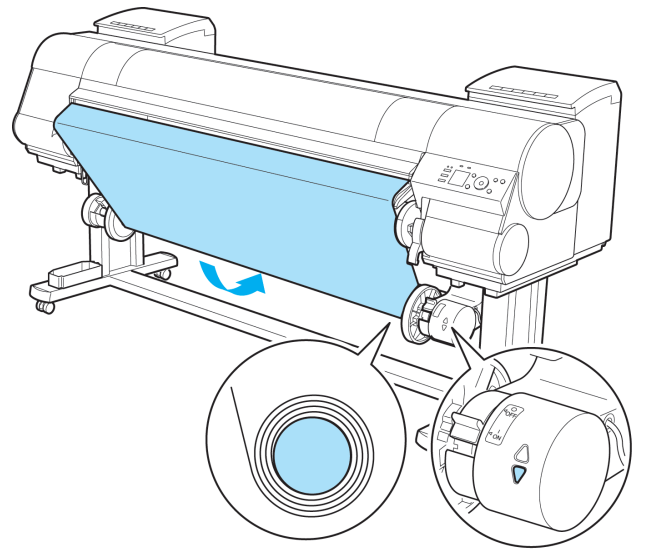

Important

- Rewind the paper so that the paper core makes at least two revolutions. If the paper is not rewound two full revolutions, repeat steps 13 and 14.
- Do not manually force the Rewind Spool or paper core to rotate them. This may damage them. To rewind or unwind rolls, press ▲ or ▼ on the Media Take-up Unit.

- 15** You can unwind rolls by holding down ▼ on the control panel.

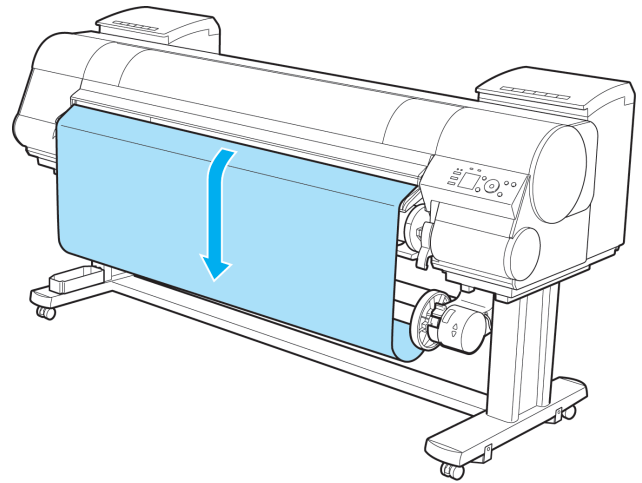

- 16** Refer to the following table and securely insert the Weight Flange and Weight Joint suitable for the type and width of roll into the Weight Roll.

The following list identifies Weight Roll and Weight Flange you can use. A Color Label is applied to each Weight Roll.

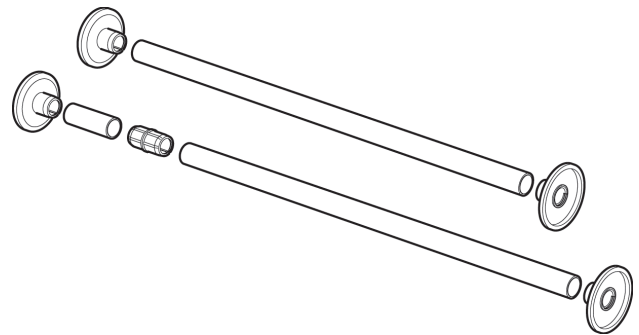

Weight Roll

Roll Width	Weight Roll to Use
B2 Width: 515.0 mm (20.3 in)	D
B1 Width: 728.0 mm (28.7 in)	A+E
B0 Width: 1,030.0 mm (40.6 in)	A+G
A1 Width: 594.0 mm (23.4 in)	E
A0 Width: 841.0 mm (33.1 in)	B+E
431.8 mm (17 in)	C
609.6 mm (24 in)	E
762.0 mm (30 in)	B+D
914.4 mm (36 in)	G
1,066.8 mm (42 in)	C+E
1,117.6 mm (44 in)	D+E
1270.0 mm (50 in)	D+F
1371.6 mm (54 in)	E+F
1524.0 mm (60 in)	E+G

Weight Flange

Roll Type	Weight Flange to Use
Canon Premium Glossy Paper 2 280, Semi-Glossy Photo Paper, Canon Premium Glossy Paper 2 280, Heavy-weight SemiGlossy Photo Paper, Fine Art Photo, Fine Art Heavyweight Photo, Fine Art Textured, Canvas Matte, Canon Proofing Paper, Canon Coated Paper, Canon Heavyweight Coated Paper, Extra Heavyweight Coated Paper, Colored Coated Paper, Adhesive Synthetic Paper, Synthetic Paper, Backprint Film, Backlit Film, Canon Flame-Resistant Cloth, Fabric Banner, Thin Fabric Banner	Weight Flange 1 (*1)
Premium Matte Paper	Weight Flange 2

*1: If you cannot retract stiff paper well using Weight Flange 1 or if the diameter of the retracted paper is wider than the Rewind Spool, use Weight Flange 2. When using Weight Flange 2, adjust the paper feed amount by executing **Auto(GenuinePpr)** or **Auto(OtherPaper)**. (See "Automatic Banding Adjustment." →P.814)



Important

- Do not use combinations other than those identified here.
- Insert the Weight Flange and Weight Joint firmly on the Weight Roll.
- Use identical Weight Flange on the left and right ends. Insert matching Weight Flanges (1 or 2) on both ends of the Weight Roll.



Note

- Keep unused weight rolls, weight joints, and weight flanges handy by putting them in the box and putting the box under the Stand .

17 Set the Weight Roll gently on top of the slack in the roll paper.

The media take-up unit is now ready for use. Printed rolls can now be rewound automatically.

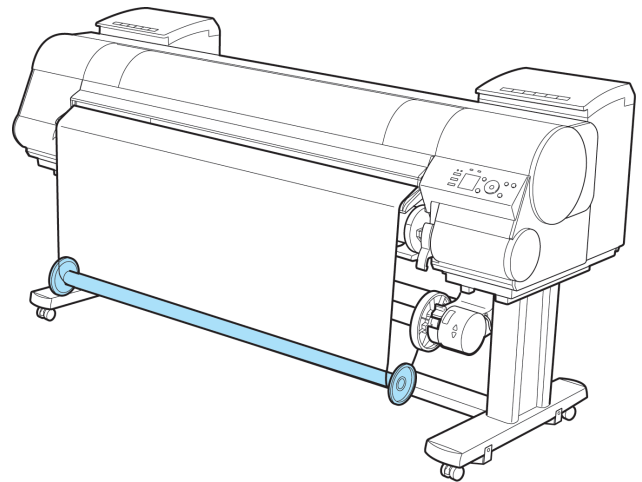

Important

- Always set the Weight Roll on the paper. Failure to do this may cause rewinding problems.
- When setting the Weight Roll on the paper, avoid touching the paper core and causing the wound roll to become misaligned on the left and right end. If it is misaligned on the left and right ends, a rewinding problem may result.



Note

- When the media take-up unit is in use, an icon indicating the take-up mode is shown on the Display Screen.



Removing Printed Documents from the Media Take-up Unit

1 Press the **Feed** button.



2 Hold down the ▼ button to advance the roll a little. To protect the paper that has been rewound, advance it an amount longer than the outer circumference.

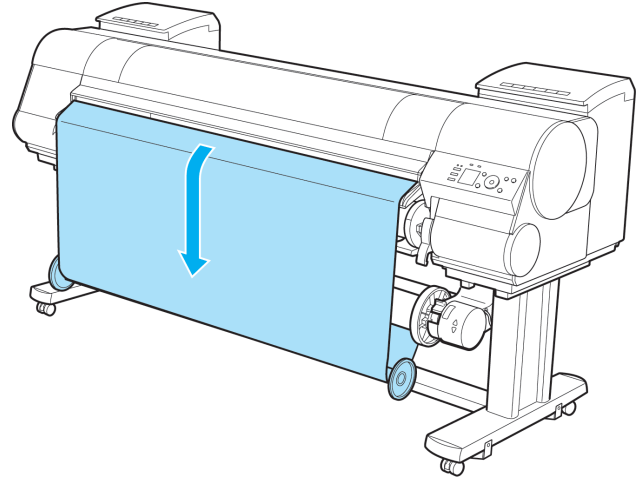

3 Remove the Weight Roll from the roll paper.

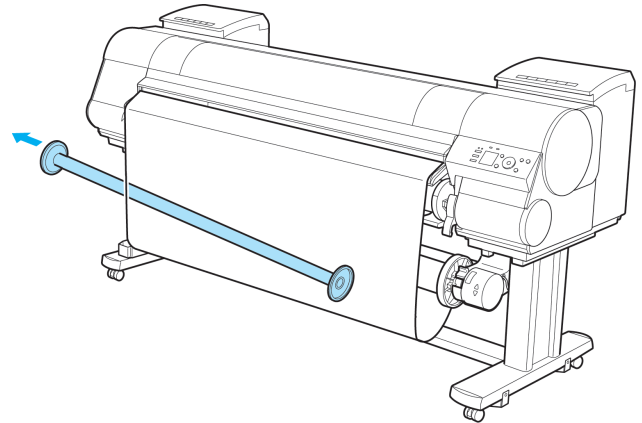

4 Press the **Cut** button.



- 5 Press ▲ or ▼ to select **Yes**. As you hold the trailing edge of the printed document, press the **OK** button. The roll is now cut.



- Always hold the trailing edge of printed documents when cutting rolls. If you do not hold the documents, they may fall on the floor and the printed surface may become soiled.

- 6 Hold the trailing edge of the printed document and press the ▼ button on the Media Take-up Unit to re-wind the printed document.

Apply adhesive tape to the rewound paper to hold it in place, if necessary.

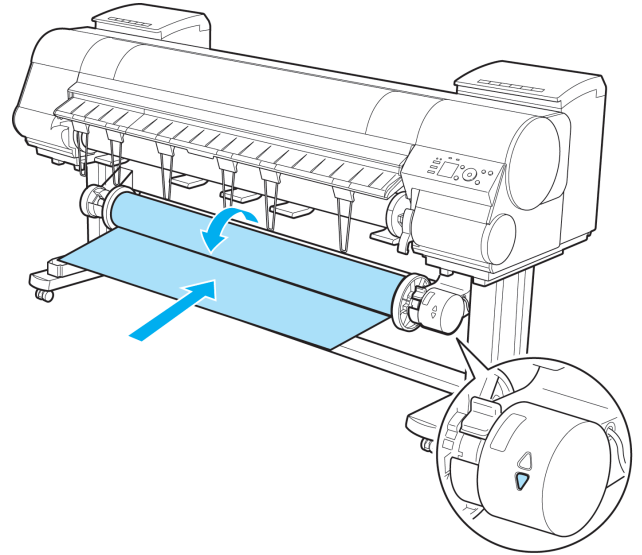

- Be careful not to scratch the printed surface.

- 7 Turn off the Media Take-up Unit by pushing in the Re-wind Mode Switch.

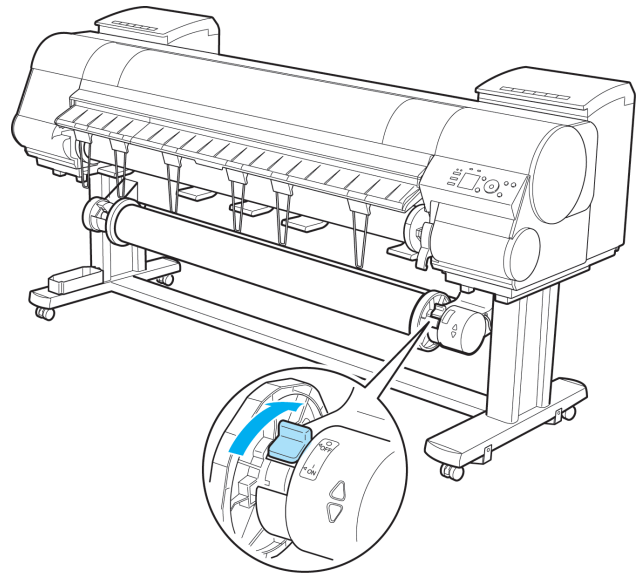

8 Remove the Rewind Spool from the Media Take-up Unit.

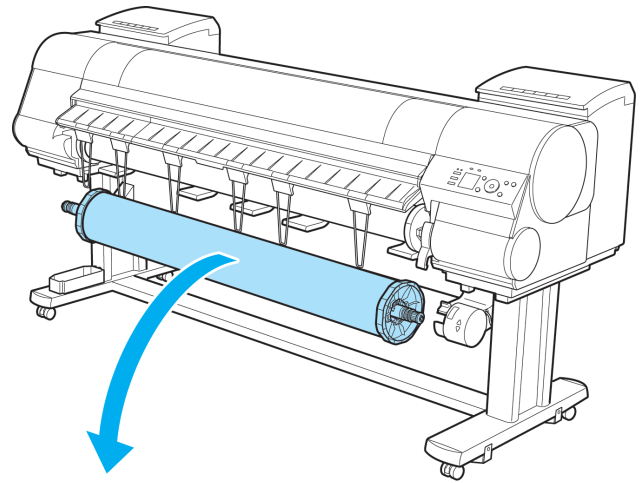

Important

- Always turn off the Media Take-up Unit before removing the Rewind Spool. The Media Take-up Unit may be damaged if you do not turn it off first.
- Remove the Rewind Spool, pulling off both ends from the Media Take-up Unit at once. If you do not pull off both ends at once, the Media Take-up Unit may become damaged.

9 Unlock the flange on the left side of the Rewind Spool by lifting the lever (a) from the shaft side. Remove the flange.

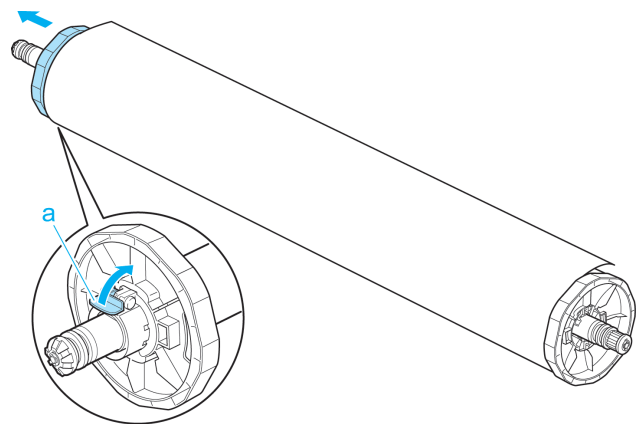

10 Remove the entire paper core with the rewind printed documents from the Rewind Spool.

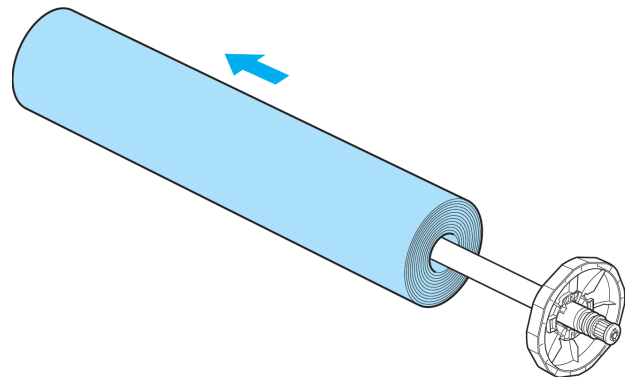

Note

- You can leave the Rewind Spool on the Media Take-up Unit even when it is not used for rewinding rolls.

Media Configuration Tool (Windows)

The Features of Media Configuration Tool	590
Installation Procedures	591
Starting Method	593
Media Configuration Tool Main Window	593
Editing Media Type Information for Genuine Paper and Feed Confirmed Paper	594
Adding Media Types	596
Changing Media Names	598
Deleting Media Types You Have Added	600
Switching Media Types Display Show/Hide	602
Changing the Display Order of Media Types	603
Using Paper Other than Genuine Paper and Feed Confirmed Paper	605
Compatible Paper	606
Add Custom Paper	607
Delete Custom Paper	613
Edit Custom Paper	614
Export Custom Media Information	615
Import Custom Media Information	615
Warnings	617

The Features of Media Configuration Tool

In imagePROGRAF, the best printer settings for each paper are collected together in media information files in order to give the highest quality printing results. Settings for Canon genuine paper and Canon feed confirmed paper are provided by Canon in these media information files.



- Canon genuine paper and Canon feed confirmed paper are detailed in the Paper Reference Guide. Any other paper is called custom paper.

The Media Configuration Tool allows you to perform the following tasks.

- When supported paper has been newly added to the printer, you can add that media type to the printer control panel and printer driver by using the media information file provided by Canon.
- You can customize Canon genuine paper and feed confirmed paper media information files to create a media information file for custom paper (paper that is neither Canon genuine paper or feed confirmed paper), and add that media type to the printer control panel and printer driver. Furthermore, you can also import the created media information file into other computers and printers, and add media types to the printer drivers and printers of the computers where the data was imported.
- You can rearrange lists of the types of paper on the printer control panel and in printer driver dialog boxes and rename them, in addition to other functions.



- Normally, the Media Configuration Tool is installed and the media information is configured when you install the printer driver from the User Software CD-ROM. Use this software if you want to add new media information or edit existing media information.

- Administration of paper information using the Media Configuration Tool should be performed by the printer administrator.

Drivers Applicable with Media Configuration Tool

- imagePROGRAF Printer Driver

Installation Procedures

The Media Configuration Tool installation screen appears when you start the installation of a new version of the Media Configuration Tool. The installation procedure started from this screen is described below.



Important

- If the printer driver is installed from the User Software CD-ROM, the Media Configuration Tool is also installed and the media information is also configured. Therefore, the following procedure does not normally need to be performed. To install the Media Configuration Tool without using the User Software CD-ROM, such as when you have downloaded a new version of the Media Configuration Tool from the Canon website, use the following procedure.
- You must be logged in as Administrator when installing software in Windows.

- 1 Start the Media Configuration Tool installer.
Click the **Next** button.

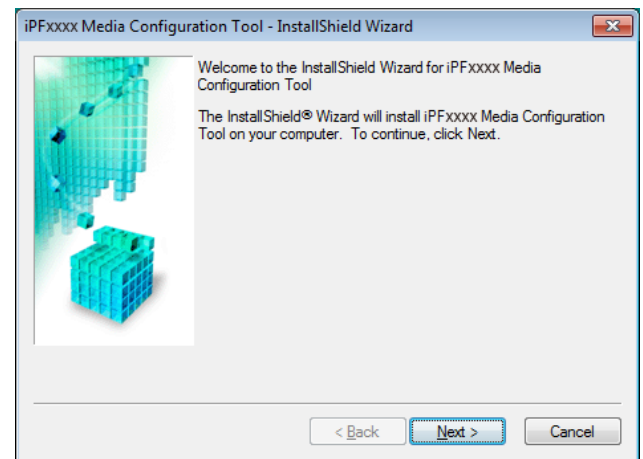

- 2 The next screen presents selections for the country or area where the printer is used.
Select a country or territory then click the **Next** button.

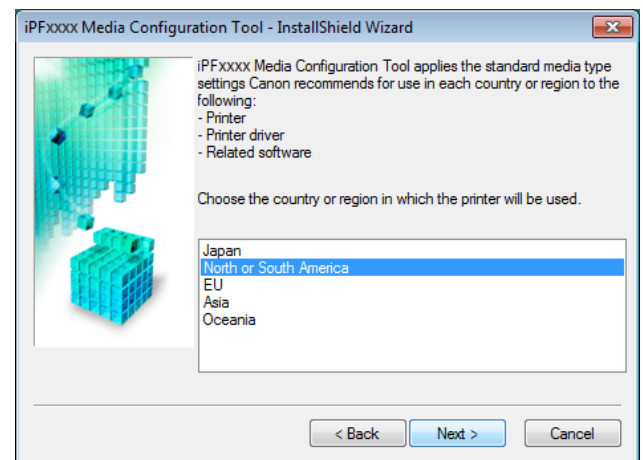

- 3** The **License Agreement** is displayed. Select **I accept the terms of the license agreement** and click the **Next** button.

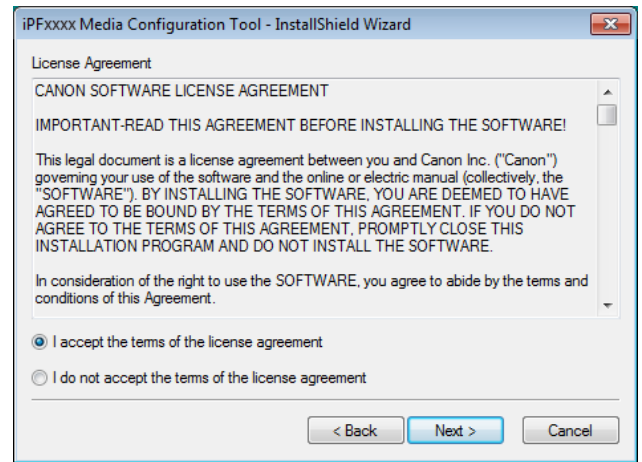

- 4** The **Choose Destination Location** screen appears. Select the destination folder then click the **Next** button.

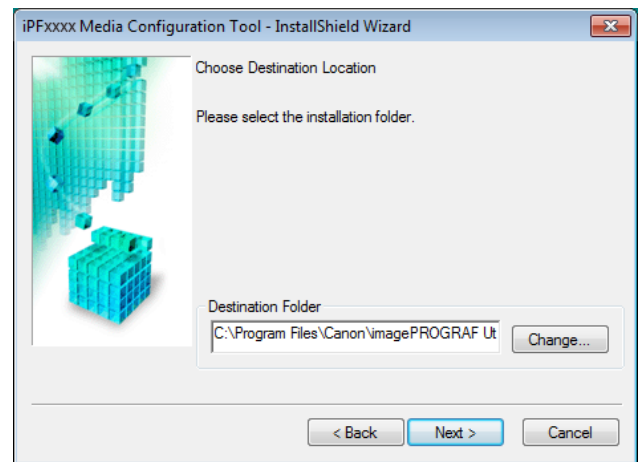

- 5** The **Ready to Install the Program** screen appears. Click the **Install** button.

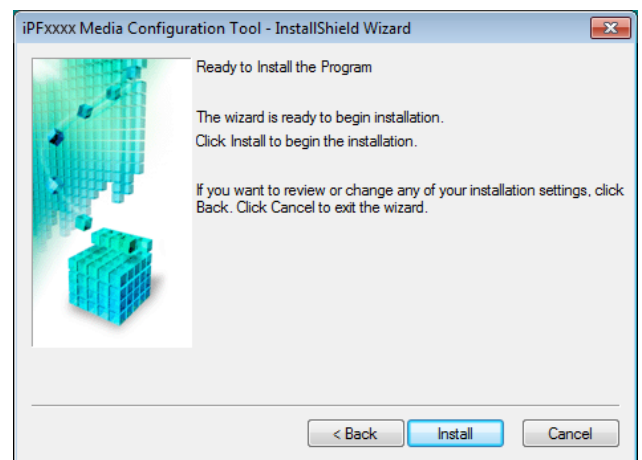

- 6** All the required files are copied to your computer and **InstallShield Wizard Complete** screen appears. Click the **Finish** button.

This completes the installation of Media Configuration Tool.

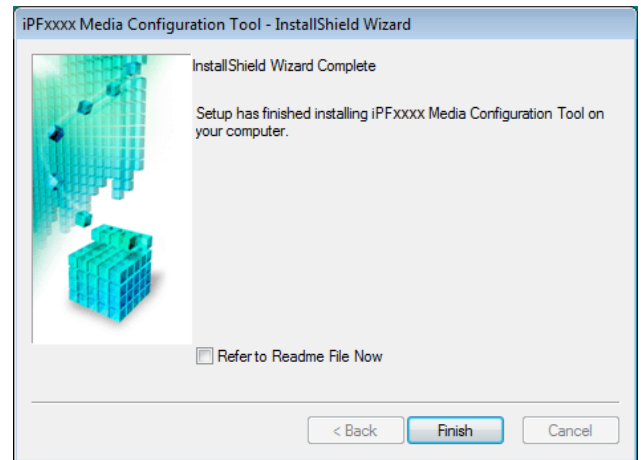

Starting Method

Follow the procedure below to start Media Configuration Tool.

From the **start** menu go to **All Programs > iPFxxxx Media Configuration Tool > iPFxxxx Media Configuration Tool**.

Media Configuration Tool main window is displayed.

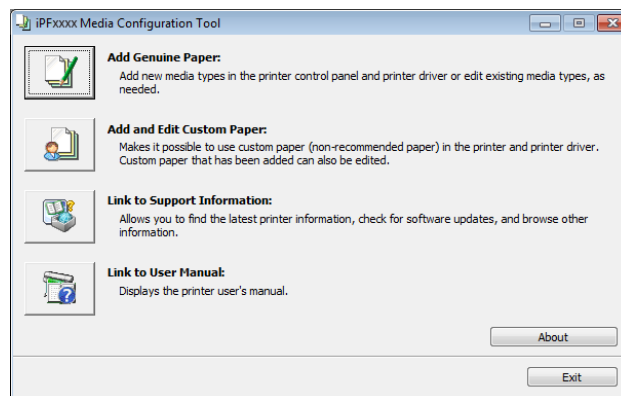

Media Configuration Tool Main Window

The explanation below is on the Media Configuration Tool main window.

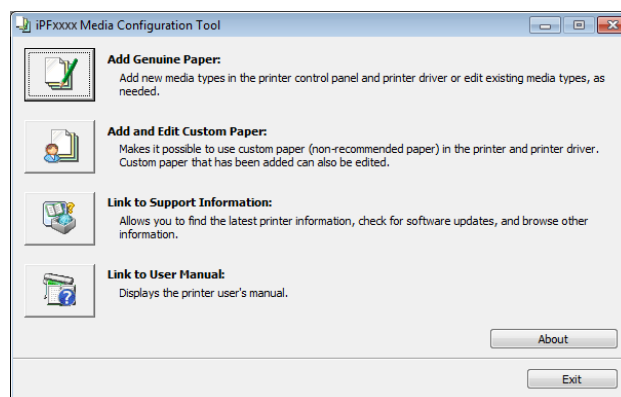

Note

- For the step to open the Media Configuration Tool main window, see "Starting Method." →P.593

- **Add Genuine Paper** button

When this button is clicked, the **Edit Media Types** dialog box is displayed, which allows you to add media information files released by Canon to the printer control panel and printer driver. You can also change names, toggle between displaying and hiding, and delete added media types.

You can also change the display order of Canon genuine paper and custom paper.

Refer to Editing Media Type Information for Genuine Paper and Feed Confirmed Paper →P.594 for details on **Add Genuine Paper**.

- **Add and Edit Custom Paper** button

When this button is clicked, the **Add and Edit Custom Paper** dialog box is displayed, which allows you to added custom paper to the printer control panel and printer driver.

Refer to Using Paper Other than Genuine Paper and Feed Confirmed Paper →P.605 for details on **Add and Edit Custom Paper**.

- **Link to Support Information** button

Opens **imagePROGRAF Support Information**. You can check information such as the latest information for the product and software version upgrade information.

- **Link to User Manual** Button

Click this button to display the User's Guide. This function requires that the User's Guide be installed on your computer.

Editing Media Type Information for Genuine Paper and Feed Confirmed Paper

To add genuine paper and feed confirmed paper to the printer control panel and printer driver and edit the media type information, click the **Add Genuine Paper** button in the Media Configuration Tool main window.

Confirm the printer, where media type information is to be updated, to be displayed in **Printer** in the **Select Printer** dialog box, and then click the **Next** button.

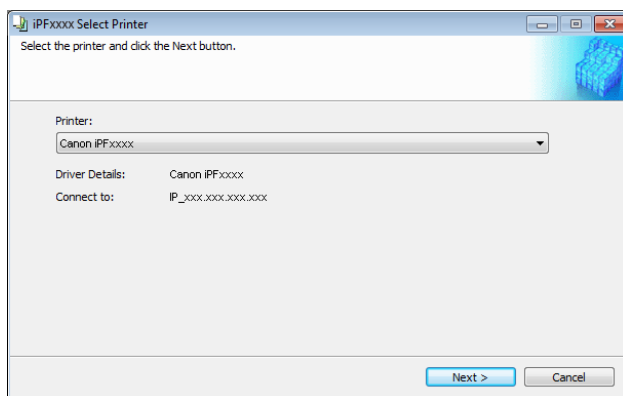

Communication with the printer begins.



- Do not attempt to print or turn the printer off while the program is communicating with the printer.

Important

The **Edit Media Types** dialog box is displayed.



- The printer cannot be changed after this.

Note

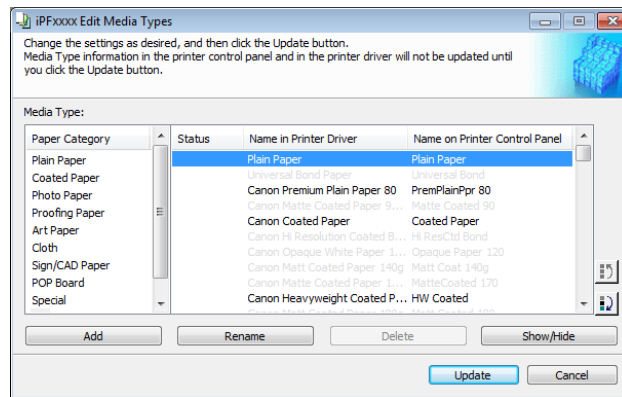

Note

- Paper that is displayed grayed out does not appear in the printer driver or printer panel.

• Add Button

To add genuine paper or feed confirmed paper to the printer control panel and printer driver, click this button. For details on the procedure for adding media types, see "Adding Media Types." →P.596



Important

- To add media types, download the media information file (.amf file) in advance from the Canon website.

• Rename Button

To change the name on the printer control panel and the name in the printer driver for genuine paper and feed confirmed paper, select the paper to change and click this button.

For details on the procedure for changing paper display names, see "Changing Media Names." →P.598

• Delete Button

To delete added genuine paper and feed confirmed paper from the printer control panel and printer driver, select the paper to delete and click this button.

For details on the procedure for deleting added media types, see "Deleting Media Types You Have Added."

→P.600

• Show/Hide Button

To change whether or not genuine paper or feed confirmed paper is displayed in the printer control panel and printer driver, select the paper to change and click this button.

For details on the procedure for changing whether or not to display media types, see "Switching Media Types Display Show/Hide." →P.602

• Change Display Order button (or)

To change the display order of a media type in the printer control panel and printer driver, select the paper to change and click this button.

For details on the procedure for changing the display order of media types, see "Changing the Display Order of Media Types." →P.603



Note

- The display order for custom paper can also be changed.



- When you update the media type information, perform the same update on all of the PCs that are using that printer.



- It may not be possible to deleting, showing/hiding, and changing the display order under some conditions.
- If a display name is displayed grayed out, that media type will not appear in the printer driver or printer panel.

Adding Media Types

Media information files (.amf files) released by Canon are registered in the printer control panel and printer driver.



- Do not perform printing on the target printer while adding the media types.
- Reinstalling Media Configuration Tool after registering a media information file may delete the registered media information file. In this case, first download and install latest Media Configuration Tool, then download and register the required media information file.

1 Open the **Edit Media Types** dialog box, and then click the **Add** button.

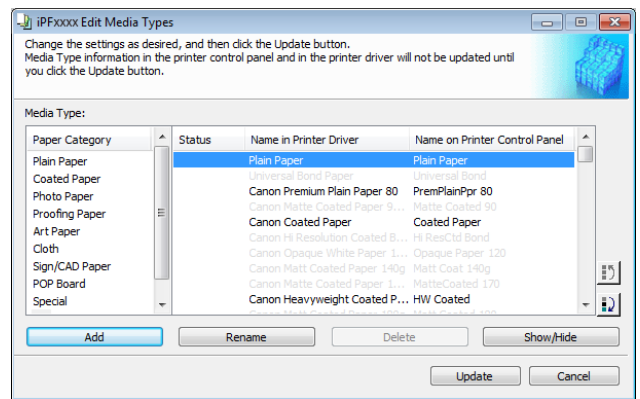

- For details on the procedure for opening the **Edit Media Types** dialog box, see "Editing Media Type Information for Genuine Paper and Feed Confirmed Paper." →P.594

2 The **Add Media Type** dialog box displays. Click the **Browse** button.

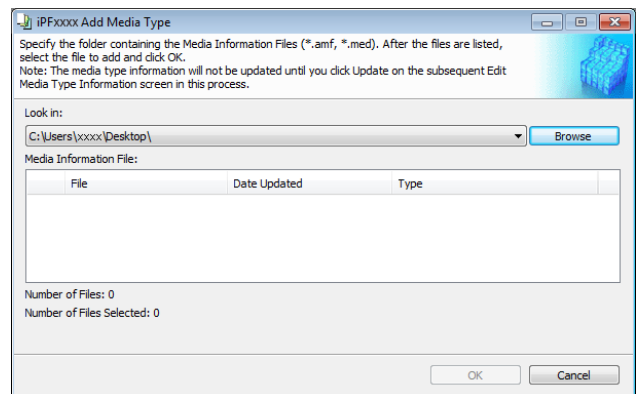

- 3** Open the folder that contains the media information files (.amf files).

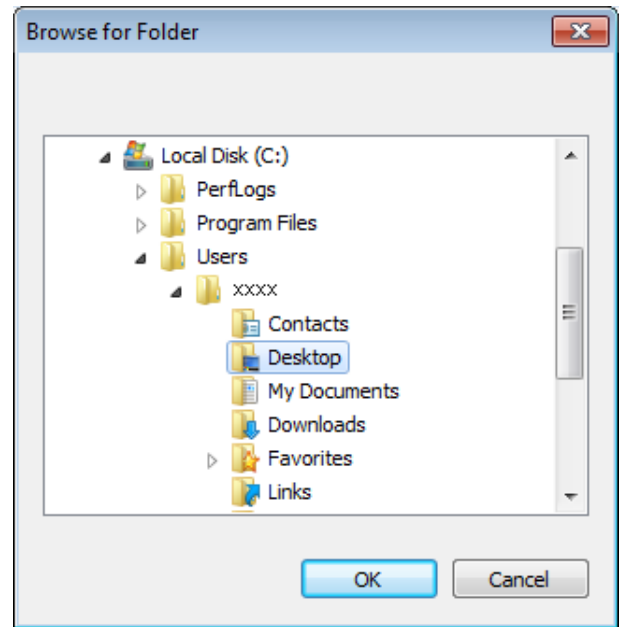

- 4** The names of the media information files contained in the selected folder are displayed in **Media Information File** in the **Add Media Type** dialog box. Select the check box for the paper you want to add and click the **OK** button.

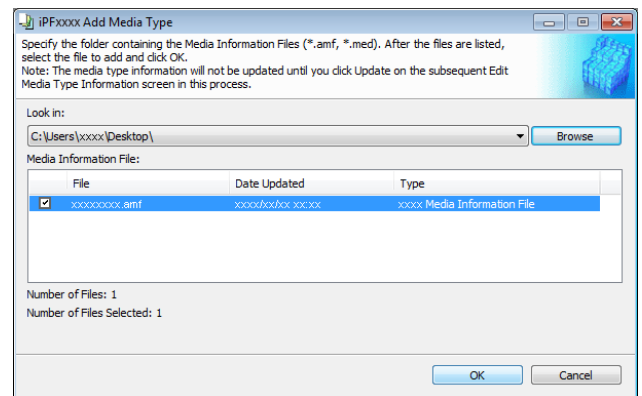

Note

- If **Master Media Information File** is displayed as the **Type** of the **Media Information File**, the media type display order and media type display/non-display settings are initialized. Reconfigure these after added the master media information file.

- 5** Click **OK** when the confirmation message is displayed.

- 6** In the **Edit Media Types** dialog box, click the **Update** button.

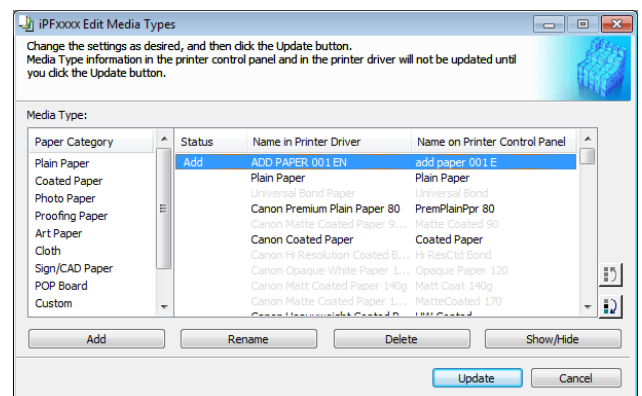

7 The **Confirm Update** dialog box is displayed. Configure Update Target and click the **Execute** button. Communication with the printer begins.

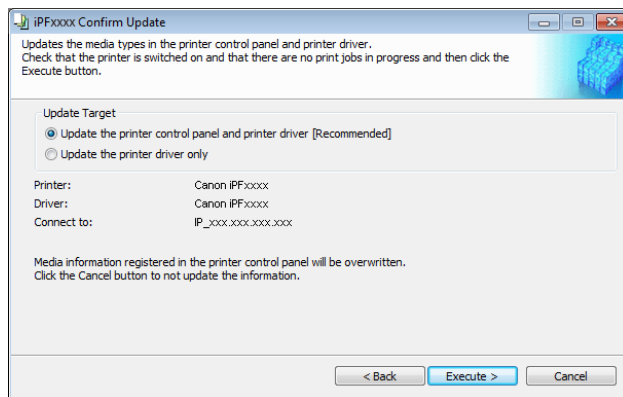

Note

- You should normally select **Update the printer control panel and printer driver**.



Important

- When setting a data to the printer that differs from the data to be updated, the selected media information file is updated. When you would like to remain the data that is set to the printer, click the **Cancel** button.
- Do not attempt to print or turn the printer off while the program is communicating with the printer.

8 Click the **OK** button.

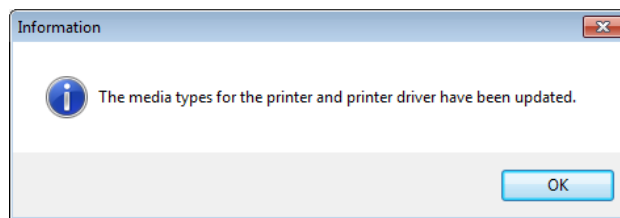

Changing Media Names

1 Open the **Edit Media Types** dialog box.

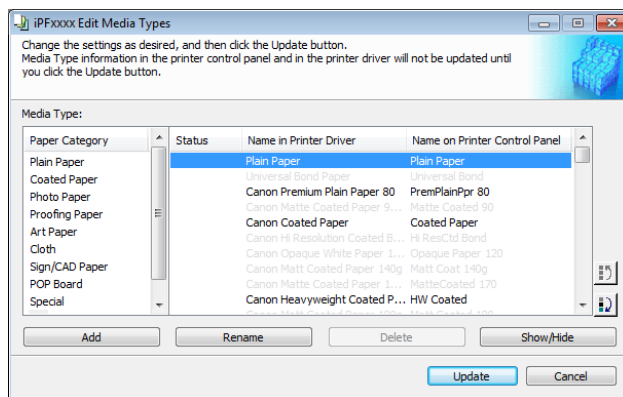

Note

- For details on the procedure for opening the **Edit Media Types** dialog box, see "Editing Media Type Information for Genuine Paper and Feed Confirmed Paper." →P.594

2 In the **Media Type** list, select the name to change. Click the **Rename** button.

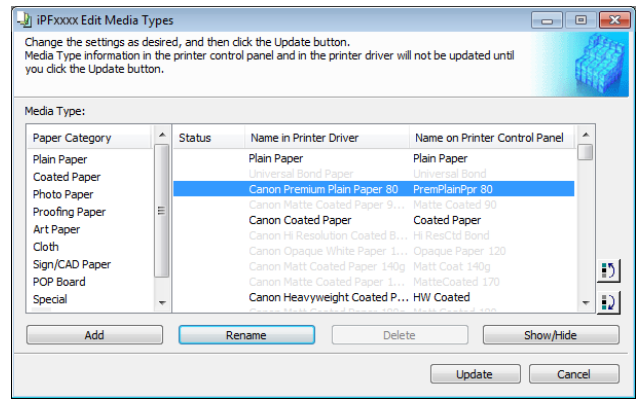

3 The **Rename Media** dialog box is displayed. Edit the names in **Name in Printer Driver** and **Name on Control Panel** and click the **OK** button.

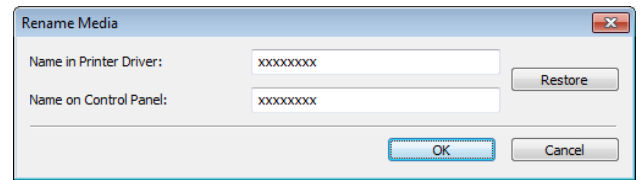

-  To restore the original names, click the **Restore** button.
- Note** • The characters that can be entered for **Name in Printer Driver** and **Name on Control Panel** are stated below.
alphanumeric, space, "-", ".", "_", "()", "+", "%", ";", "/"
- For **Name in Printer Driver** up to 32 one Byte characters can be entered, and for **Name on Control Panel** up to 16 one Byte characters can be entered.

4 In the **Edit Media Types** dialog box, click the **Update** button.

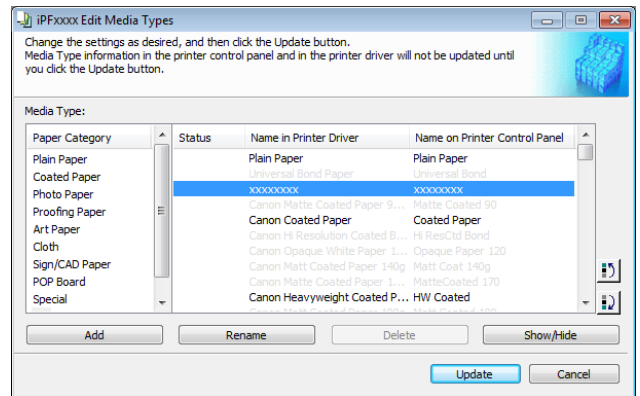

5 The **Confirm Update** dialog box is displayed. Configure **Update Target** and click the **Execute** button. Communication with the printer begins.

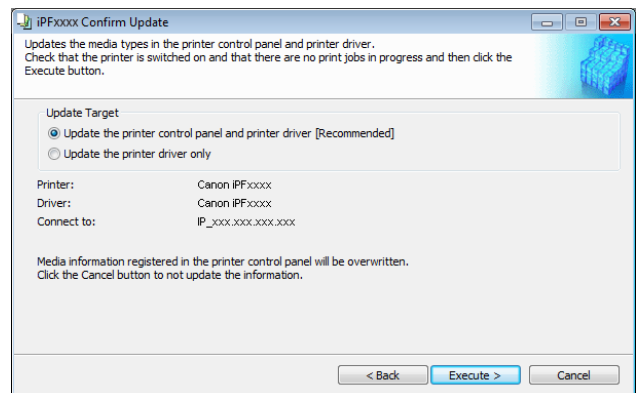



- You should normally select **Update the printer control panel and printer driver.**



- When setting a data to the printer that differs from the data to be updated, the selected media information file is updated. When you would like to remain the data that is set to the printer, click the **Cancel** button.
- Do not attempt to print or turn the printer off while the program is communicating with the printer.

6 Click the **OK** button.

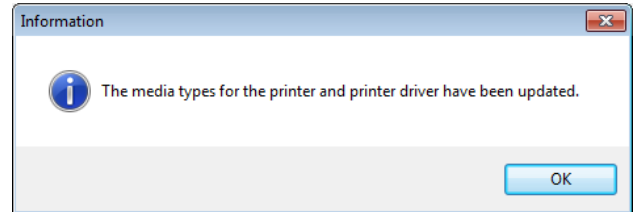

Deleting Media Types You Have Added

1 Open the **Edit Media Types** dialog box.

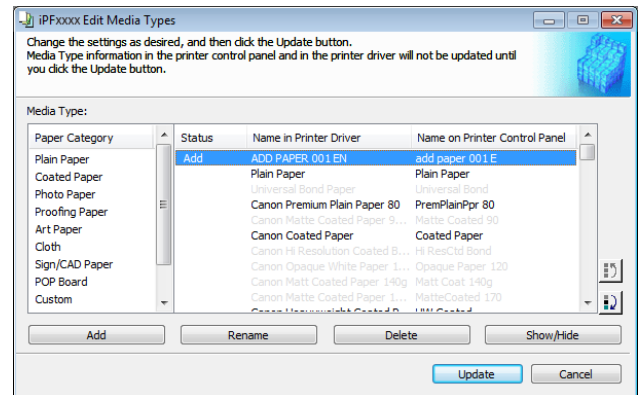

- For details on the procedure for opening the **Edit Media Types** dialog box, see "Editing Media Type Information for Genuine Paper and Feed Confirmed Paper." →P.594

2 In the **Media Type** list, select the name of the media to delete.
Click the **Delete** button.

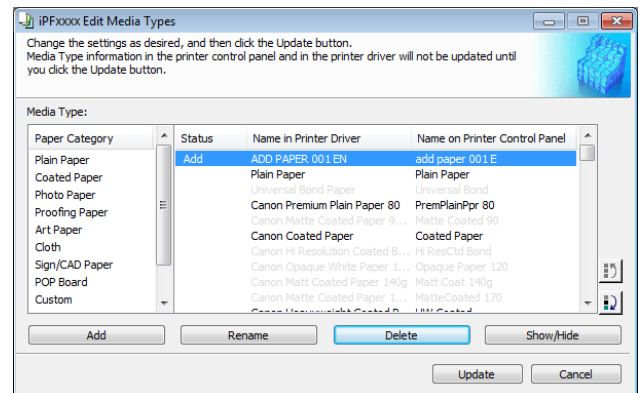

- Only paper for which **Status** in the **Media Type** is **Add** can be deleted.

- 3** In the **Edit Media Types** dialog box, click the **Update** button.

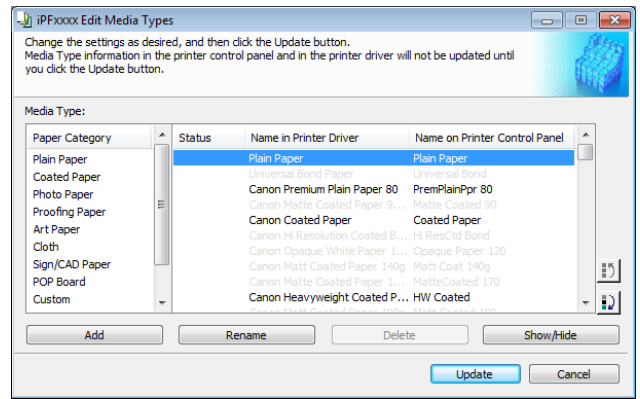

- 4** The **Confirm Update** dialog box is displayed. Click the **Execute** button. Communication with the printer begins.

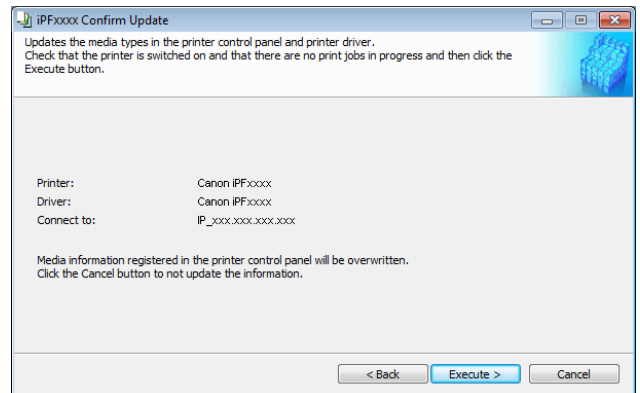

Important

- When setting a data to the printer that differs from the data to be updated, the selected media information file is updated. When you would like to remain the data that is set to the printer, click the **Cancel** button.
- Do not attempt to print or turn the printer off while the program is communicating with the printer.

- 5** Click the **OK** button.

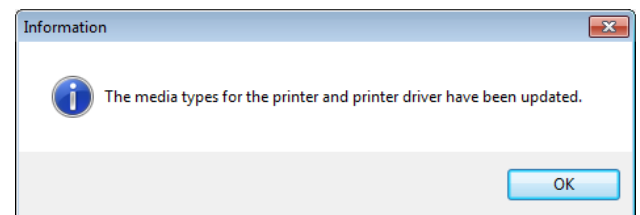

Switching Media Types Display Show/Hide

1 Open the **Edit Media Types** dialog box.

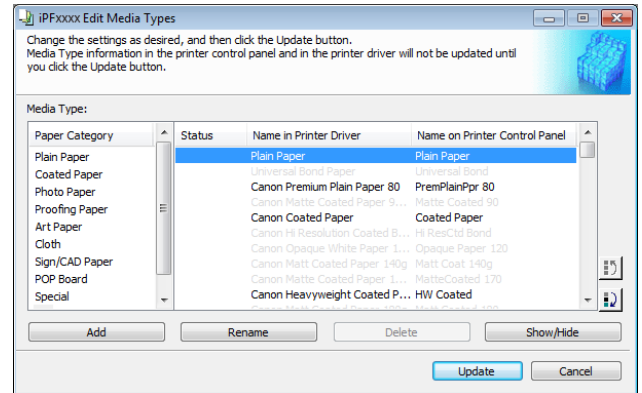

Note

- For details on the procedure for opening the **Edit Media Types** dialog box, see "Editing Media Type Information for Genuine Paper and Feed Confirmed Paper." →P.594

2 In the **Media Type** list, select the name of the media to switch off or on for display. Click the **Show/Hide** button. The selected paper is alternately shown or hidden.

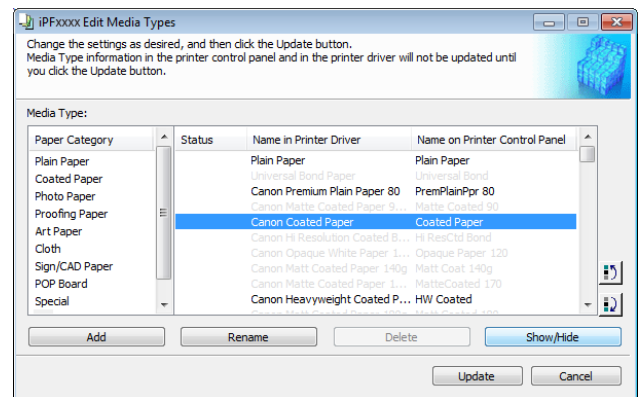

Note

- You can select multiple paper.
- The names of media switched for non-display appear grayed out in the **Media Type** list.
- Each time you click the **Show/Hide** button, the display mode cycles from showing both the printer driver and printer panel, to hiding both the printer driver and printer panel, and then to showing only the printer panel.

3 In the **Edit Media Types** dialog box, click the **Update** button.

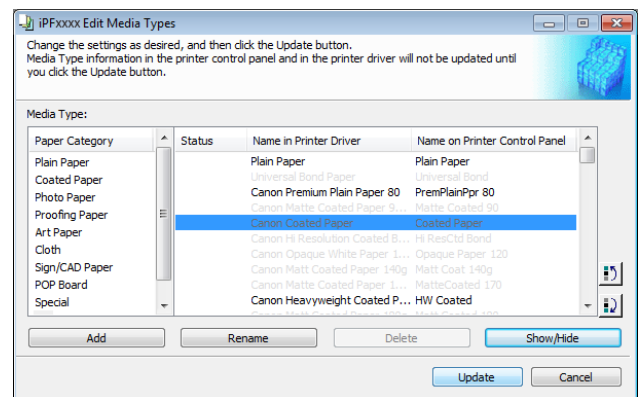

- 4** The **Confirm Update** dialog box is displayed. Configure Update Target and click the **Execute** button. Communication with the printer begins.

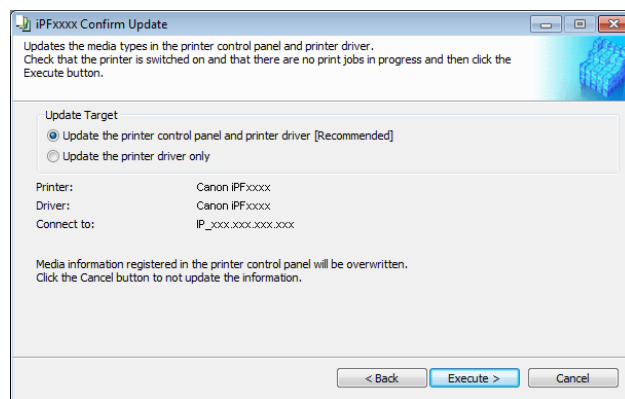

Note

- You should normally select **Update the printer control panel and printer driver**.



Important

- When setting a data to the printer that differs from the data to be updated, the selected media information file is updated. When you would like to remain the data that is set to the printer, click the **Cancel** button.
- Do not attempt to print or turn the printer off while the program is communicating with the printer.

- 5** Click the **OK** button.

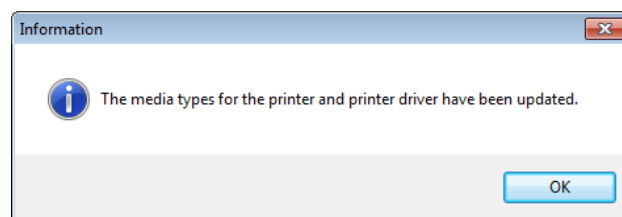

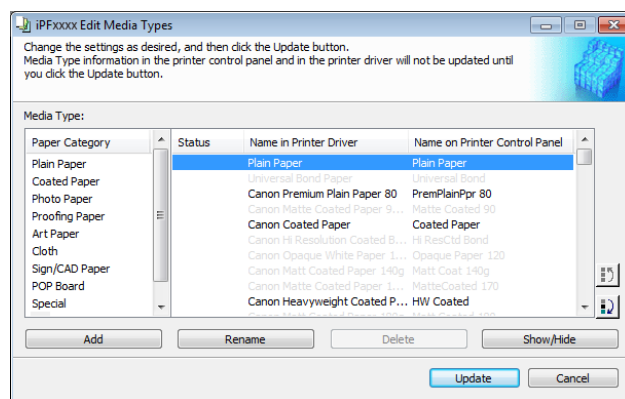

Changing the Display Order of Media Types

- 1** Open the **Edit Media Types** dialog box.



Note

- For details on the procedure for opening the **Edit Media Types** dialog box, see "Editing Media Type Information for Genuine Paper and Feed Confirmed Paper." →P.594

2 Select the paper in the **Media Type** list for which to change the display order, and then click the buttons to move the item ( or ).
The selected item moves one line up or down for every button click.

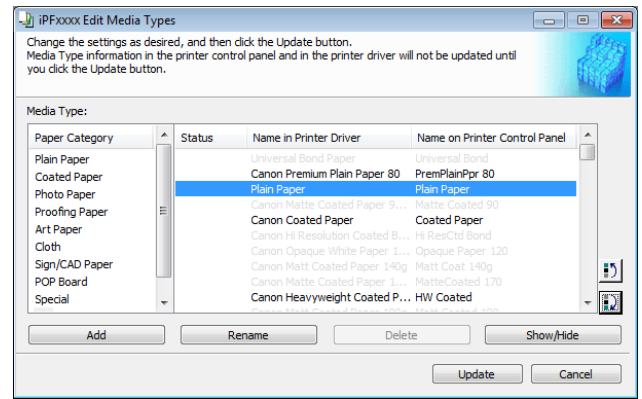

3 In the **Edit Media Types** dialog box, click the **Update** button.

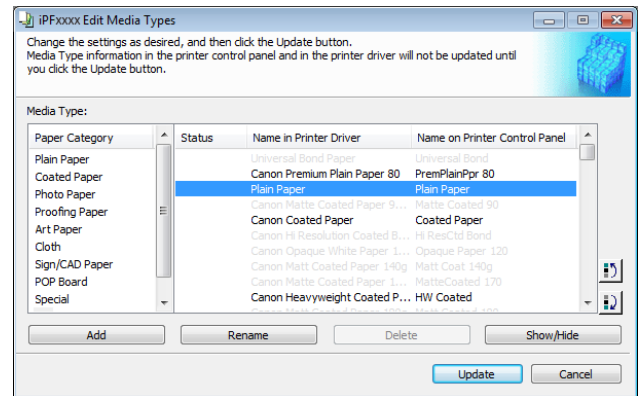

4 The **Confirm Update** dialog box is displayed. Configure Update Target and click the **Execute** button. Communication with the printer begins.

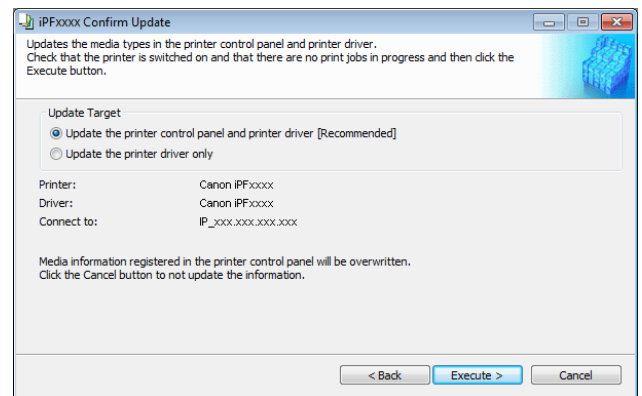

- You should normally select **Update the printer control panel and printer driver**.



- When setting a data to the printer that differs from the data to be updated, the selected media information file is updated. When you would like to remain the data that is set to the printer, click the **Cancel** button.
- Do not attempt to print or turn the printer off while the program is communicating with the printer.

- 5** Click the **OK** button.

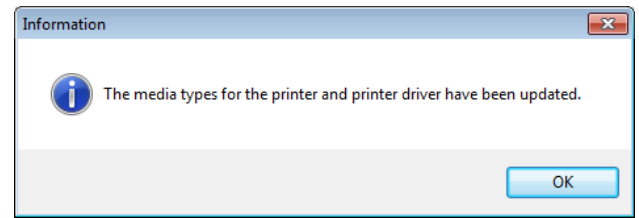

Using Paper Other than Genuine Paper and Feed Confirmed Paper

To add paper other than Canon genuine paper and feed confirmed paper to the printer control panel and printer driver, and export and import the media information file for that paper, click the **Add and Edit Custom Paper** button in the Media Configuration Tool main window.

Confirm the printer, where media type information is to be updated, to be displayed in **Printer** in the **Select Printer** dialog box, and then click the **Next** button.

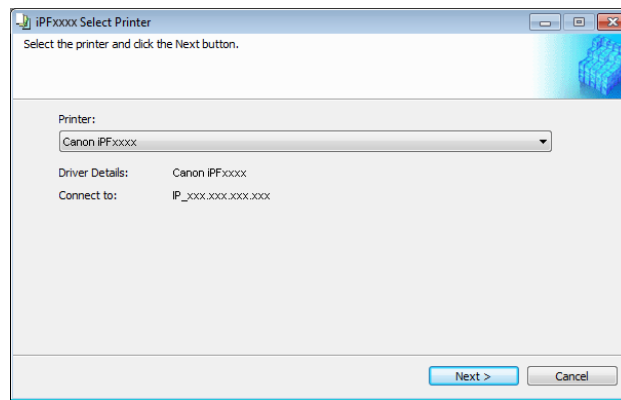

Communication with the printer begins.
The **Add and Edit Custom Paper** dialog box is displayed.

-  The printer cannot be changed after this.
- Note** Custom paper is paper other than Canon genuine paper and feed confirmed paper (paper that is detailed in the Paper Reference Guide).

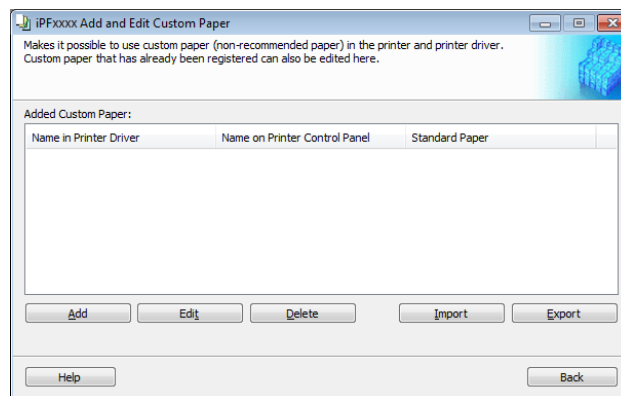

• Added Custom Paper

Added custom paper is displayed here.

- **Name in Printer Driver**
Added custom paper is displayed in the printer driver using this name.
- **Name on Printer Control Panel**

Added custom paper is displayed on the printer control panel using this name.

- **Standard Paper**

Displays the paper selected as the standard paper when the custom paper was added.

- **Add Button**

To add new custom paper to the printer control panel and printer driver, click this button.

For details on the procedure for adding custom paper, see "Add Custom Paper." →P.607

- **Edit Button**

To change the settings of added custom paper, select the paper to edit and click this button.

For details on the procedure for changing custom paper settings, see "Edit Custom Paper." →P.614

- **Delete Button**

To delete added custom paper from the printer control panel and printer driver in your computer, select the paper to delete and click this button.

For details on the procedure for deleting custom paper, see "Delete Custom Paper." →P.613

- **Import Button**

To add custom paper to the printer control panel and printer driver by importing a Custom Media Information File saved in a folder, click this button.

For details on the procedure for importing a Custom Media Information File, see "Import Custom Media Information." →P.615

- **Export Button**

To export media information for added custom paper to a file, select the paper to export and click this button.

For details on the procedure for exporting media information for custom paper, see "Export Custom Media Information." →P.615



Important

- When adding or editing custom paper, make the same changes on all of the other PCs that use the target printer. The changes can be made easily by creating a Custom Media Information File (.am1 file) using the custom paper export function and importing the file on the other PCs.
- When deleting custom paper, make the same changes on all of the other PCs that use the target printer.
- When using custom paper in another printer, always add the custom paper to that printer before use.



Note

- Canon genuine paper and feed confirmed paper cannot be changed from this dialog box. Refer to "Editing Media Type Information for Genuine Paper and Feed Confirmed Paper" →P.594 .
- Changing the display order of media types displayed in the printer control panel and printer driver is performed from the **Edit Media Types** dialog box regardless of whether it is Canon genuine paper or custom paper. Refer to "Editing Media Type Information for Genuine Paper and Feed Confirmed Paper" →P.594 .

Compatible Paper

Paper specifications

Refer to "Specifications" and "Paper" for specifications such as thickness and size of paper that can be added as custom paper (See "Specifications.") →P.942

Notes on the operating environment

In low humidity environments (below 40%), your printer may develop the following problems.

- Paper becomes curled or wrinkled.
- Paper and the printhead are more likely to touch each other, resulting in a scratched print surface or damaged printhead.
- The cut printed matter sticks to the printer and will not fall down (film media).
- Paper sticks to the printer, making its transfer impossible and preventing its normal ejection (film media).

- Uneven printing (film media)

In high humidity environments (over 60%), your printer may develop the following problems.

- Printed matter will not dry.
- Wavy paper surface
- Cut edges are ragged (fabric media).
- Margins remain due to borderless printing.



- Canon offers absolutely no guarantees regarding the print quality or paper feed properties of customer paper (paper that is not Canon genuine paper or Canon feed confirmed paper).

Add Custom Paper

In order to add new custom paper to the printer control panel and printer driver, first select the media type to use as the basis from among the Canon genuine paper and feed confirmed paper.. Add this as custom paper after making various changes to the standard paper as necessary.



Important

- Canon offers absolutely no guarantees regarding the print quality or paper feed properties of customer paper.
- For Canon genuine paper and Canon feed confirmed paper, print using the media type as recommended in the Paper Reference Guide. The print quality and feed properties are not guaranteed if you use Add Custom Paper in the Media Configuration Tool.
- Do not execute printing on the target printer while adding custom paper.
- When adding custom paper, check the specifications of paper that can be added using "Compatible Paper" →P.606 .
- Custom paper added using the add custom paper function can only be used by the printer driver. It cannot be used by other software.

- 1 Open the **Add and Edit Custom Paper** dialog box.



Note

- For details on the procedure for opening the **Add and Edit Custom Paper** dialog box, see "Using Paper Other than Genuine Paper and Feed Confirmed Paper." →P.605

- 2 Click the **Add** button.

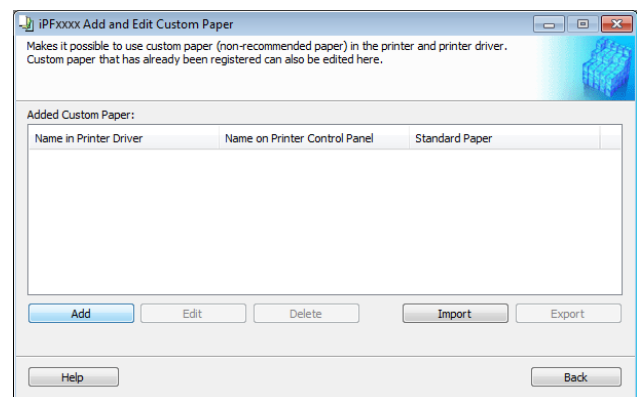

- 3 The **Step 1: Select the standard paper** dialog box is displayed. In **Paper Category**, select the category of media type to use as the basis of the custom paper you are adding.



Important

- Select the category that you think is the closest to the custom paper you are adding.

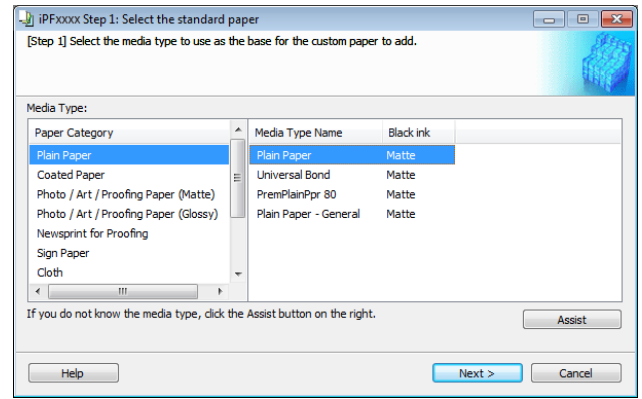

- 4** The media type names of the Canon genuine paper and feed confirmed paper within the selected category are shown in **Media Type Name**. Select the media type to use as the basis of the custom paper, and click the **Next** button.



Note

- If you do not know which media type to use as the basis of the custom paper, click the **Assist** button to open the **Media Type Selection Assistance** dialog box, and then set either the **Weight (grammage)** or the **Thickness**. The Media Configuration Tool automatically selects the appropriate paper from the selected paper category. Alternatively, select the media type called **General** from among the displayed **Media Type Name**.
- Depending on the selected category, there might not be a media type called **General**.
- Depending on the selected category, the **Assist** button may be disabled.

- 5** The **Step 2: Set the custom paper name** dialog box is displayed. Enter an arbitrary name to display in the printer control panel and printer driver, and then click the **Next** button.

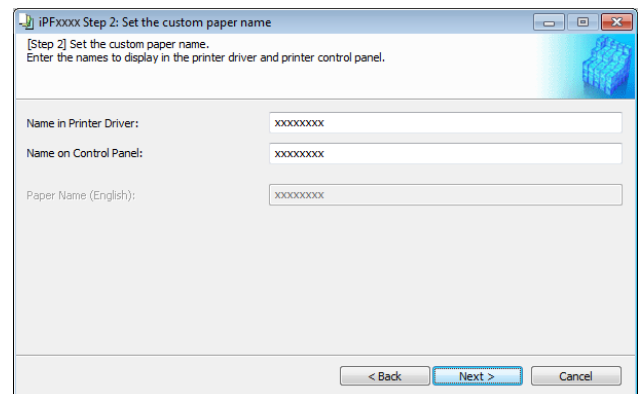

Note

- The characters that can be entered for **Name in Printer Driver** and **Name on Control Panel** are stated below.
alphanumeric, space, "-", ".", "_", "()", "+", "%", ",", "/"
- For **Name in Printer Driver** up to 32 one Byte characters can be entered, and for **Name on Control Panel** up to 16 one Byte characters can be entered.
- **Paper Name (English)** is used in keeping track of the amount of roll paper left, in status print, etc.

- 6** Load the custom paper in the printer and then click the **OK** button.

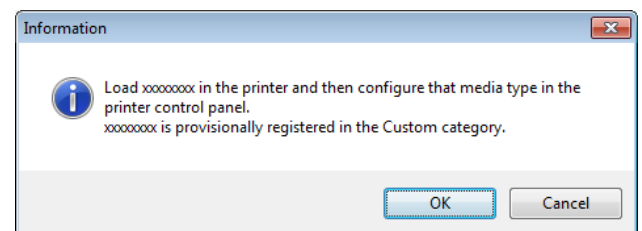



- Do not load paper that is curled or that has already been printed on.

7

The **Step 3: Paper Source Settings** dialog box is displayed. Select the paper source where the custom paper is loaded and then click the **OK** button.

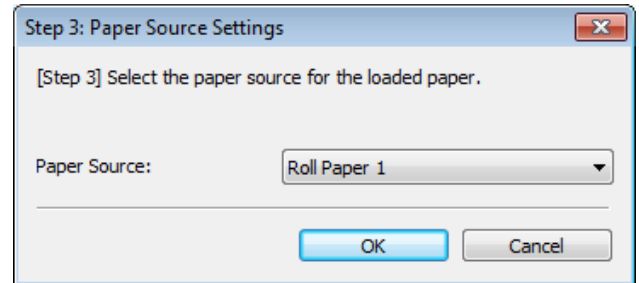

8

The **Step 4: Paper feed adjustment** dialog box is displayed. Click the **Execute** button to execute paper feed adjustment.

The adjustment pattern is printed, and the paper feed is automatically adjusted based on the printing result. Once the paper feed adjustment is complete, click the **Next** button.

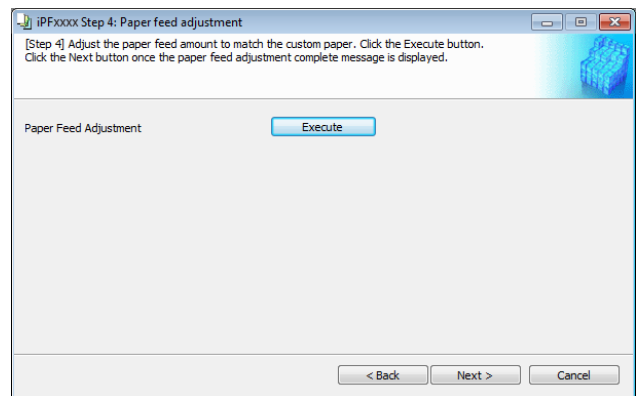

- Check that there is no paper left on the ejection guide.
- If **Paper Feed Adjustment** is not executed, horizontal stripes with different color tones may appear in the printed material. Paper feed adjustment does not need to be executed more than once. Execute paper feed adjustment only once each time you add a custom paper.

9

The **Roll Paper Settings** dialog box is displayed.



- If a paper source other than **Roll Paper** is selected in the **Step 3: Paper Source Settings** dialog box, this screen is not displayed.

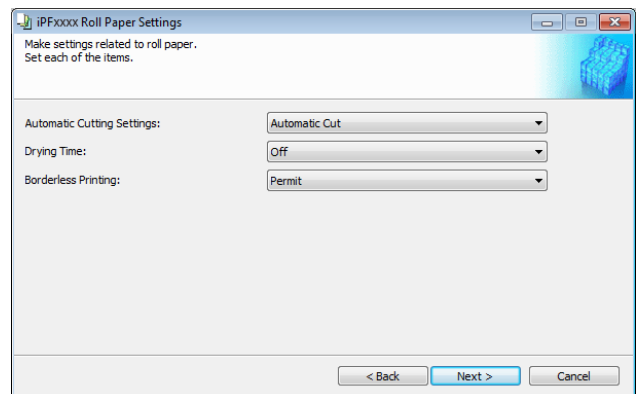

Configure the following settings as necessary, and then click the **Next** button.

Setting	Details
Automatic Cutting Settings	Configures the method for cutting roll paper when it is ejected after printing.

Setting	Details
Automatic Cutting Settings	<ul style="list-style-type: none"> • Automatic Cut :Roll paper is automatically cut by the cutter unit. • Eject Cut :When the Cut key is pressed on the printer control panel, the roll paper is cut by the cutter unit. Select this if you do not want the printed material to drop immediately after printing, such as to wait for the ink to dry. • User Cut :Cutting is not performed by the cutter unit. Cut the roll paper using scissors after each sheet. Select this for paper that cannot be cut by the cutter unit.
Drying Time	<p>Specify the time that the printer waits for ink to dry, as needed.</p> <ul style="list-style-type: none"> • Off :Ejects immediately after printing finishes. • 30 sec./1 min./3 min./5 min./10 min./30 min./60 min. :Ejects after the specified time has elapsed after printing finishes.
Borderless Printing	<p>Configures whether or not to permit borderless printing.</p> <ul style="list-style-type: none"> • Permit : Borderless printing is permitted. • Deny : Borderless printing is denied.



Important

- Depending on the paper, there are types that cannot be cut by the cutter unit, and types that speed deterioration of the blade and cause damage to the cutter. For thick paper, hard paper, etc. do not use the cutter unit, and instead cut the roll paper using scissors, etc. after printing. In this case, select **User Cut** as the **Automatic Cutting Settings**.
- If borderless printing is performed on paper where the ink drying is poor, the cutter unit may leave scratches where it touches the printed surface, or may not cut correctly. In this kind of situation, configure the amount of time to wait for the ink to dry after printing using **Drying Time**. Alternatively, if the paper cannot be cut well by the cutter, set the **Automatic Cutting Settings** to **User Cut** and cut the roll paper using scissors, etc.
- Paper where borderless printing can be performed is limited by the media type and roll paper width. Refer to "Compatible Paper" →P.606 .
- For custom paper where there is a need to set the **Automatic Cutting Settings** to **User Cut**, set the **Borderless Printing** to **Deny**.

10

The **Step 5: Configure the amount of ink used** dialog box is displayed. The upper limit on the amount of ink used to print to the custom paper is set on this screen by selecting from among several levels. First, click the **Test Print** button to perform a test print of each level.

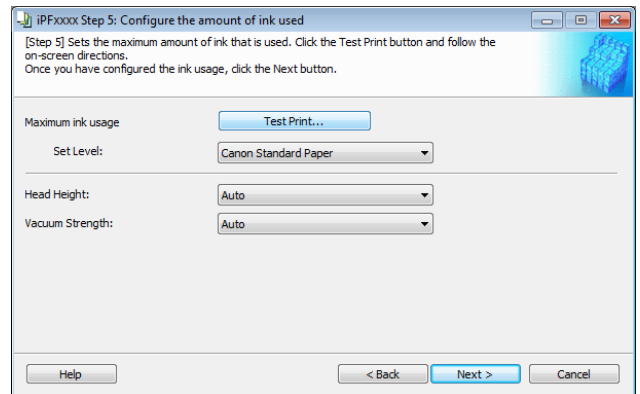

Note

- If a standard paper that does not display the **Name in Printer Driver** is selected in the screen in Step 5, you cannot perform test prints or configure the maximum amount of ink to use.

- 11** The **Test Print Settings** dialog box is displayed. Select the print priority and print quality of the test print using **Print Priority** and **Print Quality**. Set the level to test print using **Maximum ink usage** and the image to use using **Image used in test print**, and then click the **Start Print** button.

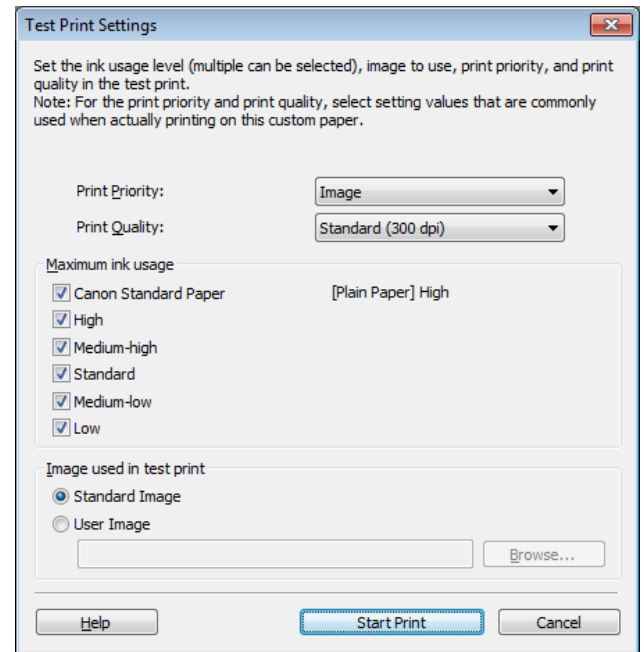

- 12** Determine and set the ink level that is thought to give the best visual test print results with no bleeding or scraping of ink.

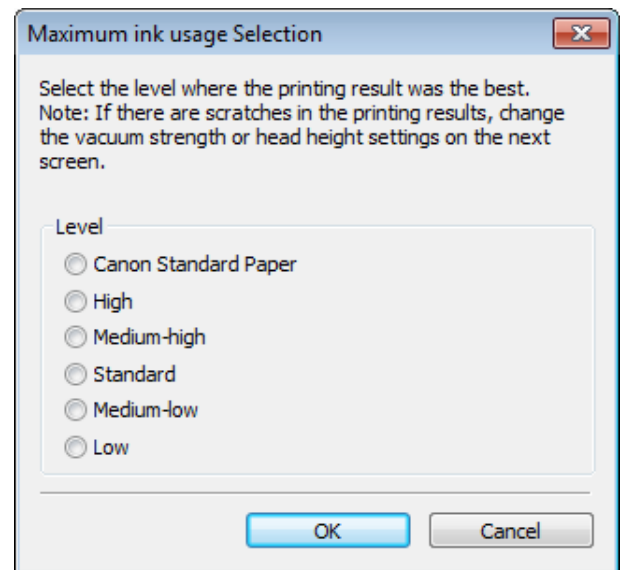



- Select the optimal ink level by referring to the help.
- Note**
- If you cannot obtain sufficiently high quality printing no matter which maximum ink usage level you select, use the **Step 1: Select the standard paper** dialog box to change the paper that is the basis of the custom paper to another paper.
 - Because this settings imposes an upper limit on the amount of ink used during printing, the printing result might not change even if the level is changed depending on the image.
 - The color tone cannot be configured using the Media Configuration Tool. Although the color tone may change when the maximum ink usage is changed, at this point you should select the optimal level by only focusing on bleeding and scraping of ink. If the color tone needs to be adjusted, provide an ICC color profile that matches the paper you are using, and select that ICC color profile in your software. For details on how to specify the ICC profile in the printer driver, see "Matching Sheet." →P.196
 - Depending on the maximum ink usage setting, some of the print qualities in the printer driver may become unselectable.

13

Configure **Head Height** and **Vacuum Strength** as required and click the **Next** button. Usually, these do not need to be set.

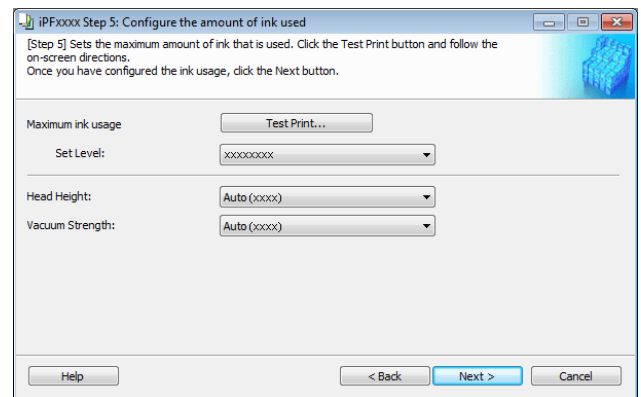

Important

- If you set the **Head Height** lower than the automatically set height in parentheses (), check that the printhead does not rub against the paper. (If the printhead rubs against the paper, there will be scratches in the printing results.) If the printhead rubs against the paper, this can cause damage to the printhead.
- If you change the **Vacuum Strength**, check that the printhead is not rubbing against the paper. (If the printhead rubs against the paper, there will be scratches in the printing results.) If the printhead rubs against the paper, this can cause damage to the printhead.
- For details on the **Head Height** and **Vacuum Strength**, refer to the help.

14

The **Step 6: Confirm the settings** dialog box is displayed. Configure the settings of the custom paper, and then click the **Next** button.

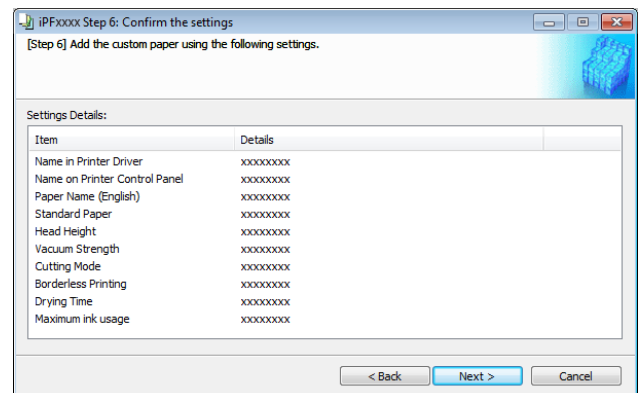

- 15** The **Confirm Update** dialog box is displayed. Confirm the updates and then click the **Execute** button.

The custom paper is added to the control panel of the printer and to the printer driver of the PC you are using.

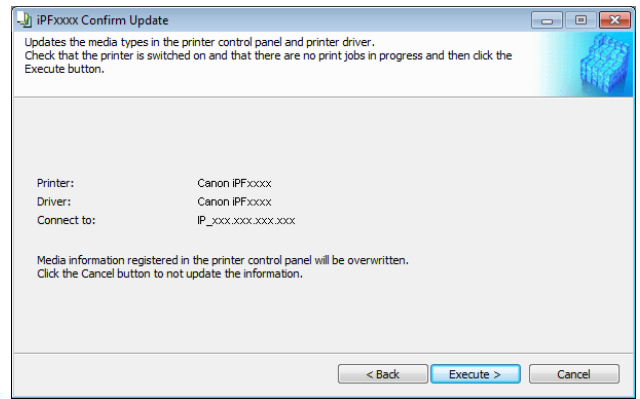

Important

- If you have added custom paper with the **POP Board / Cardboard** category as the Standard Paper, remove the loaded custom paper from the printer.



Note

- When the custom paper is correctly added to the printer driver, the name of the added custom paper is displayed in the **Edit Media Types** dialog box that is opened by **Add Genuine Paper** in the Media Configuration Tool window.

Delete Custom Paper

You can delete custom paper that you have already added from printer control panel and from the printer driver of the PC you are using.

- 1** Open the **Add and Edit Custom Paper** dialog box.



Note

- For details on the procedure for opening the **Add and Edit Custom Paper** dialog box, see "Using Paper Other than Genuine Paper and Feed Confirmed Paper." →P.605

- 2** Select the paper you want to delete from the **Added Custom Paper** list and then click the **Delete** button.

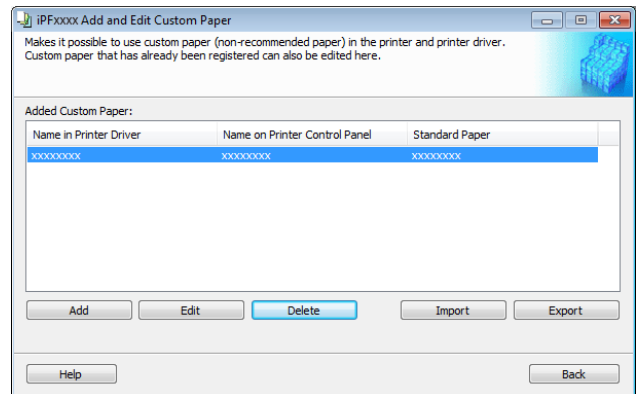

Note

- You can select multiple paper.

- The **Confirm Update** dialog box is displayed. Confirm the updates and then click the **Execute** button.

The custom paper is deleted from the control panel of the printer and from the printer driver of the PC you are using.

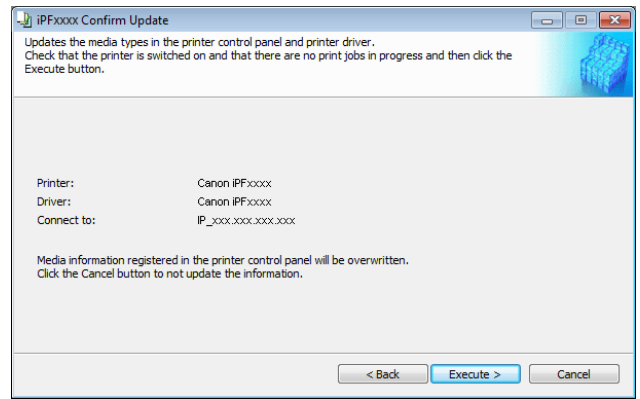

Edit Custom Paper

You can change the settings of custom paper you have already added.

- Open the **Add and Edit Custom Paper** dialog box.



Note

- For details on the procedure for opening the **Add and Edit Custom Paper** dialog box, see "Using Paper Other than Genuine Paper and Feed Confirmed Paper." →P.605

- Select the paper you want to edit from the **Added Custom Paper** list and then click the **Edit** button.

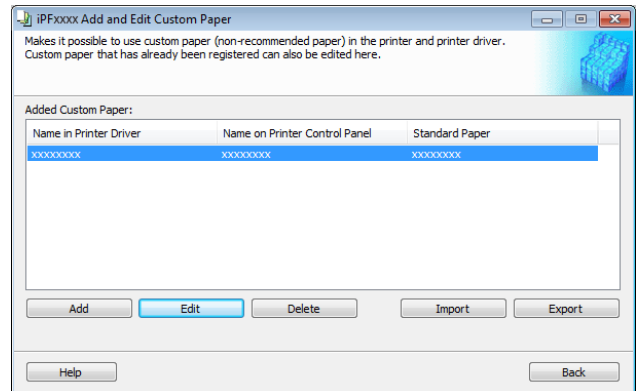

- The **View Settings** dialog box is displayed.

Follow the on-screen directions and change the settings as required.

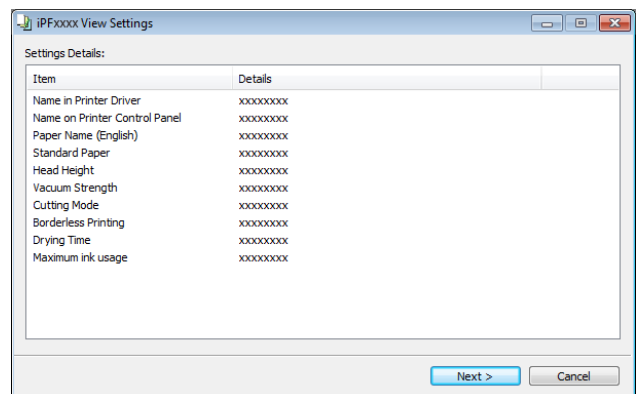

Note

- Refer to Steps 5 to 15 of the "Add Custom Paper" →P.607 for details on how to configure each setting.

Export Custom Media Information

You can export to file and save media information about custom paper that you have added. The saved Custom Media Information File can be used by importing it into another printer or PC. Refer to "Import Custom Media Information" →P.615 for details on "importing custom media information".

1 Open the **Add and Edit Custom Paper** dialog box.



Note

- For details on the procedure for opening the **Add and Edit Custom Paper** dialog box, see "Using Paper Other than Genuine Paper and Feed Confirmed Paper." →P.605

2 Select the paper you want to export to media information file from the **Added Custom Paper** list and then click the **Export** button.

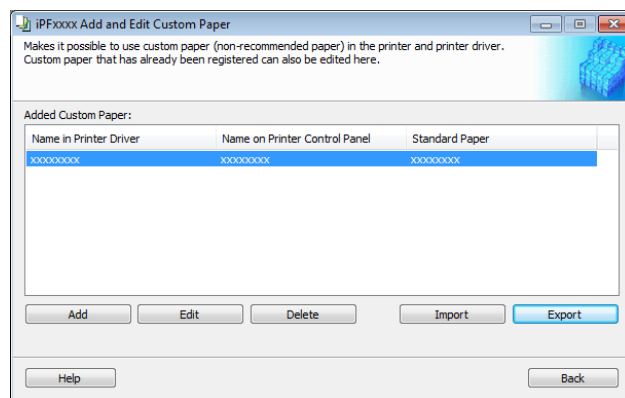

Note

- You can select multiple paper.

3 Specify the location to save the Custom Media Information File.

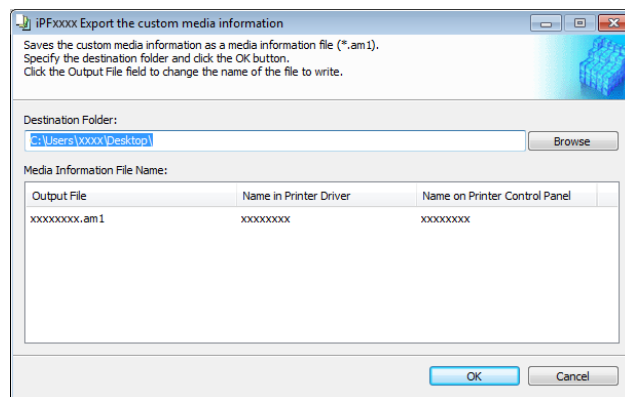

Note

- You can change the file name by selecting and editing the File. A Custom Media Information File (.am1 file) is saved.

Import Custom Media Information

You can import a Custom Media Information File that has been saved in a folder, and add the file to the printer control panel and to the printer driver of the PC you are using.

1 Open the **Add and Edit Custom Paper** dialog box.



Note

- For details on the procedure for opening the **Add and Edit Custom Paper** dialog box, see "Using Paper Other than Genuine Paper and Feed Confirmed Paper." →P.605

2 Click the **Import** button.

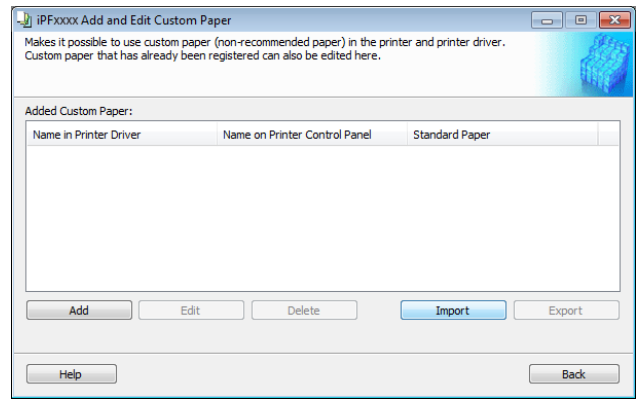

3 Select the Custom Media Information File (.am1 file) to import.

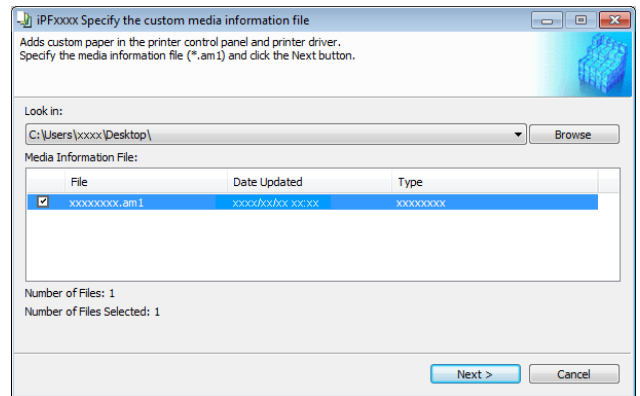

4 The **Confirm Update** dialog box opens. Click the **Execute** button.

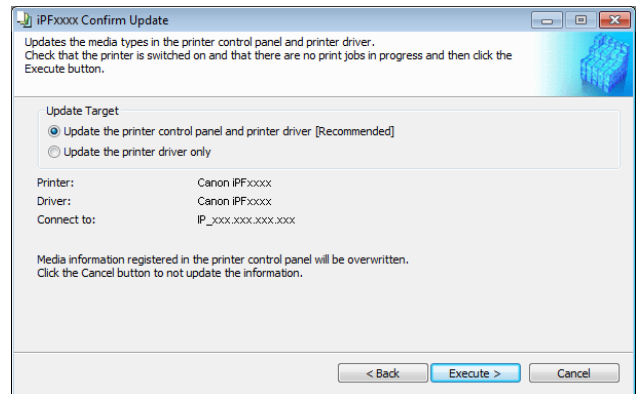

Note

- You should normally select **Update the printer control panel and printer driver**. The custom paper is added to the control panel of the printer and to the printer driver of the PC you are using.
- When the custom paper is correctly added to the printer driver, the name of the added custom paper is displayed in the **Edit Media Types** dialog box that is opened by **Add Genuine Paper** in the Media Configuration Tool window.

Warnings

Take note of the following warnings when added custom paper other than Canon genuine paper and feed confirmed paper to the printer driver and the printer itself.

About the Cutter

- Depending on the paper, there are types that cannot be cut by the cutter unit, and types that speed deterioration of the blade and cause damage to the cutter. For thick paper, hard paper, etc. do not use the cutter unit, and instead cut the roll paper using scissors, etc. after printing. In this case, select **User Cut** as the **Automatic Cutting Settings** in the **Roll Paper Settings** dialog box.



If the cutter is damaged, contact your Canon dealer for assistance.

Note For details on the methods for cutting roll paper, see "Specifying the Cutting Method for Rolls." →P.554

About the Printhead

- If the printhead rubs against the paper during printing, this may cause damage to the printhead. If the printhead is rubbing against the paper, configure the **Vacuum Strength** in the **Step 5: Configure the amount of ink used** dialog box as follows.
 - For paper-based media such as Heavyweight Coated Paper: Set to **Strong** or **Strongest**
 - For film-based media such as CAD Tracing Paper: Set to **Standard**, **Strong**, or **Strongest**
 - For thin paper of thickness 0.1mm or less: Set to **Weakest**



If the printhead still rubs even after changing the **Vacuum Strength**, set the **Head Height** to be higher in the **Step 5: Configure the amount of ink used** dialog box.

Note For details on how to handle the printhead rubbing against the paper, see "Paper rubs against the printhead." →P.897

About Borderless Printing

- When performing borderless printing on paper where the ink does not dry well, the cutter unit may leave scratches where it touches the printed surface, or may not cut correctly. In this kind of situation, configure the amount of time to wait for the ink to dry after printing using **Drying Time** in the **Roll Paper Settings** dialog box. Alternatively, if the paper cannot be cut well by the cutter, set the **Automatic Cutting Settings** to **User Cut** in the **Roll Paper Settings** dialog box, and cut the roll paper using scissors, etc.

About the Print Quality

- If the edges of images are blurry, set the **Vacuum Strength** to be weaker in the **Step 5: Configure the amount of ink used** dialog box.
- If lines are warped or scratched, set the **Head Height** to be lower in the **Step 5: Configure the amount of ink used** dialog box.
- If the amount of ink used is too much, wrinkles may appear and the ink may bleed in the printed material. Furthermore, if the amount of ink used is too little, color production may be poor and lines may become scratched. In this kind of situation, change the amount of ink used in the **Step 5: Configure the amount of ink used** dialog box.
- If horizontal bands with different color tone appear in the printed material, execute **Paper Feed Adjustment** in the **Step 4: Paper feed adjustment** dialog box. If you have already executed **Paper Feed Adjustment**, execute **Adj. Fine Feed** from the printer control panel and fine tune the amount of paper feed.



For details on **Adj. Fine Feed**, see "Fine-Tuning the Paper Feed Amount." →P.817

Note If horizontal bands appear even after executing **Adj. Fine Feed**, refer to "Banding in different colors occurs" in "Troubleshooting". (See "Banding in different colors occurs.") →P.899

- If you cannot obtain sufficiently high print quality, change the maximum ink usage, or change the media type used as the basis for the custom paper in the **Step 1: Select the standard paper** dialog box.
- If there is no luster in printed material, set the paper used as the basis for the custom paper to a paper that uses photo ink as the Black ink.
The types of Black ink used are displayed on the right side of each media type in the **Step 1: Select the standard paper** dialog box.



Note

- For details on problems with printing quality, see "Problems with the printing quality." →P.896

About the Color Tone

- The color tone cannot be configured using the Media Configuration Tool. If the color tone needs to be adjusted, provide an ICC color profile that matches the paper you are using, and select that ICC color profile in your software. For details on how to specify the ICC color profile in the printer driver, see "Matching Sheet." →P.196
- Custom paper cannot be used with the ambient light adjustment function or Monitor Matching in Color-Matching Method.

Media Configuration Tool (Mac OS X)

The Features of Media Configuration Tool	619
Procedures for Installing	620
Procedures for Uninstalling	622
Starting Method	625
Media Configuration Tool Main Window	626
Editing Media Type Information for Genuine Paper and Feed Confirmed Paper	627
Adding Media Types	628
Changing Media Names	631
Deleting Media Types You Have Added	633
Switching Media Types Display Show/Hide	635
Changing the Display Order of Media Types	637
Using Paper Other than Genuine Paper and Feed Confirmed Paper	638
Compatible Paper	640
Add Custom Paper	641
Delete Custom Paper	648
Edit Custom Paper	648
Export Custom Media Information	649
Import Custom Media Information	650
Warnings	652

The Features of Media Configuration Tool

In imagePROGRAF, the best printer settings for each paper are collected together in media information files in order to give the highest quality printing results. Settings for Canon genuine paper and Canon feed confirmed paper are provided by Canon in these media information files.



Note

- Canon genuine paper and Canon feed confirmed paper are detailed in the Paper Reference Guide. Any other paper is called custom paper.

The Media Configuration Tool allows you to perform the following tasks.

- When supported paper has been newly added to the printer, you can add that media type to the printer control panel and printer driver by using the media information file provided by Canon.
- You can customize Canon genuine paper and feed confirmed paper media information files to create a media information file for custom paper (paper that is neither Canon genuine paper or feed confirmed paper), and add that media type to the printer control panel and printer driver. Furthermore, you can also import the created media information file into other computers and printers, and add media types to the printer drivers and printers of the computers where the data was imported.
- You can rearrange lists of the types of paper on the printer control panel and in printer driver dialog boxes and rename them, in addition to other functions.



Important

- Normally, the Media Configuration Tool is installed and the media information is configured when you install the printer driver from the User Software CD-ROM. Use this software if you want to add new media information or edit existing media information.
- Administration of paper information using the Media Configuration Tool should be performed by the printer administrator.

Drivers Applicable with Media Configuration Tool

- imagePROGRAF Printer Driver

Procedures for Installing

Start the installer in the new version of Media Configuration Tool, and follow procedures below to install the Media Configuration Tool.



Important

- If the printer driver is installed from the User Software CD-ROM, the Media Configuration Tool is also installed and the media information is also configured. Therefore, the following procedure does not normally need to be performed. To install the Media Configuration Tool without using the User Software CD-ROM, such as when you have downloaded a new version of the Media Configuration Tool from the Canon website, use the following procedure.

- 1 Double click the **MCT Installer iPFxxxx for X** icon to start the Media Configuration Tool installer.



Note

- The **iPFxxxx** in the icon will be the printer name in use.

- 2 Input the administrator name and password, and click the **OK** button.



- 3 The next screen presents selections for the country or area where the printer is used. Select a country or territory then click the **OK** button.

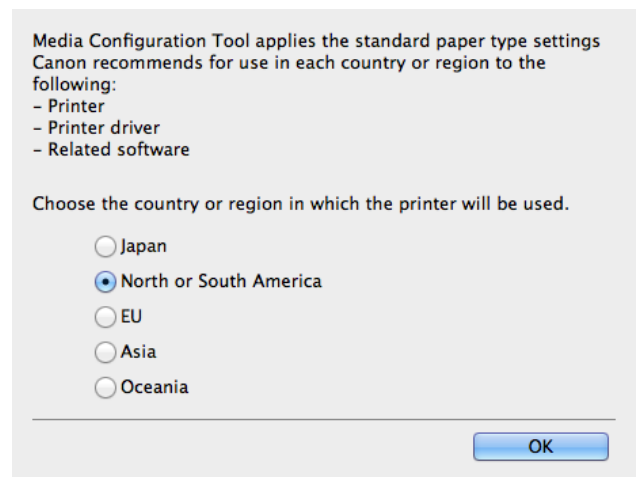

- 4** The **License** is displayed. After you have read Canon Software License Agreement, click the **Continue** button.

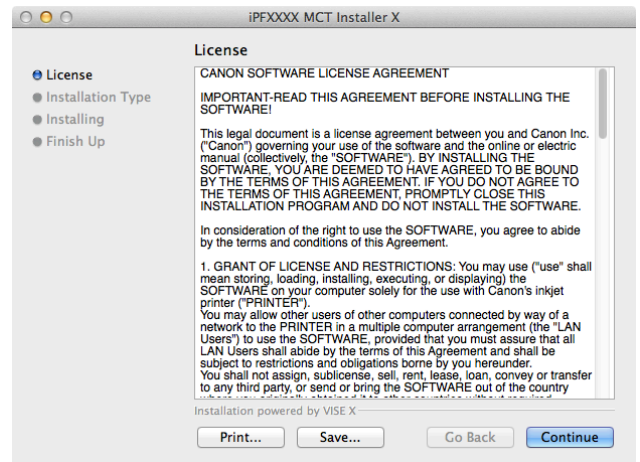

- 5** Click the **Agree** button.

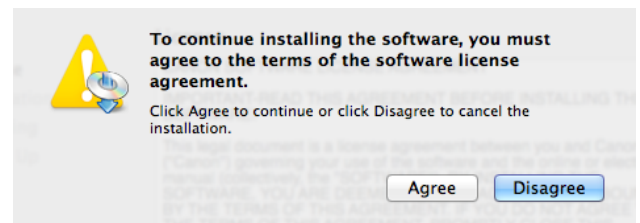

- 6** Select **Easy Install** then click the **Install** button.

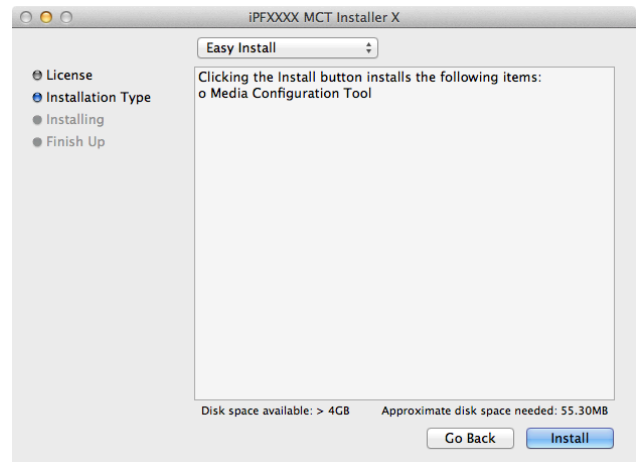

- 7** Click the **Continue** button to quit another application.

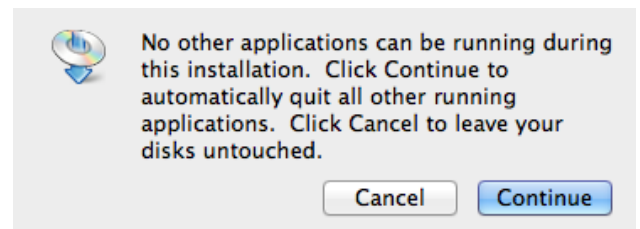

- 8** When the following message is displayed, click the **Quit** button.

The installation of Media Configuration Tool is complete.

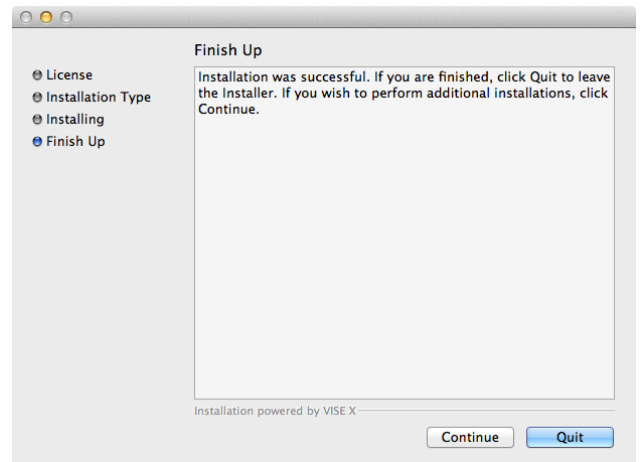

Note

- When the installation is completed properly, the **Media Configuration Tool** folder is saved in the following folder.
Applications > Canon Utilities > iPFxxxx Media Configuration Tool
- The **iPFxxxx** in the folder above will be the printer name in use.

Procedures for Uninstalling

- 1** Double click the **MCT Installer iPFxxxx for X** icon to start the Media Configuration Tool installer.



Note

- The **iPFxxxx** in the icon will be the printer name in use.

- 2** Input the administrator name and password, and click the **OK** button.



- 3** The next screen presents selections for the country or area where the printer is used. Select a country or territory then click the **OK** button.

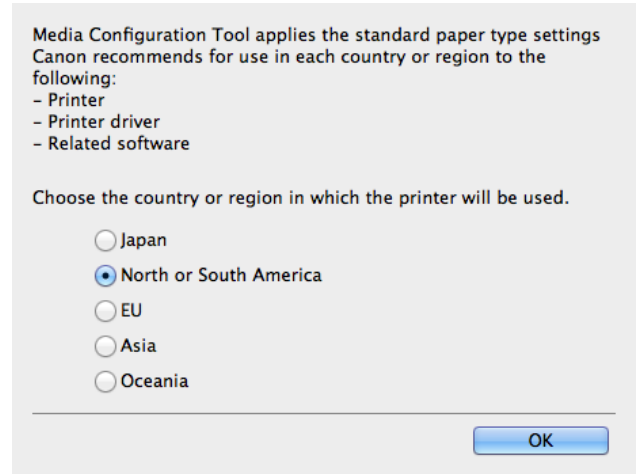

- 4** The **License** is displayed. After you have read Canon Software License Agreement, click the **Continue** button.

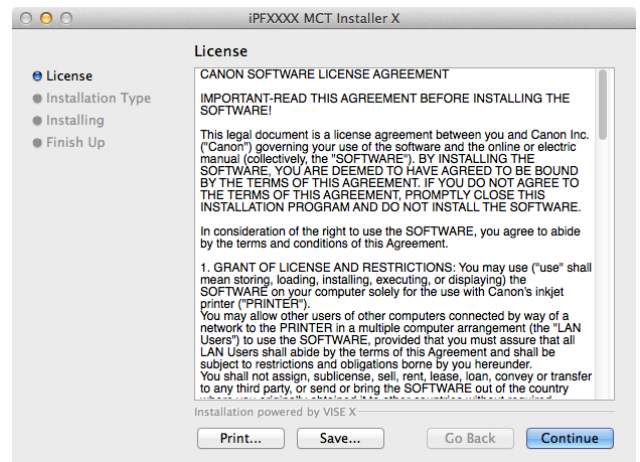

- 5** Click the **Agree** button.

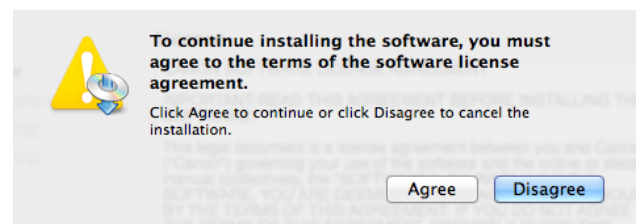

6 Select **Uninstall**.

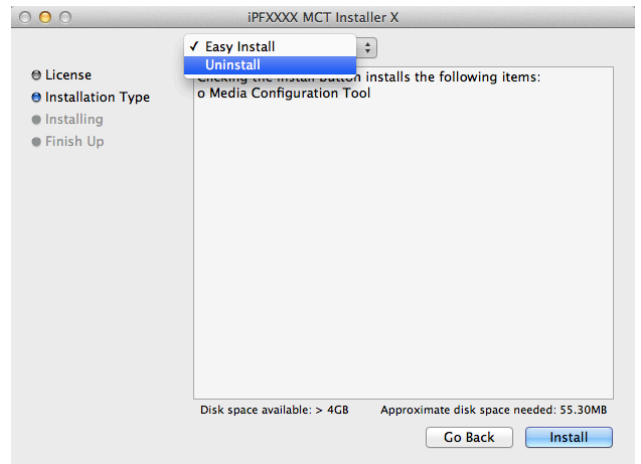

7 Click the **Uninstall** button.

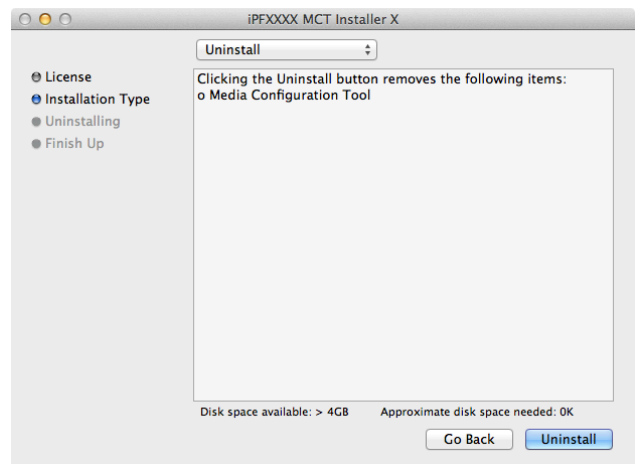

8 Press the **Continue** button when another application is running.

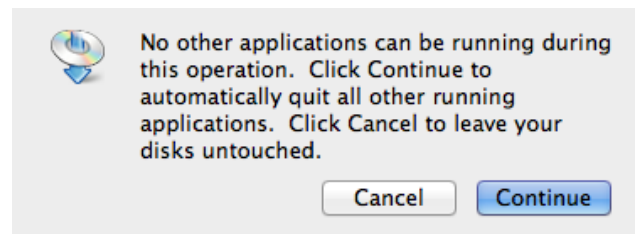

- 9 When the following message is displayed, click the **Quit** button.

Media Configuration Tool has been uninstalled.

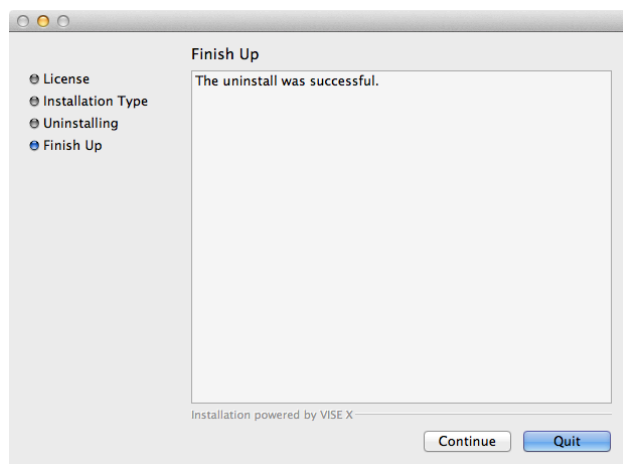

Starting Method

Follow the procedure below to start the Media Configuration Tool.

From the **Applications** menu > **Canon Utilities** > **iPFxxxx Media Configuration Tool** > **MCTxxxx.app**.
Media Configuration Tool main window is displayed.

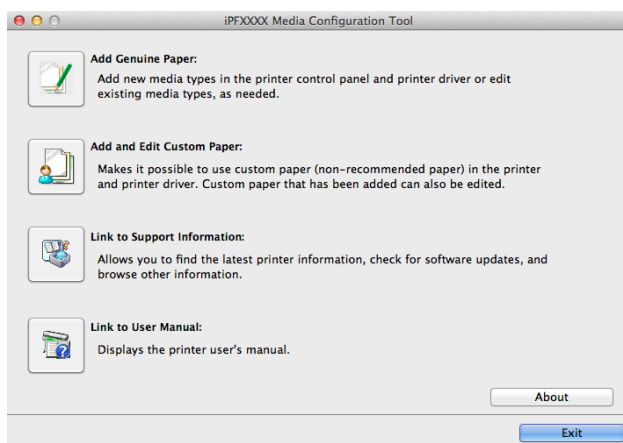

Note

- If a compatible printer driver is not installed, the Media Configuration Tool will not start. If you attempt to start the Media Configuration Tool when a printer driver is not installed, the warning message below is displayed.

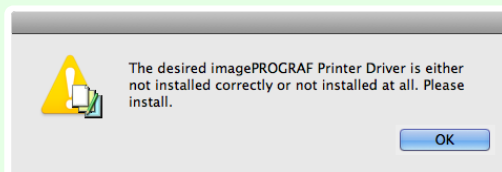

Media Configuration Tool Main Window

The explanation below is on the Media Configuration Tool main window.

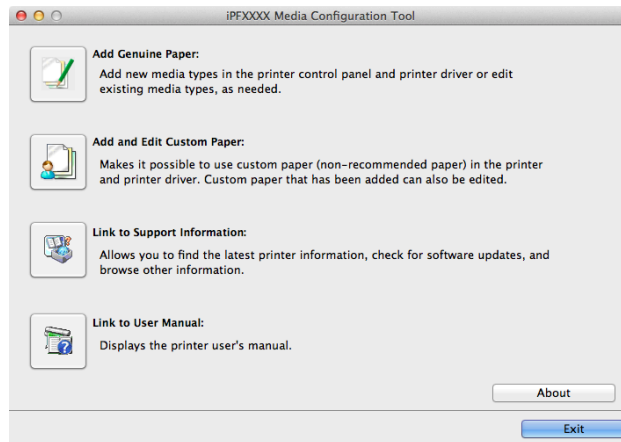

- For the step to open the Media Configuration Tool main window, see "Starting Method." →P.625

Note

• Add Genuine Paper button

When this button is clicked, the **Edit Media Types** dialog box is displayed, which allows you to add media information files released by Canon to the printer control panel and printer driver. You can also change names, toggle between displaying and hiding, and delete added media types.

You can also change the display order of Canon genuine paper and custom paper.

Refer to Editing Media Type Information for Genuine Paper and Feed Confirmed Paper →P.627 for details on **Add Genuine Paper**.

• Add and Edit Custom Paper button

When this button is clicked, the **Add and Edit Custom Paper** dialog box is displayed, which allows you to added custom paper to the printer control panel and printer driver.

Refer to Using Paper Other than Genuine Paper and Feed Confirmed Paper →P.638 for details on **Add and Edit Custom Paper**.

• Link to Support Information button

Opens **imagePROGRAF Support Information**. You can check information such as the latest information for the product and software version upgrade information.

• Link to User Manual Button

Click this button to display the User's Guide. This function requires that the User's Guide be installed on your computer.

Editing Media Type Information for Genuine Paper and Feed Confirmed Paper

To add genuine paper and feed confirmed paper to the printer control panel and printer driver and edit the media type information, click the **Add Genuine Paper** button in the Media Configuration Tool main window.

Confirm the printer, where media type information is to be updated, to be displayed in **Printer** in the **Select Printer** dialog box, and then click the **Next** button.

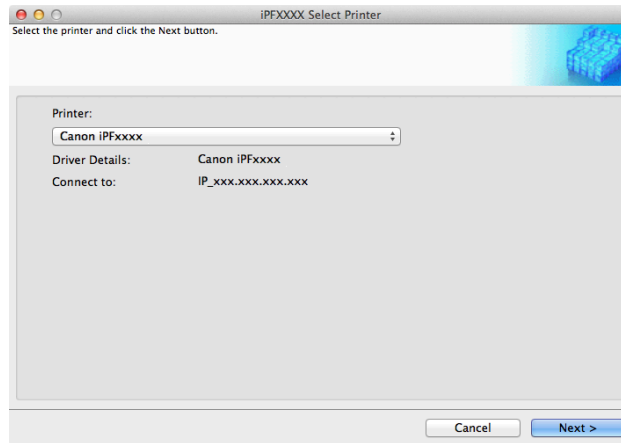

Communication with the printer begins.



- Do not attempt to print or turn the printer off while the program is communicating with the printer.

Important

The **Edit Media Types** dialog box is displayed.



- The printer cannot be changed after this.

Note

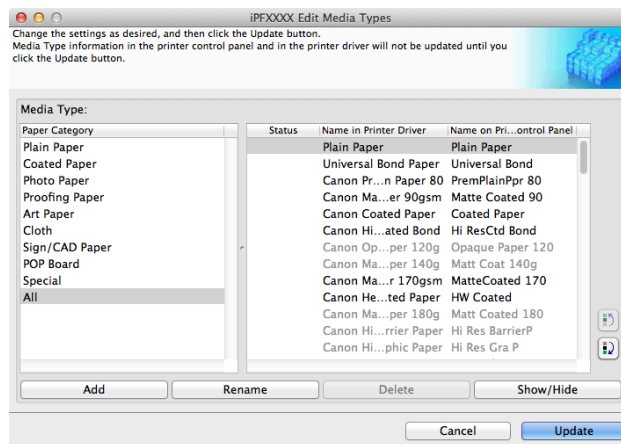

- Paper that is displayed grayed out does not appear in the printer driver or printer panel.

Note

• Add Button

To add genuine paper or feed confirmed paper to the printer control panel and printer driver, click this button.

For details on the procedure for adding media types, see "Adding Media Types." →P.628



- To add media types, download the media information file (.amf file) in advance from the Canon website.

Important

- **Rename Button**

To change the name on the printer control panel and the name in the printer driver for genuine paper and feed confirmed paper, select the paper to change and click this button.

For details on the procedure for changing paper display names, see "Changing Media Names." →P.631

- **Delete Button**

To delete added genuine paper and feed confirmed paper from the printer control panel and printer driver, select the paper to delete and click this button.



For details on the procedure for deleting added media types, see "Deleting Media Types You Have Added."

→P.633

- **Show/Hide Button**

To change whether or not genuine paper or feed confirmed paper is displayed in the printer control panel and printer driver, select the paper to change and click this button.

For details on the procedure for changing whether or not to display media types, see "Switching Media Types Display Show/Hide." →P.635

- **Change Display Order button** ( or )

To change the display order of a media type in the printer control panel and printer driver, select the paper to change and click this button.

For details on the procedure for changing the display order of media types, see "Changing the Display Order of Media Types." →P.637

 • The display order for custom paper can also be changed.
Note

 • When you update the media type information, perform the same update on all of the PCs that are using that printer.
Important

 • It may not be possible to deleting, showing/hiding, and changing the display order under some conditions.
Note

 • If a display name is displayed grayed out, that media type will not appear in the printer driver or printer panel.

Adding Media Types

Media information files (.amf files) released by Canon are registered in the printer control panel and printer driver.

 • Do not perform printing on the target printer while adding the media types.
Important

 • Reinstalling Media Configuration Tool after registering a media information file may delete the registered media information file. In this case, first download and install latest Media Configuration Tool, then download and register the required media information file.

- 1 Open the **Edit Media Types** dialog box, and then click the **Add** button.

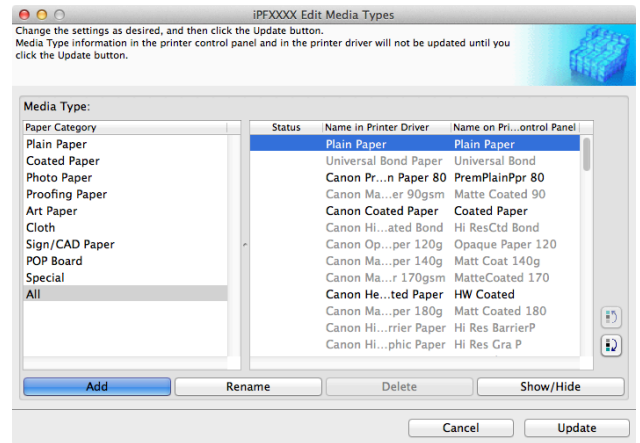

Note

- For details on the procedure for opening the **Edit Media Types** dialog box, see "Editing Media Type Information for Genuine Paper and Feed Confirmed Paper." →P.627

- 2 The **Add Media Type** dialog box displays. Click the **Browse** button.

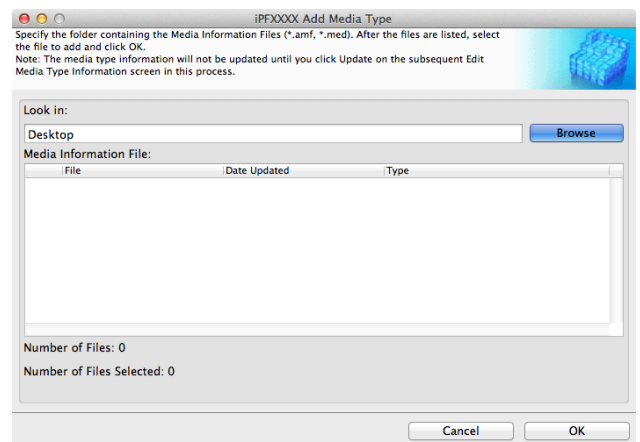

- 3 Open the folder that contains the media information files (.amf files).

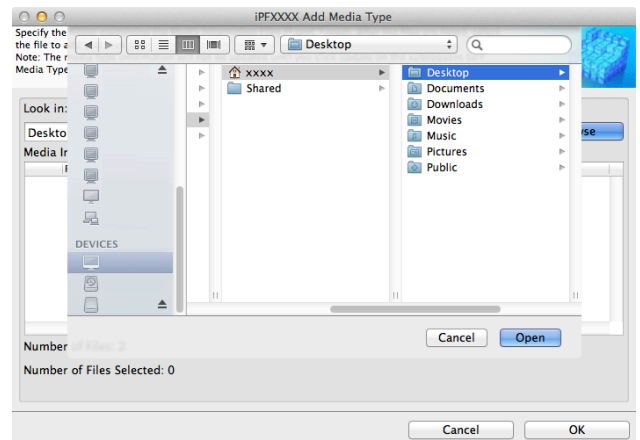

4 The names of the media information files contained in the selected folder are displayed in **Media Information File** in the **Add Media Type** dialog box. Select the check box for the paper you want to add and click the **OK** button.

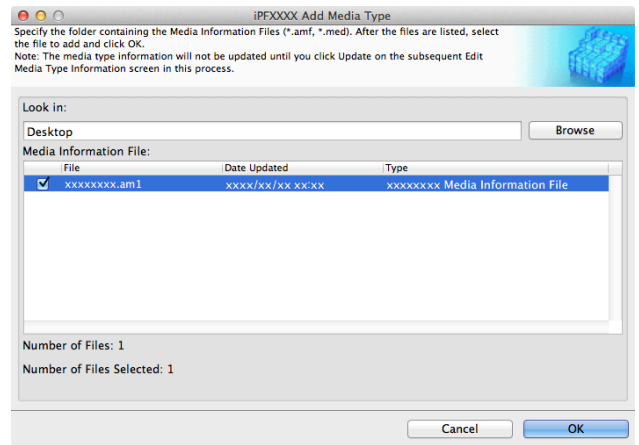

Note • If **Master Media Information File** is displayed as the **Type** of the **Media Information File**, the media type display order and media type display/non-display settings are initialized. Reconfigure these after added the master media information file.

5 Click **OK** when the confirmation message is displayed.

6 In the **Edit Media Types** dialog box, click the **Update** button.

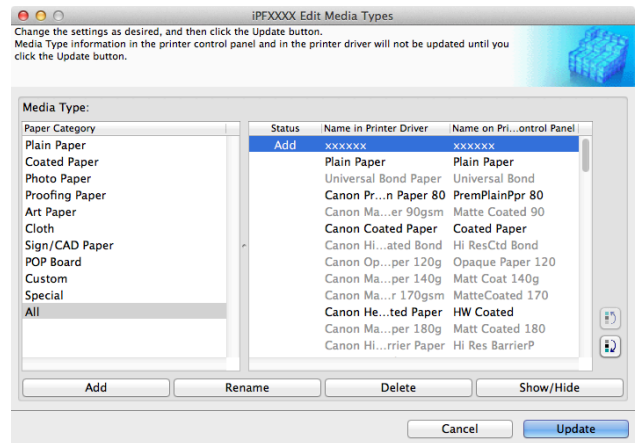

7 The **Confirm Update** dialog box is displayed. Configure **Update Target** and click the **Execute** button. Communication with the printer begins.

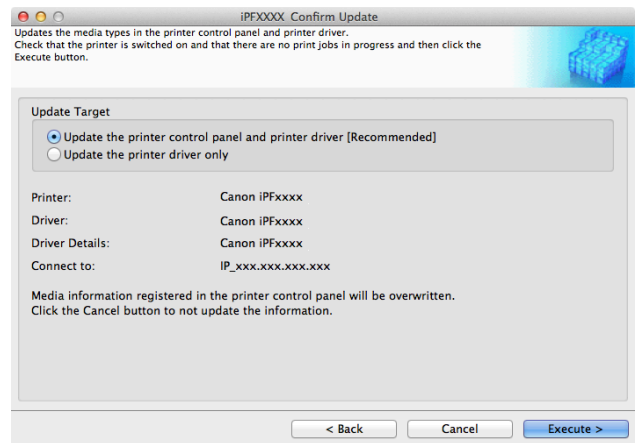

Note • You should normally select **Update the printer control panel and printer driver**.



- When setting a data to the printer that differs from the data to be updated, the selected media information file is updated. When you would like to remain the data that is set to the printer, click the **Cancel** button.
- Do not attempt to print or turn the printer off while the program is communicating with the printer.

8 Click the **OK** button.



Changing Media Names

1 Open the **Edit Media Types** dialog box.

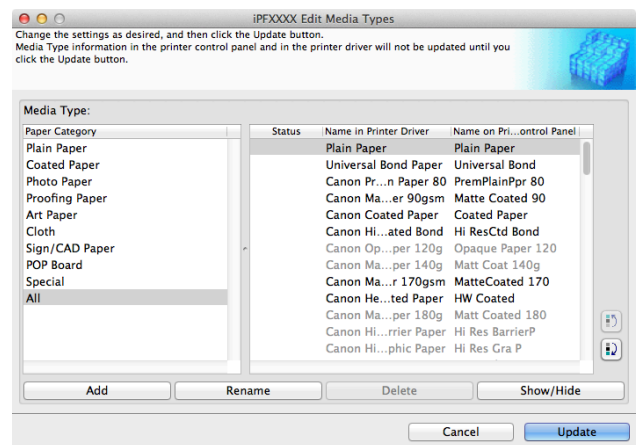

- For details on the procedure for opening the **Edit Media Types** dialog box, see "Editing Media Type Information for Genuine Paper and Feed Confirmed Paper." →P.627

2 In the **Media Type** list, select the name to change. Click the **Rename** button.

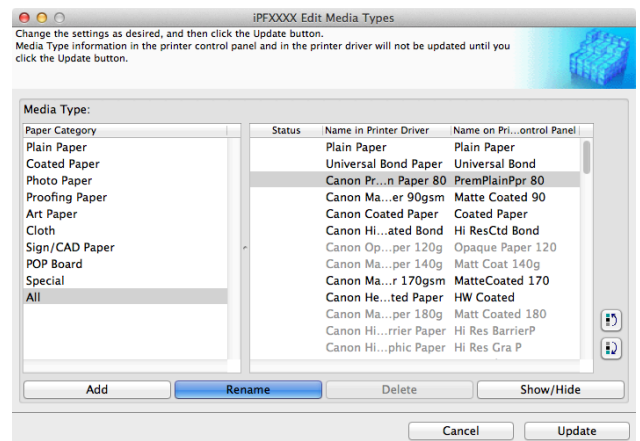

3 The **Rename Media** dialog box is displayed. Edit the names in **Name in Printer Driver** and **Name on Control Panel** and click the **OK** button.

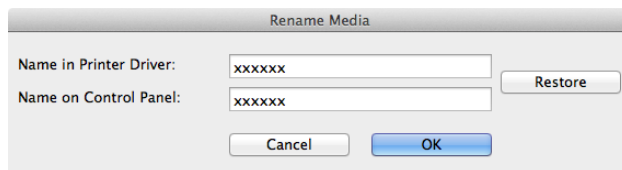

- To restore the original names, click the **Restore** button.
- Note** The characters that can be entered for **Name in Printer Driver** and **Name on Control Panel** are stated below.
alphanumeric, space, "-", ".", "_", "()", "+", "%", ",", "/"
- For **Name in Printer Driver** up to 32 one Byte characters can be entered, and for **Name on Control Panel** up to 16 one Byte characters can be entered.

4 In the **Edit Media Types** dialog box, click the **Update** button.

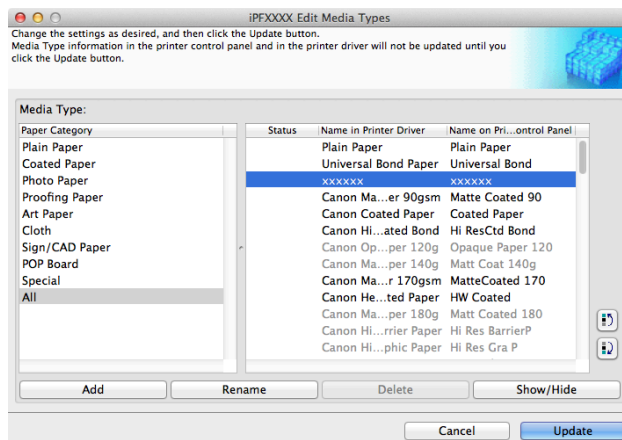

5 The **Confirm Update** dialog box is displayed. Configure **Update Target** and click the **Execute** button. Communication with the printer begins.

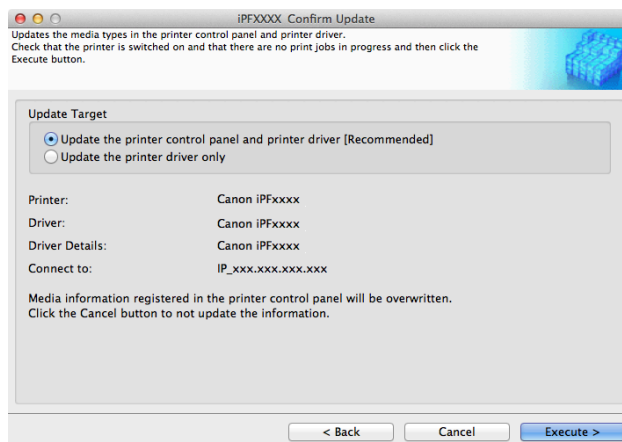

- Note** You should normally select **Update the printer control panel and printer driver**.
- Important** When setting a data to the printer that differs from the data to be updated, the selected media information file is updated. When you would like to remain the data that is set to the printer, click the **Cancel** button.
- Do not attempt to print or turn the printer off while the program is communicating with the printer.

- 6 Click the **OK** button.



Deleting Media Types You Have Added

- 1 Open the **Edit Media Types** dialog box.

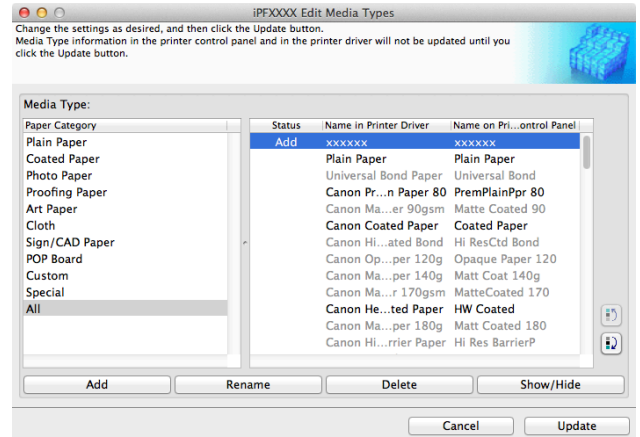

Note

- For details on the procedure for opening the **Edit Media Types** dialog box, see "Editing Media Type Information for Genuine Paper and Feed Confirmed Paper." →P.627

- 2 In the **Media Type** list, select the name of the media to delete.
Click the **Delete** button.

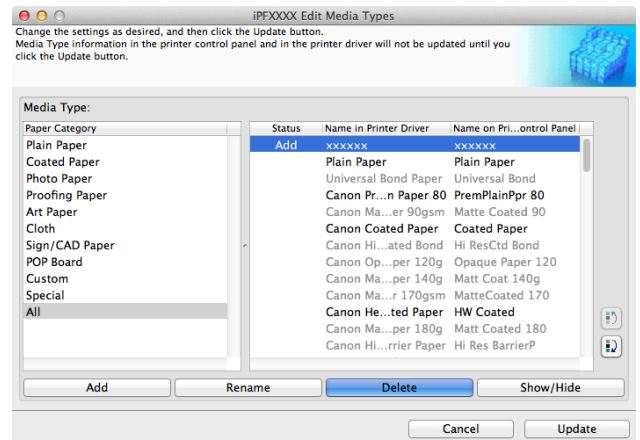

Note

- Only paper for which **Status** in the **Media Type** is **Add** can be deleted.

3 In the **Edit Media Types** dialog box, click the **Update** button.

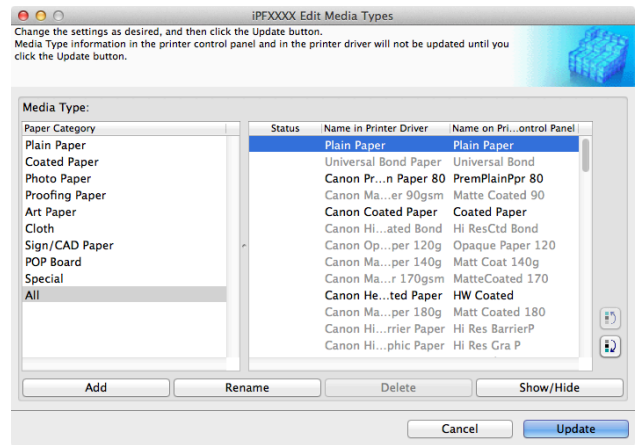

4 The **Confirm Update** dialog box is displayed. Click the **Execute** button. Communication with the printer begins.

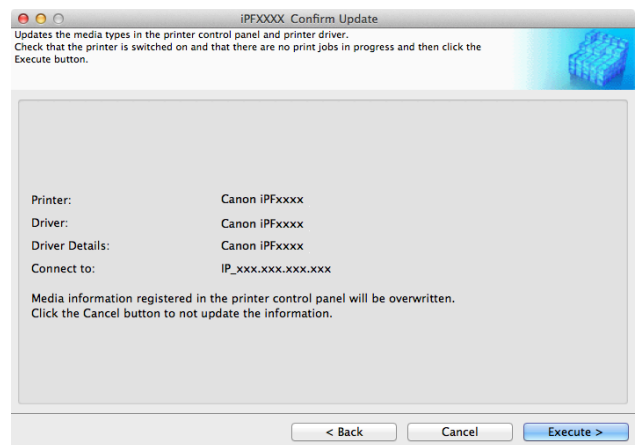

Important

- When setting a data to the printer that differs from the data to be updated, the selected media information file is updated. When you would like to remain the data that is set to the printer, click the **Cancel** button.
- Do not attempt to print or turn the printer off while the program is communicating with the printer.

5 Click the **OK** button.



Switching Media Types Display Show/Hide

- 1 Open the **Edit Media Types** dialog box.

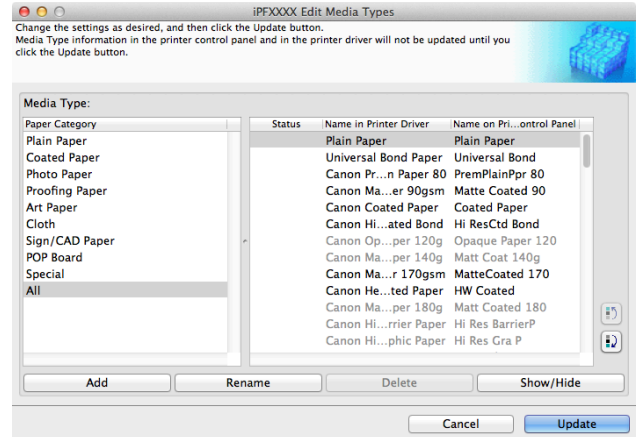

Note

- For details on the procedure for opening the **Edit Media Types** dialog box, see "Editing Media Type Information for Genuine Paper and Feed Confirmed Paper." →P.627

- 2 In the **Media Type** list, select the name of the media to switch off or on for display.
Click the **Show/Hide** button.
The selected paper is alternately shown or hidden.

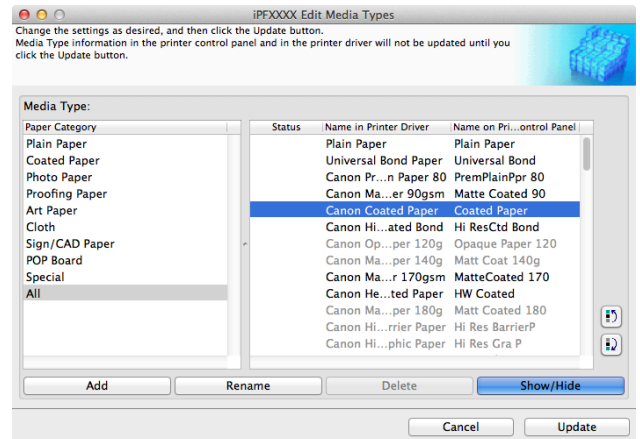

Note

- You can select multiple paper.
- The names of media switched for non-display appear grayed out in the **Media Type** list.
- Each time you click the **Show/Hide** button, the display mode cycles from showing both the printer driver and printer panel, to hiding both the printer driver and printer panel, and then to showing only the printer panel.

- 3** In the **Edit Media Types** dialog box, click the **Update** button.

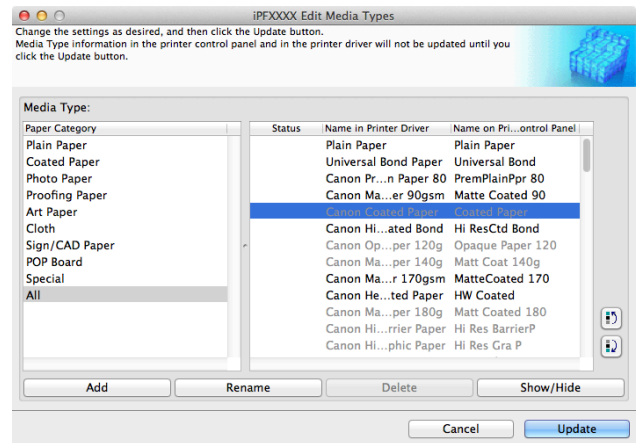

- 4** The **Confirm Update** dialog box is displayed. Configure Update Target and click the **Execute** button. Communication with the printer begins.

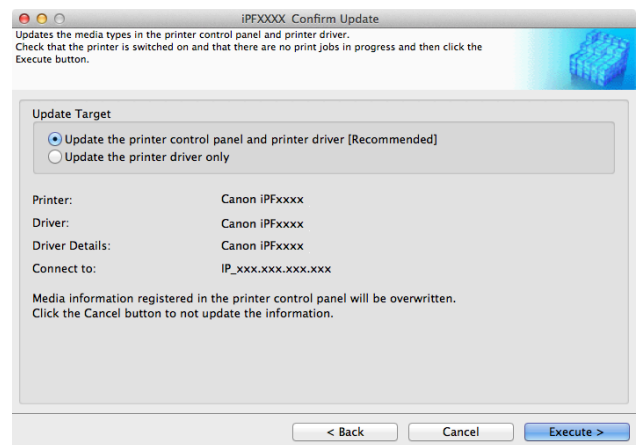

Note

- You should normally select **Update the printer control panel and printer driver**.



Important

- When setting a data to the printer that differs from the data to be updated, the selected media information file is updated. When you would like to remain the data that is set to the printer, click the **Cancel** button.
- Do not attempt to print or turn the printer off while the program is communicating with the printer.

- 5** Click the **OK** button.



Changing the Display Order of Media Types

- 1 Open the **Edit Media Types** dialog box.

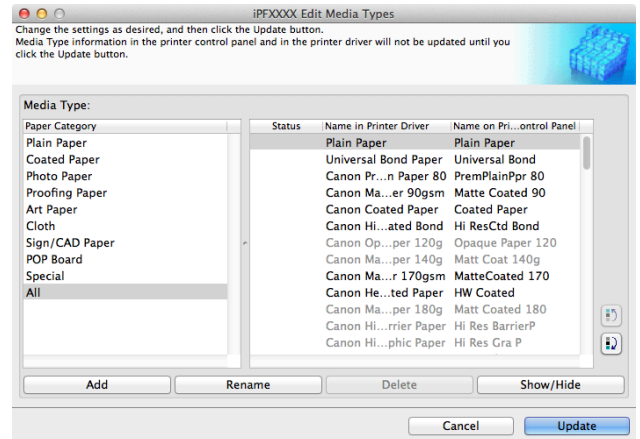

Note

- For details on the procedure for opening the **Edit Media Types** dialog box, see "Editing Media Type Information for Genuine Paper and Feed Confirmed Paper." →P.627

- 2 Select the paper in the **Media Type** list for which to change the display order, and then click the buttons to



move the item ().

The selected item moves one line up or down for every button click.

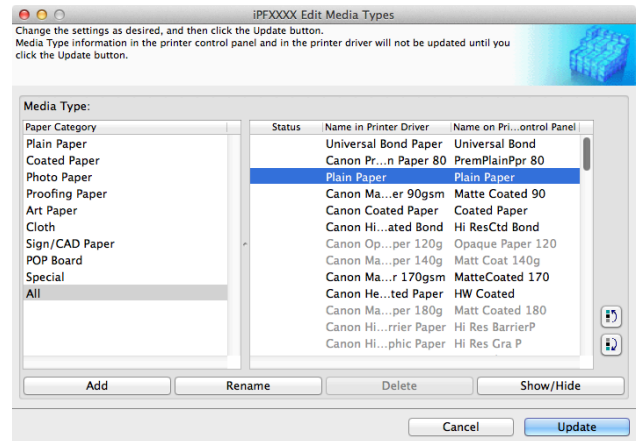

- 3 In the **Edit Media Types** dialog box, click the **Update** button.

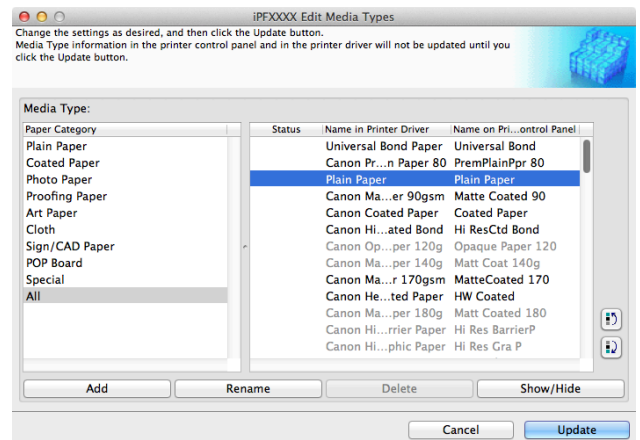

- 4** The **Confirm Update** dialog box is displayed. Configure Update Target and click the **Execute** button. Communication with the printer begins.

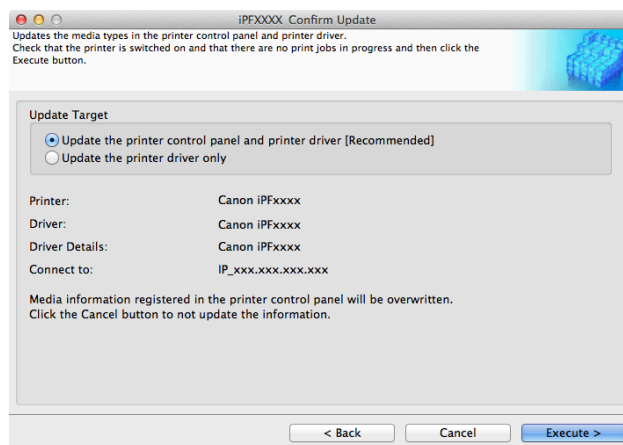

Note

- You should normally select **Update the printer control panel and printer driver**.



Important

- When setting a data to the printer that differs from the data to be updated, the selected media information file is updated. When you would like to remain the data that is set to the printer, click the **Cancel** button.
- Do not attempt to print or turn the printer off while the program is communicating with the printer.

- 5** Click the **OK** button.



Using Paper Other than Genuine Paper and Feed Confirmed Paper

To add paper other than Canon genuine paper and feed confirmed paper to the printer control panel and printer driver, and export and import the media information file for that paper, click the **Add and Edit Custom Paper** button in the Media Configuration Tool main window.

Confirm the printer, where media type information is to be updated, to be displayed in **Printer** in the **Select Printer** dialog box, and then click the **Next** button.

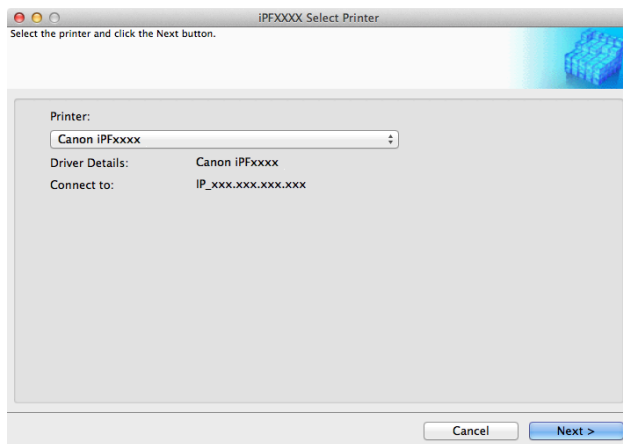

Communication with the printer begins.

The **Add and Edit Custom Paper** dialog box is displayed.



- The printer cannot be changed after this.
- Note** • Custom paper is paper other than Canon genuine paper and feed confirmed paper (paper that is detailed in the Paper Reference Guide).

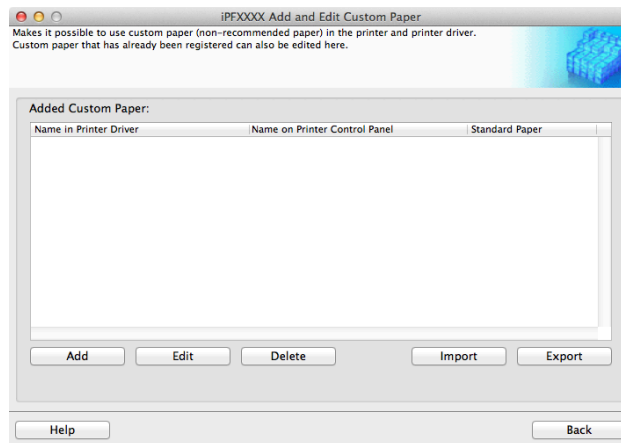

• Added Custom Paper

Added custom paper is displayed here.

- **Name in Printer Driver**
Added custom paper is displayed in the printer driver using this name.
- **Name on Printer Control Panel**
Added custom paper is displayed on the printer control panel using this name.
- **Standard Paper**
Displays the paper selected as the standard paper when the custom paper was added.

• Add Button

To add new custom paper to the printer control panel and printer driver, click this button.

For details on the procedure for adding custom paper, see "Add Custom Paper." →P.641

• Edit Button

To change the settings of added custom paper, select the paper to edit and click this button.

For details on the procedure for changing custom paper settings, see "Edit Custom Paper." →P.648

• Delete Button

To delete added custom paper from the printer control panel and printer driver in your computer, select the paper to delete and click this button.

For details on the procedure for deleting custom paper, see "Delete Custom Paper." →P.648

• Import Button

To add custom paper to the printer control panel and printer driver by importing a Custom Media Information File saved in a folder, click this button.

For details on the procedure for importing a Custom Media Information File, see "Import Custom Media Information." →P.650

• Export Button

To export media information for added custom paper to a file, select the paper to export and click this button.

For details on the procedure for exporting media information for custom paper, see "Export Custom Media Information." →P.649



- When adding or editing custom paper, make the same changes on all of the other PCs that use the target printer. The changes can be made easily by creating a Custom Media Information File (.am1 file) using the custom paper export function and importing the file on the other PCs.
- When deleting custom paper, make the same changes on all of the other PCs that use the target printer.
- When using custom paper in another printer, always add the custom paper to that printer before use.



- Canon genuine paper and feed confirmed paper cannot be changed from this dialog box. Refer to "Editing Media Type Information for Genuine Paper and Feed Confirmed Paper" →P.627 .
- Changing the display order of media types displayed in the printer control panel and printer driver is performed from the **Edit Media Types** dialog box regardless of whether it is Canon genuine paper or custom paper. Refer to "Editing Media Type Information for Genuine Paper and Feed Confirmed Paper" →P.627 .

Compatible Paper

Paper specifications

Refer to "Specifications" and "Paper" for specifications such as thickness and size of paper that can be added as custom paper (See "Specifications.") →P.942

Notes on the operating environment

In low humidity environments (below 40%), your printer may develop the following problems.

- Paper becomes curled or wrinkled.
- Paper and the printhead are more likely to touch each other, resulting in a scratched print surface or damaged printhead.
- The cut printed matter sticks to the printer and will not fall down (film media).
- Paper sticks to the printer, making its transfer impossible and preventing its normal ejection (film media).
- Uneven printing (film media)

In high humidity environments (over 60%), your printer may develop the following problems.

- Printed matter will not dry.
- Wavy paper surface
- Cut edges are ragged (fabric media).
- Margins remain due to borderless printing.



- Canon offers absolutely no guarantees regarding the print quality or paper feed properties of customer paper (paper that is not Canon genuine paper or Canon feed confirmed paper).

Add Custom Paper

In order to add new custom paper to the printer control panel and printer driver, first select the media type to use as the basis from among the Canon genuine paper and feed confirmed paper.. Add this as custom paper after making various changes to the standard paper as necessary.



Important

- Canon offers absolutely no guarantees regarding the print quality or paper feed properties of customer paper.
- For Canon genuine paper and Canon feed confirmed paper, print using the media type as recommended in the Paper Reference Guide. The print quality and feed properties are not guaranteed if you use Add Custom Paper in the Media Configuration Tool.
- Do not execute printing on the target printer while adding custom paper.
- When adding custom paper, check the specifications of paper that can be added using "Compatible Paper" →P.640 .
- Custom paper added using the add custom paper function can only be used by the printer driver. It cannot be used by other software.

1 Open the **Add and Edit Custom Paper** dialog box.



Note

- For details on the procedure for opening the **Add and Edit Custom Paper** dialog box, see "Using Paper Other than Genuine Paper and Feed Confirmed Paper." →P.636

2 Click the **Add** button.

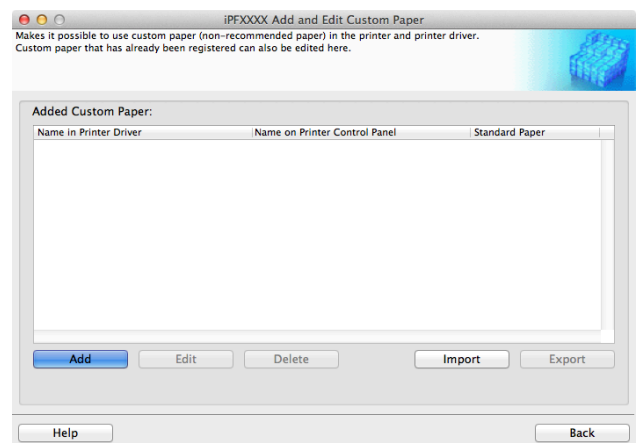

3 The **Step 1: Select the standard paper** dialog box is displayed. In **Paper Category**, select the category of media type to use as the basis of the custom paper you are adding.



Important

- Select the category that you think is the closest to the custom paper you are adding.

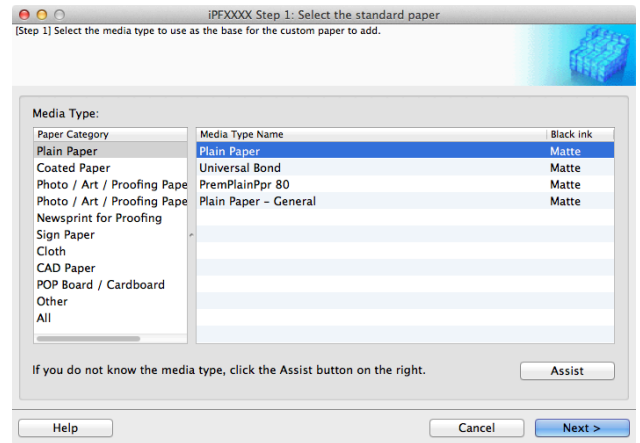

- 4** The media type names of the Canon genuine paper and feed confirmed paper within the selected category are shown in **Media Type Name**. Select the media type to use as the basis of the custom paper, and click the **Next** button.



Note

- If you do not know which media type to use as the basis of the custom paper, click the **Assist** button to open the **Media Type Selection Assistance** dialog box, and then set either the **Weight (grammage)** or the **Thickness**. The Media Configuration Tool automatically selects the appropriate paper from the selected paper category. Alternatively, select the media type called **General** from among the displayed **Media Type Name**.
- Depending on the selected category, there might not be a media type called **General**.
- Depending on the selected category, the **Assist** button may be disabled.

- 5** The **Step 2: Set the custom paper name** dialog box is displayed.

Enter an arbitrary name to display in the printer control panel and printer driver, and then click the **Next** button.

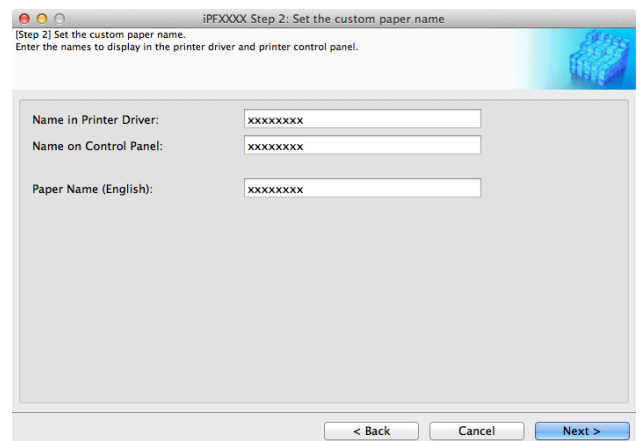

Note

- The characters that can be entered for **Name in Printer Driver** and **Name on Control Panel** are stated below.
alphanumeric, space, "-", ".", "_", "()", "+", "%", ",", "/"
- For **Name in Printer Driver** up to 32 one Byte characters can be entered, and for **Name on Control Panel** up to 16 one Byte characters can be entered.
- **Paper Name (English)** is used in keeping track of the amount of roll paper left, in status print, etc.

- 6 Load the custom paper in the printer and then click the **OK** button.



- Important** • Do not load paper that is curled or that has already been printed on.

- 7 The **Step 3: Paper Source Settings** dialog box is displayed. Select the paper source where the custom paper is loaded and then click the **OK** button.

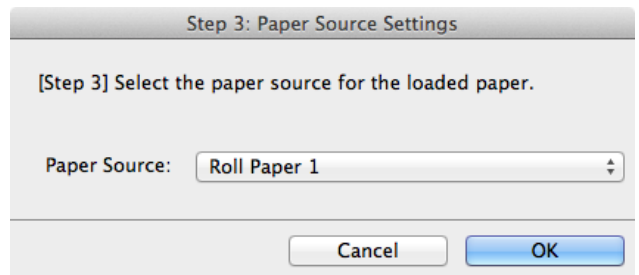

- 8 The **Step 4: Paper feed adjustment** dialog box is displayed. Click the **Execute** button to execute paper feed adjustment. The adjustment pattern is printed, and the paper feed is automatically adjusted based on the printing result. Once the paper feed adjustment is complete, click the **Next** button.

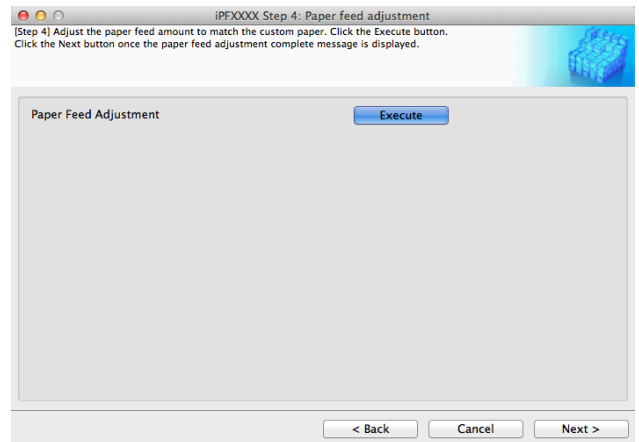

- Important** • Check that there is no paper left on the ejection guide.
• If **Paper Feed Adjustment** is not executed, horizontal stripes with different color tones may appear in the printed material. Paper feed adjustment does not need to be executed more than once. Execute paper feed adjustment only once each time you add a custom paper.

- 9 The **Roll Paper Settings** dialog box is displayed.

- Note** • If a paper source other than **Roll Paper** is selected in the **Step 3: Paper Source Settings** dialog box, this screen is not displayed.

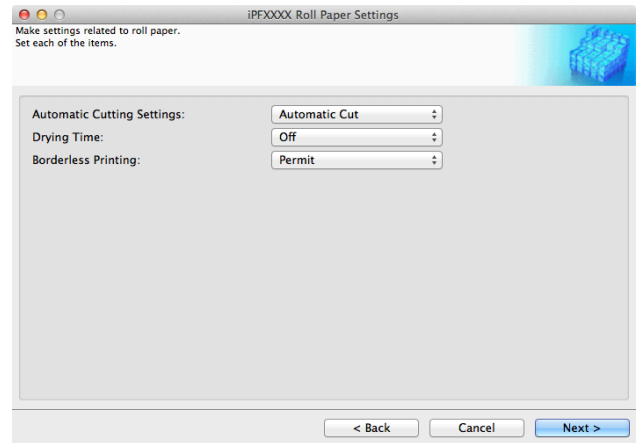

Configure the following settings as necessary, and then click the **Next** button.

Setting	Details
Automatic Cutting Settings	<p>Configures the method for cutting roll paper when it is ejected after printing.</p> <ul style="list-style-type: none"> • Automatic Cut :Roll paper is automatically cut by the cutter unit. • Eject Cut :When the Cut key is pressed on the printer control panel, the roll paper is cut by the cutter unit. Select this if you do not want the printed material to drop immediately after printing, such as to wait for the ink to dry. • User Cut :Cutting is not performed by the cutter unit. Cut the roll paper using scissors after each sheet. Select this for paper that cannot be cut by the cutter unit.
Drying Time	<p>Specify the time that the printer waits for ink to dry, as needed.</p> <ul style="list-style-type: none"> • Off :Ejects immediately after printing finishes. • 30 sec./1 min./3 min./5 min./10 min./30 min./60 min. :Ejects after the specified time has elapsed after printing finishes.
Borderless Printing	<p>Configures whether or not to permit borderless printing.</p> <ul style="list-style-type: none"> • Permit : Borderless printing is permitted. • Deny : Borderless printing is denied.



Important

- Depending on the paper, there are types that cannot be cut by the cutter unit, and types that speed deterioration of the blade and cause damage to the cutter. For thick paper, hard paper, etc. do not use the cutter unit, and instead cut the roll paper using scissors, etc. after printing. In this case, select **User Cut** as the **Automatic Cutting Settings**.
- If borderless printing is performed on paper where the ink drying is poor, the cutter unit may leave scratches where it touches the printed surface, or may not cut correctly. In this kind of situation, configure the amount of time to wait for the ink to dry after printing using **Drying Time**. Alternatively, if the paper cannot be cut well by the cutter, set the **Automatic Cutting Settings** to **User Cut** and cut the roll paper using scissors, etc.
- Paper where borderless printing can be performed is limited by the media type and roll paper width. Refer to "Compatible Paper" →P.640 .
- For custom paper where there is a need to set the **Automatic Cutting Settings** to **User Cut**, set the **Borderless Printing** to **Deny**.

10 The **Step 5: Configure the amount of ink used** dialog box is displayed.

The upper limit on the amount of ink used to print to the custom paper is set on this screen by selecting from among several levels.

First, click the **Test Print** button to perform a test print of each level.

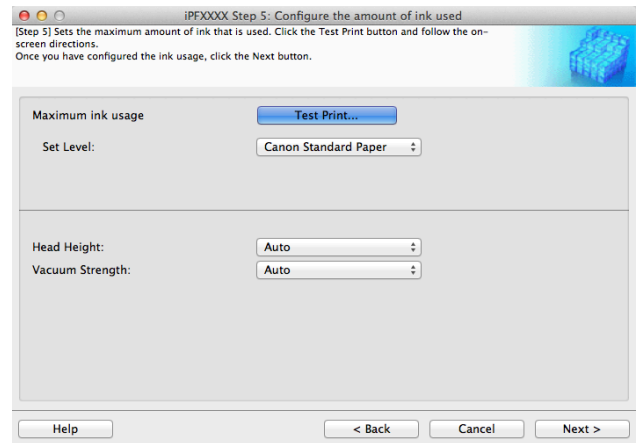

Note

- If a standard paper that does not display the **Name in Printer Driver** is selected in the screen in Step 5, you cannot perform test prints or configure the maximum amount of ink to use.

11 The **Test Print Settings** dialog box is displayed. Select the print priority and print quality of the test print using **Print Priority** and **Print Quality**. Set the level to test print using **Maximum ink usage** and the image to use using **Image used in test print**, and then click the **Start Print** button.

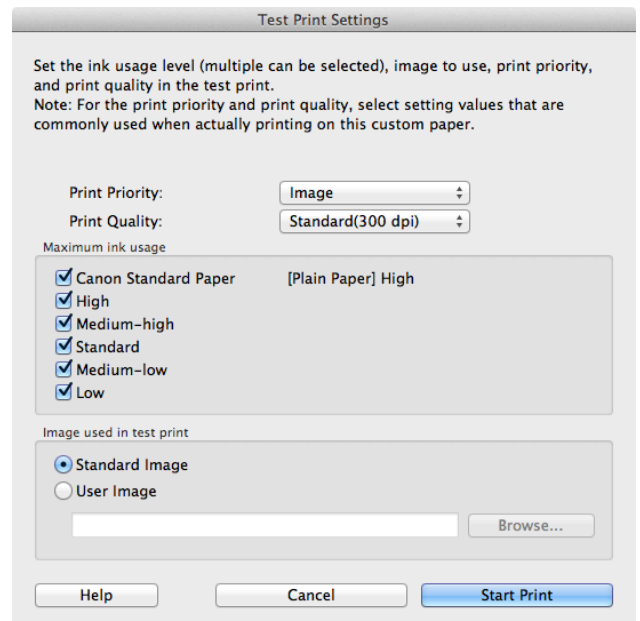

- 12** Determine and set the ink level that is thought to give the best visual test print results with no bleeding or scraping of ink.

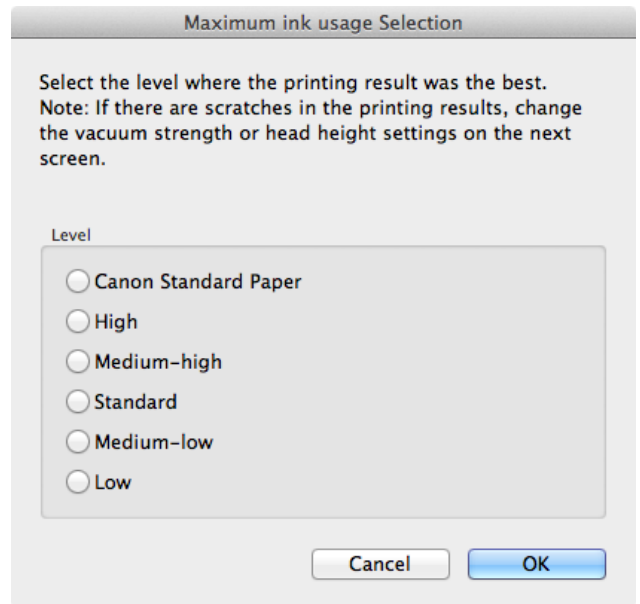

- Select the optimal ink level by referring to the help.
- Note**
- If you cannot obtain sufficiently high quality printing no matter which maximum ink usage level you select, use the **Step 1: Select the standard paper** dialog box to change the paper that is the basis of the custom paper to another paper.
 - Because this settings imposes an upper limit on the amount of ink used during printing, the printing result might not change even if the level is changed depending on the image.
 - The color tone cannot be configured using the Media Configuration Tool. Although the color tone may change when the maximum ink usage is changed, at this point you should select the optimal level by only focusing on bleeding and scraping of ink. If the color tone needs to be adjusted, provide an ICC color profile that matches the paper you are using, and select that ICC color profile in your software. For details on how to specify the ICC profile in the printer driver, see "Matching Sheet." →P.196
 - Depending on the maximum ink usage setting, some of the print qualities in the printer driver may become unselectable.

- 13** Configure **Head Height** and **Vacuum Strength** as required and click the **Next** button. Usually, these do not need to be set.

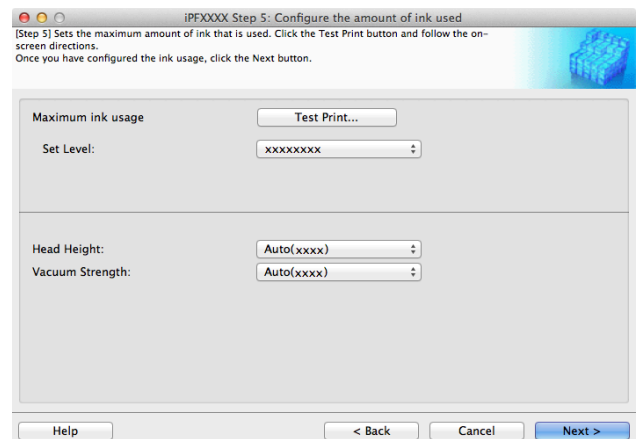



Important

- If you set the **Head Height** lower than the automatically set height in parentheses (), check that the printhead does not rub against the paper. (If the printhead rubs against the paper, there will be scratches in the printing results.) If the printhead rubs against the paper, this can cause damage to the printhead.
- If you change the **Vacuum Strength**, check that the printhead is not rubbing against the paper. (If the printhead rubs against the paper, there will be scratches in the printing results.) If the printhead rubs against the paper, this can cause damage to the printhead.
- For details on the **Head Height** and **Vacuum Strength**, refer to the help.

- 14** The **Step 6: Confirm the settings** dialog box is displayed. Configure the settings of the custom paper, and then click the **Next** button.

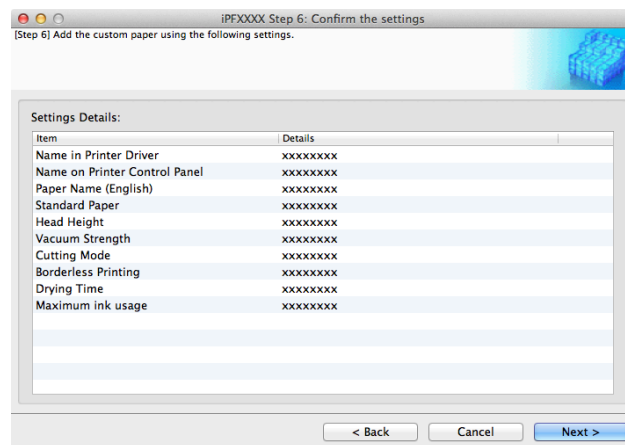

- 15** The **Confirm Update** dialog box is displayed. Confirm the updates and then click the **Execute** button.

The custom paper is added to the control panel of the printer and to the printer driver of the PC you are using.

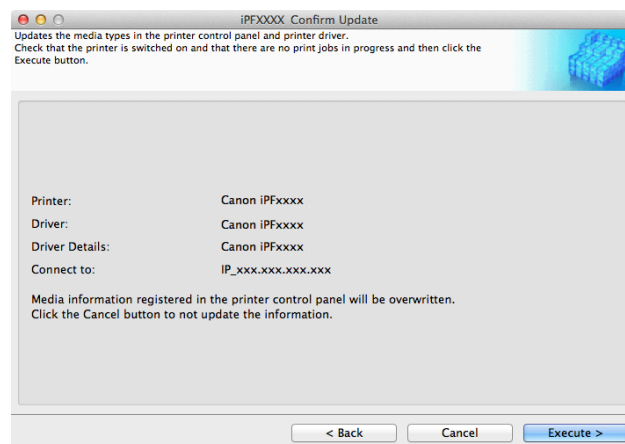

Important

- If you have added custom paper with the **POP Board / Cardboard** category as the Standard Paper, remove the loaded custom paper from the printer.



Note

- When the custom paper is correctly added to the printer driver, the name of the added custom paper is displayed in the **Edit Media Types** dialog box that is opened by **Add Genuine Paper** in the Media Configuration Tool window.

Delete Custom Paper

You can delete custom paper that you have already added from printer control panel and from the printer driver of the PC you are using.

1 Open the **Add and Edit Custom Paper** dialog box.



Note

- For details on the procedure for opening the **Add and Edit Custom Paper** dialog box, see "Using Paper Other than Genuine Paper and Feed Confirmed Paper." →P.638

2 Select the paper you want to delete from the **Added Custom Paper** list and then click the **Delete** button.

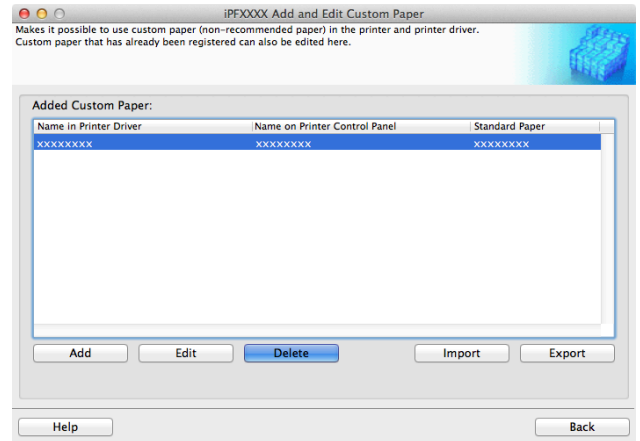

Note

- You can select multiple paper.

3 The **Confirm Update** dialog box is displayed. Confirm the updates and then click the **Execute** button.

The custom paper is deleted from the control panel of the printer and from the printer driver of the PC you are using.

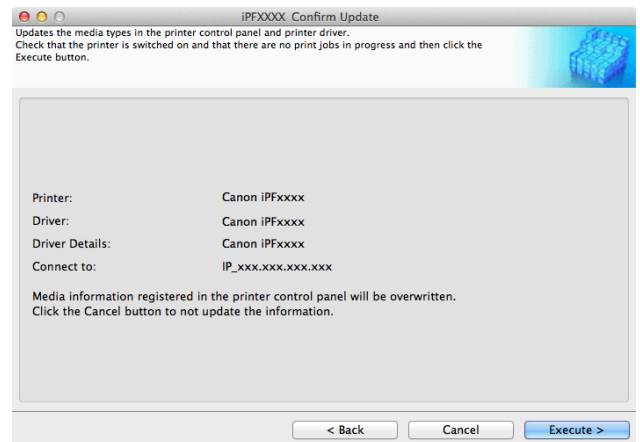

Edit Custom Paper

You can change the settings of custom paper you have already added.

1 Open the **Add and Edit Custom Paper** dialog box.



Note

- For details on the procedure for opening the **Add and Edit Custom Paper** dialog box, see "Using Paper Other than Genuine Paper and Feed Confirmed Paper." →P.638

- 2 Select the paper you want to edit from the **Added Custom Paper** list and then click the **Edit** button.

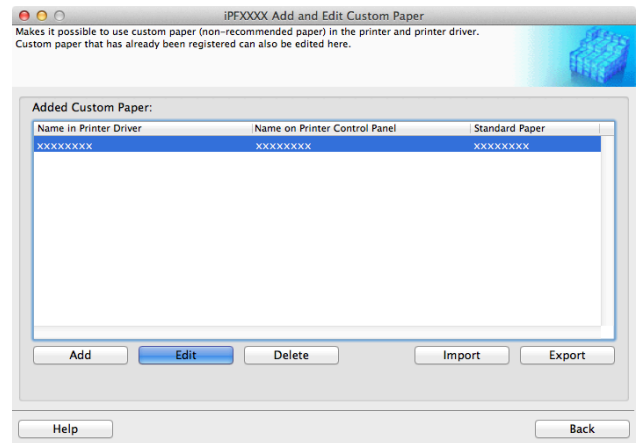

- 3 The View Settings dialog box is displayed.
Follow the on-screen directions and change the settings as required.

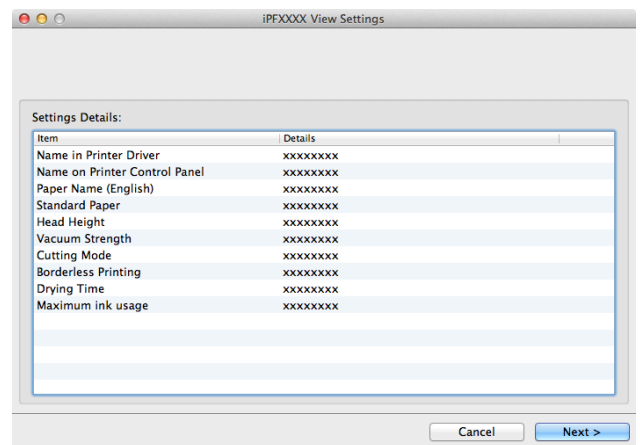

Note

- Refer to Steps 5 to 15 of the "Add Custom Paper" →P.641 for details on how to configure each setting.

Export Custom Media Information

You can export to file and save media information about custom paper that you have added. The saved Custom Media Information File can be used by importing it into another printer or PC. Refer to "Import Custom Media Information" →P.650 for details on "importing custom media information".

- 1 Open the **Add and Edit Custom Paper** dialog box.



Note

- For details on the procedure for opening the **Add and Edit Custom Paper** dialog box, see "Using Paper Other than Genuine Paper and Feed Confirmed Paper." →P.638

- 2 Select the paper you want to export to media information file from the **Added Custom Paper** list and then click the **Export** button.

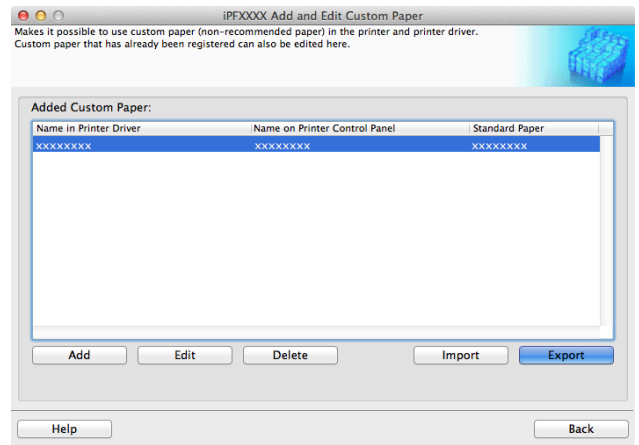

- You can select multiple paper.

- 3 Specify the location to save the Custom Media Information File.

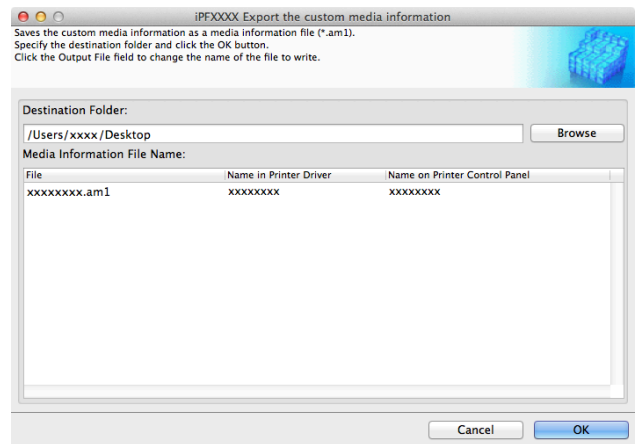

- You can change the file name by selecting and editing the File. A Custom Media Information File (.am1 file) is saved.

Import Custom Media Information

You can import a Custom Media Information File that has been saved in a folder, and add the file to the printer control panel and to the printer driver of the PC you are using.

- 1 Open the **Add and Edit Custom Paper** dialog box.



- For details on the procedure for opening the **Add and Edit Custom Paper** dialog box, see "Using Paper Other than Genuine Paper and Feed Confirmed Paper." →P.636

2 Click the **Import** button.

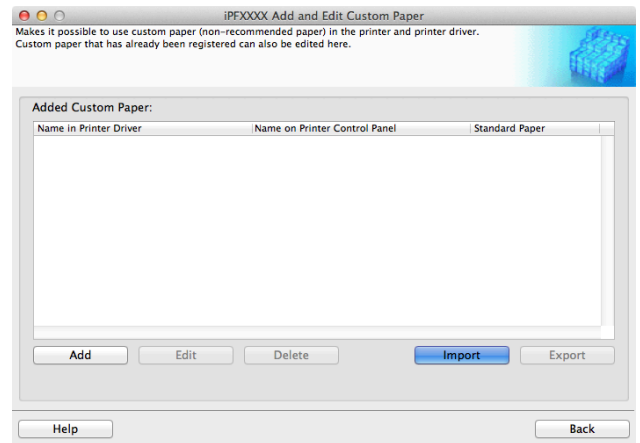

3 Select the Custom Media Information File (.am1 file) to import.

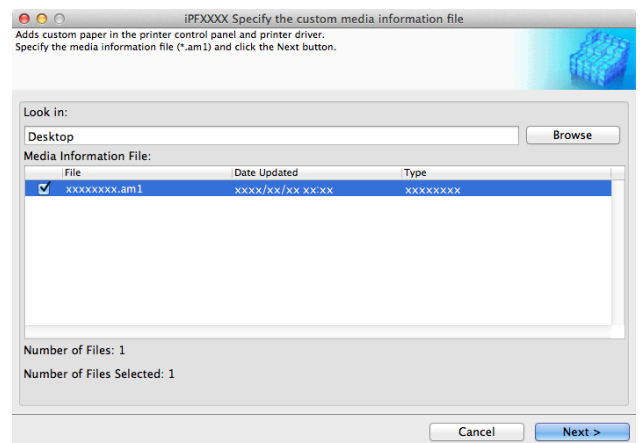

4 The **Confirm Update** dialog box opens. Click the **Execute** button.

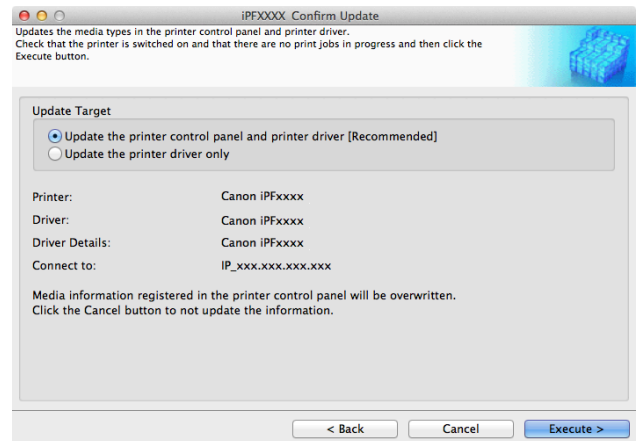

Note

- You should normally select **Update the printer control panel and printer driver**. The custom paper is added to the control panel of the printer and to the printer driver of the PC you are using.
- When the custom paper is correctly added to the printer driver, the name of the added custom paper is displayed in the **Edit Media Types** dialog box that is opened by **Add Genuine Paper** in the Media Configuration Tool window.

Warnings

Take note of the following warnings when added custom paper other than Canon genuine paper and feed confirmed paper to the printer driver and the printer itself.

About the Cutter

- Depending on the paper, there are types that cannot be cut by the cutter unit, and types that speed deterioration of the blade and cause damage to the cutter. For thick paper, hard paper, etc. do not use the cutter unit, and instead cut the roll paper using scissors, etc. after printing. In this case, select **User Cut** as the **Automatic Cutting Settings** in the **Roll Paper Settings** dialog box.



- If the cutter is damaged, contact your Canon dealer for assistance.

Note • For details on the methods for cutting roll paper, see "Specifying the Cutting Method for Rolls." →P.554

About the Printhead

- If the printhead rubs against the paper during printing, this may cause damage to the printhead. If the printhead is rubbing against the paper, configure the **Vacuum Strength** in the **Step 5: Configure the amount of ink used** dialog box as follows.
 - For paper-based media such as Heavyweight Coated Paper: Set to **Strong** or **Strongest**
 - For film-based media such as CAD Tracing Paper: Set to **Standard**, **Strong**, or **Strongest**
 - For thin paper of thickness 0.1mm or less: Set to **Weakest**



Note • If the printhead still rubs even after changing the **Vacuum Strength**, set the **Head Height** to be higher in the **Step 5: Configure the amount of ink used** dialog box.

- For details on how to handle the printhead rubbing against the paper, see "Paper rubs against the printhead." →P.897

About Borderless Printing

- When performing borderless printing on paper where the ink does not dry well, the cutter unit may leave scratches where it touches the printed surface, or may not cut correctly. In this kind of situation, configure the amount of time to wait for the ink to dry after printing using **Drying Time** in the **Roll Paper Settings** dialog box. Alternatively, if the paper cannot be cut well by the cutter, set the **Automatic Cutting Settings** to **User Cut** in the **Roll Paper Settings** dialog box, and cut the roll paper using scissors, etc.

About the Print Quality

- If the edges of images are blurry, set the **Vacuum Strength** to be weaker in the **Step 5: Configure the amount of ink used** dialog box.
- If lines are warped or scratched, set the **Head Height** to be lower in the **Step 5: Configure the amount of ink used** dialog box.
- If the amount of ink used is too much, wrinkles may appear and the ink may bleed in the printed material. Furthermore, if the amount of ink used is too little, color production may be poor and lines may become scratched. In this kind of situation, change the amount of ink used in the **Step 5: Configure the amount of ink used** dialog box.
- If horizontal bands with different color tone appear in the printed material, execute **Paper Feed Adjustment** in the **Step 4: Paper feed adjustment** dialog box. If you have already executed **Paper Feed Adjustment**, execute **Adj. Fine Feed** from the printer control panel and fine tune the amount of paper feed.



• For details on **Adj. Fine Feed**, see "Fine-Tuning the Paper Feed Amount." →P.817

Note • If horizontal bands appear even after executing **Adj. Fine Feed**, refer to "Banding in different colors occurs" in "Troubleshooting". (See "Banding in different colors occurs.") →P.899

- If you cannot obtain sufficiently high print quality, change the maximum ink usage, or change the media type used as the basis for the custom paper in the **Step 1: Select the standard paper** dialog box.
- If there is no luster in printed material, set the paper used as the basis for the custom paper to a paper that uses photo ink as the Black ink.
The types of Black ink used are displayed on the right side of each media type in the **Step 1: Select the standard paper** dialog box.



Note

- For details on problems with printing quality, see "Problems with the printing quality." →P.896

About the Color Tone

- The color tone cannot be configured using the Media Configuration Tool. If the color tone needs to be adjusted, provide an ICC color profile that matches the paper you are using, and select that ICC color profile in your software. For details on how to specify the ICC color profile in the printer driver, see "Matching Sheet." →P.196
- Custom paper cannot be used with the ambient light adjustment function or Monitor Matching in Color-Matching Method.

Memo

Basic Printing Workflow	19
Enhanced Printing Options	35
Windows Software	177
Mac OS X Software	363
Handling and Use of Paper	529

Control Panel

Operations and Display Screen	656
Printer Menu	665

Printer Parts	691
Network Setting	707
Print Job Management	741
Adjustments for Better Print Quality	803
Color Management	821
Maintenance and Consumables	833
Troubleshooting	883
Error Message	915
Specifications	941
Appendix	945

Operations and Display Screen

Control Panel	656
Control Panel Display	658
How to View Instructions With Navigate	661
Checking Instructions During Printer Operations	663

Control Panel

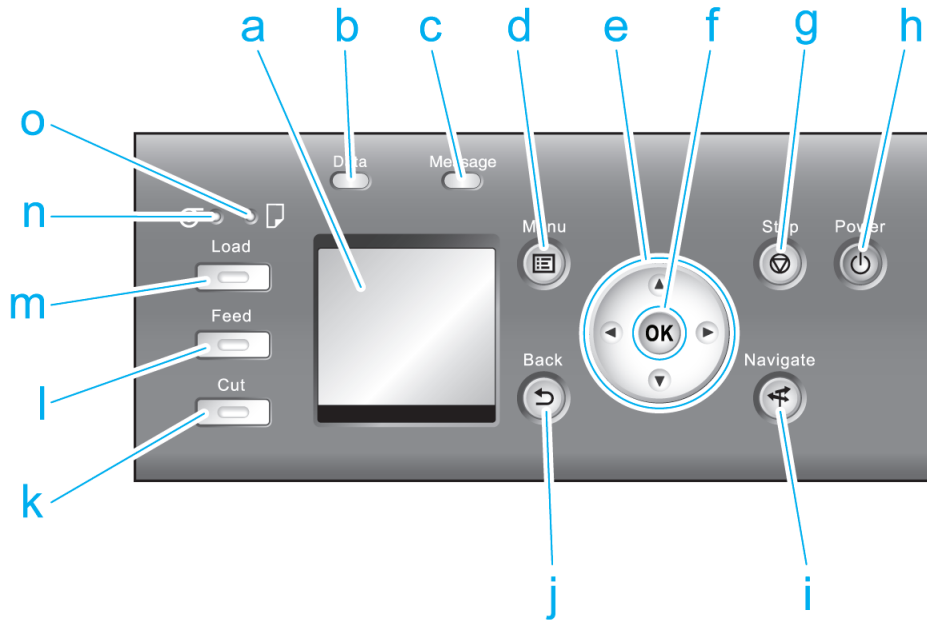

a Display Screen

Shows printer menus, as well as the printer status and messages.

b Data Lamp (green)

- Flashing

During printing, the Data lamp flashes when the printer is receiving or processing print jobs. Otherwise, this lamp flashes when the print job is paused or the printer is updating the firmware.

- Off

There are no active print jobs when the Data lamp is off.

c Message Lamp (orange)

- On

A warning message is displayed.

- Flashing

An error message is displayed.

- Off

The printer is off or is operating normally.

d Menu button

Displays the **Tab Selection screen**. (See "Menu Settings.") →P.675

e Arrow buttons

• ◀ button

Press this button on the **Tab Selection screen** to move to another tab.

In menu items requiring numerical input, press this button to move to another digit.

• ▲ button

Press this button when viewing menus to display the next menu item or setting value.

• ▶ button

Press this button on the **Tab Selection screen** to move to another tab.

In menu items requiring numerical input, press this button to move to another digit.

• ▼ button

Press this button when viewing menus to display the next menu item or setting value.

f OK button

Press this button on the **Tab Selection screen** to display the menu of the tab shown.

Pressing this button in menu items of each tab for which  is displayed at left will move to the lower level of the menu item, enabling you to execute menu commands or set menu values.

Also press this button if the Display Screen indicates to press the **OK** button.

g Stop button

Cancels print jobs in progress and ends the ink drying period.

h Power button (green)

Turns the printer on and off. (See "Turning the Printer On and Off.") [→P.21](#)

The **Power** button is lit when the printer is on or in Sleep mode.

i Navigate button

Enables you to check instructions for loading and removing paper or replacing ink tanks or printheads, as well as other operations. (See "How to View Instructions With Navigate.") [→P.661](#)

j Back button

Displays the screen before the current screen.

k Cut button

Pressing this button when rolls are loaded cuts the paper, if you have specified **Automatic** or **Eject** in **Cutting Mode** in the Control Panel menu. (See "Specifying the Cutting Method for Rolls.") [→P.554](#)

l Feed button

Pressing this button when rolls are loaded enables you to reposition the paper. (See "Feeding Roll Paper Manually.") [→P.551](#)

m Load button

Press this button when loading or replacing paper.

(See "Loading Rolls in the Printer.") [→P.541](#)

(See "Loading Sheets in the Printer.") [→P.563](#)

n Roll Media lamp (green)

Lit when rolls are selected as the paper source.

o Cut Sheet lamp (green)

Lit when sheets are selected as the paper source.



Note

- To recover from Sleep mode, any button can be pressed on the Control Panel.



Control Panel Display

After the printer starts up, the **Tab Selection screen** is displayed.

Each of the four tabs presents status, menus, and error information related to the particular tab.

Types of tabs

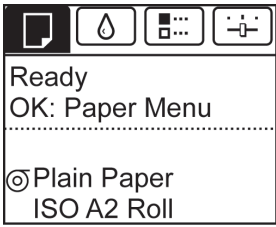
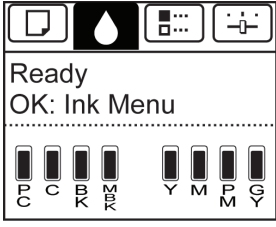
The **Tab Selection screen** presents four tabs. Each tab is represented by an icon in the top row. Press the ◀ or ▶ button to access other tabs.

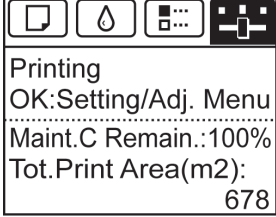
<p>Paper tab</p> 	<p>A tab indicating status and showing menus related to paper. Pressing the OK button when this tab is highlighted will display the Paper Menu.</p> <ul style="list-style-type: none"> • Top line displayed The paper icon is highlighted. • Middle line displayed Indicates the printer status and shows menu names. • Bottom line displayed The first and second lines display the paper type and size.
<p>Ink tab</p> 	<p>A tab indicating status and showing menus related to ink. Pressing the OK button when this tab is highlighted will display the Ink Menu.</p> <ul style="list-style-type: none"> • Top line displayed The ink icon is highlighted. • Middle line displayed Indicates the printer status and shows menu names. • Bottom line displayed Here, the remaining ink level is indicated. (See "Checking Ink Tank Levels.") →P.844
<p>Job tab</p> 	<p>A tab indicating status and showing menus related to print jobs. Pressing the OK button when this tab is highlighted will display the Job Menu menu.</p> <ul style="list-style-type: none"> • Top line displayed The job icon is highlighted. • Middle line displayed Indicates the printer status and shows menu names.
<p>Settings/Adj. tab</p> 	<p>A tab indicating status and showing menus related to settings and adjustment. Pressing the OK button when this tab is highlighted will display the Set./Adj. Menu.</p> <ul style="list-style-type: none"> • Top line displayed The settings/adjustment icon is highlighted. • Middle line displayed Indicates the printer status and shows menu names. • Bottom line displayed The remaining Maintenance Cartridge capacity is shown on the first line and Tot.Print Area on the second. The display unit for Tot.Print Area can be specified in the Length Unit menu. (See "Menu Settings.") →P.675

Printer status and modes

Printer status is classified according to the following five modes.

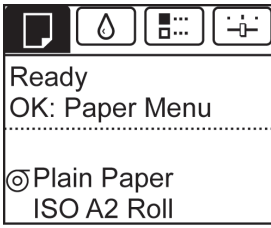
<p>Standby</p>  <p>Ready OK: Paper Menu</p> <hr/> <p>Ⓞ Plain Paper ISO A2 Roll</p>	<p>The printer is ready to receive jobs sent from the computer. Jobs sent from the computer are printed immediately.</p>
--	--

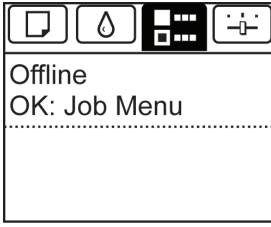
<p>Printing Paused</p>  <p>Offline OK: Job Menu</p>	<p>Printing is paused on the printer. Any jobs sent from the computer are held without being printed.</p>
---	---

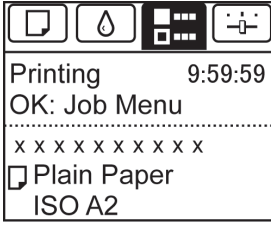
<p>Printing</p>  <p>Printing 9:59:59 OK: Job Menu</p> <hr/> <p>x x x x x x x x x x</p> <p>□ Plain Paper ISO A2</p>	<p>Printing is in progress on the printer. Jobs sent from the computer are printed after the current job. The time left until printing is finished is indicated in the upper-right corner of the screen. (Values exceeding 10 hours are not shown.)</p>
---	---

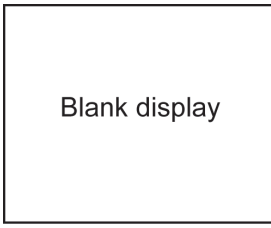
<p>Sleep</p>  <p>Blank display</p>	<p>The printer is in power-saving mode. The printer automatically enters Sleep mode to conserve power when idle for a specific period (by default, five minutes), that is, if no print jobs are received or buttons are pressed while all covers are closed.</p> <p>You can specify the period before the printer enters Sleep mode in the Sleep Timer menu. (See "Menu Settings.") →P.675</p> <p>After entering Sleep mode from Standby mode, the printer automatically recovers if print jobs are received, and the jobs are printed.</p>
--	---

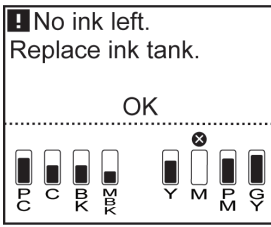
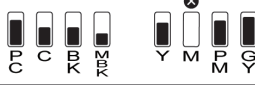
<p>Error</p>  <p>No ink left. Replace ink tank.</p> <hr/> <p>OK</p> 	<p>The printer requires your attention. Any jobs sent from the computer cannot be processed. The tab related to the error is displayed.</p> <p>For information about the display in the case of multiple errors, see "Display Transitions in Error Status."</p>
---	---

Display Transitions in Normal Status

The display transitions while the printer is in the normal status (the status where no errors have occurred) are shown below.

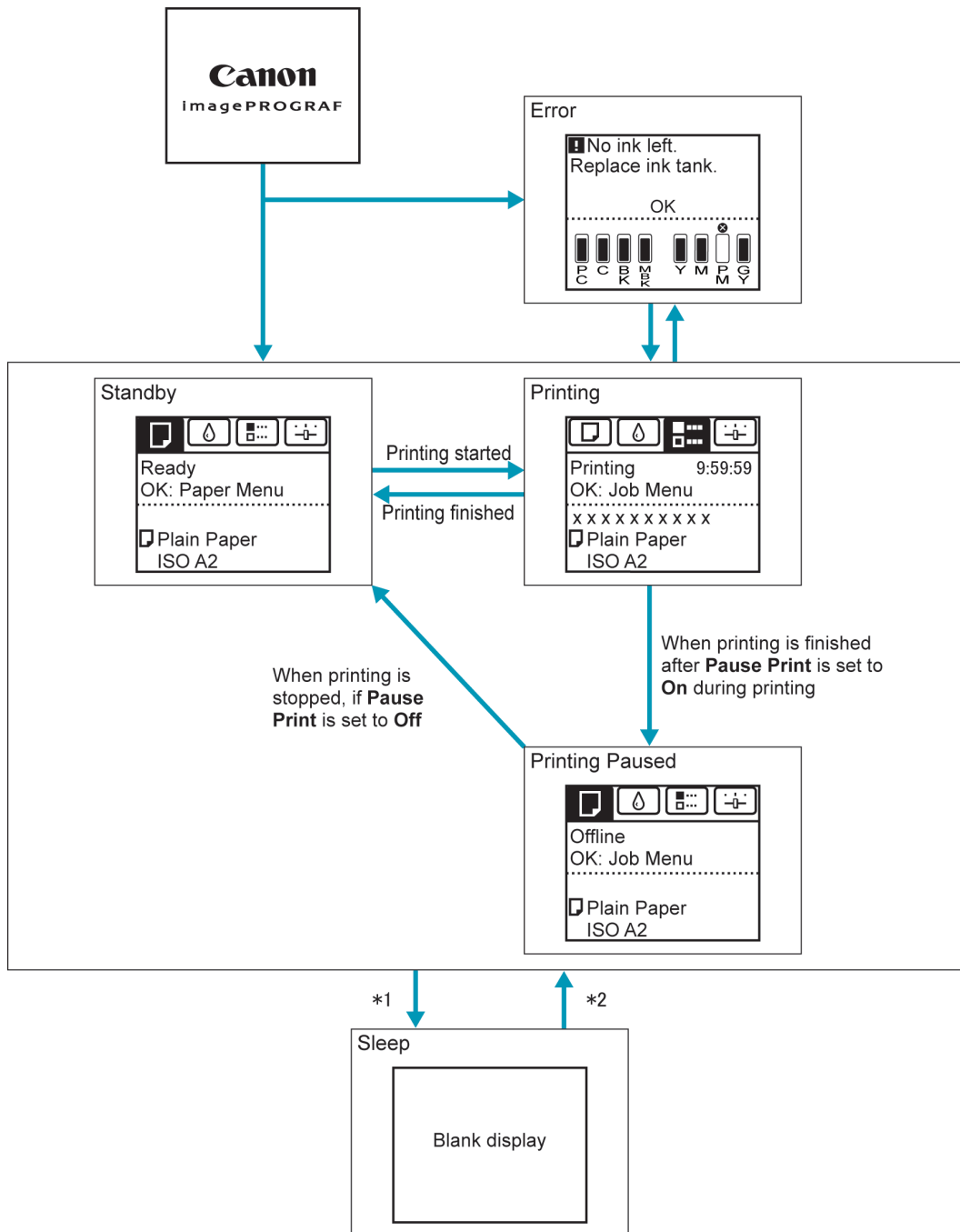

- *1: The printer automatically enters **Sleep** mode when idle for a specific period (by default, five minutes), that is, if no print jobs are received or buttons are pressed while all covers are closed. However, it does not enter **Sleep** mode while error messages are displayed or when a roll can be manually advanced by pressing the **Feed** button.
- *2: When the printer is in **Sleep** mode, you can press any button except the **Power** button to recover from **Sleep** mode. **Sleep** mode is also terminated if a print job is received or a command is issued from RemoteUI.

Display Transitions in Error Status

The display transitions while an error has occurred on the printer are shown below.

If multiple errors have occurred, the tabs for errors that have occurred other than the currently displayed error are displayed flashing. You can move between the tabs to check the errors by pressing the ◀ and ▶ keys. If multiple errors have occurred in the Job tab and Settings/Adj. tab, the error message switches every four seconds within each tab.

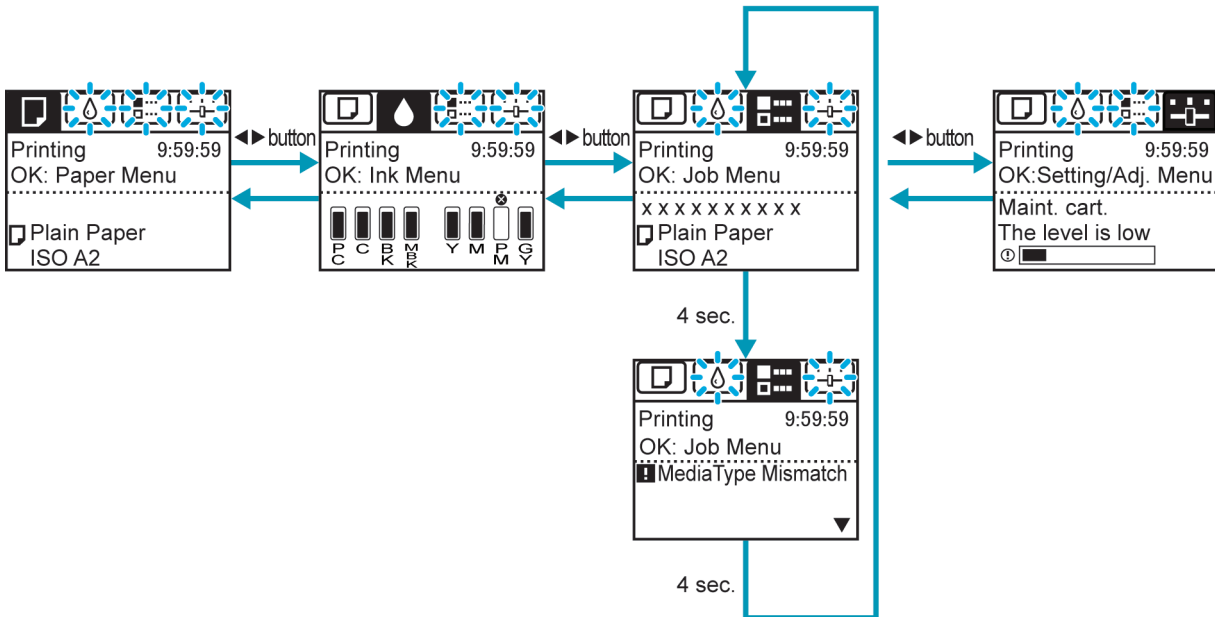

How to View Instructions With Navigate

You can refer to instructions for loading paper, replacing ink tanks, and performing other operations on the printer control panel.

- 1 Press the **Navigate** button.
- 2 Press ▲ or ▼ to select the desired navigation menu.
- 3 Press ▲ or ▼ to select **View Op. Guide**, and then press the **OK** button. Instructions are now displayed.

Example: Loading sheets

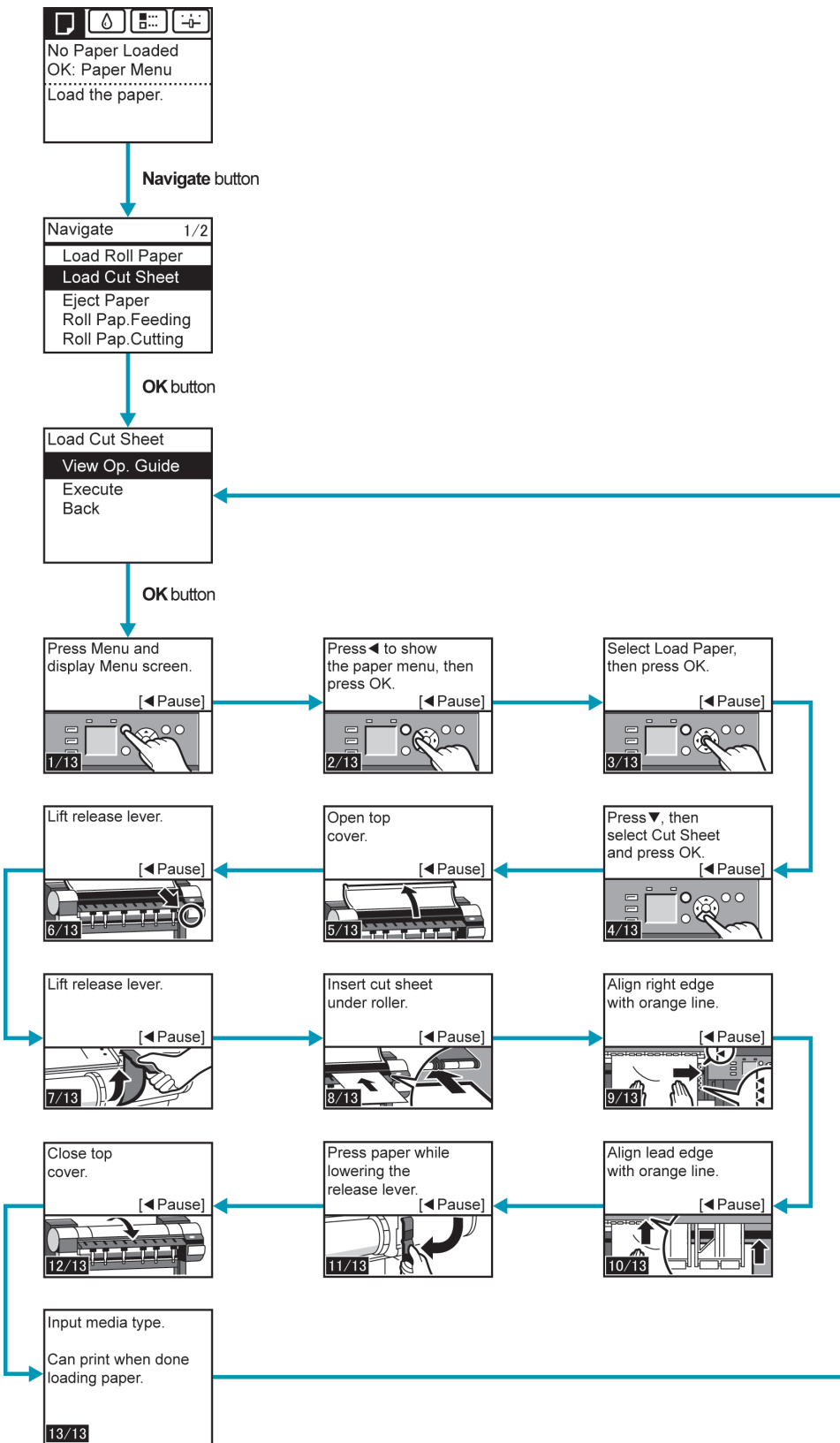

Control Panel

Operations and Display Screen

Checking Instructions During Printer Operations

You can refer to instructions on the printer control panel when loading paper, replacing ink tanks, or performing other operations.

How to view instructions

Once you complete an action described in the instructions, the printer detects the action and switches to the next instruction screen.

In the case of actions the printer cannot detect, instruction screens are switched every four seconds, and the sequence of operations is shown repeatedly.

When all actions in the sequence are finished, the instruction screen for the next step is displayed.

Example: Ink tank replacement

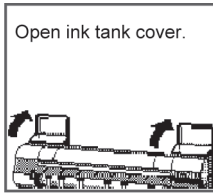

Automatically detected by the printer

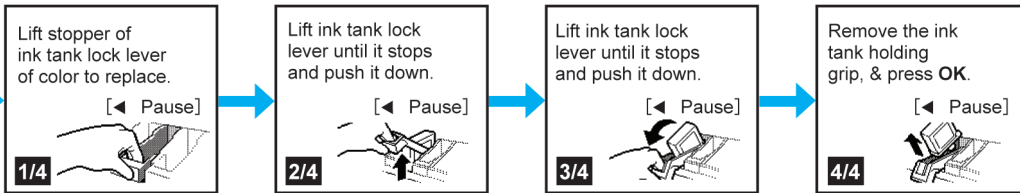

OK button

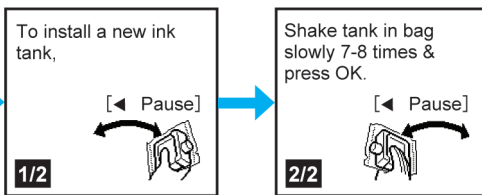

OK button

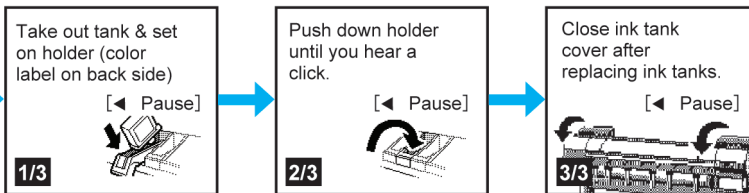

Automatically detected by the printer

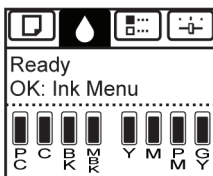

- During a continuous display of instructions, you can press the ◀ button to pause the instructions on the current screen. Press the ◀ or ▶ button to display the previous or next screens. If you do not press the ◀ or ▶ button within 30 seconds, continuous display is resumed. Press the OK button to display the instruction screen for the next step.

Printer Menu

Printer Menu Operations	665
Menu Operations	666
Menu Structure	669
Menu Settings	675
Status Print	684
Printing Interface Setting Reports	687

Printer Menu Operations

The printer menu is classified into regular menu items available when no print job is in progress and menu during printing items only available while printing is in progress.

- Regular menu operations →P.665
- Menu operations during printing →P.665

Regular menu operations

To view available menus organized on tabs, select a tab on the **Tab Selection screen** and press the **OK** button.



- If the **Tab Selection screen** is not displayed, pressing **OK** will not display menus. Menus can be selected after you resolve the problem.

The following operations are available from the menu.

- **Paper Menu**
Paper menu settings
- **Ink Menu**
Ink menu operations
- **Job Menu**
Menu operations to manage print jobs
- **Set./Adj. Menu**
Menu operations for printer adjustment and maintenance

For a description of specific menu items available, see "Menu Settings." →P.675

For instructions on selecting menu items, see "Menu Operations." →P.666



- By default, menu settings apply to all print jobs. However, for settings that are also available in the printer driver, the values specified in the printer driver take priority.

Menu operations during printing

During printing, only a limited set of menu items are displayed. Menu items that are not displayed during printing should be operated after printing has finished.

To display menus during printing, select a tab on the **Tab Selection screen** on the Control Panel, and then press the **OK** button.



- If the **Tab Selection screen** is not displayed, pressing **OK** will not display menus. Menus can be selected after you resolve the problem.

The following operations are available from the menu during printing.

- **Ink Menu**
Ink menu operations
- **Job Menu**

Menu operations to manage print jobs

- **Set./Adj. Menu**
 Fine-tuning paper feeding
 Display of printer-related information

For a description of specific menu items available, see "Menu Settings." →P.675

For instructions on selecting menu items during printing, see "Menu Operations." →P.666

Menu Operations

To view available menus organized on tabs, select a tab on the **Tab Selection screen** and press the **OK** button. For details, see "Menu Settings." →P.675

- Menus (when the Ink tab is selected and the **OK** button is pressed)

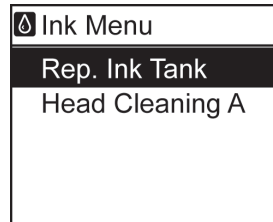

Note

- If the **Tab Selection screen** is not displayed, press the **Menu** button.

Simply press buttons on the Control Panel to access menus on various tabs from the **Tab Selection screen** and set or execute **Menu** items.

The following section describes menu operations.

- Accessing menus →P.666
- Specifying menu items →P.667
- Specifying numerical values →P.668
- Executing menu commands →P.668

Accessing menus

Printer menus are grouped by function.

Menus are displayed with the upper line selected. You can use the buttons on the Control Panel to access each menu.

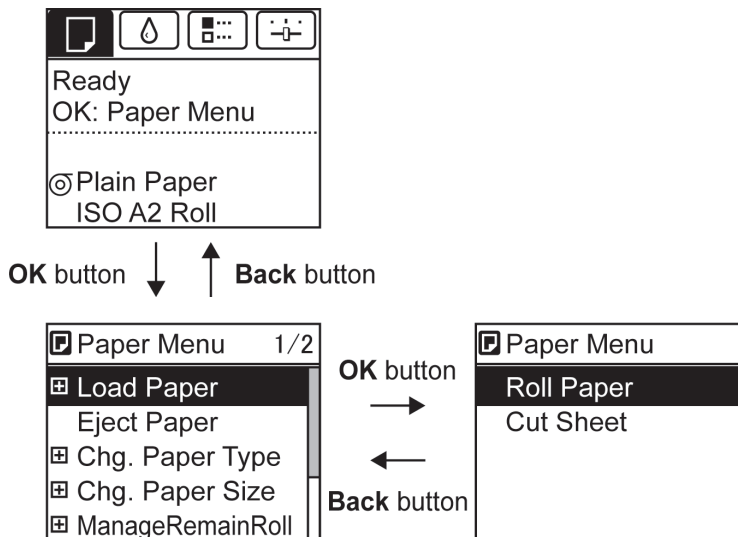

- Press **Back** to access a higher menu in the menu list, and press **OK** to access a lower one. If not all menu items are displayed, hold down **▲** or **▼** to scroll through higher and lower menu items. Items you select are highlighted.

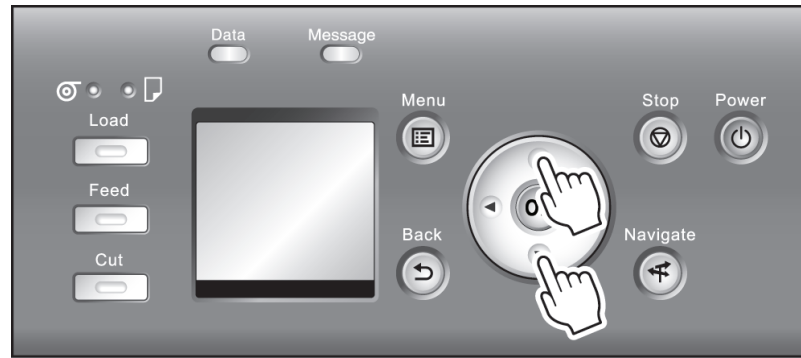

The scroll bar at right indicates the current position in the overall menu.

- Lower menus are available if **+** is displayed at left next to the second and subsequent rows. To access the lower menus, select the menu and press the **OK** button.

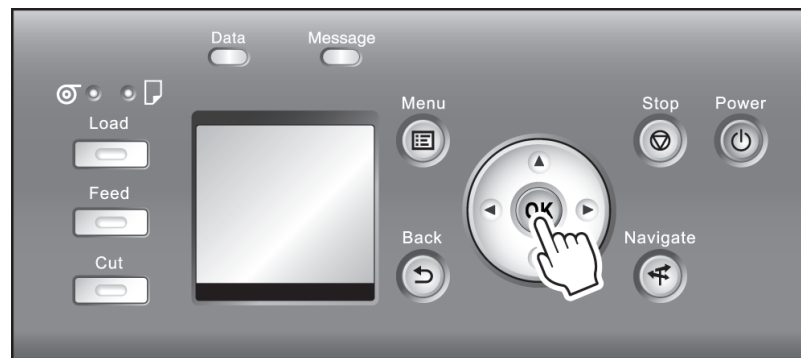

Specifying menu items

Menu items can be set as follows.

- Press **▲** or **▼** to select the desired setting, and then press the **OK** button. After two seconds, the display reverts to the upper level menu.

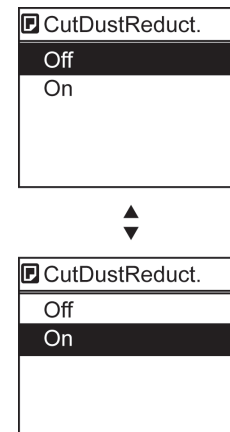

Note

- If a confirmation message is displayed regarding the setting you entered, press the **OK** button. The setting is applied, and the printer is now in **Standby**.

Specifying numerical values

Follow these steps to enter numbers. In this example, network settings items are entered.

- 1 Press the ◀ or ▶ button to move to the next field for input.

IPv4 Settings
000. 000. 000. 000
◀▶ : L/R
▼▲ : UP/DOWN
OK: Select

- 2 Press the ▲ or ▼ button to enter the value.



Note

- Hold down ▲ or ▼ to increase or decrease the value continuously.

- 3 Repeat steps 1 and 2 to complete the settings, and then press the **OK** button.



Note

- If a confirmation message is displayed regarding the setting you entered, press the **OK** button. The setting is applied, and the printer is now in **Standby**.

Executing menu commands

Menu commands can be executed as follows.

- 1 Press ▲ or ▼ to select the action to execute, and then press the **OK** button.
The menu command is now executed.

Menu Structure

The menu structure is shown categorized by tab. The * on the right side of an item indicates the default value. The printer menu is classified into regular menu items available when no print job is in progress and menu during printing items only available while printing is in progress. see "Printer Menu Operations." →P.665

Regular menu	Menu during printing
Paper Menu	Not displayed
Ink Menu	The same Ink Menu as normal is displayed.
Job Menu	The same Job Menu as normal is displayed.
Set./Adj. Menu	A limited Set./Adj. Menu containing the following items is displayed. <ul style="list-style-type: none"> • Adj. Fine Feed (*1) • Printer Info

*1: Only displayed in the menu during printing. Not displayed in the regular menu.

For instructions on menu operations, see "Menu Operations." →P.666

For details on menu items, see "Menu Settings." →P.675

Paper Menu

The **Paper Menu** is not displayed during printing.

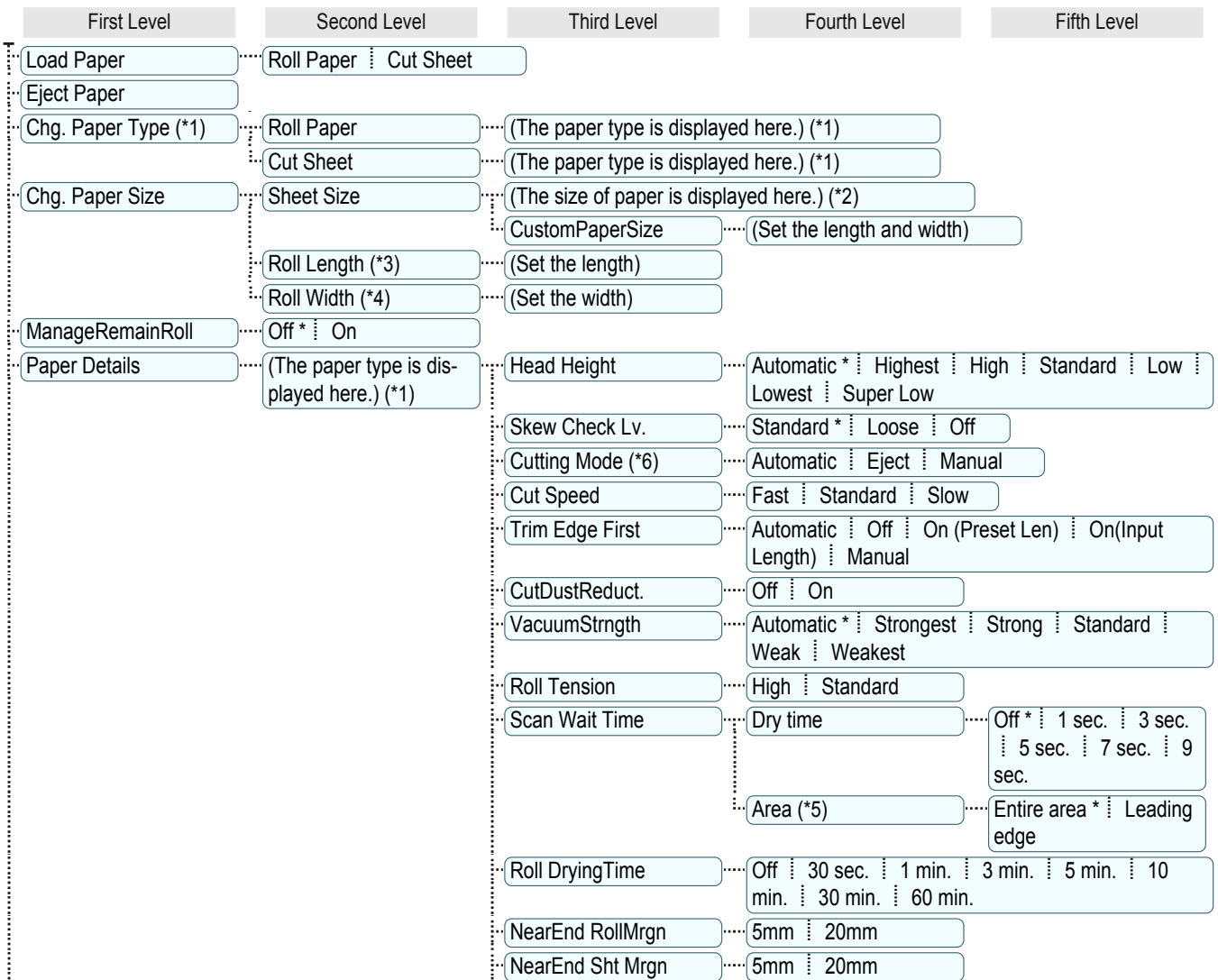

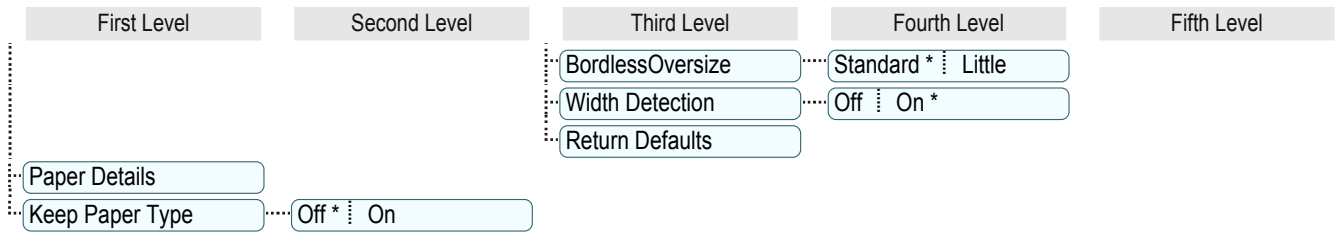

*1: For information on the types of paper the printer supports, refer to the Paper Reference Guide. (See Paper Reference Guide.) Types of paper in the printer driver and related software (as well as on the Control Panel) are updated when you install the printer driver from the User Software CD-ROM or if you update paper information with the Media Configuration Tool. (See "Updating paper information.")

→P.536

*2: For information on the sizes of paper the printer supports, see "Paper Sizes." →P.530

*3: Available only if **ManageRemainRoll** is **On**.

*4: Available only if **Width Detection** is **Off**.

*5: **Leading edge** is not available as a setting option in the **Paper Detailed Settings** dialog box of the printer driver.

*6: see "Specifying the Cutting Method for Rolls." →P.554

Ink Menu

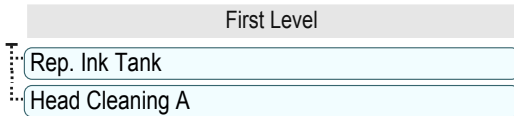

Job Menu

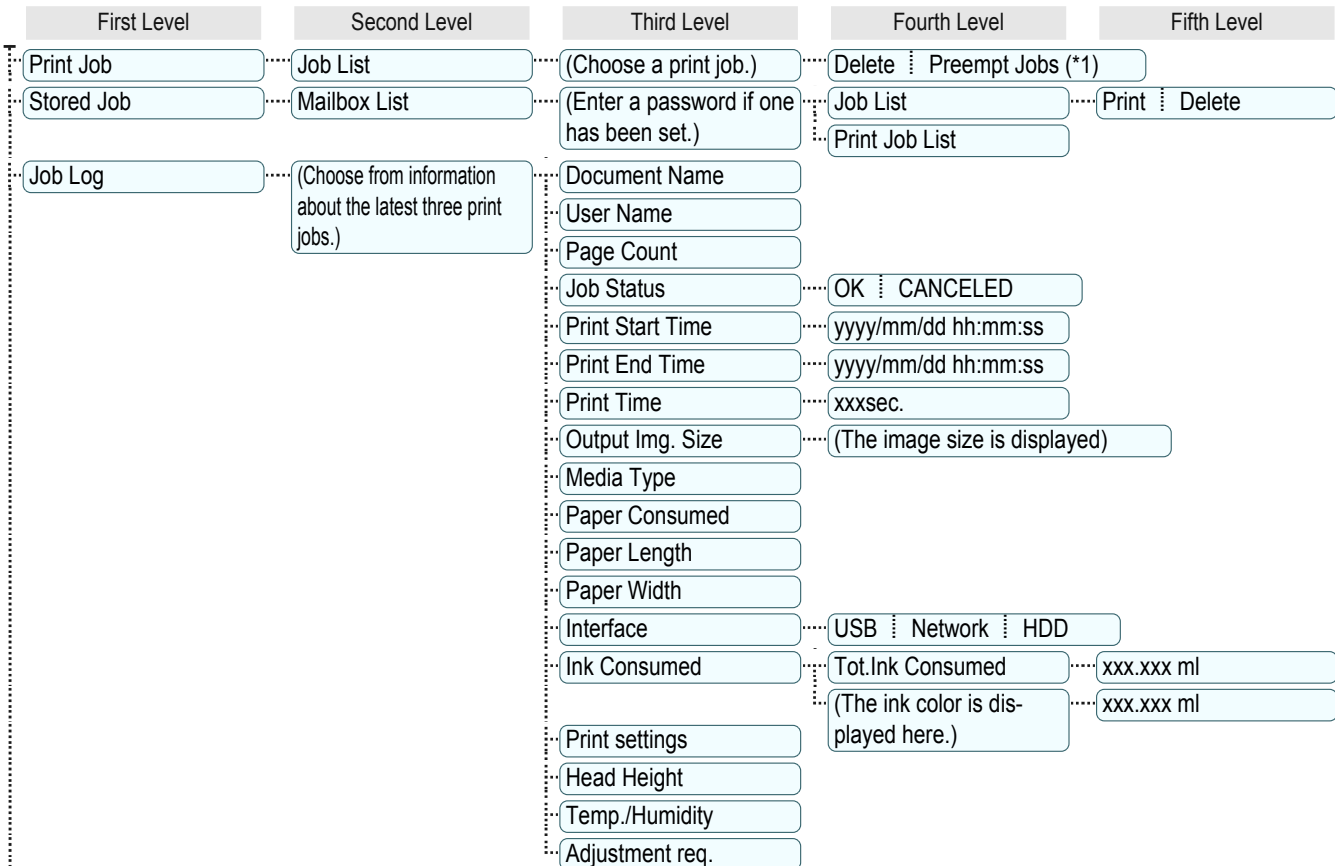

Control Panel

Printer Menu

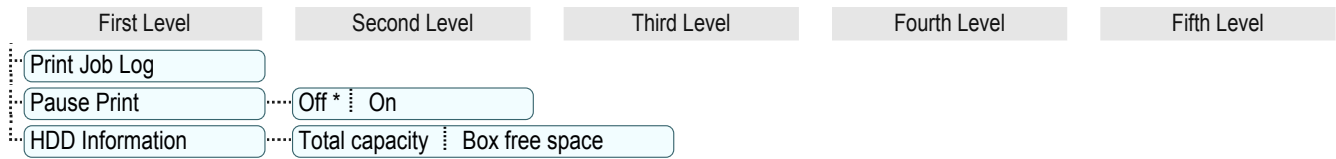

*1: If a pending job is selected, **Print Anyway** is displayed.



Set./Adj. Menu

Limited items are displayed during printing. The displayed items are indicated by annotations.

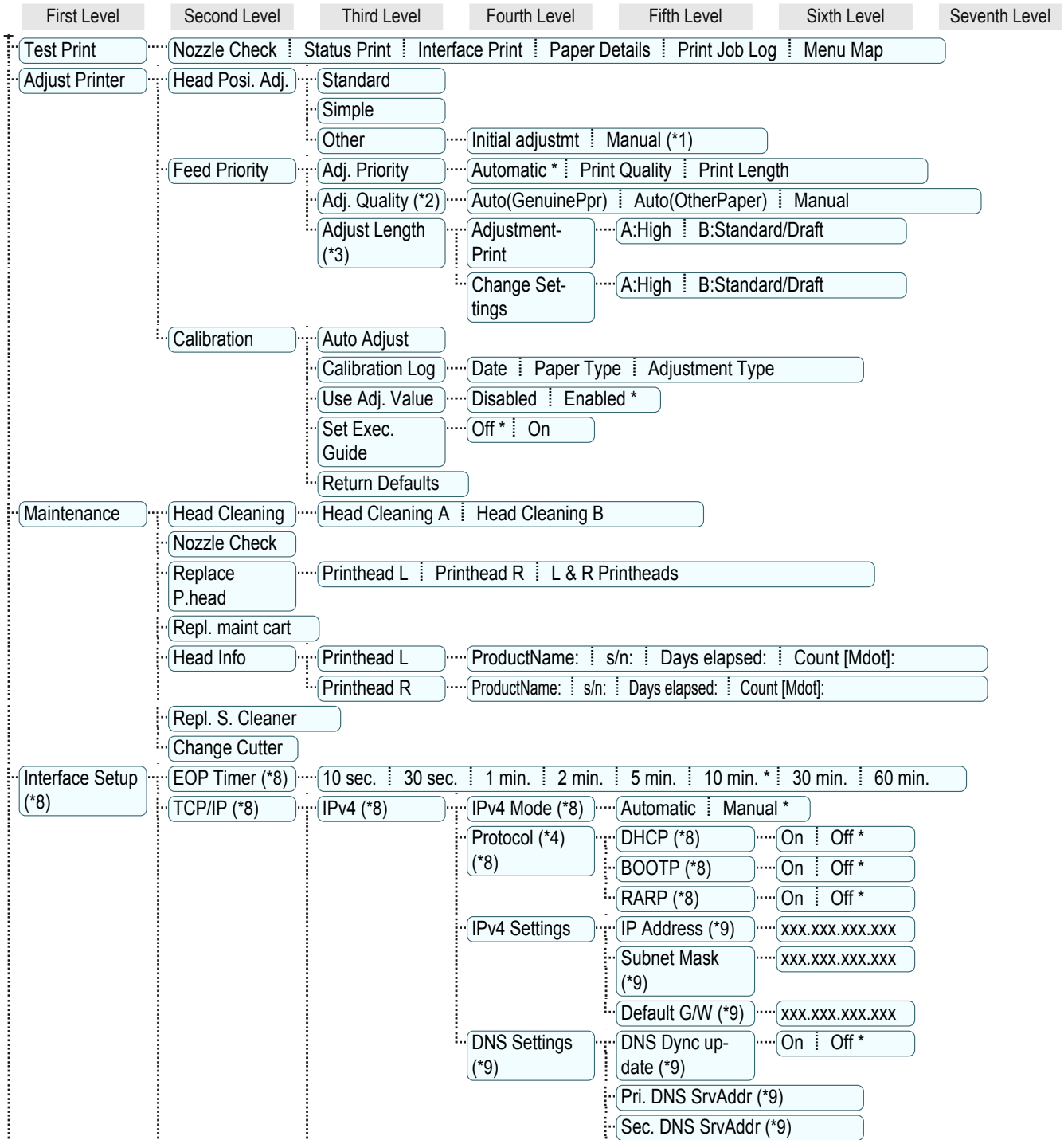

Control Panel

Printer Menu

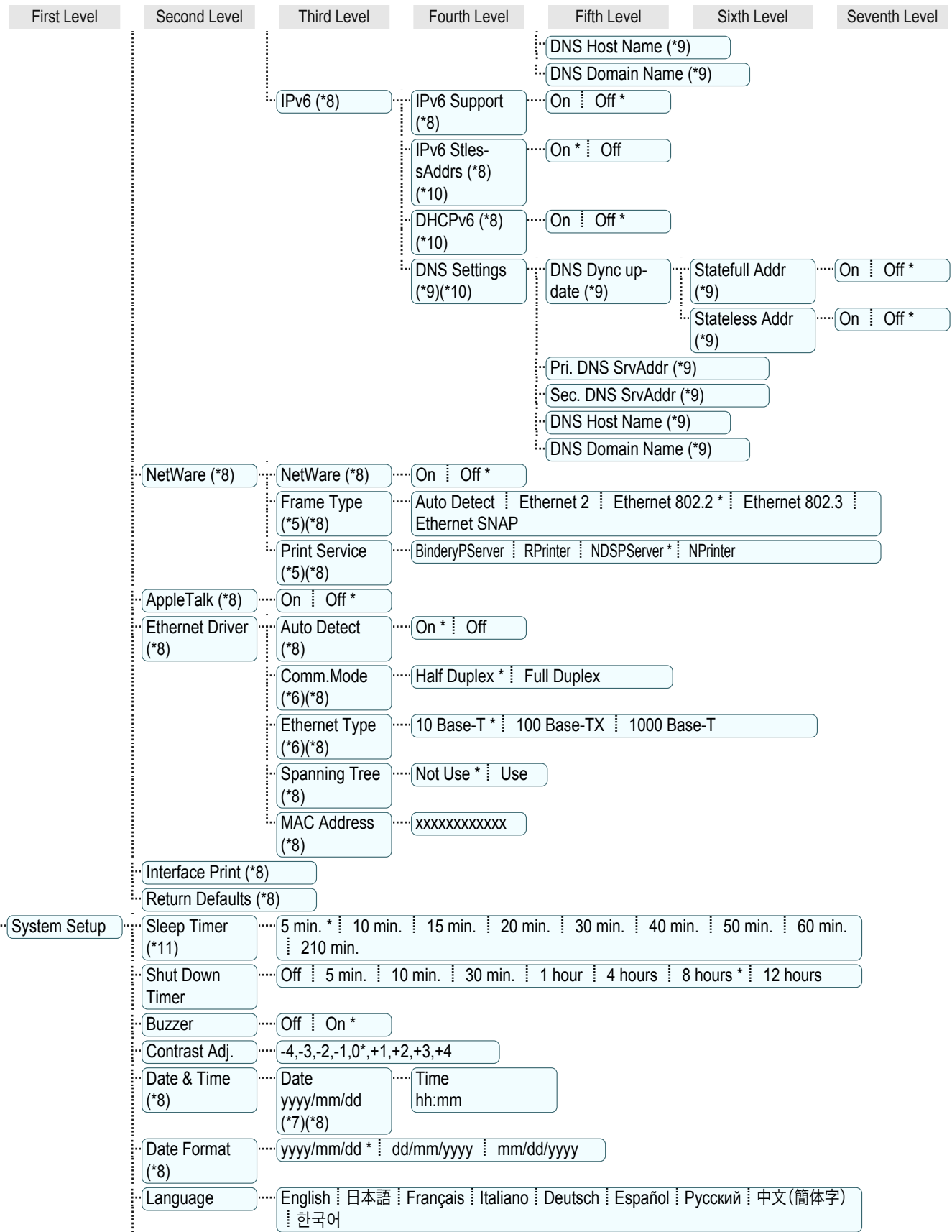

Control Panel
Printer Menu

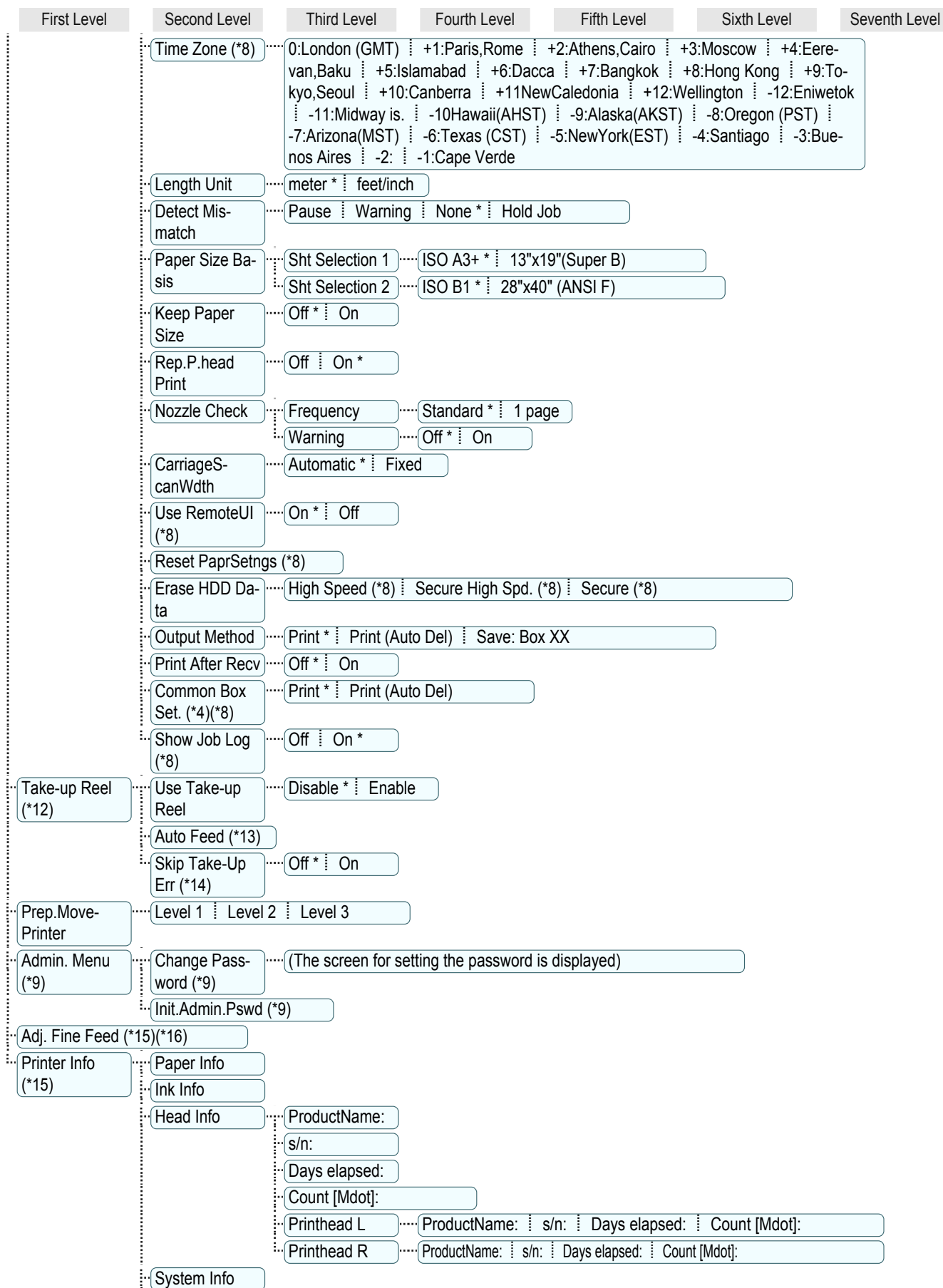

First Level

Second Level

Third Level

Fourth Level

Fifth Level

Sixth Level

Seventh Level

Error Log

Other Counter

- *1: Available after you have used **Standard** or **Initial adjustmt** in **Head Posi. Adj.** once.
- *2: Available if **Adj. Priority** is **Automatic** or **Print Quality**.
- *3: Available if **Adj. Priority** is **Automatic** or **Print Length**.
- *4: Not displayed if **IPv4 Mode** is **Manual**.
- *5: Not displayed if **NetWare** is **Off**.
- *6: Not displayed if **Auto Detect** is **On**.
- *7: Follows the setting in **Date Format**.
- *8: Viewing and configuration is possible for administrators, and only viewing for other users.
- *9: Viewing and configuration is possible for administrators only.
- *10: Not displayed if **IPv6 Support** is **Off**.
- *11: Default setting for the time to enter the power save mode/Sleep mode is recommended.
- *12: Displayed only when the Media Take-up Unit is attached.
- *13: Available if: (a) **Use Take-up Reel** is **Enable**, (b) roll paper is loaded, and (c) you have not executed **Auto Feed** for the loaded roll.
- *14: Available when **Use Take-up Reel** is **Enable**.
- *15: Displayed as the menu during printing while printing is in progress.
- *16: Not displayed in the regular menu.

Menu Settings

Menu items are as follows.

The printer menu is classified into regular menu items available when no print job is in progress and menu during printing items only available while printing is in progress. see "Printer Menu Operations." →P.665

Regular menu	Menu during printing
Paper Menu	Not displayed
Ink Menu	The same Ink Menu as normal is displayed.
Job Menu	The same Job Menu as normal is displayed.
Set./Adj. Menu	A limited Set./Adj. Menu containing the following items is displayed. <ul style="list-style-type: none"> • Adj. Fine Feed (*1) • Printer Info

*1: Only displayed in the menu during printing. Not displayed in the regular menu.

For instructions on selecting menu items, see "Menu Operations." →P.666

For details on the displayed menu hierarchy, see "Menu Structure." →P.669

Paper Menu

The **Paper Menu** is not displayed during printing.

Setting Item	Description, Instructions	
Load Paper	Select either sheets or rolls and load the paper.	
Eject Paper	Choose this item before removing loaded paper.	
Chg. Paper Type (*1)	Change the type of paper loaded. (See "Changing the Type of Paper.") →P.545	
Chg. Paper Size	Change the size of paper loaded. (See "Specifying the Paper Length.") →P.547 (See "Paper Sizes.") →P.530	
ManageRemainRoll	Choose On to print a barcode at the end of a roll before you remove it. The printed barcode can be used in managing the amount of roll paper left. Choose Off if you prefer not to print the barcode. (See "Keeping Track of the Amount of Roll Paper Left.") →P.552	
Paper Details (The type of paper is displayed here.) (*1)	Head Height	Adjust the Printhead height. (See "Troubleshooting Paper Abrasion and Blurry Images.") →P.811
	Skew Check Lv.	If you print on Japanese paper (washi) or other handmade paper that has an irregular width, choose Loose for a higher skew detection threshold, or choose Off to disable skew detection. However, if paper is loaded askew when detection is Off , note that paper jams or Platen soiling may occur.
	Cutting Mode	Specify whether or not to cut with the standard round-bladed cutter. If you choose Automatic , the roll will be cut automatically using the Cutter Unit, depending on the printer driver settings. Select Eject to prevent printed documents from falling immediately after printing such as when you wait for the ink to dry, etc. Manual prints lines at the cut position instead of cutting after printing. If you select Manual , the setting screen for detection of the paper leading edge is displayed. (See "Specifying the Cutting Method for Rolls.") →P.554
	Cut Speed	Choose the cutting speed. The preset selection represents the optimal cutting speed for the type of paper. We recommend keeping the preset cutting speed. If you use adhesive paper, choosing Slow helps prevent adhesive from sticking to the cutter and keeps the cutter sharp.

Setting Item		Description, Instructions	
Paper Details	(The type of paper is displayed here.) (*1)	Trim Edge First	Selects whether or not to automatically cut the leading edge of the roll paper when roll paper is loaded. (See "Cutting the Leading Edge of Roll Paper Automatically.") →P.560
		CutDustReduct.	If you choose On , a line will be printed at the cut position when paper cutting is selected. This option reduces the amount of debris given off after cutting. It also helps prevent adhesive from sticking to the cutter and keeps the cutter sharp if you use adhesive paper. (See "Reducing Dust from Cutting Rolls.") →P.562
		VacuumStrngth	Specify the level of suction that holds paper against the Platen. (See "Adjusting the Vacuum Strength.") →P.819
		Roll Tension	Adjust the slack of the roll paper loaded in the printer. If there is slack in thin roll paper and the paper is becoming scratched, or wrinkles or creases are occurring, set this to High to make it harder for slack to occur, and reduce the amount of scratches, etc. If you change the Roll Tension setting, We recommend that you perform Adj. Quality . (See "Automatic Banding Adjustment.") →P.814
		Scan Wait Time	Specify the time to wait for the ink to dry between each scan (after the printhead finishes moving in one direction), in consideration of how quickly the ink dries. Also specify the applicable area for the ink drying time. Select Entire area to apply the ink drying time after each scan until the document is fully printed. Select Leading edge to apply the ink drying time after each scan only in the area 110–160 mm from the leading edge. (The applicable length varies depending on the Print Quality setting.) Note that printing will take longer if you specify the Scan Wait Time setting. In particular, when Leading edge is selected, colors may be uneven in the boundary between the areas with and without a drying time.
		Roll DryingTime	Specify the time to wait for the ink to dry for each sheet.
		NearEnd RollMrgn	Specify the minimum margin at the leading edge of roll paper to ensure better printing quality at the leading edge. Note that if you choose 5mm , it may lower the printing quality at the leading edge and affect feeding accuracy. The printed surface may be scratched, and ink may adhere to the leading edge. It may also cause the Platen to become soiled.
		NearEnd Sht Mrgn	Specify a margin at the leading edge of sheets to ensure better printing quality at the leading edge. Note that if you choose 5mm , it may lower the printing quality at the leading edge and affect feeding accuracy. The printed surface may be scratched, and ink may adhere to the leading edge.
		"BordlessOver-size"	Select the amount of oversize extension of the original during borderless printing. Normally, we recommend that you set this to Standard . If it is set to "Little" , although it will reduce soiling on the back surface, white patches may remain on the printed surface.
		Width Detection	Specify this option to print inside boundaries or in other cases when specifying a particular starting position for printing. Paper width and skew are not detected if you select Off . If paper is loaded askew, paper jams or Platen soiling may occur.
	Return Defaults	Choose OK to restore Paper Details to the default values.	
Paper Details		Print the paper settings as specified in Paper Details .	
Keep Paper Type		Select On when printing on a particular type of paper regularly. (See "Changing the Type of Paper.") →P.545	

*1: For information on the types of paper the printer supports, refer to the Paper Reference Guide. (See Paper Reference Guide.) Types of paper in the printer driver and related software (as well as on the Control Panel) are updated when you install the printer driver from the User Software CD-ROM or if you update paper information with the Media Configuration Tool. (See "Updating paper information.")

→P.536

Ink Menu

Setting Item	Description, Instructions
Rep. Ink Tank	Replace the Ink Tank at this point. Follow the instructions displayed to complete the required procedure. (See "Replacing Ink Tanks.") →P.834
Head Cleaning A	Printhead cleaning options. (See "Cleaning the Printhead.") →P.847 Execute Head Cleaning A if printing is faint, oddly colored, or contains foreign substances.

Job Menu

Setting Item		Description, Instructions			
Print Job	Job List	(Choose a print job)	Delete	Delete the current job or queued jobs. (See "Managing the Job Queue (Deleting or Preempting Other Jobs).") →P.767	
			Preempt Jobs	Print the job first after the current print job is finished. (See "Managing the Job Queue (Deleting or Preempting Other Jobs).") →P.767	
Stored Job	Mailbox List	(Enter a password if one has been set.)	Job List	Print	Print the saved job.
				Delete	Delete the saved job.
			Print Job List		Print a list of saved print jobs.
Job Log	(Choose from information about the last three print jobs.)	Document Name		Indicates the document name of the selected print job.	
		User Name		Indicates the name of the user who sent the print job.	
		Page Count		Indicates the number of pages in the job.	
		Job Status		Indicates the printing results.	
		Print Start Time		Indicates when the print job was started.	
		Print End Time		Indicates when the print job was finished.	
		Print Time		Indicates the time required to print the job.	
		Output Img. Size		Indicates the image size in the print job.	
		Media Type		Indicates the type of paper in the print job.	
		Paper Consumed		Indicates the total amount of paper consumed.	
		Paper Length		Indicates the length of paper.	
		Paper Width		Indicates the width of paper.	
		Interface		Indicates the interface used for the print job.	
		Ink Consumed		Indicates a rough estimate of how much ink was consumed per job. (*1)	
		Print settings		A counter for maintenance purposes. Indicates job print settings.	
Head Height		A counter for maintenance purposes. Indicates the head height when jobs were printed.			
Temp./Humidity		A counter for maintenance purposes. Indicates the temperature and humidity when jobs were printed.			
Adjustment req.		A counter for maintenance purposes. Indicates adjustment conditions applied to jobs.			

Setting Item	Description, Instructions
Print Job Log	Print a record of print jobs, including the paper type and size, amount of ink consumed, and so on. Ink consumption indicates a rough estimate of the amount of ink consumed per print job.(*1)
Pause Print	Choose On to stop printing.
HDD Information	Indicates the total hard disk capacity and the mail box free space.

*1: A rough estimate of the amount of ink consumed per print job is displayed. Actual ink consumption may be different. The average margin of error for estimates calculated according to Canon measurement conditions for ink costs is $\pm 15\%$. Canon does not guarantee the accuracy of these estimates. Estimates may vary depending on conditions of use. Calculation of these estimates does not include ink consumed when cleaning printheads by forceful ejection of ink.

Set./Adj. Menu

Limited items are displayed during printing. The displayed items are indicated by annotations.

Setting Item	Description, Instructions		
Test Print	Nozzle Check	Print a test pattern to check the nozzles.	
	Status Print	Print information about the setting values and condition of the printer.	
	Interface Print	Print interface settings information.	
	Paper Details	Print the paper settings as specified in Paper Details .	
	Print Job Log	Print a record of print jobs, including the paper type and size, amount of ink consumed, and so on. Ink consumption indicates a rough estimate of the amount of ink consumed per print job. (*1)	
	Menu Map	Print the menu structure.	
Adjust Printer	Head Posi. Adj.	Standard	An adjustment pattern is printed and the print position is automatically adjusted to fix misaligned printing. Select Standard if vertical lines in printed material are warped or colors are out of alignment. Select Standard also if the printing results are not improved by executing Simple . (See "Automatic Adjustment to Straighten Lines and Colors.") →P.806
		Simple	An adjustment pattern is printed and the print position is automatically adjusted to fix misaligned printing. Simple executes a simple adjustment in a short time. Select Simple when frequently adjusting the printhead, such as during daily maintenance. (See "Automatic Adjustment to Straighten Lines and Colors.") →P.806
	Other	Initial adjustmt	Printhead position adjustment is executed during the initial setup. If adjusting the printhead position has not been performed such as due to an error during initial setup or the state of the operating settings when replacing the printhead, select Initial adjustmt . (See "Adjustment When Installing the Printhead.") →P.810
		Manual	Input the setting values from the adjustment pattern printing results and adjust the printing position to fix misaligned printing. Normally, select Standard . However, when printing on special paper, or if printing is not improved after Standard , try Manual . (See "Manual Adjustment to Straighten Lines and Colors.") →P.808

Setting Item			Description, Instructions		
Adjust Printer	Feed Priority	Adj. Priority	Automatic	Specify exact paper feeding, if desired. Normally, select Automatic . Choose Print Quality for attractive printing. Choosing Print Quality also makes banding less noticeable. Choose Print Length if you prefer to feed the paper an exact amount. However, note that slight banding may occur in the direction of carriage scanning when Print Length is selected.	
			Print Quality		
			Print Length		
		Adj. Quality	Auto(GenuinePpr)	Specify this mode with paper identified in the Paper Reference Guide.(See Paper Reference Guide.) The printer prints and reads a test pattern for automatic adjustment of the feed amount. (See "Automatic Banding Adjustment.") →P.814	
			Auto(OtherPaper)	Specify this mode with paper not in the Paper Reference Guide.(See Paper Reference Guide.) The printer prints and reads a test pattern for automatic adjustment of the feed amount. Note that this function takes more time and consumes more ink than Auto(GenuinePpr) . (See "Automatic Banding Adjustment.") →P.814	
			Manual	Use this mode with highly transparent media or other paper for which Auto(GenuinePpr) or Auto(OtherPaper) cannot be used. Print a test pattern for adjustment of the feed amount based on the type of paper. (See "Manual Banding Adjustment.") →P.815	
		Adjust Length	Adjustment-Print	A:High	Print a test pattern for particular types of paper to compensate for paper stretching or shrinkage, after which you enter the amount of adjustment. (See "Adjusting Line Length.") →P.818
				B:Standard/Draft	
			Change Settings	A:High	Displayed when you have selected Feed Priority > Adj. Priority > Print Length . Adjustment relative to the amount of stretching or shrinkage of the current paper. Enter either the adjustment results from AdjustmentPrint or the discrepancy that you measured (as a percentage). For paper that tends to stretch, increase the feed amount by choosing a higher adjustment value. For paper that tends to shrink, decrease the feed amount by choosing a lower adjustment value. (See "Adjusting Line Length.") →P.818
				B:Standard/Draft	
Calibration	Auto Adjust		A test pattern for color calibration is printed and the adjustment values are adjusted automatically. (See "Corrects slight differences in how colors appear (color calibration).") →P.828		
	Calibration Log		The Date , Paper Type , and Adjustment Type for which color calibration was executed are displayed on the Display Screen where you can confirm them. Common calibration and unique calibration are the Adjustment Type of color calibration. When paper is set in the printer, the history of effective color calibration for the set paper is displayed. When paper is not set in the printer, the latest history among common calibration or unique calibration is displayed. Also, a hyphen (-) is displayed when there are no execution results. (See "Corrects slight differences in how colors appear (color calibration).") →P.828 (See "Paper that can be used in Color Calibration.") →P.830		

Setting Item			Description, Instructions		
Adjust Printer	Calibration	Use Adj. Value	Choose Disabled > OK if you prefer not to apply the color calibration adjustment value in print jobs. However, printer driver settings are given priority. Choose Enabled > OK to apply the color calibration adjustment value in print jobs. However, printer driver settings are given priority.		
		"Set Exec. Guide"	If you select On , a message is displayed on the control panel at the timing recommended for executing color calibration.		
		Return Defaults	Clear the color calibration adjustment value and the execution log.		
Maintenance	Head Cleaning		Clean the Printhead. (See "Cleaning the Printhead.") →P.847 Choose Head Cleaning A if printing is faint, oddly colored, or contains foreign substances. Choose Head Cleaning B if no ink is printed at all, or if printing is not improved by Head Cleaning A .		
	Nozzle Check		Print a test pattern to check the nozzles.		
	Replace P.head		Execute when replacing the Printhead. Follow the instructions displayed to complete the required procedure. (See "Replacing the Printhead.") →P.848 Not displayed during a warning message that the remaining Maintenance Cartridge capacity is low.		
	Repl. maint cart		Execute when replacing the Maintenance Cartridge. Follow the instructions displayed to complete the required procedure. (See "Replacing the Maintenance Cartridge.") →P.860		
	Head Info	Printhead L	Indicates information about the printhead.		
		Printhead R			
	Repl. S. Cleaner		Replace the Shaft Cleaner. Follow the instructions displayed to complete the required procedure. (See "Replacing the Maintenance Cartridge.") →P.860		
	Change Cutter		Replace the Cutter Unit. Follow the instructions displayed to complete the required procedure. (See "Replacing the Cutter Unit.") →P.856 Once you replace the Cutter Unit, you can also reset the cut counter.		
Interface Setup	EOP Timer		Specify the timeout period before cancellation of print jobs that cannot be received by the printer.		
	TCP/IP	IPv4	IPv4 Mode	Choose whether the printer IP address is configured automatically or a static IP address is entered manually.	
			Protocol	DHCP	Specify the protocol used to configure the IP address automatically.
				BOOTP	
				RARP	
			IPv4 Settings	IP Address	Specify the printer network information when using a static IP address. Enter the IP address assigned to the printer, as well as the network subnet mask and default gateway. The value that was automatically configured is displayed if you have set IPv4 Mode to Automatic .
				Subnet Mask	
				Default G/W	
			DNS Settings	DNS Dync update	Specify whether DNS server registration is updated automatically.
				Pri. DNS SrvAddr	Specify the DNS server address.

Setting Item				Description, Instructions		
Interface Setup	TCP/IP	IPv4	DNS Settings	Sec. DNS SrvAddr	Specify the DNS server address.	
				DNS Host Name	Specify the DNS host name.	
				DNS Domain Name	Specify the DNS domain name.	
		IPv6	IPv6 Support		Specify whether to connect via IPv6.	
			IPv6 StatelessAddrs		Specify whether a IPv6 stateless address is used.	
			DHCPv6		Specify whether DHCPv6 settings are used.	
			DNS Settings	DNS Dync update	Statefull Addr	Specify whether DNS server registration is updated automatically.
					Stateless Addr	
			Pri. DNS SrvAddr		Specify the DNS server address.	
			Sec. DNS SrvAddr			
	DNS Host Name		Specify the DNS host name.			
	DNS Domain Name		Specify the DNS domain name.			
	NetWare	NetWare		Specify the NetWare protocol. To apply your changes, choose Register Setting .		
		Frame Type		Specify the frame type to use.		
		Print Service		Choose the print service.		
	AppleTalk			Specify whether to use the AppleTalk protocol. To apply your changes, choose Register Setting .		
	Ethernet Driver	Auto Detect		Specify the communication method. To apply your changes, choose Register Setting . Choose On for automatic configuration of the LAN communication protocol. Choose Off to use settings values of Comm.Mode and Ethernet Type .		
Comm.Mode		Choose the LAN communication method.				
Ethernet Type		Choose the LAN transfer rate.				
Spanning Tree		Choose whether spanning-tree packets are supported over the LAN.				
MAC Address		Indicates the MAC address.				
Interface Print			Print interface settings information.			
Return Defaults			Choose OK to restore Interface Setup settings to the default values.			
System Setup	Sleep Timer		Specify the period before the printer enters sleep mode.			
	Shut Down Timer		Sets the time until the printer turns off automatically. If no operations are performed on the printer for the duration of the time set in Shut Down Timer after entering Sleep mode, the printer automatically turns off.			
	Buzzer		Choose On for the buzzer to sound once for warnings and three times for errors.			
	Contrast Adj.		Adjust the Display Screen contrast level.			
	Date & Time	Date	Set the current date.			
		Time	Set the current time. Available only if the Date setting is specified.			
	Date Format		Specify the date format.			
	Language		Specify the language used on the Display Screen.			

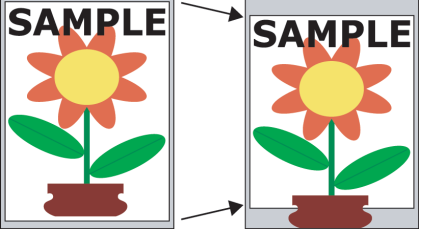
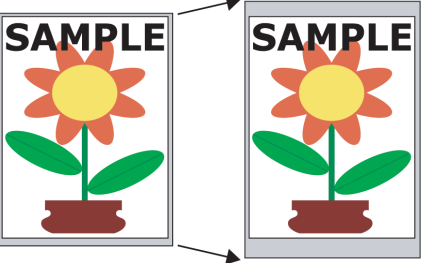
Setting Item		Description, Instructions
System Setup	Time Zone	Specify the time zone. Time zone options indicate a main city in this time zone and the difference from Greenwich Mean Time.
	Length Unit	Choose the display unit for length. Change the unit displayed for the remaining amount of roll paper, Tot.Print Area , and so on.
	Detect Mismatch	Specify printing behavior if the type and size of paper specified in the printer menu does not match the type and size in the printer driver. Choose Pause to have printing paused under these circumstances. Choose Warning to continue printing after notification. Choose None to continue printing without notification. Choose Hold Job to store jobs with mismatched types and sizes of paper on the printer hard disk, in a print queue awaiting processing. (See "Using the Printer Hard Disk.") →P.762
Paper Size Basis	Sht Selection 1	If sheet size detection is activated, choose whether ISO A3+ or 13"x19"(Super B) is applied when a sheet of an intermediate size is detected.
	Sht Selection 2	If sheet size detection is activated, choose whether ISO B1 or 28"x40" (ANSI F) is applied when a sheet of an intermediate size is detected.
Keep Paper Size		Choose On to use the paper size setting as the basis for printing instead of other settings. The margin setting of the printer menu will be used instead of the margin setting of the printer driver if the latter is smaller, which may prevent text or images in the margin from being printed.  Choose Off to give priority to margin settings. The larger value is used if the margin specified in the printer driver does not match the margin in the printer menu. 
Rep.P.head Print		Choose On to have the printer automatically execute the Advanced Adj. operations after you replace the Printhead. (See "Automatic Adjustment to Straighten Lines and Colors.") →P.806
Nozzle Check		In Frequency , specify the timing for automatic checks of nozzle clogging. Choose Standard to have the printer adjust the timing for checks based on the frequency of nozzle use. Choose 1 page to check once per page.

Setting Item		Description, Instructions	
System Setup	Nozzle Check	Select Warning > On to display warnings if the nozzles clog during printing.	
	CarriageScanWdth	Specify the scan width of the carriage during printing. Select Automatic for movement equivalent to the width of paper loaded. Selecting Fixed will reduce any soiling on the back of the paper, although printing may take a little longer.	
	Use RemoteUI	Choosing Off prohibits access from RemoteUI. Settings can only be configured from the control panel.	
	Reset PaprSetngs	Restores settings that you have changed with Media Configuration Tool to the default values.	
	Erase HDD Data	High Speed	Erases file management data for print job data stored on the printer's hard disk. (See "Erasing Data on the Printer's Hard Disk.") →P.703
		Secure High Spd.	Overwrites the entire hard disk with random data. (See "Erasing Data on the Printer's Hard Disk.") →P.703
		Secure	Overwrites the entire hard disk with 00, FF, and random data (one time each). Verification is performed to check if the data was correctly written. (See "Erasing Data on the Printer's Hard Disk.") →P.703
	Output Method	Print	Select the printing method for jobs received from software other than the printer driver. When using the printer driver, configure settings on the printer. To print as usual, select Print . Selecting Print (Auto Del) will print the job and then delete the data from the printer's hard disk. Selecting Save: Box 01 will only save the print job in the box, without printing it.
		Print (Auto Del)	
		Save: Box XX	
Print After Recv	A setting for jobs received from software other than the printer driver. When using the printer driver, configure settings on the printer. Select On to print the job after it has been saved.		
Common Box Set.	Select Print (Auto Del) to print without saving jobs in the box shared among multiple users.		
Show Job Log	Selecting Off prevents display of the log in Job Menu > Job Log . Additionally, the log is not printed if you choose Job Menu > Print Job Log . Note that because job logs are not collected, the Status Monitor accounting functions will not work correctly.		
Take-up Reel	Use Take-up Reel	Selecting Enable allows use of the Media Take-up Unit.	
	Auto Feed	Available only if Use Take-up Reel is already set to Enable . Rolls are automatically advanced to the position for attachment to the Rewind Spool.	
	Skip Take-Up Err	Available only if Use Take-up Reel is already set to Enable . Choose On to continue with printing even if an error occurs with the Media Take-up Unit. Choose Off to pause printing if a take-up error occurs.	
Prep.MovePrinter	When transferring the printer to another location, choose the level of transfer and follow the instructions on the screen. (See "Preparing to Transfer the Printer.") →P.873 Not displayed during a warning message that the remaining Maintenance Cartridge capacity is low.		
Admin. Menu	Change Password	The password that can be entered is a number from 0 to 9999999.	

Setting Item		Description, Instructions	
Admin. Menu	Change Password	The restriction states and main items are shown below. For more specific information on restricted items, see "Menu Structure." →P.669 <ul style="list-style-type: none"> Viewing and configuration by administrators only <ul style="list-style-type: none"> Change Password Init.Admin.Pswd Etc. Viewing and configuration by administrators, and only viewing by other users <ul style="list-style-type: none"> Date & Time Time Zone Use RemoteUI Etc. 	
	Init.Admin.Pswd	Choose OK to restore the Admin. Menu password to the default values.	
Adj. Fine Feed (*2)(*3)		Displayed when you have selected Feed Priority > Adj. Priority > Automatic or Print Quality . Fine-tune the feed amount manually.	
Printer Info (*2)	Paper Info	Indicates the current paper size, type, and related printer settings.	
	Ink Info	Indicates ink levels and maintenance cartridge capacity.	
	Head Info	Printhead L	Indicates information about the printhead.
		Printhead R	
	System Info	Indicates the firmware version, serial number, and interface information.	
	Error Log	Indicates the most recent error messages (up to five).	
Other Counter	Indicates the total printing volume of the printer.		

*1: A rough estimate of how much ink was consumed per job is displayed. Actual ink consumption may be different. The average margin of error for estimates calculated according to Canon measurement conditions for ink costs is ±15%. Canon does not guarantee the accuracy of these estimates. Estimates may vary depending on conditions of use. Calculation of these estimates does not include ink consumed when cleaning printheads by forceful ejection of ink.

*2: Displayed as the menu during printing while printing is in progress.

*3: Not displayed in the regular menu.

Status Print

You can print a **Status Print** report indicating the current status of the printer.

With **Status Print**, information is printed regarding the printer firmware version, various settings, and the status of consumables.

Printing Status Print reports

1

Load paper.

When using sheets, load paper of A4/Letter size. You will need at least four sheets.

The required sheet quantity varies depending on the execution log quantity of unique calibration.

- 2** On the **Tab Selection screen** of the Control Panel, press ◀ or ▶ to select Settings/Adj. tab ().

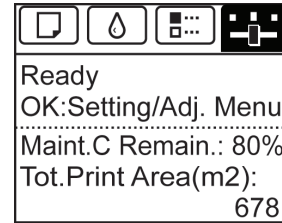

 **Note** • If the **Tab Selection screen** is not displayed, press the **Menu** button.

- 3** Press the **OK** button.
The **Set./Adj. Menu** is displayed.
- 4** Press ▲ or ▼ to select **Test Print**, and then press the **OK** button.
- 5** Press ▲ or ▼ to select **Status Print**, and then press the **OK** button.

Checking the information in **Status Print** reports

The following information is included in **Status Print** reports.

Canon imagePROGRAF iPFxxxx Status Print	Printer model
Firm	Firmware version
Boot	Boot ROM version
MIT(DBF)	MIT database format version
MIT(DB)	MIT database version
S/N	Printer serial number
Date	Indicates when the status print report was printed.

Paper Menu		Information on the loaded paper.
	Paper Type	
	Roll Media	
	Cut Sheet	
ManageRemainRoll		
Keep Paper Type		

Job Menu		Job-related information.
	Job Log	A counter for maintenance purposes. Various information about previous jobs.
	HDD Information	Indicates the total hard disk capacity and the mail box free space.
	Total capacity	
	Box free space	

Set./Adj. Menu		Settings and adjustment information.
	System Setup	Printer system settings, as well as settings regarding warnings and errors.
	Sleep Timer	
	Shut Down Timer	

Buzzer	Printer system settings, as well as settings regarding warnings and errors.	
Contrast Adj.		
Date Format		
Language		
Time Zone		
Length Unit		
Detect Mismatch		
Paper Size Basis	Paper-related settings.	
	Sht Selection 1	
	Sht Selection 2	
Keep Paper Size		
Rep.P.head Print	Settings after a test pattern was printed following head replacement.	
Nozzle Check	Nozzle-check settings.	
	Frequency	
	Warning	
CarriageScanWdth	Carriage scan width setting.	
Use RemoteUI	Settings used by RemoteUI.	
Output Method	Print job settings.	
Print After Recv		
Common Box Set.		
Show Job Log		
Adjust Printer	Adjustment settings.	
Head Posi. Adj.	A counter for maintenance purposes. Head position adjustment values for previous jobs.	
	Adjust Log	
Calibration	Color calibration settings.	
	Calibration Log (Common Calibration)	A record of when common calibration was performed.
		Date
		Paper Type
	Use Adj. Value	A setting value indicating whether color calibration adjustment values are to be applied to printing.
	Set Exec. Guide	A setting value indicating whether to display a message recommending the execution of color calibration.
Take-up Reel	Settings regarding the Media Take-up Unit.	
	Use Take-up Reel	
	Skip Take-Up Err	
Printer Info	Ink information, RAM usage, and a record of errors.	
	Ink Info	Ink-related information.
		MC
		PC, C, BK, MBK, Y, M, PM, GY
		Ink levels. The remaining ink is displayed in a five-level scale.
	System Info	Indicates the total amount of RAM.

		RAM	Indicates the total amount of RAM.
		Error Log	The past five error codes.

HEAD LOT NUMBER		Printhead lot number.	
	LOT L: R:		
PARTS STATUS		Utilization status of replacement parts that require servicing.	
	COUNTER		
COUNTER		Utilization status of the cutter, media, and other items (indicating how much they have been used).	
	CUTTER		
	MEDIA		
	LIFE TTL		
	LIFE ROLL		
	LIFE CUTSHEET		
	MEDIA 1-7, OTHER		
	NAME		
	TTL		
	ROLL		
	CUTSHEET		
	AFTER INSTALLATION		

DUTY		Counters for maintenance purposes. Needed when service is requested.	
	UNIT:m2		
	UNIT:sq.f		
	UNIT:A4 Sheet		
	UNIT:Letter Sheet		

Set./Adj. Menu		Settings and adjustment information.	
	Adjust Printer		Adjustment settings.
	Calibration		Color calibration settings.
	Calibration Log (Unique Calibration)		A record of when unique calibration was performed.
		No.	Log number.
		Paper Type	Indicates the date when calibration was performed and the type of paper used.
		Date	
		AdjType	The adjustment type.
		PatternSize	The pattern size.
		Temp/Humid	The temperature and humidity when executed.
		Backing	Information on the backing plate when executed.

Printing Interface Setting Reports

You can print an **Interface Print** report indicating the current interface settings values of the printer. **Interface Print** reports indicate settings values for TCP/IP, NetWare, and other settings.

Printing Interface Print reports

- 1 Load the paper.
If using sheets, load paper A4/Letter-sized, you will need at least three sheets.
- 2 On the **Tab Selection screen** of the Control Panel, press ◀ or ▶ to select the Settings/Adj. tab ().

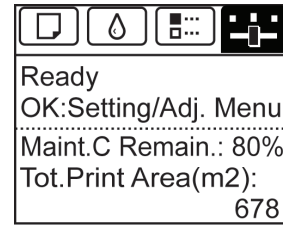

 **Note** • If the **Tab Selection screen** is not displayed, press the **Menu** button.

- 3 Press the **OK** button.
The **Set./Adj. Menu** is displayed.
- 4 Press ▲ or ▼ to select **Test Print**, and then press the **OK** button.
- 5 Press ▲ or ▼ to select **Interface Print**, and then press the **OK** button.

Confirming Interface Print information

The following information is included in the **Interface Print** report.

Canon imagePROGRAF iPFxxxx Interface Print		Printer model
Firm	Firmware Version	
Boot	Boot ROM Version	
MIT(DBF)	MIT Database Format Version	
MIT(DB)	MIT Database Version	
S/N	Printer serial number	
Date	The date when the interface setup print report was printed.	
EOP Timer	Specify the timeout period before cancellation of print jobs that cannot be received by the printer.	
TCP/IPv4	Frame Type	IPv4 settings values.
	Use DHCP	
	Use BOOTP	
	Use RARP	
	Enable DNS Dynamic Update	
	Use Zeroconf Function	
	IP Address	
	Subnet Mask	
	Gateway Address	
	LPD Printing	

Control Panel
Printer Menu

TCP/IPv4	IPP Printing	IPv4 settings values.
	IPP Printer URI	
	RAW Printing	
	Raw Mode Bi-direction	
	FTP Printing	
	Use Discovery	
	Scope	
	Primary DNS Server Address	
	Secondary DNS Server Address	
	DNS Host Name	
	DNS Domain Name	
	MulticastDNS ServiceName	
	SNMPv1	
	SNMPv3	

TCP/IPv6	Use IPv6	IPv6 settings values.	
	Use DHCPv6		Stateful Address
			Prefix Length
			Primary DNS Server Address
			Secondary DNS Server Address
	Use a stateless address		Stateless Address 1
			Prefix Length 1
			Stateless Address 2
			Prefix Length 2
			Stateless Address 3
			Prefix Length 3
			Stateless Address 4
			Prefix Length 4
			Stateless Address 5
			Prefix Length 5
			Stateless Address 6
			Prefix Length 6
	Use a link-local Address		Link-Local Address
			Prefix Length
	Use a manual address		IP Address
			Prefix Length
			Default Router Address
			Prefix Length
			Primary DNS Server Address
	Secondary DNS Server Address		
Use the same host name and domain name as IPv4	DNS Host Name		
	DNS Domain Name		

TCP/IPv6	Perform dynamic updating of stateful addresses		IPv6 settings values.	
	Dynamically update the stateless address			
	Dynamically update the manual address			
NetWare	Frame Type		NetWare settings values.	
	IPX External Network Number			
	Node Number			
	Print Application			
	Bindery PServer	File Server Name		
		Print Server Name		
		Print Server Password		
		Polling Interval		
	RPrinter	Print Server Name		
		Printer Number		
	NDS PServer	Tree Name		
		Context Name		
		Print Server Name		
		Print Server Password		
	NPrinter	Polling Interval		
Print Server Name				
	Printer Number			
AppleTalk	Phase Type		AppleTalk settings values.	
	Name			
	Network Number			
	Zone			
Network Interface	Physical Interface		Network interface settings values.	
	Transmission Rate			
	MAC Address			
	Auto Detect			
	Communication			
	Ethernet Type			
	Spanning Tree			
	Use the Jumbo Frame Function			

Basic Printing Workflow	19
Enhanced Printing Options	35
Windows Software	177
Mac OS X Software	363
Handling and Use of Paper	529
Control Panel	655

Printer Parts

Printer parts	692
Hard Disk	701
Optional accessories	705

Network Setting	707
Print Job Management	741
Adjustments for Better Print Quality	803
Color Management	821
Maintenance and Consumables	833
Troubleshooting	883
Error Message	915
Specifications	941
Appendix	945

Printer parts

Front	692
Back	694
Top Cover (Inside)	695
Carriage	696
Ink Tank Cover (Inside)	697
Stand	698
Media Take-up Unit	699
Control Panel	656

Front

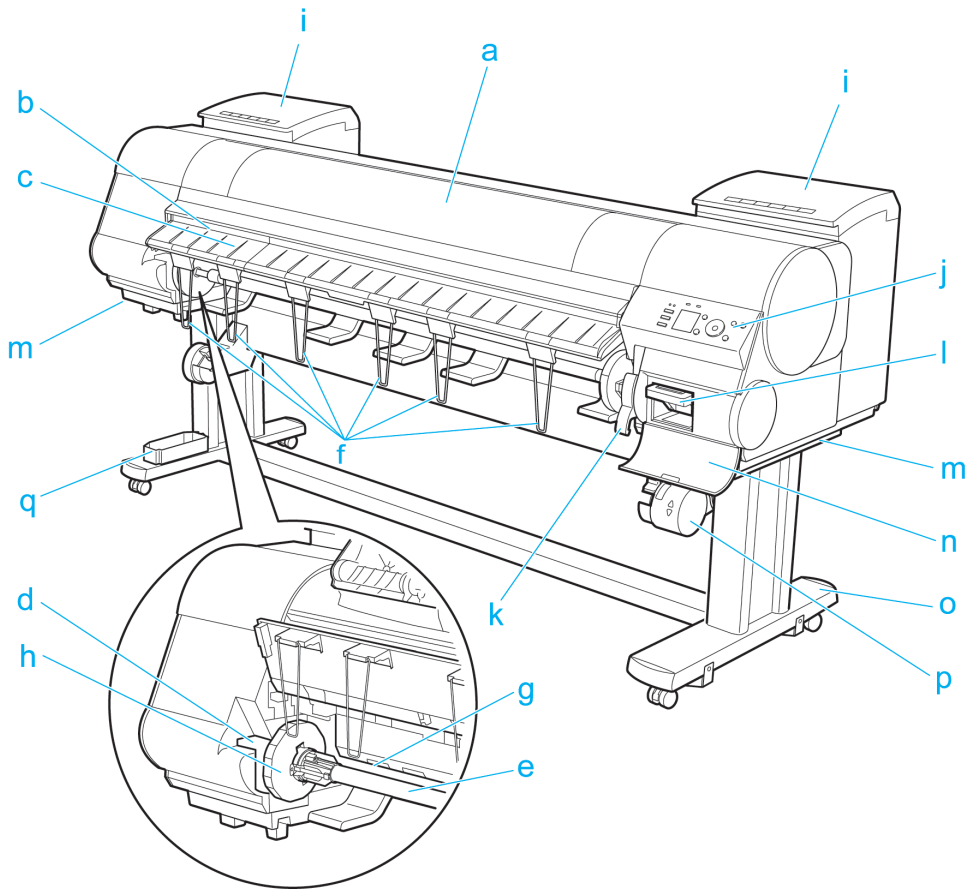

a Top Cover

Open this cover to install the Printhead, load paper, and remove any jammed paper from inside the printer as needed. (See "Top Cover (Inside).") →P.695

b Cutter Groove

Paper is cut (using the cutter or manually with scissors) over this groove.

c Ejection Guide

Guides printed documents as they are ejected. Raise the guide when loading a roll.

d Roll Holder Slot

Slide the Roll Holder into this slot.

e Roll Holder

Load the roll on this holder.

f Ejection Support

Prevents printed documents from winding around the Roll Holder or being drawn into the Paper Feed Slot.

g Paper Feed Slot

When loading a roll, insert the edge of the roll paper here.

h Holder Stopper

Secure rolls on the Roll Holder with this part.

i Ink Tank Cover

Open this cover to replace an Ink Tank. (See "Ink Tank Cover (Inside).") →P.697

j Control Panel

Use this panel to operate the printer and check the printer status. (See "Control Panel.") →P.656

k Release Lever

Releases the Paper Retainer. Lift this lever toward the front of the printer when loading paper.

l Maintenance Cartridge

Absorbs ink used for maintenance purposes such as head cleaning. (Replace the cartridge when it is full.)

m Carrying Handles

When carrying the printer, have six people hold it by these handles under both sides.

n Maintenance Cartridge Cover

Open this cover to replace the Maintenance Cartridge.

o Stand

A stand that holds the printer. Equipped with casters to facilitate moving it. (See "Stand.") →P.698

p Media Take-up Unit

Automatically winds documents printed on rolls. (See "Media Take-up Unit.") →P.699

q Accessory Box

Stores printer accessories.

Back

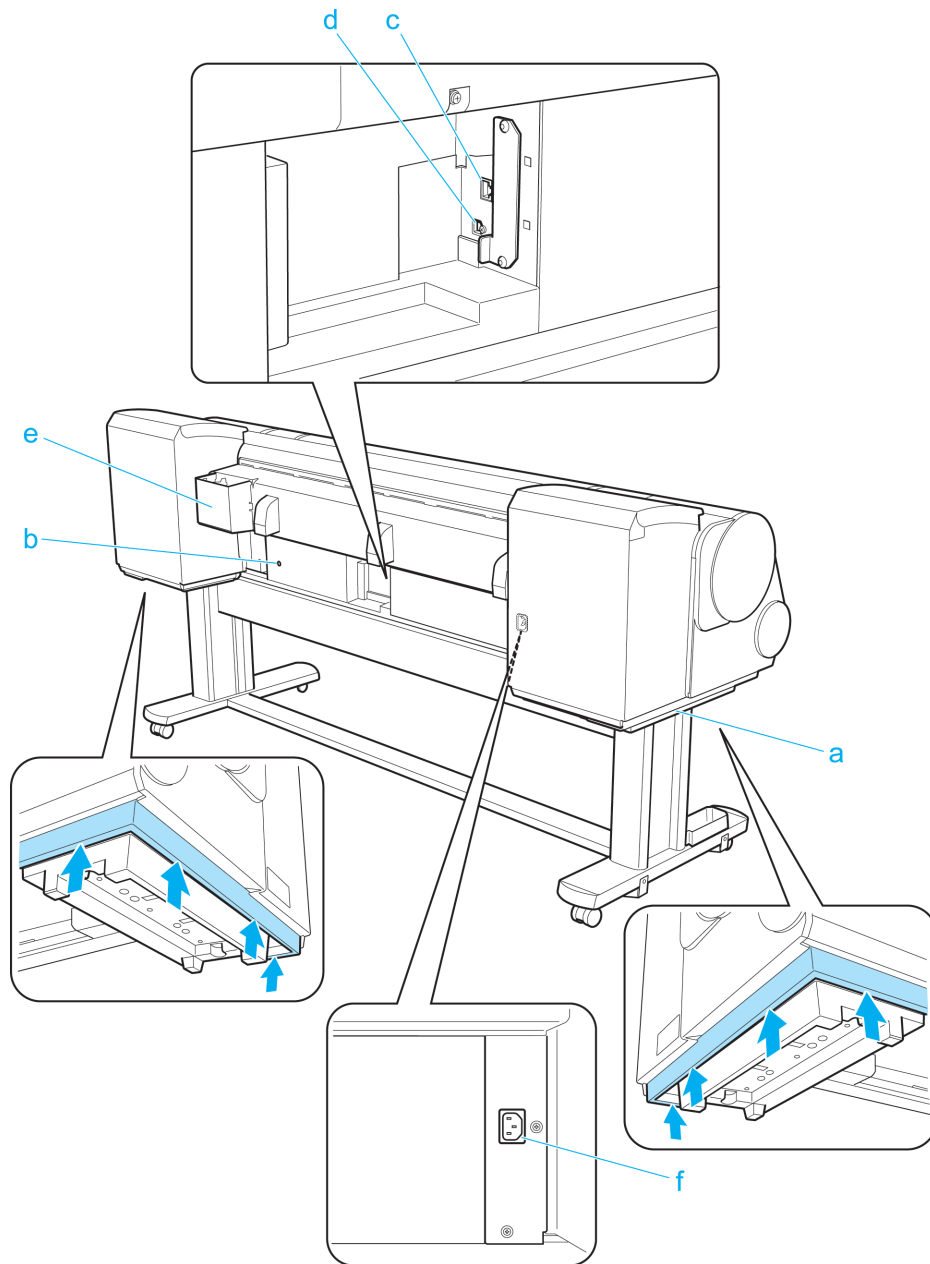
**a** Carrying Handles

When carrying the printer, have six people hold it by these handles under both sides.

b Media Take-up Unit Power Inlet

Connect the power cord of the Media Take-up Unit here.

c Ethernet Port

Connect an Ethernet cable to this port.

d USB Port

Connect a USB cable to this port. It supports Hi-Speed USB.

e Manual Pocket

Store printer manuals in this pocket.

f Power Supply Connector

Connect the power cord to this connector.

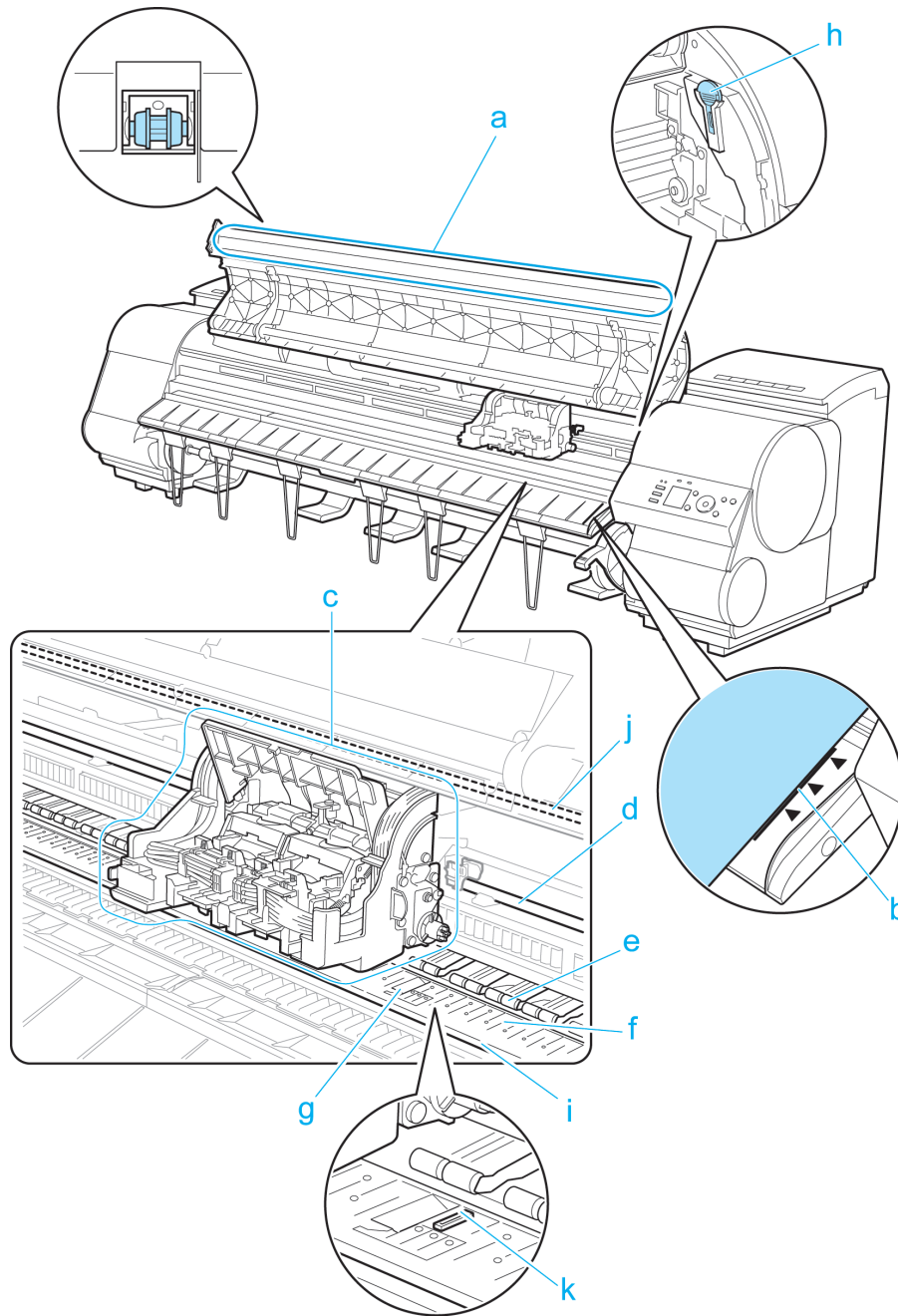
Top Cover (Inside)**a** Top Cover Roller

Prevents paper from rising when ejected.

b Paper Alignment Line

Align paper with this line when loading it.

c Carriage

Moves the Printhead. The carriage serves a key role in printing. (See "Carriage.") →P.696

d Carriage Shaft

The Carriage slides along this shaft.

e Paper Retainer

Important in supplying the paper. This retainer holds paper as it is fed.

f Platen

The Printhead moves across the platen to print. Vacuum holes on the platen hold paper in place.

g Borderless Printing Ink Grooves

For catching ink outside the edges of paper during borderless printing.

h Cleaning Brush

When cleaning inside the printer under the Top Cover, use this brush to sweep away paper dust on the Platen. Also use the brush to move the blue Switch on the Platen.

i Fixed Blade

The Cutter Unit passes over this rail to cut paper.

j Linear Scale

The linear scale serves a key role in detecting the Carriage position. Be careful not to touch this part when cleaning inside the Top Cover or clearing paper jams.

k Switch

Set the switch to the side opposite ● if the edges of printed images are blurred. Set the switch to the ● side before borderless printing. (See "Setting the Blue Switch on the Platen.") →P.901

Carriage

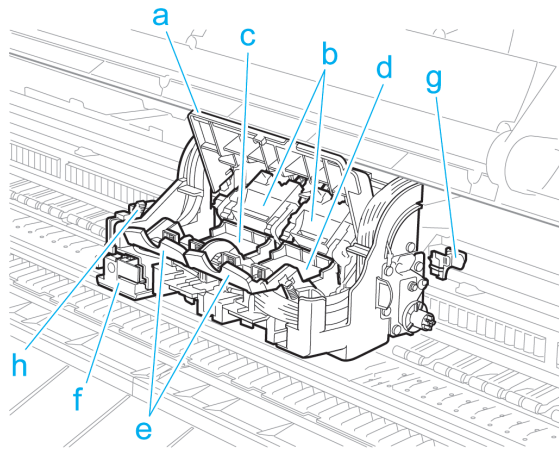
**a Carriage Cover**

Protects the Carriage.

b Printhead Fixer Cover

Holds the Printhead in place.

c Printhead L

The printhead is equipped with ink nozzles. The carriage serves a key role in printing.

d Printhead R

The printhead is equipped with ink nozzles. The carriage serves a key role in printing.

e Printhead Fixer Lever

Locks the Printhead Fixer Cover.

f Cutter Unit

A round-bladed cutter for automatic paper cutting. Retracted when not in use.

g Shaft Cleaner

Prevents the Carriage Shaft from becoming dirty.

h Cutter Unit Detachment Lever

Used when replacing the Cutter Unit.

Ink Tank Cover (Inside)

Left Side

Right Side

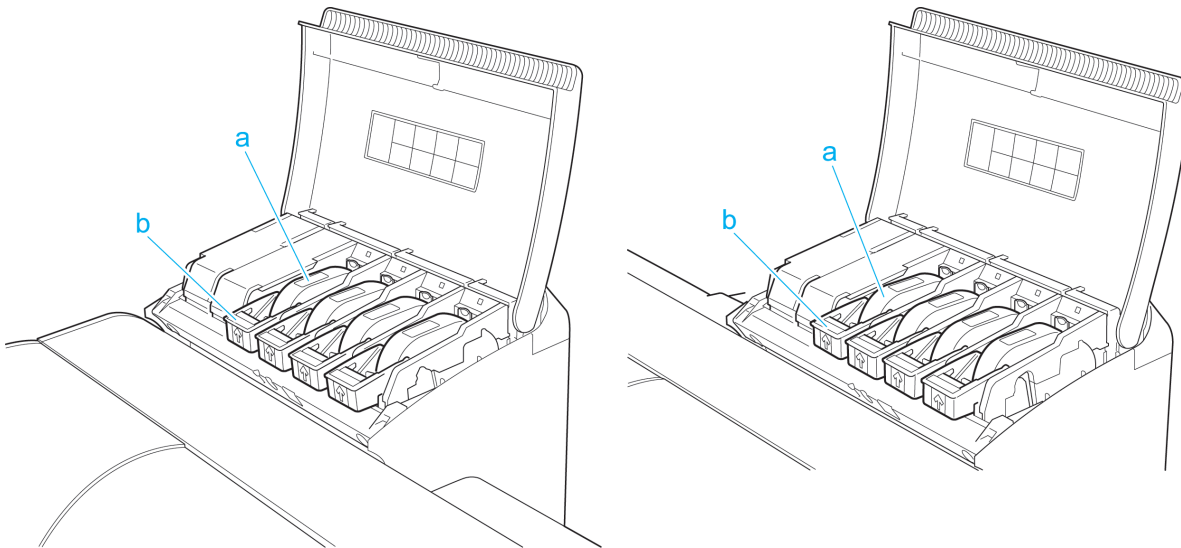

*1: Note: The figure shows the printer as loaded with 700 ml (23.7 fl oz) Ink Tank.

a Ink tanks

Cartridges of ink in various colors.

b Ink Tank Lock Lever

A lever that locks the Ink Tank in place and protects it. Lift and lower the lever when replacing an Ink Tank. To open it, lift the stopper of the lever until it stops, and then push it down toward the front. To close it, push it down until it clicks into place.

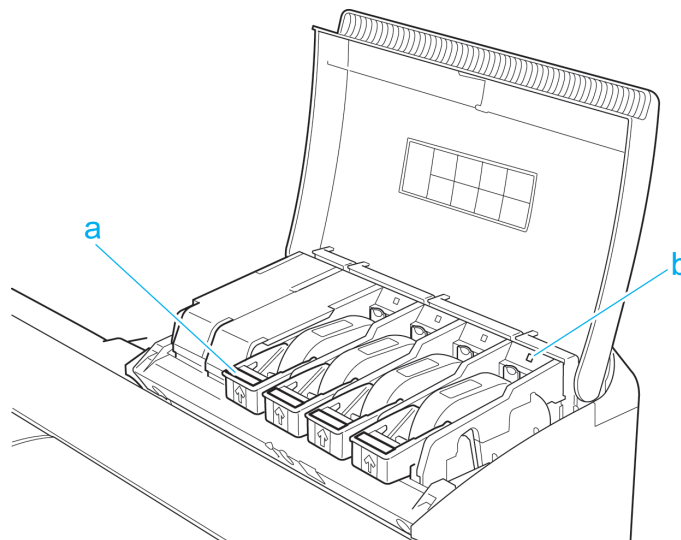

a Ink Color Label

Load an Ink Tank that matches the color and name on this label.

b Ink Lamp (Red)

Indicates the state of the Ink Tank as follows when the Ink Tank Cover is opened.

- On

The Ink Tank is installed correctly.

- Off

No Ink Tank is installed, or the ink level detection function is disabled.

- Flashing Slowly

Not much ink is left.

- Flashing Rapidly

Ink tank is empty.

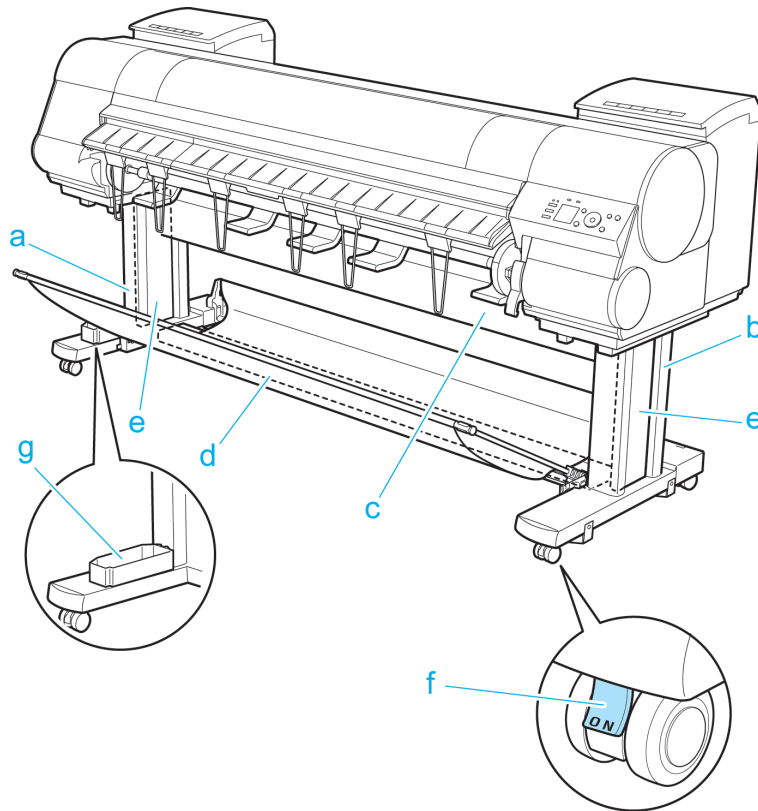
Stand**a Stand L**

The left leg of the Stand.

b Stand R

The right leg of the Stand.

c Top Stand Stay

Supports Stand L and Stand R. Attach the optional Media Take-up Unit to this part.

d Bottom Stand Stay

Supports Stand L and Stand R.

e Leg Covers

Covers for Stand L and Stand R.

f Stopper

Locks the Stand casters.

Always release the Stopper before moving the printer. Moving the printer while the Stopper is locked may scratch the casters or the floor.

g Accessory Pocket

Stores printer accessories.

Media Take-up Unit

Main Unit

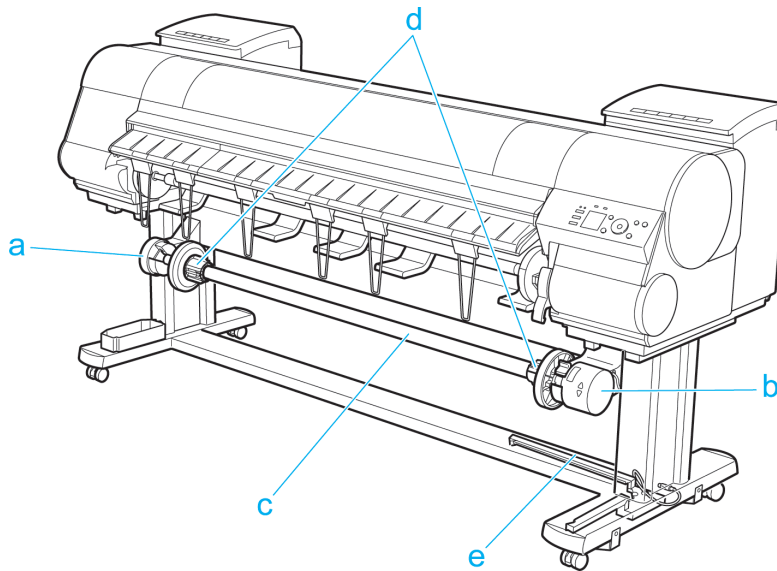
**a** Left Media Take-up Unit

Load the Rewind Spool here.

b Right Media Take-up Unit

Load the Rewind Spool here. Includes the Media Take-up Unit **Power** button, ▲ and ▼ buttons to advance or rewind paper, and a power cord.

c Rewind Spool

Winds documents printed on rolls.

d 3-inch Adapter

When rewinding rolls with 3-inch paper cores, attach the adapter to the Rewind Spool.

e Media Take-up Sensor

A sensor for automatically rewinding rolls.

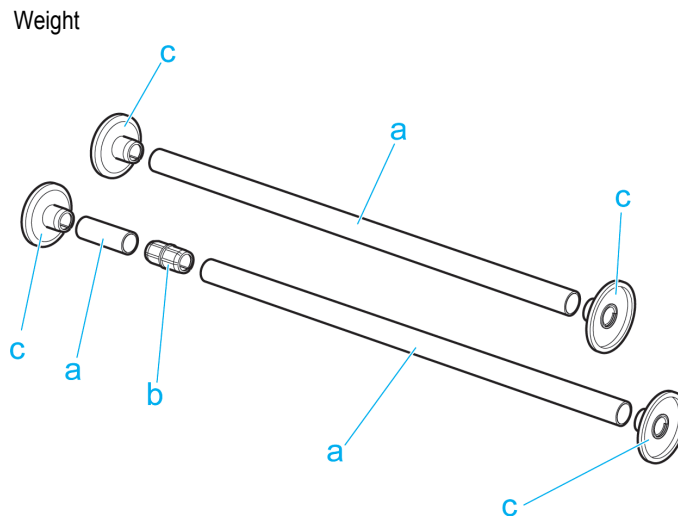

a Weight Roll (7)

Weights required when rewinding rolls. Use one roll or combine two (with a Weight Joint), depending on the roll width.

b Weight Joint

Fastens two Weight Roll.

c Weight Flange (2 Sets)

Attached to the ends of Weight Roll to adjust the weight. Use Weight Flange 1 or Weight Flange 2, depending on the type of paper. (See "Loading the Rewind Spool on the Media Take-up Unit.") →P.580

Hard Disk

Printer Hard Disk Operations	701
Checking the Free Hard Disk Space	702
Erasing Data on the Printer's Hard Disk	703

Printer Hard Disk Operations

Printer hard disk operations are available from the following programs and interfaces.

- Printer driver
- imagePROGRAF Print Plug-In
- imagePROGRAF Status Monitor
- imagePROGRAF Printmonitor
- RemoteUI
- Control Panel

The hard disk operations available through each interface are as follows.

Operation		<ul style="list-style-type: none"> • Printer driver • imagePROGRAF Print Plug-In 	<ul style="list-style-type: none"> • imagePROGRAF Status Monitor • imagePROGRAF Printmonitor 	RemoteUI	Control Panel
Saving print jobs	Save in mail box	Yes	No	No	No
	Do Not Save Print Jobs in the Common Box	No	No	No	Yes
	Save print jobs sent from sources other than the printer driver	No	No	No	Yes
Operations with saved jobs	Print saved jobs	No	Yes	Yes	Yes
	Delete saved jobs	No	Yes	Yes	Yes
Job queue management	Display job queue	No	Yes	Yes	Yes
	Delete	No	Yes	Yes	Yes
	Preempt Jobs	No	Yes	Yes	Yes
	Operations with held jobs	No	Yes	Yes	Yes
Mail box management	Move saved jobs	No	Yes	Yes	No
	Modify saved jobs	No	Yes	Yes	No
	Modify mail boxes	No	Yes	Yes	No
	Print a list of saved jobs	No	No	No	Yes
	Display a list of saved jobs	No	Yes	Yes	Yes
Other operations	Display free hard disk space	No	Yes	Yes	Yes
	Initialize hard disk	No	No	No	Yes
	Display the time of printing	No	Yes	Yes	Yes
Display error messages		No	Yes	Yes	Yes

Checking the Free Hard Disk Space

Check the space available on the printer's hard disk as follows.

This operation is available from the Control Panel, in RemoteUI, imagePROGRAF Status Monitor, and imagePROGRAF Printmonitor.

Using the Control Panel

- 1 On the **Tab Selection screen** of the Control Panel, press ◀ or ▶ to select the Job tab ().



 • If the **Tab Selection screen** is not displayed, press the **Menu** button.
Note

- 2 Press the **OK** button.
The **Job Menu** is displayed.
- 3 Press ▲ or ▼ to select **HDD Information**, and then press the **OK** button.

Using RemoteUI

To view the box list, select **Stored Job** in Job Management. On the **Stored Job** page, the free hard disk space is shown in the upper-right corner when boxes are listed.

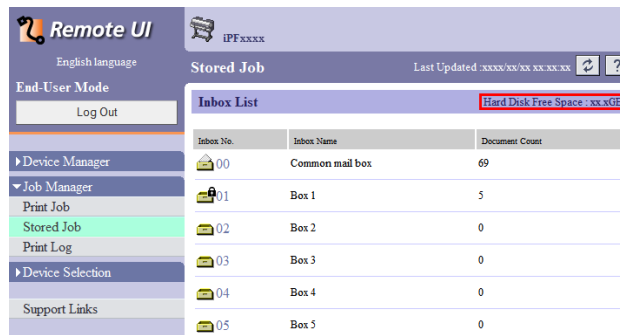

For details, refer to the RemoteUI help file.

Using imagePROGRAF Status Monitor

The **Hard Disk** sheet shows the free hard disk space.

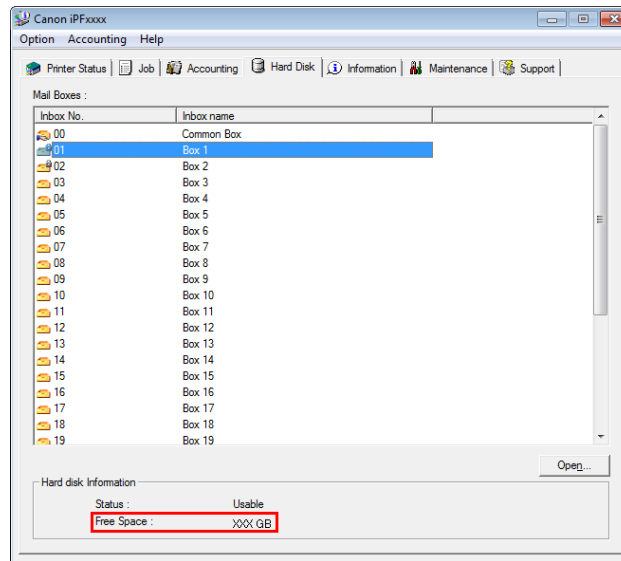

For details, refer to the imagePROGRAF Status Monitor help file.

Using imagePROGRAF Printmonitor

The **Hard Disk** pane shows the free hard disk space.

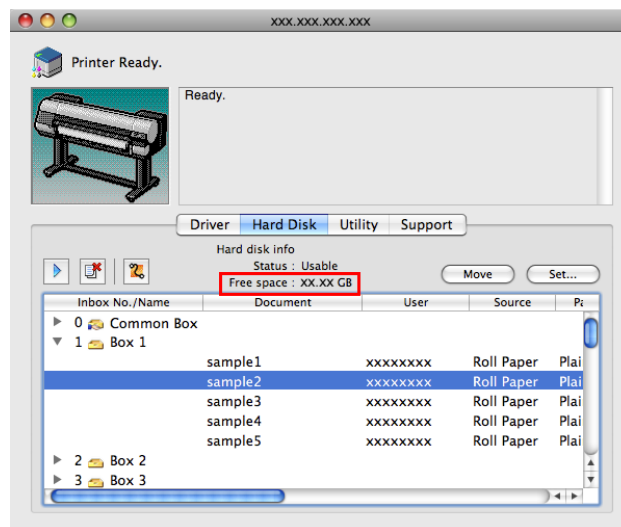

For details, refer to the imagePROGRAF Printmonitor help file.

Erasing Data on the Printer's Hard Disk

When erasing all data on the hard disk, choose from the following three options. This operation is only available from the Control Panel.

Erasure Method	Details
High Speed	Erases file management data for print job data stored on the printer's hard disk. Choose this method for relatively fast erasure. Because only the file management data is erased, the print job data itself is not erased. Note that it may be possible to read this data using commercial data recovery software.

Erasure Method	Details
Secure High Spd.	Overwrites the entire hard disk with random data. No verification is performed to check if the data was correctly written. Choose this method to erase highly confidential data. Note that it may be possible to read the overwritten data using specialized data recovery tools.
Secure	Overwrites the entire hard disk with 00, FF, and random data (one time each). Verification is performed to check if the data was correctly written. Choose this method to erase especially confidential data. It is virtually impossible to recover the overwritten data. Conforms to the DoD5220.22-M standard of the U.S. Department of Defense.



- For a more secure method of preventing data recovery, we recommend physically or magnetically destroying the hard disk. In this case, the hard disk can no longer be used.
- **Erase HDD Data** is not available if there is a job queue. Additionally, print jobs are not processed during execution of **Erase HDD Data**.

- 1 On the **Tab Selection screen** of the Control Panel, press ◀ or ▶ to select the **Settings/Adj. tab** ().

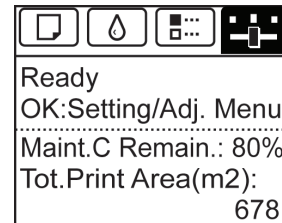

- If the **Tab Selection screen** is not displayed, press the **Menu** button.

Note

- 2 Press the **OK** button.
The **Set./Adj. Menu** is displayed.
- 3 Press ▲ or ▼ to select **System Setup**, and then press the **OK** button.
- 4 Press ▲ or ▼ to select **Erase HDD Data**, and then press the **OK** button.
- 5 Press ▲ or ▼ to select **High Speed**, **Secure High Spd.**, or **Secure**, and then press the **OK** button to display the confirmation screen.



- If a password has been set on the printer, the **Admin.Pswd** screen is displayed. In this case, enter the password and press the **OK** button to go to the next step.
- As for the time required for deletion, confirm it on the Control Panel. However, when **High Speed** is selected, this finishes in several seconds.

Note

- 6 Press ▲ or ▼ to select **Yes**, and then press the **OK** button to start erasure.
After the printer hard disk is erased, the printer automatically restarts.

Optional accessories

Roll Holder Set

Load a roll on the roll holder and then load the holder in the printer. The Roll Holder in the Roll Holder Set RH2-64 is for use with both 2-inch and 3-inch paper cores. Use the correct attachment for the particular paper core. (See "Attaching the Roll Holder to Rolls." →P.538)

- Roll Holder Set RH2-64
 - Roll Holder (for 2- and 3-inch paper cores)

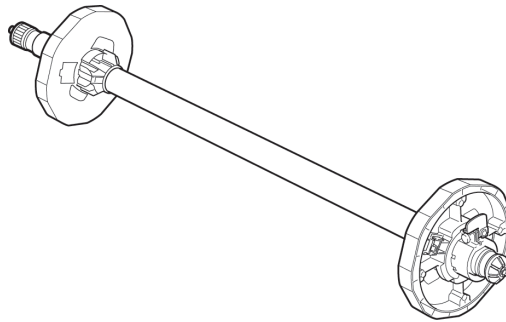

- Attachments

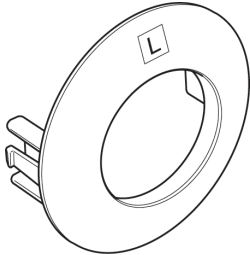
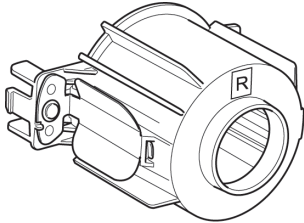
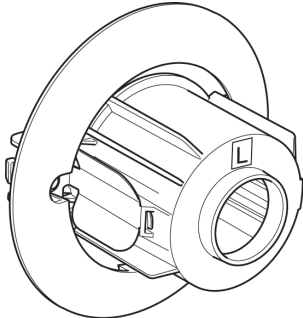
Using the 2-Inch Paper Core Attachment	Using the 3-Inch Paper Core Attachment	
2-Inch Paper Core Attachment	3-Inch Paper Core Attachment #1	3-Inch Paper Core Attachment #2
		

Memo

Basic Printing Workflow	19
Enhanced Printing Options	35
Windows Software	177
Mac OS X Software	363
Handling and Use of Paper	529
Control Panel	655
Printer Parts	691

Network Setting

Network Environment	708
Using RemoteUI	711
Initial Settings	713
NetWare Settings	720
Mac OS X Settings	728
Other Settings	734
Device Setup Utility (Windows)	738

Print Job Management	741
Adjustments for Better Print Quality	803
Color Management	821
Maintenance and Consumables	833
Troubleshooting	883
Error Message	915
Specifications	941
Appendix	945

Network Environment

Network Environment

System requirements

The system requirements, which vary depending on your network, are as follows.

- Printing over a TCP/IP network (when using IPv4)

- Compatible operating systems
 - Windows XP
 - Windows Server 2003
 - Windows Vista
 - Windows Server 2008
 - Windows 7
 - Windows Server 2003 x64
 - Windows Vista x64
 - Windows Server 2008 x64
 - Windows 7 x64
 - Mac OS X v10.2.8 or later
 - Unix (Solaris 9)
 - Unix (Red Hat 9)

- Printing over a TCP/IP network (when using IPv6)

- Compatible operating systems
 - Windows Vista
 - Windows Server 2008
 - Windows 7
 - Windows Vista x64
 - Windows Server 2008 x64
 - Windows 7 x64
 - Mac OS X v10.3.9 or later



Note

- When using IPv6, you must specify IPv6 on the Control Panel or in RemoteUI. For instructions, "Configuring TCP/IPv6 Network Settings" →P.716 or see "Configuring the Printer's TCP/IP Network Settings With RemoteUI." →P.717
- The imagePROGRAF printer driver is supported in Mac OS X v10.5.8 or later.
- The imagePROGRAF printer driver is not compatible with Unix.

- Printing over an AppleTalk network

- Compatible operating systems
 - Mac OS X v10.2.8–10.4



Note

- The printer cannot be used over a LocalTalk network.
- Compatible with EtherTalk Phase 2.
- The imagePROGRAF printer driver is not compatible with AppleTalk.

- Printing over a NetWare network

- Compatible servers
 - Novell NetWare 4.2/5.1/6.0
- Compatible clients

- Windows XP (Professional)



Note

- In NetWare 6.0, iPrint is not supported.

Network Environment

After confirming what type of network environment you will connect the printer to, set up the printer and computers as needed. For the specifications of the network interface, see "Specifications." →P.942

- Example of a Windows network

In Windows networks, print over TCP/IP.

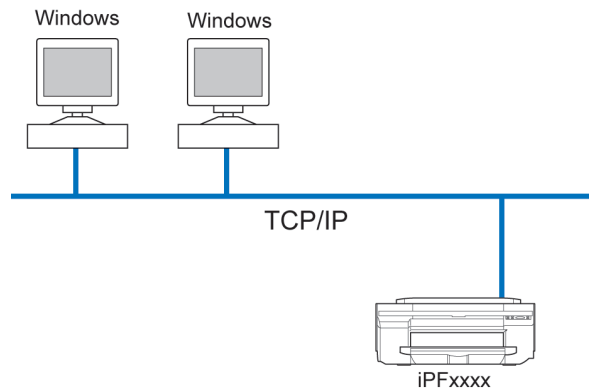

Note

- NetBIOS is not supported.

- Example of a Macintosh network

In Macintosh networks, print over TCP/IP using the Bonjour (Zeroconf) function.

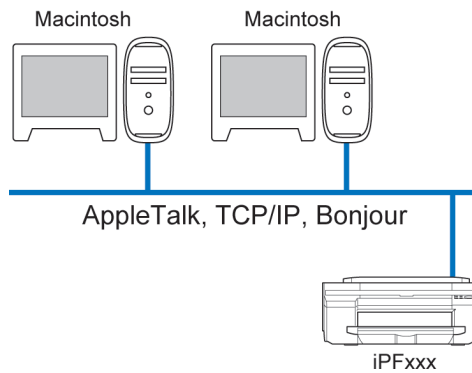

Note

- The imagePROGRAF printer driver is not compatible with AppleTalk.

• Example of a NetWare network

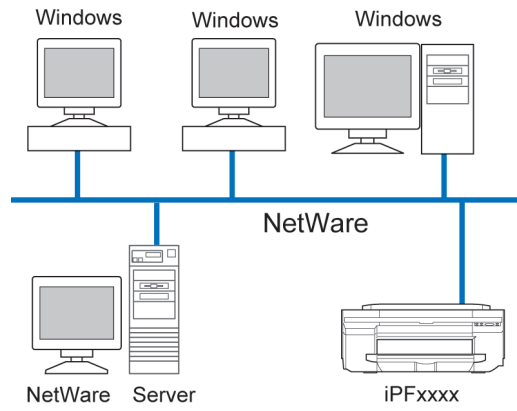

- Even if there is a NetWare server in your network environment, you can use it in conjunction with TCP/IP or AppleTalk. In this case, complete the settings for each protocol you will use.

Note

Using RemoteUI

Using RemoteUI

RemoteUI is software with which you can access the printer via the network from your Web browser to confirm the printer status, operate jobs, and configure the settings. Since the software (Web server) for using RemoteUI is built in the printer, preparing software other than a Web browser is unnecessary. You can use RemoteUI if an imagePROGRAF printer on a network is connected to your computer. If you start your Web browser and specify the IP address of the printer, the RemoteUI screen is displayed, and you can use RemoteUI.



- To use RemoteUI, an IP address must be set on the printer in advance. For the method of setting an IP address, see "Configuring the IP Address on the Printer." →P.713

What You Can Do With RemoteUI

With RemoteUI, you can access the printer via a network, configure network settings, and display the current status of the printer, various types of information, the processing status of jobs, etc.

Starting RemoteUI

Start RemoteUI by the following operations.

- Start your Web browser.
- Enter the following URL in **Address** or **Location**.
http://printer IP address or name/
Example: http://xxx.xxx.xxx.xxx/
- The RemoteUI screen is displayed.

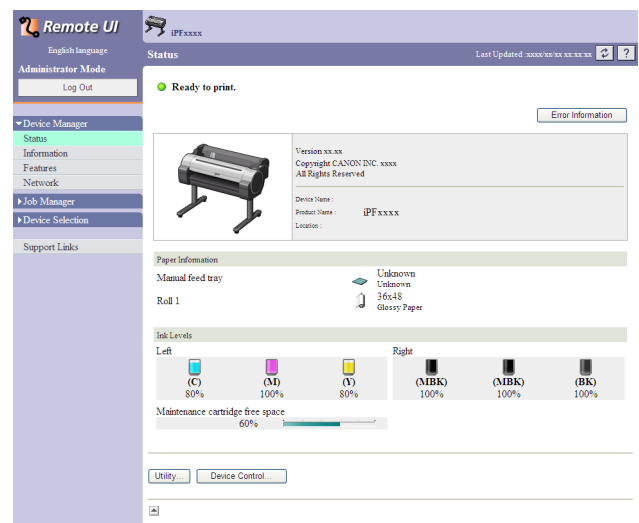

Note

- The screen slightly differs depending on the model of printer.

Configuring the Network With RemoteUI

For details on configuring printer settings for networks, refer to the following topics.

- Configuring the Printer's TCP/IP Network Settings With RemoteUI →P.717
- Configuring the Printer's AppleTalk Network Settings →P.732
- Configuring the Printer's NetWare Network Settings With RemoteUI →P.725
- Specifying Printer-Related Information →P.734

**Important**

- For the Web browser, use Netscape Navigator 6.0 or later, Internet Explorer 5.01 or later, or Firefox 1.5 or later. For Mac OS X, Safari 1.32 or later or 2.03 or later also is supported.
- This cannot be used connected via a proxy server. In environments where a proxy server is used, add the printer's IP address to **Exceptions** (addresses accessed without a proxy server) in the web browser proxy server settings. (Settings may vary depending on the network environment.)
- Enable JavaScript and cookies in the web browser.
- If you access RemoteUI with the printer name instead of its IP address, make sure the DNS settings are correctly configured.
- Depending on the network environment, you may not be able to start RemoteUI.
- Confirm whether **System Setup > Use RemoteUI** is set to **On** on the Control Panel of the printer.

**Note**

- RemoteUI also offers many other features. You can display the ink levels, check error messages and other status information, and cancel print jobs.
- By factory default, the English screen is displayed. To change the display language, select the desired language under **Language** before logging on in administrator mode.
- If you login in Administrator Mode, you can configure to use the Jumbo Frame function in the **Network** page. However, this function might not be able to be used depending on the network environment.

Initial Settings

Configuring the IP Address on the Printer	713
Configuring the IP Address Using imagePROGRAF Device Setup Utility	738
Configuring the IP Address Using the Printer Control Panel	713
Configuring the IP Address Using ARP and PING Commands	714
Configuring TCP/IPv6 Network Settings	716
Configuring the Printer Driver Destination (Windows)	716
Configuring the Printer Driver Destination (Mac OS X)	717
Configuring the Printer's TCP/IP Network Settings With RemoteUI	717

Configuring the IP Address on the Printer

You must configure the printer's IP address before using the printer in a TCP/IP network.

The printer's IP address is configured automatically when you install the printer driver following the instructions in the Setup Guide.

Configure the IP address by using imagePROGRAF Device Setup Utility, the printer Control Panel, or ARP or PING commands, if the IP address is changed, or if you change the printer connection mode to a network connection. For details on configuring the IP address, refer to the following topics.

- Configuring the IP Address Using imagePROGRAF Device Setup Utility →P.738 (Windows)
- Configuring the IP Address Using the Printer Control Panel →P.713
- Configuring the IP Address Using ARP and PING Commands →P.714



- If you use a DHCP server for automatic assignment of the printer's IP address, printing may no longer be possible after the printer is turned off and on. This is because an IP address different from before has been assigned. Thus, when using DHCP server functions, consult your network administrator and configure the settings in one of the following ways.

- Configure the setting for dynamic DNS updating
In the printer menu, either set **DNS Dync update** to **On**, or activate the setting **Enable DNS Dynamic Update** in RemoteUI.
(See "Menu Settings.") →P.675
(See "Configuring the Printer's TCP/IP Network Settings With RemoteUI.") →P.717
- Configure the setting for assignment of the same IP address each time the printer starts up



- We recommend configuring the printer's IP address even if you will use the printer in networks other than TCP/IP networks. Configuring the printer's IP address enables you to use RemoteUI to configure the network settings and manage the printer with a web browser.
For details on RemoteUI, see "Using RemoteUI." →P.711

Configuring the IP Address Using the Printer Control Panel

This topic describes how to configure the printer's IP address on the Control Panel.

- 1 On the **Tab Selection screen** of the Control Panel, press ◀ or ▶ to select the Settings/Adj. tab ().



- If the **Tab Selection screen** is not displayed, press the **Menu** button.

- 2** Press the **OK** button.
The **Set./Adj. Menu** is displayed.
- 3** Press **▲** or **▼** to select **Interface Setup**, and then press the **OK** button.
- 4** Press **▲** or **▼** to select **TCP/IP**, and then press the **OK** button.
- 5** Press **▲** or **▼** to select **IPv4**, and then press the **OK** button.
- 6** Press **▲** or **▼** to select **IPv4 Settings**, and then press the **OK** button.
- 7** Press **▲** or **▼** to select **IP Address**, and then press the **OK** button.
- 8** After you press **◀** or **▶** to select the input field, numerical input is possible.
- 9** Press the **▲** or **▼** button to enter the value.



Note

- Hold down **▲** to increase the value continuously. However, 0 follows 2 for digits of 100 and 0 follows 9 for digits of 10 and 1.
- Hold down **▼** to decrease the value continuously. However, 2 follows 0 for digits of 100 and 9 follows 0 for digits of 10 and 1.
- Hold down **▲** or **▼** to increase or decrease the value continuously.
- Make sure the IP address you enter for the printer is not the same as any computer IP address in your network.

- 10** Repeat steps 8 and 9 to complete the settings, and then press the **OK** button.

- 11** Press the **Menu** button.
If you have changed the settings, a confirmation message is displayed. Press **▲** or **▼** to select **Yes**, and then press the **OK** button.



Important

- Be sure to complete step 11. This will activate the values you have entered.
- If an error message is displayed, check the settings and correct any invalid values.



Note

- You can also specify the subnet mask and default gateway on the Control Panel.
- The DNS can also be configured from the printer Control Panel.

Configuring the IP Address Using ARP and PING Commands

This topic describes how to configure the IP address using ARP and PING commands.

To use the ARP and PING commands, you will need to know the printer's MAC address. You can confirm the MAC address on the Control Panel.

1 Check the printer's MAC address.

You can confirm the MAC address on the Control Panel as follows:

1. On the **Tab Selection screen** of the Control Panel, press ◀ or ▶ to select the Settings/Adj. tab ().

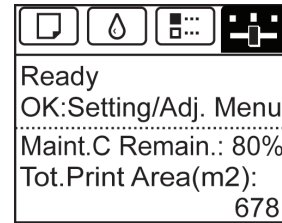

2. Press the **OK** button.
The **Set./Adj. Menu** is displayed.
3. Press ▲ or ▼ to select **Interface Setup**, and then press the **OK** button.
4. Press ▲ or ▼ to select **Ethernet Driver**, and then press the **OK** button.
5. Press ▲ or ▼ to select **MAC Address**, and then press the **OK** button.

-  If the **Tab Selection screen** is not displayed, press the **Menu** button.
- Note** You can investigate the MAC address by printing an interface setting report.
(See "Printing Interface Setting Reports.") →P.687

- 2 In Windows, open a command prompt, or in Mac OS X, start Terminal.

- 3 Execute the following command to add entries to the ARP table for managing IP addresses and corresponding MAC addresses.

`arp -s [IP address] [the printer's MAC address you have verified]`

Example: `arp -s xxx.xxx.xxx.xxx xx-xx-xx-xx-xx-xx`

-  In Mac OS X when using Terminal, enter the arp command in the format
`arp -s xxx.xxx.xxx.xxx xx-xx-xx-xx-xx-xx.`
For details, refer to the help file for the command line.

- 4 Execute the following command to send the IP address to the printer and configure it.
`ping [IP address as specified in the ARP command] -l 479`

Example: `ping xxx.xxx.xxx.xxx -l 479`

-  In -l, the l is the letter l.
- Note** In Mac OS X when using Terminal, enter the ping command in the format
`ping -s 479 xxx.xxx.xxx.xxx.`
For details, refer to the help file for the command line.

-  The subnet mask and default gateway are set to 0.0.0.0. Use RemoteUI to change the subnet mask and default gateway to match your network settings.
For details on RemoteUI, see "Using RemoteUI." →P.711

Configuring TCP/IPv6 Network Settings

When printing in a TCP/IPv6 network, you must configure the TCP/IPv6 settings on the Control Panel. Follow the steps below to configure the TCP/IPv6 network settings.

- 1 On the **Tab Selection screen** of the Control Panel, press ◀ or ▶ to select the Settings/Adj. tab ().



Note

- If the **Tab Selection screen** is not displayed, press the **Menu** button.

- 2 Press the **OK** button.
The **Set./Adj. Menu** is displayed.
- 3 Press ▲ or ▼ to select **Interface Setup**, and then press the **OK** button.
- 4 Press ▲ or ▼ to select **TCP/IP**, and then press the **OK** button.
- 5 Press ▲ or ▼ to select **IPv6**, and then press the **OK** button.
- 6 Press ▲ or ▼ to select **IPv6 Support**, and then press the **OK** button.
- 7 Press ▲ or ▼ to select **On**, and then press the **OK** button.



Important

- Once you set **IPv6 Support** to **On**, the **IPv6 StlessAddr** setting takes effect.



Note

- You can also configure **IPv6 StlessAddr** and **DHCPv6** from the printer Control Panel.
- The DNS can also be configured from the printer Control Panel.

Configuring the Printer Driver Destination (Windows)

This topic describes how to specify the printer driver destination if the printer's IP address is changed, or if you will use the printer over a network connection instead of via USB connection.

The procedure described below is the configuration based on the LPR or Raw protocol using the standard TCP/IP port in Windows (**Standard TCP/IP Port**).



Important

- If you will use the printer in a TCP/IP network, make sure the printer's IP address is configured correctly.
- Configuring the IP Address on the Printer →P.713



Note

- This section describes the procedure in Windows 7.

- 1 Open the **Devices and Printers** window.
- 2 Right-click the icon of this printer and choose **Printer Properties** to open the printer properties window.

- 3** Click the **Port** tab to display the **Port** sheet.
- 4** Click **Add Port** to display the **Printer Ports** dialog box.
- 5** In the **Available Port** list, select **Standard TCP/IP Port**.
- 6** Click **New Port**.
After the wizard starts, a window is displayed for the **Welcome to the Add Standard TCP/IP Printer Port Wizard**.
- 7** Click **Next**.
- 8** In **Printer Name or IP Address**, enter the printer's IP address. If the DNS is configured, you can also enter the DNS Domain Name.
- 9** Follow the instructions on the screen to add a printer port.
- 10** Click **Close** to close the **Printer Ports** dialog box.
- 11** Make sure the printer port you added is displayed under **Ports**, and that the port is selected.
- 12** Click **Close** to close the printer properties window.

Configuring the Printer Driver Destination (Mac OS X)

Specify the printer driver destination as follows if the printer's IP address is changed, or if you will use the printer over a network connection instead of via USB connection.

- If you switch to printing in a TCP/IP network, or if the printer's IP address is changed, see "Configuring the Destination in TCP/IP Networks." →P.728
- If you switch to printing in a Bonjour network, see "Configuring the Destination for Bonjour Network." →P.729

Configuring the Printer's TCP/IP Network Settings With RemoteUI

Follow the steps below to configure the TCP/IP network settings.

When using an IPv4 IP address

- 1** Start the web browser and enter the following URL in the **Location** (or **Address**) box to display the RemoteUI page.
http://**printer IP address or name**/
Example: http://xxx.xxx.xxx.xxx/
- 2** Select **Administrator Mode** and click **Logon**.
- 3** If a password has been set on the printer, enter the password.
- 4** Click **Network** in the **Device Manager** menu at left to display the **Network** page.
- 5** Click **Edit** in the upper-right corner of the **TCP/IPv4** group to display the **Edit TCP/IP Protocol Settings** page.

6 Refer to the TCP/IP Settings Items table to complete the settings.

TCP/IP Settings Items

Item	Details	Default Setting
Use DHCP	Activate this setting to use DHCP for configuring the IP address.	Off
Use BOOTP	Activate this setting to use BOOTP for configuring the IP address.	Off
Use RARP	Activate this setting to use RARP for configuring the IP address.	Off
Enable DNS Dynamic Update	Activate this setting to perform DNS server registration automatically.	Off
Use Zeroconf Function	Activate this setting to use Bonjour.	On
IP Address	Specify the printer's IP address.	0.0.0.0
Subnet Mask	Specify the printer's subnet mask.	0.0.0.0
Gateway Address	Specify the printer's default gateway.	0.0.0.0
LPD Printing	Activate this setting to use LDP Printing.	On
IPP Printing	Activate this setting to use IPP Printing.	On
IPP Printer URI	Specify the URI of the printer used for IPP printing using up to 252 characters.	printer
RAW Printing	Activate this setting to use Raw Printing.	On
RAW Mode Bi-direction	Activate this setting to use Raw mode bidirectional communication.	Off
FTP Printing	Activate this setting to use FTP Printing.	On
Use Discovery	Activate this setting to use SLP Discovery function.	On
Scope	Enter the SLP search range.	default
SMTP Server Address	Specify the SMTP server's IP address. You can also specify the SMTP server domain name, if desired.	0.0.0.0
Primary DNS Server Address	Specify the IP address of the primary DNS server.	0.0.0.0
Secondary DNS Server Address	Specify the IP address of the secondary DNS server.	0.0.0.0
DNS Host Name	Specify the printer host name, up to 63 characters (1–63 characters). Use single-byte letters, numbers, and - (hyphens). Do not use numbers or - for the first character or - for the last character.	NB-18GBipxxxxxx
DNS Domain Name	Specify the printer domain name, up to 63 characters. Use single-byte letters, numbers, - (hyphens), and . (periods). Do not use numbers, -, or . for the first character, or - or . for the last character.	blank
Multicast DNS Service Name	Specify the printer's Multicast DNS service name. (1–63 characters) This name will be displayed when Bonjour functions are used.	Canon iPFxxxx (xxxxxx)

7 Click **OK** to display the **Network** page.



Note

- If you specify to configure the IP address using DHCP, BOOTP, or RARP, there must be a server that supports such protocol running in the network.
- If you specify to configure the IP address using DHCP, BOOTP, or RARP, the IP address obtained by this method is used first. If you cannot obtain the IP address, the address specified in **IP Address** is used.
- It takes up to two minutes to determine whether DHCP, BOOTP, or RARP are available. We recommend clearing check boxes of options you will not use.
- If you are using a DNS server, select **Enable DNS Dynamic Update** and enter the IP Address for DNS servers and DNS domain name in **Primary DNS Server Address**, **Secondary DNS Server Address** and **DNS Domain Name**, respectively.

When using an IPv6 IP address

- 1 Start the web browser and enter the following URL in the **Location** (or **Address**) box to display the RemoteUI page.
http://**printer IP address or name**/
Example: http://xxx.xxx.xxx.xxx/
- 2 Select **Administrator Mode** and click **Logon**.
- 3 If a password has been set on the printer, enter the password.
- 4 Click **Network** in the **Device Manager** menu at left to display the **Network** page.
- 5 Click **Edit** in the upper-right corner of the **TCP/IPv6** group to display the **Edit TCP/IPv6 Protocol Settings** page.
- 6 Refer to the TCP/IPv6 Settings Items table to complete the settings.

TCP/IPv6 Settings Items

Item	Details	Default Setting
Use IPv6	Activate to enable IPv6.	Off
Use DHCPv6	Activate when using a DHCPv6 server to acquire the IP address.	Off
Use a stateless address	Activate when using an IPv6-compatible router to acquire the IP address.	On
Use a manual address	Activate when configuring the IP address manually.	Off
	IP Address	Enter the printer's IP address.
	Prefix Length	Enter the IP address prefix length.
	Default Router Address	Enter the default router address.
	Prefix Length	Enter the prefix length of the default router address.
Primary DNS Server Address	Specify the IP address of the primary DNS server.	::
Secondary DNS Server Address	Specify the IP address of the secondary DNS server.	::
Use the same host name and domain name as IPv4	Activate when using the same DNS host and domain names as for IPv4.	Off
	DNS Host Name	Specify the printer host name, up to 63 characters (1–63 characters). Use single-byte letters, numbers, and - (hyphens). Do not use numbers or - for the first character or - for the last character.
	DNS Domain Name	Specify the printer domain name, up to 63 characters. Use single-byte letters, numbers, - (hyphens), and . (periods). Do not use numbers, -, or . for the first character, or - or . for the last character.
Perform dynamic updating of stateful addresses	Activate this setting to automatically register the stateful address with the DNS server.	Off
Dynamically update the stateless address	Activate this setting to automatically register the stateless address with the DNS server.	Off
Dynamically update the manual address	Activate this setting to automatically register the manual address with the DNS server.	Off

- 7 Click **OK** to display the **Network** page.



Note

- If you are using a DNS server, select **Enable DNS Dynamic Update** and enter the IP Address for DNS servers and DNS domain name in **Primary DNS Server Address**, **Secondary DNS Server Address** and **DNS Domain Name**, respectively.

NetWare Settings

Configuring NetWare Network Settings	720
Specifying the Printer's Frame Type	720
Specifying NetWare Print Services	723
Configuring the Printer's NetWare Network Settings With RemoteUI	725

Configuring NetWare Network Settings

To print over a NetWare network, configure the network environment as follows.



Important

- To configure network settings, you must be logged in with administrative rights such as Administrator account. We recommend that your network administrator configure the network settings.



Note

- This section describes the procedure in Windows 7.

- 1 Specify the Ethernet frame type for communication between the printer and computers.
For instructions, see "Specifying the Printer's Frame Type." →P.720
- 2 Specify the NetWare print services, including the print server and queue.
For instructions, see "Specifying NetWare Print Services." →P.723
- 3 Specify NetWare protocol details besides the frame type.
For details on how to configure the settings, see "Configuring the Printer's NetWare Network Settings With RemoteUI." →P.725
After you have completed the steps above, configure each computer for printing over the NetWare network.
- 4 Connect to the NetWare network.
Install NetWare client software on each computer to be used for printing over the network, and log in to the NetWare server or tree. For instructions on connection, refer to the NetWare and operating system documentation.
- 5 Install the printer driver.
Follow the instructions of your network administrator to install the printer driver on each computer to be used for printing. When installing the printer driver, choose **Network Printer** as the printer destination, and then choose the print queue created from the NetWare print service settings.
- 6 Follow these steps to configure the printer port. This step is not necessary if you specified the printer destination during installation of the printer driver.
 1. Open the **Devices and Printers** window.
 2. Right-click the icon of this printer and choose **Printer Properties** to open the printer properties window.
 3. Click the **Port (or Advanced)** tab to display the **Port (or Advanced)** sheet.
 4. As the destination port, specify the print queue created by configuring the NetWare print service settings.

Specifying the Printer's Frame Type

To enable communication between the printer and computers on your network, specify the Ethernet frame type in your NetWare environment.

Follow the steps below to specify the frame type by using imagePROGRAF Device Setup Utility or the printer Control Panel.



Important

- Before specifying the frame type, make sure the printer is on and connected to the network.



Note

- You can specify the frame type by using RemoteUI if the printer's IP address is configured.
- For instructions on installing imagePROGRAF Device Setup Utility, see "Installing imagePROGRAF Device Setup Utility."

→P.738 .

Specifying the frame type using imagePROGRAF Device Setup Utility

- 1 Start imagePROGRAF Device Setup Utility.

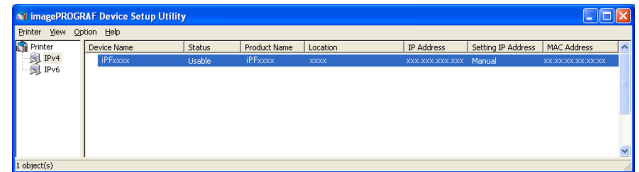

- 2 In the list of printers, select the printer to configure.

- 3 Choose **Protocol Settings** from the **Printer** menu.

- 4 Click the **NetWare** tab and select the frame type in the **NetWare Frame Type** list.

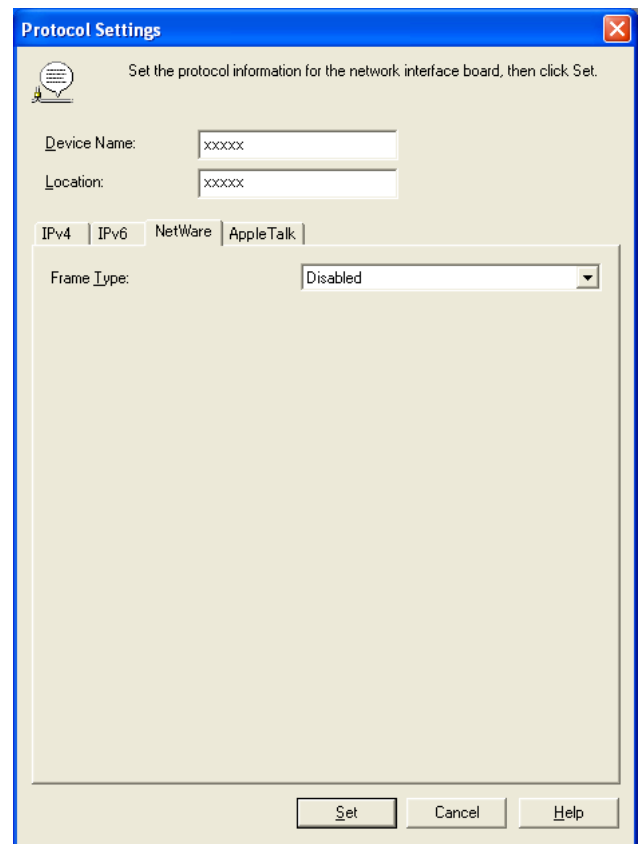

- 5 Select the **IPv4** tab. In **IP Address**, enter the IP address assigned to the printer, and then enter the subnet mask in **Subnet Mask** and the default gateway in **Gateway Address**.

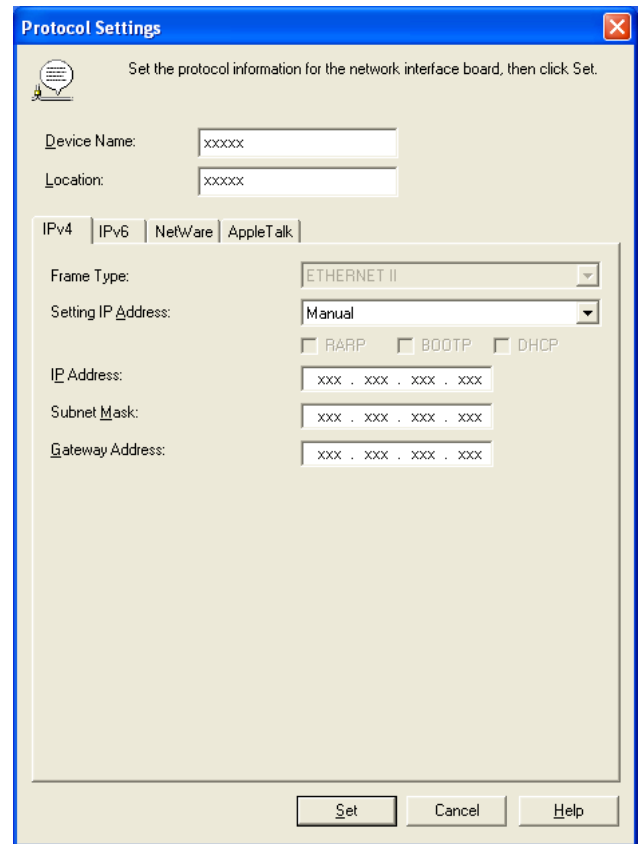

Important • You must specify the IP address here to be able to configure NetWare protocol settings using RemoteUI.

- 6 Click **Set**.
- 7 Click **OK** after the **Confirmation** message is displayed.
- 8 Exit imagePROGRAF Device Setup Utility.

Specifying the frame type using the printer Control Panel

- 1 On the **Tab Selection screen** of the Control Panel, press ◀ or ▶ to select the Settings/Adj. tab ().

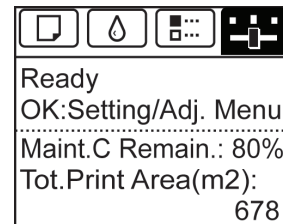

Note • If the **Tab Selection screen** is not displayed, press the **Menu** button.

- 2 Press the **OK** button. The **Set./Adj. Menu** is displayed.

- 3 Press ▲ or ▼ to select **Interface Setup**, and then press the **OK** button.
- 4 Press ▲ or ▼ to select **NetWare**, and then press the **OK** button.
- 5 Press ▲ or ▼ to select **NetWare**, and then press the **OK** button.
- 6 Press ▲ or ▼ to select **On**, and then press the **OK** button.
The display reverts to the **NetWare** menu.
- 7 Press ▲ or ▼ to select **Frame Type**, and then press the **OK** button.
- 8 Press ▲ or ▼ to select the frame type to use, and then press the **OK** button.
The display reverts to the **NetWare** menu.
- 9 Press ▲ or ▼ to select **Print Service**, and then press the **OK** button.
- 10 Press ▲ or ▼ to select the desired print service, and then press the **OK** button.
The display reverts to the **NetWare** menu.
- 11 Press the **Menu** button.
If you have changed any settings, a confirmation message is displayed. In this case, press the **OK** button.



- Be sure to complete step 11. This will activate the values you have entered.

Important



- If an error message is displayed, check the settings and correct any invalid values.

Note • To cancel this process, press the **Back** button.

Specifying NetWare Print Services

Before printing in a NetWare network, you must configure print services such as print servers, print queues, and so on. You can configure the print service settings from a computer using any of the following Novell software provided with NetWare.

- NWADMIN
- PCONSOLE



- If you use NWADMIN to configure the print service settings, Novell Client (the Novell NetWare client software) must be installed as the client software application.

Important

- NetWare networking is unsupported in Windows Vista, Windows Server 2008 and Windows 7.

This topic gives instructions for configuring NetWare print services. The order of this procedure may vary depending on the environment.

Choosing the type of print services

Before completing print service settings, choose the type of print service. Refer to the following descriptions as needed.



Note

- In NetWare 5.1 or 6.0, NDPS may also be used as the print service. If you use NDPS, use the Novell printer gateway included with NetWare. For details on configuring NDPS, refer to the NetWare documentation.

- **NDS (Novell Directory Service) and bindery**
NDS and bindery are both supported. Use the mode that is compatible with your network environment.
- **Queue server mode and remote printer mode**
Queue server mode and remote printer mode are both supported.
 - **Queue server mode**
When using queue server mode, all print server functions are supported, so there is no need for other print server software or hardware. In NDS queue server mode (NDS PServer), the NDS print server is used for printing. In bindery queue server mode (Bindery PServer), the bindery print server is used for printing. Note that if you use queue server mode, a NetWare user license is required for each network interface.
 - **Remote printer mode**
In remote printer mode, the printer is controlled by the NetWare print server. Thus, a NetWare print server is required. In NDS remote printer mode (NPrinter), the NDS print server is used for printing, and in bindery remote printer mode (RPrinter), the bindery print server is used for printing.

Using NWADMIN or PCONSOLE to set up the print server

Use NWADMIN to set up the print server if NDS queue server mode or remote printer mode is used.

1

Log into NetWare as Administrator or with equivalent rights, and then start NWADMIN.

2

Run Quick Setup.

1. Choose **Print Services Quick Setup** in the **Tools** menu.
2. Enter a desired name in **Print Server Name**. To use an existing print server, click the button at right and choose the name from the list.
3. Enter a desired printer name in **Name**.
4. To use the printer in queue server mode, choose **Other/Unknown** in **Type**. To use the printer in remote printer mode, choose **Parallel** in **Type**, click **Communications**, and set **Ports** to **LPT1** and **Connection Type** to **Manual Load**.
5. Enter a desired queue name in **Name**.
6. In **Volume**, enter the volume object (that is, the object representing the physical volume on the network) where the print queue will be created. Click the button at right to choose from a list.
7. Complete other settings as needed and click **OK**.



Note

- The print server name will be required when configuring the printer's protocol settings. Write down the print server name for future reference.
- When running Quick Setup, the printer is assigned printer number 0. When using the printer in queue server mode, do not change the printer number from 0.

3

Set a password.

1. Right-click the print server created in step 2 and choose **Details**.
2. Click **Change Password** to open the password input dialog box. Enter the password.
3. Click **OK** to close the password input dialog box.

4. Click **OK** or **Cancel** to close the details dialog box.

4 To use the printer in remote printer mode, start the print server.
To use the NetWare file server as the print server, enter **LOAD PSERVER.NLM** at the file server and press the Enter key.



Note

- This procedure is not required when using queue server mode.

Use PCONSOLE to set up the print server if bindery queue server mode or remote printer mode is used.

1 Log into NetWare as Admin and start PCONSOLE.

2 Switch to bindery mode.

3 If the print server has not been created, create it.

1. In **Available Options**, select **Quick Setup**, and press the Enter key.
2. Enter the name of the new print server, the new printer, and the queue.



Note

- The print server name will be required when configuring the printer's protocol settings. Write down the print server name for future reference.

4 Specify the printer type.

1. To use the printer in queue server mode, choose **Other/Unknown** in **Type**. To use remote printer mode, set **Printer Type** to **Parallel** and **Position** to **Manual Load**.
2. Press the Esc key.
3. After the confirmation message is displayed, choose **Yes** and press the Enter key.

5 Set a password.

1. In **Available Options**, select **Print Servers** and press the Enter key.
2. Select the print server created in step 2 and press the Enter key.
3. Select **Password**, and press the Enter key to display the password input dialog box.
4. Enter the password and press the Enter key.

6 Press the Esc key several times to display the dialog box for confirming that PCONSOLE is finished.

7 Click **Yes** to exit PCONSOLE.

Configuring the Printer's NetWare Network Settings With RemoteUI

Follow the steps below to configure NetWare protocol settings other than the frame type by using RemoteUI.



Note

- For details on RemoteUI, see "Using RemoteUI." →P.711

- 1** Start the web browser and enter the following URL in the **Location** (or **Address**) box to display the RemoteUI page.
 http://printer IP address or name/
 Example: http://xxx.xxx.xxx.xxx/
- 2** Select **Administrator Mode** and click **Logon**.
- 3** If a password has been set on the printer, enter the password.
- 4** Click **Network** in the **Device Manager** menu at left to display the **Network** page.
- 5** Click **Edit** in the upper-right corner of the **NetWare** group to display the **Edit NetWare Protocol Settings** page.
- 6** Refer to the NetWare Settings Items table to complete the settings.

NetWare Settings Items

Item	Details	Default Setting
Frame Type	Specify the type of frame to use in NetWare.	Disabled
NCP Burst Mode	Activate this setting to use NCP Burst Mode. This mode supports fast data transfer when printing in queue server mode. Normally, leave the setting On.	On
Print Application	Choose the print service. The print service selected here is enabled. Multiple print services cannot be enabled simultaneously. <ul style="list-style-type: none"> • Bindery PServer • RPrinter • NDS PServer • NPrinter 	NDS PServer
Packet Signature	Select If Requested by Server to use packet signature.	If Requested by Server
Bindery PServer	File Server Name Specify the name of a file server that has a NetWare print server. (0–47 characters)	—
	Print Server Name Specify the name of a NetWare print server. (0–47 characters)	—
	Print Server Password Set a password for the print server. (0–20 characters)	—
	Polling Interval Specify the interval to confirm jobs. (1–15 seconds)	5
RPrinter	Print Server Name Specify the name of a NetWare print server. (0–47 characters)	—
	Printer Number Specify the number of the printer connected to the NetWare print server. (0-15)	0
NDS PServer	Tree Name Specify the name of an NDS tree that has a NetWare print server. (0–32 characters)	—
	Context Name Specify the name of a context that has a NetWare print server. (0–255 characters)	—
	Print Server Name Specify the name of a NetWare print server. (0–64 characters)	—

Item		Details	Default Setting
NDS PServer	Print Server Password	Set a password for the print server. (0–20 characters)	—
	Polling Interval	Specify the interval to confirm jobs. (1–255 seconds)	5
NPrinter	Print Server Name	Specify the name of a NetWare print server. (0–47 characters)	—
	Printer Number	Specify the number of the printer connected to the NetWare print server. (0–254)	0

7

Complete the following settings based on the selected service.

- If you have selected Bindery PServer: Queue Server Mode (Using a Bindery Print Server)
 - 1.** In **File Server Name**, enter the file server name.
 - 2.** In **Print Server Name**, enter the name of the print server created in "Specifying NetWare Print Services →P.723 ."
 - 3.** In **Print Server Password**, enter the password of the print server created in "Specifying NetWare Print Services →P.723 ."
 - 4.** In **Polling Interval**, specify the interval at which the printer checks the NetWare print queue.
- If you have selected RPrinter: Remote Printer Mode (Using a Bindery Print Server)
 - 1.** In **Print Server Name**, enter the advertising name of the print server created in "Specifying NetWare Print Services →P.723 ."
 - 2.** In **Printer Number**, enter the same printer number specified in "Specifying NetWare Print Services →P.723 ."
- If you have selected NDS PServer: Queue Server Mode (Using an NDS Print Server)
 - 1.** In **Tree Name** and **Context Name**, enter the tree and context name of the print server.
 - 2.** In **Print Server Name**, enter the name of the print server created in "Specifying NetWare Print Services →P.723 ."
 - 3.** In **Print Server Password**, enter the password of the print server created in "Specifying NetWare Print Services →P.723 ."
 - 4.** In **Polling Interval**, specify the interval at which the printer checks the NetWare print queue.
- If you have selected NPrinter: Remote Printer Mode (Using a NDS Print Server)
 - 1.** In **Print Server Name**, enter the advertising name of the print server created in "Specifying NetWare Print Services →P.723 ." Usually, the advertising name is the same as the name of the print server.
 - 2.** In **Printer Number**, enter the same printer number specified in "Specifying NetWare Print Services →P.723 ."

8

Click **OK** to display the **Network** page.

Mac OS X Settings

Configuring the Destination in TCP/IP Networks 728
 Configuring the Destination for Bonjour Network 729
 Configuring the Destination for AppleTalk Networks 731
 Configuring the Printer's AppleTalk Network Settings 732

Configuring the Destination in TCP/IP Networks

Follow these steps to configure the destination when using the printer in a TCP/IP network.

Important • If you use the printer in a TCP/IP network, make sure the printer's IP address is configured correctly. (See "Configuring the IP Address Using the Printer Control Panel.") →P.713

1 Navigate to **Applications > Canon Utilities > imagePROGRAF PrinterSetup** and double-click **imagePROGRAF PrinterSetup.app**.

2 Click **Next**.

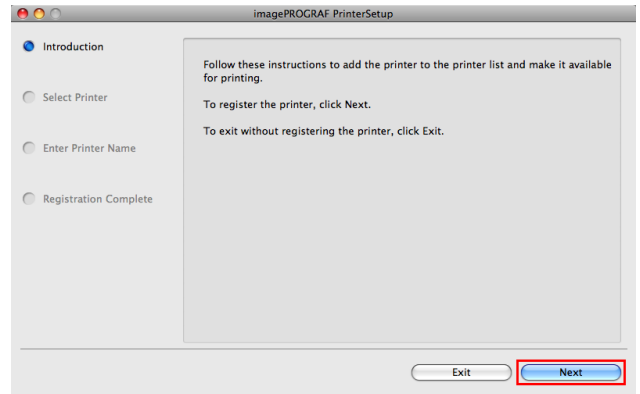

3 Click **Registering IP Address**.

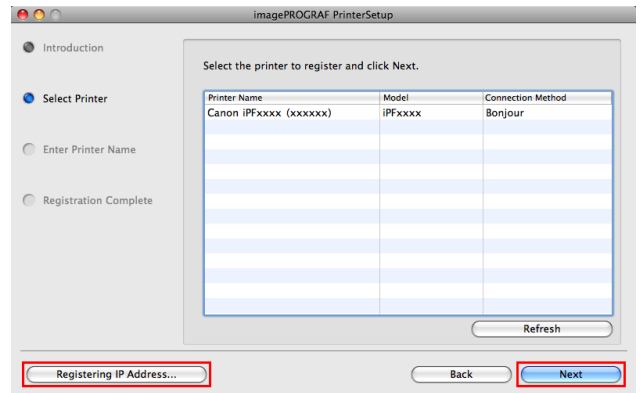

Network Setting

Mac OS X Settings

- 4** Select the model and type and then enter the IP address before clicking the **Next** button.

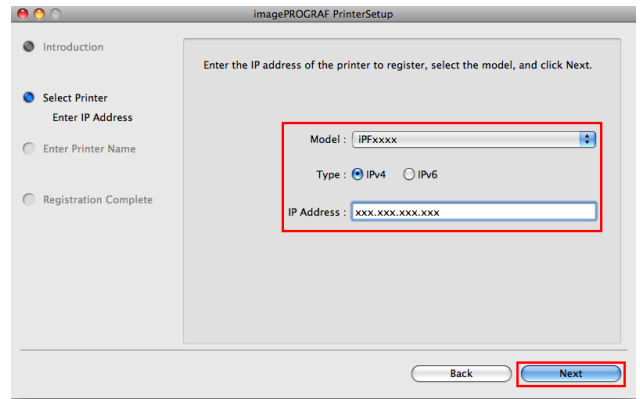

- 5** Complete **Printer Name** and **Location** as desired and click **Register**.

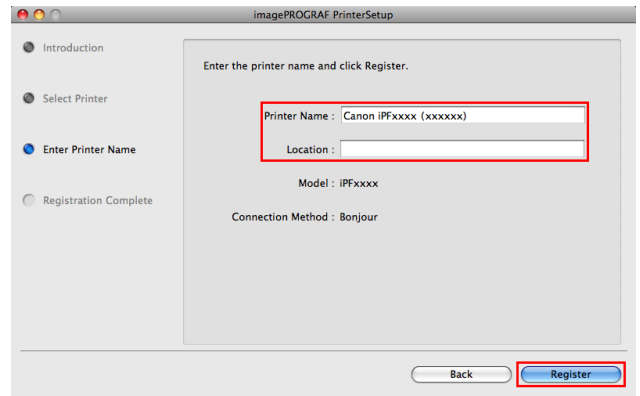

- 6** Click **Finish**.

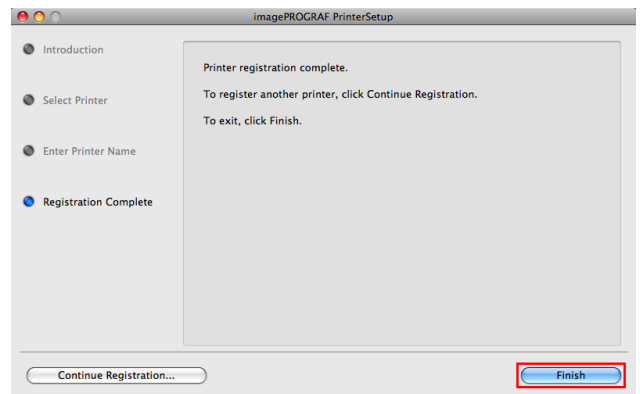

Configuring the Destination for Bonjour Network

Follow the steps below to configure the destination if you are using the printer in a network that uses the Bonjour function.



Important

- Bonjour and **IP Print (Auto)** do not support printing to a printer on other network groups that require a router for connection. Make sure the computer and printer are on the same network. For information about network settings, ask your network administrator.
- By default, Bonjour is activated on the printer. You can activate or deactivate the Bonjour function or change the printer name by using RemoteUI. For instructions on changing it, see "Using RemoteUI." →P.711

- 1** Navigate to **Applications > Canon Utilities > imagePROGRAF PrinterSetup** and double-click **imagePROGRAF PrinterSetup.app**.

Configuring the Destination for AppleTalk Networks

To print over an AppleTalk network, activate the AppleTalk protocol and configure the destination as follows.

Activating AppleTalk on the printer



Important

- By default, the AppleTalk protocol is disabled on the printer.

- On the **Tab Selection screen** of the Control Panel, press ◀ or ▶ to select the Settings/Adj. tab ().

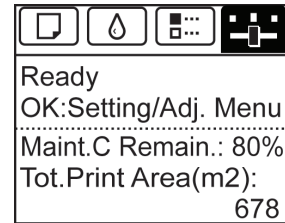

Note

- If the **Tab Selection screen** is not displayed, press the **Menu** button.

- Press the **OK** button.
The **Set./Adj. Menu** is displayed.
- Press ▲ or ▼ to select **Interface Setup**, and then press the **OK** button.
- Press ▲ or ▼ to select **AppleTalk**, and then press the **OK** button.
- Press ▲ or ▼ to select **On**, and then press the **OK** button.
- Press the **Menu** button.
If you have changed any settings, a confirmation message is displayed. In this case, press the **OK** button.



Important

- Be sure to complete step 6. This will activate the values you have entered.



Note

- By using RemoteUI, you can also specify the object name used for AppleTalk, as well as the printer zone name. For details on RemoteUI, see "Using RemoteUI." →P.711

Configuring the Destination (Mac OS X)



Important

- AppleTalk is supported in Mac OS X 10.2.8–10.4.



Note

- The following procedures are based on Mac OS X 10.4. The method of configuring the destination varies depending on the version of Mac OS X.
- The imagePROGRAF printer driver is not compatible with AppleTalk.

1 In **System Preferences**, click **Network** to display the **Network** window.

2 In **Show**, choose **Built-in Ethernet**. Next, click **AppleTalk**, select **Make AppleTalk Active**, and click **Apply now**.

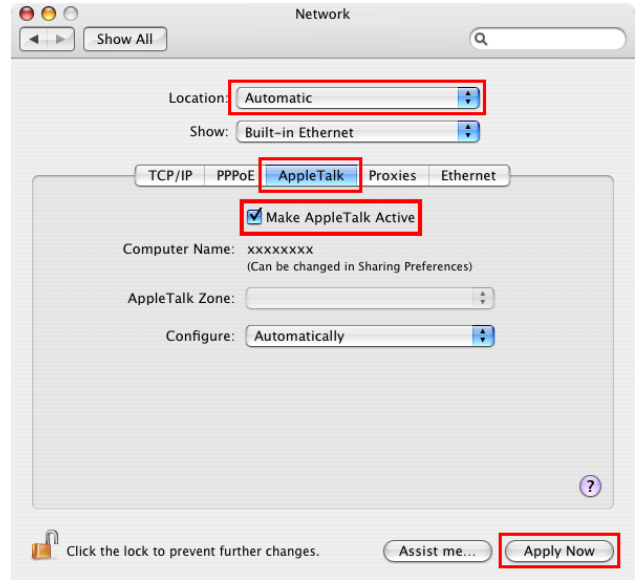

3 Close the **Network** window and save the settings.

Configuring the Printer's AppleTalk Network Settings

Follow the steps below to configure the AppleTalk network settings.

1 Start the web browser and enter the following URL in the **Location** (or **Address**) box to display the RemoteUI page.
 http://printer IP address or name/
 Example: http://xxx.xxx.xxx.xxx/

2 Select **Administrator Mode** and click **Logon**.

3 If a password has been set on the printer, enter the password.

4 Click **Network** in the **Device Manager** menu at left to display the **Network** page.

5 Click **Edit** in the upper-right corner of the **AppleTalk** group to display the **Edit AppleTalk Protocol Settings** page.

6 Refer to the AppleTalk Settings Items table to complete the settings.

AppleTalk Settings Items

Item	Details	Default Setting
Phase Type	Specify whether to use AppleTalk. If you will use AppleTalk, choose Phase 2 . If you will not use AppleTalk, choose Disabled .	Disabled
Name (*1)	Specify the object name used by AppleTalk (in up to 31 single-byte or 15 double-byte characters). However, do not use the following single-byte characters: @, *, :, and =.	Canon NB-18GB (xxxxxx)

Item	Details	Default Setting
Zone (*2)	Specify the printer zone name, up to 31 single-byte characters. However, do not use the following single-byte characters: Also avoid using * (which represents the default zone) in the middle of a string.	*

- *1: The object name you have specified in **Name** is displayed in **Printer Setup Utility** (or **Print Center**) in Mac OS X 10.2.8–10.4. If you use multiple printers in the same zone, assign a unique name to each printer. By default, the network interface name is **Canon NB-18GB (xxxxxx)**. (Here, xxxxxx is the last six digits of the printer's MAC address.)
- *2: If zones have been created on the network, enter the name of the printer's zone. If there are no zones, leave the asterisk * entry (for the default zone) as it is. If you enter a network zone name that does not match created zones, the printer will not be detected by Macintosh computers. Consult your network administrator for information on zone names.

7Click **OK** to display the **Network** page.

Other Settings

Specifying Printer-Related Information 734
 Configuring the Communication Mode Manually 735
 Email Notification When Printing is Finished or Errors Occur 736
 Initializing the Network Settings 736

Specifying Printer-Related Information

Follow the steps below to specify device information and security settings.

- 1** Start the web browser and enter the following URL in the **Location** (or **Address**) box to display the RemoteUI page.
 http://printer IP address or name/
 Example: http://xxx.xxx.xxx.xxx/
- 2** Select **Administrator Mode** and click **Logon**.
- 3** If a password has been set on the printer, enter the password.
- 4** Click **Information** in the **Device Manager** menu at left to display the **Information** page.
 To change the administrator password, click the **Change Password** button in the **Security** group.
- 5** Refer to the table of settings for device information and security as you complete these settings.
 Security setting items are displayed when you click the **Change Password** button in the **Security** group.

Device Information Settings

Item	Details	Default Setting
Device Name	Enter a device name. (0–32 characters)	blank
Location	Enter the location where the device is installed. (0–32 characters)	blank
Administrator	Enter the administrator's name. (0–32 characters)	blank
Phone	Enter the administrator's contact information. (0–32 characters)	blank
Comments(E-mail)	Enter any comments regarding the administrator. (0–32 characters)	blank

Security Settings

Item	Details	Default Setting
New Password	Enter the new password. (0-9999999)	blank
Confirm	Enter the new password again to confirm it. (0-9999999)	blank

*1: On the **Security** settings screen, besides entering a password, you can specify other security-related information, such as IP address-based SNMP or TCP usage restrictions, MAC address-based access restrictions, or IPP and FTP authentication settings.

- 6** Click **OK** to activate the settings.

Configuring the Communication Mode Manually

This topic gives instructions for configuring the communication mode manually.

- 1 On the **Tab Selection screen** of the Control Panel, press ◀ or ▶ to select the **Settings/Adj. tab** ().

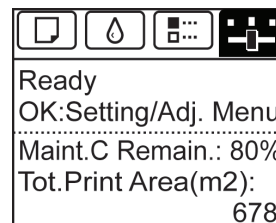

Note

- If the **Tab Selection screen** is not displayed, press the **Menu** button.

- 2 Press the **OK** button.
The **Set./Adj. Menu** is displayed.
- 3 Press ▲ or ▼ to select **Interface Setup**, and then press the **OK** button.
- 4 Press ▲ or ▼ to select **Ethernet Driver**, and then press the **OK** button.
- 5 Press ▲ or ▼ to select **Auto Detect**, and then press the **OK** button.
- 6 Press ▲ or ▼ to select **Off**, and then press the **OK** button.
The display reverts to the **Ethernet Driver** menu.
- 7 Press ▲ or ▼ to select **Comm.Mode**, and then press the **OK** button.
- 8 Press ▲ or ▼ to select the communication mode, and then press the **OK** button.
The display reverts to the **Ethernet Driver** menu.
- 9 Press ▲ or ▼ to select **Ethernet Type**, and then press the **OK** button.
- 10 Press ▲ or ▼ to select the Ethernet type, and then press the **OK** button.
The display reverts to the **Ethernet Driver** menu.
- 11 Press ▲ or ▼ to select **Spanning Tree**, and then press the **OK** button.
- 12 Press ▲ or ▼ to enable or disable spanning tree support, and then press the **OK** button.
The display reverts to the **Ethernet Driver** menu.
- 13 Press the **Menu** button.
After the confirmation message is displayed, press the **OK** button.
The new settings will take effect after the printer re-starts.

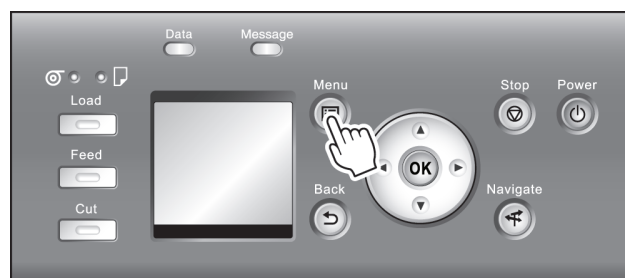



Note

- Communication can also be configured on the **Network** page in RemoteUI.

Email Notification When Printing is Finished or Errors Occur

The printer can notify you of the printer status by email. Even when you are away from the printer, you can know when printing is finished or if errors occur. Receive notification via email on your mobile phone or at your computer.

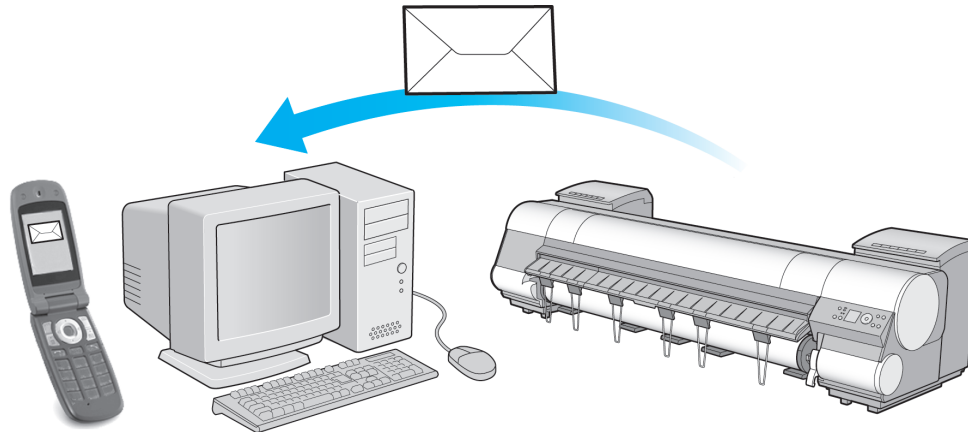

Use the imagePROGRAF Status Monitor (Windows) function to set up email recipients and message timing. Besides being informed of finished print jobs or errors, you can also complete settings for email notification when service is needed or it's time to replace consumables. For detailed instructions, see "Specifying Printer-Related Information." →P.734



Note

- For details on email notification using imagePROGRAF Status Monitor (in Windows), refer to the imagePROGRAF Status Monitor help.
- Mail server authentication is only supported with imagePROGRAF Status Monitor.

Initializing the Network Settings

Use RemoteUI to restore the network settings to the default values as follows.



Important

- Initializing the network settings will also restore the default value of the printer's IP address. As a result, the RemoteUI page cannot be displayed in the web browser after this procedure.
- For instructions on reconfiguring the IP address, see "Configuring the IP Address on the Printer." →P.713
- For details on RemoteUI, see "Using RemoteUI." →P.711

- 1 Start the web browser and enter the following URL in the **Location** (or **Address**) box to display the RemoteUI page.
http://printer IP address or name/
Example: http://xxx.xxx.xxx.xxx/
- 2 Select **Administrator Mode** and click **Logon**.
- 3 If a password has been set on the printer, enter the password.
- 4 Click **Network** in the **Device Manager** menu at left to display the **Network** page.
- 5 Click **Reset to Default settings** in the lower-right corner of the **Network Interface** group.
- 6 After confirming the message, click **OK** to restore the network settings to the default values.

**Note**

- You can also use imagePROGRAF Device Setup Utility or the Control Panel to restore the default network settings.

Device Setup Utility (Windows)

imagePROGRAF Device Setup Utility 738
 Installing imagePROGRAF Device Setup Utility 738
 Configuring the IP Address Using imagePROGRAF Device Setup Utility 738

imagePROGRAF Device Setup Utility

imagePROGRAF Device Setup Utility is a utility to establish communication between the printer and your computer by completing relevant settings. After the printer is installed, for example, you can use imagePROGRAF Device Setup Utility to complete the network settings initially.

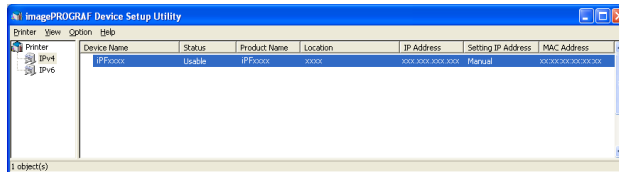

- Starting imagePROGRAF Device Setup Utility will show a list of printers found on the network. In this list, select the printer (specifically, the printer's MAC address) that you want to set up, and then configure the basic settings from your computer, such as the printer's IP address and the network frame type.
- You can see which printers are online in the network by checking the printer list. Communication between your computer and these printers is possible.



- We recommend that your network or printer administrator complete the setup work using imagePROGRAF Device Setup Utility.
- For details, refer to the imagePROGRAF Device Setup Utility help.

Installing imagePROGRAF Device Setup Utility

Install imagePROGRAF Device Setup Utility from the User Software CD-ROM provided with the printer as follows:

- 1 Insert the User Software CD-ROM in the CD-ROM drive.
- 2 On the **Setup Menu** window, click **Install Individual Software**.
- 3 Click **Install** in imagePROGRAF Device Setup Utility.
- 4 Follow the instructions on the screen to proceed with the installation.

Configuring the IP Address Using imagePROGRAF Device Setup Utility

On a computer running Windows, you can use imagePROGRAF Device Setup Utility provided with the printer to configure the printer's IP address. This topic describes how to configure the IP address using imagePROGRAF Device Setup Utility.



- To configure network settings, you must be logged in with administrative rights such as **Administrator** account. We recommend that your network administrator configure the network settings.



- For instructions on installing imagePROGRAF Device Setup Utility, see "Installing imagePROGRAF Device Setup Utility."

→P.738

When specifying an IPv4 IP address

- 1 Start imagePROGRAF Device Setup Utility from the **start** menu.

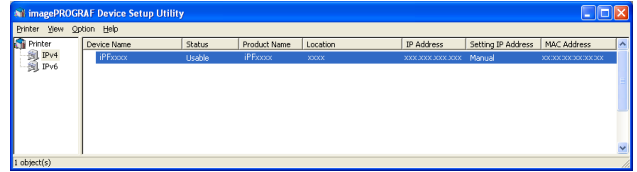

- 2 In the **Device Name** list displayed, select the printer to configure.
- 3 Choose **Protocol Settings** from the **Printer** menu.
- 4 Select the **IPv4** tab.

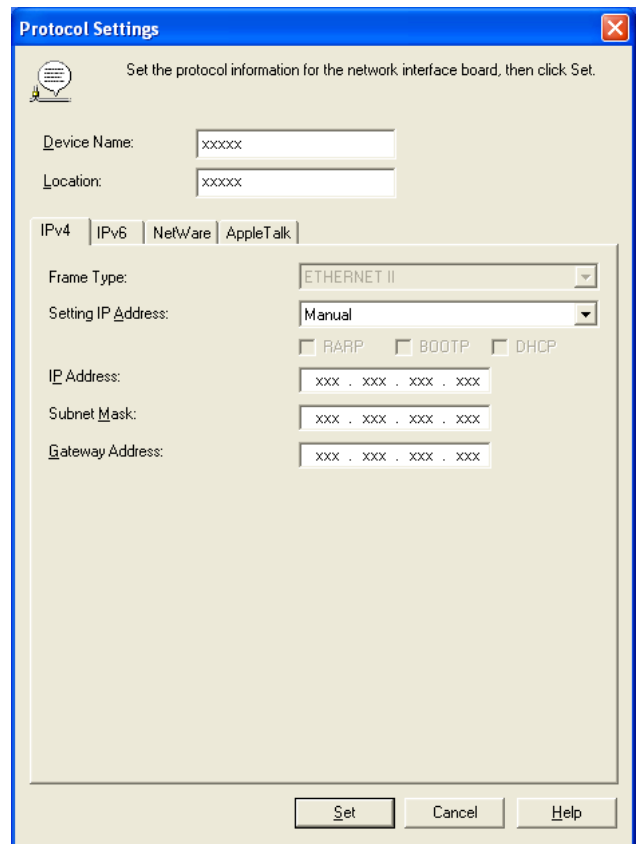

- 5 In the **Setting IP Address** list, choose **Manual**.
- 6 Enter the IP address assigned to the printer and click the **Set** button.
- 7 Click **OK** after the **Confirmation** message is displayed.
- 8 Exit imagePROGRAF Device Setup Utility.



- To configure the IP address automatically, choose **Auto** in the **Setting IP Address** list and select **DHCP**, **BOOTP**, or **RARP**.
- You can also specify the subnet mask and default gateway.

When specifying an IPv6 IP address

- 1 Start imagePROGRAF Device Setup Utility from the **start** menu.

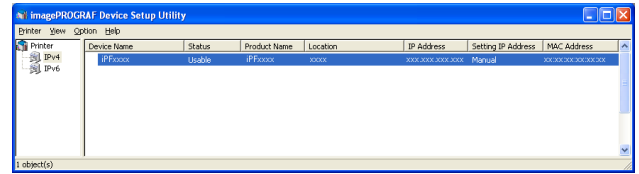

- 2 In the **Device Name** list displayed, select the printer to configure.

- 3 Choose **Protocol Settings** from the **Printer** menu.

- 4 Select the **IPv6** tab.

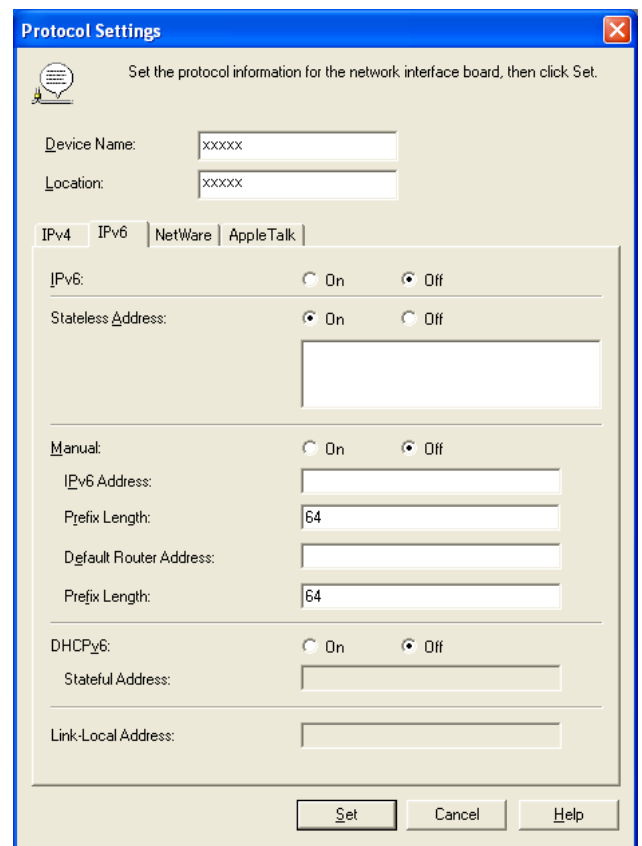

- 5 In **IPv6**, select **On**.

- 6 When there is an IPv6-compatible router in the network environment, select **On** in **Stateless Address**. Additionally, when there is a DHCPv6-compatible server in the network environment, select **On** in **DHCPv6**.



Note

- When there is no IPv6-compatible router or DHCPv6-compatible server, select **On** in **Manual** and enter the **IPv6 Address** and **Prefix Length**.

- 7 Click **Set**.

- 8 Click **OK** after the **Confirmation** message is displayed.

- 9 Exit imagePROGRAF Device Setup Utility.

Basic Printing Workflow	19
Enhanced Printing Options	35
Windows Software	177
Mac OS X Software	363
Handling and Use of Paper	529
Control Panel	655
Printer Parts	691
Network Setting	707

Print Job Management

Status Monitor (Windows)	742
Printmonitor (Mac OS X)	745
Accounting (Windows)	748
Basic Print Job Operations	762
Advanced Print Job Operations	784

Adjustments for Better Print Quality	803
Color Management	821
Maintenance and Consumables	833
Troubleshooting	883
Error Message	915
Specifications	941
Appendix	945

Status Monitor (Windows)

The Features of imagePROGRAF Status Monitor	742
Job Management Using imagePROGRAF Status Monitor	743

The Features of imagePROGRAF Status Monitor

imagePROGRAF Status Monitor is a utility for checking the printer status and managing print jobs.

Two screens are available in imagePROGRAF Status Monitor : **Printer List** shows a list of printers, and **Status Monitor** shows details for each printer.

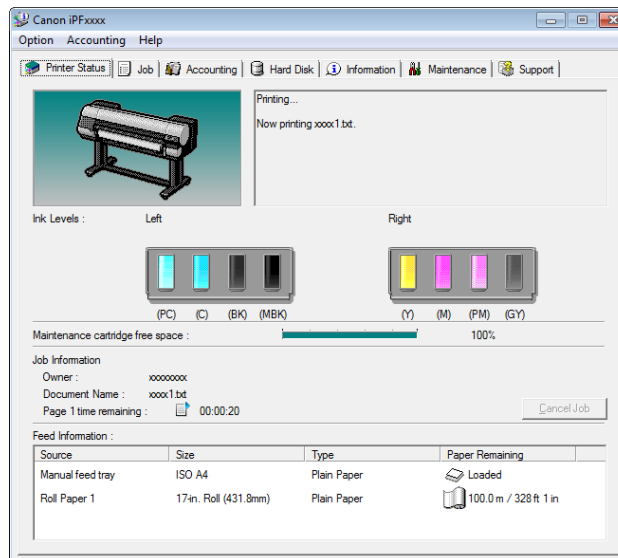
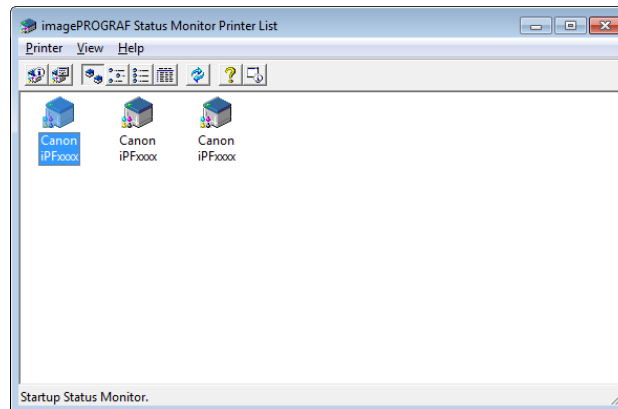

- You can view a list of the printers for which printer drivers have been installed on your computer, printers connected to your computer, and printers found on the network.
- If a printer error occurs, you can investigate the corrective action immediately.
- Printer status can be checked in real time on a computer monitor.
- Displays the ink level of every color in the printer. An icon and warning message will notify you when ink levels are low.
- The type of paper loaded in each media source is identified. You can also check to see if paper has run out.
- This way, the utility enables you to check printer information and take care of printer maintenance for optimal printing results.
- You can also set up automatic email notification of any printer problems or errors to email addresses you designate in advance.

- You can check the status of the hard disk and the documents saved on the hard disk.
- You can use the Accounting Manager to collect the print job logs for the printers and check information such as the printing costs.
For details of the Accounting Manager, see Accounting Manager →P.748 .



Note

- For details, refer to the imagePROGRAF Status Monitor help.

Job Management Using imagePROGRAF Status Monitor

You can use the **Job** sheet in imagePROGRAF Status Monitor for operations such as pausing and canceling print jobs.

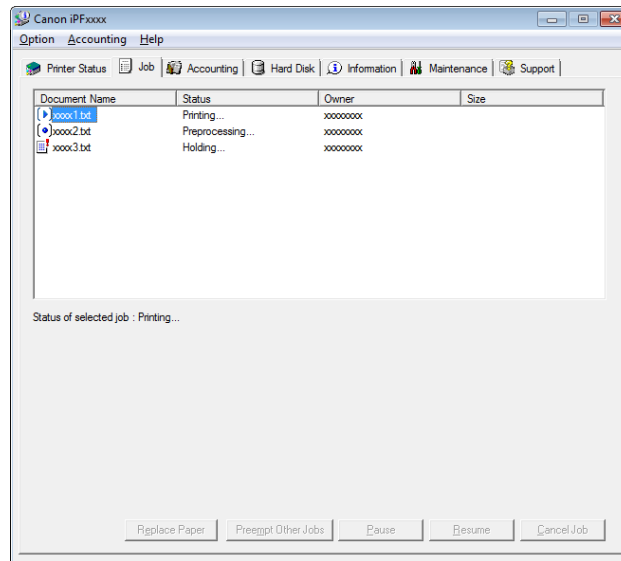

• Preempting Other Jobs

If you select a print job and click the **Preempt Other Jobs** button, the selected job is printed ahead of the job that currently precedes it in the print queue.

• Pausing/Resuming Print Jobs

Selecting a print job and clicking the **Pause** button pauses printing of the selected job.

To resume printing of a paused print job, select the print job and click the **Resume** button.



Note

- Once all the print data for a print job has been sent to the printer, the job can no longer be paused/resumed.

• Canceling Print Jobs

Selecting a print job and clicking the **Cancel Job** button cancels printing of the selected job.



Note

- You cannot cancel other users' print jobs.

• Printing Held Jobs

Printing of the job with a **Status** of **Holding** is paused because the paper specified by the driver does not match the paper currently loaded in the printer.

Use the procedure below to print the held job.

- 1 Select the held job and click the **Replace Paper** button.
- 2 Replace the paper in the printer with the correct paper.



- To continue printing without changing the paper in the printer, select the held job and click **Continue to print** button.

Note

- The printing behavior when the paper specified by the driver does not match the paper currently loaded in the printer can be changed by using **Detect Mismatch** in the operation panel menu. Refer to Menu Settings [→P.675](#) for details.

Printmonitor (Mac OS X)

The Features of imagePROGRAF Printmonitor	745
Job Management Using imagePROGRAF Printmonitor	746

The Features of imagePROGRAF Printmonitor

imagePROGRAF Printmonitor is a utility for checking the printer status and managing print jobs.

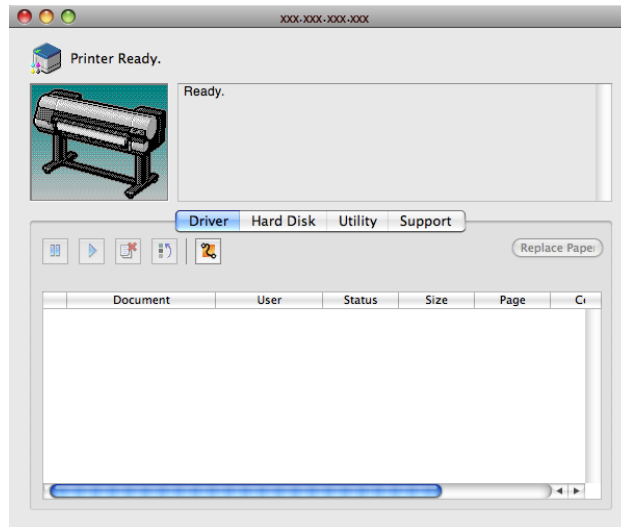

- Printer status can be checked in real time on a computer monitor.
- You can check the status of print jobs, cancel jobs, and manage them as needed.
- If a printer error occurs, you can investigate the corrective action immediately.
- You can also set up automatic email notification of any printer problems or errors to email addresses you designate in advance.
- You can check the status of the hard disk and the documents saved on the hard disk.



Note

- If the status of the desired printer is not shown in imagePROGRAF Printmonitor, select the printer again as follows.
 1. Make sure the printer is on and connected to the network or to a local port.
 2. In the **Printer** menu, select the name of the desired printer. After the printer is detected, the printer status is shown.
 3. If information about the printer is not shown in step 2, choose **Search Printer** in the **Printer** menu. Printer names listed in the **Printer** menu are updated with the printers that are now detected.
 4. In the **Printer** menu, select the name of the desired printer. After the printer is detected, the printer status is shown.

Job Management Using imagePROGRAF Printmonitor

You can use the **Driver** Panel in imagePROGRAF Printmonitor for operations such as pausing and canceling print jobs.

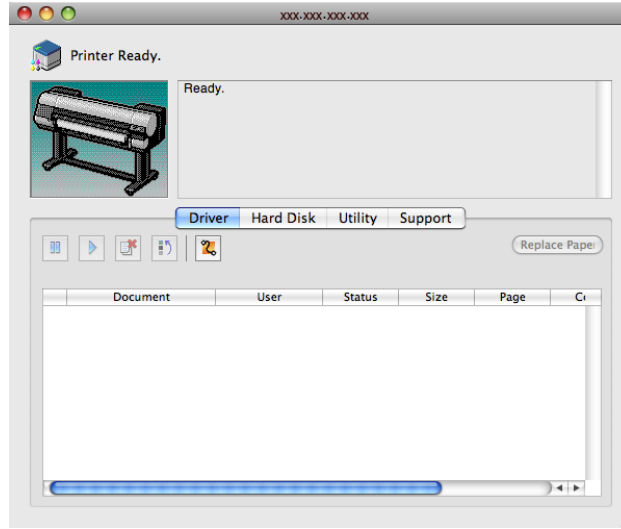

• Preempting Other Jobs

If you select a print job and click the  button, the selected job is printed ahead of the job that currently precedes it in the print queue.

• Pausing/Resuming Print Jobs

Selecting a print job and clicking the  button pauses printing of the selected job.

To resume printing of a paused print job, select the print job and click the  button.



Note

- Once all the print data for a print job has been sent to the printer, the job can no longer be paused/resumed.

• Canceling Print Jobs

Selecting a print job and clicking the  button cancels printing of the selected job.



Note

- You cannot cancel other users' print jobs.

• Printing Held Jobs

Printing of the job with a **Status** of **Holding** is paused because the paper specified by the driver does not match the paper currently loaded in the printer.

Use the procedure below to print the held job.

1 Select the held job and click the **Replace Paper** button.

2 Replace the paper in the printer with the correct paper.

**Note**

- To continue printing without changing the paper in the printer, select the held job and click **Continue to print** button.

Accounting (Windows)

Accounting Manager	748
Launching the Accounting Manager	748
Accounting Manager Main Window	749
Job List Area	751
Accounting Manager Basic Procedures	752
Configuring Unit Costs in Accounting Manager	753
Setting the Unit Cost for Ink	753
Setting the Unit Cost for Paper	754
Setting the Unit Cost for Items Other Than Ink and Paper	756
Configuring Units and Display Settings in Accounting Manager	757
Automatically Acquiring Print Job Logs at Regular Intervals	757
Canceling Regular Print Job Log Acquisition	758
Switching Between Displaying Jobs on Printer and Regularly Acquired Jobs	758
Exporting Print Job Data as a CSV File	758
Displaying Job Properties or Period Properties	759
Showing, Saving and Loading Selected Unit Cost Data	760
Showing the Total Amount of Ink and Paper Consumed	760

Accounting Manager

The Accounting Manager stores the printer's print job logs so that you can use the information for checking printing costs, etc.

The benefits of using the Accounting Manager are outlined below.

- **Print Job Log Collection**
This allows you to check which documents were printed from each printer, who printed them and when.
- **Calculation of the Total Pages Used and the Total Cost**
This allows you to use the collected print job logs to calculate totals for items such as the number of pages printed, the amount of paper used and the printing costs incurred.
- **Regular Data Acquisition for Print Jobs**
Job logs can be automatically collected periodically.
- **Exporting Print Job Data**
This allows you to export collected print job data as a CSV file.



Important

- The Accounting Manager in Status Monitor displays approximate estimates of the amount of paper consumed and the ink consumed per job. Canon cannot guarantee the accuracy of these estimates. These estimates will also vary depending on the conditions of printer use.
- Print job log collection is not performed when **Set./Adj. Menu -> Printer Info -> Show Job Log** of the control panel is **Off**. However,
 - even if **Show Job Log** is set to **Off**, regularly acquired jobs that already have been retrieved at that time are displayed.
 - When **Show Job Log** has been set to **On** again, all jobs within the printer at that time are displayed.

Launching the Accounting Manager

The procedure for launching the Accounting Manager is shown below.

- 1 Open the imagePROGRAF Status Monitor window.

- 2** Select **Accounting** in the **Accounting** menu.
Or, open the **Accounting** sheet and click the **Accounting** button.

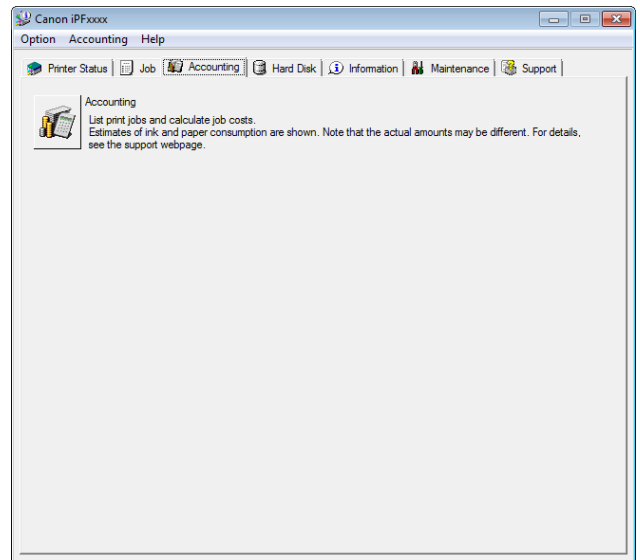

Accounting Manager Main Window

The Accounting Manager main window consists of a title bar, menu bar, toolbars, listed job selection area, job list area, totals area and status bar.

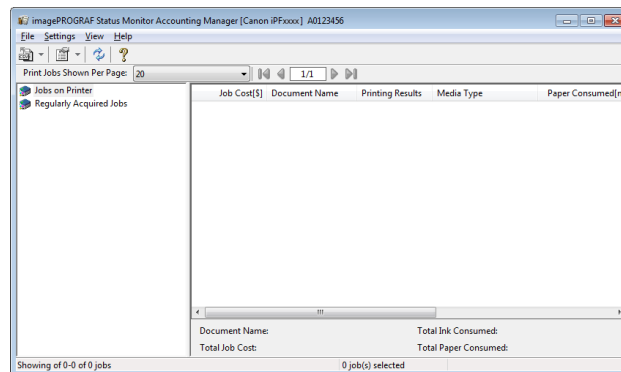

- **Title Bar**

This displays the printer model, its serial number and the port number it is using.

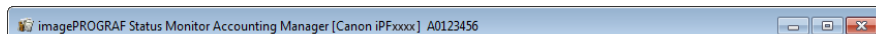

- **Menu Bar**

Allows you to select the menu options required for operation.



- **Toolbars**

Provide tool buttons and pull-down menus for the main operations.

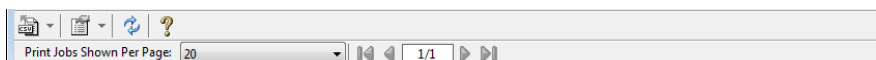

Note

- You can opt to either show or hide the toolbars in the **View** menu.

- **Listed Job Selection Area**

You can use this area to select which job log is displayed.

If you are using regular data acquisition, this area allows you to view the collective job logs for each specified period.

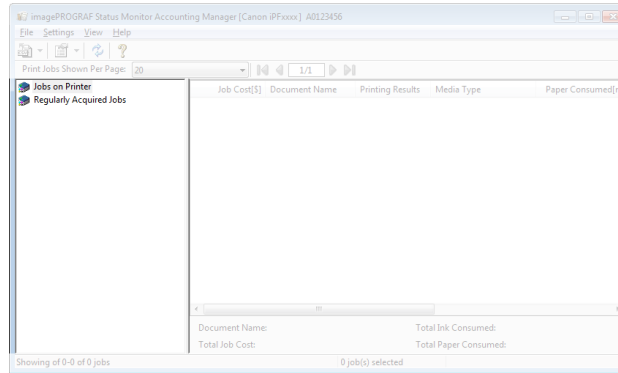

For more information on how to select the job logs displayed, see [Switching Between Displaying Jobs on Printer and Regularly Acquired Jobs](#) →P.758 .

• Job List Area

This area lists the details of acquired jobs.

Displays a list of the jobs in the printers or periodically acquired jobs. (See "Job List Area.") →P.751

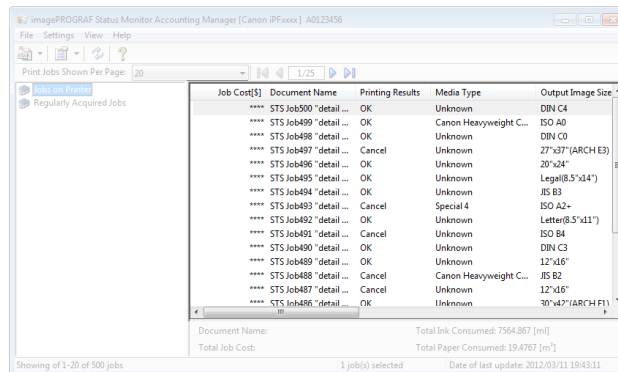

- You can change the items that are displayed and the display order using the **Advanced Display Settings** dialog box. The **Advanced Display Settings** dialog box can be displayed by selecting **Advanced Display Settings** from the **Show** menu.

• Totals Area

Displays the total costs for the selected job and the amounts of paper and ink consumed.

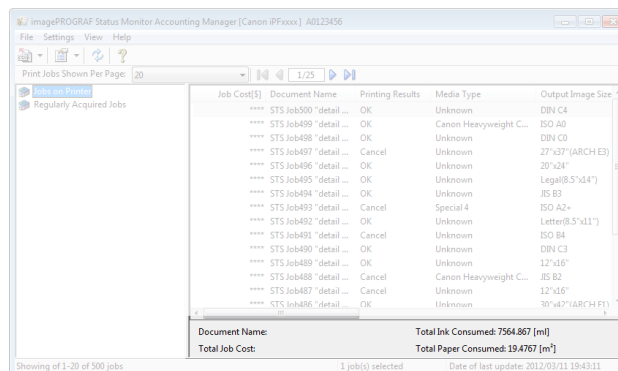

- If you are viewing regularly acquired print jobs, selecting a period on the left side of the window displays the total costs for that period and the amounts of paper and ink consumed.

- **Status Bar**

Displays messages and other information.

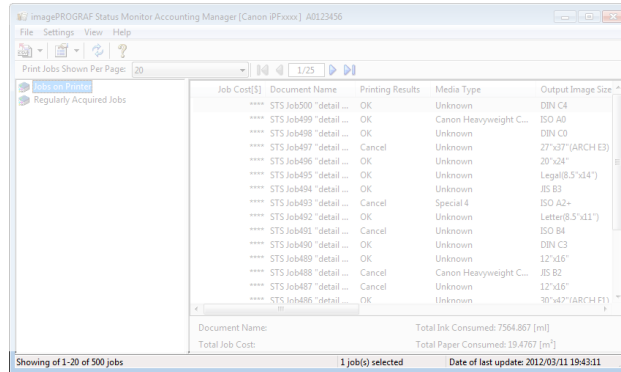

Job List Area

The job items and details that can be displayed in the job list area are as follows.

- **No.**

The job serial number.

- **Job Cost**

The cost of printing.



Note

- If the ink and paper unit costs are not set, **** is displayed.

- **Document Name**

This is the name of the printed document.

- **Printing Results**

OK is displayed when the print process was executed, and **Cancel** is displayed if the print process was not executed.

- **Media Type**

This is the type of paper used in printing.

- **Output Image Size**

The size of the image used for printing.



Note

- If the job has multiple pages, the size of the last page is displayed.

- **Paper Consumed**

The area of paper used for printing.



Note

- The **Paper Consumed** may differ from the product of **Paper Width** and **Paper Length**.

- **Paper Width**

The width of paper used for printing.



Note

- If the job has multiple pages, the width of the last page is displayed.

- **Paper Length**

The length of paper used for printing.

- **Ink Consumed**

The amount of ink used for printing.

- **Owner**

The sender of the job.

- **Print Job Start Time / Print Time**

The time when printing started and the time taken to print.

- **Number of Pages**

The number of pages printed.

- **Roll Paper Width**

The width of roll paper used for printing.

- **Paper Cost**

The cost of paper used for printing.



Note

- If the paper unit cost is not set, **** is displayed.

- **Total Ink Cost**

The total value of the cost of ink used for printing.



Note

- If the ink unit cost is not set, **** is displayed.

- **Total of Other Costs**

The total value of costs other than paper and ink.

- **Ink Cost Details**

The cost of each ink color.

- **Ink Consumption Details**

The amount of each color of ink used.

Accounting Manager Basic Procedures

The first time you use the Accounting Manager, use the following procedures to configure the settings.

1

Configure unit costs, including the costs of ink and paper.

For details of the unit cost settings, see [Configuring Unit Costs in Accounting Manager](#) →P.753 .

2

Set options such as the units displayed.

For details of the unit settings, see [Configuring Units and Display Settings in Accounting Manager](#) →P.757 .

3 If you are using Regular Data Acquisition, configure the Regular Data Acquisition settings. For details of the Regular Data Acquisition settings, see Automatically Acquiring Print Job Logs at Regular Intervals →P.757 .

4 Specify the jobs to be listed. For details of how to select the job logs displayed, see Switching Between Displaying Jobs on Printer and Regularly Acquired Jobs →P.758 .

This displays the required print job logs and lists the details.

Configuring Unit Costs in Accounting Manager

Select **Unit Costs** in the **Settings** menu to open the **Unit Costs** dialog box. Configure the unit cost settings in this dialog box.



- When you select a job and then open the **Unit Costs** dialog box, items with unit costs that have not yet been configured for that job are shown highlighted.

- Setting the Unit Cost for Ink →P.753
- Setting the Unit Cost for Paper →P.754
- Setting the Unit Cost for Items Other Than Ink and Paper →P.756

Setting the Unit Cost for Ink

Open the **Ink** sheet. Set the unit cost for ink in this sheet.

Unit Costs

Ink Paper Other

Use same price for all ink

Tank Capacity: 330 ml Price: Not Specified \$

Price List:

Ink Color	Tank Capacity[ml]	Price[\$]
PC (Photo Cyan)	330	Not Specified
C (Cyan)	330	Not Specified
BK (Black)	330	Not Specified
MBK (Matte Black)	330	Not Specified
Y (Yellow)	330	Not Specified
M (Magenta)	330	Not Specified
PM (Photo Magenta)	330	Not Specified
GY (Gray)	330	Not Specified

Ink Unit Cost Setting: PC (Photo Cyan)

Tank Capacity: 330 ml Price: Not Specified \$

Overwrite

OK Cancel Help

To set the same unit cost for all the inks

1 Select the **Use same price for all ink** checkbox.

2 Enter the **Tank Capacity** and corresponding **Price**.

3 Click the **OK** button.



Your settings are not applied until you click the **OK** button.

To set different unit costs for each ink color

1 Select the ink color to be costed.

2 Enter the **Tank Capacity** and corresponding **Price**.

3 Click the **Overwrite** button.

4 Repeat steps 1 to 3 for all the inks.

5 Click the **OK** button.



Your settings are not applied until you click the **OK** button.

Setting the Unit Cost for Paper

Opens the **Paper** sheet. This sheet is used to configure the unit cost of paper.

Unit Costs

Ink Paper Other

Price List:

Media Type	Roll Paper ...	Width[mm]	Length[m]

Delete

Paper Unit Cost Settings

Media Type: Plain Paper

Width: mm Roll Paper Width Settings...

Length: m

Price: \$

Add Overwrite

OK Cancel Help

Setting Standard Prices

- 1 Select the media type in **Media Type**.
- 2 Enter the **Width** and **Length** of the paper, as well as the **Price** for the area of the configured width x height.
- 3 Click the **Add** button. To change the unit cost of a media type that has already been configured, click the **Overwrite** button.
- 4 Click the **OK** button.



- The settings are not applied until you click the **OK** button.

Important

Specifying Price by Roll Paper

- 1 Select the media type in **Media Type**.
- 2 Click the **Roll Paper Width Settings** button to display the **Roll Paper Width Settings** dialog box.

- 3 Enter the **Roll Paper Width** and **Length** of the paper, as well as the **Price** for the configured length.
- 4 Click the **Add** button to return to the **Paper** sheet.
- 5 To change the unit cost of a media type that has already been configured, click the **Overwrite** button.
- 6 Click the **OK** button.



Important

- If you do not set the standard prices, you cannot set the price for each roll paper.
- If the **Roll Paper Width** is set to the same value as the **Width** of the paper configured in the standard prices, the cost is calculated using the price configured in the **Roll Paper Width Settings** dialog box.
- The settings are not applied until you click the **OK** button.

Setting the Unit Cost for Items Other Than Ink and Paper

Open the **Other** sheet. Use this sheet to set any price for items other than inks and paper.

The screenshot shows the 'Unit Costs' dialog box with the 'Other' tab selected. The 'Price List' table is empty. The 'Unit Costs' section has the following fields: 'Name' (text input), 'Unit Cost' (text input with a '\$' symbol), and 'Allocated' (dropdown menu set to 'Yes'). Buttons for 'Delete', 'Add', 'Overwrite', 'OK', 'Cancel', and 'Help' are visible.

- 1** Enter any name in the **Name** field.
- 2** Enter a value in **Unit Cost**.
- 3** Use **Allocated** to specify whether the costs are allocated as being incurred by the print job.
- 4** Click the **Add** button. To change the unit cost for a media type you have already set, click the **Overwrite** button.
- 5** Click the **OK** button.



- Your settings are not applied until you click the **OK** button.

Important



- You can set unit costs for up to 5 items.

Note

Configuring Units and Display Settings in Accounting Manager

Select **Units and Display** in the **Settings** menu to open the **Units and Display** dialog box. Use this dialog box to configure the display settings.

The screenshot shows a dialog box titled "Units and Display" with the following settings:

- Date Display Format: YYYY/MM/DD
- Currency Unit: \$ (Three characters or less)
- 1000 Separator: None
- Decimal Symbol: . (Period)
- Ink level: ml
- Paper Width: mm
- Paper Length: m
- Area Display Format: m²

Buttons at the bottom: OK, Cancel, Help.

• Date Display Format

Use this option to select the display format for dates. "YYYY" indicates the year, "MM" the month and "DD" the day.

• Currency Unit

Enter the currency unit. Enter a text string up to 3 characters long.

• 1000 Separator

Use this option to select the symbol used as a separator in numbers. The symbol is inserted every 3 digits.

• Decimal Symbol

Use this option to select the symbol used as a decimal point.

• Ink Consumed

Use this option to select the unit used for ink consumption.

• Paper Width

Use this to select the unit used for paper width.

• Paper Length

Use this to select the unit used for paper length.

• Area Display Format

Use this to select the unit used for paper area.

Automatically Acquiring Print Job Logs at Regular Intervals

This feature collects print job logs from the printer at regular intervals and saves the logs on your computer.

1 Select **Regular Data Acquisition** in the **Settings** menu.

2 Select **Acquire print job logs regularly**.

3 Click the **OK** button to close the dialog box.



- Print job log collection is not performed when **Set./Adj. Menu -> Printer Info -> Show Job Log** of the control panel is **Off**. However, even if **Show Job Log** is set to **Off**, regularly acquired jobs that already have been retrieved at that time are displayed.



Note

- Immediately after you configure Regular Data Acquisition, no print jobs are displayed. Wait a few moments and then select **Refresh** in the **View** menu to display the print jobs.
- A maximum of 10,000 records are saved in a print job log. If this number is exceeded, jobs are deleted from the log starting from the oldest record. To save old data, it is recommended that you export the data as a CSV file. For details of how to export print job logs as CSV files, see Exporting Print Job Data as a CSV File [→P.758](#).

Canceling Regular Print Job Log Acquisition

You can use this procedure to cancel the regular acquisition of print job logs from printers.

- 1 Select **Regular Data Acquisition** in the **Settings** menu.
- 2 Uncheck the **Acquire print job logs regularly** option.
- 3 Click the **OK** button to close the dialog box.

Switching Between Displaying Jobs on Printer and Regularly Acquired Jobs

The print job logs displayed by the Status Monitor Accounting Manager contain two types of job: Jobs on Printer and Regularly Acquired Jobs.

You can select whether to display Jobs on Printer or Regularly Acquired Jobs in the Listed Job Selection Area on the left side of the window.

• Jobs on Printer

This shows a list of the print jobs currently held on printers.

You can change the number of jobs displayed per page using the **Print Jobs Shown Per Page** setting in the **View** menu or the toolbar.

You can skip to a particular page using the **Go to** option in the **View** menu or the toolbar.



Note

- For printers with built-in hard disks, you can view up to 500 print jobs per printer.
- For printers without built-in hard disks, you can view up to 32 print jobs per printer. However, only 10 jobs can be displayed if the printer is switched off.

• Regularly Acquired Jobs

This shows a list of regularly acquired print jobs.

To view all the jobs in a set period, specify the period using **Calculate Total for Period** and then **Starting Date** (or **Starting Day of Week** or **Starting Month**) in the **View** menu or the toolbar.

For example, to view monthly job logs starting on the 1st of each month, set **Calculate Total for Period** to **Monthly** and set **Starting Date** to **1**.



Note

- Up to 10,000 regularly acquired jobs are displayed for each printer.

Exporting Print Job Data as a CSV File

You can export the collected print job data in the form of a CSV file by selecting **Export Job Cost Data** in the **File** menu.



Note

- You can also select **Export Job Cost Data** using the icon in the toolbar.

- **Selected Jobs**

Exports the data for the selected print jobs in the job list as a CSV file.



Note

- You can select multiple jobs by holding down the Shift key or Ctrl key as you click the job names.

- **Listed Jobs**

Exports the data for the print jobs currently displayed in the list as a CSV file.

Displaying Job Properties or Period Properties

You can display the **Job properties** dialog box or **Period Properties** dialog box to check detailed cost information and other items.

The **Job properties** dialog box displays detailed information about the selected job.

The **Period Properties** dialog box displays detailed information within the **Regularly Acquired Jobs** period.

- **Displaying the Job properties Dialog Box**

Select a job from the job list, and then select **Show Job Properties** from **Job properties** in the **File** menu. You can also select multiple jobs at once.



Note

- You can also display the dialog box by selecting a job, right-clicking it, and then selecting **Show Job Properties**, or by using the icon in the toolbar.

- **Displaying the Period Properties Dialog Box**

Select a period from the **Regularly Acquired Jobs** list, and then select **Show Period Properties** from **Job properties** in the **File** menu. You can also select multiple periods at once.



Note

- You can also display the dialog box by selecting and right-clicking a period and then selecting **Show Period Properties**, or by using the icon in the toolbar.

- Components of the **Job properties** Dialog Box/ **Period Properties** Dialog Box

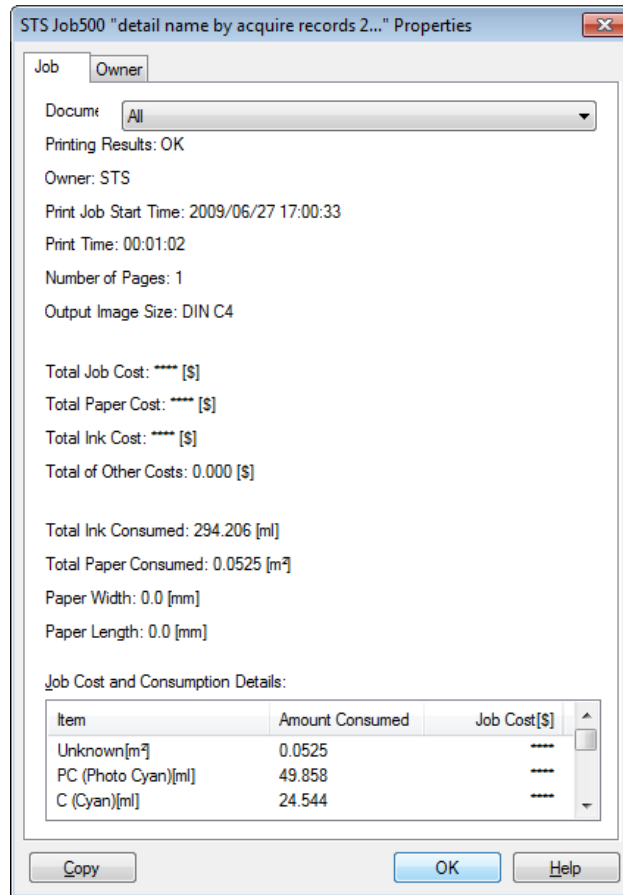

- **Job tab**
Displays detailed information about the selected job. You can display detailed information about each job by selecting the corresponding **Document Name**.
- **Owner tab**
You can display detailed information about each owner by selecting the corresponding **Owner**.
- **Copy** button
Click this button to copy the displayed text information to the clipboard.

Showing, Saving and Loading Selected Unit Cost Data

- **Show Unit Cost Data**

Select **Show Unit Cost Data** in the **File** menu to open the **Unit Cost Data** dialog box. This lists the unit costs for items such as the selected ink and paper.

You can copy text-based information in this dialog box to the clipboard by clicking the **Copy** button.

- **Save Unit Cost Data**

Select a destination folder using **Save Unit Cost Data** in the **File** menu. The unit cost data for items such as the selected ink and paper is saved as a file.

- **Load Unit Cost Data**

Selecting **Load Unit Cost Data** in the **File** menu loads saved unit cost data.

Showing the Total Amount of Ink and Paper Consumed

Select **Show Ink and Paper Consumed** in the **File** menu to open the **Show Ink and Paper Consumed** dialog box. This lists the total amounts of ink and paper consumed by the printer so far.

You can copy text-based information in this dialog box to the clipboard by clicking the **Copy** button.



- Up to 7 types of media are listed in order of the amount consumed. The total consumption for other media types is shown as **Other**.

Basic Print Job Operations

Using the Printer Hard Disk	762
Saving Print Jobs on the Printer Hard Disk	764
Managing the Job Queue (Deleting or Preempting Other Jobs)	767
Managing Pending Jobs (Printing or Deleting Jobs on Hold)	769
Printing Saved Jobs	771
Deleting Saved Jobs	776
Moving Saved Jobs	780

Using the Printer Hard Disk

The printer can save print jobs on the built-in hard disk.

Using print jobs stored on the printer enables you to print the jobs again as needed without using a computer.

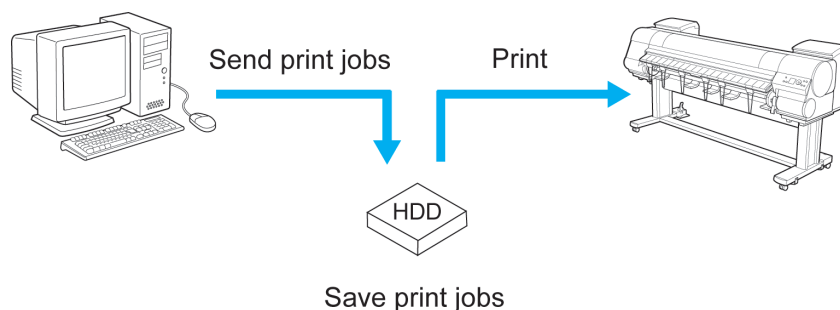

Saving print jobs offers the following benefits.

- **Save the time spent using a computer**

When you send a print job to the printer, you can save it on the printer after printing or simply save it on the printer without printing it yet. Saved print jobs can be printed in the required quantity later without the need to use a computer again.

- **Simplify reprinting, if any errors occur**

If errors occur in the middle of printing (as when paper runs out), you can resume printing after clearing the error without resending the print job from a computer.

- **Streamline printing work**

Without using a computer, you can select print jobs and print in the desired quantity. You can also select multiple print jobs to print during the same period. This enables unattended operation at night, for example.

Output Method

To save print jobs on the printer's hard disk, configure the printer driver.

In Windows, this is set using the **Output Method** dialog box.

In Mac OS X, this is set using the **Additional Settings** pane.

- **Print**

Save print jobs on the printer's hard disk after printing.

- **Save in mail box**

Save print jobs on the printer's hard disk.

- **Print after reception is complete**

This option is available in combination with **Print**. You can prevent degradation of print quality that occurs when receiving a print job is interrupted and printing is aborted in the middle.

Storage destination

The storage area on the printer's hard disk is divided into a temporary storage area and a permanent storage area. The temporary storage area stores print jobs in the job queue or shared mailbox. The permanent storage area stores jobs in personal boxes.

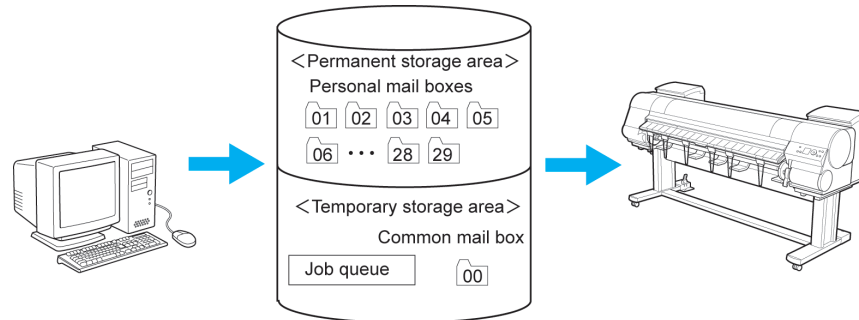

• Job queue

The job queue refers to print jobs that are being processed by the printer (saved, received, prepared for processing, printed, deleted, or held). Up to 64 jobs can be stored in the temporary storage area.

When the job queue is full, additional jobs sent from a computer are treated as "standby" jobs, to be processed when possible.

However, if all queued jobs are simply being held, the oldest job is deleted and the print job sent from the computer is processed.

• Shared mailbox

Jobs for which you have specified **Print** in **Output Method** (in Windows) or **Send job to** (in Mac OS X) are saved in the shared mailbox and classified as saved jobs.

There is one shared mailbox, numbered **00**. A password cannot be set for the shared mailbox.

Up to 100 print jobs can be saved here, but they will be deleted one after another starting with the oldest job in the following situations.

- If there are more than 100 jobs queued and saved in the shared mailbox combined
- If no more temporary storage space is available when jobs for which you have selected **Print** in **Output Method** (in Windows) or **Send job to** (in Mac OS X) are received
- If there is not enough space in the temporary or permanent storage area when jobs for which you have selected **Save in mail box** in **Output Method** (in Windows) or **Send job to** (in Mac OS X) are received

• Personal boxes

Jobs are classified as saved jobs and saved in personal boxes in the following situations.

- When a saved job stored in the shared mailbox is moved to a personal box
- When you have selected **Save in mail box** as the option in **Output Method** (in Windows) or **Send job to** (in Mac OS X)

There are 29 personal boxes, numbered **01** to **29**. You can specify a name and password for each personal box. Up to 100 print jobs can be saved in all personal boxes combined.

Saving Print Jobs on the Printer Hard Disk

To save print jobs on the printer's hard disk, configure the printer driver.

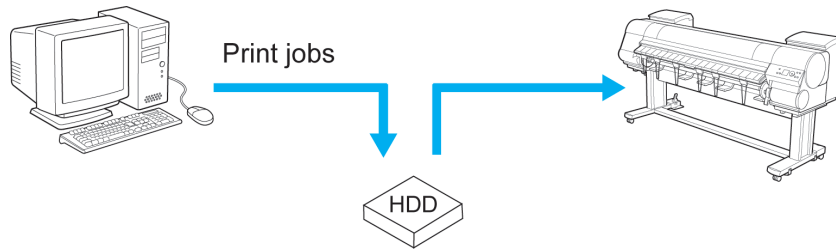

Note

- Printing from the following software also enables you to save print jobs on the printer's hard disk.

Windows

- Print Plug-In →P.257

Mac OS

- Print Plug-In →P.465

Configuring the Printer Driver in Windows

- 1 Access the **Page Setup** sheet.

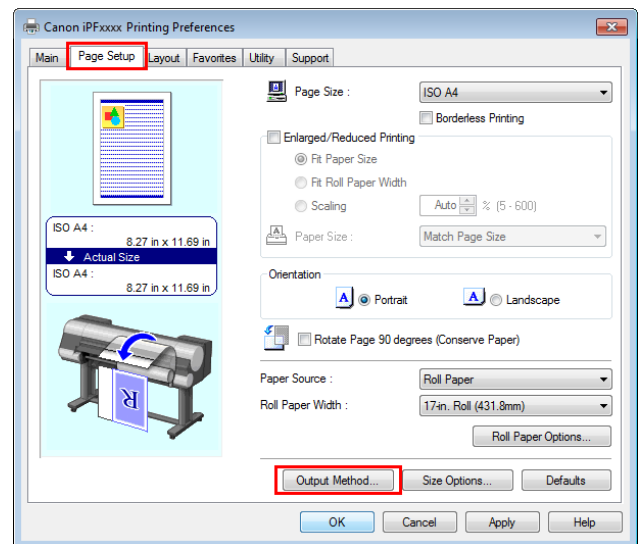

- 2** Click **Output Method** to display the **Output Method** dialog box.

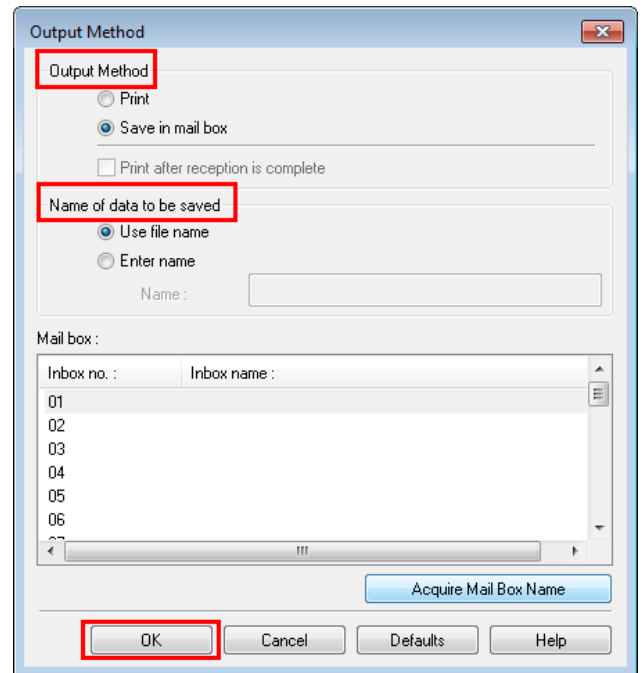

- 3** Make your selection in **Output Method**.

- **Print**

Save print jobs on the printer's hard disk after printing.

- **Save in mail box**

Save print jobs on the printer's hard disk.

If you choose **Save in mail box**, also specify the destination personal box in the **Mail box** list.

- **Print after reception is complete**

This option is available in combination with **Print**. You can prevent degradation of print quality that occurs when receiving a print job is interrupted and printing is aborted in the middle.



Note

- Click **Acquire Mail Box Name** to display personal box names in the **Mail box** list, as acquired from the printer.

- 4** In **Name of data to be saved**, specify how to name saved print jobs.

- To use the file name, choose **Use file name**.
- Otherwise choose **Enter name** and enter a name in **Name**.

- 5** Click **OK** to close the **Output Method** dialog box.

Configuring the printer driver in Mac OS

1 Access the **Additional Settings** pane.

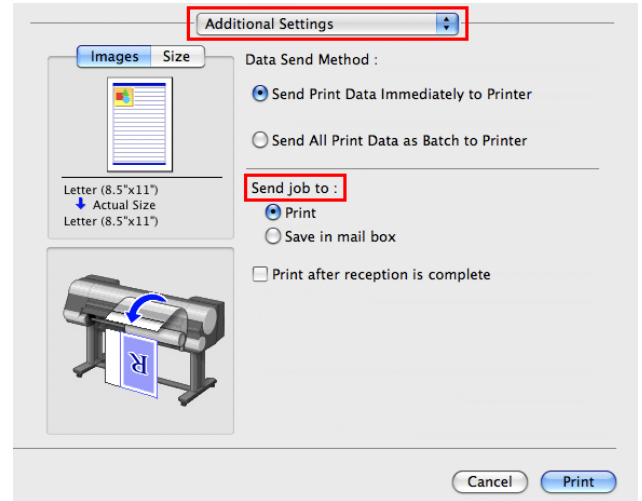

2 Make your selection in **Send job to**.

- **Print**

Save print jobs on the printer's hard disk after printing.

- **Save in mail box**

Save print jobs on the printer's hard disk.

The **Destination** dialog box is displayed if you select **Save in mail box**. Here, specify the name and personal box number for saved print jobs.

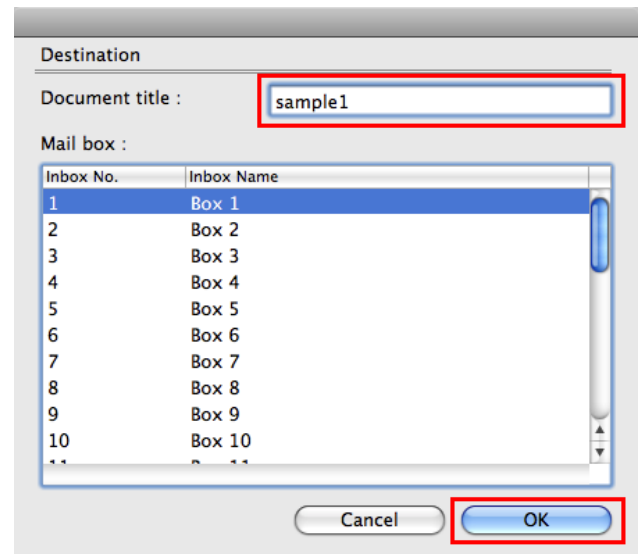

1. In **Document title**, enter a name to identify saved print jobs.



Note

- If printed from Free Layout or Preview, the **Document title** is saved under the name imagePROGRAF.

2. Select the personal box number in the **Mail box** list.

3. Click **OK** to close the **Destination** dialog box.

- **Print after reception is complete**

This option is available in combination with **Print**. You can prevent degradation of print quality that occurs when receiving a print job is interrupted and printing is aborted in the middle.

Managing the Job Queue (Deleting or Preempting Other Jobs)

Print jobs being processed by the printer are collectively called the job queue. You can delete or preempt jobs in the job queue as needed.

These operations are available from the Control Panel or in RemoteUI, imagePROGRAF Status Monitor, and imagePROGRAF Printmonitor.

- Delete
Note that only jobs that are not currently being deleted can be deleted from the job queue.

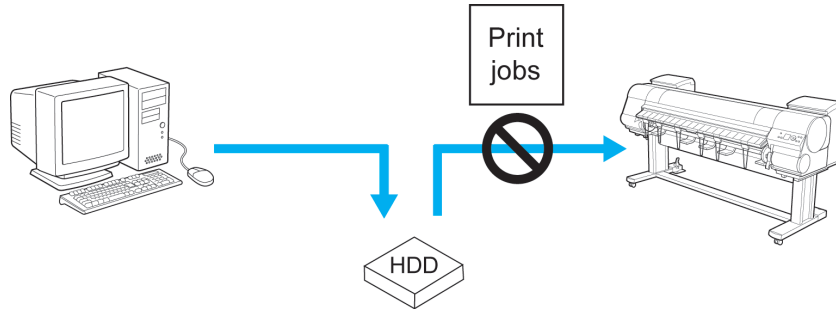

- Preempting other jobs
You can preempt other jobs by printing jobs that are currently being received or prepared for processing first.

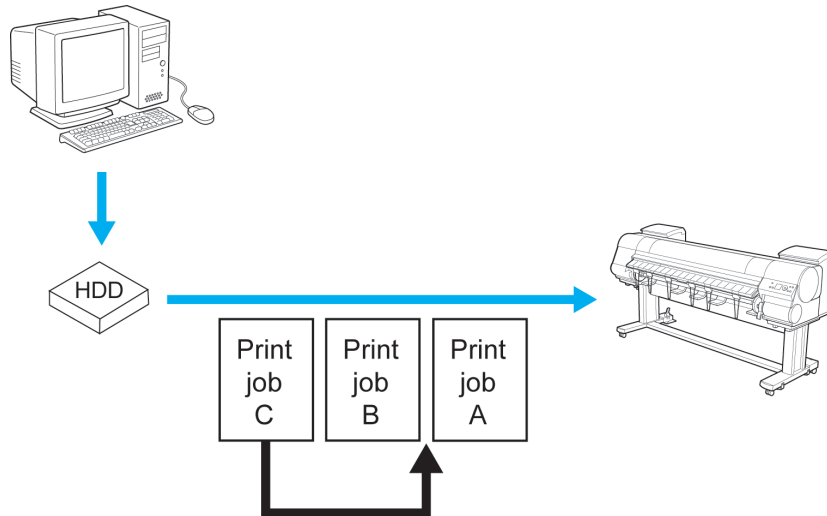

• For information on managing jobs being held, see "Managing Pending Jobs (Printing or Deleting Jobs on Hold)." →P.769

Using the Control Panel

- 1 On the **Tab Selection screen** of the Control Panel, press ◀ or ▶ to select the Job tab ().



• If the **Tab Selection screen** is not displayed, press the **Menu** button.

2 Press the **OK** button.
The **Job Menu** is displayed.

3 Manage the job queue as needed.

- Deleting jobs

1. Press **▲** or **▼** to select **Print Job**, and then press the **OK** button.
2. Press **▲** or **▼** to select the print job to delete, and then press the **OK** button.
3. Press **▲** or **▼** to select **Delete**, and then press the **OK** button.

- Preempting other jobs

1. Press **▲** or **▼** to select **Print Job**, and then press the **OK** button.
2. Press **▲** or **▼** to select the job to print first, and then press the **OK** button.
3. Press **▲** or **▼** to select **Preempt Jobs**, and then press the **OK** button.

Using RemoteUI

Manage jobs as needed on the **Print Job** page. For details, refer to the RemoteUI help.

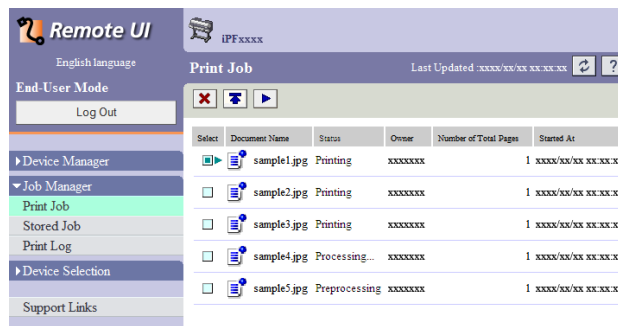

Using imagePROGRAF Status Monitor (Windows)

Manage jobs as needed on the **Job** sheet. For details, refer to the imagePROGRAF Status Monitor help file.

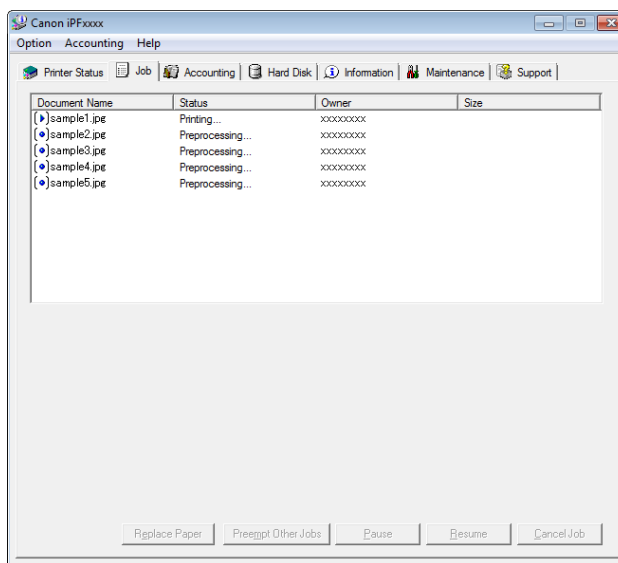

Using imagePROGRAF Printmonitor (Mac OS)

Manage jobs as needed on the **Driver** sheet. For details, refer to the imagePROGRAF Printmonitor help file.

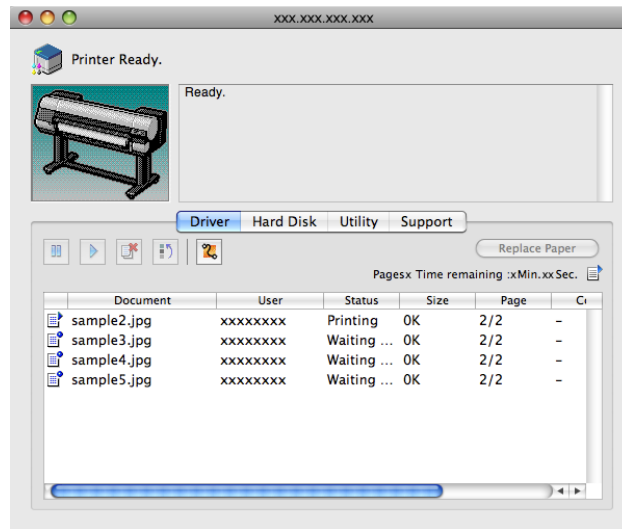

Managing Pending Jobs (Printing or Deleting Jobs on Hold)

If the type or size of paper loaded does not match the settings in the print job received when you have set **Detect Mismatch** to **Hold Job** in the Control Panel menu, the print job is held on the printer as a pending job in the job queue. Manage held jobs such as these as follows.

These operations are available from the Control Panel or in RemoteUI, imagePROGRAF Status Monitor, and imagePROGRAF Printmonitor.



Note

- As long as you do not manage held jobs from the Control Panel, imagePROGRAF Status Monitor, or imagePROGRAF Printmonitor, they will remain in the job queue. In this case, the printer processes the next job in the queue without pausing.
- To print held jobs, replace the loaded paper with the paper specified in the print job.
(See "Loading Rolls in the Printer." →P.541)
(See "Loading Sheets in the Printer." →P.563)

Using the Control Panel

- On the **Tab Selection screen** of the Control Panel, press ◀ or ▶ to select the Job tab ().

"**There are held jobs.**" is displayed if jobs are being held.

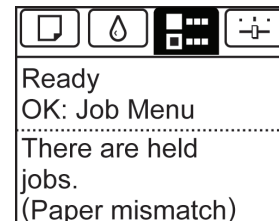

Note

- If the **Tab Selection screen** is not displayed, press the **Menu** button.

- Press the **OK** button.
The **Job Menu** menu is displayed.

- Press ▲ or ▼ to select **Print Job**, and then press the **OK** button.

- 4** Press ▲ or ▼ to select the print job to manage, and then press the **OK** button.
Held jobs are labeled with an icon.



- 5** Press ▲ or ▼ to select **Print Anyway** or **Delete**, and then press the **OK** button.

- If you choose **Print Anyway**
Press ▲ or ▼ to select **Yes** or **No**, and then press the **OK** button.
- If you choose **Delete**
Press ▲ or ▼ to select **Yes** or **No**, and then press the **OK** button.

Using RemoteUI

Manage jobs as needed on the **Print Job** page. For details, refer to the RemoteUI help file.

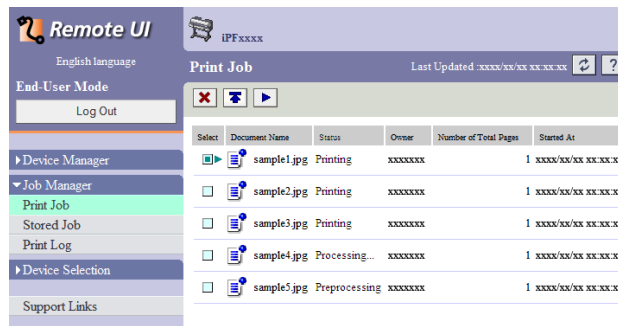

Using imagePROGRAF Status Monitor

Manage jobs as needed on the **Job** sheet. For details, see "Job Management Using imagePROGRAF Status Monitor."

→P.743

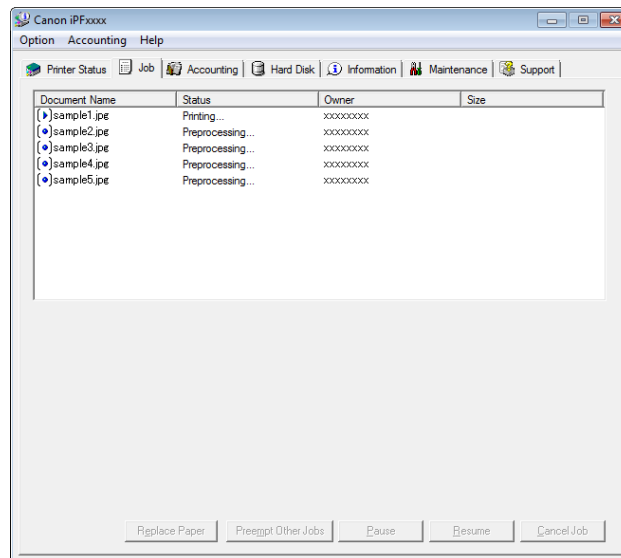

Using imagePROGRAF Printmonitor

Manage jobs as needed on the **Driver** sheet. For details, see "Job Management Using imagePROGRAF Printmonitor."

→P.746

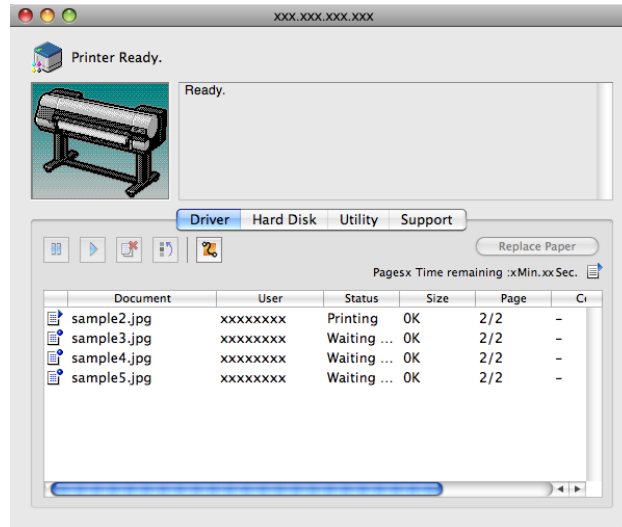

Printing Saved Jobs

Print saved print jobs stored on the printer's hard disk as follows.

These operations are available from the Control Panel or in RemoteUI, imagePROGRAF Status Monitor, and imagePROGRAF Printmonitor.

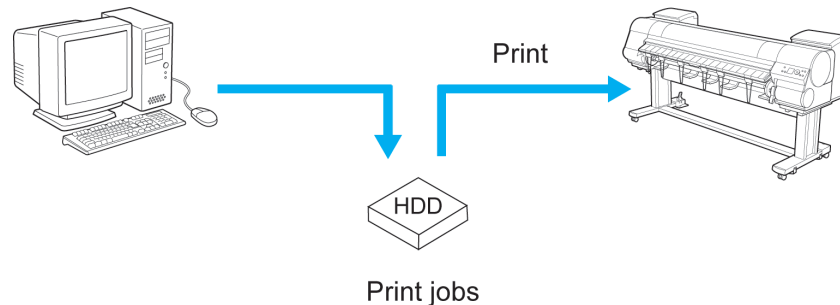

Using the Control Panel

- 1 On the **Tab Selection screen** of the Control Panel, press ◀ or ▶ to select the Job tab ().

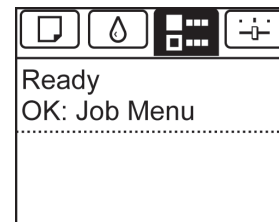

• If the **Tab Selection screen** is not displayed, press the **Menu** button.

Note

- 2 Press the **OK** button.
The **Job Menu** menu is displayed.
- 3 Press ▲ or ▼ to select **Stored Job**, and then press the **OK** button.

4 Press ▲ or ▼ to select the box number (in the range 00–29), and then press the **OK** button.



• Enter a password if one has been set, and then press the **OK** button.

Note

5 Press ▲ or ▼ to select **Job List**, and then press the **OK** button.

6 Press ▲ or ▼ to select the saved job, and then press the **OK** button.

7 Press ▲ or ▼ to select **Print**, and then press the **OK** button.

8 Specify the number of copies and press the **OK** button.

Using RemoteUI

1 On the **Stored Job** page, choose the box.



• Enter a password if one has been set.

Note

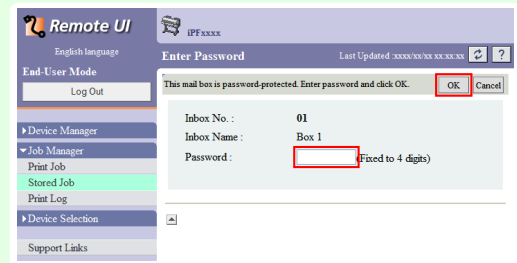

2 Select the print job and click **Resume**.

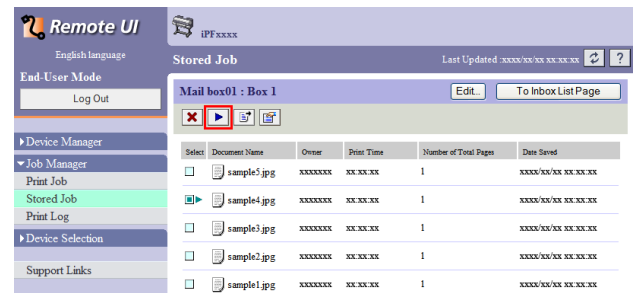

- 3** On the **Print Saved Document** page, enter the quantity to print in **Copies** and click **OK**.

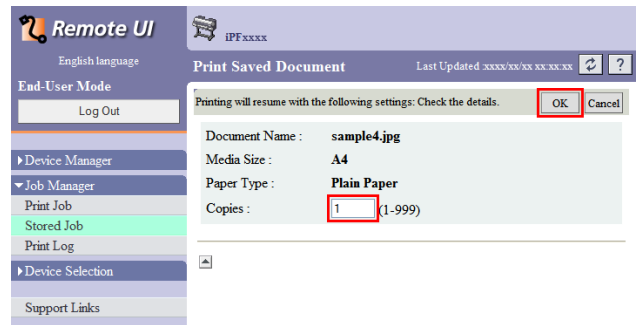

For details, refer to the RemoteUI help.

Using imagePROGRAF Status Monitor

- 1** On the **Hard Disk** sheet, select a box and click **Open**.

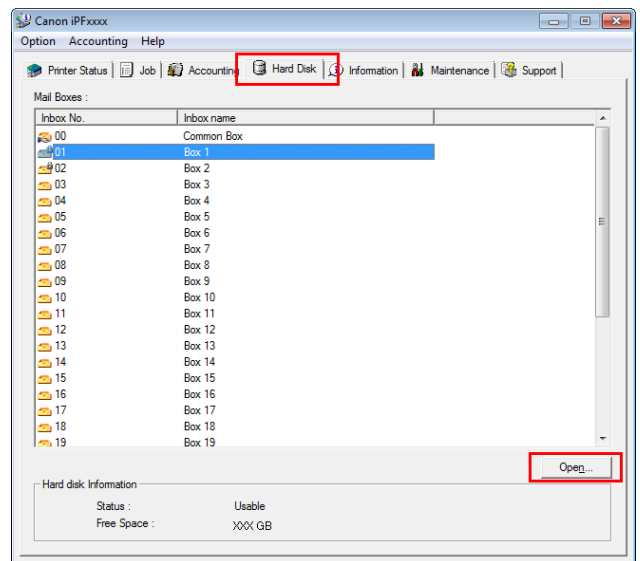

- Enter a password if one has been set.

Note

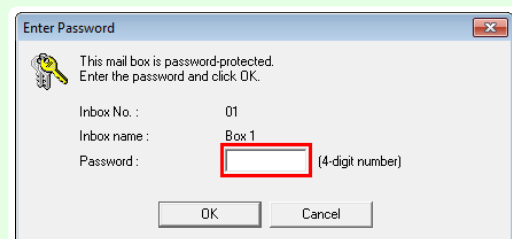

- In the **Documents** dialog box, select the print job and click **Print**.

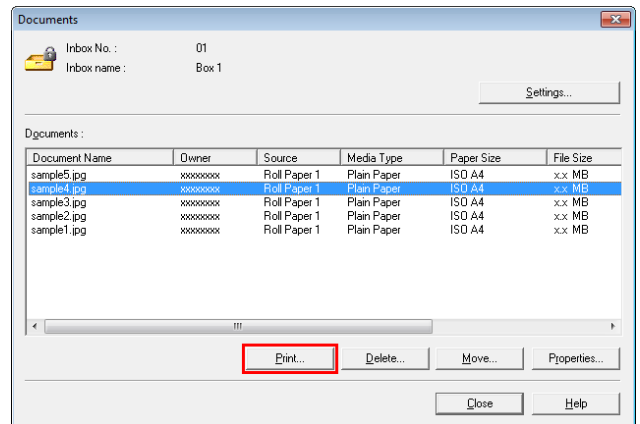

- In the **Print** dialog box, enter the quantity to print in **Copies** and click **OK**.

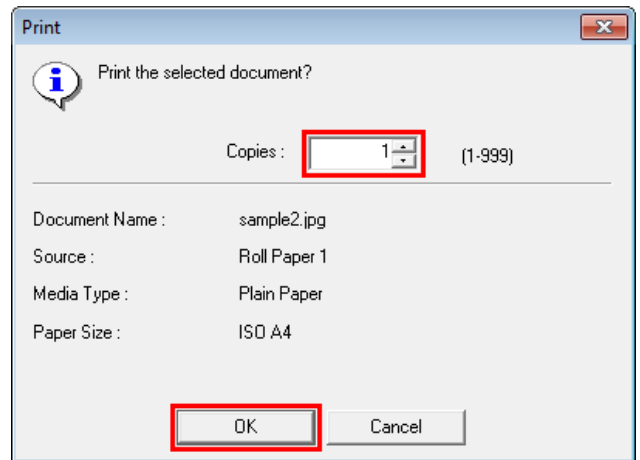

Note

- The printing time initially indicates how long it took to finish printing one copy during the previous print job. If you change the value in **Copies**, the printing time indicates the time it took to print one copy during the previous print job multiplied by the number of copies.

For details, refer to the imagePROGRAF Status Monitor help file.

Using imagePROGRAF Printmonitor

- 1 On the **Hard Disk** pane, click ► by **Inbox No./Name**.

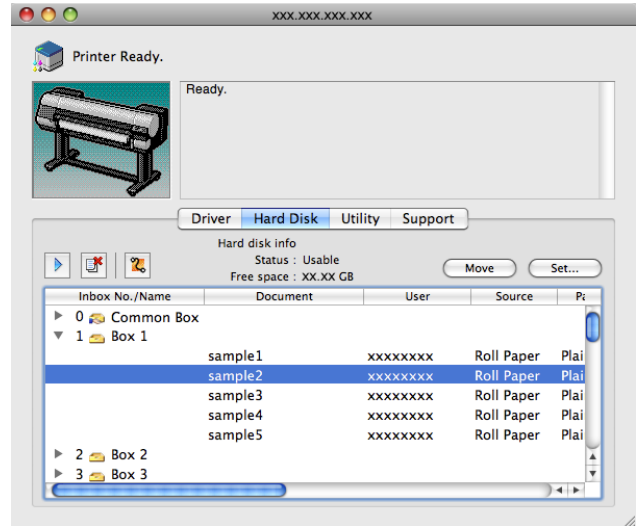

Note

- Enter a password if one has been set. The password is a four-digit number.



- 2 Select the saved job and click **Resume Printing**.

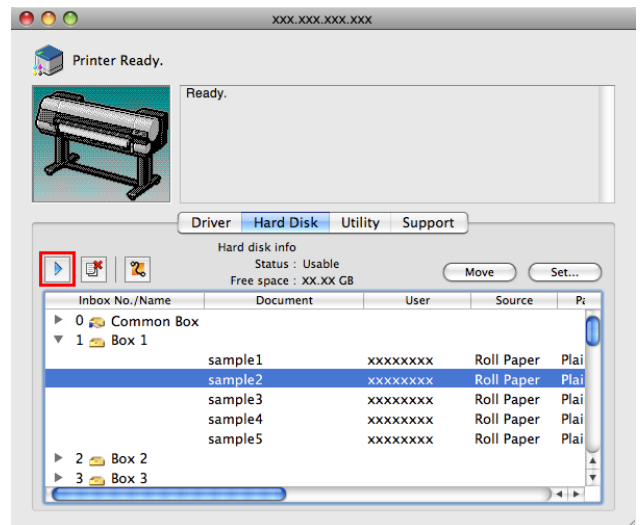

- In the **Resume Printing** dialog box, enter the quantity to print and click **OK**.

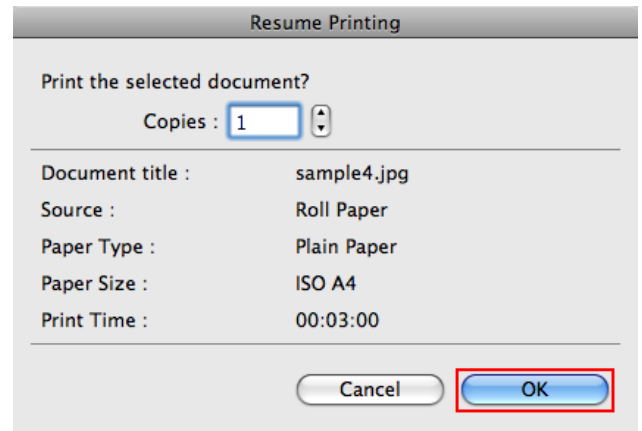

For details, refer to the imagePROGRAF Printmonitor help file.

Deleting Saved Jobs

Delete saved print jobs stored on the printer's hard disk as follows.

This operation is available from the Control Panel, in RemoteUI, imagePROGRAF Status Monitor, and imagePROGRAF Printmonitor.

Using the Control Panel

- On the **Tab Selection screen** of the Control Panel, press ◀ or ▶ to select the Job tab ().

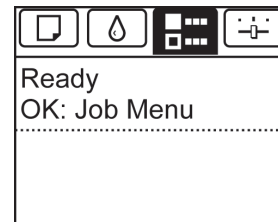

 • If the **Tab Selection screen** is not displayed, press the **Menu** button.

Note

- Press the **OK** button.
The **Job Menu** is displayed.
- Press ▲ or ▼ to select **Stored Job**, and then press the **OK** button.
- Press ▲ or ▼ to select the box number (in the range 00–29), and then press the **OK** button.

 • Enter a password if one has been set, and then press the **OK** button.

Note

- Press ▲ or ▼ to select **Job List**, and then press the **OK** button.
- Press ▲ or ▼ to select the saved job, and then press the **OK** button.
- Press ▲ or ▼ to select **Delete**, and then press the **OK** button.
- Press ▲ or ▼ to select **"Yes"**, and then press the **OK** button.

Using RemoteUI

- 1 On the **Stored Job** page, choose the mail box.

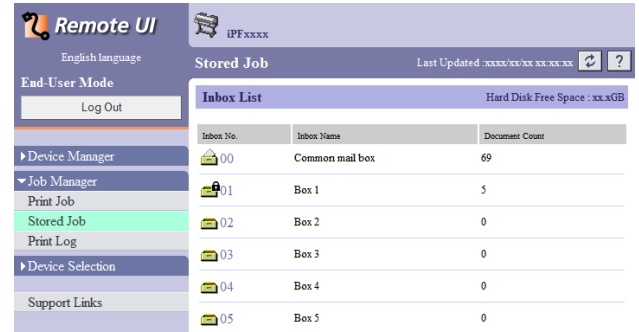

Note

- Enter a password if one has been set.

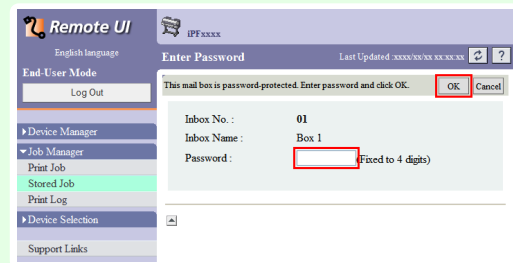

- 2 Select the print job and click **Delete**.

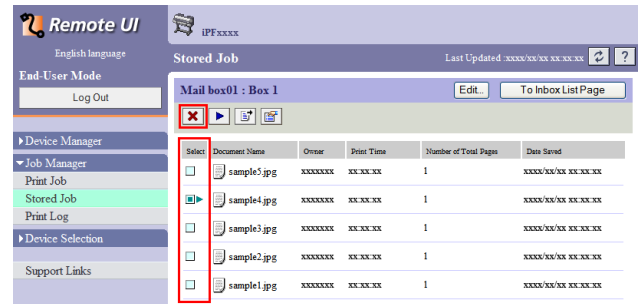

For details, refer to the RemoteUI help file.

Using imagePROGRAF Status Monitor

1 On the **Hard Disk** sheet, select a box and click **Open**.

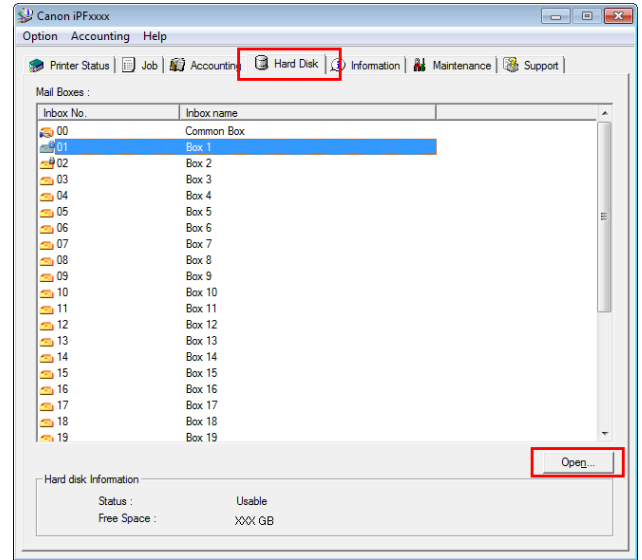

• Enter a password if one has been set.

Note

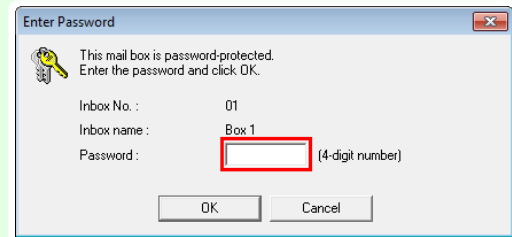

2 In the **Documents** dialog box, select the print job and click **Delete**.

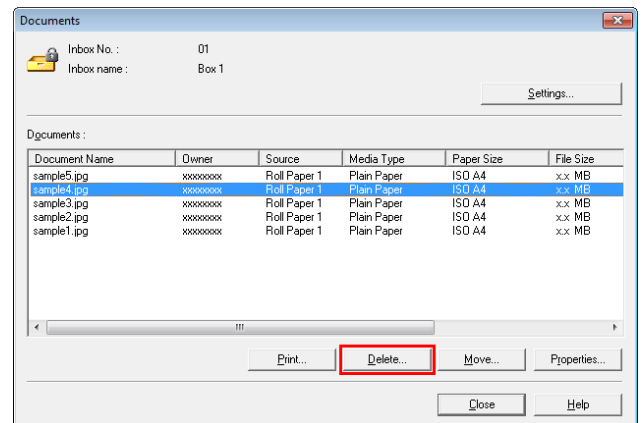

For details, refer to the imagePROGRAF Status Monitor help file.

Using imagePROGRAF Printmonitor

- 1 In the **Hard Disk** pane, click ► next to **Inbox No./Name**.

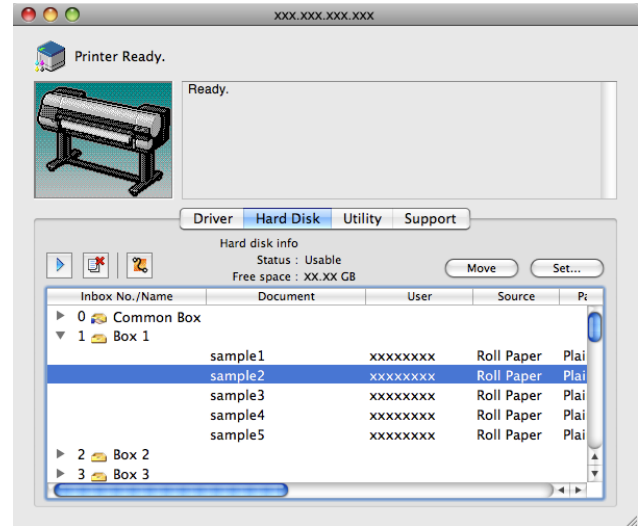

Note

- Enter a password if one has been set. The password is a four-digit number.



- 2 Select the print job and click the **Delete** button.

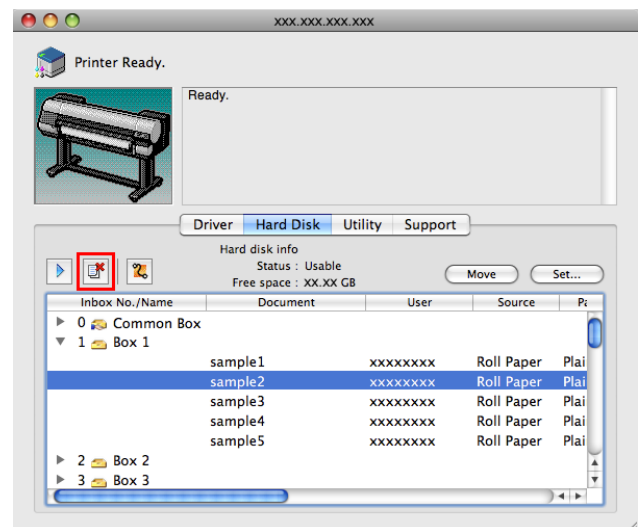

For details, refer to the imagePROGRAF Printmonitor help file.

Moving Saved Jobs

Print jobs stored on the printer's hard disk (saved jobs) can be moved from the current box to another box as follows. However, jobs saved in personal boxes cannot be moved to the shared mailbox. This operation is available in RemoteUI, imagePROGRAF Status Monitor, and imagePROGRAF Printmonitor.

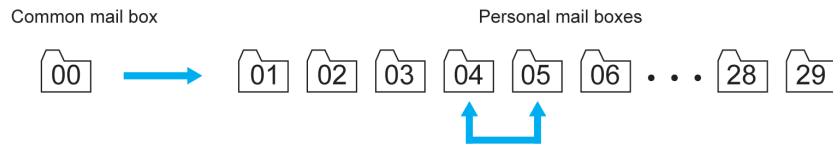

Important • Jobs stored in the shared mailbox may be automatically deleted under some conditions. To prevent jobs from being deleted, move them from the shared mailbox to personal boxes. (See "Using the Printer Hard Disk.") →P.762

Using RemoteUI

1 On the **Stored Job** page, choose the box.

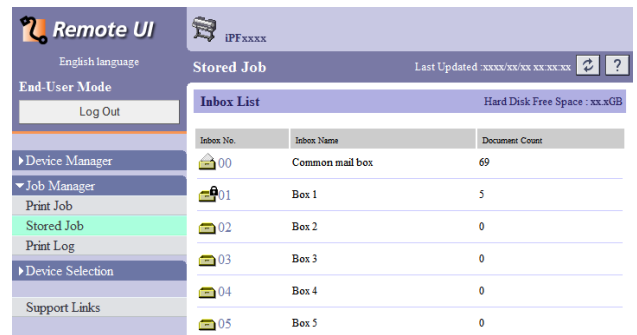

Note • Enter a password if one has been set.

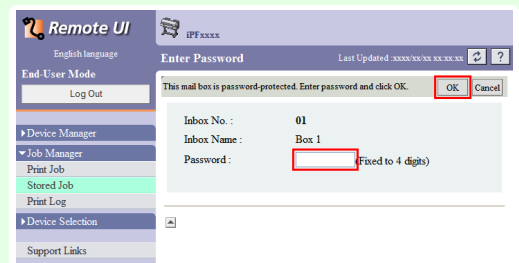

2 Select the print job and click **Move Document**.

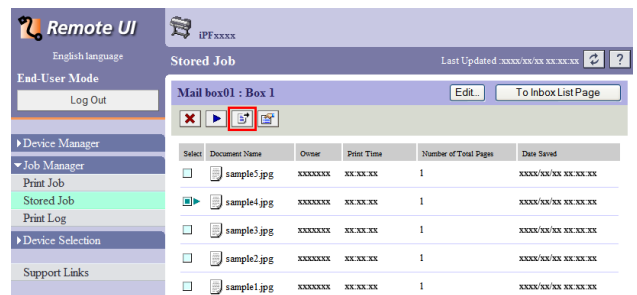

- 3** On the **Move Document** page, select the name or number of the destination personal box in the **Destination mail box** list and click **OK**.

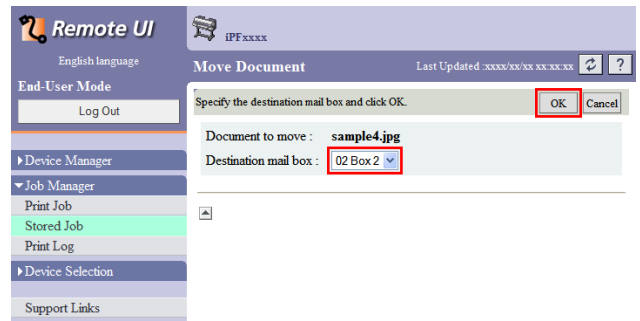

For details, refer to the RemoteUI help file.

Using imagePROGRAF Status Monitor (Windows)

- 1** On the **Hard Disk** sheet, select a box and click **Open**.

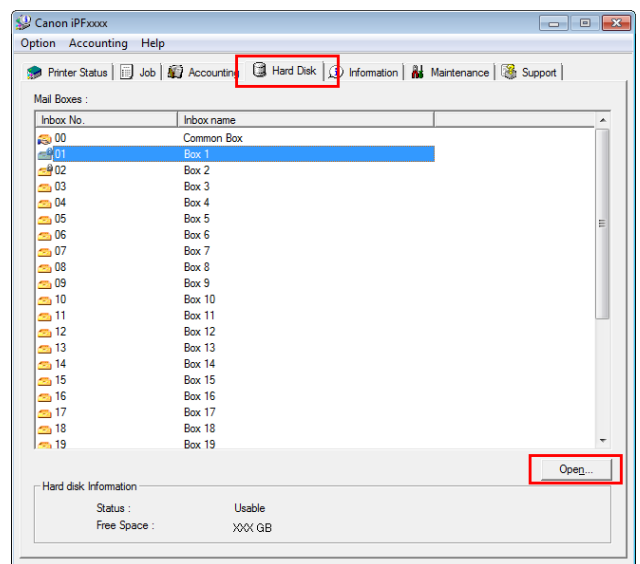

Note

- Enter a password if one has been set.

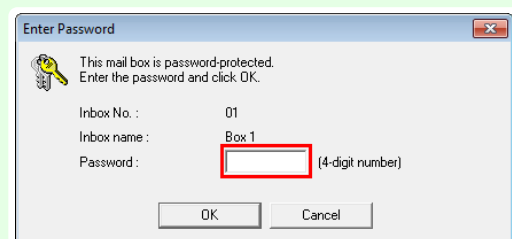

- In the **Documents** dialog box, select the print job and click **Move**.

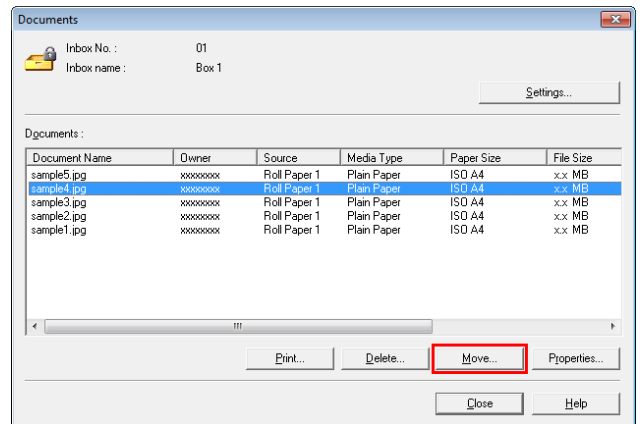

- In the **Move** dialog box, select the destination personal box and click **OK**.

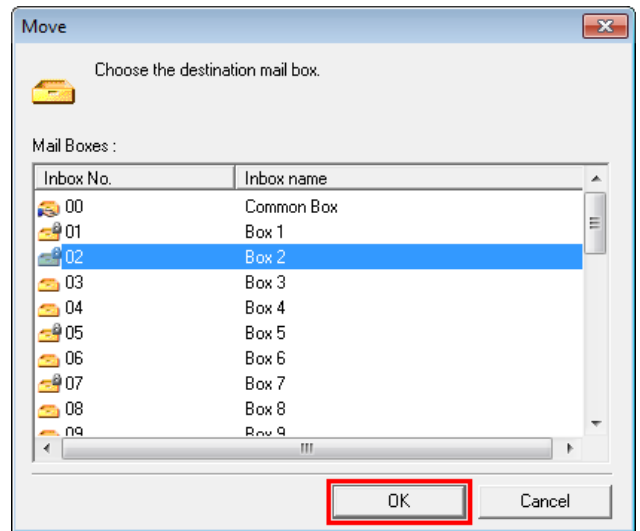

For details, refer to the imagePROGRAF Status Monitor help file.

Using imagePROGRAF Printmonitor (Macintosh)

- In the **Hard Disk** pane, click ► next to **Inbox No./Name**.

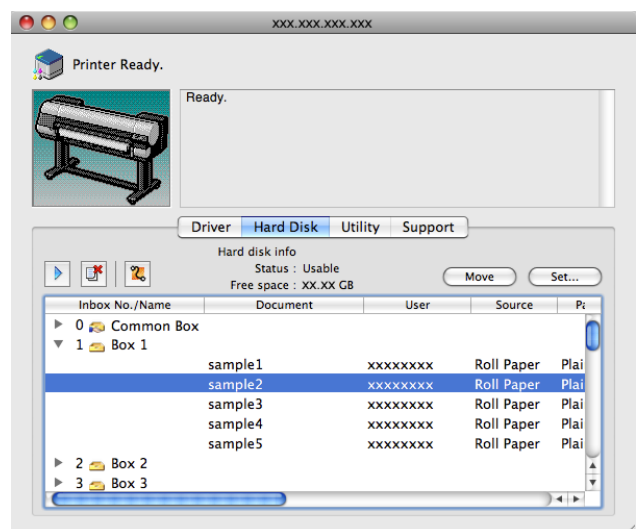



Note

- Enter a password if one has been set. The password is a four-digit number.

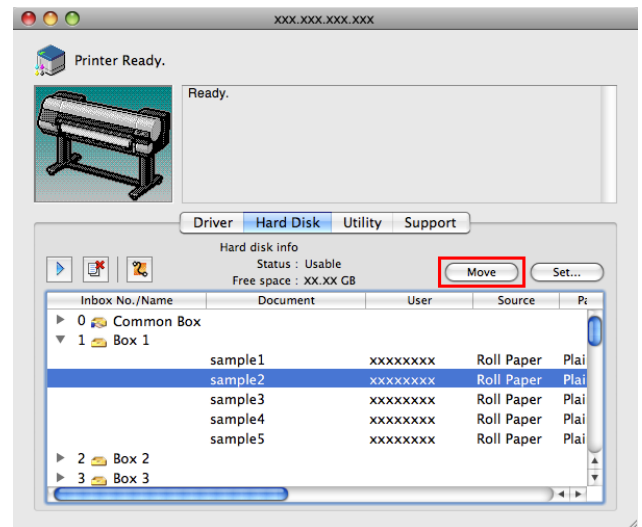

2

Select the print job and click **Move**.

3

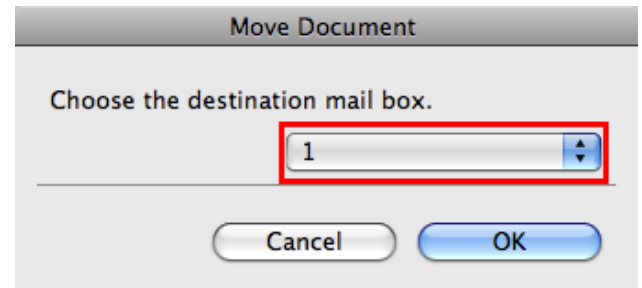
In the **Move Document** dialog box, select the destination personal box and click **OK**.

For details, refer to the imagePROGRAF Printmonitor help file.

Advanced Print Job Operations

Saving Print Jobs Sent from Sources Other than the Printer Driver	784
Printing Without Saving Jobs in the Common Box	785
Setting Passwords for Personal Boxes	786
Naming Personal Boxes	789
Displaying a List of Saved Jobs	792
Printing a List of Saved Jobs	795
Displaying Details of Saved Jobs	796
Renaming Saved Jobs	799
Printer Hard Disk Operations	701
Checking the Free Hard Disk Space	702

Saving Print Jobs Sent from Sources Other than the Printer Driver

To save print jobs sent from software or systems other than the printer driver or applications provided with the printer, complete the **Output Method** and **Print After Recv** settings in the Control Panel menu.

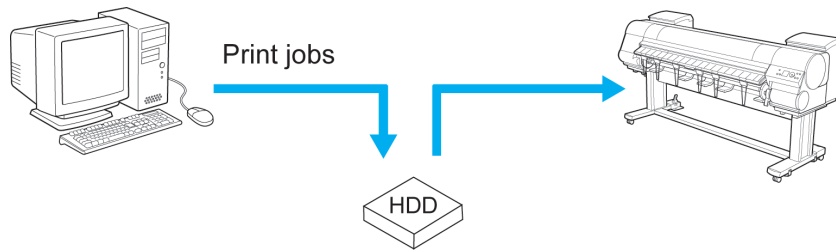

• Contact the software or system developer for information about support for this printer function.

Specifying Output Method

In **Output Method**, specify how to manage jobs, regarding printing and saving them.

- **Print**
Save print jobs automatically at the same time they are printed. (This is the default format.)
- **Print (Auto Del)**
Save print jobs temporarily at the same time they are printed and delete them after printing.
- **Save: Box 01** (Here, the number represents a box number)
Save print jobs on the printer.

1 On the **Tab Selection screen** of the Control Panel, press ◀ or ▶ to select the Settings/Adj. tab ().

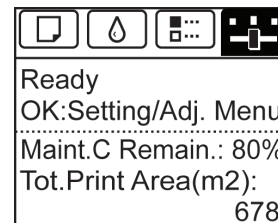

• If the **Tab Selection screen** is not displayed, press the **Menu** button.

2 Press the **OK** button.
The **Set./Adj. Menu** is displayed.

- 3 Press ▲ or ▼ to select **System Setup**, and then press the **OK** button.
- 4 Press ▲ or ▼ to select **Output Method**, and then press the **OK** button.
- 5 Press ▲ or ▼ to select **Print**, **Print (Auto Del)**, or **Save: Box 01**.
Follow these steps only when you select **Save: Box 01**.
- 6 Press ▲ or ▼ to select the box, and then press the **OK** button.

Specify **Print After Recv**

To save print jobs on the hard disk before printing, specify **Print After Recv**.

Printing will start when **Print After Recv** is set to **On**, even if you have selected **Save: Box 01** in **Output Method**.

- 1 On the **Tab Selection screen** of the Control Panel, press ◀ or ▶ to select the **Settings/Adj. tab** ().

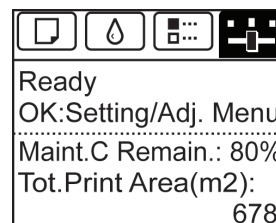

Note

- If the **Tab Selection screen** is not displayed, press the **Menu** button.

- 2 Press the **OK** button.
The **Set./Adj. Menu** is displayed.
- 3 Press ▲ or ▼ to select **System Setup**, and then press the **OK** button.
- 4 Press ▲ or ▼ to select **Print After Recv**, and then press the **OK** button.
- 5 Press ▲ or ▼ to select **On** or **Off**, and then press the **OK** button.

Printing Without Saving Jobs in the Common Box

Jobs sent from a computer for which you have selected **Print** in **Output Method** (in Windows) or **Send job to** (in Mac OS X) in the printer driver are saved in the shared mailbox. (See "Using the Printer Hard Disk.") →P.762

When **Common Box Set.** is **Print (Auto Del)** in the Control Panel menu, print jobs for which you have selected **Print** in the **Output Method** dialog box of the printer driver are deleted from the shared mailbox after printing.

Use this function when printing highly confidential documents.

- 1 On the **Tab Selection screen** of the Control Panel, press ◀ or ▶ to select the **Settings/Adj. tab** ().

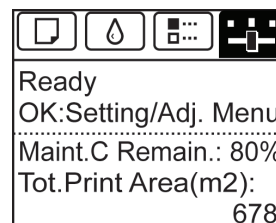

Note

- If the **Tab Selection screen** is not displayed, press the **Menu** button.

- 2** Press the **OK** button.
The **Set./Adj. Menu** is displayed.
- 3** Press **▲** or **▼** to select **System Setup**, and then press the **OK** button.
- 4** Press **▲** or **▼** to select **Common Box Set.**, and then press the **OK** button.



Note

- If a password has been set on the printer, the **Logon** screen is displayed. To change the setting, select **Administrator** and press the **OK** button. Enter the password when **Admin.Pswd** is displayed and press the **OK** button before going to the next procedure. If you select **User** and press the **OK** button, you can check settings values but cannot change them.

- 5** Press **▲** or **▼** to select **Print (Auto Del)**, and then press the **OK** button.

Setting Passwords for Personal Boxes

For greater security, you can specify a password for personal boxes. After you set a password, it will be required to modify the personal box settings, as well as to display, print, delete, move, and modify jobs saved in the personal box. This operation is available in RemoteUI, imagePROGRAF Status Monitor, and imagePROGRAF Printmonitor.

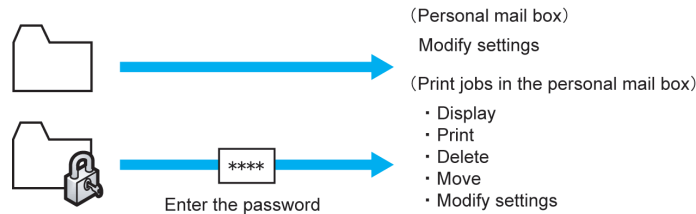

Note

- By default, no passwords are set for personal boxes.
- A password cannot be set for the shared mailbox.
- Enter a four-digit number as the password, in the range 0001–9999.
- Even if you have set passwords, they are not required to access personal boxes in Administrator Mode in RemoteUI.

Using RemoteUI

- 1** On the **Stored Job** page, choose the personal box.
- 2** Click **Edit**.

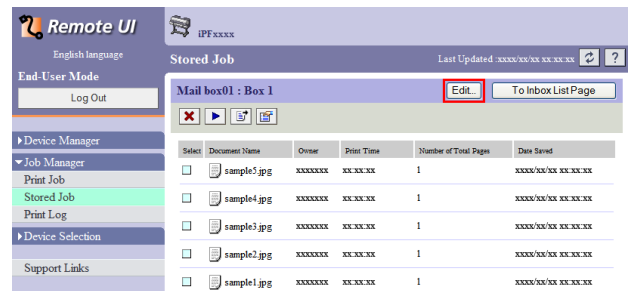

- 3** In the **Set/Register User's Inbox** dialog box, specify the password and click **OK**.

- **Set Password**
Select the check box.
- **Password**
Enter the password. (This field is limited to four digits in the range 0001–9999.)
- **Confirmation Number**

Re-enter the password to confirm it.

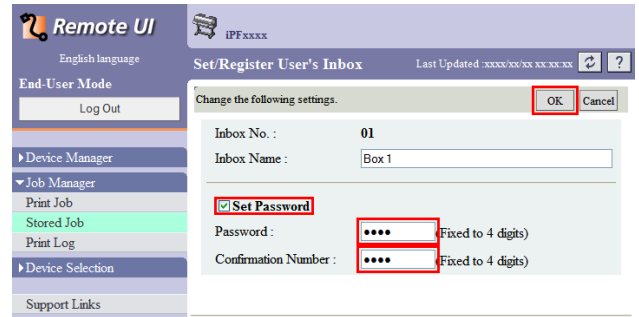

For details, refer to the RemoteUI help.

Using imagePROGRAF Status Monitor (Windows)

- 1 On the **Hard Disk** sheet, select the personal box and click **Open**.

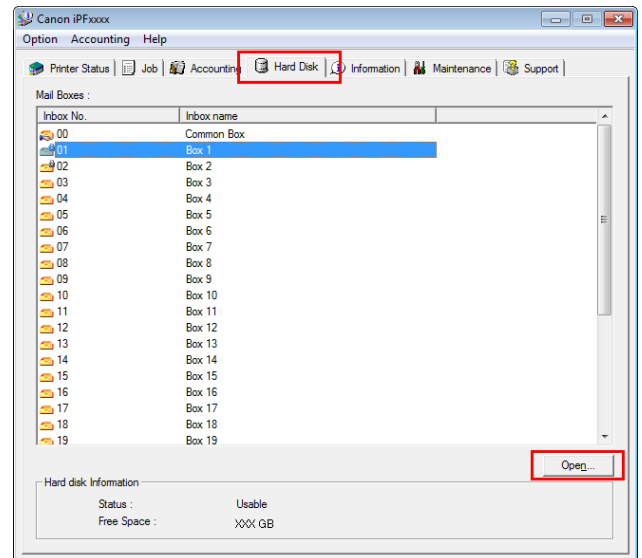

- 2 In the **Documents** dialog box, click **Settings**.

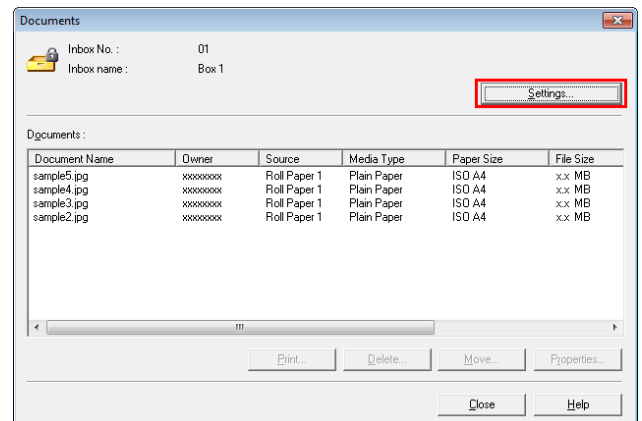

- 3 In the **Settings** dialog box, specify the password and click **OK**.

- **Set password**
Select the check box.

- **Password**
Enter the password. (This field is limited to four digits in the range 0001–9999.)
- **Re-enter to confirm**
Re-enter the password to confirm it.

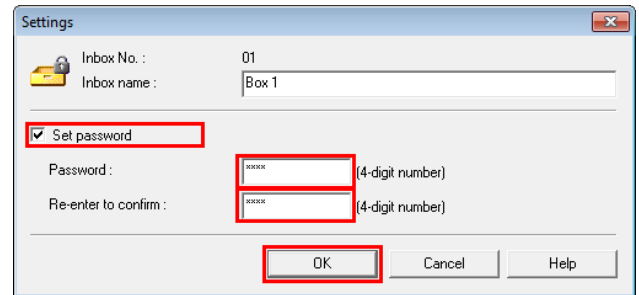

For details, refer to the imagePROGRAF Status Monitor help file.

Using imagePROGRAF Printmonitor (Macintosh)

- 1 On the **Hard Disk** pane, click ► by **Inbox No./Name**. Select a saved job in the list and click **Set**.

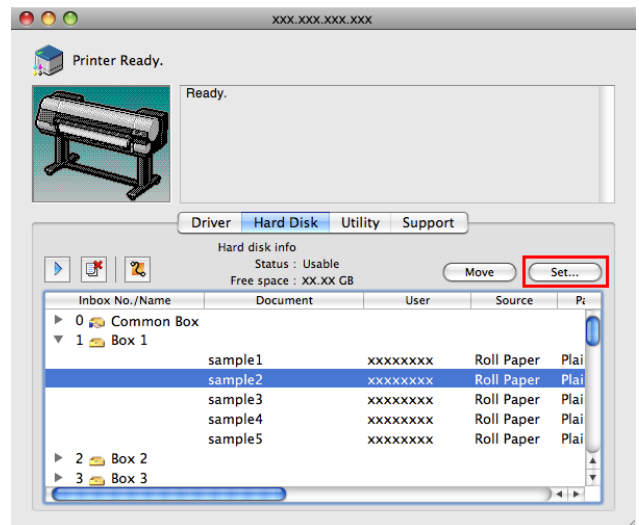

- 2 In the **Settings** dialog box, specify the password and click **OK**.

- **Set password**
Select the check box.
- **Password**
Enter the password. (This field is limited to four digits in the range 0001–9999.)
- **Verify**
Re-enter the password to confirm it.

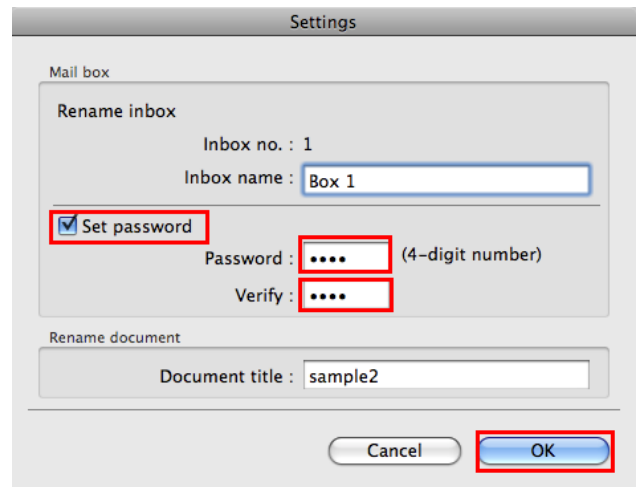

For details, refer to the imagePROGRAF Printmonitor help file.

Naming Personal Boxes

For easier identification, you can assign names to personal boxes.

This operation is available in RemoteUI, imagePROGRAF Status Monitor, and imagePROGRAF Printmonitor.

Using RemoteUI

- 1 On the **Stored Job** page, choose the personal box.

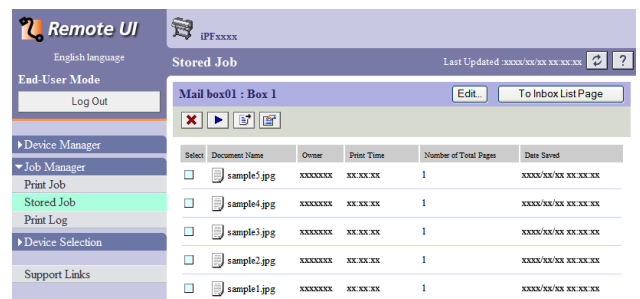

- Enter a password if one has been set for the personal box.
- Note**

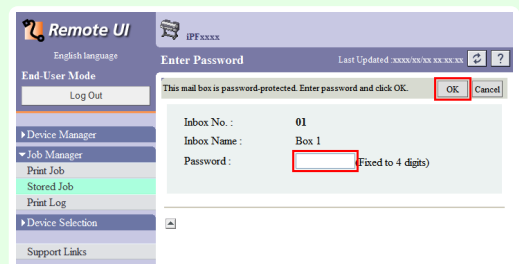

- 2 Click **Edit**.

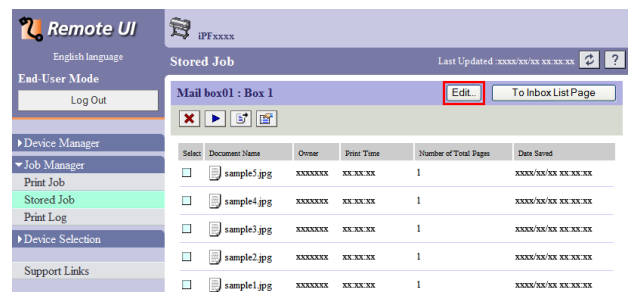

- In the **Set/Register User's Inbox** dialog box, enter the name in **Inbox Name** and click **OK**.

For details, refer to the RemoteUI help file.

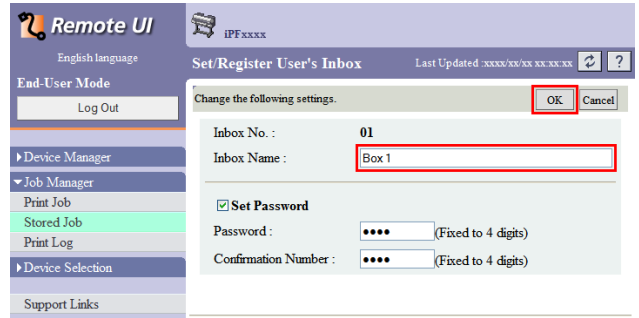

Using imagePROGRAF Status Monitor (Windows)

- On the **Hard Disk** sheet, select the personal box and click **Open**.

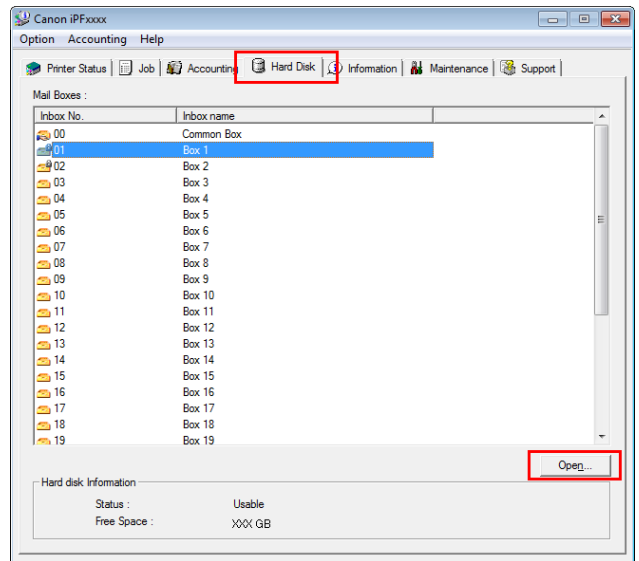

Note

- Enter a password if one has been set for the personal box.

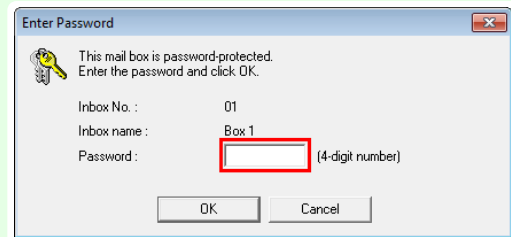

2 In the **Documents** dialog box, click **Settings**.

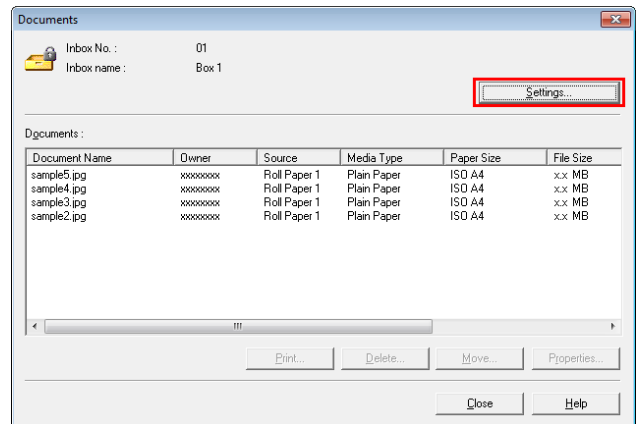

3 In the **Settings** dialog box, enter the name and click **OK**.

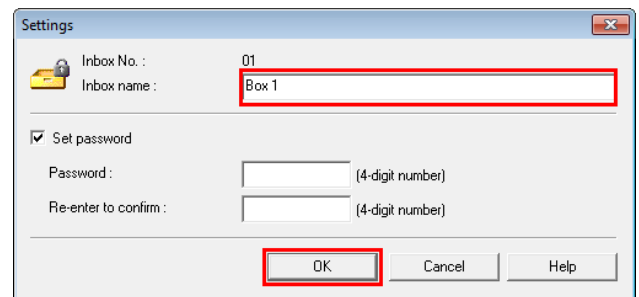

For details, refer to the imagePROGRAF Status Monitor help file.

Using imagePROGRAF Printmonitor (Macintosh)

1 In the **Hard Disk** pane, click ► next to **Inbox No./Name**. Select a saved job in the list and click **Set**.

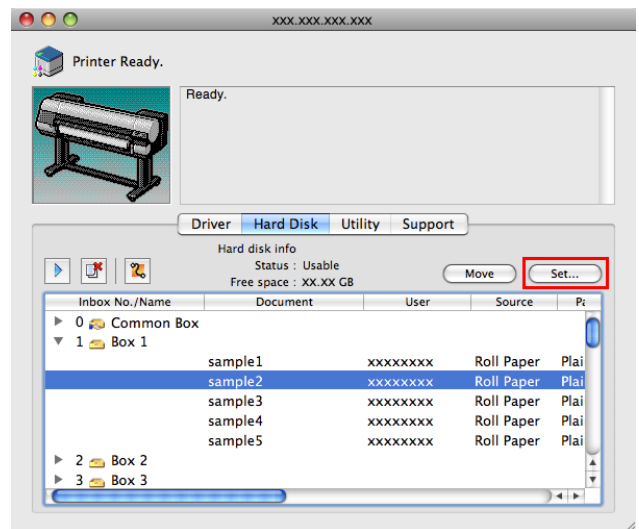



- Enter a password if one has been set. The password is a four-digit number.



- 2 In the **Settings** dialog box, enter the name and click **OK**.

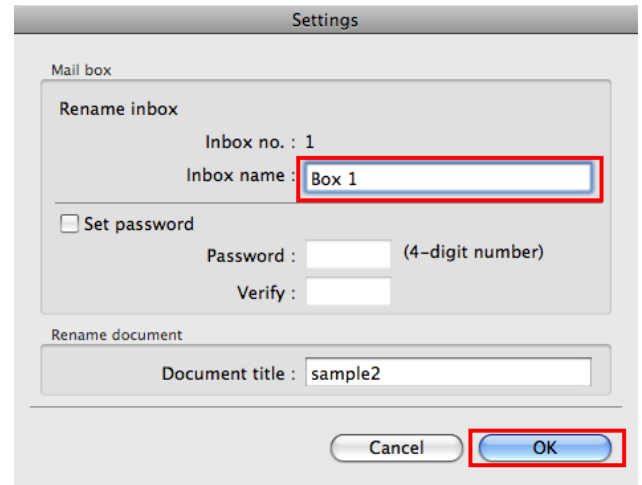

For details, refer to the imagePROGRAF Printmonitor help file.

Displaying a List of Saved Jobs

Print jobs stored on the printer's hard disk (saved jobs) can be listed by box as follows. These operations are available from the Control Panel or in RemoteUI, imagePROGRAF Status Monitor, and imagePROGRAF Printmonitor.

Using the Control Panel

- 1 On the **Tab Selection screen** of the Control Panel, press ◀ or ▶ to select the Job tab ().

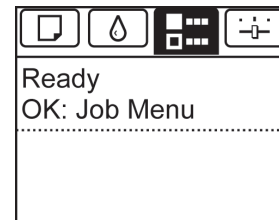

- If the **Tab Selection screen** is not displayed, press the **Menu** button.

- 2 Press the **OK** button. The **Job Menu** is displayed.
- 3 Press ▲ or ▼ to select **Stored Job**, and then press the **OK** button.

4 Press ▲ or ▼ to select the box number (in the range 00–29), and then press the **OK** button.



• Enter a password if one has been set, and then press the **OK** button.

5 Press ▲ or ▼ to select **Job List**, and then press the **OK** button.

Using RemoteUI

On the **Stored Job** page, choose the box.

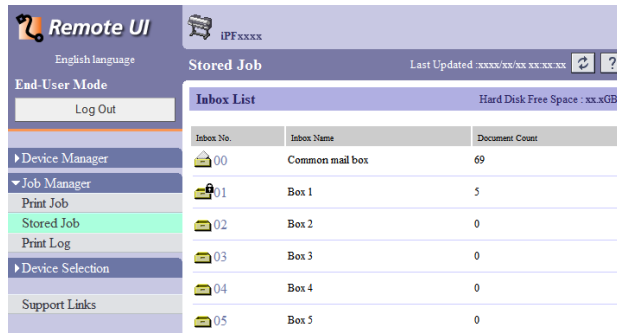

• Enter a password if one has been set.

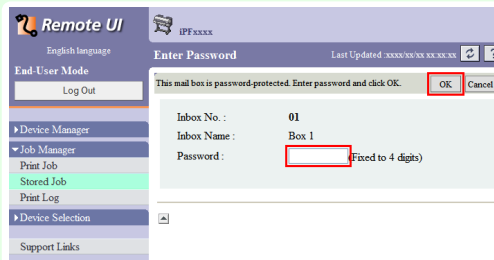

Jobs saved in the box are listed.

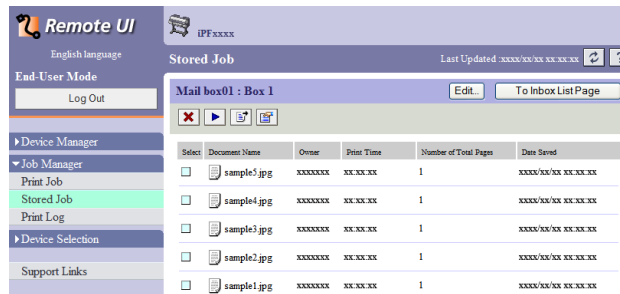

For details, refer to the RemoteUI help.

Using imagePROGRAF Status Monitor (Windows)

On the **Hard Disk** sheet, select a box and click **Open**.

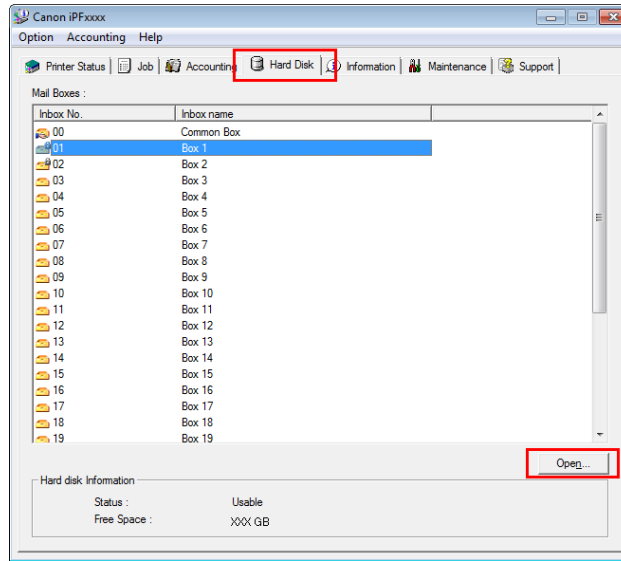

- Enter a password if one has been set.

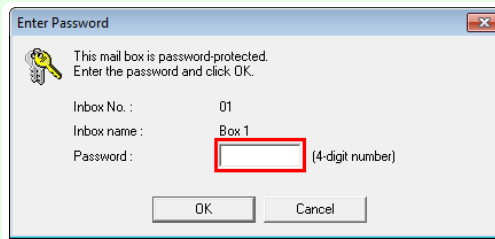

Jobs saved in that box are displayed in the **Documents** dialog box.

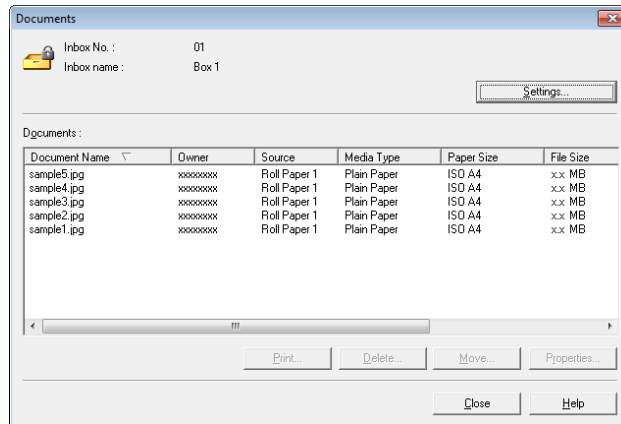

For details, refer to the imagePROGRAF Status Monitor help file.

Using imagePROGRAF Printmonitor (Macintosh)

On the **Hard Disk** pane, click ► by **Inbox No./Name**.

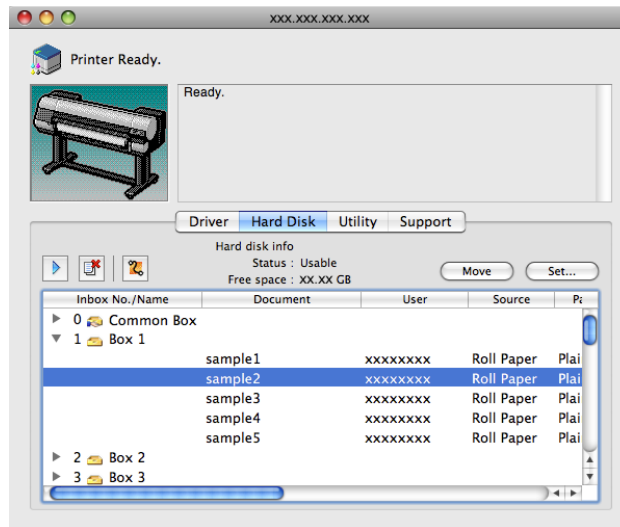

Note

- Enter a password if one has been set. The password is a four-digit number.



For details, refer to the imagePROGRAF Printmonitor help file.

Printing a List of Saved Jobs

The list of print jobs stored on the printer's hard disk (saved jobs) can be printed by box as follows.

- 1 On the **Tab Selection screen** of the Control Panel, press ◀ or ▶ to select the Job tab ().

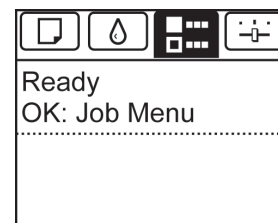

Note

- If the **Tab Selection screen** is not displayed, press the **Menu** button.

- 2 Press the **OK** button. The **Job Menu** is displayed.

3 Press ▲ or ▼ to select **Stored Job**, and then press the **OK** button.

4 Press ▲ or ▼ to select the box number (in the range 00–29), and then press the **OK** button.



Note

- Enter a password if one has been set, and then press the **OK** button.

5 Press ▲ or ▼ to select **Print Job List**, and then press the **OK** button.

Displaying Details of Saved Jobs

Details of print jobs stored on the printer's hard disk (saved jobs) can be displayed as follows.

This operation is available in RemoteUI, imagePROGRAF Status Monitor, and imagePROGRAF Printmonitor.

Using RemoteUI

1 On the **Stored Job** page, choose the box.

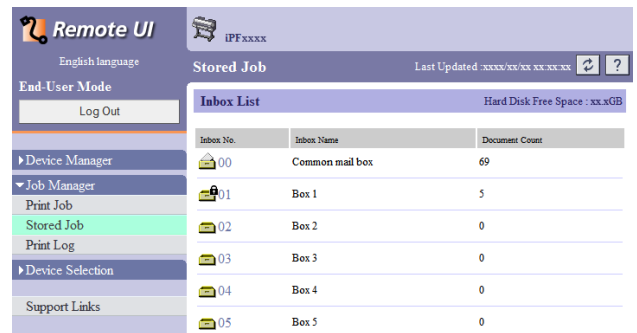

Note

- Enter a password if one has been set.

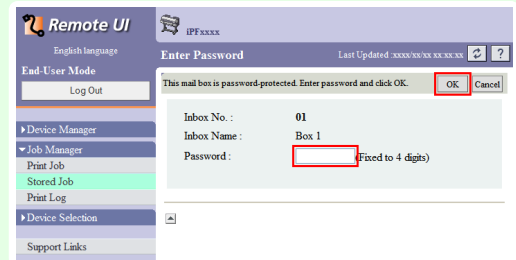

2 Select the print job and click **Details**.

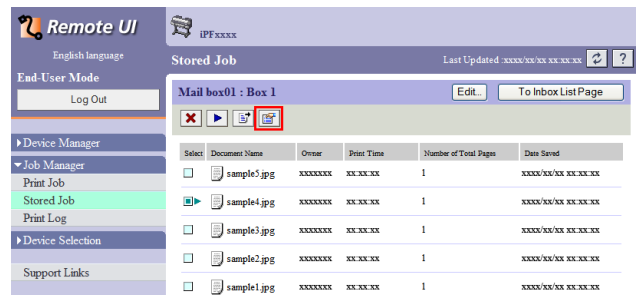

The **Details of the saved document** page is displayed.

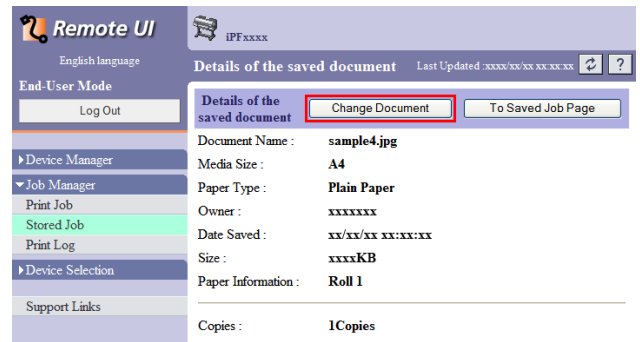

For details, refer to the RemoteUI help file.

Using imagePROGRAF Status Monitor (Windows)

- 1 On the **Hard Disk** sheet, select a box and click **Open**.

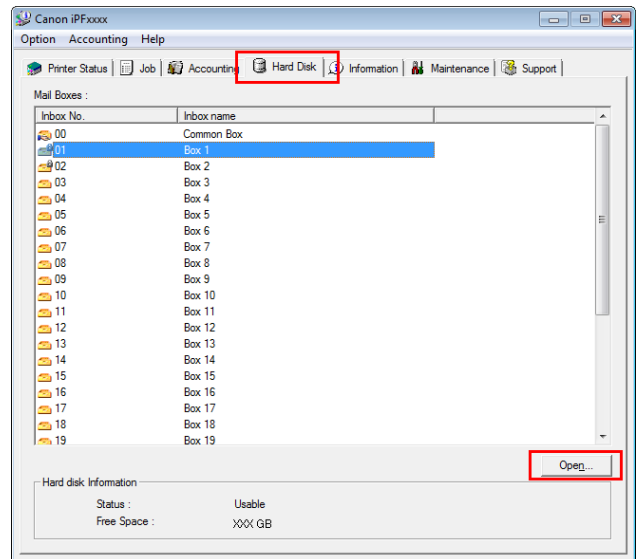

- Enter a password if one has been set.
- Note

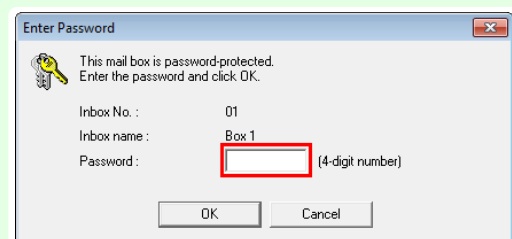

- In the **Documents** dialog box, select the print job and click **Properties**.

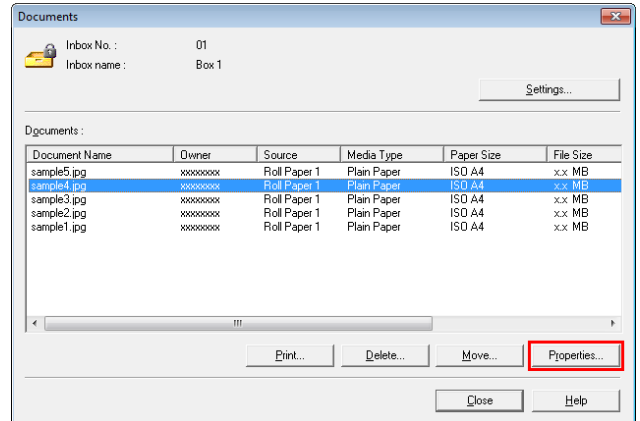

The **Properties** dialog box is displayed.

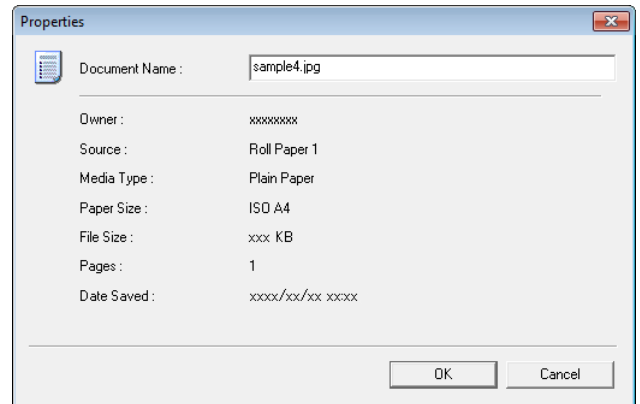

For details, refer to the imagePROGRAF Status Monitor help file.

Using imagePROGRAF Printmonitor (Macintosh)

- In the **Hard Disk** pane, click ► next to **Inbox No./Name**.

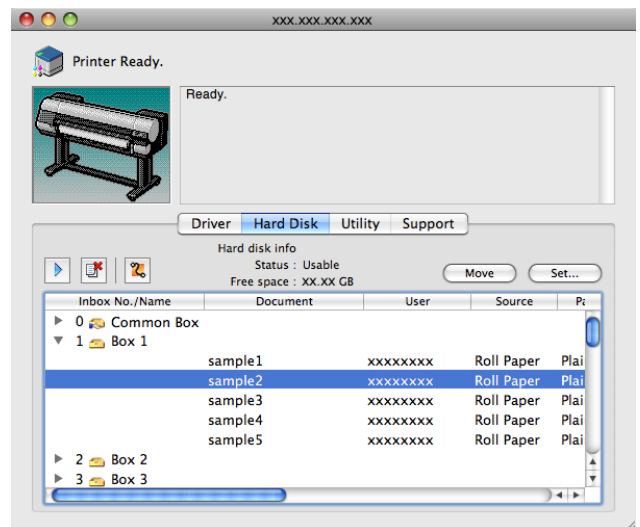



- Enter a password if one has been set. The password is a four-digit number.



For details, refer to the imagePROGRAF Printmonitor help file.

Renaming Saved Jobs

Print jobs stored on the printer's hard disk (saved jobs) can be renamed as follows. This operation is available in RemoteUI, imagePROGRAF Status Monitor, and imagePROGRAF Printmonitor.

Using RemoteUI

- 1 On the **Stored Job** page, choose the box.

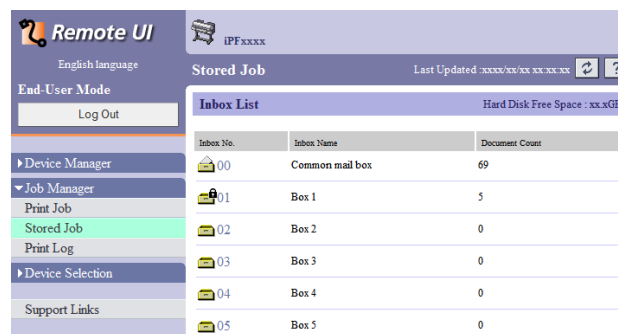

- Enter a password if one has been set.

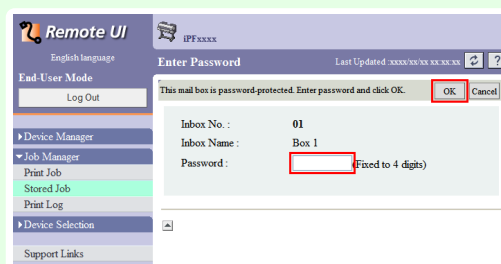

- 2 Select the print job and click **Details**.

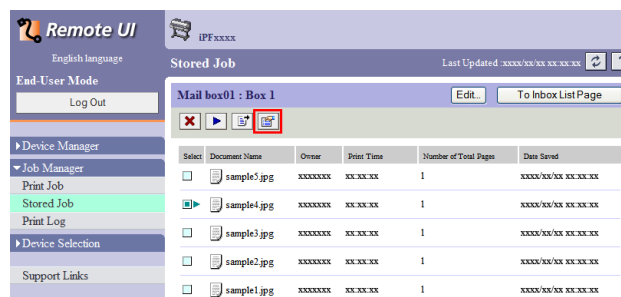

- 3** On the **Details of the saved document** page, click **Change Document**.

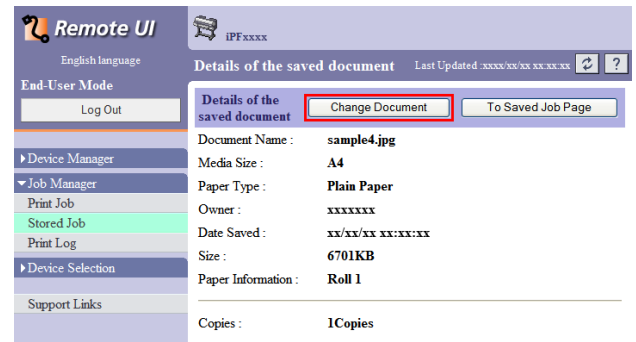

- 4** In the **Rename Saved Document** dialog box, enter the name and click **OK**.

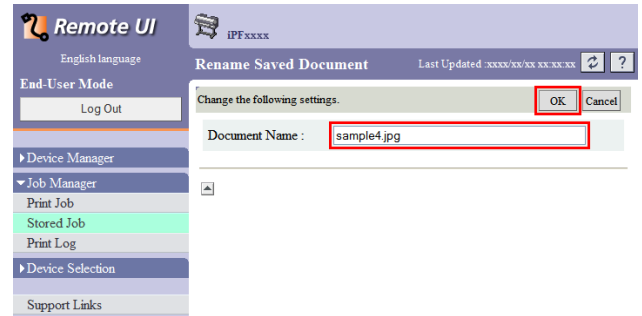

For details, refer to the RemoteUI help file.

Using imagePROGRAF Status Monitor (Windows)

- 1** On the **Hard Disk** sheet, select a box and click **Open**.

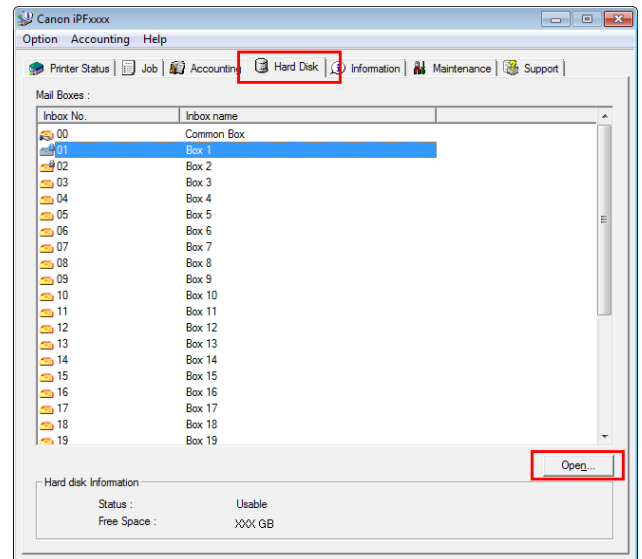

Note

- Enter a password if one has been set.

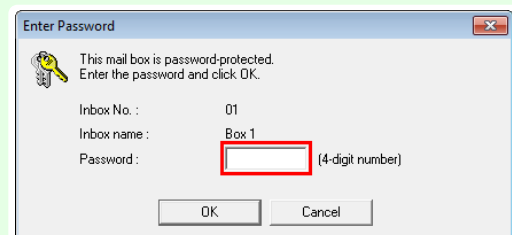

- 2** In the **Documents** dialog box, select the print job and click **Properties**.

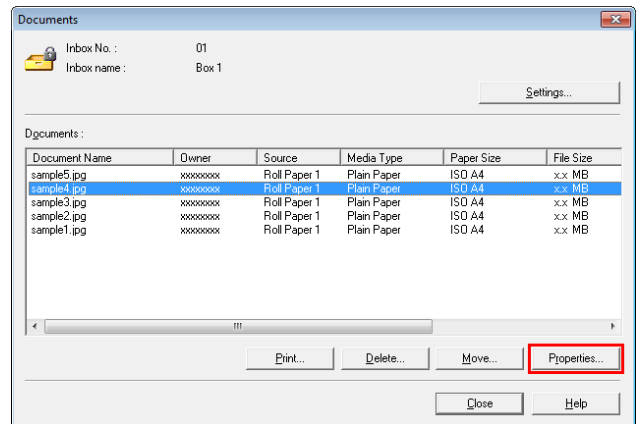

- 3** In the **Properties** dialog box, enter the new name and click **OK**.

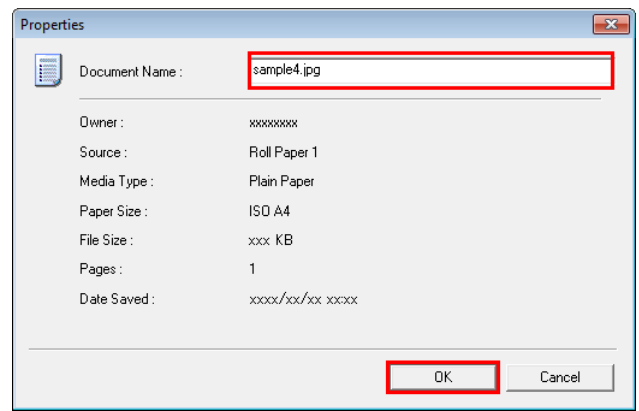

For details, refer to the imagePROGRAF Status Monitor help file.

Using imagePROGRAF Printmonitor (Macintosh)

- 1** In the **Hard Disk** pane, click ► next to **Inbox No./Name**.

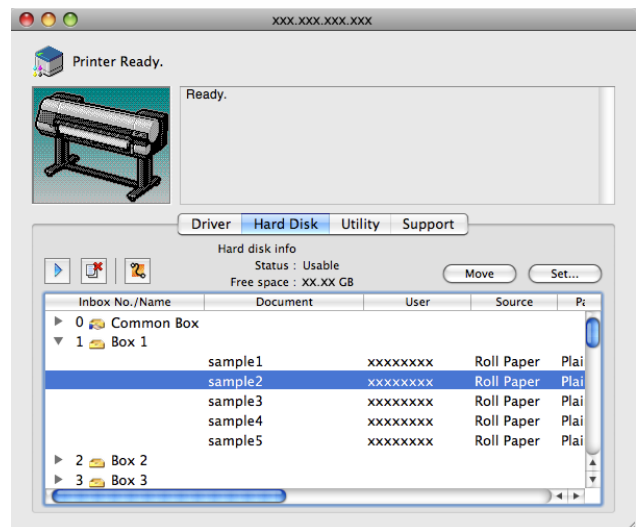



Note

- Enter a password if one has been set. The password is a four-digit number.



- 2 Select the print job and click **Set**.

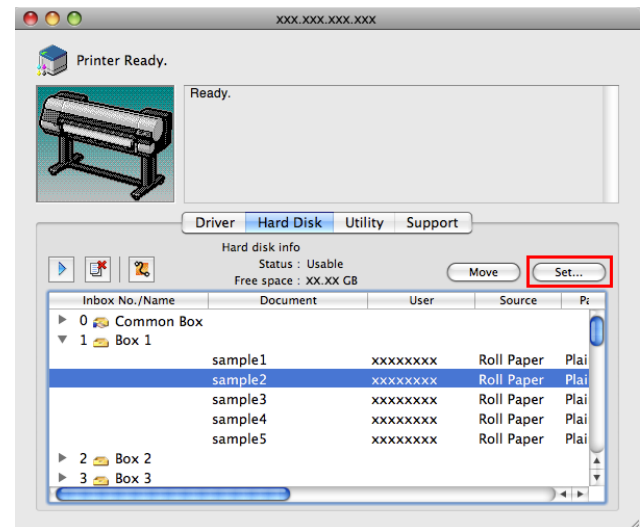

- 3 In the **Settings** dialog box, enter the new name and click **OK**.

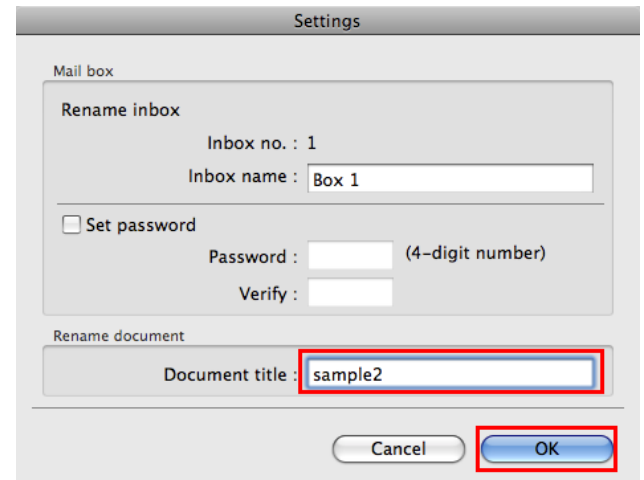

For details, refer to the imagePROGRAF Printmonitor help file.

Basic Printing Workflow	19
Enhanced Printing Options	35
Windows Software	177
Mac OS X Software	363
Handling and Use of Paper	529
Control Panel	655
Printer Parts	691
Network Setting	707
Print Job Management	741

Adjustments for Better Print Quality

Adjustment for high-precision printing	804
Adjusting the Printhead	806
Adjusting the feed amount	813

Color Management	821
Maintenance and Consumables	833
Troubleshooting	883
Error Message	915
Specifications	941
Appendix	945

Adjustment for high-precision printing

Enhancing Printing Quality

With some types of paper and under some conditions, adjusting the printer as follows with the paper to be used can enhance printing quality when printing fine lines/text or photos.

Two adjustment options are available: standard adjustment (with the Printhead height set to **Automatic**) and supplemental adjustment (used if standard adjustment is not effective).



- Ideal temperature and humidity during adjustment and for printing in general when the Printhead height is set to **Automatic** are 20–30°C and 30–60%. Under other environmental conditions, adjustment may not enhance printing quality.

Standard Adjustment

Perform standard adjustment with the Printhead height set to **Automatic**.

1 Load paper in the printer.

- Attaching the Roll Holder to Rolls →P.538
- Loading Rolls in the Printer →P.541

2 On the **Tab Selection screen** of the Control Panel, press ◀ or ▶ to select the Settings/Adj. tab ().



- If the **Tab Selection screen** is not displayed, press the **Menu** button.

3 Press the **OK** button.
The **Set./Adj. Menu** is displayed.

4 Press ▲ or ▼ to select **Adjust Printer**, and then press the **OK** button.

5 Press ▲ or ▼ to select **Head Posi. Adj.**, and then press the **OK** button.

6 Press ▲ or ▼ to select **Standard**, and then press the **OK** button.

A test pattern is printed for adjustment. This process will take about 13 minutes.



- If standard adjustment does not enhance printing quality, next try supplemental adjustment, which may be helpful.

Supplemental Adjustment

Perform supplemental adjustment with the Printhead height set to **Super Low**.



- Printing with **Head Height** set to **Super Low** may enhance printing quality, but it may also cause paper to rub against or become caught on the Printhead, which may cause paper jams or soiling on printed documents.



- We recommend that additional adjustment be executed using paper matching the following criteria.
Type: Glossy or semi-glossy photo paper, or proofing paper (in either case, roll paper only)
Thickness/weight: 300 µm or less, or 300 g/m² or less
Width: 420.0 mm (16.54 in.) or more

1 Set **Head Height** to **Super Low**. (See "Troubleshooting Paper Abrasion and Blurry Images.") →P.811



Note

- If **Super Low** is not available, select **Lowest**.

2 Execute **Standard** in **Head Posi. Adj.**.



Note

- If paper rubs against the Printhead or becomes jammed during Printhead height adjustment, try selecting a higher level in **Head Height** and performing **Standard** again.

Adjusting the Printhead

Adjusting the Printhead	806
Automatic Adjustment to Straighten Lines and Colors	806
Manual Adjustment to Straighten Lines and Colors	808
Adjustment When Installing the Printhead	810
Troubleshooting Paper Abrasion and Blurry Images	811

Adjusting the Printhead

If printed documents are affected by the following problems, try adjusting the printhead.

- Printing is faint or affected by banding in different colors

Execute **Nozzle Check** in the Control Panel menu to check for printhead nozzle clogging.

For instructions, see "Checking for Nozzle Clogging." →P.846

- Printed vertical lines are warped or colors are out of alignment

Execute **Head Posi. Adj.** in the Control Panel menu to adjust the printhead position.

- Normally, execute **Standard**.
(See "Automatic Adjustment to Straighten Lines and Colors." →P.806)
- When printing on special paper, or if printing is not improved after **Standard**, try **Manual**.
(See "Manual Adjustment to Straighten Lines and Colors." →P.808)



Note

- In the next case, execute **Initial adjustmt.**

(See "Adjustment When Installing the Printhead." →P.810)

- If adjusting the printhead position has not been performed such as due to an error during initial setup
- If **Rep.P.head Print** in the Control Panel menu is set to **Off** and adjusting the printhead position has not been performed when replacing the printhead

- Paper rubs against the printhead, or image edges are blurred

Selecting **Head Height** in the Control Panel menu and changing the printhead height may improve the situation.

(See "Troubleshooting Paper Abrasion and Blurry Images." →P.811)

Automatic Adjustment to Straighten Lines and Colors

If vertical lines in printed documents are warped or colors are out of alignment, execute **Head Posi. Adj.**. The printer will print and read a test pattern, and the Printhead position will be adjusted automatically.

There are two modes for automatic Printhead adjustment: **Standard** and **Simple**.

- **Standard**

Execute if vertical lines in printed material are warped or colors are out of alignment.

Furthermore, if **Simple** does not improve printing, try **Standard**.

- **Simple**

Executes simple adjustment in a short time.

Execute this when frequently adjusting the printhead, such as during daily inspection.



Important • This function is not available with **CAD Tracing Paper**, **CAD Translucent Matte Film**, or **CAD Clear Film**.
 • If adjustment is not possible as expected using special media, try another type of paper, or try **Manual** adjustment. (See "Manual Adjustment to Straighten Lines and Colors.") →P.808

Note • Because the results of adjustment vary depending on the type of paper used for adjustment, use the same type of paper as you will use for printing.
 • If **Standard** does not improve printing, try adjusting the printhead manually. (See "Manual Adjustment to Straighten Lines and Colors.") →P.808
 • If the printhead position was not adjusted during initial setup or when the printhead was replaced, execute **Initial adjustmt.** (See "Adjustment When Installing the Printhead.") →P.810
 • Advanced adjustment can enable superior printing quality when printing fine lines or text at high precision on glossy or semi-glossy photo or proofing paper. (See "Enhancing Printing Quality.") →P.804

Items to Prepare

When Using Rolls	An unused roll at least 254.0 mm (10.00 in) wide
When Using Sheets	Standard : Six sheets of unused paper, A4/Letter size (or one sheet when using A2) Simple : One sheet of unused paper, A4/Letter size

Perform adjustment as follows.

1 Load paper.

- Attaching the Roll Holder to Rolls →P.538
- Loading Rolls in the Printer →P.541
- Loading Sheets in the Printer →P.563

Important • Always make sure the loaded paper matches the type of paper specified on the printer. Adjustment cannot be completed correctly unless the loaded paper matches the settings.

2 On the **Tab Selection screen** of the Control Panel, press ◀ or ▶ to select the Settings/Adj. tab ().

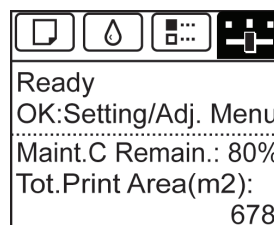

Note • If the **Tab Selection screen** is not displayed, press the **Menu** button.

3 Press the **OK** button.
 The **Set./Adj. Menu** is displayed.

- 4 Press ▲ or ▼ to select **Adjust Printer**, and then press the **OK** button.
- 5 Press ▲ or ▼ to select **Head Posi. Adj.**, and then press the **OK** button.
- 6 Press ▲ or ▼ to select **Standard** or **Simple**, and then press the **OK** button.
A test pattern is printed for adjustment.
Adjustment is now finished if you have printed on a roll.
- 7 If you are printing on cut sheets, a confirmation message is displayed on the Display Screen asking you whether to continue printing.
Press the **OK** button and follow the instructions on the Display Screen.

Manual Adjustment to Straighten Lines and Colors

If printed vertical lines are warped or colors are out of alignment, execute **Head Posi. Adj.** to adjust the Printhead alignment.

Normally, execute **Standard**.

(See "Automatic Adjustment to Straighten Lines and Colors.") →P.806

However, when printing on special paper, or if printing is not improved after **Standard**, try **Manual**.

Manual adjustment requires you to examine the printed test pattern and enter an adjustment value.



- We recommend using the type of paper you use most often for adjustment.

Note • If the printhead position was not adjusted during initial setup or when the printhead was replaced, execute **Initial adjustmt.**
(See "Adjustment When Installing the Printhead.") →P.810

Items to Prepare

When Using Rolls	An unused roll at least 254.0 mm (10.00 in) wide
When Using Sheets	Three sheets of unused paper, A4/Letter size (or one sheet when using A2)

Perform adjustment as follows.

- 1 Load paper.
 - Attaching the Roll Holder to Rolls →P.538
 - Loading Rolls in the Printer →P.541
 - Loading Sheets in the Printer →P.563
- Important** • Always make sure the loaded paper matches the type of paper specified on the printer. Adjustment cannot be completed correctly unless the loaded paper matches the settings.



- 2** On the **Tab Selection screen** of the Control Panel, press ◀ or ▶ to select the Settings/Adj. tab ().

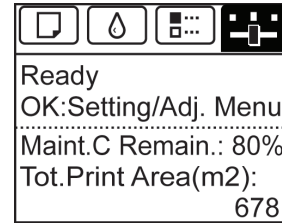



 **Note** • If the **Tab Selection screen** is not displayed, press the **Menu** button.

- 3** Press the **OK** button.
The **Set./Adj. Menu** is displayed.
- 4** Press ▲ or ▼ to select **Adjust Printer**, and then press the **OK** button.
- 5** Press ▲ or ▼ to select **Head Posi. Adj.**, and then press the **OK** button.
- 6** Press ▲ or ▼ to select **Other**, and then press the **OK** button.
- 7** Press ▲ or ▼ to select **Manual**, and then press the **OK** button.
A test pattern is printed for adjustment.

 **Note** • **Manual** may be unavailable in some cases, even if it is displayed in the menu.
If so, execute **Standard** once.
(See "Automatic Adjustment to Straighten Lines and Colors.") →P.806

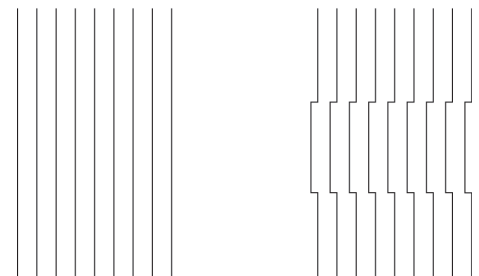
- 8** Press ▲ or ▼ to select **D**, and then press the **OK** button.
- 9** Press ▲ or ▼ to select **D-1**, and then press the **OK** button.
- 10** Examine adjustment test pattern **D-1** and determine the number with straight lines.



 **Note** • If two patterns seem equally good and you cannot decide which one is better, choose an intermediate value.
For example, choose 11 if you cannot decide whether pattern 10 or 12 is better.

- 11** Press ▲ or ▼ to select the pattern number you have decided, and then press the **OK** button.
- 12** Repeat steps 8–10 to specify the adjustment value for **D-1** to **D-36**.
Note that **D-9**, **D-21**, and **D-33** cannot be configured.

- 13** Press the **Back** button.
- 14** Press **▲** or **▼** to select **Register Setting**, and then press the **OK** button.
- 15** Press **▲** or **▼** to select **Yes**, and then press the **OK** button.
The adjustment value is now registered, and adjustment is complete.

Adjustment When Installing the Printhead

Printhead position adjustment is executed when the printhead is first installed.
This adjustment should be executed in the following situations.

- If adjusting the printhead position has not been performed such as due to an error during initial setup
- If **Rep.P.head Print** in the Control Panel menu is set to **Off** and adjusting the printhead position has not been performed when replacing the printhead



Note

- We recommend that the same paper as the paper included with the printer is used for this adjustment.

Items to Prepare

When Using Rolls	An unused roll at least 254.0 mm (10.00 in) wide
When Using Sheets	Seven sheets of unused paper, A4/Letter size (or one sheet when using A2)

Perform adjustment as follows.

- 1** Load paper.
 - Attaching the Roll Holder to Rolls →P.538
 - Loading Rolls in the Printer →P.541
 - Loading Sheets in the Printer →P.563



Important

- Always make sure the loaded paper matches the type of paper specified on the printer. Adjustment cannot be completed correctly unless the loaded paper matches the settings.

- 2** On the **Tab Selection screen** of the Control Panel, press **◀** or **▶** to select the **Settings/Adj.** tab ().

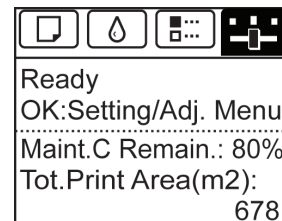

Note

- If the **Tab Selection screen** is not displayed, press the **Menu** button.

- 3** Press the **OK** button.
The **Set./Adj. Menu** is displayed.
- 4** Press **▲** or **▼** to select **Adjust Printer**, and then press the **OK** button.
- 5** Press **▲** or **▼** to select **Head Posi. Adj.**, and then press the **OK** button.
- 6** Press **▲** or **▼** to select **Other**, and then press the **OK** button.

- 7** Press ▲ or ▼ to select **Initial adjustmt**, and then press the **OK** button.
A test pattern is printed for adjustment.
Adjustment is now finished if you have printed on a roll.

- 8** If you are printing on sheets, a confirmation message is displayed requesting you to continue printing. Press the **OK** button and follow the instructions.



Note

- Advanced adjustment can enable superior printing quality when printing fine lines or text at high precision on glossy or semi-glossy photo or proofing paper.
(See "Enhancing Printing Quality.") →P.804

Troubleshooting Paper Abrasion and Blurry Images

The Printhead height setting affects printing quality.

Specifying a low Printhead height makes images clearer and enhances printing quality but may cause paper to rub against the Printhead.

On the other hand, specifying a high Printhead height will prevent paper from rubbing against the Printhead but may reduce the printing quality.



Important

- Paper rubbing against or becoming caught on the Printhead may jam or result in printed documents that are soiled.



Note

- Raise or lower the printhead, depending on the nature of the problem.
(See "Paper rubs against the printhead.") →P.897
(See "The edges of the paper are dirty.") →P.897
(See "Image edges are blurred or white banding occurs.") →P.901

- 1** On the **Tab Selection screen** of the Control Panel, press ◀ or ▶ to select the Paper tab ().



Note

- If the **Tab Selection screen** is not displayed, press the **Menu** button.

- 2** Press the **OK** button.
The **Paper Menu** is displayed.

- 3** Press ▲ or ▼ to select **Paper Details**, and then press the **OK** button.

- 4** Press ▲ or ▼ to select the type of paper, and then press the **OK** button.



Note

- When **Head Height** is set to **Automatic**, the setting value selected for the previous print job is displayed (to the right of **Automatic**) once you select the type of paper currently supplied.
However, the value is cleared when the printer is turned off or the paper is replaced.

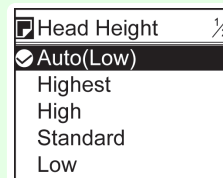

- 5** Press ▲ or ▼ to select **Head Height**, and then press the **OK** button.

6 Press ▲ or ▼ to select the desired setting value, and then press the **OK** button.



- Using **Automatic** will ensure that the printer adjusts the Printhead height to the optimal level before printing, accounting for the ambient temperature and humidity. When a setting other than **Automatic** is used, that value will always be applied.
- Depending on the type of paper, some setting values may not be available.

Adjusting the feed amount

Adjusting the Feed Amount	813
Selecting a Feed Amount Adjustment Method	813
Automatic Banding Adjustment	814
Manual Banding Adjustment	815
Fine-Tuning the Paper Feed Amount	817
Adjusting Line Length	818
Adjusting the Vacuum Strength	819

Adjusting the Feed Amount

If printed documents are affected by the following problems, try adjusting the feed amount.

- Banding in different colors
- Line length is not accurate in the direction paper is fed

To adjust the feed amount, do the following, in this order.

- 1 Depending on the issue, adjust **Adj. Priority** to suit the particular type of paper.
(See "Selecting a Feed Amount Adjustment Method.") →P.813
- 2 Execute **Adj. Quality** or **Adjust Length**, depending on the selection in **Adj. Priority**.
(See "Automatic Banding Adjustment.") →P.814
(See "Manual Banding Adjustment.") →P.815
(See "Adjusting Line Length.") →P.818
- 3 After executing **Adj. Quality**, execute **Adj. Fine Feed** for further adjustment as needed.
(See "Fine-Tuning the Paper Feed Amount.") →P.817

Selecting a Feed Amount Adjustment Method

There are two methods of adjusting the paper feed amount, **Print Quality** and **Print Length**, either of which will be applied during printing.

Since the method that is applied during printing is determined from the value of the **Adj. Priority** setting, configure the **Adj. Priority** to match the print target.

- **Print Quality** : Adjusts the feed amount to reduce banding across the sheet in printed documents. **Adj. Quality** settings are applied. When **Adj. Fine Feed** is executed, the **Adj. Fine Feed** settings are applied in addition to the **Adj. Quality** settings.
- **Print Length** : Adjusts the feed amount for better accuracy of lines in printed documents. The settings of **A:High** or **B:Standard/Draft** in **Adjust Length** are applied.
- **Automatic** : **Print Quality** or **Print Length** is selected, depending on **Print Priority** as selected in the printer driver at the time of printing.





- Either **A:High** or **B:Standard/Draft** in the **Adjust Length** menu is applied, depending on printer driver settings at the time of printing.

Follow these steps to configure the settings.

- 1 Load the paper.
 - Attaching the Roll Holder to Rolls →P.538
 - Loading Rolls in the Printer →P.541
 - Loading Sheets in the Printer →P.563

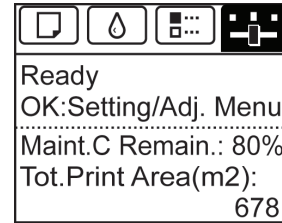
- 2** On the **Tab Selection screen** of the Control Panel, press ◀ or ▶ to select the **Settings/Adj. tab** ().



 **Note** • If the **Tab Selection screen** is not displayed, press the **Menu** button.

- 3** Press the **OK** button.
The **Set./Adj. Menu** is displayed.
- 4** Press ▲ or ▼ to select **Adjust Printer**, and then press the **OK** button.
- 5** Press ▲ or ▼ to select **Feed Priority**, and then press the **OK** button.
- 6** Press ▲ or ▼ to select **Adj. Priority**, and then press the **OK** button.
- 7** Press ▲ or ▼ to select **Automatic, Print Quality**, or **Print Length**, and then press the **OK** button.

Automatic Banding Adjustment

If printed images are affected by banding in different colors across the sheet, execute **Adj. Quality** for automatic adjustment of the paper feed amount.

There are two modes of automatic adjustment to correct banding: **Auto(GenuinePpr)** and **Auto(OtherPaper)**. In either mode, the printer prints and reads a test pattern for automatic adjustment of the feed amount.

- **Auto(GenuinePpr)**
Use this mode with paper identified in the Paper Reference Guide.
(See "Types of Paper.") →P.530
- **Auto(OtherPaper)**
Use this mode with paper not in the Paper Reference Guide, or if **Auto(GenuinePpr)** does not eliminate banding.
(See "Types of Paper.") →P.530



- Adjustment is not possible with **Auto(GenuinePpr)** and **Auto(OtherPaper)** when using highly transparent media. In this case, use **Manual** adjustment.
(See "Manual Banding Adjustment.") →P.815



- We recommend executing the adjustment if you have changed the paper type or paper size.
- **Note** Always check the **Adj. Priority** values before using **Auto(GenuinePpr)** or **Auto(OtherPaper)**.
(See "Selecting a Feed Amount Adjustment Method.") →P.813
- If additional fine-tuning is necessary after **Auto(GenuinePpr)** and **Auto(OtherPaper)**, execute **Adj. Fine Feed**.
(See "Fine-Tuning the Paper Feed Amount.") →P.817
- Use **Adjust Length** to ensure that lines in CAD drawings are printed at exactly the right length.
(See "Adjusting Line Length.") →P.818
- This may take some time, depending on the type of paper.

Items to Prepare

When Using Rolls	An unused roll at least 254.0 mm (10.00 in) wide
When Using Sheets	Auto(GenuinePpr) : One sheet of unused paper, A4/Letter size Auto(OtherPaper) : Two sheets of unused paper, A4/Letter size (or one sheet when using A2)

Perform adjustment as follows.

1 Load the paper.

- Attaching the Roll Holder to Rolls →P.538
- Loading Rolls in the Printer →P.541
- Loading Sheets in the Printer →P.563



- Always make sure the loaded paper matches the type of paper specified in the settings. Adjustment cannot be completed correctly unless the loaded paper matches the settings.

2 On the **Tab Selection screen** of the Control Panel, press ◀ or ▶ to select the Settings/Adj. tab ().

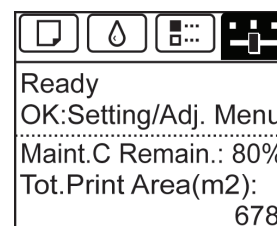

- If the **Tab Selection screen** is not displayed, press the **Menu** button.

3 Press the **OK** button.

The **Set./Adj. Menu** is displayed.

4 Press ▲ or ▼ to select **Adjust Printer**, and then press the **OK** button.

5 Press ▲ or ▼ to select **Feed Priority**, and then press the **OK** button.

6 Press ▲ or ▼ to select **Adj. Quality**, and then press the **OK** button.

7 Press ▲ or ▼ to select **Auto(GenuinePpr)** or **Auto(OtherPaper)**, and then press the **OK** button.

A test pattern is printed for adjustment.

Adjustment is now finished if you have printed on a roll or a sheet of A2 size or larger.

8 If you are printing on sheets smaller than A2 size for **Auto(OtherPaper)**, a confirmation message is shown on the Display Screen requesting you to continue printing.

Press the **OK** button and follow the instructions on the Display Screen.

Manual Banding Adjustment

If printed images are affected by banding in different colors, execute **Adj. Quality** for adjustment of the paper feed amount.

Use **Manual** adjustment with highly transparent media or other paper for which **Auto(GenuinePpr)** or **Auto(OtherPaper)** cannot be used.

(See "Automatic Banding Adjustment.") →P.814

Manual adjustment requires you to enter an adjustment value after a test pattern is printed.



- We recommend executing the adjustment if you have changed the paper type or paper size.

Note

- Always check the **Adj. Priority** values before using **Manual** adjustment.
(See "Selecting a Feed Amount Adjustment Method." →P.813)
- If additional fine-tuning is necessary after **Manual** adjustment, use **Adj. Fine Feed**
(See "Fine-Tuning the Paper Feed Amount." →P.817)
- Use **Adjust Length** to ensure that lines in CAD drawings are printed at exactly the right length.
(See "Adjusting Line Length." →P.818)

Paper to Prepare

When Using Rolls	An unused roll at least 254.0 mm (10.00 in) wide
When Using Sheets	Two sheets of unused paper of at least A4/Letter size

Perform adjustment as follows.

1

Load the paper.

- Attaching the Roll Holder to Rolls →P.538
- Loading Rolls in the Printer →P.541
- Loading Sheets in the Printer →P.563

**Important**

- Always make sure the loaded paper matches the type of paper specified. Adjustment cannot be completed correctly unless the loaded paper matches the settings.

2

On the **Tab Selection screen** of the Control Panel, press ◀ or ▶ to select the **Settings/Adj. tab** (.

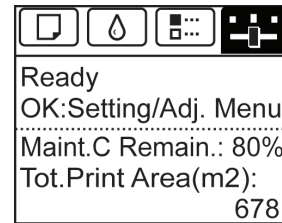
**Note**

- If the **Tab Selection screen** is not displayed, press the **Menu** button.

3

Press the **OK** button.
The **Set./Adj. Menu** is displayed.

4

Press ▲ or ▼ to select **Adjust Printer**, and then press the **OK** button.

5

Press ▲ or ▼ to select **Feed Priority**, and then press the **OK** button.

6

Press ▲ or ▼ to select **Adj. Quality**, and then press the **OK** button.

7

Press ▲ or ▼ to select **Manual**, and then press the **OK** button.
Test pattern A is printed for manual adjustment.

**Note**

- When printing on sheets, follow the instructions on the Display Screen and remove the sheet.

- 8** Examine test pattern A for adjustment. Determine the pattern in which banding is least noticeable.



Note

- If banding seems least noticeable in two patterns but you cannot decide which one is better, choose an intermediate value.
For example, choose 11 if you cannot decide whether pattern 10 or 12 is better.

- 9** Press ▲ or ▼ to select the pattern number you have decided, and then press the **OK** button. Test pattern B is printed for adjustment.



Note

- If you printed test pattern A on a sheet, follow the instructions on the Display Screen and use another sheet of the same type of paper.
Additionally, after test pattern B is printed, follow the instructions on the Display Screen and remove the sheet.

- 10** Examine test pattern B for adjustment. Determine the pattern in which banding is least noticeable.

- 11** Press ▲ or ▼ to select the pattern number you have decided, and then press the **OK** button. The adjustment value is now registered, and adjustment is complete.

Fine-Tuning the Paper Feed Amount

If the contrast is uneven or banding in different colors appears at 50 mm (2.0 in) intervals in printed documents, try executing **Adj. Fine Feed** during printing to fine-tune the feed amount.



Note

- The **Adj. Fine Feed** menu is only displayed during printing. Additionally, it is displayed when you have selected **Automatic** or **Print Quality** in **Adj. Priority** in **Feed Priority**. (See "Menu Structure.") →P.669
- Always execute **Adj. Quality** before **Adj. Fine Feed**. Once you execute **Adj. Quality**, the **Adj. Fine Feed** value will revert to 0. (See "Automatic Banding Adjustment.") →P.814
(See "Manual Banding Adjustment.") →P.815

Perform adjustment as follows.

- 1** On the **Tab Selection screen** of the Control Panel, press ◀ or ▶ to select the Settings/Adj. tab ().

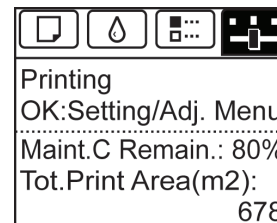

Note

- If the **Tab Selection screen** is not displayed, press the **Menu** button.

- 2** Press the **OK** button. The **Set./Adj. Menu** is displayed.

3 Press ▲ or ▼ to select **Adj. Fine Feed**, and then press the **OK** button.

4 Press ▲ or ▼ to select a setting value in the range -5 to 5, and then press the **OK** button.
At this time, if banding in dark colors appears, select a setting value in the range 1 to 5, and if banding in light colors appears, select a setting value in the range -1 to -5.

Adjusting Line Length

To ensure that lines in CAD drawings are printed at exactly the right length, use **Adjust Length** to adjust the amount that paper is advanced.

There are two options in **Adjust Length** : **AdjustmentPrint** and **Change Settings**.

- **AdjustmentPrint**
After a test pattern is printed, you will measure the discrepancy based on the results of printing.
- **Change Settings**
No test pattern is printed. Instead, you will measure a document already printed to determine the discrepancy.

Additionally, two modes are available in both **AdjustmentPrint** and **Change Settings** : **A:High** or **B:Standard/Draft**. Choose the mode that suits your particular printing application.

- **A:High**
This setting is applied when **Highest quality** or **High** is selected in **Print Quality** in the printer driver.
- **B:Standard/Draft**
This setting is applied when **Standard** or **Fast** is selected in **Print Quality** in the printer driver.



- We recommend executing the adjustment if you have changed the paper type or paper size.

Note • Always check the **Adj. Priority** values before using **Adjust Length**. (See "Selecting a Feed Amount Adjustment Method.")

→P.813

Paper to Prepare

When Using Rolls	<ul style="list-style-type: none"> • An unused roll at least 254.0 mm (10.00 in) wide • High-precision ruler
When Using Sheets	<ul style="list-style-type: none"> • One sheet of unused paper of at least A4/Letter size • High-precision ruler

Perform adjustment as follows.

1 Load the paper.

- Attaching the Roll Holder to Rolls →P.538
- Loading Rolls in the Printer →P.541
- Loading Sheets in the Printer →P.563



- Always make sure the loaded paper matches the type of paper specified. Adjustment cannot be completed correctly unless the loaded paper matches the settings.

2 On the **Tab Selection screen** of the Control Panel, press ◀ or ▶ to select the **Settings/Adj.** tab ().





Note

- If the **Tab Selection screen** is not displayed, press the **Menu** button.

3

Press the **OK** button.
The **Set./Adj. Menu** is displayed.

4

Press **▲** or **▼** to select **Adjust Printer**, and then press the **OK** button.

5

Press **▲** or **▼** to select **Feed Priority**, and then press the **OK** button.

6

Press **▲** or **▼** to select **Adjust Length**, and then press the **OK** button.

7

Press **▲** or **▼** to select **AdjustmentPrint** or **Change Settings**, and then press the **OK** button.
When you select **AdjustmentPrint**, a test pattern is printed for you to measure the scale and calculate the discrepancy. The scale bar prints **Millimeter** in 50 mm increments and **Inch** in 1-inch increments.

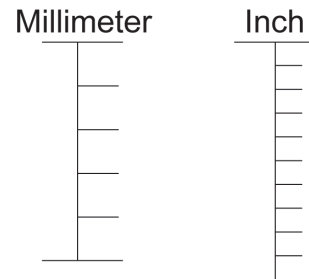

Note

- A test pattern is printed in black when you choose **A:High** or in magenta if you choose **B:Standard/Draft**.
- To cancel printing the test pattern for adjustment, hold down the **Stop** button. When "**Stop printing?**" is displayed, press **▲** or **▼** to select "**Yes**", and then press the **OK** button.

8

Press **▲** or **▼** to enter the amount of discrepancy, and then press the **OK** button.
If the scale is shorter than the actual size, use a positive setting value. If it is longer, use a negative value.
The feed amount can be adjusted in 0.02% increments.

Adjusting the Vacuum Strength

When printing on heavyweight paper or paper that curls or wrinkles easily, if the Printhead rubs against paper, adjusting the level of suction against paper on the Platen may improve results.



Important

- Paper rubbing against or becoming caught on the Printhead may jam or result in printed documents that are soiled.

1

On the **Tab Selection screen** of the Control Panel, press **◀** or **▶** to select the Paper tab ().



Note

- If the **Tab Selection screen** is not displayed, press the **Menu** button.

2

Press the **OK** button.
The **Paper Menu** is displayed.

3 Press ▲ or ▼ to select **Paper Details**, and then press the **OK** button.

4 Press ▲ or ▼ to select the type of paper, and then press the **OK** button.



- When **VacuumStrngth** is set to **Automatic**, the setting value selected for the previous print job is displayed (to the right of **Automatic**) once you select the type of paper currently supplied. However, the value is cleared when the printer is turned off or the paper is replaced.

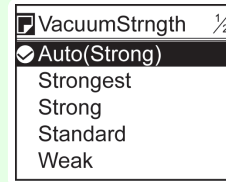

5 Press ▲ or ▼ to select **VacuumStrngth**, and then press the **OK** button.

6 Press ▲ or ▼ to select the desired setting value, and then press the **OK** button.

Basic Printing Workflow	19
Enhanced Printing Options	35
Windows Software	177
Mac OS X Software	363
Handling and Use of Paper	529
Control Panel	655
Printer Parts	691
Network Setting	707
Print Job Management	741
Adjustments for Better Print Quality	803

Color Management

Monitor Matching	822
Color Calibration	828

Maintenance and Consumables	833
Troubleshooting	883
Error Message	915
Specifications	941
Appendix	945

Monitor Matching

Printing Images to Match Monitor Colors	822
Printing Images to Match Monitor Colors (Windows)	823
Printing Images to Match Monitor Colors (Mac OS X)	825

Printing Images to Match Monitor Colors

Adjusting the colors printed so that they more closely match the colors displayed on the monitor is called "monitor matching." Using this mode requires adjustment or configuration of the settings of your monitor, the source application, the file for printing, and the printer driver.

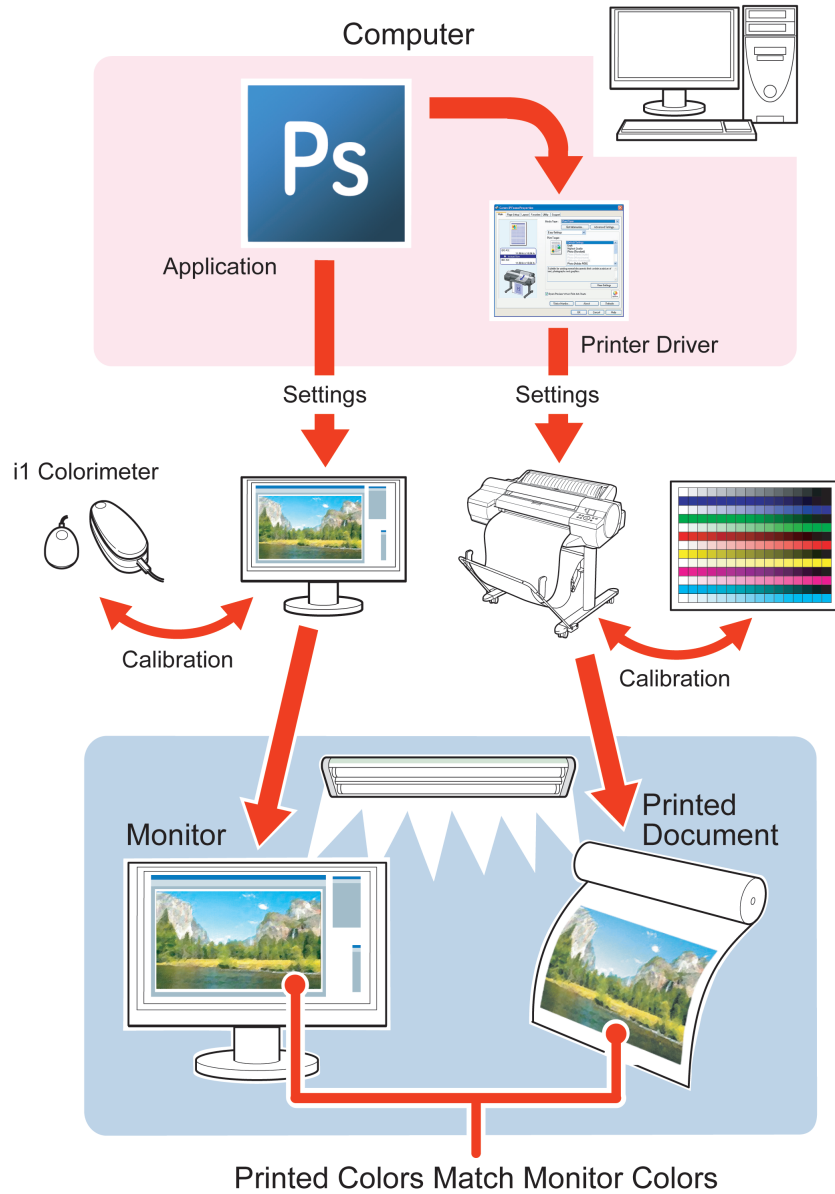

Important • Monitor matching may not be applied, or these settings may not be configurable or adjustable, depending on your monitor and the source application.

Color Management
Monitor Matching



Note

- Printing in exactly the same colors as displayed on the monitor may not be possible due to differences in the monitor and printer color gamuts.
- Calibrating your monitor requires a measuring device.
- Because colors appear different under sunlight at different times of day, we recommend following this procedure in a room not exposed to sunlight.

• Monitor Matching

The sequence in monitor matching is as follows.

1

Calibrate the printer.

Calibration improves color consistency by compensating for slight differences in how color appears due to individual variation among printheads or conditions in various printing environments.

(See "Corrects slight differences in how colors appear (color calibration).") →P.828

2

Calibrate the monitor.

i1-Display and similar measurement devices are commonly used.

Set **white point** to **6500K** or **5000K**, **Gamma** to **2.2**, and **brightness** to **120 cd**.

The exact procedure varies depending on your monitor and measurement device.

3

Open the file to print and configure settings in the source application.

Display the file in the sRGB or Adobe RGB color space.

Configure settings to prevent color conversion by the application.

In Photoshop CS3, for example, select **Color Management** in the **Print** dialog box, and then select **No Color Management** in **Color Handling**.

4

Configure and adjust printer driver settings.

Select **Monitor Matching** using the **Matching Method**, and then select the **Monitor White Point** that you set up in monitor calibration.

In **Color Space**, select the color space used when displaying the file in the source application.



Note

- To print multiple times using the same value, we recommend opening the Printer Driver dialog box from the System menu and configuring the appropriate settings. (See "Accessing the Printer Driver Dialog Box from the Operating System Menu (Windows).") →P.187

For instructions on configuring printer driver settings for monitor matching, refer to the following topic, as appropriate for your computer and operating system.

- Printing Images to Match Monitor Colors (Windows) →P.823
- Printing Images to Match Monitor Colors (Mac OS X) →P.825

Printing Images to Match Monitor Colors (Windows)

By calibrating your monitor and configuring settings in the source application in advance, you can complete settings to print in colors that are as close as possible to the colors displayed on the monitor.



Important

- Before using this feature, you must calibrate the monitor and configure settings in the source application. (See "Printing Images to Match Monitor Colors" →P.822 ")

1

Choose **Print** in the application menu.

2

Select the printer in the dialog box, and then display the printer driver dialog box. (See "Accessing the Printer Driver Dialog Box from Applications" →P.185 ")

3 Make sure the **Main** sheet is displayed.

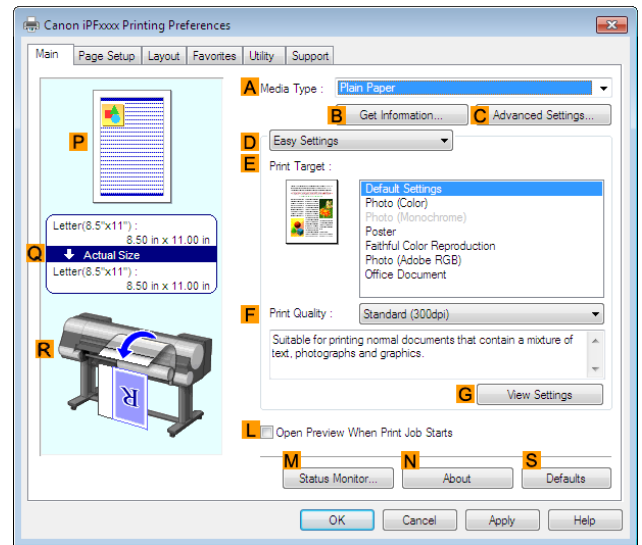

4 In the **A Media Type** list, select the type of paper that is loaded (for example, **Canon Premium Glossy Paper 2 280**).

5 Click **D Advanced Settings** to switch the print mode.

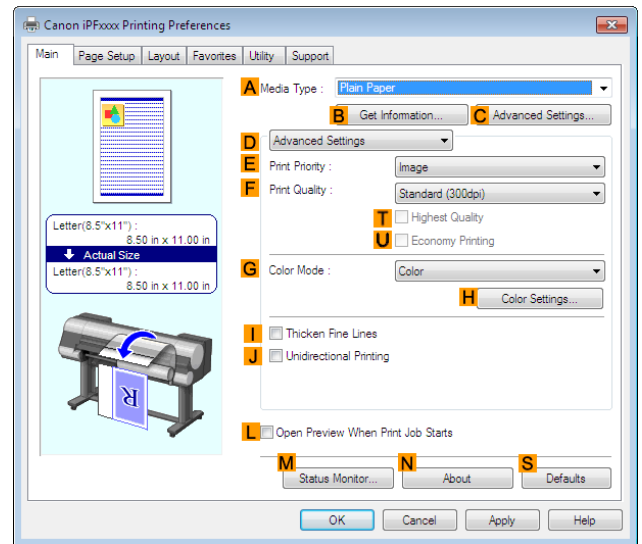

6 In **F Print Quality**, click **High**.

7 Click **Color** in the **G Color Mode** list.

8 Click **H Color Settings** to display the **Color Settings** dialog box.

- 9** Click the **Matching** tab to display the **Matching** sheet.

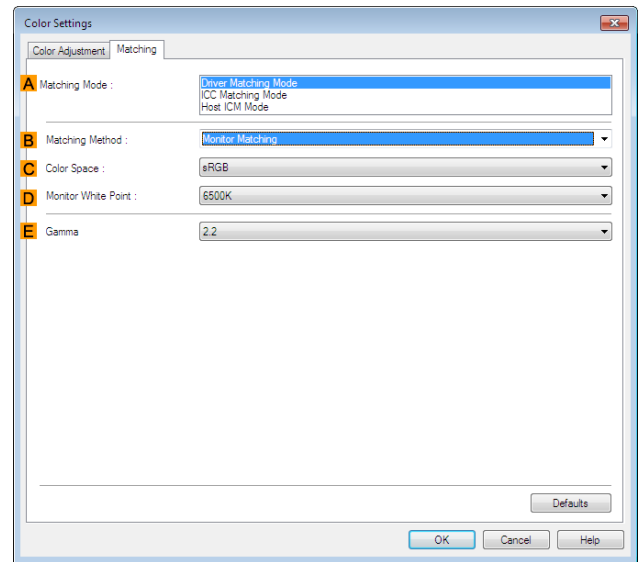

- 10** Make sure **Driver Matching Mode** is selected in **A Matching Mode**.
- 11** In **B Matching Method**, select **Monitor Matching**.
- 12** In **C Color Space**, select the color space used when displaying the file in the source application.
- 13** In **D Monitor White Point**, select the white point set on the monitor.
- 14** Click **OK**.
- 15** Confirm the print settings and print as desired.

Printing Images to Match Monitor Colors (Mac OS X)

By calibrating your monitor and configuring settings in the source application in advance, you can complete settings to print in colors that are as close as possible to the colors displayed on the monitor.



- Before using this feature, you must calibrate the monitor and configure settings in the source application. (See "Printing Images to Match Monitor Colors.") →P.822

- 1** Choose **Print** in the application menu.
- 2** Select the printer in the dialog box, and then display the printer driver dialog box. (See "Accessing the Printer Driver Dialog Box from Applications.") →P.370

3 Make sure the **Main** panel is displayed.

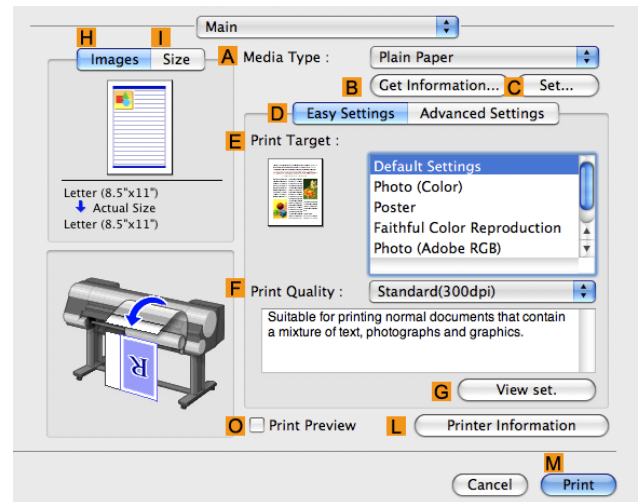

4 In the **A Media Type** list, select the type of paper that is loaded (for example, **Canon Premium Glossy Paper 2 280**).

5 Click **D Advanced Settings** to switch the print mode.

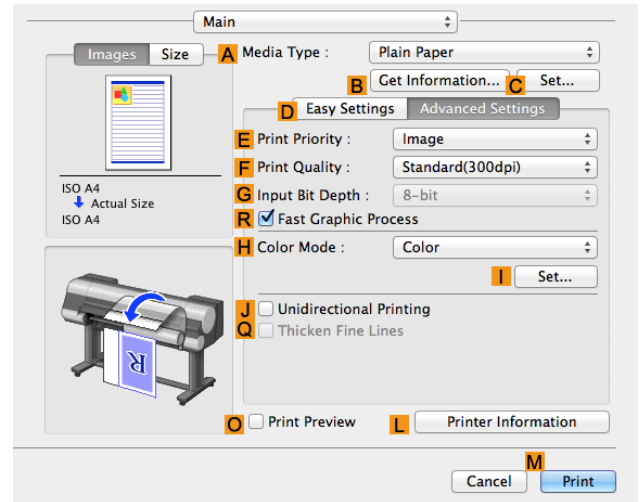

6 In **F Print Quality**, click **High**.

7 Click **Color** in the **H Color Mode** list.

8 Click **I Set** to display the **Color Settings** dialog box.

9 Click the **Matching** tab to display the **Matching** panel.

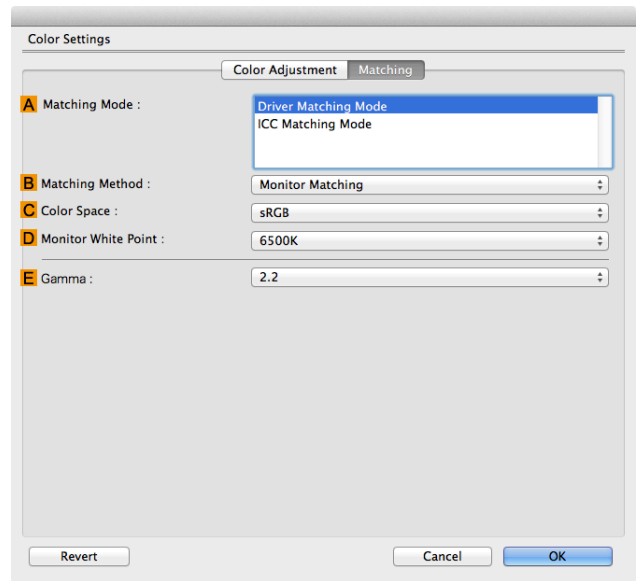

10 Make sure **Driver Matching Mode** is selected in **A Matching Mode**.

11 In **B Matching Method**, select **Monitor Matching**.

12 In **C Color Space**, select the color space used when displaying the file in the source application.

13 In **D Monitor White Point**, select the white point set on the monitor.

14 Click **OK**.

15 Confirm the print settings and print as desired.

Color Calibration

Corrects slight differences in how colors appear (color calibration) 828
 Paper that can be used in Color Calibration 830

Corrects slight differences in how colors appear (color calibration)

What is Color Calibration?

Color calibration improves color consistency by compensating for slight differences in how color appears when printing due to individual variations or aging among the printers.

Executing color calibration will print a test pattern, which will be read automatically by a sensor built in the printer. By this operation, a calibration adjustment value reflecting the print result of the test pattern is set automatically.



- When executing color calibration, keep the temperature and humidity conditions the same each time for better color consistency.
 If you execute color calibration under various conditions of temperature and humidity, correct adjustment may not be possible.
- Before color calibration, ensure the printer is not exposed to direct sunlight or other strong sources of light.
 If the printer is exposed to strong sources of light, correct adjustment may not be possible.

Recommend Timing for Color Calibration

We recommend color calibration in the following situations.

- After initial printer installation
- After Printhead replacement
- If colors seem different from before, despite using the same printing environment, under the same conditions
- To ensure uniform colors when printing on multiple printers (however, be sure to use the same version of firmware and printer driver, under the same settings)
- When the Execution Guide is displayed (Specifying Execution Guide →P.829)

Executing Color Calibration

- Prepare the printer

1 You can confirm whether the paper to be loaded can be used in color calibration.
 (See "Paper that can be used in Color Calibration." →P.830)

2 Load the paper.
 (See "Attaching the Roll Holder to Rolls." →P.538)
 (See "Loading Rolls in the Printer." →P.541)
 (See "Loading Sheets in the Printer." →P.563)

- Executing Color Calibration

1 On the **Tab Selection screen** of the Control Panel, press ◀ or ▶ to select  (Settings/Adj. tab).

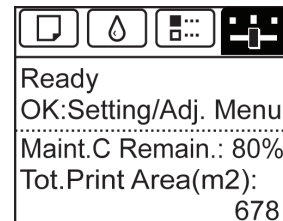



- If the **Tab Selection screen** is not displayed, press the **Menu** button.

Note

- 2 Press the **OK** button.
Set./Adj. Menu is displayed.
- 3 Press **▲** or **▼** to select **Adjust Printer**, and then press the **OK** button.
- 4 Press **▲** or **▼** to select **Calibration**, and then press the **OK** button.
- 5 Press **▲** or **▼** to select **Auto Adjust**, and then press the **OK** button.
After the environment measurements and paper are confirmed, and color calibration is executed, the calibration adjustment value is set automatically.

Applying the Calibration Adjustment Values During Printing

The application of the calibration adjustment value when printing can be set in the printer driver or on the menu of the Control Panel.

However, when the setting value of the printer driver and the setting value of the Control Panel differ, the setting of the printer driver is prioritized.

How to apply	How to operate
Configure on the printer driver menu. (Windows)	Configure Calibration Value . (See "Paper Detailed Settings Dialog Box (Windows).") →P.192
Configure on the printer driver menu. (Mac OS X)	Configure Calibration Value . (See "Paper Detailed Settings Dialog Box (Mac OS X).") →P.374
Configure on the menu of the Control Panel.	From Set./Adj. Menu , select Adjust Printer > Calibration > Use Adj. Value . (See "Menu Settings.") →P.675



Note

- After executing color calibration, you can also adjust colors as desired in the printer driver. (See "Adjusting the Color in the Printer Driver.") →P.60

Checking Color Calibration Execution Logs

You can confirm information of color calibration such as the execution date and executed paper type by the following method.

How to check	How to operate
Confirm it on the Control Panel of the printer.	From Set./Adj. Menu , select Adjust Printer > Calibration > Calibration Log . (See "Menu Settings.") →P.675
Print information about the printer.	From Set./Adj. Menu , select Test Print > Status Print . (See "Status Print.") →P.684
Confirm with imagePROGRAF Status Monitor. (Windows)	On the Information sheet of imagePROGRAF Status Monitor, click the View Calibration Log button. (See "The Features of imagePROGRAF Status Monitor.") →P.742
Confirm this in the Printer Information dialog box of the printer driver. (Mac OS X)	In the Printer Information dialog box, click the Information tab, and click the View Calibration Log button. (See "Main Pane (Mac OS X).") →P.370

Specifying Execution Guide

Execution Guide is a function in which a guide is displayed on the Control Panel, imagePROGRAF Status Monitor (Windows), imagePROGRAF Printmonitor (Macintosh), or RemoteUI when you execute color calibration.

If you enable this function, an Execution Guide is displayed in the following cases.

- When a new Printhead has been installed
- When a certain amount of printing has been executed after color calibration is executed
- When the data of color calibration has been initialized

To enable the function, set "**Set Exec. Guide**" to **On** on the menu of the Control Panel.

(See "Menu Settings.") →P.675

Paper that can be used in Color Calibration

Recommended Environment for Use of Paper

Since the recommended use environment varies according to the paper type, use within the recommended environment range suiting the paper type.

For details, refer to the Paper Reference Guide.

Paper Type and Adjustment Type

- In color calibration, you can use any of the following paper types.
Also, the adjustment type of color calibration is decided according to the paper type. (Adjustment Types of Color Calibration →P.831)
- The media types shown in the table are the names that are displayed in the printer Control Panel.

Paper Type	Country or Region of Use selected when the printer driver was installed			Adjustment Type
	Japan, Asia, Oceania	EU	North or South America	
Opaque Paper 120	Not available	Available	Not available	Common calibration
HW Coated	Available	Available	Available	Common calibration
GlossyPhoto 170g	Available	Available	Available	Common calibration
SatinPhoto 170g	Available	Available	Available	Common calibration
GlossyPhotoHG170	Available	Available	Available	Common calibration
SemGlsPhotoHG170	Available	Available	Available	Common calibration
GlossyPhoto 200g	Not available	Available	Available	Common calibration
SatinPhoto 200g	Not available	Available	Available	Common calibration
GlossyPhoto 240	Not available	Available	Available	Common calibration
SatinPhoto 240	Not available	Available	Available	Common calibration
GlossyPhotoHG255	Available	Available	Available	Common calibration
SemGlsPhotoHG255	Available	Available	Available	Common calibration
RC Photo Luster	Not available	Not available	Available	Unique calibration
Premium GI2 280	Available	Available	Available	Common calibration
Prem.SemiGI2 280	Available	Available	Available	Common calibration
PhotoProPlat adj	Available	Available	Available	Common calibration
LW Gloss Proof	Available	Not available	Available	Unique calibration
LW Matte Proof	Available	Not available	Available	Unique calibration
Proofing Paper3	Available	Not available	Available	Unique calibration
Proofing Paper	Available	Not available	Available	Common calibration
Proof SemiGI 195	Not available	Available	Not available	Unique calibration
FineArt Photo	Available	Available	Available	Common calibration

Paper Type	Country or Region of Use selected when the printer driver was installed			Adjustment Type
	Japan, Asia, Oceania	EU	North or South America	
FneArt HW Photo	Available	Available	Available	Common calibration



Note

- If the paper you are using is not specified in media type, execute color calibration using the paper where the adjustment type is Common calibration, then you can set the calibration adjustment values for the paper you are using.
- The settings for each media type can be changed using Media Configuration Tool. Not available media types can be displayed in the Control Panel by changing the settings. (See "Switching Media Types Display Show/Hide (Windows).") →P.602 (See "Switching Media Types Display Show/Hide (Mac OS X).") →P.635
- For details on the paper that can be used when **PhotoProPlat adj** is selected as the paper type, refer to the Paper Reference Guide.

Paper Sizes that can be Used in Color Calibration

Paper sizes that can be used in color calibration differ for sheets and rolls. For details, refer to the Paper Reference Guide.

When Using Rolls	An unused roll at least 254.0 mm (10.00 in) wide (however, a roll at least 406.4 mm (16.00 in) wide depending on the paper type)
When Using Sheets	One sheet of unused paper of at least A4/Letter size (however, one sheet of unused paper of at least A2 size depending on the paper type)

Registration and Confirmation of Paper Information

• To Register Paper Information on the Printer

When using newly released paper, paper information must be registered on the printer and the printer driver. Download the new version of **Media Information File** from the Canon website and install it. (See "Types of Paper.") →P.530

• To Confirm the Paper Information Registered on the Printer

When confirming the paper information registered on the printer, select **Paper Details** on the Control Panel menu, and print the detailed information of the paper. (See "Menu Settings.") →P.675



Important

- To restore the default settings, set **Reset PaprSetngs** to **Yes** in **System Setup** in the Control Panel menu. Because paper information added or modified by the Media Configuration Tool is deleted, if you have calibrated the printer using paper with information added by the Media Configuration Tool, color calibration executed this way can no longer be applied to any type of paper. If you wish to apply calibration results, prepare calibration-compatible paper that was in the original settings and perform calibration again.

Adjustment Types of Color Calibration

Color calibration has two adjustment types, Common calibration and Unique calibration, with one of these selected when color calibration is executed.

The selected adjustment type is determined from the media type that color calibration is executed on.

• Common calibration

Common calibration is a feature that allows you to use multiple media types easily in a short time because it is not necessary to execute color calibration on each media type.

If color calibration is executed on paper categorized as Common calibration, dedicated calibration adjustment values are set on the media type that Common calibration was executed on.

Furthermore, calibration adjustment values are set on all print qualities for all media types where color calibration has not been executed.

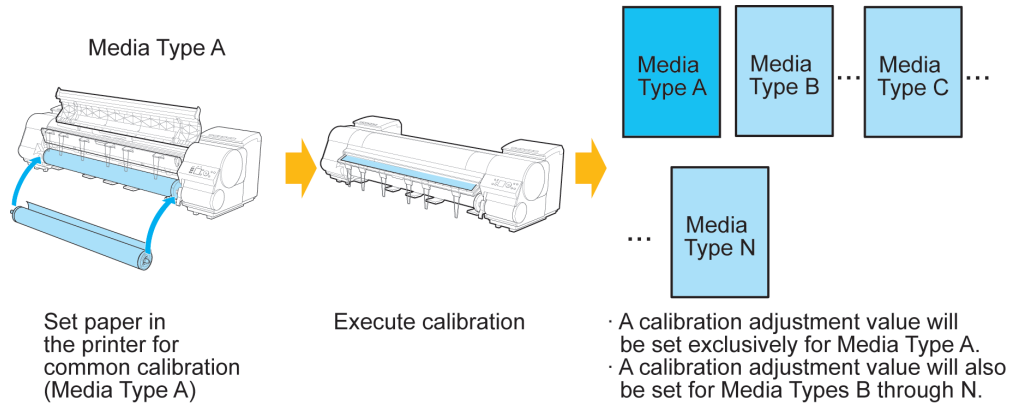

- The calibration adjustment values are not overwritten for media types where color calibration has been executed once and dedicated calibration adjustment values have been set.

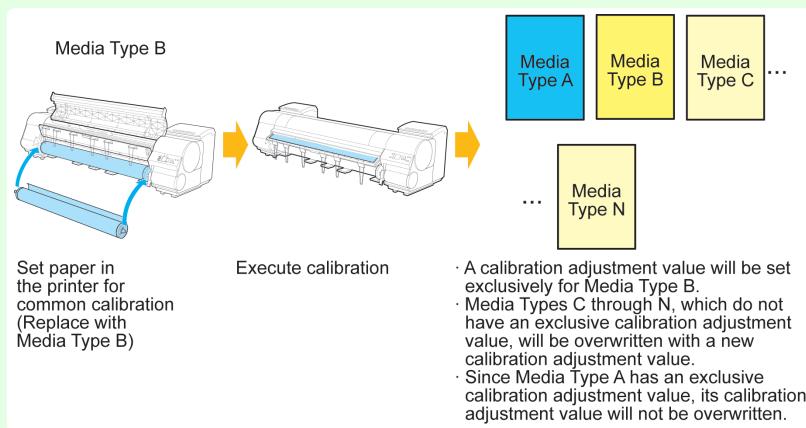

• Unique calibration

If color calibration is executed on paper categorized as Unique calibration, calibration adjustment values are set only for the media type that the color calibration was executed on.

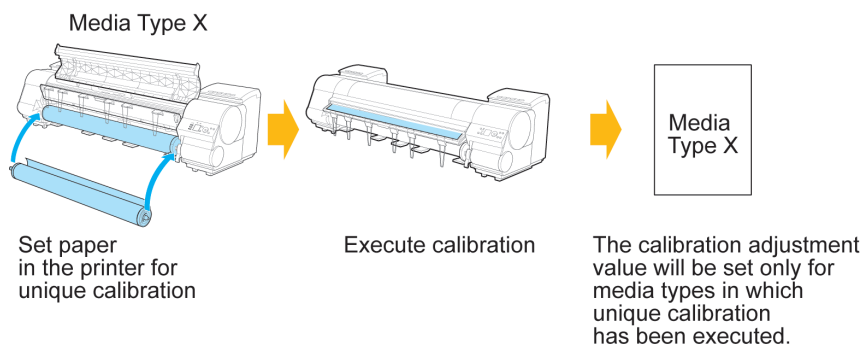

- Even if paper categorized as Unique calibration is used, if the media type has yet to execute color calibration even once and does not have any dedicated calibration adjustment values, the calibration adjustment values are overwritten when Common calibration is executed.

Basic Printing Workflow	19
Enhanced Printing Options	35
Windows Software	177
Mac OS X Software	363
Handling and Use of Paper	529
Control Panel	655
Printer Parts	691
Network Setting	707
Print Job Management	741
Adjustments for Better Print Quality	803
Color Management	821

Maintenance and Consumables

Ink Tanks	834
Printheads	846
Cutter Unit	856
Maintenance Cartridge	860
Cleaning the Printer	869
Other Maintenance	873
Consumables	881

Troubleshooting	883
Error Message	915
Specifications	941
Appendix	945

Ink Tanks

Ink Tanks 834
 Replacing Ink Tanks 834
 Checking Ink Tank Levels 844
 When to Replace Ink Tanks 845

Ink Tanks

When purchasing, check the Model number.

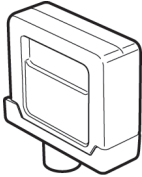
Shape	Colors	Model number	Ink Type	Capacity
	Matte black	PFI-306 MBK	Pigment ink	330 ml (11.2 fl oz)
	Black	PFI-306 BK		
	Cyan	PFI-306 C		
	Magenta	PFI-306 M		
	Yellow	PFI-306 Y		
	Photo cyan	PFI-306 PC		
	Photo magenta	PFI-306 PM		
	Gray	PFI-306 GY		

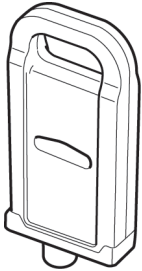
Shape	Colors	Model number	Ink Type	Capacity
	Matte black	PFI-706 MBK	Pigment ink	700 ml (23.7 fl oz)
	Black	PFI-706 BK		
	Cyan	PFI-706 C		
	Magenta	PFI-706 M		
	Yellow	PFI-706 Y		
	Photo cyan	PFI-706 PC		
	Photo magenta	PFI-706 PM		
	Gray	PFI-706 GY		



- For instructions on Ink Tank replacement, see "Replacing Ink Tanks." →P.834
- The provided Starter Ink Tanks contain 330 ml (11.2 fl oz) each.

Replacing Ink Tanks

Compatible ink tanks

For information on compatible ink tanks, see "Ink Tanks." →P.834
 Replacement ink tanks in 330 ml (11.2 fl oz) and 700 ml (23.7 fl oz) capacities are supported.



- Depending on the color, you can also use an ink tank with a different capacity.

Precautions when handling ink tanks

834 Take the following precautions when handling ink tanks.



- For safety, keep ink tanks out of the reach of children.
- If ink is accidentally ingested, contact a physician immediately.



Important

- There may be ink around the ink supply section of ink tanks you removed. Handle ink tanks carefully during replacement. The ink may stain clothing.
- Do not install used ink tanks in another model of printer. This will prevent correct ink level detection, which may damage the printer or cause other problems.
- We recommend using up an Ink Tank in the course of printing within six months after breaking the seal. Printing quality may be affected if you use older ink tanks.
- Do not leave the printer without ink tanks installed for extended periods (a month or more). Residual ink may become clogged inside the printer and affect printing quality.

How to replace an Ink Tank

1. Confirm the message. →P.835
2. Access the menu for Ink Tank replacement. →P.836 (Otherwise, open the Ink Tank Cover.)
3. Remove the Ink Tank.
 - 330 ml ink tanks →P.836
 - 700 ml ink tanks →P.837
4. Load the new Ink Tank.
 - 330 ml ink tanks →P.839
 - 700 ml ink tanks →P.841

Confirm the message

When the ink level becomes low, a message is displayed on the Display Screen.

According to the message, replace the ink tank or prepare a new ink tank. (See "When to Replace Ink Tanks.")

→P.845

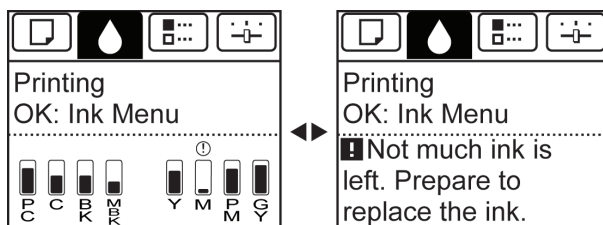

If a message requests you to replace an Ink Tank, press the **OK** button. In this case, you can skip the step **Access the menu for ink tank replacement**. Follow the instructions in **Remove the ink tanks**.

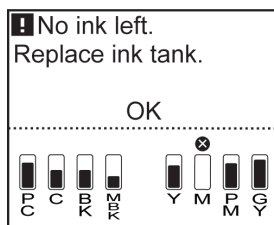

Important

- Do not remove an Ink Tank during initialization immediately after turning on the printer, or during printhead cleaning. Ink may leak out.



Note

- Ink Tank replacement is possible even during printing, when print jobs are being canceled, or when paper is being advanced.

Access the menu for Ink Tank replacement

- 1 On the **Tab Selection screen** of the Control Panel, press ◀ or ▶ to select the Ink tab ().

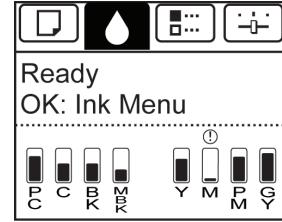

• If the **Tab Selection screen** is not displayed, press the **Menu** button.

Note

- 2 Press the **OK** button.
The **Ink Menu** is displayed.
- 3 Press ▲ or ▼ to select **Rep. Ink Tank**, and then press the **OK** button.
Instructions are displayed on the Display Screen.

Remove the Ink Tank (330 ml)

- 1 Open the Ink Tank Cover of the tank for replacement and check the Ink Lamp.
The Ink Lamp flashes quickly if there is no ink left.

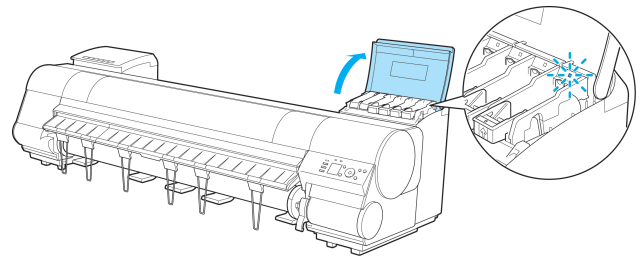

• Avoid hitting the printer when replacing an Ink Tank. Handle the printer gently when replacing tanks. Jolting the printer during printing may deteriorate print quality.

Important

- 2 Lift the stopper (a) of the Ink Tank Lock Lever for the color to replace. Lift the Ink Tank Lock Lever until it stops, and then push it down to the front.

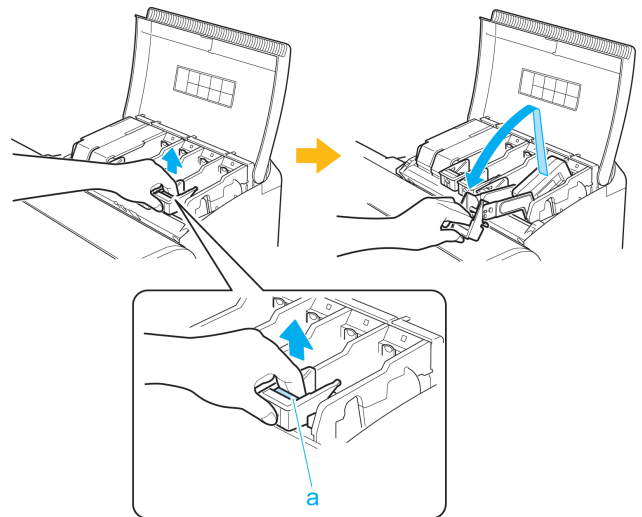

• Push the Ink Tank Lock Lever down until it locks.
• Make sure the Ink Tank Lock Lever does not return to the original position.

Note

- 3** Hold the Ink Tank by the grips (a) and remove it. Press the **OK** button.

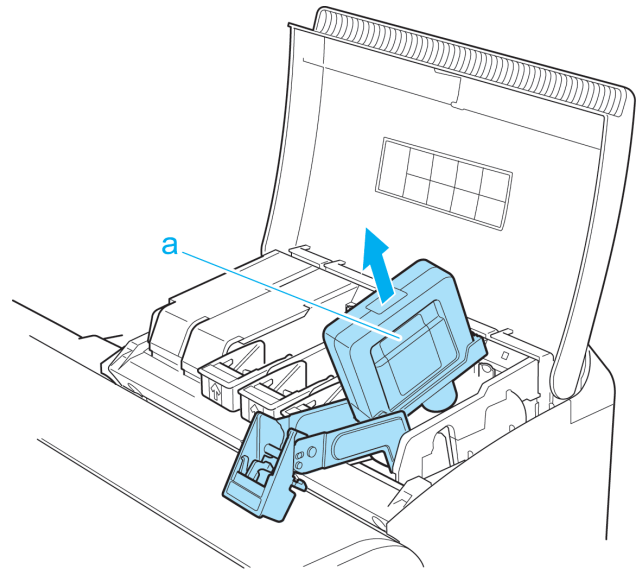

Important

- If there is still ink in the Ink Tank you removed, store it with the ink holes (a) facing up. Otherwise, ink may leak and cause stains. Put the removed Ink Tank in a plastic bag and seal it.

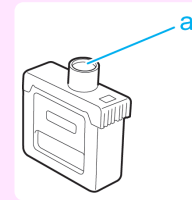

Note

- Dispose of used ink tanks according to local regulations.

Remove the Ink Tank (700 ml)

- 1** Open the Ink Tank Cover of the tank for replacement and check the Ink Lamp. The Ink Lamp flashes quickly if there is no ink left.

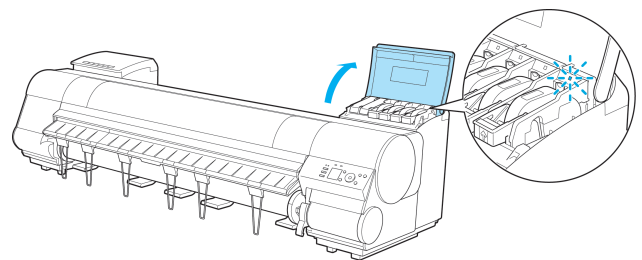

Important

- Avoid hitting the printer when replacing an Ink Tank. Handle the printer gently when replacing tanks. Jolting the printer during printing may deteriorate print quality.

- 2** Lift the stopper (a) of the Ink Tank Lock Lever for the color to replace. Lift the Ink Tank Lock Lever until it stops, and then push it down to the front.

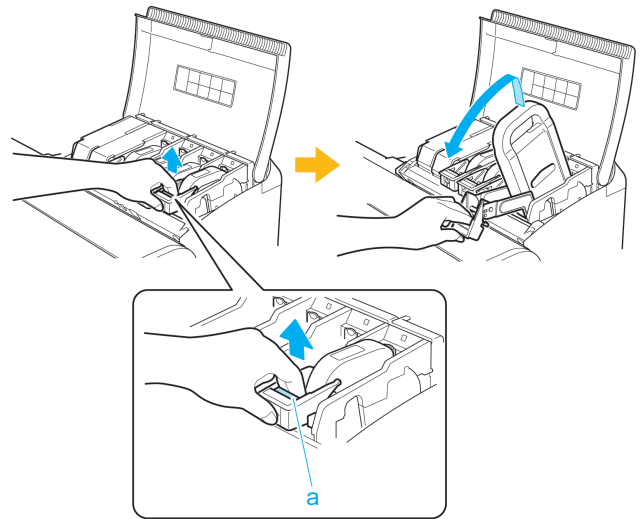

Note

- Push the Ink Tank Lock Lever down until it locks.
- Make sure the Ink Tank Lock Lever does not return to the original position.

- 3** Hold the Ink Tank by the handle (a) and remove it. Press the **OK** button.

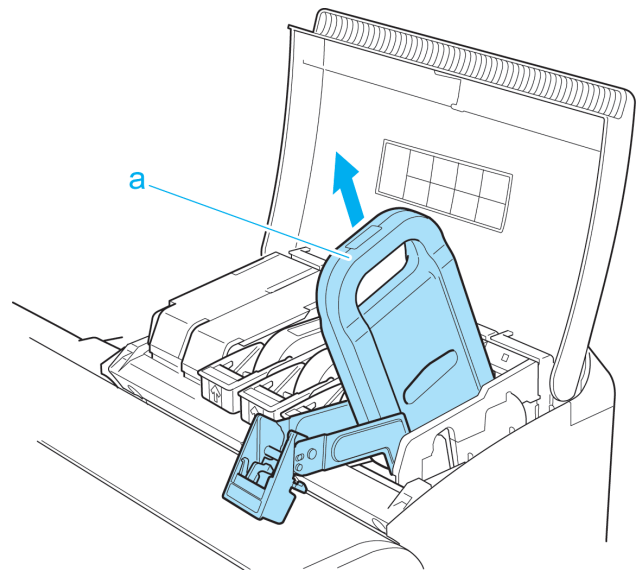



- If there is still ink in the Ink Tank you removed, store it in the box with the ink holes (a) facing up. Otherwise, ink may leak and cause stains.

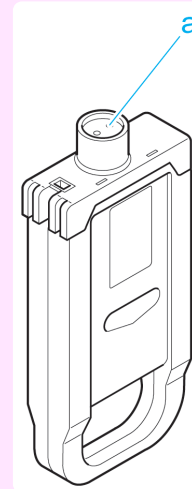

- Dispose of used ink tanks according to local regulations.

Load the Ink Tank (330 ml)

- 1 Before opening the pouch, tilt the Ink Tank to the left and right gently seven or eight times.

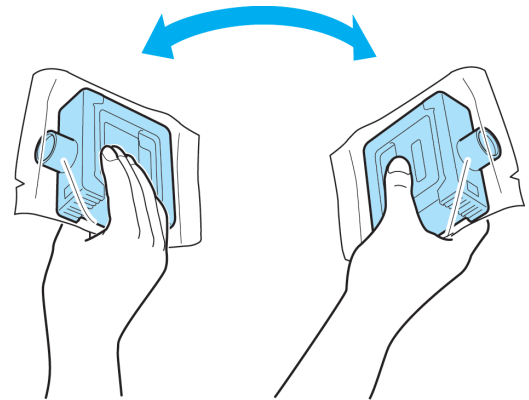

- Do not remove and agitate ink tanks that have already been installed in the printer. Ink may leak out.
- If you do not agitate the Ink Tank, the ink may settle, which may affect printing quality.

- 2 Open the pouch and remove the Ink Tank.

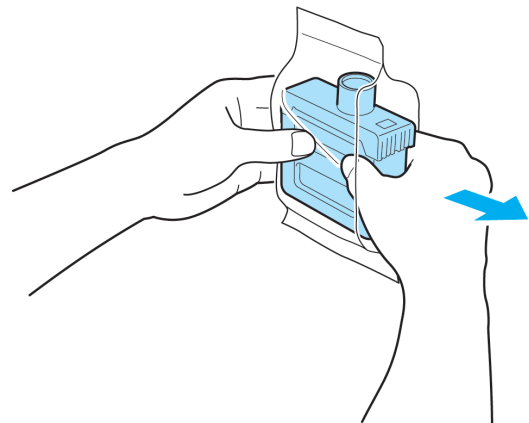



- Never touch the ink holes or electrical contacts. This may cause stains, damage the Ink Tank, and affect printing quality.

3

Press the **OK** button and insert the Ink Tank into the holder facing as shown, with the ink holes down.

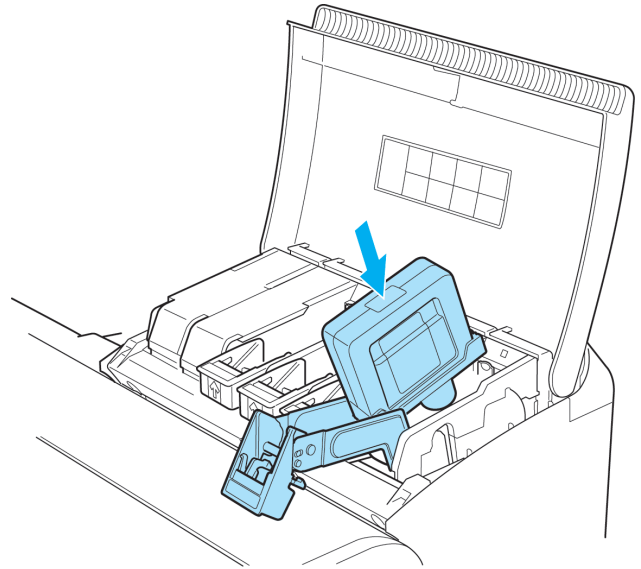

- Ink tanks cannot be loaded in the holder if the color or orientation is incorrect. If the Ink Tank does not fit in the holder, do not force it into the holder. Make sure the color of the Ink Tank Lock Lever matches the color of the Ink Tank, and check the orientation of the Ink Tank before reloading it.

4

Lift the Ink Tank Lock Lever until it stops, and then push it down until it clicks into place.

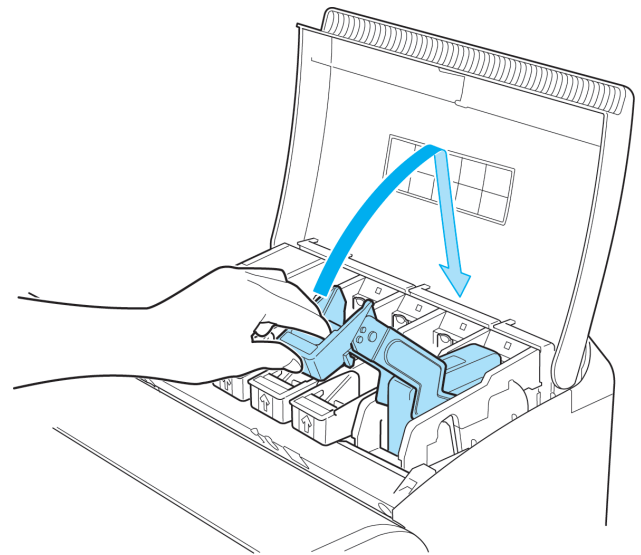

- 5** Make sure the Ink Lamp is lit in red.

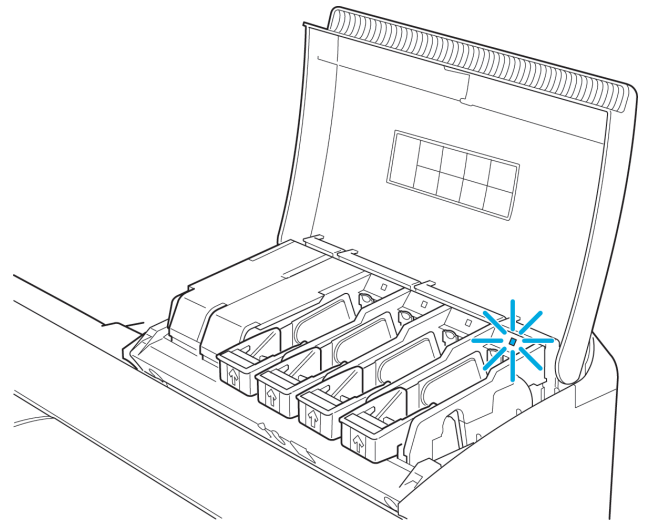

Note

- If the Ink Lamp is not lit in red, reload the tank.

- 6** Close the Ink Tank Cover.

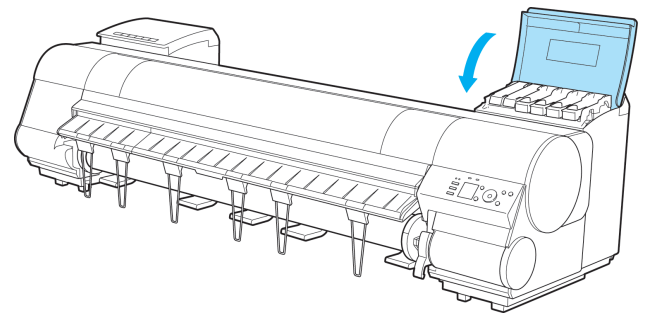

Important

- After Ink Tank replacement, always close the Ink Tank Cover. If the Ink Tank Cover cannot close, some Ink Tank Lock Lever may not be closed completely. Make sure all ink tank lock levers are fully closed.

Load the Ink Tank (700 ml)

- 1** Before opening the pouch, hold the new Ink Tank with both hands and tilt it to the left and right as shown, shaking gently it seven or eight times.

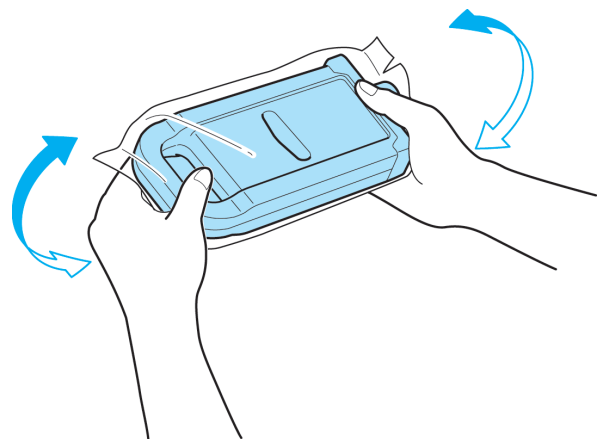

Caution

- 700 ml ink tanks are heavy, so use your whole arm to agitate it instead of just your wrist. If you agitate it using just your wrist, you may injure your wrist.



- Do not remove and agitate ink tanks that have already been installed in the printer. Ink may leak out.
- Important**
- If you do not agitate the Ink Tank, the ink may settle, which may affect printing quality.

2 Open the pouch and remove the Ink Tank.

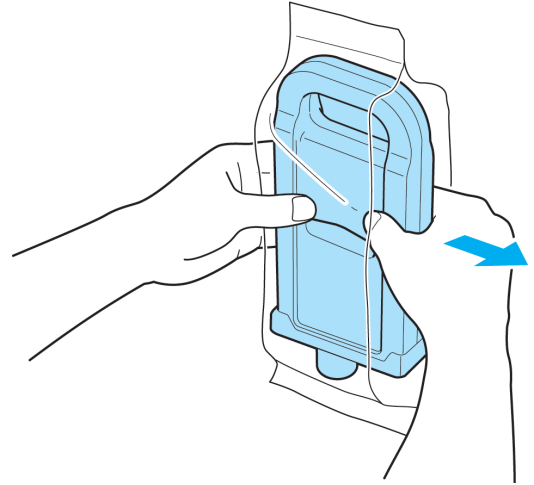

- Never touch the ink holes or electrical contacts. This may cause stains, damage the Ink Tank, and affect printing quality.
- Important**

3 Press the **OK** button and insert the Ink Tank into the holder facing as shown, with the ink holes down.

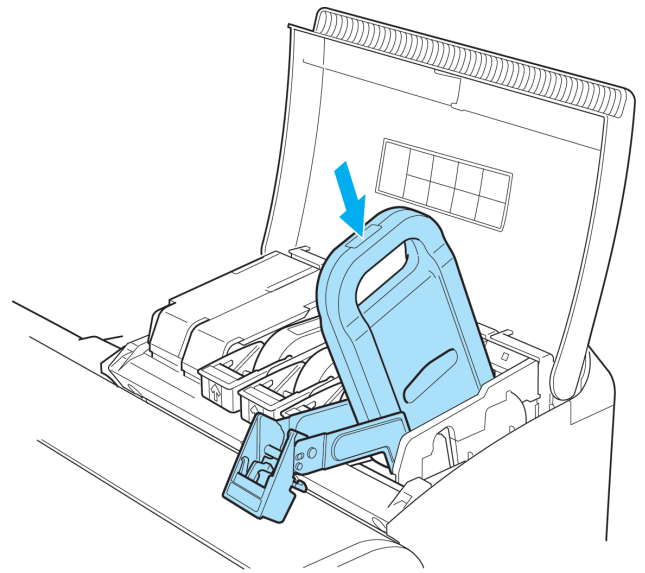

- Ink tanks cannot be loaded in the holder if the color or orientation is incorrect. If the Ink Tank does not fit in the holder, do not force it into the holder. Make sure the color of the Ink Tank Lock Lever matches the color of the Ink Tank, and check the orientation of the Ink Tank before reloading it.
- Important**

- 4** Lift the Ink Tank Lock Lever until it stops, and then push it down until it clicks into place.

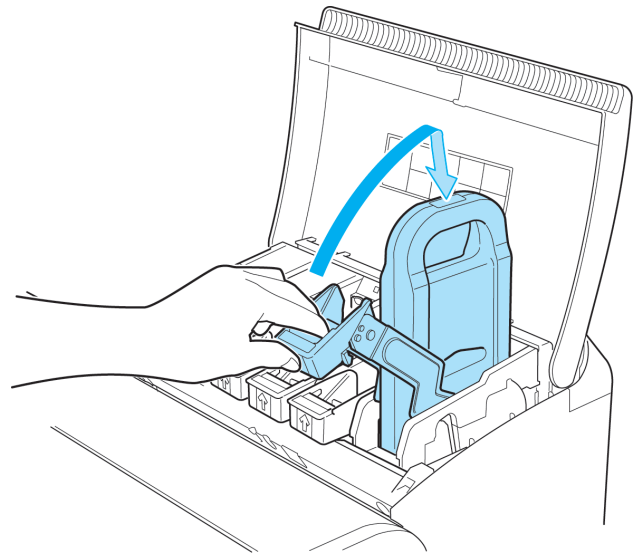

- 5** Make sure the Ink Lamp is lit in red.

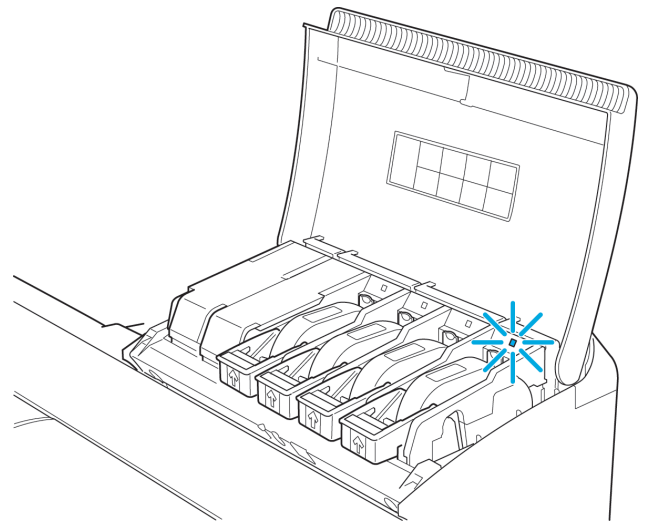

• If the Ink Lamp is not lit in red, reload the tank.

Note

- 6** Close the Ink Tank Cover.

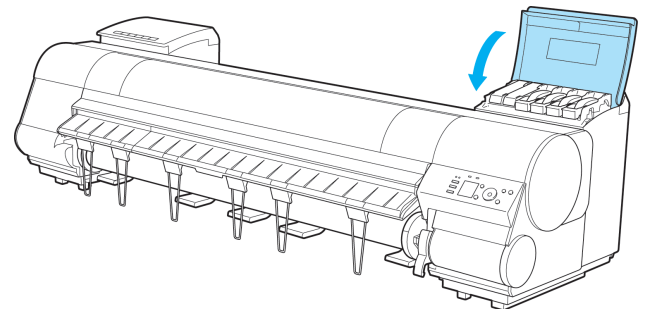



- After Ink Tank replacement, always close the Ink Tank Cover. If the Ink Tank Cover cannot close, some Ink Tank Lock Lever may not be closed completely. Make sure all ink tank lock levers are fully closed.
- To close the Ink Tank Cover when no Ink Tank is installed (as when moving the printer), push the release lever (a) as shown while returning the Ink Tank Lock Lever to the original position.

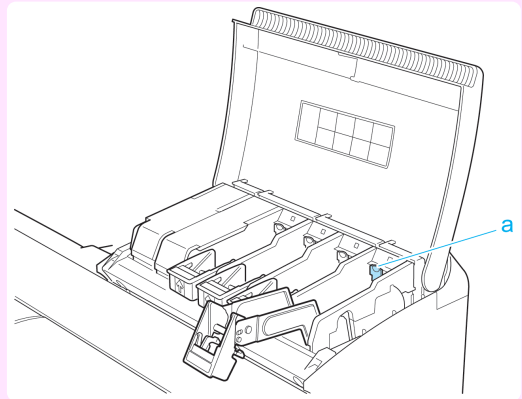

Checking Ink Tank Levels

On the Display Screen, you can check how much ink is left in the ink tanks. To check remaining Ink Tank levels, access the **Tab Selection screen** on the Control Panel and press ◀ or ▶ to select the Ink tab ().

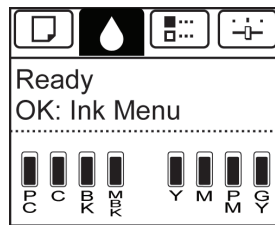

- If the **Tab Selection screen** is not displayed, press the **Menu** button.
- Note**
- If an error has occurred and the **Tab Selection screen** cannot be displayed, display **Ink Info** as follows.
 1. Press the **OK** button to display **Printer Info**.
 2. Press the ▲ or ▼ button to select **Ink Info**.
 3. Press the **OK** button.

The remaining ink levels shown on the Display Screen correspond to the inks identified by the Color Label on the bottom of the Display Screen. These symbols may be displayed above the ink level: ! if ink is low, × if no ink is left, and ? if you have deactivated ink level detection. The remaining ink level is indicated as shown below.

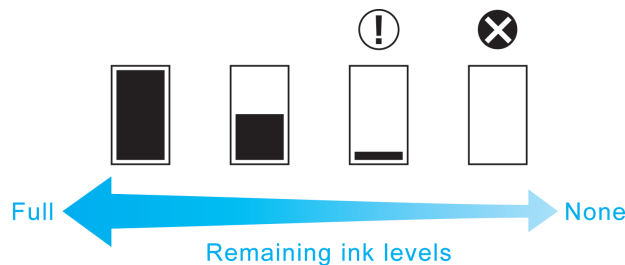

If the Display Screen indicates to replace the Ink Tank, replace the Ink Tank. If a message is displayed indicating to check the remaining ink levels, or after tasks that consume a lot of ink such as large-format printing or head cleaning, check the remaining levels and replace Ink Tank as needed. (See "Replacing Ink Tanks.") →P.834

When to Replace Ink Tanks

Replace or prepare to replace ink tanks in the following situations.

If a message for checking the ink is shown on the Display Screen

When there is little ink left, the **Message Lamp** is lit and **"Not much ink is left."** is shown on the Display Screen. You can continue to print, but prepare to replace the Ink Tank. (See "Checking Ink Tank Levels.") →P.844

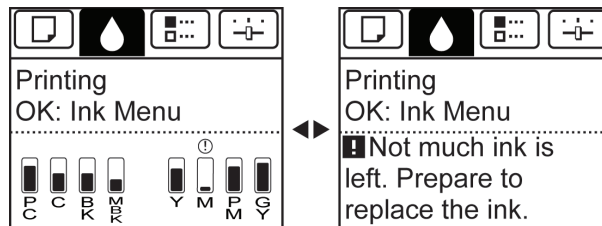

Before print jobs and maintenance that consume a lot of ink

If little ink is left, there may not be enough for large-format printing, head cleaning, and maintenance, which require a lot of ink. Replace or prepare to replace the Ink Tank.

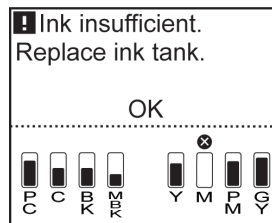

If a message for ink replacement is shown on the Display Screen

When ink runs out, the **Message Lamp** flashes, a message regarding Ink Tank replacement is shown on the Display Screen, and printing is disabled. Replace the Ink Tank at this point.

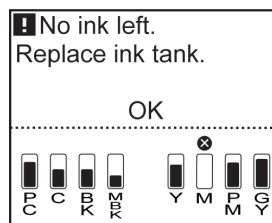

Printheads

Printhead 846

Checking for Nozzle Clogging 846

Cleaning the Printhead 847

Replacing the Printhead 848

Printhead

When purchasing, check the Model number.

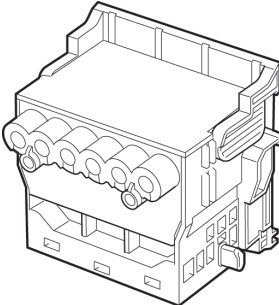
Shape	Model number
	<p>PF-05</p>



• For instructions on replacing the Printhead, see "Replacing the Printhead." →P.848

Note

Checking for Nozzle Clogging

If printing is faint or affected by banding in different colors, make sure the Printhead nozzles are clear by printing a test pattern to check the nozzles.



• Nozzles are periodically checked to ensure they are clear. Configure the settings on the Control Panel menu in **Nozzle Check**. (See "Menu Settings.") →P.675

Note

Paper to Prepare

When Using Rolls	An unused roll at least 254.0 mm (10.00 in) wide
When Using Sheets	One sheet of unused paper of at least A4/Letter size

1 Load paper.

- Attaching the Roll Holder to Rolls →P.538
- Loading Rolls in the Printer →P.541
- Loading Sheets in the Printer →P.563

2 On the **Tab Selection screen** of the Control Panel, press ◀ or ▶ to select the Settings/Adj. tab ().

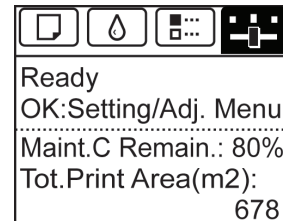

• If the **Tab Selection screen** is not displayed, press the **Menu** button.

Note

- 3** Press the **OK** button.
The **Set./Adj. Menu** is displayed.
- 4** Press **▲** or **▼** to select **Test Print**, and then press the **OK** button.
- 5** Press **▲** or **▼** to select **Nozzle Check**, and then press the **OK** button.
The printer now prints a test pattern for checking the nozzles.
- 6** Check the printing results.
If the horizontal lines are not faint or incomplete, the nozzles are clear.

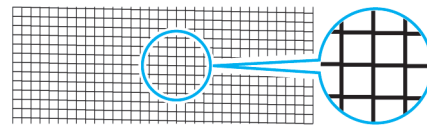

If some sections of the horizontal lines are faint or incomplete, the nozzles for those colors are clogged.

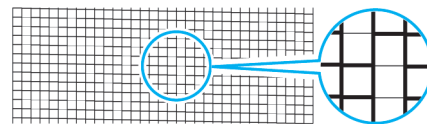

If horizontal lines are faint or incomplete, follow the steps below and check again for nozzle clogging.

- 1.** Clean the Printhead. (See "Cleaning the Printhead.") →P.847
- 2.** Print a test pattern to check the nozzles.



- If you repeat these steps several times but the horizontal lines are still faint or incomplete, contact your Canon dealer.

Cleaning the Printhead

If printing is faint, cleaning the Printhead may improve results.

Choose one of two Printhead cleaning modes (**Head Cleaning A** or **Head Cleaning B**), depending on the problem to resolve.

- **Head Cleaning A**

Use this mode if printing is faint or contains foreign substances. This method of cleaning consumes the least amount of ink.

It takes about four minutes to complete.

- **Head Cleaning B**

Use this mode if no ink is ejected at all, or if **Head Cleaning A** does not solve the problem.

It takes about five minutes to complete.



- Do not remove the Maintenance Cartridge or ink tanks during either **Head Cleaning A** or **Head Cleaning B**. Ink may leak or an error may occur.

- If printing does not improve even if you execute **Head Cleaning B**, try repeating **Head Cleaning B** once or twice. If this still does not improve printing, the Printhead may have reached the end of its useful life. Contact your Canon dealer for assistance.



- Nozzles are periodically checked to ensure they are clear. Configure the settings on the Control Panel menu in **Nozzle Check**. (See "Menu Settings.") →P.675

Perform cleaning as follows.

- 1 On the **Tab Selection screen** of the Control Panel, press ◀ or ▶ to select the Settings/Adj. tab ().

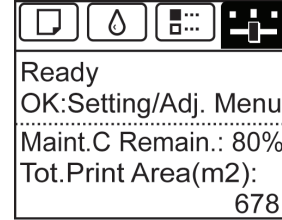

 • If the **Tab Selection screen** is not displayed, press the **Menu** button.
Note

- 2 Press the **OK** button.
The **Set./Adj. Menu** is displayed.
- 3 Press ▲ or ▼ to select **Maintenance**, and then press the **OK** button.
- 4 Press ▲ or ▼ to select **Head Cleaning**, and then press the **OK** button.
- 5 Press ▲ or ▼ to select **Head Cleaning A** or **Head Cleaning B**, and then press the **OK** button.
Head cleaning is now executed.
- 6 Print a test pattern to check the nozzles, and determine whether cleaning has cleared the nozzles. (See "Checking for Nozzle Clogging.") →P.846

Replacing the Printhead

When to replace the Printhead

This printer is equipped with two printheads.
Replace one or both printheads in the following situations.

- If the printing quality does not improve even after one or two cycles of **Head Cleaning B** from the printer menu
Replace any printheads with poor printing performance.
- If the Display Screen indicates "**Open top cover and replace the left printhead.**"
Replace the Printhead on the left side.
- If the Display Screen indicates "**Open top cover and replace the right printhead.**"
Replace the Printhead on the right side.
- If the Display Screen indicates "**Open top cover and replace the printhead.**"
Replace both printheads.
- If your Canon dealer has advised Printhead replacement
Replace the Printhead as directed.

Compatible printheads

For information on compatible printheads, see "Printhead." →P.846

Precautions when handling the Printhead

Take the following precautions when handling the Printhead.



Caution

- For safety, keep the Printhead out of the reach of children.
- If ink is accidentally ingested, contact a physician immediately.
- Do not touch the Printhead immediately after printing. The Printhead becomes extremely hot, and there is a risk of burns.



Important

- There may be ink around the nozzles of the Printhead you remove. Handle the Printhead carefully during replacement. The ink may stain clothing.
- Do not open the Printhead pouch until immediately before installation. After removing the Printhead from the pouch, install it right away. If the Printhead is left after the pouch is opened, the nozzles may dry out, which may affect printing quality.

Access the menu for Printhead replacement



Caution

- When replacing the Printhead immediately after printing, wait a few minutes before replacing it. The metal parts of the Printhead become hot during printing, and there is a risk of burns from touching these parts.



Important

- Your hands may become dirty during Printhead replacement. Use the gloves provided with the new Printhead for replacement.



Note

- Prepare a new Ink Tank when ink levels are low.
- When the remaining capacity of Maintenance cartridge is low, prepare a new Maintenance cartridge.

1 Remove any paper that has been advanced by selecting **Eject Paper** in the Control Panel menu.

- When using a roll, rewind it.
(See "Removing the Roll from the Printer.") →P.547
- When using sheets, remove the sheet.
(See "Removing Sheets.") →P.568

2 Clean inside the Top Cover. (See "Cleaning Inside the Top Cover.") →P.869

3 On the **Tab Selection screen** of the Control Panel, press ◀ or ▶ to select the Settings/Adj. tab ().



Note

- If the **Tab Selection screen** is not displayed, press the **Menu** button.

4 Press the **OK** button.
The **Set./Adj. Menu** is displayed.

5 Press ▲ or ▼ to select **Maintenance**, and then press the **OK** button.

6 Press ▲ or ▼ to select **Replace P.head**, and then press the **OK** button.

7 Press ▲ or ▼ to select the Printhead for replacement.
Select **Printhead L** when replacing the left printhead, **Printhead R** when replacing the right printhead, and **L & R Printheads** when replacing both. Make sure your selection is correct.

- Press the **OK** button.
Ink begins being drawn in. When it finishes, instructions are displayed on the Display Screen.
It takes about three minutes for ink to be drawn into the system.

Replace the Printhead

- Open the Top Cover.

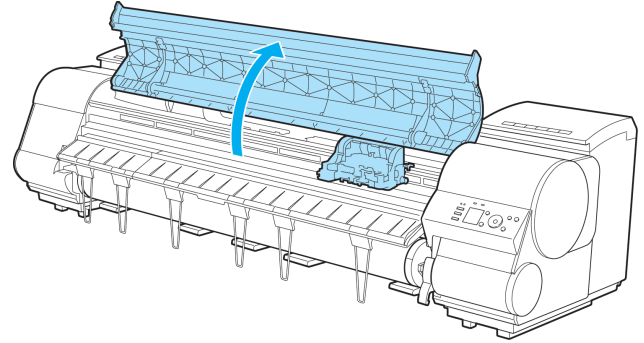

- If the Carriage Cover is dirty, use a damp cloth that you have wrung out completely to wipe it clean.

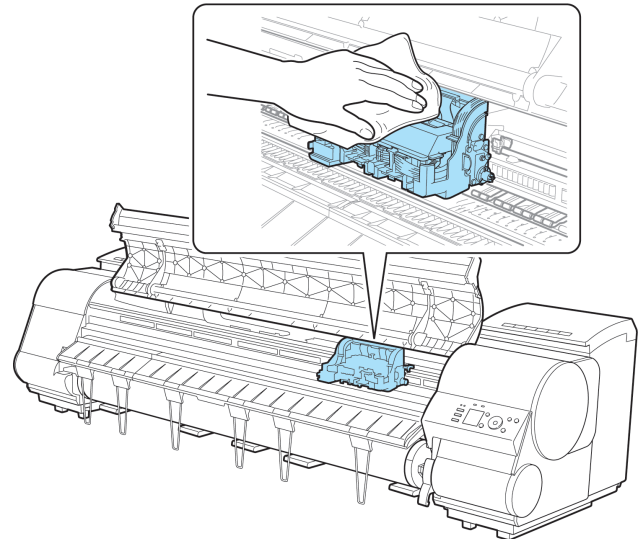



Important

- Do not touch the Linear Scale (a), Carriage Shaft (b), or Fixed Blade (c). This may stain your hands and damage the printer.

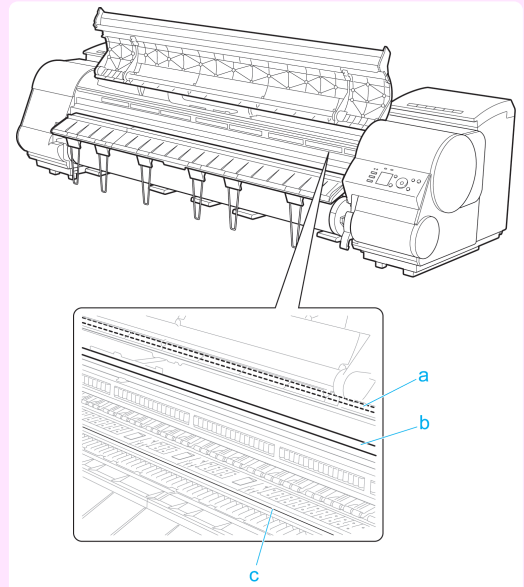

- Never touch the metal contacts of the Carriage. This may damage the printer.

3

If the ventilation duct (a) is dirty, use a damp cloth that you have wrung out completely to wipe it clean. If the Carriage is obscuring the ventilation duct, move the Carriage manually before cleaning the duct.

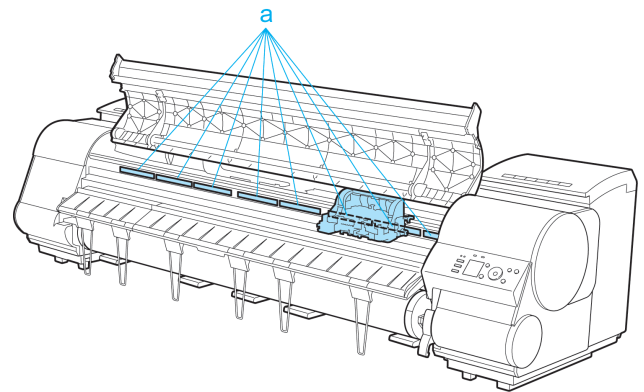

4

Pull up the Carriage Cover to open it completely.

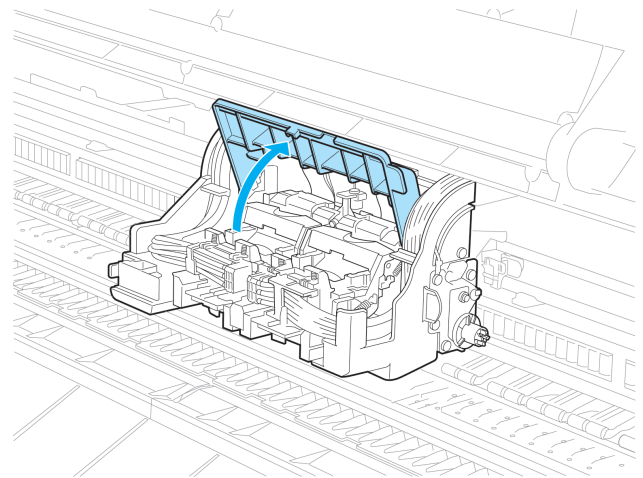

- 5** Pull the Printhead Fixer Lever forward all the way to open it completely.

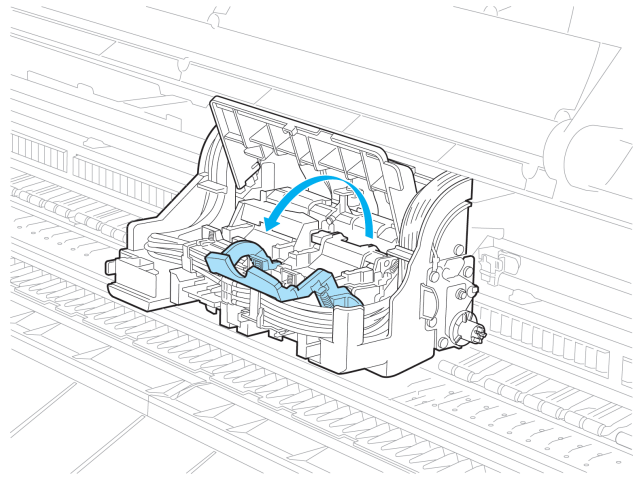

- 6** Pull up the Printhead Fixer Cover to open it completely.

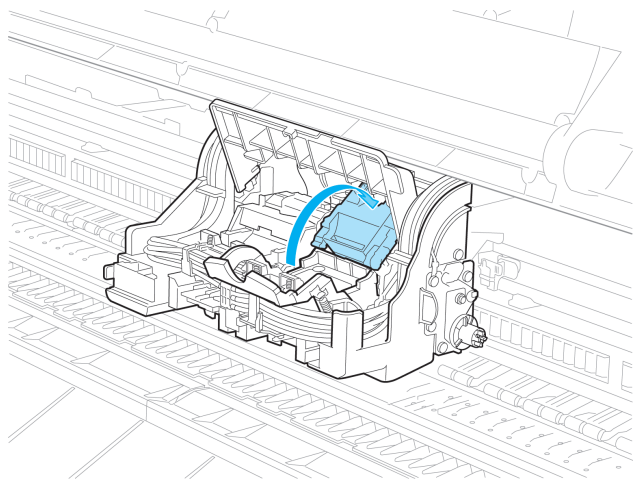

- 7** Remove the Printhead and press the **OK** button.

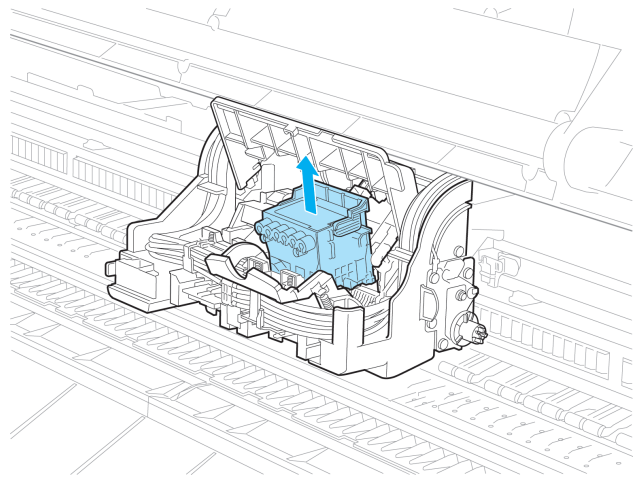

Note

- Dispose of the used Printhead in accordance with local regulations.

- 8** Holding the new Printhead by the grips (a), remove it from the pouch.

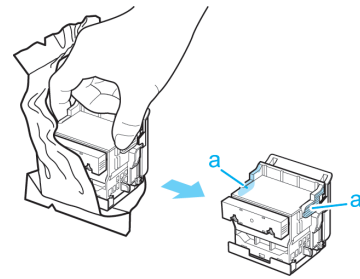

Important

- When handling the Printhead, always hold it by the grips (a). Never touch the nozzles (b) or metal contacts (c). This may damage the Printhead and affect printing quality.
- Never touch the ink supply section (d). This may cause printing problems.

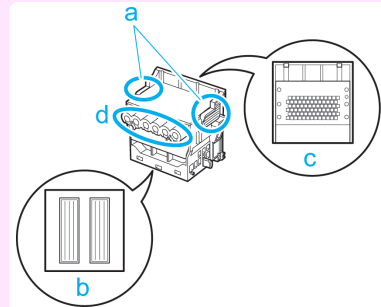

- 9** While firmly holding the Printhead you have removed, use your other hand to remove the orange Protective Part (a). Squeeze the grips (c) of Protective Part (b) and pull it down to remove it.

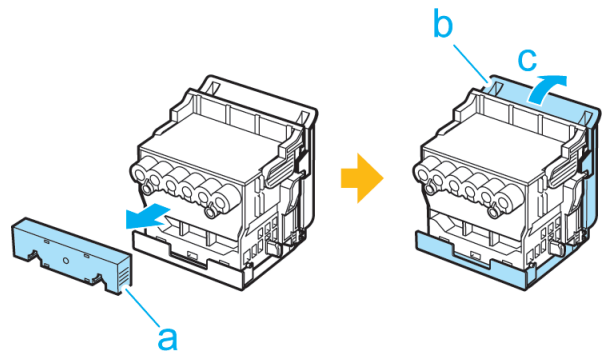

Important

- The inside surface of the Protective Part (a) and Protective Part (b) is coated with ink to protect the nozzles. Be careful not to touch these surfaces when removing the caps.
- The Printhead contains ink to protect the nozzles. We recommend removing Protective Part (b) as you hold it over the Printhead package or safely out of the way to avoid spilling ink and staining your clothes or the surrounding area. If ink accidentally spills, wipe off the ink with a dry cloth.
- If you need to put a Printhead somewhere temporarily before installation, do not keep the nozzles and metal contacts facing down. If the nozzles or metal contacts are damaged, it may affect the printing quality.
- Do not reattach the Protective Part or protective material. Dispose of these materials in accordance with local regulations.

- 10** With the nozzles facing down and the metal contacts toward the back, tilt the Printhead slightly forward and insert it into the Carriage. Carefully push the printhead firmly into the Carriage, ensuring that the nozzles and metal contacts do not touch the carriage.

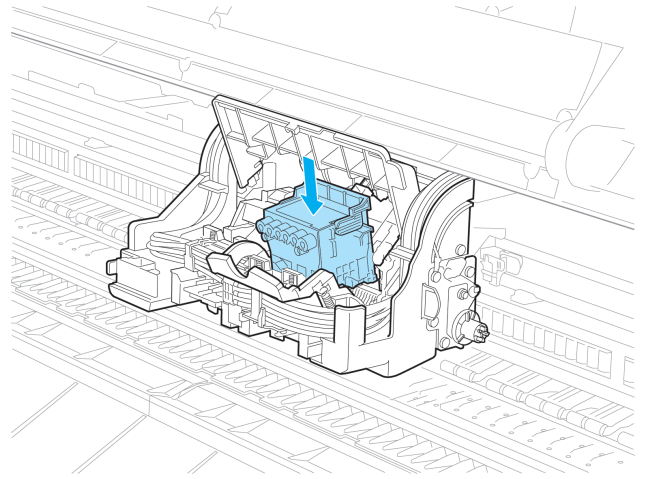

- 11** Pull the Printhead Fixer Cover down toward the front to lock the Printhead in place.

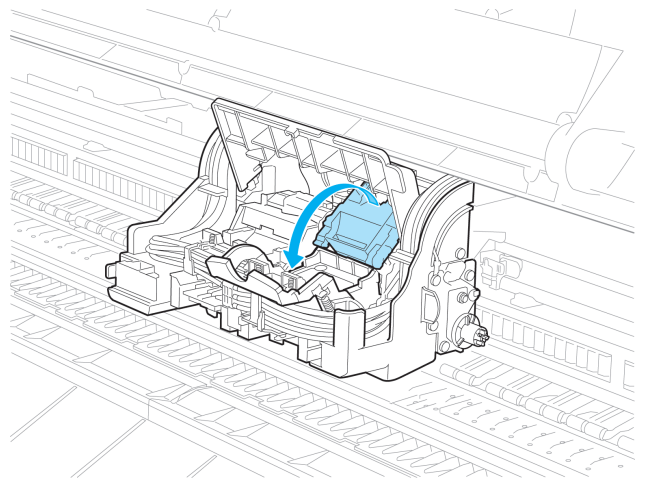

- 12** Push the Printhead Fixer Lever toward the back of the printer until it clicks.

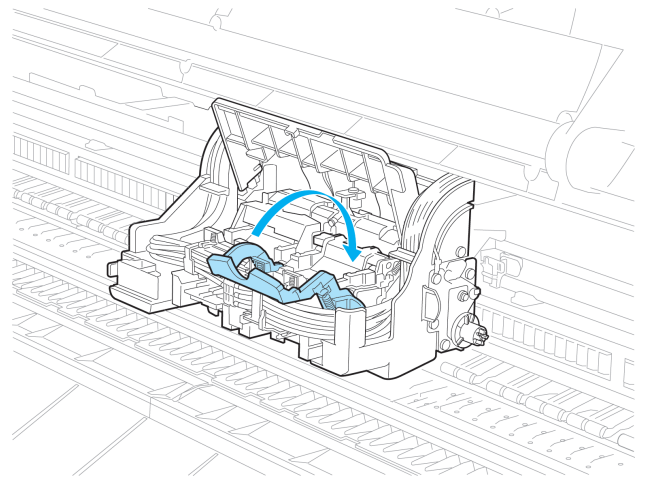

13 Push the Carriage Cover down toward the front.

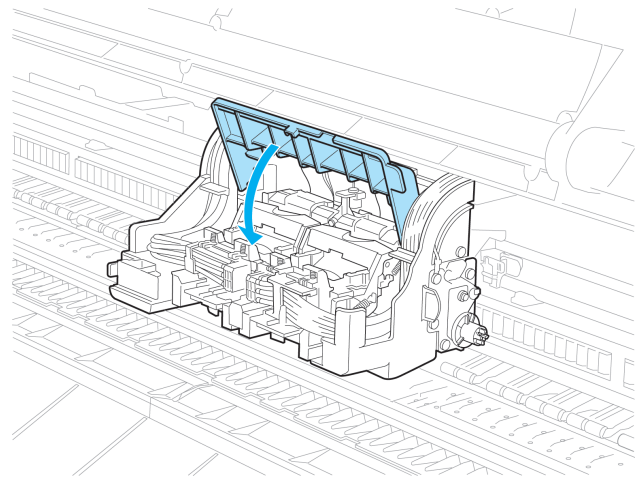

14 Close the Top Cover. Ink now fills the system. It takes about 13 minutes for ink to fill the system.

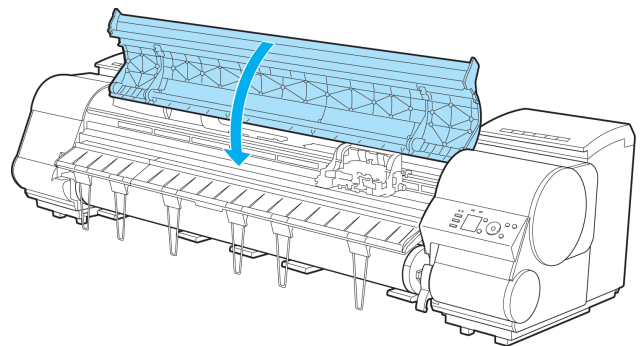

Important

- While ink is being filled, definitely do not remove the Ink Tank or Maintenance Cartridge. Ink may leak out.



Note

- The procedure is now finished if you have set **Rep.P.head Print** to **Off** in the Control Panel menu. In this case, execute **Initial adjustmt in Head Posi. Adj.** in the Control Panel menu. (See "Adjustment When Installing the Printhead.") →P.810

15 Feed paper by following the instructions on the Display Screen. After the paper has advanced, **Initial adjustmt in Head Posi. Adj.** is executed automatically.



Note

- When printing fine lines or text at high precision on glossy or semi-glossy photo or proofing paper, set the optimal Printhead height before aligning the printhead. (See "Enhancing Printing Quality.") →P.804

Cutter Unit

Cutter Unit	856
Replacing the Cutter Unit	856

Cutter Unit

When purchasing, check the Model number.

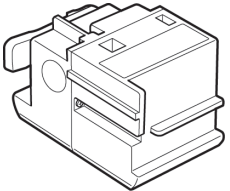
Shape	Model number
	CT-06



- For instructions on Cutter Unit replacement, see "Replacing the Cutter Unit." →P.856

Note

Replacing the Cutter Unit

Compatible Cutter Units

For information on compatible cutter units, see "Cutter Unit." →P.856

Access the menu for cutter unit replacement

- On the **Tab Selection screen** of the Control Panel, press ◀ or ▶ to select the Settings/Adj. tab ().

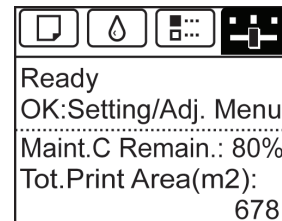

- If the **Tab Selection screen** is not displayed, press the **Menu** button.

Note

- Press the **OK** button.
The **Set./Adj. Menu** is displayed.
- Press ▲ or ▼ to select **Maintenance**, and then press the **OK** button.
- Press ▲ or ▼ to select **Change Cutter**, and then press the **OK** button.
The Carriage moves. When it finishes moving, instructions are displayed on the Display Screen.



- If you do not respond within two minutes, cutter cleaner replacement is canceled. In this case, repeat the procedure.

Note

Replacing the Cutter Unit

1 Open the Top Cover.

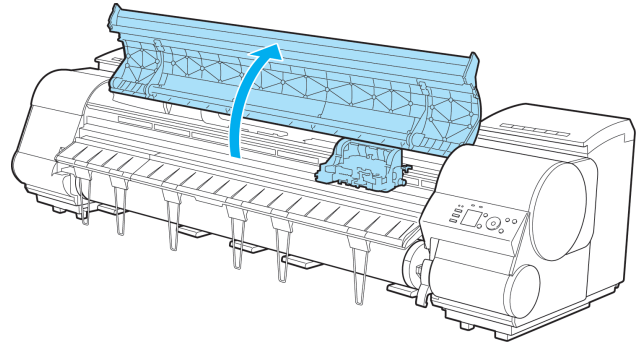

2 If the Cutter Unit or Carriage Cover is dirty, use a damp cloth that you have wrung out completely to wipe it clean.



Important

- Do not touch the Linear Scale (a), Carriage Shaft (b), or Fixed Blade (c). This may stain your hands and damage the printer.

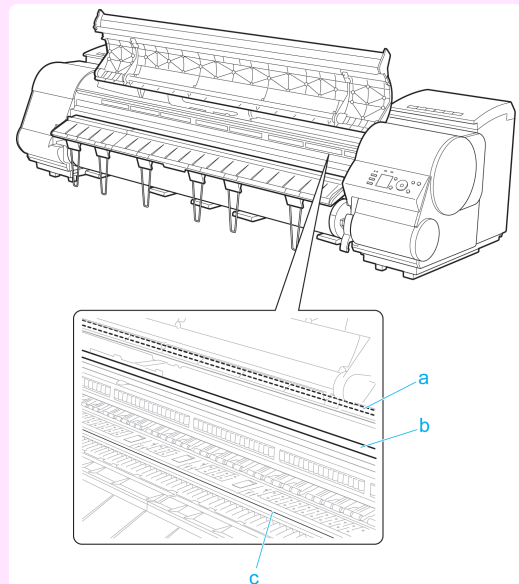

3 Push the Cutter Unit Detachment Lever to the left to unlock it.

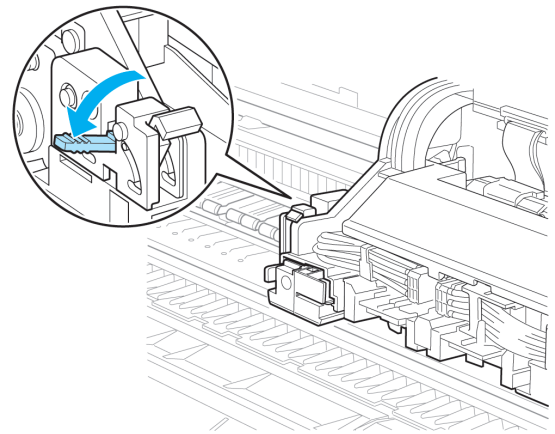

- 4** Holding the Cutter Unit by the Lock Lever (a) and grip (b), remove it from the Carriage.

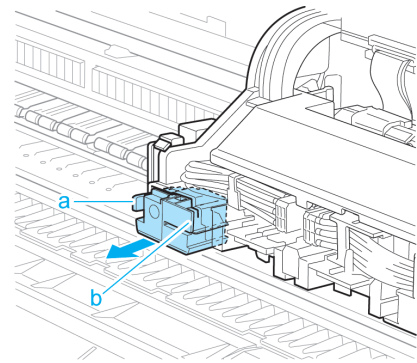

Caution

- Never touch any part of the Cutter Unit except the Lock Lever (a) and grip (b). This may stain your hands or cause injury. Additionally, this may damage the printer.
- Do not disassemble the Cutter Unit. Touching the blade may cause injury.



Note

- Dispose of the used Cutter Unit in accordance with local regulations.

- 5** Holding the new Cutter Unit by the Lock Lever (a) and grip (b), insert it on the Carriage until it clicks into place (c).



Important

- After installing the Cutter Unit, hold it only by the grip (b) and pull the Cutter Unit forward to make sure it does not come off. It may damage the printer if the Cutter Unit comes off.

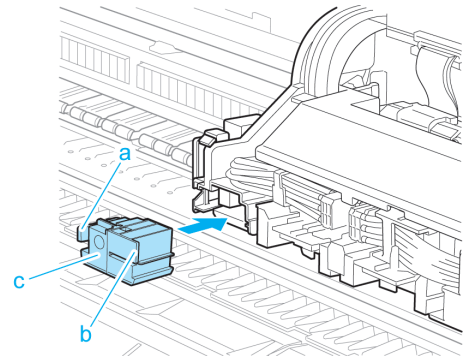

- 6** Lift the Cutter Unit Detachment Lever to lock it.

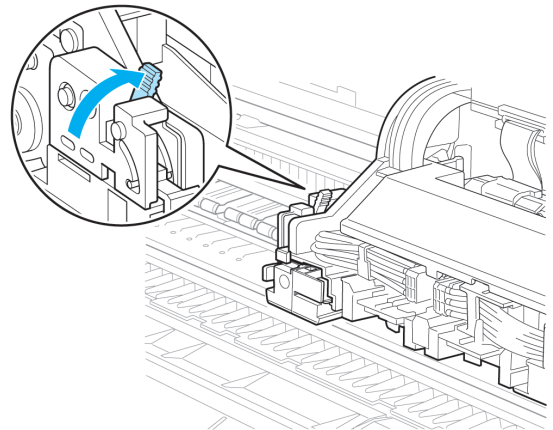

7 Close the Top Cover.

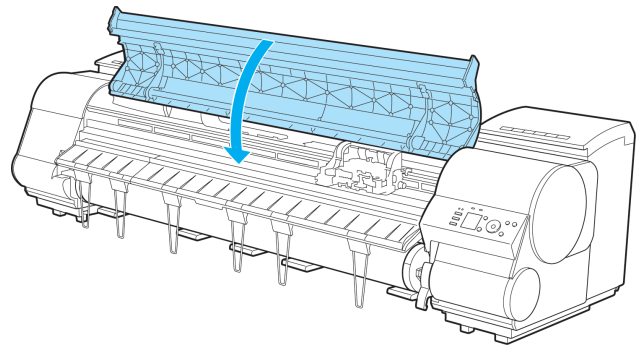

8 A confirmation message is displayed about the Cutter Unit lock. Press ▲ or ▼ to select "Yes", and then press the **OK** button.

9 The Carriage is moved, and a confirmation message is displayed about resetting the cut count. To reset the cut counter, press ▲ or ▼ to select **Yes**, and then press the **OK** button.

Maintenance Cartridge

Maintenance Cartridge	860
Replacing the Maintenance Cartridge	860
Checking the Remaining Maintenance Cartridge Capacity	867
When to Replace the Maintenance Cartridge	867

Maintenance Cartridge

When purchasing, check the Model number.
This Maintenance Cartridge comes with a Shaft Cleaner.

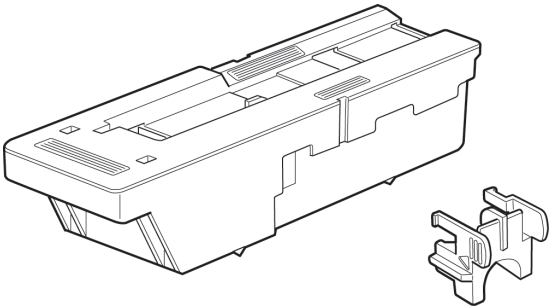
Shape	Model number
	MC-08



Note

- For instructions on replacing the Maintenance Cartridge and Shaft Cleaner, see "Replacing the Maintenance Cartridge."

→P.860

Replacing the Maintenance Cartridge

Compatible maintenance cartridges

For information on compatible maintenance cartridges, see "Maintenance Cartridge." →P.860

Precautions when handling the Maintenance Cartridge

Take the following precautions when handling the Maintenance Cartridge.



Caution

- For safety, keep the Maintenance Cartridge out of the reach of children.
- If ink is accidentally ingested, contact a physician immediately.



Important

- Do not remove the Maintenance Cartridge except to replace it. Ink may leak out.
- To prevent ink from leaking from a used Maintenance Cartridge, avoid dropping the cartridge or storing it at an angle. Otherwise, ink may leak and cause stains.
- Ink adheres to the top of the Maintenance Cartridge after it has been used. Handle the Maintenance Cartridge carefully during replacement. The ink may stain clothing.

Confirm the message

When the Maintenance Cartridge is almost empty, a message is shown on the Display Screen. According to the message, replace the Maintenance Cartridge or prepare a new Maintenance Cartridge. (See "When to Replace the Maintenance Cartridge.") →P.867

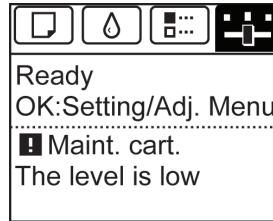

If a message is displayed requesting Maintenance Cartridge replacement, you can skip the step **Access the menu for Maintenance Cartridge replacement**. Follow the instructions in **Replace the Maintenance Cartridge**.

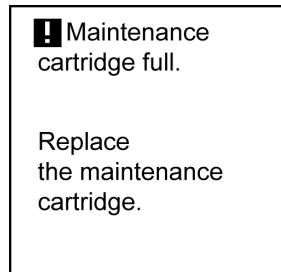

- Do not replace the Maintenance Cartridge during initialization immediately after turning on the printer, during Printhead cleaning, or when ink is being absorbed. Ink may leak out.

Access the menu for Maintenance Cartridge replacement

- 1 On the **Tab Selection screen** of the Control Panel, press ◀ or ▶ to select the Settings/Adj. tab ().

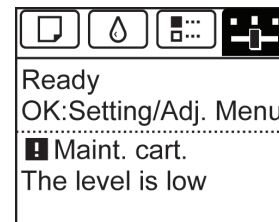

- If the **Tab Selection screen** is not displayed, press the **Menu** button.

- 2 Press the **OK** button.
The **Set./Adj. Menu** is displayed.
- 3 Press ▲ or ▼ to select **Maintenance**, and then press the **OK** button.
- 4 Press ▲ or ▼ to select **Repl. maint cart**, and then press the **OK** button.
Instructions are displayed on the Display Screen.

Replace the Maintenance Cartridge

- 1 Open the box, remove the plastic bag, packaging material, and Shaft Cleaner, and then take out the Maintenance Cartridge.

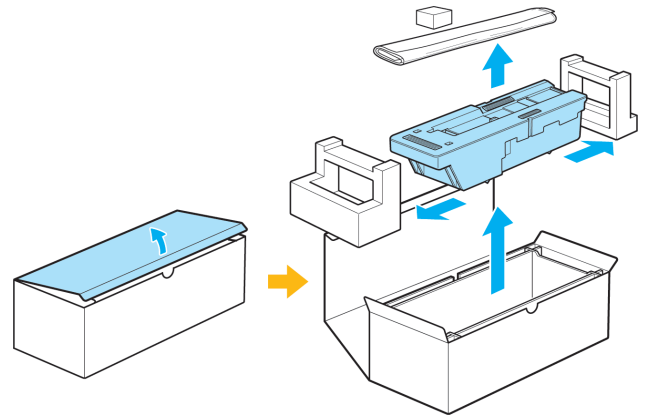

- Never touch the metal contacts (a). This may damage the Maintenance Cartridge.

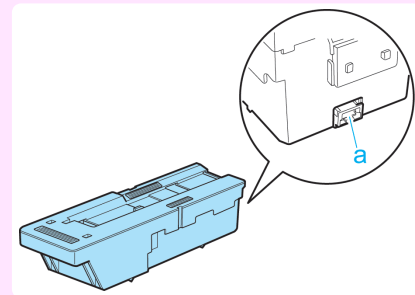

- 2 At this point, open the Maintenance Cartridge Cover.

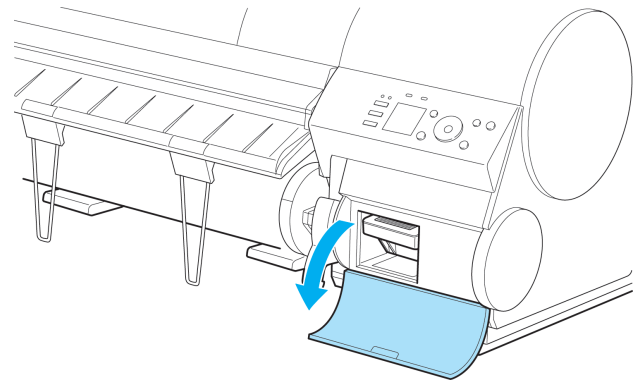

- 3 Hold the used Maintenance Cartridge by the grip (a) with one hand and put your other hand under the Maintenance Cartridge to hold it firmly on the bottom, keeping it level as you pull it out.

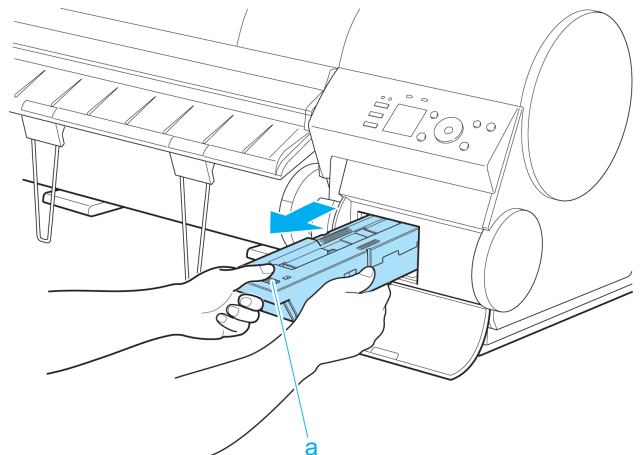



Important

- Used maintenance cartridges are heavy. Always grasp the cartridge firmly and keep the cartridge level during removal and storage. If you drop a used Maintenance Cartridge or store it at an angle, ink may leak and cause stains.
- The remaining Maintenance Cartridge capacity is recorded on each printer. Do not install a used Maintenance Cartridge in another printer.

- 4** Attach the packaging material to the used Maintenance Cartridge and put it in the box. Keep it level as you put it in the plastic bag. Expel excess air from the plastic bag and seal the zipper.

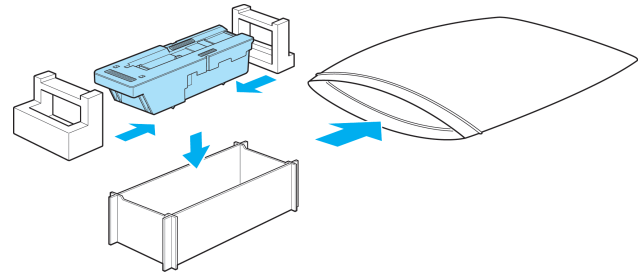

- 5** Confirm the Maintenance Cartridge is right-side up, put it in the box, and store it so that it stays level.

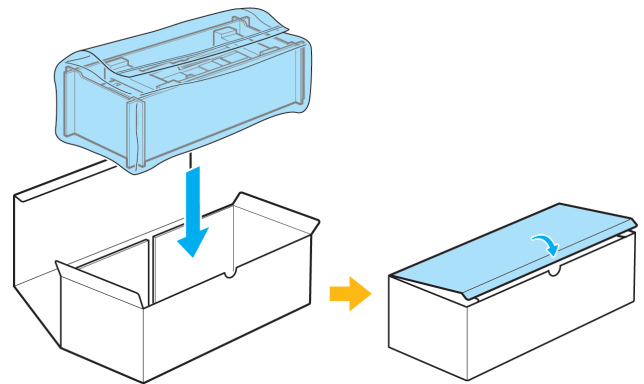

Important

- Always put the used Maintenance Cartridge back in the box and store the box on a flat surface. Otherwise, ink may leak and cause stains.



Note

- In accordance with active and ongoing environmental programs, Canon supports recycling of used maintenance cartridges. Follow the instructions provided with the new Maintenance Cartridge that describe how to process the used Maintenance Cartridge.

- 6** Wipe away any soiling on the Maintenance Cartridge Cover.

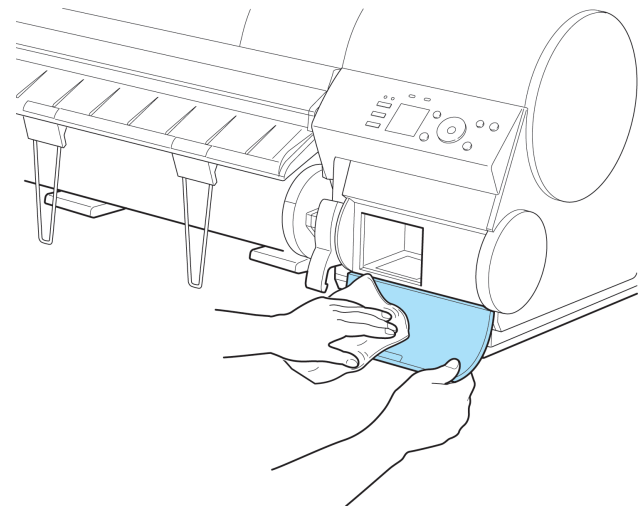

 • Support the Maintenance Cartridge Cover from underneath as you wipe it.
Important

7 Keeping the new Maintenance Cartridge level, insert it all the way in.

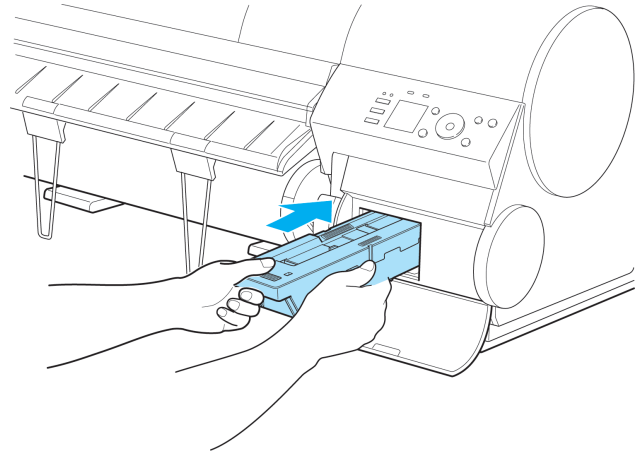

8 Close the Maintenance Cartridge Cover.

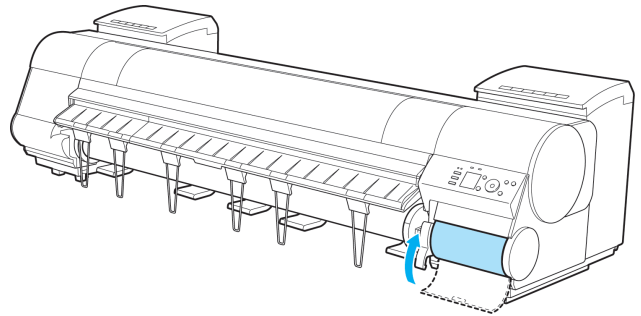

9 Press the **OK** button.
 The printer now initializes the Maintenance Cartridge. Next, replace the Shaft Cleaner.



Replacing the Shaft Cleaner

Replace the Shaft Cleaner when you replace the Maintenance Cartridge. New Shaft Cleaner is included with replacement Maintenance Cartridge.

Maintenance and Consumables

Maintenance Cartridge

After you execute **Repl. maint cart** and replace the Maintenance Cartridge, a message will appear on the Display Screen requesting you to replace the Shaft Cleaner. Select **Yes** and press the **OK** button. When a message requests you to open the Top Cover, go to step 5.

- 1 On the **Tab Selection screen** of the Control Panel, press ◀ or ▶ to select the Settings/Adj. tab ().

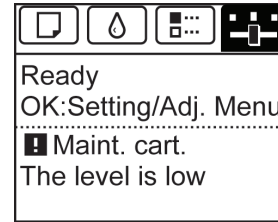

Note

- If the **Tab Selection screen** is not displayed, press the **Menu** button.

- 2 Press the **OK** button.
The **Set./Adj. Menu** is displayed.
- 3 Press ▲ or ▼ to select **Maintenance**, and then press the **OK** button.
- 4 Press ▲ or ▼ to select **Repl. S. Cleaner**, and then press the **OK** button.
The Carriage moves. When it finishes moving, instructions are displayed on the Display Screen.
- 5 Open the Top Cover.

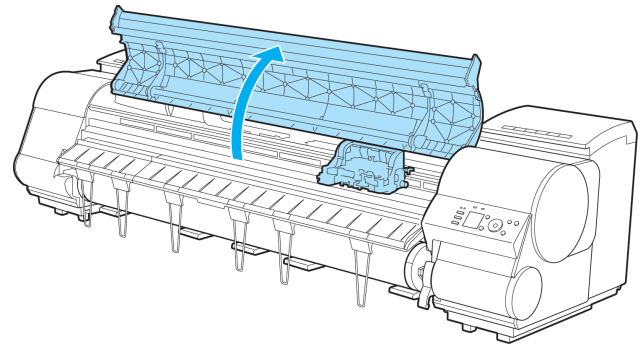

Note

- If you do not respond within two minutes, shaft cleaner replacement is canceled. In this case, repeat the procedure.

- 6 Hold the Shaft Cleaner on the right side of the Carriage by the grips (a) and pull it to the right to remove it.

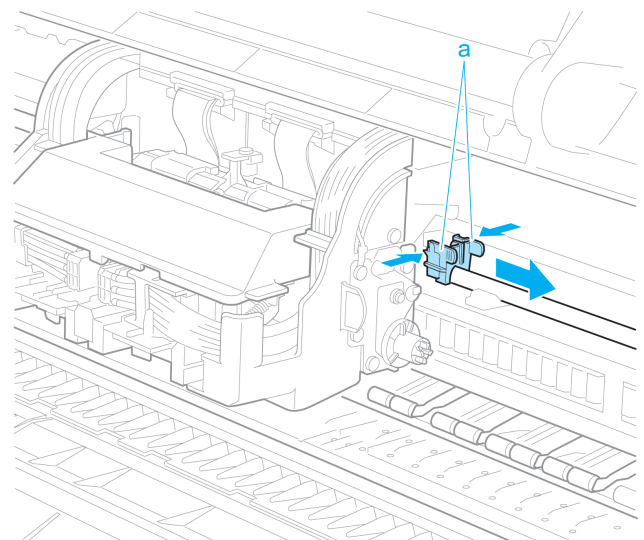



- Do not touch the Linear Scale (a), Carriage Shaft (b), or Fixed Blade (c). This may stain your hands and damage the printer.

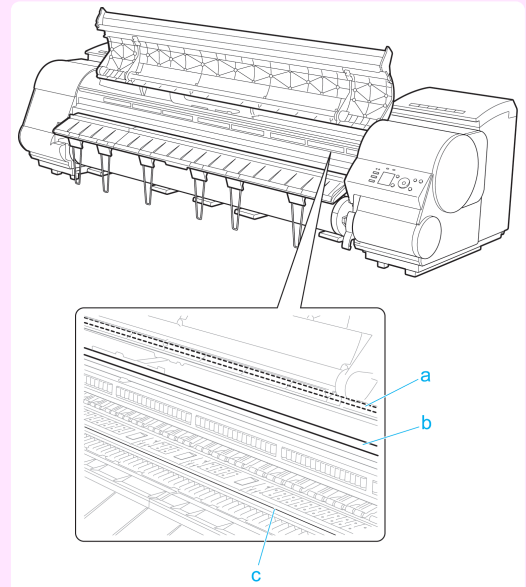

7

Holding the new Shaft Cleaner by the grips (a), attach it to the Carriage.

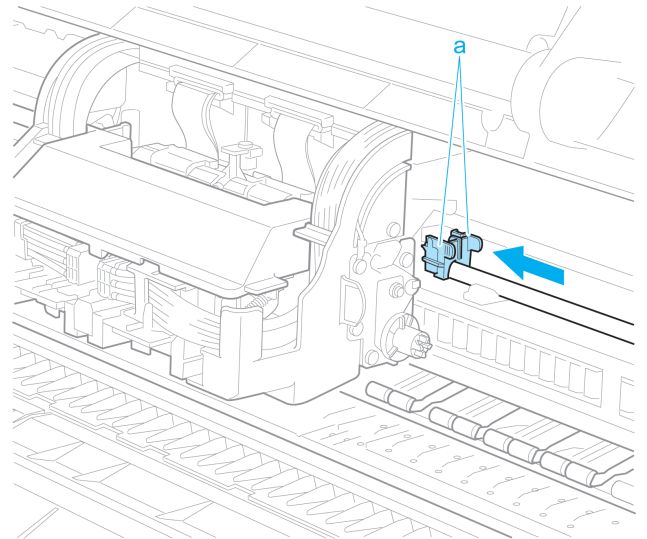

- Be sure to put the used Shaft Cleaner in the small box before putting it in the larger box with the used Maintenance Cartridge for disposal.

8

Close the Top Cover.
The Carriage moves back into position.

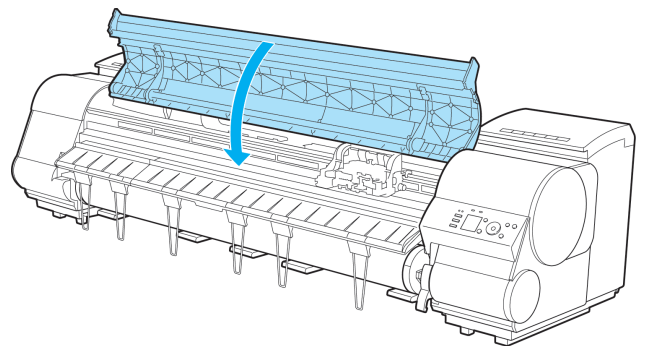

Checking the Remaining Maintenance Cartridge Capacity

The Maintenance Cartridge absorbs excess ink from borderless printing, printhead cleaning, and other processes. You can confirm the remaining capacity of the Maintenance Cartridge by checking the Maintenance Cartridge capacity shown on the Display Screen.

To check remaining Maintenance Cartridge capacity, access the **Tab Selection screen** on the Control Panel and press ◀ or ▶ to select the Settings/Adj. tab ().

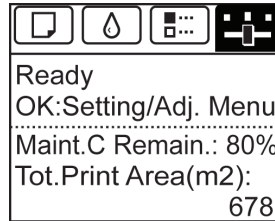

- If the **Tab Selection screen** is not displayed, press the **Menu** button.

Note

If the Display Screen indicates to replace the Maintenance Cartridge, replace the Maintenance Cartridge. If a message is displayed indicating to check the remaining capacity of the Maintenance Cartridge, or before tasks that deplete much of the capacity such as head cleaning or preparations to move the printer, check the remaining Maintenance Cartridge capacity and prepare a new Maintenance Cartridge as needed. (See "Replacing the Maintenance Cartridge.") →P.860

When to Replace the Maintenance Cartridge

Replace or prepare to replace the Maintenance Cartridge in the following situations.

If a message for checking the Maintenance Cartridge is shown on the Display Screen

When the Maintenance Cartridge is almost full, the **Message Lamp** is lit and "**The level is low**" is shown on the Display Screen. You can continue to print, but check the remaining Maintenance Cartridge capacity and prepare to replace the Maintenance Cartridge with a new one. (See "Checking the Remaining Maintenance Cartridge Capacity.")

→P.867

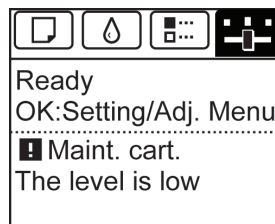

When much of the Maintenance Cartridge capacity is depleted

Printhead cleaning, Printhead replacement, and preparations to transfer the printer deplete much of the Maintenance Cartridge capacity. (In particular, preparing to move the printer depletes a lot of the capacity.) Check the remaining Maintenance Cartridge capacity before this maintenance and replace the Maintenance Cartridge if necessary.



If a message for the Maintenance Cartridge replacement is shown on the Display Screen

When the Maintenance Cartridge is almost empty, the **Message Lamp** lights, a message to replace the Maintenance Cartridge is displayed on the Display Screen, and you cannot print. Replace the Maintenance Cartridge with a new one.

 Maintenance cartridge full.

Replace the maintenance cartridge.

Cleaning the Printer

Cleaning the Printer Exterior	869
Cleaning Inside the Top Cover	869
Cleaning the Printhead	847

Cleaning the Printer Exterior

Clean the printer regularly to maintain better printing quality and help prevent problems. About once a month, clean the printer exterior.

1 Turn the printer off. (See "Turning the Printer On and Off.") →P.21

2 Unplug the power cord from the outlet.



Caution

- Always turn off the printer and unplug the power cord before cleaning or maintenance. Accidentally leaving the printer on poses a risk of injury if you touch moving parts inside the printer.

3 Using a damp cloth that you have wrung out completely, wipe away any dirt or paper dust from the Paper Feed Slot (a), power cord plug, and so on. Dry these parts with a dry cloth.

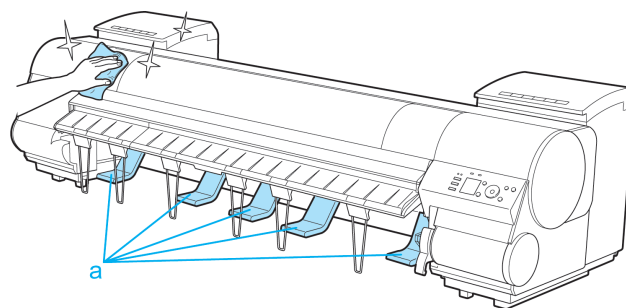

Warning

- Never use flammable solvents such as alcohol, benzene, or thinner. If these substances come into contact with electrical components inside the printer, there is a risk of fire or electrical shock.



Important

- If the Ejection Guide is dirty, it may soil the edge of the paper when the paper is cut. We recommend cleaning the Ejection Guide even if it does not appear dirty, because it may actually be covered with paper dust.

4 Plug the power cord into the outlet.

Cleaning Inside the Top Cover

Clean inside the Top Cover to maintain better printing quality and help prevent problems. Also clean inside the Top Cover in the following situations to ensure optimal operation.

- If the printed surface or the underside of paper is dirty after printing
- After you have used up a roll
- After borderless printing
- After printing on small paper
- After printing on paper that generates a lot of cutting debris
- If you have replaced the roll
- After printing on paper that generates a lot of paper dust
- If the message **"Blue platen switch is dirty."** is displayed



Important

- If the Platen inside the Top Cover becomes dirty, it may soil the underside of paper. We recommend cleaning the Platen after borderless printing or printing on small paper.
- If the Ejection Guide is dirty, it may soil the edge of the paper when the paper is cut. We recommend cleaning the Ejection Guide even if it does not appear dirty, because it may actually be covered with paper dust.

1 Open the Top Cover.

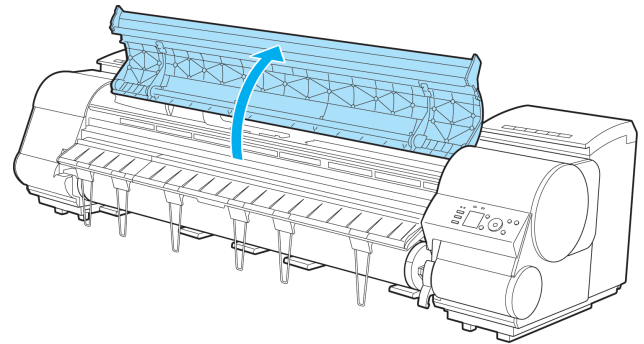

2 If paper dust has accumulated in the Vacuum holes (a) on the Platen, in the Borderless Printing Ink Grooves (b), or on the cutter guide (c), use the Cleaning Brush (d, provided with the printer) to wipe it away.

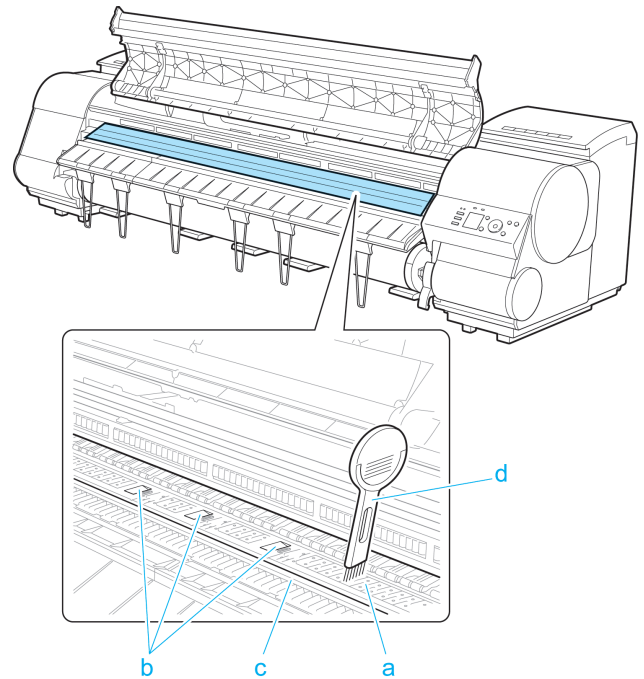

Note

- If the Cleaning Brush is dirty, rinse it in water.

- 3** Using a damp cloth that you have wrung out completely, wipe inside the Top Cover to clean it. Wipe away any ink residue and paper dust (debris from cutting) on the Top Cover Roller (a), all over the Platen (b), on the Paper Retainer (c), the Borderless Printing Ink Grooves (d), the Ejection Guide (e), the cutter guide (f), around the ink suction holes at left (g), around the Borderless Printing Ink Grooves at right (h), on the blue Switch (i), and so on.

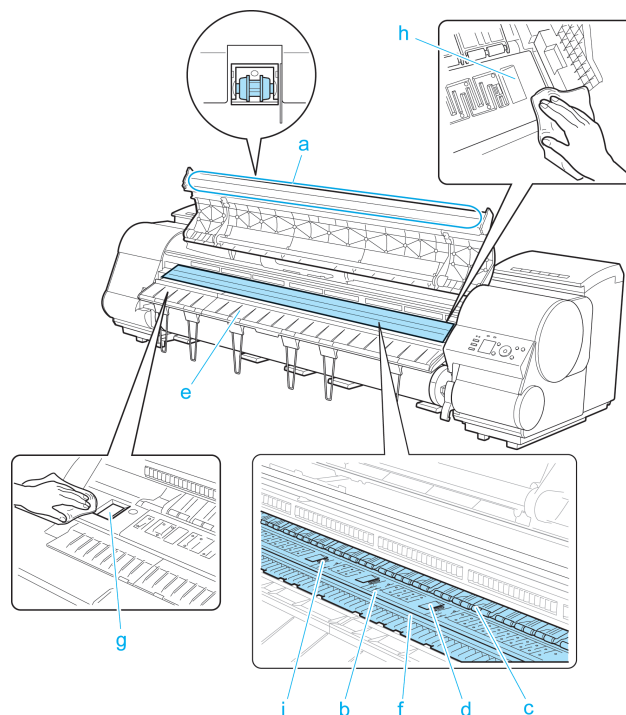

Warning

- Never use flammable solvents such as alcohol, benzene, or thinner. If these substances come into contact with electrical components inside the printer, there is a risk of fire or electrical shock.



Important

- Do not touch the Linear Scale (a), Carriage Shaft (b), or Fixed Blade (c). This may stain your hands and damage the printer.

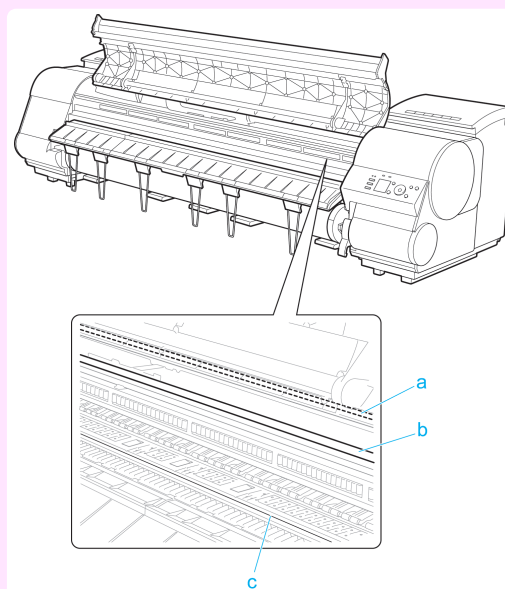

- Do not use a dry cloth to wipe inside the Top Cover. This may create a static charge, which may attract dust and affect the printing quality.
- Do not touch the clear sheet on the side of the Top Cover Roller. This may damage the roller.

4 Close the Top Cover.

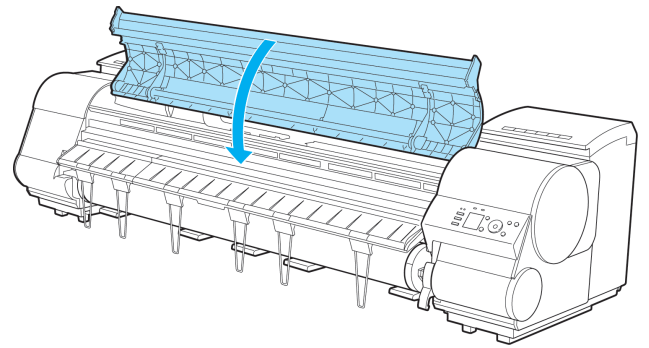

Other Maintenance

Preparing to Transfer the Printer 873
 Updating the Firmware 879

Preparing to Transfer the Printer

To protect the internal parts in transit, always follow these steps before transferring the printer to a new location. Refer to the Setup Guide for details on packing the printer and installing it after transfer.



- Be sure to contact your Canon dealer before transferring the printer to a new location. Ink may leak and damage the printer if you do not prepare the printer correctly and it is tipped or stood on end in transit.

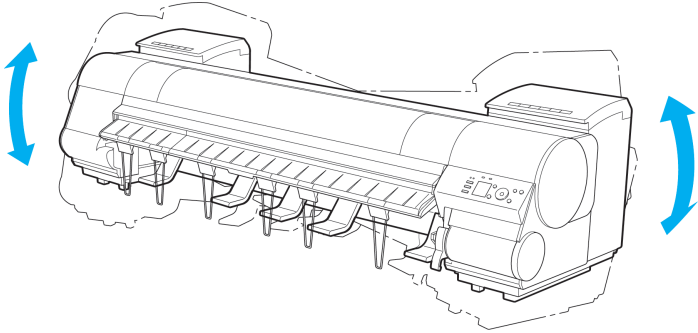
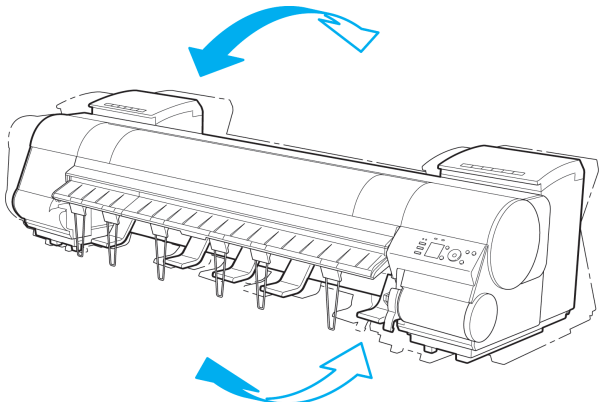

- Depending on the state of the printer, part replacement may be necessary when preparing to transfer the printer (that is, when you execute the printer menu item to prepare for transfer).
- Ink must be drawn into the Maintenance Cartridge before Level 2 or Level 3 printer transfer, as described in the following table. Prepare the Maintenance Cartridge in advance.
- Always follow the instructions of the service representative when transferring the printer under Level 3 conditions.

Level	Shipping Method (Example)	Permitted Angle of Inclination	Amount of Ink to Dispose of	Required Maintenance Cartridges(*1)
1	By truck	Lengthwise: 0–30°  Rotation: 0–10° 	0	0(*2)
2	By plane	All directions: 0–30°	Approx. 1,900 ml (64.3 fl oz)	2 or 3

Level	Shipping Method (Example)	Permitted Angle of Inclination	Amount of Ink to Dispose of	Required Maintenance Cartridges(*1)
3	Tipping the printer or holding it upright for elevators or stairs	Lengthwise: 0–90° Rotation: 0–30°	Approx. 1,900 ml (64.3 fl oz)	2 or 3

*1: This is the number of new Maintenance Cartridges required when you execute the **Prep.MovePrinter** menu. The number varies depending on the amount remaining in the Maintenance Cartridge being used.

*2: If a message instructing you to replace the Maintenance Cartridge is displayed on the Display Screen, the Maintenance Cartridge needs to be replaced.

Remove paper

1 Remove the paper.

- Rolls (See "Removing the Roll from the Printer.") →P.547
- Sheets (See "Removing Sheets.") →P.568

Access the **Prep.MovePrinter** menu

1 If a message instructing you to replace the Maintenance Cartridge is displayed on the Display Screen, replace the Maintenance Cartridge.
(See "Replacing the Maintenance Cartridge.") →P.860

2 On the **Tab Selection screen** of the Control Panel, press ◀ or ▶ to select the Settings/Adj. tab ().

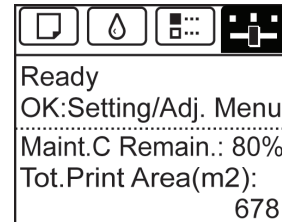

 **Note** • If the **Tab Selection screen** is not displayed, press the **Menu** button.

3 Press the **OK** button.
The **Set./Adj. Menu** is displayed.

4 Press ▲ or ▼ to select **Prep.MovePrinter**, and then press the **OK** button.

5 Press ▲ or ▼ to select the level of transfer, and then press the **OK** button.

6 Press ▲ or ▼ to select **Execute**, and then press the **OK** button to display the confirmation screen.

7 Press ▲ or ▼ to select **Yes**, and then press the **OK** button.
The printer is now prepared for transfer.

- **Level 1**
Once preparations are finished, a message on the Display Screen requests you to turn off the printer. Turn off and pack the printer. There is no need to remove the ink tanks.
(See "Pack the printer.") →P.877
- **Level 2 and Level 3**

When the preparation is finished, instructions are displayed on the Display Screen.
 Remove the ink tanks before packing the printer.
 (See "Removing Ink Tanks.") →P.875



- If consumables must be replaced, the message "**Consumables must be replaced. Call for service.**" is shown on the Display Screen and preparation is not possible. If this message is displayed, press the **OK** button and contact your Canon dealer for assistance.

Removing Ink Tanks

- 1 Open the left and right ink tank covers.

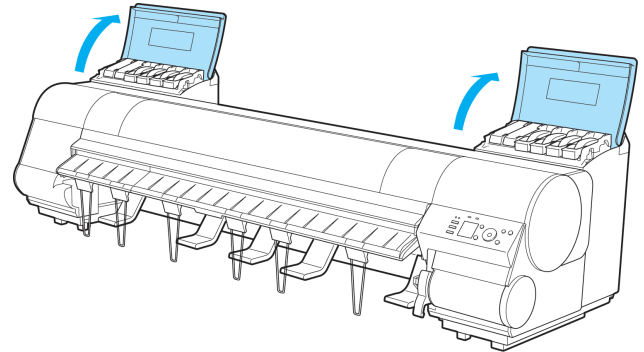

- 2 Lift the stopper (a) of the Ink Tank Lock Lever (a). Lift the Ink Tank Lock Lever until it stops, and then push it down to the front.

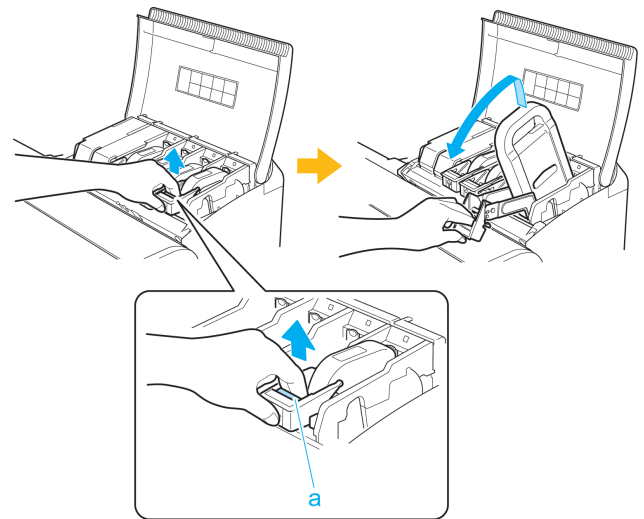

- 3** Hold the Ink Tank by the handle (a) and remove it.

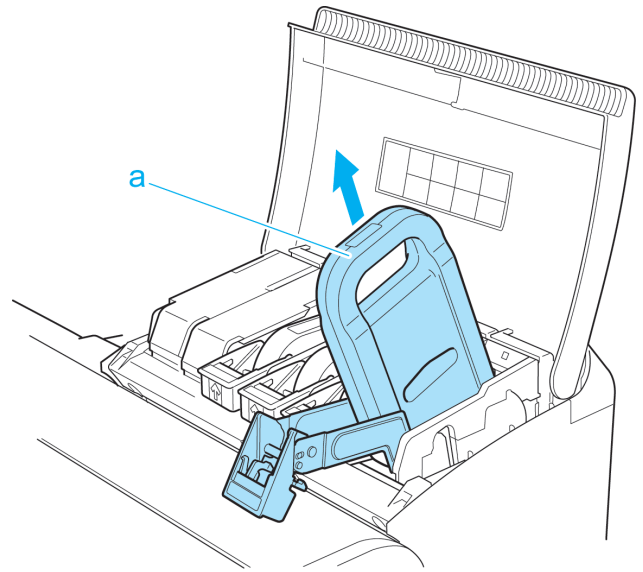

Important

- Store the Ink Tank you removed in the box with the ink holes (a) facing up. Otherwise, ink may leak and cause stains.

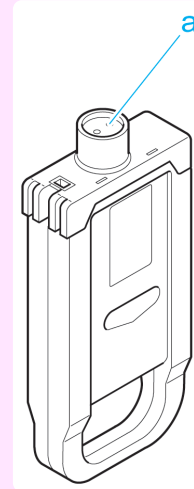

- 4** Repeat steps 2 and 3 to remove all ink tanks.

- 5** Push down the release lever (a) as shown as you gently return all ink tank lock levers to the original position.

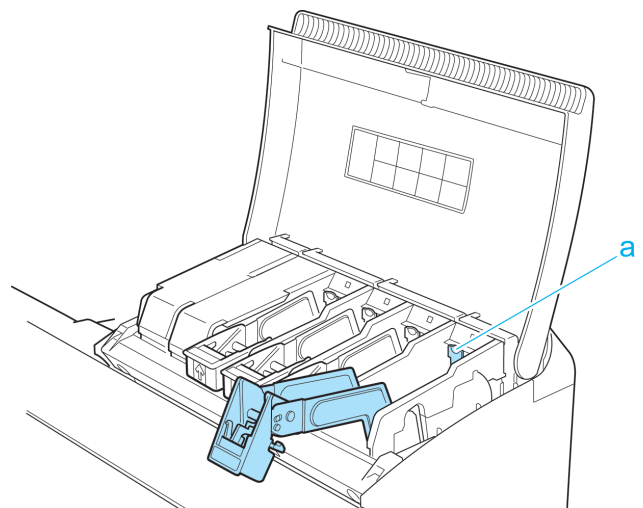

- 6** Close the Ink Tank Cover.
At this point, ink is drawn out from inside the tubes.

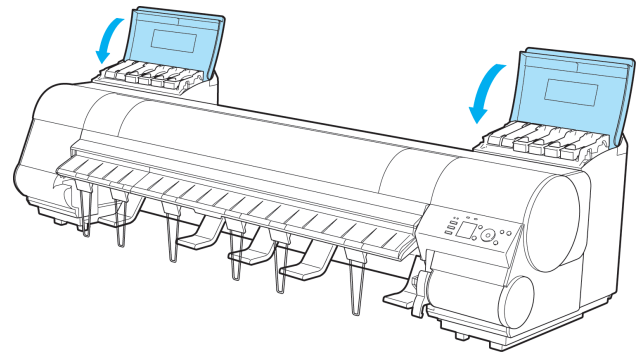

- Do not remove the Maintenance Cartridge except when the message for replacing it is displayed. If you remove the Maintenance Cartridge while ink is being drawn out, the ink may leak out.

- 7** When the process is finished, "**Preparations for moving the printer finished. Turn the power off**" is displayed. When this happens, replace the Maintenance Cartridge currently being used with a new Maintenance Cartridge.

- 8** Press the **Power** button and turn off the printer.



Pack the printer

- 1** Disconnect the printer power cord and interface cable, as well as the Media Take-up Unit Power Inlet.



- Turn the power off and then disconnect the power cord. It may damage the printer if you unplug it before it is off and transfer it in that state. If you accidentally unplug the printer, plug it in again, reinstall the ink tanks, and follow this procedure again.

- 2** Open the Top Cover and lift the Ejection Guide.

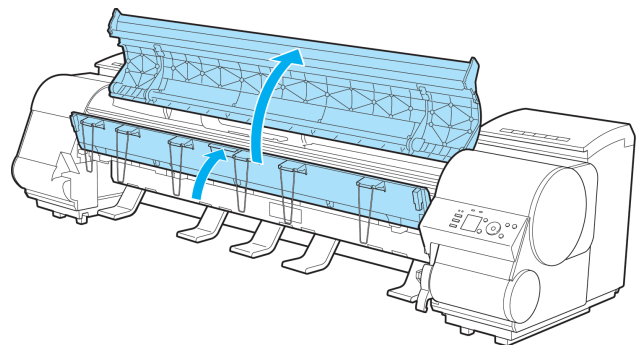

- 3** Remove the six Ejection Supports and lower the Ejection Guide.

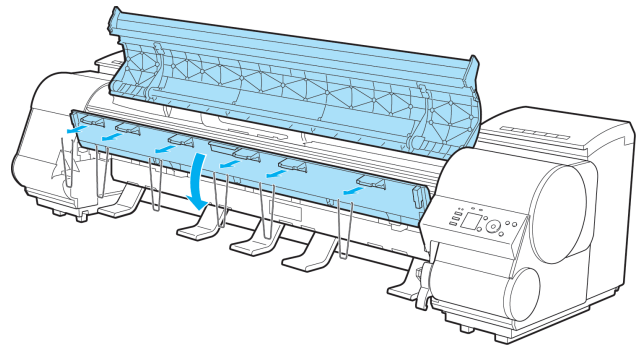

- 4** Grasp the Belt, insert it between the Belt Stopper, and affix the Belt Stopper with a hex screw at the position indicated.

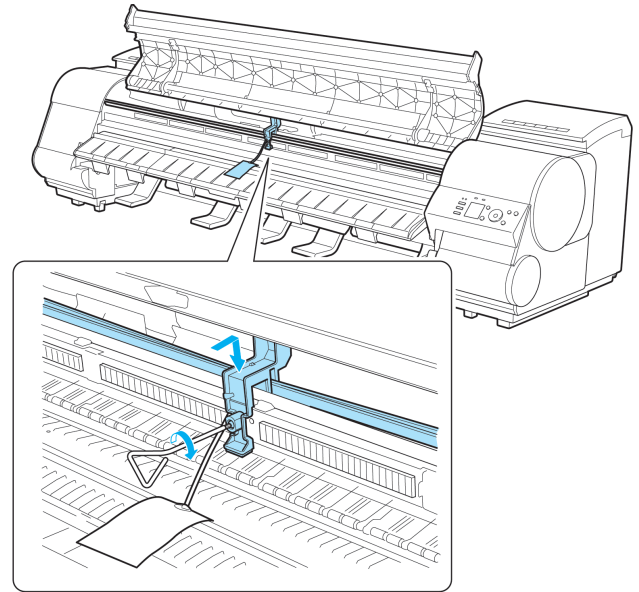

Important

- Here, the Belt Stopper is the one that was removed and stored after initial installation. Neglecting to attach the Belt Stopper may damage the printer.
- Do not touch the Linear Scale (a), Carriage Shaft (b), or Fixed Blade (c). This may stain your hands and damage the printer.

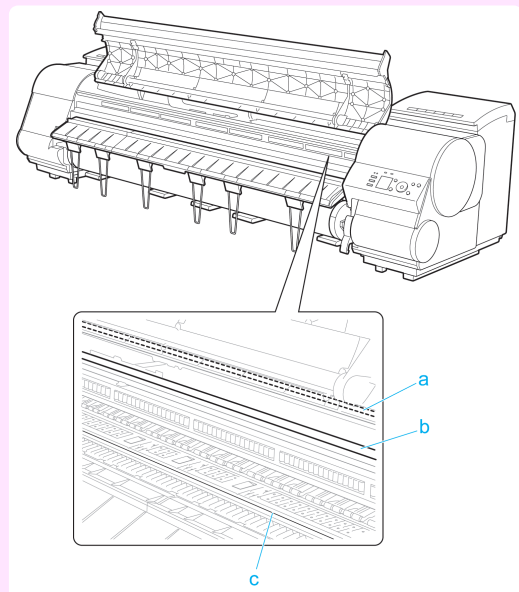

- 5** Close the Top Cover.

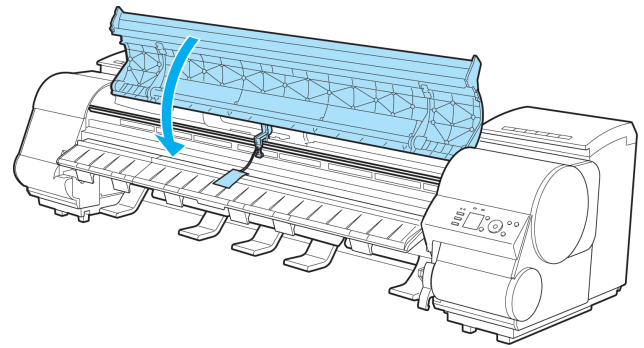

- 6** Tape down printer covers to secure them, in the reverse order of tape removal during installation.
- 7** If the Output Stacker is installed, reverse the installation procedure to remove the Output Stacker.
- 8** Remove the Stand by reversing the installation procedure, when it was attached to the printer.
- 9** Disassemble and repackage the Stand by following the installation procedure (with six people lifting the printer) in reverse.



- Do not use the procedure for rotated installation (installing by rotating the printer). This may damage the printer. For details, see Setup Guide.

- 10** Repack the Roll Holder, Holder Stopper, and printer in shipping materials, and then package them in a shipping box.

Updating the Firmware

Update the printer firmware to take advantage of new and improved printer functions.

Confirming the firmware version

- 1** On the **Tab Selection screen** of the Control Panel, press ◀ or ▶ to select the **Settings/Adj. tab** ().

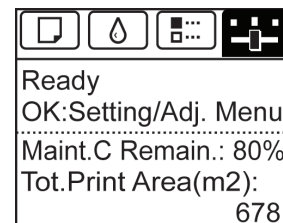

- If the **Tab Selection screen** is not displayed, press the **Menu** button.

- 2** Press the **OK** button.
The **Set./Adj. Menu** is displayed.
- 3** Press ▲ or ▼ to select **Printer Info**, and then press the **OK** button.
- 4** Press ▲ or ▼ to select **System Info**, and then press the **OK** button.
The firmware version is displayed.

Updating the Firmware

To obtain the latest firmware, visit the Canon website. If the firmware available online is newer than the installed firmware, update the printer firmware. For details on downloading and updating the firmware, visit the Canon website.

Consumables

Ink Tanks	834
Printhead	846
Cutter Unit	856
Maintenance Cartridge	860

Memo

Basic Printing Workflow	19
Enhanced Printing Options	35
Windows Software	177
Mac OS X Software	363
Handling and Use of Paper	529
Control Panel	655
Printer Parts	691
Network Setting	707
Print Job Management	741
Adjustments for Better Print Quality	803
Color Management	821
Maintenance and Consumables	833

Troubleshooting

Frequently Asked Questions	884
Problems Regarding Paper	886
Printing does not start	894
The printer stops during a print job	895
Problems with the printing quality	896
Cannot print over a network	907
Installation problems	909
Other problems	911

Error Message	915
Specifications	941
Appendix	945

Frequently Asked Questions

Frequently Asked Questions

This section presents frequently asked questions and answers. To view more detailed explanations, click the hyperlinks in the answer column.

Question	Answer
I want to easily create vertical or horizontal banners.	You can print originals that are in landscape (or portrait) orientation automatically enlarged to fit the roll width. This is an easy way to create vertical or horizontal banners. (See "Printing Vertical or Horizontal Banners (Large-Format Printing).") →P.114
Does this printer support sub-ink tank system?	This printer supports sub-ink tank system. Even if an ink tank becomes empty during printing, since a certain amount of ink always is stored in a sub-ink tank, you can replace the ink tank while printing. (See "Replacing Ink Tanks.") →P.834
I want to know how to configure roll cutting.	You can select the cutting method by the setting of the printer driver and the setting of the printer. To cut rolls automatically after printing, set Cutting Mode of the printer to Automatic and Automatic Cutting of the printer driver to Yes . When using paper for which ink adhesion takes time or the print surface is easily scratched, we recommend that you set the Cutting Mode setting of the printer to Eject . (See "Specifying the Cutting Method for Rolls.") →P.554 (See "Cutting Roll Paper After Printing.") →P.173
I want to configure so that the roll is cut automatically after waiting for the ink to dry.	In the printer driver, you can set the time for waiting until the ink dries. Also, you can set likewise on the printer. (See "Specifying the Ink Drying Time for Rolls.") →P.552 (See "Menu Structure.") →P.669
How do I print without borders?	When printing on rolls, you can perform borderless printing by configuring the printer driver. (when printing on cut sheets, you cannot perform borderless printing) (See "Borderless Printing on Paper of Equivalent Size.") →P.101 (See "Borderless Printing by Resizing Originals to Fit the Roll Width.") →P.107 (See "Borderless Printing at Actual Size.") →P.95
I want to know the paper types that can be used in this printer.	Concerning the paper that can be used in this printer, refer to the imagePROGRAF home page or the Paper Reference Guide. (See "Types of Paper.") →P.530
The paper type that I want to print is not displayed on the Display Screen.	When using newly released paper, paper information must be registered on the printer and the printer driver. Download the new version of Media Information File from the imagePROGRAF website and install it. (See "Types of Paper.") →P.530
What type of function is color calibration?	Color calibration improves color consistency by compensating for slight differences in how color appears when printing due to individual variations or aging among the printers. We recommend color calibration in the following situations. <ul style="list-style-type: none"> • After initial printer installation • After Printhead replacement • When you sense a change of color compared to previously • To print with colors aligned from multiple printers • When the execution guide is displayed (See "Corrects slight differences in how colors appear (color calibration).") →P.828
Can I perform duplex printing?	This printer cannot perform duplex printing. If you use the Folded Duplex function in the Free Layout of Windows software, you can print two pages one-sided, fold them at the center and suspend them to substitute for duplex printing. (See "Prints using Folded Duplex (Windows).") →P.245
I want to perform enlargement printing.	With the printer driver, you can specify the ratio matching the document with the paper size and width and perform enlargement printing or reduction printing. (See "Resizing Originals to Match the Paper Size.") →P.74

Question	Answer
I want to perform enlargement printing.	(See "Resizing Originals to Fit the Roll Width.") →P.78 (See "Resizing Originals by Entering a Scaling Value.") →P.84

Problems Regarding Paper

Clearing Jammed Roll Paper	886
Clearing a Jammed Sheet	889
Roll paper cannot be inserted into the paper feed slot	891
Cannot load sheets	892
Paper is not cut straight	892
Paper is not cut	892
The media take-up unit continues rotating	892
The size of clear film cannot be detected	893
Margins are wide	893
When printing on thin roll paper, the printed surface becomes scratched	893

Clearing Jammed Roll Paper

If roll paper jams, follow the steps below to remove jams.

- 1** Turn the printer off. (See "Turning the Printer On and Off.") →P.21
- 2** Open the Top Cover.

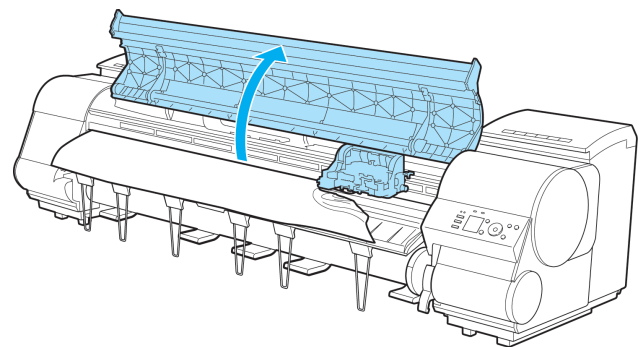

Note • If the leading edge of the roll jams in the carriage such as when the paper curls strongly, you may be able to avoid paper jamming by setting the roll cutting method to Manual and setting the detection of paper leading edge to [Off]. (See "Specifying the Cutting Method for Rolls.") →P.554

- 3** If the Carriage is out, move the Carriage out of the way, away from the paper.

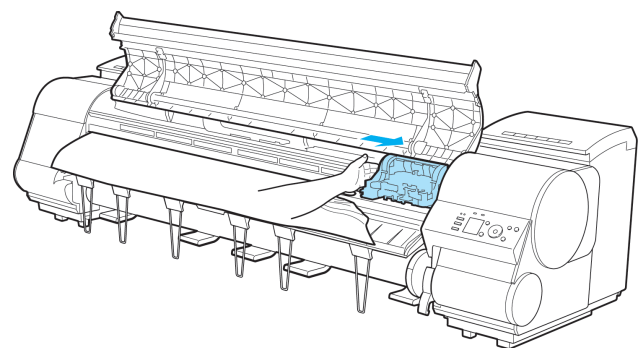

Caution • If you push the Carriage to the left edge, the blade of the Cutter Unit will be lowered in preparation to cut the paper. Be careful not to pinch your fingers between the Carriage and Platen if you have pushed the Carriage to the left edge or if a paper jam occurs during cutting.



Important

- Do not touch the Linear Scale (a), Carriage Shaft (b), or Fixed Blade (c). This may stain your hands and damage the printer.

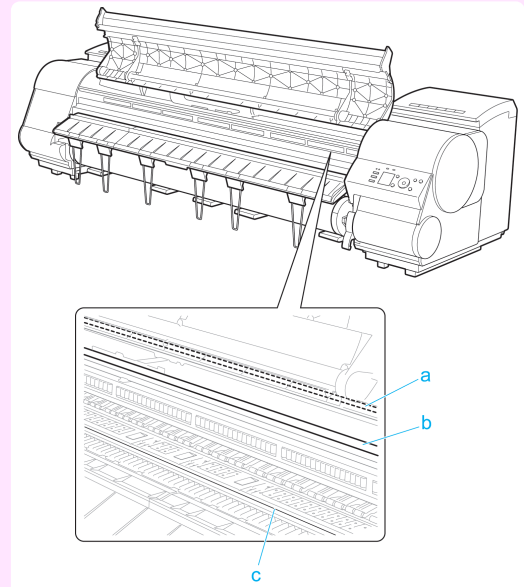

4

Lift the Release Lever.

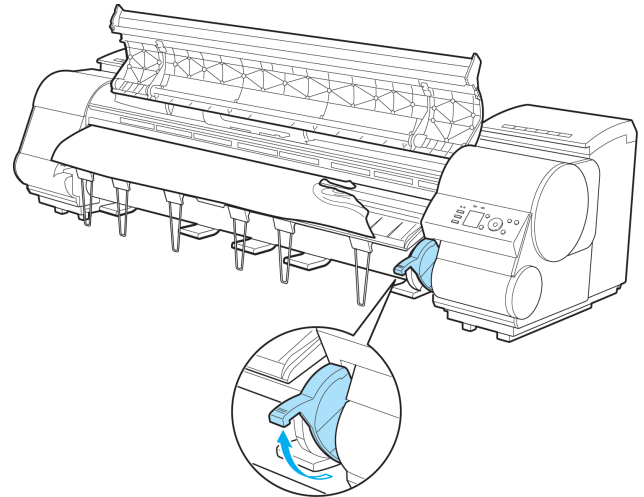

5

Holding the paper on both sides, pull the jammed portion out toward the front. Use scissors or a cutting tool to cut away the printed or wrinkled portion.

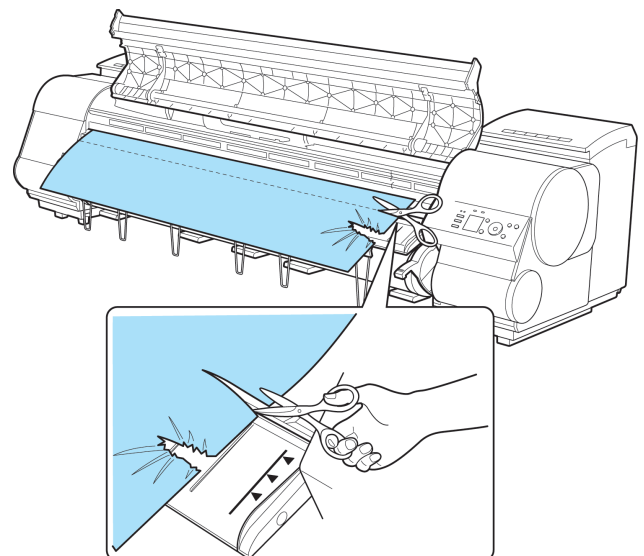



Caution

- When cutting paper, be careful to avoid injury or damage to the printer.

6

If the Carriage is on the left, move the Carriage to the right until it stops.

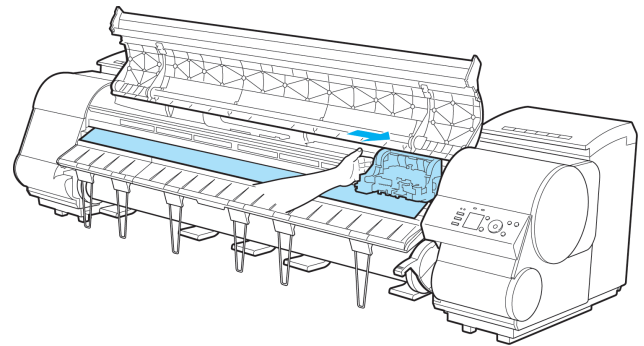

Important

- Always move the Carriage to the right side. If the Carriage is on the left, a Carriage error may occur when you turn on the printer.

7

Hold the edge of the roll paper in the middle as you gently pull it evenly to the position of the Ejection Guide (a). Align the right side of the roll paper with the Paper Alignment Line (b), keeping this side parallel to the line, and then lower the Release Lever.

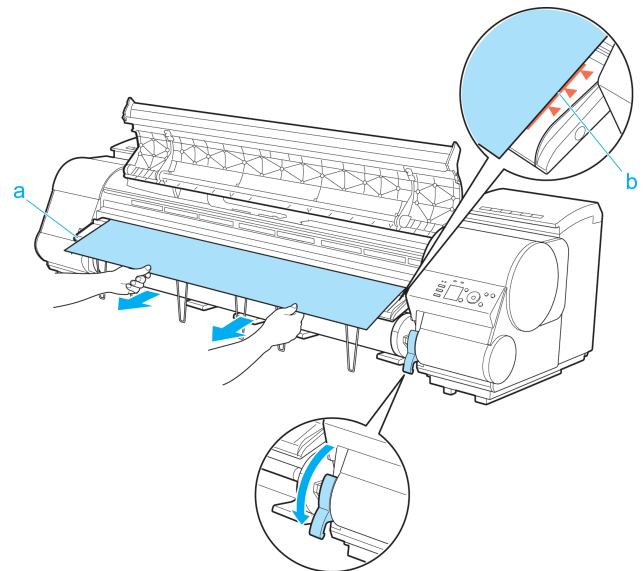

Important

- Do not force the roll paper into alignment with the Paper Alignment Line (b). This may prevent the paper from being advanced straight.

8

Close the Top Cover.

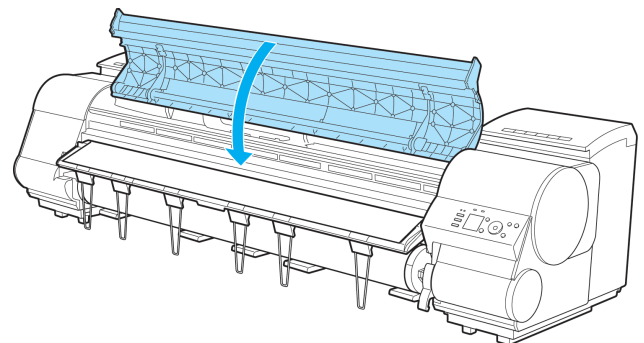

- 9** Turn the printer on. (See "Turning the Printer On and Off.") →P.21
The roll is advanced and the printer is ready to print.



Note

- For a neater edge, press the **Cut** button, select **Yes**, and cut the edge. (See "Specifying the Cutting Method for Rolls.") →P.554

Clearing a Jammed Sheet

If a sheet jams, follow the steps below to remove it.

- 1** Turn the printer off. (See "Turning the Printer On and Off.") →P.21
- 2** Open the Top Cover.

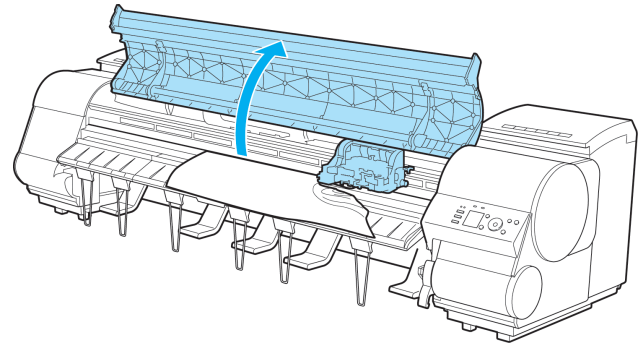

- 3** If the Carriage is out, move the Carriage out of the way, away from the paper.

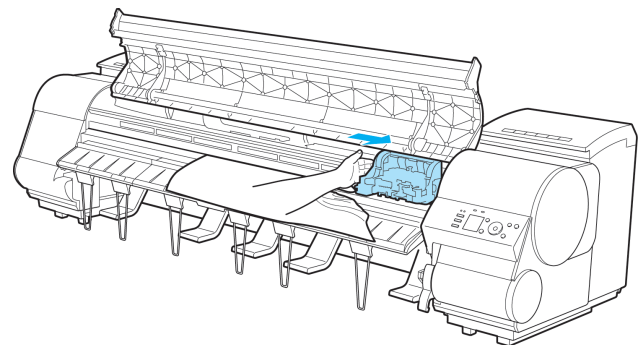

Caution

- If you push the Carriage to the left edge, the blade of the Cutter Unit will be lowered in preparation to cut the paper. Be careful not to pinch your fingers between the Carriage and Platen if you have pushed the Carriage to the left edge or if a paper jam occurs during cutting.



- Do not touch the Linear Scale (a), Carriage Shaft (b), or Fixed Blade (c). This may stain your hands and damage the printer.

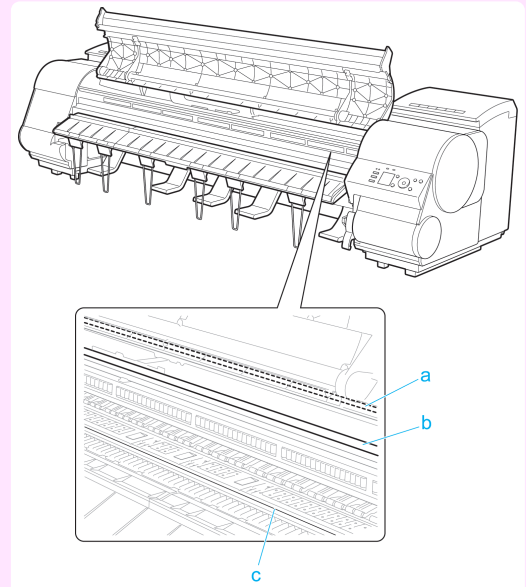

4 Lift the Release Lever.

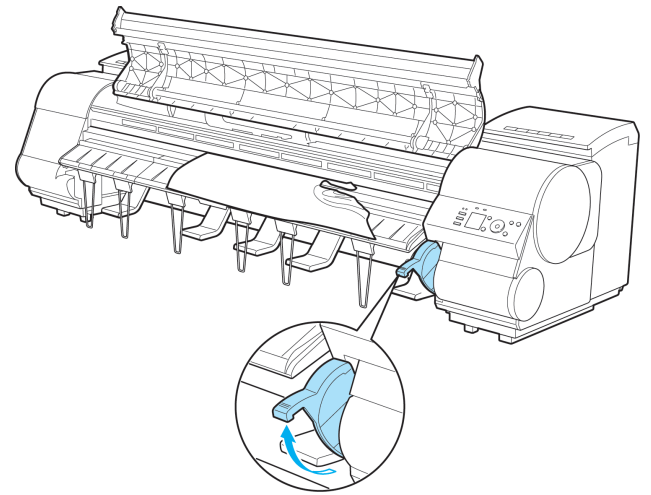

5 If the paper is visible, hold the paper and pull it out toward the front.

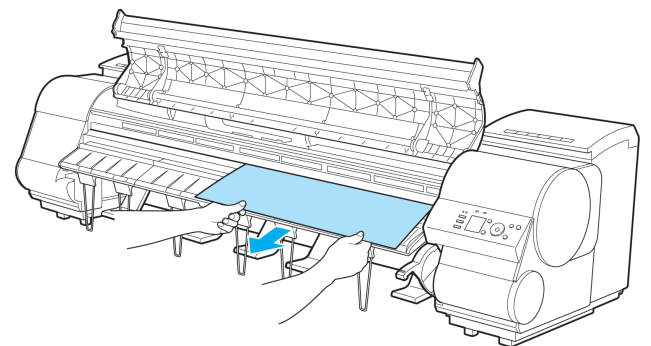

- 6** If the paper is not visible, lift the Ejection Guide, remove the Roll Holder, and clear the paper jam from below.

After removing the paper, make sure there are no other scraps of paper in the printer, and then lower the Ejection Guide.

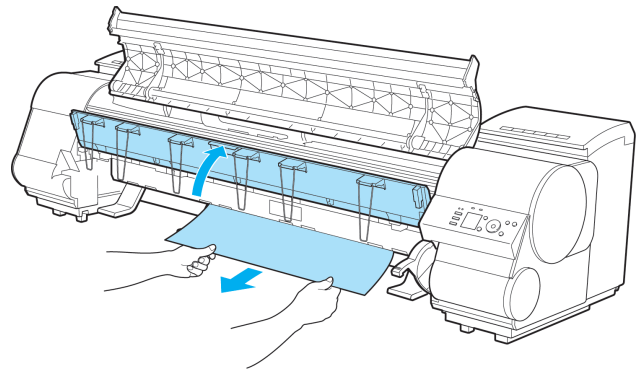

- 7** If the Carriage is on the left, move the Carriage to the right until it stops.

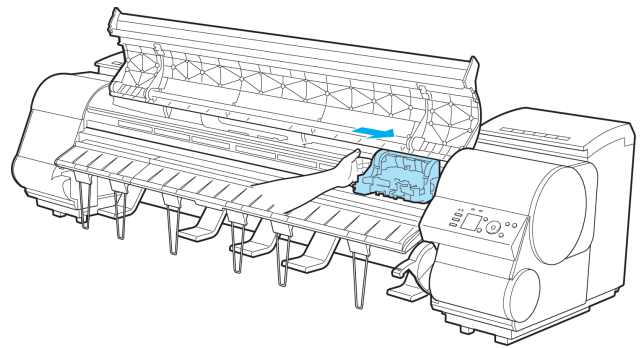

• Always move the Carriage to the right side. If the Carriage is on the left, a Carriage error may occur when you turn on the printer.

- 8** Lower the Release Lever and close the Top Cover.

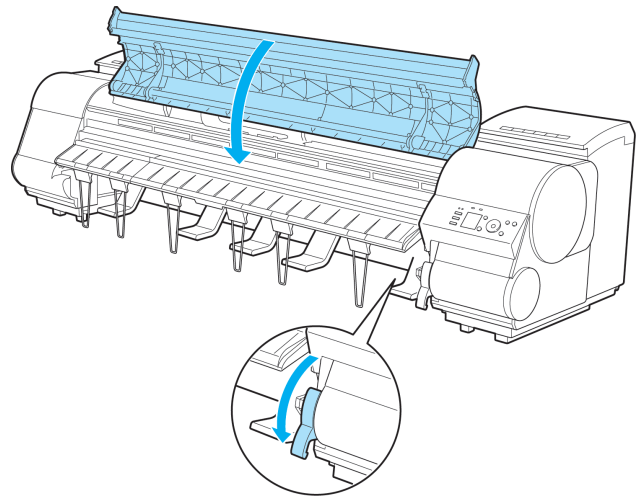

- 9** Turn the printer on. (See "Turning the Printer On and Off.") →P.21

Roll paper cannot be inserted into the paper feed slot

Cause	Corrective Action
The roll paper is warped.	Straighten out curls and reload the roll.
Paper is jammed by the paper feed slot.	Remove the jammed paper. (See "Clearing Jammed Roll Paper." →P.886) (See "Clearing a Jammed Sheet." →P.889)

Cause	Corrective Action
The paper source selection is incorrect.	Press the Load button and select the paper source.

Cannot load sheets

Cause	Corrective Action
The paper source selection is incorrect.	Press the Load button and select the paper source.

Paper is not cut straight

Cause	Corrective Action
The paper is bent or curled at the cut position.	Straighten out any curling by the edges of the paper.
Paper rises by the ends of the cut position before it is cut.	Reload the paper correctly.
You are using paper that cannot be cut with the Cutter Unit.	Specify Manual in Cutting Mode in the Control Panel menu and use scissors or a cutting tool to cut the roll after printing. (See "Specifying the Cutting Method for Rolls.") →P.554
The Cutter Unit is not installed correctly.	Reinstall the Cutter Unit correctly. (See "Replacing the Cutter Unit.") →P.856
The Cutter Unit blade is worn out.	Replace the Cutter Unit. (See "Replacing the Cutter Unit.") →P.856
Cut Speed is not configured correctly in the Control Panel menu.	Change the Cut Speed setting in the Control Panel menu. (See "Menu Structure.") →P.669
During cutting, printed documents fall out at an angle.	In the Control Panel menu, set Cutting Mode to Eject . Hold documents after printing, as they are cut. (See "Specifying the Cutting Method for Rolls.") →P.554

Paper is not cut

Cause	Corrective Action
In the printer driver, No or Print Cut Guide-line is specified in Automatic Cutting .	Specify Yes in Automatic Cutting in the printer driver. (See "Page Setup Sheet (Windows).") →P.201 (See "Paper Detailed Settings Dialog Box (Mac OS X).") →P.374
In the Control Panel menu, Cutting Mode is set to Eject or Manual .	If the Cutting Mode is Eject , press the Cut button to cut the paper. If the Cutting Mode is Manual , cut rolls with scissors or the like. (See "Specifying the Cutting Method for Rolls.") →P.554
The Cutter Unit is not installed.	Install the Cutter Unit. (See "Replacing the Cutter Unit.") →P.856
Rolls are not cut when you are using the Media Take-up Unit.	Either cut the roll paper by pressing the Cut button or lift the Release Lever and cut the roll with scissors. (See "Removing Printed Documents from the Media Take-up Unit.") →P.587

The media take-up unit continues rotating

Cause	Corrective Action
There is a foreign object in the path of the Media Take-up Sensor (indicated by a dotted line).	Remove the foreign object from the Media Take-up Sensor path. Arrange the Basket Cloth and Basket Rod so they do not interfere with the Media Take-up Sensor.

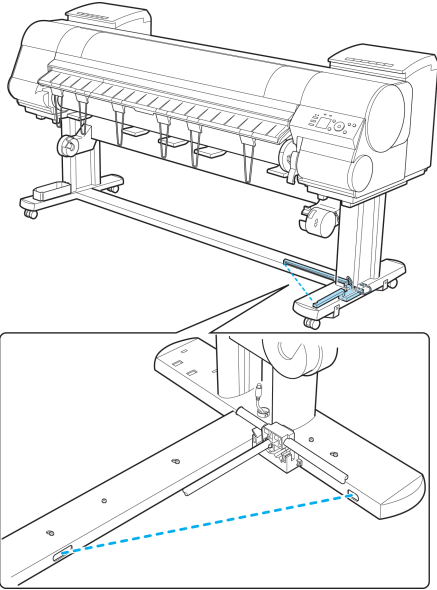
Cause	Corrective Action
	<p>Remove the foreign object from the Media Take-up Sensor path. Arrange the Basket Cloth and Basket Rod so they do not interfere with the Media Take-up Sensor.</p>
<p>The Media Take-up Sensor cord is not connected to the Right Media Take-up Unit correctly.</p>	<p>Reconnect the Media Take-up Sensor cord as follows.</p> <ol style="list-style-type: none"> 1. Turn the printer off. 2. Disconnect the Media Take-up Sensor cord from the Right Media Take-up Unit and reconnect it firmly, all the way in. 3. Turn the printer on. <p>(See "Using the Media Take-up Unit.") →P.578</p> <p>If the Media Take-up Unit continues rotating, contact your Canon dealer for assistance.</p>

The size of clear film cannot be detected

Cause	Corrective Action
<p>The Platen is soiled with ink or other substances.</p>	<p>Open the Top Cover and clean the entire Platen. (See "Cleaning Inside the Top Cover.") →P.869</p>

Margins are wide

Cause	Corrective Action
<p>Rolls are advanced a specific amount before cutting to prevent problems with cutting and paper ejection.</p>	<p>This operation is normal.</p>

When printing on thin roll paper, the printed surface becomes scratched

Cause	Corrective Action
<p>The roll paper has sagged during printing, scratching the surface of the paper and causing wrinkle creases in the paper.</p>	<p>Set Roll Tension to High in the Control Panel menu. (See "Menu Settings.") →P.675</p> <p>If you change the Roll Tension setting, We recommend that you perform Adj. Quality. (See "Automatic Banding Adjustment.") →P.814</p>

Printing does not start

The Data lamp on the Control Panel does not light up	894
The printer does not respond even if print jobs are sent	894
Ink Filling.. is displayed	894
The display screen indicates Agitating... ..	894

The Data lamp on the Control Panel does not light up

Cause	Corrective Action
The printer is not on.	Make sure the power cord is securely plugged in, all the way. Press the Power button to turn on the printer.
The target printer was not selected when printing.	In Windows, select the printer by clicking Select Printer or Printer in the printing dialog box and try printing again.
	In Mac OS X, open the dialog box of the printer driver, select the printer from the list of Printer , and try printing again.
The print job is paused.	In Windows, restart the print job as follows. <ol style="list-style-type: none"> 1. Select the printer icon in the Printers and Faxes (or Printers) window. 2. Clear Pause Printing in the File menu to restart the print job.
	In Mac OS X, restart the print job as follows. <ol style="list-style-type: none"> 1. Click Print & Fax. (This is identified as Printer Setup Utility or Print Center in other versions of Mac OS X.) 2. Select the printer, and then Resume Printer (or Start Jobs) in the Printers menu to restart the print job.

The printer does not respond even if print jobs are sent

Cause	Corrective Action
In the Control Panel menu, Pause Print is On .	Set Pause Print to Off . (See "Pausing Printing.") →P.33
You have selected Save in mail box in Output Method on the printer.	Print the job saved on the printer's hard disk. (See "Printing Saved Jobs.") →P.771
Print jobs are pending.	Manage the jobs on hold and print as needed. (See "Managing Pending Jobs (Printing or Deleting Jobs on Hold).") →P.769

Ink Filling.. is displayed

Cause	Corrective Action
The printer was forced off during operation.	Wait until the system has been filled with ink. This process may take about nine minutes.

The display screen indicates Agitating...

Cause	Corrective Action
Ink agitation is in progress.	Please wait until ink agitation is finished. The time for agitation varies depending on how long the printer was off. (Between about a minute and a half to twenty minutes.)

The printer stops during a print job

An error message is shown on the Display Screen	895
The printer ejects blank, unprinted paper	895

An error message is shown on the Display Screen

Cause	Corrective Action
An error message is displayed during printing.	Check the error message and take action as necessary. (See "Error Messages.") →P.916
The last portion of roll paper was used during a print job, and paper could not be advanced because the trailing edge is taped to the roll.	Remove the used roll and insert a new roll. (See "Removing the Roll from the Printer.") →P.547 (See "Removing the Roll Holder from Rolls.") →P.550 (See "Loading and Printing on Rolls.") →P.22

The printer ejects blank, unprinted paper

Cause	Corrective Action
The leading edge of the roll paper was cut to straighten it.	The leading edge of rolls may be cut to straighten it if Trim Edge First is set to a value other than Off in the Control Panel menu. (See "Cutting the Leading Edge of Roll Paper Automatically.") →P.560
The Printhead nozzles are clogged.	Print a test pattern to check the nozzles and make sure the Printhead is in good condition for printing. (See "Checking for Nozzle Clogging.") →P.846
A print job was received from an incompatible printer driver.	Use the correct imagePROGRAF printer driver for the printer and try printing again.
The printer is damaged.	Contact your Canon dealer for assistance.

Problems with the printing quality

Printing is faint	896
Paper rubs against the printhead	897
The edges of the paper are dirty	897
The surface of the paper is dirty	898
The back side of the paper is dirty	898
Immediately after borderless printing, the trailing edge margin is soiled during regular printing	899
Printed colors are inaccurate	899
Banding in different colors occurs	899
Colors in printed images are uneven	900
Image edges are blurred or white banding occurs	901
Setting the Blue Switch on the Platen	901
The contrast becomes uneven during printing	904
The length of printed images is inaccurate in the feeding direction	904
Images are printed crooked	905
Documents are printed in monochrome	905
Line thickness is not uniform	905
Lines or colors are misaligned	906
Borders appear in borderless printing	906

Printing is faint

Cause	Corrective Action
You may be printing on the wrong side of the paper.	Print on the printing surface.
The Printhead nozzles are clogged.	Print a test pattern to check the nozzles and see if they are clogged. (See "Checking for Nozzle Clogging.") →P.846
Because the printer was left without ink tanks installed for some time, ink has become clogged in the ink supply system.	After the ink tanks have been installed for 24 hours, run Head Cleaning B from the Control Panel. (See "Cleaning the Printhead.") →P.847
Paper is jammed inside the Top Cover.	Follow the steps below to remove the jammed piece of paper inside the Top Cover. 1. Open the Top Cover and make sure the Carriage is not over the Platen. 2. Remove any scraps of paper inside the Top Cover. (See "Clearing Jammed Roll Paper.") →P.886 (See "Clearing a Jammed Sheet.") →P.889 3. Close the Top Cover.
The ink was not dry when paper was cut.	Specify a longer drying period in the Control Panel menu, in Paper Details > Roll DryingTime . (See "Menu Settings.") →P.675
Printing may be faint if Print Quality in Advanced Settings in the printer driver is set to Standard or Fast .	In Advanced Settings of the printer driver, choose Highest quality or High in Print Quality . Printing in Fast or Standard mode is faster and consumes less ink than in Highest quality or High modes, but the printing quality is lower. (See "Giving Priority to Particular Graphic Elements and Colors for Printing.") →P.67
You are printing on paper that tends to generate dust when cut.	In the Control Panel menu, set CutDustReduct. in Paper Details to On . (See "Reducing Dust from Cutting Rolls.") →P.562

Paper rubs against the printhead

Cause	Corrective Action
The type of paper specified in the printer driver does not match the type loaded in the printer.	<p>Load paper of the same type as you have specified in the printer driver. (See "Loading Rolls in the Printer.") →P.541 (See "Loading Sheets in the Printer.") →P.563</p> <p>Make sure the same type of paper is specified in the printer driver as you have loaded in the printer.</p> <ol style="list-style-type: none"> 1. Press the Stop button and stop printing. 2. Change the type of paper in the printer driver and try printing again.
Paper has been loaded incorrectly, causing it to wrinkle.	<p>Reload the paper. (See "Loading Rolls in the Printer.") →P.541 (See "Loading Sheets in the Printer.") →P.563</p>
The Printhead is set too low in the Control Panel menu.	<p>In the Control Panel menu, set Head Height to Automatic. (See "Troubleshooting Paper Abrasion and Blurry Images.") →P.811</p>
You are printing on heavyweight paper or paper that curls or wrinkles easily after absorbing ink.	<p>When printing on Canon Heavyweight Coated Paper or other paper-based media, choose a VacuumStrength setting of Strong or Strongest in the Control Panel menu. If rubbing still occurs, in the Control Panel menu, use a higher Head Height setting. (See "Adjusting the Vacuum Strength.") →P.819 (See "Troubleshooting Paper Abrasion and Blurry Images.") →P.811</p> <p>When printing on CAD Tracing Paper or other film-based media, choose a VacuumStrength setting of Standard, Strong, or Strongest in the Control Panel menu. If rubbing still occurs, in the Control Panel menu, use a higher Head Height setting. (See "Adjusting the Vacuum Strength.") →P.819 (See "Troubleshooting Paper Abrasion and Blurry Images.") →P.811</p> <p>When printing on paper 0.1 mm (0.004 in) thick or less, choose a VacuumStrength setting of Weakest in the Control Panel menu. If rubbing still occurs, in the Control Panel menu, use a higher Head Height setting. (See "Adjusting the Vacuum Strength.") →P.819 (See "Troubleshooting Paper Abrasion and Blurry Images.") →P.811</p>
When you have loaded paper, the paper you have loaded does not match the type selected on the Control Panel.	<p>Be sure to select the correct type of paper in the Control Panel menu when loading paper. (See "Loading Rolls in the Printer.") →P.541 (See "Loading Sheets in the Printer.") →P.563</p>
Since the leading edge of the paper strongly warps upward or ripples, the leading edge of the paper rubs against the printhead.	<p>Set Cutting Mode to Manual on the Control Panel menu, and select Off for the paper leading edge detection setting.</p> <p>In this case, when keeping track of the amount of roll paper left, set ManageRemainRoll to Off before loading the roll paper and then set ManageRemainRoll to On after loading the roll paper. (See "Specifying the Cutting Method for Rolls.") →P.554 (See "Keeping Track of the Amount of Roll Paper Left.") →P.552</p>

The edges of the paper are dirty

Cause	Corrective Action
The Platen has become dirty after borderless printing or printing on small paper.	<p>Open the Top Cover and clean the Platen. (See "Cleaning Inside the Top Cover.") →P.869</p>
The type of paper as specified on the printer does not match the type specified in the printer driver.	<p>Make sure the same type of paper is specified on the printer as in the printer driver. (See "Changing the Type of Paper.") →P.545</p> <p>Make sure the same paper type is specified in the printer driver as on the printer.</p> <ol style="list-style-type: none"> 1. Press the Stop button and stop printing. 2. Change the type of paper in the printer driver and try printing again.
The paper is wrinkled or warped.	<p>Straighten out the wrinkles or curls and reload the paper. Do not use paper that has been printed on previously. (See "Loading Rolls in the Printer.") →P.541</p>

Cause	Corrective Action
The paper is wrinkled or warped.	(See "Loading Sheets in the Printer.") →P.563
A cut line is printed because CutDustReduct. is On in the Control Panel menu to reduce cutting dust.	If this function is not needed, set CutDustReduct. to Off in the Control Panel menu. (See "Menu Settings.") →P.675
The Printhead is set too low in the Control Panel menu.	In the Control Panel menu, set Head Height to Automatic . (See "Troubleshooting Paper Abrasion and Blurry Images.") →P.811
You are printing on heavyweight paper or paper that curls or wrinkles easily after absorbing ink.	When printing on Canon Heavyweight Coated Paper or other paper-based media, choose a VacuumStrngth setting of Strong or Strongest in the Control Panel menu. If rubbing still occurs, in the Control Panel menu, use a higher Head Height setting. (See "Adjusting the Vacuum Strength.") →P.819 (See "Troubleshooting Paper Abrasion and Blurry Images.") →P.811
	When printing on CAD Tracing Paper or other film-based media, choose a VacuumStrngth setting of Standard , Strong , or Strongest in the Control Panel menu. If rubbing still occurs, in the Control Panel menu, use a higher Head Height setting. (See "Adjusting the Vacuum Strength.") →P.819 (See "Troubleshooting Paper Abrasion and Blurry Images.") →P.811
The Ejection Guide is soiled.	Clean the Ejection Guide. (See "Cleaning the Printer Exterior.") →P.869

The surface of the paper is dirty

Cause	Corrective Action
The Paper Retainer is soiled.	Clean the Paper Retainer. (See "Cleaning Inside the Top Cover.") →P.869
You are using a paper that does not dry easily.	In the Control Panel menu, set Roll DryingTime to at least 1 min . (See "Menu Settings.") →P.675
	When paper that does not dry easily is used for printing, it may curl during printing and touch the Output Tray. In this case, in the Control Panel menu, complete the settings for Dry time and Area in Scan Wait Time . However, note that printing will now take longer. (See "Menu Settings.") →P.675

The back side of the paper is dirty

Cause	Corrective Action
The Platen has become dirty after borderless printing or printing on small paper.	Open the Top Cover and clean the Platen. (See "Cleaning Inside the Top Cover.") →P.869
	In the Control Panel menu, set CarriageScanWdth to Fixed . (See "Menu Settings.") →P.675
The Platen has become soiled because you have set Width Detection to Off in the Control Panel menu.	Set Width Detection to On in the Control Panel menu, and then open the Top Cover and clean the Platen. (See "Cleaning Inside the Top Cover.") →P.869
	Open the Top Cover and clean the Platen. After this, manually advance the roll onto the Platen before printing. (See "Cleaning Inside the Top Cover.") →P.869 (See "Feeding Roll Paper Manually.") →P.551
The Platen suction is too strong.	In the Control Panel menu, reduce the level of VacuumStrngth . (See "Adjusting the Vacuum Strength.") →P.819
" BordlessOversize " is set to Standard in the Control Panel menu.	Set " BordlessOversize " to " Little " in the Control Panel menu. (See "Menu Settings.") →P.675

Immediately after borderless printing, the trailing edge margin is soiled during regular printing

Cause	Corrective Action
Depending on your printing environment, after borderless printing in which the leading and trailing edge of the roll is cut automatically, any ink adhering to the cutter unit may rub off on the next printed document.	<p>Follow these steps to change the Between Pages setting of Drying Time to a value between about 30 seconds and 3 minutes before trying borderless printing again.</p> <ol style="list-style-type: none"> 1. On the Main sheet of the printer driver, click Advanced Settings by Media Type. 2. Select an ink drying time in the list for the Between Pages setting of Drying Time.

Printed colors are inaccurate

Cause	Corrective Action
Color adjustment has not been activated in the Advanced Settings of the printer driver.	In the Advanced Settings of the printer driver, access Color Settings in Color Mode to adjust colors. (See "Main Sheet (Windows).") →P.188 (See "Main Pane (Mac OS X).") →P.370
Colors have not been adjusted on the computer or monitor.	Refer to the computer and monitor documentation to adjust the colors. Adjust the settings of the color management software, referring to the software documentation as needed.
The Printhead nozzles are clogged.	Print a test pattern to check the nozzles and see if they are clogged. (See "Checking for Nozzle Clogging.") →P.846
In the Windows printer driver, Application Color Matching Priority is not selected.	Click Special Settings on the Layout sheet of the printer driver and select Application Color Matching Priority in the dialog box. (See "Layout Sheet (Windows).") →P.206
There may be a slight difference in how colors are printed after Printhead replacement because of individual variation among print-heads.	Execute color calibration. (See "Corrects slight differences in how colors appear (color calibration).") →P.828
Printhead characteristics gradually change through repeated use, and colors may change.	Execute color calibration. (See "Corrects slight differences in how colors appear (color calibration).") →P.828
Color may change slightly even on the same model of printer if you use a different version of the firmware or printer driver, or when you print under different settings or in a different printing environment.	Follow these steps to prepare the printing environment. <ol style="list-style-type: none"> 1. Use the same version of firmware or printer driver. (See "Updating the Firmware.") →P.879 2. Specify the same value for all settings items. 3. Execute color calibration. (See "Corrects slight differences in how colors appear (color calibration).") →P.828
When reinstalling the printer driver, you changed the region selection of the Media Configuration Tool. Changing the region selection of the Media Configuration Tool deletes the region-specific paper information originally registered on the printer before installation. Using paper with deleted information when executing color calibration will prevent the resulting calibration adjustment value from being applied to all other types of the paper.	Prepare paper compatible with calibration in the newly selected region and perform calibration again. (See "Corrects slight differences in how colors appear (color calibration).") →P.828

Banding in different colors occurs

Cause	Corrective Action
The paper feed amount is out of adjustment.	Adjust the feed amount. (See "Adjusting the Feed Amount.") →P.813
Printing does not proceed smoothly because print jobs are interrupted during transmission.	Exit other applications and cancel other print jobs.

Cause	Corrective Action
In the Control Panel menu, Adj. Priority is set to Print Length .	Setting Adj. Priority to Print Quality in the Control Panel menu and adjusting the feed amount may improve results. (See "Adjusting the Feed Amount.") →P.813
The Printhead is out of alignment.	Adjust the Printhead alignment. (See "Automatic Adjustment to Straighten Lines and Colors.") →P.806
The Printhead nozzles are clogged.	Print a test pattern to check the nozzles and see if they are clogged. (See "Checking for Nozzle Clogging.") →P.846
Streaks may occur if you set the Print Quality too low.	Choose a higher level of Print Quality in the Advanced Settings of the printer driver and try printing again. Printing in Fast or Standard mode is faster and consumes less ink than in Highest quality or High modes, but the printing quality is lower. (See "Giving Priority to Particular Graphic Elements and Colors for Printing.") →P.67
The type of paper specified in the printer driver does not match the type loaded in the printer.	Load paper of the same type as you have specified in the printer driver. (See "Loading Rolls in the Printer.") →P.541 (See "Loading Sheets in the Printer.") →P.563
	Make sure the same type of paper is specified in the printer driver as you have loaded in the printer. 1. Press the Stop button and stop printing. 2. Change the type of paper in the printer driver and try printing again.

Colors in printed images are uneven

Cause	Corrective Action
Line Drawing/Text is selected when printing images in many solid colors.	In Print Priority in the Advanced Settings of the printer driver, choose Image .
You are printing on paper that curls easily.	Printed colors may appear uneven on the leading edge of paper that is susceptible to curling. Select a stronger level in VacuumStrength in the Control Panel menu to increase suction against the paper, or specify a leading margin of 20 mm (0.79 in) or more. (See "Adjusting the Vacuum Strength.") →P.819
Printed colors may be uneven if you set the Print Quality too low.	Choose a higher level of Print Quality in the Advanced Settings of the printer driver. Printing in Fast or Standard mode is faster and consumes less ink than in Highest quality or High modes, but the printing quality is lower. (See "Giving Priority to Particular Graphic Elements and Colors for Printing.") →P.67
Color may be uneven between dark and light image areas.	Select Unidirectional Printing in the Advanced Settings of the printer driver.
When borderless printing is used, the edge of the paper is cut during printing. Thus, ink density may be slightly uneven at the leading edges.	Specify No in Auto Cut in the printer driver before printing. In this case, the paper can be printed without borders on the left and right sides only. Cut the printed document ejected from the printer, and then use scissors or a cutting tool to cut away the edges on the top and bottom.
	Choose a higher level of Print Quality in the Advanced Settings of the printer driver. (See "Giving Priority to Particular Graphic Elements and Colors for Printing.") →P.67
The Printhead is out of alignment.	Adjust the Printhead alignment. (See "Automatic Adjustment to Straighten Lines and Colors.") →P.806
Allowing printed documents to dry on top of each other may cause uneven colors.	To avoid uneven colors, we recommend drying each sheet separately.
Density may be uneven if you use Glossy Paper or Canon Coated Paper .	In Advanced Settings of the printer driver, choose Highest quality or High in Print Quality .
The type of paper specified in the printer driver does not match the type loaded in the printer.	Load paper of the same type as you have specified in the printer driver. (See "Loading Rolls in the Printer.") →P.541 (See "Loading Sheets in the Printer.") →P.563
	Make sure the same type of paper is specified in the printer driver as you have loaded in the printer.

Cause	Corrective Action
The type of paper specified in the printer driver does not match the type loaded in the printer.	<ol style="list-style-type: none"> 1. Press the Stop button and stop printing. 2. Change the type of paper in the printer driver and try printing again.
Scan Wait Time > Area in the Control Panel menu is set to Leading edge .	When Scan Wait Time > Area is set to Leading edge , colors may be uneven 110–160 mm from the leading edge. (The position varies depending on the Print Quality setting.) In this case, select Scan Wait Time > Area > Entire area . However, note that printing will now take longer. (See "Menu Settings.") →P.675

Image edges are blurred or white banding occurs

Cause	Corrective Action
The Platen suction is too strong.	In the Control Panel menu, reduce the level of VacuumStrngth . (See "Adjusting the Vacuum Strength.") →P.819
	Close the blue Switch on the platen so that it matches the paper size. (See "Setting the Blue Switch on the Platen.") →P.901
Incorrect Printhead alignment value.	When printing fine lines or text at high precision on glossy or semi-glossy photo or proofing paper, set the optimal Printhead height before aligning the printhead. (See "Enhancing Printing Quality.") →P.804
	In the Control Panel menu, set Head Height to a lower height. (See "Troubleshooting Paper Abrasion and Blurry Images.") →P.811
The type of paper specified in the printer driver does not match the type loaded in the printer.	Load paper of the same type as you have specified in the printer driver. (See "Loading Rolls in the Printer.") →P.541 (See "Loading Sheets in the Printer.") →P.563
	Make sure the same type of paper is specified in the printer driver as you have loaded in the printer. <ol style="list-style-type: none"> 1. Press the Stop button and stop printing. 2. Change the type of paper in the printer driver and try printing again.

Setting the Blue Switch on the Platen

If printed documents exhibit the following symptoms, adjust the setting of the blue Switch on the Platen.

- Image edges are blurred
- Image edges are affected by white banding



- Always set the blue Switch on the Platen to the ● side for borderless printing. Printing quality may be affected if the Switch is incorrectly set.

1 Remove any loaded paper that will not be used.

- Rolls (See "Removing the Roll from the Printer.") →P.547
- Sheet (See "Removing Sheets.") →P.568

2 Open the Top Cover.

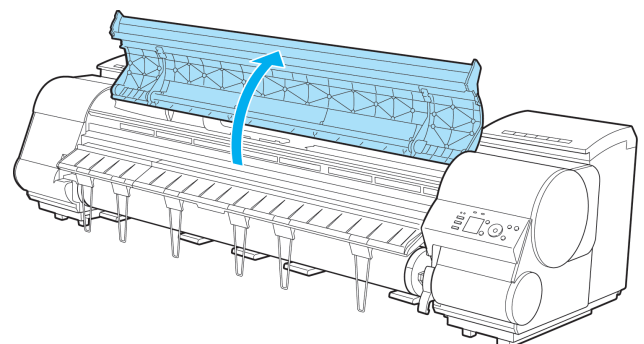

3 Remove the Cleaning Brush (a).

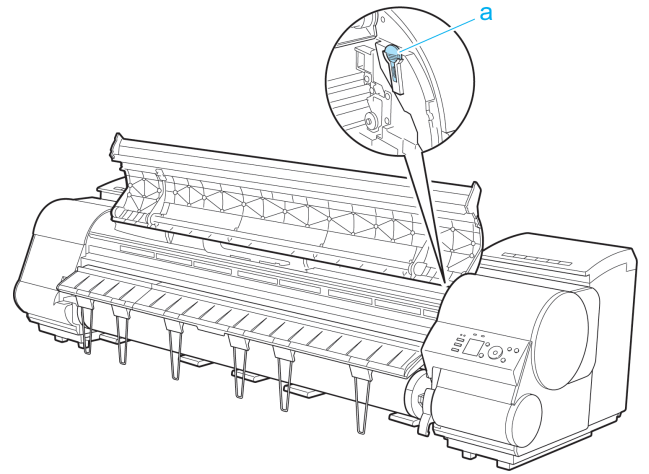

4 Using the back of the Cleaning Brush, move the first Switch to the side opposite ●.

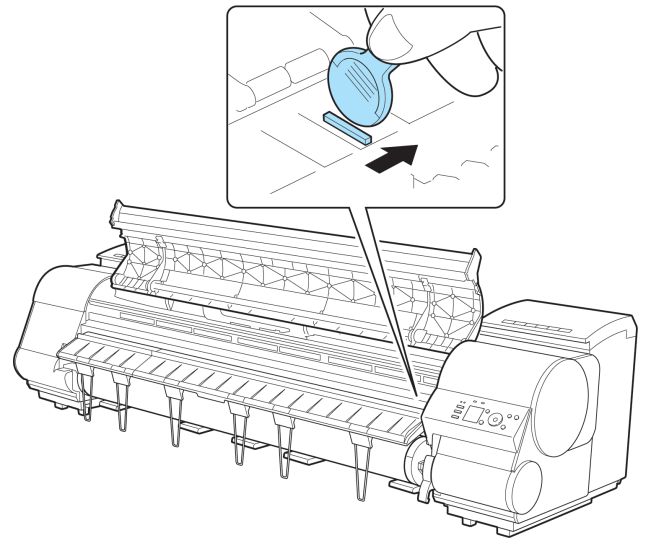

- 5** Refer to the following table to confirm the number on the Platen (a) that corresponds to the size of paper for printing.

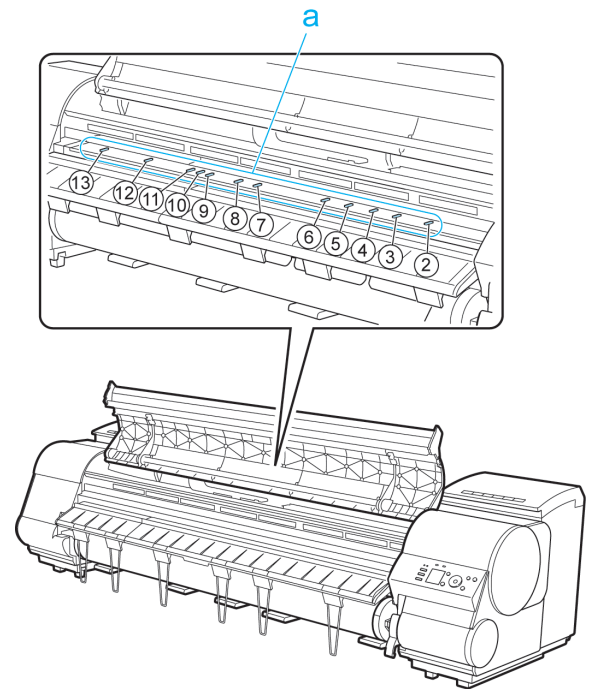

Number	Dimensions
2	254.0 mm (10.00 in)
3	355.6 mm (14.00 in)
4	431.8 mm (17.00 in)
5	515.0 mm (JIS B2 or B3)
6	594.0 mm (ISO A1 or A2) or 609.6 mm (24.00 in)
7	841.0 mm (ISO A0 or A1)
8	914.4 mm (36.00 in)
9	1030.0 mm (JIS B0 or B1)
10	1066.8 mm (42.00 in)
11	1117.6 mm (44.00 in)
12	1270.0 mm (50.00 in)
13	1524.0 mm (60.00 in)

- 6** Using the back of the Cleaning Brush, move the Switch to the side opposite ●, corresponding to the size of the paper for printing.
In this case, note that you will move the switch in the opposite direction from the direction in step 4.



Note

- The Switch only moves number 1 and the number that matches the paper size. Set all of the switches where the number does not match the paper size in switches number 2 and higher to the ● side.

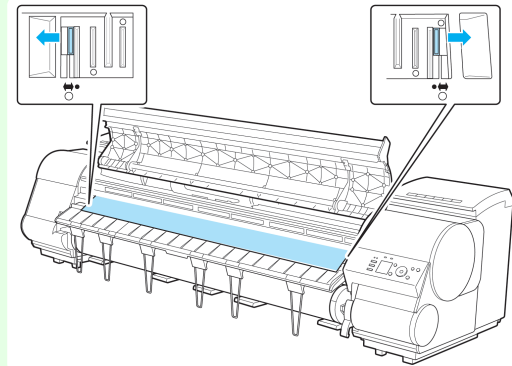

- 7** Close the Top Cover.

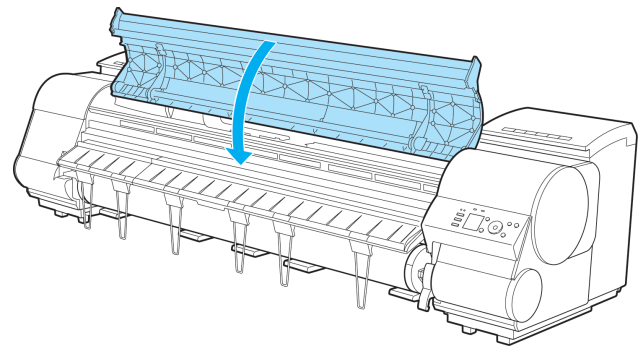

The contrast becomes uneven during printing

Cause	Corrective Action
The paper feed amount is out of adjustment.	Adjust the feed amount. (See "Adjusting the Feed Amount.") →P.813
The type of paper specified in the printer driver does not match the type loaded in the printer.	Load paper of the same type as you have specified in the printer driver. (See "Loading Rolls in the Printer.") →P.541 (See "Loading Sheets in the Printer.") →P.563
	Make sure the same type of paper is specified in the printer driver as you have loaded in the printer. 1. Press the Stop button and stop printing. 2. Change the type of paper in the printer driver and try printing again.

The length of printed images is inaccurate in the feeding direction

Cause	Corrective Action
In the Control Panel menu, Adj. Priority is set to Print Quality .	Set Adj. Priority to Print Length in the Control Panel menu, and then execute Adjust Length . (See "Adjusting the Feed Amount.") →P.813
The type of paper specified in the printer driver does not match the type loaded in the printer.	Load paper of the same type as you have specified in the printer driver. (See "Loading Rolls in the Printer.") →P.541 (See "Loading Sheets in the Printer.") →P.563
	Make sure the same type of paper is specified in the printer driver as you have loaded in the printer.

Cause	Corrective Action
The type of paper specified in the printer driver does not match the type loaded in the printer.	<ol style="list-style-type: none"> 1. Press the Stop button and stop printing. 2. Change the type of paper in the printer driver and try printing again.

Images are printed crooked

Cause	Corrective Action
In the Control Panel menu, Skew Check Lv. is set to Loose or Off .	In the Control Panel menu, set Skew Check Lv. to Standard . (See "Menu Settings.") →P.675
In the Control Panel menu, Width Detection is set to Off .	Set Width Detection to On in the Control Panel menu. (See "Menu Settings.") →P.675
Roll paper is loaded askew.	If there is a gap between the roll paper and roll holder, reload the roll. (See "Attaching the Roll Holder to Rolls.") →P.538 (See "Loading Rolls in the Printer.") →P.541

Documents are printed in monochrome

Cause	Corrective Action
In the Advanced Settings of the printer driver, Monochrome or Monochrome (Photo) , is specified in Color Mode .	In the Advanced Settings of the printer driver, specify Color in Color Mode and try printing again.
The Printhead nozzles are clogged.	Print a test pattern to check the color ink nozzles and see if they are clogged. Checking for Nozzle Clogging →P.846

Line thickness is not uniform

Cause	Corrective Action
In the Special Settings dialog box of the Windows printer driver, Fast Graphic Process is selected.	<p>Access the printer driver Properties dialog box from Print in the File menu of the source application, and follow these steps to print.</p> <ol style="list-style-type: none"> 1. Clear the option Open Preview When Print Job Starts on the Main sheet. 2. Clear the option Page Layout on the Layout sheet. 3. Click the Special Settings button on the Layout sheet to display the Special Settings dialog box, and then clear the option Fast Graphic Process.
The blue Switch on the platen is set incorrectly.	Move the Switch numbered corresponding to the size of paper for printing opposite to the ● position. (See "Setting the Blue Switch on the Platen.") →P.901
The type of paper specified in the printer driver does not match the type loaded in the printer.	<p>Load paper of the same type as you have specified in the printer driver. (See "Loading Rolls in the Printer.") →P.541 (See "Loading Sheets in the Printer.") →P.563</p> <p>Make sure the same type of paper is specified in the printer driver as you have loaded in the printer.</p> <ol style="list-style-type: none"> 1. Press the Stop button and stop printing. 2. Change the type of paper in the printer driver and try printing again.
Incorrect Printhead alignment value.	<p>When printing fine lines or text at high precision on glossy or semi-glossy photo or proofing paper, set the optimal Printhead height before aligning the printhead. (See "Enhancing Printing Quality.") →P.804</p> <p>In the Control Panel menu, use a lower Head Height setting. (See "Troubleshooting Paper Abrasion and Blurry Images.") →P.811</p>
Depending on the type of paper, the thickness of printed lines may be noticeably inconsistent.	Specify Proof in Print Priority in the printer driver. (See "Giving Priority to Particular Graphic Elements and Colors for Printing.") →P.67

Lines or colors are misaligned

Cause	Corrective Action
The Printhead is not being aligned correctly.	Adjust the Printhead alignment. (See "Automatic Adjustment to Straighten Lines and Colors.") →P.806 (See "Manual Adjustment to Straighten Lines and Colors.") →P.808
	When printing fine lines or text at high precision on glossy or semi-glossy photo or proofing paper, set the optimal Printhead height before aligning the printhead. (See "Enhancing Printing Quality.") →P.804
	In the Control Panel menu, use a lower Head Height setting. (See "Troubleshooting Paper Abrasion and Blurry Images.") →P.811
The type of paper specified in the printer driver does not match the type loaded in the printer.	Load paper of the same type as you have specified in the printer driver. (See "Loading Rolls in the Printer.") →P.541 (See "Loading Sheets in the Printer.") →P.563
	Make sure the same type of paper is specified in the printer driver as you have loaded in the printer. 1. Press the Stop button and stop printing. 2. Change the type of paper in the printer driver and try printing again.
Depending on the type of paper, printed lines may be noticeably misaligned.	Specify Proof in Print Priority in the printer driver. (See "Giving Priority to Particular Graphic Elements and Colors for Printing.") →P.67

Borders appear in borderless printing

Cause	Corrective Action
If borderless printing was performed at the actual size, paper wider than the page size was selected.	When performing borderless printing at the actual size, use roll paper with the same width as the width of the page size. (See "Borderless Printing at Actual Size.") →P.95
The printing image data has margins.	Check that the printing image data does not have any objects like crop marks and transparent objects.
Margins are configured in the application software you are using.	Check that no margins are configured in the application software you are using.
" BordlessOversize " is set to " Little " in the Control Panel menu.	Set " BordlessOversize " to Standard in the Control Panel menu. (See "Menu Settings.") →P.675

Cannot print over a network

Cannot connect the printer to the network	907
Cannot print over a TCP/IP network	907
Cannot print over a NetWare network	907
Cannot print over AppleTalk or Bonjour networks	908

Cannot connect the printer to the network

Cause	Corrective Action
The Ethernet cable is not connected correctly to the printer's Ethernet port.	<ol style="list-style-type: none"> 1. Make sure the printer is connected to the network with the correct Ethernet cable, and then turn the printer on. For instructions on connecting the cable, refer to the Setup Guide. 2. Make sure the Link indicator is lit. The top and bottom indicators are lit if the printer is connected via 1000Base-T. The bottom indicator is green if the printer is connected via 100BASE-TX, and the top indicator is orange if connected via 10BASE-T. If the Link indicator is not lit, check the following points. <ul style="list-style-type: none"> • Make sure the hub is on. • Make sure the end of the Ethernet cable is connected correctly. Insert the Ethernet cable until it clicks and locks in place. • Make sure there is no problem with the Ethernet cable. If there is any problem, replace the Ethernet cable. • Check the communication mode with the hub. Although the printer normally detects the hub communication mode and transmission rate automatically (in auto negotiation mode), sometimes the hub settings cannot be detected. In this case, configure the connection method manually, specifying the communication mode in use. (See "Configuring the Communication Mode Manually.") →P.735

Cannot print over a TCP/IP network

Cause	Corrective Action
The printer's IP address is not configured correctly.	Make sure the printer's IP address is configured correctly. (See "Configuring the IP Address Using imagePROGRAF Device Setup Utility.") →P.738 (See "Configuring the IP Address Using the Printer Control Panel.") →P.713
The printer's TCP/IP network settings are not configured correctly.	Make sure the printer's TCP/IP network settings are configured correctly. (See "Configuring the Printer's TCP/IP Network Settings With RemoteUI.") →P.717
The computer you are trying to print from is not configured correctly.	Make sure the computer's TCP/IP network settings are configured correctly. (See "Configuring the Printer Driver Destination (Windows).") →P.716 (See "Configuring the Destination in TCP/IP Networks (Mac OS X).") →P.728

Cannot print over a NetWare network

Cause	Corrective Action
The printer's NetWare settings are not configured correctly.	Make sure the printer's NetWare settings are configured correctly. In particular, make sure a valid frame type is selected. For details, see "Configuring the Printer's NetWare Network Settings With RemoteUI." →P.725
The computer you are trying to print from is not configured correctly.	Make sure the computer's NetWare settings are configured correctly. For details, see "Configuring NetWare Network Settings." →P.720
The NetWare server and services are not configured correctly.	Check the following points. <ol style="list-style-type: none"> 1. Make sure the NetWare file server is running.

Cause	Corrective Action
The NetWare server and services are not configured correctly.	<ol style="list-style-type: none"> 2. Make sure there is enough free disk space on the NetWare file server. Insufficient disk space may prevent you from processing large print jobs. 3. Start NWADMIN or PCONSOLE and confirm that the print service is configured correctly and the print queue is available. 4. If data transmission to a printer on another subnet fails, deactivate NCP burst mode in that printer's network protocol settings. 5. If the printer is used in queue server mode, specify Other/Unknown as the printer type.
The printer was turned off and on when not disconnected from the server.	Leave the printer off for at least 30 seconds, and then restore power.

Cannot print over AppleTalk or Bonjour networks

Cause	Corrective Action
The AppleTalk protocol is not enabled on the printer.	Activate AppleTalk on the printer. (See "Configuring the Printer's AppleTalk Network Settings.") →P.732
The computer you are trying to print from is not configured correctly.	Make sure the computer's AppleTalk settings are configured correctly. (See "Configuring the Destination for AppleTalk Networks (Mac OS X).") →P.731 (See "Configuring the Destination for Bonjour Network (Mac OS X).") →P.729
The computer and printer are not on the same network.	Due to the nature of Bonjour, you cannot print if the printer is on another network behind a router. Make sure the computer and printer are on the same network. For information about network settings, ask your network administrator.

Installation problems

Removing Installed Printer Drivers

Follow these steps to remove installed printer drivers and utilities.

Removing printer drivers (Windows)

Remove the printer driver as follows.



- The following instructions are for Windows XP. The method of removing printer drivers varies depending on the version of Windows.

- From the Windows **start** menu, select **Programs > Canon Printer Uninstaller > imagePROGRAF Printer Driver Uninstaller** to display the **Delete Printer** window.
- Select the printer in the list and click **Delete**.
- Click **Yes** after the **Warning** message is displayed.
- Make sure that the printer has been removed from the list, and then click **Exit**.

Removing printer drivers and imagePROGRAF Printmonitor (Macintosh)

Remove the printer driver or imagePROGRAF Printmonitor as follows.

- Insert the User Software CD-ROM provided with the printer in the CD-ROM drive.
- Start the printer driver installer included in the User Software CD-ROM. Open the **OS X** folder and double-click **iPF Driver Installer X**.
- In the upper left menu, choose **Uninstall**, and then click **Uninstall**.
- Follow the instructions on the screen to remove the printer driver or imagePROGRAF Printmonitor.

Removing imagePROGRAF Status Monitor (Windows)

Remove imagePROGRAF Status Monitor as follows.



- The following instructions are for Windows XP. The method of removing printer drivers varies depending on the version of Windows.

- Select **Control Panel** from the **start** menu.
- Select **Add or Remove Programs**.
- Select **imagePROGRAF Status Monitor**, and then click the **Change/Remove** button.

Removing imagePROGRAF Device Setup Utility (Windows)

Remove imagePROGRAF Device Setup Utility as follows.



- The following instructions are for Windows XP. The method of removing printer drivers varies depending on the version of Windows.

- 1** From the Windows **start** menu, select **Programs > imagePROGRAF Device Setup Utility > Uninstaller (imagePROGRAF Device Setup Utility)** to start the wizard.
- 2** In the wizard window, click **Delete**, and then click **Next**.
- 3** Follow the instructions on the screen to remove imagePROGRAF Device Setup Utility.

Other problems

The printer does not go on	911
The printer takes time to start up	911
If the Printer Makes a Strange Sound	911
Messages advising to check the maintenance cartridge are not cleared	911
The printer consumes a lot of ink	912
Ink Level Detection	912

The printer does not go on

Cause	Corrective Action
The printer is unplugged.	Plug the power cord into the outlet, and then turn on the printer.
The specified voltage is not supplied.	Check the voltage of the outlet and breaker. (See "Specifications.") →P.942

The printer takes time to start up

Cause	Corrective Action
The printer may have shut down incorrectly last time. This may happen after power outages or if the printer is unplugged before it is turned off. In this case, the next time power is restored, the printer's hard disk is checked, and startup may take some time.	Please wait a while, because it may take several minutes to finish checking the hard disk. If an error message is displayed after the hard disk check, follow the instructions indicated to resolve the problem.

If the Printer Makes a Strange Sound

Cause	Corrective Action
The printer makes a sound during operation.	<p>The following sounds do not indicate a problem with the printer.</p> <ul style="list-style-type: none"> • There is a sound of suction from the Platen. To prevent paper from rising, paper is held against the Platen by suction from Vacuum holes under it. • Roll paper makes a fluttering sound during printing. There may be a fluttering sound when large paper is advanced. • You suddenly hear the sound of cleaning operations. At regular intervals, for printer maintenance, cleaning operations will begin automatically, even if the printer is in Sleep mode. • You suddenly hear the sound of ink agitation. At regular intervals, to ensure optimal printing quality, the ink is agitated automatically, even if the printer is in Sleep mode. Ink agitation takes about a minute and a half. The ink is also agitated automatically under the following conditions. Note that other operations are not possible while Agitating... is displayed on the control panel. <ul style="list-style-type: none"> • After the printer is turned on • After data transmission • After ink tank replacement <p>In other cases, contact your Canon dealer.</p>

Messages advising to check the maintenance cartridge are not cleared

Cause	Corrective Action
The printer has not detected the new Maintenance Cartridge that was used to replace the old one.	Remove the new Maintenance Cartridge you have just installed and insert it again firmly. (See "Replacing the Maintenance Cartridge.") →P.860

The printer consumes a lot of ink

Cause	Corrective Action
Many full-page color images are printed.	In print jobs such as photos, images are filled with color. This consumes a lot of ink. This does not indicate a problem with the printer.
Head Cleaning B in the Control Panel menu is executed frequently.	Head Cleaning B in the Control Panel menu consumes a lot of ink. This does not indicate a problem with the printer. Unless the printer has been moved or stored for a long period or you are troubleshooting Printhead problems, we recommend not performing Head Cleaning B , to the extent possible.
You have just finished initial installation, when more ink is consumed to fill the system.	After initial installation or at the first-time use after transfer, ink flows into the system between the Ink Tank and Printhead, which may cause the ink level indicators to drop to 80%. This does not indicate a problem with the printer.
The Printhead nozzles are clogged.	Check for nozzle clogging. (See "Checking for Nozzle Clogging.") →P.846

Ink Level Detection

Ink level detection will be deactivated if you load ink tanks once emptied.

Ink level detection

Ink tanks specified for this printer feature an ink level detection function to prevent the ink from running out during printing, which prevents printer damage. (See "Ink Tanks.") →P.834

This function will not work correctly if you use refill ink tanks. As a result, printing stops. Thus, before using refill ink tanks, you must cancel the ink level detection.

Printing with the ink level detection canceled may lead to printer damage and printing problems. Canon Inc. is not liable for any damage that may occur as a result of refilling ink.



- After ink level detection has been released, this function cannot be reactivated for currently loaded Ink Tank. To use ink level detection again, replace the Ink Tank with new ones specified for use with the printer.
- Repeatedly removing and inserting an Ink Tank may damage the connection between the Ink Tank and the printer, which may cause ink leakage from the Ink Tank and damage the printer.

Releasing ink level detection

- 1 On the Display Screen, a message indicates that the ink level cannot be detected. After checking the message, press the ► button.

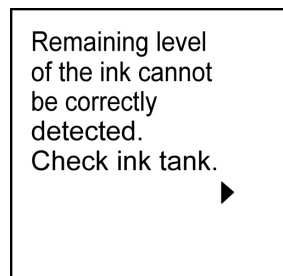

- 2 Press ▲ or ▼ to select **Information**, and then press the **OK** button.

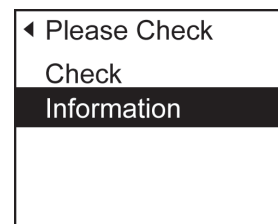

- 3** A confirmation message is shown on the Display Screen about releasing ink level detection. After checking the message, press the ► button.

Tank once emptied is used. Printing stopped due to ink level unknown. ►

- 4** After checking the message, press the ► button.

To continue, you must release ink level detection. ◀▶

- 5** Press ▲ or ▼ to select **Yes**, and then press the **OK** button.

◀ Release?
No
Yes

- 6** Check the message and press the ► button.

Release ink level detection after confirming that ink is in ink tank. ►

- 7** Check the message and press the ► button.

Canon is not liable for damages due to ink tank filling. ◀▶

8 Press ▲ or ▼ to select **Yes**, and then press the **OK** button.

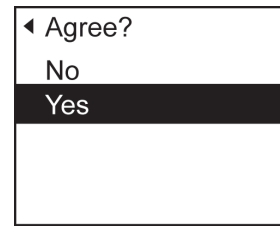

9 A confirmation message about updating ink information is shown on the Display Screen. After checking the message, press the ► button.

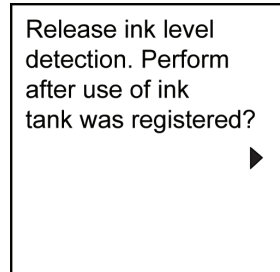

10 Press ▲ or ▼ to select **Yes**, and then press the **OK** button.

Ink level detection is now released.

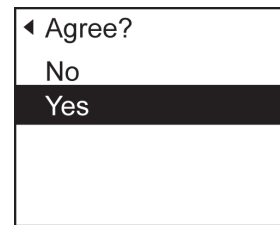

Basic Printing Workflow	19
Enhanced Printing Options	35
Windows Software	177
Mac OS X Software	363
Handling and Use of Paper	529
Control Panel	655
Printer Parts	691
Network Setting	707
Print Job Management	741
Adjustments for Better Print Quality	803
Color Management	821
Maintenance and Consumables	833
Troubleshooting	883

Error Message

Error Messages	916
Messages regarding paper	918
Messages regarding ink	928
Messages regarding printing or adjustment	930
Messages regarding printheads	933
Messages regarding the maintenance cartridge	935
Messages regarding the hard disk	936
Other Messages	938

Specifications	941
Appendix	945

Error Messages

Before borderless printing, move the blue platen switch.	931
Blue platen switch is dirty.	932
Borderless printing not possible.	926
Borderless printing not possible. Paper stretched or shrank.	931
Calibration There is a problem with the multi-sensor.	939
Cannot adjust paper feed.	932
Cannot adjust printhead.	933
Cannot calibrate.	930
Cannot cut this paper.	924
Cannot detect paper.	924
Cannot execute this command. Use other paper.	930
Cannot feed paper.	924
Cannot recognize print head x. (x is L, R, or not displayed)	934
Check printed document.	932
Close Ink Tank Cover.	928
End of paper feed.	925
ERROR Exxx-xxxx (x represents a letter or number)	938
Excessive temperature or humidity.	930
Execute printhead cleaning.	934
File read error.	936
GARO Wxxxx (x represents a number)	938
Hard disk error.	936
Hardware error. xxxxxxxx-xxxx (x represents a letter or number)	938
Ink insufficient.	928
Ink tank is empty.	929
Insufficient paper for job.	921
Mail box full. Delete unwanted data.	936
Mail box full. Now printing without saving data.	936
Mail box nearly full.	936
Maint. cart. The level is low.	935
Maintenance cartridge full.	935
Maintenance cartridge problem.	935
Maximum jobs stored.	936
Media take-up unit ready.	926
MediaType Mismatch.	918
Move the blue platen switch No.xx to the right. (xx represents a number)	932
Multi-sensor error.	939
No ink left.	928
No ink tank loaded.	929
No Maintenance Cartridge capacity.	935
No maintenance cartridge.	935
No sheets.	923
Not much ink is left.	929
Paper jam.	923
Paper loaded askew.	924
Paper mismatch.	918
Paper position not suitable for borderless printing.	926
Paper size not detected.	920
PapWidth Mismatch.	920

Parts replacement time has passed.	939
PHeads: wrong pos.	933
Please calibrate using above paper.	931
Please commn calibr using above paper.	931
Please execute common calibration.	931
Prepare for parts replacement.	939
Regular printing is selected, but a roll is loaded.	923
Rel lever is in wrong position.	925
Remaining level of the ink cannot be correctly detected.	928
Rewinding error.	925
Roll printing is selected, but sheets are loaded.	922
Roll printing is selected.	922
Sheet printing is selected.	923
The following ink tanks cannot be recognized.	929
The mail box is full.	936
The paper is too small.	919
The paper is too small.	919
The roll is empty.	922
This paper cannot be used as size is not supported.	921
Top cover is open.	938
Turn on the media take-up unit.	926
Unknown file.	939
Wrong maintenance cartridge.	935
Wrong x printhead. (x is L, R, or not displayed)	933
x printhead error (x is L, R, or not displayed)	933

Messages regarding paper

Paper mismatch 918

MediaType Mismatch 918

The paper is too small. 919

The paper is too small. 919

PaprWidth Mismatch 920

Paper size not detected. 920

Insufficient paper for job 921

This paper cannot be used as size is not supported. 921

Cannot execute this command. Use other paper. 930

Roll printing is selected. 922

Roll printing is selected, but sheets are loaded. 922

The roll is empty. 922

No sheets. 923

Sheet printing is selected. 923

Regular printing is selected, but a roll is loaded. 923

Paper jam. 923

Paper loaded askew. 924

Cannot detect papr 924

Cannot feed paper. 924

Cannot cut this paper. 924

End of paper feed. 925

Rel lever is in wrong position. 925

Rewinding error. 925

Media take-up unit ready. 926

Turn on the media take-up unit. 926

Borderless printng not possible. 926

Paper position not suitable for borderless printing. 926

Error Message

Messages regarding paper

Paper mismatch

Cause	Corrective Action
You tried to print a test pattern for printer adjustment on several sheets, but sheets of different types or sizes of paper were used.	<p>When printing a test pattern for adjustment, use sheets of the same size and type of paper, in the required quantity.</p> <p>Press ▲ or ▼ to select Change Paper, press the OK button, and replace the paper.</p> <p>(See "Loading and Printing on Sheets.") →P.25</p> <p>The printer now starts printing the test pattern.</p> <p>Press ▲ or ▼ to select Stop Printing, and then press the OK button.</p>

MediaType Mismatch

Cause	Corrective Action
When Detect Mismatch in the Control Panel menu is set to Pause , the type of paper loaded does not match the type specified in the printer driver.	<p>Follow these steps to ensure the paper type matches on the printer and in the printer driver.</p> <ol style="list-style-type: none"> 1. Press ▲ or ▼ to select Stop Printing, and then press the OK button. 2. Change the paper type setting in the printer driver to the type loaded in the printer and try printing again. <p>Follow these steps to ensure the paper type matches on the printer and in the printer driver.</p>

Cause	Corrective Action
When Detect Mismatch in the Control Panel menu is set to Pause , the type of paper loaded does not match the type specified in the printer driver.	<ol style="list-style-type: none"> 1. Press ▲ or ▼ to select Change Paper, and then press the OK button. 2. Replace the loaded paper with paper of the type and size you have specified in the printer driver. (See "Loading and Printing on Rolls.") →P.22 (See "Loading and Printing on Sheets.") →P.25 <p>Press ▲ or ▼ to select Print, and then press the OK button to resume printing. However, note that this error may cause paper jams and affect the printing quality.</p>
You tried to print a test pattern for printer adjustment on several sheets, but sheets of different types of paper were used.	<p>When printing a test pattern for adjustment, use sheets of the same type of paper, in the required quantity. Replace the paper as follows and perform adjustment again.</p> <ol style="list-style-type: none"> 1. Lift the Release Lever and stop printing. 2. Replace the paper. (See "Loading and Printing on Sheets.") →P.25 3. Execute adjustment again from the control panel menu.
When Detect Mismatch in the Control Panel menu is set to Warning , the type of paper loaded does not match the type specified in the printer driver.	You can continue to print, but note that this error may cause problems in the printing results.

The paper is too small.

Cause	Corrective Action
When Detect Mismatch in the Control Panel menu is set to Pause or Hold Job , paper smaller than the size specified in the printer driver is loaded.	<p>Press ▲ or ▼ to select Print, and then press the OK button to resume printing. However, note that this error may cause paper jams and affect the printing quality.</p> <p>Adjust the paper size setting in the printer driver to match the size loaded in the printer as follows.</p> <ol style="list-style-type: none"> 1. Press ▲ or ▼ to select Stop Printing, and then press the OK button. 2. Change the paper size setting in the printer driver to the size loaded in the printer and try printing again. <p>Replace the loaded paper with paper of a size that matches the size setting in the printer driver as follows.</p> <ol style="list-style-type: none"> 1. Press ▲ or ▼ to select Change Paper, and then press the OK button to stop printing. 2. Replace the loaded paper to match the settings in the printer driver and try printing again. (See "Loading and Printing on Rolls.") →P.22 (See "Loading and Printing on Sheets.") →P.25
When Detect Mismatch in the Control Panel menu is set to Warning , paper smaller than the size specified in the printer driver is loaded.	You can continue to print, but note that this error may cause problems in the printing results.

The paper is too small.

"Replace paper with A4/LTR (vertical) or larger"

Cause	Corrective Action
The loaded paper is too small. (When you have attempted to print a test print sheet or other printer status information.)	<p>Replace the paper with paper of A4/Letter (vertical) size or larger as follows.</p> <ol style="list-style-type: none"> 1. Press ▲ or ▼ to select Change Paper, press the OK button, and remove the paper. (See "Removing Sheets.") →P.568 2. Switch to paper A4/Letter (vertical) or larger. (See "Loading and Printing on Sheets.") →P.25

Cause	Corrective Action
The loaded paper is too small. (When you have attempted to print a test print sheet or other printer status information.)	The printer will resume printing. Press ▲ or ▼ to select Stop Printing , and then press the OK button.

"Replace roll with 10 in. wide or larger roll."

Cause	Corrective Action
The loaded paper is too small. (When you have attempted to print a test print sheet or other printer status information.)	<p>Replace the roll with a roll 10 inches in width or larger as follows.</p> <ol style="list-style-type: none"> 1. Press ▲ or ▼ to select Change Paper, and then press the OK button. (See "Removing the Roll from the Printer.") →P.547 (See "Removing the Roll Holder from Rolls.") →P.550 2. Replace the roll with a roll 10 inches wide or larger. (See "Attaching the Roll Holder to Rolls.") →P.538 (See "Loading Rolls in the Printer.") →P.541 The printer will resume printing. <p>Press ▲ or ▼ to select Stop Printing, and then press the OK button.</p>

PapWidth Mismatch

Cause	Corrective Action
When Detect Mismatch in the Control Panel menu is set to Pause or Hold Job , the width of the loaded roll does not match the width specified in Fit Roll Paper Width in the printer driver.	<p>Press ▲ or ▼ to select Print, and then press the OK button to resume printing. However, note that this error may cause paper jams and affect the printing quality.</p> <p>Press ▲ or ▼ to select Stop Printing, and then press the OK button.</p> <p>Follow these steps to replace the roll to match the width specified in the printer driver.</p> <ol style="list-style-type: none"> 1. Press ▲ or ▼ to select Change Paper, and then press the OK button. (See "Removing the Roll from the Printer.") →P.547 (See "Removing the Roll Holder from Rolls.") →P.550 2. Replace with paper of the width configured in the printer driver. (See "Attaching the Roll Holder to Rolls.") →P.538 (See "Loading Rolls in the Printer.") →P.541 The printer now starts printing the print job. <p>Make sure the roll width selected in the dialog box displayed when you select Fit Roll Paper Width in the printer driver matches the width of the roll loaded in the printer, and then try printing again.</p>

Paper size not detected.

Cause	Corrective Action
Paper has been loaded askew, or warped paper has been loaded.	<p>Lift up the Release Lever and reload the paper. (See "Loading Rolls in the Printer.") →P.541 (See "Loading Sheets in the Printer.") →P.563</p> <p>If "Not finished printing. Finish printing remaining jobs?" is displayed on the Display Screen, press the OK button. Printing will resume, starting from the page on which the error occurred.</p>

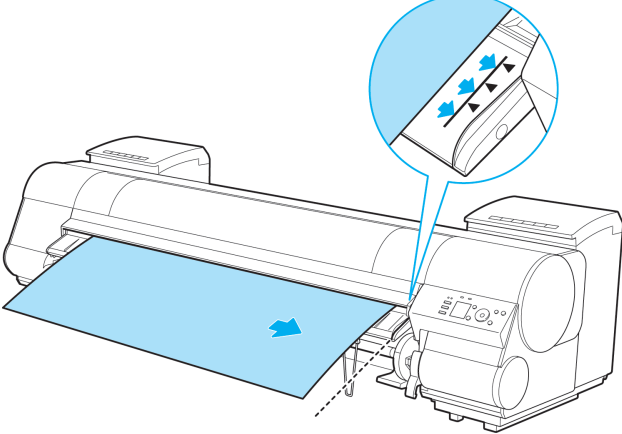
Cause	Corrective Action
	<p>If this error recurs after you reload the roll, remove the Roll Holder from the printer, push the roll firmly in until it touches the Roll Holder flange, and reload the Roll Holder in the printer. (See "Attaching the Roll Holder to Rolls.") →P.538</p>
<p>Because the Platen is soiled with ink or other substances, the size of the clear film cannot be detected.</p>	<p>Open the Top Cover and clean the entire Platen. (See "Cleaning Inside the Top Cover.") →P.869</p>

Insufficient paper for job

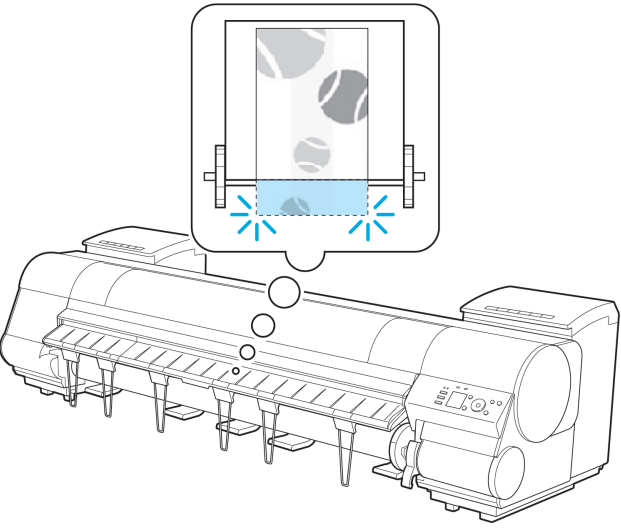
Cause	Corrective Action
<p>The printer has received a print job longer than the amount of roll paper left when ManageRemainRoll in the Control Panel menu is On.</p> 	<p>Press ▲ or ▼ to select Print, and then press the OK button to resume printing. When using the Media Take-up Unit, press ▲ or ▼ to select Print, and then press the OK button to resume printing. However, the roll paper may run out during the print job and you may not be able to print all of the document.</p> <p>Press ▲ or ▼ to select Change Paper, and then press the OK button. Change the Paper Source of the printer driver, or replace the roll with a roll that has enough paper for the print job, and then print. When using the Media Take-up Unit, press ▲ or ▼ to select Stop Printing, and then press the OK button to stop printing. Remove the printed document from the Media Take-up Unit, replace the roll with a roll that has enough paper for the print job, and then try printing again. (See "Removing the Roll from the Printer.") →P.547 (See "Loading Rolls in the Printer.") →P.541 (See "Removing Printed Documents from the Media Take-up Unit.") →P.587</p> <p>Press ▲ or ▼ to select Stop Printing or press the Stop button to stop printing.</p>

This paper cannot be used as size is not supported.

Cause	Corrective Action
<p>Paper that is too large for the printer has been loaded.</p>	<p>Lift the Release Lever and load paper of the correct size. (See "Paper Sizes.") →P.530</p>

Cause	Corrective Action
Paper that is too small for the printer has been loaded.	Lift the Release Lever and load paper of the correct size. (See "Paper Sizes.") →P.530
Paper has been loaded that is too small to print the test pattern for printhead adjustment or nozzle checking.	Lift the Release Lever and load unused paper A4/Letter (vertical) or larger. More than one sheet may be required depending on the adjustment.

Roll printing is selected.

Cause	Corrective Action
You have attempted to print on a roll, but no roll is loaded.	Press ▲ or ▼ to select Load Roll Paper , and then press the OK button. Load the roll, and then print. (See "Attaching the Roll Holder to Rolls.") →P.538 (See "Loading Rolls in the Printer.") →P.541
	Press ▲ or ▼ and select Stop Printing or press the Stop button to stop printing.

Roll printing is selected, but sheets are loaded.

Cause	Corrective Action
A print job for rolls was received when a sheet is loaded.	Follow these steps to load and print on a roll. <ol style="list-style-type: none"> 1. Press ▲ or ▼ to select Eject Paper, press the OK button, and remove the sheet. (See "Removing Sheets.") →P.568 2. Load a new roll. (See "Loading Rolls in the Printer.") →P.541 The printer now starts printing the print job.
	Press ▲ or ▼ to select Stop Printing , and then press the OK button.

The roll is empty.

Cause	Corrective Action
The roll is empty.	Follow these steps to replace the used roll with a new roll of the same type and size. <ol style="list-style-type: none"> 1. Lift the Release Lever and remove the roll. (See "Removing the Roll from the Printer.") →P.547 (See "Removing the Roll Holder from Rolls.") →P.550 2. Load the new roll. (See "Attaching the Roll Holder to Rolls.") →P.538 (See "Loading Rolls in the Printer.") →P.541 3. If no barcode was printed on the roll, specify the type of paper. (See "Changing the Type of Paper.") →P.545 4. When you have selected ManageRemainRoll > On in the control panel menu and a barcode is not printed on the roll, also specify the paper length. (See "Specifying the Paper Length.") →P.547 5. If "Not finished printing. Finish printing remaining jobs?" is shown on the Display Screen, press the OK button. Printing will resume, starting from the page on which the error occurred.
There is remaining roll paper, but because it could not be advanced, it could not be detected. <ul style="list-style-type: none"> • If the trailing edge of the paper is taped to the roll paper core 	The paper was not advanced because the trailing edge is taped to the roll paper core. Remove the used roll paper and insert a new roll paper. (See "Removing the Roll from the Printer.") →P.547 (See "Removing the Roll Holder from Rolls.") →P.550 (See "Loading and Printing on Rolls.") →P.22
There is remaining roll paper, but because it could not be advanced, it could not be detected.	The paper was not advanced because the unused portion of the roll paper is heavy and is placing a burden on the printer. It may be helpful to change the printing mode, which will change the paper feed timing.

Cause	Corrective Action
<ul style="list-style-type: none"> If the unused portion of the roll paper is heavy and is placing a burden on the printer 	Choose a higher level of Print Quality in the Advanced Settings of the printer driver. (See "Giving Priority to Particular Graphic Elements and Colors for Printing.") →P.67

No sheets.

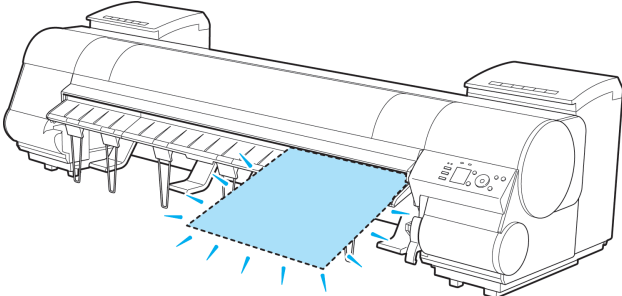
Cause	Corrective Action
<p>A sheet has come out of the printer during printing.</p> 	<ol style="list-style-type: none"> Lift the Release Lever and remove the paper. Reload the paper. (See "Loading Sheets in the Printer.") →P.563

Sheet printing is selected.

Cause	Corrective Action
You have attempted to print on a sheet, but no sheet is loaded.	<p>Press ▲ or ▼ to select Load Paper, and then press the OK button. Load a sheet, and then print. (See "Loading and Printing on Sheets.") →P.25</p> <p>Press ▲ or ▼ and select Stop Printing or press the Stop button to stop printing.</p>

Regular printing is selected, but a roll is loaded.

Cause	Corrective Action
A print job for printing on sheets was sent when a roll is loaded.	<ol style="list-style-type: none"> Press ▲ or ▼ to select Remove Roll Paper, and then press the OK button to stop printing. After removing the roll, load and print on a sheet of the type and size of paper you have specified in the printer driver. (See "Removing the Roll from the Printer.") →P.547 (See "Loading and Printing on Sheets.") →P.25 <p>Press ▲ or ▼ to select Stop Printing, and then press the OK button to stop printing.</p>
You are using a roll with the Media Take-up Unit, but a print job requiring sheets was sent.	<ol style="list-style-type: none"> Press the OK button to stop printing. After removing the roll, load and print on a sheet of the type and size of paper you have specified in the printer driver. (See "Removing Printed Documents from the Media Take-up Unit.") →P.587 (See "Loading and Printing on Sheets.") →P.25

Paper jam.

Cause	Corrective Action
A paper jam occurred in the printer during printing.	<ol style="list-style-type: none"> Lift the Release Lever and remove the jammed paper. (See "Clearing Jammed Roll Paper.") →P.886 (See "Clearing a Jammed Sheet.") →P.889 Load the paper. (See "Loading Rolls in the Printer.") →P.541 (See "Loading Sheets in the Printer.") →P.563 If "Not finished printing. Finish printing remaining jobs?" is shown on the Display Screen, press the OK button. Printing will resume, starting from the page on which the error occurred.

Paper loaded askew.

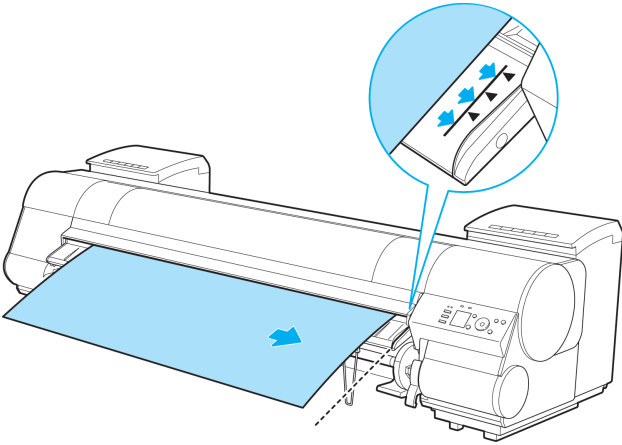
Cause	Corrective Action
<p>Paper loaded crooked was detected when the paper was advanced.</p> 	<p>Lift up the Release Lever and reload the paper. (See "Loading Rolls in the Printer.") →P.541 (See "Loading Sheets in the Printer.") →P.563</p> <p>If this error recurs after you reload the roll, remove the Roll Holder from the printer, push the roll firmly in until it touches the Roll Holder flange, and reload the Roll Holder in the printer. (See "Attaching the Roll Holder to Rolls.") →P.538</p>



• To disable this message (if it is displayed repeatedly despite reloading paper, for example), choose **Off** or **Loose** in the **Skew Check Lv.** setting of the printer menu. However, this may cause jams and printing problems because paper may be askew when printed. Also, the Platen may become soiled, which may soil the back of the next document when it is printed.

Cannot detect paper

Cause	Corrective Action
<p>The printer could not detect the paper.</p>	<p>Reload the paper as follows.</p> <ol style="list-style-type: none"> 1. Remove the paper and press the OK button. 2. Reload the paper. (See "Loading Sheets in the Printer.") →P.563 (See "Loading Rolls in the Printer.") →P.541

Cannot feed paper.

Cause	Corrective Action
<p>Paper could not be advanced correctly during feeding.</p>	<ol style="list-style-type: none"> 1. Lift the Release Lever and remove the jammed paper. (See "Clearing Jammed Roll Paper.") →P.886 (See "Clearing a Jammed Sheet.") →P.889 2. Load paper. 3. Lower the Release Lever. 4. If "Not finished printing. Finish printing remaining jobs?" is shown on the Display Screen, press the OK button. Printing will resume, starting from the page on which the error occurred. (See "Loading Rolls in the Printer.") →P.541 (See "Loading Sheets in the Printer.") →P.563

Cannot cut this paper.

Cause	Corrective Action
<p>There are sheets left on the Ejection Guide.</p>	<ol style="list-style-type: none"> 1. Lift the Release Lever and remove the paper. 2. Load paper. 3. Lower the Release Lever.

Cause	Corrective Action
There are sheets left on the Ejection Guide.	<p>4. If "Not finished printing. Finish printing remaining jobs?" is shown on the Display Screen, press the OK button. Printing will resume, starting from the page on which the error occurred.</p> <p>(See "Loading Rolls in the Printer.") →P.541</p>
There is a foreign object by the Output Tray, obstructing the Cutter Unit.	<p>1. Lift the Top Cover and remove the foreign object.</p> <p>2. If "Not finished printing. Finish printing remaining jobs?" is shown on the Display Screen, press the OK button. Printing will resume, starting from the page on which the error occurred.</p>
You are not using the printer under the recommended environmental conditions for the paper.	Use the printer only where the recommended environmental conditions for the paper are met. Note that various environmental conditions are recommended for various types of paper. For details on the recommended environmental conditions, see the Paper Reference Guide. (See Paper Reference Guide.)
You are using paper that is not compatible with automatic cutting.	<p>1. Specify Manual as the cutting method and use scissors or a cutting tool to cut the roll. (See "Specifying the Cutting Method for Rolls.") →P.554 For information about paper that is compatible with automatic cutting, see the Paper Reference Guide. (See Paper Reference Guide.)</p> <p>2. Lift the Release Lever and remove the paper.</p>
In other cases, the Cutter Unit may be damaged.	Contact your Canon dealer for assistance.

End of paper feed.

Cause	Corrective Action
Although an attempt was made to advance the paper manually, it reached the limit position that can be advanced.	Canceling manual advancing. (See "Feeding Roll Paper Manually.") →P.551
Paper can be retracted only up to 17 mm (0.7 in) when using the Media Take-up Unit.	Canceling manual advancing.

Rel lever is in wrong position.

Cause	Corrective Action
The Release Lever is up.	Lower the Release Lever. If the error occurs again, turn off the printer and wait a while before restoring power.

Rewinding error.

Cause	Corrective Action
There is some foreign object near the Media Take-up Unit sensor and the roll cannot be detected.	Remove the foreign object near the sensor.
The Media Take-up Unit sensor is soiled and the roll cannot be detected.	Wipe the sensor with a dry cloth to clean it.
The roll is out of range of detection by the Media Take-up Unit sensor.	Reload the roll. Press the OK button to clear the error. (See "Loading Rolls in the Printer.") →P.541 (See "Loading the Rewind Spool on the Media Take-up Unit.") →P.580
A paper jam has occurred and the roll cannot be rewound.	Remove the paper from the Media Take-up Unit. Press the OK button to clear the error.
The Media Take-up Unit sensor is damaged.	Contact your Canon dealer for assistance.

*1: Printing will stop momentarily if an error involving the Media Take-up Unit occurs. If you prefer printing not to stop, set **Skip Take-Up Error On**. However, note that this error may cause paper jams and affect the printing quality.

Media take-up unit ready.

Cause	Corrective Action
The Take-up Reel setting in the printer Set./Adj. Menu was changed from Enable to Disable , but a print job was received before the roll was removed.	Press ▲ or ▼ to select Stop Printing , and then press the OK button to stop printing. The mode switches from take-up mode to regular mode after you change the Take-up Reel setting in the Set./Adj. Menu from Enable to Disable and lift the Release Lever to remove a roll, or after you execute Paper Cutting .
	Press ▲ or ▼ to select Print , and then press the OK button to resume printing.

Turn on the media take-up unit.

Cause	Corrective Action
The Take-up Reel setting in the control panel menu was changed to Enable while the power to the Take-up Reel was off and the Roll Media lamp on the control panel was lit.	Turn the Media Take-up Unit on.
	The Take-up Reel setting in the control panel menu changes to Disable .

Borderless printing not possible.

Cause	Corrective Action
The print job received specifies a type or width of paper that is not compatible with borderless printing.	Follow these steps to change the settings of the print job to enable borderless printing. <ol style="list-style-type: none"> 1. Press ▲ or ▼ to select Stop Printing, and then press the OK button. 2. Make sure the correct printer driver for the printer is selected and try printing again. For information on types of paper compatible with borderless printing, refer to the Paper Reference Guide. (See Paper Reference Guide.)
	Select None when you have set Detect Mismatch on the control panel to Warning . However, note that this error may cause paper jams and affect the printing quality.
	Press ▲ or ▼ to select Print With Border , and then press the OK button to continue printing. The document will be printed with a border.
The loaded paper is a size not compatible with borderless printing.	Press ▲ or ▼ to select Stop Printing , and then press the OK button.
	Replace the paper with paper compatible for borderless printing as follows. <ol style="list-style-type: none"> 1. Press ▲ or ▼ to select Change Paper, and then press the OK button. (See "Removing the Roll from the Printer." →P.547) (See "Removing the Roll Holder from Rolls." →P.550) 2. Replace the paper with paper compatible for borderless printing. (See "Attaching the Roll Holder to Rolls." →P.538) (See "Loading Rolls in the Printer." →P.541) The printer now starts printing the print job. For information on types of paper compatible with borderless printing, refer to the Paper Reference Guide. (See Paper Reference Guide.)
	Press ▲ or ▼ to select Print With Border , and then press the OK button to continue printing. The document will be printed with a border.

Paper position not suitable for borderless printing.

Cause	Corrective Action
Because paper expands or contracts depending on the environment of use, it may become narrower or wider than the supported width for borderless printing.	Press ▲ or ▼ to select Stop Printing , and then press the OK button. Use each type of paper only where the recommended environmental conditions are met. For details on environmental conditions for various paper, see the Paper Reference Guide. (See Paper Reference Guide.)
	Select None when you have set Detect Mismatch in the Control Panel menu to Warning .

Cause	Corrective Action
Because paper expands or contracts depending on the environment of use, it may become narrower or wider than the supported width for borderless printing.	However, note that this error may affect the printing quality.
The paper is loaded askew.	Press ▲ or ▼ to select Change Paper and straighten the paper so that the edges are between the ink grooves for borderless printing. Insert the roll firmly until it touches the flange of the Roll Holder. (See "Attaching the Roll Holder to Rolls.") →P.538
	Select None when you have set Detect Mismatch in the Control Panel menu to Warning . However, note that this error may affect the printing quality.
	Press ▲ or ▼ to select Print With Border , and then press the OK button to continue printing. The document will be printed with a border.
	Press ▲ or ▼ to select Stop Printing , and then press the OK button.

Messages regarding ink

Ink insufficient.	928
No ink left.	928
Remaining level of the ink cannot be correctly detected.	928
Close Ink Tank Cover	928
Ink tank is empty.	929
Not much ink is left.	929
No ink tank loaded.	929
The following ink tanks cannot be recognized.	929

Ink insufficient.

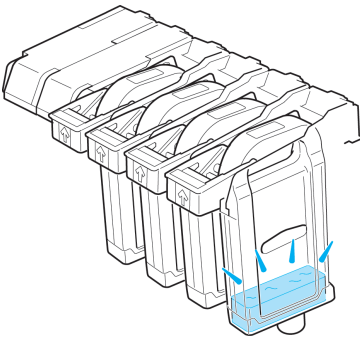
Cause	Corrective Action
<p>The ink level is low, so you cannot print, clean the Printhead, or do other operations that require ink.</p> 	<p>Press the OK button and replace the Ink Tank that is low with a new Ink Tank. (See "Replacing Ink Tanks.") →P.834</p>

No ink left.

Cause	Corrective Action
<p>There is no ink left. There are no ink colors with × displayed above the remaining ink indicator.</p>	<p>Press the OK button, open the Ink Tank Cover, and replace the Ink Tank for the color that is out of ink. (See "Replacing Ink Tanks.") →P.834</p>

Remaining level of the ink cannot be correctly detected.

Cause	Corrective Action
<p>Ink level detection cannot work correctly if you use refill ink tanks.</p>	<p>The refill ink tank can no longer be used. See the section Ink level detection and take the appropriate action. (See "Ink Level Detection.") →P.912</p>

Close Ink Tank Cover

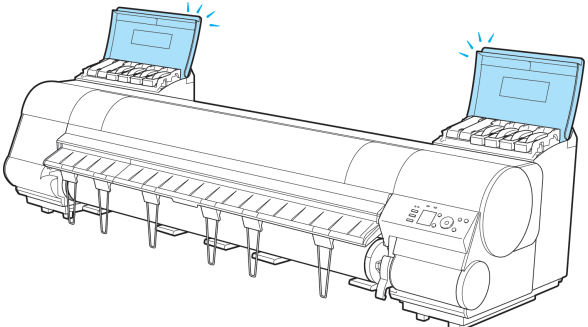
Cause	Corrective Action
<p>The Ink Tank Cover is open.</p> 	<p>Close the Ink Tank Cover.</p>

Ink tank is empty.

Cause	Corrective Action
<p>There is no ink left in an ink tank. There are no ink colors with ✕ displayed above the remaining ink indicator in the Ink tab top screen. (See "Checking Ink Tank Levels.") →P.844</p>	<p>Open the Ink Tank Cover, and replace the Ink Tank for the color that is out of ink. (See "Replacing Ink Tanks.") →P.834</p>

Not much ink is left.

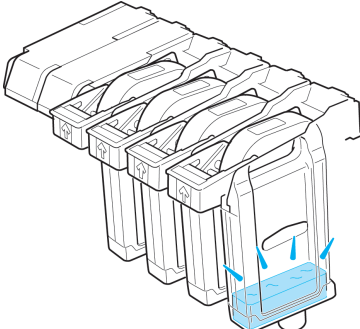
Cause	Corrective Action
<p>Not much ink is left.</p> 	<p>Prepare a new Ink Tank. We recommend replacing the Ink Tank with a new Ink Tank at this point if you plan to print large-format or high-quantity jobs.</p>

No ink tank loaded.

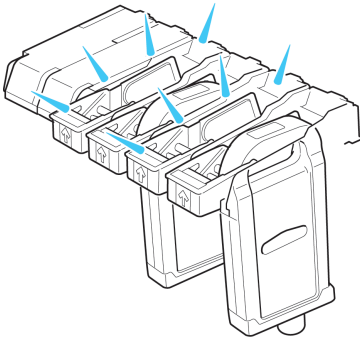
Cause	Corrective Action
<p>There is no Ink Tank of the indicated color in the printer.</p> 	<p>Load the Ink Tank. (See "Replacing Ink Tanks.") →P.834</p>
<p>There is a problem with the Ink Tank.</p>	<p>Replace it with a new Ink Tank. (See "Replacing Ink Tanks.") →P.834</p>

The following ink tanks cannot be recognized.

Cause	Corrective Action
<p>An Ink Tank that is incompatible with the printer is loaded.</p>	<p>Load an Ink Tank that is compatible with the printer. (See "Replacing Ink Tanks.") →P.834</p>

Messages regarding printing or adjustment

Cannot execute this command. Use other paper.	930
Cannot adjust printhead.	933
Cannot calibrate.	930
Excessive temperature or humidity.	930
Please execute common calibration.	931
Please commn calibr using above paper.	931
Please calibrate using above paper.	931
Borderless printing not possible. Paper stretched or shrank.	931
Before borderless printing, move the blue platen switch.	931
Borderless printing not possible.	926
Blue platen switch is dirty.	932
Move the blue platen switch No.xx to the right. (xx represents a number)	932
Cannot adjust paper feed.	932
Check printed document.	932

Cannot execute this command. Use other paper.

Cause	Corrective Action
Paper compatible with color calibration is not loaded.	<ol style="list-style-type: none"> 1. Press the OK button to clear the error. 2. Load paper that is compatible with color calibration. See the Paper Reference Guide. (See Paper Reference Guide.) <p>Always make sure the loaded paper matches the type of paper in the printer paper settings. Adjustment cannot be completed correctly unless the loaded paper matches the settings.</p>

Cannot calibrate.

Cause	Corrective Action
The paper for printing a test pattern is soiled. Otherwise, you have loaded colored paper.	Press the OK button to clear the error. Load unused paper compatible with color calibration. (See Paper Reference Guide.)
The test pattern was printed too faintly.	Press the OK button to clear the error. Take steps to remedy faint printing. (See "Printing is faint." →P.896)
Direct sunlight or strong lighting may be shining on the printer and causing the sensor to malfunction.	Press the OK button to clear the error. Take steps to ensure the printer is not used when exposed to direct sunlight or strong lighting.

Excessive temperature or humidity.

Cause	Corrective Action
The temperature or humidity where the printer is installed is out of the acceptable range for operation.	<p>Press ▲ or ▼ to select Stop, and then press the OK button to stop printing. Use the printer under suitable environmental conditions. Also note that various environmental conditions are recommended for various types of paper. For details on the recommended environmental conditions, see the Paper Reference Guide. (See Paper Reference Guide.)</p> <p>Press ▲ or ▼ to select Continue, and then press the OK button to continue with color calibration. However, note that correct adjustment may not be possible.</p>

Please execute common calibration.

Cause	Corrective Action
<p>There is not even one Common calibration execution result. Note that this is displayed when all of the following are satisfied.</p> <ul style="list-style-type: none"> • If "Set Exec. Guide" is On in the Control Panel menu. • If the printer is loaded with a type of paper on which color calibration cannot be executed. 	<p>Execute Common calibration. (See "Corrects slight differences in how colors appear (color calibration).") →P.828</p> <p>Set "Set Exec. Guide" to Off on the Control Panel menu. (See "Menu Structure.") →P.669</p>

Please commn calibrtr using above paper.

Cause	Corrective Action
<p>It is now recommended that you execute Common calibration. Note that this is displayed when "Set Exec. Guide" in the Control Panel menu is set to On and any of the following is true.</p> <ul style="list-style-type: none"> • If the printer is loaded with a type of paper on which color calibration cannot be executed and the predefined conditions since executing the Common calibration the last time have been reached. • Although a media type that color calibration can be executed on is loaded in the printer, there is no record or performing color calibration on that media, and the designated criteria from executing Common calibration the last time have been reached. 	<p>Execute Common calibration. (See "Corrects slight differences in how colors appear (color calibration).") →P.828</p> <p>Set "Set Exec. Guide" to Off on the Control Panel menu. (See "Menu Structure.") →P.669</p>

Please calibrate using above paper.

Cause	Corrective Action
<p>It is now recommended that you execute Unique calibration. Note that this is displayed when "Set Exec. Guide" in the Control Panel menu is set to On and any of the following is true.</p> <ul style="list-style-type: none"> • If the printer is loaded with a type of paper on which color calibration can be executed, but there is no record of having executed color calibration on that paper or a record of having executed Common calibration other any other type of paper. • If the printer is loaded with a type of paper on which color calibration can be executed, there is a record of having executed color calibration on that paper, and the predefined conditions since executing the color calibration the last time have been reached. 	<p>Execute Unique calibration. (See "Corrects slight differences in how colors appear (color calibration).") →P.828</p> <p>Set "Set Exec. Guide" to Off on the Control Panel menu. (See "Menu Structure.") →P.669</p>

Borderless printng not possible. Paper stretched or shrank.

Cause	Corrective Action
<p>The loaded roll has expanded or contracted due to environmental conditions, making it wider or narrower than the supported width for borderless printing.</p>	<p>Press the OK button to stop printing.</p> <p>Use each type of paper only where the recommended environmental conditions are met. For details on environmental conditions for various paper, see the Paper Reference Guide. (See Paper Reference Guide.)</p>

Before borderless printing, move the blue platen switch.

Cause	Corrective Action
<p>The blue Switch on the platen was set to the side opposite • when a borderless print job was received.</p>	<p>Before borderless printing, set the blue Switch on the platen to the • side. (See "Setting the Blue Switch on the Platen.") →P.901</p>

Blue platen switch is dirty.

Cause	Corrective Action
The blue Switch on the platen is dirty.	Open the Top Cover and clean the blue Switch on the platen. (See "Cleaning Inside the Top Cover.") →P.869

Move the blue platen switch No.xx to the right. (xx represents a number)

Cause	Corrective Action
The printer has detected that the blue Switch on the platen needed in main-tenance during printing is set away from the ● mark.	Set blue platen Switch of the indicated number toward the ● side. (See "Setting the Blue Switch on the Platen.") →P.901

Cannot adjust paper feed.

Cause	Corrective Action
The Printhead nozzles are clogged.	Execute Adj. Quality again, as follows. <ol style="list-style-type: none"> 1. Press the OK button to clear the error. 2. Print a test pattern to check the nozzles. (See "Checking for Nozzle Clogging.") →P.846 3. Clean the Printhead if the nozzles are clogged. (See "Cleaning the Printhead.") →P.847 4. Execute Adj. Quality again. (See "Automatic Banding Adjustment.") →P.814
Highly transparent film is loaded that cannot be used for automatic feed amount adjustment.	Press the OK button to clear the error, and then adjust the feed amount manually. (See "Manual Banding Adjustment.") →P.815

Check printed document.

Cause	Corrective Action
The Printhead nozzles are becoming clogged.	If printing is faint, clean the Printhead. (See "Cleaning the Printhead.") →P.847

Messages regarding printheads

Cannot adjust printhead.	933
PHeads: wrong pos.	933
Wrong x printhead. (x is L, R, or not displayed)	933
x printhead error (x is L, R, or not displayed)	933
Cannot recognize print head x. (x is L, R, or not displayed)	934
Execute printhead cleaning.	934

Cannot adjust printhead.

Cause	Corrective Action
The Printhead nozzles are clogged.	Execute Head Posi. Adj. again, as follows. <ol style="list-style-type: none"> 1. Press the OK button to clear the error. 2. Print a test pattern to check the nozzles. (See "Checking for Nozzle Clogging.") →P.846 3. Clean the Printhead if the nozzles are clogged. (See "Cleaning the Printhead.") →P.847 4. Execute Head Posi. Adj. again. (See "Automatic Adjustment to Straighten Lines and Colors.") →P.806
The Printhead cannot be aligned; highly transparent film is loaded.	Press the OK button to clear the error. We recommend using a type of paper that you often use, other than film, for Printhead adjustment. (See "Automatic Adjustment to Straighten Lines and Colors.") →P.806

PHeads: wrong pos.

Cause	Corrective Action
The printheads are installed in the wrong positions.	Open the Top Cover and switch the Printhead used once in the right side to the right side. Switch the Printhead used once in the left side to the left side.

Wrong x printhead. (x is L, R, or not displayed)

Cause	Corrective Action
An incompatible Print-head has been installed.	Open the Top Cover. Replace the Printhead L with a new one if Printhead L is displayed and the Printhead R if Printhead R is displayed. If neither left or right is indicated, replace both Printhead L and Printhead R with new ones. (See "Replacing the Printhead.") →P.848

x printhead error (x is L, R, or not displayed)

Cause	Corrective Action
There is a problem with the Print-head.	Follow these steps to replace the Printhead. <ol style="list-style-type: none"> 1. Open the Top Cover. 2. Replace the Printhead L with a new one if Printhead L is displayed and the Printhead R if Printhead R is displayed. If neither left or right is indicated, replace both Printhead L and Printhead R with new ones. (See "Replacing the Printhead.") →P.848
	Follow these steps to replace the Printhead. <ol style="list-style-type: none"> 1. Turn off the printer, wait a while, and then turn it on again. 2. Open the Top Cover. 3. Replace the left printhead with a new one if Printhead L is displayed and the right one if Printhead R is displayed. If neither left or right is indicated, replace both printheads. (See "Replacing the Printhead.") →P.848

Cannot recognize print head x. (x is L, R, or not displayed)

Cause	Corrective Action
No Printhead is installed.	<p>Follow these steps to install the Printhead.</p> <ol style="list-style-type: none"> 1. Open the Top Cover. 2. Install the Printhead L if Printhead L is displayed and the Printhead R if Printhead R is displayed. If neither left or right is indicated, install both Printhead L and Printhead R. (See "Replacing the Printhead.") →P.848
The Printhead cannot be recognized because it is not installed correctly.	<p>Follow these steps to reinstall the Printhead.</p> <ol style="list-style-type: none"> 1. Open the Top Cover. 2. Reinstall the Printhead L if Printhead L is displayed and the Printhead R if Printhead R is displayed. If neither left nor right is indicated, re-install both Printhead L and Printhead R. (See "Replacing the Printhead.") →P.848

Execute printhead cleaning.

Cause	Corrective Action
The Printhead nozzles are clogged.	<p>Follow these steps to clean the Printhead.</p> <ol style="list-style-type: none"> 1. Stop printing by pressing ▲ or ▼ to select Stop Printing. 2. Clean the Printhead. (See "Cleaning the Printhead.") →P.847 <p>If the message is still displayed when printing, replace the Printhead. (See "Replacing the Printhead.") →P.848</p> <p>Press ▲ or ▼ to select Print, and then press the OK button to resume printing. However, note that this error may affect the printing quality.</p> <p>If OK is shown on the Display Screen, clean the Printhead.</p> <ol style="list-style-type: none"> 1. Press the OK button on the Control Panel to stop printing. 2. Clean the Printhead. (See "Cleaning the Printhead.") →P.847 <p>If the message is still displayed when printing, replace the Printhead. (See "Replacing the Printhead.") →P.848</p>

Messages regarding the maintenance cartridge

No maintenance cartridge.	935
Wrong maintenance cartridge.	935
Maint. cart. The level is low	935
No Maintenance Cartridge capacity.	935
Maintenance cartridge full.	935
Maintenance cartridge problem.	935

No maintenance cartridge.

Cause	Corrective Action
The Maintenance Cartridge is not installed.	Install the Maintenance Cartridge. (See "Replacing the Maintenance Cartridge.") →P.860

Wrong maintenance cartridge.

Cause	Corrective Action
A Maintenance Cartridge for a different model of printer is installed.	Replace it with the Maintenance Cartridge for your particular model. (See "Maintenance Cartridge.") →P.860

Maint. cart. The level is low

Cause	Corrective Action
The Maintenance Cartridge is almost full.	You can continue to print, but prepare a new Maintenance Cartridge to use when the message for replacement is displayed.

No Maintenance Cartridge capacity.

Cause	Corrective Action
The Maintenance Cartridge cannot absorb enough ink for Printhead cleaning or other operation.	After confirming that the printer has stopped operating, replace the Maintenance Cartridge. (See "Replacing the Maintenance Cartridge.") →P.860

Maintenance cartridge full.

Cause	Corrective Action
The Maintenance Cartridge is full.	After confirming that the printer has stopped operating, replace the Maintenance Cartridge. (See "Replacing the Maintenance Cartridge.") →P.860

Maintenance cartridge problem.

Cause	Corrective Action
An incompatible or used Maintenance Cartridge has been installed.	Install an unused Maintenance Cartridge specified for use with the printer. (See "Replacing the Maintenance Cartridge.") →P.860

Messages regarding the hard disk

Hard disk error.	936
File read error.	936
The mail box is full.	936
Mail box full. Now printing without saving data.	936
Mail box nearly full.	936
Maximum jobs stored.	936
Mail box full. Delete unwanted data	936

Hard disk error.

Cause	Corrective Action
The format of the printer's hard disk is invalid.	Press the OK button to start reformatting the hard disk. When formatting is finished, data on the printer hard disk is erased and the printer automatically restarts.

File read error.

Cause	Corrective Action
Files on the printer's hard disk have become corrupted.	Restart the printer. Only the corrupted files will be deleted, and the printer will restart.

The mail box is full.

Cause	Corrective Action
There is no more space on the printer's hard disk.	Press the Stop button and stop printing.
	Delete print jobs from the queue. (See "Managing the Job Queue (Deleting or Preempting Other Jobs).") →P.767
	Delete unneeded jobs stored in personal boxes. (See "Deleting Saved Jobs.") →P.776

Mail box full. Now printing without saving data.

Cause	Corrective Action
No more space is available on the printer's hard disk, so jobs are now printed without saving them. (Print jobs can no longer be saved on the hard disk.)	After printing, this message is cleared.
	Delete unneeded jobs stored in personal boxes. (See "Deleting Saved Jobs.") →P.776

Mail box nearly full.

Cause	Corrective Action
The free hard disk space left for Personal Boxes in the printer's hard disk does not have more than 1 GB, combined.	Delete unneeded jobs stored in Personal Boxes. (See "Deleting Saved Jobs.") →P.776

Maximum jobs stored.

Cause	Corrective Action
100 jobs are stored in the personal box.	Delete unneeded jobs stored in personal boxes. (See "Deleting Saved Jobs.") →P.776

Mail box full. Delete unwanted data

Cause	Corrective Action
100 jobs are stored in the Personal Box.	Press the Stop button and stop printing.
	Delete print jobs from the queue.

Cause	Corrective Action
100 jobs are stored in the Personal Box.	(See "Managing the Job Queue (Deleting or Preempting Other Jobs).") →P.767
	Delete unneeded jobs stored in personal boxes. (See "Deleting Saved Jobs.") →P.776

Other Messages

GARO Wxxxx (x represents a number)	938
ERROR Exxx-xxxx (x represents a letter or number)	938
Hardware error. xxxxxxxx-xxxx (x represents a letter or number)	938
Top cover is open.	938
Prepare for parts replacement.	939
Parts replacement time has passed.	939
Unknown file.	939
Calibration There is a problem with the multi-sensor.	939
Multi-sensor error	939

GARO Wxxxx (x represents a number)

Cause	Corrective Action
There is a problem with the print job.	Try printing again, using the correct printer driver.
	It is also possible to continue printing in this state. However, you may not be able to obtain the desired printing results.

ERROR Exxx-xxxx (x represents a letter or number)

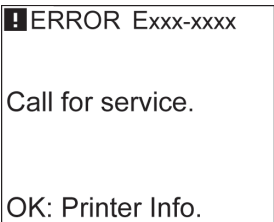
Cause	Corrective Action
An error requiring service may have occurred. 	Write down the error code and message, turn off the printer, and contact your Canon dealer for assistance.

Hardware error. xxxxxxxx-xxxx (x represents a letter or number)

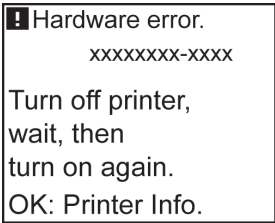
Cause	Corrective Action
The last portion of roll paper was used during a print job. The paper was not advanced because the trailing edge is taped to the roll.	Turn off the printer and remove the roll from the printer before restoring power.
Fastening tape or the Belt Stopper has not been removed inside the Top Cover.	Turn off the printer, open the Top Cover and remove the tape or the Belt Stopper before restoring power.
An error requiring service may have occurred. 	Turn off the printer and wait at least three seconds before restoring the power. If the message is displayed again, write down the error code and message, turn off the printer, and contact your Canon dealer for assistance.

Top cover is open.

Cause	Corrective Action
The printer has detected that the Top Cover is open.	Open the Top Cover fully, remove any foreign objects, and close the Top Cover again.
	If the error occurs again, turn off the printer and wait a while before restoring power.

Prepare for parts replacement.

Cause	Corrective Action
It is almost time to replace consumables for which service is required.	If "Parts replacement time has passed." is displayed, you can continue to use the printer for some time. Contact your Canon dealer for assistance.

Parts replacement time has passed.

Cause	Corrective Action
It is past the recommended time to replace consumables for which service is required.	Contact your Canon dealer for assistance.

Unknown file.

Cause	Corrective Action
Data sent to keep the printer up to date (such as paper information) is in the wrong format.	Check the data. Turn off the printer and wait a while before restoring power, and then resend the data.
You have uploaded firmware for a different model.	Check the firmware version. Turn off the printer and wait a while before restoring power, and then resend the firmware. If the message is displayed again, contact your Canon dealer for assistance.

Calibration There is a problem with the multi-sensor.

Cause	Corrective Action
The performance of a sensor inside the printer may be impaired.	Press the OK button and cancel calibration. Contact your Canon dealer for assistance.

Multi-sensor error

Cause	Corrective Action
Direct sunlight or strong lighting may be shining on the printer and causing the sensor to malfunction.	Take steps to ensure the printer is not used when exposed to direct sunlight or strong lighting.
The performance of a sensor inside the printer may be impaired.	Turn off the printer and wait at least three seconds before restoring the power. If the message is displayed again, contact your Canon dealer for assistance.

Memo

User's Guide

Basic Printing Workflow	19
Enhanced Printing Options	35
Windows Software	177
Mac OS X Software	363
Handling and Use of Paper	529
Control Panel	655
Printer Parts	691
Network Setting	707
Print Job Management	741
Adjustments for Better Print Quality	803
Color Management	821
Maintenance and Consumables	833
Troubleshooting	883
Error Message	915

Specifications

Printer Specifications	942
------------------------------	-----

Appendix	945
----------	-----

Printer Specifications

Specifications	942
Print Area	943

Specifications



- The following values may vary depending on the operating environment.

Printer

Power supply	100–240 V AC (50/60 Hz)		
Power consumption	During operation	190 W max.	
		100–120 V: 5 W max.	
		220–240 V: 6 W max.	
	Off	0.5 W max. (*1)	
Operating noise (*2)	Sound pressure level	During operation	Approx. 52 dB (A)
		Standby	35 dB (A) max.
	Audio power level (during operation)		Approx. 6.8 bels
Operating environment	Temperature	15–30°C (59–86°F)	
	Humidity	10–80%, non-condensing	
Dimensions (W × D × H)	Printer and Stand (including Roll Holder and Media Take-up Unit)	2,299 × 766 × 1,144 mm (90.5 × 30.2 × 45.0 in)	
Weight	Printer and Stand (including Roll Holder and Media Take-up Unit) (not including Printhead and Ink Tank)	Approx. 162 kg (357.1 lb)	
Space for installation (W × D × H)	Printer and Stand	2,699 × 1,466 × 1,500 mm (106.3 × 57.7 × 59.1 in)	
Applicable standards	International Energy Star Program (worldwide), Law on Promoting Green Purchasing (Japan), GPN, RoHS directive, IT Eco Declaration (Europe), WEEE, U.S. presidential directives, J-MOSS (Green Mark), Chinese RoHS, ErP Lot6 (Europe)		

*1: The printer uses a trace amount of power even when turned off. To stop all power consumption, turn off the printer and unplug the power cord.

*2: Calculation based on ISO 7779. Operating conditions: On the **Main** sheet of the printer driver, **Media Type > Canon Coated Paper, Advanced Settings > Print Priority > Image, and Print Quality > Standard**.

Printing performance

Print method	Bubblejet
Maximum resolution	2400 dpi horizontally (*1) × 1200 dpi vertically
Printhead	PF-05 ×2
Number of nozzles	C,PC,PM,GY : 2560 nozzles X 2 BK,MBK,M,Y: 2560 nozzles X 1

*1: Prints with a minimum 1/2400 inch dot pitch between ink droplets.

Memory and hard disk

Memory	640 MB	
Hard disk capacity	250 GB	
	Personal mail boxes (Permanent storage area)	140 GB
Print job storage capacity	Common Box	100 jobs
	Personal Boxes	100 jobs

Interface

Hi-Speed USB	Format	Internal port
	Mode	Full-speed (12 Mbps), high-speed (480 Mbps), bulk transfer
	Connector	Series B (4-pin)
Gigabit Ethernet	Format	Internal port
	Specification	IEEE 802.3 10Base-T, IEEE 802.3u 100Base-TX/Auto-Negotiation, IEEE 802.3ab 1000Base-T/Auto-Negotiation, IEEE 802.3x Full Duplex
	Protocols	IPX/SPX (Netware 4.2, 5.1, 6.0), SNMP (Canon-MIB compatible), HTTP, TCP/IP (IPv4/IPv6), AppleTalk

Ink

For information on the ink the printer supports, see "Ink Tanks." →P.834

Paper

For information on the types of paper the printer supports, refer to the Paper Reference Guide. (See Paper Reference Guide.)

For information on the paper sizes the printer supports, see "Paper Sizes." →P.530

Paper width	Rolls	254–1,524 mm (10–60 in)
	Sheets	203.2–1,524 mm (8–60 in)
Minimum paper length	203.2 mm (8.0 in)	
Maximum printable length (*1)	Rolls	18 m (19.7 yd)
	Sheets	1,600 mm (63.0 in)
Thickness	Rolls	0.07–0.8 mm (0.0028–0.031 in)
	Sheets	0.07–0.8 mm (0.0028–0.031 in)
Roll maximum outer diameter	150 mm (6 in) or shorter	
Supported paper core inner diameter	2 inches / 3 inches	
Print area	For details, see "Print Area." →P.943	

*1: Varies depending on the operating system or application.

Print Area

A margin required by the printer is added with respect to the size of paper loaded in the printer. Except in borderless printing, the actual printing area corresponds to the paper size minus the space for this margin.



- **Printable Area:** The area that can be printed.
- **Note** There is no margin (that is, a margin of 0 mm) during borderless printing on rolls.
- **Recommended Print Area:** We recommend printing within this area.
- To print so that your original matches the print area exactly, use an oversized paper size that includes the required margin. (See "Printing on Oversize Paper." →P.90)

	Margins of Printable Area			Margins of Recommended Print Area		
	Top Edge	Bottom Edge	Sides	Top Edge	Bottom Edge	Sides
Sheets	5 mm (0.20 in)	23 mm (0.91 in)	5 mm (0.20 in)	20 mm (0.79 in)	23 mm (0.91 in)	5 mm (0.20 in)
Rolls	0/5 mm (0/0.20 in)	0/5 mm (0/0.20 in)	0/5 mm (0/0.20 in)	20 mm (0.79 in)	5 mm (0.20 in)	5 mm (0.20 in)

Sheets



• **Printable Area:**

A margin of 5 mm (0.20 in) on top, 23 mm (0.91 in) on bottom, and 5 mm (0.20 in) on left and right sides is required.

• **Recommended Print Area:**

A margin of 20 mm (0.79 in) on top, 23 mm (0.91 in) on bottom, and 5 mm (0.20 in) on left and right sides is required.

Rolls



• **Printable Area:**

A margin of 5 mm (0.20 in) on all sides is required. During borderless printing, the margin on all sides is 0 mm. For information on paper compatible with borderless printing, see the Paper Reference Guide. (See "Types of Paper." →P.530)

• **Recommended Print Area:**

A margin of 20 mm (0.79 in) on top, 5 mm (0.20 in) on bottom, and 5 mm (0.20 in) on left and right sides is required.

Basic Printing Workflow	19
Enhanced Printing Options	35
Windows Software	177
Mac OS X Software	363
Handling and Use of Paper	529
Control Panel	655
Printer Parts	691
Network Setting	707
Print Job Management	741
Adjustments for Better Print Quality	803
Color Management	821
Maintenance and Consumables	833
Troubleshooting	883
Error Message	915
Specifications	941

Appendix

Safety Precautions	946
Manuals for this printer	950
How to use this manual	952
Disposal of the product	959



Safety Precautions

Safety Precautions 946
 Legal Notices 948



Safety Precautions

Follow the warnings and precautions below to use the printer safely. Do not perform any operations or procedures other than as described in this manual. Doing so may result in unexpected accidents and can cause a fire or electrical shocks.

Printer location

-  **Warning**
 - Do not set up the printer in any location exposed to alcohol, thinner, or other volatile liquids. If these substances come into contact with electrical components inside the printer, there is a risk of fire or electrical shock.
-  **Caution**
 - Never install the printer on an unstable or vibrating surface. If it falls over, this could cause personal injury.
 - Never set up the printer in a location that is exposed to high humidity or large amounts of dust, or exposed to direct sunlight, high temperature, or open flame. This could cause a fire or electrical shock. Use the printer location in an environment where temperature and humidity are within the ranges of 15 °C to 30 °C (59 °F to 86 °F) and 10 to 80% RH (with no condensation).
 - Never place the printer on a heavy wool or shag carpet. The fibers may enter the printer and cause a fire.
 - Keep the area around the power outlet clear of items so that you can disconnect the power cable immediately if the printer starts operating abnormally. In the event of a printer malfunction, remove the power cable from the outlet as soon as possible to prevent fire and electrical shocks.
 - Do not install the printer near sources of strong electromagnetic fields, whether equipment that generates such fields or places where such fields occur. This could damage the printer or cause malfunction.

Power Supply

-  **Warning**
 - Never handle the power cable with wet hands. Doing so may cause electrical shock.
 - Insert the power cable securely and completely into the power source. If the power cable is not inserted completely, this could cause a fire or electrical shock.
 - Do not use any power cable other than the one provided. This could cause a fire or electrical shock. Never use the power cable with any other electrical device.
 - Never cut the power cable or attempt to modify it, and never stretch it or bend it forcefully. Never place a heavy object on the power cable. Damaged sections of the power cable could cause a short circuit and may cause a fire or electrical shock.
 - Never connect the power cable to a power strip or any power source shared by other electrical devices. This could cause a fire or electrical shock.
 - Never knot the power cable or wrap it around itself. This could cause a fire or electrical shock.
 - Periodically disconnect the power cable and use a dry cloth to wipe away dust that has collected on the plug and the area around the power outlet. Leaving the power cable plugged in and not cleaned for a long period, especially in an area subject to dust, oil, and humidity, could cause the insulation material to deteriorate and lead to a fire.
-  **Caution**
 - Always grip the plug to remove the power cable from the power outlet. Pulling on the power cable could damage the cable and lead to a fire or electrical shock.
 - Never use an extension cord. This could cause a fire or electrical shock.
 - Never use any power source other than 100–120 / 220–240 V AC. This could cause a fire or electrical shock. The printer operating conditions are described below. Use the printer under the following conditions.
 Power supply voltage: 100–120 / 220–240 V AC
 Power supply frequency: 50/60 Hz

In an Emergency



Warning

- If the printer emits smoke or strange odors, continuing to use the printer may cause a fire or electrical shock. Switch the printer off immediately and remove the power plug from the power outlet. Contact the nearest service center.

Cleaning the Printer



Warning

- For cleaning, use a cloth dampened in water. Never use flammable solvents such as alcohol, benzene, or thinner. If these substances come into contact with electrical components inside the printer, there is a risk of fire or electrical shock.



Caution

- Always disconnect the power cable from the outlet before cleaning the printer. If the printer is switched on accidentally, moving parts inside the printer may cause personal injuries.

Pacemakers



Warning

- This printer generates a low-level magnetic field. Anyone wearing a pacemaker who experiences discomfort while working around the printer should leave the area. Consult a physician before continuing to work around the printer.

Moving the Printer



Caution

- Moving the printer requires at least six people, holding it on both sides. Be careful to avoid back strain and other injuries.
- When moving the printer, firmly grasp the Carrying Handles under each side. The printer may be unsteady if you hold it at other positions, which poses a risk of injury from dropping the printer.

Printhead, Ink Tanks, and Maintenance Cartridge



Caution

- Always store consumables in a safe location out of the reach of small children. If a child licks or ingests ink accidentally, seek medical assistance immediately.
- If ink accidentally gets in your eyes, immediately rinse with water.
If ink gets on your skin, immediately clean it off with soap and water.
If irritation persists in your eyes or on your skin, contact a physician immediately.
- Avoid dropping or shaking printheads, ink tanks, and maintenance cartridges. Spilled ink can stain clothing and the work area.
- Never touch the electrical contacts of the Printhead after printing. The contacts become extremely hot and can cause minor burns.

Other



Warning

- Never disassemble the printer or attempt repairs. There are high voltage parts inside the printer that can cause a fire or electrical shock.
- Never use flammable sprays around the printer. The gas of flammable sprays can cause a fire or electrical shock, if it contacts high voltage points inside the printer.
- After removing the Cutter Unit, never touch the cutting edge (a). This could cause personal injury.

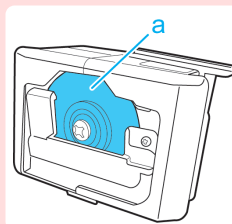



Caution

- Never place anything on the printer such as small metal objects (paper clips, staples), liquids, any type of liquid container that contains flammable liquids (alcohol, benzene, etc.). If such objects fall into the printer, this could cause a fire or electrical shock.
- Never insert your hand into the printer while it is printing. Moving parts inside the printer can cause injuries.
- To prevent a fire hazard or dangerous electric shock, if a foreign object falls into or a liquid spills into the printer, press the Power button immediately to switch the printer off, unplug the printer power cable from the outlet, and then call for service. If you continue to use the printer, this could cause a fire or electrical shock.



Important

- Connect the interface cable correctly. To avoid damage, before connection make sure that the shape of the cable connector matches the connection point on the printer.
- During printing, turn on the ventilation system in the room.
- We recommend ensuring ample space for installation.

Legal Notices

FCC Regulations (U.S.A)

Canon Large Format Printer

iPF9400S

This device complies with Part 15 of the FCC Rules. Operation is subject to the following two conditions: (1) This device may not cause harmful interference, and (2) this device must accept any interference received, including interference that may cause undesired operation.

Note: This equipment has been tested and found to comply with the limits for class B digital device, pursuant to Part 15 of the FCC Rules. These limits are designed to provide reasonable protection against harmful interference in a residential installation.

This equipment generates, uses and can radiate radio frequency energy and, if not installed and used in accordance with the instructions, may cause harmful interference to radio communications. However, there is no guarantee that interference will not occur in a particular installation. If this equipment does cause harmful interference to radio or television reception, which can be determined by turning the equipment off and on, the user is encouraged to try to correct the interference by one or more of the following measures:

- Reorient or relocate the receiving antenna.
- Increase the separation between the equipment and receiver.
- Connect the equipment into an outlet on a circuit different from that to which the receiver is connected.
- Consult the dealer or an experienced radio/TV technician for help.

Use of shielded cable is required to comply with Class B limits in Subpart B of Part 15 of FCC Rules.

Do not make any changes or modifications to the equipment unless otherwise specified in the manual.

If such changes or modifications should be made, you could be required to stop operation of the equipment.

Canon U.S.A. Inc.

One Canon Plaza, Lake Success, NY 11042, U.S.A.

Tel No. 516-328-5600

For CA, USA Only

Included battery contains Perchlorate Material - special handling may apply.

See <http://www.dtsc.ca.gov/hazardouswaste/perchlorate/> for detail.

Trademarks

- Canon, the Canon logo, and imagePROGRAF are trademarks or registered trademarks of CANON INC.
- Microsoft and Windows are trademarks of Microsoft Corporation, registered in the U.S. and other countries.
- Macintosh is trademark of Apple Inc., registered in the U.S. and other countries.

- Other company and product names in this manual are trademarks or registered trademarks of their respective owners.

Copyright

- Unauthorized reproduction of this user manual in whole or part is prohibited.

Legal Notice

- It is illegal to reproduce currency, bills, negotiable securities and other documents prohibited by law. Reproduction of such items may be subject to criminal prosecution.
- It is illegal to reproduce legal certificates, licenses, travel tickets, and certain public and private documents prohibited from reproduction by law. Reproduction of such items may be subject to criminal prosecution.
- Please note that intellectual property protected by copyright may not be reproduced without the express permission of the copyright holder except for personal or household use under limited circumstances.

Manuals for this printer

Manuals for this printer	950
About This User Manual	950

Manuals for this printer

This printer has the following manuals.



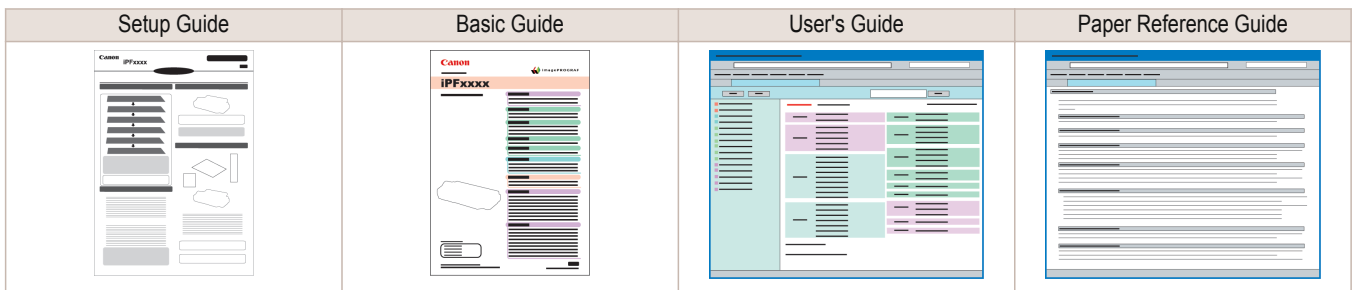

Name	Contents	Medium
Setup Guide	Instructions for unpacking and setting up the printer, and for installing the software and electronic manuals.	Printed Manuals
Basic Guide	Descriptions of basic printer operations.	
User's Guide	Detailed instructions for using the printer.	Electronic manuals
Paper Reference Guide	This guide describes about the types and specifications of the available media on the printer.	



About This User Manual

• Symbols

The following symbols are used in this user manual to indicate safety information and explanations on restrictions or precautions in use.

	Warning	Indicates warning items for which operating error poses a risk of death or serious injury. To ensure safe use, always follow these warnings.
	Caution	Indicates caution items for which operating error poses a risk of injury. To ensure safe use, always follow these cautions.
	Important	Indicates important information and restrictions that definitely are to be followed during operation. Be sure to read this information to prevent troubles, malfunctions, or damage to equipment or property by operating errors.
	Note	Indicates helpful reference information and supplemental information on particular topics.

• Button names and user interface elements

Key and button names on the control panel and user interface elements in software (such as menus and buttons) are indicated as follows in this user manual.

Control panel buttons	Example: Press the OK button.
Control panel messages	Example: Head Cleaning is displayed.
Software interface items (menus and buttons)	Example: Click OK .
Keyboard keys	Example: Press the Tab key.

- **Cross-reference**

Other pages or manuals that provide related information are indicated as follows in this user manual.

Cross-reference in the same user manual	Example: see "Turning the Printer On and Off." →P.21 Click the link to jump to the corresponding page.
Cross-reference in related manuals	Example: See the Paper Reference Guide.
Other cross-reference	Example: See the printer driver help.

- **Figures and software screens**

- Figures in this user manual may be different from the actual appearance of the printer in some cases.
- Screens depicted in this user manual for the printer driver or other software may be different from the actual screens because of subsequent updates.

- **May we request**

- The information in this user manual is subject to change without notice.
- We strive to ensure accuracy of information in this user manual, but if you notice errors or omissions, please contact us.

How to use this manual

Searching Topics 952
 HTML Version of the Manual for Printing 953

Searching Topics

You can find information in topics of this User Manual by searching for relevant terms.

1 Enter a term and click the **Search** button.



To search for multiple terms at once, enter a space between each term.

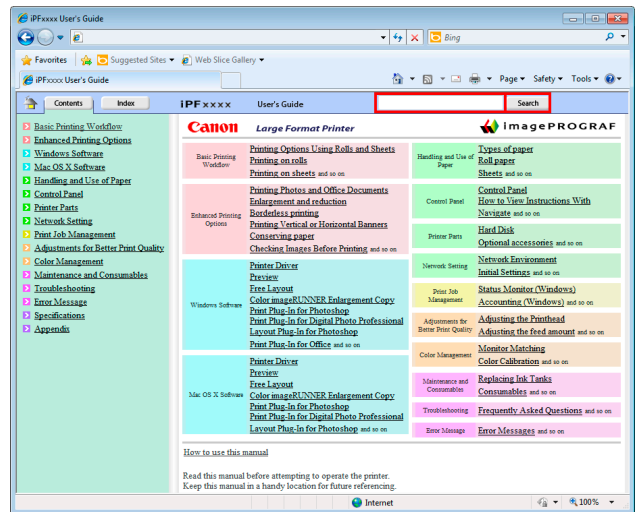

Search results are listed at left.

2 Click a topic you want to read. The terms you searched for will be highlighted in the topic.

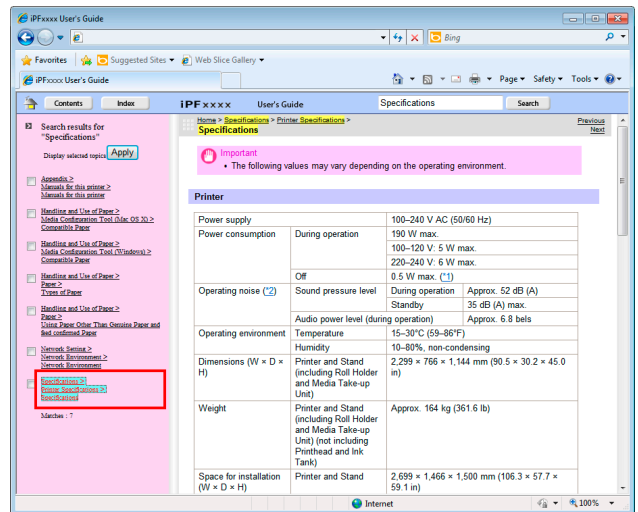

To review multiple topics at once, select the check box of desired topics and click the **Apply** button.

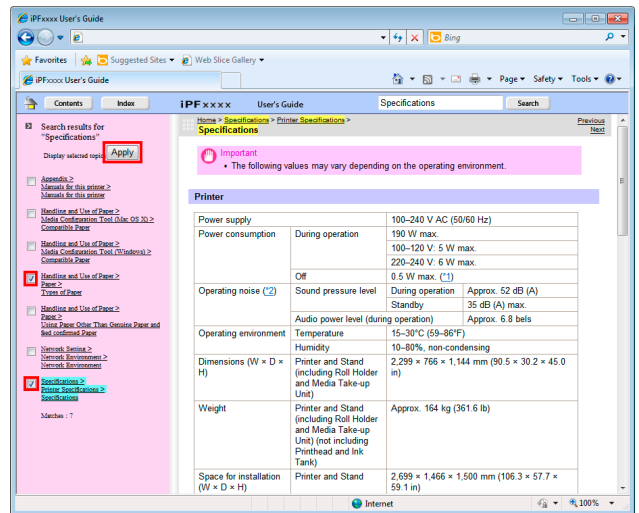

HTML Version of the Manual for Printing

You can select a group of topics in the table of contents or individual topics in this manual for printing. The following procedure describes how to do this, using the information in **Basic Printing Workflow** as an example.

Printing a group of topics in the manual

When you access printable HTML versions of the content from section titles in the table of contents, you can specify a group of topics to print.

- 1 Click a section title in the table of contents. Here, **Basic Printing Workflow** is used as an example.

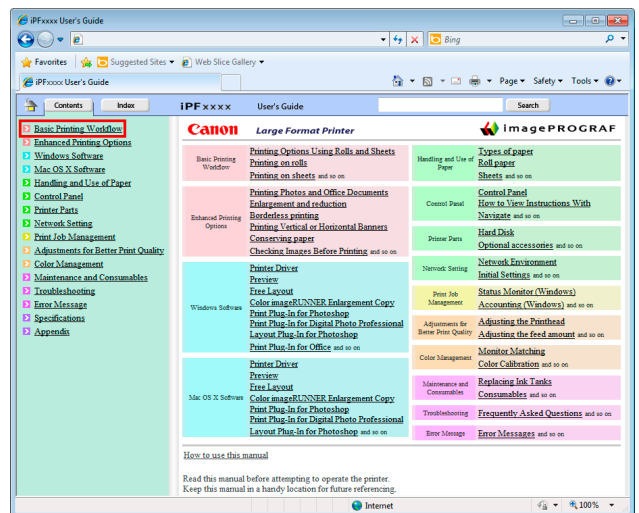

2 Click **Access to the HTML for printing** in the title area.

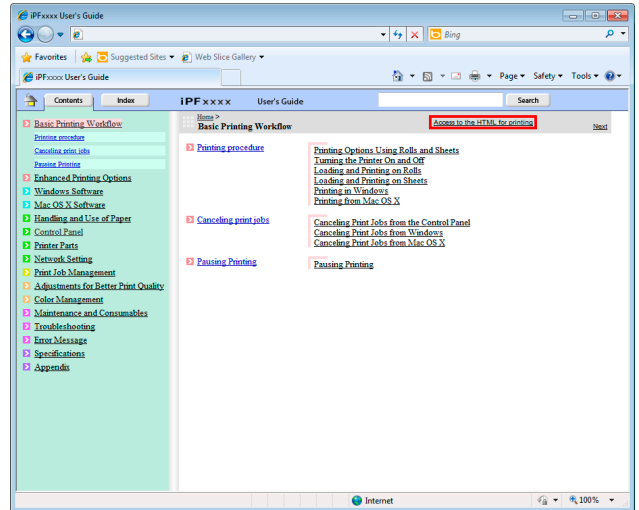

The topics in **Basic Printing Workflow** are displayed together in HTML format, ready for printing.

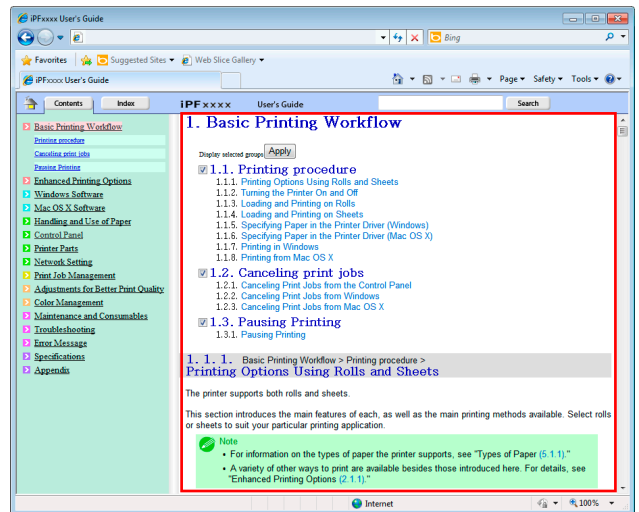

3 Clear the sections you will not print and click the **Apply** button.

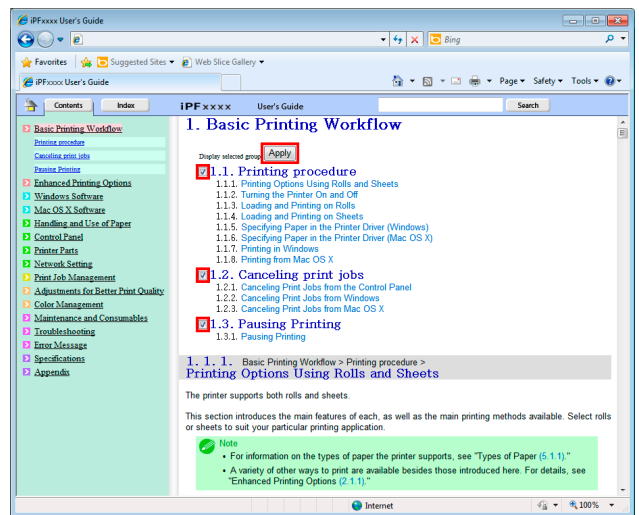

Printing a group of individual topics in the manual

When you access printable HTML versions from subtitles in the table of contents, you can specify a group of topics to print.

- 1 Click a section title in the table of contents. Here, **Basic Printing Workflow** is used as an example.

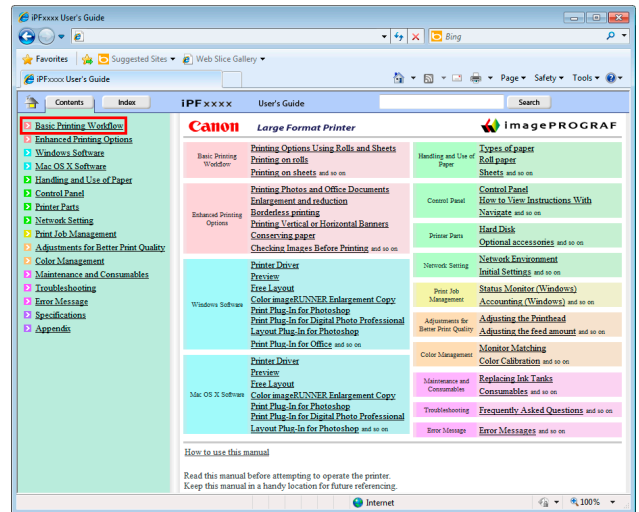

- 2 Under **Basic Printing Workflow**, click **Printing Procedure**.

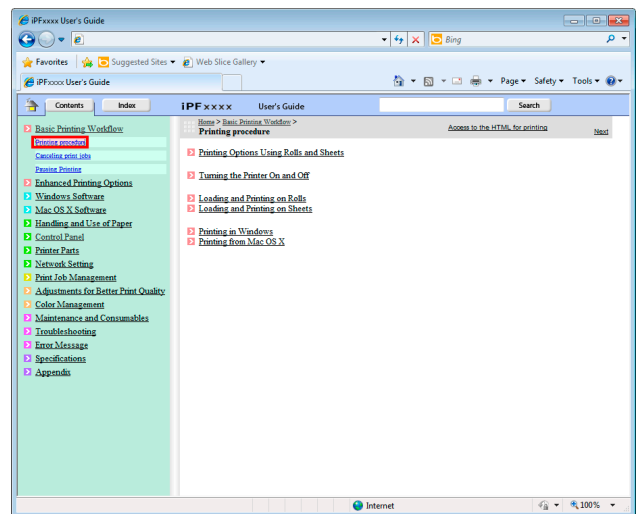

- 3 Click **Access to the HTML for printing** in the title area.

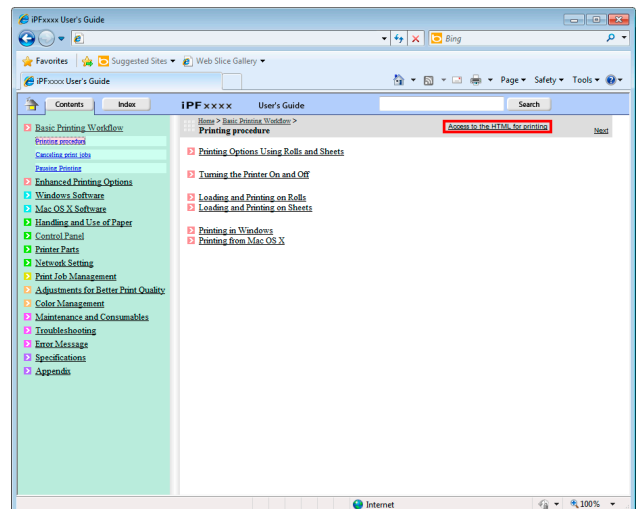

The topics in **Printing Procedure** are displayed together in HTML format, ready for printing.

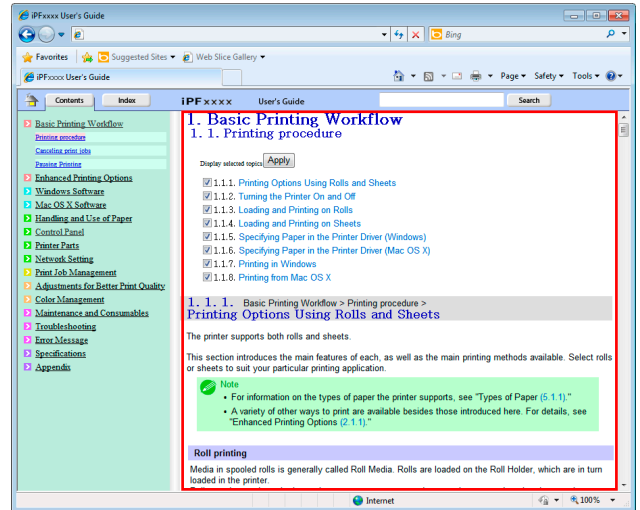

4 Clear the topics you will not print and click the **Apply** button.

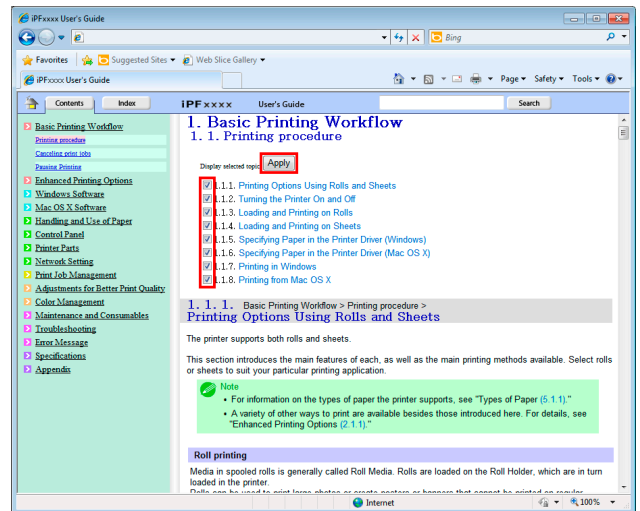

Printing selected topics

Print selected topics as follows.

1 Access the printing dialog box as follows, depending on your computer's operating system.

• Windows

In Windows, right-click anywhere in the explanation area except on a figure or a link. In the shortcut menu, click **Print** to display the **Print** dialog box.

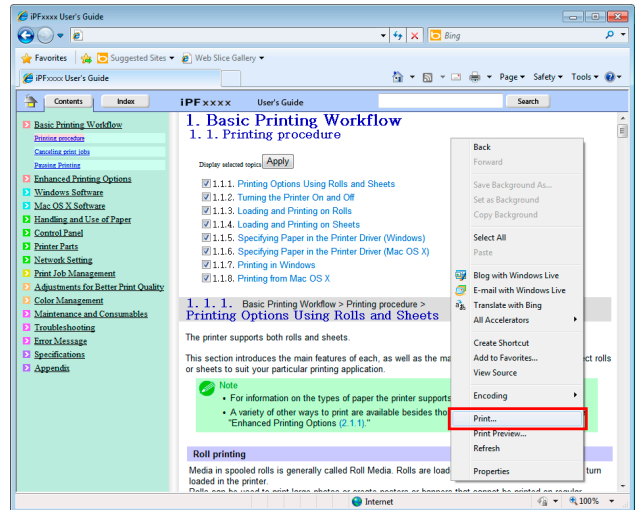

• Macintosh

On a Macintosh computer, click anywhere in the explanation area except on a figure or a link while holding the Ctrl key. In the shortcut menu, click **Print Frame** to display the **Print** dialog box.

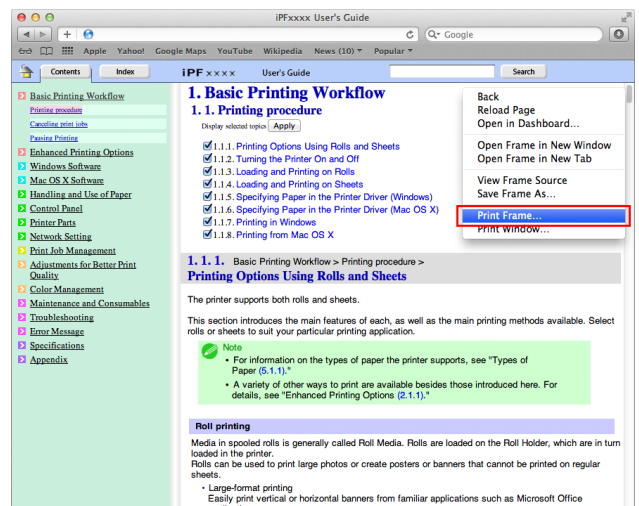

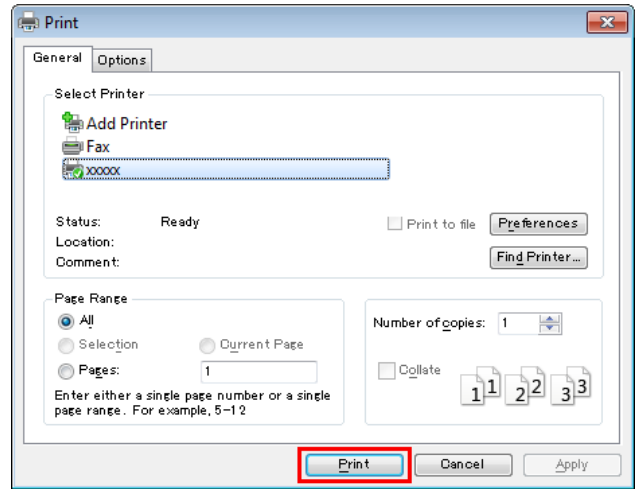

2 Specify conditions as needed, and then click **Print** (Windows) or **Print** (Macintosh).

- Windows

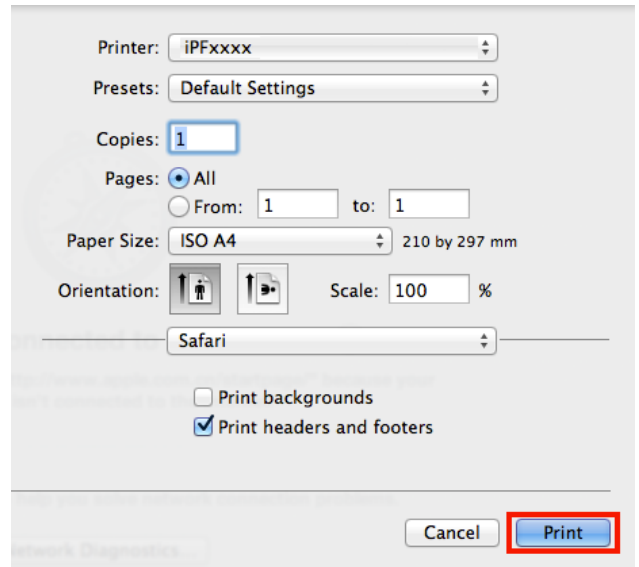

- Macintosh



 • To print only individual topics that are displayed, use this method.

Note

Disposal of the product

WEEE Directive

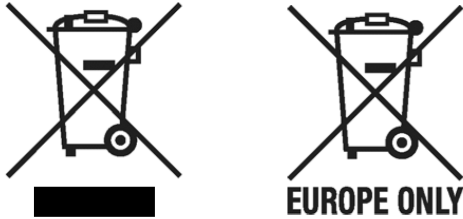

European Union (and EEA) only.

These symbols indicate that this product is not to be disposed of with your household waste, according to the WEEE Directive (2002/96/EC), the Battery Directive (2006/66/EC) and/or your national laws implementing those Directives. This product should be handed over to a designated collection point, e.g., on an authorized one-for-one basis when you buy a new similar product or to an authorized collection site for recycling waste electrical and electronic equipment (EEE) and batteries and accumulators. Improper handling of this type of waste could have a possible impact on the environment and human health due to potentially hazardous substances that are generally associated with EEE. Your cooperation in the correct disposal of this product will contribute to the effective usage of natural resources. For more information about the recycling of this product, please contact your local city office, waste authority, approved scheme or your household waste disposal service or visit www.canon-europe.com/environment.

(EEA: Norway, Iceland and Liechtenstein)

Uitsluitend bestemd voor de Europese Unie (en EER).

Met deze symbolen wordt aangegeven dat dit product in overeenstemming met de AEEA-richtlijn (2002/96/EC), de richtlijn 2006/66/EC betreffende batterijen en accu's en/of de plaatselijk geldende wetgeving waarin deze richtlijnen zijn geïmplementeerd, niet bij het normale huisvuil mag worden weggegooid. Dit product dient te worden ingeleverd bij een hiervoor aangewezen inzamelpunt, bijv. door dit in te leveren bij een hiertoe erkend verkooppunt bij aankoop van een gelijksoortig product, of bij een officiële inzameldienst voor de recycling van elektrische en elektronische apparatuur (EEA) en batterijen en accu's. Door de potentiële gevaarlijke stoffen die gewoonlijk gepaard gaan met EEA, kan onjuiste verwerking van dit type afval mogelijk nadelige gevolgen hebben voor het milieu en de menselijke gezondheid. Uw medewerking bij het op juiste wijze weggooien van dit product draagt bij tot effectief gebruik van natuurlijke bronnen. Voor verdere informatie over recycling van dit product kunt u contact opnemen met uw plaatselijke gemeente, afvaldienst, officiële dienst voor klein chemisch afval of afvalstortplaats, of kunt u terecht op www.canon-europe.com/environment.

(EER: Noorwegen, IJsland en Liechtenstein)

Endast för EU (och EEA).

De här symbolerna anger att produkten inte får slängas i hushållssoporna enligt WEEE-direktivet (2002/96/EG), batteridirektivet (2006/66/EG) och/eller nationell lagstiftning som implementerar dessa direktiv. Produkten ska lämnas in på en där för anvisad samlingsplats, t.ex. hos handlare som är auktoriserade att byta in varor då nya, liknande köps (en mot en) eller på en återvinningsstation auktoriserad att hantera elektrisk och elektronisk utrustning (EE-utrustning) samt batterier och ackumulatörer. Olämplig hantering av avfall av den här typen kan ha negativ inverkan på miljön och människors hälsa på grund av de potentiellt farliga ämnen som vanligen återfinns i elektrisk och elektronisk utrustning. Din medverkan till en korrekt avfallshantering av produkten bidrar till effektiv användning av naturresurserna. Om du vill ha mer information om var du kan lämna in den här produkten, kontakta ditt lokala kommunkontor, berörd myndighet eller företag för avfallshantering eller besök www.canon-europe.com/environment.

(EEA: Norge, Island och Liechtenstein)

Pouze Evropská unie (a EHP)

Tento symbol znamená, že podle směrnice o OEEZ (2002/96/ES), směrnice o bateriích (2006/66/ES) a/nebo podle vnitrostátních právních prováděcích předpisů k těmto směrnici nemá být tento výrobek likvidován s odpadem z domácností. Tento výrobek má být vrácen do určeného sběrného místa, např. v rámci autorizovaného systému odběru jednoho výrobku za jeden nově prodaný podobný výrobek, nebo do autorizovaného sběrného místa pro recyklaci odpadních elektrických a elektronických zařízení (OEEZ) a baterií a akumulátorů. Nevhodné nakládání s tímto druhem odpadu by mohlo mít negativní dopad na životní prostředí a lidské zdraví, protože elektrická a elektronická zařízení zpravidla obsahují potenciálně nebezpečné látky. Vaše spolupráce na správné likvidaci tohoto výrobku napomůže efektivnímu využívání přírodních zdrojů. Chcete-li získat podrobné informace týkající se recyklace tohoto výrobku, obraťte se prosím na místní úřad, orgán pro nakládání s odpady, schválený systém nakládání s odpady či společnost zajišťující likvidaci domovního odpadu nebo navštivte webové stránky www.canon-europe.com/environment.

(EHP: Norsko, Island a Lichtenštejnsko)

Gjelder kun EU (og EØS).

Disse symbolene indikerer at dette produktet ikke skal kastes sammen med husholdningsaffald, i henhold til WEEE-direktivet (2002/96/EF), batteridirektivet (2006/66/EF) og/eller nasjonal lov som har implementert disse direktivene. Produktet må leveres til et dertil egnet innsamlingspunkt, det vil si på en autorisert en-til-en-basis når en kjøper et nytt lignende produkt, eller til et autorisert innsamlingssted for resirkulering av avfall fra elektrisk og elektronisk utstyr (EE-utstyr) og batterier og akkumulatorer. Feil håndtering av denne typen avfall kan være miljø- og helseskadelig på grunn av potensielt skadelige stoffer som ofte brukes i EE-utstyr. Din innsats for korrekt avhending av produktet vil bidra til effektiv bruk av naturressurser. Du kan få mer informasjon om resirkulering av dette produktet ved å kontakte lokale myndigheter, avfallsadministrasjonen, et godkjent program eller husholdningens renovasjonsselskap, eller gå til www.canon-europe.com/environment.

(EØS: Norge, Island og Liechtenstein)

Len Európska únia (a EHP)

Tieto symboly označujú, že podľa smernice o odpade z elektrických a elektronických zariadení (OEEZ) 2002/96/ES, smernice o batériách (2006/66/ES) a/alebo podľa vnútroštátnych právnych predpisov zahŕňajúcich tieto smernice sa tento produkt nesmie likvidovať spolu s domácim odpadom. Tento produkt je potrebné odovzdať do určenej zberne, napr. prostredníctvom výmeny za kúpu nového podobného produktu, alebo do autorizovaného zberného miesta na recykláciu odpadu z elektrických a elektronických zariadení (EEZ) a batérií a akumulátorov. Nesprávna manipulácia s takýmto typom odpadu môže mať negatívny vplyv na životné prostredie a ľudské zdravie, pretože elektrické a elektronické zariadenia obsahujú potenciálne nebezpečné látky. Vašou spoluprácou na správnej likvidácii tohto produktu prispejete k účinnému využívaniu prírodných zdrojov. Ďalšie informácie o recyklácii tohto produktu získate od svojho miestneho úradu, úradu zodpovedného za odpad, zo schváleného plánu o OEEZ alebo od spoločnosti zaisťujúcej likvidáciu domáceho odpadu alebo na webovej stránke www.canon-europe.com/environment.

(EHP: Nórsko, Írsko a Lichtenštajnsko)

Solo per l'Unione Europea e lo Spazio Economico Europeo.

Questi simboli indicano che il prodotto non può essere smaltito con i rifiuti domestici, ai sensi della Direttiva RAEE (2002/96/CE), della Direttiva sulle Batterie (2006/66/CE) e/o delle leggi nazionali che attuano tali Direttive. Il prodotto deve essere conferito a punto di raccolta designato, ad esempio il rivenditore in caso di acquisto di un nuovo prodotto simile oppure un centro di raccolta autorizzato per il riciclaggio di rifiuti di apparecchiature elettriche ed elettroniche (RAEE) nonché di batterie e accumulatori. Un trattamento improprio di questo tipo di rifiuti può avere conseguenze negative sull'ambiente e sulla salute umana a causa delle sostanze potenzialmente nocive solitamente contenute in tali rifiuti. La collaborazione dell'utente per il corretto smaltimento di questo prodotto contribuirà a un utilizzo efficace delle risorse naturali ed eviterà di incorrere in sanzioni amministrative ai sensi dell'art. 50 e successivi del Decreto Legislativo n. 22/97. Per ulteriori informazioni sul riciclaggio di questo prodotto, contattare le autorità locali, l'ente responsabile della raccolta dei rifiuti, un rivenditore autorizzato o il servizio di raccolta dei rifiuti domestici, oppure visitare il sito www.canon-europe.com/environment.

(Spazio Economico Europeo: Norvegia, Islanda e Liechtenstein)

Samo za Evropsko unijo (in Evropski gospodarski prostor).

Ti simboli pomenijo, da tega izdelka skladno z Direktivo OEE0 (2002/96/ES), Direktivo 2006/66/ES in/ali nacionalno zakonodajo, ki uvaja ti direktivi, ne smete odlagati z nesortiranimi gospodinjskimi odpadki. Ta izdelek je treba odnesti na izbrano zbirno mesto, t. j. pooblaščenno trgovino, kjer ob nakupu novega (podobnega) izdelka vrnete starega, ali na pooblaščenno zbirno mesto za ponovno uporabo odpadne električne in elektronske opreme (EEO) ter baterij in akumulatorjev. Neustrezno ravnanje s to vrsto odpadkov lahko negativno vpliva na okolje in človeško zdravje zaradi potencialno nevarnih snovi, ki so pogosto povezane z EEO. Vaše sodelovanje pri pravilnem odlaganju tega izdelka predstavlja pomemben prispevek k smotrni izrabi naravnih virov. Za več informacij o ponovni uporabi tega izdelka se obrnite na lokalni mestni urad, pristojno službo za odpadke, predstavnika pooblaščenega programa za obdelavo odpadkov ali na lokalno komunalno. Lahko pa tudi obiščete našo spletno stran www.canon-europe.com/environment.

(Evropski gospodarski prostor: Norveška, Islandija in Lihtenštajn)

Kizárólag az Európai Unió (valamint az EEA) részére.

Ezek a szimbólumok azt jelzik, hogy a termék hulladékkezelése a háztartási hulladéktól különválasztva, a WEEE - elektromos és elektronikus berendezések hulladékairól szóló (2002/96/EK) irányelvnek és, az elemekről és akkumulátorokról, valamint a hulladékelemekről és -akkumulátorokról szóló (2006/66/EK) irányelvnek megfelelően, és/vagy ezen irányelveknek megfelelő helyi előírások szerint történik. Ezen terméket az arra kijelölt gyűjtőhelyre kell juttatni, pl., hasonló termék vásárlásakor a régi becserelésére vonatkozó hivatalos program keretében, vagy az elektromos és elektronikus berendezések (EEE) hulladékainak gyűjtésére, valamint a hulladékelemek és hulladékkumulátorok gyűjtésére kijelölt hivatalos gyűjtőhelyre. Az ilyen jellegű hulladékok nem előírászerű kezelése az elektromos és elektronikus berendezésekhez (EEE) általánosan kapcsolható potenciálisan veszélyes anyagok révén hatással lehet a környezetre és az egészségre. Ezen termék megfelelő módon történő eltávolításával Ön is hozzájárul a természeti források hatékony használatához. A termék újrahazsnosítását illetően informálódjon a helyi polgármesteri hivatalnál, a helyi közterület-fenntartó vállalatnál, a hivatalos hulladéklerakó telephelyen, vagy a háztartási hulladék begyűjtését végző szolgáltatónál, illetve látogasson el a www.canon-europe.com/environment internetes oldalra.

(EEA : Norvégia, Izland és Liechtenstein)

Apenas para a União Europeia (e AEE)

Estes símbolos indicam que este produto não deve ser eliminado juntamente com o seu lixo doméstico, segundo a Directiva REEE de 2002/96/CE, a Directiva de Baterias (2006/66/CE) e / ou a sua legislação nacional que transponha estas Directivas. Este produto deve ser entregue num ponto de recolha designado, por exemplo num local autorizado de troca quando compra um equipamento novo idêntico, ou num local de recolha autorizado para reciclar equipamento eléctrico e electrónico (EEE) em fim de vida, bem como pilhas e baterias. O tratamento inadequado deste tipo de resíduos pode ter um impacto negativo no ambiente e na saúde humana, devido a substâncias potencialmente perigosas que estão associadas com equipamentos do tipo EEE. A sua cooperação no tratamento correcto deste produto irá contribuir para a utilização mais eficaz dos recursos naturais. Para obter mais informações acerca de como reciclar este produto, por favor contacte as suas autoridades locais responsáveis pela matéria, serviço de recolha aprovado para pilhas e baterias ou serviço de recolha de resíduos sólidos domésticos da sua municipalidade, ou visite www.canon-europe.com/environment.

(AEE: Noruega, Islândia, e Liechtenstein)

Üksnes Euroopa Liit (ja Euroopa Majanduspiirkond).

Antud sümbolid viitavad sellele, et vastavalt WEEE direktiivile (2002/96/EÜ), patareide direktiivile (2006/66/EÜ) ja/või nimetatud direktiive rakendavatele riiklikele õigusaktidele ei või seda toodet visata ära koos majapidamisjäätmetega. Antud toode tuleb anda vastavasse kogumispunkti, nt üks ühe vastu, kui ostad uue sarnase toote, või vastavasse elektri- ja elektroonikaseadmete jäätmete ning patareide ja akude ümbertöötlemiseks mõeldud kogumispunkti. Antud liiki prügi vale käitlemine võib kahjustada keskkonda ja inimeste tervist elektri- ja elektroonikajäätmetes tavaliselt leiduvate potentsiaalselt ohtlike ainete tõttu. Antud toote ettenähtud nõuete kohase kõrvaldamisega aitate efektiivselt kasutada loodusvarasid. Täiendava teabe saamiseks antud toote ringlussevõtu kohta võtke ühendust kohaliku linnavalitsusega, jäätmekäitlejaga, lubatud skeemiga või majapidamisjäätmete prügilateenistusega või külastage Interneti-lehekülge www.canon-europe.com/environment.

(Euroopa Majanduspiirkond: Norra, Island ja Liechtenstein)

Paredzēts tikai Eiropas Savienības valstīm (un EVA).

Šie simboli norāda, ka atbilstoši ES direktīvai par izlietotu elektrisku un elektronisku aparāturu (2002/96/EK), direktīvai par baterijām un akumulatoriem (2006/66/EK) un vietējai likumdošanai no šī produkta nedrīkst atbrīvoties, izmetot to kopā ar sadzīves atkritumiem. Šis produkts ir jānodod piemērotā savākšanas punktā, piemēram, autorizētā veikalā, kur iegādājaties līdzīgu jaunu produktu un veco atstājat vietā, vai autorizētā dienestā, kas nodarbojas ar izlietotas elektriskās un elektroniskās aparatūras (waste electrical and electronic equipment — WEEE) otrreizēju pārstrādi. Nepareizi apejoties ar šāda veida izlietotu aparāturu, var apdraudēt vidi un cilvēka veselību potenciāli bīstamu vielu dēļ, kas parasti ietilpst elektriskajā un elektroniskajā aparātūrā lietotajos sakausējumos. Turklāt pareiza atbrīvošanās no šī produkta sekmē racionālu dabas resursu izlietojumu. Lai saņemtu plašāku informāciju par vietām, kur izlietotu aparāturu var nodot otrreizējai pārstrādei, sazinieties ar vietējās pašvaldības pārstāvjiem, dienestu, kas atbild par atkritumu savākšanu, pilnvarotu WEEE struktūru vai iestādi, kas veic atbrīvošanos no sadzīves atkritumiem vai apmeklējiet tīmekļa vietni www.canon-europe.com/environment.

(Eiropas Ekonomiskā zona: Norvēģija, Īslande un Lihtenšteina).

Tik Europos Sąjungai (ir Europos Ekonominei Zonai)

Šie simboli reiškia, kad šio gaminio negalima išmesti į buitines atliekas, kaip reikalauja WEEE Direktyva (2002/96/EB) ir Baterijų Direktyva (2006/66/EB) ir (ar) jūsų šalies nacionaliniai įstatymai, kuriais šios Direktyvos yra įgyvendinamos. Šį gaminį reikia pristatyti į specialų surinkimo punktą, pavyzdžiui, mainais, kai jūs perkate naują panašų gaminį arba į specialią surinkimo vietą, kuri perdirba elektrinės ir elektroninės įrangos atliekas bei naudotas baterijas ir akumulatorius. Dėl netinkamo šio tipo atliekų tvarkymo gali nukentėti aplinka bei iškyla grėsmė žmogaus sveikatai dėl potencialiai kenksmingų medžiagų, iš esmės susijusių su elektrine ir elektronine įranga. Bendradarbiaudami teisingai utilizuojant šiuos gaminius, jūs padėsite efektyviai naudoti gamtinius išteklius. Daugiau informacijos apie gaminio perdirbimą jums gali suteikti vietinis biuras, atliekų tvarkymo bendrovė, sertifikuoti organai ar buitinių atliekų surinkimo įmonės. Be to, aplankykite interneto svetainę www.canon-europe.com/environment.

(Europos Ekonominė Zona: Norvegija, Islandija ir Lichtenšteinas)

Union européenne (et Espace économique européen) uniquement.

Ces symboles indiquent que ce produit ne doit pas être mis au rebut avec les ordures ménagères, comme le spécifient la Directive européenne DEEE (2002/96/EC), la Directive européenne relative à l'élimination des piles et des accumulateurs usagés (2006/66/EC) et les lois en vigueur dans votre pays, appliquant ces directives. Ce produit doit être confié à un point de collecte désigné, par exemple, chaque fois que vous achetez un produit similaire neuf, ou à un point de collecte agréé pour le recyclage équipements électriques ou électroniques (EEE) et des piles et accumulateurs. Le traitement inapproprié de ce type de déchet risque d'avoir des répercussions sur l'environnement et la santé humaine, du fait de la présence de substances potentiellement dangereuses généralement associées aux équipements électriques ou électroniques. Votre coopération envers la mise au rebut correcte de ce produit contribuera à l'utilisation efficace des ressources naturelles. Pour de plus amples informations sur le recyclage de ce produit, veuillez contacter vos services municipaux, votre éco-organisme ou les autorités locales. Vous pouvez également vous rendre sur le site www.canon-europe.com/environment.

(Espace économique européen : Norvège, Islande et Liechtenstein)

Tylko kraje Unii Europejskiej (i Europejskiego Obszaru Gospodarczego).

Te symbole oznaczają, że produkt należy wyrzucać oddzielnie od odpadów domowych, zgodnie z dyrektywą WEEE w sprawie zużytego sprzętu elektrycznego i elektronicznego (2002/96/EC) lub dyrektywą w sprawie baterii (2006/66/EC) i/lub przepisami krajowymi, wdrażającymi te dyrektywy. Zużyty sprzęt powinien zostać przekazany do punktu zbiórki sprzętu (EEE), a w przypadku zakupu nowego na zasadzie wymiany jeden do jednego przy zakupie podobnego co do rodzaju produktu. Użytkownicy baterii i akumulatorów mają obowiązek korzystać z dostępnego programu zwrotu, recyklingu i utylizacji baterii i akumulatorów. Niewłaściwe postępowanie z tego typu odpadami może mieć wpływ na środowisko i zdrowie ludzi ze względu na substancje potencjalnie niebezpieczne ogólnie związane ze zużytym sprzętem elektrycznym i elektronicznym. Państwa współpraca w zakresie właściwej utylizacji tego produktu przyczyni się do efektywnego wykorzystania zasobów naturalnych. W celu uzyskania informacji o sposobie recyklingu tego produktu prosimy o kontakt z właściwym urzędem miejskim lub zakładem gospodarki komunalnej lub zapraszamy na stronę www.canon-europe.com/environment.

(Europejski Obszar Gospodarczy: Norwegia, Islandia i Liechtenstein)

Gælder kun i EU (og EØS).

Disse symboler betyder, at produktet ikke må bortskaffes sammen med husholdningsaffald i henhold til WEEE-direktivet (2002/96/EF), batteridirektivet (2006/66/EF) og/eller den lokale lovgivning, som disse direktiver er gennemført i. Produktet skal afleveres på et godkendt indsamlingssted, f.eks. i overensstemmelse med en godkendt én-for-én-procedure, når du indkøber et nyt tilsvarende produkt, eller på et godkendt indsamlingssted for genanvendeligt affald fra elektrisk og elektronisk udstyr samt for batterier og akkumulatører. Forkert håndtering af denne type affald kan muligvis få negative konsekvenser for miljøet og menneskers helbred på grund af de potentielt sundhedsskadelige substanser, der generelt associeres med elektrisk og elektronisk udstyr. Når du foretager korrekt bortskaffelse af produktet, bidrager dette også til effektiv brug af naturressourcerne. Kontakt din kommune, den lokale affaldsmyndighed, forvalterne af en godkendt affaldsordning eller det lokale affaldsanlæg, eller besøg www.canon-europe.com/environment for at få flere oplysninger om genbrug af dette produkt.

(EØS: Norge, Island og Liechtenstein)

Ευρωπαϊκή Ένωση (και ΕΟΧ) μόνο.

Αυτά τα σύμβολα υποδεικνύουν ότι αυτό το προϊόν δεν πρέπει να απορρίπτεται μαζί με τα οικιακά απορρίμματα, σύμφωνα με την Οδηγία για τα Απόβλητα Ηλεκτρικού και Ηλεκτρονικού Εξοπλισμού (ΑΗΗΕ) (2002/96/ΕΚ), την Οδηγία για τις Ηλεκτρικές Στήλες (2006/66/ΕΚ) ή/και την εθνική νομοθεσία που εφαρμόζει τις Οδηγίες εκείνες. Αυτό το προϊόν πρέπει να παραδίδεται σε καθορισμένο σημείο συλλογής, π.χ. σε μια εξουσιοδοτημένη βάση ανταλλαγής, όταν αγοράζετε ένα νέο παρόμοιο προϊόν ή σε μια εξουσιοδοτημένη θέση συλλογής για την ανακύκλωση των αποβλήτων ηλεκτρικού και ηλεκτρονικού εξοπλισμού (ΗΗΕ) και ηλεκτρικών στηλών και συσσωρευτών. Ο ακατάλληλος χειρισμός αυτού του τύπου αποβλήτων θα μπορούσε να έχει πιθανό αρνητικό αντίκτυπο στο περιβάλλον και την υγεία του ανθρώπου, λόγω δυνητικών επικίνδυνων ουσιών που γενικά συνδέονται με τον ΗΗΕ. Η συνεργασία σας για τη σωστή απόρριψη αυτού του προϊόντος θα συμβάλει στην αποτελεσματική χρήση των φυσικών πόρων. Για περισσότερες πληροφορίες σχετικά με ανακύκλωση αυτού του προϊόντος, επικοινωνήστε με το τοπικό γραφείο της πόλης σας, την υπηρεσία απορριμμάτων, το εγκεκριμένο σχήμα ή την υπηρεσία απόρριψης οικιακών αποβλήτων ή επισκεφθείτε τη διεύθυνση www.canon-europe.com/environment.

(Ευρωπαϊκός Οικονομικός Χώρος: Νορβηγία, Ισλανδία και Λιχτενστάιν)

Sólo para la Unión Europea (y el Área Económica Europea).

Estos símbolos indican que este producto no debe desecharse con los residuos domésticos de acuerdo con la Directiva sobre RAEE (2002/96/CE) y la Directiva sobre Pilas y Acumuladores (2006/66/CE) y/o la legislación nacional que implemente dichas Directivas. Este producto deberá entregarse en un punto de recogida designado, por ejemplo, en un establecimiento autorizado al adquirir un producto nuevo similar o en un centro autorizado para la recogida de residuos de aparatos eléctricos y electrónicos (RAEE), baterías y acumuladores. La gestión incorrecta de este tipo de residuos puede afectar al medio ambiente y a la salud humana debido a las sustancias potencialmente nocivas que suelen contener estos aparatos. Su cooperación en la correcta eliminación de este producto contribuirá al correcto aprovechamiento de los recursos naturales. Los usuarios tienen derecho a devolver pilas, acumuladores o baterías usados sin coste alguno. El precio de venta de pilas, acumuladores y baterías incluye el coste de la gestión medioambiental de su desecho, y bajo ninguna circunstancia se indicará por separado la cuantía de dicho coste en la información y la factura suministradas a los usuarios finales. Si desea más información sobre el reciclado de este producto, póngase en contacto con el departamento municipal, el servicio o el organismo encargado de la gestión de residuos domésticos o visite www.canon-europe.com/environment.

(Área Económica Europea: Noruega, Islandia y Liechtenstein)

Vain EU- ja EEA-alueelle.

Nämä tunnukset osoittavat, että sähkö- ja elektroniikkalaiteromua koskeva direktiivi (WEEE-direktiivi, 2002/96/EY), paristoista ja akuista annettu direktiivi (2006/66/EY) sekä kansallinen lainsäädäntö kieltävät tuotteen hävittämisen talousjätteen mukana. Tuote on vietävä asianmukaiseen keräyspisteeseen, esimerkiksi kodinkoneliikkeeseen uutta vastaavaa tuotetta ostettaessa tai viralliseen sähkö- ja elektroniikkalaiteromun tai paristojen ja akkujen keräyspisteeseen. Sähkö- ja elektroniikkalaiteromun virheellinen käsittely voi vahingoittaa ympäristöä ja ihmisten terveyttä, koska laitteet saattavat sisältää ympäristölle ja terveydelle haitallisia aineita. Tuotteen asianmukainen hävittäminen säästää samalla luonnonvaroja. Jos haluat lisätietoja tämän tuotteen kierrätyksestä, ota yhteys kunnan jätehuoltoviranomaisiin tai käyttämäsi jätehuolto-yhtiöön tai käy osoitteessa www.canon-europe.com/environment.

(EEA-maat: Norja, Islanti ja Liechtenstein)

Samo za Europsku uniju (i Europski gospodarski prostor).

Oznaka pokazuje da se baterije i akumulatori, korišteni u ovom proizvodu, odlažu odvojeno od kućnog otpada, u skladu s direktivom 2002/96/ EZ-a ("Direktiva") i lokalnim zahtjevima koji primjenjuju te Direktive. Ovaj bi proizvod trebao biti prenesen do određene točke sakupljanja, npr. na neku dozvoljenu bazu u omjeru 1:1 kada kupite novi sličan proizvod, ili na ovlašteno mjesto za sakupljanje istrošene električne i elektronske opreme, (waste electrical and electronic equipment – EEE) baterija i akumulatora. Neodgovarajuće rukovanje ovim tipom otpada može utjecati na okoliš i ljudsko zdravlje zbog potencijalno opasnih supstanci koje se najčešće nalaze uz EEE. Vaša suradnja u pravilnom zbrinjavanju ovog proizvoda doprinjet će efikasnoj uporabi prirodnih resursa. Za više informacija o recikliranju ovog proizvoda, molimo vas da kontaktirate svoj lokalni gradski ured, lokalne vlasti, pogledate odobrenu shemu, kontaktirajte vašu komunalnu službu za uklanjanje radioaktivnog otpada ili posjetite www.canon-europe.com/environment.

(Europski gospodarski prostor: Norveška, Island i Lihtenštajn)

Nur Europäische Union (und EWR)

Diese Symbole weisen darauf hin, dass dieses Produkt gemäß WEEE-Richtlinie 2002/96/EG (Richtlinie über Elektro- und Elektronik-Altgeräte), Batterien-Richtlinie (2006/66/EG) und/oder nationalen Gesetzen zur Umsetzung dieser Richtlinien nicht über den Hausmüll entsorgt werden darf. Dieses Produkt muss bei einer dafür vorgesehenen Sammelstelle abgegeben werden. Dies kann z. B. durch Rückgabe beim Kauf eines neuen ähnlichen Produkts oder durch Abgabe bei einer autorisierten Sammelstelle für die Wiederaufbereitung von Elektro- und Elektronik-Altgeräten sowie Batterien und Akkumulatoren geschehen. Der unsachgemäße Umgang mit Altgeräten kann aufgrund potenziell gefährlicher Stoffe, die häufig in Elektro- und Elektronik-Altgeräte enthalten sind, negative Auswirkungen auf die Umwelt und die menschliche Gesundheit haben. Durch Ihre Mitarbeit bei der sachgemäßen Entsorgung dieses Produkts tragen Sie zu einer effektiven Nutzung natürlicher Ressourcen bei. Um weitere Informationen über die Wiederverwertung dieses Produkts zu erhalten, wenden Sie sich an Ihre Stadtverwaltung, den öffentlich-rechtlichen Entsorgungsträger, eine autorisierte Stelle für die Entsorgung von Elektro- und Elektronik-Altgeräten oder Ihre Müllabfuhr oder besuchen Sie www.canon-europe.com/environment.

(EWR: Norwegen, Island und Liechtenstein)

Только для Европейского Союза (Европейской экономической зоны).

Эти символы указывают, что данный продукт не должен утилизироваться вместе с хозяйственно-бытовыми отходами в соответствии с Директивой WEEE (2002/96/EC), Директивой об аккумуляторах 2006/66/EC и/или законами Вашей страны, осуществляющими данные Директивы. Данное изделие должно быть передано в предназначенный для этого пункт сбора, например, на основе авторизованного обмена «один к одному», когда Вы покупаете подобное новое изделие, или в авторизованное место сбора отходов электрического и электронного оборудования, батарей и аккумуляторов для переработки. Неправильное обращение с отходами подобного типа может иметь влияние на окружающую среду и здоровье человека из-за потенциально опасных для здоровья веществ, которые, как правило, тесно связаны с электрическим и электронным оборудованием. Ваше сотрудничество в области правильной утилизации данного изделия вносит вклад в рациональное использование природных ресурсов. Чтобы узнать больше информации о переработке отходов батарей и аккумуляторов, пожалуйста, обратитесь в местную городскую администрацию, орган по работе с отходами или предприятие по утилизации отходов, или зайдите на www.canon-europe.com/environment.

(Европейская экономическая зона: Норвегия, Исландия и Лихтенштейн)

Només per a la Unió Europea (i EEA)

Aquests símbols indiquen que aquest producte no s'ha de llençar amb les escombraries de la llar, d'acord amb la RAEE (2002/96/EC), la Directiva relativa a piles i acumuladors (2006/66/EC) i la legislació nacional que implementi aquestes directives. Aquest producte s'hauria de lliurar en un dels punts de recollida designats, com per exemple, intercanviant un per un en comprar un producte similar o lliurant-lo en un lloc de recollida autoritzat per al reciclatge de residus d'aparells elèctrics i electrònics (EEE) i piles i acumuladors. La manipulació inadequada d'aquest tipus de residus podria tenir un impacte negatiu en l'entorn i en la salut humana, a causa de les substàncies potencialment perilloses que normalment estan associades a l'EEE. La vostra cooperació a l'hora de rebutjar correctament aquest producte contribuirà a la utilització efectiva dels recursos naturals. Els usuaris tenen dret a retornar les bateries o els acumuladors usats sense cap càrrec. El preu de venda de les bateries i els acumuladors inclou el cost de la gestió ambiental dels residus i, sota cap circumstància, l'import d'aquest cost s'especificarà per separat en aquest fullet o en la factura que es lliuri a l'usuari final. Per a més informació sobre el reciclatge d'aquest producte, contacteu amb l'oficina municipal, les autoritats encarregades dels residus, el pla de residus homologat o el servei de recollida d'escombraries domèstiques de la vostra localitat o visiteu www.canon-europe.com/environment.

(EEA: Noruega, Islàndia i Liechtenstein)

Doar pentru Uniunea Europeană (și EEA).

Aceste simboluri indică faptul că acest produs nu trebuie evacuat împreună cu deșeurile menajere, în conformitate cu Directiva WEEE (2002/96/EC), Directiva referitoare la baterii (2006/66/EC) și/sau legile dvs. naționale ce implementează aceste Directive. Acest produs trebuie înmănat punctului de colectare adecvat, ex: printr-un schimb autorizat unu la unu atunci când cumpărați un produs nou similar sau la un sit de colecție autorizat pentru reciclarea reziduurilor de echipament electric și electronic (EEE) și baterii și acumulatori. Administrarea neadecvată a acestui tip de deșeuri, ar putea avea un impact asupra mediului și asupra sănătății umane datorită substanțelor cu potențial de risc care sunt în general asociate cu EEE. Cooperarea dvs. în direcția evacuării corecte a acestui produs va contribui la o utilizare eficientă a resurelor naturale. Pentru mai multe informații despre reciclarea acestui produs, vă rugăm să contactați biroul dvs. local, autoritățile responsabile cu deșeurile, schema aprobată sau serviciul dvs. responsabil cu deșeurile menajere sau vizitați-ne la www.canon-europe.com/environment.

(EEA: Norvegia, Islanda, Lichtenstein)

Yalnızca Avrupa Birliği (ve AEA).

Bu simgeler, WEEE Direktifi (2002/96/AT), Pil Direktifi (2006/66/AT) ve/veya bu Direktifleri uygulamaya koyan ulusal kanunlarınız uyarınca bu ürünün evsel atıklarınızla birlikte atılmaması gerektiğini gösterir. Bu ürün örneğin, benzer bir yeni ürün aldığınızda yetkili bir değiştirme esaslı toplama noktası veya elektrikli ve elektronik cihazlar (EEE) ile pil ve akü geri dönüşümü için yetkili bir toplama merkezi gibi belirlenmiş bir toplama noktasına götürülmelidir. Bu gibi atıkların gerektiği şekilde işlem görmemesi genel olarak EEE ile bağlantılı olan tehlikeli olabilecek maddeler nedeniyle çevre ve insan sağlığı üzerinde olumsuz etkiye yol açabilir. Bu ürünün düzgün şekilde atılması için işbirliği yapmanız doğal kaynakların verimli şekilde kullanımına katkıda bulunacaktır. Bu ürünün geri dönüşümü hakkında daha fazla bilgi için lütfen belediyeniz, atık merkeziniz, onaylı atık programı veya çöp toplama servisine başvurun ya da www.canon-europe.com/environment adresini ziyaret edin.

(AEA: Norveç, İzlanda ve Lihtenştayn)

Тільки для Європейського Союзу (та Європейської економічної зони).

Ці символи вказують, що даний продукт не повинен утилізуватися разом з господарчо-побутовими відходами згідно Директиви WEEE (2002/96/EC), Директиви про батареї 2006/66/EC та/або законів Вашої країни, що реалізують ці Директиви. Даний виріб повинно бути передано до призначеного приймального пункту, наприклад, на базі авторизованого обміну «один до одного», якщо Ви купите подібний новий продукт, або до авторизованого місця збору відходів електричного та електронного обладнання, батарей та акумуляторів для подальшої переробки. Невідповідне обходження з подібними відходами може завдавати впливу на оточуюче середовище і здоров'я людини через присутність потенційно небезпечних речовин, які загалом тісно пов'язані з електричним та електронним обладнанням. Ваша співпраця щодо відповідної утилізації даного виробу робить внесок у раціональне використання природних ресурсів. Будь ласка, зверніться до місцевої адміністрації, органу по роботі з відходами або підприємства по утилізації відходів, щоб дізнатися більше про переробку даного виробу, або зверніться на www.canon-europe.com/environment.

(Європейська економічна зона: Норвегія, Ісландія та Ліхтенштейн)

Само за Европейския съюз (и ЕИП).

Тези символи указват, че този продукт не може да се изхвърля заедно с боклука от вашето домакинство, според Директивата ИУЕЕО (2002/96/EC), Директивата за батерии (2006/66/EC) и/или вашите национални закони, които изпълняват тези Директиви. Този продукт трябва да бъде предаден в обозначен събирателен пункт, т.е. в одобрена база, когато купувате нов подобен продукт или в одобрен събирателен пункт за рециклиране на отпадъци от електрическо и електронно оборудване (ЕЕО), батерии и акумулаторни батерии. Неправилното третиране на този вид отпадъци може да има потенциален вреден ефект върху околната среда и човешкото здраве, поради възможните опасни вещества, с които обикновено се свързва ЕЕО. Вашето съдействие за правилното изхвърляне на този продукт ще допринесе за ефективната употреба на естествените ресурси. За повече информация относно рециклирането на този продукт, моля свържете се с вашия местен офис, с органа, който отговаря за отпадъчните продукти, одобрената програма или учреждениято по изхвърляне на боклука на вашето домакинство, или посетете www.canon-europe.com/environment.

(ЕИП: Норвегия, Исландия и Лихтенщайн)

الاتحاد الأوروبي (والمنطقة الاقتصادية الأوروبية) فقط

تشير هذه الرموز إلى عدم التخلص من هذا المنتج في النفايات المنزلية العادية طبقاً لتوجيه الاتحاد الأوروبي WEEE (الخاص بنفايات المعدات الكهربائية والإلكترونية) (EC/96/2002)، والتوجيه الخاص بالبطاريات (EC/66/2006)، و/ أو القوانين المحلية التي تنطبق على تلك التوجيهات. يجب تقديم هذا المنتج إلى أحد مراكز تجميع النفايات المخصصة، على سبيل المثال، على أساس فردي عند شراء أحد المنتجات الجديدة المماثلة أو إلى موقع التجميع المعتمد الخاص بإعادة تدوير المعدات الكهربائية والإلكترونية (EEE) والبطاريات والمراكم. التعامل غير الصحيح مع هذا النوع من النفايات قد يكون له تأثيراً على البيئة وصحة الإنسان بسبب المواد الخطيرة المحتملة المرتبطة بشكل عام بتوجيه EEE (المعدات الكهربائية والإلكترونية). تعاونك في التخلص الملائم من هذا المنتج سيساهم في الاستعمال الفعال للمصادر الطبيعية. للحصول على مزيد من المعلومات حول إعادة تدوير هذا المنتج، برجاء الاتصال بمكتب المدينة المحلي الخاص بك، أو سلطة التخلص من النفايات أو البرنامج المعتمد أو مرفق خدمة التخلص من النفايات المنزلية أو التفضل بزيارة الموقع www.canon-europe.com/environment

(المنطقة الاقتصادية الأوروبية : النرويج، وأيسلندا وليختنشتاين)

Memo

Index

A

Accounting 748, 749, 752, 753, 757
Additional Settings Pane 387
Adjusting the Color in the Printer Driver 60
Adjusting the Vacuum Strength 819
Adobe RGB 43, 46, 294, 502
AppleTalk Network 731, 732

B

Bonjour Network 729

C

CAD 58
Checking Ink Tank Levels 844
Cleaning 847, 869
Clearing a Jammed Sheet 889
Color Adjustment 194, 198, 402, 428
Color imageRUNNER Enlargement Copy 246, 247, 448, 449, 450
Configuring NetWare Network Settings 720
Configuring the IP Address 713, 714, 738

D

Deleting Saved Jobs 776
Device Settings Sheet 212
Device Setup Utility 738
Drying Time 552

F

Favorites Sheet 209
Frame Type 720
Free Layout 223, 225, 417, 419

G

GARO Wxxxx (x represents a number) 938

H

Hardware error 938

I

Interface 687

L

Large-Format Printing 114
Layout Sheet 206
Loading and Printing on Sheets 25

M

Main Pane 370
Main Sheet 188, 267, 474

Maintenance Cartridge 860, 867, 935
Media Take-up Unit 578, 580, 587, 699
Menu Operations 665, 666
Menu Structure 669

N

Navigate 661
NetWare network 907
Nozzle 846

O

Orientation 168, 170, 340, 352
Output Method 204
Oversize 90

P

Page Setup Pane 385
Page Setup Sheet 201, 270, 477
Personal Box 786, 789
PosterArtist 52
Power 341, 343, 345, 348, 349, 350, 352
Preparing to Transfer the Printer 873
Print Job Log 757, 758
Printer Driver Settings 178, 364
Printer Hard Disk Operations 701
Printhead 806, 810, 846, 847, 848
Printing Posters in Sections 140
Printing Saved Jobs 771
Printing Vertical or Horizontal Banners 114, 115, 119
Printing at Actual Size 95, 96, 98
Printing from Photoshop 42
Printing on Rolls 22

R

Removing the Roll 547, 550
Replacing Ink Tanks 834
Replacing the Cutter Unit 856
Rewinding error 925
Roll Holder 538, 705

S

Saving Print Jobs 764, 784
Size Options 205, 284, 491
Special Settings 208, 361
Specifications 942
Specifying Paper in the Printer Driver 36, 180, 366
Status Print 684
Strange Sound 911
Support Pane 387
Support Sheet 211, 275, 482

U

Using the Output Stacker	572
Utility Sheet	210

W

Watermark	165, 166
When to Replace Ink Tanks	845

Memo



Canon Inc.

30-2, Shimomaruko 3-chome, Ohta-ku, Tokyo 146-8501, Japan

Canon U.S.A., Inc.

One Canon Plaza, Lake Success, NY 11042 U.S.A

Canon Europe Ltd.

3 The Square, Stockley Park, Uxbridge, Middlesex, UB11 1ET United Kingdom

Canon (China) Co., Ltd.

15F Jinbao Building No.89 Jinbao Street, Dongcheng District, Beijing 100005, China

Canon Australia Pty. Ltd.

1 Thomas Holt Drive, North Ryde, Sydney, N.S.W.2113, Australia