

Canon

EOS 1200D



ENGLISH

**INSTRUCTION
MANUAL**

The "Quick Reference Guide" is included at the end of this manual.

Introduction

The EOS 1200D is a digital single-lens reflex camera featuring a fine-detail CMOS sensor with approx. 18.0 effective megapixels, DIGIC 4, high-precision and high-speed 9-point AF, approx. 3.0 fps continuous shooting, Live View shooting, and Full High-Definition (Full HD) movie shooting.

Before Starting to Shoot, Be Sure to Read the Following

To avoid botched pictures and accidents, first read the “Safety Precautions” (p.307-309) and “Handling Precautions” (p.20, 21). Also, read this manual carefully to ensure that you use the camera correctly.

Refer to This Manual While Using the Camera to Further Familiarize Yourself with the Camera

While reading this manual, take a few test shots and see how they come out. You can then better understand the camera. Be sure to store this manual safely, too, so that you can refer to it again when necessary.

Testing the Camera Before Use and Liability

After shooting, play images back and check whether they have been properly recorded. If the camera or memory card is faulty and the images cannot be recorded or downloaded to a computer, Canon cannot be held liable for any loss or inconvenience caused.

Copyrights

Copyright laws in your country may prohibit the use of your recorded images or copyrighted music and images with music in the memory card for anything other than private enjoyment. Also be aware that certain public performances, exhibitions, etc., may prohibit photography even for private enjoyment.

Item Check List

Before starting, check that all the following items have been included with your camera. If anything is missing, contact your dealer.

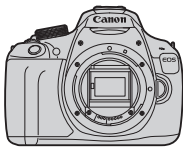

Camera

(with eyecup and body cap)



Battery Pack LP-E10
(with protective cover)



Battery Charger
LC-E10/LC-E10E*

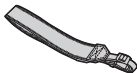

Wide Strap



Interface Cable



EOS Solution Disk
(Software)

* Battery Charger LC-E10 or LC-E10E is provided. (The LC-E10E comes with a power cord.)

- The Instruction Manuals provided are listed on the next page.
- If you purchased a Lens Kit, check that the lenses are included.
- Depending on the Lens Kit type, lens instruction manuals may also be included.
- Be careful not to lose any of the above items.



When you need Lens Instruction Manuals, download them from the Canon website (p.4).

The lens instruction manuals (PDF) are for lenses sold individually. Note that when purchasing the Lens Kit, some of the accessories included with the lens may not match those listed in the Lens Instruction Manual.

Instruction Manuals



Camera Basic Instruction Manual

The booklet is the Basic Instruction Manual.

More detailed Instruction Manuals (PDF files) can be downloaded from the Canon website.

Downloading and Viewing the Instruction Manuals (PDF Files)

1 Download the Instruction Manuals (PDF files).

- Connect to the Internet and access the following Canon website.

www.canon.com/icpd

- Select your country or region of residence and download the Instruction Manuals.

Instruction Manuals Available for Download

- Camera Instruction Manual
- Camera Basic Instruction Manual
- Lens Instruction Manuals
- Software Instruction Manuals

2 View the Instruction Manuals (PDF files).

- Double-click a downloaded Instruction Manual (PDF file) to open it.
- To view the Instruction Manuals (PDF files), Adobe Acrobat Reader DC or other Adobe PDF viewer (most recent version recommended) is required.
- Adobe Acrobat Reader DC can be downloaded free from the Internet.
- To learn how to use a PDF viewer, refer to its Help section.

Compatible Cards

The camera can use the following cards regardless of capacity: **If the card is new or was previously formatted by another camera or computer, it is recommended that you format the card with this camera** (p.50).

- SD memory cards
- SDHC memory cards
- SDXC memory cards



The camera can use UHS-I cards, but since it is not compatible with the UHS-I standard, reading/writing speeds will be equivalent to SD Speed Class 10 at most.

Cards that Can Record Movies

When shooting movies, use a large-capacity SD card rated SD Speed Class 6 “CLASS 6” or higher.

- If you use a slow-writing card when shooting movies, the movie may not be recorded properly. Also, if you play back a movie on a card with a slow reading speed, the movie may not play back properly.
- If you want to shoot still photos while shooting a movie, you will need an even faster card.
- To check the card's reading/writing speed, refer to the card manufacturer's website.



In this manual, “card” refers to SD memory cards, SDHC memory cards, and SDXC memory cards.

* **The camera does not come with a card for recording images/movies.** Please purchase it separately.

Quick Start Guide

1

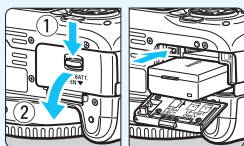

Insert the battery (p.32).

- To charge the battery, see page 30.

2

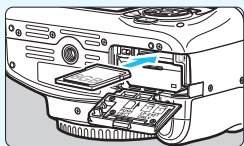

Insert a card (p.32).

- With the card's label facing toward the back of the camera, insert it into the card slot.

3

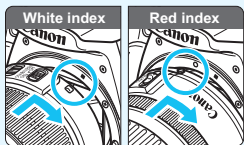

Attach the lens (p.40).

- Align the lens's white or red index with the camera's index in the matching color.

4

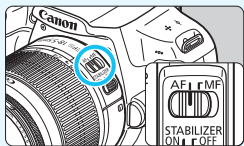

Set the lens focus mode switch to <AF> (p.40).

5

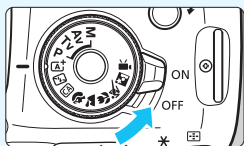

Set the power switch to <ON> (p.35).

- When the LCD monitor displays the date/time/zone setting screens, see page 37.

6

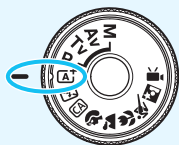

Set the Mode Dial to **<AI+>** (Scene Intelligent Auto) (p.56).

- All the necessary camera settings will be set automatically.

7



Focus on the subject (p.45).

- Look through the viewfinder and aim the viewfinder center over the subject.
- Press the shutter button halfway, and the camera will focus on the subject.
- If necessary, the built-in flash will be raised automatically.

8

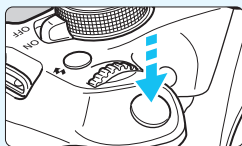

Take the picture (p.45).

- Press the shutter button completely to take the picture.

9







Review the picture (p.180).

- The image just captured will be displayed for 2 sec. on the LCD monitor.
- To display the image again, press the **<▶>** button (p.80).



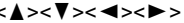



- To shoot while looking at the LCD monitor, see “Live View Shooting” (p.133).
- To view the images captured so far, see “Image Playback” (p.80).
- To delete an image, see “Erasing Images” (p.227).

Conventions Used in this Manual

Icons in this Manual

-  : Indicates the Main Dial.
-  : Indicates the  cross keys on the top, bottom, left, and right.
-  : Indicates the Setting button.
-  : Indicates that the corresponding function remains active for 4 sec., 6 sec., 10 sec., or 16 sec. respectively after you let go of the button.

* In this manual, the icons and markings indicating the camera's buttons, dials, and settings correspond to the icons and markings on the camera and on the LCD monitor.

-  : Indicates a function that can be changed by pressing the <MENU> button and changing the setting.
-  : Shown at the upper right of a page title to indicate a function that is available only in the Creative Zone modes (p.26).
- (p.**)
-  : Warning to prevent shooting problems.
-  : Supplemental information.
-  : Tips or advice for better shooting.
-  : Problem-solving advice.

Basic Assumptions

- All operations explained in this manual assume that the power switch is <ON> (p.35).
- It is assumed that all the menu settings and Custom Functions are set to their defaults.
- The illustrations in this manual show the camera attached with the EF-S18-55mm f/3.5-5.6 IS II lens as an example.

Chapters

For first-time DSLR users, Chapters 1 and 2 explain the camera's basic operations and shooting procedures.

	Introduction	2
1	Getting Started	29
2	Basic Shooting and Image Playback	55
3	Creative Shooting	81
4	Advanced Shooting	103
5	Shooting with the LCD Monitor (Live View Shooting)	133
6	Shooting Movies	153
7	Handy Features	179
8	Image Playback	203
9	Post-Processing Images	233
10	Printing Images	239
11	Customizing the Camera	255
12	Reference	267
13	Downloading Images to Your Computer	313
14	Quick Reference Guide and Index	321



Contents at a Glance

Shooting

- **Shoot automatically** → **p.55-79** (Basic Zone modes)
- **Shoot continuously** → **p.98** (📷 Continuous shooting)
- **Take a picture of yourself in a group** → **p.100** (🕒 Self-timer)
- **Freeze the action** → **p.104** (Tv Shutter-priority AE)
- **Blur the action**
- **Blur the background** → **p.62** (📷 Creative Auto)
- **Keep the background in sharp focus** → **p.106** (Av Aperture-priority AE)
- **Adjust the image brightness (exposure)** → **p.112** (Exposure compensation)
- **Shoot in low light** → **p.56, 101** (📷 Flash photography)
p.88 (ISO speed setting)
- **Shoot without flash** → **p.61** (📷 Flash Off)
p.64, 72 (📷 Flash off)
- **Shoot fireworks at night** → **p.110** (Bulb exposure)
- **Shoot while viewing the LCD monitor** → **p.133** (📷 Live View shooting)
- **Shoot movies** → **p.153** (🎬 Movie shooting)

Image Quality

- **Shoot with image effects matching the subject** → **p.91** (Picture Style)
- **Make a large-size print of the picture** → **p.84** (📷 L, 📷 L, RAW)





- **Take many pictures** → p.84 (▲ S1, ▲ S1, S2, S3)

Focusing

- **Change the point of focus** → p.95 (☒ AF point selection)
- **Shoot a moving subject** → p.68, 94 (AI Servo AF)

Playback

- **View the images on the camera** → p.80 (▶ Playback)
- **Search for pictures quickly** → p.204 (☒ Index display)
p.205 (📄 Image browsing)
- **Rate images** → p.208 (Ratings)
- **Prevent important images from accidental deletion** → p.225 (🔒 Image protection)
- **Delete unnecessary images** → p.227 (🗑️ Delete)
- **Auto play images and movies** → p.218 (Slide show)
- **View the photos or movies on a TV set** → p.222 (High-Definition TV set)
- **Adjust the LCD monitor brightness** → p.181 (LCD monitor brightness)
- **Apply special effect to images** → p.234 (Creative filters)

Printing

- **Print pictures easily** → p.239 (Direct printing)



Index to Features

Power

- **Battery**
 - Charging → p.30
 - Installing/Removing → p.32
 - Battery check → p.36
- **Household power outlet** → p.268
- **Auto power off** → p.35

Cards

- **Installing/Removing** → p.32
- **Formatting** → p.50
- **Release shutter without card** → p.180

Lens

- **Attaching/Detaching** → p.40
- **Zoom** → p.41
- **Image Stabilizer** → p.43

Basic Settings

- **Dioptric adjustment** → p.44
- **Language** → p.39
- **Date/Time/Zone** → p.37
- **Beeper** → p.180
- **LCD off/on button** → p.193
- **LCD brightness adjustment** → p.181

Recording Images

- **Creating/Selecting a folder** → p.182
- **File numbering** → p.184

Image Quality

- **Image-recording quality** → p.84
- **Picture Style** → p.91
- **White balance** → p.127
- **Color space** → p.131
- **Image enhancement features**
 - Auto Lighting Optimizer → p.119
 - Lens peripheral illumination correction → p.120
 - Noise reduction for long exposures → p.260
 - Noise reduction for high ISO speeds → p.261
 - Highlight tone priority → p.261

AF

- **AF operation** → p.93
- **AF point selection** → p.95
- **Manual focusing** → p.97

Drive

- **Drive mode** → p.24
- **Continuous shooting** → p.98
- **Self-timer** → p.100
- **Maximum burst** → p.86

Shooting

- **Shooting mode** → p.26
- **ISO speed** → p.88
- **Feature guide** → p.53
- **Bulb** → p.110
- **Metering mode** → p.111
- **Quick Control** → p.46

Exposure Adjustment

- Exposure compensation → p.112
- AEB → p.114
- AE lock → p.116

Flash

- Built-in flash → p.101
 - Flash exposure compensation → p.113
 - FE lock → p.117
- External flash → p.270
- Flash control → p.194

Live View Shooting

- Live View shooting → p.133
- Autofocusing (AF) methods → p.142
- Aspect ratio → p.140
- Grid display → p.139
- Quick Control → p.138

Movie Shooting

- Movie shooting → p.153
- Sound recording → p.174
- Grid display → p.175
- Manual exposure → p.156
- Still photo shooting → p.161
- Quick Control → p.163
- Video snapshot → p.166

Playback

- Image review time → p.180
- Single-image display → p.80
- Shooting information display → p.229
- Index display → p.204

- Image browsing (Jump display) → p.205
- Magnified view → p.206
- Image rotation → p.207
- Rating → p.208
- Movie playback → p.214
- Editing out movie's first/last scene → p.216
- Slide show → p.218
- Viewing images on a TV set → p.222
- Protect → p.225
- Erase → p.227
- Quick Control → p.210

Image Editing

- Creative filters → p.234
- Resize → p.237

Printing

- PictBridge → p.242
- Print Order (DPOF) → p.249
- Photobook Set-up → p.253

Customization

- Custom Functions (C.Fn) → p.256
- My Menu → p.265

Software

- Downloading images to a computer → p.313
- Software instruction manual → p.316











Contents

Introduction	2
Item Check List.....	3
Instruction Manuals	4
Compatible Cards.....	5
Quick Start Guide	6
Conventions Used in this Manual.....	8
Chapters.....	9
Contents at a Glance.....	10
Index to Features	12
Handling Precautions	20
Nomenclature	22





1 Getting Started **29**









Charging the Battery	30
Installing and Removing the Battery and Card.....	32
Turning on the Power	35
Setting the Date, Time, and Zone	37
Selecting the Interface Language.....	39
Attaching and Detaching a Lens	40
Lens Image Stabilizer	43
Basic Operation.....	44
Q Quick Control for Shooting Functions	46
MENU Menu Operations.....	48
Formatting the Card	50
Switching the LCD Monitor Display	52
Feature Guide	53

2 Basic Shooting and Image Playback 55

 Fully Automatic Shooting (Scene Intelligent Auto).....	56
 Full Auto Techniques (Scene Intelligent Auto).....	59
 Disabling Flash	61
 Creative Auto Shooting.....	62
 Shooting Portraits	65
 Shooting Landscapes	66
 Shooting Close-ups	67
 Shooting Moving Subjects	68
 Shooting Night Portraits	69
 Quick Control.....	71
Shoot by Ambience Selection.....	73
Shoot by Lighting or Scene Type.....	77
 Image Playback	80

3 Creative Shooting 81

P : Program AE.....	82
Setting the Image-Recording Quality	84
ISO: Changing the ISO Speed.....	88
 Optimal Image Characteristics for the Subject (Picture Style) ...	91
AF: Changing the Autofocus Operation (AF Operation)	93
 Selecting the AF Point	95
Subjects Difficult to Focus.....	97
MF : Manual Focus	97
 Continuous Shooting	98
 Using the Self-timer	100
 Using the Built-in Flash	101







4	Advanced Shooting	103
	Tv : Conveying the Subject's Movement	104
	Av : Changing the Depth of Field	106
	Depth of Field Preview	108
	M : Manual Exposure	109
	 Changing the Metering Mode	111
	Setting Exposure Compensation	112
	Auto Exposure Bracketing	114
	 Locking the Exposure	116
	 Locking the Flash Exposure	117
	Auto Correction of Brightness and Contrast (Auto Lighting Optimizer) ...	119
	Correcting the Image's Dark Corners	120
	 Customizing Image Characteristics (Picture Style)	122
	 Registering Preferred Image Characteristics (Picture Style) ...	125
	WB : Matching the Light Source (White Balance)	127
	 Adjusting the Color Tone for the Light Source	129
	Setting the Color Reproduction Range (Color Space)	131
5	Shooting with the LCD Monitor (Live View Shooting)	133
	 Shooting with the LCD Monitor	134
	Shooting Function Settings	138
	Menu Function Settings	139
	Using AF to Focus (AF Method)	142
	MF: Focusing Manually	150
6	Shooting Movies	153
	 Shooting Movies	154
	Autoexposure Shooting	154
	Manual Exposure Shooting	156
	Shooting Still Photos	161











Shooting Function Settings	163
Setting the Movie Recording Size	164
Shooting Video Snapshots	166
Menu Function Settings	172



7 Handy Features 179

Handy Features	180
Disabling the Beeper	180
Card Reminder	180
Setting the Image Review Time	180
Setting the Auto Power-off Time	181
Adjusting the LCD Monitor Brightness	181
Creating and Selecting a Folder	182
File Numbering Methods	184
Setting Copyright Information	186
Auto Rotation of Vertical Images	188
Checking Camera Settings	189
Reverting the Camera to the Default Settings	190
Turning the LCD Monitor Off/On	193
Changing the Shooting Settings Screen Color	193
Setting the Flash	194
Appending Dust Delete Data	198
Manual Sensor Cleaning	200

8 Image Playback 203

  Searching for Images Quickly	204
 /  Magnified View	206
 Rotating the Image	207
Setting Ratings	208
 Quick Control for Playback	210
 Enjoying Movies	212

 Playing Movies	214
 Editing a Movie's First and Last Scenes	216
Slide Show (Auto Playback)	218
Playback on a High-Definition TV set	222
 Protecting Images	225
 Erasing Images	227
DISP. Shooting Information Display	229
9 Post-Processing Images	233
 Applying Creative Filters	234
 Resizing JPEG Images	237
10 Printing Images	239
Preparing to Print	240
 Printing	242
Cropping the Image	247
 Digital Print Order Format (DPOF)	249
 Direct Printing of Print-Ordered Images	252
 Specifying Images for a Photobook	253
11 Customizing the Camera	255
Setting Custom Functions	256
Custom Function Settings	258
C.Fn I: Exposure	258
C.Fn II: Image	260
C.Fn III: Autofocus/Drive	262
C.Fn IV: Operation/Others	263
Registering My Menu	265

12	Reference	267
	Using a Household Power Outlet.....	268
	 Using the Remote Switch.....	269
	External Speedlites.....	270
	 Using Eye-Fi Cards.....	272
	Function Availability Table According to Shooting Mode.....	274
	System Map.....	276
	Menu Settings.....	278
	Troubleshooting Guide.....	284
	Error Codes.....	296
	Specifications.....	297
	Safety Precautions.....	307
13	Downloading Images to Your Computer	313
	Downloading Images to a Computer.....	314
	About the Software.....	316
	Installing the Software.....	317
14	Quick Reference Guide and Index	321
	Quick Reference Guide.....	322
	Index.....	334

Handling Precautions

Camera Care

- This camera is a precision instrument. Do not drop it or subject it to physical shock.
- The camera is not waterproof and cannot be used underwater. If you accidentally drop the camera into water, promptly consult the nearest Canon Service Center. Wipe off any water droplets with a dry and clean cloth. If the camera has been exposed to salty air, wipe it with a well-wrung wet cloth.
- Never leave the camera near anything having a strong magnetic field such as a magnet or electric motor. Also avoid using or leaving the camera near anything emitting strong radio waves, such as a large antenna. Strong magnetic fields can cause camera misoperation or destroy image data.
- Do not leave the camera in excessive heat, such as in a car in direct sunlight. High temperatures can cause the camera to malfunction.
- The camera contains precision electronic circuitry. Never attempt to disassemble the camera yourself.
- Do not block the built-in flash, mirror operation with your finger, etc. Doing so may cause a malfunction.
- Use a blower to blow away dust on the lens, viewfinder, reflex mirror, and focusing screen. Do not use cleaners that contain organic solvents to clean the camera body or lens. For stubborn dirt, take the camera to the nearest Canon Service Center.
- Do not touch the camera's electrical contacts with your fingers. This is to prevent the contacts from corroding. Corroded contacts can cause camera misoperation.
- If the camera is suddenly brought in from the cold into a warm room, condensation may form on the camera and internal parts. To prevent condensation, first put the camera in a sealed plastic bag and let it adjust to the warmer temperature before taking it out of the bag.
- If condensation forms on the camera, do not use the camera. This is to avoid damaging the camera. If there is condensation, remove the lens, card and battery from the camera, and wait until condensation has evaporated before using the camera.
- If the camera will not be used for an extended period, remove the battery and store the camera in a cool, dry, well-ventilated location. Even while the camera is in storage, press the shutter button a few times once in a while to check that the camera is still working.
- Avoid storing the camera where there are chemicals that result in rust and corrosion such as in a chemical lab.

- If the camera has not been used for an extended period, test all its functions before using it. If you have not used the camera for some time or if there is an important shoot such as a foreign trip coming up, have the camera checked by your Canon dealer or check the camera yourself and make sure it is working properly.
- If you use continuous shooting, Live View shooting, or movie shooting for a prolonged period, the camera may become hot. This is not a malfunction.

LCD Monitor

- Although the LCD monitor is manufactured with very high precision technology with over 99.99% effective pixels, there may be a few dead pixels displaying only black or red, etc. among the remaining 0.01% or less pixels. Dead pixels are not a malfunction. They do not affect the images recorded.
- If the LCD monitor is left on for a prolonged period, screen burn-in may occur where you see remnants of what was displayed. However, this is only temporary and will disappear when the camera is left unused for a few days.
- The LCD monitor display may seem slow in low temperatures, or look black in high temperatures. It will return to normal at room temperature.

Cards

To protect the card and its recorded data, note the following:

- Do not drop, bend, or wet the card. Do not subject it to excessive force, physical shock, or vibration.
- Do not touch the card's electronic contacts with your fingers or anything metallic.
- Do not affix any stickers, etc., on the card.
- Do not store or use the card near anything that has a strong magnetic field, such as a TV set, speakers, or magnet. Also avoid places prone to having static electricity.
- Do not leave the card in direct sunlight or near a heat source.
- Store the card in a case.
- Do not store the card in hot, dusty, or humid locations.

Lens

After detaching the lens from the camera, put down the lens with the rear end up and attach the lens caps to avoid scratching the lens surface and electrical contacts.

Smudges Adhering to the Front of the Sensor

Besides dust entering the camera from outside, in rare cases lubricant from the camera's internal parts may adhere to the front of the sensor. If visible spots remain on the image, having the sensor cleaned by a Canon Service Center is recommended.



Nomenclature

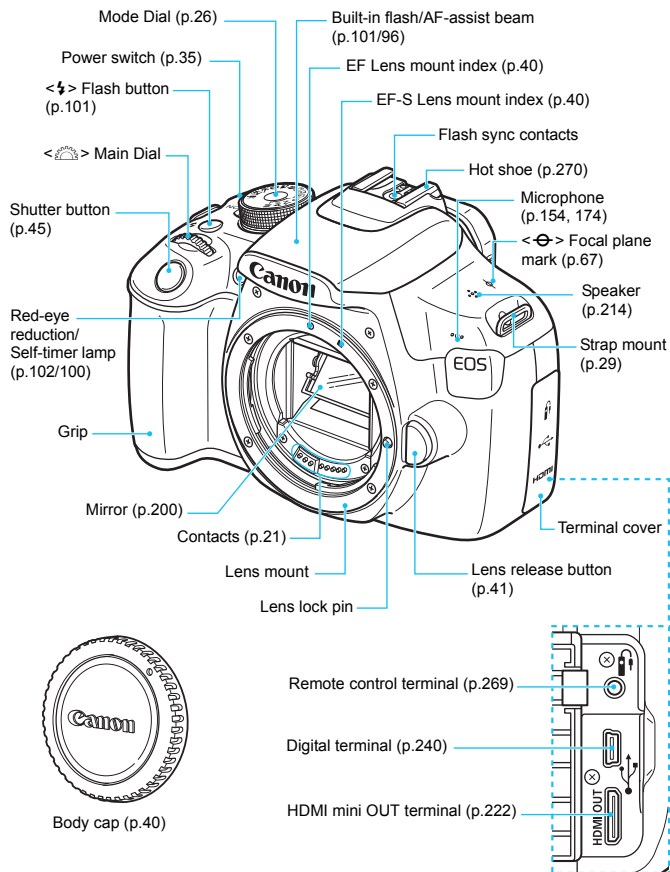

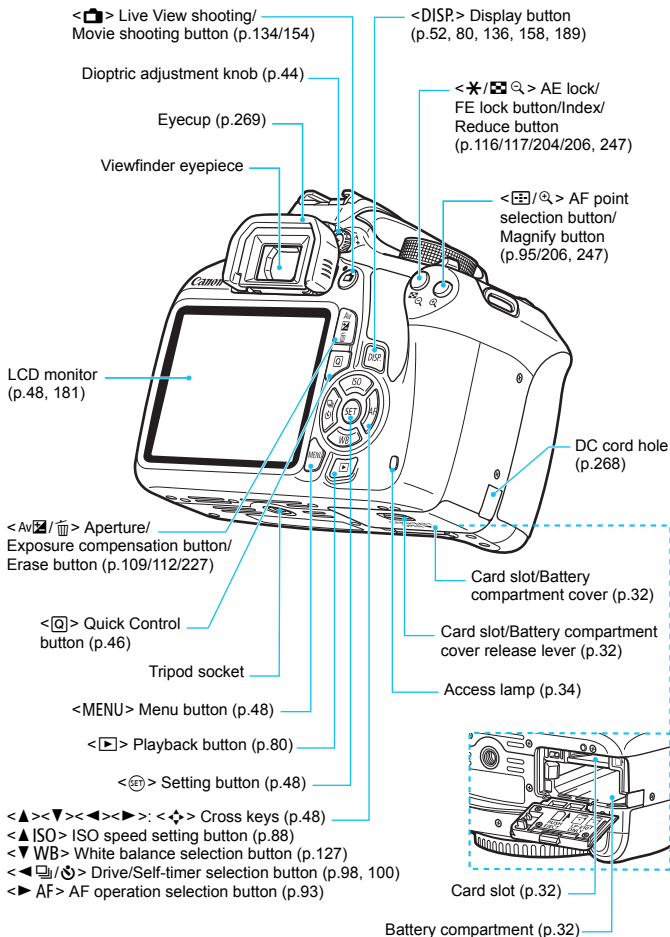

Shooting Settings (in Creative Zone modes, p.26)

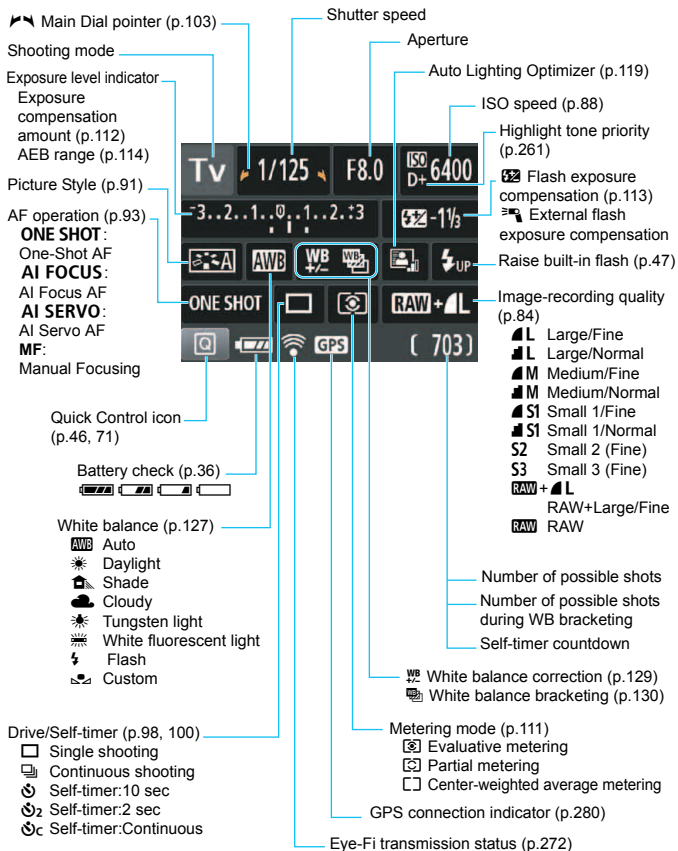

The display will show only the settings currently applied.

Viewfinder Information

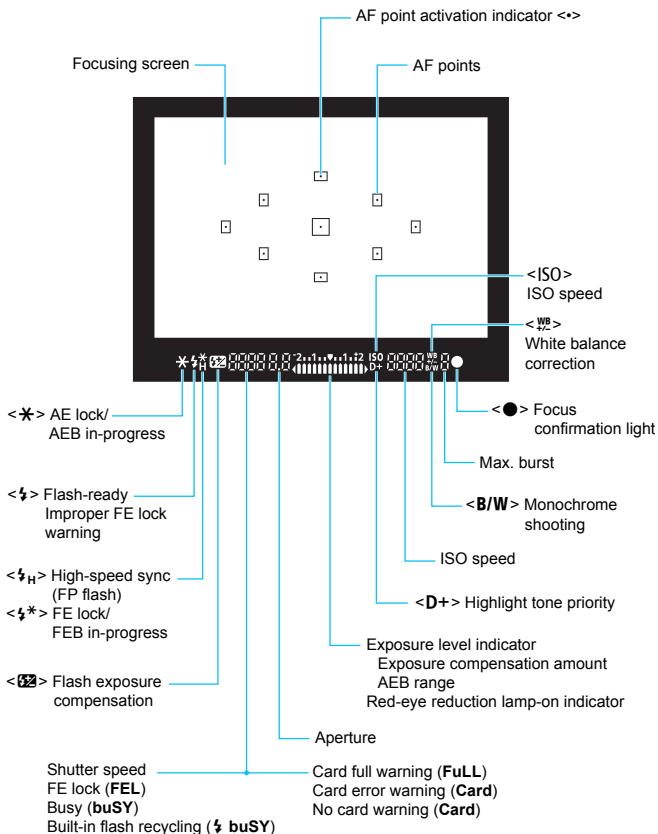

The display will show only the settings currently applied.

Mode Dial

The Mode Dial includes the Basic Zone modes, Creative Zone modes, and the Movie shooting mode.

Creative Zone Modes

These modes give you more control for shooting various subjects.

- P** : Program AE (p.82)
- Tv** : Shutter-priority AE (p.104)
- Av** : Aperture-priority AE (p.106)
- M** : Manual exposure (p.109)

Basic Zone Modes

All you do is press the shutter button. The camera sets everything to suit the subject or scene.

- A+** : Scene Intelligent Auto (p.56)
- [Flash Off]** : Flash Off (p.61)
- CA** : Creative Auto (p.62)

Image Zone Modes

- [Portrait]** : Portrait (p.65)
- [Landscape]** : Landscape (p.66)
- [Close-up]** : Close-up (p.67)
- [Sports]** : Sports (p.68)
- [Night Portrait]** : Night Portrait (p.69)

[Movie Shooting]
(p.153)

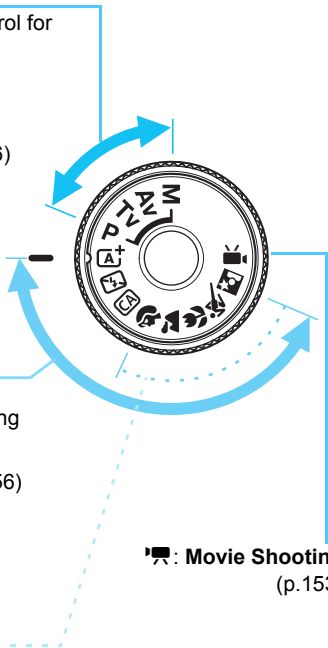

Lens

Lens without a distance scale

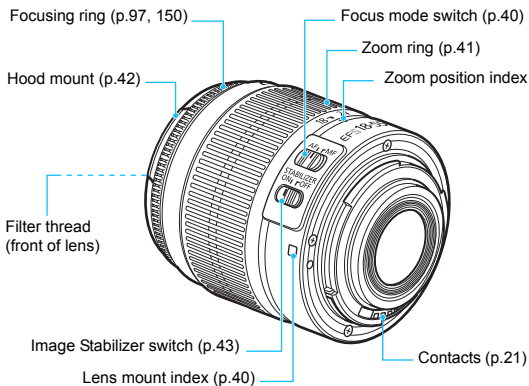

Battery Charger LC-E10

Charger for Battery Pack LP-E10 (p.30).

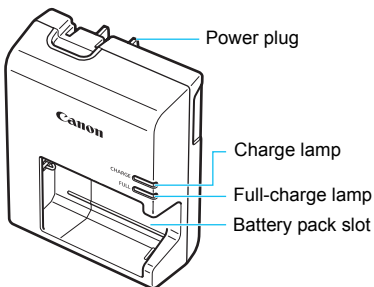

**IMPORTANT SAFETY INSTRUCTIONS-SAVE THESE INSTRUCTIONS.
DANGER-TO REDUCE THE RISK OF FIRE OR ELECTRIC SHOCK,
CAREFULLY FOLLOW THESE INSTRUCTIONS.**

For connection to a supply not in the U.S.A., use an attachment plug adapter of the proper configuration for the power outlet, if needed.

Battery Charger LC-E10E

Charger for Battery Pack LP-E10 (p.30).

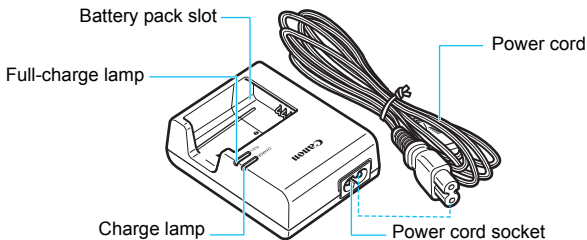

1

Getting Started

This chapter explains preparatory steps before you start shooting and basic camera operations.

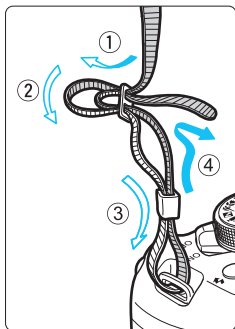

Attaching the Strap

Pass the end of the strap through the camera's strap mount eyelet from the bottom. Then pass it through the strap's buckle as shown in the illustration. Pull the strap to take up any slack and make sure the strap will not loosen from the buckle.

- The eyepiece cover is also attached to the strap (p.269).

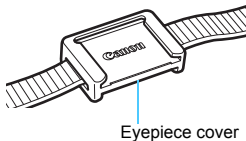

Charging the Battery

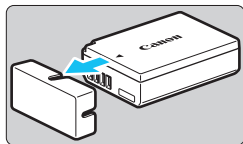

1 Remove the protective cover.

- Detach the protective cover provided with the battery.

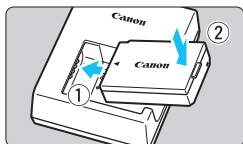

2 Attach the battery.

- As shown in the illustration, attach the battery securely to the charger.
- To detach the battery, follow the above procedure in reverse.

LC-E10

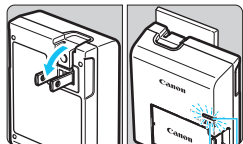

3 Recharge the battery.

For LC-E10

- As shown by the arrow, flip out the battery charger's prongs and insert the prongs into a power outlet.

For LC-E10E

- Connect the power cord to the charger and insert the plug into a power outlet.

Full-charge lamp

Charge lamp

LC-E10E

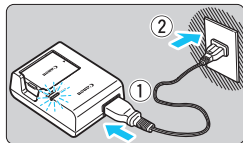

- ▶ Recharging starts automatically and the charge lamp lights up in orange.
- ▶ When the battery is fully recharged, the full-charge lamp will light up in green.

- It takes approx. 2 hours to fully recharge a completely exhausted battery at room temperature (23°C / 73°F). The time required to recharge the battery will vary greatly depending on the ambient temperature and the battery's remaining capacity.
- For safety reasons, recharging in low temperatures (6°C - 10°C / 43°F - 50°F) will take longer (up to approx. 4 hours).



Tips for Using the Battery and Charger

- **Upon purchase, the battery is not fully charged.**
Charge the battery before use.
 - **Recharge the battery on the day before or on the day it is to be used.**
Even during storage, a charged battery will gradually drain and lose its capacity.
 - **After recharging the battery, detach it and disconnect the charger from the power outlet.**
 - **When not using the camera, remove the battery.**
If the battery is left in the camera for a prolonged period, a small amount of power current is released, resulting in excess discharge and shorter battery life. Store the battery with the protective cover (provided) attached. Storing the battery when it is fully charged may lower the battery's performance.
 - **The battery charger can also be used in foreign countries.**
The battery charger is compatible with a 100 V AC to 240 V AC 50/60 Hz power source. If necessary, attach a commercially-available plug adapter for the respective country or region. Do not attach any portable voltage transformer to the battery charger. Doing so can damage the battery charger.
 - **If the battery becomes exhausted quickly even after being fully charged, the battery has reached the end of its service life.**
Purchase a new battery.
-
- After disconnecting the charger's power plug, do not touch the prongs for at least 3 sec.
 - Do not charge any battery other than a Battery Pack LP-E10.
 - Battery Pack LP-E10 is dedicated to Canon products only. Using it with an incompatible battery charger or product may result in malfunction or accidents for which Canon cannot be held liable.

Installing and Removing the Battery and Card

Load a fully charged Battery Pack LP-E10 into the camera. The camera can use an SD, SDHC, or SDXC memory card (sold separately). The captured images are recorded onto the card.

- **Make sure the card's write-protect switch is set upward to enable writing/erasing.**

Installing the Battery and Card

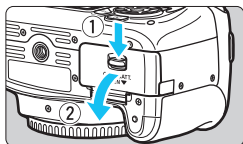

1 Open the cover.

- Slide the lever as shown by the arrows and open the cover.

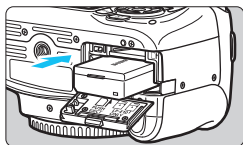

2 Insert the battery.

- Insert the end with the battery contacts.
- Insert the battery until it locks in place.

Write-protect switch

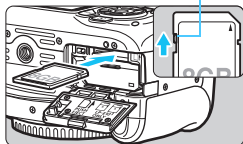

3 Insert the card.

- As shown by the illustration, face the card's label side toward the back of the camera and insert it until it clicks in place.

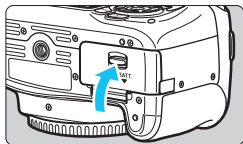

4 Close the cover.

- Press the cover until it snaps shut.
- When you set the power switch to <ON>, the number of possible shots (p.36) will be displayed on the LCD monitor.



After opening the card slot/battery compartment cover, be careful not to swing it back further. Otherwise, the hinge may break.



- The number of possible shots depends on the remaining capacity of the card, image-recording quality, ISO speed, etc.
- Setting [📷 1: Release shutter without card] to [Disable] will prevent you from forgetting to insert a card (p.180).

Removing the Battery and Card

1 Set the power switch to <OFF>
(p.35).

2 Open the cover.

- Make sure the access lamp is off, then open the cover.
- If [Recording...] is displayed, close the cover.

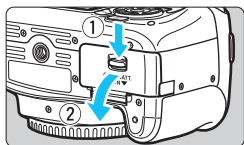

3 Remove the battery.

- Press the battery lock lever as shown by the arrow and remove the battery.
- To prevent short circuiting of the battery contacts, be sure to attach the provided protective cover (p.30) to the battery.

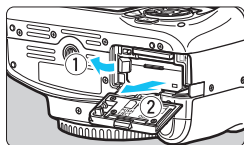

4 Remove the card.

- Gently push in the card, then let it go to eject.
- Pull the card straight out.

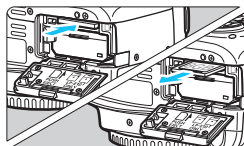

5 Close the cover.

- Press the cover until it snaps shut.



- **When the access lamp is lit or blinking, it indicates that images are being written to or read by the card, being erased, or data is being transferred. Do not open the card slot/battery compartment cover. Also, never do any of the following while the access lamp is lit or blinking. Otherwise, it can damage the image data, card, or camera.**
 - **Removing the card.**
 - **Removing the battery.**
 - **Shaking or banging the camera around.**
- If the card already contains recorded images, the image number may not start from 0001 (p.184).
- If a card-related error message is displayed on the LCD monitor, remove and reinsert the card. If the error persists, use a different card. If you can transfer all the images on the card to a computer, transfer all the images, then format the card with the camera (p.50). The card may then return to normal.
- Do not touch the card's contacts with your fingers or metal objects. Do not expose the contacts to dust or water. If a smudge adheres to the contacts, contact failure may result.
- The camera cannot use MultiMediaCards (MMC). (A card error will appear.)

Turning on the Power

If you turn on the power and the date/time/zone setting screen appears, see page 37 to set the date/time/zone.

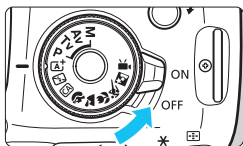

- <ON> : The camera turns on.
- <OFF> : The camera is turned off and does not operate. Set to this position when not using the camera.

MENU Auto Power Off

- To save battery power, the camera turns off automatically after approx. 30 seconds of non-operation. To turn on the camera again, just press the shutter button halfway (p.45).
- You can set the auto power off time with [**1**: Auto power off] (p.181).





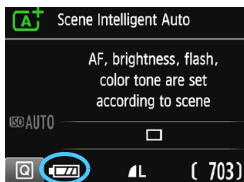

If you set the power switch to <OFF> while an image is being recorded to the card, [**Recording...**] will be displayed and the power will turn off after the card finishes recording the image.

Checking the Battery Level

When the power is turned on, the battery level will be indicated in one of the four levels.



-  : Battery level is sufficient.
-  : Battery level is low, but the camera can still be used.
-  : Battery will be exhausted soon. (Blinks)
-  : Recharge the battery.

Number of Possible Shots

Temperature	Room Temperature (23°C / 73°F)	Low Temperatures (0°C / 32°F)
No Flash	Approx. 600 shots	580
50% Flash Use	Approx. 500 shots	410

- The figures above are based on a fully-charged Battery Pack LP-E10, no Live View shooting, and CIPA (Camera & Imaging Products Association) testing standards.



- Doing any of the following will exhaust the battery sooner:
 - Pressing the shutter button halfway for a prolonged period.
 - Activating the AF frequently without taking a picture.
 - Using the lens Image Stabilizer.
 - Using the LCD monitor often.
- The number of possible shots may decrease depending on the actual shooting conditions.
- The lens operation is powered by the camera's battery. Depending on the lens used, the battery power may be consumed faster.
- For the number of possible shots with Live View shooting, see page 135.

MENU Setting the Date, Time, and Zone

When you turn on the power for the first time or if the date/time/zone have been reset, the date/time/zone setting screen will appear. Follow the steps below to set the time zone first. If you set the camera to the correct time zone for where you currently live, when you travel to another time zone you can simply set the camera to the correct time zone for your destination to adjust the camera's date/time automatically. **Note that the date/time appended to recorded images will be based on this date/time setting. Be sure to set the correct date/time.**

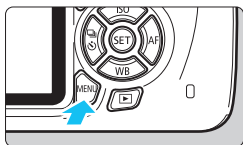

1 Display the menu screen.

- Press the <MENU> button to display the menu screen.



2 Under the [Y2] tab, select [Date/Time/Zone].

- Press the <◀> <▶> keys to select the [Y2] tab.
- Press the <▲> <▼> keys to select [Date/Time/Zone], then press <SET>.

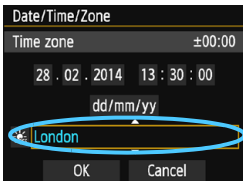

3 Set the time zone.

- [London] is set by default.
- Press the <◀> <▶> keys to select the time zone box.
- Press <SET> so <□> is displayed.
- Press the <▲> <▼> keys to select the time zone, then press <SET>. (Returns to <□>.)



- The menu setting procedure is explained on pages 48-49.
- In step 3, the time displayed on the upper right of the screen is the time difference compared with Coordinated Universal Time (UTC). If you do not see your time zone, set the time zone while referring to the difference with UTC.

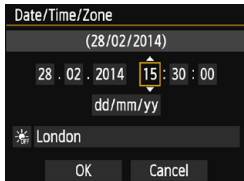

4 Set the date and time.

- Press the <◀> <▶> keys to select the number.
- Press <SET> so <☐> is displayed.
- Press the <▲> <▼> keys to set the number, then press <SET>. (Returns to <☐>.)

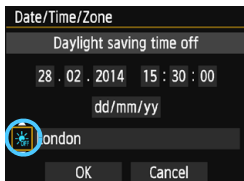

5 Set the daylight saving time.

- Set it if necessary.
- Press the <◀> <▶> keys to select [☀].
- Press <SET> so <☐> is displayed.
- Press the <▲> <▼> keys to select [☀], then press <SET>.
- When the daylight saving time is set to [☀], the time set in step 4 will advance by 1 hour. If [☀] is set, the daylight saving time will be canceled and the time will go back by 1 hour.

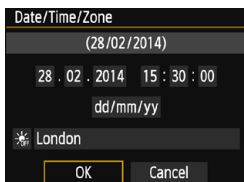

6 Exit the setting.

- Press the <◀> <▶> keys to select [OK], then press <SET>.
- ▶ The date/time/zone and daylight saving time will be set and the menu will reappear.

⚠ The date/time/zone settings may be reset in the following cases. If this happens, set the date/time/zone again.

- When the camera is stored without the battery.
- When the camera's battery becomes exhausted.
- When the camera is exposed to below freezing temperatures for a prolonged period.

- The date/time that was set will start from when you press <SET> in step 6.
- After changing the time zone, check that the correct date/time has been set.

MENU Selecting the Interface Language

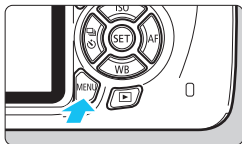

1 Display the menu screen.

- Press the <MENU> button to display the menu screen.

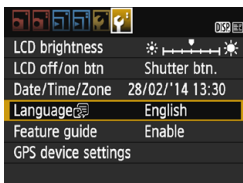

2 Under the [F2] tab, select [Language].

- Press the <<<> >>> keys to select the [F2] tab.
- Press the <▲> <▼> keys to select [Language], then press <SET>.



3 Set the desired language.

- Press the <◇> cross keys to select the language, then press <SET>.
- ▶ The interface language will change.

English	Norsk	Română
Deutsch	Svenska	Türkçe
Français	Español	العربية
Nederlands	Ελληνικά	ελληνικά
Dansk	Русский	简体中文
Português	Polski	繁體中文
Suomi	Čeština	한국어
Italiano	Magyar	日本語
Українська		

Attaching and Detaching a Lens

The camera is compatible with all Canon EF and EF-S lenses. **The camera cannot be used with EF-M lenses.**

Attaching a Lens

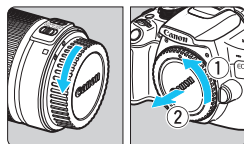

1 Remove the caps.

- Remove the rear lens cap and the body cap by turning them as shown by the arrows.

White index

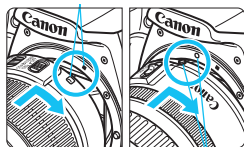

2 Attach the lens.

- Align the lens's red or white index with the camera's index matching the same color. Turn the lens as shown by the arrow until it clicks in place.

Red index

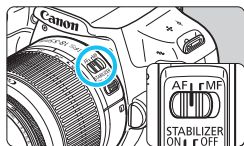

3 Set the lens focus mode switch to <AF>.

- <AF> stands for autofocus.
- If it is set to <MF> (manual focus), autofocus will not operate.

4 Remove the front lens cap.

Minimizing Dust

- When changing lenses, do it quickly in a place with minimal dust.
- When storing the camera without a lens attached, be sure to attach the body cap to the camera.
- Remove dust on the body cap before attaching it.

Zooming

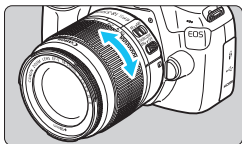

To zoom, turn the zoom ring on the lens with your fingers.

If you want to zoom, do it before focusing. Turning the zoom ring after achieving focus may throw off the focus.

Detaching the Lens

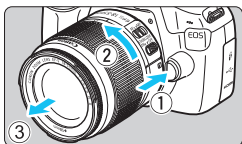

While pressing the lens release button, turn the lens as shown by the arrows.

- Turn the lens until it stops, then detach it.
- Attach the rear lens cap to the detached lens.



- Do not look at the sun directly through any lens. Doing so may cause loss of vision.
- When attaching or detaching a lens, set the camera's power switch to <OFF>.
- If the front part (focusing ring) of the lens rotates during autofocus, do not touch the rotating part.



Image Conversion Factor

Since the image sensor size is smaller than the 35mm film format, it will look like the lens focal length is increased by approx. 1.6x.



Image sensor size (Approx.)
(22.3 x 14.9 mm / 0.88 x 0.59 in.)

35mm image size
(36 x 24 mm / 1.42 x 0.94 in.)

Attaching a Lens Hood

A lens hood can block unwanted light and diminish rain, snow, dust etc. adhering to the front of the lens. Before storing the lens in a bag, etc., you can attach the hood in reverse.

- **If there is no index mark on the lens and hood:**

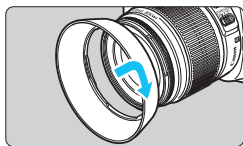

Attach the lens hood.

- Turn the hood as shown by the arrow to attach it securely.

- **If there is an index mark on the lens and hood:**

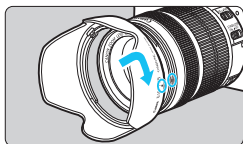

- 1 Align the red dots on the hood and lens edges, then turn the hood as shown by the arrow.**

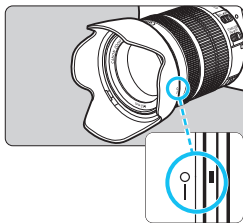

- 2 Turn the hood as shown in the illustration.**

- Turn the hood clockwise until it attaches securely.

- If you do not attach the hood properly, it may obstruct the image's periphery, making it look dark.
- When attaching or detaching the hood, grasp the base of the hood when turning it. Grasping the hood's edges when turning it may deform the hood, resulting in failure to turn.
- When using the camera's built-in flash, detach the hood. Otherwise, the hood will obstruct part of the flash.

Lens Image Stabilizer

When you use an Image Stabilizer (IS) lens, camera shake is corrected to obtain a sharper shot. The procedure explained here is based on the EF-S18-55mm f/3.5-5.6 IS II lens as an example.

* IS stands for Image Stabilizer.

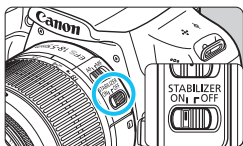

- 1 Set the IS switch to <ON>.**
 - Set also the camera's power switch to <ON>.
- 2 Press the shutter button halfway.**
 - ▶ The Image Stabilizer will operate.
- 3 Take the picture.**
 - When the picture looks steady in the viewfinder, press the shutter button completely to take the picture.



- The Image Stabilizer is not effective if the subject moves at the time of exposure.
- For bulb exposures, set the IS switch to <OFF>. If <ON> is set, Image Stabilizer misoperation may occur.
- The Image Stabilizer may not be effective for excessive shaking such as on a rocking boat.



- The Image Stabilizer can operate with the lens's focus mode switch set to either <AF> or <MF>.
- When using a tripod, you can still shoot with the IS switch set to <ON> with no problem. However, to save battery power, setting the IS switch to <OFF> is recommended.
- The Image Stabilizer is effective even when the camera is mounted on a monopod.
- Some IS lenses enable you to switch the IS mode manually to suit the shooting conditions. However, the EF-S18-55mm f/3.5-5.6 IS II switches the IS mode automatically.

Basic Operation

Adjusting the Viewfinder Sharpness

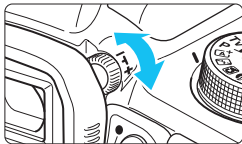

Turn the dioptic adjustment knob.

- Turn the knob left or right so that the AF points (nine boxes) in the viewfinder look sharp.

If the camera dioptic adjustment still cannot provide a sharp viewfinder image, using E-series Dioptic Adjustment Lenses (sold separately) is recommended.

Holding the Camera

To obtain sharp images, hold the camera still to minimize camera shake.

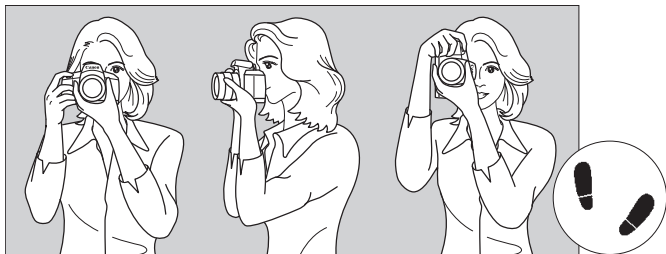

Horizontal shooting

Vertical shooting

1. Wrap your right hand around the camera grip firmly.
2. Hold the lens bottom with your left hand.
3. Rest your hand's right index finger lightly on the shutter button.
4. Press your arms and elbows lightly against the front of your body.
5. To maintain a stable stance, place one foot slightly ahead of the other.
6. Press the camera against your face and look through the viewfinder.

To shoot while looking at the LCD monitor, see page 133.

Shutter Button

The shutter button has two steps. You can press the shutter button halfway. Then you can further press the shutter button completely.



Pressing Halfway

This activates autofocus and the automatic exposure system that sets the shutter speed and aperture.

The exposure setting (shutter speed and aperture) is displayed in the viewfinder (ⓘ4).

While you press the shutter button halfway, the LCD monitor will turn off (p.193).

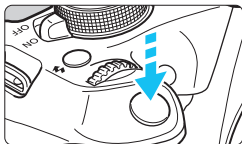

Pressing Completely

This releases the shutter and takes the picture.

Preventing Camera Shake

Hand-held camera movement during the moment of exposure is called camera shake. It can cause blurred pictures. To prevent camera shake, note the following:

- Hold and steady the camera as shown on the preceding page.
- Press the shutter button halfway to autofocus, then slowly press the shutter button completely.



- If you press the shutter button completely without pressing it halfway first, or if you press the shutter button halfway and then press it completely immediately, the camera will take a moment before it takes the picture.
- Even during menu display, image playback, or image recording, you can instantly go back to shooting-ready by pressing the shutter button halfway.

Q Quick Control for Shooting Functions

You can directly select and set the shooting functions displayed on the LCD monitor. This is called the Quick Control.



1 Press the **<Q>** button.

- ▶ The Quick Control screen will appear (10).

2 Set the desired function.

- Press the **<⬆>** cross keys to select a function.
- ▶ The selected function and Feature guide (p.53) will appear.
- Turn the **<⚙>** dial to change the setting.

Basic Zone Modes

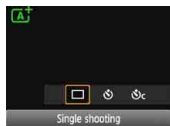

Creative Zone Modes

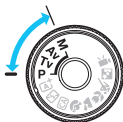

3 Take the picture.

- Press the shutter button completely to take the picture.
- ▶ The captured image will be displayed.

 For the functions settable in Basic Zone modes and the setting procedure, see page 71.

Sample Quick Control Screen

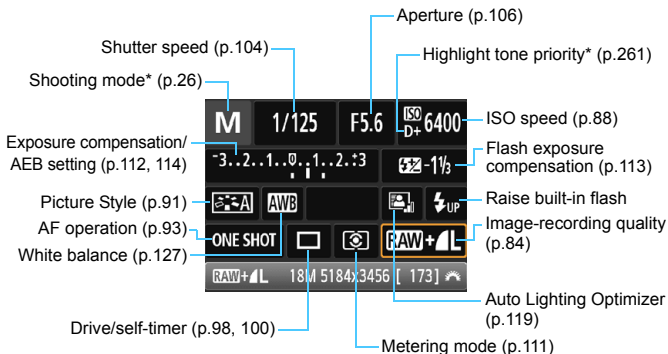

- * These functions cannot be set with the Quick Control screen.
- When you select <FLASH UP> and press <SET>, the built-in flash will pop-up.

Function Setting Screen



- Select the desired function and press <SET>. The function setting screen will appear.
- Press the <◀> <▶> keys or turn the <DISP.> dial to change some of the settings. Also, some functions can be set by pressing the <DISP.> button.
- Press <SET> to finalize the setting and return to the Quick Control screen.

MENU Menu Operations

You can set various settings with the menus such as the image-recording quality, date/time, etc.

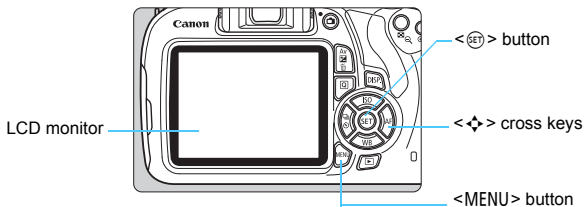

Menu Screen

The menu tabs and items displayed will differ depending on the shooting mode.

Basic Zone Modes



Movie Shooting Mode

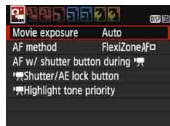
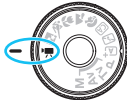

Creative Zone Modes

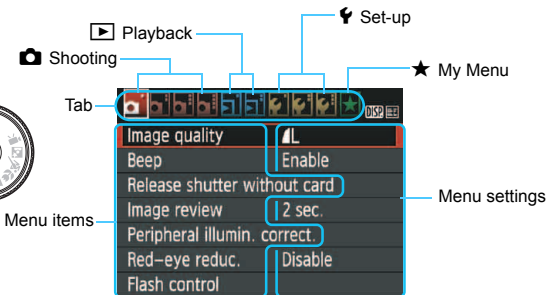
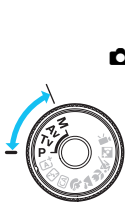

Menu Setting Procedure

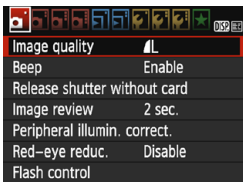

1 Display the menu screen.

- Press the <MENU> button to display the menu screen.

2 Select a tab.

- Press the <◀> <▶> keys to select a tab (group of functions).
- For example, in this manual, “the [📷3] tab” refers to the screen displayed when the third 📷 (Shooting) tab from the left [📷:] is selected.



3 Select the desired item.

- Press the <▲> <▼> keys to select the option, then press <SET>.



4 Select the setting.

- Press the <▲> <▼> or <◀> <▶> keys to select the desired setting. (Some settings require you to press either the <▲> <▼> or <◀> <▶> keys to select it.)
- The current setting is indicated in blue.



5 Set the desired setting.

- Press <SET> to set it.

6 Exit the setting.

- Press the <MENU> button to return to the shooting function settings display.



- In step 2, you can also turn the <📷> dial to select a menu tab.
- The explanation of menu functions hereinafter assumes that you have pressed the <MENU> button to display the menu screen.
- To cancel, press the <MENU> button.
- For details about each menu item, see page 278.

MENU Formatting the Card

If the card is new or was previously formatted by another camera or computer, format the card with the camera.

⚠ When the card is formatted, all images and data in the card will be erased. Even protected images will be erased, so make sure there is nothing you need to keep. If necessary, transfer the images and data to a computer, etc., before formatting the card.

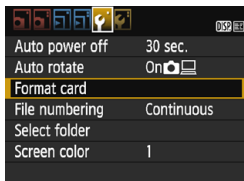

1 Select [Format card].

- Under the [**1**] tab, select [**Format card**], then press <SET>.

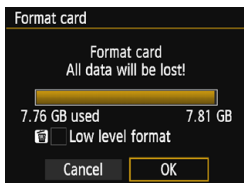

2 Format the card.

- Select [**OK**], then press <SET>.
- ▶ The card will be formatted.
- ▶ When the formatting is completed, the menu will reappear.

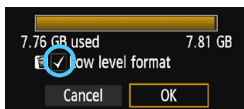

- For low-level formatting, press the <[**✓**]> button to append [**Low level format**] with a checkmark <✓>, then select [**OK**].



Execute [Format card] in the following cases:

- The card is new.
- The card was formatted by a different camera or a computer.
- The card is full with images or data.
- A card-related error is displayed (p.296).

Low-level Formatting

- Perform low-level formatting if the card's recording or reading speed seems slow or if you want to totally erase data in the card.
- Since low-level formatting will format all recordable sectors in the card, the formatting will take slightly longer than normal formatting.
- You can stop the low-level formatting by selecting **[Cancel]**. Even in this case, normal formatting will be completed and you can use the card as usual.



- When the card is formatted or data is erased, only the file management information is changed. The actual data is not completely erased. Be aware of this when selling or discarding the card. When discarding the card, execute low-level formatting or destroy the card physically to prevent the personal data from being leaked.
- **Before using a new Eye-Fi card, the software on the card must be installed on your computer. Then format the card with the camera.**



- The card capacity displayed on the card format screen may be smaller than the capacity indicated on the card.
- This device incorporates exFAT technology licensed from Microsoft.

Switching the LCD Monitor Display

The LCD monitor can display the shooting settings screen, menu screen, captured images, etc.

Shooting Settings

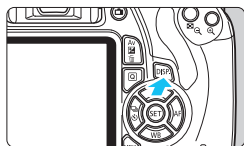

- When you turn on the power, the shooting settings will be displayed.
- **When you press the shutter button halfway, the display will turn off. And when you let go of the shutter button, the display will turn on.**
- **You can also turn off the display by pressing the <DISP.> button.** Press the button again to turn on the display.

Menu Functions

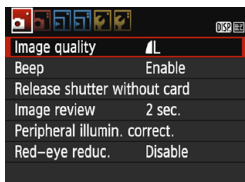

- Appears when you press the <MENU> button. Press the button again to return to the shooting settings screen.

Captured Image



- Appears when you press the <▶> button. Press the button again to return to the shooting settings screen.

- You can set [**F2: LCD off/on btn**] so that the shooting settings display does not keep turning off and on (p.193).
- Even when the menu screen or captured image is displayed, pressing the shutter button will enable you to shoot immediately.

Feature Guide

The Feature guide appears when you change the shooting mode or set a shooting function, Live View shooting, movie shooting, or Quick Control for playback, and displays a brief description of that mode, function or option. It also displays a description when you select a function or option on the Quick Control screen. The Feature guide turns off when you further proceed with any operation.

● Shooting mode (Sample)

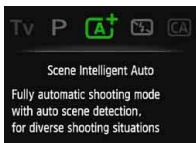

● Quick Control (Sample)

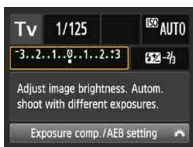

Shooting settings



Live View shooting



Playback

MENU Disabling the Feature Guide



Select [Feature guide].

- Under the [F2] tab, select [Feature guide], then press <SET>.
- Select [Disable], then press <SET>.



2

Basic Shooting and Image Playback

This chapter explains how to use the Basic Zone modes on the Mode Dial for best results and how to play back images.

With Basic Zone modes, all you do is point and shoot while the camera sets everything automatically (p.72, 274). Also, to prevent botched pictures due to mistaken operations, advanced shooting function settings cannot be changed.

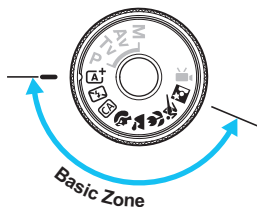

Auto Lighting Optimizer

In Basic Zone modes, the Auto Lighting Optimizer (p.119) will adjust the image automatically to obtain the optimum brightness and contrast. It is also enabled by default in Creative Zone modes.

[A⁺] Fully Automatic Shooting (Scene Intelligent Auto) ■

<[A⁺> is a fully automatic mode. The camera analyzes the scene and sets the optimum settings automatically. It also adjusts focus automatically by detecting whether the subject is still or moving (p.59).



1 Set the Mode Dial to **<[A⁺>**.

AF point

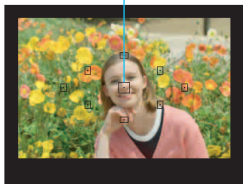

2 Aim any AF point over the subject.

- All the AF points will be used to focus, and generally the closest object will be focused.
- Aiming the center AF point over the subject will make focusing easier.

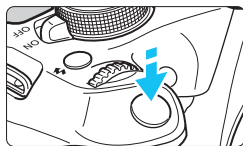

3 Focus on the subject.

- Press the shutter button halfway. The lens elements will shift to focus.
- ▶ The dot inside the AF point achieving focus flashes briefly in red. At the same time, the beeper will sound and the focus confirmation light **<●>** in the viewfinder will light up.
- ▶ If necessary, the built-in flash will be raised automatically.



Focus confirmation light



4 Take the picture.

- Press the shutter button completely to take the picture.
- ▶ The captured image will be displayed for 2 sec. on the LCD monitor.
- After you finish shooting, push down the built-in flash with your fingers.



The <AF> mode makes the colors look more impressive in nature, outdoor, and sunset scenes. If the desired color tone is not obtained, use a Creative Zone mode and select a Picture Style other than <Picture Style A> and shoot (p.91).

? FAQ

- **The focus confirmation light <●> blinks and focus is not achieved.**

Aim the AF point over an area with good contrast, then press the shutter button halfway (p.45). If you are too close to the subject, move away and try again.

- **Multiple AF points flash simultaneously.**

This indicates that focus is achieved at all those AF points. When the AF point covering the desired subject flashes, take the picture.

- **The beeper continues to beep softly. (The focus confirmation light <●> does not light up.)**

It indicates that the camera is focusing continuously on a moving subject. (The focus confirmation light <●> does not light up.) You can take sharp pictures of a moving subject.

Note that focus lock (p.59) will not work in this case.

- **Pressing the shutter button halfway does not focus on the subject.**

If the focus mode switch on the lens is set to <MF> (manual focus), set it to <AF> (autofocus).

- **The flash fired even though it was daylight.**

For a backlit subject, the flash may fire to help lighten the subject's dark areas. If you do not want the flash to fire, use the Flash off mode (p.61). Other than the flash setting, the camera will shoot with the same settings as with .

- **The flash fired and the picture came out extremely bright.**

Move further away from the subject and shoot. When shooting flash photography, if the subject is too close to the camera, the picture may come out extremely bright (overexposure).

- **In low light, the built-in flash fired a series of flashes.**

Pressing the shutter button halfway may trigger the built-in flash to fire a series of flashes to assist autofocusing. This is called AF-assist beam. Its effective range is approx. 4 meters/13.1 feet.

- **When flash was used, the bottom part of the picture came out unnaturally dark.**



The shadow of the lens barrel was captured in the picture because the subject was too close to the camera. Move further away from the subject and shoot. If a hood is attached to the lens, remove it before taking the flash picture.

Full Auto Techniques (Scene Intelligent Auto) ■

Recomposing the Shot



Depending on the scene, position the subject toward the left or right to create a balanced background and good perspective.

In the  mode, while you press the shutter button halfway to focus on a still subject, the focus will be locked. You can then recompose the shot and press the shutter button completely to take the picture. This is called “focus lock”. Focus lock is also possible in other Basic Zone modes (except ).

Shooting a Moving Subject



In the  mode, if the subject moves (distance to camera changes) while or after you focus, AI Servo AF will take effect to focus on the subject continuously. (The beeper will continue beeping softly.) As long as you keep aiming the AF point on the subject while pressing the shutter button halfway, the focusing will be continuous. When you want to take the picture, press the shutter button completely.

Live View Shooting

You can shoot while viewing the image on the LCD monitor. This is called “Live View shooting”. For details, see page 133.



1 Display the Live View image on the LCD monitor.

- Press the button.
- ▶ The Live View image will appear on the LCD monitor.



2 Focus on the subject.

- Aim the center AF point on the subject.
- Press the shutter button halfway to focus.
- ▶ When focus is achieved, the AF point will turn green and the beeper will sound.
- ▶ If necessary, the built-in flash will be raised automatically.

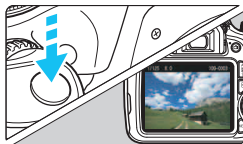

3 Take the picture.

- Press the shutter button completely.
- ▶ The picture will be taken and the captured image is displayed on the LCD monitor.
- ▶ After the image review ends, the camera will return to Live View shooting automatically.
- Press the button to end the Live View shooting.

Disabling Flash

The camera analyzes the scene and sets the optimum settings automatically. In places where flash photography is prohibited such as in a museum or an aquarium, use the <  > (Flash Off) mode. This mode is also effective for capturing the particular ambience of a scene, such as candlelight scenes.

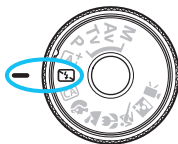

Shooting Tips

- **Prevent camera shake if the numeric display in the viewfinder blinks.**

Under low light when camera shake is prone to occur, the viewfinder's shutter speed display will blink. Hold the camera steady or use a tripod. When using a zoom lens, use the wide-angle end to reduce blur caused by camera shake even while handholding the camera.

- **Take portraits without flash.**

In low-light conditions, tell the subject to keep still until the picture is taken. Any movement by the subject during shooting may result in the subject being blurred in the picture.

CA Creative Auto Shooting

In the <CA> mode, you can easily change the depth of field, drive/self-timer, and flash firing. You can also choose the ambience you want to convey in your images. The default settings are the same as the <A+> mode.

* CA stands for Creative Auto.



1 Set the Mode Dial to <CA>.

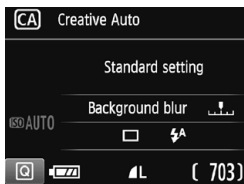

2 Press the <Q> button. (10)

▶ The Quick Control screen will appear.

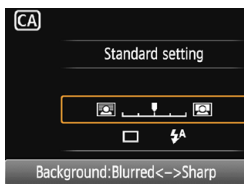

3 Set the desired function.

- Press the <4-way> cross keys to select a function.
- ▶ The selected function and Feature guide (p.53) will appear.
- For the setting procedure and details on each function, see pages 63-64.

4 Take the picture.

- Press the shutter button completely to take the picture.

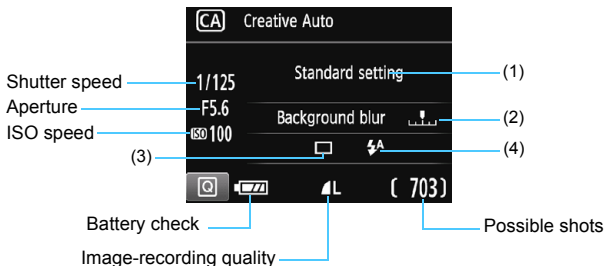

Pressing the **<Q>** button enables you to set the following:

(1) Ambience-based shots





You can set the ambience you want to convey in your images. Press the **<◀>** **<▶>** keys or turn the **<☀>** dial to select the desired ambience. You can also select it from a list by pressing **<SET>**. For details, see page 73.

(2) Blurring/sharpening the background



If you move the index mark toward the left, the background will look more blurred. If you move it toward the right, the background will look more in focus. If you want to blur the background, see “Shooting Portraits” on page 65. Press the **<◀>** **<▶>** keys or turn the **<☀>** dial to select the desired ambience.

Depending on the lens and shooting conditions, the background may not look so blurred. This function cannot be set (grayed out) if the built-in flash is raised and **<⚡>** or **<⚡>** has been selected. If flash is used, this setting will not be applied.

(3) Drive/self-timer: Press  and set it with   or the  dial.



 **Single shooting** : Shoot one image at a time.





 **Continuous shooting:**

While you hold down the shutter button completely, shots will be taken continuously. You can shoot up to approx. 3 shots per second.

 **Self-timer: 10 sec** :The picture is taken 10 seconds after you press the shutter button.

 **Self-timer: Continuous:**

Press the   keys to set the number of multiple shots (2 to 10) to be taken with the self-timer. 10 seconds after you press the shutter button, the set number of multiple shots will be taken.





(4) Flash firing: Press  and set it with   or the  dial.

 **Auto flash** : The flash fires automatically when necessary.

 **Flash on** : The flash fires at all times.

 **Flash off** : The flash is disabled.

 If you use an external Speedlite, **[Flash firing]** cannot be set.

-  When using the self-timer, see the  notes on page 100.
-  When using , see "Disabling Flash" on page 61.

Shooting Portraits

The <> (Portrait) mode blurs the background to make the human subject stand out. It also makes skin tones and hair look softer.

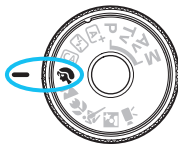

Shooting Tips

- **The further the distance between the subject and background, the better.**

The further the distance between the subject and background, the more blurred the background will look. The subject will also stand out better against an uncluttered dark background.

- **Use a telephoto lens.**

If you have a zoom lens, use the telephoto end to fill the frame with the subject from the waist up. Move in closer if necessary.

- **Focus the face.**

Check that the AF point covering the face flashes. For close-ups of the face, focus on the eyes.



- If you hold down the shutter button, you can shoot continuously to capture subtle changes in the subject's pose and facial expression (max. approx. 3 shots/sec.).
- If necessary, the built-in flash will pop up automatically.

Shooting Landscapes

Use the <  > (Landscape) mode for wide scenery or to have everything in focus from near to far. For vivid blues and greens, and very sharp and crisp images.

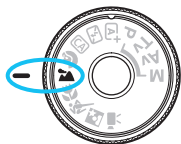

Shooting Tips

- **With a zoom lens, use the wide-angle end.**

When using the wide-angle end of a zoom lens, objects near and far will be in focus. It also adds breadth to landscapes.

- **Shooting night scenes.**

Since the built-in flash will be disabled, this mode <  > is also good for night scenes.

Use a tripod to prevent camera shake.

If you want to shoot a person against a night scene, set the Mode Dial to <  > (Night Portrait) and use a tripod (p.69).





The flash will not fire even in backlit or low-light conditions.

Shooting Close-ups

When you want to shoot flowers or small things up close, use the <  > (Close-up) mode. To make small things appear much larger, use a macro lens (sold separately).



Shooting Tips

- **Use a simple background.**
A simple background makes small objects such as flowers stand out better.
- **Move as close as possible to the subject.**
Check the lens for its minimum focusing distance. Some lenses have indications such as <  0.25m/0.8ft > on them. The lens minimum focusing distance is measured from the <  > (focal plane) mark on the top of the camera to the subject. If you are too close to the subject, the focus confirmation light <  > will blink. If you use flash and the bottom of the picture looks unusually dark, move away from the subject.
- **With a zoom lens, use the telephoto end.**
If you have a zoom lens, using the telephoto end will make the subject look larger.

Shooting Moving Subjects

Use the  (Sports) mode to shoot a moving subject, such as a running person or a moving vehicle.

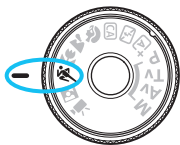

Shooting Tips

- **Use a telephoto lens.**

The use of a telephoto lens is recommended for shooting from a distance.

- **Use the center AF point to focus.**

Aim the center AF point over the subject, then press the shutter button halfway to autofocus. During autofocusing, the beeper will continue beeping softly. If focus cannot be achieved, the focus confirmation light  will blink.

When you want to take the picture, press the shutter button completely. If you hold down the shutter button, you will be able to maintain autofocusing during continuous shooting of the subject's movement (max. approx. 3 shots per sec.).



 Under low light when camera shake is prone to occur, the viewfinder's shutter speed display on the bottom left will blink. Hold the camera steady and shoot.

Shooting Night Portraits

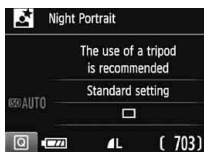
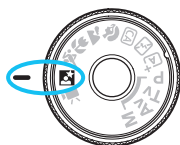
To shoot people at night and obtain a natural-looking night scene in the background, use the  (Night Portrait) mode. Using a tripod is recommended.



Shooting Tips

- **Use a wide-angle lens and a tripod.**
When using a zoom lens, use the wide-angle end to obtain a wide night view. Also, use a tripod to prevent camera shake.
- **Check the subject's brightness.**
Under low light, the built-in flash will fire automatically to obtain a good exposure of the subject.
It is recommended that you play back the image after the shooting to check the image brightness. If the subject looks dark, move nearer and shoot again.
- **Also shoot with the  (Scene Intelligent Auto) mode.**
Since camera shake is prone to occur with night shots, shooting also in the  mode is recommended.

 During Live View shooting, it may be difficult to focus on dots of light such as in a night scene. In such a case, it is recommended that you set the AF method to [**Quick mode**] and shoot. If it is still difficult to focus, set the lens's focus mode switch to <**MF**> and focus manually.

- 
- Tell the subject to keep still even after the flash fires.
 - If you use the self-timer together with flash, the self-timer lamp will light up briefly after the picture is taken.

Q Quick Control

In Basic Zone modes when the shooting function settings screen is displayed, you can press the <Q> button to display the Quick Control screen. The table on the next page shows the functions that can be set with the Quick Control screen in each Basic Zone mode.

1 Set the Mode Dial to a Basic Zone mode.

2 Press the <Q> button. (10)

- ▶ The Quick Control screen will appear.

Example: Portrait mode

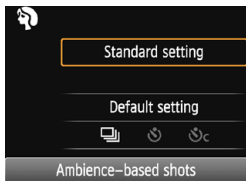





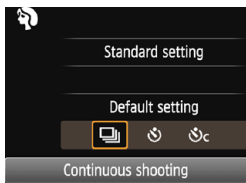









3 Set the functions.

- Press the <▲> <▼> keys to select a function. (This step is not necessary in the A^+ / M mode.)
- ▶ The selected function and Feature guide (p.53) will appear.
- Press the <◀> <▶> keys or turn the <Sun> dial to change the setting.



Settable Functions in Basic Zone Modes

●: Set automatically ○: User selectable □: Not selectable

Function		 (p.56)	 (p.61)	 (p.62)	 (p.65)	 (p.66)	 (p.67)	 (p.68)	 (p.69)
Drive mode	 : Single shooting	○	○	○	□	○	○	□	○
	 : Continuous shooting	□	□	○	○	□	□	○	□
	Self-timer	 : 10 sec.	○	○	○	○	○	○	○
 : Continuous shooting*		○	○	○	○	○	○	○	○
Flash firing	 : Automatic firing	●	□	●	●	□	●	□	●
	 : Flash on (Fires at all times)	□	□	○	□	□	□	□	□
	 : Flash off	□	●	○	□	●	□	●	□
Ambience-based shots (p.73)		□	□	○	○	○	○	○	○
Light/scene-based shots (p.77)		□	□	□	○	○	○	○	□
Blurring/sharpening the background (p.63)		□	□	○	□	□	□	□	□

* Use the <▲> <▼> keys to set the number of continuous shots.

 If you change the shooting mode or set the power switch to <OFF>, the camera will revert to the default settings (except the self-timer).

Shoot by Ambience Selection

Except in the <A+> and <A-> Basic Zone modes, you can select the ambience for shooting.

Ambience	A+	A-	CA	☺	🌄	🌸	🌿	🏠	Ambience Effect
(1) Standard setting	<input type="checkbox"/>	<input type="checkbox"/>	<input type="radio"/>	<input type="radio"/>	<input type="radio"/>	<input type="radio"/>	<input type="radio"/>	<input type="radio"/>	No setting
(2) Vivid	<input type="checkbox"/>	<input type="checkbox"/>	<input type="radio"/>	<input type="radio"/>	<input type="radio"/>	<input type="radio"/>	<input type="radio"/>	<input type="radio"/>	Low / Standard / Strong
(3) Soft	<input type="checkbox"/>	<input type="checkbox"/>	<input type="radio"/>	<input type="radio"/>	<input type="radio"/>	<input type="radio"/>	<input type="radio"/>	<input type="radio"/>	Low / Standard / Strong
(4) Warm	<input type="checkbox"/>	<input type="checkbox"/>	<input type="radio"/>	<input type="radio"/>	<input type="radio"/>	<input type="radio"/>	<input type="radio"/>	<input type="radio"/>	Low / Standard / Strong
(5) Intense	<input type="checkbox"/>	<input type="checkbox"/>	<input type="radio"/>	<input type="radio"/>	<input type="radio"/>	<input type="radio"/>	<input type="radio"/>	<input type="radio"/>	Low / Standard / Strong
(6) Cool	<input type="checkbox"/>	<input type="checkbox"/>	<input type="radio"/>	<input type="radio"/>	<input type="radio"/>	<input type="radio"/>	<input type="radio"/>	<input type="radio"/>	Low / Standard / Strong
(7) Brighter	<input type="checkbox"/>	<input type="checkbox"/>	<input type="radio"/>	<input type="radio"/>	<input type="radio"/>	<input type="radio"/>	<input type="radio"/>	<input type="radio"/>	Low / Medium / High
(8) Darker	<input type="checkbox"/>	<input type="checkbox"/>	<input type="radio"/>	<input type="radio"/>	<input type="radio"/>	<input type="radio"/>	<input type="radio"/>	<input type="radio"/>	Low / Medium / High
(9) Monochrome	<input type="checkbox"/>	<input type="checkbox"/>	<input type="radio"/>	<input type="radio"/>	<input type="radio"/>	<input type="radio"/>	<input type="radio"/>	<input type="radio"/>	Blue / B/W / Sepia

- 1 Set the Mode Dial to any of the following modes: <CA>, <☺>, <🌄>, <🌸>, <🌿>, or <🏠>.



- 2 Display the Live View image.
 - Press the <📷> button to display the Live View image.



- 3 On the Quick Control screen, select the desired ambience.
 - Press the <Q> button (📷10).
 - Press the <▲> <▼> keys to select [Standard setting]. [Ambience-based shots] will appear on the screen.
 - Press the <◀> <▶> keys or turn the <☀> dial to select the ambience.
 - ▶ The LCD monitor will display how the image will look with the selected ambience.



4 Set the ambience effect.

- Press the <▲> <▼> keys to select the effect bar so that **[Effect]** appears at the bottom.
- Press the <◀> <▶> keys or turn the <☀> dial to select the desired effect.

5 Take the picture.

- Press the shutter button completely to take the picture.
- To return to viewfinder shooting, press the <📷> button to exit Live View shooting. Then press the shutter button completely to take the picture.
- If you change the shooting mode or set the power switch to <OFF>, the setting will revert back to **[Standard setting]**.

- ⚠
- The Live View image shown with the ambience setting applied will not look exactly the same as the actual photo.
 - Using flash may minimize the ambience effect.
 - In bright outdoors, the Live View image you see on the LCD monitor may not have exactly the same brightness or ambience as the actual photo. Set **[🔧2: LCD brightness]** to 4 and look at the Live View image so that the LCD monitor is unaffected by outside light.

- 📷
- If you do not want the Live View image to be displayed when setting functions, press the <📷> button after step 1 and set **[Ambience-based shots]** and **[Effect]**.

Ambience Settings

(1) **Standard setting**

Standard image characteristics for the respective shooting mode. Note that <👤> has image characteristics geared for portraits and <🏞️> is geared for landscapes. Each ambience is a modification of the respective shooting mode's image characteristics.

(2) **Vivid**

The subject is given a sharp, vivid look. This results in a photo that looks more impressive than the one taken with [**Standard setting**].

(3) **Soft**

The subject is de-emphasized, giving them a softer, daintier look. Good for portraits, pets, flowers, etc.

(4) **Warm**

Colors are made warmer and the subject is de-emphasized, making them seem warmer and gentler. Good for portraits, pets, and other subjects to which you want to give a warm look.

(5) **Intense**

While the overall brightness is slightly lowered, the subject is emphasized for a more intense feeling. Makes the human or living subject stand out more.

(6) **Cool**

The overall brightness is slightly lowered with a cooler color cast, giving the photo a dusky, quiet mood. Makes subjects in the shade look more calm and impressive.

(7) **Brighter**

The picture will look brighter.

(8) **Darker**

The picture will look darker.

(9) **Monochrome**

The picture will be monochrome. You can select the monochrome color to be black and white, sepia, or blue. When **[Monochrome]** is selected, **<B/W>** will appear in the viewfinder.

Shoot by Lighting or Scene Type

In the <📷>, <🏞️>, <🌸>, and <🌧️> Basic Zone modes, you can shoot with settings that match the lighting or scene type. Normally, [Default setting] is adequate, but if the settings match the lighting condition or scene type, the picture will look more accurate to your eyes.

For Live View shooting, if you set both [Light/scene-based shots] and [Ambience-based shots] (p.73), setting [Light/scene-based shots] at first is recommended. This will make it easier to see the resulting effect on the LCD monitor.

Lighting or Scene	A+	📷	CA	📷	🏞️	🌸	🌧️	📷
(1) Default setting				○	○	○	○	
(2) Daylight				○	○	○	○	
(3) Shade				○	○	○	○	
(4) Cloudy				○	○	○	○	
(5) Tungsten light				○		○	○	
(6) Fluorescent light				○		○	○	
(7) Sunset				○	○	○	○	

- 1 Set the Mode Dial to any of the following modes: <📷>, <🏞️>, <🌸>, or <🌧️>.

- 2 Display the Live View image.

- Press the <📷> button to display the Live View image.





3 On the Quick Control screen, select the lighting or scene type.

- Press the <Q> button (☼10).
- Press the <▲> <▼> keys to select **[Default setting]**. **[Light/scene-based shots]** will appear on the screen.
- Press the <◀> <▶> keys or turn the <☼> dial to select the lighting or scene type.
 - ▶ The resulting image with the selected lighting or scene type will be displayed.

4 Take the picture.

- Press the shutter button completely to take the picture.
- To return to viewfinder shooting, press the <📷> button to exit Live View shooting. Then press the shutter button completely to take the picture.
- If you change the shooting mode or set the power switch to <OFF>, the setting will revert back to **[Default setting]**.

- If you use flash, the setting will switch to **[Default setting]**. (However, the shooting information will display the lighting or scene type that was set.)
- If you want to set this together with **[Ambience-based shots]**, set the lighting or scene type that best matches the ambience you have set. In the case of **[Sunset]**, for example, warm colors will become prominent so the ambience you set may not work well.

📷 If you do not want the Live View image to be displayed when setting functions, press the <Q> button after step 1 and set **[Light/scene-based shots]**.

Lighting or Scene Type Settings

(1) **Default setting**

Default setting suited for most subjects.

(2) **Daylight**

For subjects under sunlight. Gives more natural-looking blue skies and greenery, and reproduces light-colored flowers better.

(3) **Shade**

For subjects in the shade. Suitable for skin tones, which may look too bluish, and for light-colored flowers.

(4) **Cloudy**

For subjects under overcast skies. Makes skin tones and landscapes, which may otherwise look dull on a cloudy day, look warmer. Also effective for light-colored flowers.

(5) **Tungsten light**

For subjects lit under tungsten lighting. Reduces the reddish-orange color cast caused by tungsten lighting.

(6) **Fluorescent light**

For subjects under fluorescent lighting. Suited for all types of fluorescent lighting.

(7) **Sunset**

Suitable when you want to capture the sunset's impressive colors.

Image Playback

The easiest way to play back images is explained below. For more details on the playback procedure, see page 203.



1 Play back the image.

- Press the <▶> button.
- ▶ The last captured image or last image played back will appear.



2 Select an image.

- To view images starting with the last captured image, press the <◀> key. To view images starting with the first (oldest) image, press the <▶> key.
- Each time you press the <DISP.> button, the display format will change.



With basic information



Basic information +
Image quality/Playback number

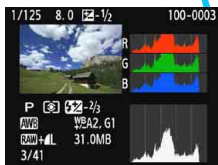

Histogram

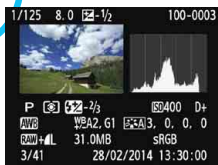

Shooting information display

3 Exit the image playback.

- Press the <▶> button to exit the image playback and return to the shooting settings display.

3

Creative Shooting

In the Basic Zone modes, to prevent spoiled shots, most advanced functions are set automatically and cannot be changed. In the <P> (Program AE) mode, you can set various functions and be more creative.

- In the <P> mode, the camera sets the shutter speed and aperture automatically to obtain a standard exposure.
- The difference between the Basic Zone modes and <P> is explained on pages 274-275.
- The functions explained in this chapter can also be used in the <Tv>, <Av>, and <M> modes explained in Chapter 4.
- The ☆ icon at the upper right of the page title indicates that the function is available only in Creative Zone modes (p.26).

* <P> stands for Program.

* AE stands for Auto Exposure.

P: Program AE

The camera automatically sets the shutter speed and aperture to suit the subject's brightness. This is called Program AE.



1 Set the Mode Dial to <P>.



2 Focus on the subject.

- Look through the viewfinder and aim the selected AF point over the subject. Then press the shutter button halfway.
- ▶ The dot inside the AF point achieving focus lights up briefly in red, and the focus confirmation light <●> on the viewfinder's bottom right lights up (in One-Shot AF mode).
- ▶ The shutter speed and aperture will be set automatically and displayed in the viewfinder.



3 Check the display.

- A standard exposure will be obtained as long as the shutter speed and aperture displays do not blink.

4 Take the picture.

- Compose the shot and press the shutter button completely.

⚠ If you use a TS-E lens to shift or tilt the lens or use an Extension Tube, the standard exposure may not be obtained or an irregular exposure may result.



Shooting Tips

● Change the ISO speed. Use the built-in flash.

To match the subject and ambient lighting level, you can change the ISO speed (p.88) or use the built-in flash (p.101). In the <P> mode, the built-in flash will not fire automatically. When indoors or during low light shooting, it is recommended that you press the <⚡> (flash) button to raise the built-in flash. (You can also raise the built-in flash by selecting <⚡_{UP}> on the Quick Control screen.)

● Change the program using Program shift.

After pressing the shutter button halfway, turn the <PROGRAM> dial to change the shutter speed and aperture setting combination (program). Program shift is canceled automatically after the picture is taken. Program shift is not possible with flash.

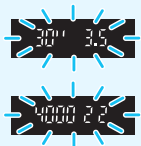

- If the “30” shutter speed and the lower f/number blink, it indicates underexposure. Increase the ISO speed or use flash.
- If the “4000” shutter speed and the higher f/number blink, it indicates overexposure. Decrease the ISO speed.



Differences Between <P> and <A+> (Scene Intelligent Auto)

In the <A+> mode, many functions, such as the AF operation and metering mode, are set automatically to prevent spoiled shots. The functions you can set are limited. With <P> mode, only the shutter speed and aperture are set automatically. You can freely set the AF operation, metering mode, and other functions (p.274).

MENU Setting the Image-Recording Quality

You can select the pixel count and the image quality. Ten image-recording quality settings are provided: **L**, **L**, **M**, **M**, **S1**, **S1**, **S2**, **S3**, **RAW** + **L**, **RAW**.

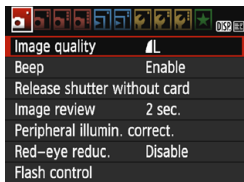

1 Select [Image quality].

- Under the [**1**] tab, select [Image quality], then press <SET>.
- ▶ [Image quality] will appear.

Recorded pixels (pixel count)



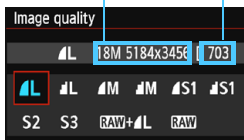



Possible shots



2 Select the image-recording quality.

- The respective quality's pixel count and number of possible shots will be displayed to help you select the desired quality. Then press <SET>.

Guide to Image-recording Quality Settings (Approx.)

Image Quality			Pixels Recorded (megapixels)	File Size (MB)	Possible Shots	Maximum Burst	
 L	High quality	JPEG	Approx. 17.9 (18M)	6.4	1110	69	
				3.2	2190	2190	
 M	Medium quality		Approx. 8.0 (8.0M)	3.4	2100	2100	
				1.7	4100	4100	
 S1	Low quality		Approx. 4.5 (4.5M)	2.2	3270	3270	
				1.1	6210	6210	
S2			Approx. 2.5 (2.5M)	1.3	5440	5440	
S3				Approx. 0.35 (0.3M)	0.3	21060	21060
 RAW +  L		High quality	Approx. 17.9 (18M)		24.5+6.4	230	4
 RAW				24.5	290	6	

* Figures for the file size, number of possible shots, and maximum burst are based on Canon's 8 GB test card and testing standards (3:2 aspect ratio, ISO 100, and Standard Picture Style). **These figures will vary depending on the subject, card brand, aspect ratio, ISO speed, Picture Style, Custom Functions, and other settings.**

? FAQ

- I want to select the image-recording quality matching the paper size for printing.

Paper size

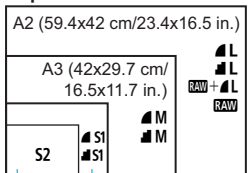

A4 (29.7x21 cm/11.7x8.3 in.)
12.7x8.9 cm/5.0x3.5 in.

Refer to the diagram on the left when choosing the image-recording quality. If you want to crop the image, selecting a higher quality (more pixels) such as **L**, **L**, **RAW** + **L**, or **RAW** is recommended. **S2** is suitable for playing the image on a digital photo frame. **S3** is suitable for emailing the image or using it on a website.

- What's the difference between **L** and **L**?

These settings indicate the different levels of image quality caused by different compression rates. The **L** setting produces a higher image quality with the same number of pixels. Although **L** produces a slightly lower image quality, this allows more images to be saved to the card. Both **S2** and **S3** have **L** (Fine) quality.

- I was able to take more shots than the number of possible shots indicated.

Depending on the shooting conditions, you may be able to take more shots than was indicated. It may also be fewer than indicated. The number of possible shots displayed is only approximate.

- Does the camera display the maximum burst?

The maximum burst is displayed in the viewfinder's right side. Since it is only a single-digit indicator **0 - 9**, any number higher than 8 will be displayed only as "9". Note that this number will also be displayed even when no card is installed in the camera. Be careful not to shoot without a card in the camera.

- When should I use **RAW**?

RAW images must be processed on a computer. For details, see "**RAW**" and "**RAW** + **L**" on the next page.

RAW

RAW is the raw image data before it is made into **L** or other images. **RAW** images cannot be viewed on a computer without the use of EOS software, such as Digital Photo Professional (provided, p.316). However, you can perform various adjustments on them that are impossible with other image types such as **L**. **RAW** is effective when you want to precisely adjust the image yourself or shoot an important subject.

RAW + L

RAW + L records a **RAW** image and a **L** image with a single shot. The two images are saved to the card simultaneously. The two images will be saved in the same folder with the same file numbers (file extension .JPG for JPEG and .CR2 for RAW). **L** images can also be viewed or printed even with a computer which does not have the EOS software installed.



RAW Image Processing Software

- The use of “Digital Photo Professional” (EOS software, p.316) is recommended when viewing RAW images on a computer.
- Older versions of Digital Photo Professional may not be able to process RAW images taken with this camera. If an older version of Digital Photo Professional is installed on your computer, update (overwrite) it as follows.
 - When the software CD-ROM (EOS Solution Disk) is provided with the camera:
 - Install Digital Photo Professional from the CD-ROM.
 - When the software CD-ROM (EOS Solution Disk) is not provided with the camera:
 - Download a version of Digital Photo Professional compatible with this camera from the Canon website.
- Commercially-available software may not be able to display RAW images taken with this camera. For compatibility information, contact the software manufacturer.

ISO: Changing the ISO Speed ☆

Set the ISO speed (image sensor's sensitivity to light) to suit the ambient light level. In Basic Zone modes, the ISO speed is set automatically (p.89).



1 Press the <▲ ISO> button.

- ▶ [ISO speed] will appear.

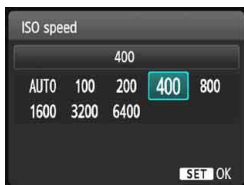

2 Set the ISO speed.

- Press the <◀> <▶> keys or turn the <☀> dial to select the desired ISO speed, then press <Ⓢ>.
- With [AUTO] selected, the ISO speed will be set automatically (p.89).

ISO Speed Guide

ISO Speed	Shooting Situation (No flash)	Flash Range
ISO 100 - 400	Sunny outdoors	The higher the ISO speed, the farther the flash range will extend (p.101).
ISO 400 - 1600	Overcast skies or evening time	
ISO 1600 - 6400, H	Dark indoors or night	

* High ISO speeds will result in grainier images.



- Under [**4**: Custom Functions (C.Fn)], if [**2**: ISO expansion] is set to [**1**: On], "H" (equivalent to ISO 12800) can also be set (p.258).
- Under [**4**: Custom Functions (C.Fn)], if [**10**: Flash button function] is set to [**1**: ISO speed], you can set the ISO speed with the <⚡> button.



- Under [**4**: Custom Functions (C.Fn)], if [**6**: Highlight tone priority] is set to [**1**: Enable], ISO 100 and "H" (equivalent to ISO 12800) cannot be selected (p.261).
- Shooting in high temperatures may result in images that look grainier. Long exposures can also cause irregular colors in the image.



- When you shoot at high ISO speeds, noise (such as dots of light and banding) may become noticeable.
- If you use a high ISO speed and flash to shoot a close subject, overexposure may result.
- As "H" (equivalent to ISO 12800) is an expanded ISO speed setting, noise (such as dots of light and banding) and irregular colors will be more noticeable, and the resolution will be lower than usual.

ISO [AUTO]

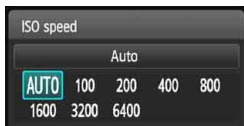

If the ISO speed is set to **[AUTO]**, the actual ISO speed setting will be displayed when you press the shutter button halfway. As indicated on the next page, the ISO speed will be set automatically to suit the shooting mode.

Shooting Mode	ISO Speed Setting
	Automatically set within ISO 100 - 3200
P/Tv/Av/M ^{*1}	Automatically set within ISO 100 - 6400 ^{*2}
	ISO 100
With flash	ISO 800 ^{*3*4*5}

*1: Fixed at ISO 800 for bulb exposures.

*2: Depends on the maximum ISO speed limit set.

*3: If fill flash results in overexposure, ISO 100 or a higher ISO speed will be set.

*4: If bounce flash is used with an external Speedlite in a Basic Zone (except) mode or <P>, ISO 800 - 1600 (or up to the maximum limit) will be set automatically.

*5: Fixed at ISO 400 if the maximum limit is ISO 400.



- When [AUTO] is set, the ISO speed is indicated in whole-stop increments. However, the ISO speed is actually set in finer increments. Therefore, in the image's shooting information (p.229), you may find an ISO speed such as 125 or 640 displayed as the ISO speed.
- In the mode, the ISO speed shown in the table is actually used even if ISO 100 is not displayed.

MENU Setting the Maximum ISO Speed for [ISO Auto] ☆

For ISO Auto, you can set the maximum ISO speed limit within ISO 400 - ISO 6400.

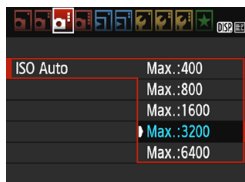

Under the [3] tab, select [ISO Auto], then press < >. Select the ISO speed, then press < >.

Optimal Image Characteristics for the Subject ☆

By selecting a Picture Style, you can obtain image characteristics matching your photographic expression or the subject.

In Basic Zone modes, you cannot select the Picture Style.



1 Select [Picture Style].

- Under the [ 2] tab, select [Picture Style], then press <SET>.
- ▶ The Picture Style selection screen will appear.

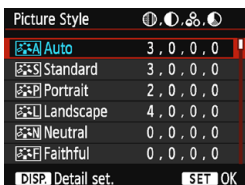

2 Select a Picture Style.

- Press the <▲> <▼> keys to select a Picture Style, then press <SET>.
- The Picture Style will be set and the menu will reappear.

Picture Style Characteristics

Auto

The color tones will be adjusted automatically to suit the scene. The colors will look vivid, especially for blue skies, greenery and sunsets, in nature, outdoor and sunset scenes.

 If the desired color tone is not obtained with [Auto], use another Picture Style.

Standard

The image looks vivid, sharp, and crisp. This is a general-purpose Picture Style suitable for most scenes.

Portrait

For nice skin tones. The image looks softer. Suited for close-up portraits.

By changing the [Color tone] (p.123), you can adjust the skin tone.

Landscape

For vivid blues and greens, and very sharp and crisp images. Effective for impressive landscapes.

Neutral

This Picture Style is for users who prefer to process images with their computer. For natural colors and subdued images.

Faithful

This Picture Style is for users who prefer to process images with their computer. When the subject is captured under a color temperature of 5200K, the color is adjusted colorimetrically to match the subject's color. Images will appear subdued.

Monochrome

Creates black-and-white images.



Black-and-white images shot in formats other than **RAW** cannot be reverted to color. If you want to later shoot pictures in color, make sure the **[Monochrome]** setting has been canceled. When **[Monochrome]** is selected, **<B/W>** will appear in the viewfinder.

User Def. 1-3

You can register a basic style such as **[Portrait]**, **[Landscape]**, a Picture Style file, etc., and adjust it as desired (p.125). Any User Defined Picture Style that has not been set will have the same default settings as the **[Auto]** Picture Style.

AF: Changing the Autofocus Operation ☆

You can select the AF (autofocus) operation characteristics suiting the shooting conditions or subject. In Basic Zone modes, the optimum AF operation is set automatically for the respective shooting mode.

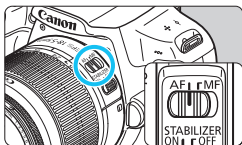

- 1 Set the lens's focus mode switch to <AF>.

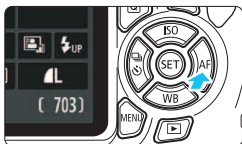

- 2 Press the <▶ AF> button.
▶ [AF operation] will appear.

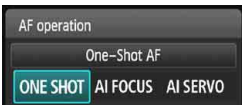

- 3 Select the AF operation.
 - Press the <◀> <▶> keys or turn the <⦿> dial to select the desired AF operation, then press <SET>.

- 4 Focus on the subject.
 - Aim the AF point over the subject and press the shutter button halfway. The camera will then autofocus in the selected AF operation.

One-Shot AF for Still Subjects

Suited for still subjects. When you press the shutter button halfway, the camera will focus only once.

- When focus is achieved, the dot inside the AF point achieving focus lights up briefly in red, and the focus confirmation light <●> in the viewfinder will also light up.
- With evaluative metering (p.111), the exposure setting will be set at the same time as focus is achieved.
- While you hold down the shutter button halfway, the focus will be locked. You can then recompose the shot if desired.

- 
- If focus cannot be achieved, the focus confirmation light <●> in the viewfinder will blink. If this occurs, the picture cannot be taken even if the shutter button is pressed completely. Recompose the shot and try to focus again, or see “Subjects Difficult to Focus” (p.97).
 - If [📷 1: Beep] is set to [Disable], the beeper will not sound when focus is achieved.

AI Servo AF for Moving Subjects

This AF operation is suited for moving subjects when the focusing distance keeps changing. While you hold down the shutter button halfway, the camera will keep focusing on the subject continuously.

- The exposure is set at the moment the picture is taken.
- When the AF point selection (p.95) is automatic, the camera first uses the center AF point to focus. During autofocusing, if the subject moves away from the center AF point, focus tracking continues as long as the subject is covered by another AF point.



With AI Servo AF, the beeper will not sound even when focus is achieved. Also, the focus confirmation light <●> in the viewfinder will not light up.

AI Focus AF for Switching the AF Operation Automatically

AI Focus AF switches the AF operation from One-Shot AF to AI Servo AF automatically if a still subject starts moving.

- After the subject is focused in One-Shot AF, if the subject starts moving, the camera will detect the movement, change the AF operation automatically to AI Servo AF, and keep tracking the moving subject.



When focus is achieved in the AI Focus AF operation with the Servo mode active, the beeper will sound softly. However, the focus confirmation light <●> in the viewfinder will not light up. Note that focus will not be locked in this case.

Selecting the AF Point ☆

In Basic Zone modes, the camera will normally focus the closest subject automatically. Therefore, it may not always focus on your target subject. In the <P>, <Tv>, <Av>, and <M> modes, you can select the AF point and use it to focus on the target subject.

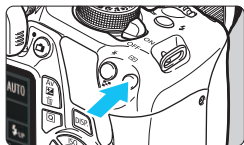



1 Press the button. (06)

- ▶ The selected AF point will be displayed on the LCD monitor and in the viewfinder.



2 Select the AF point.

- Use the  cross keys to select the AF point.
- While looking through the viewfinder, you can select the AF point by turning the  dial until the desired AF point lights up in red.
- When all the AF points light up, automatic AF point selection will be set. The AF point will be selected automatically to focus on the subject.
- Pressing  toggles the AF point selection between the center AF point and automatic AF point selection.

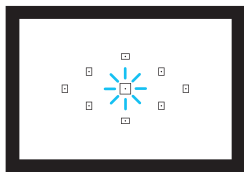

3 Focus on the subject.

- Aim the selected AF point over the subject and press the shutter button halfway to focus.



Shooting Tips

- **When shooting a portrait up close, use One-Shot AF and focus on the eyes.**

If you focus on the eyes first, you can then recompose and the face will remain sharp.

- **If it is difficult to focus, select and use the center AF point.**

The center AF point is the most sensitive among the nine AF points.





- **To make it easier to focus on a moving subject, set the camera to automatic AF point selection and AI Servo AF (p.94).**

The center AF point will first be used to focus on the subject. During autofocusing, if the subject moves away from the center AF point, focus tracking continues as long as the subject is covered by another AF point.

AF-Assist Beam with the Built-in Flash

Under low-light conditions, when you press the shutter button halfway, the built-in flash may fire a brief burst of flashes. This illuminates the subject to enable easier autofocusing.



- The AF-assist beam will not be fired from the built-in flash in the following shooting modes: ,  and .
- The AF-assist beam cannot be emitted with AI Servo AF operation.
- The effective range of the AF-assist beam emitted by the built-in flash is approx. 4 meters/13.1 feet.
- In Creative Zone modes, when you raise the built-in flash with the  button (p.101), the AF-assist beam will be emitted when necessary. Note that depending on the setting for [7: **AF-assist beam firing**] under [**43: Custom Functions (C.Fn)**], AF beam will not be emitted (p.262).



If you use an Extender (sold separately) and the *f*/number becomes higher than *f*/5.6, AF shooting will not be possible (except in [**FlexiZone - Single**] and [**Live mode**] during Live View shooting). For details, refer to the Extender's instruction manual.

Subjects Difficult to Focus

Autofocus can fail to achieve focus (viewfinder's focus confirmation light <●> blinks) with certain subjects such as the following:

- Very low-contrast subjects
(Example: Blue skies, solid-color flat surfaces, etc.)
- Subjects in very low light
- Extremely backlit and reflective subjects
(Example: Cars with highly reflective bodies, etc.)
- Near and far subjects covered by an AF point
(Example: Animals in cages, etc.)
- Repetitive patterns
(Example: Skyscraper windows, computer keyboards, etc.)

In such cases, do either of the following:

- (1) With One-Shot AF, focus on an object at the same distance as the subject and lock the focus before recomposing the shot (p.59).
- (2) Set the lens's focus mode switch to <MF> and focus manually.

 For subjects difficult to focus during Live View shooting with [FlexiZone - Single] and [Live mode], see page 146.

MF: Manual Focus

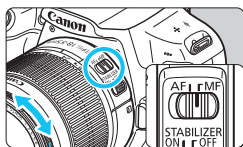

Focusing ring

1 Set the lens's focus mode switch to <MF>.

2 Focus on the subject.

- Focus by turning the lens's focusing ring until the subject looks sharp in the viewfinder.

 If you press the shutter button halfway during manual focusing, the AF point achieving focus will light up briefly in red, the beeper will sound, and the focus confirmation light <●> in the viewfinder will light up.

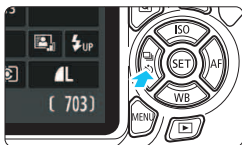

Continuous Shooting ☆

You can shoot up to approx. 3 shots per second. This is effective for shooting a child running toward you or capturing different facial expressions.



1 Press the <◀   > button.

2 Select < >.

- Press the <◀> <▶> keys or turn the < > dial to select continuous shooting < >, then press < >.

3 Take the picture.

- The camera shoots continuously while you hold down the shutter button completely.

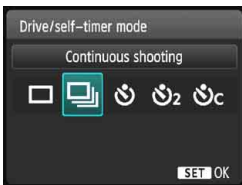

Shooting Tips

Also set the AF operation (p.93) matching the subject.

• **For a moving subject**

When AI Servo AF is set, focusing will be continuous during continuous shooting.

• **For a still subject**

When One-Shot AF is set, the camera will focus only once during continuous shooting.



- Under [**3: Custom Functions (C.Fn)**], if [**5: High ISO speed noise reduction**] is set to [**2: Strong**] (p.261), the maximum burst during continuous shooting will greatly decrease. Also, the continuous shooting speed may be slower.
- When the battery level is low, the continuous shooting speed may become slightly slower.
- In AI Servo AF operation, the continuous shooting speed may become slightly slower depending on the subject and the lens used.
- The continuous shooting speed may also decrease indoors and under low light.

Using the Self-timer

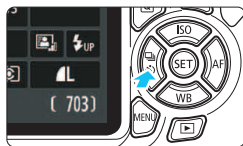

1 Press the **<◀ [] Ⓢ >** button.

2 Select the self-timer.

- Press the **<◀>** keys or turn the **< [] >** dial to select the self-timer, then press **< [SET] >**.

Ⓢ : 10-sec. self-timer

Ⓢ2 : 2-sec. self-timer[☆]

Ⓢc : 10-sec. self-timer plus
continuous shots



Press the **<▲>** **<▼>** keys to set the number of shots (2 to 10) to be taken with the self-timer.

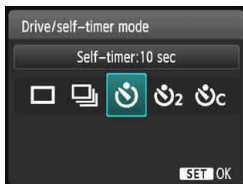

3 Take the picture.

- Look through the viewfinder, focus on the subject, then press the shutter button completely.

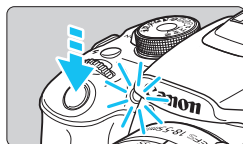

- ▶ You can check the self-timer operation with the self-timer lamp, beeper, and countdown display (in seconds) on the LCD monitor.
- ▶ Two seconds before the picture is taken, the self-timer lamp will light up and the beeper will sound faster.

- With **<Ⓢc>**, the interval between shots may be prolonged depending on the shooting conditions such as the image-recording quality or flash.
- If you do not look through the viewfinder when you press the shutter button, attach the eyepiece cover (p.269). If stray light enters the viewfinder when the picture is taken, it may throw off the exposure.

- After taking self-timer shots, playing back the image (p.80) to check focus and exposure is recommended.
- When using the self-timer to shoot only yourself, use focus lock (p.59) on an object at about the same distance as where you will stand.
- To cancel the self-timer after it starts, press the **<◀ [] Ⓢ >** button.

⚡ Using the Built-in Flash

Indoors, in low light, or in backlit conditions in daylight, just raise the built-in flash and press the shutter button to take flash pictures. In the <P> mode, the shutter speed (1/60 sec. - 1/200 sec.) will be set automatically to prevent camera shake.

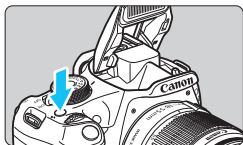

1 Press the <⚡> button.

- In Creative Zone modes, you can press the <⚡> button anytime to take flash pictures.
- While the flash is recycling, “⚡buSY” is displayed in the viewfinder, and [BUSY⚡] is displayed on the LCD monitor.



2 Press the shutter button halfway.

- In the bottom left of the viewfinder, check that the <⚡> icon is lit.

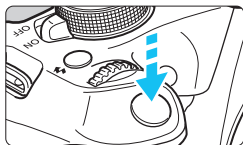

3 Take the picture.

- When focus is achieved and you press the shutter button completely, the flash will fire for the picture.

Effective Flash Range

(Approx. in meters/feet)

ISO Speed (p.88)	EF-S18-55mm f/3.5-5.6 IS II	
	Wide Angle: f/3.5	Telephoto: f/5.6
ISO 100	1-2.6 / 3.3-8.5	1-1.6 / 3.3-5.2
ISO 200	1-3.7 / 3.3-12.1	1-2.3 / 3.3-7.5
ISO 400	1-5.3 / 3.3-17.4	1-3.3 / 3.3-10.8
ISO 800/AUTO*	1-7.4 / 3.3-24.3	1-4.6 / 3.3-15.1
ISO 1600	1.3-10.5 / 4.3-34.4	1-6.6 / 3.3-21.7
ISO 3200	1.9-14.9 / 6.2-48.9	1.2-9.3 / 3.9-30.5
ISO 6400	2.6-21.0 / 8.5-68.9	1.6-13.1 / 5.2-43.0
H: ISO 12800	3.7-29.7 / 12.1-97.4	2.3-18.6 / 7.5-61.0

* For fill flash, the ISO speed may be set lower than ISO 800.

💡 Shooting Tips

- **If the subject is far away, increase the ISO speed** (p.88).
By increasing the ISO speed, you can extend the flash range.
- **In bright light, decrease the ISO speed.**
If the exposure setting in the viewfinder blinks, decrease the ISO speed.
- **Detach the lens hood. Do not get too close to the subject.**
If the lens has a hood attached or you are too close to the subject, the bottom of the picture may look dark due to the obstructed flash. For important shots, check the image on the LCD monitor to make sure the flash exposure looks natural (not dark at the bottom).

MENU Red-eye Reduction

Using the red-eye reduction lamp before taking a flash picture can reduce red eye.

Red-eye reduction will function in any shooting mode except <M>, <A>, <S>, or <P>.

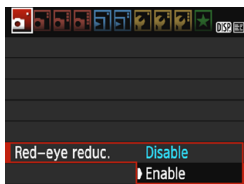

- Under the [CAMERA 1] tab, select [Red-eye reduc.], then press <SET>.
- Select [Enable], then press <SET>.
- For flash photography, when you press the shutter button halfway, the red-eye reduction lamp will light up. Then when you press the shutter button completely, the picture will be taken.

- The red-eye reduction feature is most effective when the subject looks at the red-eye reduction lamp, when the room is well lit, or when you are close to the subject.
- When you press the shutter button halfway, the scale display on the bottom of the viewfinder will shrink and turn off. For best results, take the picture after this scale display turns off.
- The effectiveness of red-eye reduction varies depending on the subject.



4

Advanced Shooting

This chapter builds on Chapter 3 and introduces more ways to shoot creatively.

- The first half of this chapter explains how to use the <Tv>, <Av>, and <M> modes on the Mode Dial.
- All the functions explained in Chapter 3 can also be used in the <Tv>, <Av>, and <M> modes.
- To see which functions can be used in each shooting mode, see page 274.
- The ☆ icon at the upper right of the page title indicates that the function is available only in Creative Zone modes (p.26).

Main Dial Pointer



The pointer icon <👉> displayed together with the shutter speed, aperture setting, or exposure compensation amount indicates that you can turn the <👉> dial to adjust the respective setting.

Tv: Conveying the Subject's Movement

You can either freeze the action or create motion blur with the **<Tv>** (Shutter-priority AE) mode on the Mode Dial.

* **<Tv>** stands for Time value.



Blurred motion
(Slow shutter speed: 1/30 sec.)



Frozen action
(Fast shutter speed: 1/2000 sec.)



1 Set the Mode Dial to **<Tv>**.



2 Set the desired shutter speed.

- See “Shooting Tips” for advice on setting the shutter speed.
- Turning the  dial to the right sets a faster shutter speed, and turning it to the left sets a slower one.



3 Take the picture.

- When you focus and press the shutter button completely, the picture will be taken at the selected shutter speed.



Shutter Speed Display

The LCD monitor displays the shutter speed as a fraction. However, the viewfinder displays only the denominator. “0”5” indicates 0.5 sec. and “15”” is 15 sec.



Shooting Tips

- **To freeze the motion of a fast-moving subject**
Use a fast shutter speed such as 1/4000 sec. to 1/500 sec.
- **To blur a running child or animal and convey an impression of motion**
Use a medium shutter speed such as 1/250 sec. to 1/30 sec. Follow the moving subject through the viewfinder and press the shutter button to take the picture. If you use a telephoto lens, hold it steady to prevent camera shake.
- **To blur a flowing river or fountain**
Use a slow shutter speed of 1/30 sec. or slower. Use a tripod to prevent hand-held camera shake.
- **Set the shutter speed so that the aperture display does not blink.**

If you press the shutter button halfway and change the shutter speed while the aperture is displayed, the aperture display will also change to maintain the same exposure (amount of light reaching the image sensor). If you exceed the adjustable aperture range, the aperture display will blink to indicate that the standard exposure cannot be obtained.

If the exposure will be too dark, the maximum aperture (smallest number) will blink. To obtain a standard exposure, turn the  dial to the left to set a slower shutter speed or increase the ISO speed.

If the exposure will be too bright, the minimum aperture (highest number) will blink. To obtain a standard exposure, turn the  dial to the right to set a faster shutter speed or decrease the ISO speed.



⚡ Using the Built-in Flash

To obtain a correct flash exposure, the flash output will be set automatically (autoflash exposure) to match the automatically-set aperture. The shutter speed can be set from 1/200 sec. to 30 sec.

Av: Changing the Depth of Field

To blur the background or to make everything near and far look sharp, set the Mode Dial to <Av> (Aperture-priority AE) to adjust the depth of field (range of acceptable focus).

* <Av> stands for Aperture value, which is the size of the diaphragm hole inside the lens.



Blurred background
(With a low aperture f/number: f/5.6)



Sharp foreground and background
(With a high aperture f/number: f/32)



1 Set the Mode Dial to <Av>.

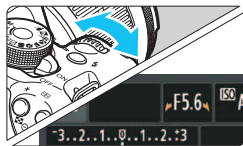

2 Set the desired aperture.

- The higher the f/number, the wider the depth of field where sharper focus is obtained in both the foreground and background.
- Turning the <aperture dial> to the right will set a higher f/number (smaller aperture opening), and turning it to the left will set a lower f/number (larger aperture opening).



3 Take the picture.

- Focus and press the shutter button completely. The picture will be taken with the selected aperture.



Aperture Display

The higher the f/number, the smaller the aperture opening will be. The apertures displayed will differ depending on the lens. If no lens is attached to the camera, "00" will be displayed for the aperture.

 **Shooting Tips**

- **When using an aperture with a high f/number or shooting in low light scenes, note that camera shake can occur.**

A higher aperture f/number will make the shutter speed slower. Under low light, the shutter speed can be as long as 30 sec. In such cases, increase the ISO speed and hold the camera steady or use a tripod.

- **The depth of field depends not only on the aperture, but also on the lens and on the subject distance.**

Since wide-angle lenses have a wide depth of field (range of acceptable focus in front of and behind the point of focus), you need not set a high aperture f/number to obtain a sharp picture from the foreground to the background. On the other hand, a telephoto lens has a narrow depth of field.

And the closer the subject, the narrower the depth of field. A farther subject will have a wider depth of field.

- **Set the aperture so that the shutter speed display does not blink.**

If you press the shutter button halfway and change the aperture while the shutter speed is displayed, the shutter speed display will also change to maintain the same exposure (amount of light reaching the image sensor). If you exceed the adjustable shutter speed range, the shutter speed display will blink to indicate that the standard exposure cannot be obtained.

If the picture will be too dark, the “30” (30 sec.) shutter speed display will blink. To obtain a standard exposure, turn the  dial to the left to set a lower aperture f/number or increase the ISO speed.

If the picture will be too bright, the “4000” (1/4000 sec.) shutter speed display will blink. To obtain a standard exposure, turn the  dial to the right to set a higher aperture f/number or decrease the ISO speed.



⚡ Using the Built-in Flash

To obtain a correct flash exposure, the flash output will be set automatically to match the set aperture (autoflash exposure). The shutter speed will be set automatically between 1/200 sec. - 30 sec. to suit the scene's brightness.

In low light, the main subject is exposed with the auto flash metering, and the background is exposed with a slow shutter speed set automatically. Both the subject and background look properly exposed (automatic slow-speed flash sync). If you are handholding the camera, keep it steady to prevent camera shake. Using a tripod is recommended. To prevent a slow shutter speed, under [**⚡3: Custom Functions (C.Fn)**], set [**3: Flash sync. speed in Av mode**] to [**1: 1/200-1/60 sec. auto**] or [**2: 1/200 sec. (fixed)**] (p.259).

MENU Depth of Field Preview [☆]

The aperture opening (diaphragm) changes only at the moment when the picture is taken. Otherwise, the aperture remains fully open. Therefore, when you look at the scene through the viewfinder or on the LCD monitor, the depth of field will look narrow. With the procedure below, you can check the depth of field before taking the picture.

1 Enable depth-of-field preview to be used.

- Under [**⚡3: Custom Functions (C.Fn)**], set [**9: Assign SET button**] to [**4: Depth-of-field preview**] (p.264).
- For details about Custom Function settings, see page 256.

2 Exit the menu.

- Press the <MENU> button two times to exit the menu.

3 Press the <SET> button.

- ▶ The aperture will be stopped down so you can see the depth of field.



While looking at the Live View image (p.134) and holding down the <SET> button, you can change the aperture and see how the depth of field changes.

M: Manual Exposure

You can set both the shutter speed and aperture manually as desired. While referring to the exposure level indicator in the viewfinder, you can set the exposure as desired. This method is called manual exposure.

* <M> stands for Manual.



1 Set the Mode Dial to <M>.



2 Set the ISO speed (p.88).

3 Set the shutter speed and aperture.

- To set the shutter speed, turn the <S> dial.
- To set the aperture, hold down the <Av> button and turn the <A> dial.



Standard exposure index



Exposure level mark

4 Focus on the subject.

- Press the shutter button halfway.
- ▶ The exposure setting will be displayed in the viewfinder.
- The exposure level mark <L> indicates how far the current exposure level is from the standard exposure level.

5 Set the exposure and take the picture.

- Set the shutter speed and aperture as desired.
- If the exposure level exceeds ± 2 stops from the standard exposure, the end of the exposure level indicator will display <L> or <R> in the viewfinder. (On the LCD monitor, if the exposure level is higher than ± 3 stops, the <L> icon will blink at where <-3> or <+3> is displayed.)



- If [CAM2: Auto Lighting Optimizer] (p.119) is set to any setting other than [Disable], the image may still look bright even if a darker exposure has been set.
- If ISO Auto is set, the ISO speed setting will change to suit the shutter speed and aperture in order to obtain a standard exposure. Therefore, you may not obtain the desired exposure effect.

⚡ Using the Built-in Flash

To obtain a correct flash exposure, the flash output will be set automatically (autoflash exposure) to match the manually-set aperture. The shutter speed can be set from 1/200 sec. to 30 sec or bulb.

BULB: Bulb Exposures

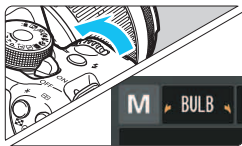

Elapsed exposure time

A bulb exposure keeps the shutter open for as long as you hold down the shutter button. It can be used to shoot fireworks and other subjects requiring long exposures.

In step 3 on the preceding page, turn the <  > dial to the left to set <BULB>.

The elapsed exposure time will be displayed on the LCD monitor.

- ⓘ During the bulb exposure, do not point the camera toward an intense light source, such as the sun on a sunny day or an intense artificial light source. Doing so may damage the image sensor or the camera's internal components.
- Since bulb exposures produce more noise than usual, the image may look slightly grainy.
- You can reduce the noise due to long exposures by setting [4: Long exp. noise reduction] under [⚡3: Custom Functions (C.Fn)] to [1: Auto] or [2: On] (p.260).
- If ISO Auto is set for a bulb exposure, the ISO speed will be fixed at ISO 800 (p.90).



 For bulb exposures, using a tripod and a remote switch (sold separately, p.269) is recommended.

Changing the Metering Mode ☆

Three methods (metering modes) to measure the subject's brightness are provided. Normally, evaluative metering is recommended.

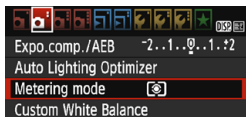
In Basic Zone modes, automatic selection is set automatically.



- 1 **Select [Metering mode].**
 - Under the [2] tab, select [**Metering mode**], then press < >.

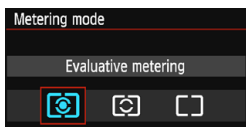

- 2 **Set the metering mode.**
 - Select the desired metering mode, then press < >.

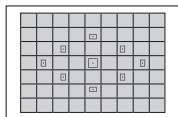

Evaluative metering

This is a general-purpose metering mode suited even for backlit subjects. The camera sets the exposure automatically to suit the scene.

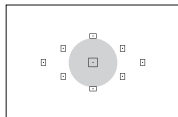





Partial metering

Effective when the background is much brighter than the subject due to backlighting, etc. The gray area in the left figure is where the brightness is metered to obtain the standard exposure.



Center-weighted average metering

The brightness is metered at the image center and then averaged for the entire scene. This metering mode is for advanced users.

 With  (Evaluative metering), the exposure setting will be locked when you press the shutter button halfway and focus is achieved. With  (Partial metering) and  (Center-weighted average metering), the exposure setting is set at the moment of exposure. (The exposure setting is not locked when you press the shutter button halfway.)

Setting Exposure Compensation ☆

Av Setting Exposure Compensation

Set exposure compensation if the exposure (without flash) does not come out as desired. This feature can be used in Creative Zone modes (except <M>). You can set the exposure compensation up to ± 5 stops in 1/3-stop increments.

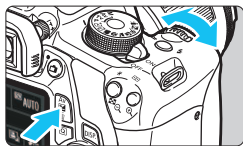

Increased exposure for a brighter image



Decreased exposure for a darker image



Dark exposure



Increased exposure for a brighter image

Making it brighter:

Hold down the <Av> button and turn the <Exposure Compensation> dial to the right (increased exposure).

Making it darker:

Hold down the <Av> button and turn the <Exposure Compensation> dial to the left (decreased exposure).

- ▶ As shown in the figure, the exposure level is displayed on the LCD monitor and in the viewfinder.
- After taking the picture, cancel the exposure compensation by setting it back to 0.

- The exposure compensation amount displayed in the viewfinder goes up to only ± 2 stops. If the exposure compensation amount exceeds ± 2 stops, the end of the exposure level indicator will display <L> or <R>.
- If you want to set exposure compensation exceeding ± 2 stops, setting it with [CAMERA 2: Expo.comp./AEB] (p.114) or with the Quick Control screen (p.46) is recommended.

Flash Exposure Compensation

Set flash exposure compensation if the flash exposure of the subject does not come out as desired. You can set the exposure compensation up to ± 2 stops in 1/3-stop increments.



1 Press the $\langle \text{Q} \rangle$ button. (10)

- ▶ The Quick Control screen will appear (p.46).



2 Select [$\text{Flash Exposure Compensation}$].

- Press the $\langle \text{Left/Right} \rangle$ cross keys to select [$\text{Flash Exposure Compensation}$ *].
- ▶ [**Flash exposure comp.**] will be displayed at the bottom of the screen.



3 Set the exposure compensation amount.

- To make the flash exposure brighter, turn the $\langle \text{Sun} \rangle$ dial to the right (increased exposure).
To make it darker, turn the $\langle \text{Sun} \rangle$ dial to the left (decreased exposure).
- ▶ When you press the shutter button halfway, the $\langle \text{Flash Exposure Compensation} \rangle$ icon will appear in the viewfinder.
- **After taking the picture, cancel the flash exposure compensation by setting it back to 0.**

 If [**2: Auto Lighting Optimizer**] (p.119) is set to any setting other than [**Disable**], the image may look bright even if a decreased exposure compensation or decreased flash exposure compensation is set.

 You can also set flash exposure compensation with [**Built-in flash func. setting**] under [**1: Flash control**] (p.195).

MENU Auto Exposure Bracketing ☆

This feature takes exposure compensation a step further by varying the exposure automatically (up to ± 2 stops in $1/3$ -stop increments) with three shots as shown below. You can then choose the best exposure. This is called AEB (Auto Exposure Bracketing).



Standard exposure



Darker exposure
(Decreased exposure)



Brighter exposure
(Increased exposure)



1 Select [Expo.comp./AEB].

- Under the [CAMERA] tab, select [Expo.comp./AEB], then press <MENU>.

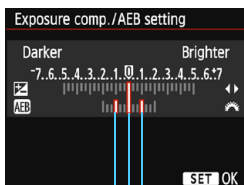

AEB range

2 Set the AEB range.

- Turn the <DISP> dial to set the AEB range.
- Press the <LEFT> <RIGHT> keys to set the exposure compensation amount. If AEB is combined with exposure compensation, AEB will be applied centering on the exposure compensation amount.
- Press <MENU> to set it.
- When you press the <MENU> button to exit the menu, the AEB range will be displayed on the LCD monitor.

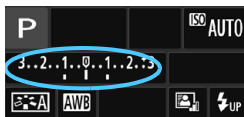

3 Take the picture.

- Focus and press the shutter button completely. The three bracketed shots will be taken in this sequence: standard exposure, decreased exposure, and increased exposure.

Canceling AEB

- Follow steps 1 and 2 to turn off the AEB range display.
- The AEB setting will also be canceled automatically if the power switch is set to <OFF>, flash recycling is completed, etc.



Shooting Tips

- **Using AEB with continuous shooting**
If <[]> continuous shooting (p.98) is set and you press the shutter button completely, the three bracketed shots will be taken continuously in this sequence: standard exposure, decreased exposure, and increased exposure.
- **Using AEB with <[]> single shooting**
Press the shutter button three times to take the three bracketed shots. The three bracketed shots will be exposed in the following sequence: standard exposure, decreased exposure, and increased exposure.
- **Using AEB with the self-timer**
If you use the self-timer <[]> <[]₂> (p.100), the three bracketed shots will be taken continuously after 10 sec. or 2 sec. With <[]_C> (p.100) set, the number of continuous shots will be three times the number set.



- AEB will not work with flash or bulb exposures.
- If []2: **Auto Lighting Optimizer** (p.119) is set to any setting other than [Disable], the effect of AEB may be minimal.

* Locking the Exposure ☆

You can lock the exposure when the area of focus is to be different from the exposure metering area or when you want to take multiple shots at the same exposure setting. Press the < * > button to lock the exposure, then recompose and take the shot. This is called AE lock. It is effective for backlit subjects.

1 Focus on the subject.

- Press the shutter button halfway.
- ▶ The exposure setting will be displayed.

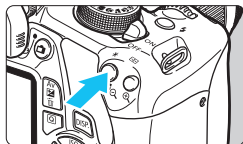

2 Press the < * > button. (⊙4)

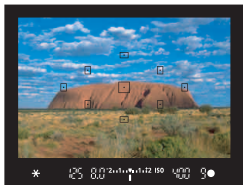

- ▶ The < * > icon lights up in the viewfinder to indicate that the exposure setting is locked (AE lock).
- Each time you press the < * > button, the current exposure setting is locked.



3 Recompose and take the picture.

- If you want to maintain the AE lock while taking more shots, hold down the < * > button and press the shutter button to take another shot.

AE Lock Effects

Metering Mode (p.111)	AF Point Selection Method (p.95)	
	Automatic Selection	Manual Selection
 *	AE lock is applied at the AF point that achieved focus.	AE lock is applied at the selected AF point.
	AE lock is applied at the center AF point.	

* When the lens's focus mode switch is set to <MF>, AE lock is applied at the center AF point.

✳ Locking the Flash Exposure ☆

If the subject is on the side of the frame and you use flash, the subject may turn out to be too bright or dark depending on the background, etc. This is when FE lock is effective. After setting the proper flash exposure for the subject, you can recompose (put the subject toward the side) and shoot. This feature can also be used with a Canon EX-series Speedlite.

* FE stands for Flash Exposure.

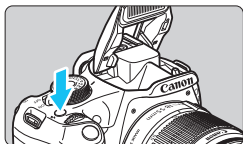

1 Press the <⚡> button.

- ▶ The built-in flash will rise.
- Press the shutter button halfway and look in the viewfinder to check that the <⚡> icon is lit.



2 Focus on the subject.

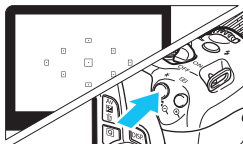

3 Press the <✳> button. (Ⓜ16)

- Aim the viewfinder center over the subject where you want to lock the flash exposure, then press the <✳> button.
- ▶ The flash will fire a preflash and the required flash output is calculated and retained in memory.
- ▶ In the viewfinder, "FEL" is displayed for a moment and <⚡*> will light up.
- Each time you press the <✳> button, a preflash is fired and the required flash output is calculated and retained in memory.



4 Take the picture.

- Compose the shot and press the shutter button completely.
- ▶ The flash is fired when the picture is taken.



* Locking the Flash Exposure *

- If the subject is too far away and beyond the effective range of the flash, the <⚡> icon will blink. Move closer to the subject and repeat steps 2 to 4.
- FE lock is not possible during Live View shooting.

MENU Auto Correction of Brightness and Contrast ☆

If the image comes out dark or the contrast is low, the brightness and contrast can be corrected automatically. This function is called Auto Lighting Optimizer. The default setting is [Standard]. With JPEG images, the correction is applied when the image is captured. In Basic Zone modes, [Standard] is set automatically.

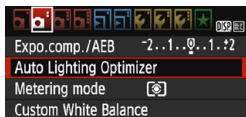

1 Select [Auto Lighting Optimizer].

- Under the [2] tab, select [Auto Lighting Optimizer], then press <SET>.

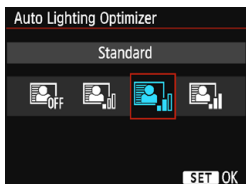

2 Select the setting.

- Select the desired setting, then press <SET>.

3 Take the picture.

- The image will be recorded with the brightness and contrast corrected if necessary.



- Under [3: Custom Functions (C.Fn)], if [6: Highlight tone priority] is set to [1: Enable], the Auto Lighting Optimizer will be set automatically to [Disable] and the setting cannot be changed.
- If the Auto Lighting Optimizer's effect is too strong and the image is too bright, set [Low] or [Disable].
- If a setting other than [Disable] is set and you use exposure compensation or flash exposure compensation to darken the exposure, the image may still come out bright. If you want a darker exposure, set this function to [Disable].
- Depending on the shooting conditions, noise may increase.

MENU Correcting the Image's Dark Corners

Due to the lens characteristics, the four corners of the picture may look darker. This phenomenon is called lens light fall-off or drop in peripheral illumination and can be corrected. The default setting is **[Enable]**. With JPEG images, the correction is applied when the image is captured. For RAW images, it can be corrected with Digital Photo Professional (EOS software, p.316).

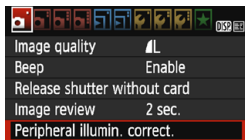

1 Select **[Peripheral illumin. correct.]**.

- Under the [**1**] tab, select **[Peripheral illumin. correct.]**, then press <SET>.

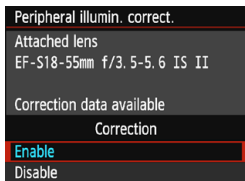

2 Select the setting.

- Check that **[Correction data available]** is displayed for the attached lens.
- If **[Correction data not available]** is displayed, see “Lens Correction Data” on the next page.
- Select **[Enable]**, then press <SET>.

3 Take the picture.

- The image will be recorded with the peripheral illumination corrected.



Correction disabled



Correction enabled

Lens Correction Data

The camera already contains lens peripheral illumination correction data for approx. 25 lenses. In step 2, if you select **[Enable]**, the peripheral illumination correction will be applied automatically for any lens whose correction data has been registered in the camera.

With EOS Utility (EOS software, p.316), you can check which lenses have their correction data registered in the camera. You can also register the correction data for unregistered lenses. For details, refer to the EOS Utility Instruction Manual.



- Peripheral illumination correction cannot be applied to JPEG images already taken.
- Depending on shooting conditions, noise may appear on the image periphery.
- When using a non-Canon lens, setting the corrections to **[Disable]** is recommended, even if **[Correction data available]** is displayed.
- If you use the magnified view during Live View shooting, the peripheral illumination correction will not be reflected in the image shown on the LCD monitor.



- If the effect of the correction is not visible, magnify the image after shooting and check it again.
- Corrections can be applied even when an Extender or Life-size Converter is attached.
- If the correction data for the attached lens has not been registered to the camera, the result will be the same as when the correction is set to **[Disable]**.
- The correction amount applied will be slightly lower than the maximum correction amount settable with Digital Photo Professional (EOS software).
- If the lens does not have distance information, the correction amount will be lower.
- The higher the ISO speed, the lower the correction amount will be.

Customizing Image Characteristics ☆

You can customize a Picture Style by adjusting individual parameters such as **[Sharpness]** and **[Contrast]**. To see the resulting effects, take test shots. To customize **[Monochrome]**, see page 124.



1 Select [Picture Style].

- Under the **[CAMERA 2]** tab, select **[Picture Style]**, then press **<SET>**.
- The Picture Style selection screen will appear.

2 Select a Picture Style.

- Select a Picture Style, then press the **<DISP.>** button.

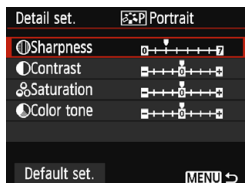

3 Select a parameter.

- Select a parameter such as **[Sharpness]**, then press **<SET>**.



4 Set the parameter.

- Press the **<◀>** **<▶>** keys to adjust the parameter as desired, then press **<SET>**.
- Press the **<MENU>** button to save the adjusted parameters. The Picture Style selection screen will reappear.
- Any parameter settings different from the default will be displayed in blue.

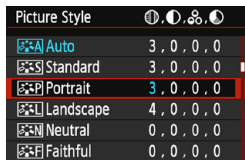

- By selecting **[Default set.]** in step 3, you can revert the respective Picture Style to its default parameter settings.
- To shoot with the Picture Style you adjusted, follow step 2 on page 91 to select the adjusted Picture Style, then shoot.

Parameter Settings and Effects

Sharpness

Adjusts the sharpness of the image.

To make it less sharp, set it toward the **0** end. The closer it is to **0**, the softer the image will look.

To make it sharper, set it toward the **7** end. The closer it is to **7**, the sharper the image will look.

Contrast

Adjusts the image contrast and the vividness of colors.

To decrease the contrast, set it toward the minus end. The closer it is to **-**, the more muted the image will look.

To increase the contrast, set it toward the plus end. The closer it is to **+**, the crisper the image will look.

Saturation

Adjusts the color saturation in the image.

To decrease the color saturation, set it toward the minus end. The closer it is to **-**, the more diluted the colors will look.

To increase the color saturation, set it toward the plus end. The closer it is to **+**, the bolder the colors will look.

Color tone

Adjusts the color tone of skin.

To make the skin color redder, set it toward the minus end. The closer it is to **-**, the redder the skin tone will look.

To reduce skin redness, set it toward the plus end. The closer it is to **+**, the more yellow the skin tone will look.

Monochrome Adjustment

For Monochrome, you can also set **[Filter effect]** and **[Toning effect]** in addition to **[Sharpness]** and **[Contrast]** explained on the preceding page.

Filter Effect

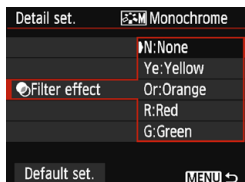

With a filter effect applied to a monochrome image, you can make white clouds or green trees stand out more.

Filter	Sample Effects
N: None	Normal black-and-white image with no filter effects.
Ye: Yellow	The blue sky will look more natural, and the white clouds will look crisper.
Or: Orange	The blue sky will look slightly darker. The sunset will look more brilliant.
R: Red	The blue sky will look quite dark. Fall leaves will look crisper and brighter.
G: Green	Skin tones and lips will appear muted. Green tree leaves will look crisper and brighter.

Increasing the **[Contrast]** will make the filter effect more pronounced.

Toning Effect

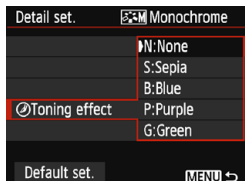

By applying a toning effect, you can create a monochrome image in that color. It can make the image look more impressive.

The following can be selected: **[N:None]**, **[S:Sepia]**, **[B:Blue]**, **[P:Purple]** or **[G:Green]**.

🔧 Registering Preferred Image Characteristics ☆

You can select a base Picture Style such as [Portrait] or [Landscape], adjust its parameters as desired and register it under [User Def. 1], [User Def. 2], or [User Def. 3].

You can create multiple Picture Styles with different settings for parameters such as sharpness and contrast.

You can also adjust the parameters of a Picture Style that has been registered to the camera with EOS Utility (EOS software, p.316).

1 Select [Picture Style].

- Under the [📷2] tab, select [Picture Style], then press <SET>.
- The Picture Style selection screen will appear.

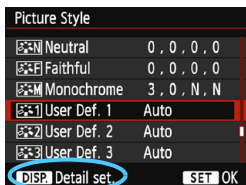

2 Select [User Def. *].

- Select [User Def. *], then press <DISP.>.
- The Detail setting screen will appear.

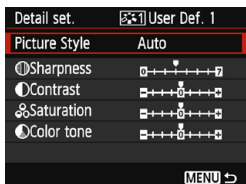

3 Press <SET>.

- With [Picture Style] selected, press <SET>.

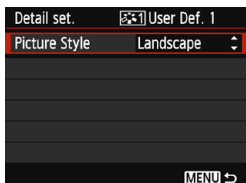

4 Select the base Picture Style.

- Press the <▲> <▼> keys to select the base Picture Style, then press <SET>.
- To adjust the parameters of a Picture Style that has been registered to the camera with EOS Utility (EOS software), select the Picture Style here.

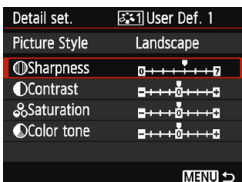

5 Select a parameter.

- Select a parameter such as **[Sharpness]**, then press <SET>.



6 Set the parameter.

- Press the <◀> <▶> keys to adjust the parameter as desired, then press <SET>. For details, see “Customizing Image Characteristics” on pages 122-124.

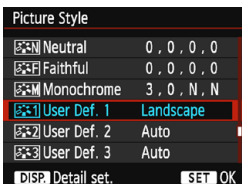

- Press the <MENU> button to register the modified Picture Style. The Picture Style selection screen will then reappear.
 - ▶ The base Picture Style will be indicated on the right of **[User Def. *]**.
 - ▶ If the settings in a Picture Style registered under **[User Def. *]** have been modified from the base Picture Style settings, the Picture Style's name will be displayed in blue.

- If a Picture Style has already been registered under **[User Def. *]**, changing the base Picture Style in step 4 will nullify the parameter settings of the registered Picture Style.
- If you execute **[Clear all camera settings]** (p.190), all the **[User Def. *]** settings will revert to their defaults. Picture Styles registered via EOS Utility (EOS software) will have only their modified parameters reverted to their default settings.

- To shoot with a registered Picture Style, follow step 2 on page 91 to select **[User Def. *]**, then shoot.
- Regarding the procedure to register a Picture Style file to the camera, refer to the EOS Utility Instruction Manual (p.316).

WB: Matching the Light Source ☆

The function adjusting the color tone so that white objects look white in the picture is called white balance (WB). Normally, the <AWB> (Auto) setting will obtain the correct white balance. If natural-looking colors cannot be obtained with <AWB>, you can select the white balance that matches the light source or set it manually by shooting a white object.



- 1 Press the <▼ WB> button.
▶ [White balance] will appear.

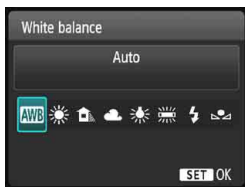

- 2 Select a white balance setting.
 - Press the <◀> <▶> keys or turn the <WHEEL> dial to select the desired setting, then press <SET>.
 - The “Approx. ****K” (K: Kelvin) displayed for the white balance settings <☀>, <🏠>, <☁>, <⚡> or <📷> is the respective color temperature.

📷 Custom White Balance

Custom white balance enables you to manually set the white balance for a specific light source for better accuracy. Perform this procedure under the actual light source to be used.

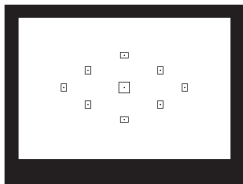

- 1 Shoot a white object.
 - A plain, white object should fill the viewfinder's center.
 - Focus manually and set the standard exposure for the white object.
 - You can use any white balance setting.

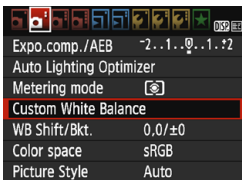

2 Select [Custom White Balance].

- Under the [CAMERA] tab, select [Custom White Balance], then press <SET>.
- ▶ The custom white balance selection screen will appear.



3 Import the white balance data.

- Select the image that was captured in step 1, then press <SET>.
- ▶ On the dialog screen that appears, select [OK] and the data will be imported.
- When the menu reappears, press the <MENU> button to exit the menu.



4 Select [WB] (Custom).

- Press the <▼ WB> button.
- Select [WB] (Custom), then press <SET>.

- If the exposure obtained in step 1 differs greatly from the standard exposure, a correct white balance may not be obtained.
- In step 3, images captured while the Picture Style was set to [Monochrome] (p.92) and images processed with a Creative filter cannot be selected.

- Instead of a white object, a gray chart or 18% gray reflector (commercially available) can produce a more accurate white balance.
- The personal white balance registered with EOS Utility (EOS software, p.316) will be registered under [WB]. If you perform step 3, the data for the registered personal white balance will be erased.

WB \pm Adjusting the Color Tone for the Light Source \star

You can correct the white balance that has been set. This adjustment will have the same effect as using a commercially-available color temperature conversion filter or color compensating filter. Each color can be corrected to one of nine levels.

This function is for advanced users who are familiar with using color temperature conversion or color compensating filters.

White Balance Correction

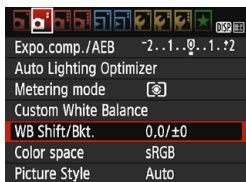

1 Select [WB Shift/Bkt.].

- Under the [📷2] tab, select [WB Shift/Bkt.], then press <SET>.
- ▶ The WB correction/WB bracketing screen will appear.

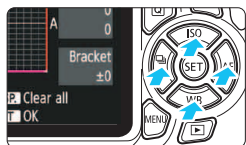

2 Set the white balance correction.

- Press the <⬅➡> cross keys to move the "■" mark to the desired position.
- B is for blue, A for amber, M for magenta, and G for green. The image's color balance will be corrected towards the selected color.
- On the upper right, "Shift" indicates the direction and correction amount.
- Pressing the <DISP.> button will cancel all the [WB Shift/Bkt.] settings.
- Press <SET> to exit the setting and return to the menu.

Sample setting: A2, G1

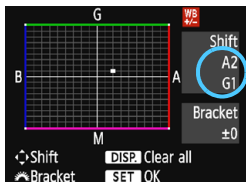

- When the white balance is corrected, <WB> will be displayed in the viewfinder and on the LCD monitor.
- One level of the blue/amber correction is equivalent to approx. 5 mireds of a color temperature conversion filter. (Mired: Measuring unit indicating the density of a color temperature conversion filter.)

White Balance Auto Bracketing

With just one shot, three images with different color tones can be recorded simultaneously. Based on the color temperature of the current white balance setting, the image will be bracketed with a blue/amber bias or magenta/green bias. This is called white balance bracketing (WB-BKT). White balance bracketing is possible up to ± 3 levels in single-level increments.



B/A bias ± 3 levels

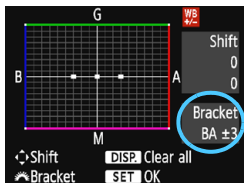

Set the white balance bracketing amount.

- In step 2 for “White Balance Correction”, when you turn the  dial, the “■” mark on the screen will change to “■■■” (3 points). Turning the dial to the right sets the B/A bracketing, and turning it to the left sets the M/G bracketing.
- ▶ On the right, “Bracket” indicates the bracketing direction and correction amount.
- Pressing the <DISP.> button will cancel all the [WB Shift/Bkt.] settings.
- Press $\langle \text{SET} \rangle$ to exit the setting and return to the menu.

Bracketing Sequence

The images will be bracketed in the following sequence: 1. Standard white balance, 2. Blue (B) bias, and 3. Amber (A) bias, or 1. Standard white balance, 2. Magenta (M) bias, and 3. Green (G) bias.

⚠ During WB bracketing, the maximum burst for continuous shooting will be lower and the number of possible shots will also decrease to approx. one-third the normal number.

- You can also set white balance correction and AEB together with white balance bracketing. If you set AEB in combination with white balance bracketing, a total of nine images will be recorded for a single shot.
- Since three images are recorded for one shot, it takes longer to record the shot to the card.
- “BKT” stands for bracketing.

MENU Setting the Color Reproduction Range ☆

The range of reproducible colors is called the color space. With this camera, you can set the color space for captured images to sRGB or Adobe RGB. For normal shooting, sRGB is recommended. In Basic Zone modes, sRGB is set automatically.

1 Select [Color space].

- Under the [CAMERA 2] tab, select [Color space], then press < (SET) >.

2 Set the desired color space.

- Select [sRGB] or [Adobe RGB], then press < (SET) >.



Adobe RGB

This color space is mainly used for commercial printing and other industrial uses. This setting is not recommended if you are not familiar with image processing, Adobe RGB, and Design rule for Camera File System 2.0 (Exif 2.21 or higher). The image will look very subdued in a sRGB computer environment and with printers not compatible with Design rule for Camera File System 2.0 (Exif 2.21 or higher). Post-processing of the image with computer software will therefore be required.



- If the captured still photo was shot in the Adobe RGB color space, the first character in the file name will be an underscore “_”.
- The ICC profile is not appended. Refer to explanations about the ICC profile in the Digital Photo Professional Instruction Manual (p.316).



5

Shooting with the LCD Monitor (Live View Shooting)

You can shoot while viewing the picture on the camera's LCD monitor. This is called "Live View shooting".

Live View shooting is effective for still subjects which do not move.

If you handhold the camera and shoot while viewing the LCD monitor, camera shake can cause blurred images. Using a tripod is recommended.



Remote Live View Shooting

With EOS Utility (EOS software, p.316) installed on your computer, you can connect the camera to the computer and shoot remotely while viewing the computer screen. For details, refer to the EOS Utility Instruction Manual (p.316).

Shooting with the LCD Monitor



1 Display the Live View image.

- Press the  button.
- ▶ The Live View image will appear on the LCD monitor.
- The Live View image will closely reflect the brightness level of the actual image you capture.



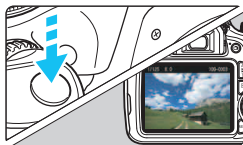

2 Focus on the subject.

- When you press the shutter button halfway, the camera will focus with the current AF method (p.142).



3 Take the picture.

- Press the shutter button completely.
- ▶ The picture will be taken and the captured image will be displayed on the LCD monitor.
- ▶ After the image review ends, the camera will return to Live View shooting automatically.
- Press the  button to exit the Live View shooting.

-  ● The image's field of view is approx. 100% (when the image-recording quality is set to JPEG  L).
- The metering mode will be fixed to evaluative metering for Live View shooting.
- In Creative Zone modes, you can check the depth of field by setting [9: Assign SET button] under [4:3: Custom Functions (C.Fn)] to [4: Depth-of-field preview].
- During continuous shooting, the exposure set for the first shot will also be applied to subsequent shots.

Enabling Live View Shooting

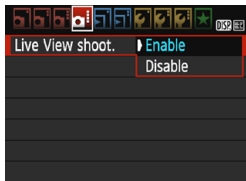

Set [**Live View shoot.**] to [**Enable**]. In Basic Zone modes, the Live View menu options will be displayed under [**2**], and in Creative Zone modes, they will be displayed under [**4**].

Number of Possible Shots with Live View Shooting

Temperature	Shooting Conditions	
	No Flash	50% Flash Use
Room temperature (23°C / 73°F)	Approx. 190 shots	Approx. 180 shots
Low temperatures (0°C / 32°F)	Approx. 180 shots	Approx. 170 shots

- The figures above are based on a fully-charged Battery Pack LP-E10 and CIPA (Camera & Imaging Products Association) testing standards.
- With a fully-charged Battery Pack LP-E10, continuous Live View shooting is possible for approx. 1 hr. 25 min. at room temperature (23°C / 73°F).



- Do not point the camera toward an intense light source, such as the sun on a sunny day or an intense artificial light source. Doing so may damage the image sensor or the camera's internal components.
- **Cautions for using Live View shooting are on pages 151-152.**



- When flash is used, there will be two shutter sounds, but only one shot will be taken. Also, the time to take the picture after you press the shutter button completely will be slightly longer than with viewfinder shooting.
- If the camera is not operated for a prolonged period, the power will turn off automatically after the time set in [**1: Auto power off**] (p.181). If [**1: Auto power off**] is set to [**Disable**], Live View shooting will end automatically after 30 min. (camera power remains on).
- With an HDMI cable (sold separately), you can display the Live View image on a TV set (p.222).

Information Display

- Each time you press the <DISP.> button, the information display will change.

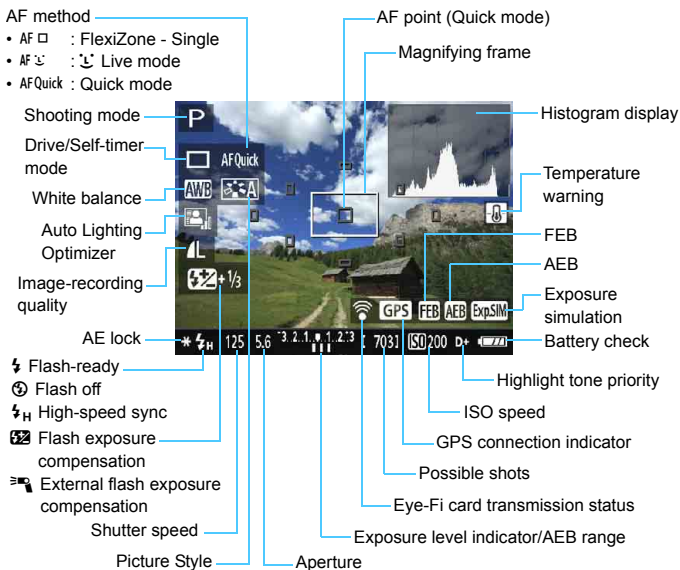

- When <Exp.SIM> is displayed in white, it indicates that the Live View image brightness is close to what the captured image will look like.
- If <Exp.SIM> is blinking, it indicates that the Live View image is displayed at a brightness that differs from the actual shooting result because of low- or bright-light conditions. However, the actual image recorded will reflect the exposure setting. Note that noise may be more noticeable than the actual image recorded.
- If flash is used or bulb is set, the <Exp.SIM> icon and histogram will be grayed out (for your reference). The histogram may not be properly displayed in low- or bright-light conditions.

Final Image Simulation

The final image simulation reflects the settings of the Picture Style, white balance and other functions in the Live View image so you can see what the captured image will look like.

During shooting, the Live View image will automatically reflect the function settings listed below.

Final Image Simulation During Live View Shooting

- Picture Style
 - * All settings such as sharpness, contrast, color saturation, and color tone will be reflected.
- White balance
- White balance correction
- Ambience-based shots
- Lighting/scene-based shots
- Exposure
- Depth of field preview (With C.Fn-9-4 set and <  > ON)
- Auto Lighting Optimizer
- Peripheral illumination correction
- Highlight tone priority
- Aspect ratio (image area confirmation)

Shooting Function Settings

Function settings particular to Live View shooting are explained here.

Q Quick Control

If you press the **<Q>** button while the image is displayed on the LCD monitor in a Creative Zone mode, you can set any of the following: AF method, Drive/self-timer, White balance, Picture Style, Auto Lighting Optimizer, Image-recording quality, and ISO speed. In Basic Zone modes, you can set the AF method and the settings shown in the table on page 72.



1 Press the **<Q>** button.

- ▶ The functions settable with Quick Control will appear on the left of the screen.
- If the AF method is **<AFQuick>**, the AF point will also be displayed. You can also select the AF point (p.148).

2 Select a function and set it.

- Press the **<▲>** **<▼>** keys to select a function.
- ▶ The selected function and Feature guide (p.53) will appear.
- Press the **<◀>** **<▶>** keys or turn the **<DISP/OK>** dial to set the function. Pressing **<SET>** will display the respective function setting screen.

3 Exit the setting.

- Press the **<Q>** button to return to Live View shooting.

 In Creative Zone modes, if **[10: Flash button function]** is set to **[1: ISO speed]** in **[4:3 Custom Functions (C.Fn)]**, you can raise the built-in flash with Quick Control. The ISO speed will be set with the **<L>** button.

Menu Function Settings

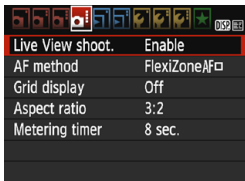

The menu options displayed are as follows.

The settable functions on this menu screen apply only to Live View shooting. These functions do not take effect during viewfinder shooting (settings are disabled).

In Basic Zone modes, the Live View menu options will be displayed under [📷2], and in Creative Zone modes, they will be displayed under [📷4].

- **Live View shooting**

You can set Live View shooting to [Enable] or [Disable].

- **AF method**

You can select [FlexiZone - Single], [Live mode], or [Quick mode]. See pages 142-149 for more information about the AF method.

- **Grid display**

With [Grid 1⇄] or [Grid 2###], you can display grid lines. You can check horizontal or vertical tilt when shooting.

● Aspect ratio [★]

The image's aspect ratio can be set to [3:2], [4:3], [16:9], or [1:1]. The area surrounding the Live View image is masked in black when the following aspect ratios are set: [4:3] [16:9] [1:1]. JPEG images will be saved with the set aspect ratio. RAW images will always be saved with the [3:2] aspect ratio. The selected aspect ratio information is added to the RAW image file. When you process the RAW image with the EOS software, this allows you to generate an image with the same aspect ratio that was set for shooting. In the case of the [4:3], [16:9], and [1:1] aspect ratios, the aspect-ratio lines will appear during image playback, but the lines are not actually drawn on the image.

Image Quality	Aspect Ratio and Pixel Count (approx.)			
	3:2	4:3	16:9	1:1
L	5184x3456	4608x3456	5184x2912*	3456x3456
RAW	(17.9 megapixels)	(16.0 megapixels)	(15.1 megapixels)	(11.9 megapixels)
M	3456x2304	3072x2304	3456x1944	2304x2304
	(8.0 megapixels)	(7.0 megapixels)	(6.7 megapixels)	(5.3 megapixels)
S1	2592x1728	2304x1728	2592x1456*	1728x1728
	(4.5 megapixels)	(4.0 megapixels)	(3.8 megapixels)	(3.0 megapixels)
S2	1920x1280	1696x1280*	1920x1080	1280x1280
	(2.5 megapixels)	(2.2 megapixels)	(2.1 megapixels)	(1.6 megapixels)
S3	720x480	640x480	720x400*	480x480
	(350,000 pixels)	(310,000 pixels)	(290,000 pixels)	(230,000 pixels)

- The asterisked image-recording quality settings do not match the respective aspect ratio exactly.
- The image area displayed for the asterisked aspect ratio is slightly larger than the recorded area. Check the captured images on the LCD monitor when shooting.
- If you use a different camera to directly print images shot with this camera in the 1:1 aspect ratio, the images may not be correctly printed.

- **Metering timer**[☆]

You can change how long the exposure setting is displayed (AE lock time). In Basic Zone modes, metering timer is fixed at 8 sec.



Selecting any of the following operations will stop Live View shooting. To start Live View shooting again, press the < > button.

- [3: Dust Delete Data], [2: Clean manually], [3: Clear settings], or [3: Firmware ver.]

Using AF to Focus (AF Method)

Selecting the AF Method

You can select an AF method to suit the shooting conditions and your subject. The following AF methods are provided: [**FlexiZone - Single**], [**Live mode**] (face detection, p.143), and [**Quick mode**] (p.148). If you want to achieve precise focus, set the lens's focus mode switch to <MF>, magnify the image, and focus manually (p.150).



Select the AF method.

- Under the [**4**] tab, select [**AF method**]. (In Basic Zone modes, it is under the [**2**] tab.)
- Select the desired AF method, then press <SET>.
- While the Live View image is displayed, you can press the <Q> button to select the AF method on the Quick Control screen (p.138).

FlexiZone - Single: AF □

The image sensor is used to focus. Although AF is possible with the Live View image displayed, **the AF operation will take longer than with the Quick mode**. Also, achieving focus may be more difficult than with the Quick mode.



AF point

1 Display the Live View image.

- Press the <CAM> button.
- ▶ The Live View image will appear on the LCD monitor.
- ▶ The AF point <□> will appear.

2 Move the AF point.

- Press the <DIRECTION> cross keys to move the AF point to where you want to focus. (It cannot go to the edges of the picture.)
- Press <SET> to return the AF point to the center. (If C.Fn-9 is set, hold down the <Av/ISO/AF-ON/AF-ON> button and press <SET>.)

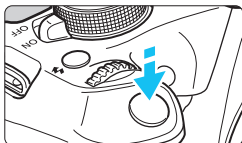

3 Focus on the subject.

- Aim the AF point over the subject and press the shutter button halfway.
- ▶ When focus is achieved, the AF point will turn green and the beeper will sound.
- ▶ If focus is not achieved, the AF point will turn orange.



4 Take the picture.

- Check the focus and exposure, then press the shutter button completely to take the picture (p.134).

☺ (Face detection) Live Mode: AF ☺

Human faces are detected and focused with the same AF method as [FlexiZone - Single]. Have the person whose picture you want to take face the camera.



1 Display the Live View image.

- Press the <☑> button.
- ▶ The Live View image will appear on the LCD monitor.

2 Select an AF point.

- When a face is detected, the <☺> frame will appear over the face to be focused.
- If multiple faces are detected, <☺☺> will be displayed. Use the <◀> <▶> keys to move the <☺> frame over the face you want to focus.

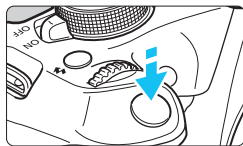

3 Focus on the subject.

- Press the shutter button halfway and the camera will focus on the face covered by the <[]> frame.
- ▶ When focus is achieved, the AF point will turn green and the beeper will sound.
- ▶ If focus is not achieved, the AF point will turn orange.
- If a face cannot be detected, the AF point <[]> will be displayed and AF will be executed at the center.



4 Take the picture.

- Check the focus and exposure, then press the shutter button completely to take the picture (p.134).

- If the subject's face is significantly out of focus, face detection will not be possible. If the lens enables manual focusing even while the lens's focus mode switch is set to <AF>, turn the focusing ring to attain rough focus. The face will then be detected and <[]> will be displayed.
- An object other than a human face may be detected as a face.
- Face detection will not work if the face is very small or large in the picture, too bright or too dark, tilted horizontally or diagonally, or partially hidden.
- The <[]> may cover only part of the face.

- When you press <[SET]>, the AF method will switch to the **[Live mode]** (p.142). You can press the <[AF-ON]> key to move the AF point. Press <[SET]> again to return to **[Face detection] Live Mode**. (If C.Fn-9 is set, hold down the <[Av]/[M]> button and press <[SET]>.)
- Since AF is not possible with a face detected near the edge of the picture, the <[]> will be grayed out. Then if you press the shutter button halfway, the center AF point <[]> will be used to focus.

Notes for [FlexiZone - Single] and [Live mode]

AF Operation

- Focusing will take longer than with [Quick mode].
- Even when focus has been achieved, pressing the shutter button halfway will focus again.
- You cannot focus a moving subject continuously.
- The image brightness may change during and after the AF operation.
- If the light source changes while the Live View image is displayed, the screen may flicker and focusing may be difficult. If this happens, exit Live View shooting and execute autofocus under the actual light source.
- When [FlexiZone - Single] is set and you press the <Q> button, the area covered by the AF point will be magnified. Press the shutter button halfway to focus while in the magnified view. This is effective when the camera is attached to a tripod and you need to attain very precise focus. If focusing is difficult in magnified view, return to the normal display and use AF. Note that the AF speed may differ between the normal and magnified views.
- If you magnify the view after focusing with [FlexiZone - Single] in the normal view, precise focus may not be achieved.
- If [Live mode] is set, magnified view is not possible.

Shooting Conditions that Make Focusing Difficult

- Low-contrast subjects such as the blue sky, solid-color flat surfaces or when highlight or shadow details are lost.
- Subjects in low light.
- Stripes and other patterns where there is contrast only in the horizontal direction.
- Subjects with repetitive patterns (skyscraper windows, computer keyboards, etc.).
- Fine lines and subject outlines.
- Under a light source whose brightness, color, or pattern keeps changing.
- Night scenes or dots of light.
- Under fluorescent or LED light sources and when the image flickers.
- Extremely small subjects.
- Subjects at the edge of the picture.
- Subjects strongly reflecting light.
- The AF point covers both near and distant subjects (such as an animal in a cage).
- Subjects that keep moving within the AF point and cannot keep still due to camera shake or subject blur.
- A subject approaching or moving away from the camera.
- Autofocusing while the subject is very far out of focus.
- Soft focus effect is applied with a soft focus lens.
- A special effect filter is used.
- Noise (spots, banding, etc.) appears on the screen during AF.



- If focus is not achieved with the shooting conditions on the preceding page, set the lens's focus mode switch to **<MF>** and focus manually.
- If you use AF with any of the following lenses, using [**Quick mode**] is recommended. Autofocusing with [**FlexiZone - Single**] or [**Live mode**] may take longer or correct focus may not be achieved.

EF50mm f/1.4 USM, EF50mm f/1.8 II, EF50mm f/2.5 Compact Macro,
EF100mm f/2.8 Macro USM, EF75-300mm f/4-5.6 III,
EF75-300mm f/4-5.6 III USM

For information on discontinued lenses, refer to your local Canon website.



- If you shoot a peripheral subject and it is slightly out of focus, aim the center AF point over the subject to focus, focus again and then take the picture.
- The AF-assist beam will not be emitted. However, if an EX-series Speedlite (sold separately) equipped with an LED light is used, the LED light will turn on for AF-assist when necessary.
- In magnified view, the higher the magnification, the more difficult focusing will be, due to camera shake during handheld shooting (the same as when the lens's focus mode switch is set to **<MF>**). Using a tripod is recommended.

Quick Mode: AFQuick

The dedicated AF sensor is used to focus in One-Shot AF (p.93), using the same AF method as with viewfinder shooting.

Although you can focus on the target subject quickly, **the Live View image will be interrupted momentarily during the AF operation.**

You can use nine AF points to focus (automatic selection). You can also select one AF point to focus and focus only the area covered by that AF point (manual selection).

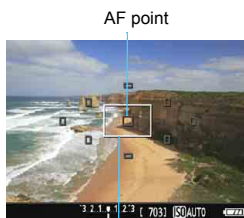

Magnifying frame





1 Display the Live View image.

- Press the <  > button.
- ▶ The Live View image will appear on the LCD monitor.
- The small boxes on the screen are the AF points, and the larger box is the magnifying frame.



Quick mode

2 Select the AF point. ☆

- Press the <  > button ( 10) to display the Quick Control screen.
- ▶ The settable functions will be displayed on the left of the screen.
- Press the <  > <  > keys to make the AF point selectable.
- Turn the <  > dial to select the AF point.



Manual selection

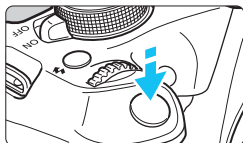

3 Focus on the subject.

- Aim the AF point over the subject and press the shutter button halfway.
- ▶ The Live View image will turn off, the reflex mirror will go back down, and AF will be executed. (No picture is taken.)
- ▶ When focus is achieved, the AF point that achieved focus will turn green and the Live View image will reappear.
- ▶ If focus is not achieved, the AF point will turn orange and blink.



4 Take the picture.

- Check the focus and exposure, then press the shutter button completely to take the picture (p.134).



You cannot take a picture during autofocus. Take the picture while the Live View image is displayed.

MF: Focusing Manually

You can magnify the image and focus precisely with manual focus.

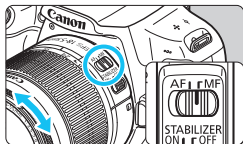

1 Set the lens's focus mode switch to <MF>.

- Turn the lens's focusing ring to focus roughly.

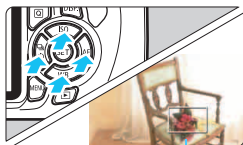

2 Move the magnifying frame.

- Press the <⬆> cross keys to move the magnifying frame to the position where you want to focus.
- Press <SET> to return the magnifying frame to the center. (If C.Fn-9 is set, hold down the <Av/☒/☒> button and press <SET>.)

Magnifying frame

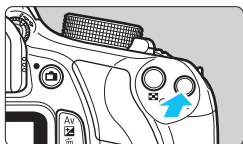

3 Magnify the image.

- Press the <Q> button.
- ▶ The area within the magnifying frame will be magnified.
- Each time you press the <Q> button, the view will change as follows:

→ 5x → 10x → Normal view →



4 Focus manually.

- While looking at the magnified image, turn the lens's focusing ring to focus.
- After achieving focus, press the <Q> button to return to the normal view.

AE lock
Magnified area position

Magnification

5 Take the picture.

- Check the focus and exposure, then press the shutter button to take the picture (p.134).



Live View Shooting Cautions

Image Quality

- When you shoot at high ISO speeds, noise (such as dots of light and banding) may become noticeable.
- Shooting in high temperatures may cause noise and irregular colors in the image.
- If Live View shooting is used continuously for a long period, the camera's internal temperature may rise, and image quality may deteriorate. Always exit Live View shooting when you are not shooting.
- If you shoot a long exposure while the camera's internal temperature is high, image quality may deteriorate. Exit Live View shooting and wait a few minutes before shooting again.

White and Red Internal Temperature Warning Icons

- If the camera's internal temperature increases due to prolonged Live View shooting or under a high ambient temperature, a white or red icon will appear.
- The white icon indicates that the image quality of still photos will deteriorate. It is recommended that you temporarily exit Live View shooting and allow the camera to cool down before shooting again.
- The red icon indicates that the Live View shooting will soon stop automatically. If this happens, you will not be able to shoot again until the camera's internal temperature decreases. Exit Live View shooting or turn off the power and let the camera rest for a while.
- Using Live View shooting at a high temperature for a prolonged period will cause the or icon to appear earlier. When you are not shooting, turn off the camera.
- If the camera's internal temperature is high, the image quality of high ISO speed images or long exposures may deteriorate even before the white icon is displayed.

Shooting Result

- If you take the picture in magnified view, the exposure may not come out as desired. Return to the normal view before taking the picture. In magnified view, the shutter speed and aperture will be displayed in orange. Even if you take the picture in magnified view, the image will be captured in the normal view range.
- If [Q2: Auto Lighting Optimizer] (p.119) is set to other than [Disable], the image may look bright even if a decreased exposure compensation or decreased flash exposure compensation is set.
- If you use a TS-E lens (except the TS-E17mm f/4L or TS-E24mm f/3.5L II) and shift or tilt the lens or use an Extension Tube, the standard exposure may not be obtained or an irregular exposure may result.

Live View Shooting Cautions

Live View Image

- Under low- or bright-light conditions, the Live View image may not reflect the brightness of the captured image.
- Even if a low ISO speed is set, noise may be noticeable in the displayed Live View image under low light. However, when you shoot, the image recorded will have minimal noise. (The image quality of the Live View image is different from that of the recorded image.)
- If the light source (illumination) within the image changes, the screen may flicker. If this happens, exit Live View shooting and resume Live View shooting under the actual light source.
- If you point the camera in a different direction, it may throw off the Live View image's correct brightness momentarily. Wait until the brightness level stabilizes before shooting.
- If there is a very bright light source in the picture, the bright area may appear black on the LCD monitor. However, the actual captured image will correctly show the bright area.
- In low light, if you set the [**F2: LCD brightness**] to a bright setting, noise or irregular colors may appear in the Live View image. However, the noise or irregular colors will not be recorded in the captured image.
- When you magnify the image, the image sharpness may look more pronounced than in the actual image.

Custom Functions

- During Live View shooting, some Custom Function settings will not take effect (p.257).

Lens and Flash

- During Live View shooting, focus preset for super telephoto lenses cannot be used.
- FE lock is not possible when the built-in flash or an external Speedlite is used. Modeling flash will not work with an external Speedlite.

Do not hold the camera in the same position for long periods of time.

Even if the camera does not feel too hot, prolonged contact with the same body part may cause skin redness, blistering or low-temperature contact burns. The use of a tripod is recommended for people with circulation problems or very sensitive skin, or when using the camera in very hot places.

6

Shooting Movies

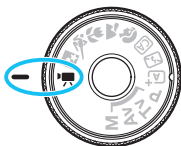

Movie shooting is enabled by setting the Mode Dial to <[movie icon]>. The movie recording format will be MOV.

- For cards that can record movies, see page 5.



Full HD 1080

Full HD 1080 indicates compatibility with High-Definition featuring 1080 vertical pixels (scanning lines).



Shooting Movies

Connecting the camera to a TV set is recommended to play back the movies shot (p.222).

Autoexposure Shooting



1 Set the Mode Dial to <Movie>.

- ▶ The reflex mirror will make a sound, then the image will appear on the LCD monitor.

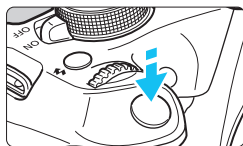

2 Focus on the subject.

- Before shooting a movie, focus with AF or manual focus (p.142-150).
- When you press the shutter button halfway, the camera will focus with the current AF method.



3 Shoot the movie.

- Press the <Start/Stop> button to start shooting a movie. To stop movie shooting, press <Start/Stop> again.
- ▶ While the movie is being shot, the “●” mark will be displayed on the upper right of the screen.

Recording movie



Microphone



- Cautions for movie shooting are on pages 177 and 178.
- If necessary, also read the Live View shooting cautions on pages 151 and 152.



- The ISO speed (ISO 100 - ISO 6400), shutter speed, and aperture are set automatically.
- You can press the <M/>> button (p.116) to lock the exposure (AE lock). The exposure setting will be displayed for the number of seconds set with [C/M 2: Metering timer]. After applying AE lock during movie shooting, you can cancel it by pressing the <M/>> button. (AE lock setting is retained until you press the <M/>> button.)
- By holding down the <Av/>> button and turning the <DIAL/>> dial, you can set the exposure compensation.
- Pressing the shutter button halfway displays the shutter speed and ISO speed on the screen's bottom. This is the exposure setting for still photo shooting (p.158). The exposure setting for movie shooting is not displayed. Note that the exposure setting for movie shooting may differ from that for still photo shooting.
- If you shoot a movie with autoexposure, the shutter speed and aperture will not be recorded in the image information (Exif).

Using an EX-series Speedlite (Sold Separately) Equipped with an LED Light

With autoexposure movie shooting, the camera will automatically turn on the Speedlite's LED light under low-light conditions. **For details, refer to the EX Speedlite's instruction manual.**

Manual Exposure Shooting

You can freely set the shutter speed, aperture, and ISO speed for movie shooting. Using manual exposure to shoot movies is for advanced users.



1 Set the Mode Dial to <Movie>.

- ▶ The reflex mirror will make a sound, then the image will appear on the LCD monitor.



2 Select [Movie exposure].

- Press the <MENU> button and under the [Movie 1] tab, select [Movie exposure], then press <SET>.

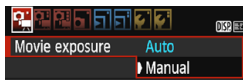

3 Select [Manual].

- ▶ Select [Manual], then press <SET>.

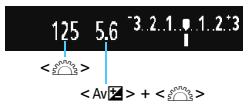

4 Set the shutter speed and aperture.

- To set the shutter speed, turn the <Shutter Speed> dial. The settable shutter speeds depend on the frame rate <Frame Rate>.
 - 60/50 : 1/4000 sec. - 1/60 sec.
 - 30/25/24 : 1/4000 sec. - 1/30 sec.
- To set the aperture, hold down the <Av> button and turn the <Aperture> dial.

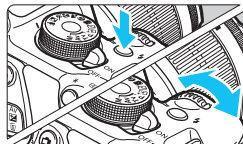

5 Set the ISO speed.

- Press the <Lightning Bolt> button and press the <Left> <Right> keys or turn the <ISO Speed> dial to select the ISO speed.
- For details on the ISO speed, see the next page.

6 Focus and shoot the movie.

- The procedure is the same as steps 2 and 3 for “Autoexposure Shooting” (p.154).

ISO Speed During Manual Exposure Shooting

- With [Auto], the ISO speed will be set automatically within ISO 100 - ISO 6400.
- You can set the ISO speed manually within ISO 100 - ISO 6400 in whole-stop increments.
- If [C:1: Highlight tone priority] is set to [Enable], the ISO speed will be ISO 200 - ISO 6400.



- AE lock and autoexposure cannot be used.
- Changing the shutter speed or aperture during movie shooting is not recommended since the changes in the exposure will be recorded.
- If you change the shutter speed while shooting under fluorescent or LED lighting, image flicker may be recorded.



- With ISO Auto, the movie shooting can record a suitable exposure even when the ambient brightness changes.
- By pressing the <DISP.> button, you can display the histogram.
- When shooting a movie of a moving subject, a shutter speed of 1/30 sec. to 1/125 sec. is recommended. The faster the shutter speed, the less smooth the subject's movement will look.

Information Display

- Each time you press the <DISP.> button, the information display will change.

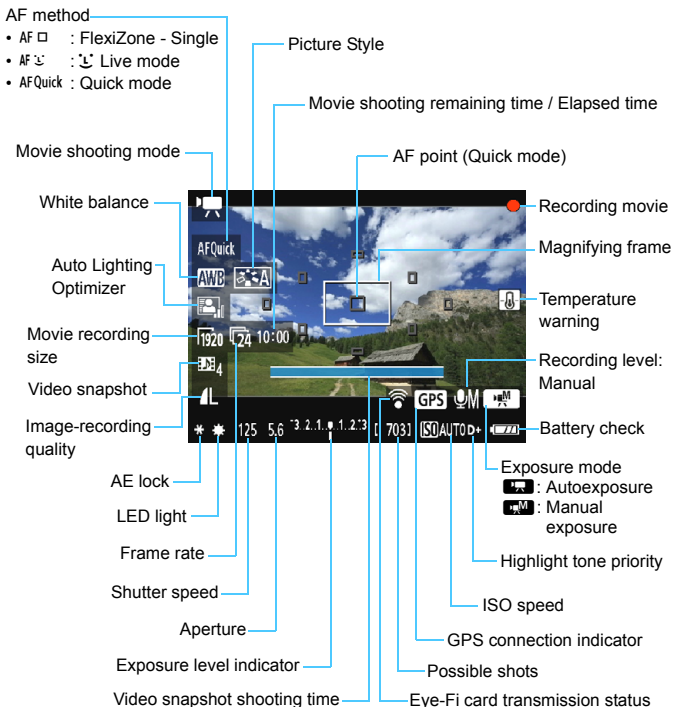

- If there is no card in the camera, the movie shooting remaining time will be displayed in red.
- When movie shooting starts, the movie shooting remaining time will change to the elapsed time.

Notes on Movie Shooting







Do not hold the camera in the same position for long periods of time.

Even if the camera does not feel too hot, prolonged contact with the same body part may cause skin redness, blistering or low-temperature contact burns. The use of a tripod is recommended for people with circulation problems or very sensitive skin, or when using the camera in very hot places.



- Do not point the camera toward an intense light source, such as the sun on a sunny day or an intense artificial light source. Doing so may damage the image sensor or the camera's internal components.
- If **<AWB>** is set and the ISO speed or aperture changes during movie shooting, the white balance may also change.
- If you shoot a movie under fluorescent or LED lighting, the movie may flicker.
- Shooting a few test movies is recommended where you will perform zooming during movie shooting. Zooming during movie shooting may result in recording of changes in exposure or mechanical sound of the lens, or images may be out of focus.
- Pressing the **<Q>** button during movie shooting will not magnify the image.
- Be careful not to cover the microphone (p.154) with your finger, etc.
- **Cautions for movie shooting are on pages 177 and 178.**
- **If necessary, also read the Live View shooting cautions on pages 151 and 152.**



- Movie-related settings are under the **[ 1]**, **[ 2]**, and **[ 3]** tabs (p.172).
- A movie file is recorded each time you shoot a movie.
- The movie image's field of view is approx. 100% (with movie recording size set to []).
- Monaural sound is recorded by the camera's built-in microphone (p.154).
- With a fully-charged Battery Pack LP-E10, the total movie shooting time will be as follows: approx. 1 hr. 15 min. at room temperature (23°C/73°F), and approx. 1 hr. 10 min. at low temperatures (0°C/32°F).
- During movie shooting, focus preset for super telephoto lenses cannot be used.

Final Image Simulation

The final image simulation reflects the settings of the Picture Style, white balance and other functions in the image so you can see what the captured image will look like.

During movie shooting, the image displayed will automatically reflect the effects of the function settings listed below.

Final Image Simulation for Movie Shooting

- Picture Style
 - * All settings such as sharpness, contrast, color saturation, and color tone will be reflected.
- White balance
- Exposure
- Depth of field
- Auto Lighting Optimizer
- Peripheral illumination correction
- Highlight tone priority

Shooting Still Photos

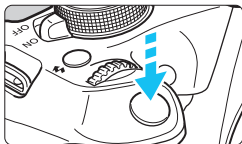



While shooting a movie, you can also take a still photo by pressing the shutter button completely.

Shooting Still Photos in the Mode

- If you take a still photo during movie shooting, the movie will record a still moment lasting approx. 1 sec.
- The captured still photo will be recorded to the card, and the movie shooting will resume automatically when the Live View image is displayed.
- The movie and still photo will be recorded as separate files on the card.
- Functions particular to still photo shooting are shown below. Other functions will be the same as for movie shooting.

Function	Settings
Image-Recording Quality	As set in [ 1: Image quality]. When the movie recording size is [1920x1080] or [1280x720], the aspect ratio will be 16:9. When the size is [640x480], the aspect ratio will be 4:3.
ISO Speed	<ul style="list-style-type: none"> • With autoexposure shooting: Automatically set within ISO 100 - ISO 3200. • With manual exposure shooting: See “ISO Speed During Manual Exposure Shooting” on page 157.
Exposure Setting	<ul style="list-style-type: none"> • With autoexposure shooting: Automatically-set shutter speed and aperture (displayed when pressing the shutter button halfway). • With manual exposure shooting: Manually-set shutter speed and aperture.
AEB	Canceled
Drive/Self-timer	Single shooting (Continuous shooting and self-timer disabled)
Flash	Flash off

When [ 1: **AF w/ shutter button during** ] is set to [**Enable**] (p.172), pressing the shutter button halfway during movie shooting will execute focusing. However, the following may occur.

- Focus may become far off momentarily.
- The brightness of the recorded movie may change.
- The recorded movie may be momentarily still.
- The movie may record the lens operation noise.
- You cannot shoot still photos when focus is not achieved, such as when the subject is moving.

Shooting Function Settings

Function settings particular to movie shooting are explained here.

Quick Control

If you press the <Q> button while the image is displayed on the LCD monitor, you can set any of the following: AF method, White balance, Picture Style, Auto Lighting Optimizer, Movie-recording size, Video snapshot, and Image-recording quality (still photos).



1 Press the <Q> button. (10)

- ▶ The settable functions will be displayed.
- If the AF method is <AFQuick>, the AF point will also be displayed. You can also select the AF point (p.148).

2 Select a function and set it.

- Press the <▲> <▼> keys to select a function.
- ▶ The selected function and Feature guide (p.53) will appear.
- Press the <◀> <▶> keys or turn the <DIAL> dial to set the function. Pressing <SET> will display the respective function setting screen.

3 Exit the setting.

- Press the <Q> button to return to movie shooting.



For manual exposures, image-recording quality (still photos) setting changes to ISO speed setting.

MENU Setting the Movie Recording Size

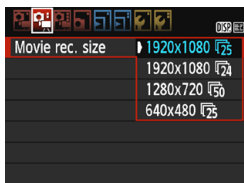

The menu option [**2: Movie rec. size**] enables you to select the movie's image size [****x****] and frame rate [**125**] (frames recorded per second). The [**125**] (frame rate) switches automatically depending on the [**2: Video system**] setting.

● Image Size

- [**1920x1080**] (**125**) : Full High-Definition (Full HD) recording quality. The aspect ratio will be 16:9.
- [**1280x720**] (**150**) : High-Definition (HD) recording quality. The aspect ratio will be 16:9.
- [**640x480**] (**125**) : Standard-definition recording quality. The aspect ratio will be 4:3.

● Frame Rate (fps: frames per second)

- 125**/**160** : For areas where the TV format is NTSC (North America, Japan, Korea, Mexico, etc.).
- 125**/**150** : For areas where the TV format is PAL (Europe, Russia, China, Australia, etc.).
- 124** : Mainly for motion pictures.

Total Movie Recording Time and File Size Per Minute

Movie Recording Size		Total Recording Time (approx.)			File Size (approx.)
		4 GB Card	8 GB Card	16 GB Card	
[1920x1080]	30	11 min.	22 min.	44 min.	330 MB/min.
	25				
	24				
[1280x720]	60	11 min.	22 min.	44 min.	330 MB/min.
	50				
[640x480]	30	46 min.	1 hr. 32 min.	3 hr. 4 min.	82.5 MB/min.
	25				

- **Movie Files Exceeding 4 GB**

Due to the file system, movie shooting will stop automatically if the file size of a single movie clip reaches 4 GB. You can start shooting a movie again by pressing the <CAM> button. (A new movie file starts being recorded.)

- **Movie Shooting Time Limit**

The maximum recording time of one movie clip is 29 min. 59 sec. If the movie shooting time reaches 29 min. 59 sec., the movie shooting will stop automatically. You can start shooting a movie again by pressing the <CAM> button. (A new movie file starts being recorded.)



An increase of the camera's internal temperature may cause movie shooting to stop before the maximum recording time shown in the table above (p.177).

MENU Shooting Video Snapshots

You can shoot a series of short movie clips lasting approx. 2 sec., 4 sec., or 8 sec. called video snapshots. The video snapshots can be joined together into a single movie called a video snapshot album. You can thereby show quick highlights of a trip or event.

A video snapshot album can also be played together with background music (p.170, 215).

Video Snapshot Album Concept

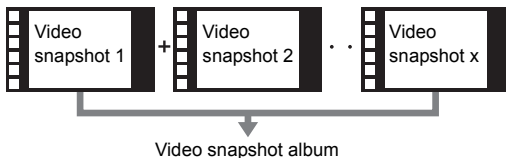

Setting the Video Snapshot Shooting Duration

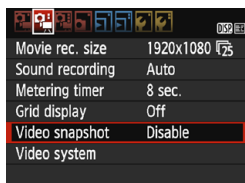

1 Select [Video snapshot].

- Under the [CAMERA 2] tab, select [Video snapshot], then press <SET>.

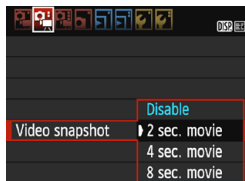

2 Select the [Video snapshot] shooting time.

- Select the shooting time for one video snapshot, then press <SET>.
- Press the <MENU> button to exit the menu and return to the movie shooting screen.

Creating a Video Snapshot Album

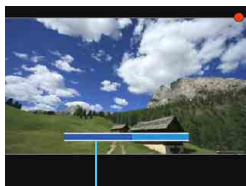

Shooting duration

3 Shoot the first video snapshot.

- Press the < [CAMERA] > button, then shoot.
- ▶ The blue bar indicating the shooting duration will gradually decrease. After the set shooting duration elapses, the shooting stops automatically.
- ▶ The confirmation dialog will appear (p.168).



4 Save as a video snapshot album.

- Select [[MENU] Save as album], then press < (SET) >.
- ▶ The movie clip will be saved as the video snapshot album's first video snapshot.



5 Continue to shoot more video snapshots.



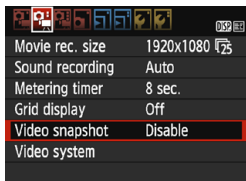



- Repeat step 3 to shoot the next video snapshot.
- Select [[MENU] Add to album], then press < (SET) >.
- To create another video snapshot album, select [[MENU] Save as a new album].
- Repeat step 5 as necessary.













6 Exit the video snapshot shooting.

- Set [Video snapshot] to [Disable].
To return to normal movie shooting, be sure to set [Disable].
- Press the < MENU > button to exit the menu and return to the normal movie shooting screen.

Options in Steps 4 and 5

Function	Description
 Save as album (Step 4)	The movie clip will be saved as the video snapshot album's first video snapshot.
 Save as album (Step 5)	The video snapshot just recorded will be added to the album recorded immediately before.
 Save as a new album (Step 5)	A new video snapshot album is created and the movie clip is saved as the first video snapshot. Select [OK] on the confirmation dialog. The new album will be a different file from the previously recorded album.
 Playback video snapshot (Steps 4 and 5)	The video snapshot just recorded will be played. For playback operations, see the table below.
 Do not save to album (Step 4)	The video snapshot you just recorded will be erased instead of being saved to the album. Select [OK] on the confirmation dialog.
 Delete without saving to album (Step 5)	

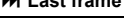
[Playback video snapshot] Operations

Function	Playback Description
 Exit	The previous screen will reappear.
 Play	By pressing <SET> , you can play or pause the just-recorded video snapshot.
 First frame	Displays the first scene of the album's first video snapshot.
 Skip backward*	Each time you press <SET> , the video snapshot skips back by a few seconds.
 Previous frame	Each time you press <SET> , the previous frame is displayed. If you hold down <SET> , it will rewind the movie.
 Next frame	Each time you press <SET> , the movie will play frame-by-frame. If you hold down <SET> , it will fast forward the movie.
 Skip forward*	Each time you press <SET> , the video snapshot skips forward by a few seconds.
 Last frame	Displays the last scene of the album's last video snapshot.
	Playback position
mm' ss"	Playback time (minutes:seconds)
 Volume	You can adjust the built-in speaker's (p.214) volume by turning the <SET> dial.

* With **[Skip backward]** and **[Skip forward]**, the skipping duration will correspond to the number of seconds set under **[Video snapshot]** (approx. 2 sec., 4 sec., or 8 sec.).



Cautions for Shooting Video Snapshots

- You can add to an album only video snapshots with the same duration (approx. 2 sec., 4 sec., or 8 sec. each).
- Note that if you do any of the following while shooting video snapshots, a new album will be created for subsequent video snapshots.
 - Changing the [**Movie rec. size**] (p.164).
 - Changing the [**Video snapshot**]'s shooting time (p.166).
 - Changing the [**Sound rec.**] setting from [**Auto**] or [**Manual**] to [**Disable**] or from [**Disable**] to [**Auto**] or [**Manual**] (p.174).
 - Opening the card slot/battery compartment cover.
 - You stop using the DC Coupler DR-E10 (sold separately) and Compact Power Adapter CA-PS700 (sold separately).
 - Updating the firmware.
- The sequence of snapshots in an album cannot be changed.
- Video snapshots taken afterward cannot be added to an existing album.
- You cannot take still photos while shooting a video snapshot.
- The shooting duration of a video snapshot is only approximate. Depending on the frame rate, the shooting duration displayed during playback may not be exact.

Playing an Album

You can play the completed video snapshot album in the same way as a normal movie (p.214).



1 Play back the movie.

- Press the <▶> button to display image.



2 Select the album.

- In the single-image display, the [SET] icon displayed on the upper left of the screen indicates a video snapshot album.
- Press the <◀> <▶> keys to select a video snapshot album, then press <SET>.



3 Play back the album.

- On the movie playback panel displayed, select [▶] (Play), then press <SET>.



Background Music

- You can play background music when you play back albums, normal movies, and slide shows on the camera (p.170, 215). To play background music, you must first copy the background music to the card using EOS Utility (EOS software). For information on how to copy the background music, refer to the EOS Utility Instruction Manual (p.316).
- Music recorded on the memory card must be used only for private enjoyment. Do not violate the rights of the copyright holder.

EOS Software Usable with Albums

- **EOS Video Snapshot Task:** Enables the editing of albums. This is a function of ImageBrowser EX.

MENU Menu Function Settings

Menu options under the [C:1], [C:2], and [C:3] tabs are explained below.

[C:1]

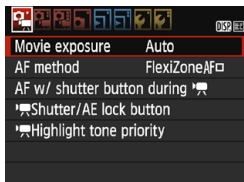

- **Movie exposure**

Normally, set this to **[Auto]**.

Setting it to **[Manual]** will enable you to manually set the ISO speed, shutter speed, and aperture for movie shooting (p.156).

- **AF method**

The AF methods are the same as described on pages 142-149. You can select **[FlexiZone - Single]**, **[Live mode]**, or **[Quick mode]**. Note that continuous focusing of a moving subject is not possible.

- **AF with shutter button during movie recording**

When **[Enable]** is set, AF is possible during movie shooting.

However, continuous autofocus is not possible. If you autofocus during movie shooting, the focus may be momentarily thrown off or the exposure may be changed. The movie will also record the lens operation noise.

During movie shooting, if the AF method is set to **[Quick mode]**, AF will be executed in **[FlexiZone - Single]**.

- The settings under the [C:1], [C:2], and [C:3] menu tabs will take effect only in the <[C:1]> mode. They will not be applied in shooting modes other than the <[C:1]> mode.
- The **[AF method]** setting will also be applied to Live View shooting.

- **☑ Shutter/AE lock button**

You can change the function assigned to the shutter button's halfway position and to the AE lock button.

- **AF/AE lock:**

Normal function. Press the shutter button halfway to execute AF.

Press the <★> button for AE lock.

- **AE lock/AF:**

Press the shutter button halfway for AE lock. For AF, press the <★> button. Convenient when you want to focus on, and meter at different parts of the picture.

- **AF/AF lock, no AE lock:**

Press the shutter button halfway to execute AF. While you autofocus by pressing the shutter button halfway, you can pause the autofocus by holding down the <★> button. You can resume the autofocus by letting go of the <★> button. AE lock is not possible.

- **AE/AF, no AE lock:**

Press the shutter button halfway for metering. For AF, press the <★> button. AE lock is not possible.

- **☑ Highlight tone priority**

If [Enable] is set, highlight detail will be improved. The dynamic range is expanded from the standard 18% gray to bright highlights. The gradation between the grays and highlights becomes smoother. The settable ISO speed range will be ISO 200 - ISO 6400. The Auto Lighting Optimizer will also be set automatically to [Disable] and cannot be changed.

[CAM 2]

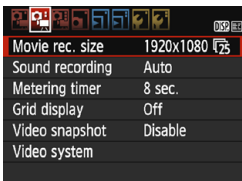

- **Movie recording size**

You can set the movie recording size (image size and frame rate). For details, see page 164.

- **Sound recording**

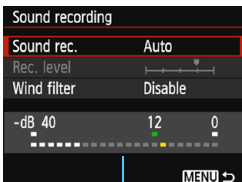

Level meter

Sound will be recorded by the built-in monaural microphone. An external microphone cannot be used.

[Sound rec.] and [Rec. level] options

[Auto] : The sound-recording level is adjusted automatically. Auto level control will operate automatically in response to the sound level.

[Manual] : For advanced users. You can adjust the sound-recording level to one of 64 levels. Select **[Rec. level]** and look at the level meter while pressing the <◀> <▶> keys to adjust the sound-recording level. While looking at the peak hold indicator (approx. 3 sec.), adjust so that the level meter sometimes lights up the “12” (-12 dB) mark on the right for the loudest sounds. If it exceeds “0”, the sound will be distorted.

[Disable] : Sound will not be recorded.

[Wind filter]

When set to **[Enable]**, it reduces wind noise when there is wind outdoors.

Note that **[Enable]** will also reduce low bass sounds, so set this function to **[Disable]** when there is no wind. It will record a more natural sound than with **[Enable]**.



Sound is recorded at a sampling rate of 48 kHz/16-bit.

- **Metering timer**

You can change how long the exposure setting is displayed (AE lock time).

- **Grid display**

With **[Grid 1 \equiv]** or **[Grid 2 \equiv]**, you can display grid lines. You can check horizontal or vertical tilt when shooting.

- **Video snapshot**

You can shoot video snapshots. For details, see page 166.

- **Video system**

Select **[NTSC]** or **[PAL]** to suit your TV set's video system (p.164).



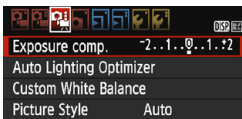

The Metering timer and Grid display settings will also be reflected in Live View shooting.

[ 3]

- **Exposure compensation**

Although exposure compensation can be set up to ± 5 stops, exposure compensation for movies is restricted only up to ± 3 stops. For still photos, exposure compensation may extend up to ± 5 stops.

- **Auto Lighting Optimizer**

The Auto Lighting Optimizer can be set as explained on page 119. If the [ 1] menu tab's [ **Highlight tone priority**] is set to **[Enable]**, the Auto Lighting Optimizer will be set automatically to **[Disable]** and cannot be changed.

- **Custom White Balance**

As explained on page 127, the image for custom white balance can be selected.

- **Picture Style**

The Picture Style can be set as explained on page 91.



Movie Shooting Cautions

White <[Icon]> and Red <[Icon]> Internal Temperature Warning Icons

- If the camera's internal temperature increases due to prolonged movie shooting or under a high ambient temperature, a white <[Icon]> or red <[Icon]> icon will appear.
- The white <[Icon]> icon indicates that the image quality of still photos will deteriorate. It is recommended that you stop still photo shooting for a while and allow the camera to cool down. Since movie image quality will hardly be affected, you can still shoot movies.
- The red <[Icon]> icon indicates that movie shooting will soon be terminated automatically. If this happens, you will not be able to shoot again until the camera's internal temperature decreases. Turn off the power and let the camera rest for a while.
- Shooting a movie at a high temperature for a prolonged period will cause the <[Icon]> or <[Icon]> icon to appear earlier. When you are not shooting, turn off the camera.

Recording and Image Quality

- If the attached lens has an Image Stabilizer and you set the Image Stabilizer (IS) switch to <ON>, the Image Stabilizer will operate at all times even if you do not press the shutter button halfway. The Image Stabilizer consumes battery power and may shorten the total movie shooting time or decrease the number of possible shots. If you use a tripod or if the Image Stabilizer is not necessary, it is recommended that you set the IS switch to <OFF>.
- The camera's built-in microphone will also pick up the operation sound and mechanical sound of the camera during shooting.
- If the brightness changes during autoexposure movie shooting or if AF operates during movie shooting, that part may look momentarily still when you play back the movie.
- If there is a very bright light source in the picture, the bright area may appear black on the LCD monitor. The movie will be recorded in almost the same way you see it on the LCD monitor.
- In low light, noise or irregular colors may appear in the image. The movie will be recorded in almost the same way you see it on the LCD monitor.

Movie Shooting Cautions

Recording and Image Quality

- If you use a card with a slow writing speed, a five-level indicator may appear on the right of the screen during movie shooting. It indicates how much data has not yet been written to the card (remaining capacity of the internal buffer memory). The slower the card, the faster the indicator will climb upward. If the indicator becomes full, movie shooting will stop automatically.

If the card has a fast writing speed, the indicator will either not appear or the level (if displayed) will hardly go upward.

First, shoot a few test movies to see if the card can write fast enough.

If you take still photos during movie shooting, the movie shooting may stop. Setting a low image-recording quality for still images may resolve this problem.



Indicator

Still Photo Shooting During Movie Shooting

- Regarding the image quality of still photos, see “Image Quality” on page 151.

Playback and TV set connection

- If you connect the camera to a TV set with an HDMI cable (p.222) and shoot a movie at [1920x1080] or [1280x720], the movie being shot will be displayed in a small size on the TV set. The movie will still be recorded in the movie-recording size that was set.
- If you connect the camera to a TV set (p.222) and shoot a movie, the TV set will not output any sound during the shooting. However, the sound will be properly recorded.

7

Handy Features

- Disabling the Beeper (p.180)
- Card Reminder (p.180)
- Setting the Image Review Time (p.180)
- Setting the Auto Power-off Time (p.181)
- Adjusting the LCD Monitor Brightness (p.181)
- Creating and Selecting a Folder (p.182)
- File Numbering Methods (p.184)
- Setting Copyright Information (p.186)
- Auto Rotation of Vertical Images (p.188)
- Checking Camera Settings (p.189)
- Reverting the Camera to the Default Settings (p.190)
- Turning the LCD Monitor Off/On (p.193)
- Changing the Shooting Settings Screen Color (p.193)
- Setting the Flash (p.194)
- Appending Dust Delete Data (p.198)
- Manual Sensor Cleaning (p.200)

Handy Features

MENU Disabling the Beeper

You can prevent the beeper from sounding when focus is achieved or during self-timer operation.



Under the [**1**] tab, select [**Beeper**], then press < **SET** >. Select [**Disable**], then press < **SET** >.

MENU Card Reminder

This setting prevents shooting if there is no card in the camera.



Under the [**1**] tab, select [**Release shutter without card**], then press < **SET** >. Select [**Disable**], then press < **SET** >.

If there is no card inserted in the camera and you press the shutter button, “**Card**” will be displayed in the viewfinder, and you cannot release the shutter.

MENU Setting the Image Review Time

You can set how long the image is displayed on the LCD monitor immediately after capture. If [**Off**] is set, the image will not be displayed immediately after image capture. If [**Hold**] is set, the image review will be displayed up until the [**1: Auto power off**] time has elapsed. During image review, if you operate any camera controls such as pressing the shutter button halfway, the image review will end.



Under the [**1**] tab, select [**Image review**], then press < **SET** >. Select the desired setting, then press < **SET** >.

MENU Setting the Auto Power-off Time

To save battery power, the camera turns off automatically after the set time of idle operation elapses. You can set this auto power-off time. When the camera has turned off due to auto power off, you can turn it on again by pressing the shutter button halfway or pressing any of the following buttons: <MENU>, <DISP.>, <▶>, <📷>, etc.

If [Disable] is set, either turn off the camera or press the <DISP.> button to turn off the LCD monitor to save battery power.

Even when [Disable] is set, if the camera is not used for 30 min., the LCD monitor will turn off automatically. To turn on the LCD monitor again, press the <DISP.> button.



Under the [**1**] tab, select [**Auto power off**], then press <SET>. Select the desired setting, then press <SET>.

MENU Adjusting the LCD Monitor Brightness

You can adjust the brightness of the LCD monitor to make it easier to read.



Under the [**2**] tab, select [**LCD brightness**], then press <SET>. Press the <◀> <▶> keys to adjust the brightness on the adjustment screen, then press <SET>.

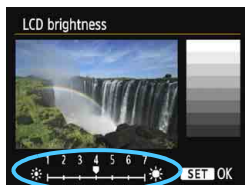

When checking the exposure of an image, set the LCD monitor brightness to 4 and prevent the ambient light from affecting the image.

MENU Creating and Selecting a Folder

You can freely create and select the folder where the captured images are to be saved.

This operation is optional since a folder will be created automatically for saving captured images.

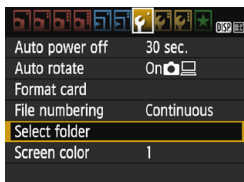
Creating a Folder**1 Select [Select folder].**

- Under the [**1**] tab, select [**Select folder**], then press <SET>.

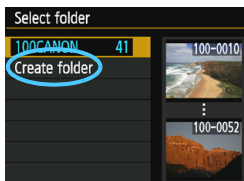
**2 Select [Create folder].**

- Select [**Create folder**], then press <SET>.

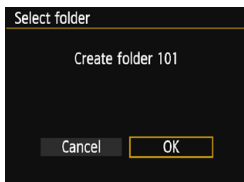
**3 Create a new folder.**

- Select [**OK**], then press <SET>.
- ▶ A new folder with the folder number increased by one is created.

Selecting a Folder

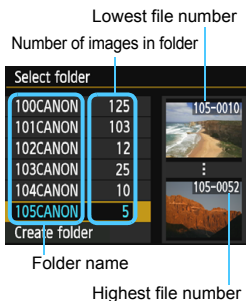

- With the folder selection screen displayed, select a folder and press \langle SET \rangle .
- ▶ The folder where the captured images will be saved is selected.
- Subsequently captured images will be recorded into the selected folder.

Folders

As with “100CANON” for example, the folder name starts with three digits (the folder number) followed by five alphanumeric characters. A folder can contain up to 9999 images (file number 0001 - 9999). When a folder becomes full, a new folder with the folder number increased by one is created automatically. Also, if manual reset (p.185) is executed, a new folder will be created automatically. Folders numbered from 100 to 999 can be created.

Creating Folders with a Computer

With the card open on the screen, create a new folder named “DCIM”. Open the DCIM folder and create as many folders as necessary to save and organize your images. The folder name must follow the format “100ABC_D”. The first three digits are the folder number, from 100 to 999. The final five characters can be any combination of upper- and lower-case letters from A to Z, numerals, and the underscore “_”. The space cannot be used. Also note that two folder names cannot share the same three-digit folder number (for example, “100ABC_D” and “100W_XYZ”), even if the remaining five characters in each name are different.

MENU File Numbering Methods

The image files will be numbered from 0001 to 9999 in the order the images are taken, then saved in a folder. You can change how the file number is assigned.

The file number will appear on your computer in this format:

IMG_0001.JPG

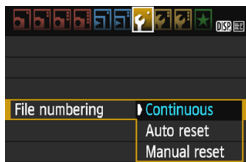

Under the [**1**] tab, select [**File numbering**], then press <SET>. The available settings are described below. Select the option, then press <SET>.

- **[Continuous]:** The file numbering continues in sequence even after you replace the card or create a folder.

Even after you replace the card or create a new folder, the file numbering continues in sequence up to 9999. This is convenient when you want to save images numbered anywhere between 0001 to 9999 in multiple cards or folders into one folder in your computer. If the replacement card or existing folder already contains images recorded previously, the file numbering of the new images may continue from the file numbering of the existing images on the card or in the folder. If you want to use continuous file numbering, it is recommended that you use a newly-formatted card each time.

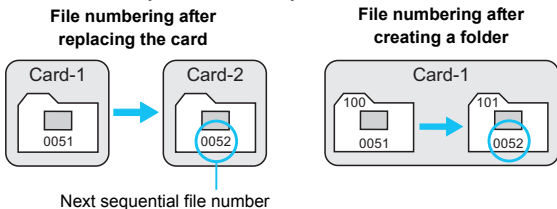

- **[Auto reset]: The file numbering restarts from 0001 each time the card is replaced or a new folder is created.**

When you replace the card or create a folder, the file numbering restarts from 0001 for the new images saved. This is convenient if you want to organize images according to cards or folders.

If the replacement card or existing folder already contains images recorded previously, the file numbering of the new images may continue from the file numbering of the existing images on the card or in the folder. If you want to save images with the file numbering starting from 0001, use a newly formatted card each time.

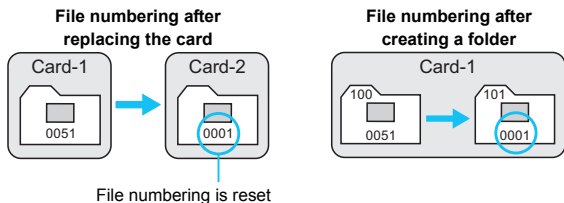

- **[Manual reset]: To reset the file numbering to 0001 manually or to start from file number 0001 in a new folder.**

When you reset the file numbering manually, a new folder is created automatically and the file numbering of images saved to that folder starts from 0001.

This is convenient if you want to use different folders for the images taken yesterday and the ones taken today, for example. After the manual reset, the file numbering returns to continuous or auto reset. (There will be no manual reset confirmation screen.)



If the file number in folder 999 reaches 9999, shooting will not be possible even if the card still has storage capacity. The LCD monitor will display a message telling you to replace the card. Replace it with a new card.



For both JPEG and RAW images, the file name will start with "IMG_". Movie file names will start with "MVI_". The extension will be ".JPG" for JPEG images, ".CR2" for RAW images, and ".MOV" for movies.

MENU Setting Copyright Information ☆

When you set the copyright information, it will be appended to the image as Exif information.

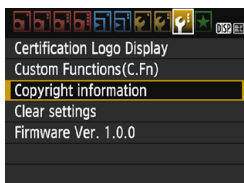

- 1 **Select [Copyright information].**
 - Under the [**3**] tab, select [**Copyright information**], then press <SET>.

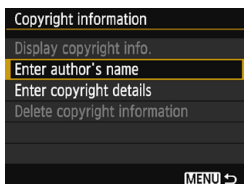

- 2 **Select the option to be set.**
 - Select [**Enter author's name**] or [**Enter copyright details**], then press <SET>.
 - ▶ The text entry screen will appear.
 - Select [**Display copyright info.**] to check the copyright information currently set.
 - Select [**Delete copyright information**] to delete the copyright information currently set.

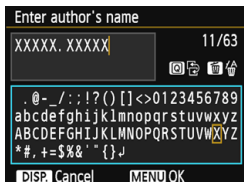

- 3 **Enter text.**
 - Refer to "Text Entry Procedure" on the next page and enter the copyright information.
 - Enter up to 63 alphanumeric characters and symbols.
- 4 **Exit the setting.**
 - After entering the text, press the <MENU> button to exit.

Text Entry Procedure

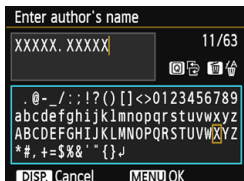

- **Changing the Entry Area:**
 Press the <Q> button to toggle between the top and bottom entry areas.
- **Moving the Cursor:**
 Press the <◀> <▶> keys to move the cursor.
- **Entering Text:**
 In the bottom area, press the <⬆> cross keys or turn the <⌚> dial to select a character, then press <SET> to enter it.
- **Deleting a Character:**
 Press the <⏮> button to delete one character.
- **Exiting:**
 After entering the text, press the <MENU> button to finalize the text entry and return to the screen in step 2.
- **Canceling the Text Entry:**
 To cancel the text entry, press the <DISP.> button to cancel it and return to the screen in step 2.



You can also set or check the copyright information with EOS Utility (EOS software, p.316).

MENU Auto Rotation of Vertical Images

Vertical images are rotated automatically so they are displayed vertically on the camera's LCD monitor and on the computer instead of horizontally. You can change the setting for this feature.

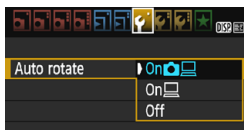

Under the [**1**] tab, select [**Auto rotate**], then press <[**SET**]>. The available settings are described below. Select the option, then press <[**SET**]>.

- [**On**] : The vertical image is automatically rotated during playback on both the camera's LCD monitor and on the computer.
- [**On**] : The vertical image is automatically rotated only on the computer.
- [**Off**] : The vertical image is not automatically rotated.

? FAQ

- **The vertical image is not rotated during the image review immediately after it is captured.**
Press the <[**▶**]> button and the image playback will display the rotated image.
- **[On] is set, but the image does not rotate during playback.**
Auto rotate will not work with vertical images captured while [**Auto rotate**] was set to [**Off**]. If the vertical image is taken while the camera is pointed up or down, the image may not be rotated automatically for playback. In such a case, see "Rotating the Image" on page 207.
- **On the camera's LCD monitor, I want to rotate an image captured when [On] had been set.**
Set [**On**], then play back the image. It will be rotated.
- **The vertical image does not rotate on the computer screen.**
The software used is not compatible with image rotation. Use the EOS software instead.

DISP. Checking Camera Settings

While the menu is displayed, press the <DISP.> button to display the camera's major function settings.

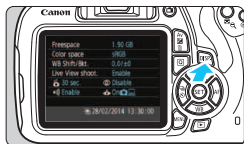

- While the menu is displayed, press the <DISP.> button to display the settings.
- Press the <DISP.> button again to return to the menu.

Settings display

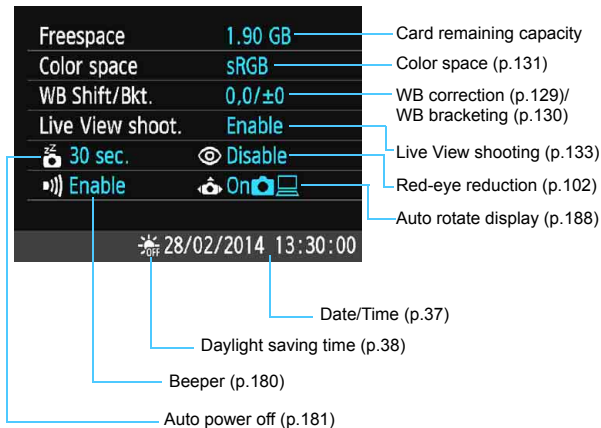

MENU Reverting the Camera to the Default Settings ☆

The camera's shooting settings and menu settings can be reverted to their defaults. This option is available in Creative Zone modes.

**1 Select [Clear settings].**

- Under the [**3**] tab, select [**Clear settings**], then press <SET>.

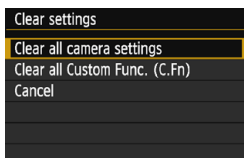
**2 Select [Clear all camera settings].**

- Select [**Clear all camera settings**], then press <SET>.

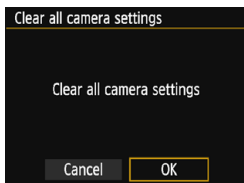
**3 Select [OK].**

- Select [**OK**], then press <SET>.
- ▶ Setting [**Clear all camera settings**] will reset the camera to the default settings as shown on the next pages.



? FAQ

- **Clearing all camera settings:**
After the procedure above, select [**Clear all Custom Func. (C.Fn)**] in [**3: Clear settings**] to clear all the Custom Function settings (p.256).









Shooting Settings

AF operation	One-Shot AF
AF point selection	Automatic selection
Drive/self-timer	<input type="checkbox"/> (Single shooting)
Metering mode	 (Evaluative metering)
ISO speed	AUTO (Auto)
ISO Auto	Max.: 3200
Exposure compensation/AEB	Canceled
Flash exposure compensation	0 (Zero)
Custom Functions	Unchanged

Recording Images

Image quality	 L
Picture Style	Auto
Auto Lighting Optimizer	Standard
Peripheral illumination correction	Enable/ Correction data retained
Color space	sRGB
White balance	 (Auto)
Custom white balance	Canceled
White balance correction	Canceled
White balance bracketing	Canceled
File numbering	Continuous
Dust Delete Data	Erase



Camera Settings

Auto power off	30 sec.
Beep	Enable
Release shutter without card	Enable
Image review time	2 sec.
Histogram display	Brightness
Image jump with 	 (10 images)
Auto rotate	On  
LCD brightness	    
LCD off/on button	Shutter button
Date/Time/Zone	Unchanged
Language	Unchanged
Screen color	1
Feature guide	Enable
Copyright information	Unchanged
Control over HDMI	Disable
Eye-Fi transmission	Disable
My Menu settings	Unchanged
Display from My Menu	Disable

Live View Shooting

Live View shooting	Enable
AF method	FlexiZone - Single
Grid display	Off
Aspect ratio	3:2
Metering timer	8 sec.

Movie Shooting

Movie exposure	Auto
AF method	FlexiZone - Single
AF with shutter button during movie shooting	Disable
 Shutter/AE lock button	AF/AE lock
 Highlight tone priority	Disable
Movie recording size	1920x1080
Sound recording	Auto
Metering timer	8 sec.
Grid display	Off
Video snapshot	Disable
Video system	Unchanged
Exposure compensation	Canceled
Auto Lighting Optimizer	Standard
Custom White Balance	Canceled
Picture Style	Auto

 Regarding GPS settings, refer to the GPS unit's instruction manual.

MENU Turning the LCD monitor Off/On

The shooting settings display (p.52) can be turned on or off by pressing the shutter button halfway.



Under the [**2**] tab, select [**LCD off/on btn**], then press <SET>. The available settings are described below. Select the desired setting, then press <SET>.

- [**Shutter btn.**]: When you press the shutter button halfway, the display will turn off. And when you let go of the shutter button, the display will turn on.
- [**Shutter/DISP**]: When you press the shutter button halfway, the display will turn off. The display will remain off even after you let go of the shutter button. To turn on the display, press the <DISP.> button.
- [**Remains on**]: Display remains on even when you press the shutter button halfway. To turn off the display, press the <DISP.> button.

MENU Changing the Shooting Settings Screen Color

You can change the background color of the shooting settings screen.



Under the [**1**] tab, select [**Screen color**], then press <SET>. Select the desired color, then press <SET>.

When you exit the menu, the selected color will be displayed for the shooting settings screen.

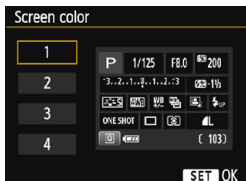

MENU Setting the Flash ☆

The built-in flash and external Speedlite settings can be set with the camera's menu. You can use the camera's menu to set the external Speedlite function settings only if **an EX-series Speedlite compatible with this function is attached**.

The setting procedure is the same as when setting a camera menu function.

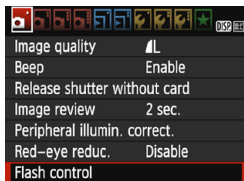

Select [Flash control].

- Under the [📷 1] tab, select [Flash control], then press <SET>.
- ▶ The flash control screen will appear.

[Flash firing]

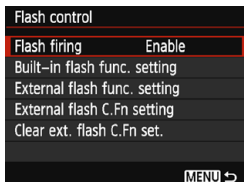

- Normally, set this to [Enable].
- If [Disable] is set, neither the built-in flash nor the external Speedlite will fire. This is useful when you only want to use the flash's AF-assist beam.

Even if [Flash firing] is set to [Disable], if focus is difficult to achieve in low light, the built-in flash may still fire a series of flashes (AF-assist beam, p.96).

[Built-in flash func. setting] and [External flash func. setting]

With [Built-in flash func. setting] and [External flash func. setting], you can set the functions in the table below. The functions displayed under [External flash func. setting] will vary depending on the Speedlite model.

Built-in flash func. setting	
Flash mode	E-TTL II
Shutter sync.	1st curtain
Flash exp. comp	-2..1..0..1..2
E-TTL II meter.	Evaluative
MENU 	

- Select [Built-in flash func. setting] or [External flash func. setting].
- ▶ The flash functions will be displayed. The highlighted functions can be selected and set.

[Built-in flash func. setting] and [External flash func. setting] Functions

Function	[Built-in flash func. setting]	[External flash func. setting]	Page
Flash mode	E-TTL II (Fixed)	○	196
Shutter synchronization		○	196
FEB*	-	○	-
Flash exposure compensation		○	113
E-TTL II flash metering		○	196
Zoom*	-	○	-
Wireless functions*	-	○	-

* Regarding [FEB] (Flash exposure bracketing), [Zoom], and [Wireless func.], refer to the Speedlite's instruction manual compatible with the function.



- Cautions for Radio Transmission Wireless Flash Shooting
 - Radio transmission wireless flash shooting cannot be set with the camera. Use the Speedlite to set the function.
 - Set flash sync speed to 1/100 or less.
 - High-speed synchronization is not possible.
 - Group flash is not possible.
- The camera may not be able to set some of the functions of [Flash mode], [Zoom], and [MULTI flash], depending on the Speedlite model used. In such a case, use the Speedlite to set the functions.

● Flash mode

When using an external Speedlite, you can select the flash mode to suit your desired flash shooting.

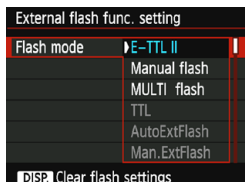

- **[E-TTL II]** is the standard mode of EX-series Speedlites for automatic flash shooting.
- **[Manual flash]** enables you to set the flash output yourself. This is for advanced users.
- Regarding other flash modes, refer to the instruction manual of an external Speedlite compatible with the functions.

● Shutter synchronization

Normally, set this to **[1st curtain]** so that the flash fires immediately after the exposure starts.

If **[2nd curtain]** is set, the flash will fire right before the shutter closes. When this is combined with a slow shutter speed, you can create a trail of light such as from car headlights at night. With E-TTL II (autoflash exposure), two flashes will be fired: Once when you press the shutter button completely, and once immediately before the exposure ends. Also, with shutter speeds faster than 1/30 sec., 1st curtain synchronization will automatically take effect.

If an external Speedlite is attached, you can also select **[Hi-speed]** (⚡_H). For details, refer to the Speedlite's instruction manual.

● Flash exposure compensation

See “Flash Exposure Compensation” on page 113.

● E-TTL II flash metering

For normal flash exposures, set it to **[Evaluative]**. **[Average]** is for advanced users. As with an external Speedlite, the metering is averaged for the entire area. Flash exposure compensation may be necessary.

- **Clear flash settings**

On the [External flash func. setting] screen, press the <DISP.> button to display the screen to clear the flash settings. **When you select [OK], the settings for the built-in flash and external Speedlite will be cleared.**

Setting the External Speedlite Custom Functions

The Custom Functions displayed under [External flash C.Fn setting] will vary depending on the Speedlite model.

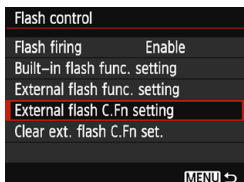

1 Display the Custom Function.

- Select [External flash C.Fn setting], then press <SET>.

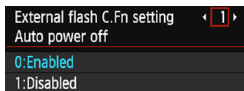

2 Set the Custom Function.

- Press the <◀> <▶> keys to select the function number, then set the function. The procedure is the same as setting the camera's Custom Functions (p.256).
- To clear all the Custom Function settings, select [Clear ext. flash C.Fn set.] in step 1.

MENU Appending Dust Delete Data ☆

Dusts entering the camera can adhere to the image sensor and cause dust spots to be visible on the captured images. To erase these dust spots, you can append the Dust Delete Data to the images. The Dust Delete Data is used by Digital Photo Professional (EOS software, p.316) to erase the dust spots automatically.

Preparation

- Prepare a solid white object such as a sheet of paper.
- Set the lens focal length to 50 mm or longer.
- Set the lens's focus mode switch to <MF> and set the focus to infinity (∞). If the lens has no distance scale, look at the front of the lens and turn the focusing ring clockwise all the way.

Obtaining the Dust Delete Data

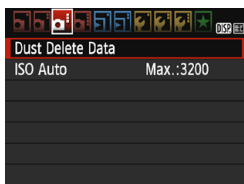

- 1 **Select [Dust Delete Data].**
 - Under the [CAMERA] tab, select [Dust Delete Data], then press <SET>.

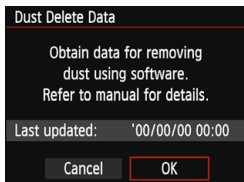

- 2 **Select [OK].**
 - Select [OK], then press <SET>. Instructions will appear.

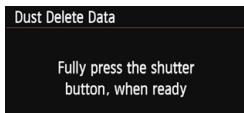

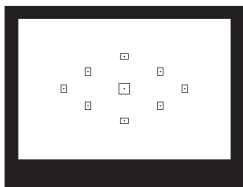

3 Shoot a solid-white object.

- At a distance of 20 cm - 30 cm (0.7 ft. - 1.0 ft.), fill the viewfinder with a patternless, solid-white object and take a picture.
- ▶ The picture will be taken in aperture-priority AE mode at an aperture of f/22.
- Since the image will not be saved, the data can still be obtained even if there is no card in the camera.
- ▶ When the picture is taken, the camera will start collecting the Dust Delete Data. When the Dust Delete Data is obtained, a message will appear. Select [OK], and the menu will reappear.
- If the data was not obtained successfully, an error message will appear. Follow the “Preparation” procedure on the preceding page, then select [OK]. Take the picture again.

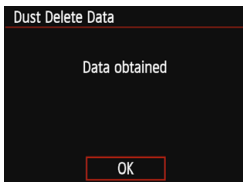

Dust Delete Data

After the Dust Delete Data is obtained, it is appended to all the JPEG and RAW images captured thereafter. Before an important shoot, it is recommended that you update the Dust Delete Data by obtaining it again. For details about using Digital Photo Professional (EOS software, p.316) to erase dust spots, refer to the Digital Photo Professional Instruction Manual (p.316).

The Dust Delete Data appended to the image is so small that it hardly affects the image file size.

 Be sure to use a solid-white object such as a new sheet of white paper. If the paper has any pattern or design, it may be recognized as dust data and affect the accuracy of the dust deletion with the EOS software.

MENU Manual Sensor Cleaning ☆

If dusts adhere to the image sensor and dust spots appear on the images, you can clean the image sensor yourself with a camera blower. Before cleaning the sensor, detach the lens from the camera.

The surface of the image sensor is extremely delicate. If the sensor needs to be cleaned directly, having it done by a Canon Service Center is recommended.



1 Select [Clean manually].

- Under the [**2**] tab, select [**Clean manually**], then press <SET>.

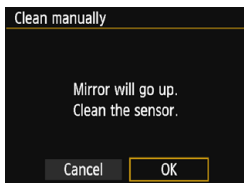

2 Select [OK].

- Select [**OK**], then press <SET>.
- ▶ In a moment, the reflex mirror will lockup and the shutter will open.

3 Clean the sensor.

4 End the cleaning.

- Set the power switch to <OFF>.

 If you use a battery, make sure it is fully charged.

 For the power source, using the DC Coupler DR-E10 (sold separately) and Compact Power Adapter CA-PS700 (sold separately) is recommended.



- **While cleaning the sensor, never do any of the following. If the power is cut off, the shutter will close and the shutter curtains and image sensor may get damaged.**
 - **Setting the power switch to <OFF>.**
 - **Opening the card slot/battery compartment cover.**
- The surface of the image sensor is extremely delicate. Clean the sensor with care.
- Use a plain blower without any brush attached. A brush can scratch the sensor.
- Do not insert the blower tip inside the camera beyond the lens mount. If the power is turned off, the shutter will close and the shutter curtains or reflex mirror may get damaged.
- Never use pressurized air or gas to clean the sensor. The blowing force can damage the sensor or the spray gas can freeze on the sensor and scratch it.
- If the battery level becomes low while you clean the sensor, the beeper will sound as a warning. Stop cleaning the sensor.
- If a smudge that cannot be removed with a blower remains, having the sensor cleaned by a Canon Service Center is recommended.



8

Image Playback

This chapter explains functions related to viewing photos and movies, with more detail than in Chapter 2 “Basic Shooting and Image Playback”. Here you will find explanations of how to play back and erase photos and movies with the camera and view them on a TV set.

Images shot and saved with another device

The camera may not be able to properly display images captured with a different camera, edited with a computer, or that have had their file names changed.

▶ Searching for Images Quickly

🔍 Display Multiple Images on One Screen (Index Display)

Search for images quickly with the index display showing four or nine images on one screen.



1 Play back the image.

- When you press the <▶> button, the last image captured will be displayed.

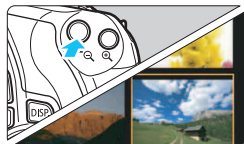

2 Switch to the index display.

- Press the <🔍> button.
- ▶ The 4-image index display will appear. The selected image is highlighted in an orange frame.
- Press the <🔍> button again to switch to the 9-image display.
- Pressing the <🔍> button will switch the display between nine images, four images and one image displayed.



3 Select an image.

- Press the <⬆️⬇️⬇️⬆️> cross keys to move the orange frame to select an image.
- Turning the <🌀> dial will display image(s) on the next or previous screen.
- Press <SET> in the index display to display the selected image as a single image.

Jump through Images (Jump Display)

In the single-image display, you can turn the <  > dial to jump through the images forward or backward according to the jump method set.



1 Select [Image jump w/].

- Under the [▶2] tab, select [Image jump w/ ], then press < (SET) >.

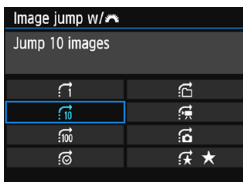

2 Select the jump method.

- Press the < ⬆ > cross keys to select the jump method, then press < (SET) >.

: Display images one by one

: Jump 10 images

: Jump 100 images

: Display by date

: Display by folder

: Display movies only

: Display stills only

: Display by image rating (p.208)

Turn the <  > dial to select.

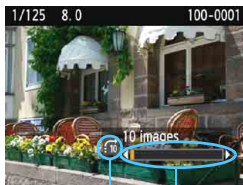

Jump method

Playback position

3 Browse by jumping.

- Press the < ▶ > button to play back images.
- In the single-image display, turn the <  > dial.
- You can browse images with the method you have set.



- To search images according to the shooting date, select [Date].
- To search images according to folder, select [Folder].
- If the card contains both movies and still photos, select [Movies] or [Stills] to display only one or the other.
- If no images match the selected [Rating], you cannot browse through the images with the <  > dial.



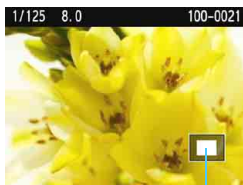
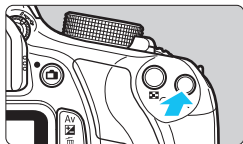

Magnified View

You can magnify a captured image by approx. 1.5x to 10x on the LCD monitor.





Magnified area position

1 Magnify the image.

- Press the  button during image playback.
- ▶ The image will be magnified.
- If you hold down the  button, the image will be magnified until it reaches the maximum magnification.
- Press the   button to reduce the magnification. If you hold down the button, the magnification will be reduced to the single-image display.

2 Scroll around the image.

- Use the  cross keys to scroll around the magnified image.
- To exit magnified view, press the  button and the single-image display will reappear.

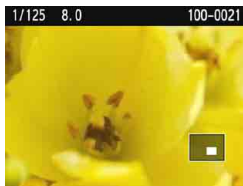
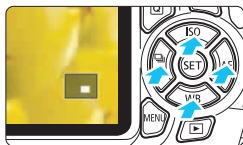



- In magnified view, you can turn the  dial to view another image at the same magnification.
- The image cannot be magnified during the image review immediately after shooting.
- A movie cannot be magnified.

Rotating the Image

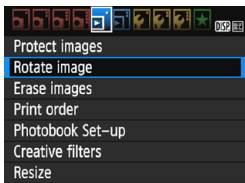
You can rotate the displayed image to the desired orientation.



1 Select [Rotate image].

- Under the [ 1] tab, select [Rotate image], then press < >.



2 Select an image.







- Press the <<◀> <▶> keys to select the image to be rotated.
- You can also select an image in the index display (p.204).



3 Rotate the image.

- Each time you press < >, the image will rotate clockwise as follows:
90° → 270° → 0°.
- To rotate another image, repeat steps 2 and 3.
- To exit and return to the menu, press the <MENU> button.



- If you have set [ 1: Auto rotate] to [On  ] (p.188) before taking vertical shots, you need not rotate the image as described above.
- If the rotated image is not displayed in the rotated orientation during image playback, set [ 1: Auto rotate] to [On  ].
- A movie cannot be rotated.

MENU Setting Ratings

You can rate images (still photos and movies) with one of five rating marks: [★]/[☆]/[☆☆]/[☆☆☆]/[☆☆☆☆]. This function is called rating.



1 Select [Rating].

- Under the [▶2] tab, select [Rating], then press <SET>.



2 Select an image.

- Press the <◀> <▶> keys to select a still photo or movie to be rated.
- You can display three images by pressing the <☒ Q> button. To return to the single-image display, press the <Q> button.



3 Rate the image.

- Press the <▲> <▼> keys to select a rating.
- ▶ The total number of images rated will be counted and displayed for each rating.
- To rate another image, repeat steps 2 and 3.
- To return to the menu, press the <MENU> button.











The total number of images with a given rating that can be displayed is up to 999. If there are more than 999 images with a given rating, [###] will be displayed for that rating.

Taking Advantage of Ratings

- With [▶2: **Image jump w/**], you can display only images with a specific rating.
- With [▶2: **Slide show**], you can play back only images with a specific rating.
- With Digital Photo Professional (EOS software, p.316), you can select only images with a specific rating (still photos only).
- With Windows 8.1, Windows 8, Windows 7, etc., you can see each file's rating as part of the file information display or in the provided image viewer (still photos only).

Quick Control for Playback

During single-image display, you can press the  button to set any of the following: [: **Protect images**], [: Rotate image], [: **Rating**], [: Creative filters], [: Resize] (JPEG images only), [: **Image jump w/ **].

For movies, only the functions in bold above can be set.









1 Press the button.

- During image playback, press the  button.
- ▶ The Quick Control options will appear.









2 Select a function and set it.

- Press the   keys to select a function.
- ▶ The name and current setting of the selected function are displayed at the bottom of the screen.
- Set it by pressing the   keys.
- For Creative filters and Resize, press  and set the function. For details, see page 234 for Creative filters and page 237 for Resize. To cancel, press the .

3 Exit the setting.

- Press the  button to exit the Quick Control screen.

 To rotate an image, set [**1: Auto rotate**] to [**On**  ]. If [**1: Auto rotate**] is set to [**On** ] or [**Off**], the [**Rotate image**] setting will be recorded to the image, but the camera will not rotate the image for display.

-  • Pressing the < > button during the index display will switch to the single-image display and the Quick Control icons will appear. Pressing the < > button again will return to the index display.
- For images taken with another camera, the options you can select may be limited.

Enjoying Movies

You can play back movies in the following three ways:

Playback on a TV Set (p.222)



An HDMI cable (sold separately) is necessary to connect the camera to a TV set. Also, an HDMI terminal on a TV set is required.

When the camera is connected to a TV set with an HDMI cable, you can play back movies and still photos on the TV set.

If you have a High-Definition TV set and connect your camera with an HDMI cable, you can watch Full High-Definition (Full HD: 1920x1080) and High-Definition (HD: 1280x720) movies with higher image quality.

- The camera does not have an audio/video OUT terminal. Therefore, the camera cannot be connected to a TV set with an analog AV cable.
- Since hard disk recorders do not have an HDMI IN terminal, the camera cannot be connected to a hard disk recorder with an HDMI cable.
- Even if you connect the camera to a hard disk recorder with a USB cable, you cannot play or save movies and still photos.
- If the playback device is not compatible with MOV files, the movie cannot be played back.

Playback on the Camera's LCD Monitor (p.214-221)

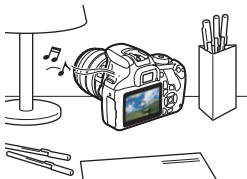



You can play back movies on the camera's LCD monitor. You can also edit out the movie's first and last scenes, and play back the still photos and movies on the card in an automatic slide show.

- 
 A movie edited with a computer cannot be rewritten to the card and played back with the camera. However, video snapshot albums edited with EOS Video Snapshot Task (p.171) can be played on the camera.

Playback and Editing with a Computer (p.316)



The movie files recorded on the card can be transferred to a computer and played back with ImageBrowser EX (EOS software).

- 
 - 
 To have the movie play back smoothly on a computer, use a high-performance computer. Regarding the computer hardware requirements for ImageBrowser EX, refer to the ImageBrowser EX User Guide (PDF).
 - 
 If you want to use commercially-available software to play back or edit the movies, be sure it is compatible with MOV files. For details on commercially-available software, contact the software manufacturer.

▶▶ Playing Movies



1 Play back the image.

- Press the <▶> button to display an image.



2 Select a movie.

- Press the <◀> <▶> keys to select a movie.
- In the single-image display, the <▶▶ SET > icon displayed on the upper left of the screen indicates a movie. If the movie is a video snapshot, [▶▶ SET] will be displayed.
- In the index display, perforations at the left edge of a thumbnail indicate a movie. **As movies cannot be played from the index display, press <SET> to switch to the single-image display.**



3 In the single-image display, press <SET>.

- ▶ The movie playback panel will appear at the bottom of the screen.







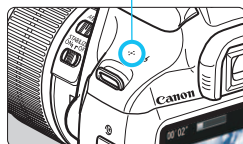











4 Play back the movie.

- Select [▶] (Play), then press <SET>.
- ▶ The movie will start playing.
- You can pause the movie playback by pressing <SET>.
- You can adjust the sound volume by turning the <◀▶> dial even during movie playback.
- For more details on the playback procedure, see the next page.

Speaker



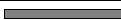

Movie Playback Panel

Operation	Playback Description
 Exit	Returns to the single-image display.
 Play	Pressing <  > toggles between play and stop.
 Slow motion	Adjust the slow motion speed by pressing the <  > <  > keys. The slow-motion speed is indicated at the upper right of the screen.
 First frame	Displays the movie's first frame.
 Previous frame	Each time you press <  >, the previous frame is displayed. If you hold down <  >, it will rewind the movie.
 Next frame	Each time you press <  >, the movie will play frame-by-frame. If you hold down <  >, it will fast forward the movie.
 Last frame	Displays the movie's last frame.
 Edit	Displays the editing screen (p.216).
 Background music*	Plays back a movie with the selected background music (p.221).
	Playback position
mm' ss"	Playback time (minutes:seconds)
 Volume	You can adjust the built-in speaker's (p.214) volume by turning the <  > dial.

* When background music is set, the movie's sound will not be played.

 The camera may not be able to play back movies shot with another camera.

- 
- With a fully-charged Battery Pack LP-E10, the continuous playback time at room temperature (23°C/73°F) will be as follows: Approx. 2 hr 20 min.
 - During the single-image display, you can press the <DISP.> button to change the display format (p.230).
 - If you connect the camera to a TV set (p.222) to play back a movie, adjust the sound volume with the TV set. (Turning the <  > dial will not change the sound volume.)
 - If you took a still photo while you shot the movie, the still photo will be displayed for approx. 1 sec. during the movie playback.

✂ Editing a Movie's First and Last Scenes

You can edit out the first and last scenes of a movie in approx. 1-sec. increments.



1 On the movie playback screen, select [✂].

- ▶ The editing screen will be displayed.



2 Specify the part to be edited out.

- Select either [✂] (Cut beginning) or [✂] (Cut end), then press <SET>.
- Press the <◀> <▶> keys to see another frame. Holding it down will fast forward the frames.
- After deciding which part to edit out, press <SET>. The portion highlighted in gray on the top of the screen is what will remain.

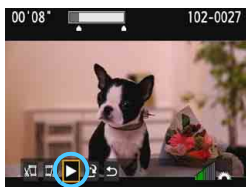

3 Check the edited movie.

- Select [▶] and press <SET> to play back the portion highlighted in gray.
- To change the editing, go back to step 2.
- To cancel the editing, select [↶], then press <SET>. Select [OK] on the confirmation screen, then press <SET>.

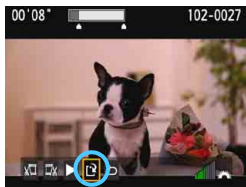

4 Save the edited movie.

- Select [**L2**], then press <Ⓔ>.
- ▶ The save screen will appear.
- To save it as a new movie, select [**New file**]. To save it and overwrite the original movie file, select [**Overwrite**], then press <Ⓔ>.
- On the confirmation screen, select [**OK**], then press <Ⓔ> to save the edited movie and return to the movie playback screen.



- Since the editing is performed in approx. 1-sec. increments (position indicated by [**✂**] on the top of the screen), the actual position where the movie is edited may differ from the position you specified.
- If the card does not have enough free space, [**New file**] will not be available.
- When the battery level is low, movie editing is not possible. Use a fully-charged battery.

MENU Slide Show (Auto Playback)

You can play back the images on the card as an automatic slide show.



Number of images to be played

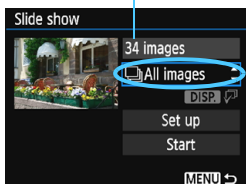

1 Select [Slide show].

- Under the [▶] 2 tab, select [Slide show], then press <SET>.

2 Select the images to be played.

- Press the <▲> <▼> keys to select the desired option, then press <SET>.

All images/Movies/Stills

- Press the <▲> <▼> keys to select one of the following: [📁 All images], [🎬 Movies], or [📷 Stills]. Then press <SET>.

Date/Folder/Rating

- Press the <▲> <▼> keys to select one of the following: [📅 Date], [📁 Folder], or [★ Rating].
- When <DISP. [right arrow]> is highlighted, press the <DISP.> button.
- Press the <▲> <▼> keys to select the option, then press <SET>.

[Date]

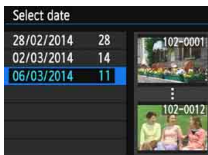







[Folder]



[Rating]



Item	Playback Description
 All images	All the still photos and movies on the card will be played back.
 Date	Still photos and movies taken on the selected shooting date will be played back.
 Folder	Still photos and movies in the selected folder will be played back.
 Movies	Only the movies on the card will be played back.
 Stills	Only the still photos on the card will be played back.
 Rating	Only the still photos and movies with the selected rating will be played back.

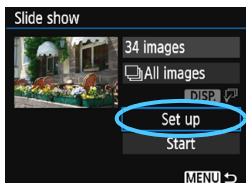

3 Set [Set up] as desired.

- Press the <▲> <▼> keys to select [Set up], then press <SET>.
- Set the [Display time], [Repeat] (repeated playback), [Transition effect] (effect when changing images), and [Background music] for the still photos.
- The background music selection procedure is explained on page 221.
- After selecting the settings, press the <MENU> button.

[Display time]



[Repeat]



[Transition effect]

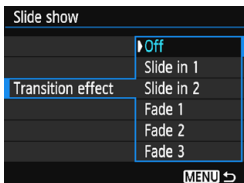

[Background music]

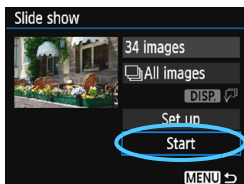
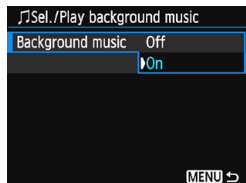

4 Start the slide show.

- Press the <▲> <▼> keys to select [Start], then press <SET>.
- ▶ After [Loading image...] is displayed, the slide show will start.

5 Exit the slide show.

- To exit the slide show and return to the setting screen, press the <MENU> button.

- To pause the slide show, press <SET>. During pause, [||] will be displayed on the upper left of the image. Press <SET> again to resume the slide show.
- During auto playback, you can press the <DISP.> button to change the still photo display format (p.80).
- During movie playback, you can adjust the sound volume by turning the <Speaker> dial.
- During auto playback or pause, you can press the <◀> <▶> keys to view another image.
- During auto playback, auto power off will not work.
- The display time may vary depending on the image.
- To view the slide show on a TV set, see page 222.

Selecting the Background Music

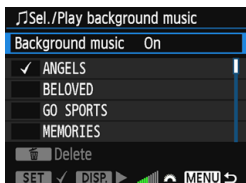

1 Select [Background music].

- Set [Background music] to [On], then press <SET>.
- If the card has no background music, you cannot perform step 2.

2 Select the background music.

- Press the <▲> <▼> keys to select the desired background music, then press <SET>. You can also select multiple background music tracks.

3 Play the background music.

- To listen to a sample of the background music, press the <DISP.> button.
- Press the <▲> <▼> keys to play another background music track. To stop listening to the background music, press the <DISP.> button again.
- Adjust the sound volume by turning the <VOL.> dial.
- To delete a background music track, press the <▲> <▼> keys to select the track, then press the <DELETE> button.



At the time of purchase, you cannot select background music with the camera. You must first use EOS Utility (EOS software) to copy the background music to the card. For details, refer to the EOS Utility Instruction Manual.

Playback on a High-Definition TV set

You can play back movies and still photos on a TV set. An HDMI cable (sold separately) is necessary to connect the camera to a TV set. Also, an HDMI terminal on a TV set is required.

- Adjust movie sound volume with the TV set. The sound volume cannot be adjusted with the camera.
- Before connecting or disconnecting the cable between the camera and TV set, turn off the camera and TV set.
- Depending on the TV set, part of the image displayed may be cut off.

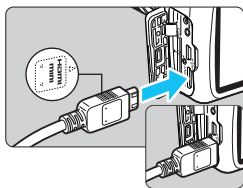

1 Connect the HDMI cable to the camera.

- With the plug's <▲HDMI MINI> logo facing the front of the camera, insert it into the <HDMI OUT> terminal.

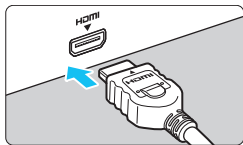

2 Connect the HDMI cable to the TV set.

- Connect the HDMI cable to the TV set's HDMI IN port.

3 Turn on the TV set and switch the TV set's video input to select the connected port.

4 Set the camera's power switch to <ON>.

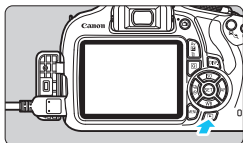

5 Press the <▶> button.

- ▶ The image will appear on the TV screen. (Nothing will be displayed on the camera's LCD monitor.)
- The images will automatically be displayed at the TV set's optimum resolution.
- By pressing the <DISP.> button, you can change the display format.
- To play back movies, see page 214.



- Do not connect any other device's output to the camera's <HDMI OUT> terminal. Doing so may cause a malfunction.
- Certain TV sets may not be able to play back the captured images.

Using HDMI CEC TV Sets

If the TV set connected to the camera with an HDMI cable is compatible with HDMI CEC*, you can use the TV set's remote control for playback operations.

* An HDMI-standard function enabling HDMI devices to control each other so that you can control them with one remote control unit.



1 Set [Ctrl over HDMI] to [Enable].

- Under the [▶2] tab, select [Ctrl over HDMI], then press <SET>.
- Select [Enable], then press <SET>.

2 Connect the camera to a TV set.

- Use an HDMI cable to connect the camera to the TV set.
- ▶ The TV set's input will switch automatically to the HDMI port connected to the camera.

3 Press the camera's <▶> button.

- ▶ An image will appear on the TV screen and you can use the TV set's remote control to play back images.

4 Select an image.

- Point the remote control toward the TV set and press the ←/→ button to select an image.

Still photo playback menu

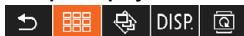

Movie playback menu



- ↶ : Return
- ☐☐☐ : 9-image index
- 📺 : Play movie
- 👉 : Slide show
- DISP. : Display shooting info
- 🔄 : Rotate

5 Press the remote control's Enter button.

- ▶ The menu appears and you can perform the playback operations shown on the left.
- Press the remote control's ←/→ button to select the desired option, then press the Enter button. For a slide show, press the ↑/↓ button to select an option, then press the Enter button.
- If you select **[Return]** and press the Enter button, the menu will disappear and you can use the ←/→ button to select an image.

- Some TV sets require you to first enable the HDMI CEC connection. For details, refer to the TV set's instruction manual.
- Certain TV sets, even those compatible with HDMI CEC, may not operate properly. In such a case, disconnect the HDMI cable, set **[▶2: Ctrl over HDMI]** to **[Disable]**, and use the camera to control the playback operation.

Protecting Images

Protecting an image prevents it from being erased accidentally.

MENU Protecting a Single Image

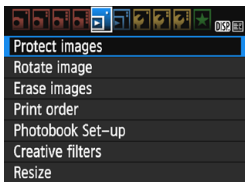

1 Select [Protect images].

- Under the [ 1] tab, select [**Protect images**], then press <SET>.
- ▶ The protect setting screen will appear.

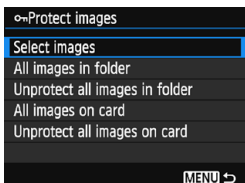

2 Select [Select images].

- Select [**Select images**], then press <SET>.
- ▶ An image will be displayed.

Image protection icon



3 Protect the image.

- Press the <◀> <▶> keys to select the image to be protected, then press <SET>.
- ▶ When an image is protected, the <📷> icon will appear on the top of the screen.
- To cancel the image protection, press <SET> again. The <📷> icon will disappear.
- To protect another image, repeat step 3.
- To return to the menu, press the <MENU> button.

MENU Protecting All Images in a Folder or on a Card

You can protect all the images in a folder or on a card at one time.

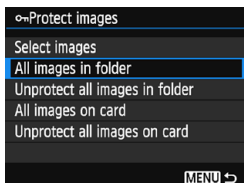

When you select [**All images in folder**] or [**All images on card**] in [**▶ 1: Protect images**], all the images in the folder or on the card will be protected.

To cancel the image protection, select [**Unprotect all images in folder**] or [**Unprotect all images on card**].

! If you format the card (p.50), the protected images will also be erased.

- Movies can also be protected.
- Once an image is protected, it cannot be erased by the camera's erase function. To erase a protected image, you must first cancel the protection.
- If you erase all the images (p.228), only the protected images will remain. This is convenient when you want to erase unnecessary images all at once.

Erasing Images

You can either select and erase unnecessary images one by one or erase them in one batch. Protected images (p.225) will not be erased.

- 1 **Once an image is erased, it cannot be recovered. Make sure you no longer need the image before erasing it. To prevent important images from being erased accidentally, protect them. Erasing a **RAW** + **L** image will erase both the RAW and JPEG images.**

Erasing a Single Image



- 1 Play back the image to be erased.

- 2 Press the **<trash can>** button.

- ▶ The Erase menu will appear at the bottom of the screen.



- 3 Erase the image.

- Select **[Erase]**, then press **<SET>**. The image displayed will be erased.

MENU Checkmarking **<✓>** Images to Be Erased in a Batch

By appending checkmarks **<✓>** to the images to be erased, you can erase multiple images at one time.

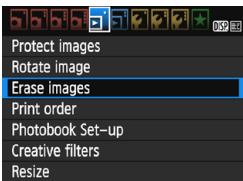

- 1 Select **[Erase images]**.

- Under the **[▶1]** tab, select **[Erase images]**, then press **<SET>**.

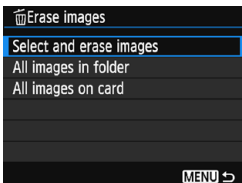

2 Select [Select and erase images].

- Select [**Select and erase images**], then press <SET>.
- ▶ An image will be displayed.
- To display the three-image display, press the <☒ Q> button. To return to the single-image display, press the <Q> button.



3 Select the images to be erased.

- Press the <◀> <▶> keys to select the image to be erased, then press the <▲> <▼> keys.
- ▶ A checkmark <✓> will be displayed on the upper left of the screen.
- To select other images to be erased, repeat step 3.

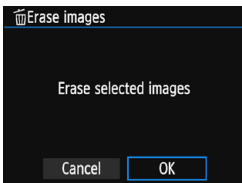

4 Erase the image.

- Press the <☒> button.
- Select [**OK**], then press <SET>.
- ▶ The selected images will be erased.

MENU Erasing All Images in a Folder or on a Card

You can erase all the images in a folder or on a card at one time. When [**▶ 1: Erase images**] is set to [**All images in folder**] or [**All images on card**], all the images in the folder or on the card will be erased.

 To also erase protected images, format the card (p.50).

DISP. Shooting Information Display

Sample Still Photo Taken in a Creative Zone Mode

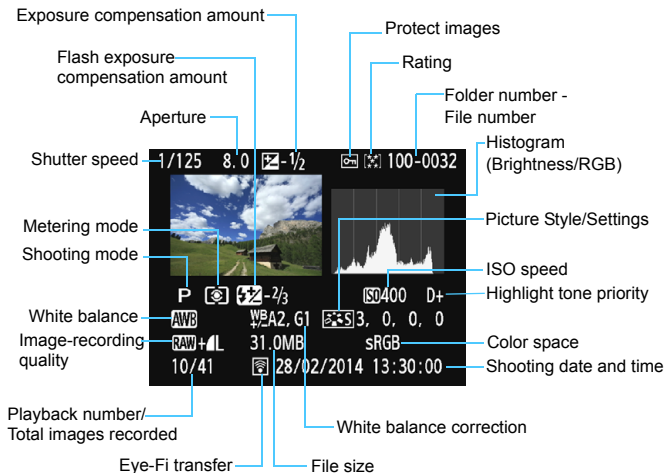

* With **RAW+L** images, the **RAW** file size is displayed.

* For still photos taken during movie shooting, <[Movie Icon]> will be displayed.

* If a Creative filter or Resize has been applied to the image, the <[RAW+]> icon will change to <[Filter/Resize Icon]>.

* Images taken with flash without any flash exposure compensation are marked with the <[Flash Icon]>. Images taken with flash exposure compensation are marked with the <[Flash Icon with +]> icon.

Sample Still Photo Taken in a Basic Zone Mode

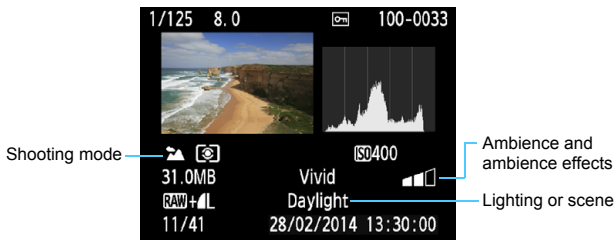

* With images taken in a Basic Zone mode, the information displayed will differ depending on the shooting mode.

Sample Movie

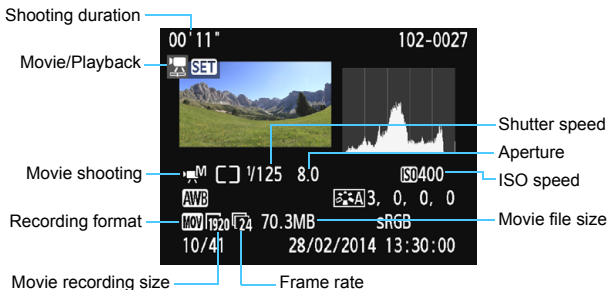

* If manual exposure was used, the shutter speed, aperture, and ISO speed (when set manually) will be displayed.

* The icon will be displayed for video snapshots.

● Highlight Alert

When the shooting information is displayed, any overexposed areas of the image will blink. To obtain more image detail in the overexposed areas, set the exposure compensation to a negative amount and shoot again.

● Histogram

The brightness histogram shows the exposure level distribution and overall brightness. The RGB histogram is for checking the color saturation and gradation. The display can be switched with [**▶2: Histogram disp**].

[Brightness] Display

This histogram is a graph showing the distribution of the image's brightness level. The horizontal axis indicates the brightness level (darker on the left and brighter on the right), while the vertical axis indicates how many pixels exist for each brightness level. The more pixels there are toward the left, the darker the image. The more pixels there are toward the right, the brighter the image. If there are too many pixels on the left, the shadow detail will be lost. If there are too many pixels on the right, the highlight detail will be lost. The gradation in-between will be reproduced. By checking the image and its brightness histogram, you can see the exposure level inclination and the overall gradation.

Sample Histograms



Dark image



Normal brightness



Bright image

[RGB] Display

This histogram is a graph showing the distribution of each primary color's brightness level in the image (RGB or red, green, and blue). The horizontal axis indicates the color's brightness level (darker on the left and brighter on the right), while the vertical axis indicates how many pixels exist for each color brightness level. The more pixels there are toward the left, the darker and less prominent the color. The more pixels there are toward the right, the brighter and denser the color. If there are too many pixels on the left, the respective color information will be lacking. If there are too many pixels on the right, the color will be too saturated with no gradation. By checking the image's RGB histogram, you can see the color's saturation and gradation condition, as well as white balance inclination.



9

Post-Processing Images

After taking a picture, you can apply a Creative filter or resize the image (reduce the number of pixels).



- The camera may not be able to process images taken with another camera.
- Post-processing images as described in this chapter is not possible while the camera is connected to a computer via the interface cable.

Applying Creative Filters

You can apply the following Creative filters to an image and save it as a new image: Grainy B/W, Soft focus, Fish-eye effect, Toy camera effect, and Miniature effect.

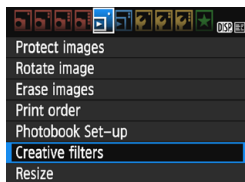

1 Select [Creative filters].

- Under the [▶1] tab, select [Creative filters], then press <Ⓢ>.
- ▶ An image will be displayed.



2 Select an image.

- Select the image you want to apply a filter to.
- By pressing the <Ⓢ Q> button, you can switch to the index display and select an image.



3 Select a filter.

- When you press <Ⓢ>, the types of Creative filters will be displayed (p.236).
- Press the <◀> <▶> keys to select a Creative filter, then press <Ⓢ>.
- ▶ The image will be displayed with the effects of the filter applied.

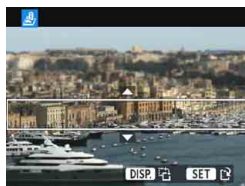

4 Adjust the filter effect.

- Press the <◀> <▶> keys to adjust the filter effect, then press <Ⓢ>.
- For the Miniature effect, press the <▲> <▼> keys and select the image area (within the white frame) where you want the image to look sharp, then press <Ⓢ>.

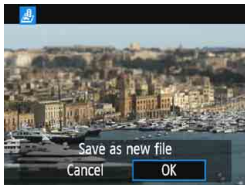





5 Save the image.

- Select **[OK]** to save the image.
- Check the destination folder and image file number, then select **[OK]**.
- To apply filters to another image, repeat steps 2 to 5.
- To return to the menu, press the **<MENU>** button.



- When shooting **RAW + L** or **RAW** image, a filter effect will be applied to the **RAW** image and the image will be saved as a JPEG image.
- If an aspect ratio was set for a **RAW** image and a filter effect is applied to it, the image will be saved in the aspect ratio that was set.

Creative Filter Characteristics

-  **Grainy B/W**
Creates a grainy black-and-white photo. You can change the black-and-white effect by adjusting the contrast.
-  **Soft focus**
Gives the image a soft look. You can change the degree of softness by adjusting the blur.
-  **Fish-eye effect**
Gives the effect of a fish-eye lens. The image will have a barrel-type distortion.
Depending on the level of this filter effect, the area trimmed along the periphery of the image changes. Also, since this filter effect will magnify the image center, the apparent resolution at the center may degrade depending on the number of recorded pixels. Set the filter effect in step 4 while checking the resulting image.
-  **Toy camera effect**
Darkens the photo's corners and applies a color tone that makes it look as if it was shot by a toy camera. You can change the color cast by adjusting the color tone.
-  **Miniature effect**
Creates a diorama effect. You can change where the image looks sharp. In step 4 on page 234, if you press the <DISP.> button, you can switch between the white frame's vertical and horizontal orientations.

Resizing JPEG Images

You can resize an image to make the pixel count lower and save it as a new image. Resizing an image is possible only with JPEG L/M/S1/S2 images. **JPEG S3 and RAW images cannot be resized.**

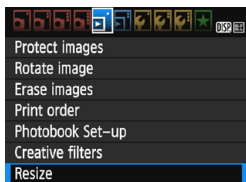

1 Select [Resize].

- Under the [] 1 tab, select [Resize], then press <SET>.
- ▶ An image will be displayed.



2 Select an image.

- Select the image you want to resize.
- By pressing the < > button, you can switch to the index display and select an image.

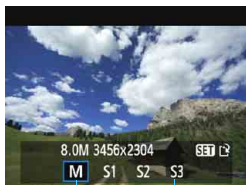

3 Select the desired image size.

- Press <SET> to display the image sizes.
- Press the <◀> <▶> keys to select the desired image size, then press <SET>.

Target sizes

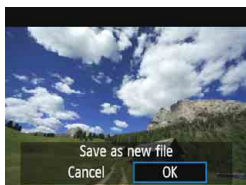

4 Save the image.

- Select [OK] to save the resized image.
- Check the destination folder and image file number, then select [OK].
- To resize another image, repeat steps 2 to 4.
- To return to the menu, press the <MENU> button.

Resize Options According to Original Image Size

Original Image Size	Available Resize Settings			
	M	S1	S2	S3
L	<input type="radio"/>	<input type="radio"/>	<input type="radio"/>	<input type="radio"/>
M		<input type="radio"/>	<input type="radio"/>	<input type="radio"/>
S1			<input type="radio"/>	<input type="radio"/>
S2				<input type="radio"/>
S3				

Image Sizes

The image size displayed in step 3 on the preceding page, such as [***M ***x***], has a 3:2 aspect ratio. The image size according to aspect ratios is shown in the table below.

The asterisked image-recording quality figures do not exactly match the aspect ratio. The image will be cropped slightly.

Image Quality	Aspect Ratio and Pixel Count (Approx.)			
	3:2	4:3	16:9	1:1
M	3456x2304 (8.0 megapixels)	3072x2304 (7.0 megapixels)	3456x1944 (6.7 megapixels)	2304x2304 (5.3 megapixels)
S1	2592x1728 (4.5 megapixels)	2304x1728 (4.0 megapixels)	2592x1456* (3.8 megapixels)	1728x1728 (3.0 megapixels)
S2	1920x1280 (2.5 megapixels)	1696x1280* (2.2 megapixels)	1920x1080 (2.1 megapixels)	1280x1280 (1.6 megapixels)
S3	720x480 (350,000 pixels)	640x480 (310,000 pixels)	720x400* (290,000 pixels)	480x480 (230,000 pixels)

10

Printing Images

- **Printing** (p.240)
You can connect the camera directly to a printer and print out the images on the card. The camera is compliant with “PictBridge”, which is the standard for direct printing.
- **Digital Print Order Format (DPOF)** (p.249)
DPOF (Digital Print Order Format) enables you to print images recorded on the card according to your printing instructions such as the image selection, quantity to print, etc. You can print multiple images in one batch or give the print order to a photofinisher.
- **Specifying Images for a Photobook** (p.253)
You can specify images on the card for printing in a photobook.

Preparing to Print

The direct printing procedure can be performed entirely with the camera while you look at the camera's LCD monitor.

Connecting the Camera to a Printer

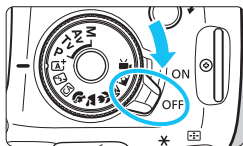

- 1 Set the camera's power switch to <OFF>.

- 2 Set up the printer.

- For details, refer to the printer's instruction manual.

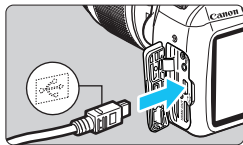

- 3 Connect the Camera to the Printer.

- Use the interface cable provided with the camera.
- Connect the cable to the camera's digital terminal with the cable plug's <↔> icon facing the front of the camera.
- To connect to the printer, refer to the printer's instruction manual.

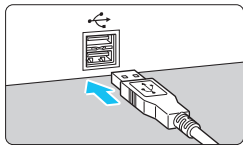

- 4 Turn on the printer.

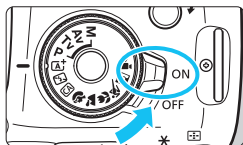

- 5 Set the camera's power switch to <ON>.

- ▶ Some printers may make a beeping sound.

PictBridge



6 Play back the image.

- Press the <▶> button.
- ▶ The image will appear, with the <PictBridge icon> on the upper left of the screen to indicate that the camera is connected to a printer.



- Before using the printer, make sure it has a PictBridge connection port.
- Movies cannot be printed.
- The camera cannot be used with printers conforming only to CP Direct or Bubble Jet Direct.
- Do not use any interface cable other than the one provided.
- If there is a long beeping sound in step 5, it indicates a problem with the printer. Resolve the problem displayed in the error message (p.248).



- You can also print RAW images taken with this camera.
- If you use a battery pack to power the camera, make sure it is fully charged. With a fully-charged battery pack, you can print for approx. 2 hr. 40 min.
- Before disconnecting the cable, first turn off the camera and printer. Hold the plug (not the cord) to pull out the cable.
- For direct printing, using the DC Coupler DR-E10 (sold separately) and Compact Power Adapter CA-PS700 (sold separately) to power the camera is recommended.

Printing

The screen display and setting options will differ depending on the printer. Some settings may not be available. For details, refer to the printer's instruction manual.

Printer-connected icon



1 Select the image to be printed.

- Check that the icon is displayed on the upper left of the LCD monitor.
- Press the <◀> <▶> keys to select the image to be printed.

2 Press <SET>.

- ▶ The print setting screen will appear.

Print setting screen

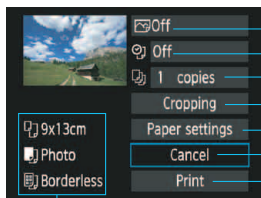

- Sets printing effects (p.244).
- Sets date or file number imprinting to on or off.
- Sets quantity to be printed.
- Sets print area (p.247).
- Sets paper size, type, and layout.
- Returns to the screen in step 1.
- Starts printing.

The paper size, type, and layout you have set are displayed.

* Depending on the printer, certain settings such as the date and file number imprinting and cropping may not be selectable.

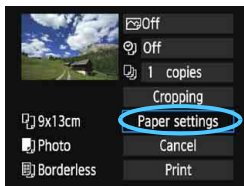

3 Select [Paper settings].

- Select [Paper settings], then press <SET>.
- ▶ The paper settings screen will appear.

Setting the Paper Size

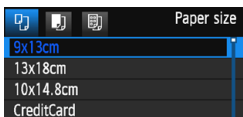

- Select the size of the paper loaded in the printer, then press <SET>.
- ▶ The paper type screen will appear.

Setting the Paper Type

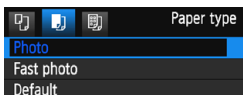

- Select the type of the paper loaded in the printer, then press <SET>.
- ▶ The page layout screen will appear.

Setting the Page Layout

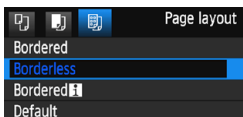

- Select the page layout, then press <SET>.
- ▶ The print setting screen will reappear.

Bordered	The print will have white borders along the edges.
Borderless	The print will have no borders. If your printer cannot print borderless prints, the print will have borders.
Bordered [i]	The shooting information* ¹ will be imprinted on the border on 9x13 cm or larger prints.
xx-up	Option to print 2, 4, 8, 9, 16, or 20 images on one sheet.
20-up [i] 35-up [i]	20 or 35 images will be printed as thumbnails on A4 or Letter size paper* ² . • [20-up [i]] will have the shooting information* ¹ imprinted.
Default	The page layout will vary depending on the printer model or its settings.

*1: From the Exif data, the camera name, lens name, shooting mode, shutter speed, aperture, exposure compensation amount, ISO speed, white balance, etc., will be imprinted.

*2: After ordering the prints with "Digital Print Order Format (DPOF)" (p.249), printing by following "Direct Printing of Print-Ordered Images" (p.252) is recommended.

 If the image's aspect ratio is different from the printing paper's aspect ratio, the image may be cropped significantly when you print it as a borderless print. If the image is cropped, it may look grainier on the paper due to the fewer number of pixels.

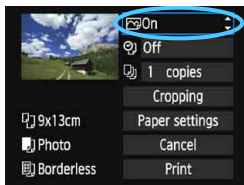

4 Set the printing effects (image optimization).

- Set them if necessary. If you do not need to set any printing effects, go to step 5.
- **Contents displayed on the screen differ depending on the printer.**
- Select the option, then press **<SET>**.
- Select the desired printing effect, then press **<SET>**.
- If the **<DISP>** icon is displayed brightly next to **<DISP>**, you can also adjust the printing effect (p.246).

Printing Effect	Description
On	The image will be printed using the printer's standard colors. The image's Exif data is used to make automatic corrections.
Off	No automatic correction will be applied.
Vivid	The image will be printed with higher saturation to produce more vivid blues and greens.
NR	Image noise is reduced before printing.
B/W B/W	Prints in black-and-white with true blacks.
B/W Cool tone	Prints in black-and-white with cool, bluish blacks.
B/W Warm tone	Prints in black-and-white with warm, yellowish blacks.
Natural	Prints the image in the actual colors and contrast. No automatic color adjustment is applied.
Natural M	The printing characteristics are the same as the "Natural" setting. However, this setting enables finer printing adjustments than with "Natural".
Default	The printing will differ depending on the printer. For details, refer to the printer's instruction manual.

* When you change the printing effects, changes are reflected in the image displayed on the upper left of the screen. Note that the printed image may look slightly different from the displayed image, which is only an approximation. This also applies to [Brightness] and [Adjust levels] on page 246.



5 Set the date and file number imprinting.

- Set them if necessary.
- Select <☺>, then press <SET>.
- Set the print settings as desired, then press <SET>.



6 Set the number of copies.

- Set it if necessary.
- Select <☺>, then press <SET>.
- Set the number of copies, then press <SET>.

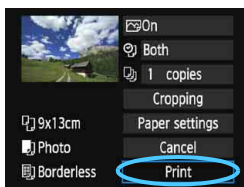

7 Start printing.

- Select [Print], then press <SET>.



- The **[Default]** setting for printing effects and other options are the printer's own default settings as set by the printer's manufacturer. Refer to the printer's instruction manual to find out what the **[Default]** settings are.
- Depending on the image's file size and image-recording quality, it may take some time for the printing to start after you select **[Print]**.
- If image tilt correction (p.247) is applied, it may take longer to print the image.
- To stop the printing, press <SET> while **[Stop]** is displayed, then select **[OK]**.
- If you execute **[Clear all camera settings]** (p.190), all the settings will revert to their defaults.

Adjustment of Printing Effects

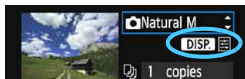

In step 4 on page 244, select the printing effect. When the <☰> icon is displayed brightly next to <DISP.>, you can press the <DISP.> button. You can then adjust the printing effect. What can be adjusted or what is displayed will depend on the selection made in step 4.

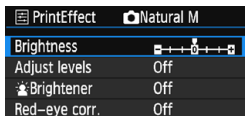

Brightness

The image brightness can be adjusted.

Adjust levels

When you select [**Manual**], you can change the histogram's distribution and adjust the image's brightness and contrast.

With the Adjust levels screen displayed, press the <DISP.> button to change the position of the <█>. Press the <◀> <▶> keys to freely adjust the shadow level (0-127) or highlight level (128-255).



Brightener

Effective in backlit conditions that can make the subject's face look dark. When [**On**] is set, the face will be brightened for printing.

Red-eye corr.

Effective in flash images where the subject has red eye. When [**On**] is set, the red eye will be corrected for printing.

- The [**Brightener**] and [**Red-eye corr.**] effects will not be reflected on the screen.
- When [**Detail set.**] is selected, you can adjust the [**Contrast**], [**Saturation**], [**Color tone**], and [**Color balance**]. To adjust the [**Color balance**], use the <⬆> cross keys. B is for blue, A for amber, M for magenta, and G for green. The image's color balance will be corrected towards the selected color.
- If you select [**Clear all**], all the printing effect settings will be reverted to their defaults.

Cropping the Image

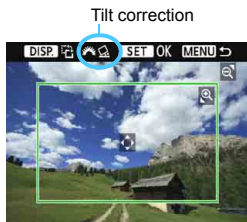

You can crop the image and print only an enlarged version of the cropped portion, as if the image had been recomposed.

Set the cropping right before printing. If you change the print settings after setting the cropping, you may have to set the cropping again before printing.

- 1 On the print setting screen, select [Cropping].
- 2 Set the cropping frame size, position, and aspect ratio.
 - The image area within the cropping frame will be printed. The cropping frame's aspect ratio can be changed with [Paper settings].

Changing the Cropping Frame Size

When you press the <Q> or <Q> button, the size of the cropping frame will change. The smaller the cropping frame, the larger the image magnification will be for printing.

Moving the Cropping Frame

Press the <⬆> cross keys to move the frame over the image vertically or horizontally. Move the cropping frame until it covers the desired image area.

Rotating the Frame

Pressing the <DISP.> button will toggle the cropping frame between the vertical and horizontal orientations. This enables you to create a vertically oriented print from a horizontal image.

Image Tilt Correction

By turning the <☀> dial, you can adjust the image tilt angle up to ± 10 degrees in 0.5-degree increments. When you adjust the image tilt, the <Q> icon on the screen will turn blue.

- 3 Press <SET> to exit the cropping.
 - ▶ The print setting screen will reappear.
 - You can check the cropped image area on the upper left of the print setting screen.

- Depending on the printer, the cropped image area may not be printed as you specified.
- The smaller you make the cropping frame, the grainier the picture will look in the print.
- While cropping the image, look at the camera's LCD monitor. If you look at the image on a TV screen, the cropping frame may not be displayed accurately.



Handling Printer Errors

If you resolve a printer error (no ink, no paper, etc.) and select **[Continue]** to resume printing but it does not resume, operate the buttons on the printer to resume printing. For details on resuming the printing, refer to the printer's instruction manual.

Error Messages

If a problem occurs during printing, an error message will appear on the camera's LCD monitor. Press <  > to stop printing. After fixing the problem, resume printing. For details on how to fix a printing problem, refer to the printer's instruction manual.

Paper Error

Check whether the paper is properly loaded in the printer.

Ink Error

Check the printer's ink level and the waste ink tank.

Hardware Error

Check for any printer problems other than paper and ink problems.

File Error

The selected image cannot be printed via PictBridge. Images taken with a different camera or images edited with a computer may not be printable.

Digital Print Order Format (DPOF)

You can set the print type, date imprinting, and file number imprinting. The print settings will be applied to all print-ordered images. (They cannot be set individually for each image.)

Setting the Printing Options

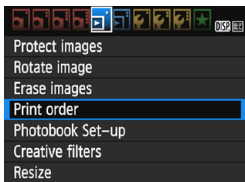

1 Select [Print order].

- Under the [**1**] tab, select [**Print order**], then press <SET>.

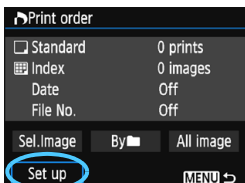

2 Select [Set up].

- Select [**Set up**], then press <SET>.

3 Set the option as desired.

- Set the [**Print type**], [**Date**], and [**File No.**].
- Select the option to be set, then press <SET>. Select the desired setting, then press <SET>.

[Print type]

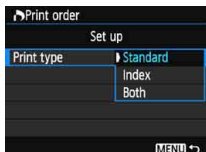



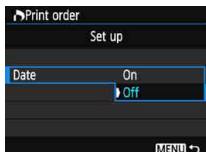

[Date]

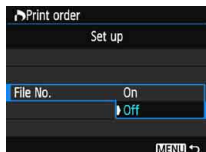

[File No.]



Print type		Standard	Prints one image on one sheet.
		Index	Multiple thumbnail images are printed on one sheet.
	 	Both	Prints both the standard and index prints.
Date	On	[On] imprints the recorded date on the print.	
	Off		
File number	On	[On] imprints the file number on the print.	
	Off		

4 Exit the setting.

- Press the <MENU> button.
- ▶ The print order screen will reappear.
- Next, select **[Sel. Image]**, **[By ■■■]**, or **[All image]** to order the images to be printed.

- Even if **[Date]** and **[File No.]** are set to **[On]**, the date or file number may not be imprinted depending on the print type setting and printer model.
- With **[Index]** prints, the **[Date]** and **[File No.]** cannot both be set to **[On]** at the same time.
- When printing with DPOF, use the card whose print order specifications have been set. It will not work if you just extract images from the card and try to print them.
- Certain DPOF-compatible printers and photofinishers may not be able to print the images as you specified. Refer to the printer's instruction manual before printing, or check with your photofinisher about compatibility when ordering prints.
- Do not insert into the camera a card whose print order was set by a different camera and then try to specify a print order. The print order may be overwritten. Also, depending on the image type, the print order may not be possible.

 RAW images and movies cannot be print ordered. You can print RAW images with PictBridge (p.240).

Print Ordering

Sel.Image

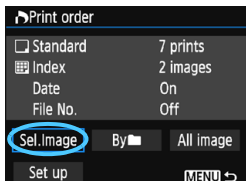

Select and order images one by one. To display the three-image display, press the <[Grid Icon] [Magnifying Glass Icon]> button. To return to the single-image display, press the <[Magnifying Glass Icon]> button.

Press the <MENU> button to save the print order to the card.



[Standard] [Both]

Press the <▲> <▼> keys to set the number of copies to be printed for the displayed image.

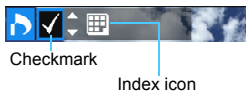

[Index]

Press the <▲> <▼> keys to add a checkmark to the box <[Checkmark Icon]>. The image will be included in the index print.

By [Folder Icon]

Select [**Mark all in folder**] and select the folder. A print order for one copy of all the images in the folder will be placed. If you select [**Clear all in folder**] and select the folder, the print order for all the images in the folder will be canceled.

All image

If you select [**Mark all on card**], one copy of all the images on the card will be set for printing. If you select [**Clear all on card**], the print order will be cleared for all the images on the card.



- Note that RAW images and movies will not be included in the print order even if you set [**By [Folder Icon]**] or [**All image**].
- When using a PictBridge printer, print no more than 400 images for one print order. If you specify more than this, all the images may not be printed.

Direct Printing of Print-Ordered Images

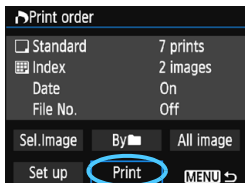

With a PictBridge printer, you can easily print images with DPOF.

1 Prepare to print.

- See page 240.

Follow the “Connecting the Camera to a Printer” procedure up to step 5.

2 Under the [▶ 1] tab, select [Print order].

3 Select [Print].

- [Print] will be displayed only if the camera is connected to a printer and printing is possible.

4 Set the [Paper settings] (p.242).

- Set the printing effects (p.244) if necessary.

5 Select [OK].

- Before printing, be sure to set the paper size.
- Certain printers cannot imprint the file number.
- If [Bordered] is set, certain printers may imprint the date on the border.
- Depending on the printer, the date may appear faint if it is imprinted on a bright background or on the border.

- Under [Adjust levels], [Manual] cannot be selected.
- If you stopped the printing and want to resume printing the remaining images, select [Resume]. Note that printing will not resume if any of the following are the case:
 - You changed the print order of or deleted any print ordered images before resuming the printing.
 - When index is set, you changed the paper setting before resuming the printing.
 - The card's remaining capacity was low when you paused the printing.
- If a problem occurs during printing, see page 248.

☑ Specifying Images for a Photobook

You can specify images (up to 998) to be used in a photobook. When you use EOS Utility (EOS software) to transfer images to a computer, the specified images will be copied into a dedicated folder. This function is useful for ordering photobooks online and for printing photobooks on a printer.

Specifying One Image at a Time

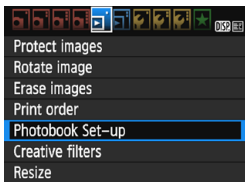

1 Select [Photobook Set-up].

- Under the [] tab, select [**Photobook Set-up**], then press <SET>.

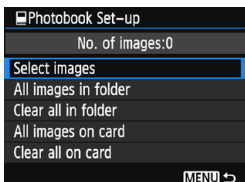

2 Select [Select images].

- Select [**Select images**], then press <SET>.
- ▶ An image will be displayed.
- To display the three-image display, press the < <Q> button. To return to the single-image display, press the <Q> button.



3 Select the image to be specified.

- Press the << >> keys to select the image to be specified, then press the <▲> <▼> keys.
- Repeat this step to select another image. The number of images that have been specified will be displayed on the upper left of the screen.
- To cancel the image specification, press the <▲> <▼> keys again.
- To return to the menu, press the <MENU> button.

Specifying All Images in a Folder or on a Card

You can specify all the images in a folder or on a card at one time.

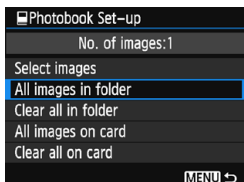

When [▶ 1: **Photobook Set-up**] is set to [**All images in folder**] or [**All images on card**], all the images in the folder or on the card will be specified.

To cancel the image specification, select [**Clear all in folder**] or [**Clear all on card**].

ⓘ Do not specify images already specified for a photobook in another camera for another photobook with this camera. The photobook settings may be overwritten.

📄 RAW images and movies cannot be specified.

11

Customizing the Camera

You can customize various camera functions to suit your picture-taking preferences with Custom Functions. Custom Functions can be set and used only in Creative Zone modes.

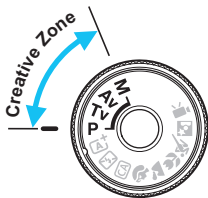

MENU Setting Custom Functions ☆

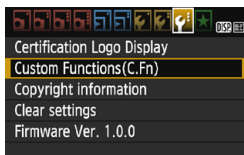

1 Select [Custom Functions (C.Fn)].

- Under the [**F3**] tab, select [**Custom Functions (C.Fn)**], then press <SET>.

Custom Function number

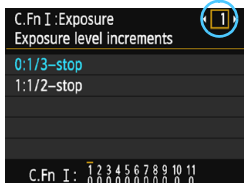

2 Select the Custom Function number.

- Press the <◀> <▶> keys to select the Custom Function number, then press <SET>.

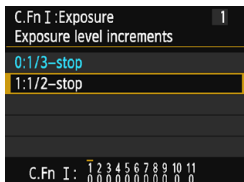

3 Change the setting as desired.

- Press the <▲> <▼> keys to select the desired setting (number), then press <SET>.
- Repeat steps 2 and 3 if you want to set other Custom Functions.
- At the bottom of the screen, current Custom Function settings are indicated below the respective function numbers.

4 Exit the setting.

- Press the <MENU> button.
- ▶ The screen for step 1 will reappear.

Clearing All Custom Functions

Under [**F3: Clear settings**], select [**Clear all Custom Func. (C.Fn)**] to clear all the Custom Function settings (p.190).

Custom Functions

C.Fn I: Exposure

			 Live View shooting
1	Exposure level increments	p.258	<input type="radio"/>
2	ISO expansion		<input type="radio"/>
3	Flash sync. speed in Av mode	p.259	<input type="radio"/>

C.Fn II: Image

4	Long exposure noise reduction	p.260	<input type="radio"/>
5	High ISO speed noise reduction	p.261	<input type="radio"/>
6	Highlight tone priority		<input type="radio"/>

C.Fn III: Autofocus/Drive

7	AF-assist beam firing	p.262	<input type="radio"/> (With AFQuick*)
---	-----------------------	-------	---------------------------------------

* If you use an EX-series Speedlite (sold separately) equipped with an LED light, the LED light will turn on for AF-assist even in the AF □ or AF ƒ mode.

C.Fn IV: Operation/Others

8	Shutter/AE lock button	p.263	<input type="radio"/>
9	Assign SET button	p.264	<input type="radio"/> (Except 3)
10	Flash button function		<input type="radio"/>
11	LCD display when power ON		



- Custom Functions cannot be set during movie shooting. (Settings already set will be disabled.)
- The shaded Custom Function does not function during Live View (LV) shooting. (Settings already set will be disabled.)

MENU Custom Function Settings ☆

Custom Functions are organized into four groups based on the function type: C.Fn I: Exposure, C.Fn II: Image, C.Fn III: Autofocus/Drive, C.Fn IV: Operation/Others.

C.Fn I: Exposure

C.Fn-1 Exposure level increments

0: 1/3-stop

1: 1/2-stop

Sets 1/2-stop increments for the shutter speed, aperture, exposure compensation, AEB, flash exposure compensation, etc. This is effective when you prefer to control the exposure in less fine increments than 1/3-stop.

 With setting 1, the exposure level will be displayed in the viewfinder and on the LCD monitor as shown below.



C.Fn-2 ISO expansion

0: Off

1: On

When you set the ISO speed, you will be able to set "H" (equivalent to ISO 12800). Note that if [C.Fn-6: Highlight tone priority] is set to [1: Enable], "H" cannot be set.

C.Fn-3 Flash sync. speed in Av mode

You can set the flash sync speed for flash photography in the aperture-priority AE (**Av**) mode.

0: Auto

The flash sync speed is set automatically within a range of 1/200 sec. to 30 sec. to suit the scene's brightness. With an external Speedlite, high-speed sync will also be possible.

1: 1/200-1/60 sec. auto

Prevents a slow shutter speed from being set in low-light conditions. It is effective for preventing subject blur and camera shake. However, while the subject will be properly exposed with the flash, the background may come out dark.

2: 1/200 sec. (fixed)

The flash sync speed is fixed to 1/200 sec. This more effectively prevents subject blur and camera shake than with [**1/200-1/60 sec. auto**]. However, in low light, the subject's background will come out darker than with [**1/200-1/60 sec. auto**].



When 1 or 2 is set, high-speed sync cannot be used with an external Speedlite.

C.Fn II: Image

C.Fn-4 Long exposure noise reduction

0: Off

1: Auto

For 1 sec. or longer exposures, noise reduction is performed automatically if noise typical of long exposures is detected. This [Auto] setting is effective in most cases.

2: On

Noise reduction is performed for all exposures of 1 sec. or longer. The [2: On] setting may be effective for noise that cannot be detected or reduced with the [1: Auto] setting.

- With settings 1 and 2, after the picture is taken, the noise reduction process may take the same amount of time as the exposure. You cannot take another picture until the noise reduction process is completed.
- At ISO 1600 and higher, noise may be more pronounced with setting 2 than with setting 0 or 1.
- With setting 1 or 2, if a long exposure is shot with the Live View image displayed, "BUSY" will be displayed during the noise reduction process. The Live View display will not appear until the noise reduction is completed. (You cannot take another picture.)

C.Fn-5 High ISO speed noise reduction

Reduces the noise generated in the image. Although the noise reduction is applied at all ISO speeds, it is particularly effective at high ISO speeds. At low ISO speeds, the noise in the darker parts of the image (shadow areas) is further reduced. Change the setting to suit the noise level.

0: Standard

2: Strong

1: Low

3: Disable



- With setting 2, the maximum burst during continuous shooting will greatly decrease. Also, the continuous shooting speed may be slower.
- If you play back a **RAW** or **RAW+L** image with the camera or print an image directly, the effect of the high ISO speed noise reduction may look minimal. You can check the noise reduction effect or print noise-reduced images with Digital Photo Professional (EOS software, p.316).

C.Fn-6 Highlight tone priority

0: Disable

1: Enable

Improves the highlight detail. The dynamic range is expanded from the standard 18% gray to bright highlights. The gradation between the grays and highlights becomes smoother.



- With setting 1, the Auto Lighting Optimizer (p.119) is automatically set to **[Disable]** and the setting cannot be changed.
- With setting 1, noise (grainy image, banding, etc.) may become slightly more pronounced than with setting 0.



With setting 1, the ISO speed settable range will be ISO 200 - ISO 6400. Also, the **<D+>** icon will be displayed on the LCD monitor and in the viewfinder when highlight tone priority is enabled.

C.Fn III: Autofocus/Drive

C.Fn-7 AF-assist beam firing

Enables or disables the AF-assist beam of the built-in flash or the EOS-dedicated external Speedlites.

0: Enable

The AF-assist beam will be emitted when necessary.

1: Disable

The AF-assist beam is not emitted. This prevents the AF-assist beam from disturbing others.

2: Enable external flash only

If an external Speedlite is attached, it will emit the AF-assist beam when necessary. The camera's built-in flash will not fire the AF-assist beam.

3: IR AF assist beam only

When an external Speedlite is attached, only an infrared AF-assist beam will be emitted. This prevents any Speedlite which uses a series of intermittent flashes (like the built-in flash) from firing the AF-assist beam.

With an EX-series Speedlite equipped with an LED light, the LED light will not automatically turn on for AF-assist.

 If an external Speedlite's **[AF-assist beam firing]** Custom Function is set to **[Disabled]**, the Speedlite will not emit the AF-assist beam even if the camera's C.Fn-7 is set to 0, 2, or 3.

C.Fn IV: Operation/Others

C.Fn-8 Shutter/AE lock button

0: AF/AE lock

1: AE lock/AF

This is convenient when you want to focus and meter separately. Press the <★> button to autofocus, and press the shutter button halfway to apply AE lock.

2: AF/AF lock, no AE lock

In the AI Servo AF operation, you can press the <★> button to pause the AF operation momentarily. This prevents the AF from being thrown off by any obstacle passing between the camera and subject. The exposure is set at the moment the picture is taken.

3: AE/AF, no AE lock

This is useful for subjects that keep moving and stopping repeatedly. During AI Servo AF, you can press the <★> button to start or stop the AI Servo AF operation. The exposure is set at the moment the picture is taken. Thus, the optimum focusing and exposure will always be achieved as you wait for the decisive moment.



During Live View shooting

- With setting 1 or 3, press the <★> button for One-Shot AF.
- With setting 2, press the shutter button halfway for One-Shot AF.

C.Fn-9 Assign SET button

You can assign a frequently-used function to <SET>. When the camera is ready to shoot, pressing the <SET> button will display the respective function setting screen.

0: Normal (disabled)

1: Image quality

The Image quality setting screen will appear. Select the desired image-recording quality, then press <SET>.

2: Flash exposure compensation

The Flash exposure compensation setting screen will appear. Set the flash exposure compensation, then press <SET>.

3: LCD monitor On/Off

Assigns the same function as the <DISP.> button.

4: Depth-of-field preview

The lens will stop down to the aperture that was set, and you can see the depth of field (range of acceptable focus) in the viewfinder or in the Live View image.

C.Fn-10 Flash button function

0: Raise built-in flash

1: ISO speed

The ISO speed setting screen will appear. Press the <◀> <▶> keys or turn the <ISO> dial to change the ISO speed. You can also refer to the viewfinder to set the ISO speed.

C.Fn-11 LCD display when power ON

0: Display on

When the power switch is turned on, the shooting settings will be displayed (p.52).

1: Previous display status

If you pressed the <DISP.> button and turned off the camera while the LCD monitor was off, the shooting settings will not be displayed when you turn on the camera again. This helps to save battery power. The menu screens and image playback will still be displayed when used.

If you pressed the <DISP.> button to display the shooting settings and then turn off the camera, the shooting settings will be displayed when you turn on the camera again.

MENU Registering My Menu ☆

Under the My Menu tab, you can register up to six menu options and Custom Functions whose settings you change frequently.

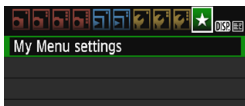

1 Select [My Menu settings].

- Under the [★] tab, select [My Menu settings], then press <SET>.

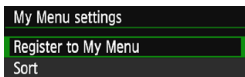

2 Select [Register to My Menu].

- Select [Register to My Menu], then press <SET>.

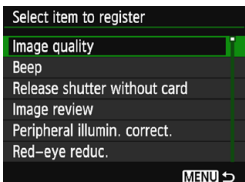

3 Register the desired items.

- Select the item, then press <SET>.
- On the confirmation dialog, select [OK] and press <SET> to register the item.
- You can register up to six items.
- To return to the screen in step 2, press the <MENU> button.

My Menu Settings

• Sort

You can change the order of the registered items in My Menu. Select [Sort] and select the item whose order you want to change. Then press <SET>. With [◆] displayed, press the <▲> <▼> keys to change the order, then press <SET>.

• Delete item/items and Delete all items

You can delete any of the registered items. [Delete item/items] deletes one item at a time, and [Delete all items] deletes all registered items.

• Display from My Menu

When [Enable] is set, the [★] tab will be displayed first when you display the menu screen.



12

Reference

This chapter provides reference information for camera features, system accessories, etc.



Certification Logo

Under the [**3**] tab, if you select [**Certification Logo Display**] and press <[**SET**]>, some of the logos of the camera's certifications will appear. Other certification logos can be found in this Instruction Manual, on the camera body, and on the camera's package.

Using a Household Power Outlet

You can power the camera with a household power outlet by using the DC Coupler DR-E10 and Compact Power Adapter CA-PS700 (both sold separately).

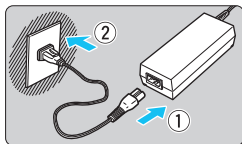

1 Connect the power cord.

- Connect the power cord as shown in the illustration.
- After using the camera, unplug the power plug from the power outlet.

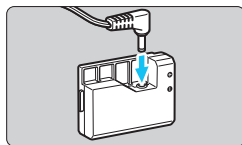

2 Connect the DC Coupler.

- Connect the DC cord's plug to the DC Coupler.

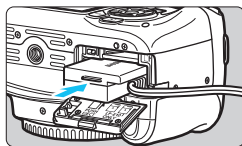

3 Insert the DC Coupler.

- Open the cover and insert the DC Coupler until it locks in place.

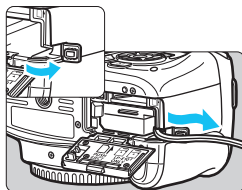

4 Push in the DC cord.

- Open the DC cord hole cover and install the cord as shown.
- Close the cover.

 Do not connect or disconnect the power cord while the camera's power switch is set to <ON>.

Using the Remote Switch

Remote Switch RS-60E3 (sold separately) comes with an approx. 60 cm/ 2.0 ft cord. When connected to the camera's remote control terminal, it can be pressed halfway and completely, just like the shutter button.

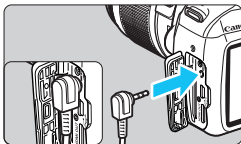

Remote Controller RC-6, RC-1, and RC-5 (all sold separately) cannot be used with this camera.

Using the Eyepiece Cover

When you use the self-timer, bulb, or Remote Switch and do not look through the viewfinder, stray light entering the viewfinder can cause the image to look dark. To prevent this, use the eyepiece cover (p.29) attached to the camera strap.

During Live View shooting and movie shooting, attaching the eyepiece cover is unnecessary.

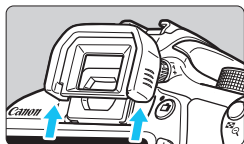

1 Detach the eyecup.

- Push the bottom of the eyecup to detach.

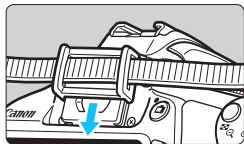

2 Attach the eyepiece cover.

- Slide the eyepiece cover down into the eyepiece groove to attach it.
- After taking the picture, detach the eyepiece cover and attach the eyecup by sliding it down into the eyepiece groove.

External Speedlites

EOS-dedicated, EX-series Speedlites

Basically operates like a built-in flash for easy operation.



When an EX-series Speedlite (sold separately) is attached to the camera, almost all the autoflash control is done by the camera. In other words, it is like a high-output flash attached externally in place of the built-in flash.

For detailed instructions, refer to the EX-series Speedlite's instruction manual. This camera is a Type-A camera that can use all the features of EX-series Speedlites.



Shoe-mount Speedlites

Macro Lites

- With an EX-series Speedlite not compatible with flash function settings (p.195), only **[Flash exp. comp]** and **[E-TTL II meter.]** can be set for **[External flash func. setting]**. (**[Shutter sync.]** can also be set with certain EX-series Speedlites.)
- If flash exposure compensation is set with the external Speedlite, the flash exposure compensation icon displayed on the camera's LCD monitor will change from  to .
- If the external Speedlite's Custom Function has the flash metering mode set to TTL autoflash, the flash will fire at full output only.

Canon Speedlites Other Than the EX-series

- **With an EZ/E/EG/ML/TL-series Speedlite set in TTL or A-TTL autoflash mode, the flash can be fired at full output only.** Set the camera's shooting mode to <M> (manual exposure) or <Av> (aperture-priority AE) and adjust the aperture setting before shooting.
- When using a Speedlite that has manual flash mode, shoot in the manual flash mode.

Using Non-Canon Flash Units

Sync Speed

The camera can synchronize with compact, non-Canon flash units at 1/200 sec. or slower shutter speeds. Use a sync speed slower than 1/200 sec.

Be sure to test the flash unit beforehand to make sure it synchronizes properly with the camera.



- If the camera is used with a flash unit or flash accessory dedicated to another camera brand, the camera may not operate properly and malfunction may result.
- Do not attach a high-voltage flash unit on the camera's hot shoe. It may not fire.

Using Eye-Fi Cards

With a commercially-available Eye-Fi card already set up, you can automatically transfer captured images to a computer or upload them to an online service via a wireless LAN.

The image transfer is a function of the Eye-Fi card. For instructions on how to set up and use the Eye-Fi card or to troubleshoot any image transfer problems, refer to the Eye-Fi card's instruction manual or contact the card manufacturer.

 **The camera is not guaranteed to support Eye-Fi card functions (including wireless transfer). In case of an issue with an Eye-Fi card, please check with the card manufacturer. Also note that approval is required to use Eye-Fi cards in many countries or regions. Without approval, use of the card is not permitted. If it is unclear whether the card has been approved for use in your area, please check with the card manufacturer.**

1 Insert an Eye-Fi card (p.32).

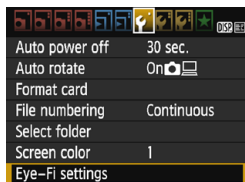

2 Select [Eye-Fi settings].

- Under the [ 1] tab, select [**Eye-Fi settings**], then press <SET>.
- This menu is displayed only when an Eye-Fi card is inserted into the camera.



3 Enable Eye-Fi transmission.

- Select [**Eye-Fi trans.**], then press <SET>.
- Select [**Enable**], then press <SET>.
- If you set [**Disable**], automatic transmission will not occur even with the Eye-Fi card inserted (transmission status icon ).

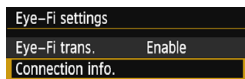

4 Display the connection information.

- Select [**Connection info.**], then press <SET>.

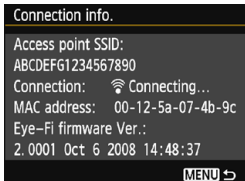

5 Check the [Access point SSID:].

- Check that an access point is displayed for [Access point SSID:].
- You can also check the Eye-Fi card's MAC address and firmware version.
- Press the <MENU> button three times to exit the menu.



Transmission status icon

6 Take the picture.

- ▶ The picture is transferred and the <Wi-Fi> icon switches from gray (not connected) to one of the icons below.
- For transferred images, [Image icon] is displayed in the shooting information display (p.229).

- ◻ (Gray) **Not connected** : No connection with access point.
- ◻ (Blinking) **Connecting...**: Connecting to access point.
- ◻ (Displayed) **Connected** : Connection to access point established.
- ◻ (1) **Transferring...** : Image transfer to access point in progress.

⚠ Cautions for Using Eye-Fi Cards

- If “⚠” is displayed, an error occurred while retrieving the card information. Turn the camera's power switch off, and on again.
- Even if [🔌1: Eye-Fi trans.] is set to [Disable], it may still transmit a signal. In hospitals, airports, and other places where wireless transmissions are prohibited, remove the Eye-Fi card from the camera.
- If the image transfer does not function, check the Eye-Fi card and computer settings. For details, refer to the card's instruction manual.
- Depending on the wireless LAN's connection conditions, the image transfer may take longer or it may be interrupted.
- Because of the transmission function, the Eye-Fi card may become hot.
- The battery power will be consumed faster.
- During the image transfer, auto power off will not take effect.
- If you insert a wireless LAN card other than an Eye-Fi card, [🔌1: Eye-Fi settings] will not appear on the menu. Also, the transmission status icon <Wi-Fi> will not appear on the LCD monitor.

Function Availability Table According to Shooting Mode

●: Set automatically ○: User selectable □: Not selectable/Disabled

Mode Dial		Basic Zone							Creative Zone				📷	
		A+	📷	CA	📷	📷	📷	📷	P	Tv	Av	M	📷	📷 ^{*1}
All image quality settings selectable		○	○	○	○	○	○	○	○	○	○	○	○	○
ISO speed	Automatically set/ISO Auto	●	●	●	●	●	●	●	○	○	○	○	○	
	Manual								○	○	○	○	○ ^{*2}	
	Maximum for Auto								○	○	○	○		
Picture Style	Automatically set/Auto	●	●	●	●	●	●	●	○	○	○	○	○	
	Manual selection								○	○	○	○	○	
Ambience-based shots				○	○	○	○	○						
Lighting/scene-based shots					○	○	○	○						
Blurring/sharpening the background				○										
White balance	Auto	●	●	●	●	●	●	●	○	○	○	○	○	
	Preset								○	○	○	○	○	
	Custom								○	○	○	○	○	
	Correction/Bracketing								○	○	○	○		
Auto Lighting Optimizer		●	●	●	●	●	●	●	○	○	○	○	○	
Peripheral illumination correction		○	○	○	○	○	○	○	○	○	○	○	○	
Long exposure noise reduction									○	○	○	○		
High ISO speed noise reduction		●	●	●	●	●	●	●	○	○	○	○		
Highlight tone priority									○	○	○	○	○	
Color space	sRGB	●	●	●	●	●	●	●	○	○	○	○		
	Adobe RGB								○	○	○	○		
Focusing	One-Shot AF				●	●	●	●	○	○	○	○	AF □ AF ⚡ AFQuick ^{*3}	
	AI Servo AF							●	○	○	○			
	AI Focus AF	●	●	●					○	○	○	○		
	AF point selection	●	●	●	●	●	●	●	○	○	○	○	AFQuick	
	AF-assist beam	●		●	● ^{*4}	●	● ^{*4}	●	○	○	○	○		
	Manual (MF)	○	○	○	○	○	○	○	○	○	○	○	○	

*1: The 📷 icon indicates still photo shooting during movie shooting.

*2: Settable only for manual exposures.

*3: If used during movie shooting, it will switch to <AF □>.

*4: If the AF method is <AFQuick> during Live View shooting, the external Speedlite will emit the AF-assist beam when necessary.

Mode Dial		Basic Zone							Creative Zone				📢	
		Ⓐ+	📷	CA	📷	📷	📷	📷	P	Tv	Av	M	📢	📷 ^{*1}
Metering mode	Evaluative metering	●	●	●	●	●	●	●	○	○	○	○		
	Metering mode selection								○	○	○	○		
Exposure	Program shift								○					
	Exposure compensation								○	○	○		○ ^{*6}	
	AEB								○	○	○	○		
	AE lock								○	○	○		○ ^{*6}	
	Depth-of-field preview								○ (C.Fn-9-4)					
Drive/ self-timer	Single shooting	○	○	○		○	○		○	○	○	○		●
	Continuous shooting			○	○			○	○	○	○			
	🕒 (10 sec.)	○	○	○	○	○	○	○	○	○	○			
	🕒 ₂ (2 sec.)								○	○	○	○		
	🕒 _c (Continuous)	○	○	○	○	○	○	○	○	○	○	○		
Built-in flash	Automatic firing	●		○	●		●							
	Flash on (Fires at all times)			○					○	○	○	○		
	Flash off		●	○		●		●		○	○	○	○	●
	Red-eye reduction	○		○	○		○		○	○	○	○		
	FE lock								○	○	○	○		
	Flash exposure compensation								○	○	○	○		
External flash	Function settings								○	○	○	○		
	Custom Function settings								○	○	○	○		
Live View shooting		○	○	○	○	○	○	○	○	○	○	○		
Aspect ratio ^{*5}									○	○	○	○		
Quick Control		○	○	○	○	○	○	○	○	○	○	○	○	
Feature guide		○	○	○	○	○	○	○	○	○	○	○	○	

*5: Settable only for Live View shooting.

*6: Settable only for autoexposures.

System Map

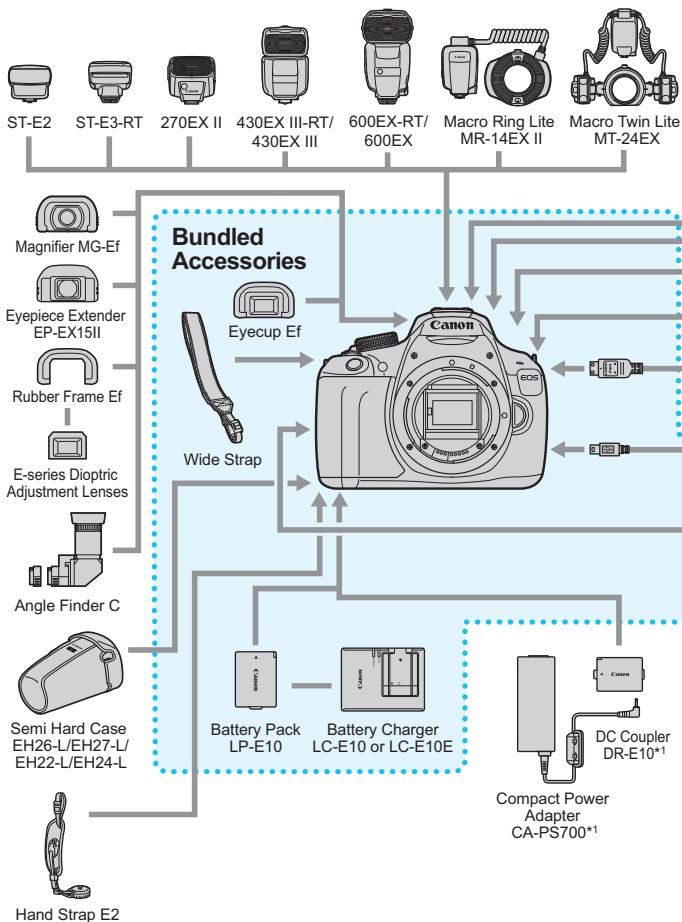

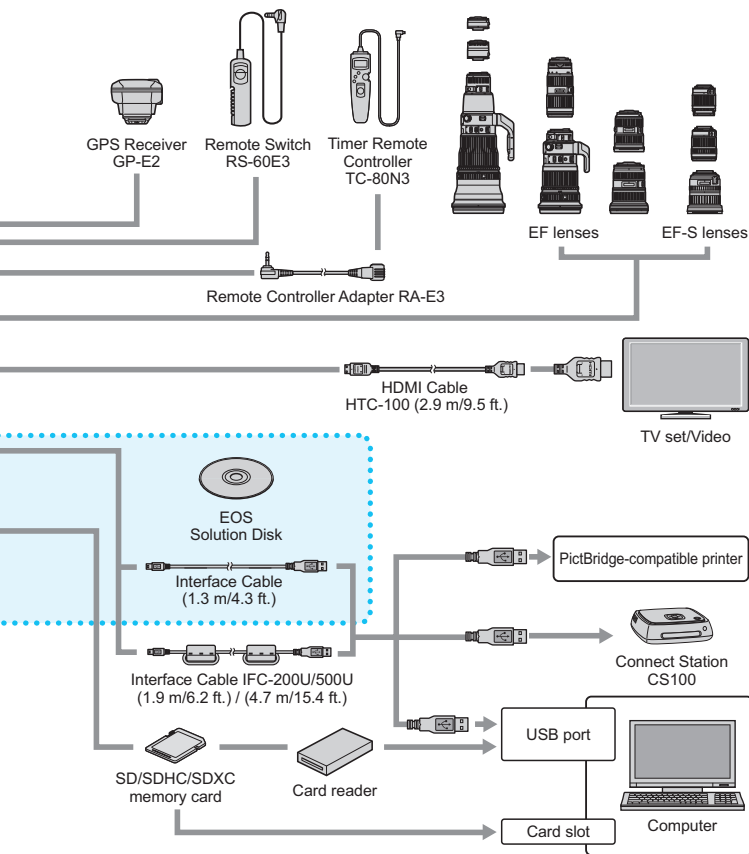

*1: AC Adapter Kit ACK-E10 can also be used.

* When using the GP-E2 with this camera, connect it to the camera with the cable provided with the GP-E2.

* All cable lengths given are approximate figures.

MENU Menu Settings

Viewfinder Shooting and Live View Shooting

📷 Shooting 1 (Red)

Page

Image quality	L / L / M / S1 / S1/S2/S3 / RAW + L / RAW	84
Beep	Enable / Disable	180
Release shutter without card	Enable / Disable	180
Image review time	Off / 2 sec. / 4 sec. / 8 sec. / Hold	180
Peripheral illumination correction	Enable / Disable	120
Red-eye reduction	Disable / Enable	102
Flash control	Flash firing / Built-in flash function setting / External flash function setting / External flash C.Fn setting / Clear external flash C.Fn setting	194

📷 Shooting 2 (Red)

Exposure compensation/AEB	1/3-stop or 1/2-stop increments, ±5 stops (AEB: ±2 stops)	114
Auto Lighting Optimizer	Disable / Low / Standard / High	119
Metering mode	Evaluative metering / Partial metering / Center-weighted average metering	111
Custom White Balance	Manual setting of white balance	127
White balance shift/ bracketing	WB correction: White balance correction BKT setting: White balance bracketing	129 130
Color space	sRGB / Adobe RGB	131
Picture Style	Auto / Standard / Portrait / Landscape / Neutral / Faithful / Monochrome / User Def. 1-3	91 122 125



Shaded menu options are not displayed in Basic Zone modes.

Shooting 3 (Red)

Page

Dust Delete Data	Obtains data to be used to erase dust spots	198
ISO Auto	Max.:400 / Max.:800 / Max.:1600 / Max.:3200 / Max.:6400	90

Shooting 4* (Red)

Live View shooting	Enable / Disable	135
AF method	FlexiZone - Single /  Live mode / Quick mode	142
Grid display	Off / Grid 1  / Grid 2 	139
Aspect ratio	3:2 / 4:3 / 16:9 / 1:1	140
Metering timer	4 sec. / 8 sec. / 16 sec. / 30 sec. / 1 min. / 10 min. / 30 min.	141

* In Basic Zone modes, it will appear as the [ 2] Shooting 2 tab.

Playback 1 (Blue)



Protect images	Select images / All images in folder / Unprotect all images in folder / All images on card / Unprotect all images on card	225
Rotate image	Rotate images	207
Erase images	Select and erase images / All images in folder / All images on card	227
Print order	Specify images to be printed (DPOF)	249
Photobook set-up	Select images / All images in folder / Clear all in folder / All images on card / Clear all on card	253
Creative filters	Grainy B/W / Soft focus / Fish-eye effect / Toy camera effect / Miniature effect	234
Resizing	Downsize the image's pixel count	237

▶ Playback 2 (Blue)

Page

Histogram display	Brightness / RGB	231
Image jump with 	1 image / 10 images / 100 images / Date / Folder / Movies / Stills / Rating	205
Slide show	Playback description / Display time / Repeat / Transition effect / Background music	218
Rating	[OFF] / [.] / [·] / [··] / [···] / [····]	208
Control over HDMI	Disable / Enable	223

⚙ Set-up 1 (Yellow)

Auto power off	30 sec. / 1 min. / 2 min. / 4 min. / 8 min. / 15 min. / Disable	181
Auto rotate	On  / On  / Off	188
Format card	Initialize and erase data on the card	50
File numbering	Continuous / Auto reset / Manual reset	184
Select folder	Create and select a folder	182
Screen color	Select the shooting settings screen color	193
Eye-Fi settings	Appears when an Eye-Fi card (commercially available) has been inserted.	272

⚙ Set-up 2 (Yellow)

LCD brightness	Seven brightness levels provided	181
LCD off/on button	Shutter button / Shutter/DISP / Remains on	193
Date/Time/Zone	Date (year, month, day) / Time (hour, min., sec.) / Daylight saving time / Time zone	37
Language 	Select the interface language	39
Clean manually	Clean image sensor manually	200
Feature guide	Enable / Disable	53
GPS device settings	Settings available when the GPS Receiver GP-E2 (sold separately) is attached	281

🔧 Set-up 3 (Yellow)

Page

Certification Logo Display	Displays some of the logos of the camera's certifications	267
Custom Functions (C.Fn)	Customize camera functions as desired	256
Copyright information	Display copyright information / Enter author's name / Enter copyright details / Delete copyright information	186
Clear settings	Clear all camera settings / Clear all Custom Func. (C.Fn)	190
Firmware version	For updating the firmware	-

★ My Menu (Green)

My Menu settings	Register frequently-used menu options and Custom Functions	265
-------------------------	--	-----





🔊 Cautions for Using GPS Receiver GP-E2 (sold separately)

- Check if your country or area allows the use of GPS and follow any legal regulations.
- When using the GP-E2 with the camera, connect it to the camera with the cable that came with the GP-E2. If you do not use the provided cable, the geotag information will not be appended to the image when you shoot.
- Certain functions of the GP-E2 will not work with this camera. Note the following:
 - The shooting direction is not recorded. (The electronic compass cannot be used.)
 - The geotag information can be appended to a movie when the shooting starts. However, the location will not be displayed on Map Utility (EOS software). Check the location with the camera.









Movie Shooting

Movie 1 (Red)

Page









Movie exposure	Auto / Manual	172
AF method	FlexiZone - Single /  Live mode / Quick mode	172
AF with shutter button during movie shooting 	Disable / Enable	172
 Shutter button / AE lock button	AF/AE lock / AE lock/AF / AF/AF lock, no AE lock / AE/AF, no AE lock	173
 Highlight tone priority	Disable / Enable	173

Movie 2 (Red)

Movie recording size	1920x1080 ( /30/  /24) / 1280x720 ( /60/ ) / 640x480 ( /30/ )	164
Sound recording	Sound recording: Auto / Manual / Disable	174
	Recording level	
	Wind filter: Disable / Enable	
Metering timer	4 sec. / 8 sec. / 16 sec. / 30 sec. / 1 min. / 10 min. / 30 min.	175
Grid display	Off / Grid 1  / Grid 2 	175
Video snapshots	Disable / 2 sec. movie / 4 sec. movie / 8 sec. movie	166
Video system	For NTSC / For PAL	175

 **Movie 3 (Red)**

Page

Exposure compensation	1/3-stop increments, ± 5 stops	176
Auto Lighting Optimizer	Disable / Low / Standard / High	176
Custom White Balance	Manual setting of white balance	176
Picture Style	 Auto /  Standard /  Portrait /  Landscape /  Neutral /  Faithful /  Monochrome /  User Def. 1-3	176

**Menus for Movie Shooting Mode**

- The [Movie 1], [Movie 2], and [Movie 3] tabs appear only in the movie shooting mode.
- The [Camera 2], [Camera 3], [Camera 4], [Function 3], and [Star] tabs do not appear.
- The following menu items do not appear:
 - [Camera 1]: Red-eye reduction, Flash control
 - [Function 1]: Screen color
 - [Function 2]: LCD off/on button, Clean manually

Troubleshooting Guide

If a problem occurs with the camera, first refer to this Troubleshooting Guide. If this Troubleshooting Guide does not resolve the problem, contact your dealer or nearest Canon Service Center.

Power-Related Problems

The battery pack does not recharge.

- Do not use any battery pack other than a genuine Canon Battery Pack LP-E10.

The battery charger's lamp blinks.

- If the battery charger has a problem, the protection circuit will stop the charging and the charge lamp will blink in orange. If this happens, unplug the charger's power plug from the power outlet and detach the battery pack. Attach the battery pack to the charger again and wait a while before connecting the charger to a power outlet again.

The camera does not operate even when the power switch is set to <ON>.

- Make sure the battery is properly installed in the camera (p.32).
- Make sure the card slot/battery compartment cover is closed (p.32).
- Recharge the battery (p.30).
- Press the <DISP.> button (p.52).

The access lamp still remains on or blinks even when the power switch is set to <OFF>.

- If the power is turned off while an image is being recorded to the card, the access lamp will remain on or continue to blink for a few seconds. When the image recording is completed, the power will turn off automatically.

The battery becomes exhausted quickly.

- Use a fully-charged battery pack (p.30).
- The rechargeable battery pack performance will degrade over repeated use. Purchase a new one.
- The number of possible shots will decrease with any of the following operations:
 - Pressing the shutter button halfway for a prolonged period.
 - Activating the AF frequently without taking a picture.
 - Using the lens's Image Stabilizer.
 - Using the LCD monitor frequently.
 - Continuing Live View shooting or movie shooting for a prolonged period.
 - Leaving the Eye-Fi card communication function on.

The camera turns off by itself.

- Auto power off is in effect. If you do not want auto power off to take effect, set [**1**: **Auto power off**] to [**Disable**] (p.181).
- Even if [**1**: **Auto power off**] is set to [**Disable**], the LCD monitor will still turn off after the camera is left idle for 30 min. (The camera's power does not turn off.) Press the <DISP.> button to turn on the LCD monitor.

Shooting-Related Problems

The lens cannot be attached.

- The camera cannot be used with EF-M lenses (p.40).

No images can be shot or recorded.

- Make sure the card is properly inserted (p.32).
- Slide the card's write-protect switch to the write/erase position (p.32).
- If the card is full, replace the card or delete unnecessary images to make space (p.32, 227).
- If you try to focus in the One-Shot AF while the focus confirmation light <●> in the viewfinder blinks, a picture cannot be taken. Press the shutter button halfway again to refocus automatically, or focus manually (p.45, 97).

The card cannot be used.

- If a card error message is displayed, see page 34 or 296.

The image is out of focus.

- Set the lens's focus mode switch to <AF> (p.40).
- To prevent camera shake, press the shutter button gently (p.44, 45).
- If the lens has an Image Stabilizer, set the IS switch to <ON>.
- In low light, the shutter speed may become slow. Use a faster shutter speed (p.104), set a higher ISO speed (p.88), use flash (p.101), or use a tripod.

I cannot lock the focus and recompose the shot.

- Set the AF operation to One-Shot AF. Focus lock is not possible in the AI Servo AF, or when servo takes effect in AI Focus AF (p.93).

Horizontal stripes appear, or the exposure or color tone look strange.

- Horizontal stripes (noise) or irregular exposures can be caused by fluorescent light, LED bulbs, or other light sources during viewfinder or Live View shooting. Also, the exposure or color tone may not come out properly. A slow shutter speed may solve the problem.

The standard exposure cannot be obtained or the exposure is irregular.

- During viewfinder shooting or Live View shooting, if you use a TS-E lens (except the TS-E17mm f/4L or TS-E24mm f/3.5L II) and shift or tilt the lens or use an Extension Tube, the standard exposure may not be obtained or the exposure may be irregular.

The continuous shooting speed is slow.

- Depending on the lens type, shutter speed, aperture, subject conditions, brightness, etc., the continuous shooting speed may become slower.

The maximum burst during continuous shooting is lower.

- Under [**3: Custom Functions (C.Fn)**], set [**5: High ISO speed noise reduct'n**] to [**0: Standard**], [**1: Low**], or [**3: Disable**]. If it is set to [**2: Strong**], the maximum burst during continuous shooting will greatly decrease (p.261).
- During WB bracketing, the maximum burst for continuous shooting will decrease (p.130).
- If you shoot something that has fine detail (such as a field of grass), the file size will be larger and the actual maximum burst may be lower than the numbers listed on page 85.

ISO 100 cannot be set.

- Under [**F3: Custom Functions (C.Fn)**], if [**6: Highlight tone priority**] is set to [**1: Enable**], ISO 100 cannot be set. If [**0: Disable**] is set, ISO 100 can be set (p.261). This also applies to movie shooting (p.173).

ISO speed [H] (equivalent to ISO 12800) cannot be set.

- Under [**F3: Custom Functions (C.Fn)**], if [**6: Highlight tone priority**] is set to [**1: Enable**], the [**H**] ISO speed (equivalent to ISO 12800) cannot be selected even when [**2: ISO expansion**] is set to [**1: On**]. If [**6: Highlight tone priority**] is set to [**0: Disable**], [**H**] can be set (p.261).

The Auto Lighting Optimizer cannot be set.

- Under [**F3: Custom Functions (C.Fn)**], if [**6: Highlight tone priority**] is set to [**1: Enable**], Auto Lighting Optimizer cannot be set. If [**0: Disable**] is set, the Auto Lighting Optimizer can be set (p.261).

Even though I set a decreased exposure compensation, the image comes out bright.

- Set [**2: Auto Lighting Optimizer**] to [**Disable**]. When [**Standard**], [**Low**] or [**High**] is set, even if you set a decreased exposure compensation or flash exposure compensation, the image may come out bright (p.119).

When I use the <Av> mode with flash, the shutter speed becomes slow.

- If you shoot at night when the background is dark, the shutter speed becomes slow automatically (slow-sync shooting) so that both the subject and background are properly exposed. To prevent a slow shutter speed, under [**F3: Custom Functions (C.Fn)**], set [**3: Flash sync. speed in Av mode**] to [**1: 1/200-1/60 sec. auto**] or [**2: 1/200 sec. (fixed)**] (p.259).

The built-in flash is raised by itself.

- In shooting modes (<A+> <CA> <P> <M> <S>) whose default settings are <F> (Auto flash), the built-in flash will rise automatically when necessary.

The built-in flash does not fire.

- If you shoot continuously with the built-in flash at short intervals, the flash may stop firing to protect the flash unit.

The flash always fires at full output.

- If you use a flash unit other than an EX-series Speedlite, the flash will always be fired at full output (p.271).
- Under [**1: Flash control**], if [**Flash metering mode**] for [**External flash C.Fn setting**] is set to [TTL], the flash will always fire at full output (p.197).

I cannot set flash exposure compensation when using an external Speedlite.

- If flash exposure compensation has already been set with the external Speedlite, flash exposure compensation cannot be set with the camera. When the external Speedlite's flash exposure compensation is canceled (set to 0), flash exposure compensation can be set with the camera.

High-speed sync cannot be set in the <Av> mode.

- Under [**3: Custom Functions (C.Fn)**], set [**3: Flash sync. speed in Av mode**] to [**0: Auto**] (p.259).

The camera makes a noise when it is shaken.

- The built-in flash's pop-up mechanism moves slightly. This is normal and not a malfunction.

The shutter makes two shooting sounds during Live View shooting.

- If you use flash, the shutter will make two sounds each time you shoot (p.135).

During Live View and movie shooting, a white <🔥> or red <🔥> icon is displayed.

- It indicates that the camera's internal temperature is high. If the white <🔥> icon is displayed, the still photo's image quality may deteriorate. If the red <🔥> icon is displayed, it indicates that the Live View or movie shooting will soon stop automatically (p.151, 177).

Movie shooting stops by itself.

- If the card's writing speed is slow, movie shooting may stop automatically. Use an SD Speed Class 6 "CLASS 6" or faster card. To find out the card's reading/writing speed, refer to the card manufacturer's website, etc.
- If a movie clip's file size reaches 4 GB or the shooting length reaches 29 min. 59 sec., the movie shooting will stop automatically.

The ISO speed cannot be set for movie shooting.

- If [📷 1: Movie exposure] is set to [Auto], the ISO speed will be set automatically. If [Manual] is set, you can set the ISO speed manually (p.156).

The exposure changes during movie shooting.

- If you change the shutter speed or aperture during movie shooting, the changes in the exposure may be recorded.
- Zooming the lens during movie shooting can cause changes in the exposure regardless of whether the lens' maximum aperture changes or not. The changes in the exposure may be recorded as a result.

The subject looks distorted during movie shooting.

- If you move the camera to the left or right quickly (high-speed panning) or shoot a moving subject, the image may look distorted.

The image flickers or horizontal stripes appear during movie shooting.

- Flickering, horizontal stripes (noise), or irregular exposures can be caused by fluorescent light, LED bulbs, or other light sources during movie shooting. Also, changes in the exposure (brightness) or color tone may be recorded. With manual exposure, a slow shutter speed may solve the problem.

Display Problems

The menu screen shows fewer tabs and options.

- In Basic Zone modes and in movie shooting mode, certain tabs and menu options are not displayed. Set the shooting mode to a Creative Zone mode (p.48).

The file name's first character is an underscore (“_”).

- Set the color space to sRGB. If Adobe RGB is set, the first character will be an underscore (p.131).

The file name starts with “MVI_”.

- It is a movie file (p.185).

The file numbering does not start from 0001.

- If the card already contains recorded images, the image number may not start from 0001 (p.184).

The shooting date and time displayed is incorrect.

- Make sure the correct date and time has been set (p.37).
- Check the time zone and daylight saving time (p.37).

The date and time is not in the picture.

- The shooting date and time does not appear in the picture. The date and time is recorded in the image data as shooting information. When printing, you can imprint the date and time in the picture by using the date and time recorded in the shooting information (p.245).

[###] is displayed.

- If the card has recorded a number of images greater than the camera can display, [###] will be displayed (p.209).

The LCD monitor does not display a clear image.

- If the LCD monitor is dirty, use a soft cloth to clean it.
- In low or high temperatures, the LCD monitor display may seem slow or may look black. It will return to normal at room temperature.

[Eye-Fi settings] does not appear.

- **[Eye-Fi settings]** will appear only when an Eye-Fi card is inserted in the camera. If the Eye-Fi card has a write-protect switch set to the LOCK position, you will not be able to check the card's connection status or disable Eye-Fi transmission (p.272).

Playback Problems

Part of the image blinks in black.

- It is the highlight alert (p.231). Overexposed highlight areas with a loss of highlight detail will blink.

The image cannot be erased.

- If the image is protected, it cannot be erased (p.225).

The movie cannot be played back.

- Movies edited with a computer using ImageBrowser EX (p.316) or other EOS software cannot be played back with the camera. However, video snapshot albums edited with EOS Video Snapshot Task (p.171) can be played back on the camera.

When the movie is played back, camera operation noise can be heard.

- If you operate the camera's dials or lens during movie shooting, the operation noise will also be recorded.

The movie has still moments.

- During autoexposure movie shooting, if there is a drastic change in the exposure level, the recording will stop momentarily until the brightness stabilizes. In such cases, shoot movies with manual exposure (p.156).

I cannot connect the camera to my TV set.

- An HDMI cable (sold separately) is necessary to connect the camera to a TV set. Using the HDMI Cable HTC-100 (sold separately) is recommended (p.222).
- Also check that your TV set has an HDMI IN terminal. If the TV set does not have an HDMI IN terminal and has only an A/V IN jack, the camera cannot be connected.

No image appears on the TV screen.

- Make sure the HDMI cable's plug is inserted all the way in (p.222).

My card reader does not recognize the card.

- Depending on the card reader and computer OS used, SDXC cards may not be correctly recognized. If this occurs, connect your camera to the computer with the provided interface cable, then transfer the images to your computer using EOS Utility (EOS software, p.316).

I cannot resize the image.

- JPEG S3 and RAW images cannot be resized with the camera (p.237).

Printing-Related Problems

There are fewer printing effects than listed in the instruction manual.

- Contents displayed on the screen differ depending on the printer. This instruction manual lists all the printing effects available (p.244).

Computer Connection Problems

I cannot download images to a computer.

- Install the EOS software (EOS Solution Disk CD-ROM) on the computer (p.317-318).

Error Codes

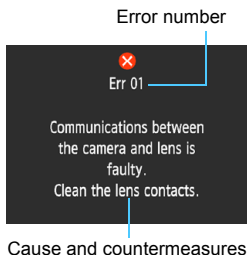

If there is a problem with the camera, an error message will appear. Follow the on-screen instructions.

Number	Error Message and Solution
01	Communications between the camera and lens is faulty. Clean the lens contacts.
	→ Clean the electrical contacts on the camera and lens or use a Canon lens (p.21, 22).
02	Card cannot be accessed. Reinsert/change card or format card with camera.
	→ Remove and insert the card again, replace the card, or format the card (p.32, 50).
04	Cannot save images because card is full. Replace card.
	→ Replace the card, erase unnecessary images, or format the card (p.32, 227, 50).
05	The built-in flash could not be raised. Turn the camera off and on again.
	→ Operate the power switch (p.35).
10, 20 30, 40 50, 60 70, 80 99	An error prevented shooting. Turn the camera off and on again or re-install the battery.
	→ Operate the power switch, remove and install the battery pack again, or use a Canon lens (p.35, 32).

* If the error still persists, write down the error number and contact your nearest Canon Service Center.

Specifications

• Type

Type:	Digital, single-lens reflex, AF/AE camera with built-in flash
Recording media:	SD memory card, SDHC memory card, SDXC memory card
Image sensor size:	Approx. 22.3 x 14.9 mm
Compatible lenses:	Canon EF lenses (including EF-S lenses) * Excluding EF-M lenses (35mm-equivalent focal length is approx. 1.6 times the lens focal length)
Lens mount:	Canon EF mount

• Image Sensor

Type:	CMOS sensor
Effective pixels:	Approx. 18.0 megapixels
Aspect ratio:	3:2
Dust delete feature:	Dust Delete Data appending, Clean manually

• Recording System

Recording format:	Design rule for Camera File System (DCF) 2.0
Image type:	JPEG, RAW (14-bit Canon original) RAW+JPEG Large simultaneous recording possible
Pixels recorded:	L (Large) : Approx. 17.9 megapixels (5184 x 3456) M (Medium) : Approx. 8.0 megapixels (3456 x 2304) S1 (Small 1) : Approx. 4.5 megapixels (2592 x 1728) S2 (Small 2) : Approx. 2.5 megapixels (1920 x 1280) S3 (Small 3) : Approx. 350,000 pixels (720 x 480) RAW : Approx. 17.9 megapixels (5184 x 3456)
Create/select a folder:	Possible
File numbering:	Continuous, Auto reset, Manual reset

• Image Processing During Shooting

Picture Style:	Auto, Standard, Portrait, Landscape, Neutral, Faithful, Monochrome, User Def. 1 - 3
Basic+:	Ambience-based shots, Light/scene-based shots
White balance:	Auto, Preset (Daylight, Shade, Cloudy, Tungsten light, White fluorescent light, Flash), Custom White Balance correction and White balance bracketing possible * Flash color temperature information transmission enabled
Noise reduction:	Applicable to long exposures and high ISO speed shots
Automatic image brightness correction:	Auto Lighting Optimizer
Highlight tone priority:	Provided
Lens aberration correction:	Provided

• Viewfinder

Type:	Eye-level pentamirror
Coverage:	Vertical/Horizontal approx. 95% (with Eye point approx. 21 mm)
Magnification:	Approx. 0.8x (-1 m ⁻¹ with 50mm lens at infinity)
Eye point:	Approx. 21 mm (from eyepiece lens center at -1 m ⁻¹)
Built-in dioptic adjustment:	Approx. -2.5 - +0.5 m ⁻¹ (dpt)
Focusing screen:	Fixed, Precision Matte
Mirror:	Quick-return type
Depth-of-field preview:	Enabled with Custom Function setting

• Autofocus

Type:	TTL secondary image-registration, phase detection
AF points:	9-point (Cross-type AF sensitive to f/5.6 with center AF point)
Focusing brightness range:	EV 0 - 18 (Center AF point) EV 1 - 18 (Other AF points) (With One-Shot AF, at room temperature, ISO 100)
AF operation:	One-Shot AF, AI Servo AF, AI Focus AF
AF-assist beam:	Small series of flashes fired by built-in flash

• Exposure Control

Metering modes:	63-zone TTL full-aperture metering <ul style="list-style-type: none"> • Evaluative metering (linked to all AF points) • Partial metering (approx. 10% of viewfinder at center) • Center-weighted average metering
Brightness metering range:	EV 1 - 20 (at room temperature, ISO 100)
Exposure control:	Program AE (Scene Intelligent Auto, Flash Off, Creative Auto, Portrait, Landscape, Close-up, Sports, Night Portrait, Program), Shutter-priority AE, Aperture-priority AE, Manual exposure
ISO speed: (Recommended exposure index)	Basic Zone modes*: ISO 100 - ISO 3200 set automatically * Portrait: ISO 100 Creative Zone modes: ISO 100 - ISO 6400 set manually (whole-stop increments), ISO 100 - ISO 6400 set automatically, maximum ISO speed settable for ISO Auto, or expandable to "H" (equivalent to ISO 12800)
Exposure compensation:	Manual: ±5 stops in 1/3- or 1/2-stop increments AEB: ±2 stops in 1/3- or 1/2-stop increments (can be combined with manual exposure compensation)
AE lock:	Auto: Applied in One-Shot AF with evaluative metering when focus is achieved Manual: By AE lock button

• Shutter

Type:	Electronically-controlled, focal-plane shutter
Shutter speeds:	1/4000 sec. to 30 sec. (Total shutter speed range. Available range varies by shooting mode.), Bulb, X-sync at 1/200 sec.

• Flash

Built-in flash:	Retractable, auto pop-up flash Guide No.: Approx. 9.2/30.2 (ISO 100, in meters/feet) or approx. 13/42.7 (ISO 200, in meters/feet) Flash coverage: Approx. 17mm lens angle of view Recycling time approx. 2 sec.
External flash:	EX-series Speedlite
Flash metering:	E-TTL II autoflash
Flash exposure compensation:	±2 stops in 1/3- or 1/2-stop increments
FE lock:	Provided
PC terminal:	None

• Drive System

Drive modes:	Single shooting, Continuous shooting, Self-timer with 10-sec. or 2-sec. delay and 10-sec. delay with continuous shooting
Continuous shooting speed:	Max. approx. 3.0 shots/sec.
Max. burst (Approx.):	JPEG Large/Fine: 69 shots RAW: 6 shots RAW+JPEG Large/Fine: 4 shots * Figures are based on Canon's 8 GB test card and testing standards (ISO 100 and Standard Picture Style).

• Live View Shooting

Aspect ratio:	3:2, 4:3, 16:9, 1:1
Focus methods:	Contrast detection (FlexiZone-Single, Face detection Live mode), Phase-difference detection (Quick mode) Manual focus (approx. 5x / 10x magnification possible)
Focusing brightness range:	EV 1 - 18 (at room temperature, ISO 100)
Metering modes:	Real-time metering with image sensor
Brightness metering range:	EV 0 - 20 (at room temperature, ISO 100)
Grid display:	Two types

• Movie Shooting

Recording format:	MOV
Movie:	MPEG-4 AVC/H.264 Variable (average) bit rate
Audio:	Linear PCM
Recording size and frame rate:	1920x1080 (Full HD): 30p/25p/24p 1280x720 (HD) : 60p/50p 640x480 (SD) : 30p/25p * 30p: 29.97 fps, 25p: 25.00 fps, 24p: 23.98 fps, 60p: 59.94 fps, 50p: 50.00 fps
File size:	1920x1080 (30p/25p/24p): Approx. 330 MB/min. 1280x720 (60p/50p) : Approx. 330 MB/min. 640x480 (30p/25p) : Approx. 82.5 MB/min.
Focusing:	Same as focusing with Live View shooting
Metering modes:	Center-weighted average and evaluative metering with the image sensor * Automatically set by the focusing mode
Brightness metering range:	EV 0 - 20 (at room temperature, ISO 100)
Exposure control:	Autoexposure and manual exposure
Exposure compensation:	±3 stops in 1/3-stop increments (Still photos: ±5 stops)
ISO speed:	With autoexposure shooting:
(Recommended exposure index)	ISO 100 - ISO 6400 set automatically (ISO 100 - ISO 3200 for still photo shooting) With manual exposure: ISO 100 - ISO 6400 set automatically/manually
Video snapshots:	Settable to 2 sec./4 sec./8 sec.
Sound recording:	Built-in monaural microphone Sound-recording level adjustable, wind filter provided
Grid display:	Two types
Still photo shooting:	Possible

• LCD Monitor

Type:	TFT color liquid-crystal monitor
Monitor size and dots:	Approx. 7.5 cm (3.0-in.) (4:3) with approx. 460,000 dots
Brightness adjustment:	Manual (7 levels)
Interface languages:	25
Feature guide:	Displayable

• Playback

Image display formats:	Basic info, basic info + image quality/playback number, shooting info. display, histogram, image index (4/9)
Zoom magnification:	Approx. 1.5x - 10x
Highlight alert:	Overexposed highlights blink
Image browsing methods:	Single image, jump by 10 or 100 images, by shooting date, by folder, by movies, by stills, by rating
Image rotation:	Possible
Ratings:	Provided
Movie playback:	Enabled (LCD monitor, HDMI OUT) Built-in speaker
Image protection:	Possible
Slide show:	All images, by date, by folder, by movies, by stills, by rating Five transition effects selectable
Background music:	Selectable for slide shows and movie playback

• Post-Processing of Images

Creative filters:	Grainy B/W, Soft focus, Fish-eye effect, Toy camera effect, Miniature effect
Resize:	Possible

• Direct Printing

Compatible printers:	PictBridge-compatible printers
Printable images:	JPEG and RAW images
Print ordering:	DPOF Version 1.1 compliant

• Custom Functions

Custom Functions:	11
My Menu registration:	Possible
Copyright information:	Entry and inclusion enabled

• Interface

Digital terminal:	Computer communication, Direct printing (Hi-Speed USB equivalent), GPS Receiver GP-E2 connection
HDMI mini OUT terminal:	Type C (Auto switching of resolution), CEC-compatible
Remote control terminal:	For Remote Switch RS-60E3
Eye-Fi card:	Compatible

• Power

Battery:	Battery Pack LP-E10 (Quantity 1) * AC power usable with household power outlet accessories
Number of possible shots: (Based on CIPA testing standards)	With viewfinder shooting: Approx. 500 shots at room temperature (23°C/73°F), approx. 410 shots at low temperatures (0°C/32°F) With Live View shooting: Approx. 180 shots at room temperature (23°C/73°F), approx. 170 shots at low temperatures (0°C/32°F)
Movie shooting time:	Approx. 1 hr. 15 min. at room temperature (23°C/73°F) Approx. 1 hr. 10 min. at low temperatures (0°C/32°F) (with a fully-charged Battery Pack LP-E10)

• Dimensions and Weight

Dimensions (W x H x D):	Approx. 129.6 x 99.7 x 77.9 mm / 5.10 x 3.93 x 3.07 in.
Weight:	Approx. 480 g / 16.93 oz. (CIPA Guidelines), Approx. 435 g / 15.34 oz. (Body only)

• Operation Environment

Working temperature range:	0°C - 40°C / 32°F - 104°F
Working humidity:	85% or less

• Battery Pack LP-E10

Type:	Rechargeable lithium-ion battery
Rated voltage:	7.4 V DC
Battery capacity:	860 mAh
Working temperature range:	During charging: 6°C - 40°C / 43°F - 104°F During shooting: 0°C - 40°C / 32°F - 104°F
Working humidity:	85% or less
Dimensions (W x H x D):	Approx. 36.2 x 14.7 x 49.0 mm / 1.4 x 0.6 x 1.9 in.
Weight:	Approx. 45 g / 1.6 oz.

• Battery Charger LC-E10

Compatible battery:	Battery Pack LP-E10
Recharging time:	Approx. 2 hours (at 23°C/73°F)
Rated input:	100 - 240 V AC (50/60 Hz)
Rated output:	8.3 V DC / 580 mA
Working temperature range:	6°C - 40°C / 43°F - 104°F
Working humidity:	85% or less
Dimensions (W x H x D):	Approx. 67.0 x 30.5 x 87.5 mm / 2.6 x 1.2 x 3.4 in.
Weight:	Approx. 85 g / 3.0 oz.

• Battery Charger LC-E10E

Compatible battery:	Battery Pack LP-E10
Power cord length:	Approx. 1 m / 3.3 ft.
Recharging time:	Approx. 2 hours (at 23°C/73°F)
Rated input:	100 - 240 V AC (50/60 Hz)
Rated output:	8.3 V DC / 580 mA
Working temperature range:	6°C - 40°C / 43°F - 104°F
Working humidity:	85% or less
Dimensions (W x H x D):	Approx. 67.0 x 30.5 x 87.5 mm / 2.6 x 1.2 x 3.4 in.
Weight:	Approx. 82 g / 2.9 oz. (excluding power cord)

• EF-S18-55mm f/3.5-5.6 IS II

Angle of view:	Diagonal extent: 74°20' - 27°50'
	Horizontal extent: 64°30' - 23°20'
	Vertical extent: 45°30' - 15°40'
Lens construction:	11 elements in 9 groups
Minimum aperture:	f/22 - 36
Closest focusing distance:	0.25 m / 0.82 ft. (From image sensor plane)
Max. magnification:	0.34x (at 55mm)
Field of view:	207 x 134 - 67 x 45 mm / 8.1 x 5.3 - 2.6 x 1.8 in. (at 0.25 m / 0.82 ft.)
Image Stabilizer:	Lens shift type
Filter size:	58 mm
Lens cap:	E-58 II
Max. diameter x length:	Approx. 68.5 x 70.0 mm / 2.7 x 2.8 in.
Weight:	Approx. 200 g / 7.1 oz.
Hood:	EW-60C (sold separately)
Case:	LP814 (sold separately)

• **EF-S18-55mm f/3.5-5.6 III**

Angle of view:	Diagonal extent: 74°20' - 27°50' Horizontal extent: 64°30' - 23°20' Vertical extent: 45°30' - 15°40'
Lens construction:	11 elements in 9 groups
Minimum aperture:	f/22 - 36
Closest focusing distance:	0.25 m / 0.82 ft. (From image sensor plane)
Max. magnification:	0.34x (at 55mm)
Field of view:	207 x 134 - 67 x 45 mm / 8.1 x 5.3 - 2.6 x 1.8 in. (at 0.25 m / 0.82 ft.)
Filter size:	58 mm
Lens cap:	E-58 II
Max. diameter x length:	Approx. 68.5 x 70.0 mm / 2.7 x 2.8 in.
Weight:	Approx. 195 g / 6.9 oz.
Hood:	EW-60C (sold separately)
Case:	LP814 (sold separately)

- All the data above is based on Canon's testing standards and CIPA (Camera & Imaging Products Association) testing standards and guidelines.
- Dimensions, maximum diameter, length and weight listed above are based on CIPA Guidelines (except weight for camera body only).
- Product specifications and the exterior are subject to change without notice.
- If a problem occurs with a non-Canon lens attached to the camera, consult the respective lens manufacturer.

Trademarks

- Adobe is a trademark of Adobe Systems Incorporated.
- Microsoft and Windows are trademarks or registered trademarks of Microsoft Corporation in the United States and/or other countries.
- Macintosh and Mac OS are trademarks of Apple Inc., registered in the U.S. and other countries.
- SDXC logo is a trademark of SD-3C, LLC.
- HDMI, HDMI logo, and High-Definition Multimedia Interface are trademarks or registered trademarks of HDMI Licensing LLC.
- All other trademarks are the property of their respective owners.

About MPEG-4 Licensing

"This product is licensed under AT&T patents for the MPEG-4 standard and may be used for encoding MPEG-4 compliant video and/or decoding MPEG-4 compliant video that was encoded only (1) for a personal and non-commercial purpose or (2) by a video provider licensed under the AT&T patents to provide MPEG-4 compliant video. No license is granted or implied for any other use for MPEG-4 standard."

* Notice displayed in English as required.

Use of genuine Canon accessories is recommended

This product is designed to achieve excellent performance when used with genuine Canon accessories.

Canon shall not be liable for any damage to this product and/or accidents such as fire, etc., caused by the malfunction of non-genuine Canon accessories (e.g., a leakage and/or explosion of a battery pack). Please note that this warranty does not apply to repairs arising out of the malfunction of non-genuine Canon accessories, although you may request such repairs on a chargeable basis.

Safety Precautions

The following precautions are provided to prevent harm or injury to yourself and others. Make sure to thoroughly understand and follow these precautions before using the product.

If you experience any malfunctions, problems, or damage to the product, contact the nearest Canon Service Center or the dealer from whom you purchased the product.



Warnings: Follow the warnings below. Otherwise, death or serious injuries may result.

- To prevent fire, excessive heat, chemical leakage, explosions, and electrical shock, follow the safeguards below:
 - Do not use any batteries, power sources, or accessories not specified in the Instruction Manual. Do not use any home-made or modified batteries.
 - Do not short-circuit, disassemble, or modify the battery. Do not apply heat or solder to the battery. Do not expose the battery to fire or water. Do not subject the battery to strong physical shock.
 - Do not insert the battery's plus and minus ends incorrectly.
 - Do not recharge the battery in temperatures outside the allowable ambient temperature range. Also, do not exceed the recharging time indicated in the Instruction Manual.
 - Do not insert any foreign metallic objects into the electrical contacts of the camera, accessories, connecting cables, etc.
- When disposing of a battery, insulate the electrical contacts with tape to prevent contact with other metallic objects or batteries. This is to prevent a fire or an explosion.
- If excessive heat, smoke, or fumes are emitted when recharging the battery, immediately unplug the battery charger from the power outlet to stop recharging. Otherwise, it may cause a fire, heat damage or electrical shock.
- If the battery leaks, changes color, deforms, or emits smoke or fumes, remove it immediately. Be careful not to get burned in the process. It may cause a fire, electrical shock or skin burn if you keep using it.
- Prevent any battery leakage from contacting your eyes, skin, and clothing. It can cause blindness or skin problems. If the battery leakage contacts your eyes, skin, or clothing, flush the affected area with lots of clean water without rubbing it. See a physician immediately.
- Do not leave any cords near a heat source. It can deform the cord or melt the insulation and cause a fire or electrical shock.
- Do not hold the camera in the same position for long periods of time. Even if the camera does not feel too hot, prolonged contact with the same body part may cause skin redness, blistering or low-temperature contact burns. Using a tripod is recommended for people with circulation problems or very sensitive skin, or when using the camera in very hot places.
- Do not fire the flash at anyone driving a car or other vehicle. It may cause an accident.

- When the camera or accessories are not in use, make sure to remove the battery and disconnect the power plug from the equipment before storing. This is to prevent electrical shock, excessive heat, fire, or corrosion.
- Do not use the equipment where there is flammable gas. This is to prevent an explosion or a fire.
- If you drop the equipment and the casing breaks open to expose the internal parts, do not touch the internal parts. There is a possibility of an electrical shock.
- Do not disassemble or modify the equipment. High-voltage internal parts can cause electrical shock.
- Do not look at the sun or an extremely bright light source through the camera or lens. Doing so may damage your vision.
- Keep equipment out of the reach of children and infants, including when in use. Straps or cords may accidentally cause choking, electrical shock, or injury. Choking or injury may also occur if a child or infant accidentally swallows a camera part or accessory. If a child or infant swallows a part or accessory, consult a physician immediately.
- Do not store the equipment in dusty or humid places. Likewise, store the battery with its protective cover attached to prevent short-circuit. This is to prevent a fire, excessive heat, electrical shock, or burn.
- Before using the camera inside an airplane or hospital, check if it is allowed. Electromagnetic waves emitted by the camera may interfere with the plane's instruments or the hospital's medical equipment.
- To prevent a fire and electrical shock, follow the safeguards below:
 - Always insert the power plug all the way in.
 - Do not handle a power plug with wet hands.
 - When unplugging a power plug, grasp and pull the plug instead of the cord.
 - Do not scratch, cut, or excessively bend the cord or put a heavy object on the cord. Also do not twist or tie the cords.
 - Do not connect too many power plugs to the same power outlet.
 - Do not use a cord whose wire is broken or insulation is damaged.
- Unplug the power plug periodically and clean off the dust around the power outlet with a dry cloth. If the surrounding is dusty, humid, or oily, the dust on the power outlet may become moist and short-circuit the outlet, causing a fire.
- Do not connect the battery directly to an electrical outlet or a car's cigarette lighter outlet. The battery may leak, generate excessive heat or explode, causing a fire, burns or injuries.
- A thorough explanation of how to use the product by an adult is required when the product is used by children. Supervise children while they are using the product. Incorrect usage may result in electrical shock or injury.
- Do not leave a lens or lens-attached camera in the sun without the lens cap attached. Otherwise, the lens may concentrate the sun's rays and cause a fire.
- Do not cover or wrap the product with a cloth. Doing so may trap heat within and cause the casing to deform or catch fire.
- Be careful not to get the camera wet. If you drop the product in the water or if water or metal get inside the product, promptly remove the battery. This is to prevent a fire and an electrical shock.
- Do not use paint thinner, benzene, or other organic solvents to clean the product. Doing so may cause fire or a health hazard.

**Cautions:** Follow the cautions below. Otherwise physical injury or property damage may result.

- Do not use or store the product inside a car under the hot sun or near a heat source. The product may become hot and cause skin burns. Doing so may also cause battery leakage or explosion, which will degrade the performance or shorten the life of the product.
- Do not carry the camera around when it is attached to a tripod. Doing so may cause injury. Also make sure the tripod is sturdy enough to support the camera and lens.
- Do not leave the product in a low-temperature environment for an extended period of time. The product will become cold and may cause injury when touched.
- Do not fire the flash near the eyes. It may hurt the eyes.
- Never play the provided CD-ROM in a drive that is not compatible with the CD-ROM. If you use it in a music CD player, you may damage the speakers and other components. When using headphones, there is also a risk of injury to your ears from excessively loud volume.



Only for European Union and EEA (Norway, Iceland and Liechtenstein)

These symbols indicate that this product is not to be disposed of with your household waste, according to the WEEE Directive (2012/19/EU), the Battery Directive (2006/66/EC) and/or national legislation implementing those Directives.

If a chemical symbol is printed beneath the symbol shown above, in accordance with the Battery

Directive, this indicates that a heavy metal (Hg = Mercury, Cd = Cadmium, Pb = Lead) is present in this battery or accumulator at a concentration above an applicable threshold specified in the Battery Directive.

This product should be handed over to a designated collection point, e.g., on an authorized one-for-one basis when you buy a new similar product or to an authorized collection site for recycling waste electrical and electronic equipment (EEE) and batteries and accumulators. Improper handling of this type of waste could have a possible impact on the environment and human health due to potentially hazardous substances that are generally associated with EEE. Your cooperation in the correct disposal of this product will contribute to the effective usage of natural resources.

For more information about the recycling of this product, please contact your local city office, waste authority, approved scheme or your household waste disposal service or visit www.canon-europe.com/weee, or www.canon-europe.com/battery.

CAUTION

RISK OF EXPLOSION IF BATTERY IS REPLACED BY AN INCORRECT TYPE.
DISPOSE OF USED BATTERIES ACCORDING TO LOCAL REGULATION.





13

Downloading Images to Your Computer

This chapter explains how to download images from the camera to your computer, gives an overview of the software on the EOS Solution Disk (CD-ROM), and explains how to install the software on your computer.



EOS Solution Disk
(Software)

Downloading Images to a Computer

You can use the EOS software to download the images in the camera to your computer. There are two ways to do this.

Downloading by Connecting the Camera to the Computer

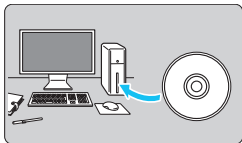

1 Install the software (p.317).

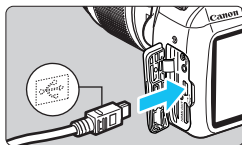

2 Use the provided interface cable to connect the camera to your computer.

- Use the interface cable provided with the camera.
- Connect the cable to the camera's digital terminal with the cable plug's icon facing the front of the camera.
- Connect the cord's plug to the computer's USB terminal.

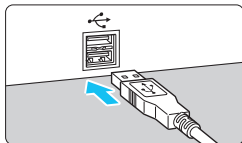

3 Use EOS Utility to download the images.

- For details, refer to the EOS Utility Instruction Manual.

Downloading Images with a Card Reader

You can also use a card reader to download images to your computer.

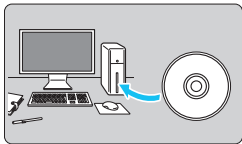

1 Install the software (p.317).

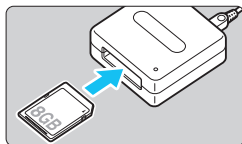

2 Insert the card into the card reader.

3 Use Canon software to download the images.

- ▶ Use Digital Photo Professional.
- ▶ Use ImageBrowser EX.
- For details, refer to the Software Instruction Manual.



When downloading images from the camera to your computer using a card reader without using EOS software, copy the DCIM folder on the card to your computer.

About the Software



EOS Solution Disk

This disk contains various software for EOS cameras.

⚠ Note that the software provided with previous cameras might not support still photos and movie files shot with this camera. Please use the software provided with this camera.

1 EOS Utility

Communication Software for the Camera and Computer

- You can download images (still images/movies) you have shot with the camera to your computer.
- You can set the various settings of the camera from your computer.
- You can shoot photos remotely by connecting the camera to your computer.
- You can copy background music tracks to the card, and play the background music during playback.

2 Digital Photo Professional

Image Viewing and Editing Software

- You can view, edit and print shot images on your computer at high-speed.
- You can edit images with originals remaining unchanged.
- Can be used by a wide range of users from amateurs to professionals. It is especially recommended for users who mainly shoot RAW images.

3 Picture Style Editor

Picture Style File Creating Software

- This software is aimed at advanced users who are experienced in processing images.
- You can edit Picture Style to your unique image characteristics and create/save an original Picture Style file.

4 ImageBrowser EX

Image Viewing and Editing Software

- Connect to the Internet to download and install the software*
- You can view, browse and print JPEG images on your computer.
- You can play movies (MOV files), video snapshot albums, and extract still photos from movies.
- Recommended for novices who are using a digital camera for the first time and amateur users.

* EOS Solution Disk is necessary for downloading and installing ImageBrowser EX.

Installing the Software

Installing the Software on Windows

Compatible OS **Windows 8.1** **Windows 8** **Windows 7** **Windows Vista**
Windows XP

1 Check that the camera is not connected to your computer.



- **Do not connect the camera to your computer before you install the software. The software will not be installed correctly.**
- When downloading and installing ImageBrowser EX, follow the steps below as with other EOS software included on the EOS Solution Disk. Note that Internet connection is necessary. Downloading or installing software is not possible in environments with no Internet connection.
- Even if your computer already has ImageBrowser EX installed, follow the steps below to reinstall ImageBrowser EX. It will be updated to the latest version with features optimized for your camera. Also, the latest functions may be added with the auto update feature.
- For software other than ImageBrowser EX, if a previous version is installed, follow the steps below to reinstall the software. (The newer version will overwrite the previous version.)

2 Insert the EOS Solution Disk (CD).

3 Select your geographic area, country and language.

4 Click **[Easy Installation]** to start installation.

- Follow the on-screen instructions to complete the installation procedure.
- If prompted, install Microsoft Silverlight.

5 Click **[Finish]** when the installation has completed.

6 Remove the CD.

Installing the Software on Macintosh

Compatible OS

MAC OS X 10.7 - 10.9

1 Check that the camera is not connected to your computer.



- **Do not connect the camera to your computer before you install the software. The software will not be installed correctly.**
- When downloading and installing ImageBrowser EX, follow the steps below as with other EOS software included on the EOS Solution Disk. Note that Internet connection is necessary. Downloading or installing software is not possible in environments with no Internet connection.
- Even if your computer already has ImageBrowser EX installed, follow the steps below to reinstall ImageBrowser EX. It will be updated to the latest version with features optimized for your camera. Also, the latest functions may be added with the auto update feature.
- For software other than ImageBrowser EX, if a previous version is installed, follow the steps below to reinstall the software. (The newer version will overwrite the previous version.)

2 Insert the EOS Solution Disk (CD).

- On your computer's desktop, double-click and open the CD-ROM icon, and then double-click **[setup]**.

3 Select your geographic area, country and language.

4 Click **[Easy Installation]** to start installation.

- Follow the on-screen instructions to complete the installation procedure.

5 Click **[Restart]** when the installation has completed.







6 Once the computer has restarted, remove the CD.





14

Quick Reference Guide and Index

Menu Operations.....	p.322
Image-recording Quality.....	p.323
 Picture Style.....	p.323
 Quick Control.....	p.324
Nomenclature.....	p.325
Basic Zone modes.....	p.327
 Using the Built-in Flash.....	p.327
Creative Zone modes.....	p.328
P : Program AE.....	p.328
Tv : Shutter-priority AE.....	p.328
Av : Aperture-priority AE.....	p.328
AF: AF Operation.....	p.329
 AF Point.....	p.329
ISO: ISO speed.....	p.330
 Drive/Self-timer.....	p.330
 Live View shooting.....	p.331
 Movie Shooting.....	p.332
Image Playback.....	p.333

Quick Reference Guide

Menu Operations

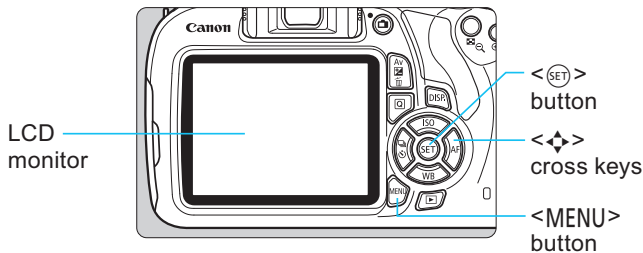

1. Press the <MENU> button to display the menu.
2. Press the <◀▶> keys to select a tab, then press the <▲> <▼> keys to select the desired item.
3. Press <SET> to display the setting.
4. After setting the item, press <SET>.

Basic Zone Modes



Movie Shooting Mode



Creative Zone Modes

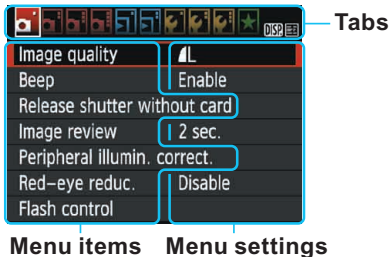
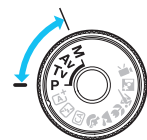
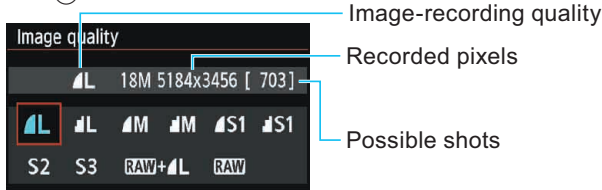

Image-Recording Quality

- Select [**📷 1: Image quality**], then press <SET>.
- Press the <◀> <▶> keys to select a quality, then press <SET>.



Picture Style ☆



- Select [**📷 2: Picture Style**], then press <SET>.
- Press the <▲> <▼> keys to select the Picture Style, then press <SET>.

Style	Description
Auto	Color tones optimized for the particular scene.
Standard	Vivid colors and sharp images.
Portrait	Nice skin tones and slightly sharp images.
Landscape	Vivid blue skies and greenery, and very sharp images.
Monochrome	Black-and-white images.

- For < > (Neutral) and < > (Faithful), see page 92.

Q Quick Control



- Press the <Q> button.
- ▶ The Quick Control screen will appear.

Basic Zone Modes

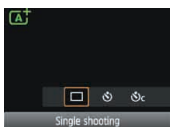

Creative Zone Modes

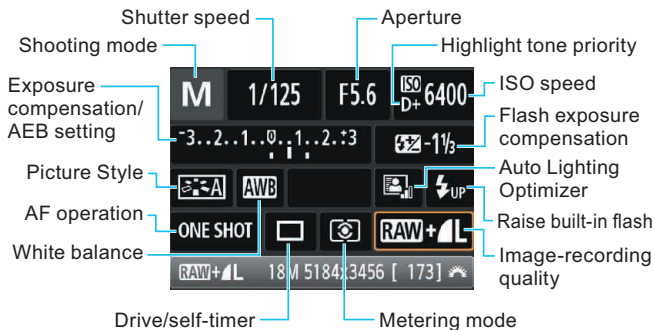

- In Basic Zone modes, settable functions vary depending on the shooting mode.
- Press the <⬆> cross keys to select a function, then turn the <⌚> dial to set it.

Nomenclature

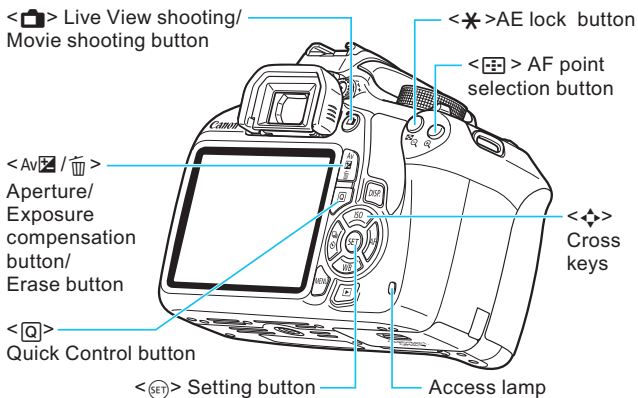
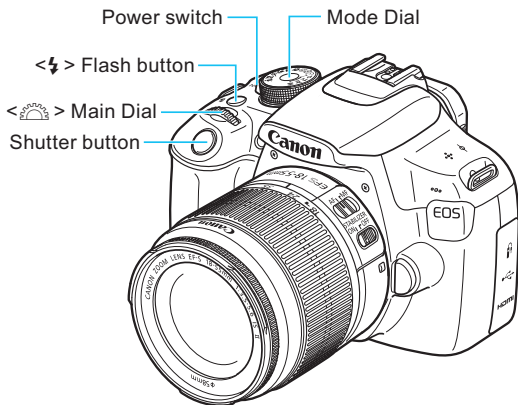

Shooting Settings

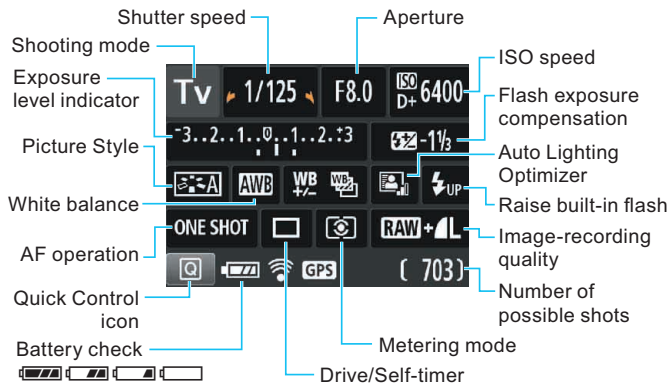

Viewfinder Information

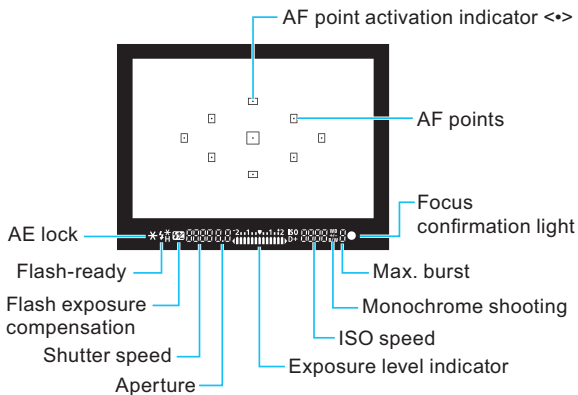

Basic Zone Modes



All the settings necessary for shooting are set automatically. You just press the shutter button, and the camera does the rest.

- | | |
|------------------------|----------------|
| Scene Intelligent Auto | Landscape |
| Flash Off | Close-up |
| Creative Auto | Sports |
| Portrait | Night Portrait |

⚡ Using the Built-in Flash

Basic Zone Modes

If necessary, the built-in flash will be raised and fire automatically in low-light or backlit conditions (with certain shooting modes).

Creative Zone Modes

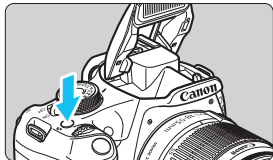

- Press the <⚡> button to raise the built-in flash, then shoot.

Creative Zone Modes



You can change the camera settings as desired to shoot in various ways.

P: Program AE

The camera automatically sets the shutter speed and aperture in the same way as the $\langle \text{A}^+ \rangle$ mode.

- Set the Mode Dial to $\langle \text{P} \rangle$.

Tv: Shutter-priority AE

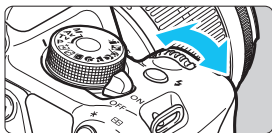

- Set the Mode Dial to $\langle \text{Tv} \rangle$.
- Turn the $\langle \text{shutter speed dial} \rangle$ to set the desired shutter speed, then focus on the subject.
- ▶ The aperture will be set automatically.
- If the aperture display blinks, turn the $\langle \text{shutter speed dial} \rangle$ until it stops blinking.



Av: Aperture-priority AE

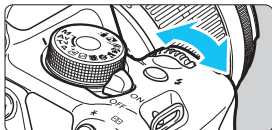

- Set the Mode Dial to $\langle \text{Av} \rangle$.
- Turn the $\langle \text{aperture dial} \rangle$ to set the desired aperture, then focus on the subject.
- ▶ The shutter speed will be set automatically.
- If the shutter speed display blinks, turn the $\langle \text{aperture dial} \rangle$ until it stops blinking.



AF: AF Operation☆

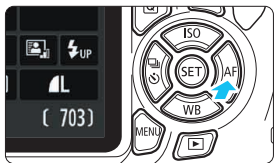

- Set the lens's focus mode switch to <AF>.
- Press the <▶AF> button.
- Press the <◀▶> keys or turn the <☀> dial to select the desired AF operation, then press <SET>.

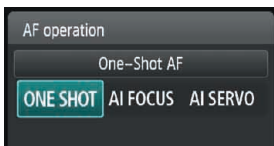

ONE SHOT (One-Shot AF):

For still subjects

AI FOCUS (AI Focus AF):

Switches the AF operation automatically

AI SERVO (AI Servo AF):

For moving subjects

AF Point☆

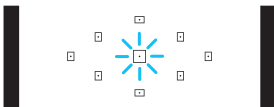
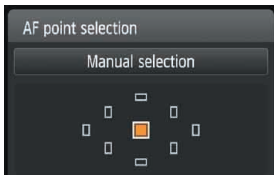

- Press the <☒> button.
- Press the <⬆️⬇️⬇️⬆️> cross keys to select the AF point.
- While looking through the viewfinder, you can select the AF point by turning the <☀> dial until the desired AF point flashes in red.
- Pressing <SET> toggles the AF point selection between the center AF point and automatic AF point selection.

ISO: ISO Speed ☆

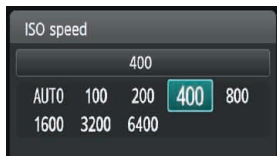
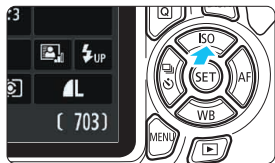

- Press the <▲ISO> button.
- Press the <◀▶> <▶▶> keys or turn the <⚙️> dial to select the ISO speed, then press <SET>.
- When [AUTO] is selected, the ISO speed is set automatically. When you press the shutter button halfway, the ISO speed setting is displayed.

Drive/Self-timer ☆

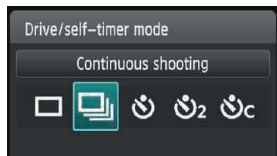
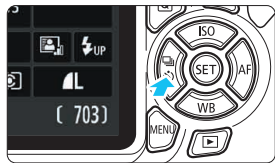

- Press the <◀▶> <▶▶> button.
- Press the <◀▶> <▶▶> keys or turn the <⚙️> dial to select the drive mode, then press <SET>.

□ : **Single shooting**

☰ : **Continuous shooting**

⌚ : **Self-timer:10 sec.***

⌚₂ : **Self-timer:2 sec.**

⌚_c : **Self-timer:Continuous***

* The <⌚> and <⌚_c> drive modes can be selected in all shooting modes (except <▶▶>).

Live View Shooting





- Press the  button to display the Live View image.

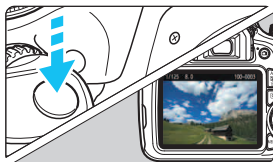

- Press the shutter button halfway to focus.



- Press the shutter button completely to take the picture.

- Live View shooting settings will appear under the [ 2] menu tab in Basic Zone modes and under the [ 4] menu tab in Creative Zone modes.

● Number of Possible Shots (Live View Shooting)

Temperature	No Flash	50% Flash Use
At 23°C / 73°F	Approx. 190 shots	Approx. 180 shots

Movie Shooting (Autoexposure)



- Set the Mode Dial to .



- Press the shutter button halfway to focus.



- Press the button to start shooting a movie.
- To stop movie shooting, press the button again.

Recording movie

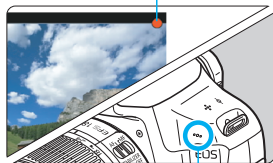

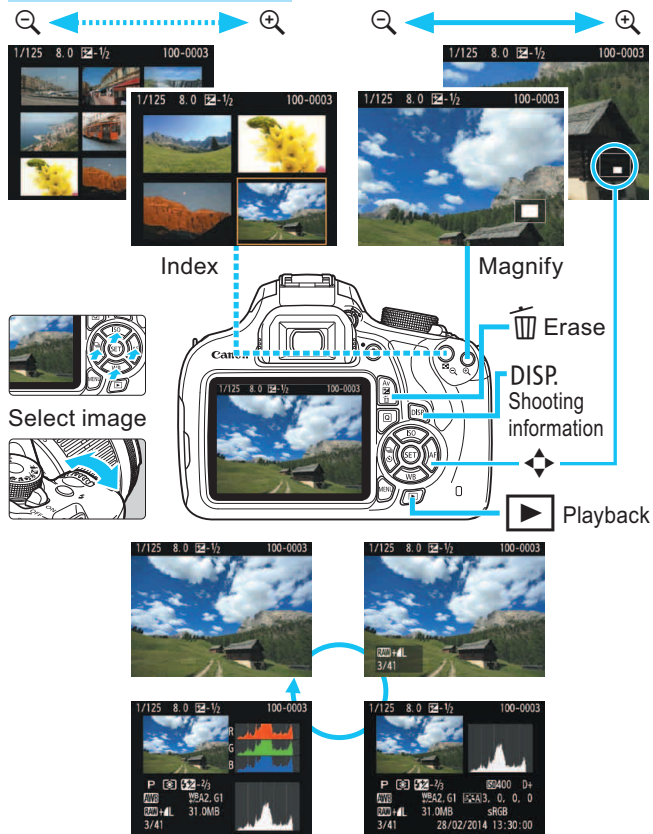

Microphone

Image Playback



Index

- Numerics**
- 10- or 2-sec. self-timer..... 100
- 1280x720 (movie)..... 164
- 1920x1080 (movie)..... 164
- 640x480 (movie)..... 164
- 9-point AF auto selection..... 95
- A**
-  (Scene Intelligent Auto)..... 56
- AC Adapter..... 268
- Access lamp..... 34
- Accessories..... 3
- Adobe RGB..... 131
- AE lock..... 116
- AEB
(Auto Exposure Bracketing)... 114, 258
- AF → Focusing
- AF point..... 95
- AI FOCUS (AI Focus AF)..... 94
- AI SERVO (AI Servo AF)..... 94
- Ambience-based shots..... 73
- Aperture-priority AE..... 106
- Aspect ratio..... 140
- Auto Lighting Optimizer..... 55, 119
- Auto playback..... 218
- Auto power off..... 35, 181
- Auto reset..... 185
- Auto rotate..... 188
- Autofocus..... 93, 95
- Automatic selection (AF)..... 95
- Automatic selection of AF point..... 95
- Av (Aperture-priority AE)..... 106
- B**
- B/W (Monochrome)..... 92, 124
- Background music..... 221
- Basic Zone modes..... 26
- Battery..... 30, 32, 36
- Battery check..... 36
- Beeper..... 180
- Black-and-white image..... 73, 92, 124
- Bracketing..... 114, 130
- Brightness (exposure)..... 112
 - Auto Exposure Bracketing (AEB)..... 114, 258
 - Autoexposure lock (AE lock).... 116
 - Exposure compensation..... 112
 - Measurement method (metering mode)..... 111
- Built-in flash..... 101
 - Function settings..... 195
- BULB (bulb exposure)..... 110
- C**
-  (Creative Auto)..... 62
- Cable..... 3, 212, 222, 240, 276, 316
- Camera
 - Clearing the camera settings... 190
 - Holding the camera..... 44
 - Settings display..... 189
- Camera shake..... 44
- Cards..... 21, 32, 50
 - Card reminder..... 180
 - Formatting..... 50
 - Low-level formatting..... 51
 - SD speed class..... 5
 - Troubleshooting..... 34, 51
 - Write-protect switch..... 32
- Center-weighted average metering..... 111
- Charger..... 28, 30
- Cleaning (image sensor)..... 200

- Clearing the camera settings 190
 - Close-ups 67
 - Color space
(color reproduction range)..... 131
 - Color temperature 127
 - Color tone 123
 - Continuous file numbering 184
 - Continuous shooting 98
 - Contrast 123
 - Copyright information 186
 - Creative Auto 62
 - Creative filters 234
 - ★ (Creative Zone) icon 8
 - Creative Zone modes 26
 - Custom Functions 256
- D**
- Date/time 37
 - Daylight saving time 38
 - DC Coupler 268
 - Depth-of-field preview 108, 264
 - Dial 22, 103
 - Digital terminal 240, 316
 - Dioptric adjustment 44
 - Direct printing 240
 - DPOF
(Digital Print Order Format)..... 249
 - Drive mode 24, 64, 98
 - Dust Delete Data 198
- E**
- Erasing images 227
 - Error codes 296
 - Evaluative metering 111
 - Exposure compensation 112
 - Exposure level increments 258
 - External flash 270
 - Custom Functions 197
 - Eyecup 269
 - Eye-Fi card 272
 - Eyepiece cover 29, 269
- F**
- Faithful 92
 - FE lock 117
 - Feature guide 53
 - FEB (flash exposure bracketing) ... 195
 - File extension 185
 - File name (file numbering) 184
 - File size 85, 165, 229
 - Filter effect 124
 - Final image simulation 137, 160
 - Fine (image-recording quality) 24
 - Firmware version 281
 - First-curtain synchronization 196
 - Fish-eye effect 236
 - Flash
 - Built-in flash 101
 - Custom Functions 197
 - Effective range 101
 - External flash 270
 - FE lock 117
 - Flash control 194
 - Flash exposure compensation . 113
 - Flash mode 196
 - Flash off 61, 64, 72
 - Flash sync contacts 22
 - Flash sync speed 259, 271
 - Manual flash 196
 - Red-eye reduction 102
 - Shutter synchronization
(1st/2nd curtain) 196
 - Focus confirmation light 56

Focus lock..... 59

Focus mode switch 40, 97, 150

Focusing

- AF method..... 142, 172
- AF operation..... 93
- AF point selection..... 95
- AF-assist beam 96, 262
- Beeper..... 180
- Difficult-to-focus subjects... 97, 146
- Manual focusing 97
- Out of focus 43, 44, 97, 146
- Recomposing 59

Folder creation/selection..... 182

Formatting (card initialization)..... 50

Frame rate 164

Full Auto (Scene Intelligent Auto) ... 56

Full High-Definition
(Full HD) 164, 212

Function availability by
shooting mode 274

G

Grainy B/W 236

Grid display..... 139, 175

H

HDMI..... 212, 222

HDMI CEC 223

High ISO speed noise reduction... 261

High-Definition (HD)
movies 164, 212, 222

Highlight alert..... 231

Highlight detail loss..... 231

Highlight tone priority..... 173, 261

Histogram (Brightness/RGB) 231

Hot shoe 22, 270

Household power..... 268

I

ICC profile 131

Image area..... 41

Image dust prevention..... 198, 200

Image-recording quality..... 84

Image review time 180

Image Stabilizer (lens)..... 43

Image Zone 26

Images

- Auto playback 218
- Auto rotate 188
- Erasing..... 227
- Highlight alert..... 231
- Histogram 231
- Image characteristics
(Picture Style) 91, 122, 125
- Index 204
- Jump display
(image browsing) 205
- Magnified view 206
- Manual rotation 207
- Numbering 184
- Playback 80, 203
- Protection..... 225
- Rating 208
- Review time 180
- Shooting information..... 229
- Slide show 218
- Transfer..... 272
- Viewing on a TV set..... 212, 222

Index display 204

ISO speed 88

- Automatic setting (Auto) 89
- ISO expansion 258
- Maximum ISO speed for
ISO Auto 90

- J**
- JPEG.....85
 - Jump display.....205
- L**
- Landscape.....66, 92
 - Language selection.....39
 - Large (image-recording quality).....24
 - LCD monitor.....21
 - Brightness adjustment.....181
 - Image playback.....80, 203
 - Menu screen.....48, 278
 - Screen color.....193
 - Shooting settings.....24, 52
 - Lens.....27, 40
 - Image Stabilizer.....43
 - Lock release.....41
 - Peripheral illumination correction.....120
 - Lighting/scene-based shots.....77
 - Live View shooting.....60, 133
 - Aspect ratio.....140
 - Face detection Live mode (AF).....143
 - FlexiZone - Single.....142
 - Grid display.....139
 - Information display.....136
 - Manual focusing.....97, 150
 - Metering timer.....141
 - Possible shots.....135
 - Quick Control.....138
 - Quick mode.....148
 - Long exposure noise reduction.....260
 - Long exposures.....110
- M**
- M (Manual exposure).....109
 - Macro photography.....67
 - Magnified view.....150, 206
 - Malfunction.....284
 - Manual exposure.....109, 156
 - Manual focus (MF).....97
 - Manual reset.....185
 - Manual selection (AF).....95
 - Manual white balance.....127
 - Maximum burst.....85, 86
 - Medium (image-recording quality).....24
 - Memory cards → Cards
 - Menu.....48
 - My Menu.....265
 - Setting procedure.....49
 - Settings.....278
 - MENU** icon.....8
 - Metering mode.....111
 - Metering timer.....141, 175
 - MF (manual focusing).....97, 150
 - Microphone.....154
 - Miniature effect.....236
 - Mode Dial.....26
 - Monochrome.....73, 92, 124
 - Movies.....153
 - AF method.....163, 172
 - Autoexposure.....154
 - Editing.....216
 - File size.....165
 - Frame rate.....164
 - Grid display.....175
 - Information display.....158
 - Manual exposure.....156
 - Manual focusing.....154
 - Metering timer.....175
 - Movie recording size.....164
 - Playback.....214
 - Quick Control.....163

Recording time	165
Sound recording	174
Still photo shooting	161
Video snapshot album	166
Video snapshots	166
Viewing on a TV set	212, 222
Wind filter	175
My Menu	265

N

Neutral	92
Night Portrait	69
Night scenes	66, 69
Noise reduction	
High ISO speed	261
Long exposures	260
Nomenclature	22
Non-Canon flash units	271
Normal (image-recording quality) ...	24
NTSC	164, 282

O

ONE SHOT (One-Shot AF)	93
------------------------------	----

P

P (Program AE)	82
PAL	164, 282
Paper settings (printing)	242
Partial metering	111
Peripheral illumination correction ...	120
Personal white balance	128
Photobook set-up	253
PictBridge	239
Picture Style	91, 122, 125
Pixels	84
Playback	80, 203
Portrait	65, 91

Possible shots	36, 84, 135
----------------------	-------------

Power

Auto power-off	181
Battery check	36
Household power	268
Possible shots	36, 84, 135
Recharging	30
Predictive (AI Servo)	94
Pressing completely	45
Pressing halfway	45
Printing	239
Cropping	247
Page layout	243
Paper settings	242
Photobook set-up	253
Print order (DPOF)	249
Printing effects	244
Tilt correction	247
Program AE	82
Program shift	83
Protecting images	225

Q

[Q] (Quick Control)	46, 71, 138, 163, 210
Quick mode	148

R

Rating mark	208
RAW	24, 85, 87
RAW+JPEG	24, 85, 87
Recharging	30
Red-eye reduction	102
Release shutter without card	180
Remote switch	269
Resizing	237
Reverting to default settings	190

Rotation (image) 188, 207, 247

S

Safety Precautions.....307

Saturation.....123

SD, SDHC, SDXC cards → Cards

Second-curtain synchronization.....196

Self-timer.....100

Sensor cleaning200

Sepia (monochrome)73, 124

Sharpness.....123

Shooting information display.....229

Shooting mode.....26

Av (Aperture-priority AE)106

M (Manual exposure).....109

P (Program AE)82

Tv (Shutter-priority AE).....104

 (Scene Intelligent Auto).....56

 (Flash Off).....61

 (Creative Auto)62

 (Portrait)65

 (Landscape)66

 (Close-up).....67

 (Sports).....68

 (Night Portrait)69

Shooting settings24, 52

Shutter button45

Shutter synchronization196

Shutter-priority AE.....104

Single shooting64, 275

Single-image display.....80

Single-point AF95

Slide show.....218

Small

(image-recording quality)24, 238

Soft focus236

Software.....318

Speaker214

Sports68

sRGB.....131

Strap29

System map276

T

Temperature warning.....151, 177

Time zone.....37

Tone priority.....173, 261

Toning effect (monochrome).....124

Toy camera effect236

Tripod socket.....23

Tv (Shutter-priority AE).....104

U

USB (digital) terminal240, 316

V

Video snapshot album.....166

Video snapshots166

Video system.....164, 175

Viewfinder.....25

 Dioptic adjustment44

Viewing on a TV set212, 222

Volume (movie playback)215

W

WB (white balance)127

White balance.....127

 Bracketing130

 Correction129

 Custom.....127

 Personal.....128

Wind filter175



CANON INC.

30-2 Shimomaruko 3-chome, Ohta-ku, Tokyo 146-8501, Japan

Europe, Africa & Middle East

CANON EUROPA N.V.

PO Box 2262, 1180 EG Amstelveen, The Netherlands

For your local Canon office, please refer to your warranty card or to www.canon-europe.com/Support

The product and associated warranty are provided in European countries by Canon Europa N.V.

The descriptions in this Instruction Manual are current as of May 2016. For information on the compatibility with any products introduced after this date, contact any Canon Service Center. For the latest version Instruction Manual, refer to the Canon website.