

Canon

MULTIMEDIA PROJECTOR
WUX6500
User's Manual



Safety Instructions

Before Use

Installation Procedure

Connection Procedure

Projection Procedure

Convenient Features

Using Menus

Menu Configuration

Menu Description

Advanced Projection

Maintenance

Product Specifications

Troubleshooting

Basic Guide

Advanced Guide

Other Information

ENG

How to Use This Manual

Thank you for purchasing a Canon projector.

The WUX6500 Multimedia Projector is a high-performance projector that is capable of projecting a high-resolution computer screen and high-quality digital image on a large screen.

This Manual

This is the user's manual for WUX6500 Multimedia Projectors (hereafter, "projector"). The "Basic Guide" section describes installation and basic use of the projector. Descriptions of menus and how to connect the projector to a network are given in the "Advanced Guide" section. Read this manual thoroughly to make the most of your projector. We recommend requesting installation by a qualified technician or the Canon Customer Support Center.

Symbols of Button Operations

The projector can be operated using the buttons on the remote control or on the side of the projector. The remote control allows you to operate all functions of the projector.

In this document, the button's operations are shown as below.

Operation of buttons
on side of projector

Remote control button
operation

Indicate the buttons to
be pressed

Selecting Screen Aspect

Select the correct aspect ratio for the screen which is used.

1 Press the MENU button to display the menu window.

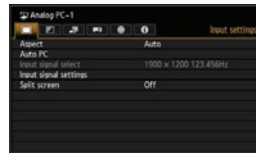
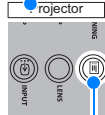

Symbols Used in This Manual

Sections labeled with these symbols give the following kinds of information.



Indicates precautions and information to note when using the projector.

Table of Contents

How to Use This Manual	2
Projector Highlights	5
Safety Instructions	7
Safety Precautions.....	8
CAUTION ON HANGING FROM THE CEILING	8
AC Power Cord Requirement.....	11
Federal Communication Commission Notice	12
Precautions for Use	14
Installation and Handling	
Precautions	15
Precautions on the Lamp	17
Precautions for the Batteries of the Remote Control	18
For Safe Use	20
Before Installation	22
Precautions When Carrying/Shipping the Projector	22
Precautions for Installation.....	22
Open Source Software	27
Before Use	28
Included Accessories	28
Part Names	29
Projector	29
Side Control.....	30
LED Indicators.....	31
Input Terminal	33
Remote Control	35
Preparing the Remote Control.....	37
Basic Guide	39
Installation Procedure	40
Setting Up the Projector	40
Relationship Between Image Size and Projecting Distance	43
Lens Shift Function	47
Connection Procedure	49
Connecting a Computer	49
Connecting AV Equipment.....	51
Plugging the Projector In	52
Projection Procedure	53
Step 1 Turn the Projector On	53
Step 2 Select an Input Signal.....	56
Step 3 Adjust the Image	57
Step 4 Select an Aspect Ratio (Screen Aspect) Matching the Screen.....	63
Step 5 Adjusting Keystone Distortion	67
Step 6 Select the Image Quality (Image Mode)	70
Step 7 Turn the Projector Off.....	71
Convenient Features	72
Adjusting the Volume	74
Muting the Sound.....	74
Zooming Part of an Image.....	75
Advanced Guide	77
Using Menus	78
Menu Configuration	78
Basic Menu Operations	79
Menu Configuration	81
Menu Description	90
Input settings	90
Image adjustment	96
Install settings.....	104
System settings	116
Network settings	127
Completing Projector Settings	129
Completing Computer Settings	136
Checking Projector Information	156
Advanced Projection	157
Projecting Images on a USB Flash Drive	157
Description of USB File Browser.....	159
Selecting an Image for Projection	160
Operating the Projected Image.....	160
Running a Slideshow of Data Saved in a USB Flash Memory	161
Split-Screen Display	161
Projecting from Multiple Projectors at Once (Edge Blending)	162
Other Information	169
Maintenance	170
Cleaning the Projector and the Air Filter	170
Cleaning the Air Filter.....	171
Replacing the Air Filter.....	172
Replacing the Lamp.....	173
Replacement Lamp	175

Table of Contents

- Lamp Replacement Procedure 176**
- Installing / Removing the Lens**
- Unit 178**
- Product Specifications 183**
- Relationship between Aspect and**
- Screen Aspect 183**
- Displayed Test Patterns 187**
- Supported Signal Types 188**
- Troubleshooting 198**
- LED Indicator Details 198**
- Symptoms and Solutions 199**
- Index 205**
- Option 207**

Installation and Handling Precautions
Précautions d'installation et de manipulation
Precauciones de instalación y manejo
Hinweise zur Aufstellung und Handhabung
Precauzioni relative all'installazione e a come si maneggia il proiettore
Voorzorgsmaatregelen voor installatie en behandeling
Forsigtighedsregler ved installation og håndtering
Försiktighetsåtgärder vid montering och hantering
Asennusta ja käsittelyä koskevat varotoimet
安装和搬运注意事项

설치 및 취급 절차
安裝與使用注意事項
設置および取り扱い上のご注意



Y T 1 7 5 1 9 0 0 0

YT1-7519-000 ©CANON INC. 2017

ENG

Store this document together with the "Important Information" (booklet) and the "User's Manual" (CD-ROM).

Warning

Installation and Handling Precautions



Prohibition



Caution

- Do not install the projector in a location that is damp, or where there is a lot of dust, oily smoke or tobacco smoke. Doing so could cause contamination of optical components such as the lens and the mirror and may result in deterioration of image quality. In addition, oil can degrade the plastic, which could result in a ceiling-mounted projector falling from its mounting.
- Do not use adhesives, lubricants, oils, or alkaline detergents for maintenance of the projector. They could adhere to the plastic and deteriorate it, possibly resulting in the projector falling if it is ceiling-mounted.
- Make sure to implement anti-fall measures such as an anti-fall wire when installing the projector in high places, for example, installing it on the ceiling.

FRA

Conservez ce document avec les « Informations importantes » (livret) et le « Mode d'emploi » (CD-ROM).

Avertissement

Précautions d'installation et de manipulation



Interdiction



Attention

- N'installez pas le projecteur dans un endroit humide ou très poussiéreux, ou dans lequel il serait exposé à des fumées contenant des particules de graisse ou de tabac. Les composants optiques, comme l'objectif ou le miroir, pourraient être contaminés, et la qualité de l'image en serait altérée. De plus, l'huile peut détériorer le plastique, ce qui pourrait provoquer la chute du projecteur monté au plafond.
- N'utilisez pas de colle, de lubrifiants, d'huiles ou de détergents alcalins pour l'entretien du projecteur. Ils pourraient se coller au plastique et l'endommager, ce qui pourrait provoquer la chute du projecteur s'il est monté au plafond.
- Veillez à mettre en place des mesures antichute telles qu'un câble antichute lors de l'installation du projecteur en hauteur, par exemple au plafond.

SPA

Guarde este documento junto con la "Información importante" (folleto) y las "Instrucciones de uso" (CD-ROM).

Advertencia

Precauciones de instalación y manejo



Prohibición



Atención

- No instale el proyector en un lugar húmedo o donde haya polvo, humo de tabaco o grasa. De hacerlo, los componentes ópticos como la lente y el espejo podrían ensuciarse, afectando a la calidad de imagen. Además, la grasa puede degradar el plástico, lo cual podría causar el desprendimiento del proyector montado en el techo respecto de su montura.
- No utilice adhesivos, lubricantes, aceites o detergentes alcalinos para el mantenimiento del proyector. Tales sustancias podrían adherirse al plástico y deteriorarlo, lo que podría causar la caída del proyector si está montado en el techo.
- Al instalar el proyector en lugares elevados, como por ejemplo en el techo, asegúrese de tomar medidas contra la caída del aparato, tales como el uso de un cable de sujeción.

ITA

Conservare questo documento insieme a "Informazioni importanti" (opuscolo) e al "Manuale d'uso" (CD-ROM).

Avvertenza

Precauzioni relative all'installazione e a come si maneggia il proiettore



Divieto



Attenzione

- Non installare il proiettore in luoghi umidi o in presenza di grandi quantitativi di polvere, fumo oleoso o fumo di tabacco. In caso contrario, si potrebbe provocare la contaminazione dei componenti ottici quali l'obiettivo e lo specchio, e provocare il deterioramento della qualità dell'immagine. Inoltre, l'olio può degradare la plastica, il che potrebbe risultare nella caduta di un proiettore montato a soffitto dal suo attacco.
- Non utilizzare adesivi, lubrificanti, oli o detergenti alcalini per la manutenzione del proiettore. Potrebbero aderire alla plastica e deteriorarla, con la possibilità di causare la caduta del proiettore, qualora sia montato a soffitto.
- Quando si intende installare il proiettore in ubicazioni elevate, ad esempio quando si intende installarlo sul soffitto, accertarsi di implementare misure di prevenzione delle cadute, ad esempio un cavo metallico anticaduta.

GER

Bewahren Sie dieses Dokument zusammen mit „Wichtige Informationen“ (Broschüre) und dem „Benutzerhandbuch“ (CD-ROM) auf.

Warnung

Hinweise zur Aufstellung und Handhabung



Verbot



Vorsicht

- Stellen Sie den Projektor nicht an einem Ort auf, an dem er Feuchtigkeit, Staub, starken Öldünsten oder Zigarettenrauch ausgesetzt ist. Andernfalls könnten die optischen Bauteile (Objektiv, Spiegel) verschmutzt werden, was zu einer Verschlechterung der Bildqualität führen würde. Darüber hinaus kann Öl den Kunststoff zersetzen. Dies kann dazu führen, dass ein an der Decke montierter Projektor aus seiner Halterung fällt.
- Verwenden Sie keine Klebstoffe, Schmiermittel, Öle oder alkalische Reinigungsmittel für die Wartung des Projektors. Sie könnten an dem Kunststoff anhaften und ihn beschädigen. Dies kann dazu führen, dass der Projektor herunterfällt, wenn er an einer Decke montiert ist.
- Achten Sie darauf, dass der Projektor bei der Montage in einer hohen Position (z. B. an der Decke) gegen Absturz gesichert wird (z. B. mit einem Drahtseil).

NLD

Bewaar dit document samen met het boekje „Belangrijke informatie“ en de „Gebruikershandleiding“ (CD-ROM).

Waarschuwing

Voorzorgsmaatregelen voor installatie en behandeling



Verboden



Voorzichtig

- Installeer de projector niet in een vochtige of stoffige ruimte of op een plaats met vettige rook of tabaksrook. Dit kan verontreiniging van de optische componenten zoals de lens en de spiegel veroorzaken en kan verslechtering van de beeldkwaliteit tot gevolg hebben. Daarnaast kunnen vet en olie het kunststof aantasten waardoor een projector die aan het plafond is bevestigd, zou kunnen vallen.
- Gebruik voor het onderhoud van de projector geen hechtmiddelen, smeerolie, andere olie of alkalische schoonmaakmiddelen. Deze blijven mogelijk achter op het kunststof, waardoor dit wordt aangetast. Hierdoor zou de projector kunnen vallen als deze aan het plafond is gemonteerd.
- Zorg ervoor dat u valpreventiemaatregelen neemt, bijvoorbeeld door een veiligheidskabel te gebruiken, als u de projector op een hoge plaats installeert, bijvoorbeeld aan het plafond.

DEN

Opbevar dette dokument sammen med "Vigtige oplysninger" (hæfte) og "Brugervejledningen" (CD-ROM).

⚠ Advarsel**Forsigtighedsregler ved installation og håndtering**

Forbud

- Undlad at installere projektoren et sted, der er fugtigt, eller hvor der er meget støv, oliedampe eller cigaretrøg. Ellers kan det resultere i, at de optiske dele, som f.eks. linsen og spejlet, kontamineres, og billedkvaliteten forringes. Desuden kan olie nedbryde plastikken, hvilket kan medføre, at en loftsmonteret projektor falder ned fra sin montering.
- Undlad at bruge klæbestoffer, smøremidler, olier eller alkaliske rengøringsmidler til at vedligeholde projektoren. De kan sætte sig fast på plastikken og forringe den og muligvis medføre, at projektoren falder ned, hvis den er monteret i loftet.
- Sørg for at benytte forholdsregler til forebyggelse af fald, for eksempel en sikkerhedslinje, når projektoren monteres på højtliggende steder, for eksempel når den monteres i loftet.



Forsigtig

SWE

Förvara det här dokumentet tillsammans med "Viktig information" (häfte) och "Användarhandbok" (CD-ROM).

⚠ Varning**Försiktighetsåtgärder vid montering och hantering**

Förbjudet



Observera

- Montera inte projektorn på en plats som är fuktig eller där det finns mycket damm, oljig rök eller tobaksrök. Detta kan förorena optiska komponenter, t.ex. lins och spegel, och kan leda till försämrad bildkvalitet. Dessutom kan olja bryta ned plasten, vilket kan leda till att projektorn faller ned från sitt fäste om den är takmonterad.
- Använd inte lim, smörjmedel, oljor eller alkaliska rengöringsmedel vid underhållet av projektorn. Sådana ämnen kan klibba fast på plasten och bryta ned eller på annat sätt skada den, vilket eventuellt kan leda till att projektorn faller ned om den är takmonterad.
- Använd alltid en fallskyddskabel eller vidtag andra fallskyddsåtgärder när du monterar projektorn på högt uppsatta platser, till exempel vid montering i taket.

FIN

Säilytä tämä asiakirja yhdessä tuotteiden "Tärkeää tietoa" (kirjanen) ja "Käyttöopas" (CD-ROM) kanssa.

⚠ Varoitus**Asennusta ja käsittelyä koskevat varotoimet**

Kielto

- Älä aseta projektoria paikkaan, joka on kostea, jossa on paljon pölyä, öljyistä savua tai tupakansavua. Se saattaa johtaa optisten osien, kuten objektiivin ja peilin likaantumiseen, sekä saattaa heikentää kuvan laatua. Lisäksi öljy voi heikentää muoviva, mikä voi aiheuttaa kattoon asennetun projektorin putoamisen kiinnityksestään.
- Älä käytä liimoja, voiteluaineita, öljyjä tai emäksisiä puhdistusaineita projektorin huoltamisessa. Ne voivat kiinnittyä muoviin ja heikentää sitä, mikä voi johtaa projektorin putoamiseen, jos se on kiinnitetty kattoon.
- Varmista, että teet kaikki putoamisen estävät toimenpiteet, kuten putoamisen estävä vajjeri, kun asennat projektorin korkealle, esimerkiksi asennat sen kattoon.



Huomio

CHI

请将此文与“使用说明书（手册、CD-ROM）一起保管。

⚠ 警告**安装和搬运注意事项**

禁止



注意

- 切勿将投影机安装在潮湿或多尘、有油烟或香烟烟雾的地方。否则可能会污染光学部件(如镜头和反光镜), 会导致影像质量下降。此外, 油会侵蚀塑料, 降低其性能, 有可能导致安装在天花板上的投影机从其安装位置掉落。
- 请勿使用粘合剂、润滑剂、机油或碱性除垢剂来维护投影机。这些物质可能会附着在塑料上并对其造成损坏, 如果投影机安装在天花板上, 有可能导致投影机掉落。
- 在高处安装投影机时(如将其安装在天花板上), 请务必采取防坠落措施, 如防坠落金属丝。

KOR

이 종이를 [중요 정보(책자)] 및 [사용 설명서(CD-ROM)]와 함께 보관해 주십시오.

⚠ 경고**설치 및 취급 절차**

금지



주의

- 습기나 먼지, 유연이나 담배 연기가 많은 장소에는 설치하지 마십시오. 렌즈나 미러 등의 광학부품에 이물질이 부착되어 화질을 손상시키는 원인이 될 수 있습니다. 또한 오일은 플라스틱의 품질을 저하시켜 천정에 장착된 프로젝터가 떨어질 수 있습니다.
- 프로젝터의 유지관리를 위해 접착제, 윤활제, 오일 또는 알칼리성 세제를 사용하지 마십시오. 플라스틱에 접촉되어 플라스틱을 손상시킬 수 있으며 프로젝터가 천정에 장착된 경우 떨어질 수 있습니다.
- 프로젝터를 높은 곳에 설치할 때 (예 :천정에 설치) 는 낙하 방지 와이어와 같은 낙하 방지 조치를 취하십시오.

FOR

請將此文與“重要資訊”和“使用說明書(CD-ROM)一同保管。

⚠ 警告**安裝與使用注意事項**

禁止



注意

- 請勿將投影機安裝在潮濕或者有很多灰塵、油煙或香菸煙霧的地方。這樣做可能會使得鏡頭與鏡片之類光學組件被污染, 而且可能會造成影像品質劣化。此外, 油會讓塑膠劣化, 而這可能會使得安裝在天花板上的投影機從其安裝處掉下來。
- 請勿使用黏性、潤滑、油性或鹼性清潔劑保養投影機。它們可能會附着在塑膠上而令其劣化, 如果投影機安裝在天花板上, 可能會造成投影機掉下來。
- 將投影機安裝在高處如天花板上時, 務必要採取防止掉落的措施, 例如, 防止掉落的鋼纜。

JPN

この紙を「重要なお知らせ(冊子)」および「使用説明書(CD-ROM)」と一緒に保管してください。

⚠ 警告**設置および取り扱い上のご注意**

禁止



注意

- 湿気やホコリ、油煙やタバコの煙が多い場所には設置しないでください。レンズやミラーなどの光学部品に汚れが付着して、画質を損なう原因になることがあります。また、油により樹脂が劣化し、天吊り設置の場合に落下するおそれがあります。
- 本機のメンテナンスの際に接着剤、潤滑剤、油、アルカリ性洗剤などを使用しないでください。付着すると樹脂が劣化し、天吊り設置の場合に落下するおそれがあります。
- 天吊りのように高所に設置する場合は必ず落下防止ワイヤーなどの落下防止措置をプロジェクター本体に施してください。

Projector Highlights

High-Resolution LCOS Projection

Projection at 1920x1200 (WUXGA), thanks to high-resolution reflective liquid crystal on silicon (LCOS) panels.

HDBaseT Input

The projector supports HDBaseT, a next-generation connectivity standard. HDBaseT offers a convenient connection for carrying high-quality video and audio signals equivalent to HDMI across distances up to 100 m over a single LAN cable. This port can also be used to connect the projector to a network.

(P50, P51, P120, P121, P127)

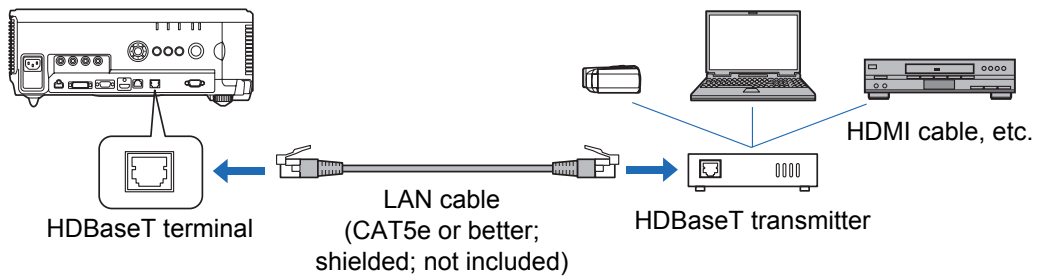

Lens Shift

Lens shift enables motorized image repositioning up, down, left, or right (P47) for greater freedom in installation.

Motorized Zoom and Focus Adjustment

Efficient setup using motorized zoom and focus adjustment.

Five Lens Units Available

Choose the optimal lens unit for the projection distance or purpose.

Split-Screen Display

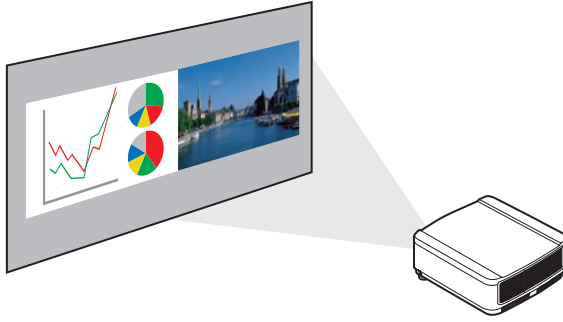

Splits the screen for projection of two separate input signals at once. (P161)

Edge Blending

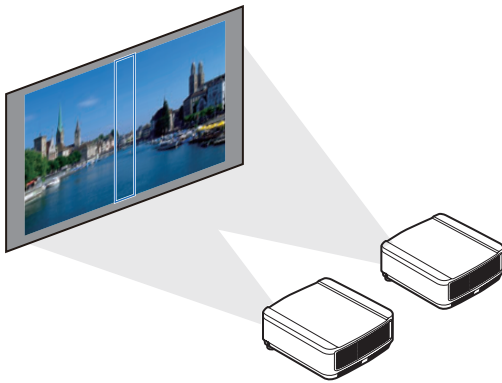

Blend the overlapping edges of images from multiple projectors to make the overall image more seamless. (P162)

Networked Multi-Projection (NMPJ)

Project images from multiple computers via a network connection. For details on Networked Multi-Projection (NMPJ), refer to the NMPJ user's manual.

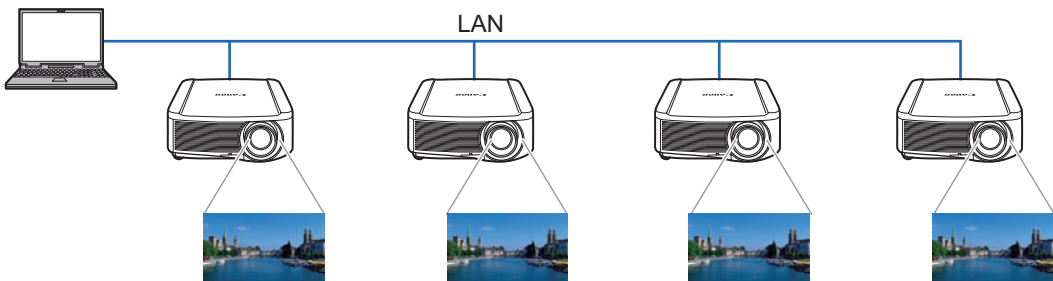





Safety Instructions

Before installing and operating the projector, read this manual thoroughly. This projector provides many convenient features and functions. Operating the projector properly enables you to manage those features and maintain it in good condition for many years to come.

Improper operation may result in not only shortening the product life, but also malfunctions, fire hazards, or other accidents.

If your projector does not seem to be operating properly, read this manual again, check operations and cable connections, and try the solutions in the “Troubleshooting” section in the back of this manual. If the problem still persists, contact the Canon Customer Support Center.

	CAUTION RISK OF ELECTRIC SHOCK DO NOT OPEN	
CAUTION: TO REDUCE THE RISK OF ELECTRIC SHOCK, DO NOT REMOVE COVER (OR BACK). NO USER-SERVICEABLE PARTS INSIDE EXCEPT LAMP REPLACEMENT. REFER SERVICING TO QUALIFIED SERVICE PERSONNEL.		
	THIS SYMBOL INDICATES THAT DANGEROUS VOLTAGE CONSTITUTING A RISK OF ELECTRIC SHOCK IS PRESENT WITHIN THIS UNIT.	
	THIS SYMBOL INDICATES THAT THERE ARE IMPORTANT OPERATING AND MAINTENANCE INSTRUCTIONS FOR THIS UNIT IN THE OWNER'S MANUAL.	

CAUTION Not for use in a computer room as defined in the Standard for the Protection of Electronic Computer / Data Processing Equipment, ANSI / NFPA 75.
--

Safety Precautions

WARNING:

- **THIS APPARATUS MUST BE GROUNDED.**
- **TO REDUCE THE RISK OF FIRE OR ELECTRIC SHOCK, DO NOT EXPOSE THIS APPLIANCE TO RAIN OR MOISTURE.**
- This projector produces intense light from the projection lens. Do not stare directly into the lens, otherwise eye damage could result. Be especially careful that children do not stare directly into the beam.
- Install the projector in a proper position. Otherwise it may result in a fire hazard.
- Allowing the proper amount of space on the top, sides, and rear of the projector cabinet is critical for proper air circulation and cooling of the unit. The diagrams shown here indicates the minimum space required. If the projector is to be built into a compartment or similarly enclosed, these minimum distances must be maintained.

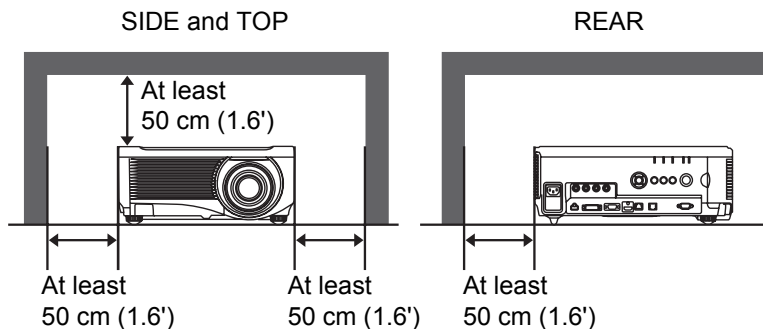

- Do not cover the ventilation slots on the projector. Heat build-up can reduce the service life of your projector, and can also be dangerous.
- If the projector is unused for an extended time, unplug the projector from the power outlet.
- Do not project the same image for a long time.

An afterimage may remain on the LCD panels due to the characteristics of the panels of the projector.

CAUTION ON HANGING FROM THE CEILING

When hanging the projector from the ceiling, clean the air intake vents and top of the projector periodically with a vacuum cleaner. If you leave the projector unclean for a long time, the cooling fans can be clogged with dust, and it may cause a breakdown or a disaster.

DO NOT SET THE PROJECTOR IN GREASY, WET, OR SMOKY CONDITIONS SUCH AS IN A KITCHEN TO PREVENT A BREAKDOWN OR A DISASTER. IF THE PROJECTOR COMES IN CONTACT WITH OIL OR CHEMICALS, IT MAY BECOME DETERIORATED.

■ READ AND KEEP THIS OWNER'S MANUAL FOR LATER USE.

All the safety and operating instructions should be read before beginning to operate the product.

Read all of the instructions given here and retain them for later use. Unplug this projector from the AC power supply before cleaning. Do not use liquid or aerosol cleaners on the projector. Use a damp cloth for cleaning.

Follow all warnings and instructions marked on the projector.

For added protection of the projector during a lightning storm, or when it is left unattended or unused for long periods of time, unplug it from the wall outlet. This will prevent damage due to lightning and power surges.

Do not expose this unit to rain or use near water... for example, in a wet basement, near a swimming pool, etc...

Do not use attachments not recommended by the manufacturer as they may result in hazards.

Do not place this projector on an unstable cart, stand, or table. The projector may fall, causing serious injury to a child or adult, and serious damage to the projector. Use only with a cart or stand recommended by the manufacturer, or sold with the projector. Wall or shelf mounting should be carried out in accordance with the manufacturer's directions, and should use a mounting kit approved by the manufacturers.

An appliance and cart combination should be moved with care. Sudden stops, excessive force, and uneven surfaces may cause the appliance and cart combination to overturn.



Slots and openings in the rear and front of the cabinet are provided for ventilation, to insure reliable operation of the equipment and to protect it from overheating.

The openings should never be covered with cloth or other materials, and the bottom opening should not be blocked by placing the projector on a bed, sofa, rug, or other similar surface. This projector should never be placed near or over a radiator or heat register.

This projector should not be placed in a built-in installation such as a book case unless proper ventilation is provided.

Safety Instructions

Never push objects of any kind into this projector through cabinet slots as they may touch dangerous voltage points or short out parts that could result in a fire or electric shock. Never spill liquid of any kind onto the projector.

Do not install the projector near the ventilation duct of air-conditioning equipment.

This projector should be operated using only the type of power source indicated on the marking label. If you are not sure of the type of power supplied, contact the Canon Customer Support Center or local power company.

Do not overload wall outlets and extension cords as this can result in fire or electric shock. Do not allow anything to rest on the power cord. Do not locate this projector where the cord may be damaged by people walking on it.

Do not attempt to service this projector yourself as opening or removing covers may expose you to dangerous voltages or other hazards. Refer all servicing to qualified service personnel.

Unplug this projector from the wall outlet and refer servicing to qualified service personnel under the following conditions:

- a. When the power cord or plug is damaged or frayed.
- b. If liquid has been spilled into the projector.
- c. If the projector has been exposed to rain or water.
- d. If the projector does not operate normally after following the operating instructions. Adjust only those controls that are covered in the operating instructions as improper adjustment of other controls may result in damage and will often require extensive work by a qualified technician to restore the projector to normal operating condition.
- e. If the projector has been dropped or the cabinet has been damaged.
- f. When the projector exhibits a distinct change in performance-this indicates a need for servicing.

When replacement parts are required, be sure the service technician uses replacement parts specified by the manufacturer that have the same characteristics as the original parts. Unauthorized substitutions may result in fire, electric shock, or injury.

Upon completion of any service or repairs to this projector, ask the service technician to perform routine safety checks to determine that the projector is in safe operating condition.

AC Power Cord Requirement

The AC Power Cord supplied with this projector meets the requirements for use in the country you purchased it.

AC Power Cord for the United States and Canada:

The AC Power Cord used in the United States and Canada is listed by the Underwriters Laboratories (UL) and certified by the Canadian Standard Association (CSA).

The AC Power Cord has a grounding-type AC line plug. This is a safety feature to ensure the plug fits into the power outlet. Do not try to tamper with this safety feature. Should you be unable to insert the plug into the outlet, contact your electrician.

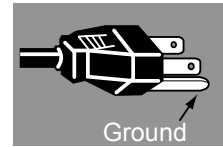

THE SOCKET-OUTLET SHOULD BE INSTALLED NEAR THE EQUIPMENT AND EASILY ACCESSIBLE.



For the U.S. and Canada, LAMP (S) INSIDE THIS PRODUCT CONTAIN MERCURY AND MUST BE RECYCLED OR DISPOSED OF ACCORDING TO LOCAL, MUNICIPAL, STATE, PROVINCIAL, OR FEDERAL LAWS. For lamp recycling and disposal information please call 1-800-OK-CANON for the U.S. and Canada.



Only for European Union and EEA (Norway, Iceland and Liechtenstein)

These symbols indicate that this product is not to be disposed of with your household waste, according to the WEEE Directive (2012/19/EU), the Battery Directive (2006/66/EC) and/or national legislation implementing those Directives.



If a chemical symbol is printed beneath the symbol shown above, in accordance with the Battery Directive, this indicates that a heavy metal (Hg = Mercury, Cd = Cadmium, Pb = Lead) is present in this battery or accumulator at a concentration above an applicable threshold specified in the Battery Directive.

This product should be handed over to a designated collection point, e.g., on an authorized one-for-one basis when you buy a new similar product or to an authorized collection site for recycling waste electrical and electronic equipment (EEE) and batteries and accumulators. Improper handling of this type of waste could have a possible impact on the environment and human health due to potentially hazardous substances that are generally associated with EEE. Your cooperation in the correct disposal of this product will contribute to the effective usage of natural resources.

For more information about the recycling of this product, please contact your local city office, waste authority, approved scheme or your household waste disposal service or visit

www.canon-europe.com/weee, or www.canon-europe.com/battery.

Federal Communication Commission Notice

This device complies with Part 15 of the FCC Rules. Operation is subject to the following two conditions:

1. This device may not cause harmful interference, and
2. This device must accept any interference received, including interference that may cause undesired operation.







Note: This equipment has been tested and found to comply with the limits for a Class A digital device, pursuant to Part 15 of the FCC Rules. These limits are designed to provide reasonable protection against harmful interference when the equipment is operated in a commercial environment. This equipment generates, uses, and can radiate radio frequency energy and, if not installed and used in accordance with the instruction manual, may cause harmful interference to radio communications. Operation of this equipment in a residential area is likely to cause harmful interference in which case the user will be required to correct the interference at his own expense. The cable with a ferrite core provided with the projector must be used with this equipment in order to comply with Class A of the FCC Rules. Use of a shielded cable is required to comply with Class A of FCC Rules. Do not make any changes or modifications to the equipment unless otherwise specified in the instructions. If such changes or modifications should be made, you could be required to stop operation of the equipment.

Warning:

This is a class A product. In a domestic environment this product may cause radio interference in which case the user may be required to take adequate measures. The cable with a ferrite core provided with the projector must be used with this equipment in order to comply with Class A .
Use of a shielded cable is required to comply with Class A .

Safety Symbols in this Manual

This section describes the safety symbols used in this manual. Important projector safety information is identified by the following symbols. Always observe the safety information by these symbols.

 Warning	Denotes the risk of death or serious injury from improper handling if the information is not observed. To ensure safe use, always observe this information.
 Caution	Denotes the risk of injury from improper handling if the information is not observed. To ensure safe use, always observe this information.
	Denotes the risk of electric shock from improper handling if the information is not observed. To ensure safe use, always observe this information.
	Denotes the risk of burns from improper handling if the information is not observed. To ensure safe use, always observe this information.
 Prohibition	Denotes prohibited actions.
 Caution	Denotes required actions or information that must be observed.

Precautions for Use

As this section contains important safety-related information, be sure to read the following carefully beforehand in order to use your projector correctly and safely.

Warning

During installation, keep the projector plug easily accessible so that the projector can be unplugged immediately if necessary, or keep a circuit breaker within reach.

If the following situations occur, turn the power off, remove the power plug from the power outlet and contact the Canon Customer Support Center. Failure to do so could cause a fire or result in an electric shock.



- If smoke is emitted
- If an unusual smell or noise is emitted
- If water or other liquid has entered the projector
- If metal or any other foreign material has entered the projector
- If the projector is knocked over or dropped and the cabinet is damaged

Pay attention to the following points regarding the power source, power plug and handling of the connector. Failure to do so may cause a fire or electric shock.



- Do not place any objects on the power cord and do not allow it to become trapped under the projector.
- Do not cover the power cord with a carpet.
- Do not modify or excessively bend, twist, pull, wind, or bundle the power cord.
- Keep the power cord away from heaters and other sources of heat.
- Do not use a damaged power cord. If the power cord is damaged, purchase a replacement from your dealer.
- The power cord included with this projector is for use exclusively with this product. Do not use this cord for other products.

Warning

Pay attention to the following points regarding the power source, power plug and handling of the connector. Failure to do so may cause a fire or electric shock.



- Do not use any power source with a voltage other than the voltage indicated (AC 100–240 V).
- Do not pull the power cord and be sure to hold the power plug or connector when removing. Incorrect handling may damage the power cord.
- Do not insert any metal objects into the contact parts of the power plug or connector.



- Do not remove the power plug or connector with wet hands.



- Insert the power plug and connector securely up to the base. Additionally, do not use a damaged power plug or an outlet that is loose.
- When using an extension cord, do not exceed the cord's rated capacity.



- Periodically inspect the power plug and outlet and remove any dust or dirt from between the plug and the outlet.

Installation and Handling Precautions

Pay attention to the following points regarding installation and handling of the projector. Failure to do so may cause a fire, electric shock or personal injury.



- Do not use the projector where it might get wet, such as outdoors or by bathtubs or showers.
- Do not place containers containing a liquid on top of the projector.



- Do not touch the projector itself, the power cord, or the cable if lightning strikes.



- Do not move the projector until you have switched off the power, removed the power plug from the power outlet and unplugged any other cables.
- Unplug the projector before cleaning or maintenance.
- Before you attach or replace a lens unit, be sure to unplug the power plug of the projector from the power outlet.

RISK GROUP 3 (RG3) label

RISK GROUP 3

WARNING

Possibly hazardous optical radiation emitted from this product.
Do not look at operating lamp. Eye injury may result.

GROUPE DE RISQUE 3

AVERTISSEMENT

Ce produit peut émettre des rayonnements optiques dangereux.
Ne regardez pas dans la lampe lorsqu'elle est allumée. Cela peut provoquer des blessures aux yeux.

RISIKOGRUPPE 3

WARNUNG

Möglicherweise gefährliche optische Strahlung von diesem Produkt emittiert.
Blicken Sie nicht in die eingeschaltete Lampe. Augenschäden können auftreten.

リスクグループ 3

警告

製品から強い光が投写されるため、動作中のランプを見ないでください。目に悪影響を与えるおそれがあります。

RISK GROUP 3

경고

이 제품에서 방출 아마도 위험한 광 방사선.
동작 중인 램프를 보지 마십시오. 눈에 나쁜 영향을 미칠 우려가 있습니다.

风险组别 3

警告

可能有害的光学辐射本产品。
请勿注视运行中的灯。可能会导致眼睛受伤。



YB7-3885

Warning

Pay attention to the following points regarding installation and handling of the projector. Failure to do so may cause a fire, electric shock or personal injury.



Prohibition

- Do not remove the cabinet from the projector or disassemble it. The interior of the projector contains high-voltage components as well as parts that are hot. If inspection, maintenance or repair is required, contact the Canon Customer Support Center.
- Do not disassemble or modify the projector (including consumable parts) or the remote control.
- Do not look directly into the exhaust vents during use.
- Do not insert any object into vents in the projector, such as the air intake vent or exhaust vents.
- Do not place a pressurized can in front of the exhaust vents. The pressure of the contents of the can may increase due to heat from the exhaust vents and this could result in an explosion.
- When cleaning off dust or dirt from projector parts such as the lens or filter, never use any spray that is flammable. Internal parts that become hot may ignite and cause a fire.



Prohibition

- Light from the projector is classified as Risk Group 3 (RG3) according to IEC 62471:2006.



- Possibly hazardous optical radiation emitted from this product. Do not look at operating lamp. Eye injury may result. Pay particular attention to prevent small children from doing so.
- When setting the projector on a high surface for projection, be sure the surface is flat and stable.
- Do not use the projector on a soft surface such as carpet or sponge mat, etc. Doing so could cause heat to build up inside the projector and this could result in a fire.
- For ceiling mounting precautions, refer to the installation manual included with the ceiling mount (sold separately).



Caution

- When hanging the projector from a ceiling, put the projector down on the floor or a workbench before attaching or replacing the lens unit. Failure to do so could result in parts falling off the projector and may cause an accident or personal injury.

Precautions on the Lamp

This projector uses a high-pressure mercury lamp, which must be handled carefully and correctly as described below.

The mercury lamp has the following characteristics.

- The lamp will gradually become darker over time.
- Impact, abrasion, or use of worn-out lamps may cause lamps to rupture (accompanied by a loud noise) or burn out.
- Lamps are more likely to rupture after the lamp replacement message is displayed (see “Replacing the Lamp” (P173)). Replace the lamp with a new one as soon as possible.
- Useful life of lamps varies widely from lamp to lamp and depending on the environment of use. Some lamps may fail or rupture soon after they are first used.

Warning

Note the following precautions during lamp replacement or when a lamp has ruptured. Failure to do so could result in an electric shock, personal injury or burns.



- Before replacing the lamp, always unplug the projector and wait at least one hour.
- If the lamp ruptures, dust and gas (containing mercury vapor) may come out of the exhaust vents. If this happens, immediately open the windows and doors to provide ventilation to the room. Ruptured lamps may scatter shards of glass inside the projector. Contact the qualified technician or Canon Customer Support Center for cleaning and inspection of the projector interior and lamp replacement.
- If you accidentally inhale gas from the lamp or get any pieces in your eyes or mouth, consult a doctor immediately.

Note the following precautions when replacing lamps that stop working. Failure to do so could result in personal injury.



Caution

- If illumination suddenly stops, either when you turn the projector on or after it has been on for a while, the lamp may have ruptured. In this case, never attempt to replace the lamp by yourself. Always request service from the Canon Customer Support Center.
- With ceiling-mounted projectors, the lamp may fall out when you open the lamp cover, or during replacement. During replacement, stand to the side of the lamp cover, not directly under it.

Precautions for the Batteries of the Remote Control

Pay attention to the following points regarding handling of batteries. Failing to do so could result in a fire or personal injury.



Prohibition

- Do not heat, short circuit or disassemble the batteries, or place them in a fire.
- Do not attempt to recharge the batteries that are included with the remote control.



Caution

- Remove the batteries when they are flat or when the remote control will not be used for a long period of time.
- When replacing the batteries, replace both at the same time. Also, do not use two batteries of a different type at the same time.
- Insert the batteries with the + and - terminals in the correct directions.
- If any liquid from inside the batteries leaks out and contacts your skin, be sure to wash the liquid off thoroughly.

Caution

Pay attention to the following points regarding installation and handling of the projector.

- If the projector will not be used for a long period of time, be sure to remove the power plug from the power outlet to ensure safety. Failure to do so presents a risk of fire if dust accumulates on the plug or outlet.
- Parts of the cabinet around and above the exhaust vents may become hot during projection. Touching these areas during operation could cause burns to the hands. Pay particular attention in preventing young children from touching these parts. Additionally, do not place any metal objects around or above the exhaust vents. Due to the heat from the projector, doing so could cause an accident or personal injury.
- Do not place the projector where it may be exposed to oily smoke or steam, such as near kitchen counters or humidifiers. Doing so may cause fire or electric shock.
- Do not place any heavy objects on top of the projector or sit / stand on it. Pay particular attention to prevent small children from doing so. The projector may be knocked over and this could result in damage or a personal injury.
- Do not place the projector on an unstable or slanted surface. Doing so may cause the projector to fall or be knocked over and could result in a personal injury.
- Do not place any objects in front of the lens during projection. Doing so could cause a fire.
- Presenters in front of the projector should stand where the light does not seem too bright, and where their shadow does not fall on the screen.
- The projector is provided with a lens shift function to move the lens up, down, left, and right using the motor. Do not touch the lens while it is moving. Touching the lens when it is moving may result in personal injury.
- Before replacing the lens unit, wait at least one hour after the projector is turned off to allow the projector to cool thoroughly. Failure to do so could result in a burn or injury.



Prohibition



When handling the lamp, pay attention to the following points.

- Lamps are more likely to rupture once the lamp replacement message has been displayed. Replace the lamp with a new one as soon as possible.
- Be sure not to handle the lamp immediately after it has been used. Be sure to switch off the power and wait for approximately 1 hour for the lamp and the projector to cool down sufficiently. Failure to do so could result in a burn or personal injury due to heat from the lamp or projector.
- Be prepared by keeping a spare lamp.
- Dispose of used mercury lamps in accordance with local regulations.



Caution



Caution

Pay attention to the following points when carrying or transporting the projector.



Caution

- This projector is a precision instrument. Do not knock it over or subject it to impacts.
- When carrying or holding up the projector after attaching the lens unit, be sure not to hold the lens. Doing so may cause damage to the lens unit.
- Protection of the projector cannot be guaranteed if used packaging or shock-absorbent materials are reused. Fragments from shock-absorbent material may also enter the interior of the projector which could cause a malfunction.
- If transportation is necessary, the lens unit should be removed before transporting the projector. If the projector is subjected to excessive impacts during transportation, the lens unit may be damaged.
- Disconnect the cables connected to the projector. Carrying the projector while the cables are attached may cause an accident.
- Retract the adjustable feet before moving the projector. Leaving the feet extended may cause damage.
- Do not touch the lens with bare hands. Doing so may result in deterioration of image quality.

Caution

Pay attention to the following points when installing or using the projector.

- Be careful of condensation.
If the projector is abruptly taken to a warmer location, or if the room temperature rises abruptly, moisture in the air may condense on the lens and mirror, causing the image to become blurred.
- Do not install the projector in a location where the temperature is high or low. Doing so may cause a malfunction. Ranges for the environment of use and storage are as follows.
 - Environment of use: 0°C (32°F) to 40°C (104°F), up to 85% RH
 - Storage temperature: -30°C (-22°F) to 60°C (140°F)
- When using the projector at altitudes above 2,300 m (7,545.8'), or when projecting upward or downward:
Adjust projector installation settings from the menu (P108). Failure to adjust the settings may shorten the lamp life or damage the lamp.
- Do not install the projector facing the wrong direction. Install the projector so that it is not tilted left or right by more than 10°. (P25)
- Do not block the air intake or exhaust vents. Blocking the vents may trap heat inside the projector, which may shorten the useful life of optical components or other parts and damage the projector.
- Install the projector leaving at least 50 cm (1.6') between air intake/exhaust vents and walls. Failure to do so may trap heat inside the projector and damage it.
- Do not place any objects on top of the projector that may change shape or color due to heat.
- Do not install the projector in a location that is damp, or where there is a lot of dust, oily smoke or tobacco smoke. Doing so could cause contamination of optical components such as the lens and the mirror and may result in deterioration of image quality.
- Do not install the projector near high-voltage electrical power lines or an electrical power source.
- Clean the air filter regularly. (P171) Dust that accumulates inside over long periods without cleaning may eventually damage the projector or affect picture quality.



Caution

Before Installation

Precautions When Carrying/Shipping the Projector

Prepare the projector as described below before carrying it.



- **Disconnect the cables connected to the projector.** Carrying the projector with the cables attached may cause an accident.
- **Retract the adjustable feet before moving the projector.** Leaving the feet extended may cause damage.
- **Do not subject the projector to strong impacts or vibrations.**

Precautions for Installation

Be sure to read “Safety Instructions” and “For Safe Use” (P7 – P21). Also take the following precautions during installation.



- **Do not strike the projector or subject it to impact.** Doing so may cause a malfunction.
- **Do not stand the projector vertically, lean it against another object, or otherwise place it in an unstable state.** The projector may be damaged if it tips over.

■ Do Not Use in the Following Environments



- **Locations with excessive humidity, dust, oily smoke or tobacco smoke**
Adhesion to the lens, mirrors or other optical parts may reduce image quality.
- **Near high-voltage power lines or sources of electrical power**
This may cause malfunction.
- **On soft surfaces such as carpets or cushioned mats**
This may cause a fire or damage the projector.
- **Locations with excessive temperature or humidity**
This may damage the projector. Acceptable ranges for operating and storage temperature and humidity are as follows.
* Operating temperature and humidity applies to when the projector is projecting or in standby mode.

Operating temperature	Operating humidity	Storage temperature
0°C (32°F) – 40°C (104°F)	Up to 85%	-30°C (-22°F) – 60°C (140°F)

■ Do Not Touch the Lens with Bare Hands



- Do not touch the lens with bare hands. Any smudges or fingerprints on the lens may affect image quality.

■ Allow a 30 Min. Warm Up before Focus Adjustment (P59), if Possible

The focus position may not stabilize immediately after startup, due to lamp heat. When adjusting focus, it is also helpful to use the test pattern (10) (P115, P187).

■ Install at a Sufficient Distance from Walls and Other Obstructions



If the air intake or exhaust vent is blocked, heat will accumulate inside the projector, possibly resulting in a shortened projector lifetime or a malfunction. Similarly, do not install in narrow, enclosed spaces with poor ventilation. Install in a well-ventilated location.

Ensure a minimum clearance of 50 cm (1.6 ft.) above, on both sides, and behind the projector, as shown below.

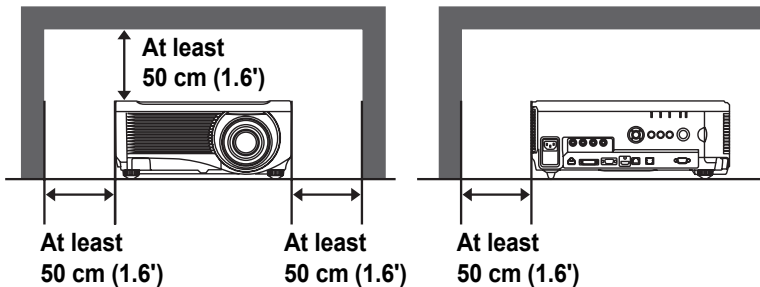
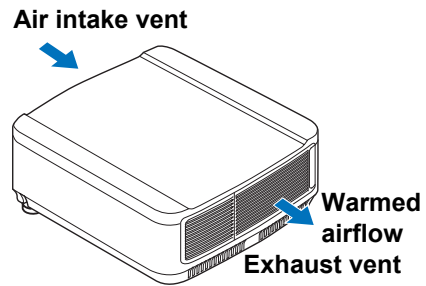

■ Be Careful of Condensation

If the temperature of the room rises suddenly, moisture in the air may condense on the projector lens and mirror, causing the image to become blurred. Wait until the condensation has evaporated for the image projected to return to normal.

■ At Altitudes above 2,300 m (7,545.8'), Adjust the Settings

Projector settings must be adjusted when using the projector at altitudes of 2,300 m (7,545.8') or higher. Specifically, refer to instructions for [Fan mode] (P108) in the [Install settings] menu.

■ When Using Mounted on the Ceiling



When the projector is used mounted on the ceiling or installed in a high location, it is necessary to periodically clean the air intake and exhaust vents, and the area around the air filter. Dust that accumulates in intake or exhaust vents may impair ventilation, raising the temperature inside and posing a risk of damage or fire. Use a vacuum cleaner or similar means to remove dust from the intake vent and exhaust vent.

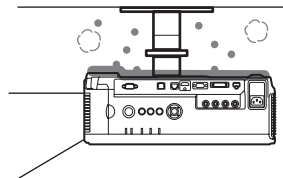

■ Install Facing in the Correct Direction



Caution

- The projector can be installed facing any direction, as shown below. However, projection upward or downward may shorten the useful life of the lamp. [Install settings] of the projector must also be adjusted.
- For upward or downward projection, refer to instructions for [Vertical projection] (P108) in the [Install settings] menu.
- Do not attempt to install the projector for upward or downward projection by yourself. Always request installation by a qualified technician or the Canon Customer Support Center.

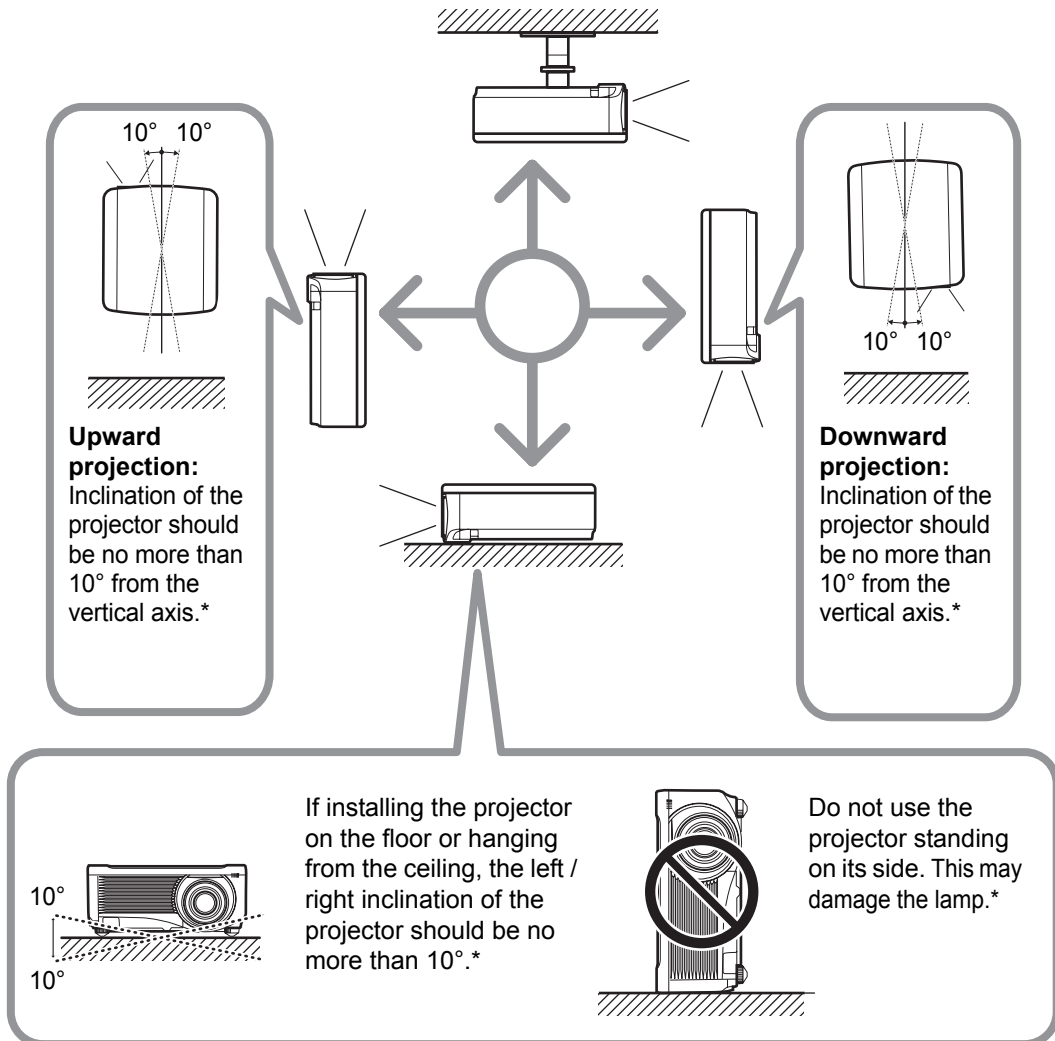

* Failure to do so may damage the lamp.



There are no options for installing the projector other than the ceiling attachment.

Copyright Notice

Please note that enlarging or reducing the size of an image for commercial purposes or public presentation may infringe on the legally protected copyright or the copyright holder of the original material.

Ensure Network Security

Take measures to ensure network security. Note that Canon is not liable in any way for direct or indirect loss from network security incidents, such as unauthorized access.

Before using the projector, configure the appropriate projector, computer, and network security settings.

Install the projector in a network protected by a firewall or other security measures. Do not connect it directly to the Internet.

About Trademarks

- Ethernet is a registered trademark of Xerox Corporation.
- Microsoft, Windows, Windows Vista, Windows 7, Windows 8, Windows 8.1 and Windows 10 are registered trademarks or trademarks of Microsoft Corporation in the United States and / or other countries.
- Mac, Mac OS and Macintosh are trademarks of Apple Inc., registered in the United States and / or other countries.
- HDMI, the HDMI logo and High-Definition Multimedia Interface are trademarks or registered trademarks of HDMI Licensing, LLC.
- PJLink is a registered trademark of JBMIA and pending trademark in some countries.
- PJLink is a registered trademark, or an application has been submitted for trademark, in Japan, the United States and / or other countries or regions.
- AMX is a trademark of AMX Corporation.
- Crestron®, Crestron RoomView®, and Crestron Connected™ are registered trademarks of Crestron Electronics, Inc.
- HDBaseT™ and the HDBaseT Alliance logo are trademarks of the HDBaseT Alliance.
- All other trademarks are the property of their respective owners.

The product contains Open Source Software modules. For details, refer to the third-party software license file “Third-Party Software” in the License folder of the user’s manual CD-ROM. Each module’s license conditions are also available in the same folder.

■ Software under the GNU General Public License Version 2

Contained programs are free software; you can redistribute them and/or modify them under the terms of the GNU General Public License attached to each copy of the program.

Each program is distributed in the hope that it will be useful, but WITHOUT ANY WARRANTY; without even the implied warranty of MERCHANTABILITY or FITNESS FOR A PARTICULAR PURPOSE. Please see “NO WARRANTY” and “NO SUPPORT” stated below. For more detail, please see full text of the GNU General Public License.

NO WARRANTY

BECAUSE THE PROGRAM IS LICENSED FREE OF CHARGE, THERE IS NO WARRANTY FOR THE PROGRAM, TO THE EXTENT PERMITTED BY APPLICABLE LAW. EXCEPT WHEN OTHERWISE STATED IN WRITING THE COPYRIGHT HOLDERS AND/OR OTHER PARTIES PROVIDE THE PROGRAM “AS IS” WITHOUT WARRANTY OF ANY KIND, EITHER EXPRESSED OR IMPLIED, INCLUDING, BUT NOT LIMITED TO, THE IMPLIED WARRANTIES OF MERCHANTABILITY AND FITNESS FOR A PARTICULAR PURPOSE. THE ENTIRE RISK AS TO THE QUALITY AND PERFORMANCE OF THE PROGRAM IS WITH YOU. SHOULD THE PROGRAM PROVE DEFECTIVE, YOU ASSUME THE COST OF ALL NECESSARY SERVICING, REPAIR OR CORRECTION.

IN NO EVENT UNLESS REQUIRED BY APPLICABLE LAW OR AGREED TO IN WRITING WILL ANY COPYRIGHT HOLDER, OR ANY OTHER PARTY WHO MAY MODIFY AND/OR REDISTRIBUTE THE PROGRAM AS PERMITTED ABOVE, BE LIABLE TO YOU FOR DAMAGES, INCLUDING ANY GENERAL, SPECIAL, INCIDENTAL OR CONSEQUENTIAL DAMAGES ARISING OUT OF THE USE OR INABILITY TO USE THE PROGRAM (INCLUDING BUT NOT LIMITED TO LOSS OF DATA OR DATA BEING RENDERED INACCURATE OR LOSSES SUSTAINED BY YOU OR THIRD PARTIES OR A FAILURE OF THE PROGRAM TO OPERATE WITH ANY OTHER PROGRAMS), EVEN IF SUCH HOLDER OR OTHER PARTY HAS BEEN ADVISED OF THE POSSIBILITY OF SUCH DAMAGES.

NO SUPPORT

Canon Inc., and all its subsidiaries or its dealers do not make any support service regarding the source code. Canon Inc., and all its subsidiaries or its dealers shall not respond to any questions or enquiries, from you or any other customers, regarding the source code.

Before Use

Included Accessories

Before use, make sure the following items are included in the package.

- Remote control

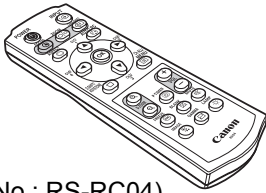

(part No.: RS-RC04)



Optional remote controls are also available (RS-RC05). The RS-RC05 can also be used as a wired remote. (P38)

- Batteries for the remote control

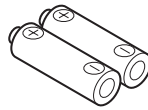

(AAA size x2)

- Computer cable (1.8 m / 5.9')
(mini D-sub 15-pin / mini D-sub 15-pin)

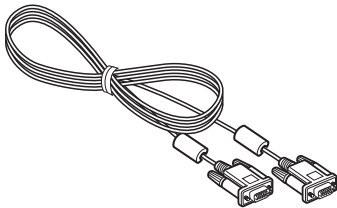

- Power cord
(1.8 m / 5.9')

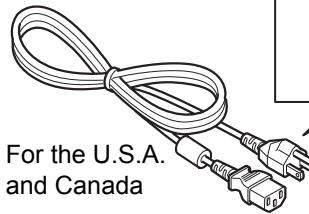

For Continental Europe

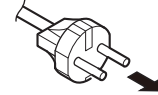

For the U.S.A. and Canada

- Important Information

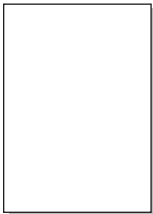

- User's Manual (CD-ROM)

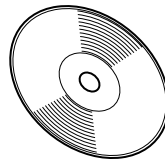

- Warranty Card

Part Names

Projector

Power cord connector (P52)

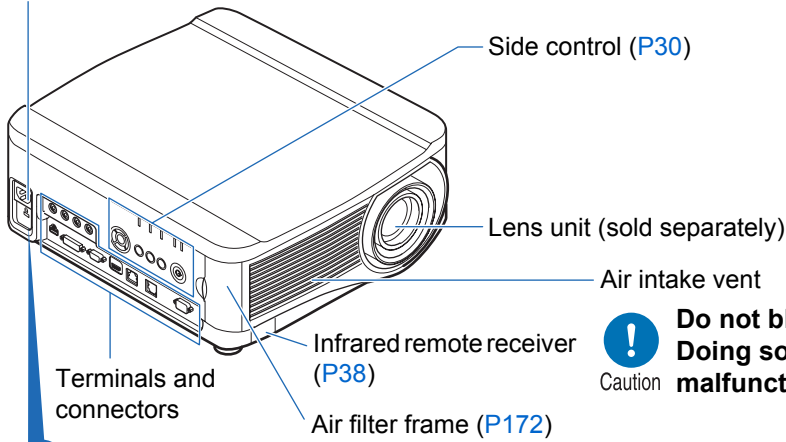

Do not block the air intake.
Doing so may cause a malfunction.



Anti-theft lock hole
An anti-theft wire cable (not included) can be connected.

■ Rear Side

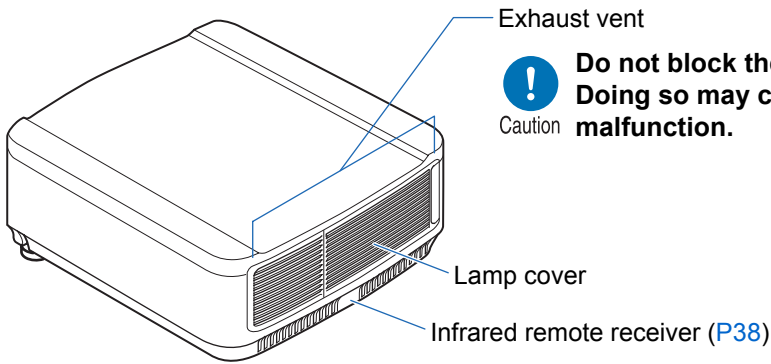

Do not block the air exhaust.
Doing so may cause a malfunction.

Bottom Side

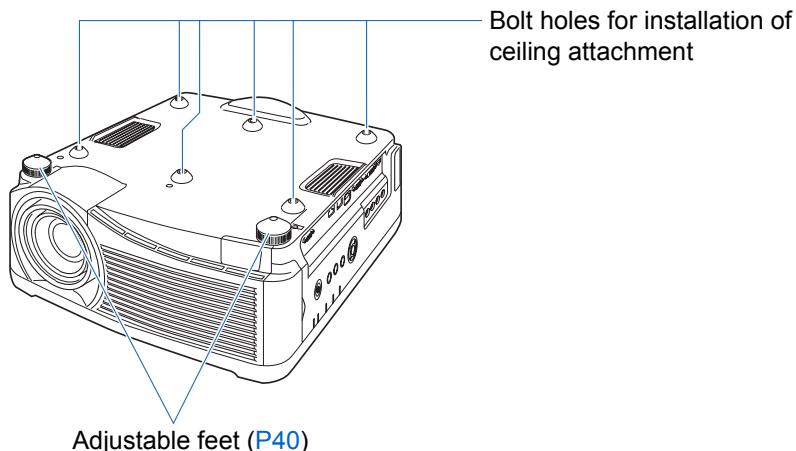



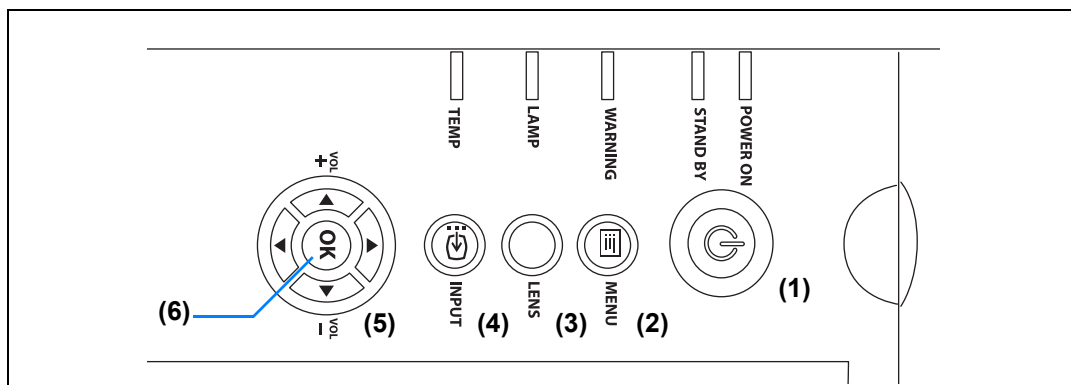

Side Control



- (1) **POWER button (P53, P71)**
Turns the projector on or off.
- (2) **MENU button (P78)**
Displays a menu on the screen.
- (3) **LENS button**
Each time the button is pressed, the screen changes to focus adjustment (P59), zoom (image size) adjustment (P60), or lens shift (image position) adjustment (P61). To adjust, use the [▲] / [▼] or the [◀] / [▶] buttons.
- (4) **INPUT button (P56)**
Switches the input signal.
- (5) **Pointer / VOL buttons (P79)**
Up, down, left, or right in menu navigation or other operations. Adjust the sound volume.
[▲] VOL+ button: Increases the volume.
[▼] VOL- button: Decreases the volume.
Selects the upper, lower, left or right item in the menu.
- (6) **OK button (P79)**
Determines the item selected from the menu.

LED Indicators







































































The projector status is shown by the LED indicators (off / lit / flashing).

 POWER ON	• POWER ON (green) : Lights up or flashes under normal conditions when the power is on.
 STAND BY	• STAND BY (red) : Lights up or flashes during standby or when the projector is shut down.
 WARNING	• WARNING (red) : Lights up or flashes when an error occurs.
 LAMP	• LAMP (orange) : Lights up or flashes when a problem occurs with the lamp or lamp cover.
 TEMP	• TEMP (red) : Lights up or flashes when the internal temperature is high.

LED Indicator Displays

The LED indicators flash or illuminate to indicate the operating status of the projector.

Legend: Example of when the POWER ON indicator is on; : Off : Lit : Flashing



LED indicator					Operating status
POWER ON (green)	STAND BY (red)	WARNING (red)	LAMP (orange)	TEMP (red)	
					Not plugged in.
					In standby mode.
					Power is on.
					Transitioning from standby mode to power on.
					Cooling down while transitioning from power on to standby mode or power management mode.
					In power management mode, with the lamp off.
					Nearly time to replace the lamp (in standby mode).
					Nearly time to replace the lamp (during projecting).
					Internal temperature is high (in standby mode).
					Internal temperature is high (during projecting).
					A lamp error has occurred.
					A temperature error has occurred.
					The lamp cover is open.
					Another error has occurred.

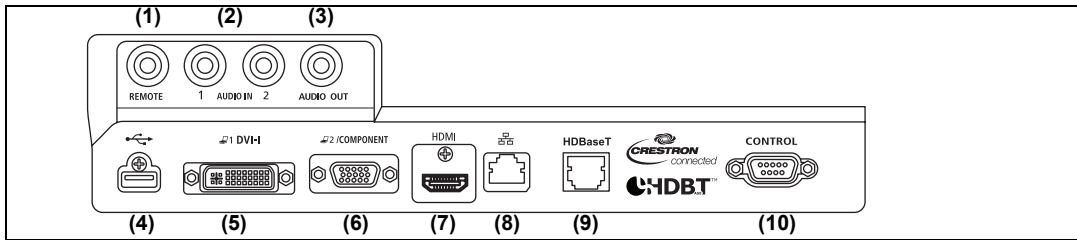

A flashing LAMP indicator means that it is almost time to replace the lamp. Prepare a replacement lamp.

Input Terminal



- (1) **Terminal for wired remote control (REMOTE) (P38)**
This terminal is used to connect the optional remote control (RS-RC05) using a cable.
- (2) **AUDIO IN terminal (AUDIO IN) (P49, P50, P51)**
Terminals for audio input. Audio supplied to these terminals is played through the internal speaker when you select [Audio in] as the source audio terminal for the selected source video. (P119)
- (3) **AUDIO OUT terminal (AUDIO OUT) (P49, P50, P51)**
Outputs the audio to external AV equipment. This outputs the audio signal that corresponds to the projected image signal.
- (4) **USB port (P157)**
Connects a USB flash drive. Used for projection of images on a USB flash drive, or for firmware updates.
- (5) **DVI-I terminal ( DVI-I) (P49)**
Connects the external monitor output from a computer.
Receives digital PC signal (Digital PC).
A VGA-DVI-I cable can also be used to receive analog computer signals (Analog PC-1).
- (6) **ANALOG PC-2 / COMPONENT input terminal ( / COMPONENT) (P50, P51)**
Receives the analog PC signal (Analog PC-2).
A component cable can be used to receive the component image signal (Component).
- (7) **HDMI terminal (HDMI) (P50, P51)**
Receives digital video signals (HDMI).
Carries both video and audio signals across a single cable.
- (8) **LAN port (P127)**
Connects the LAN cable (shielded twisted pair).
Used to connect the projector to a network.
- (9) **HDBaseT terminal (P50, P51, P127)**
Receives HDBaseT input including digital video and audio signals.
A single LAN cable (shielded twisted pair) can be used for both video and audio input.
This port can also be used to connect the projector to a network.

Before Use

(10) Service port (CONTROL) (P195)

Used to control the projector with user commands (P196 – P197).

Remote Control

The projector can be operated using buttons on the remote control or the side control on the projector.

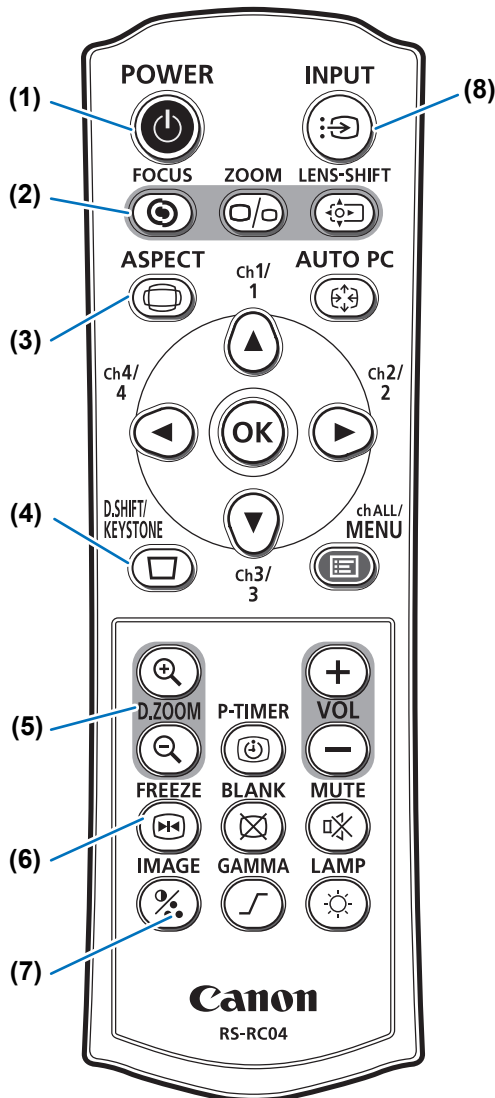

(1) POWER button (P53, P71)
Turns the projector on or off.

(2) FOCUS button (P59)
Adjusts focusing.
[▲] / [▶] buttons:
Moves the focus position further away.
[▼] / [◀] buttons:
Moves the focus position nearer.

(3) ASPECT button (P65, P91)
Changes the aspect ratio mode.

(4) D.SHIFT/KEYSTONE button (P67)
Corrects keystone distortion.
The [Keystone] setting enables both horizontal/vertical keystone correction (by adjusting top/bottom/left/right length) and corner correction.

- Moves the image up, down, left, or right when the screen aspect setting is [16:9 D. image shift] or [4:3 D. image shift] is selected. (P64, P65)
- To move the image, use the [▲] / [▼] or the [◀] / [▶] buttons.

(5) D.ZOOM button (P75)
Zooms the image in or out digitally.
[+] button: Zooms the image in (up to 12x).
[-] button: Zooms the image out (1x minimum).
[▲] / [▼] / [◀] / [▶] buttons:
Move the zoom-in location.

(6) FREEZE button (P72)
Freezes the projected image.

(7) IMAGE button (P70)
Switches the image mode (image quality).

(8) INPUT button (P56)
Switches the input signal.

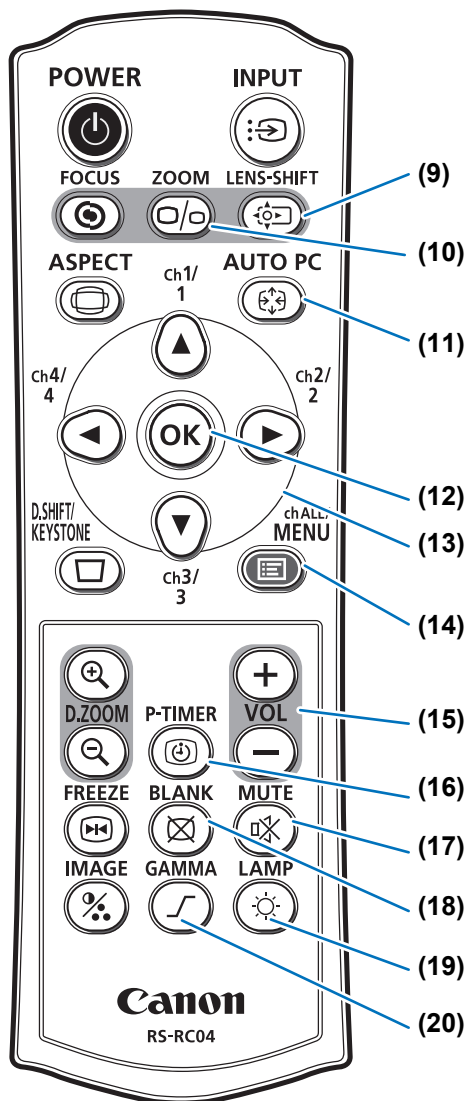

(9) LENS-SHIFT button (P61)
 Moves the lens up, down, left, or right.
 [▲] / [▼] / [◀] / [▶] buttons:
 Moves the image.

(10) ZOOM button (P60)
 Adjusts the image size.
 [▲] / [▶] buttons:
 Increase the image size.
 [▼] / [◀] buttons:
 Decrease the image size.

(11) AUTO PC button (P58)
 Adjusts tracking etc. automatically in accordance with the signal from a computer when the analog PC input is selected.

(12) OK button (P79)
 Determines the item selected from the menu.

(13) Pointer buttons (P79)
 Selects the upper, lower, left or right item in the menu. Also used to assign a channel to the remote control.

(14) MENU button (P78)
 Displays a menu on the screen. Also used to assign a channel to the remote control. (P119)

(15) VOL button (P74)
 Adjusts the sound volume.
 [+] button: Increases the volume.
 [-] button: Decreases the volume.

(16) P-TIMER button
 Cannot be used on this projector.

(17) MUTE button (P74)
 Mutes the sound.

(18) BLANK button (P72)
 Temporarily blacks out the image.

(19) LAMP button (P102)
 Displays the power saver settings screen, where you can adjust the lamp mode (Full power / Power saver) (P102), set the power management (P121) and specify the network standby settings (P131).

(20) GAMMA button (P98)
 Adjusts the gamma of the image.
 [▶] button:
 Corrects dark parts of the image so that they are easier to see.
 [◀] button:
 Corrects bright parts of the image so that they are easier to see.

Preparing the Remote Control

■ Installing Remote Control Batteries

- 1** Open the battery compartment lid. Slide the lid while pressing it down.

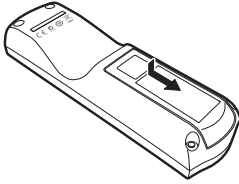

- 2** Insert batteries. Insert 2 new AAA batteries in the compartment with the + and – terminals positioned correctly.

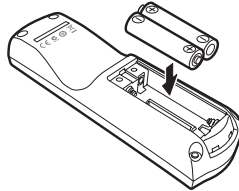

- 3** Close the compartment lid. Slide the lid until you hear a click to securely close it.

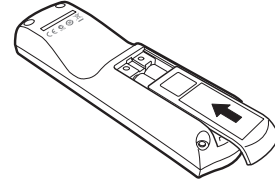

- If buttons on the remote control are inoperative when you attempt to operate the projector, replace the batteries with new ones.
- Do not drop the remote control or subject it to impact.
- Do not spill any liquids on the remote control. Doing so may cause a malfunction.



Warning



Prohibition



Caution

Pay attention to the following points when handling the batteries. Failing to do so could result in a fire or personal injury.

- Do not heat, short circuit or disassemble the batteries, or place them in a fire.
- Do not attempt to recharge the batteries that are included with the remote control.
- Remove the batteries when they are flat or when the remote control will not be used for a long period of time.
- When replacing the batteries, replace both at the same time. Also, do not use two batteries of a different type at the same time.
- Insert the batteries with the + and - terminals in the correct directions.
- If any liquid from inside the batteries leaks out and contacts your skin, be sure to wash the liquid off thoroughly.

■ Remote Control Operating Range

The remote control is an infrared type. Point it at the infrared remote receiver on the front or rear of the projector to operate it.

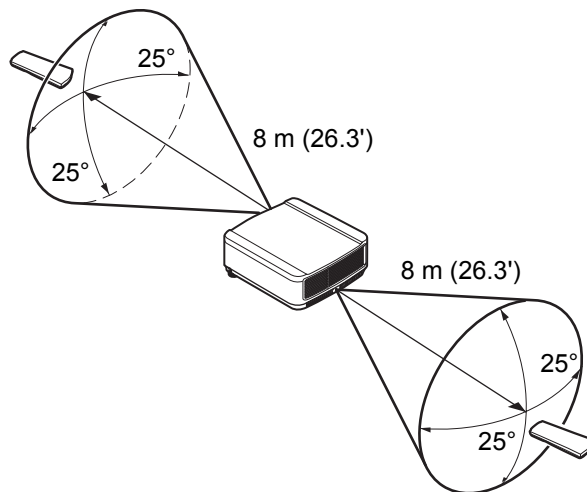

- Use the remote control no further than approximately 8 m (26.3') from the projector.
- Use the remote control within an angle of 25° in any direction from directly in front of the infrared remote receiver.
- The remote control may be inoperative if there is an obstacle between the remote control and the projector or the infrared remote receiver on the projector is exposed to direct sunlight or strong light of lighting equipment.
- When you use 2 or more projectors at the same time, you can change the channel settings to prevent the 2 remote controls from interfering with each other. (P119)

■ Using an Optional Wired Remote (RS-RC05)

To use a wired remote control with the projector, use the RS-RC05, sold separately. Use a cable with a ø3.5 mm stereo mini jack (not included).

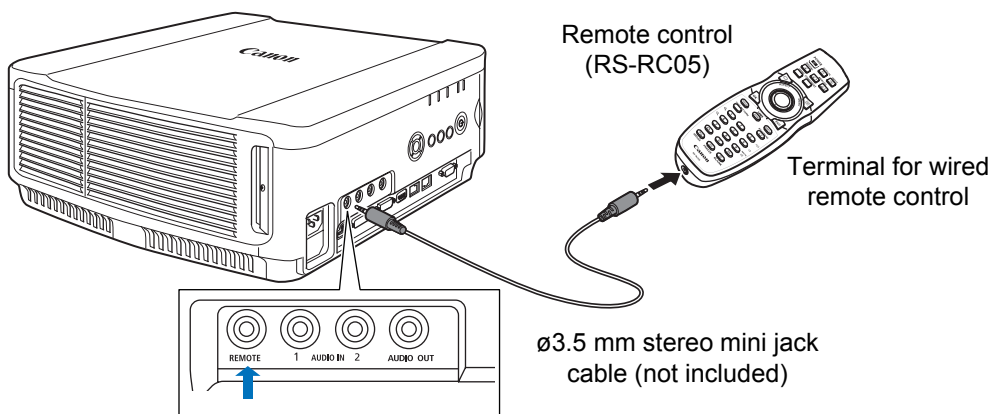

- Infrared operations cannot be performed if a cable is connected to the projector or the remote control.
- Use a cable with a ø3.5 mm stereo mini jack (not included) with a length of 30 m (98.4') or less.

Basic Guide

Safety Instructions

Before Use

Installation Procedure

Connection Procedure

Projection Procedure

Convenient Features

Using Menus

Menu Configuration

Menu Description

Advanced Projection

Maintenance

Product Specifications

Troubleshooting

Basic Guide

Advanced Guide

Other Information

Installation Procedure

Before setting up the projector, be sure to read “Before Installation” (P22).

Setting Up the Projector

■ Positioning the Projector in Front of the Screen

Place the projector in front of the screen.



- To avoid keystone distortion, install the projector so that it is at right angles to the screen.
- The screen must not be exposed to direct sunlight or light from lighting equipment. In a bright room, it is recommended that lights be turned off, curtains be drawn, and other steps taken to make the screen easier to see.

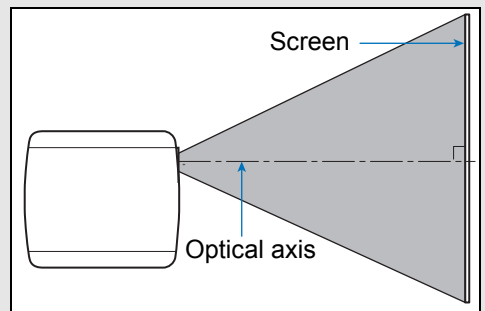

■ Floor Installation

To adjust the projection position when the projector is installed on the floor, use the lens shift function (P47, P61) to adjust up / down / left / right. You can also use the adjustable feet to incline the projector upward by up to 6°.

For information about the relationship between screen size and projection distance, refer to page 43.

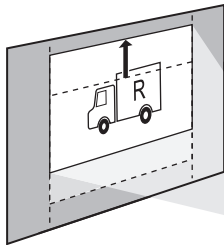

Lens shift

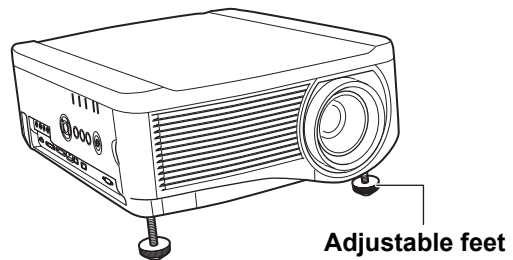

■ Installation Tilted Upward

To correct keystone distortion when the projector is tilted upward (using adjustable feet, for example), perform keystone correction (P67) or corner adjustment (P68).

■ Installation on High Surfaces

For projection from a shelf or other high surface, the projector can be installed upside-down and the projected image inverted.



When setting the projector on a high surface for projection, be sure the surface is flat and stable. Failure to do so poses a risk of the projector falling and causing accidents or injury.

■ Ceiling Mounting or Rear Projection

You can mount the projector on the ceiling (ceiling mounting) with it turned upside down or place it behind the screen (rear projection) if you use a translucent screen.

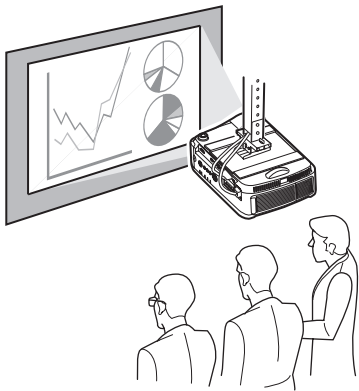

Ceiling mounting

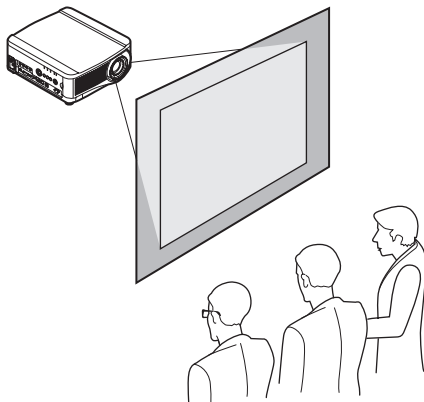

Rear projection

Make sure to use the optional ceiling attachment. For the ceiling attachment, refer to “Option” (P207). For details, refer to the assembly and installation manual provided with the ceiling attachment.

Mounting the Projector on the Ceiling

You can mount the projector on the ceiling. The ceiling attachment (part No.: RS-CL11) is required in order to mount the projector on the ceiling. Depending on the installation environment, an extension pipe (part No.: RS-CL08 or RS-CL09) may also be required. Contact the Canon Customer Support Center for more detailed information.

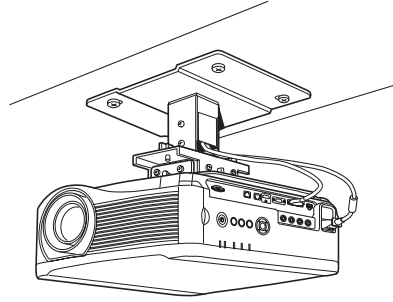

Caution

- **Make sure to use the optional ceiling attachment.**
- **You should never install the ceiling attachment by yourself.**



If you mount the projector on the ceiling, you have to invert the projected image by selecting [Image flip H/V] from the menu. (P105)

Relationship Between Image Size and Projecting Distance

The projected image size is determined by the distance between the projector and the screen (projection distance) as well as the zoom. Refer to the following table and decide the distance between the projector and screen.

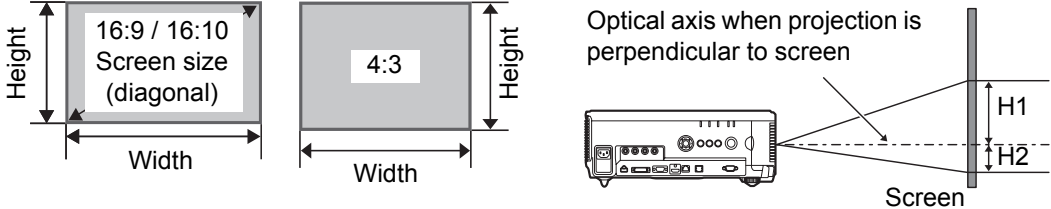

- H1 and H2 are the distances when lens shift is the default value below.
- Standard Zoom Lens / Long Zoom Lens / Ultra Long Zoom Lens / Wide Zoom Lens: +50% (up / down), 0% (left / right)
- Short Fixed Lens: 0% (up / down / left / right)

WUX6500

Lens unit	Diagonal when 16:10	Image size (cm)						Projection distance m (feet)		Distance from optical axis when projection is perpendicular to screen (cm)	
		16:10		16:9		4:3		16:10		H1	H2
		Width	Height	Width	Height	Width	Height	Wide limit	Tele limit		
Standard Zoom Lens RS-IL01ST	40	86	54	89	50	81	61	1.3 (4.3)	1.9 (6.2)	54	0
	60	129	81	133	75	122	91	1.9 (6.2)	2.9 (9.5)	81	0
	80	172	108	177	100	163	122	2.6 (8.5)	3.9 (12.8)	108	0
	100	215	135	221	125	203	152	3.2 (10.5)	4.8 (15.7)	135	0
	150	323	202	332	187	305	229	4.8 (15.7)	7.2 (23.6)	202	0
	200	431	269	443	249	406	305	6.4 (21.0)	9.6 (31.5)	269	0
	250	538	337	553	311	508	381	8.0 (26.2)	12.1 (39.7)	337	0
	300	646	404	664	374	610	457	9.6 (31.5)	14.5 (47.6)	404	0
	350	754	471	775	436	711	533	11.3 (37.1)	16.9 (55.4)	471	0
	400	862	538	886	498	813	610	12.9 (42.3)	19.3 (63.3)	538	0
	450	969	606	996	560	914	686	14.5 (47.6)	21.7 (71.2)	606	0
	500	1077	673	1107	623	1016	762	16.1 (52.8)	24.1 (79.1)	673	0
550	1185	740	1218	685	1118	838	17.7 (58.1)	26.6 (87.3)	740	0	
600	1292	808	1328	747	1219	914	19.3 (63.3)	29.0 (95.1)	808	0	

Installation Procedure

Lens unit	Diagonal when 16:10	Image size (cm)						Projection distance m (feet)		Distance from optical axis when projection is perpendicular to screen (cm)	
		16:10		16:9		4:3		16:10		H1	H2
		Width	Height	Width	Height	Width	Height	Wide limit	Tele limit		
Long Zoom Lens RS-IL02LZ	40	86	54	89	50	81	61	1.9 (6.2)	3.2 (10.5)	54	0
	60	129	81	133	75	122	91	2.8 (9.2)	4.8 (15.7)	81	0
	80	172	108	177	100	163	122	3.8 (12.5)	6.4 (21.0)	108	0
	100	215	135	221	125	203	152	4.7 (15.4)	8.0 (26.2)	135	0
	150	323	202	332	187	305	229	7.1 (23.3)	12.1 (39.7)	202	0
	200	431	269	443	249	406	305	9.5 (31.2)	16.1 (52.8)	269	0
	250	538	337	553	311	508	381	11.9 (39.0)	20.2 (66.3)	337	0
	300	646	404	664	374	610	457	14.2 (46.6)	24.2 (79.4)	404	0
	350	754	471	775	436	711	533	16.6 (54.5)	28.3 (92.8)	471	0
	400	862	538	886	498	813	610	19.0 (62.3)	32.3 (106.0)	538	0
	450	969	606	996	560	914	686	20.9 (68.6)	35.6 (116.8)	606	0
	500	1077	673	1107	623	1016	762	23.8 (78.1)	40.4 (132.5)	673	0
	550	1185	740	1218	685	1118	838	26.1 (85.6)	44.5 (146.0)	740	0
600	1292	808	1328	747	1219	914	28.5 (93.5)	48.5 (159.1)	808	0	
Short Fixed Lens RS-IL03WF	40	86	54	89	50	81	61	0.7 (2.3)		27	27
	60	129	81	133	75	122	91	1.0 (3.3)		41	41
	80	172	108	177	100	163	122	1.4 (4.6)		54	54
	100	215	135	221	125	203	152	1.7 (5.6)		68	68
	150	323	202	332	187	305	229	2.6 (8.5)		101	101
	200	431	269	443	249	406	305	3.4 (11.2)		135	135
	250	538	337	553	311	508	381	4.3 (14.1)		168	168
300	646	404	664	374	610	457	5.2 (17.1)		202	202	

Lens unit	Diagonal when 16:10	Image size (cm)						Projection distance m (feet)		Distance from optical axis when projection is perpendicular to screen (cm)	
		16:10		16:9		4:3		16:10		H1	H2
		Width	Height	Width	Height	Width	Height	Wide limit	Tele limit		
Ultra Long Zoom Lens RS-IL04UL	60	129	81	133	75	122	91	4.6 (15.1)	9.0 (29.5)	81	0
	80	172	108	177	100	163	122	6.1 (20.0)	12.0 (39.4)	108	0
	100	215	135	221	125	203	152	7.6 (24.9)	14.9 (50.2)	135	0
	150	323	202	332	187	305	229	11.4 (37.4)	22.3 (77.3)	202	0
	200	431	269	443	249	406	305	15.2 (49.7)	29.8 (97.8)	269	0
	250	538	337	553	311	508	381	18.9 (62.0)	37.2 (122.0)	337	0
	300	646	404	664	374	610	457	22.7 (74.5)	44.6 (146.3)	404	0
	350	754	471	775	436	711	533	26.4 (86.6)	52.0 (170.6)	471	0
	400	862	538	886	498	813	610	30.2 (99.1)	59.4 (194.9)	538	0
	450	969	606	996	560	914	686	34.0 (111.5)	66.8 (219.2)	606	0
	500	1077	673	1107	623	1016	762	37.7 (123.7)	74.2 (243.4)	673	0
	550	1185	740	1218	685	1118	838	41.5 (136.2)	81.6 (267.7)	740	0
	600	1292	808	1328	747	1219	914	45.2 (148.3)	89.0 (292.0)	808	0

Installation Procedure

Lens unit	Diagonal when 16:10	Image size (cm)						Projection distance m (feet)		Distance from optical axis when projection is perpendicular to screen (cm)	
		16:10		16:9		4:3		16:10		H1	H2
		Width	Height	Width	Height	Width	Height	Wide limit	Tele limit		
Wide Zoom Lens RS-IL05WZ	40	86	54	89	50	81	61	0.9 (3.0)	1.3 (4.3)	54	0
	60	129	81	133	75	122	91	1.3 (4.3)	1.9 (6.2)	81	0
	80	172	108	177	100	163	122	1.7 (5.6)	2.6 (8.5)	108	0
	100	215	135	221	125	203	152	2.2 (7.2)	3.2 (10.5)	135	0
	150	323	202	332	187	305	229	3.2 (10.5)	4.9 (16.1)	202	0
	200	431	269	443	249	406	305	4.3 (14.1)	6.5 (21.3)	269	0
	250	538	337	553	311	508	381	5.4 (17.7)	8.1 (26.6)	337	0
	300	646	404	664	374	610	457	6.5 (21.3)	9.7 (31.8)	404	0
	350	754	471	775	436	711	533	7.5 (24.6)	11.4 (37.4)	471	0
	400	862	538	886	498	813	610	8.6 (28.2)	13.0 (42.7)	538	0
	450	969	606	996	560	914	686	9.7 (31.8)	14.6 (47.9)	606	0
	500	1077	673	1107	623	1016	762	10.8 (35.4)	16.3 (53.5)	673	0
	550	1185	740	1218	685	1118	838	11.8 (38.7)	17.9 (58.7)	740	0
	600	1292	808	1328	747	1219	914	12.9 (42.3)	19.5 (64.0)	808	0

Lens Shift Function

The projector includes a lens shift function. Operation of the buttons slides the lens up, down, left, and right, moving the image position. For instructions, refer to "Adjusting the Image Position" (P61).

The amount of lens shift is indicated as a percentage relative to the image height and width.

The table below shows the lens shift for each lens.

Lens unit	WUX6500
Standard Zoom Lens (RS-IL01ST)	Up (1): +55% Down (2): -15% Left / right (3): ±10%
Long Zoom Lens (RS-IL02LZ)	
Ultra Long Zoom Lens (RS-IL04UL)	
Wide Zoom Lens (RS-IL05WZ)	
Short Fixed Lens (RS-IL03WF)	Up (1): +5% Down (2): -5% Left / right (3): ±2%

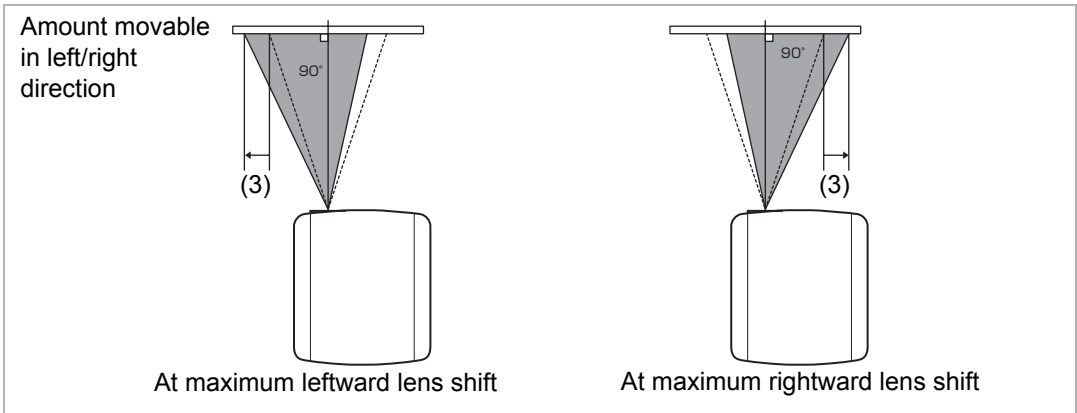
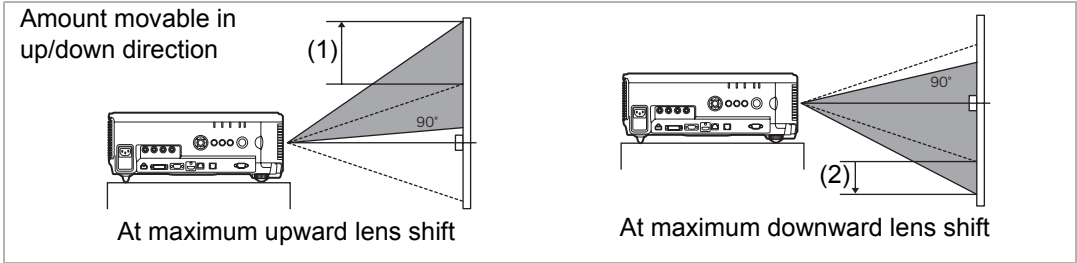

Area Outside the Lens Shift Range

With the Standard Zoom Lens, Long Zoom Lens, Ultra Long Zoom Lens, and Wide Zoom Lens, when the shift exceeds 44% in the upward direction, the amount of available shift in the left / right directions decreases. When the lens is shifted upward to the maximum (1), the amount of available shift in the left / right direction is $\pm 2\%$.

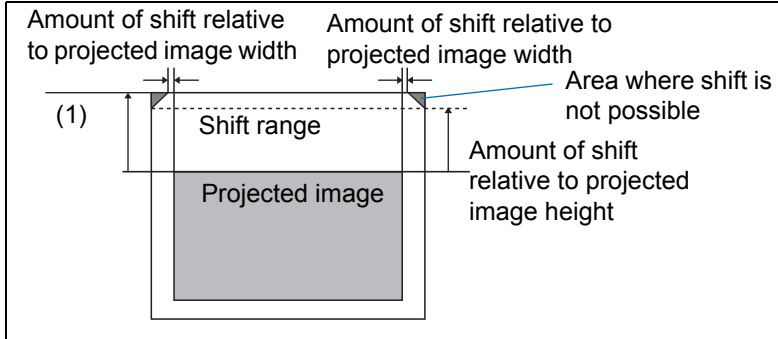

The more you shift the Short Fixed Lens up or down, the less you can shift it left or right. At the position of maximum lens shift upward or downward, the lens cannot be shifted left or right.

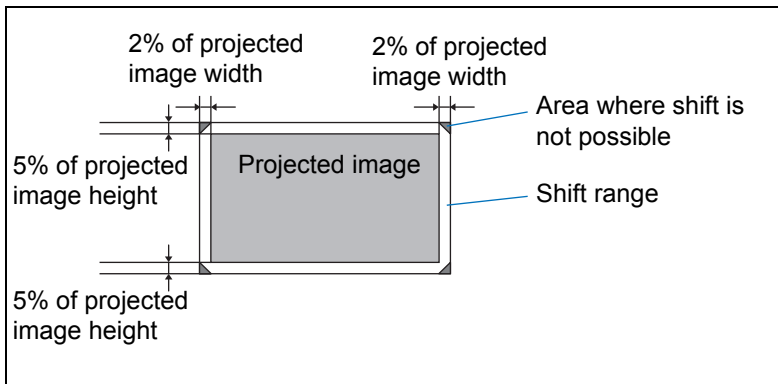

Connection Procedure



Caution

Before connecting the projector to other equipment, turn off both the projector and the other equipment.

Connecting a Computer

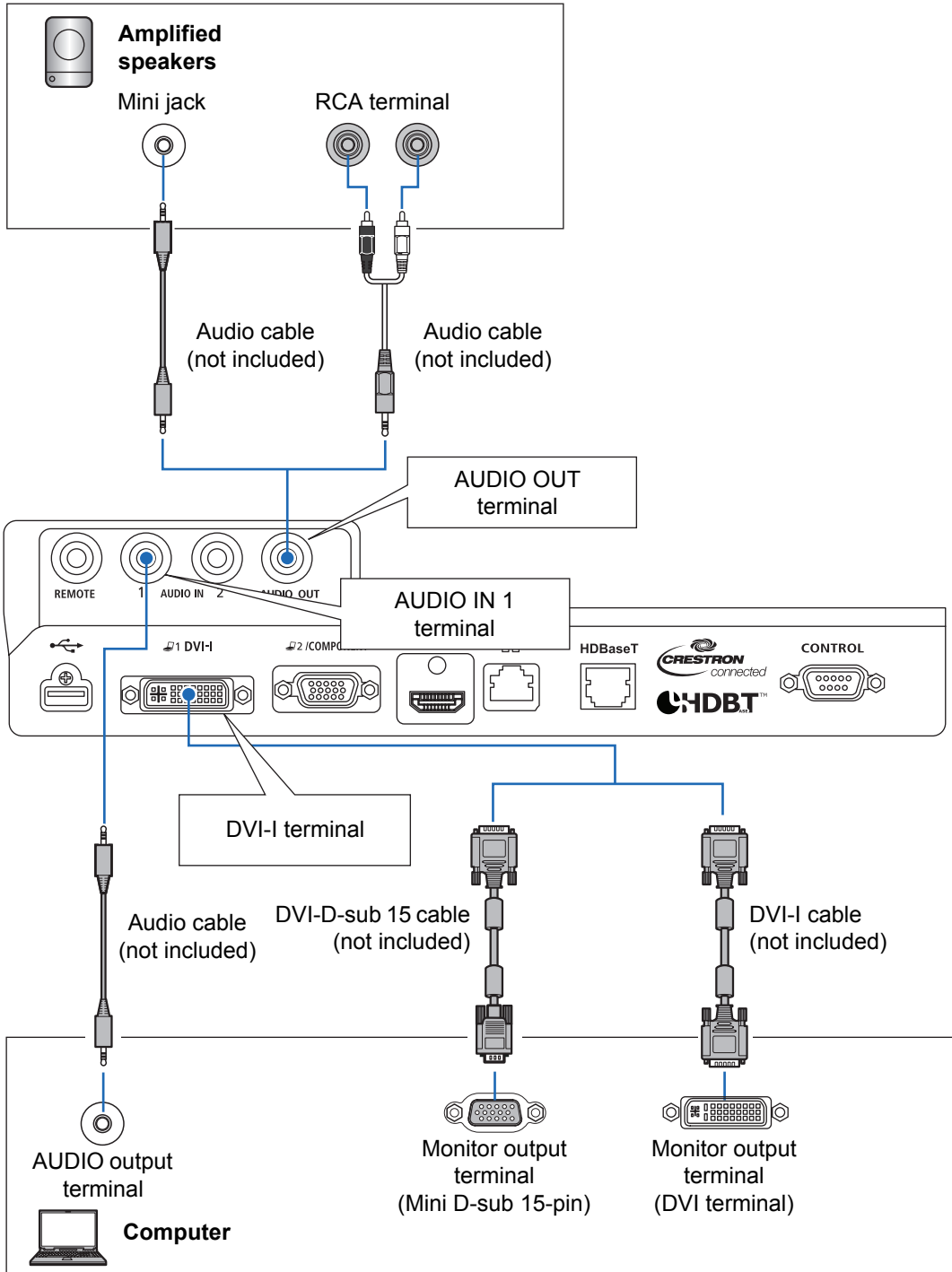

Connection Procedure

Connecting a Computer (continued)

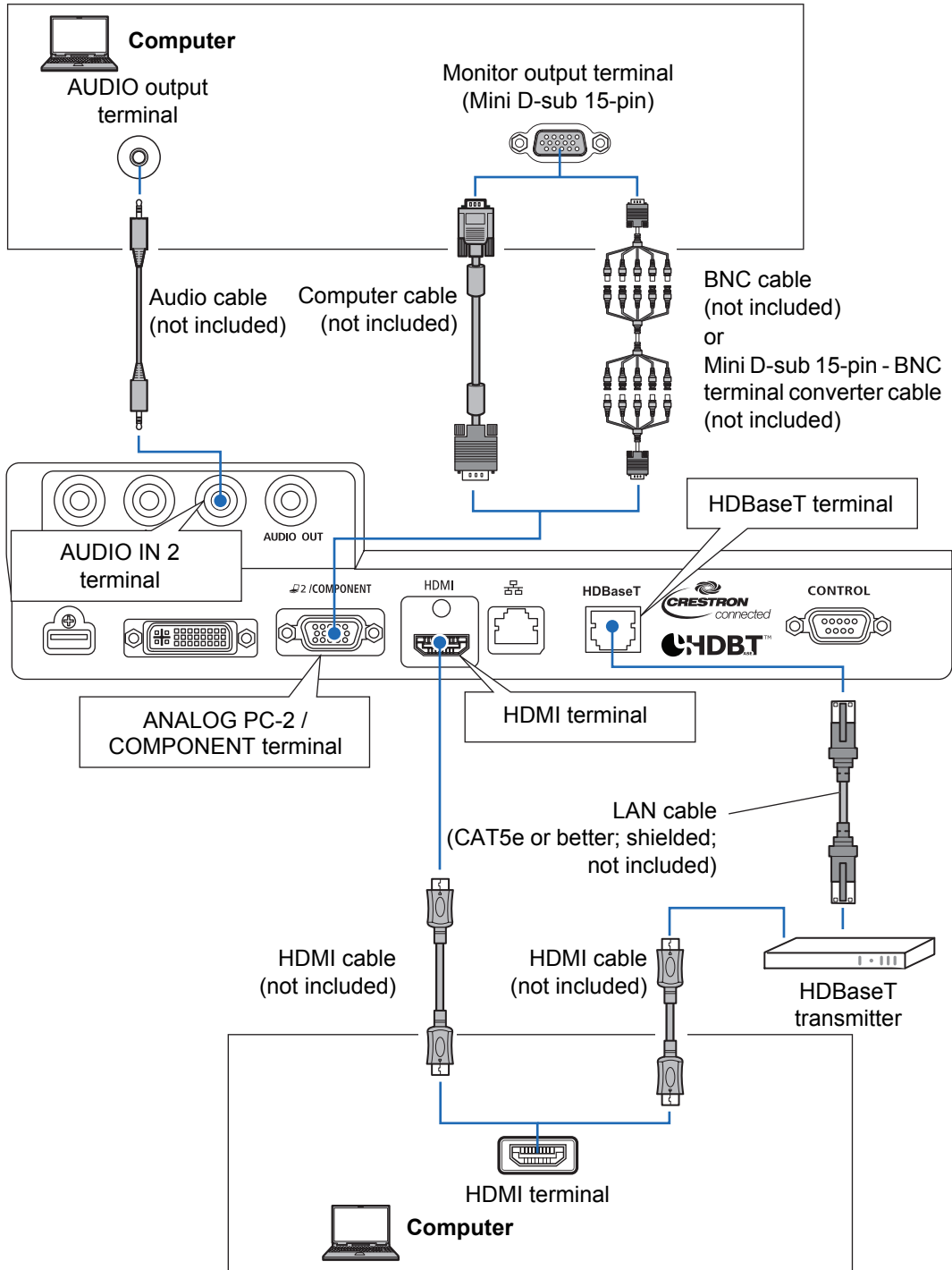

Connecting AV Equipment

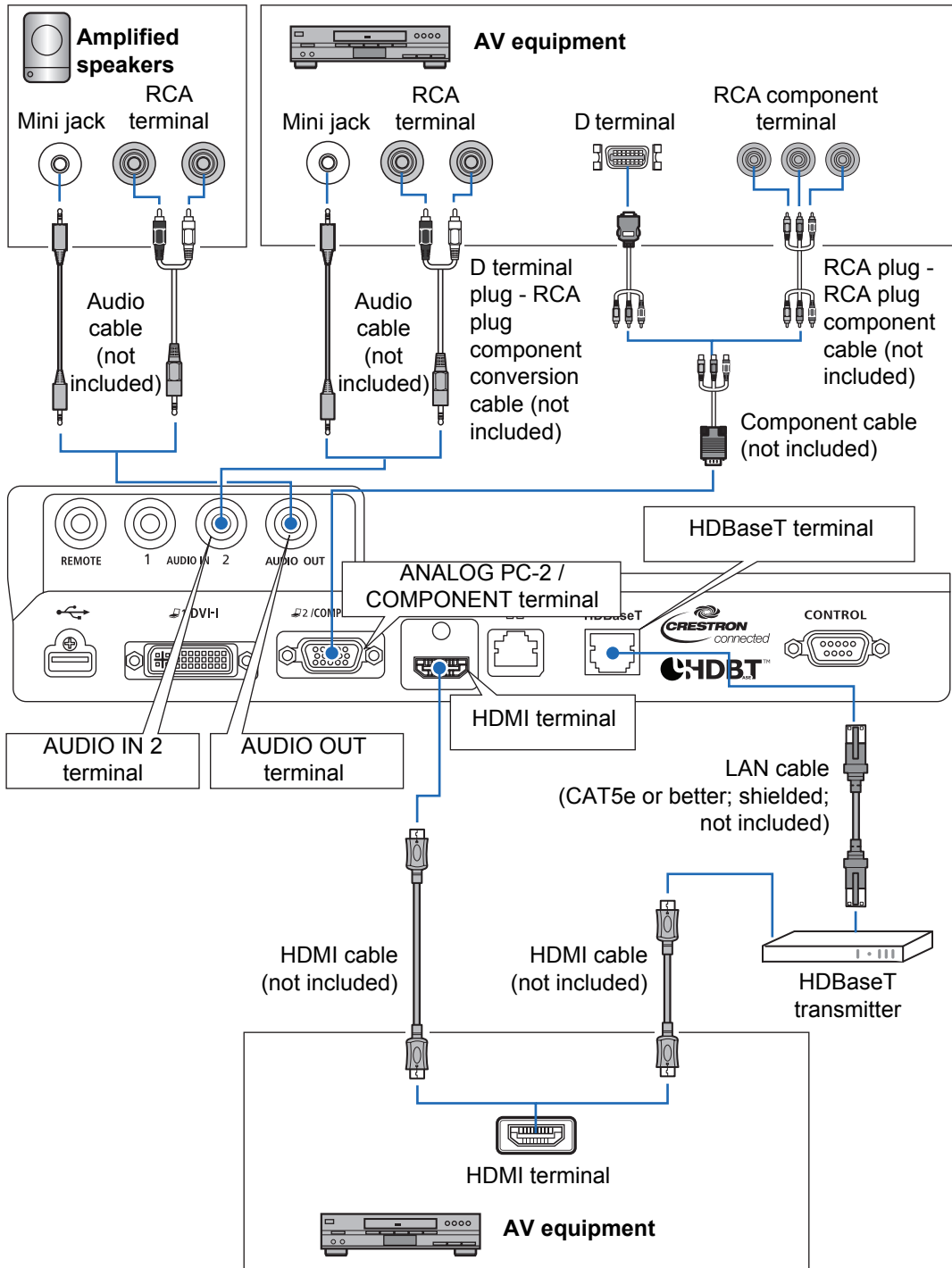



Notes on HDBaseT

- Use a shielded cable rated at CAT5e or better.
- Maximum transmission distance is 100 m.
- However, maximum transmission distance may be shorter in some environments.
- Do not use the LAN cable when it is coiled or bundled.
- Inserting or removing the LAN cable during projection may cause noise.
- Connectivity with all HDBaseT transmitters on the market is not guaranteed.
- Some HDBaseT transmitters may not enable correct projection when used to connect source equipment to the projector.

Plugging the Projector In

Connect the power cord to the projector and plug it in.

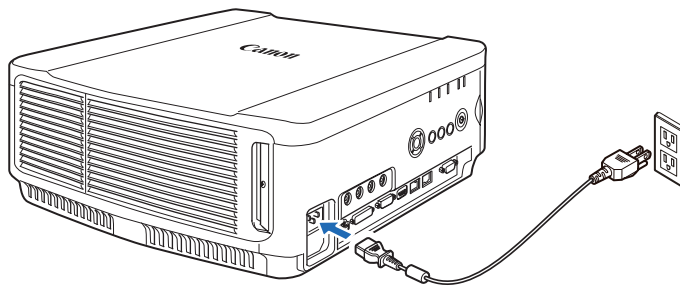

Warning

Insert the power plug and connector securely up to the base.



- After turning off the projector, wait at least 5 minutes before turning it on again. Turning the projector on immediately after turning it off may shorten the lamp life.
- Unplug the power cord when the projector is not in use.

Projection Procedure

Step 1 Turn the Projector On

- 1 Check the connection between the projector and the computer or AV equipment. (P49 - P51)**
For instructions on connecting the power cord, refer to “Plugging the Projector In” (P52).
- 2 Press the POWER button.**
The [POWER ON] indicator initially flashes green, after which it remains lit.

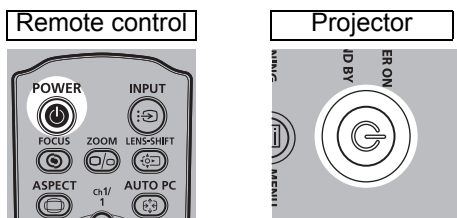

The countdown window is displayed for approximately 20 seconds, and then the projection is started. Press the **OK** button to hide the countdown window.



- Network functions are not available for the first 40 seconds after startup.
- A window appears when the projector is turned on for the first time. You can select a language to be used by the projector for displaying menus and messages in the window. Select the desired language with the pointer buttons and press the **OK** button. (P54)
You can change the language from the menu at a later time. (P123)

- 3 Turn on the computer or AV equipment power.**

Changing Operations When Projector is Turned On

You can change operations when the projector is turned on as follows.

- You can turn on the projector by connecting the power cord, without pressing the **POWER** button. (P122)
- You can change the countdown window. (P118)
- You can skip the countdown window. (P118)

When the Projector Is Left Idle

If no signal is received, the power management feature automatically turns off the projector after a certain period of inactivity (by the factory default, 15 minutes). (P121)

■ When the Language Selection Screen Appears

A screen appears when the projector is turned on for the first time. You can select a language to be used by the projector for displaying menus and messages in the window. Select the desired language with the pointer buttons and press the **OK** button.

You can change the language from the menu at a later time. (P123)

If the language selection screen is out of focus, adjust the focus. (P59)

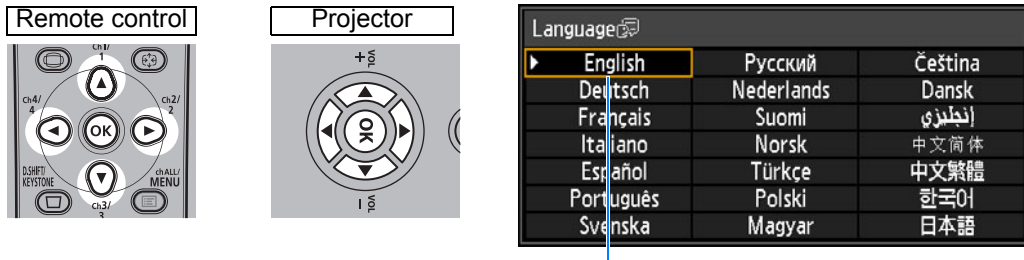

An item highlighted in orange will be selected.

■ When the Password Input Screen Appears

If you have set a password, the password input screen appears. Enter your password. (P124)

■ When “No signal” Appears

With a notebook computer, the user must turn on the external monitor output. (P55)
Press the **INPUT** button to select the input signal. (P56)

■ When Notebook Computer Screen Does Not Appear

Set your notebook computer to output signals to an external monitor. For more details, refer to “Changing Notebook Computer Screen Output” (P55).

■ Adjusting Image

- Set the display resolution of the computer to the highest resolution or the resolution closest to that setting. (P57)
- Use the auto PC function to adjust shift in computer image or the flickering of the screen. (P58)
- Adjust the size of projected images by zooming. For the Standard Zoom Lens, Long Zoom Lens, Ultra Long Zoom Lens, and Wide Zoom Lens, use optical zoom (P60). For the Short Fixed Lens, use digital zoom (P106).
- Correct any keystone distortion by pressing the **D.SHIFT/KEYSTONE** button. (P67)
- Select the aspect ratio of the projected image (screen aspect) or a screen mode (aspect) according to the aspect ratio of the screen, type of input image signal etc. (P63 – P66)
- Select an image mode depending on the projected image. (P70)



The image can also be adjusted by projecting a test pattern (P187).

Changing Notebook Computer Screen Output

For projection from a notebook computer, the computer settings must be adjusted to switch display output.

This operation is not required for a desktop computer.

■ Turning on External Monitor Output

You can turn on the external monitor output via keyboard operation.

To turn on the external monitor output with most computers, press the function key ([F1] to [F12]) which is marked with the external monitor icon while holding down the [Fn] key.

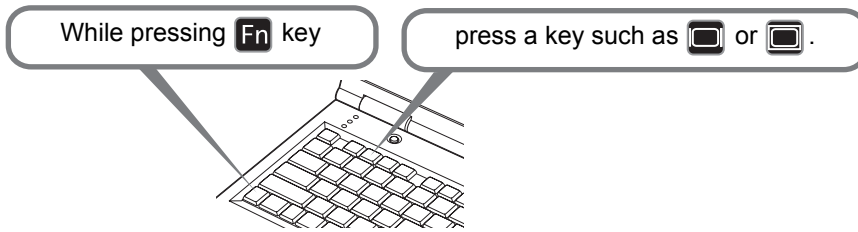

- The function key you use and the method used to turn on the external monitor output vary depending on the model. For details, see the manual for your notebook computer.
- With Windows 10, Windows 8.1, Windows 8 or Windows 7, you can turn on image output by holding down the Windows logo key and pressing the [P] key.

Step 2 Select an Input Signal

Select the input signal in the [Input] menu when you want to project a digital PC or AV equipment signal, or to switch between inputs when multiple computers or multiple sets of AV equipment are connected.

Skip this step if you have not changed the input signal since the last projection.

1 Press the INPUT button to display the window shown below.

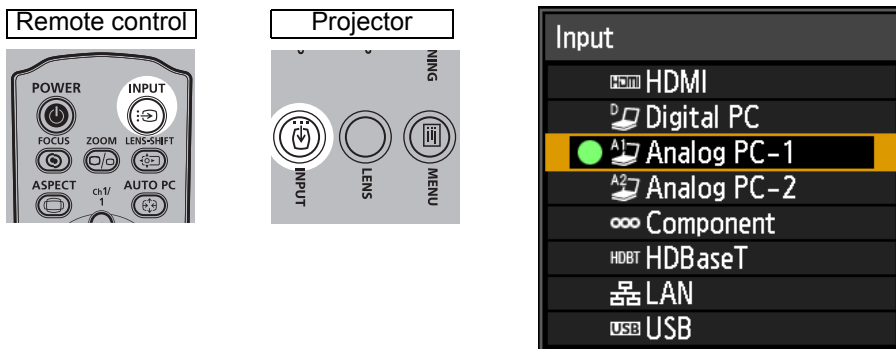

The currently active input signal is marked with a green circle and enclosed by an orange border.

Names of input signals available for projection are displayed in white, and unavailable signal names are grayed out. However, [Digital PC] and [Analog PC-1] may be grayed out even when available.

2 You can switch the available input signal types by pressing the INPUT button.

You can select the target input signal with [▲] / [▼].

3 Press the OK button to confirm the input signal type.



- Screens of computers connected to the projector over a network can be projected when you have selected [LAN] as the input signal. For details, refer to the NMPJ user's manual.
- Images on USB flash drives can be projected when you have selected [USB] as the input signal. For details, refer to "Projecting Images on a USB Flash Drive" (P157).
- In split-screen mode, the side without control rights is identified by a white circle.

Step 3 Adjust the Image

Setting the Display Resolution of the Computer

Based on the maximum resolution of the projector, set the display resolution of the computer to the resolution closest to the output signal resolution of the projector. (P188)

Maximum resolution

1920 X 1200 dots

■ Windows 10

- 1 Open the [Control Panel] from the start menu, then select [Appearance and Personalization] - [Adjust screen resolution] in the [Control Panel Home].
- 2 Click the [Resolution] tab, and move the slider to select the resolution closest to the maximum output signal resolution of the projector.
- 3 Click the [OK] button.

■ Windows 8 / 8.1

- 1 Move the cursor toward the upper or lower right corner to access the menu.
- 2 Click [Settings], and then click [Control Panel].
- 3 From [Control Panel Home] - [Appearance and Personalization], select [Adjust screen resolution].
- 4 Click the [Resolution] tab, and move the slider to select the resolution closest to the maximum output signal resolution of the projector.
- 5 Click the [OK] button.

■ Windows 7

- 1 Open the [Control Panel] from the start menu, then select [Appearance and Personalization] - [Adjust screen resolution].
- 2 Click the [Resolution] tab, and move the slider to select the resolution closest to the maximum output signal resolution of the projector.
- 3 Click the [OK] button.

■ Windows Vista

- 1 Open the [Control Panel] from the start menu, then select [Appearance and Personalization] - [Adjust screen resolution] in the [Control Panel Home].
- 2 Select the resolution closest to the maximum output signal resolution of the projector from the [Resolution] list.
- 3 Click the [OK] button.

■ Mac OS X

- 1 Open the Apple Menu and select [System Preferences].
- 2 In the [System Preferences] window, click the [Displays] icon to display the Display window.
- 3 Select the [Display] tab and select the resolution closest to the maximum output signal resolution of the projector from the [Resolutions] list.
- 4 Close the [System Preferences] window.

Auto PC Adjustment

If the image display is shifted or there is flickering of the screen when [Analog PC-1] or [Analog PC-2] is selected, press the **AUTO PC** button to adjust the projector to the optimal condition.

The adjustment results will be stored. If the projector is used again with the same computer, when the input signal is selected the image will be projected automatically under the same conditions that were previously adjusted.

Remote control

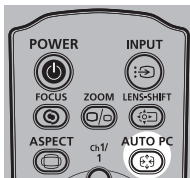

- If the Auto PC adjustment is insufficient, perform the following operations.
- Select the input signal that matches the resolution of the computer from [Input signal select]. (P91)
 - If adjustment is insufficient even when using the above operation, adjust [Total dots], [Tracking], [Horizontal position], [Vertical position], [Horizontal pixels] and [Vertical pixels] in [Input signal settings]. (P92)
 - For the signal types supported by the projector, see the table on [page 188](#) to [189](#).

Focusing, Resizing, or Moving the Image

■ Adjusting Image Focus

To adjust the focus, press the **FOCUS** button on the remote control or the **LENS** button on the projector.

For the projection distances of the lens unit, refer to “Relationship Between Image Size and Projecting Distance” on [page 43](#).

- 1 Press either the **FOCUS** button on the remote control or the **LENS** button on the projector to display the focus adjustment window.

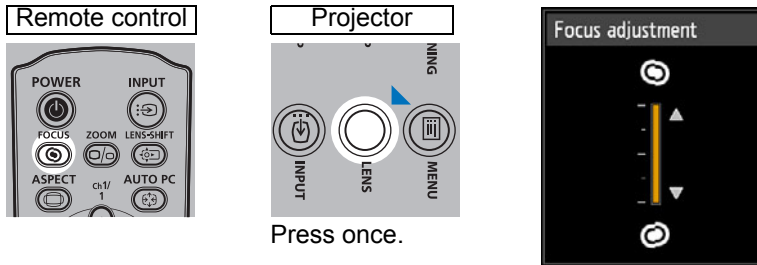

- 2 Press the pointer buttons to adjust the focus.

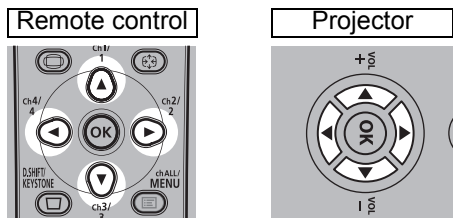

To adjust the focus, use the [▲] / [▶] / [▼] / [◀] buttons on the remote control or projector.

To continue adjusting the focus in a specific direction, hold down the [▲] / [▼] buttons on the remote control or projector.

- 3 When the focus is adjusted optimally, press the **OK** button or the **FOCUS** button.

■ Adjusting Image Size

The size of the projected image can be adjusted by pressing the **ZOOM** button on the remote control or the **LENS** button on the projector. Change the projector installation position if your desired image is too large or too small to adjust it with the zoom function. (P40)

- 1 Press either the ZOOM button on the remote control or the LENS button on the projector twice to display the zoom adjustment window.**

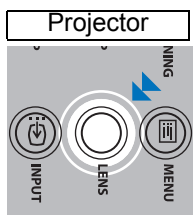
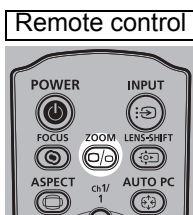

Press twice.

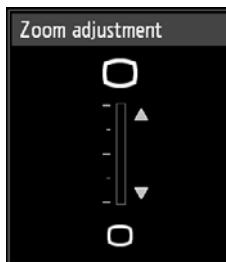

- 2 Press the pointer buttons to adjust the image size.**

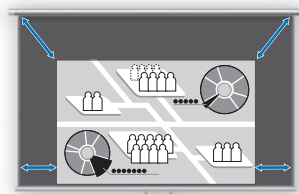
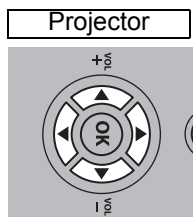
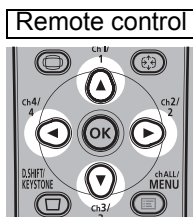

To enlarge the image, use the [▲] / [▶] buttons on the remote control or projector.

To reduce the image, use the [▼] / [◀] buttons on the remote control or projector.

To continue adjusting the size in a specific direction, hold down the [▲] / [▼] / [◀] / [▶] buttons on the remote control or projector.

- 3 When the desired image size is selected, press the OK button or the ZOOM button.**



When the Short Fixed Lens (RS-IL03WF) is attached, digital zoom adjustment is performed in place of optical zoom adjustment.

■ Adjusting the Image Position

To adjust the screen position up, down, left, or right, press the **LENS-SHIFT** button on the remote control or the **LENS** button on the projector. It can change the projected screen to the most suitable position by moving the position of the lens up/down/left/right.



- The available range for lens shift (percentage of movement relative to the screen size) varies depending on the lens unit which is used. (P47)
- Lens shift is not available in each corner for the Short Fixed Lens (RS-IL03WF) or in the top left and top right for the other lenses. (P48)

- 1 Press either the LENS-SHIFT button on the remote control or the LENS button on the projector three times to display the lens shift adjustment window.**

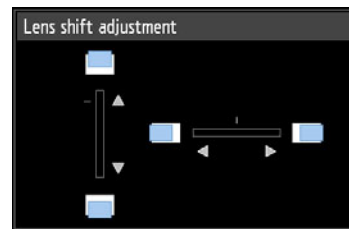
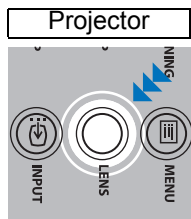
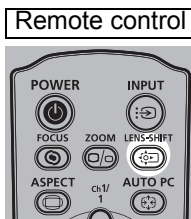

Press three times.

- 2 Press the pointer buttons to adjust.**

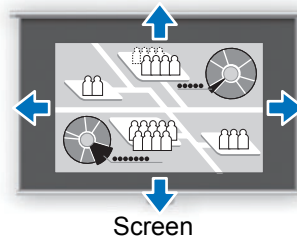
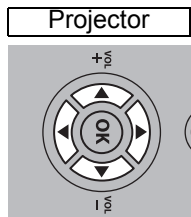
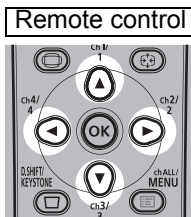

To raise or lower the image, use the [▲] / [▼] buttons on the remote control or projector.

To move the image left or right, use the [◀] / [▶] buttons on the remote control or projector.

To continue moving the image in a specific direction, hold down the corresponding button.

- 3 When the desired position is reached, press the OK button.**

■ Resetting the Position

The lens position after movement with the lens shift function is not returned when the power is turned off. To return it to its original position, perform reset.

During screen position adjustment, press and hold the **LENS-SHIFT** button on the remote control or the **LENS** button on the projector to display the [Lens shift reset] window. The selections for the lens currently used are displayed. Use the pointer buttons to select one of them, then press the **OK** button.

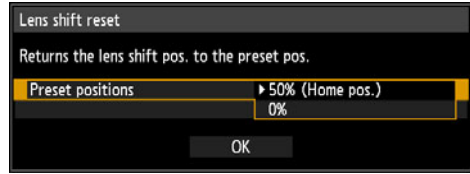

Lens unit type	Available items
Standard Zoom Lens RS-IL01ST	50% (Home position): Up 50%, left / right 0% 0%: Up / down / left / right 0%
Long Zoom Lens RS-IL02LZ	
Ultra Long Zoom Lens RS-IL04UL	
Wide Zoom Lens RS-IL05WZ	
Short Fixed Lens RS-IL03WF	0% (Home position): Up / down / left / right 0%

Step 4 Select an Aspect Ratio (Screen Aspect) Matching the Screen

Select an optimum aspect ratio of the projected image (screen aspect) or an optimum screen mode (aspect) according to the aspect ratio of the screen, type of input image signal and so on for the projection to make best use of the screen size.

[Screen aspect] Select the same screen aspect ratio as the screen you are using.

[Aspect] In general, select [Auto].

You may need to change the setting depending on the resolution of the computer or other AV equipment connected. If the image is not projected with the desired aspect ratio, refer to “Relationship between Aspect and Screen Aspect” on [page 183](#).

Selecting Screen Aspect

Select the correct aspect ratio for the screen which is used.

1 Press the MENU button to display the menu window.

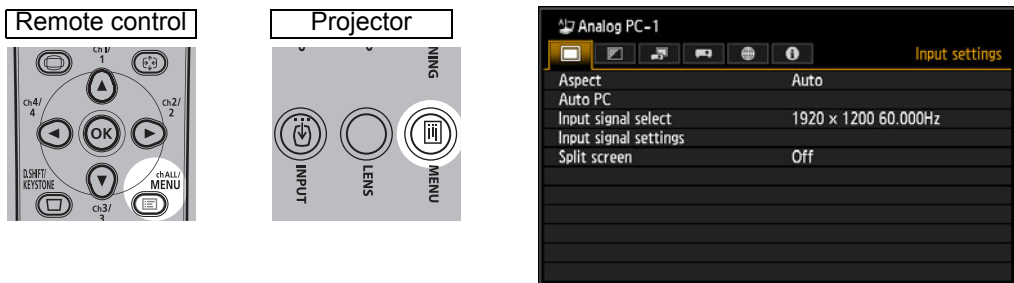

2 Press the [◀] / [▶] buttons to select the [Install settings] tab.

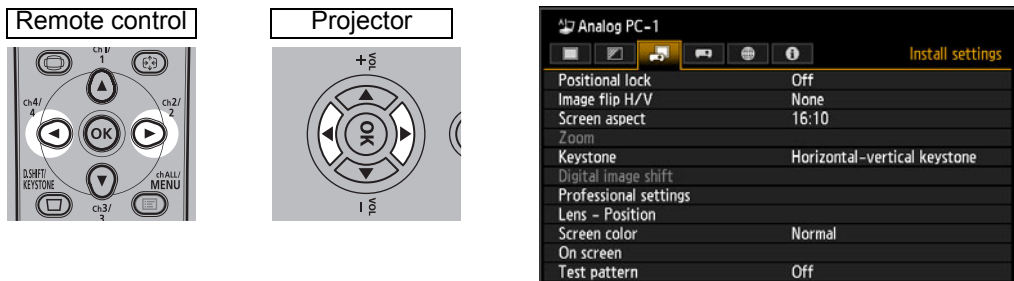

When the Short Fixed Lens is attached and if the projected image does not fit on the screen, you can display the image by electronically reducing its size. The [Zoom] setting will appear in the menu only when the Short Fixed Lens (RS-IL03WF) is attached.

- 3** Select [Screen aspect] with the [▲] / [▼] buttons, and then press the OK button.

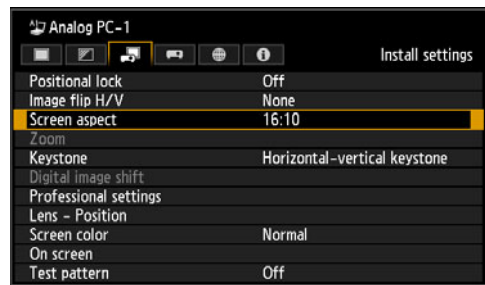
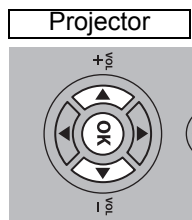
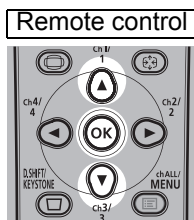

- 4** Use the [▲] / [▼] buttons to select the desired contents.

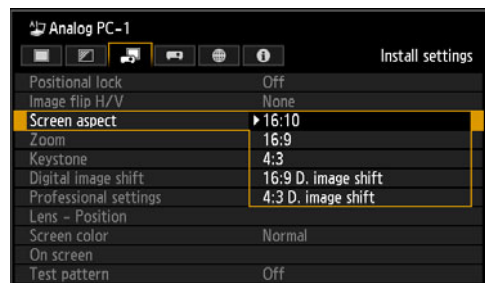
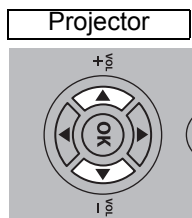
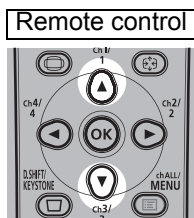

16:10

Select this when you use a screen with an aspect ratio of 16:10. Also select this screen aspect when projecting on a wall. You can correct keystone distortion with this mode. (P67)



16:10 screen

16:9

Select this when you use a screen with an aspect ratio of 16:9. You can correct keystone distortion with this mode. (P67)



16:9 screen

4:3

Select this when you use a screen with an aspect ratio of 4:3. You can correct keystone distortion with this mode. (P67)



4:3 screen

16:9 D. image shift

Select this when you use a screen with an aspect ratio of 16:9. Keystone correction cannot be performed in this mode. However, it is possible to move the image up / down when projecting level. For details about how to move the image, refer to "Digital image shift" on page 107.

4:3 D. image shift

Select this when you use a screen with an aspect ratio of 4:3. Keystone correction cannot be performed in this mode. However, it is possible to move the image left / right when projecting level. For details about how to move the image, refer to “Digital image shift” on [page 107](#).

- 5 Press the OK button to accept your setting and then press the MENU button.**

Resetting the Image Shift

Perform the following steps to reset the image shift adjustment.

- 1 Access the [D. image shift adjustment] window and press the D.SHIFT/KEYSTONE button to display the [D. image shift reset] window.**
- 2 Next, select [OK] with the [◀] button, and then press the OK button.**
Your specified [D.image shift adjustment] is now reset.

Select the Aspect

Select [Aspect] based on the input signal type, aspect ratio of the screen and resolution. For more details about aspect ratios, refer to “Relationship between Aspect and Screen Aspect” on [page 183](#).

Types of Aspect Ratios

■ Auto

An image is projected at the aspect ratio of the input signal. Select this mode for normal image projection.

■ 16:10

The image is projected using an input signal aspect ratio of 16:10. Select this if an image of 16:10 aspect ratio cannot be correctly projected in [Auto] mode.



There may be some cases when this cannot be selected, depending on the input signal and/or resolution.

■ 16:9

The image is projected using an input signal aspect ratio of 16:9. Select this if an image of 16:9 aspect ratio cannot be correctly projected in [Auto] mode.

■ 4:3

The image is projected using an input signal aspect ratio of 4:3. Select this if an image of 4:3 aspect ratio cannot be correctly projected in [Auto] mode.

Projection Procedure

■ Zoom

This cuts the upper / lower or left / right part of the screen according to the screen aspect and zooms in the center of the image. Select this if a letter box is displayed (black lines at the top/bottom of the screen) when watching video.



There may be some cases when this cannot be selected, depending on the input signal and/or resolution.

■ True size

The image is projected with the original resolution of the input signal. Screens of computers with a lower display resolution than the projector are displayed smaller but clearer than in other aspect ratios.



There may be some cases when this cannot be selected, depending on the input signal and/or resolution.

Selecting an Aspect Ratio

Press the **ASPECT** button on the remote control and select an appropriate aspect ratio. Press the **ASPECT** button to change the aspect ratio type. For more details about aspect ratios, refer to “Relationship between Aspect and Screen Aspect” on [page 183](#).

Remote control

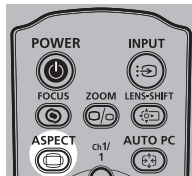

Example:



You can also select any aspect ratio from [Aspect] in the menu. (P91)



Some aspect ratios may not appear depending on the type of input signal.

Step 5 Adjusting Keystone Distortion

To correct keystone distortion, press the **D.SHIFT/KEystone** button.

Two types of correction are available: horizontal/vertical correction and corner correction.

Use horizontal/vertical keystone correction to adjust image width or height distortion separately, and use corner correction to adjust the position of each corner of the image.

For instructions on switching keystone correction, refer to “Keystone” (P106).



- The result of keystone adjustment is stored in memory. If you place the projector in the same position, the keystone adjustment is not necessary.
- If keystone distortion is excessive and cannot be fully corrected, straighten the projector so that it faces the screen directly.
- Signals are processed digitally when keystone distortion is corrected. The image may look different from the original one. In addition, the aspect ratio of the image may change.
- The digital image shift function is accessed when this button is pressed and the screen aspect is [4:3 D. image shift] or [16:9 D. image shift]. (P107)

■ Horizontal/Vertical Keystone Correction



[Zoom] (P106) in the [Install settings] menu is not available during horizontal/vertical keystone correction.

- 1 Press the **D.SHIFT/KEystone** button on the remote control to display the horizontal-vertical keystone adjustment window when [Keystone] is set to [Horizontal-vertical keystone].

Remote control

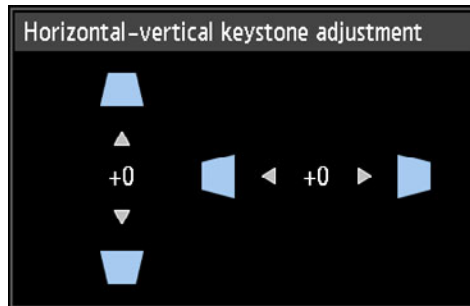
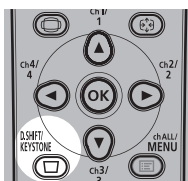

2 Press the pointer buttons to adjust the dimensions.

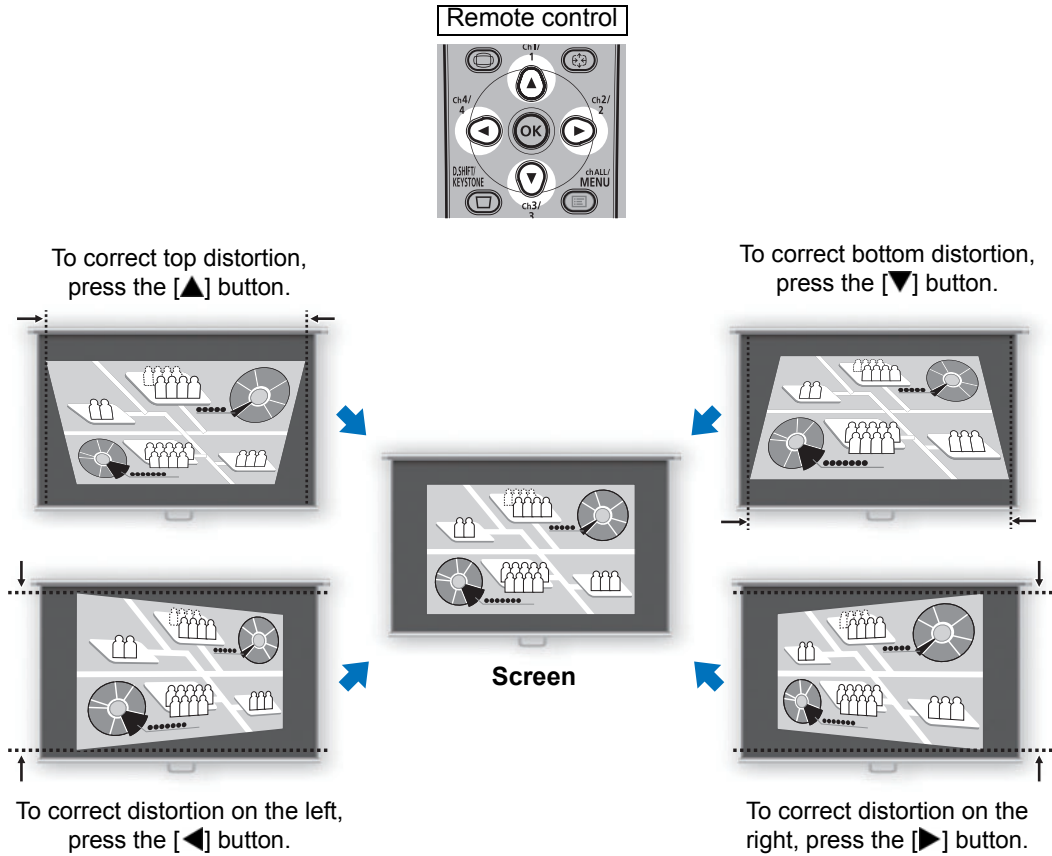

3 When keystone distortion has been corrected, press the OK button.

■ Corner Adjustment

- 1 Press the D.SHIFT/KEYSTONE button on the remote control to display the corner adjustment window when [Keystone] is set to [Corner adjustment].

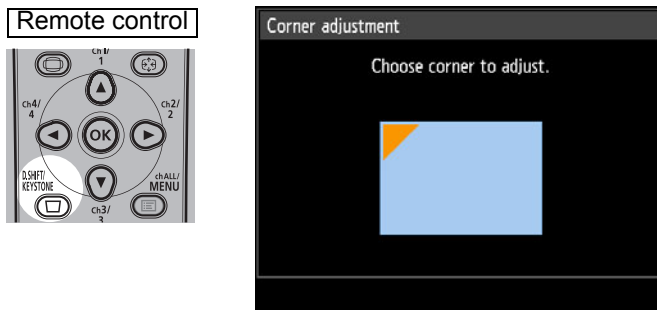

- Press the pointer button of the corner for correction, and then press the OK button.

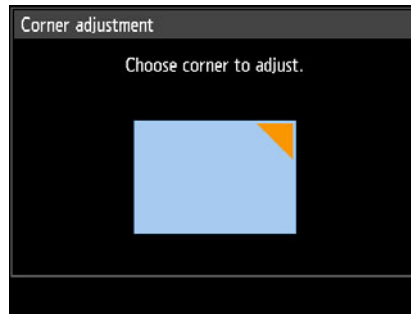
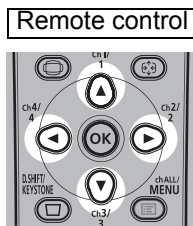

- Press the pointer buttons to adjust the corner.

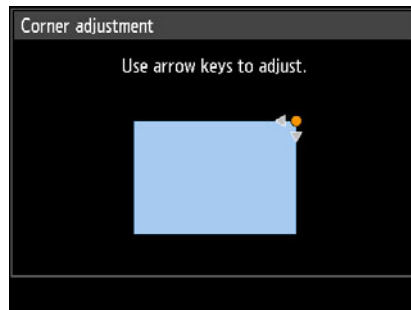
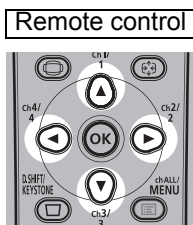

- When you have finished correcting, press the OK button.



Corner adjustment settings will be cleared if you subsequently use [Zoom] (P106) in the [Install settings] menu.

Resetting the Keystone Adjustment

Horizontal-vertical keystone and corner adjustment can be reset as follows.

- First, press the D.SHIFT/KEYSTONE button on the remote control twice to display the [Keystone reset] window.
- Next, select [OK] with the [◀] button, and then press the OK button. Your specified keystone adjustment is now reset.

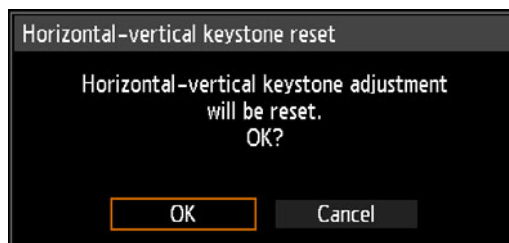

Step 6 Select the Image Quality (Image Mode)

You can select an image mode to suit the projected image.

In each image mode, you can further adjust the brightness, contrast, sharpness, gamma, color adjustment, advanced adjustment, and lamp mode. (P97)

Image Modes

Available image modes vary depending on the selected input signal and whether [HDMI image input] (P121) and [HDBaseT image input] (P121) is set to [Auto] or [Computer].

○: Compatible —: Not compatible

Image mode	Compatible input signals		Functions (1) Ambient Brightness (2) Types of Images (3) Image Mode Characteristics
	<ul style="list-style-type: none"> • Digital PC • Analog PC-1/2 • HDMI*1 • HDBaseT*2 • LAN • USB 	<ul style="list-style-type: none"> • Component • HDMI*3 • HDBaseT*4 	
Standard	○	○	(1) Bright (2) Computer screens, or media played with video software (3) Whites and natural colors
Presentation	○	—	(1) Bright (2) Images mainly consisting of text (3) Keeps the screen bright
Dynamic	—	○	(1) Bright (2) Media played with video software (3) Keeps the screen bright
VividPhoto	○	—	(1) Somewhat dark (2) Digital photos (3) Produces vibrant colors
Video	—	○	(1) Somewhat dark (2) Video from camcorders (3) Close to the color space of TVs
Photo/sRGB	○	○	(1) Somewhat dark (2) Digital photos from sRGB-compatible cameras (3) Conforms to the sRGB standard
Cinema	—	○	(1) Dark (2) Movies (3) Designed especially for movies
User 1 – 5	○	○	Up to 5 user-selected combinations of image quality settings can be stored in the memory (P97). Stored settings can be selected as an image mode.

*1 [HDMI image input] set to [Computer]

*2 [HDBaseT image input] set to [Computer]

*3 [HDMI image input] set to [Auto]

*4 [HDBaseT image input] set to [Auto]

■ Selecting an Image Mode

Press the **IMAGE** button on the remote control to select.

The image mode changes each time the **IMAGE** button is pressed. (The displayed image modes vary depending on the selected input signal.)

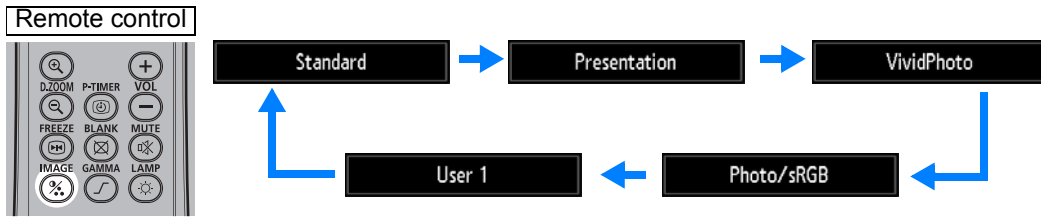

You can also select any image mode from the [Image mode] menu. (P97)

- User settings 1 - 5 are displayed when the desired image settings have been created and stored using the user memory function in the image adjustment menu. (P97)

Step 7 Turn the Projector Off

1 Press the **POWER** button to display the window shown below.

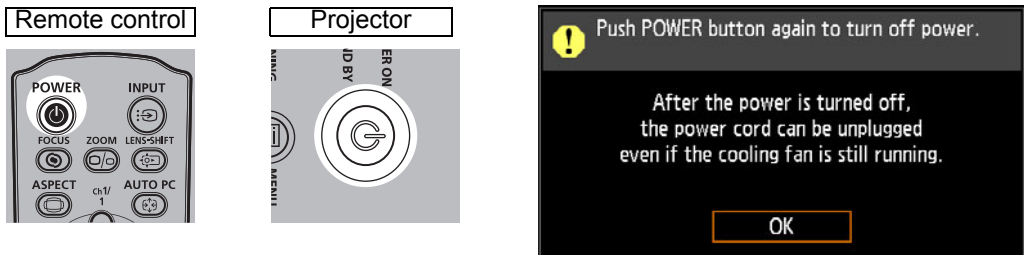

2 When this window is displayed, press the **POWER** button again to turn off the power.

After you turn the power off, the projector will enter standby mode once it cools down.



- If you want to continue projecting without turning off the power, press a button other than **POWER**, or else wait until the confirmation message disappears.
- After turning off the projector, wait at least 5 minutes before turning it on again. It may shorten the lamp life if you turn on the projector immediately after turning it off.
- Using the projector for extended periods may shorten the life of the lamp and internal optical components.
- Unplug the projector if it will not be used for an extended period.

Convenient Features

This section describes features convenient during presentations and in other situations.

Temporarily Blacking Out an Image

Projection can be temporarily blanked after a presentation, or to divert the audience's attention away from the screen.

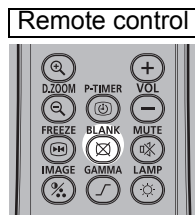

Press the **BLANK** button to black out the image.
Press the **BLANK** button again to show the image.

- You can set the screen state while blanking out the image in the menu. ([P117](#))
- The lamp remains illuminated while the image is blanked out.

Freezing the Picture

Projection can be temporarily frozen during computer operations that would be distracting, or to pause playback of video or animation.



Press the **FREEZE** button to freeze the moving image. The projector shows the following icon.
Press the **FREEZE** button again to return to the original display.

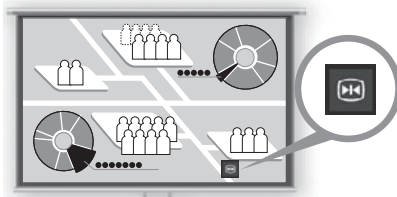

Screen

- It is also cancelled when the input signal is terminated.

Projecting Images Stored on a USB Flash Drive

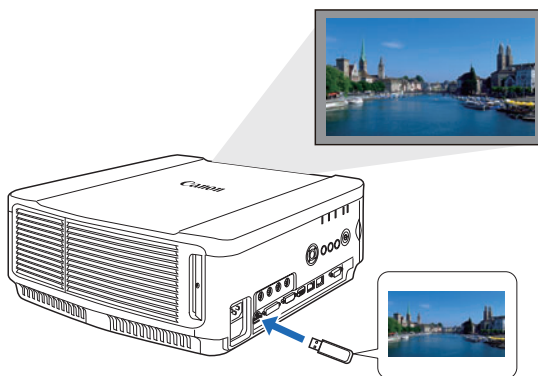

Even without using a computer, you can project images stored on a USB flash drive simply by connecting it to the USB port.

For instructions on projection from a USB flash drive in the projector's USB port, see "Projecting Images on a USB Flash Drive" ([P157](#)).

Projecting a Test Pattern from the Menu

Even without any input signals, the projector can project a test pattern. Test patterns can be projected during installation to check how the projector is installed. For details on projecting test patterns, see “Install settings” (P104) or “Displayed Test Patterns” (P187).

Set Power-Saving Settings

Set power-saving settings as needed.

The following four settings are available. For details, refer to the page describing each function.

- **Lamp mode (P102)**
Adjust lamp and fan power consumption in the image mode.
- **Power management mode (P121)**
Automatically turns off the lamp or the power after a certain period if the projector is idle without an input signal.
- **Power management duration (P122)**
Specify the period after which the lamp or the projector should go off automatically if left idle without an input signal when [Power management mode] is set to [Lamp off] or [Standby].
- **Network standby settings (P131)**
Conserve energy in standby mode, as needed.

Adjusting the Volume

Useful when:

- You want to adjust the volume level of the projector or external speakers.

Remote control



Press the **VOL** button. The following screen appears.



- You can also adjust the volume level with the [▲] / [▼] buttons of the projector.
- Adjust the volume or mute setting on the computer if the volume level is too low.
- You can also adjust the volume level of the speakers connected via the audio output terminal.

Muting the Sound

Useful when:

- You want to temporarily mute unnecessary sound.
- You want to immediately mute the sound.

Remote control



Press the **MUTE** button to mute the sound. The projector shows the following icon.

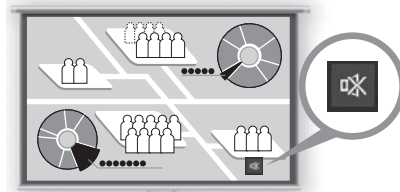

Screen

Press the **MUTE** button again to cancel the mute function.

- You can also mute the sound of the speakers connected via the audio output terminal.

Zooming Part of an Image

Useful when:

- Zooming in on an object such as a small graph during a presentation (up to 12x).
- Focusing on the current subject.

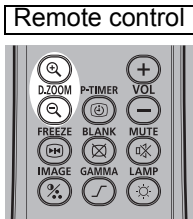

Press the **+ D.ZOOM** button to enlarge a part of the image. Press the **- D.ZOOM** button to reduce the image size.

- The magnification appears on the screen.

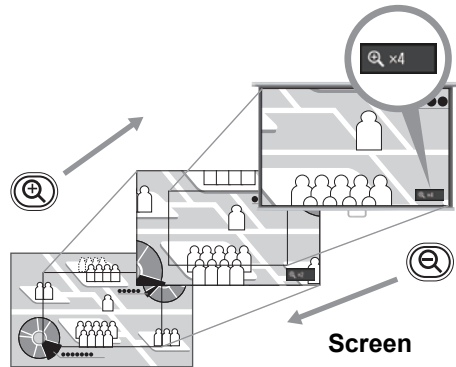

You can move the enlarged area by using the **[▲] / [▼] / [◀] / [▶]** buttons.

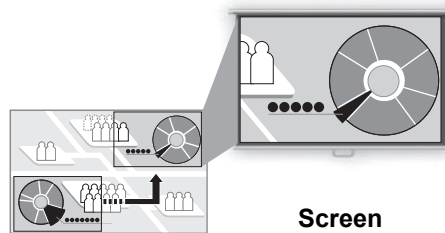
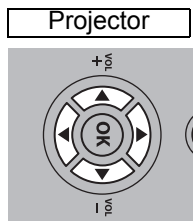
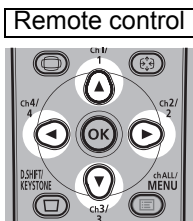

You can restore the original size of the image by pressing the **OK** button.



The **D.ZOOM** buttons work differently than [Zoom] in the [Install settings] menu (P106).

Advanced Guide

Safety Instructions

Before Use

Installation Procedure

Connection Procedure

Projection Procedure

Convenient Features

Using Menus

Menu Configuration

Menu Description

Advanced Projection

Maintenance

Product Specifications

Troubleshooting

Basic Guide

Advanced Guide

Other Information

Using Menus

Use the menus to set the operation of the projector in detail.

Menu Configuration

The menu screen is divided into 6 tabs as shown below.

 **[Input settings] tab (P90)**
You can set the type of signal or the method of projection of the images input.

 **[Image adjustment] tab (P96)**
You can adjust the image quality and colors according to your preference.

 **[Install settings] tab (P104)**
This setting is used when installing the projector.

 **[System settings] tab (P116)**
You can set the operation of the projector.

 **[Network settings] tab (P129)**
These settings are for when using the projector from a PC via a network.

 **[Information] tab (P156)**
You can check information about the signal types of the images projected and other information.

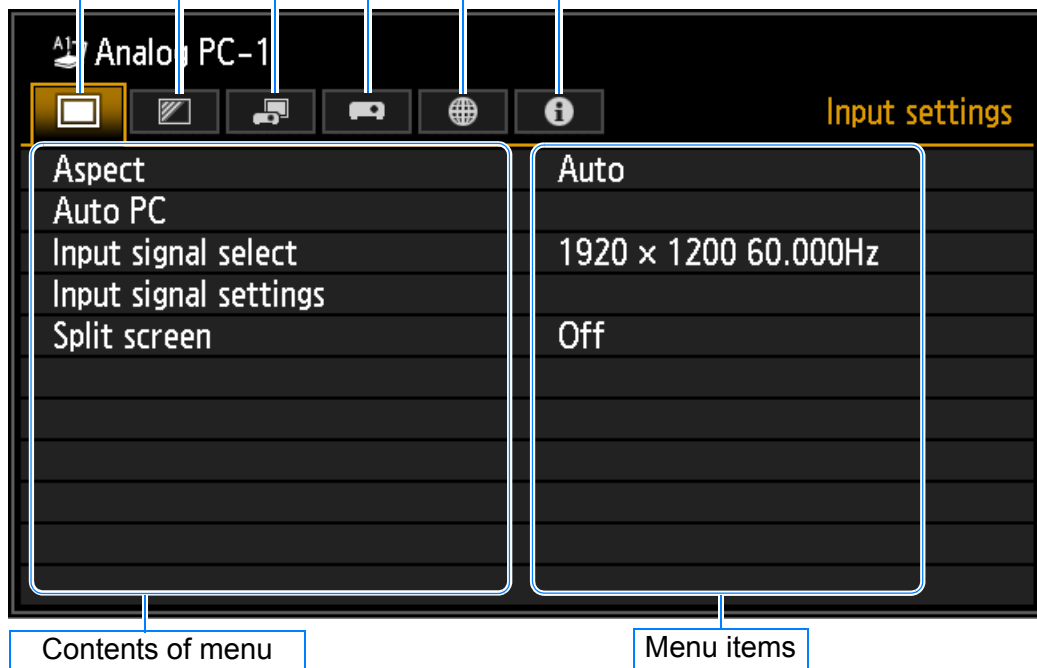

Basic Menu Operations

- 1** Press the **MENU** button to display the menu window.

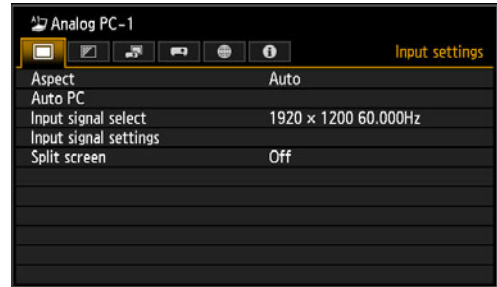
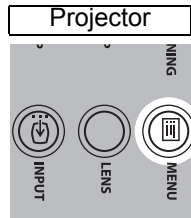
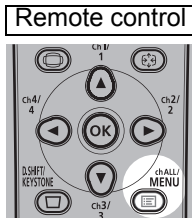

- 2** Press the [**◀**] / [**▶**] buttons to select a tab.

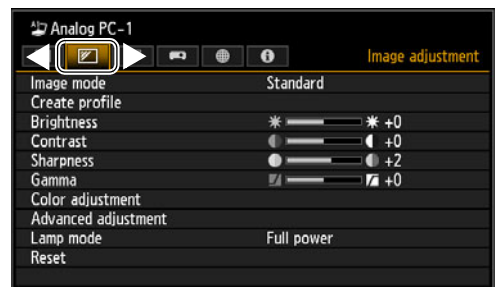
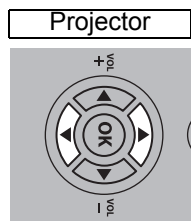
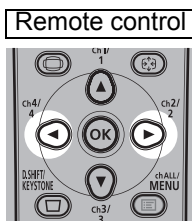

- If the tab position is not highlighted in orange, press the [**▲**] / [**▼**] buttons to move the current selection to the top.

- 3** Press the [**▲**] / [**▼**] buttons to select an item.

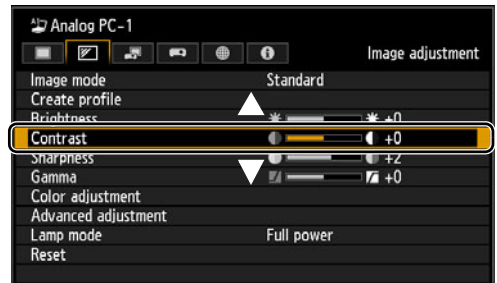
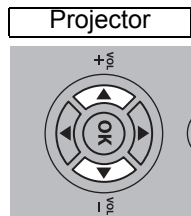
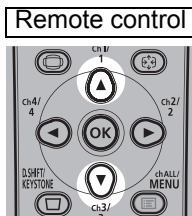

- 4** Select contents.

How to select the contents varies depending on the item.

Selecting from a list Example: Aspect (P91)

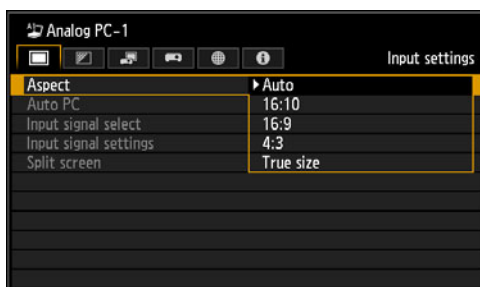

1. Select [Aspect].
2. Press the **OK** button or [**▶**] button to display a list of the contents.
3. Use the [**▲**] / [**▼**] buttons to select the desired contents.
4. When you have found the contents you desired, press the **OK** button or [**▶**].

Adjusting with the [◀] / [▶] buttons Example: Contrast (P98)

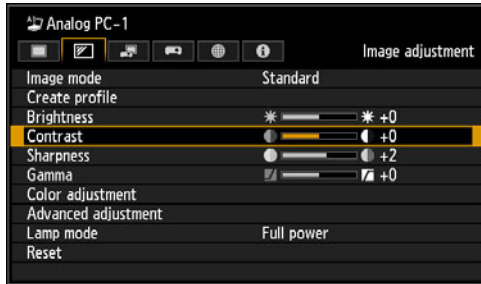

1. Select [Contrast].
2. Use the [◀] / [▶] buttons to adjust the setting.

Selecting from a different screen (1) Example: Menu position (P113)

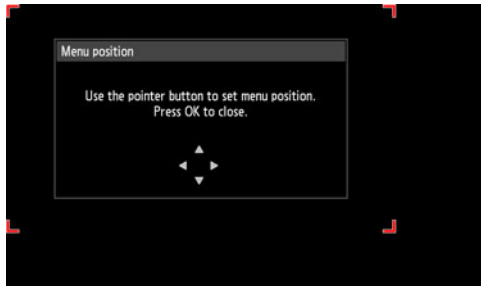

1. Select [Menu position].
2. Press the **OK** button to display a different screen.
3. Then follow the instruction on the screen.

Selecting from a different screen (2) Example: Tracking (P92)

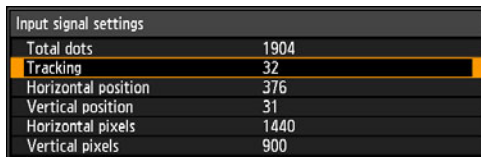

1. Select [Input signal settings].
2. Press the **OK** button to display a different screen.
3. Select [Tracking].
4. Use the [▲] / [▼] buttons to select the setting, then use the [◀] / [▶] buttons to select the value.

5 Pressing the MENU button causes the menu screen to disappear.

Menu Configuration

Input settings (P90)

Aspect	Digital PC / Analog PC-1/2 / HDMI (when [HDMI In] is [Computer]) / HDBaseT (when [HDBaseT In] is [Computer]) P91 Auto* 16:10 16:9 4:3 True size HDMI (when [HDMI In] is [Auto]) / Component / HDBaseT (when [HDBaseT In] is [Auto]) Auto* 16:9 4:3 Zoom True size USB / LAN Auto
Auto PC	Analog PC-1 / 2 P91
Input signal select	Analog PC-1 / 2 P91 640 x 480 : 1920 x 1200
Input signal settings	Analog PC-1 / 2 P92 Total dots Tracking Horizontal position Vertical position Horizontal pixels Vertical pixels
Input level	HDMI / HDBaseT P93 Auto* Normal Expanded
Color space	HDMI / HDBaseT P94 Auto* RGB YCbCr
Over scan*1	HDMI / HDBaseT P94 Off On
Progressive	Component / HDMI / HDBaseT P95 Off Film/auto* Video 1 Video 2 25p/30p(PsF)

* Factory default, or state after [Factory defaults] is executed.

*1 Factory default settings are based on these conditions: [On] when HDMI ([HDMI In]) is [Auto], and [Off] when it is [Computer].

Menu Configuration

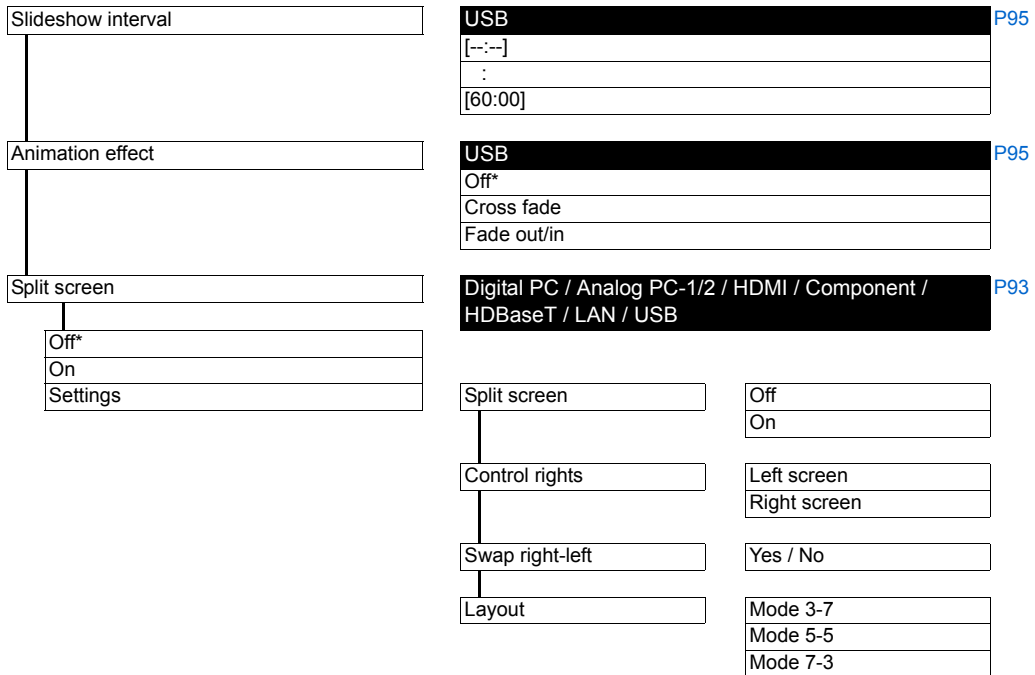
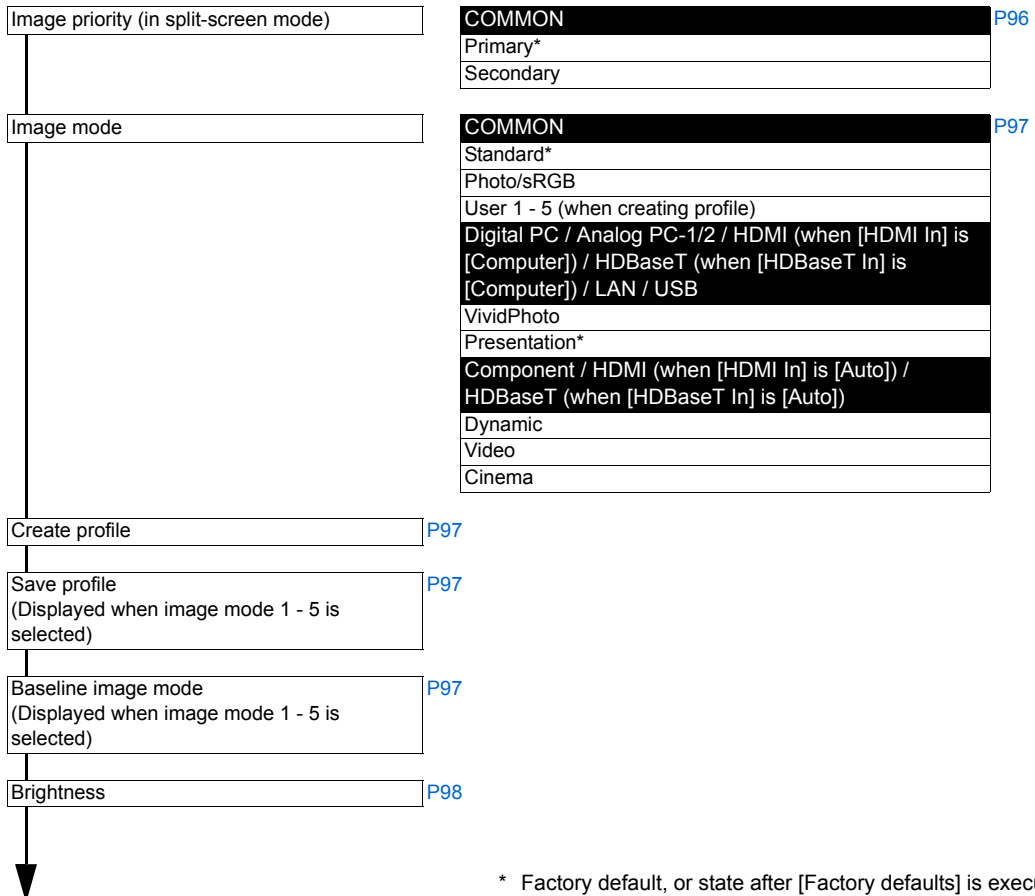
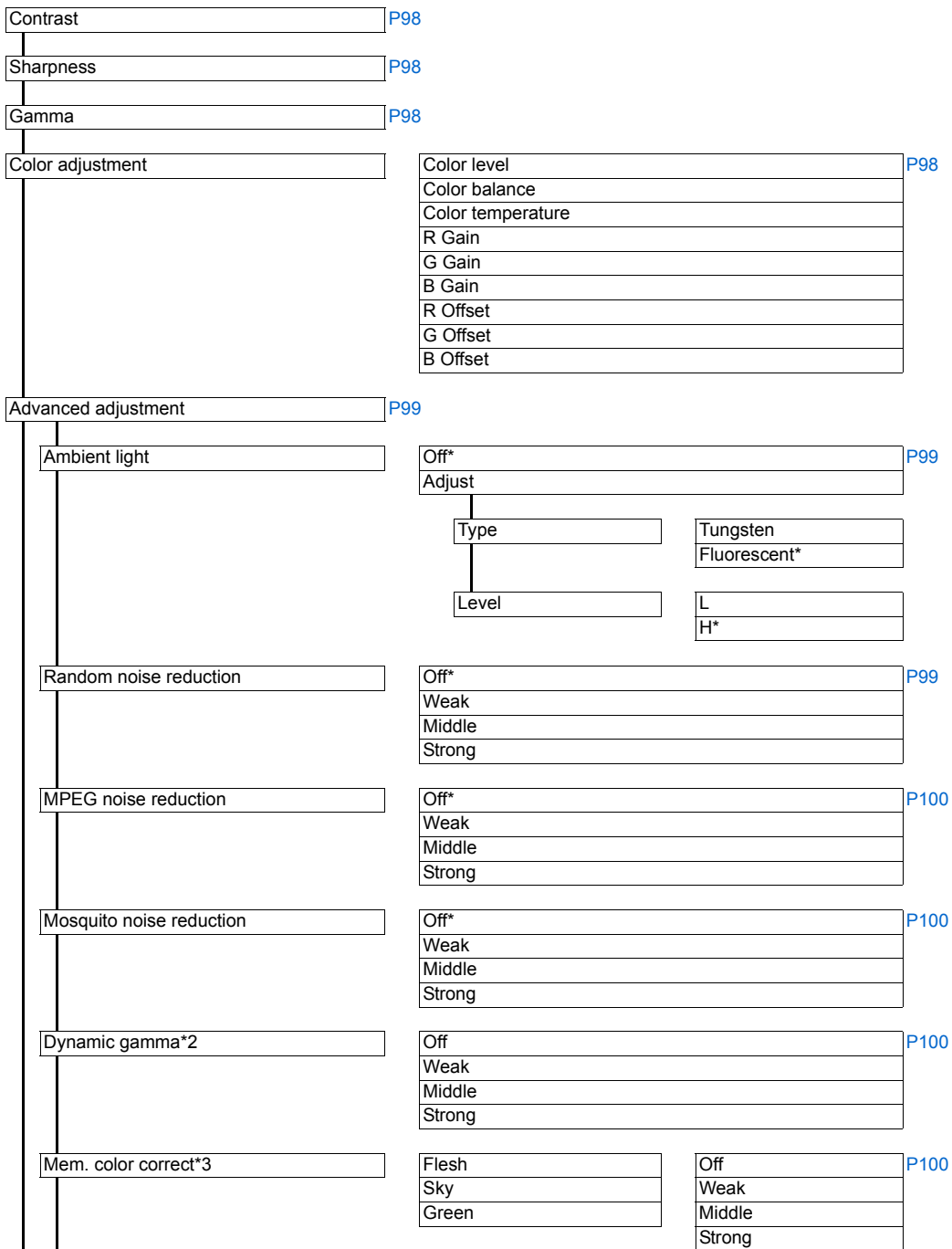

Image adjustment (P96)



* Factory default, or state after [Factory defaults] is executed.



* Factory default, or state after [Factory defaults] is executed.

Under the following setting, differs from factory defaults.

- *2 • For Analog PC-1/2, Digital PC or HDMI (when [HDMI In] is [Computer]), the factory default is [Off].
 - [Weak] by default for Component or HDMI (when [HDMI In] is [Auto]).
- *3 • [Off] by default for HDMI (when [HDMI In] is [Computer]), or for Digital PC, Analog PC (1 or 2), USB, or LAN.
 - HDMI (when [HDMI In] is [Auto]) or COMPONENT: Weak



Menu Configuration

6-axis color adjust	Off*	P101
	Adjust	
	Hue	
	Saturation	
	Brightness	
	Reset	
Fine-Tune Gamma		P101
Lamp control	Off*	P102
	On	
Lamp mode	Full power*	P102
	Power saver	
Reset		P103

Install settings (P104)

Positional lock	Off*	P105
	On	
Image flip H/V	None*	P105
	Ceiling mounted	
	Rear	
	Rear, Ceiling mounted	
Screen aspect	16:10*	P105
	16:9	
	4:3	
	16:9 D. image shift	
	4:3 D. image shift	
Zoom		P106
Keystone	Horizontal-vertical keystone*	P106
	Corner adjustment	
	Reset	
Digital image shift		P107
Professional settings		
Micro-digital image shift	Off*	P107
	Adjust	
Registration	Off*	P107
	Adjust	
Fan mode	Normal*	P108
	High altitude	
Vertical projection	Off*	P108
	Upward	
	Downward	



* Factory default, or state after [Factory defaults] is executed.

Edge blending	Off* Adjust Side Color blending adjustment Black level adjustment Marker Reset	P109
Lens - Position	Load position 1-3 Save position 1-3 Lens shift reset	P112
Screen color	Normal* Greenboard Adjust Red / Green / Blue	P113
On screen		P113
Menu position	Upper L Upper R Center* Lower L Lower R	P113
Guide	Off On*	P113
Show input status	Off On*	P114
Overheat warning display	Off* On	P114
Menu display time	Normal* Extended	P114
Lamp warning display	Off On*	P115
Air filter warning display	Off On*	P115
Split screen ID display	Off On*	P115
Test pattern	Off* On	P115

* Factory default, or state after [Factory defaults] is executed.

System settings (P116)

User screen settings	P117
Logo capture	P117
Logo position	Upper L Upper R Center Lower L Lower R
No signal screen	Black Blue* User logo
Screen when blank	Black* Blue User logo
Projector on	Skip Canon logo* User logo
Interface settings	P118
Key repeat	Off On*
Key lock	Off* Main unit Remote (wireless)
Remote control channel	Ch1 - 4 Independent*
Audio in terminal select	P119
HDMI	Off Audio in 1 Audio in 2 HDMI*
Digital PC	Off Audio in 1* Audio in 2
Analog PC-1	Off Audio in 1* Audio in 2
Analog PC-2	Off Audio in 1 Audio in 2*
Component	Off Audio in 1 Audio in 2*



* Factory default, or state after [Factory defaults] is executed.

HDBaseT	Off Audio in 1 Audio in 2 HDBaseT*	
LAN	Off Audio in 1 Audio in 2 LAN*	
USB	Off Audio in 1* Audio in 2	
HDBaseT	Off* On Image signal quality	P120
Communication settings	Serial communication Service port* HDBaseT Detail Baud rate Data bits Parity Stop bit 1* 2	P120
HDMI image input	Auto Computer*	
HDBaseT image input	Auto Computer*	
Power management mode	Disabled Lamp off Standby*	P121
Power management duration	5 min. 10 min. 15 min.* 20 min. 30 min. 60 min.	P122
Direct power on	Off* On	P122
Beep	Off On*	P122
Motion blur reduction	Off* On	P123

* Factory default, or state after [Factory defaults] is executed.

Menu Configuration

Language	English	Turkish	P123
	German	Polish	
	French	Hungarian	
	Italian	Czech	
	Spanish	Danish	
	Portuguese	Arabic	
	Swedish	Chinese (Simplified)	
	Russian	Chinese (Traditional)	
	Dutch	Korean	
	Finnish	Japanese	
	Norwegian		
Other settings			P124
Password settings	Off*		P124
	On		
Register password	Password input		P125
[Fn] button settings	Disable*		P125
	Split screen		
Gamma restore	Off*		P125
	Adjust		
Lamp counter	Reset / Return		P125
Air filter counter	Reset / Return		P126
Power counter			P126
Firmware	Yes / No		P126
Factory defaults	OK / Cancel		P126

Network settings (P127)

Network settings lock	Unlock	P130
	Lock*	
Network password setting	Off	P130
	On*	
Register network password		P130
Network standby settings	Normal	P131
	Low-power*	
Network function	Off*	P131
	On	
Detailed settings		P132
IP address		
Gateway address		



* Factory default, or state after [Factory defaults] is executed.

MAC address		
DHCP	Off*	
	On	
TCP/IP settings	IP address	
	Subnet mask	
	Gateway address	
	Apply	
Network setting initialization	Yes / No	
PJLink	Off	P134
	On*	
AMX Device Discovery	Off*	P135
	On	
Crestron RoomView	Off*	P135
	On	

Information (P156)

Model name
Input signal
Firmware
Serial no.
Projector usage time
IP address
E-mail sender address
E-mail recipient address
Projector name
Comments
System information ID



The following settings are not reset even when factory defaults are restored.

- Selected input signal
- Lamp counter
- Language
- Remote control channel
- Network settings
- Air filter counter
- Micro-digital image shift
- Registration
- Fan mode
- Vertical projection
- HDBaseT
- Wired network
- Serial communication
- User profile
- Lens - Position
- Projector usage time
- Power counter

* Factory default, or state after [Factory defaults] is executed.

Menu Description

Input settings

This section describes settings for aspect ratio, resolution, and projection from a USB flash drive.

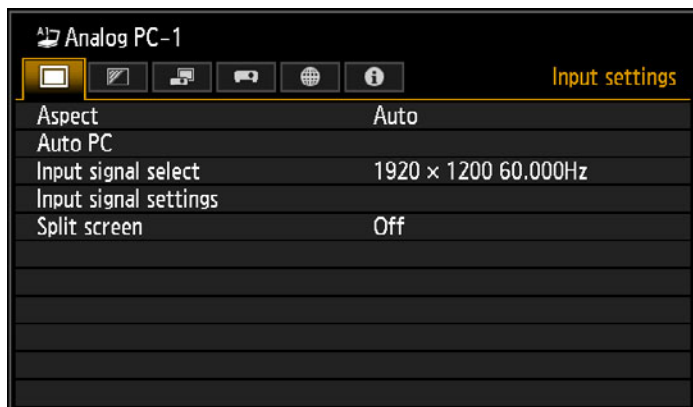

(When the input signal is Analog PC-1)

Menu	Function	Details
Aspect	Select an image aspect ratio.	P91
Auto PC	Automatically adjusts display position misalignment and screen flickering.	P91
Input signal select	Manually set a resolution to suit computer images.	P91
Input signal settings	Complete input signal settings.	P92
Split screen	Project two input images side by side.	P93
Input level	Select the input level for HDMI or HDBaseT signals.	P93
Color space	Select the color space for HDMI or HDBaseT signals.	P94
Over scan	Trim peripheral distortion from HDMI or HDBaseT images before projection.	P94
Progressive	Select progressive processing for still images in cinematic content or moving images in videos.	P95
Slideshow interval	Specify how long individual images on a USB flash drive are projected in slideshows.	P95
Animation effect	Specify the transition between images on a USB flash drive in slideshows.	P95

Menus that are not available are grayed out or hidden.

Aspect

 > [Input settings] > **[Aspect]**

Select a projection aspect ratio for images.

Option	Function
Auto	An image is projected at the aspect ratio of the input signal. Suitable for most projection.
16:10	The image is projected using an input signal aspect ratio of 16:10.
16:9	The image is projected using an input signal aspect ratio of 16:9.
4:3	The image is projected using an input signal aspect ratio of 4:3.
Zoom	This cuts the upper/lower or left/right part of the screen according to the screen aspect and zooms in or out of the center of the image.
True size	The image is projected with the original resolution of the input signal.

Menus that are not available are grayed out or hidden.



- For LAN and USB input, [Auto] is selected automatically.
- Different contents are displayed for different screen aspects or input signal types.
- The **ASPECT** button on the remote control can also be used to select the [Aspect] settings.

Auto PC

 > [Input settings] > **[Auto PC]**

Automatically adjusts display position misalignment and screen flickering.



- If the Auto PC adjustment is insufficient, perform the following operations.
- Select the input signal that matches the computer resolution from [Input signal select].
 - If adjustment remains insufficient, adjust [Total dots], [Tracking], [Horizontal/Vertical position] and [Horizontal/Vertical pixels] in [Input signal settings]. (P92)
 - For supported signals, see the table on page 188 – 189.

Input signal select

 > [Input settings] > **[Input signal select]**

Select a suitable resolution if Auto PC (P58) does not project computer images correctly.

Select the input signal that matches the computer resolution. Press the **OK** button to confirm the setting, and then press the **MENU** button.



For supported signals, see the table on page 188 – 189.

Input signal settings

 > [Input settings] > **[Input signal settings]**

Complete input signal settings. Use the [◀] / [▶] buttons to adjust the levels as needed.

Input signal settings	
Total dots	1904
Tracking	32
Horizontal position	376
Vertical position	31
Horizontal pixels	1440
Vertical pixels	900
Return	

Submenu	Function
Total dots	Adjust the total number of horizontal dots. Adjust it when stripes are displayed on the screen.
Tracking	Fine-tune the timing of image generation from signals. Adjusts the tracking when the image distorts or flickers.
Horizontal position	Adjust the horizontal image position to correct horizontal misalignment.
Vertical position	Adjust the vertical image position to correct vertical misalignment.
Horizontal pixels	Adjust the horizontal image resolution.
Vertical pixels	Adjust the vertical image resolution.

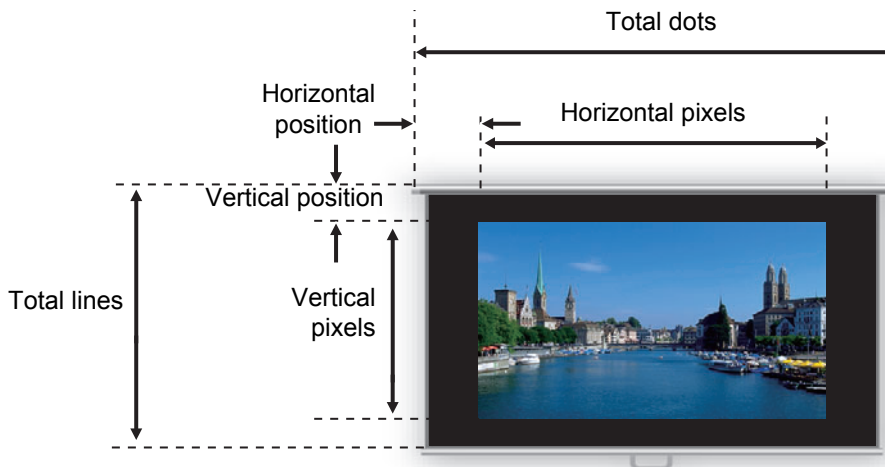

Perform this adjustment if the Auto PC function (P91) cannot adjust the projected image correctly.





Split screen

 > [Input settings] > **[Split screen]**

Two input images from devices connected to the projector can be projected side by side.

Option	Function												
Off	Exit split-screen mode.												
On	Activate split-screen mode.												
Settings	<table border="1"> <thead> <tr> <th>Submenu</th> <th>Function</th> </tr> </thead> <tbody> <tr> <td>Split screen</td> <td>Switch between normal and split-screen projection.</td> </tr> <tr> <td>Control rights</td> <td>Select the image to control. When the left image is selected, 1 is displayed, and when the right image is selected, 2 is displayed.</td> </tr> <tr> <td>Swap right-left</td> <td>Switch the sides that images are projected on.</td> </tr> <tr> <td rowspan="3">Layout</td> <td>Mode 3-7 Use 30% of the screen width for the left side and 70% for the right.</td> </tr> <tr> <td>Mode 5-5 Use 50% of the screen width for the left side and 50% for the right.</td> </tr> <tr> <td>Mode 7-3 Use 70% of the screen width for the left side and 30% for the right.</td> </tr> </tbody> </table>	Submenu	Function	Split screen	Switch between normal and split-screen projection.	Control rights	Select the image to control. When the left image is selected, 1 is displayed, and when the right image is selected, 2 is displayed.	Swap right-left	Switch the sides that images are projected on.	Layout	Mode 3-7 Use 30% of the screen width for the left side and 70% for the right.	Mode 5-5 Use 50% of the screen width for the left side and 50% for the right.	Mode 7-3 Use 70% of the screen width for the left side and 30% for the right.
	Submenu	Function											
	Split screen	Switch between normal and split-screen projection.											
	Control rights	Select the image to control. When the left image is selected, 1 is displayed, and when the right image is selected, 2 is displayed.											
	Swap right-left	Switch the sides that images are projected on.											
	Layout	Mode 3-7 Use 30% of the screen width for the left side and 70% for the right.											
		Mode 5-5 Use 50% of the screen width for the left side and 50% for the right.											
Mode 7-3 Use 70% of the screen width for the left side and 30% for the right.													



- Network and USB input cannot be combined for split-screen display. Similarly, HDBaseT and HDMI input cannot be combined.
- Control can be switched to the other side by pressing the [ / ] on the remote control when  or  is displayed in the center of the image area.
- When you switch to split-screen display, the left and right signals and input status are shown in the input window.

For details on split-screen mode, see “Split-Screen Display” (P161).

Input level

 > [Input settings] > **[Input level]**

Adjust the input level for content projected via HDMI or HDBaseT.

Option	Function
Auto	Automatically switches the input level based on the input signal.
Normal	Limits the input level to 16 - 235.
Expanded	Enables a full input level of 0 - 255.

Menu Description



- You can select this only when the type of signal sent from AV equipment is RGB.
- In [Auto] mode, the signal level is selected automatically. (Some AV equipment and HDBaseT transmitters may not support this.)
- If your AV equipment HDMI output can be set to [Normal] or [Expanded], we recommend [Expanded]. The contrast of images will be improved and dark scenes will be rendered more realistically. In this case, set [Input Level] to [Auto] or [Expanded]. For more detailed information, refer to the user's manual for the AV equipment connected to the projector.

Color space



> [Input settings] > **[Color space]**

Select the color space for HDMI or HDBaseT signals.

Option	Function
Auto	Selects the optimal color format for input signals.
RGB	Forces the projector to handle the input signal as an RGB signal.
YCbCr	Forces the projector to handle the input signal as a color difference signal.

Over scan



> [Input settings] > **[Over scan]**

Select this setting to trim peripheral distortion from content projected via HDMI or HDBaseT.

Option	Function
Off	Project all (100%) of the input signal. The images projected may be smaller than the full projection screen.
On	Project images with peripheral distortion removed. (5% of the image is trimmed, along the edges.)



With some signal resolutions, image edges may be cut off. In such a case, select [Off].

Progressive



> [Input settings] > **[Progressive]**

Performs progressive processing optimized for still images in cinematic content or moving images in videos.

Option	Function
Off	Does not perform progressive processing.
Film/auto	Suitable for still images or typical moving images. Performs progressive processing for video or cinematic content.
Video 1	Suitable for projecting video with high image quality and relatively slow movement. Performs progressive processing optimized for HD video.
Video 2	Suitable for projecting video with faster movement. Performs progressive processing optimized for fast-moving video.
25p/30p (PsF)	Performs progressive processing optimized for 1080 PsF/25 or 1080 PsF/30 video (25 or 30 fps, respectively).



- Select [Off] when flickers and horizontal lines are noticeable in media that has a lot of fast-moving action.
- Not available in split-screen mode.

Slideshow interval



> [Input settings] > **[Slideshow interval]**

You can project images on a USB flash drive automatically, one after another. Use the [◀] / [▶] buttons to set the interval after which images are switched in a range of 1 seconds to 60 minutes, in the format min.:sec.



- Switching the input signal to an option other than [USB] will stop any slideshow in progress. To resume the slideshow from the last image shown, return the input signal to [USB].
- If you use digital zoom during a slideshow, the digital zoom will be cancelled when you switch to the next image.

Animation effect



> [Input settings] > **[Animation effect]**

Specify the transition for slideshows of images on a USB flash drive.

Option	Function
Off	Disable slideshow transitions.
Cross fade	Fade out one image as the next image fades in.
Fade out/in	Fade out one image to black, and then fade the next image in.

Image adjustment

This section describes image quality settings such as brightness, contrast, and sharpness.

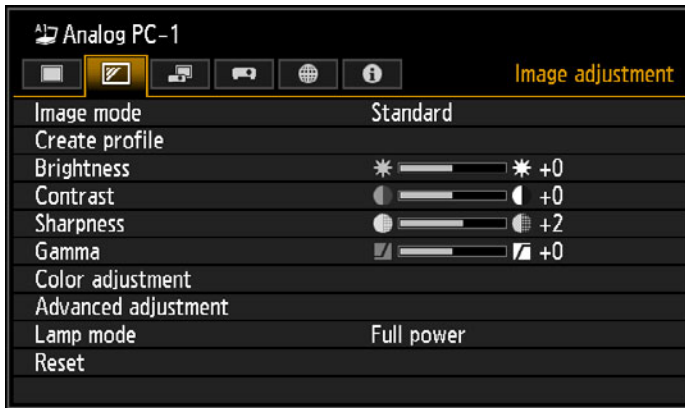

(When the input signal is Analog PC-1)

Menu	Function	Details
Image mode *	Select overall image quality to suit the projected image.	P97
Create profile	Save desired image quality settings as profiles.	P97
Baseline image mode	Shows the image mode that is basis of the profile.	P97
Brightness *	Adjust image brightness.	P98
Contrast *	Adjust image contrast.	P98
Sharpness *	Adjust image sharpness.	P98
Gamma *	Correct loss of detail in shadows or highlights.	P98
Color adjustment *	Fine-tune image colors.	P98
Advanced adjustment *	Fine-tune noise reduction and color tone.	P99
Lamp mode *	Select the lamp brightness.	P102
Reset	Restore default image settings.	P103
Image priority *	Select which side is the basis for image processing in split-screen mode.	P103

Menus that are not available are grayed out or hidden.

* Any adjustments you make are stored for each combination of input signal and image mode.

Image mode

 > [Image adjustment] > **[Image mode]**

Select the overall image quality for projected images. Can also be selected by pressing the **IMAGE** button on the remote control. (P70)

Option	Types of Images	Characteristics
Standard	Computer screens, or media played with video software	Bright overall; white, with natural colors
Presentation	Images mainly consisting of text	Bright overall
Dynamic	Video content	Bright overall
VividPhoto	Digital photos	Subdued brightness overall, with vibrant colors
Video	Video from camcorders	Somewhat dark; colors resemble TV
Photo/sRGB	Digital photos from sRGB-compatible cameras	Somewhat dark; conforms to the sRGB standard
Cinema	Movies	Designed especially for movies
User 1 - 5	Up to five user profiles can be stored for your selected image quality settings. Stored profiles are available in this setting as an image mode.	

Menus that are not available are grayed out or hidden.



You can adjust the image quality by adjusting the following items in each image mode: [Brightness], [Contrast], [Sharpness], [Gamma], [Color adjustment], [Advanced adjustment], and [Lamp mode]

Create profile

 > [Image adjustment] > **[Create profile]**

Save desired image quality settings in up to five user profiles.



- The saved settings consist of the brightness, contrast, sharpness, gamma, color adjustment, advanced adjustment, and lamp mode.
- Although only five user profiles are displayed, different profiles can be created to apply depending on whether the projector is connected to a computer (with Analog PC, Digital PC, HDMI (when [HDMI image input] (P121) is [Computer]), or HDBaseT (when [HDBaseT image input] (P121) is [Computer])), AV equipment (with Component, HDMI (when [HDMI image input] (P121) is [Auto]), or HDBaseT (when [HDBaseT image input] (P121) is [Auto])), a LAN, or a USB flash drive. As a result, it is possible to save up to 10 settings.
- The image mode name which was the basis for the settings change is also saved in the user memory. When a user memory is selected as the image mode, the image mode that was the base for that user memory is displayed in the menu as [Baseline image mode].

Brightness

 > [Image adjustment] > **[Brightness]**

Adjust image brightness.

Contrast

 > [Image adjustment] > **[Contrast]**

Sharpen or soften image contrast.

Sharpness

 > [Image adjustment] > **[Sharpness]**

Adjust image sharpness.

Gamma

 > [Image adjustment] > **[Gamma]**

Correct image areas that are too dark or too bright to see clearly. Can also be selected by pressing the **GAMMA** button on the remote control.



For more detailed adjustment, use Fine-Tune Gamma (P101).

Color adjustment

 > [Image adjustment] > **[Color adjustment]**

Adjust color-related settings such as color level, color balance, and color temperature.

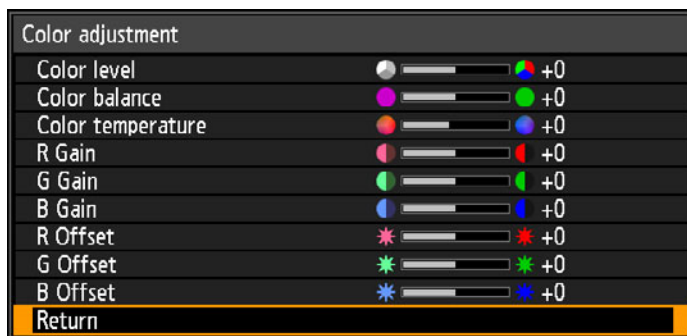

Submenu	Function
Color level	Adjusts the intensity of colors.
Color balance	Adjusts the color balance of a purplish or greenish image.
Color temperature	Adjusts the white color temperature.
R / G / B Gain	Adjust the gain of each color.
R / G / B Offset	Adjusts the color offset of each color.

Advanced adjustment

 > [Image adjustment] > **[Advanced adjustment]**

Fine-tune noise reduction and color tone.

Advanced adjustment	
Ambient light	Off
Random noise reduction	Off
MPEG noise reduction	Off
Dynamic gamma	Off
Mem. color correct	
6-axis color adjust	Off
Fine-Tune Gamma	
Return	

Ambient light

Minimize the effect of ambient light on the screen.

Option	Function	
Off	Projects an image with no correction.	
Adjust	Type	Tungsten For ambient light from conventional light bulbs or fluorescent light of this color.
		Fluorescent For ambient light from a “day white” fluorescent source.
	Level	L For an ordinary brightness of ambient light.
		H For bright ambient light.

Examples of Ambient Light Level Settings

Level	Example Location
L	Projection room, sports bar, etc.
H	Conference room, lecture room, etc.

 The [Ambient light] setting is available in Photo/sRGB, Video, and Cinema image modes. (P97)

Random noise reduction

Reduce random image noise*.

* Effective on noise with an irregular frequency or amplitude.

Option	Function
Off	Disables random noise reduction.
Weak Middle Strong	Specify one of three levels of intensity of the random noise reduction.

 • Select [Weak] for fast-moving images or [Strong] for slow-moving images.
• This setting is not displayed for LAN or USB input.

MPEG noise reduction

Reduce MPEG image noise*.

* Block noise resembles pixelation and may affect either on JPEG images or in MPEG video.

Option	Function
Off	Disables MPEG noise reduction.
Weak Middle Strong	Specify one of three levels of intensity of the MPEG noise reduction.



This setting is not displayed for LAN or USB input.

Mosquito noise reduction

Reduce mosquito noise*.

* A type of noise affecting image edges or areas where colors change significantly, either on JPEG images or in MPEG video.

Option	Function
Off	Disables mosquito noise reduction.
Weak Middle Strong	Specify one of three levels of intensity of the mosquito noise reduction.



This setting is not displayed for HDMI, Digital PC, Analog PC-1, Analog PC-2, or Component input signals.

Dynamic gamma

You can adjust the gradation representation of light and dark portions of an image automatically.

Option	Function
Off	Disable dynamic gamma adjustment.
Weak Middle Strong	Specify one of three levels of dynamic gamma adjustment.



Mem. color correct

Enhances skin tones, blue skies, and greens, so that these colors are more consistent with people's remembered impressions.

Submenu	Function	
Flesh Sky Green	Off	Disable correction.
	Weak Middle Strong	Specify the level of correction.

6-axis color adjust

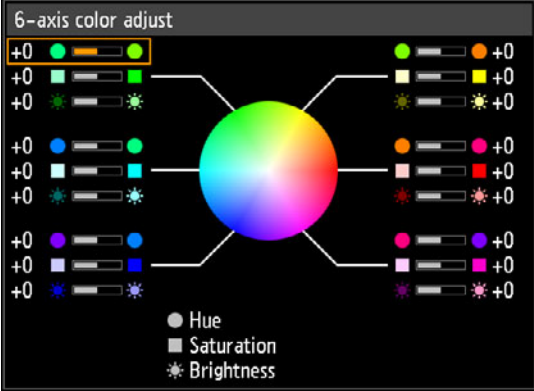
Fine-tune RGB (red, green, blue) and CMY (cyan, magenta, yellow) hues in images.

Option	Function
Off	Disables 6-axis color adjustment.
Adjust	 <p>Use the [▲] / [▼] buttons to select [○ Hue], [□ Saturation], or [☆ Brightness], and use the [◀] / [▶] buttons for adjustment.</p> <ul style="list-style-type: none"> When you are finished adjusting the color, press the OK button. <p> Adjustment is not applied to the projected menu itself.</p>
Reset	Returns all adjustment values to zero.

Fine-Tune Gamma

Adjust white, red, green, and blue gamma curves. Red, green, and blue can be adjusted separately. Adjustments to white are also applied to the three other colors. Note that adjusting any color will overwrite previous adjustments.

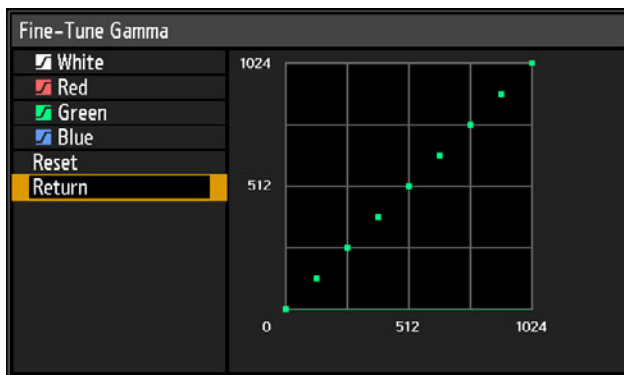

- For details on gamma correction, see [page 98](#).
- Use input signals or a test pattern for adjustment.
- Adjustment is not applied to the projected menu itself.
- Use the [▲] / [▼] buttons to select a color, and then press the **OK** button. Next use the [◀] / [▶] buttons to select a point on the gamma curve, and then use the [▲] / [▼] buttons to adjust the position of the point. When adjustment is finished, press the **OK** button to confirm the setting.

Lamp control

Dims the lamp automatically when the input signal is completely black.

Option	Function
Off	No lamp control.
On	Lamp control. Dims the lamp in response to fully black input signals. Normal brightness is restored once the input signal changes from fully black.

- The projector automatically enters standby mode if the lamp is dimmed (that is, if the input signal is fully black) for more than one hour. A countdown window is displayed 10 minutes before entering standby.
- The lamp is not dimmed when projection is blanked, when no signals are supplied, or when black is projected during gamma restore.
- Lamp control is not available for the following settings:
 - In split-screen mode
 - During test pattern projection
 - When [Lamp mode] is set to [Power saver]
 - When [Vertical projection] is set to [Upward] or [Downward]
 - When [Fan mode] is set to [High altitude]
- No lamp control is performed in the first 20 minutes after the projector is turned on.



- All image adjustments are stored as modified settings for the current input signal and image mode.
- Resolution may seem lower with [Random noise reduction], [MPEG noise reduction], or [Mosquito noise reduction].

Lamp mode



> [Image adjustment] > **[Lamp mode]**

Reducing the lamp brightness reduces power consumption and cooling fan noise.

Option	Function
Full power	Projects images at full brightness.
Power saver	Reduces lamp brightness to save energy.



- This setting can also be adjusted from the power saver settings screen by pressing the **LAMP** button on the remote control.
- The lamp mode is set to [Power saver] and cannot be changed when [Install settings] > [Fan mode] is set to [High altitude].

Reset

 > [Image adjustment] > **[Reset]**

Restore the current image quality settings to the factory defaults.

Option	Function
OK	Resets the image adjustment settings.
Cancel	Cancels resetting of the image adjustment settings.



- Performing reset when [Image mode] is set to a profile from [User 1] to [User 5] will restore the settings originally saved for that user profile.
- Only the setting for the combination of input signal and image mode for the current projection is reset.

Image priority

 > [Image adjustment] > **[Image priority]**

Select which side image adjustment settings to apply in split-screen mode.

Option	Function
Primary	Use the side with control rights as the [Primary] side. For image adjustment settings that are not configured separately, [Primary] side settings apply to both sides.
Secondary	Not available when the [Primary] side has control rights. To reverse the side given priority for image adjustment (whether on the left or right side), switch control rights to the other side and change [Secondary] to [Primary].



- **Can be independently configured**
Brightness (P98), Contrast (P98), Gamma (P98), Color adjustment (P98), Fine-Tune Gamma (P101)
- **[Primary] setting also applies to [Secondary]**
Image mode (P97), Advanced adjustment except Fine-Tune Gamma (P99 - P101), Lamp mode (P102)

Install settings

Adjust projection to suit the screen or the type of images, or how the projector is installed.

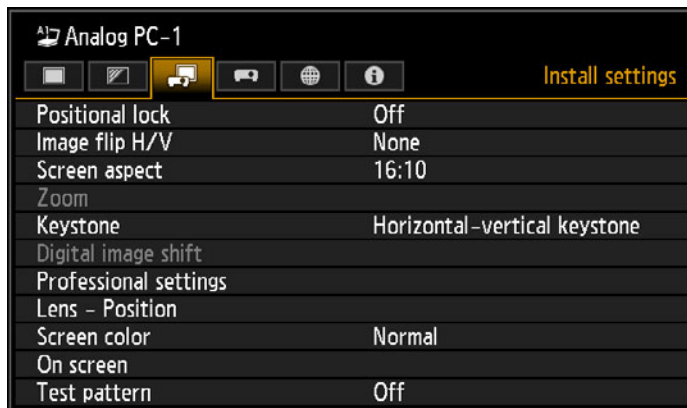

(When the input signal is Analog PC-1)

Menu	Function	Details
Positional lock	Operation of installation related functions can be prohibited.	P105
Image flip H/V	Specify settings for projection from behind the screen, from the ceiling, or both.	P105
Screen aspect	Select an aspect ratio that matches that of the projection screen. (P63)	P105
Zoom	Digitally reduce images projected with a Short Fixed Lens.	P106
Keystone	Set the type of keystone correction.	P106
Digital image shift	Moves the position of the projected image.	P107
Professional settings	Specify settings for image positioning and the altitude of installation.	P107
Lens - Position	Save the current lens information, or restore previous lens conditions that were saved.	P112
Screen color	Adjust projection colors to suit the screen color.	P113
On screen	Specify display details for on-screen menus, help, and warning or precaution icons.	P113
Test pattern	Project a test pattern to check the resolution and color of projection during installation.	P115

Positional lock

 > [Install settings] > **[Positional lock]**

Operation of installation-related functions can be prohibited.

- Image flip H/V • Screen aspect • Keystone
- Save position (in [Lens - Position]) • Lens shift reset
- Digital image shift • Professional settings

Option	Function
Off	The positional lock is not used.
On	Prevents adjustment of installation-related functions.

Press the **OK** button to confirm the setting, and then press the **MENU** button.

Image flip H/V

 > [Install settings] > **[Image flip H/V]**

Specify the orientation of how the projector is installed.

Option	Function
None	Select for normal projection, without inversion.
Ceiling mounted	Select when the projector is installed upside-down on the ceiling. The projected image is inverted in both vertical and horizontal directions.
Rear	Select this to project an image from behind the screen. The projected image is inverted in the horizontal direction.
Rear, Ceiling mounted	Select this to project an image from behind the screen with the projector hung from the ceiling. The projected image is inverted in the vertical direction.



- To hang the projector from the ceiling, use the optional bracket. Contact the Canon Customer Support Center for more detailed information.
- Image flipping will reset any adjustment for keystone distortion. In this case, redo the adjustment.

Screen aspect

 > [Install settings] > **[Screen aspect]**

Select an aspect ratio that matches that of the projection screen.

Option	Function
16:10	Select this when you use a screen with an aspect ratio of 16:10.
16:9	Select this when you use a screen with an aspect ratio of 16:9.
4:3	Select this when you use a screen with an aspect ratio of 4:3.
16:9 D. Image Shift	Select this when you use a screen with an aspect ratio of 16:9. Although keystone correction is not available in this mode, images can be shifted up or down. (P64)
4:3 D. Image Shift	Select this when you use a screen with an aspect ratio of 4:3. Although keystone correction is not available in this mode, images can be shifted left or right. (P65)

Menu Description



- Changing the screen aspect will reset any keystone or digital image shift setting.
- [Auto] may be automatically selected for the aspect depending on the screen aspect setting.

Zoom



[MENU] > [Install settings] > [Zoom]

When the Short Fixed Lens is attached and if the projected image does not fit on the screen, you can display the image by electronically reducing its size. This type of zooming reduces overall image dimensions, relative to the center of the image. Press the [◀] button on the remote control to project images at a reduced size, and press the [▶] button to enlarge images to full size. Images can be projected at 75-100% of the original size.



- D.ZOOM buttons on the remote control cannot be used for this [Zoom] function.
- [Zoom] is not available when the following features are used.
 - Horizontal/vertical keystone correction
 - Split-screen mode (P161)
- Using [Zoom] after specifying corner adjustment (P166) will clear corner adjustment settings and apply the zoom setting. Instead, use [Zoom] before fine-tuning the image position with corner adjustment.
- If images still extend off the screen even after you use [Zoom], you can use corner adjustment (P166) to finetune the position of image corners, so that images fit on the screen.
- Switching to lenses other than the Short Fixed Lens will reset the setting to 100%.

Keystone



[MENU] > [Install settings] > [Keystone]

Two types of keystone correction are available: horizontal/vertical keystone and corner adjustment. Keystone correction can also be reset. Keystone correction can also be applied by pressing the **KEYSTONE** button on the remote control.

Submenu	Function
Horizontal-vertical keystone	Apply horizontal-vertical keystone correction. Image height and length is adjusted.
Corner adjustment	Apply corner adjustment. Each corner of the image can be repositioned.
Reset	Resets the specified keystone value.



- Pressing the **KEYSTONE** button when the screen aspect is 16:9 D. image shift or 4:3 D. image shift will apply digital image shift.
- Resetting the keystone value will also reset the zoom setting for the Short Fixed Lens (RS-IL03WF).

Digital image shift

 > [Install settings] > **[Digital image shift]**

Moves the position of the projected image.

When screen aspect is 16:9 D. Image Shift, move images vertically using the [▲] / [▼] buttons, and for 4:3 D. Image Shift, move images horizontally using the [◀] / [▶] buttons.



This cannot be selected when the screen aspect is 16:9, 16:10 or 4:3.

Professional settings

 > [Install settings] > **[Professional settings]**

Specify advanced installation settings.

Professional settings	
Micro-digital image shift	Off
Registration	Off
Fan mode	Normal
Vertical projection	Off
Edge blending	Off
Return	

Micro-digital image shift

Use this setting to fine-tune the position of the projected image.

Submenu	Function
Off	Does not perform micro digital image shift.
Adjust	Adjust Use the [▲] / [▼] buttons for vertical shift and the [◀] / [▶] buttons for horizontal shift.
	Chart Displays a chart to assist in adjustment. Watch the chart as you fine-tune the position.
	Return Dismiss the chart.

Registration

Adjusts colors that are out of alignment. You can adjust red, green and blue registration independently.

Submenu	Function
Off	Does not perform image registration.
Adjust	Red / Green / Blue Use the [▲] / [▼] buttons for vertical shift and the [◀] / [▶] buttons for horizontal shift.
	Chart Displays a chart to assist in adjustment. Watch the chart as you fine-tune the position.
	Return Dismiss the chart.

Fan mode

Switch the fan mode to suit installation at low or high altitudes (above 2,300 m (7,545.8')).

Option	Function
Normal	Setting for altitudes lower than 2,300 m (7,545.8').
High altitude	Setting for altitudes of 2,300 m (7,545.8') or higher.



- Incorrect settings may shorten the useful life of the lamp or other parts.
- The lamp mode is set to [Power saver] and cannot be changed when [Install settings] > [Fan mode] is set to [High altitude].

Vertical projection

You can ensure adequate cooling by switching the fan mode to suit upward- or downward-facing installations. For precautions on vertical projection, see “Install Facing in the Correct Direction” (P25).

Option	Function
Off	Does not alter the fan mode.
Upward	Setting for use when the projector faces upward.
Downward	Setting for downward projection.



- Be sure to perform this setting to use vertical projection.
- Projecting vertically without using this setting will shorten the useful life of the lamp and other parts.
- Even if you complete this setting, vertical projection will result in a shorter useful life of the lamp and other parts than horizontal projection.

Edge blending

Brightness and colors of overlapping edges of images from multiple projectors, which form a blending area, can be adjusted for a more seamless appearance. For detailed instructions, see “Projecting from Multiple Projectors at Once (Edge Blending)” (P162).

[Off] Disable blending.

[Adjust] Display the menu for blending area adjustment.

Edge blending		
Side	Width	Start position
Left	0	0
Right	0	0
Top	0	0
Bottom	0	0
Color blending adjustment		
	Off	
Black level adjustment		
	Off	
Marker		
	Off	
Reset		
Corner adjustment		
Return		

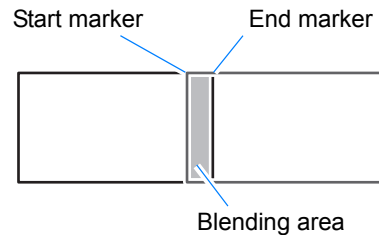

When adjusting the image projected from the right side



- Adjustment may not eliminate different colors or brightnesses in the blending area.
- For best edge-blending results, use all projectors in the same image mode and make the following adjustments.
 - (1) Brightness, contrast, R/G/B gain and offset, black level, blending color, color temperature, color level, color balance, sharpness, and gamma (P98)
 - (2) Color adjustment, by using 6-axis color adjustment (P101)
 - (3) Gamma adjustment, by using fine-tune gamma (P101)
 - (4) Corner adjustment, using keystone correction (P106)

Menu Description

Submenu	Function		
Side	Left, Right, Top, Bottom	Select the direction of the blending area to adjust.	
	Width	Specify the width between the start and end markers.	
	Start position	Moves the position of the start marker.	
	 <ul style="list-style-type: none"> • Large blending areas may cover input signal dialog boxes and other interface elements. In this case, momentarily set edge blending to [Off] and check the display. • Although the starting marker is normally aligned with the image edge, it can also be aligned toward the center of the image. In this case, the black blending area will lie outside of the starting marker. 		
Color blending adjustment	Adjust unwanted colors or discrepancies between colors in the blending area.		
	Submenu	Function	
	Off	Do not adjust colors of blended images.	
	Adjust	Adjust unwanted colors or discrepancies between colors in the blending area.	
		Option	Function
White		Simultaneously adjust red, green, and blue to correct unwanted colors or discrepancies in the blending area.	
Red/Green/Blue	Individually adjust red, green, and blue to correct unwanted colors or discrepancies in the blending area.		

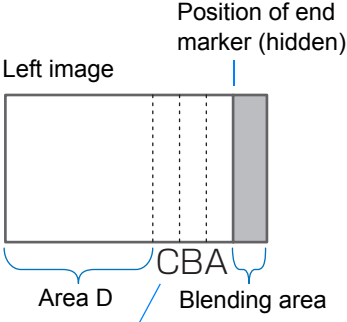
Submenu	Function						
Black level adjustment	<p>Because black is lighter in the blending area than in other areas, you can adjust the black level outside the blending area to make this difference in brightness less noticeable.</p>  <p>Area A: Black level cannot be adjusted. Area B: Adjust to a black level different from that of area D. Area C: Adjust to provide a smooth transition relative to the black levels of areas B and D.</p>						
	<p>Off Do not adjust the black level.</p>						
	<p>Area Adjust areas C - A to smoothen the boundaries of the blending area.</p> <table border="1" data-bbox="399 813 1208 987"> <thead> <tr> <th>Option</th> <th>Function</th> </tr> </thead> <tbody> <tr> <td>Side</td> <td>Select the direction to adjust from Left/Right/Top/Bottom.</td> </tr> <tr> <td>A-Width/ B-Width/ C-Width</td> <td>Adjust the widths of areas A - C.</td> </tr> </tbody> </table>	Option	Function	Side	Select the direction to adjust from Left/Right/Top/Bottom.	A-Width/ B-Width/ C-Width	Adjust the widths of areas A - C.
	Option	Function					
Side	Select the direction to adjust from Left/Right/Top/Bottom.						
A-Width/ B-Width/ C-Width	Adjust the widths of areas A - C.						
<p>Black level Adjust the black level brightness and color of areas B and D.</p> <table border="1" data-bbox="399 1078 1208 1222"> <thead> <tr> <th>Option</th> <th>Function</th> </tr> </thead> <tbody> <tr> <td>B/D-area base</td> <td>Adjust the black level brightness of B/D areas.</td> </tr> <tr> <td>B/D-area red / green / blue</td> <td>Adjust the red, green, and blue components of B/D area black levels individually.</td> </tr> </tbody> </table>	Option	Function	B/D-area base	Adjust the black level brightness of B/D areas.	B/D-area red / green / blue	Adjust the red, green, and blue components of B/D area black levels individually.	
Option	Function						
B/D-area base	Adjust the black level brightness of B/D areas.						
B/D-area red / green / blue	Adjust the red, green, and blue components of B/D area black levels individually.						
Marker	<p>Show the blending area markers.</p>						
	<table border="1" data-bbox="399 1271 1208 1418"> <thead> <tr> <th>Option</th> <th>Function</th> </tr> </thead> <tbody> <tr> <td>Off</td> <td>Hide the blending area markers.</td> </tr> <tr> <td>On</td> <td>Show the blending area markers. The start marker is red, and the end marker is green.</td> </tr> </tbody> </table>	Option	Function	Off	Hide the blending area markers.	On	Show the blending area markers. The start marker is red, and the end marker is green.
	Option	Function					
Off	Hide the blending area markers.						
On	Show the blending area markers. The start marker is red, and the end marker is green.						
Reset	Reset the marker settings.						

Menu Description

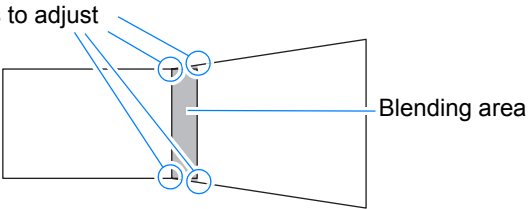
Submenu	Function
Corner adjustment	<p>Correct image distortion by aligning corners of the blending area with the image from the reference projector. For multi-projection alignment, align the corners with the projector blending area (already adjusted) that forms the basis.</p> 
	<p>Left, Right, Top, Bottom Select the direction of the blending area to adjust. As you reposition the corners of the selected area, the overall image changes to match the adjustment.</p> <ul style="list-style-type: none"> • Sides set to an edge-blending width of 12 or more can be adjusted when [Keystone] is set to [Corner adjustment] and the aspect ratio is [16:10]. • To reset adjustment, use [Keystone] (P69).

Lens - Position

 > [Install settings] > **[Lens - Position]**

The projector can save information about the lens position in memory. Up to three sets of lens information (including focus, zoom, and lens shift settings) can be saved, and the lens can be restored to these positions.

Submenu	Function
Load position 1-3	Restores the lens to the positions saved using Save position 1-3.
Save position 1-3	Saves the lens position as positions 1-3.
Lens shift reset	Restores the lens to the original position.

- To lock (protect) the saved position, set [Positional lock] (P105) to [On].
- The values of the following settings are saved in addition to the lens position information:
 - Horizontal/vertical keystone / corner adjustment
 - Screen color
 - Screen aspect
 - Zoom
 - Digital image shift
- [Load position] is not available unless you perform [Save position] once.
- The original lens position varies depending on the type of lens used.
- When saved lens positions are restored, images may be projected in a slightly different position than the saved position.
- Specifying a somewhat smaller image size than the screen size (image area) enables you to switch among multiple lens positions without having the image extend off the screen.
- When precise positioning is needed, use lens shift, zoom, and focus functions for fine adjustment.

Screen color

 > [Install settings] > **[Screen color]**

You can adjust the color quality of the images projected according to the color of the projection screen.

Submenu	Function
Normal	Select this if a standard type of projection screen is used. The images are projected in a light quality similar to that of natural light.
Greenboard	Select if a dark green surface such as a blackboard is used as the screen. The color quality similar to [Normal] is obtained on the greenboard.
Adjust	Select to fine-tune red, green and blue.

On screen

 > [Install settings] > **[On screen]**

Specify display details for on-screen menus, help, and warning or precaution icons.

On screen	
Menu position	
Guide	On
Show input status	On
Overheat warning display	Off
Menu display time	Normal
Lamp warning display	On
Air filter warning display	On
Split screen ID display	On
Return	

Menu position

Reposition menu display.

Use the [▲] / [▶] / [▼] / [◀] buttons to move the menu to the desired position.

Guide

Shows the guide screen.

Option	Function
Off	Hides the guide screen.
On	Shows the guide screen.



The guide screen is shown at the following cases.

- No input signal is detected. (P54)
- An invalid button is pressed in [BLANK], [FREEZE], or [D.ZOOM] mode. (P35)
- When positional lock (P105) is set to [On] and buttons locked by this feature are pressed.
- When the projector is already on and the **POWER** button is pressed.

Show input status

Specify whether signal status is shown when there is no signal or when you are completing signal settings.

Option	Function
Off	The input status is not displayed.
On	The input status is displayed.

Overheat warning display

Specify whether the icon warning of high temperature (🔥) is shown when the internal temperature is high and the projector may overheat.

Option	Function
Off	Disable high temperature warning icon display.
On	Enable high temperature warning icon display.

Menu display time

Extend menu display from the standard 10 or 30 seconds to 3 minutes.

Option	Function
Normal	The menu is displayed for 10 or 30 seconds.
Extended	The menu is displayed for 3 minutes.

The following display times are also changed.

Item	[Normal]	[Extended]
- MENU screen - Power-Saving Settings (P73)	30 seconds	3 minutes
- Input (P56) - Keystone adjustment (P67) - Keystone reset (P69) - Focus adjustment (P59) - Zoom adjustment (P60) - Lens shift adjustment (P61) - Lens shift reset (P62) - D.image shift adjustment (P64) - D.image shift reset (P65) - Aspect (P65) - Image mode (P70) - Volume adjustment (P74) - Gamma correction (P98)	10 seconds	3 minutes

Lamp warning display

Specify whether to show a lamp replacement message after the lamp has been used for a specified period.

Option	Function
Off	The prepare lamp message and the lamp warning are not displayed.
On	The prepare lamp message and the lamp warning are displayed.



- When it is almost time to replace the lamp, the projector's [LAMP] indicator will flash. For details, see "LED Indicator Displays" (P32).
- Setting display to [Off] will disable both the message to prepare a replacement lamp and the warning to replace the lamp. To review the replacement timing, check the lamp counter (P125).
- Lamps that are still used after the timing for lamp replacement are more likely to rupture. Replace the lamp with a new one as soon as possible.

Air filter warning display

A message advising you to perform cleaning can be set to display when the filter needs cleaning.

Option	Function
Off	The air filter warning is not displayed.
On	The air filter warning is displayed.



Setting [Air filter warning display] to [Off] will disable display of the warning to clean the air filter. We recommend checking the air filter counter (P126) occasionally to know when to replace the filter.

Split screen ID display

Specify whether to show the digit (1 or 2) identifying screens in split-screen mode. Note that even if [Off] is selected, corner markers will be shown to indicate the side with control rights.

Option	Function
Off	Hides the screen ID.
On	Shows the screen ID.

Test pattern

 > [Install settings] > [Test pattern]

You can project a test pattern (P187) to check resolution, color, and other details even without supplying an input signal.

Option	Function
Off	Disable test pattern display.
On	Enable test pattern display.



- While the test pattern menu is displayed, you can use the [▲] / [▼] buttons to switch patterns. Additionally, options of test pattern that have options can be changed with the [◀] / [▶] buttons.
- The test pattern menu is no longer displayed after a little while, but you can view it again by pressing the [▲] / [▼] buttons.

System settings

Customize projector and remote control operation, beeping, and other details after startup, during standby, and in other situations.

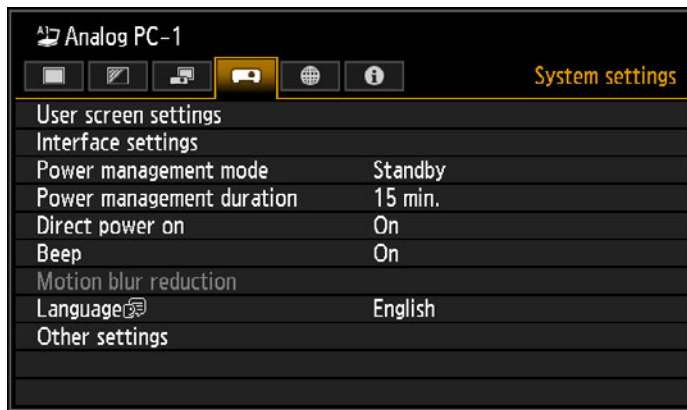

(When the input signal is Analog PC-1)

Menu	Function	Details
User screen settings	Customize user screens shown at startup, when no signal is detected, and in other situations.	P117
Interface settings	Specify interface details such as settings for input signals of connected equipment.	P118
Power management mode	You can specify to turn the lamp or projector off automatically after a certain period if the projector and remote control are not used, or if there is no input signal.	P121
Power management duration	Specify how long before the lamp is turned off or the projector enters standby, depending on the [Power management mode] setting.	P122
Direct power on	You can turn on the projector by connecting the power cable without pressing the POWER button.	P122
Beep	You can select whether a beep sounds or not when you operate the projector.	P122
Motion blur reduction	Motion blur is blurring that occurs during video playback. Motion blur reduction can make this blurring less noticeable.	P123
Language	You can select the language in which the menus are displayed.	P123
Other settings	Set a password, reset counters for lamp or air filter replacement, and access other settings and information.	P124

User screen settings

 > [System settings] > [User screen settings]

Capture a logo and specify logo display settings.

User screen settings	
Logo capture	
Logo position	Center
No signal screen	Blue
Screen when blank	Black
Projector on	Canon logo
Return	

Logo capture

Registers the current image as a user logo. Registered user logos can be shown when no signal is received, when the **BLANK** button is pressed, or as the startup image.

Option	Function
OK	Display the image for logo registration. Align the image with the red boundary lines indicating the portion that will be stored, and then press the OK button. The portion of the image within the boundary lines is now registered.
Cancel	Cancels logo registration.



Only images at an aspect ratio of 16:10 can be registered as user logos.

Logo position

Specify the position of registered user logos as follows.

You can specify the position after a logo has been registered. Choose from upper left, upper right, center, lower left, or lower right.

No signal screen

Customize the screen shown when no input signals are received.

Option	Function
Black	The screen is all black.
Blue	The screen is all blue.
User logo	The user logo is projected.

Screen when blank

Select the screen shown when projection is temporarily blanked out by pressing the **BLANK** button on the remote control.

Option	Function
Black	The screen is all black.
Blue	The screen is all blue.
User logo	The user logo is projected.

Projector on

Select a logo to project after startup until input signals can be projected.

Option	Function
Skip	A black screen is projected.
Canon logo	Displays the Canon logo that was registered in advance at the factory.
User logo	The user logo is projected.

Interface settings



> [System settings] > [Interface settings]

Specify interface details such as settings for input signals of connected equipment.

Interface settings	
Key repeat	On
Key lock	Off
Remote control channel	Independent
Audio in terminal select	
HDBaseT	On
Communication settings	
HDMI image input	Auto
HDBaseT image input	Auto
Return	

Key repeat

Key repeat enables projector or remote control buttons to be held down instead of pressing them repeatedly.

Option	Function
Off	Key repeat is not enabled.
On	Key repeat is enabled.

Key lock

Lock the projector to prevent direct or remote control operation.

Option	Function
Off	Disables the key lock.
Main unit	Operation is not possible using the main unit. Use the remote control.
Remote (wireless)	Disables infrared remote control operations (P38). Use buttons on the main unit. Operation is also possible with an optional wired remote control (RS-RC05).

To Unlock Key Lock Function

Turn off the projector and unplug the power plug. Hold down the **OK** button on the main unit and plug in the power cord, as you continue to hold down the **OK** button. In a moment, a beep will sound, and the controls will be unlocked.



When you access this setting from the projector's side controls, [Main unit] is not available. Similarly, when you access the setting from the remote control, [Remote (wireless)] is not available.

Remote control channel

Separate channels can be assigned to up to four projectors so that a single remote control can be used with each projector.

Selecting the Projector Channel

If an optional wired remote control (RS-RC05) is used, there is no need to set the remote control channel.

Option	Function
Ch1 Ch2 Ch3 Ch4	Select the remote control channel to use with this projector.
Independent	Can be controlled from a remote control set to any channel.

Selecting a Channel on the Remote Control

After changing the projector channel from the menu, always change the remote control channel accordingly.

Ch1	Hold both the OK button and [▲] button for 3 seconds.
Ch2	Hold both the OK button and [▶] button for 3 seconds.
Ch3	Hold both the OK button and [▼] button for 3 seconds.
Ch4	Hold both the OK button and [◀] button for 3 seconds.
Independent	Hold both the OK button and MENU button for 3 seconds.

Audio in terminal select

Select the source terminal for audio output.

Option	Function
Off	No audio is output.
Audio in 1	Use audio signals from AUDIO IN 1 for audio output.
Audio in 2	Use audio signals from AUDIO IN 2 for audio output.
HDMI	Use HDMI audio signals for audio output.
HDBaseT	Use HDBaseT audio signals for audio output.
LAN	Use LAN audio signals for audio output. Audio is transferred by the NMPJ application.  Audio is transferred via the port selected in [Communication settings] > [Wired network] (P120).

HDBaseT

Enable or disable HDBaseT. Refer to the following sections for details on HDBaseT connections. For video/audio details, see “Connection Procedure” (P50, P51). For network details, see “Connection Methods” (P127).

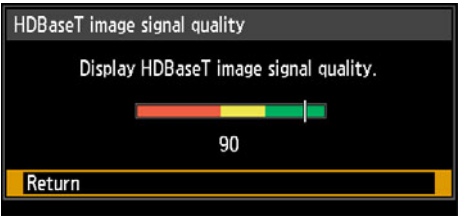
Option	Function
Off	Disable HDBaseT.
On	Enable HDBaseT.
Image signal quality	The HDBaseT input signal value received is indicated by a white line. 
	High Indicated by the green portion. This is the recommended level.
	Middle Indicated by the yellow portion. The signal is fluctuating. Check the cable.
	Low Indicated by the red portion. The signal cannot be used. Fix the cable connection or replace the cable.



Do not coil or bundle cables.

Communication settings

Select ports used for serial communication and network connections. Otherwise, you can refer to this setting to check setting values for the port selected for serial communication.

Submenu	Function	
Serial communication	Service port	Use the service port (CONTROL).
	HDBaseT	Use the HDBaseT port.
	Details	
	Option	Function
	Baud rate	Modulation rate, in bits per second.
	Data bits	Number of bits of data.
	Parity	Number of parity bits.
Stop bit	Length of mark representing the end of data bits. Select 1 or 2.	
Wired network	LAN port	Use the LAN port.
	HDBaseT	Use the HDBaseT port.



- [HDBaseT] is not available when [HDBaseT] is set to [Off].
- [Wired network] is not available when [Network function] (P131) is set to [Off].
- Changes to the wired network setting do not take effect immediately. To apply [Wired network] settings, restart the projector.

HDMI image input

Set the type of equipment which is connected to the HDMI port. Note that to some extent, the [HDMI image input] setting determines which image modes are available. (P70)

Option	Function
Auto	Select when AV equipment will be connected. Image processing, menu displays, and other elements are adjusted for video equipment.
Computer	Select when a computer will be connected. Image processing, menu displays, and other elements are adjusted for a computer.

HDBaseT image input

Specify the type of equipment connected to the HDBaseT port. Note that to some extent, the [HDBaseT image input] setting determines which image modes are available. (P70)

Option	Function
Auto	Select when AV equipment will be connected. Image processing, menu displays, and other elements are adjusted for video equipment.
Computer	Select when a computer will be connected. Image processing, menu displays, and other elements are adjusted for a computer.

Power management mode



> [System settings] > **[Power management mode]**

You can specify to turn the lamp or projector off automatically after a certain period if the projector and remote control are not used, or if there is no input signal.

Option	Function
Disabled	Disable power management mode.
Lamp off	Only turns the lamp off.
Standby	Turns the projector off and puts it in standby.



- Projection resumes when the same input signal is restored, when the remote control or projector is operated, or when a user command to activate the projector is received.
- After the projector enters standby, restoring projection requires the same steps as when turning the projector on normally.
- When [Disabled] is selected, [Direct power on] (P122) is not available.
- This setting can also be adjusted from the power saver settings screen by pressing the **LAMP** button on the remote control.

Power management duration

 > [System settings] > **[Power management duration]**

Specify how long before the lamp is turned off or the projector enters standby, depending on the [Power management mode] setting.

Option	Function
5 min. - 60 min.	After 30 seconds without an input signal when the projector is idle, the projector starts displaying a countdown of the selected time.



- If conditions that would start countdown are met while you are blanking projection, blanking is canceled.
- Once countdown begins, audio output stops.

Direct power on

 > [System settings] > **[Direct power on]**

You can turn on the projector by connecting the power cable without pressing the **POWER** button.

Option	Function
Off	The POWER button must be pressed to turn the projector on.
On	You can turn on the projector by connecting the power cable only.



- Before enabling direct power on, be sure to set [Power management mode] to an option other than [Disabled]. When [Disabled] is selected, [Direct power on] is not available.
- After turning off the projector, wait at least 5 minutes before turning it on again. It may shorten the lamp life if you turn on the projector immediately after turning it off.
- The projector is also equipped with a Direct Power Off feature. No damage is caused to the projector even if it is unplugged during projection to turn it off without pressing the **POWER** button. However, setting adjustments made immediately before unplugging the projector may not be stored.

Beep

 > [System settings] > **[Beep]**

You can select whether a beep sounds or not when you operate the projector.

Option	Function
Off	Disables the beep.
On	Enables the beep.



The beep will not sound if you mute the projector sound with the **MUTE** button on the remote control.

Motion blur reduction

 > [System settings] > **[Motion blur reduction]**

Motion blur is blurring that occurs during video playback. Motion blur reduction can make this blurring less noticeable.

Option	Function
Off	Motion blur reduction is not performed.
On	Motion blur reduction is performed.



- If reducing motion blur produces distracting image noise, select [Off].
- Effects of motion blur reduction cannot be checked during menu display.
- Especially effective for motion of computer graphics and similar high-resolution images.
- This feature is not available during LAN/USB input.

Language

 > [System settings] > **[Language]**

Select the menu display language.

Language		
English English	Русский Russian	Čeština Czech
Deutsch German	Nederlands Dutch	Dansk Danish
Français French	Suomi Finnish	إنجليزي Arabic
Italiano Italian	Norsk Norwegian	中文简体 Chinese (Simplified)
Español Spanish	Türkçe Turkish	中文繁體 Chinese (Traditional)
Português Portuguese	Polski Polish	한국어 Korean
Svenska Swedish	Magyar Hungarian	日本語 Japanese

Other settings

 > [System settings] > **[Other settings]**

Lock operation with a password, set a password, reset counters for lamp or air filter replacement, and access other settings and information.

Other settings	
Password settings	Off
Register password	
[Fn] button settings	Disable
Gamma restore	Off
Lamp counter	
Air filter counter	
Firmware	00.010002
Factory defaults	
Return	

Password settings

Disables the projector unless the correct password is entered.

Option	Function
Off	The projector can be used even if no password is entered.
On	The projector cannot be used unless you enter your password.

To Cancel the Password

Cancellation on the Projector	Turn off the projector and unplug the power plug. Hold down the MENU button on the side control and connect the power plug. Make sure to keep holding down the MENU button until a beep sounds. When the projector beeps, the password is canceled. (The entered password is also reset.)
Cancellation on the Remote Control	To forcibly cancel the password from the remote control, in standby state press the MENU button 3 times, then press the POWER button.



- You cannot set [On] unless you have completed [Register password]. Once you set a password, the password entry screen appears at power-on. Enter a 4 digit password.
Enter the password using the [▲] / [▶] / [▼] / [◀] buttons.
If the password is valid, the projection starts. If you enter a wrong password three times, the power will be turned off.
- The projector also goes off after three minutes of inactivity on the password input screen.

Register password

You can register a password for starting projection.

Enter a 4 digit password.

Enter the password using the [▲] / [▶] / [▼] / [◀] buttons.

The 4-digit password is entered from the left to right digits. When the final digit is entered, the password is automatically registered.

Press the **MENU** button to abort the registration.

[Fn] button settings

You can select a function to be assigned to the **Fn** button on a remote control.

Option	Function
Disable	Disables assigning a function to the Fn button on the remote control.
Split screen	Enables split-screen mode toggling using the Fn button on the remote control.



Select the function to assign to the **Fn** button of a remote control (RS-RC05, sold separately).

Gamma restore

Restore the original gamma if, after the projector has been used for some time, you notice that tone curves have changed, or if neutral colors have become tinted. Gamma restore can only be used when the lamp has been on for approximately 30 minutes or longer.

Submenu	Function
Off	Returns to the factory default without performing Gamma restore.
Adjust	Restore the original gamma and apply the result.



- If Gamma restore is performed, the tone characteristics and achromatic color will be restored as close as possible to the condition when the projector was purchased, however it is not possible to restore it completely to the original condition.
- If Gamma restore is performed, the adjustment screen will be projected for approximately 150 seconds.
- To cancel Gamma restore, press the **POWER** button.

Lamp counter

You can reset the lamp counter that indicates the time for lamp replacement.

For details on lamp counter display, see “Replacing the Lamp” (P173).



- Do not reset the lamp counter except when you have replaced the lamp. Otherwise, the lamp counter cannot indicate the correct timing for replacing the lamp.
- Lamps are more likely to rupture once the lamp replacement message has been displayed (P173). Replace the lamp with a new one as soon as possible.
- The lamp counter provides an estimate of the time remaining until the lamp must be replaced. This value is based on the hours in use and the present load on the lamp.
- The number of hours indicated is equivalent to use under these conditions: [Vertical projection] (P108) set to [Off], and [Lamp mode] (P102) set to [Full power].

Air filter counter

This resets the counter which reminds you of the time for cleaning and replacing the air filter.



For details on replacing or cleaning the filter, see [P171](#) - [P172](#).

Power counter

Indicates the total time that the projector has been connected to a power supply.



This value is not reset even if [Factory defaults] is executed.

Firmware

Update the projector firmware.

Check the version indicated before updating the firmware.

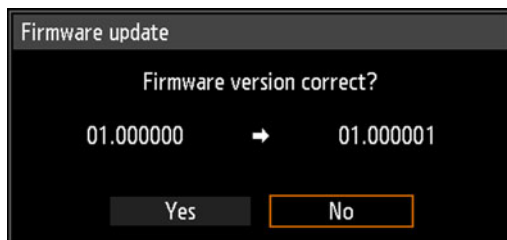

Update the projector firmware as follows.

1. Download updated firmware from the Canon website and store it at the root directory on a USB flash drive.
2. Insert the USB flash drive in the USB port.
3. Follow the instructions shown to complete the update process.



- Firmware versions shown here are for illustration only and differ from actual versions.
- In some cases, it may not be possible to download updates. For details, contact the Canon Customer Support Center.
- Firmware updating takes a few minutes. During the update, the LED indicator will flash in red. Do not turn off the projector while the LED is flashing. After the update, the projector will automatically turn itself off and enter standby mode.

Factory defaults

You can reset the menu item settings and restore the system settings to the factory defaults.

Option	Function
OK	Settings are reset to default.
Cancel	Settings are not reset to default.

Network settings

Network Connection Overview

Connecting the projector to a network enables you to control the projector from a computer and receive notification of projector errors via email.

Depending on the method of network connection, preparation on the computer side may be necessary. The following is an explanation of preparation on the computer side.

Connection Methods

To connect the projector to a computer network, use a LAN cable. The LAN cable can be connected to either the LAN port or HDBaseT port.

When using the LAN port, connect the projector as follows.

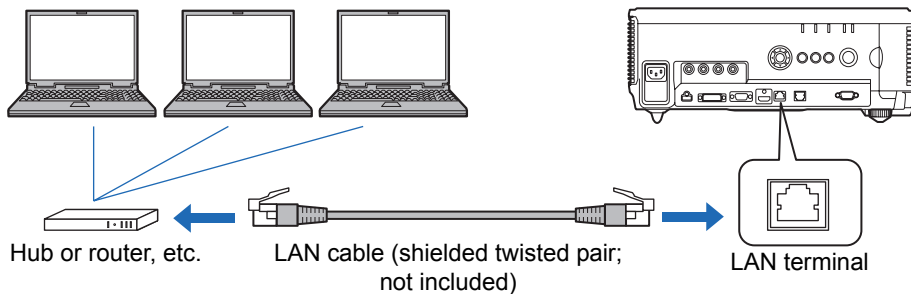

When using the HDBaseT port, connect the projector as follows.

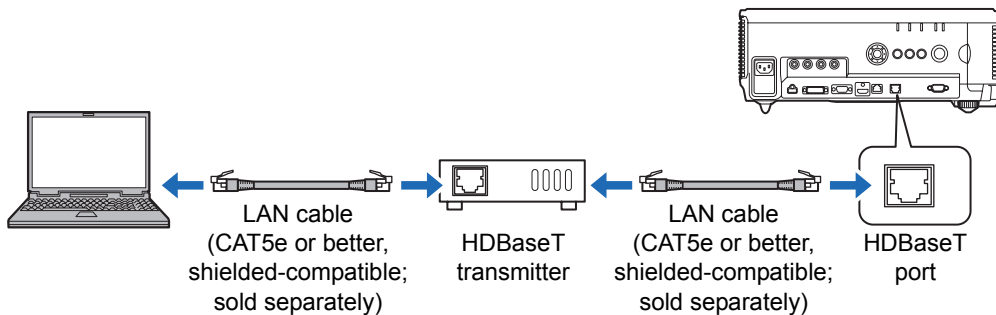

- The LAN port and HDBaseT port cannot be used at the same time for a network connection.
- Network connectivity provided by the HDBaseT port and LAN port is identical, except that the HDBaseT provides a maximum transfer speed of 100 Mbps.
- When the [Network function] setting of the projector is set to [Off] (Network Connections is disabled), switch it to [On] to enable it. (P131)
- Select which port to use in [Communication settings] > [Wired network] (P120).
- Referring to “Checking Projector Information” (P156), confirm that the projector’s IP address is not the same as that of other computers on the network. To set a projector IP address, follow the instructions in “Controlling the Projector from a Computer” (P154) and use the web screen, or use projector TCP/IP settings. (P132)

Menu Description

- When you connect the computer to the network for the first time, it is also necessary to perform settings on the computer. In this case, consult the network administrator regarding the necessary settings.



In a network environment where a DHCP server is operating, choose [On] on the projector [DHCP] screen to enable the DHCP function and connect it. ([P132](#))

Completing Projector Settings

Settings described in this section apply to the network connections, setting a network password, and other aspects of networked projection.

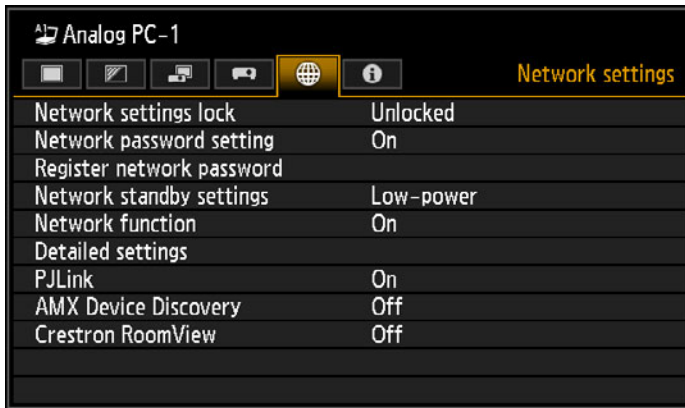

(When the input signal is Analog PC-1)

Menu	Function	Details
Network settings lock	Lock network settings to prevent changes.	P130
Network password setting	Activate or deactivate password protection for network settings.	P130
Register network password	Set a network password.	P130
Network standby settings	Specify the extent of network functionality in standby mode.	P131
Network function	You can turn the projector network function on or off.	P131
Detailed settings	Display and set advanced settings for network connections.	P132
PJLink	Enable or disable PJLink.	P134
AMX Device Discovery	Enable or disable AMX Device Discovery.	P135
Crestron RoomView	Enable or disable Crestron RoomView.	P135

Network settings lock

 > [Network Settings] > **[Network settings lock]**

You can lock/unlock the network settings so that they cannot be changed.

Option	Function
Unlock	Cancels the lock and allows other network settings to be changed. The password must be entered in order to cancel the lock. Use the [▲]/[▶]/[▼]/[◀] buttons to enter the 4-digit password.
Lock	Lock the settings.



- **Forcibly canceling the network lock**

Press these buttons in the following order to cancel the lock: [▲] [OK] [▶] [OK] [▼] [OK]. This operation resets the network password to [▲] [▲] [▲] [▲].

- Setting [Network password setting] to [Off] leaves network settings unlocked.

Network password setting

 > [Network settings] > **[Network password setting]**

You can set whether or not a password is required in order to change the projector network settings.

Option	Function
Off	A network password is not used.
On	A network password is used.

Register network password

 > [Network settings] > **[Register network password]**

Use the [▲] / [▶] / [▼] / [◀] buttons to enter the projector network password.



Network standby settings



> [Network settings] > **[Network standby settings]**

Specify the network function operating status in standby mode as follows.

Option	Function
Normal	All network functions are available even in standby mode, including the web screen, control over the network, and PJLink.
Low-power	All network functions are available even in standby mode. However, the projector may be less responsive than usual when some functions are initially used.



- [Low-power] may delay access over the network for some functions. For faster access, select [Normal].
- Power consumption when Network function is [On] varies depending on whether Network standby settings is set to Normal or Low-power.
- This setting can also be adjusted from the power saver settings screen by pressing the **LAMP** button on the remote control.

Network function



> [Network settings] > **[Network function]**

Enable or disable network function.

Specifying [Off] can save energy.



Option	Function
Off	Disable the network function.
On	Enable the network function.

Detailed settings

 > [Network settings] > **[Detailed settings]**

Display and manually change the IP address, gateway address, and other settings. Available only when the network function is [On].

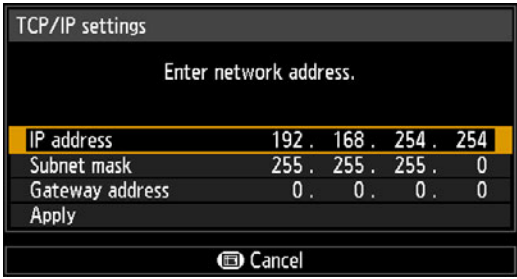
Detailed settings	
IP address	192 . 168 . 254 . 254
Gateway address	0 . 0 . 0 . 0
MAC address	■■■■■■■■■■
DHCP	Off
TCP/IP settings	
Network setting initialization	
Return	

Menu	Function						
IP address	IP address of the projector.						
Gateway address	Gateway address of the projector.						
MAC address	MAC address of the projector.						
DHCP	<table border="1"> <thead> <tr> <th>Option</th> <th>Function</th> </tr> </thead> <tbody> <tr> <td>Off</td> <td>Disables the DHCP function. TCP/IP settings must be configured manually.</td> </tr> <tr> <td>On</td> <td>Enables the DHCP function. Searches the DHCP server. There is no need to configure TCP/IP settings (IP address, subnet mask, and gateway address), because the IP address is acquired from the DHCP server.</td> </tr> </tbody> </table>	Option	Function	Off	Disables the DHCP function. TCP/IP settings must be configured manually.	On	Enables the DHCP function. Searches the DHCP server. There is no need to configure TCP/IP settings (IP address, subnet mask, and gateway address), because the IP address is acquired from the DHCP server.
	Option	Function					
Off	Disables the DHCP function. TCP/IP settings must be configured manually.						
On	Enables the DHCP function. Searches the DHCP server. There is no need to configure TCP/IP settings (IP address, subnet mask, and gateway address), because the IP address is acquired from the DHCP server.						
TCP/IP settings	<p>Change or specify the IP address, subnet mask, and gateway address used for connections.</p>  <p> This menu is not available (grayed out) when [DHCP] is [On].</p> <p> If an invalid value is entered, the message “Invalid entry” appears. If this occurs, enter a valid value.</p>						

Menu	Function
Network setting initialization	<p>The following network settings are initialized.</p> <p>Settings configured from the projector menu</p> <ul style="list-style-type: none"> • Network settings lock (P130) • Network password setting (P130) • Register network password (P130) • Network standby settings (P131) • Network function (P131) • Detailed settings(P132) • PJLink (P134) • AMX Device Discovery (P135) • Crestron RoomView (P135) <p>Settings configured from the web screen</p> <ul style="list-style-type: none"> • [Password] (P143) • [Network] (P144) • [NMPJ Password] (P145) • [Mail] (P146) • [Mail auth] (P147) • [SNMP] (P148) • [Projector info.] (P149) • [PJLink] (P150)

PJLink



> [Network settings] > [PJLink]

You can enable or disable the PJLink network function of the projector.

When this function is enabled, control is possible over a network using PJLink commands.

Option	Function
Off	Disables the PJLink function.
On	Enables the PJLink function.



- The projector conforms to Class 1 as defined in PJLink standards established by the Japan Business Machine and Information System Industries Association (JBMIA). This projector supports all commands that are defined by PJLink Class 1, and has been verified as conforming to the PJLink standard Class 1 definition.
- For details on using PJLink, see “Setting PJLink [PJLink]” (P150).

What is PJLink?

In September 2003, the PJLink Working Group was established under the Data Projector Committee. During the first year, this PJLink Working Group standardized PJLink as a new interface specification for projectors.

PJLink is a unified standard for operation and control of projectors.

It allows centralized control of projectors and operation from a controller for all projectors regardless of manufacturer.

The objective is for JBMIA to improve convenience for users and expand the use of projectors through early systemization for network monitoring and control of projectors, which will become the mainstream in the future.

Class 1: Standardization of control and monitoring specifications for basic projector functions

Basic projector control: Power control, input selection, etc.

Acquisition of projector information and status: Power status, input selection status, error status, lamp use time, etc.

JBMIA: Japan Business Machine and Information System Industries Association.

The JBMIA is an organization which was launched in 1960 and changed its name on April 1, 2002.

PJLink website: <http://pjlink.jbmia.or.jp/english/>



PJLink is a registered trademark of JBMIA and pending trademark in some countries.

PJLink is a registered trademark, or an application has been submitted for trademark, in Japan, the United States and / or other countries or regions.

AMX Device Discovery

 > [Network settings] > **[AMX Device Discovery]**

In a network environment, AMX Device Discovery can be used to enable other equipment to discover the projector. For networks without AMX Device Discovery, select [Off].

Option	Function
Off	Disables AMX Device Discovery.
On	Enables AMX Device Discovery. The projector will periodically send out AMX beacon packets over the network.



- For details on AMX Device Discovery, visit the AMX website.
<http://www.amx.com/>

Crestron RoomView

 > [Network settings] > **[Crestron RoomView]**

Crestron RoomView enables centralized management of multiple projectors over a network. Networked projectors can be remotely controlled to troubleshoot issues, check the useful life of lamps, or turn the projectors on or off. Specify whether to use Crestron RoomView.

Option	Function
Off	Disable Crestron RoomView.
On	Enables Crestron RoomView. A port for RoomView will be opened, and the projector will respond to CIP packets. Communication is possible via the RoomView Express/Server application or via Crestron Controller. (P150)



- For details on Crestron RoomView, visit the Crestron® website.
<http://www.crestron.com/>

Completing Computer Settings

Specifying an IP Address

Instructions for setting a computer's IP address are as follows for each operating system.

■ Windows 10

- 1 Right-click the Start button (Windows logo) in the lower left of the screen.**
 - In desktop mode (from the desktop screen)
The same operation is possible by pressing Win+X.
- 2 In the shortcut menu displayed in the lower left, click [Control Panel].**
- 3 Click [View network status and tasks].**
 - In Icon View:
Click [Network and Sharing Center].
- 4 Click [Change adapter settings].**
- 5 Right-click [Ethernet], and then click [Properties].**
- 6 In the [This connection uses the following items] list, select [Internet Protocol Version 4 (TCP/IPv4)] and click the [Properties] button. Make a note of the original network settings (IP address, subnet mask, default gateway, etc).**
- 7 Select [Use the following IP address] and set the IP address and subnet mask.**

The factory default IP address for the projector is "192.168.254.254". Set an IP address which is different from this.
- 8 When finished, click the [OK] button, and then click the [Close] button in the [Ethernet Properties] window to close it.**

■ Windows 8 / 8.1

- 1 Right-click on the start screen background and click [All Apps] in the lower right.**
 - Windows 8.1 Users:
Click the down arrow in the lower left of the start screen.
- 2 Click [Control Panel].**
 - From the Desktop:
Press Win+X.
In the shortcut menu displayed in the lower left, click [Control Panel].
- 3 Click [View network status and tasks].**
 - In Icon View:
Click [Network and Sharing Center].
- 4 Click [Change adapter settings].**
- 5 Right-click [Ethernet], and then click [Properties].**
- 6 In the [This connection uses the following items] list, select [Internet Protocol Version 4 (TCP/IPv4)] and click the [Properties] button. Make a note of the original network settings (IP address, subnet mask, default gateway, etc).**
- 7 Select [Use the following IP address] and set the IP address and subnet mask.**

The factory default IP address for the projector is “192.168.254.254”. Set an IP address which is different from this.
- 8 When finished, click the [OK] button, and then click the [Close] button in the [Ethernet Properties] window to close it.**

■ Windows 7

- 1** From the PC [Start] menu, select [Control Panel].
- 2** Click on [Network and Internet], then click on [View network status and tasks].
- 3** From the menu on the left side of the window, click on [Change adapter settings].
- 4** Right-click [Local Area Connection], and open [Properties].
- 5** Select [Internet Protocol Version 4 (TCP/IPv4)] and click the [Properties] button. Make a note of the original network settings (IP address, subnet mask, default gateway, etc).
- 6** Select [Use the following IP address] and set the IP address and subnet mask.
The factory default IP address for the projector is “192.168.254.254”. Set an IP address which is different from this.
- 7** When the settings are completed, click the [OK] button and then click the [OK] button on the [Local Area Connection Properties] window to close it.

■ Windows Vista

- 1** From the PC [Start] menu, select [Control Panel].
- 2** Click on [View network status and tasks].
- 3** From the menu on the left side of the window, click on [Manage network connections].
- 4** Right-click [Local Area Connection], and open [Properties].
- 5** Select [Internet Protocol Version 4 (TCP/IPv4)] and click the [Properties] button. Make a note of the original network settings (IP address, subnet mask, default gateway, etc).
- 6** Select [Use the following IP address] and set the IP address and subnet mask.
The factory default IP address for the projector is “192.168.254.254”. Set an IP address which is different from this.
- 7** When the settings are completed, click the [OK] button and then click the [OK] button on the [Local Area Connection Properties] window to close it.

■ Mac OS X

- 1 Open the Apple Menu and select [System Preferences].
- 2 In the System Preferences window, click [Network] to display the Network window.
- 3 Select [Built-in Ethernet] and click the [TCP/IP] tab. Make a note of the original network settings (IP address, subnet mask, router, DNS server, etc.).
- 4 Create a new network environment and set the IP address and subnet mask.
The factory default IP address for the projector is “192.168.254.254”. Set an IP address which is different from this.
- 5 Click [Apply] to close the network preference window.

■ Resetting the IP Address Setting of the Computer

Follow the same procedure as for changing the IP address and reset the values to the original values based on the notes taken before the change.

Setting Up the Network

■ Displaying the Network Configuration Screen

- 1 Turn on the computer and projector.



Network functions are not available for the first 40 seconds after projector startup.

- 2 Launch a web browser, enter “http://(projector IP address)” in the address bar, and press the Enter key.
The projector web screen appears.



Menu Description

The following information is displayed.

Network Multiple Projection Download	For downloading the Networked Multi-Projection (NMPJ) program.*
Projector control	Displays the projector control screen.
Settings	Shows the settings screen.
Projector name	The name of the projector on the network
Comment	Relevant notes, such as where the projector is installed
MAC address	The MAC address of the projector
IP address	The IP address of the projector
PowerStatus	The power status of the projector
LampModeFullPower	Lamp operating time in [Full power] lamp mode
LampModePowerSaver	Lamp operating time in [Power saver] lamp mode
LampTimeConverted	Lamp operating time (converted value)
FilterTime	Air filter operating time
Alert	Error message (if an error has occurred) Temperature abnormality Faulty lamp Faulty cooling fan Faulty air filter unit Faulty power supply Faulty lens connector Unknown error

* For details on downloading the Networked Multi-Projection (NMPJ) application, refer to the NMPJ user's manual.



The factory default IP address is "192.168.254.254". If DHCP settings are used, ask the network administrator for the projector IP address. It is possible to check the IP address from the projector menu. (P132)

3 Click [Settings] on the web screen.
The password input window appears.

- 4** Enter the user name and password on the password input window, then click [OK].

The factory default user name is “root” and the password is “system”.

The settings screen is displayed. Complete the network settings on this screen.

The screenshot shows the WUX6500 settings interface. On the left is a menu with options: Password, Network, NMPI Password, Mail, Mail auth, Send test mail, SNMP, Projector info., PiLink, Crestron, and Initialize. The 'Password' option is selected. The main area displays a 'Password' form with three input fields: 'User name' (containing 'root'), 'New password' (containing '*****'), and 'Confirm new password' (containing '*****'). Each field has a character count of 4-15. At the bottom right of the form are 'OK' and 'Cancel' buttons. At the top right of the screen are 'Projector control' and 'Back to top' buttons.



To control the projector from the computer, click [Projector control]. (P154)

■ Network Setting

- 1** Select a function to set up from the settings screen menu.

The screenshot shows the WUX6500 settings interface with the 'Network' option selected in the left menu. The main area displays a 'Wired network status' form. The 'MAC address' is 00:1E:8F:FA:56:67. The 'DHCP' dropdown is set to 'OFF'. The 'IP address' is 192.168.254.1, 'Subnet mask' is 255.255.255.0, and 'Default gateway' is 0.0.0.0. 'OK' and 'Cancel' buttons are at the bottom right. 'Projector control' and 'Back to top' buttons are at the top right.

Menu Description

- 2** Enter setting details in the fields shown (1), and then click [OK] (2).

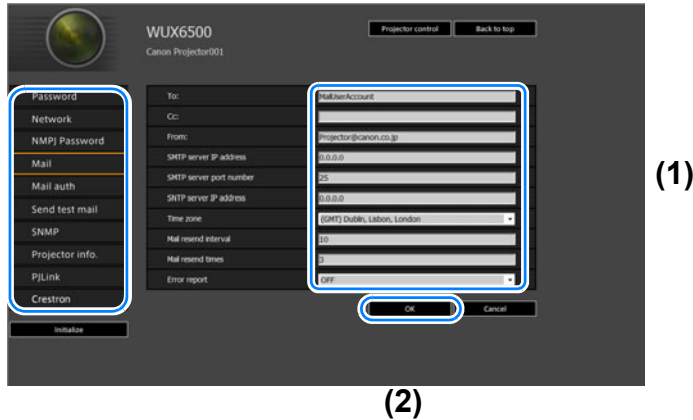

- 3** A confirmation window appears. Check the contents and if they are correct, click [Apply].

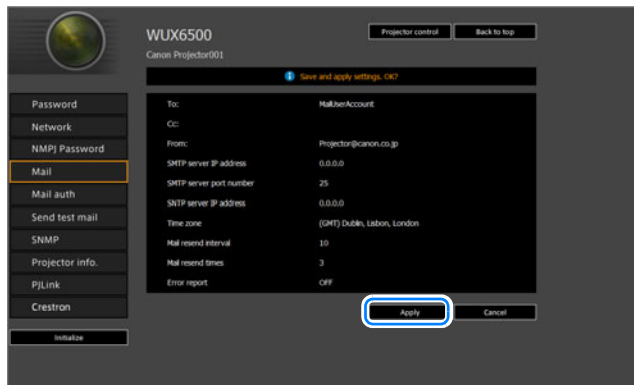

The settings are applied to the projector. Selecting [Network] or [Password] in the menu will cause this message to be displayed: “Save completed. Please change setting and reconnect.” If you select functions other than above, “Save completed” is displayed. Click [Back to top] to return to the top page of the web screen.

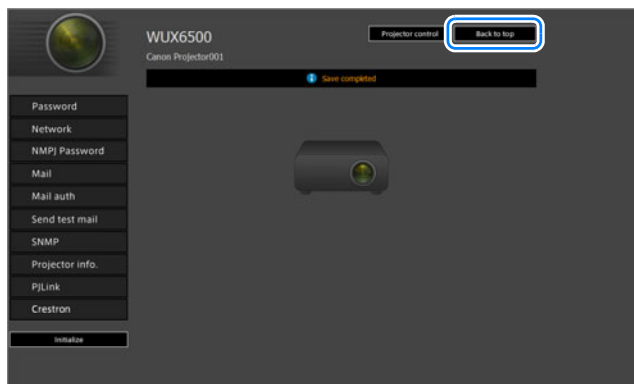

Setting a Password [Password]

From [Password] in the settings screen, you can set a user name and password for web screen login. For the setting procedure, refer to “Network Setting” (P141).

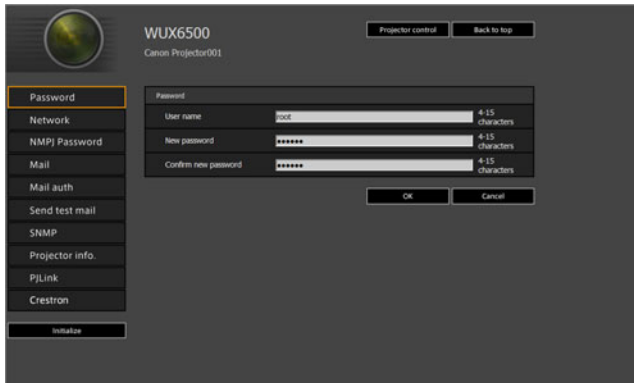

Item	Explanation	Factory default setting
User name	When logging into the web screen, enter the user name in 1-byte alphanumeric characters and symbols (4 -15 characters).	root
New password	When logging into the web screen, enter the password in 1-byte alphanumeric characters and symbols (4 -15 characters).	system
Confirm new password	For confirmation, enter the same password that you entered in [New password].	system

Setting Basic Information [Network]

From [Network] in the settings screen, you can log into the web screen and set basic network information. For the setting procedure, refer to “Network Setting” (P141).

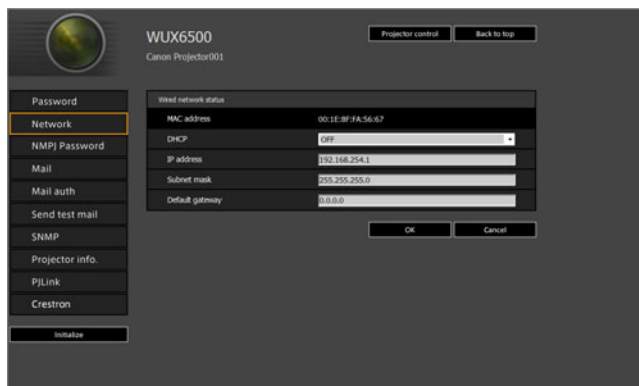

Item	Explanation	Factory default setting
MAC address	Shows the projector's MAC address.	The MAC address of the projector
DHCP	Select whether to turn the DHCP function on or off. The following settings cannot be configured manually when this setting is [ON], because the IP address is acquired from the server. [IP address] [Subnet mask] [Default gateway]	OFF
IP address	Enter the IP address of the projector in 1-byte numbers.	192.168.254.254
Subnet mask	Enter the subnet mask in 1-byte numbers.	255.255.255.0
Default gateway	Enter the default gateway IP address in 1-byte numbers.	0.0.0.0



If settings related to TCP/IP were changed, it is necessary to disconnect and reconnect to the network.

If the network subnet mask was changed, select [Subnet mask] in the above screen and set the new subnet mask.

Specifying Networked Multi-Projection Settings [NMPJ Password]

From [NMPJ Password] in the settings screen, you can specify the items needed for NMPJ authentication. For the setting procedure, refer to “Network Setting” (P141).

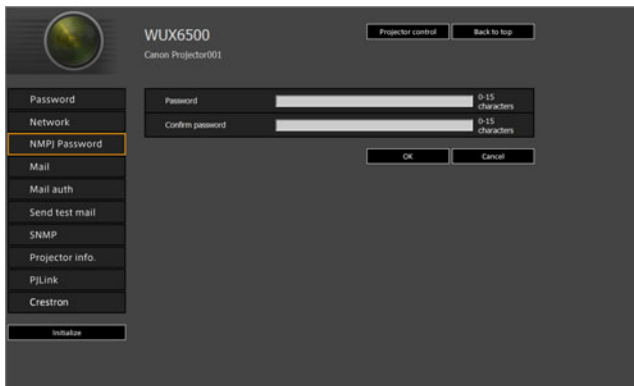

Item	Explanation	Factory default setting
Password	Enter the password required for a networked multi-projection connection in single-byte alphanumeric characters (0-15 characters).	<Blank>
Confirm password	For confirmation, enter the same password as you entered in [Password].	<Blank>



For details on Networked Multi-Projection (NMPJ), refer to the NMPJ user's manual.

Setting Up Email [Mail]

From [Mail] in the settings screen, you can set the items necessary to send error mails and test mails. For the setting procedure, refer to “Network Setting” (P141).

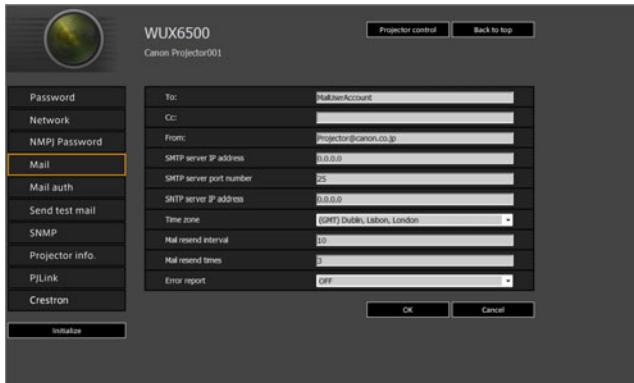

Item	Explanation	Factory default setting
To:	Enter the recipient address for error mails in 1-byte alphanumeric characters and symbols (1 - 63 characters).	MailUserAccount
Cc:	Enter the CC address for error mails in 1-byte alphanumeric characters and symbols (1 - 63 characters).	<Blank>
From:	Enter the sender address for error mails in 1-byte alphanumeric characters and symbols (1 - 63 characters).	Projector@canon.co.jp
SMTP server IP address	Enter the SMTP server IP address in 1-byte numbers.	0.0.0.0
SMTP server port number	Enter the SMTP server port number in 1-byte numbers (1 - 65535).	25
SNTP server IP address	Enter the SNTP server IP address in 1-byte numbers.	0.0.0.0
Time zone	Select the time zone where the projector is used.	(GMT) Dublin, Lisbon, London
Mail resend interval*	Enter the interval for resending mail when an error occurred (unit: seconds) within the range of 0 - 59 seconds using 1-byte numbers.	10
Mail resend times	Enter the number of times to resend mail when an error occurred within the range of 0 - 255 using 1-byte numbers.	3
Error report	Select whether to turn the error mail sending function on or off.	OFF

* When the interval is set to 0 seconds, repeated attempts to send mail are made (as set in [Mail resend times]) without pausing between attempts.

Mail Authentication Settings [Mail auth]

From [Mail auth] in the settings screen, you can configure the settings for authentication of mail that is sent when an error occurs. For the setting procedure, refer to “Network Setting” (P141).

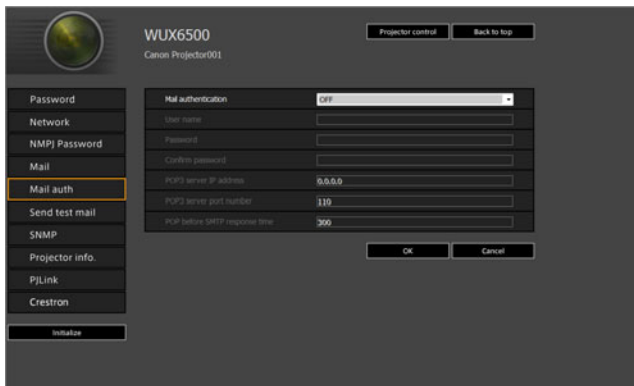

Item	Explanation	Factory default setting
Mail authentication	Select the mail authentication method. If OFF is selected, the other mail authentication settings cannot be changed.	OFF
User name	Enter the user name to use for mail authentication in 1-byte alphanumeric characters and symbols (1 - 63 characters).	<Blank>
Password	Enter the password for mail authentication in 1-byte alphanumeric characters and symbols (1 - 63 characters).	<Blank>
Confirm password	For confirmation, enter the same password as you entered in [Password].	<Blank>
POP3 server IP address	Enter the POP3 server IP address in 1-byte numbers.	0.0.0.0
POP3 server port number	Enter the POP3 server port number in 1-byte numbers (1 - 65535).	110
POP before SMTP response time	Enter the SMTP authentication timeout period after POP3 authentication (unit: milliseconds) using 1-byte numbers (0 - 9999 milliseconds).	300

Menu Description

Sending a Test Mail [Send test mail]

From [Send test mail] in the settings screen, you can send a test mail to the mail address that was set in [Mail]. The settings cannot be changed from this screen.

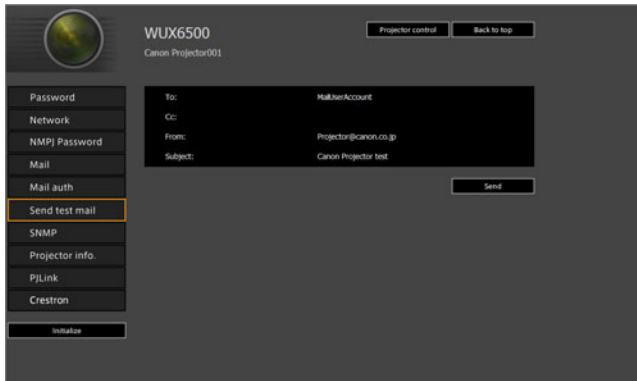

Item	Explanation
To:	The recipient address which was set from [Mail] in the settings screen (P146) is displayed.
Cc:	The CC address which was set from [Mail] in the settings screen (P146) is displayed.
From:	The sender address which was set from [Mail] in the settings screen (P146) is displayed.
Subject:	The predetermined mail title “Canon Projector test” is displayed.

SNMP Settings [SNMP]

From [SNMP] in the settings screen, you can configure the settings related to control of projectors which use SNMP (Simple Network Management Protocol). For the setting procedure, refer to “Network Setting” (P141).

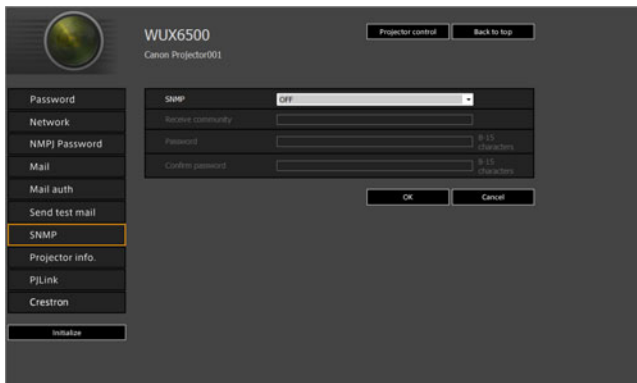

Item	Explanation	Factory default setting
SNMP	Select the SNMP function version. If OFF is selected, the SNMP function will be turned off and the other settings in this screen cannot be changed.	OFF
Receive community	Enter the community name which will receive projector information in 1-byte alphanumeric characters and symbols (1 - 15 characters).	<Blank>
Password	Enter the community settings password in 1-byte alphanumeric characters and symbols (8 - 15 characters). It can be set only when the SNMP version is V3.	<Blank>
Confirm password	For confirmation, enter the same password as you entered in [Password].	<Blank>

Setting Projector Information [Projector info.]

From [Projector info.] in the settings screen, you can enter relevant comments such as projector names and locations where projectors are installed so that the information can be used to identify projectors when multiple projectors are installed on the network. For the setting procedure, refer to “Network Setting” (P141).

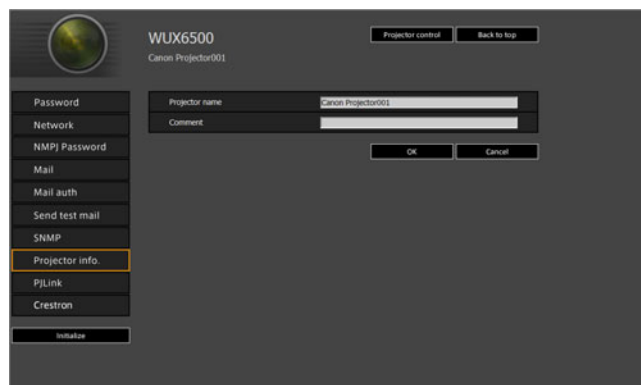

Item	Explanation	Factory default setting
Projector name	Enter the projector name in 1-byte alphanumeric characters and symbols (1 - 63 characters).	Canon Projector001
Comment	Enter any relevant notes, such as where the projector is installed.	<Blank>



Some characters such as # cannot be used for [Projector name] and [Comment].

Setting PJLink [PJLink]

From [PJLink] in the settings screen, you can set the PJLink functions which are the standard for projector management on a network. For the setting procedure, refer to “Network Setting” (P141). For information about PJLink, refer to “What is PJLink?” (P134).

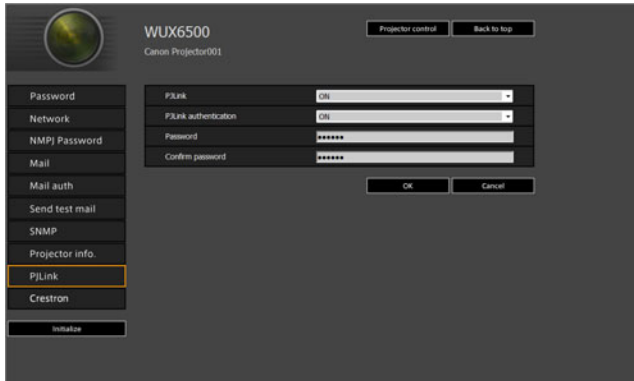

Item	Explanation	Factory default setting
PJLink	Turn the PJLink function on or off. If OFF is selected, the PJLink function will be turned off and the other settings in this screen cannot be changed.	ON
PJLink authentication	Select whether to turn the PJLink authentication function on or off. The following settings cannot be changed when this setting is [OFF]. [Password] [Confirm password]	ON
Password	Enter the PJLink authentication password in 1-byte alphanumeric characters (1 - 32 characters).	system
Confirm password	For confirmation, enter the same password that you entered in [Password].	system

Setting Up a Controller Manufactured by Crestron Electronics [Crestron Controller]

The [Crestron e-Control] screen will open. For details on the Crestron Controller, visit the Crestron website.

<http://www.crestron.com/>

Setting Errors

When a setting-related error occurs, the error name is displayed on the screen, and a “!” mark is displayed next to the input field which caused the error.

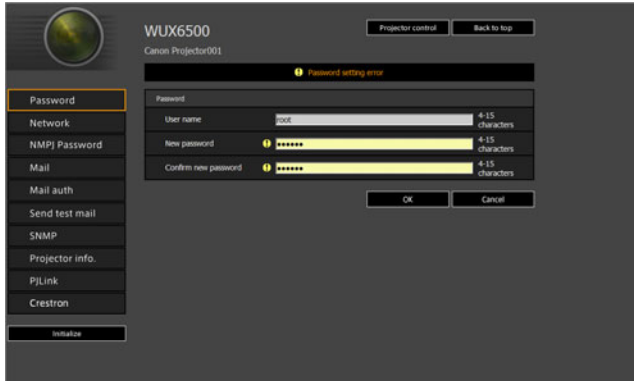

The error meanings are as shown below.

Error	Meaning
Input error	A setting outside the valid range was set on the settings screen.
Password setting error	The set password and confirmation password did not match.
Invalid SMTP	The SMTP server IP address has not been set.
System failed to connect SMTP server.	Failed to connect to the SMTP server when sending a test mail.
System failed to connect POP3 server.	Failed to connect to the POP3 server attempting to send a test mail.
System doesn't support this auth type.	An authentication type was set which is not supported by the server.
System failed to authenticate.	Authentication failed attempting to send a test mail.
The system failed to send the test mail.	Sending of test mail failed due to a connection failure with the SMTP server or an error which does not ordinarily occur.
Unknown error	Unknown error

Resetting Network Settings to the Default Settings

- 1 Perform steps 1 - 3 on “Displaying the Network Configuration Screen” (P139) to display the settings screen.
- 2 Click [Initialize].



- 3 A confirmation window appears. Click [OK].

■ Error Notification Mails

The messages shown in the following error list are sent when an error occurs in the projector.

Error list

Errors related to temperature	Error name	Temperature abnormality
	Text	The temperature inside the projector is too high for some reason or the outside air temperature is higher than the specified one. If the problem is inside the projector, check whether the projector is installed and operated normally, turn off the projector to cool its inside, and retry projection. If the same warning occurs again, the projector may be defective. Contact your dealer.
Errors related to the lamp	Error name	Faulty lamp
	Text	The lamp has burnt out. Replace the lamp with a new one. If the same warning occurs again, the lamp drive circuit may be defective. Contact your dealer.
Errors related to the fan	Error name	Faulty cooling fan
	Text	The cooling fan or another component may be defective. Contact your dealer.
Errors related to the air filter	Error name	Faulty air filter unit
	Text	The air filter unit is not installed properly. Check whether the air filter unit is installed properly. If it is installed properly, the air filter unit detection switch may be defective. Contact your dealer.
Errors related to the power	Error name	Faulty power supply
	Text	The voltage of part of the power supply is abnormally high or any other problem has occurred in the power supply. Contact your dealer.
Errors related to the lens connector	Error name	Faulty lens connector
	Text	The lens cable is not connected to the lens unit. Check whether the lens cable is connected to the lens unit properly. If it is connected properly, the lens connector or cable may be defective. Contact your dealer.

Controlling the Projector from a Computer

When the projector is connected to a network, it is possible to control the projector from a computer via the network.

- 1 Turn on the computer and projector.**
- 2 Launch a web browser, enter “http://(projector IP address)” in the address bar, and press the Enter key.**
The projector web screen appears.



The factory default IP address is “192.168.254.254”. If DHCP settings are used, ask the network administrator for the projector IP address. It is possible to check the IP address from the projector menu.

- 3 Click [Projector control] on the web screen.**
The password input window appears.
- 4 Enter the user name and password on the password input window, then click [OK].**
The factory default user name is “root” and the password is “system”.
The projector control screen appears.

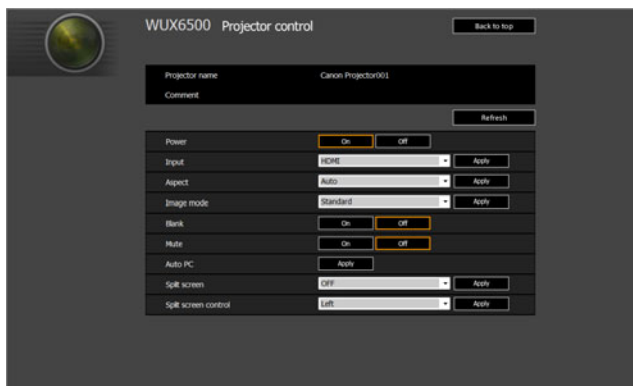

The projector can be controlled from this screen.

Item	Explanation
Projector name	The name of the connected projector is displayed. (P149)
Comment	Shows notes, such as where the projector is installed. (P149)
Refresh	Refreshes the displayed contents with the most recent information.
Power	Turns projector power on or off.
Input	Select an input signal and click [Apply] to change to that input signal. (P56)
Aspect	Select an aspect and click [Apply] to change to that aspect. (P65)
Image mode	Select an image mode and click [Apply] to change to that image mode. (P70)
Blank	Switches the blank setting on or off. (P72)
Mute	Switches the mute setting on or off. (P36)
Auto PC	Click [Apply] to perform Auto PC adjustment. (P58)

Item	Explanation
Split screen	Select the setting for split-screen mode and click [Apply] to switch to split-screen projection.
Split screen control	Select the control rights setting for split-screen mode and click [Apply] to switch the side currently under control.
Information	The control results and control error information are displayed at the top of the screen.

5 When the operations are finished, click [Back to top] to return the initial web screen.

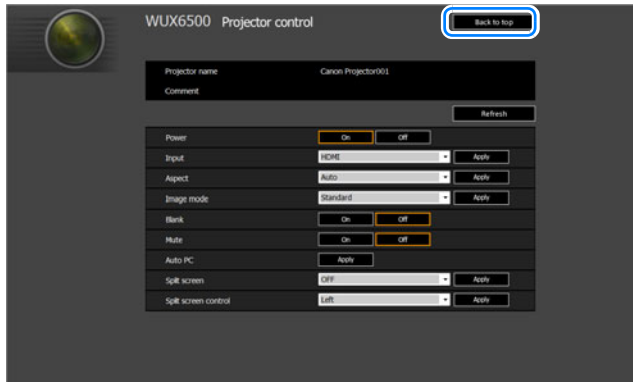

Checking Projector Information

You can check information about the signal types of the images projected and other information.

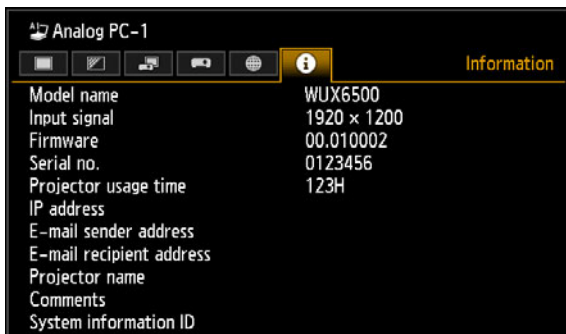

Menu	Function
Model name	Shows the model name.
Input signal	Details of the input signal currently selected Information such as the type, resolution, frequency, and color format of the signal is displayed.
Firmware	Current firmware version
Serial no.	Serial number unique to this projector
Projector usage time	Shows the total time the projector has been on.
IP address*	IP address used when connected to a network.
E-mail sender address*	Sender e-mail address used for sending error mails (P146)
E-mail recipient address*	Displays [Already set] or [Not set] to show whether a recipient e-mail address has been set for receiving error mails. (P146)
Projector name*	Name which identifies this projector on the network (P149)
Comments*	Comments such as the location in which the projector is installed are displayed. (P149)
System information ID	System information. Normally this is not displayed.

* The values are not displayed when network functions are [Off].

Projecting Images on a USB Flash Drive

JPEG images stored on a USB flash drive connected to the projector can be projected as follows. Individual images can be selected for projection, or you can project all images in a slideshow. JPEG images up to 10912×8640 can be projected.



- USB flash drives with security features are not recognized by the projector and cannot be selected as the image source.
- If the projector cannot mount the file system, the drive name is grayed out and the following icon is displayed. In this case, the USB flash drive cannot be used.

 USB1 USB CARD1

1 Insert the USB flash drive in the USB port.

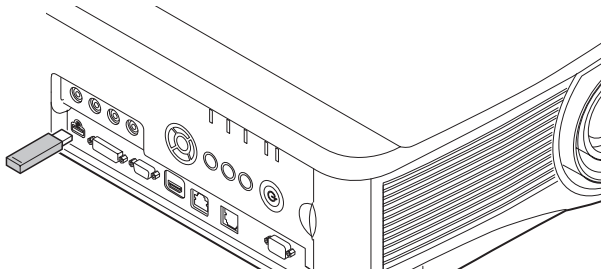

Either connect the USB flash drive directly to the projector's USB port or use a USB cable to connect a USB multi-card reader. USB flash drives connected via a USB hub will not be recognized.

2 Press the INPUT button to select [USB].

Thumbnails of JPEG files on the USB flash drive are now listed.

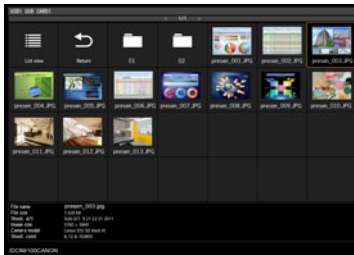

- Up to six USB flash drives, 999 folders, or 9,999 files can be displayed.
- If there are multiple drives, a drive selection screen is displayed. Use the [▲] / [▼] buttons to select the desired drive, and then press the **OK** button. Files on the drive are now listed.
- On file and drive selection screens, you can switch between thumbnail and list display.
- Network input is not available when [USB] is selected as the other input signal in split-screen display.

3 Select a file to project.



Motion blur reduction is not available when projecting JPEG files on a USB flash drive.
(P123)

4 Switch to other images as needed.

To switch to the previous image, press the [▲] button.

To switch to the next image, press the [▼] button.

To rotate images left 90°, press the [◀] button.

To rotate images right 90°, press the [▶] button.

5 After projection is finished, remove the USB flash drive.



The projector can also play a slideshow of images on a USB flash drive automatically.
(P161)

Description of USB File Browser

If a USB flash memory is connected to the projector, the USB file browser appears. In the USB file browser, you can select the image file to be projected by operating the file list in the USB memory device.

Thumbnail view

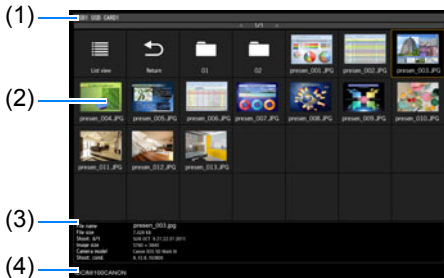

List view

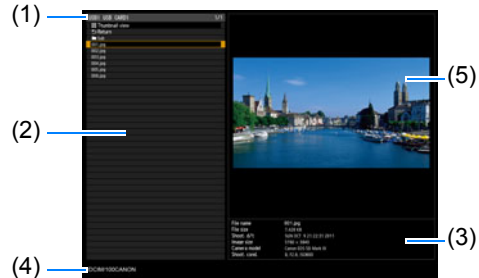

(1) List title

Identifies the current USB flash drive and number of pages in the file list displayed. (Current page number/total number of pages)

(2) Drive/file list

Lists recognized USB flash drives and files in folders on the drive, by name. Select an image file or folder with the pointer buttons. The following icons are shown.

Icon	Function
	Recognized USB flash drive
	Unrecognized USB flash drive (in thumbnail view)
	Unrecognized USB flash drive (in list view)
	No removable media in the card reader or similar device
	Switch to list view (from thumbnail view)
	Switch to thumbnail view (from list view)
	Go to the parent folder
	Folder
	Unsupported JPEG file (in thumbnail view)

File or folder names in Arabic are not displayed correctly.

(3) File information area

Information of the image selected in the file list appears here.

- File name
- File size
- Shoot. d/t
- Image size
- Camera model
- Shoot. cond.

(4) File path area

Path name of the image selected in the file list appears here.

(5) Preview area (in list view)

Image selected in the Drive/file list appears with reduced size. is displayed when an unsupported JPEG format is selected. If a folder is currently selected, the folder icon appears.

Selecting an Image for Projection

This section describes the steps for selecting an image in the USB file browser and projecting on the screen.

■ Selecting a Drive

This step may not be necessary when a USB flash drive is connected directly to the projector's USB port.

If a USB memory card reader having multiple memory slots is connected, the drive (memory slot) list is displayed in the file list.

Select the drive in which the memory card is inserted with [▲] / [▼], and press the **OK** button.

- Active drives are displayed in white text, while inactive drives are grayed out.

■ Selecting a Folder

In list view, folders that contain images can be selected.

- To return to the higher level, select [].

■ Selecting an Image File for Projection

When you select an image file, a small preview of the image is shown in the preview area.

For full-screen projection of the image, press the **OK** button.

To return to the higher level, select [].

■ Changing the View

To switch the view, select [Thumbnail view] or [List view] in the drive or file list and press the **OK** button.

Operating the Projected Image

When images are projected, you can perform the following operations.

Project the previous or next image by pressing the [▲] / [▼] buttons.

Rotate images left or right 90° by pressing the [◀] / [▶] buttons.

Return to the USB file browser by pressing the **OK** button.

- These operations are also available during slideshows. (Except during transitions.)
- If the image contains rotational information, the image is rotated to an appropriate direction automatically.

Running a Slideshow of Data Saved in a USB Flash Memory

Multiple images on a USB flash drive can be projected consecutively, with each shown for a specific interval.

■ Creating an Image File Folder

During slideshows, files in a folder are projected in alphabetical order by file name. Keep this in mind when preparing the files in a folder on the USB flash drive.

■ Setting a Slideshow Interval

Set the projection interval in [Slideshow interval] (P95) in the menu.

Split-Screen Display

Two input images can be projected side by side. This is split-screen display. When you activate split-screen display, the current image is shown on the left side, and the new image is shown at right. You can change the source of images shown on each side by pressing the **INPUT** button. However, you cannot specify the same input signal (terminal) as the source for both sides.



Network and USB input cannot be combined for split-screen display. Similarly, HDBaseT and HDMI input, Analog PC-2 and Component input, or Digital PC and Analog PC-1 input cannot be combined.

- 1 Supply two signals to the projector.**
- 2 Press the MENU button on the remote control to select the [Input settings] tab.**
- 3 Select [Split screen] and set it to [On].**



- A number is displayed in the center of the screen. The screen at left is labeled “1,” and the screen at right, “2.” The image labeled with a number has “control rights,” and the sound for that image will be played.
- For split-screen image adjustment, use the [Image priority] setting (P103).
- Some functions are not available, such as [Image flip H/V] (P105), [Screen aspect] (P105), [Keystone] (P106), [Digital image shift] (P107), [Professional settings] (P107) and [Logo capture] (P117).
- Image mode colors differ somewhat from those in single-image mode.

- 4 If ▷ or ◁ is displayed in the center of the image area, you can switch control to the other side.**

5 Press the INPUT button, and then select the input signal for the side with control rights.

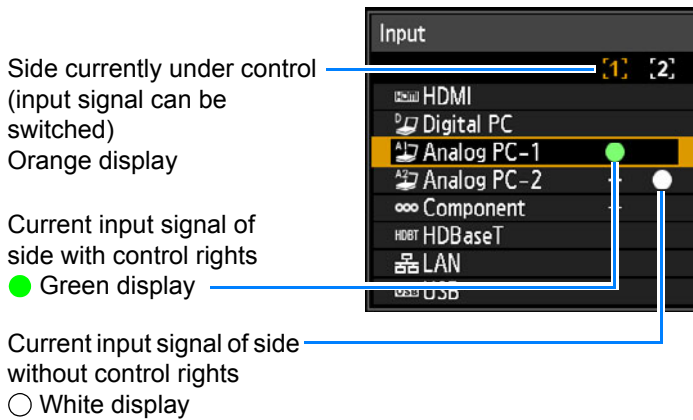

- If you specify [LAN] or [USB] as an input signal, the screen width is evenly divided between the left and right areas. (P93)
- When projection resumes from standby or after the lamp is momentarily turned off in split-screen mode, display reverts to single-image mode, showing the input signal with display rights.

Projecting from Multiple Projectors at Once (Edge Blending)

Overlapping edges of images from multiple projectors used together can be blended to make the overall image more seamless.

■ Basic Instructions

Follow these steps when using two projectors side by side.

1 In the [Install settings] menu, select [Professional settings] > [Edge blending] > [Adjust].



- If you have already completed edge blending settings, selecting [Adjust] will apply them.
- To restore the default settings before adjustment, select [Reset].

2 Set [Marker] to [On].

Marker lines are projected on the images. The red marker indicates the start position for adjustment, and the green marker, the end position.

Edge blending		
Side	Width	Start position
Left	0	0
Right	0	0
Top	0	0
Bottom	0	0
Color blending adjustment Off		
Black level adjustment Off		
Marker Off		
Reset		
Corner adjustment		
Return		



By default, the green and red markers are displayed in the same position, so only the red marker is visible.

3 Adjust [Start position] for the side where images overlap. Move the start marker to the outer edge of the overlapping area.

4 Adjust [Width]. Move the end marker to the inner edge of the overlapping area.

The area between the starting and ending markers is called the blending area. Shading is applied to this area, and the brightness is adjusted to match portions that overlap with other areas. After you complete settings for one image, do the same thing for the other one to specify the blending area. Adjust the settings to make the blending area for each image the same.

5 Set [Marker] to [Off].

■ Color Adjustment

In overlapping projection, portions of images in the overlapping area that pick up other colors or are miscolored may be more noticeable. You can make this overlapping area appear less distracting by performing Color blending adjustment.

1 In the [Install settings] menu, select [Professional settings] > [Edge blending] > [Adjust] > [Color blending adjustment] > [Adjust].

2 As you watch the image, adjust the value to eliminate unwanted colors in the overlapping area.

Color blending adjustment		
White		+0
Red		+0
Green		+0
Blue		+0
Return		

First adjust red, green, and blue together by changing the [White] value, and then adjust [Red], [Green], and [Blue] values individually.

3 Repeat this adjustment on all projectors.

■ Black Level Adjustment

In overlapping projection, dark colors are projected with less intensity than other colors in the overlapping area. You can make this overlapping area less distracting by adjusting the black level of non-overlapping image areas.

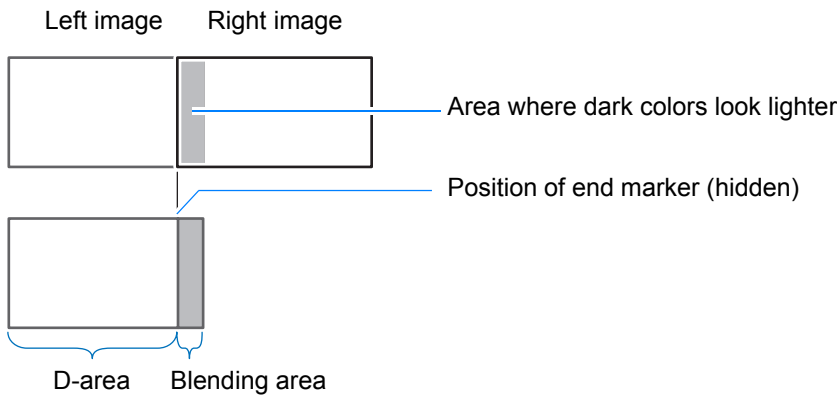

Here, the non-overlapping image area (from the end marker toward the center of the image) is called area “D.”

Normally, three areas are identified in the context of end markers: A, B, and C. In the following instructions, only area D is adjusted, and the widths of A, B, and C are left at the default value of 0.



To prepare for adjustment, set [No signal screen] to [Black], start projection with no input signal, and turn off the room lights, so that you can check dark image areas. (P117)

- 1** In the [Install settings] menu, select [Professional settings] > [Edge blending] > [Adjust] > [Black level adjustment] > [Adjust].
- 2** Select [Adjustment type] > [Black level].
- 3** After selecting [D-area base], as you watch the image, adjust the values so that the brightness and colors of the blending area and area D match.

Black level adjustment	
Adjustment type	Black level
B-area base	0
B-area red	+0
B-area green	+0
B-area blue	+0
D-area base	0
D-area red	+0
D-area green	+0
D-area blue	+0
Return	

Adjust [D-area base] to lighten the black level, and adjust [Red], [Green], and [Blue] to obtain an optimal black level color tone, as needed.

- 4** Repeat this adjustment on all projectors.

■ Smoother Overlapping Areas

The black level along the right edge of area D (along the blending area) may be more noticeable than that of surrounding areas.

By adjusting the black level of area B, you can make the transition smoother.

To compensate, adjust each area as follows.

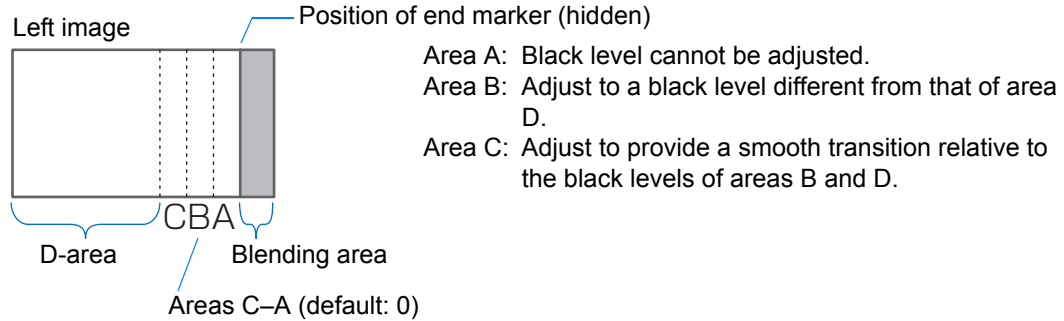

When the projected image has multiple blending areas (on the top, bottom, and each side), the width of areas A, B, and C must be adjusted to suit these blending areas.

In this example, instructions are given for adjusting area B.

1 In the [Install settings] menu, select [Professional settings] > [Edge blending] > [Adjust] > [Black level adjustment] > [Adjust].

2 Select [Adjustment type] > [Area] > [Side] > [Right].

3 Select [B-width], and then specify the width of area B.

Adjust the width of area B to roughly match the area where the black level is noticeable.

This will make the width of area D narrower.

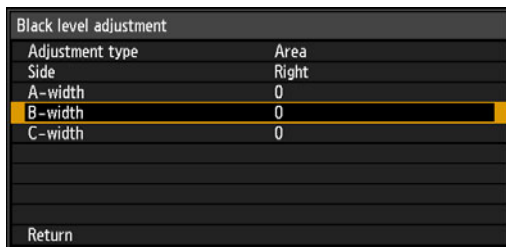

4 Shading is applied to this area, and the brightness is adjusted to match portions that overlap with other areas.



Results of adjusting the black level of area B are applied to all sides.

5 As you watch the image, adjust the width of areas A, B, and C.

6 Readjust the black level of area B, as needed.

- To reduce distracting colors and colors that are out of alignment in areas where the images overlap, perform [Color blending adjustment] targeting the main tone in the envisaged projected image.



- If you perform adjustments using [Color blending adjustment] or other menus, that may not eliminate the distracting colors and differences in brightness in areas where the images overlap.
- Blending can be fine-tuned by adjusting [Adjustment type] > [Black level] > [Red], [Green], and [Blue].

■ Corner Adjustment

Projected images from multiple projectors used in overlapping projection must be precisely repositioned. Positions of each corner in the blending area can be aligned with the blending area of the reference projector.



- First, complete [Side] adjustment as described in “Basic Instructions” (P162).
- Sides set to an edge-blending width of 12 or more can be adjusted when [Keystone] is set to [Corner adjustment] and the aspect ratio is [16:10].
- To reset adjustment, use [Keystone] (P106).
- A small edge-blending width may limit the amount of adjustment available.

- 1 On the reference projector, configure keystone (P106) and edge-blending (P109) settings, and then set the edge-blending markers to [On] (P163).
- 2 In the [Install settings] menu, select [Professional settings] > [Edge blending] > [Adjust] > [Corner adjustment].
- 3 Select a point to adjust, and move it so that the image as a whole looks symmetrical.

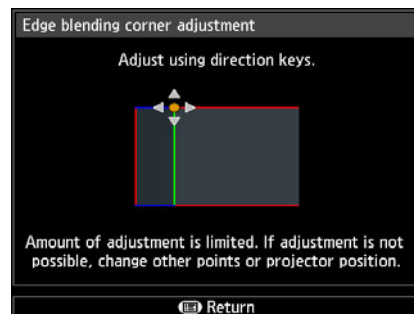
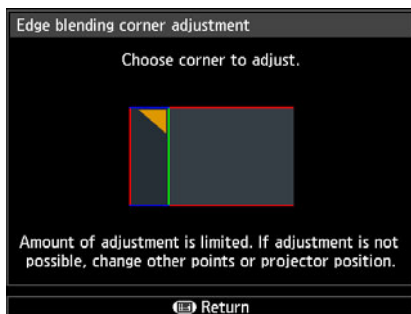

- 4** As you watch the projected images, fine-tune markers of the projector you are adjusting so that they overlap the reference projector markers as much as possible.

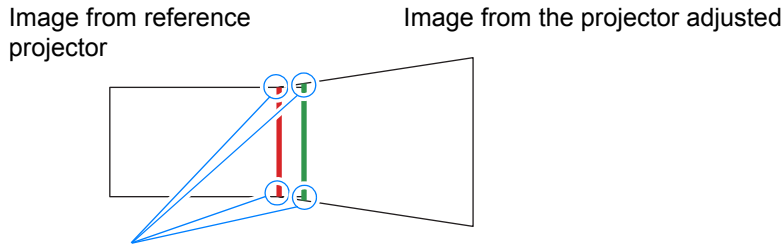

Adjust positions of each of the four corners in the overlapping area. Correcting the position of one point will also move the point on the opposite side of the overlapping area, so that the screen as a whole is corrected.

- 5** Set the reference projector's edge-blending markers to [Off] (P163).

Other Information

Safety Instructions

Before Use

Basic Guide

Installation Procedure

Connection Procedure

Projection Procedure

Convenient Features

Advanced Guide

Using Menus

Menu Configuration

Menu Description

Advanced Projection

Other Information

Maintenance

Product Specifications

Troubleshooting

Cleaning the Projector and the Air Filter

Clean the projector frequently to prevent dust from settling on the surface. A dirty lens may ruin the quality of the projected image.



Before cleaning the projector, always turn it off, unplug it after the cooling fan stops, and wait at least one hour. Otherwise, you may get burned because the main unit is very hot immediately after the projector is turned off.

Wipe the projector's main unit softly with a soft cloth. If the projector is heavily soiled, soak the cloth in water with a small amount of detergent in it, squeeze the cloth thoroughly, and then wipe the projector with it. After cleaning, wipe the projector with a dry cloth.

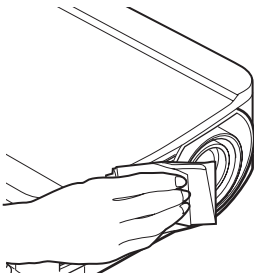

- Never use volatile cleaning liquid or benzine, as these may damage the finish of the projector.
- When using a chemical dust cloth, make sure to read the instructions thoroughly.
- When cleaning the projector's lens, use a commonly available air blower or lens cleaning paper. The lens surface is easily damaged, so do not use a hard cloth or tissues.

Request Internal Cleaning Regularly

Dust that accumulates over long periods without cleaning may eventually cause fire or electric shock. Once a year, request internal cleaning from the Canon Customer Support Center. (Note that a fee is charged.) Cleaning before damp, rainy seasons is especially effective.

Cleaning the Air Filter

The air filter protects the lens and mirror inside the projector from dust and dirt. Should the air filter become clogged with dust, the projector may be damaged since it will block the air flow into the projector and raise the internal temperature of the projector. The following screen is displayed when turning on the projector if the air filter needs to be cleaned. Clean the air filter if it is displayed.

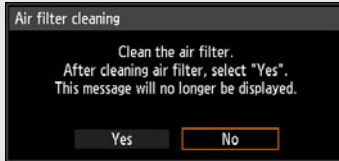

- Only the [◀], [▶], **OK** and **POWER** buttons are available while this screen is displayed. (When you press the **POWER** button, the “Push POWER button again to turn off power.” message appears.)
- When this screen has disappeared after being displayed for 10 seconds, all buttons become operable.

- Turn the power of the projector off and pull out the power plug.
- Hook your finger around the air filter handle on the front of the projector and remove the air filter. Use a vacuum cleaner to clean off the dust.
- If the air filter cleaning screen is displayed when turning on the projector after cleaning the air filter, select [Yes] and press the **OK** button. The air filter counter is reset, and the message is no longer displayed.
- This screen is not displayed when [Air filter warning display] is set to [Off]. (P115)
Reset the air filter counter manually. (P126)



Do not rinse the air filter in water. This may damage the air filter and projector.

Replacing the Air Filter

Follow the procedure below when replacing the air filter.

1 Turn off the projector power and remove the power plug.

2 Hook your finger around the air filter frame handle on the side of the projector, and pull the air filter out to remove it.

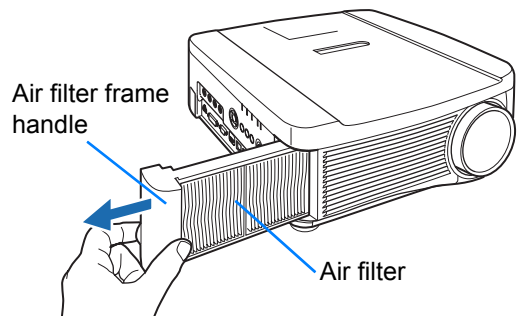

3 Remove the filter from the air filter frame. First disengage the tab on the inside, then remove the entire air filter from the frame.

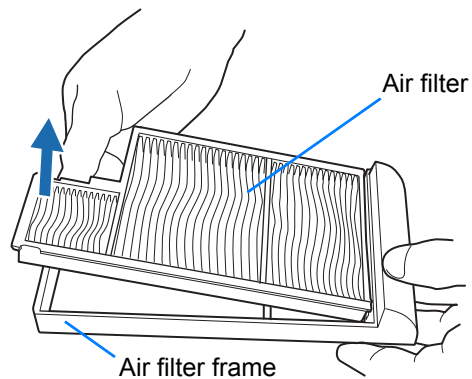

4 Install a new air filter into the frame. First insert the air filter tab into the groove on the handle side of the frame, then press the air filter into the frame.

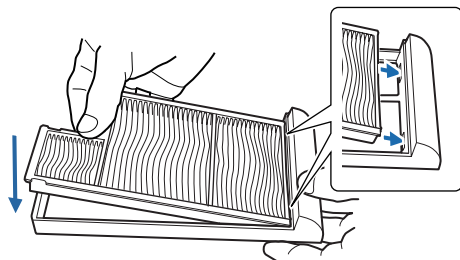

5 Securely insert the frame holding the air filter, all the way into the projector.

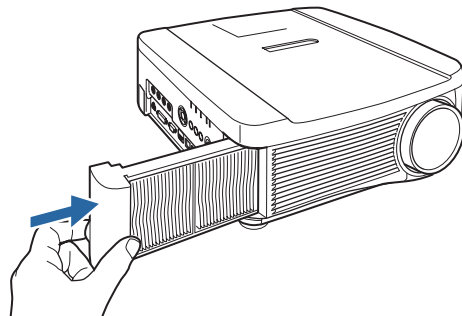

- Handle the air filter carefully. If damaged, the air filter will not work properly.
- When the lamp is replaced, it is recommended that you also replace the air filter.
- Replacement lamp part no.: RS-LP11
- Contact the Canon Customer Support Center for further information.
- Replacement air filter part no.: RS-FL01

Replacing the Lamp

When the usage time of the lamp exceeds a certain amount of time, the following message (two types) is displayed for 10 seconds every time the projector is turned on.

2,700 hours to less than 3,000 hours



Prepare a new lamp when this screen is displayed.

- Only the [◀], [▶], **OK**, **POWER**, **FOCUS**, **ZOOM** and **LENS SHIFT** buttons are available while this screen is displayed.
- When you press the **POWER** button, “Push POWER button again to turn off power.” message appears.
- After this screen has been displayed for 10 seconds and disappeared, all buttons become operable.
- This message will not be displayed again if you select [No] in response to the message “Do you want to display this message again?”.

3,000 hours or more

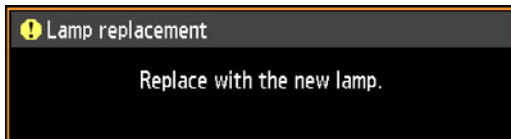

If a lamp replacement message is displayed, refer to “Lamp Replacement Procedure” (P176).

- Only the **POWER**, **OK**, **FOCUS**, **ZOOM** and **LENS SHIFT** buttons are available while this screen is displayed.
- When you press the **POWER** button, the “Push POWER button again to turn off power.” message appears.
- When this screen has disappeared after being displayed for 10 seconds, all buttons become operable.
- You can check the usage time of the lamp in [Lamp counter] in the [System settings] menu. (P125)
- This screen is not displayed when [Lamp warning display] is set to [Off]. (P115)



Caution

- Lamps are more likely to rupture once the lamp replacement message has been displayed. Replace the lamp with a new one as soon as possible.
- Lamps should be replaced about every 3,000 hours. Note that there is no guarantee about how long lamps will last.
- Useful life of lamps varies widely from lamp to lamp and depending on the environment of use. Some lamps may fail or rupture soon after they are first used.
- Dispose of used lamps in accordance with local regulations.

Replacement Lamp

This projector uses the following lamps.

Lamp part no.: RS-LP11

Contact the Canon Customer Support Center when purchasing a replacement lamp.

Precautions when replacing lamps that stop working

If the illumination suddenly stops when the projector is in use or after you turn it on, the lamp may be broken. In this case, never attempt to replace the lamp by yourself. Always request service from the qualified technician or Canon Customer Support Center. Additionally, with ceiling-mounted projectors, the lamp may fall out when you open the lamp cover or while you are attempting to replace it. During replacement, stand to the side of the lamp cover, not directly under it. If the lamp breaks and any glass shards or other pieces get in your eyes or mouth, consult a doctor immediately.



Before replacing the lamp, always turn off the projector, unplug it after the cooling fan stops, and wait at least one hour. Do not touch the lamp immediately after turning the projector off. It is very hot initially and poses a risk of burns.



- Be sure to use the specified lamp.
- Contact the Canon Customer Support Center for further information. This can also be purchased from the Canon website.
- Do not touch the inner glass surface when you replace the lamp. Doing so may cause deterioration to the projector's performance.
- Handle lamps with care. Impact or abrasion may cause lamps to rupture while they are in use. If a lamp ruptures, contact the Canon Customer Support Center and follow the instructions in “Note the following precautions when replacing lamps that stop working. Failure to do so could result in personal injury.” (P18).
- When replacing the lamp, do not remove any screws other than those specified.



Lamp Replacement Procedure

- 1 Turn off the projector power and remove the power plug.
- 2 Loosen one screw and open the lamp cover in the direction of the arrow.
The lamp cover screw is attached to the lamp cover and designed to prevent it from falling off.

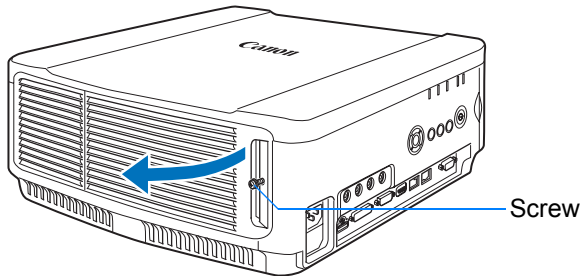

- 3 Loosen the 3 screws on the inside of the lamp unit, then slowly pull out the lamp unit in the direction of the arrow.
Even when the screws are loosened, they will not fall off the lamp unit.

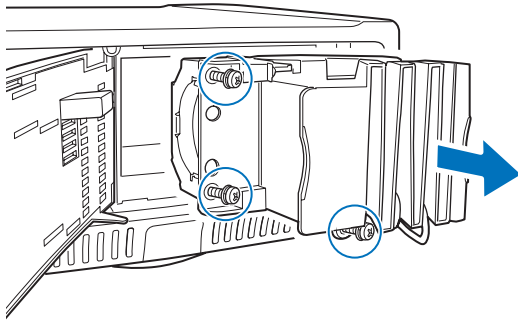

- 4 Fully insert a new lamp unit and secure it with the 3 screws.
- 5 Close the lamp cover and tighten the screws.
- 6 Turn on the power. Bring up the menu and select [System settings] > [Other settings] > [Lamp counter].

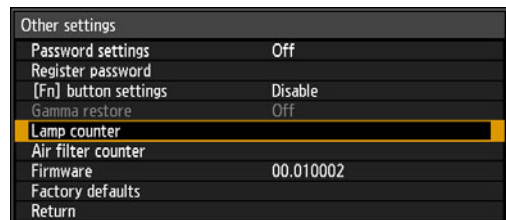

7 Select [Reset] > [Yes] to reset the lamp counter.

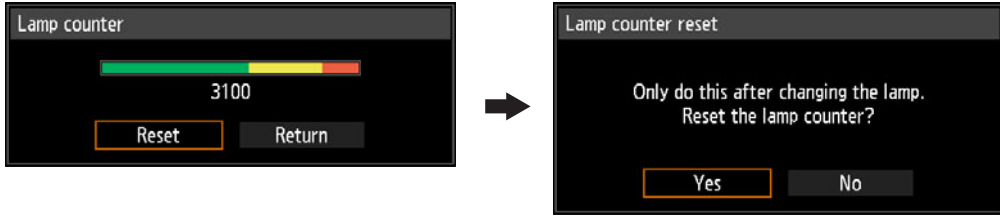

- It is recommended that you also replace the air filter when you replace the lamp. (P170)
- Contact the Canon Customer Support Center for further information.
- Replacement air filter part no.: RS-FL01

Installing / Removing the Lens Unit

■ Installing the Lens Unit



Warning

- Before installing or removing the lens unit, be sure to disconnect the power plug or connector. Failure to do so may result in fire, electric shock, or injury.

- When hanging the projector from a ceiling, put the projector down on the floor or a workbench before attaching or replacing the lens unit. Failure to do so could result in parts falling off the projector and may cause an accident or personal injury.

- Do not touch the lens when the lens is moving (the lens is shifting) to adjust the projected image after installation. There is the risk of injury.



Caution

- Before replacing the lens unit, make sure to turn off the projector, wait at least 1 hour to allow the projector to cool thoroughly. Failure to do so may result in burns or other injuries.

- Do not attempt to install or remove the lens unit yourself. Be sure to request this service from a qualified technician or contact the Canon Customer Support Center.

- When installing and removing the lens unit, be sure not to touch the surface of the lens with your hands or scratch it.

- Do not apply force to parts (e.g. lead wires) that are connected to the lens unit or lens motor. Doing so may cause a malfunction.

- Do not replace the lens unit in a dusty location. If any dust or dirt enters the projector, this may adversely affect picture quality.

- When carrying or holding up the projector after attaching the lens unit, be sure not to hold the lens. Doing so may cause damage to the lens unit.

- If transportation is necessary, the lens unit should be removed before transporting the projector. If the projector is subjected to excessive impacts during transportation, the lens unit may be damaged.

- For details about which devices the projector is compatible with, contact the Canon Customer Support Center.



Caution

- 1 Use a Phillips-head screwdriver and loosen the lamp cover screw, then open the lamp cover.**

The lamp cover screw is attached to the lamp cover and designed to prevent it from falling off.

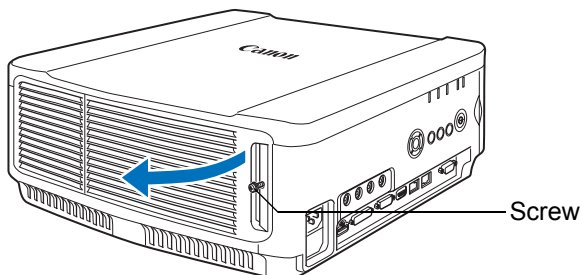

- 2** Loosen the cosmetic panel screw, then slide the cosmetic panel toward the rear to remove it.

The cosmetic panel screw is attached to the cosmetic panel and designed to prevent it from falling off.

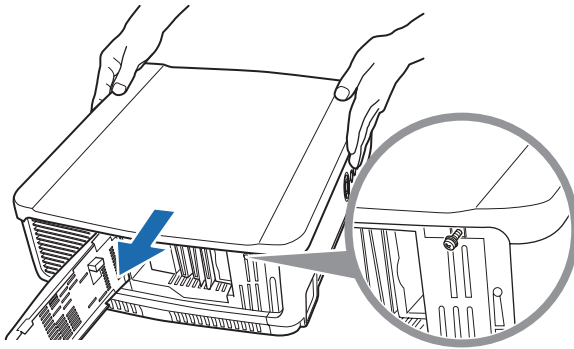

- 3** In order to prevent damage, close the lamp cover and temporarily fasten the screw.

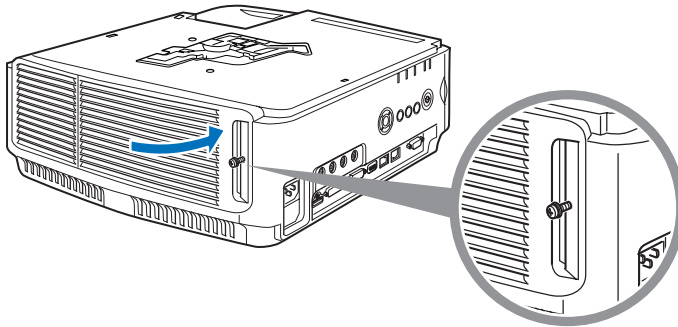

- 4** Remove the sleeve screws (2 on top and 2 on bottom).

After the 2 screws on top are removed, turn the projector upside down on a flat desk or similar location and remove the 2 screws from the bottom.

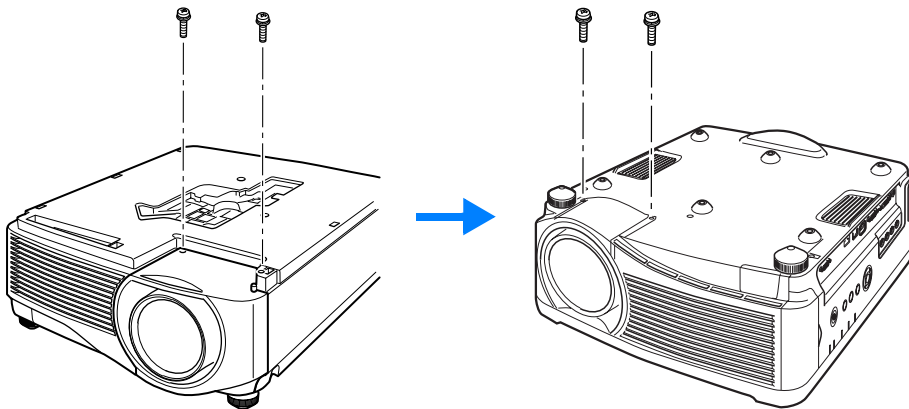

- 5** Then turn the projector back over and remove the sleeve.

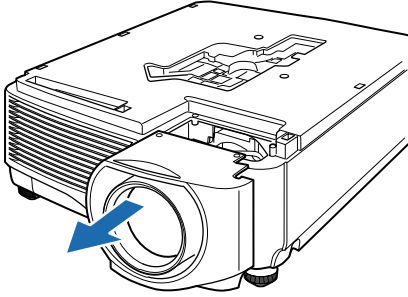

- 6** Referring to the following illustration, insert the lens connector of the lens unit into the front right side of the projector slowly until it contacts the end. At this time, pull out the lens cable shown in the illustration and fix it.

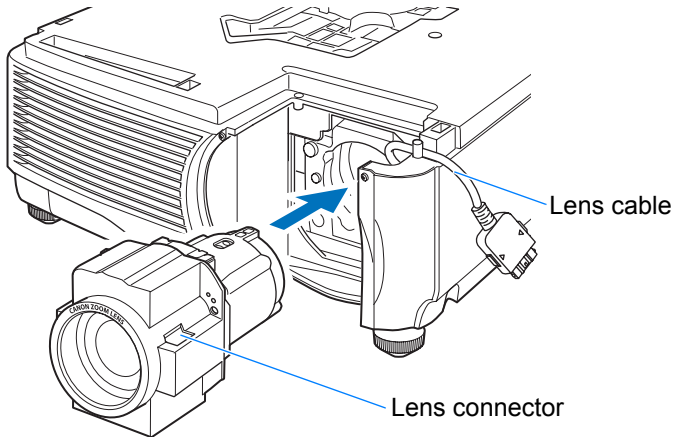

- 7** Tighten the 4 screws to fasten the lens unit in place.
The 4 lens unit screws are attached to the lens unit and cannot be removed.

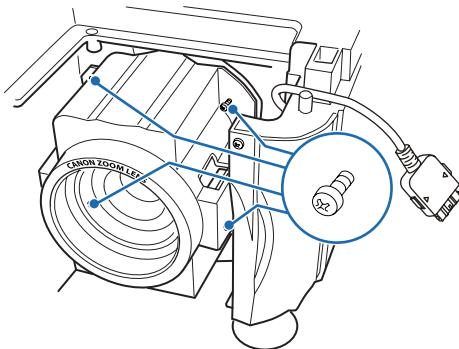

- 8** Insert the projector lens cable into the connector until a click sound is heard.

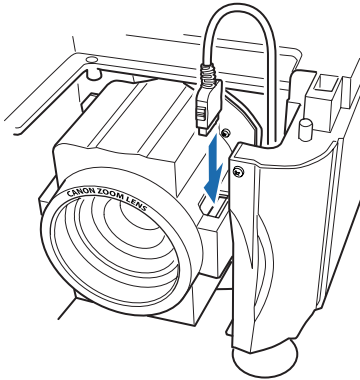

- 9** Reinstall the sleeve, cosmetic panel, and lamp cover in their original positions.



When the power is first turned on after the lens unit has been installed or replaced, lens shift initialization operation will be performed. It will take approximately 1 minute for the initialization operation to start up. However, if the lens has been replaced with a lens of the same model number, initialization operation will not be performed. The position will be the same as before the lens was replaced.



Caution

The lens shift initialization operation uses the motor to move the lens up / down / left / right. Do not touch the lens. Doing so could result in an injury.



Caution

When installing and removing the lens unit, be sure to fix the lens cable as shown in the illustration. When inserting the lens unit, it is possible to damage the lens cable between the lens unit and projector.

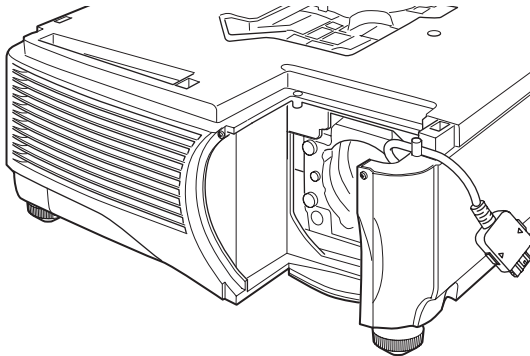

■ Removing the Lens Unit

- 1** Perform steps 1 to 5 of “Installing the Lens Unit” (P178 – P180) to remove the sleeve.
- 2** Disconnect the lens cable from the lens connector.



When pulling out (disconnecting) the lens cable, press the buttons on both sides of the lens cable connector while pulling out the cable.

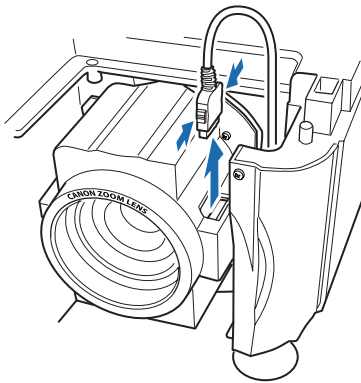

- 3** Fix the lens cable as shown in the illustration and loosen the 4 screws to remove the lens unit.

The 4 lens unit screws are attached to the lens unit and cannot be removed.

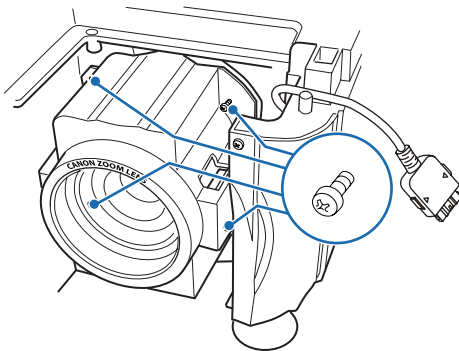

Relationship between Aspect and Screen Aspect

This section describes the relationship between screen aspect (P63) and aspect (P65).

Select an optimum aspect ratio of the projected image (screen aspect) or an optimum screen mode (aspect) according to the aspect ratio of the screen, type of input image signal and so on for the projection to make best use of the screen size.

- If a computer image with an aspect ratio of 16:9 is not projected correctly when the setting is [Auto], select [16:9] as the screen aspect.
- For a 16:9 image with black borders at the top and bottom, such as a terrestrial broadcast movie, you can project the 16:9 image area so that it is projected on the entire screen by selecting [Zoom] in [Aspect].

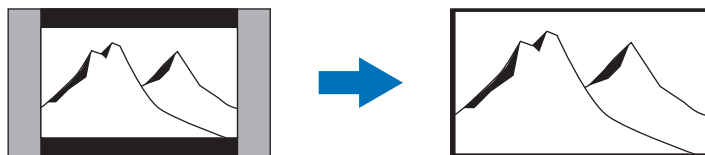

There may be some cases that [Zoom] cannot be selected depending on the input signal and/or resolution.

- For keystone correction (P67), select an option other than [4:3 D. image shift] or [16:9 D. image shift] for Screen aspect.

■ When projecting at the original aspect ratio on a 16:10 screen

Original Aspect Ratio	Screen aspect setting (P63)	Aspect setting (P65)	Screen image
(16:10) 1920 x 1200 1440 x 900 1280 x 800	[16:10]	[16:10] [Auto]	
(16:9) 1920 x 1080 1280 x 720		[16:9] [Auto]	
(4:3) 1600 x 1200 1400 x 1050 640 x 480		[4:3] [Auto]	

■ When projecting at the original aspect ratio on a 16:9 screen

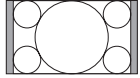
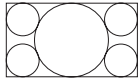
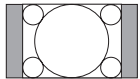
Original Aspect Ratio	Screen aspect setting (P63)	Aspect setting (P65)	Screen image
(16:10) 1920 x 1200 1440 x 900 1280 x 800	[16:9] [16:9 D. image shift]	[Auto]	
(16:9) 1920 x 1080 1280 x 720		[16:9] [Auto]	
(4:3) 1600 x 1200 1400 x 1050 640 x 480		[4:3] [Auto]	

■ When projecting at the original aspect ratio on a 4:3 screen

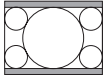
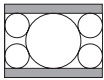
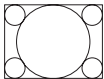
Original Aspect Ratio	Screen aspect setting (P63)	Aspect setting (P65)	Screen image
(16:10) 1920 x 1200 1440 x 900 1280 x 800	[4:3] [4:3 D. image shift]	[Auto]	
(16:9) 1920 x 1080 1280 x 720		[16:9] [Auto]	
(4:3) 1600 x 1200 1400 x 1050 640 x 480		[4:3] [Auto]	

■ When projecting to fill a 16:10 screen

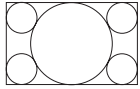
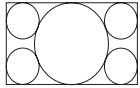
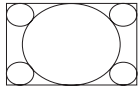
Original Aspect Ratio	Screen aspect setting (P63)	Aspect setting (P65)	Screen image
(16:10) 1920 x 1200 1440 x 900 1280 x 800	[16:10]	[16:10] [Auto]	
(16:9) 1920 x 1080 1280 x 720		[16:10]	
(4:3) 1600 x 1200 1400 x 1050 640 x 480		[16:10]	

■ When projecting to fill a 16:9 screen

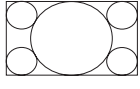
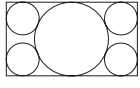
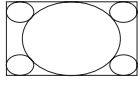
Original Aspect Ratio	Screen aspect setting (P63)	Aspect setting (P65)	Screen image
(16:10) 1920 x 1200 1440 x 900 1280 x 800	[16:9] [16:9 D. image shift]	[16:9]	
(16:9) 1920 x 1080 1280 x 720		[16:9] [Auto]	
(4:3) 1600 x 1200 1400 x 1050 640 x 480		[16:9]	

■ When projecting to fill a 4:3 screen

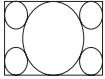
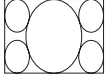
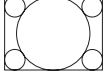
Original Aspect Ratio	Screen aspect setting (P63)	Aspect setting (P65)	Screen image
(16:10) 1920 x 1200 1440 x 900 1280 x 800	[4:3] [4:3 D. image shift]	[4:3]	
(16:9) 1920 x 1080 1280 x 720		[4:3]	
(4:3) 1600 x 1200 1400 x 1050 640 x 480		[4:3] [Auto]	

Displayed Test Patterns

To access the test pattern menu, from the [Install settings] menu, select [Test pattern] > [On] (P115).

While the test pattern is displayed, you can use the [▲] / [▼] buttons to switch patterns. Also, if there is an option pattern available, you can use the [◀] / [▶] buttons to switch pattern. A dialog box is shown during test pattern display that identifies the current test pattern and provides operating instructions.

The following test patterns can be displayed.

Use [▲] / [▼] to switch patterns

Use [◀] / [▶] to switch option patterns

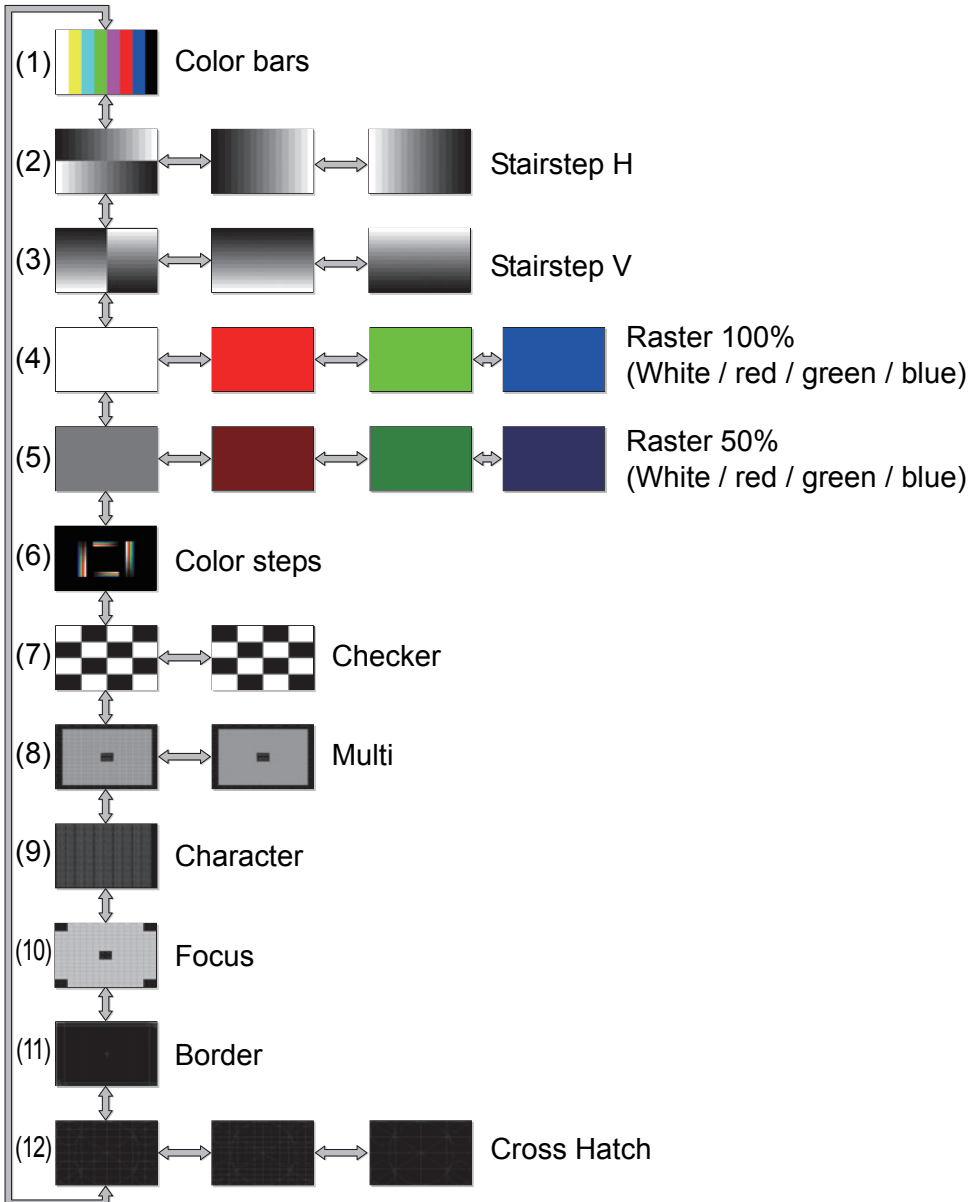

Supported Signal Types

This projector supports the following signal types.

If your computer or AV equipment is compatible with any one of these signal types, the projector's Auto PC function selects the input signal type to project an image appropriately.

Analog PC

Resolution (dots)	Signal type	Horizontal frequency (kHz)	Vertical frequency (Hz)
640 x 480	VGA	31.469	59.940
720 x 480	–	31.469	59.940
720 x 576	–	31.250	50.000
800 x 600	SVGA	37.879	60.317
848 x 480	–	31.020	60.000
1024 x 768	XGA	48.363	60.004
1280 x 768	WXGA	47.776	59.870
		47.396	59.995
1280 x 800		49.702	59.810
49.306		59.910	
1280 x 960	–	60.000	60.000
1280 x 1024	SXGA	63.981	60.020
1366 x 768	–	47.712	59.790
1400 x 1050	SXGA+	64.744	59.948
		65.317	59.978
1440 x 900	WXGA+	55.935	59.887
		55.469	59.901
1600 x 900	–	60.000	60.000
1600 x 1200	UXGA	75.000	60.000
1680 x 1050	WSXGA+	64.674	59.883
		65.290	59.954
1920 x 1080	–	56.250	50.000
		67.500	60.000
1920 x 1200	WUXGA	74.038	59.950

Digital PC

Resolution (dots)	Signal type	Horizontal frequency (kHz)	Vertical frequency (Hz)	
640 x 480	D-VGA	31.469	59.940	
720 x 480	–	31.469	59.940	
720 x 576	–	31.250	50.000	
800 x 600	D-SVGA	37.879	60.317	
1024 x 768	D-XGA	48.363	60.004	
1280 x 720	–	37.500	50.000	
		45.000	60.000	
1280 x 800		D-WXGA	49.702	59.810
49.306		59.910		
1280 x 1024	D-SXGA	63.981	60.020	
1366 x 768	–	47.712	59.790	
1400 x 1050	D-SXGA+	64.744	59.948	
		65.317	59.978	
1440 x 900	D-WXGA+	55.935	59.887	
		55.469	59.901	
1600 x 900	–	60.000	60.000	
1600 x 1200	D-UXGA	75.000	60.000	
1680 x 1050	D-WSXGA+	64.674	59.883	
		65.290	59.954	
1920 x 1080	–	27.000	24.000	
		56.250	50.000	
		67.500	60.000	

Resolution (dots)	Signal type	Horizontal frequency (kHz)	Vertical frequency (Hz)
1080PsF (1920 x 1080i)	-	27.000	24.000
		28.125	25.000
		33.750	30.000
1920 x 1200	D-WUXGA	74.038	59.950

HDMI/HDBaseT

Connecting to a computer

Resolution (dots)	Signal type	Horizontal frequency (kHz)	Vertical frequency (Hz)
640 x 480	VGA	31.469	59.940
800 x 600	SVGA	37.879	60.317
1024 x 768	XGA	48.363	60.004
1280 x 800	WXGA	49.702	59.810
		49.306	59.910
1280 x 1024	SXGA	63.981	60.020
1366 x 768	-	47.712	59.790
1400 x 1050	SXGA+	64.744	59.948
		65.317	59.978
1440 x 900	WXGA+	55.935	59.887
		55.469	59.901
1600 x 900	-	60.000	60.000
1600 x 1200	UXGA	75.000	60.000
1680 x 1050	WSXGA+	64.674	59.883
		65.290	59.954
1920 x 1200	WUXGA	74.038	59.950

Connecting with AV equipment

Signal type	Horizontal frequency (kHz)	Vertical frequency (Hz)
480p	31.469	59.940
576p	31.250	50.000
720p	37.500	50.000
	45.000	60.000
1080i	28.125	50.000
	33.750	60.000
1080p	27.000	24.000
	56.250	50.000
	67.500	60.000

Component

Signal type	Horizontal frequency (kHz)	Vertical frequency (Hz)
480i	15.734	59.940
480p	31.469	59.940
576i	15.625	50.000
576p	31.250	50.000
720p	37.500	50.000
	45.000	60.000
1080i	28.125	50.000
	33.750	60.000
1080p	56.250	50.000
	67.500	60.000
1080PsF	27.000	24.000
	28.125	25.000
	33.750	30.000

- * The specifications in the table above are subject to change without notice.
- * This projector does not support any computer output signal with a dot clock of higher than 162 MHz.
- * Use a computer cable in which all pins are connected. If the cable is a type in which all pins are not connected, the image may not be correctly displayed.

■ Projector

Model name		WUX6500
Display system		Reflective liquid crystal panel (LCOS) : 3 panels
Optical system		Color separation by dichroic mirror / polarizing beam splitter and color composition by prism
Display device	Effective display area size	0.71" / 16:10
	Effective number of pixels	2,304,000 (1920 x 1200)
	Other features	Active matrix system
Projection lens	Zoom (*4)	1.5x (Electric)
	Focus	Electric
	Lens shift (*4)	V: -15% to +55% (Electric), H: ±10% (Electric)
	Focal length (*4)	f = 23.0 to 34.5 mm (0.9" - 1.4")
	F value (*4)	F1.89 to F2.65
Light source		High pressure mercury lamp 370 W
Image size / Projection distance (*4)		Minimum: 101.6 cm (40") to Maximum: 1524 cm (600"), Projection distance: 1.3 m to 29.0 m (4.3'- 95.1')
Number of colors		16,770,000 colors
Brightness (*1) (*2)		6,500 lumen
Contrast ratio (*1) (*3)		2000:1 (Fully white : fully black, native)
Ratio of brightness at periphery to center (*1) (*4)		88%
Speaker		5W monaural
Supported input signal types		Refer to "Supported Signal Types" (P188 - P189)
Display resolution	Computer signal input	Maximum input resolution 1920 x 1200 dots
	Video signal input	Maximum input resolution 1920 x 1200 dots
Video signals	Analog PC input	WUXGA / UXGA / WSXGA+ / SXGA+ / WXGA+ / FWXGA / WXGA / SXGA / XGA / SVGA / VGA
	Digital PC input	WUXGA / UXGA / WSXGA+ / SXGA+ / WXGA+ / FWXGA / WXGA / SXGA / XGA / SVGA / VGA
	Digital video input	1080p / 1080i / 720p / 576p / 480p
	Component video input	1080p / 1080i / 720p / 576p / 576i / 480p / 480i
Video signal input terminal	Mini D-sub 15-pin	Analog PC, Component
	DVI-I	Analog PC, Digital PC (29-pin DVI connector)
	HDMI	Digital PC, Digital Video
	RJ-45 (HDBaseT)	HDBaseT input (video / audio / control / network)

Model name		WUX6500
Other terminals and connectors	Mini jack x 2	AUDIO IN
	Mini jack	AUDIO OUT
	Mini jack	Wired remote control
	RS-232C	CONTROL (Dsub9)
	USB	USB Type A
	RJ-45	Network connections (1000BASE-T/100BASE-TX/10BASE-T)
Noise		43dB / 39dB (lamp mode: Full power / Power saver)
Operating temperature		0°C (32°F) to 40°C (104°F)
Power supply		AC100V to 240V 50 / 60Hz
Full power		500W
Power consumption in standby mode	Networking and HDBaseT off	0.3W
	Low-power networking on, HDBaseT off	0.7W
	Networking off, HDBaseT on	1.9W
	Low-power networking and HDBaseT on	2.0W
Standard dimensions		380 mm (W) x 170 mm (H) x 430 mm (D) / 15.0 (W) x 6.7 (H) x 16.9 (D) in
Weight		8.5 kg / 18.7 lbs
Accessories		Remote control, remote control dry-cell batteries, power cord, PC cable, Important Information, User's Manual (CD-ROM) and Warranty Card

*1 Compliance with ISO21118-2012

*2 When using a Standard Zoom Lens (RS-IL01ST) in [Presentation] image mode and [Full power] lamp mode.

*3 When using a Standard Zoom Lens (RS-IL01ST) in [Presentation] image mode and setting the lamp control to [On].

*4 When using a Standard Zoom Lens (RS-IL01ST).

* 99.99% or more of the LCD panel pixels are effective. During projection, 0.01% or less of pixels may stay lit or unlit due to the characteristics of the LCD panel.

* Using the projector continuously for an extended period of time may accelerate the deterioration of optical parts.

* Product specifications and appearance are subject to change without prior notice.

■ Remote Control

Type	RS-RC04	RS-RC05 (Option)
Power supply	DC 3.0V, using two AAA-size batteries	DC 3.0V, using two AA-size batteries
Operating range	Approx. 8 m ± 25° horizontal and vertical (to infrared remote receiver)	
Dimensions	43 mm (W) x 23 mm (H) x 135 mm (D) / 1.7 (W) x 0.9 (H) x 5.3 (D) in.	51 mm (W) x 28 mm (H) x 176 mm (D) / 2.0 (W) x 1.1 (H) x 6.9 (D) in.
Weight	56 g / 2.0 oz	100 g / 3.5 oz

■ Specification of Each Lens Unit (Option)

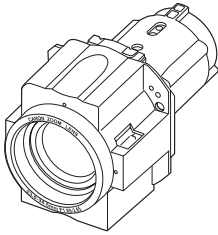
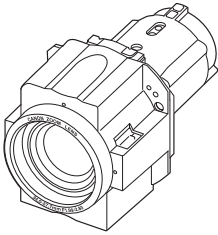
Name	Standard Zoom Lens	Long Zoom Lens
Model number	RS-IL01ST	RS-IL02LZ
External View		
Focal length	23.0 - 34.5 mm (0.9 - 1.4")	34.0 - 57.7 mm (1.3 - 2.3")
F number	1.89 - 2.65	1.99 - 2.83
Width	97.4 mm (3.8")	97.4 mm (3.8")
Height	106.5 mm (4.2")	106.5 mm (4.2")
Length	173.4 mm (6.8")	173.4 mm (6.8")
Weight	550 g (1.2 lbs)	755 g (1.7 lbs)
Zoom ratio	1.5x	1.7x
Projection distance	1.3 - 29.0 m (4.3 - 95.1')	1.9 - 48.5 m (6.2 - 159.1')
Size 100 projection distance	3.2 - 4.8 m (10.5 - 15.7')	4.7 - 8.0 m (15.4 - 26.2')

For details about the amount of lens shift, refer to "Lens Shift Function" on [page 47](#).

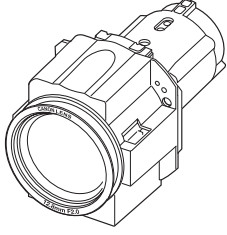
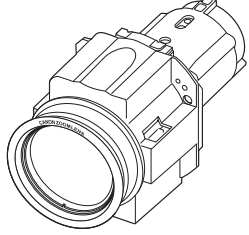
Name	Short Fixed Lens	Ultra Long Zoom Lens
Model number	RS-IL03WF	RS-IL04UL
External View		
Focal length	12.8 mm (0.5")	53.6 - 105.6 mm (2.1 - 4.2")
F number	2.0	2.34 - 2.81
Width	97.4 mm (3.8")	97.4 mm (3.8")
Height	106.5 mm (4.2")	106.5 mm (4.2")
Length	175.2 mm (6.9")	184.2 mm (7.3")
Weight	910 g (2.0 lbs)	940 g (2.1 lbs)
Zoom ratio	—	1.95x
Projection distance	0.7 - 5.2 m (2.3 - 17.1')	4.6 - 90.0 m (15.1 - 295.3')
Size 100 projection distance	1.7 m (5.6')	7.7 - 15.0 m (25.3 - 49.2')

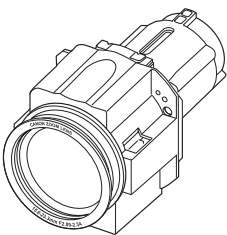
Name	Wide Zoom Lens
Model number	RS-IL05WZ
External View	
Focal length	15.6 - 23.3 mm (6.0 - 9.0")
F number	2.09 - 2.34
Width	97.4 mm (3.8")
Height	106.5 mm (4.2")
Length	180.3 mm (7.1")
Weight	905 g (2.0 lbs)
Zoom ratio	1.5x
Projection distance	0.9 - 19.5 m (3.0 - 64.0')
Size 100 projection distance	2.2 - 3.2 m (7.2 - 10.5')

For details about the amount of lens shift, refer to “Lens Shift Function” on [page 47](#).

■ External View

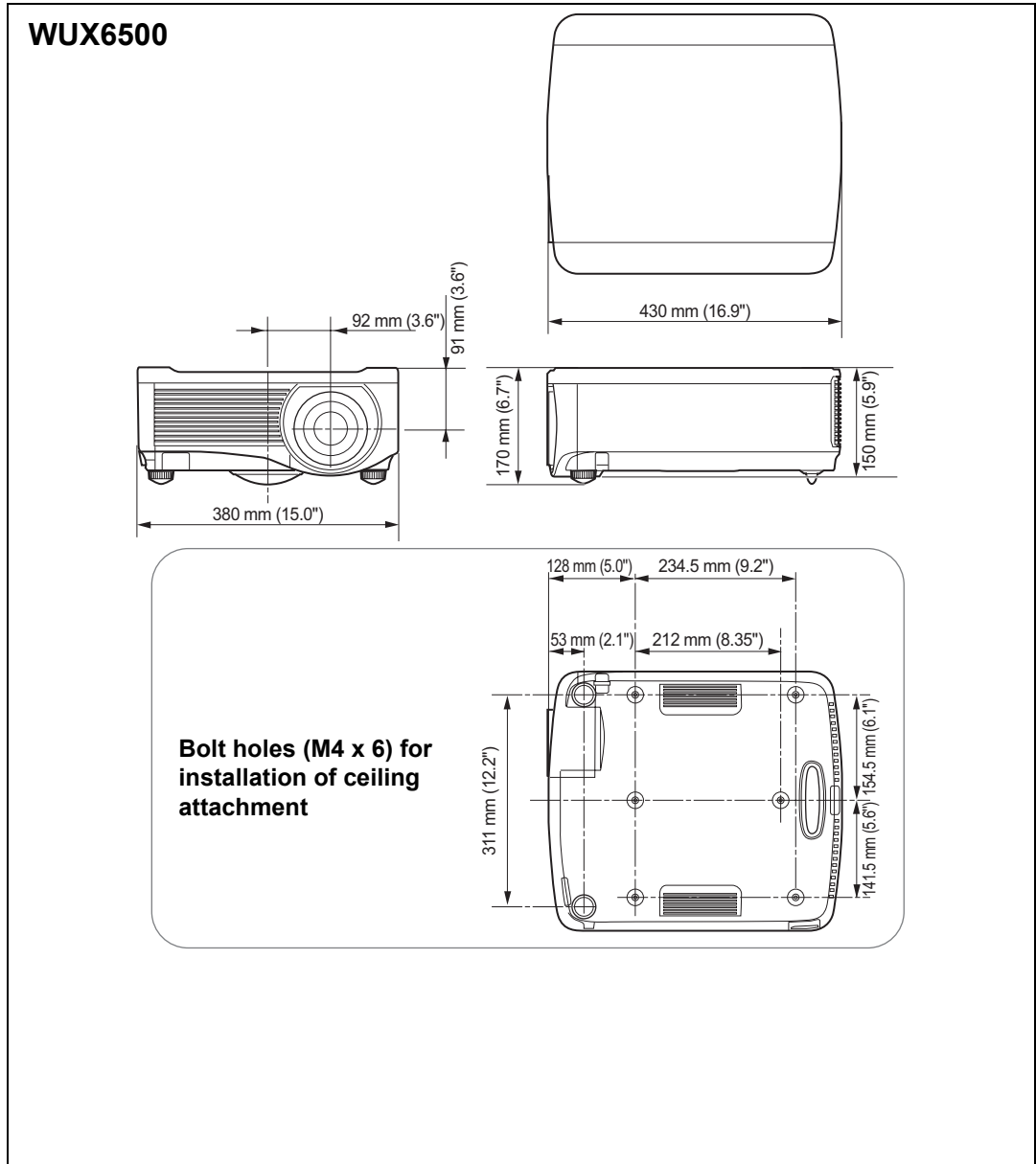

■ ANALOG PC-2 / COMPONENT Terminal

This terminal is used as a computer ANALOG PC input or COMPONENT input terminal. Use a D-sub computer cable.

The terminal specifications for the ANALOG PC input and COMPONENT input are the same.

Mini D-sub 15-pin

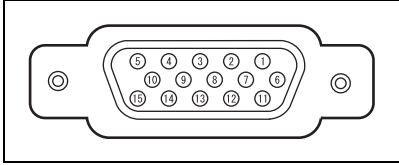

Pin No.	Signal	Pin No.	Signal
1	R	9	+5 V power
2	G	10	Ground (Vertical sync.)
3	B	11	Ground
4	OPEN	12	DDC data
5	Ground (Horizontal sync.)	13	Horizontal sync.
6	Ground (R)	14	Vertical sync.
7	Ground (G)	15	DDC clock
8	Ground (B)		

■ Service Port (CONTROL)

Pin assignment

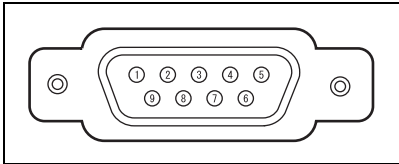

Pin No.	Signal
1	OPEN
2	RxD
3	TxD
4	OPEN
5	GND
6	OPEN
7	Internal pull-up
8	OPEN
9	OPEN

Communication format

Communication mode : RS-232C, asynchronous, half-duplex communication

Communication speed : 19200bps

Character length : 8 bits

Stop bits : Switchable between 1 bit and 2 bits. Factory default, or state after [Factory defaults] is executed, is 1 bit.

Parity : None

Flow control : None



The service port is not available when [HDBaseT] is set to [On] and [Serial communication] is set to [HDBaseT].

User commands

Commands		ASCII representation	Binary representation
Power supply	Power on	POWER=ON<CR>	50h 4Fh 57h 45h 52h 3Dh 4Fh 4Eh 0Dh
	Power off	POWER=OFF<CR>	50h 4Fh 57h 45h 52h 3Dh 4Fh 46h 46h 0Dh
Power status acquisition		GET=POWER<CR>	47h 45h 54h 3Dh 50h 4Fh 57h 45h 52h 0Dh
Input source	HDMI	INPUT=HDMI<CR>	49h 4Eh 50h 55h 54h 3Dh 48h 44h 4Dh 49h 0Dh
	Digital PC	INPUT=D-RGB<CR>	49h 4Eh 50h 55h 54h 3Dh 44h 2Dh 52h 47h 42h 0Dh
	Analog PC-1	INPUT=A-RGB1<CR>	49h 4Eh 50h 55h 54h 3Dh 41h 2Dh 52h 47h 42h 31h 0Dh
	Analog PC-2	INPUT=A-RGB2<CR>	49h 4Eh 50h 55h 54h 3Dh 41h 2Dh 52h 47h 42h 32h 0Dh
	Component	INPUT=COMP<CR>	49h 4Eh 50h 55h 54h 3Dh 43h 4Fh 4Dh 50h 0Dh
	LAN	INPUT=LAN<CR>	49h 4Eh 50h 55h 54h 3Dh 4Ch 41h 4Eh 0Dh
	USB	INPUT=USB<CR>	49h 4Eh 50h 55h 54h 3Dh 55h 53h 42h 0Dh
HDBaseT	INPUT=HDBT<CR>	49h 4Eh 50h 55h 54h 3Dh 48h 44h 42h 54h 0Dh	
Input source acquisition		GET=INPUT<CR>	47h 45h 54h 3Dh 49h 4Eh 50h 55h 54h 0Dh
Image Mode	Standard	IMAGE=STANDARD<CR>	49h 4Dh 41h 47h 45h 3Dh 53h 54h 41h 4Eh 44h 41h 52h 44h 0Dh
	Presentation	IMAGE=PRESENTATION<CR>	49h 4Dh 41h 47h 45h 3Dh 50h 52h 45h 53h 45h 4Eh 54h 41h 54h 49h 4Fh 4Eh 0Dh
	VividPhoto	IMAGE=VIVID_PHOTO<CR>	49h 4Dh 41h 47h 45h 3Dh 56h 49h 56h 49h 44h 5Fh 50h 48h 4Fh 54h 4Fh 0Dh
	Photo/sRGB	IMAGE=PHOTO_SRGB<CR>	49h 4Dh 41h 47h 45h 3Dh 50h 48h 4Fh 54h 4Fh 5Fh 53h 52h 47h 42h 0Dh
	Dynamic	IMAGE=DYNAMIC<CR>	49h 4Dh 41h 47h 45h 3Dh 44h 59h 4Eh 41h 4Dh 49h 43h 0Dh
	Video	IMAGE=VIDEO<CR>	49h 4Dh 41h 47h 45h 3Dh 56h 49h 44h 45h 4Fh 0Dh
	Cinema	IMAGE=CINEMA<CR>	49h 4Dh 41h 47h 45h 3Dh 43h 49h 4Eh 45h 4Dh 41h 0Dh
	User 1	IMAGE=USER_1<CR>	49h 4Dh 41h 47h 45h 3Dh 55h 53h 45h 52h 5Fh 31h 0Dh
	User 2	IMAGE=USER_2<CR>	49h 4Dh 41h 47h 45h 3Dh 55h 53h 45h 52h 5Fh 32h 0Dh
	User 3	IMAGE=USER_3<CR>	49h 4Dh 41h 47h 45h 3Dh 55h 53h 45h 52h 5Fh 33h 0Dh
	User 4	IMAGE=USER_4<CR>	49h 4Dh 41h 47h 45h 3Dh 55h 53h 45h 52h 5Fh 34h 0Dh
User 5	IMAGE=USER_5<CR>	49h 4Dh 41h 47h 45h 3Dh 55h 53h 45h 52h 5Fh 35h 0Dh	
Image mode acquisition		GET=IMAGE<CR>	47h 45h 54h 3Dh 49h 4Dh 41h 47h 45h 0Dh

Commands		ASCII representation	Binary representation
Brightness	Brightness value setting	BRI=<value><CR>	42h 52h 49h 3Dh <numeric code> 0Dh
Brightness acquisition		GET=BRI<CR>	47h 45h 54h 3Dh 42h 52h 49h 0Dh
Sharpness	Sharpness value setting	SHARP=<value><CR>	53h 48h 41h 52h 50h 3Dh <numeric code> 0Dh
Sharpness acquisition		GET=SHARP<CR>	47h 45h 54h 3Dh 53h 48h 41h 52h 50h 0Dh
Contrast	Contrast value setting	CONT=<value><CR>	43h 4Fh 4Eh 54h 3Dh <numeric code> 0Dh
Contrast acquisition		GET=CONT<CR>	47h 45h 54h 3Dh 43h 4Fh 4Eh 54h 0Dh
Aspect	Auto	ASPECT=AUTO<CR>	41h 53h 50h 45h 43h 54h 3Dh 41h 55h 54h 4Fh 0Dh
	4:3	ASPECT=4:3<CR>	41h 53h 50h 45h 43h 54h 3Dh 34h 3Ah 33h 0Dh
	16:9	ASPECT=16:9<CR>	41h 53h 50h 45h 43h 54h 3Dh 31h 36h 3Ah 39h 0Dh
	16:10	ASPECT=16:10<CR>	41h 53h 50h 45h 43h 54h 3Dh 31h 36h 3Ah 31h 30h 0Dh
	Zoom	ASPECT=ZOOM<CR>	41h 53h 50h 45h 43h 54h 3Dh 5Ah 4Fh 4Fh 4Dh 0Dh
	True size	ASPECT=TRUE<CR>	41h 53h 50h 45h 43h 54h 3Dh 54h 52h 55h 45h 0Dh
Aspect value acquisition		GET=ASPECT<CR>	47h 45h 54h 3Dh 41h 53h 50h 45h 43h 54h 0Dh
Lamp mode	Full power	LAMP=FULL<CR>	4Ch 41h 4Dh 50h 3Dh 46h 55h 4Ch 4Ch 0Dh
	Power saver	LAMP=ECO<CR>	4Ch 41h 4Dh 50h 3Dh 45h 43h 4Fh 0Dh
Lamp mode value acquisition		GET=LAMP<CR>	47h 45h 54h 3Dh 4Ch 41h 4Dh 50h 0Dh
Blank	Blank On	BLANK=ON<CR>	42h 4Ch 41h 4Eh 4Bh 3Dh 4Fh 4Eh 0Dh
	Blank Off	BLANK=OFF<CR>	42h 4Ch 41h 4Eh 4Bh 3Dh 4Fh 46h 46h 0Dh
Blank acquisition		GET=BLANK<CR>	47h 45h 54h 3Dh 42h 4Ch 41h 4Eh 4Bh 0Dh

LED Indicator Details

When there is a problem with the projector, the LED indicator on the side of the projector illuminates or flashes continuously after the projector is turned off.

- Wait until the cooling fan stops and disconnect the power plug from the electrical outlet before dealing with the problem.

LED indicator status	Meaning	Cause and countermeasure
WARNING and TEMP are lit.	Temperature abnormality	The temperature inside the projector is too high for some reason or the outside air temperature is higher than the operating range. If the problem is inside the projector, check whether the projector is installed and operating normally, unplug the projector from the power outlet to cool down the projector interior and then restart projection. If the air intake or exhaust vent is blocked, remove the obstacle. If the air filter is clogged, clean or replace it. (P171, P172) If the same warning occurs again, there may be a malfunction in the projector. Contact the Canon Customer Support Center.
WARNING and LAMP are lit.	Faulty lamp	The lamp does not illuminate. If the lamp does not illuminate, replace it. (P173) If the same warning occurs again, there may be a malfunction in the lamp drive circuit. Contact the Canon Customer Support Center.
WARNING flashes 3 times, LAMP is lit.	Faulty lamp cover	The lamp cover is open. Unplug the projector from the power outlet, then install the lamp cover correctly and turn on the projector again. If the lamp cover has been installed properly, there may be a malfunction in the lamp cover detection switch. Contact the Canon Customer Support Center.
WARNING (only) flashes 4 times repeatedly.	Faulty cooling fan	There may be a malfunction in the cooling fan or another component. Unplug the projector from the electrical outlet, then plug it back into the outlet and turn on the projector again. Contact the Canon Customer Support Center if the same warning occurs again.
WARNING (only) flashes 5 times repeatedly.	Faulty power supply	Abnormal voltage is applied to some parts in the power supply or another failure may have occurred. Unplug the projector from the electrical outlet, then plug it back into the outlet and turn on the projector again. Contact the Canon Customer Support Center if the same warning occurs again.

LED indicator status	Meaning	Cause and countermeasure
WARNING (only) flashes 3 times repeatedly.	Filter error	The air filter is not installed. Check whether or not the air filter is installed correctly. Contact the Canon Customer Support Center if the same warning occurs again.
WARNING (only) flashes 6 times repeatedly.	Faulty lens connector	The lens cable is not connected to the lens unit correctly. Unplug the projector, connect the lens cable to the lens unit correctly, and then plug the projector in again. Contact the Canon Customer Support Center if the same warning occurs again.

Symptoms and Solutions

■ You Cannot Turn on the Projector

Cause	Countermeasure
The power cord is not connected correctly.	Check whether the power cord is connected correctly. (P52)
The power cord has just been connected.	Wait at least one second after plugging the projector in until you press the POWER button. You cannot turn the projector on immediately after plugging it in. (P53)
The lamp cover is open.	Unplug the projector from the power outlet, then install the lamp cover correctly and turn on the projector again.
The safety device is activated because the air intake or the exhaust vent is blocked and the internal temperature of the projector has increased.	When the safety device is active, the [POWER ON] indicator does not turn on when you connect the power cord. You cannot disable this safety device. Remove any obstacle that is blocking the air intake or exhaust vent and contact the Canon Customer Support Center.
The lens connector is not attached correctly.	The lens cable is not connected to the lens unit correctly. Unplug the projector, connect the lens cable to the lens unit correctly, and then plug the projector in again. Contact the Canon Customer Support Center if the same warning occurs again.
The air filter is not installed correctly.	Check whether the air filter is installed correctly. (P172)
Key lock is enabled.	Check that Key lock (P118) is not enabled for the projector or the remote control.

■ You Cannot Project an Image from the Projector

Cause	Countermeasure
A cable is not connected correctly.	Check whether the projector is connected to the computer or AV equipment correctly. (P49 - P51)
20 seconds have not elapsed since the projector was turned on.	When the projector is turned on, the opening window is displayed for approximately 20 seconds. To project an image immediately, press the OK button on the remote control or side control. (P30, P35)
No image is sent from the AV equipment.	Check whether an image is played on the connected video camcorder, DVD, etc.
Connection with the input terminal has not been performed correctly.	Check whether the AV equipment is connected to the projector input terminal correctly. (P33)
No input signal type has been selected for the connected AV equipment.	Check that the same input signal has been correctly selected for the connected AV equipment from the [INPUT] menu. (P56)
The input signal type is incorrect.	Check whether the selected input signal type is correct. (P91, P188)
The BLANK function has been selected.	Press the BLANK button on the remote control. (P72)
No image is projected due to a problem with the computer.	Turn first the projector and then the computer off and then back on again.
The external monitor output is not set on the notebook computer correctly.	Turn on the external monitor output on the notebook computer. To turn on the external monitor output, press the [LCD] or [VGA] function key or a key with an icon for the external monitor, while holding down the [Fn] key on the keyboard of the notebook computer. With Windows 10 / Windows 8.1 / Windows 8 / Windows 7, you can turn on image output by holding down the Windows logo key and pressing the [P] key. (P55) The combination of keys used to perform this operation varies depending on the model of notebook computer. For more detailed information, refer to the manual that came with your computer.
The computer is set to dual screen (multi-display) mode.	If dual screen mode is selected, change the computer display output to mirroring mode. The output setting method varies among computer manufacturers. For more detailed information, refer to the manual that came with your computer.

Cause	Countermeasure
The image files are not compatible with USB File Browser.	Projection from USB flash drives requires JPEG images with a resolution not exceeding 10912x8640, single-byte alphanumeric file names, and a FAT-formatted drive.
The LAN cable (shielded twisted pair) is not connected correctly.	When [LAN] or [HDBaseT] is selected in the [Input] menu, check whether the LAN cable (shielded twisted pair) is connected to the projector correctly. (P127)
[HDBaseT] was changed from [On] to [Off] while [Communication settings] > [Wired network] was set to [HDBaseT].	Configure the [HDBaseT] setting again as follows. (P120) If [HDBaseT] is selected in the [Input] menu, change the [HDBaseT] setting from [Off] to [On] again.

■ There is no Sound

Cause	Countermeasure
The audio cable is not connected correctly.	Check the audio cable connection. (P49, P51)
The MUTE function is enabled.	Press the MUTE button on the remote control. (P36)
The volume level is adjusted to the minimum.	Press the VOL button on the remote control or the VOL+ button on the side control to adjust the volume level. (P30, P36)
An audio cable with a built-in resistor is used.	Use an audio cable without a built-in resistor.
Audio in terminal select is [Off].	Change the Audio In terminal to the appropriate setting. (P119)

■ The Projected Image Is Blurred

Cause	Countermeasure
The image is out of focus.	Adjust the focus. (P59)
The distance to the screen is too short.	Check whether the distance to the screen is appropriate. (P43)
The projector is not placed straight in front of the screen.	Check whether the projector is placed obliquely to the screen. A slight error in the projection angle can be corrected through the keystone adjustment function. (P67)

Cause	Countermeasure
The projector has been moved to a place where the temperature varies a lot.	When the projector is moved from a location where the temperature is low to a location where the temperature is high, condensation may form on the lens. The condensation will evaporate after a period of time and the projector will be able to project a normal image.
The lens is stained.	Clean the lens. (P170)
The tracking is bad.	Adjust the tracking with the [Auto PC] (P91) or [Tracking] (P92) function.
Video is blurred.	Activate motion blur reduction. (P123)
Motion blur reduction is not available.	Motion blur reduction is not available in projection using USB flash drives or networked multi-projection.
The sharpness setting is not available.	Sharpness cannot be adjusted during split-screen display.

■ You Cannot Project an Image Appropriately

Cause	Countermeasure
The projected image is inverted in the vertical or horizontal direction.	The ceiling mounted / rear projection setting is incorrect. Check the [Image flip H/V] setting in the [Install settings] menu. (P105)
The dot clock of the input signal is higher than 162 MHz.	Set the signal dot clock to 162 MHz or less on your computer.
A computer cable is used in which some pins are not connected.	Use a computer cable in which all pins are connected.

■ The Projector Power Turns Off

Cause	Countermeasure
The air intake or exhaust vent is blocked.	Check whether the air intake or exhaust vent is blocked. If the air intake or exhaust vent is blocked, the temperature inside the projector will increase and the power is automatically turned off to protect the projector. (The [WARNING] indicator and [TEMP] indicator are lit.) Wait until the projector temperature drops, then make sure that the intake and exhaust vents are not blocked and turn on the projector. (P29, P53)
The air filter is dirty.	Check whether the air filter is clogged with dust. If the air filter is clogged, clean or replace the air filter. (P171, P172)

Cause	Countermeasure
The lamp has ruptured (or there is a lamp malfunction).	If the lamp has ruptured, follow the instructions in “Note the following precautions when replacing lamps that stop working. Failure to do so could result in personal injury.” (P18).
The operating environment is inappropriate.	Check whether the operating temperature is between 0°C (32°F) and 40°C (104°F). (P22) Projector settings must be adjusted when using the projector at altitudes of 2,300 m (7,545.8') or higher. In the [Install settings] menu, set [Fan mode] under [Professional settings] to [High altitude]. (P108)

■ The Projector Cannot Join the Network

Cause	Countermeasure
The LAN cable (shielded twisted pair) is not connected correctly.	Check whether the LAN cable (shielded twisted pair) is connected to the projector correctly. (P127)
[HDBaseT] was changed from [On] to [Off] while [Communication settings] > [Wired network] was set to [HDBaseT].	Configure the [HDBaseT] setting again as follows. (P120) <ol style="list-style-type: none"> 1. Change the [HDBaseT] setting from [Off] to [On] again. 2. Change the wired network setting from [LAN port] to [HDBaseT]. 3. Following the instructions shown, press the POWER button to enter standby mode temporarily. 4. After at least five minutes, press the POWER button again.
The projector has not been on long enough (less than about 40 seconds).	Network connections are not available until about 40 seconds after startup. Wait at least 40 seconds, and then try to connect again. (P139)

■ You Cannot Operate the Remote Control

Cause	Countermeasure
Batteries are not installed properly or they have run out.	Check whether batteries are installed correctly. If batteries are installed correctly, replace them with new batteries. (P37)
You are operating the remote control from the outside of the remote control operating range.	Check whether you are operating the remote control within the remote control operating range of the main unit of the projector. (P38)
There is an obstacle between the projector and the remote control.	Remove the obstacle between the infrared remote receiver of the main unit of the projector and the remote control or point the remote control in an obstacle-free path.
You are operating the remote control in an unsuitable operating environment.	Check whether the infrared remote receiver of the main unit of the projector is exposed to direct sunlight or strong light of lighting apparatus. (P38)
The channel setting of the remote control does not match the setting of the projector.	Check whether the channel setting of the remote control has been changed. You can check the [Remote control channel] setting in the [System settings] menu. (P119)
The key lock function is preventing operation of the remote control.	Check whether [Key lock] is enabled to disable the remote control operation. In the [System settings] menu, set [Key lock] to [Off]. (P118)
Light from the room lights is entering the infrared remote receiver.	Block the light.

Numerics

6-axis color adjust 101

A

Adjusting keystone distortion 67
 Adjusting the volume..... 74
 Air filter..... 172
 Ambient light 99
 AMX Device Discovery 135
 Analog PC..... 56
 ANALOG PC-1 / DVI-I terminal..... 33
 ANALOG PC-2 / COMPONENT input
 terminal..... 33
 ASPECT..... 66
 Aspect..... 65, 183
 AUDIO IN terminal 33
 AUDIO OUT terminal 33
 Auto (Aspect) 65
 Auto PC..... 58, 91
 Auto PC Adjustment..... 58

B

Beep..... 122
 BLANK 72
 Brightness 98

C

Ceiling mounted 41, 105
 Connecting to AV equipment 51
 Contrast 98
 Corner Adjustment 68, 166
 Crestron RoomView..... 135

D

D. ZOOM..... 75
 Digital zoom 35
 Direct power on..... 122
 Display resolution (Preparing the
 computer) 57

DVI-I terminal 33
 Dynamic gamma 100

E

Edge blending 6, 109, 162
 Effect of ambient light..... 99

F

FREEZE 72

G

Gamma 98

H

HDBaseT..... 5, 120, 121
 HDBaseT terminal 33, 50, 51
 HDMI terminal 33

I

IMAGE..... 71
 Image adjustment..... 78, 96
 Image mode (Image quality) 70
 Information 78, 156
 INPUT 56
 Input settings..... 78, 90
 Input signal select 56
 Input terminal 33
 Install settings..... 78, 104

K

Key lock..... 118
 KEYSTONE..... 67
 Keystone 67

L

Lamp mode 102
 Lamp replacement 173, 176
 LAN port..... 33

Language 123
 LED indicator 31, 198
 Lens - Position 112
 Lens shift..... 47
 Logo display 118

M

Memory color correction 100
 Menu 78
 MUTE 74
 Muting the sound 74

N

Network password 130
 Network settings 78, 127
 Networked Multi-Projection (NMPJ)
 6, 145
 Noise reduction 99, 100

O

OK..... 36
 Optical zoom 60

P

Password 124, 125
 PJLink 134, 150
 POWER 53, 71
 Power-Saving Settings..... 73
 Projecting from Multiple Projectors at
 Once (Edge Blending)..... 162
 Projector on..... 118

R

Rear projection..... 41, 105
 Registration..... 107
 Remote control..... 35, 37, 119
 Reset..... 69, 103, 126

S

Screen aspect 63, 183
 Screen color 113
 Selecting a language..... 123
 Setting display status 90
 Sharpness 98
 Side control 30
 Signal type 188
 Slideshows 95, 161
 Split-screen display 161
 System settings..... 78, 116

T

Test pattern..... 187
 Tracking..... 92
 True size (Aspect) 66
 Turning on external monitor output
 (preparing the notebook computer)
 55

U

USB Port 33

V

VOL 74

W

WARNING indicator 31, 198

Z

Zooming part of an image 75

Option

- | | |
|---|--|
| <ul style="list-style-type: none">• Lamp
Part No.: RS-LP11• Ceiling attachment
Part No.: RS-CL11• Ceiling-mount pipe
(350 - 550 mm / 13.8 - 21.7 in)
Part No.: RS-CL08*• Ceiling-mount pipe
(550 - 950 mm / 21.7 - 37.4 in)
Part No.: RS-CL09* | <ul style="list-style-type: none">• Air filter
Part No.: RS-FL01• Remote control
Part No.: RS-RC04• Remote control
Part No.: RS-RC05 |
|---|--|

* Use the above materials to hang the projector from the ceiling. For details, refer to the assembly and installation manual provided with the ceiling attachment.



CANON INC.

30-2, Shimomaruko 3-chome, Ohta-ku, Tokyo 146-8501, Japan

CANON U.S.A. INC.

One Canon Park, Melville, New York 11747, U.S.A.

For all inquires concerning this product, call toll free in the U.S. 1-800-OK-CANON

CANON EUROPE LTD.

3 The Square, Stockley Park, Uxbridge, Middlesex, UB11 1ET United Kingdom

CANON EUROPA N.V.

Bovenkerkerweg 59, 1185 XB Amstelveen, The Netherlands