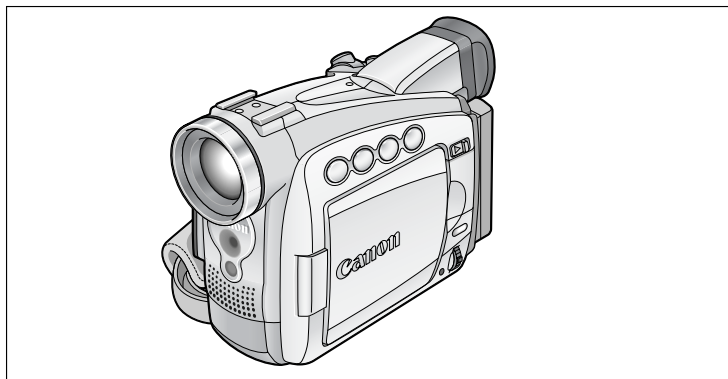

# Canon

## Digital Video Camcorder Instruction Manual

**English**

# MV750i/MV730i/ MV700i/MV700/MV690

**Introduction**
**Basic Functions**
**Advanced  
Functions**
**Editing**
**Mini DV** Digital  
Video  
Cassette



  
BUBBLE JET  
DIRECT

  
PictBridge

**MV750i/MV730i**
**Using a  
Memory Card**
**MV750i/MV730i**

Please read also the following instruction manuals.

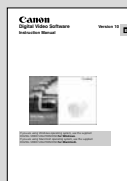
- Digital Video Software
- DV Network Software

**MV750i/MV730i**
**Direct  
Printing**
**Additional  
Information**
**PAL**

# **Important Usage Instructions**

---

**WARNING:**



**TO REDUCE THE RISK OF ELECTRIC SHOCK, DO NOT REMOVE COVER (OR BACK). NO USER SERVICEABLE PARTS INSIDE. REFER SERVICING TO QUALIFIED SERVICE PERSONNEL.**

**WARNING:**



**TO REDUCE THE RISK OF FIRE OR ELECTRIC SHOCK, DO NOT EXPOSE THIS PRODUCT TO RAIN OR MOISTURE.**

**CAUTION:**

**TO REDUCE THE RISK OF ELECTRIC SHOCK AND TO REDUCE ANNOYING INTERFERENCE, USE THE RECOMMENDED ACCESSORIES ONLY.**

**CAUTION:**

DISCONNECT THE MAINS PLUG FROM THE SUPPLY SOCKET WHEN NOT IN USE.

CA-570 identification plate is located on the bottom.



- Use of CV-150F/CV-250F DV cable is necessary to comply with the technical requirement of EMC Directive.

# Using this Manual

Thank you for purchasing the Canon MV750i/MV730i/MV700i/MV700/MV690. Please read this manual carefully before you use the camcorder and retain it for future reference.

Change the display language before you begin (75).

## Symbols and References Used in This Manual





-  : Precautions related to the camcorder operation.
-  : Additional topics that complement the basic operating procedures.
-  : Reference page number.
- Capital letters are used to refer to buttons on the camcorder or the wireless controller (MV750i/MV730i).
- [ ] are used to refer to menu items displayed on the screen.
- “Screen” refers to the LCD and the viewfinder screen.
- Please note that the illustrations mainly refer to the MV750i.

Operating modes (see below)

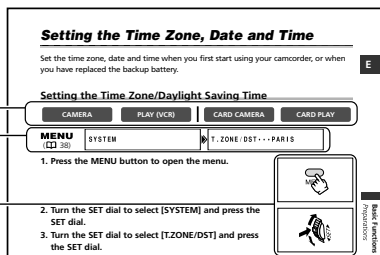
Menu item and its default setting.

Button and switches to be operated



Operating Mode	POWER Switch	TAPE/CARD Switch
CAMERA	CAMERA	 (TAPE)
PLAY (VCR)	PLAY (VCR)	 (TAPE)
CARD CAMERA	CAMERA	 (CARD)
CARD PLAY	PLAY (VCR)	 (CARD)

Shaded area : MV750i/MV730i only.

**CAMERA** : Function can be used in this mode.

**CAMERA** : Function cannot be used in this mode.

## Trademark Acknowledgements

- Canon and Bubble Jet are registered trademarks of Canon Inc.
- Mini DV is a trademark.
- SD is a trademark.
- Windows® is either a registered trademark or trademark of Microsoft Corporation in the United States and/or other countries.
- Macintosh and Mac OS are trademarks of Apple Computer, Inc., registered in the United States and other countries.
- Other names and products not mentioned above may be registered trademarks or trademarks of their respective companies.

# Table of Contents

---

## Introduction

---

Important Usage Instructions .....	2
Using this Manual .....	3
Checking Supplied Accessories .....	6
Components Guide .....	7

## Basic Functions

---

### Preparations

Preparing the Power Supply .....	11
Loading/Unloading a Cassette .....	14
Installing the Backup Battery .....	15
Preparing the Camcorder .....	16
<b>(MV750i/MV730i)</b> Using the Wireless Controller .....	18
Setting the Time Zone, Date and Time .....	19

### Recording

Recording Movies on a Tape .....	22
Recording Still Images on a Tape .....	27
Zooming .....	28
Tips for Making Better Videos .....	30

### Playback

Playing Back a Tape .....	31
Adjusting the Volume .....	33
Playing Back on a TV Screen .....	34

## Using the Full Range of Features

---

Menus and Settings .....	38
--------------------------	----

### Recording

Using the Recording Programs .....	45
Using the Night Modes .....	48
Skin Detail Function .....	49
Adjusting the AE Shift .....	50
Adjusting the Focus Manually .....	51
Setting the White Balance .....	53
Setting the Shutter Speed .....	55
Using the Self-Timer .....	57
Changing the Recording Mode (SP/LP) .....	58
Audio Recording .....	59
Using Digital Effects .....	61

### Playback

Magnifying the Image .....	68
Displaying the Data Code .....	69
End Search .....	71
<b>(MV750i/MV730i)</b> Returning to a Pre-marked Position .....	72
<b>(MV750i/MV730i)</b> Photo Search/Date Search .....	73

## Other Functions

Customizing the Camcorder .....	74
Changing the Display Language .....	75
<b>MV750i/MV730i</b> Changing the Remote Sensor Mode .....	76
Other Camcorder Settings .....	77

## Editing

Recording to a VCR or Digital Video Device .....	79
<b>MV750i/MV730i/MV700i</b> Recording from Analog Video Devices (VCR, TV or Camcorder) .....	81
<b>MV750i/MV730i/MV700i</b> Recording from Digital Video Devices (DV Dubbing) .....	82
<b>MV750i/MV730i/MV700i</b> Converting Analog Signals into Digital Signals (Analog-Digital Converter) .....	84
<b>MV750i/MV730i</b> Replacing Existing Scenes (AV Insert) .....	86
<b>MV750i/MV730i</b> Audio Dubbing .....	88
Connecting to a Computer Using a DV (IEEE1394) Cable .....	91

## **MV750i/MV730i** Using a Memory Card

Inserting and Removing a Memory Card .....	92
Selecting the Image Quality/Size .....	93
File Numbers .....	95
Recording Still Images on a Memory Card .....	96
Reviewing a Still Image Right after Recording .....	100
Recording Motion JPEG Movies on a Memory Card .....	101
Selecting the Focusing Point .....	103
Recording Panoramic Images (Stitch Assist Mode) .....	104
Playing Back a Memory Card .....	106
Protecting Images .....	109
Erasing Images .....	110
Combining Images (Card Mix) .....	111
Copying Still Images .....	115
Formatting a Memory Card .....	117
Connecting to a Computer Using a USB Cable .....	118
Creating a Start-up Image .....	119





## **MV750i/MV730i** Direct Printing

Printing Still Images .....	120
Selecting the Print Settings (Paper/Style) .....	123
Printing with Print Order Settings .....	126

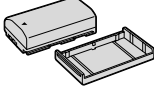

## Additional Information

Screen Displays .....	128
List of Messages .....	131
Maintenance/Others .....	134
Troubleshooting .....	140
System Diagram .....	143
Optional Accessories .....	144
Specifications .....	147
Index .....	149

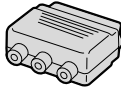
## Checking Supplied Accessories

<p>Lens Cap and Lens Cap Cord</p> 	<p>Lithium Button Battery CR1616</p> 	<p>SS-900 Shoulder Strap</p> 	<p>BP-508 Battery Pack</p> 
<p>CA-570 Compact Power Adapter (incl. power cord)</p> 	<p>STV-250N Stereo Video Cable</p> 	<p>PC-A10 SCART Adapter (Europe and Asia)</p> 	

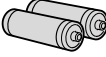
### **MV750i/MV730i**

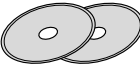
<p>WL-D82 Wireless Controller</p> 	<p>Two AA (R6) Batteries</p> 	<p>SDC-8M SD Memory Card (containing sample images)</p> 	<p>IFC-300PCU USB Cable</p> 
<p>DIGITAL VIDEO SOLUTION DISK For Windows For Macintosh</p> 			

### **MV750i**

<p>WA-30.5 Wide Attachment</p> 
--

# Components Guide

MV750i/MV730i/MV700i/MV700/MV690

E

Introduction

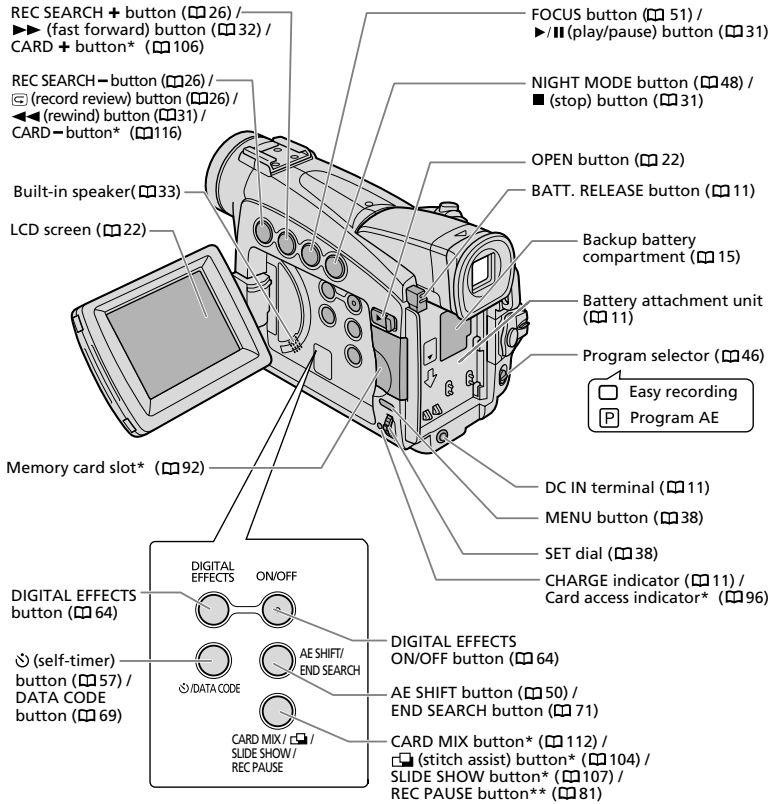

\* MV750i/MV730i only.

\*\* MV750i/MV730i/MV700i only.

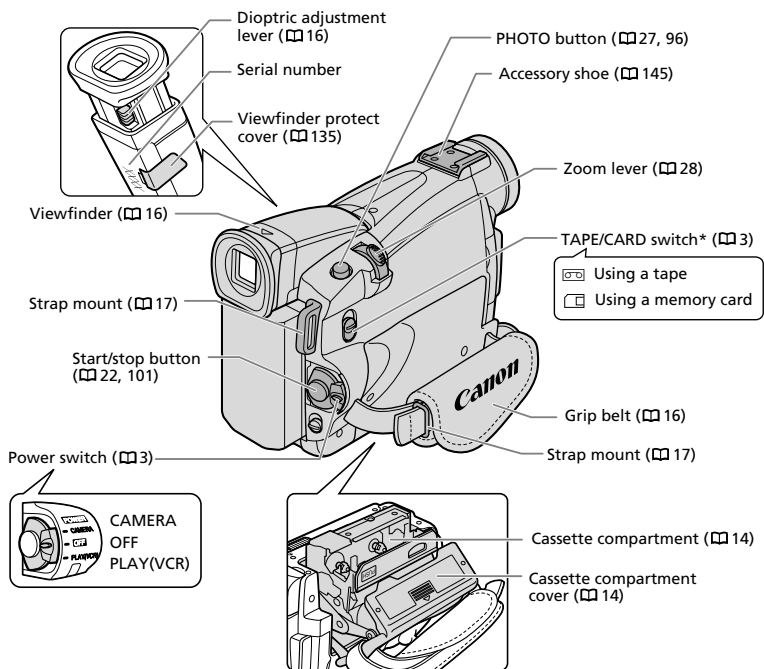

\* MV750i/MV730i only.



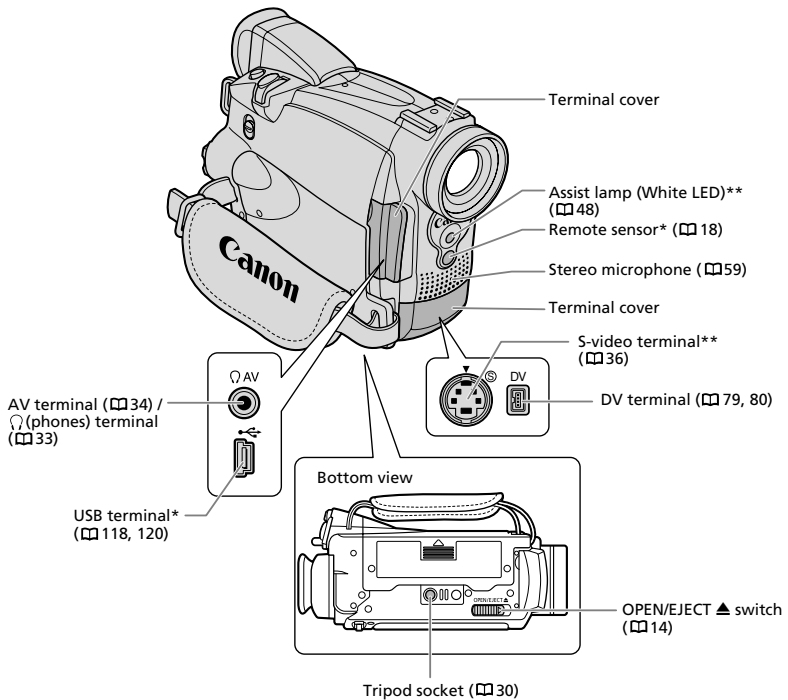

\* MV750i/MV730i only.

\*\* MV750i only.

## MV750i/MV730i WL-D82 Wireless Controller

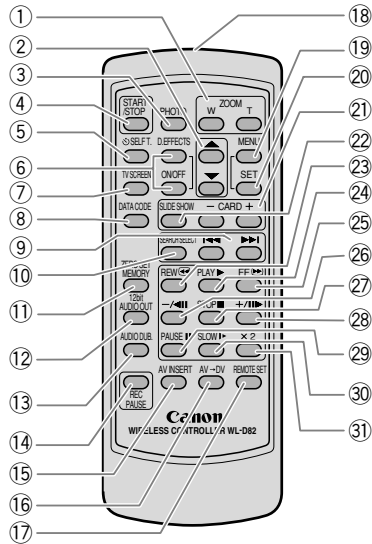

- |   |   |
|---|---|
| ① Zoom buttons ( ㉑28)                     | ①7 REMOTE SET button ( ㉑76)               |
| ② Select buttons ( ㉑38)                   | ①8 Transmitter                            |
| ③ PHOTO button ( ㉑27, 96)                 | ①9 MENU button ( ㉑38)                     |
| ④ START/STOP button ( ㉑22, 101)           | ②0 SET button ( ㉑38)                      |
| ⑤ $\odot$ SELF T. button ( ㉑57)           | ②1 CARD -/+ buttons ( ㉑106)               |
| ⑥ D. EFFECTS button, ON/OFF button ( ㉑64) | ②2 SLIDE SHOW button ( ㉑107)              |
| ⑦ TV SCREEN button ( ㉑128)                | ②3 REW $\leftarrow$ button ( ㉑31)         |
| ⑧ DATA CODE button ( ㉑69)                 | ②4 PLAY $\rightarrow$ button ( ㉑31)       |
| ⑨ $\leftarrow/\rightarrow$ buttons ( ㉑73) | ②5 FF $\rightarrow$ button ( ㉑32)         |
| ⑩ SEARCH SELECT button ( ㉑73)             | ②6 $\leftarrow/\mathbb{1}$ button ( ㉑32)  |
| ⑪ ZERO SET MEMORY button ( ㉑72)           | ②7 STOP $\blacksquare$ button ( ㉑31)      |
| ⑫ 12bit AUDIO OUT button ( ㉑89)           | ②8 $\rightarrow/\mathbb{1}$ button ( ㉑32) |
| ⑬ AUDIO DUB. button ( ㉑88)                | ②9 PAUSE $\mathbb{1}$ button ( ㉑32)       |
| ⑭ REC PAUSE button ( ㉑81)                 | ③0 SLOW $\rightarrow$ button ( ㉑32)       |
| ⑮ AV INSERT button ( ㉑86)                 | ③1 $\times 2$ button ( ㉑32)               |
| ⑯ AV $\rightarrow$ DV button ( ㉑84)       |   |

# Preparing the Power Supply

## Attaching the Battery Pack

1. Turn the **POWER** switch to **OFF**.
2. Move the **viewfinder** upward.
3. Attach the battery pack to the camcorder.
  - Remove the terminal cover of the battery pack.
  - Press lightly and slide it in the direction of the arrow until it clicks.

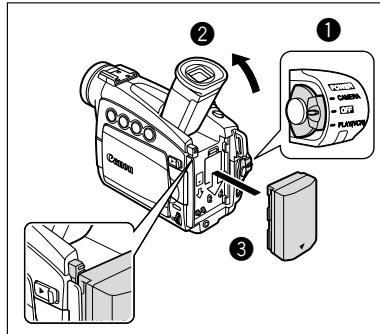

## Charging the Battery Pack

1. Connect the power cord to the adapter.
2. Plug the power cord into a power outlet.
3. Connect the power adapter to the camcorder's **DC IN** terminal.

The **CHARGE** indicator starts flashing. It glows steadily when charging is complete.
4. When charging is complete, disconnect the power adapter from the camcorder. Unplug the power cord from the power outlet and disconnect it from the adapter.
5. Remove the battery pack after use.

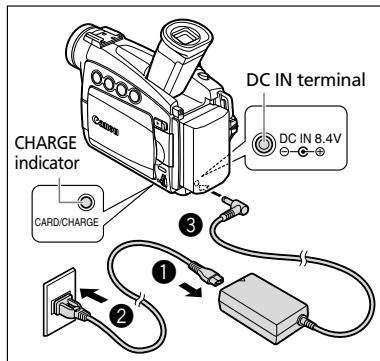

Press the **BATT. RELEASE** button to remove the battery.

## Using a Household Power Source

1. Turn the **POWER** switch to **OFF**.
2. Connect the power cord to the power adapter.
3. Plug the power cord into a power outlet.
4. Connect the power adapter to the camcorder's **DC IN** terminal.

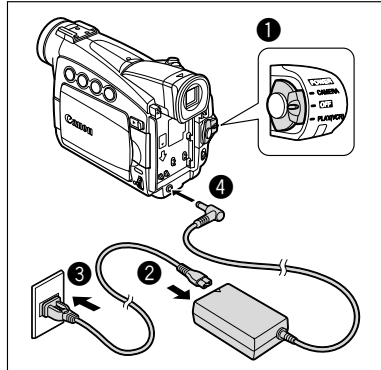

- Turn off the camcorder before connecting or disconnecting the power adapter.
- If the adapter is used close to a TV, it may cause picture interference. Move the adapter away from the TV or the aerial cable.
- Do not connect any products that are not expressly recommended to the camcorder's DC IN terminal or to the power adapter.
- You may hear some noise from the power adapter during use. This is not a malfunction.
- Do not disconnect and reconnect the power cord while charging a battery pack. The battery pack may not be charged correctly even if the CHARGE indicator glows steady. The battery pack may also not be charged correctly when a power outage occurs during charging. Remove the battery pack and attach it back to the camcorder.



- The battery pack may be defective when the CHARGE indicator flashes rapidly.
- The CHARGE indicator informs you about the charge status.
  - 0-50%: Flashes once every second
  - More than 50%: Flashes twice every second
  - 100%: Glows steadily

### ○ **Charging, Recording and Playback Times**

Below times are approximate and vary according to the charging, recording or playback conditions.

		BP-508 (Supplied)	BP-512/ BP-511 (Optional)	BP-514 (Optional)	BP-522 (Optional)	BP-535 (Optional)
<b>Charging Time</b>		110 min.	120 min.	150 min.	210 min.	310 min.
<b>Max. Recording Time</b>	Viewfinder	125 min.	225 min.	260 min.	455 min.	730 min.
	LCD	85 min.	155 min.	180 min.	320 min.	520 min.
<b>Typical Recording Time*</b>	Viewfinder	65 min.	125 min.	145 min.	255 min.	405 min.
	LCD	45 min.	85 min.	100 min.	175 min.	280 min.
<b>Playback Time</b>		90 min.	170 min.	195 min.	345 min.	550 min.

\* Approximate times for recording with repeated operations such as start/stop, zooming, power on/off. Actual time may be shorter.

- Charge the battery pack in temperatures between 5 °C and 40 °C.
- A lithium ion battery pack can be charged at any charge state. Unlike conventional battery packs, you do not need to completely use or discharge it before charging.
- We recommend that you prepare battery packs 2 to 3 times longer than you think you might need.
- To conserve battery charge, turn off the camcorder instead of leaving it in record pause mode.

E

## Loading/Unloading a Cassette

Use only video cassettes marked with the Mini DV logo.

**1. Slide and hold the OPEN/EJECT switch and open the cassette compartment cover.**

The cassette compartment opens automatically.

**2. Load/unload the cassette.**

- Load the cassette with the window facing the grip belt.
- Unload the cassette by pulling it straight out.

**3. Press the **PUSH** mark on the cassette compartment until it clicks.**

**4. Wait for the cassette compartment to retract automatically and close the cassette compartment cover.**

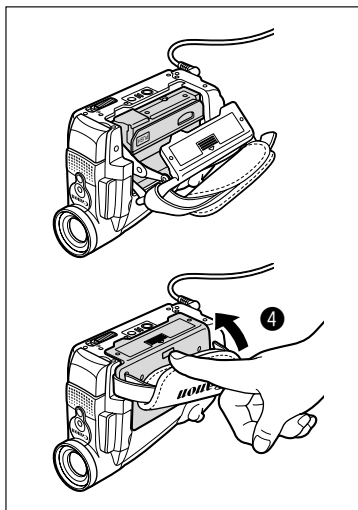
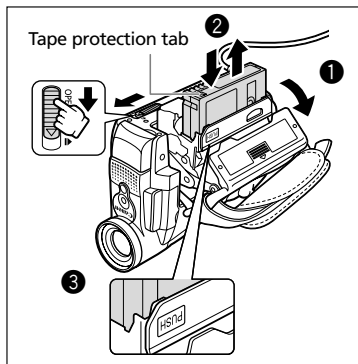

○ Do not interfere with the cassette compartment while it is opening or closing automatically, or attempt to close the cover before the cassette compartment has fully retracted.

○ Be careful not to get your fingers caught in the cassette compartment cover.



If the camcorder is connected to a power source, cassettes can be loaded/unloaded even if the POWER switch is set to OFF.

## Installing the Backup Battery

The backup battery allows the camcorder to retain date, time (📅 19) and other camcorder settings while the power source is disconnected. Power the camcorder from a household power source when replacing the backup battery to retain the settings.

E

1. Open the backup battery cover.
2. Insert the lithium battery with the + side facing outward.

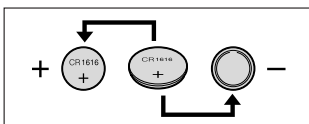

3. Close the cover.

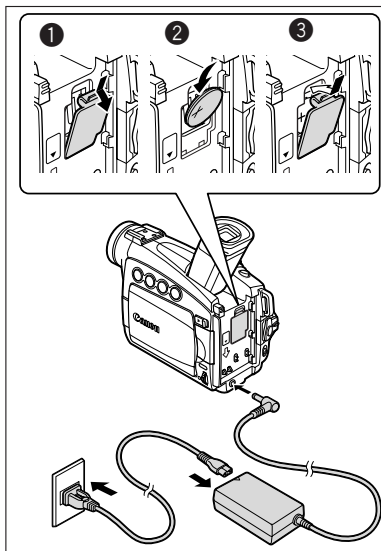

### WARNING!

- The battery used in this device may present a fire or chemical burn hazard if mistreated. Do not recharge, disassemble, heat above 100 °C or incinerate the battery.
- Replace the battery with a CR1616 made by Panasonic, Hitachi Maxell, Sony, Toshiba, Varta or Renata. Use of other batteries may present a risk of fire or explosion.
- The used battery should be returned to the supplier for safe disposal.



- Do not pick up the battery using tweezers or other metal tools as this will cause a short circuit.
- Wipe the battery with a clean dry cloth to ensure proper contact.
- Keep the battery out of reach of children. If it is swallowed, seek medical assistance immediately. The battery case may break and the battery fluids may damage stomach and intestines.
- Do not disassemble, heat or immerse the battery in water to avoid the risk of explosion.



The backup battery has a life span of about a year. 🔴 flashes in red to inform you that it needs to be replaced.

## Preparing the Camcorder

### Adjusting the Viewfinder (Dioptric Adjustment)

1. Turn on the camcorder and keep the LCD panel closed.
2. Pull out the viewfinder.
3. Adjust the diopter adjustment lever.

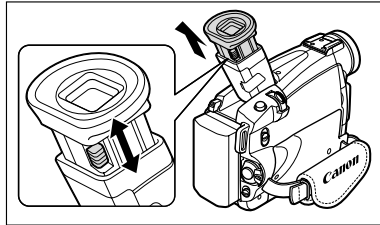

### Attaching the Lens Cap

1. Attach the cord to the lens cap.
2. Pass the grip belt through the loop with the metal fitting on the cord.

Press the buttons on the lens cap when attaching/removing it. Hook the lens cap on the grip belt while you are recording, and place it over the lens when you have finished.

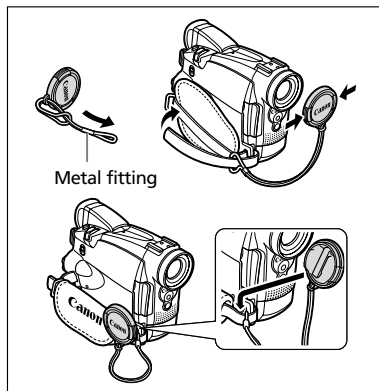

### Fastening the Grip Belt

Hold the camcorder with your right hand and adjust the belt with your left.

Adjust the grip belt so that you can reach the zoom lever and photo button with your index finger, and the start/stop button with your thumb.

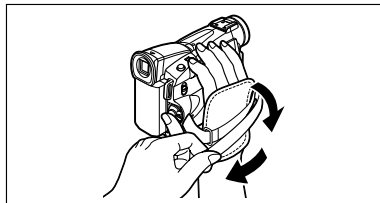



## Attaching the Shoulder Strap

Pass the ends through the strap mount and adjust the length of the strap.

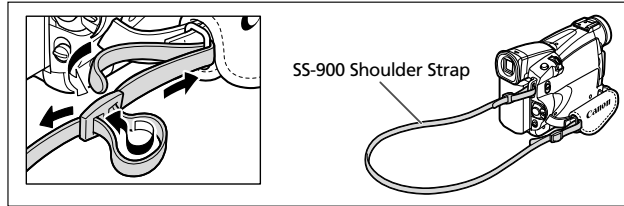

E

## **MV750i** Mounting the Wide Attachment

The WA-30.5 Wide Attachment gives you a wide perspective for indoor shots or panoramic views (0.6×). The wide attachment is for use at maximum wide-angle.

Screw the wide attachment fully into the lens filter thread.

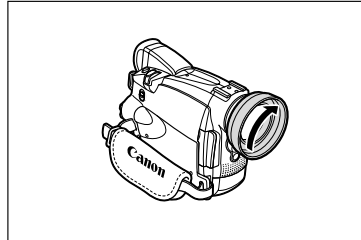

Basic Functions -  
Preparations



- Do not look directly at the sun or other strong light sources through the wide attachment. It could damage your eyesight.
- If you zoom to telephoto, the picture will not be in focus.
- The wide attachment may obstruct the remote sensor (the range of the wireless controller narrows), or may cause a shadow to appear on the picture when recording with a video light or the assist lamp (White LED).
- Filters cannot be used with the wide attachment.
- If dust accumulates on the wide attachment or on the camcorder lens, clean both lenses gently with a blower brush.
- Do not touch the lens to avoid smudges and fingerprints.
- Do not store the wide attachment in a humid place as it may mold.

## **MV750i/MV730i** Using the Wireless Controller

Point it at the camcorder's remote sensor when you press the buttons.

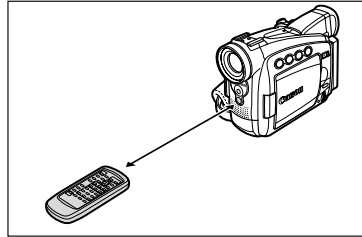

### Inserting Batteries

The wireless controller operates with two AA (R6) batteries.

1. **Open the battery cover.**
2. **Insert the batteries following the + and - markings.**  
Replace both batteries.
3. **Close the battery cover.**

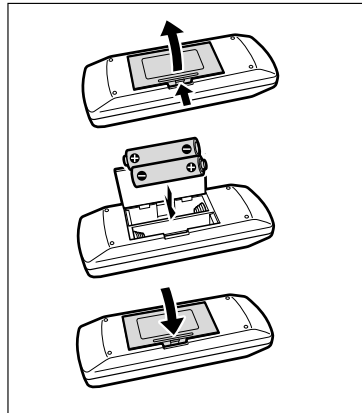

- Camcorder and wireless controller are equipped with 2 remote sensor modes ( 76). If the wireless controller does not work, check if camcorder and wireless controller are set to the same mode.
- The wireless controller may not work properly when the remote sensor is subjected to strong light sources or direct sunlight.

# Setting the Time Zone, Date and Time

Set the time zone, date and time when you first start using your camcorder, or when you have replaced the backup battery.

E

## Setting the Time Zone/Daylight Saving Time

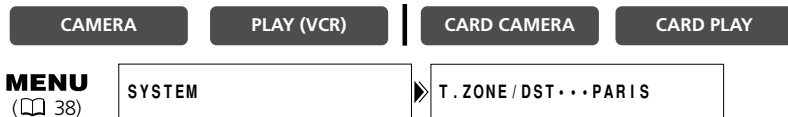

1. Press the MENU button to open the menu.

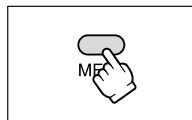

2. Turn the SET dial to select [SYSTEM] and press the SET dial.

3. Turn the SET dial to select [T.ZONE/DST] and press the SET dial.

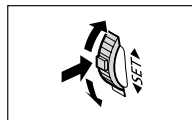

The time zone setting appears (see table on the next page). The default setting is Paris.

4. Turn the SET dial to select the setting option that represents your time zone and press the SET dial.

To adjust for daylight saving time, select the time zone with the \* next to the area.

## Setting the Date and Time



5. Turn the SET dial to select [D/TIME SET] and press the SET dial.

The year display starts to flash.

6. Turn the SET dial to select the year, and press the SET dial.

- The next part of the display starts flashing.
- Set the month, day, hours and minutes in the same way.

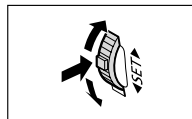

7. Press the MENU button to close the menu and to start the clock.

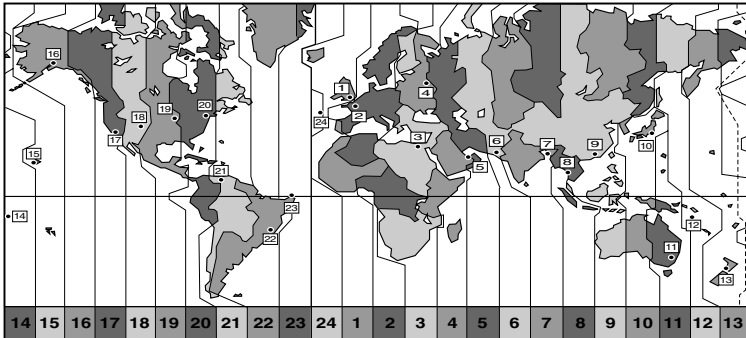
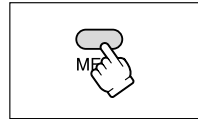

No.	Time zone	No.	Time zone
1	LONDON	13	WELLGTM (Wellington)
2	PARIS	14	SAMOA
3	CAIRO	15	HONOLU. (Honolulu)
4	MOSCOW	16	ANCHOR. (Anchorage)
5	DUBAI	17	L.A. (Los Angeles)
6	KARACHI	18	DENVER
7	DACCA	19	CHICAGO
8	BANGKOK	20	N.Y. (New York)
9	H. KONG (Hong Kong)	21	CARACAS
10	TOKYO	22	RIO (Rio de Janeiro)
11	SYDNEY	23	FERNAN. (Fernando de Noronha)
12	SOLOMON	24	AZORES



Once you have set time zone, date and time, you do not need to reset the clock each time you travel to another time zone. Just set the time zone to the one of your destination, and the camcorder automatically adjusts the clock.

## Displaying Date and Time during Recording

You can display the date and time in the lower left corner of the screen.



E

1. Press the MENU button to open the menu.

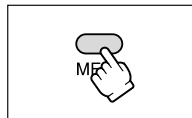

2. Turn the SET dial to select [DISPLAY SETUP/ [Globe icon] ] and press the SET dial.

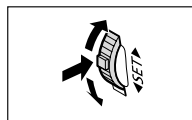

3. Turn the SET dial to select [D/T DISPLAY] and press the SET dial.

4. Turn the SET dial to select [ON].

5. Press the MENU button to close the menu.

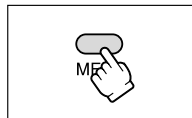

Basic Functions -  
Preparations

# Recording Movies on a Tape

## Before You Begin Recording

Make a test recording first to check if the camcorder operates correctly. Before you make important recordings, clean the video heads (📖 135).

## Recording

1. Remove the lens cap.

2. Set the camcorder to CAMERA mode.

- **MV750i/MV730i** Set the POWER switch to CAMERA and the TAPE/CARD switch to .
- **MV700i/MV700/MV690** Set the POWER switch to CAMERA.

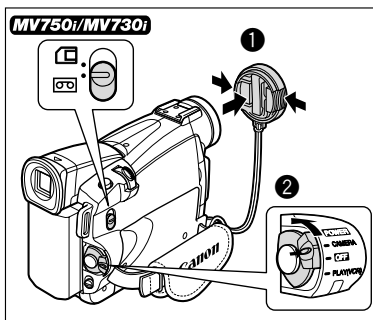

3. Push the OPEN button at the LCD panel and open the LCD panel.

4. Press the start/stop button to begin recording.

Press the start/stop button again to pause recording.

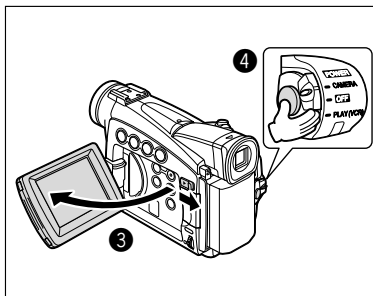

## When You Have Finished Recording

1. Turn the POWER switch to OFF.

2. Close the LCD panel and return the viewfinder into its initial position.

3. Replace the lens cap.

4. Unload the cassette.

5. Disconnect the power source.



- Wait until the tape counter stops completely before you start recording.
- When you do not remove the cassette, you can record the next scene without producing any noise or blank sections between the recordings even if you turn the camcorder off.
- Bright light may make it difficult to use the LCD screen. In such case, use the viewfinder instead.

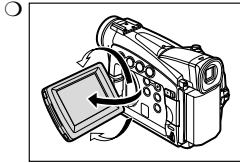

You can rotate the LCD panel. Make sure to open the LCD panel at 90 degrees before rotating it.

- When recording near loud sounds (such as fireworks, drums or concerts), sound may become distorted or may be recorded not in the actual sound level.
- **The camcorder will shut off after 5 minutes when left in record pause mode to protect tape and video heads. "⚠️ AUTO POWER OFF" appears 20 seconds before shutoff. To continue recording, turn the POWER switch to OFF and then back to CAMERA.**
- **About the LCD and viewfinder screen: The screens are produced with extremely high-precision manufacturing techniques, with more than 99.99% of the pixels operating to specification. Less than 0.01% of the pixels may occasionally misfire or appear as black or green dots. This has no effect on the recorded image and does not constitute a malfunction.**

## Allowing the Subject to Monitor the LCD Screen

You can rotate the LCD panel so that the screen faces in the same direction as the lens. The viewfinder switches on allowing you to use the viewfinder while the subject can monitor the screen.

The image appears mirror reversed (LCD MIRROR ON). However, you can choose to display the image as it is being recorded (LCD MIRROR OFF).

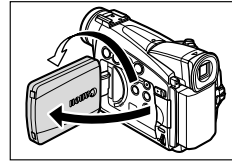

CAMERA

PLAY (VCR)

CARD CAMERA

CARD PLAY

**MENU**

( 38 )

DISPLAY SETUP /

▶ LCD MIRROR...ON

1. Press the MENU button to open the menu.

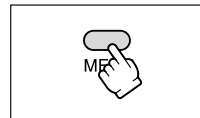

2. Turn the SET dial to select [DISPLAY SETUP/ ] and press the SET dial.
3. Turn the SET dial to select [LCD MIRROR] and press the SET dial.
4. Turn the SET dial to select [OFF].
5. Press the MENU button to close the menu.

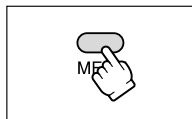
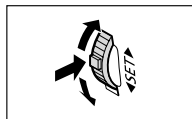

When [LCD MIRROR] is set to [ON], only tape (MV750i/MV730i: or card) operation and self-timer displays appear on the LCD screen (all displays appear on the viewfinder screen).

## Adjusting the Brightness of the LCD Screen

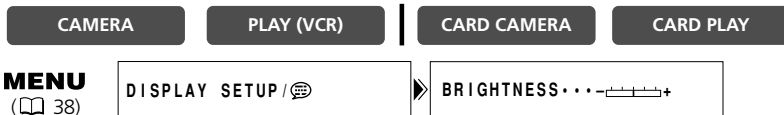

1. Press the MENU button to open the menu.

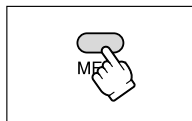

2. Turn the SET dial to select [DISPLAY SETUP/ ] and press the SET dial.
3. Turn the SET dial to select [BRIGHTNESS] and press the SET dial.
4. Turn the SET dial to adjust the brightness level.
5. Press the MENU button to close the menu.

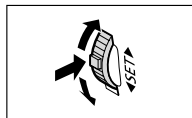

Changing the brightness of the LCD screen does not affect that of the viewfinder or the recordings.



## Screen Displays during Recording

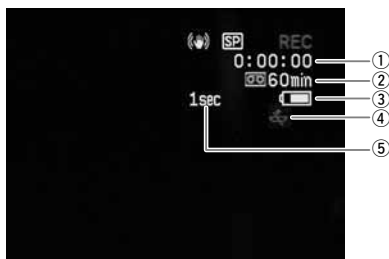

### ① Time code

Indicates the recording time in hours, minutes and seconds.

### ② Remaining tape

Indicates the remaining time of the tape in minutes. END flashes when the tape reaches the end.

- When the time left is less than 15 seconds, the remaining tape time may not appear.
- Depending on the type of the tape, the indication may not be displayed correctly.

### ③ Remaining battery charge

The battery symbol indicates the charge status of the battery pack.



- The battery symbol starts flashing in red when the battery pack is empty.
- When you attach an empty battery pack, the power may turn off without displaying the battery symbol.
- The actual battery charge may not be indicated accurately depending on the condition under which battery pack and camcorder are used.

### ④ When the battery icon flashes

The battery icon flashes in red when the lithium button battery is not installed, or when it runs out.

### ⑤ Recording reminder

The camcorder counts from 1 to 10 seconds when you start recording. This is helpful to avoid scenes that are too short.

## Searching and Reviewing when Recording

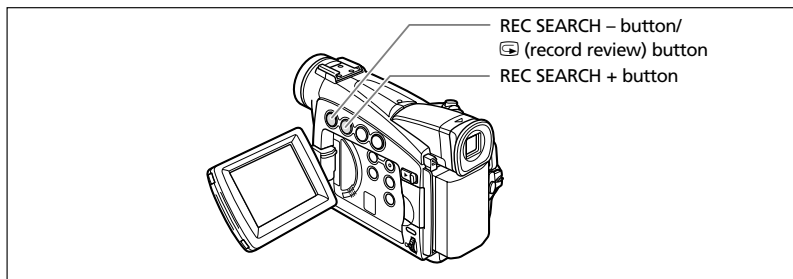

### Record Review

CAMERA

PLAY (VCR)

CARD CAMERA

CARD PLAY

In record pause mode, this function allows you to review the last few seconds of your recording to check if it has been recorded properly.

#### Press and release the ⏮ (record review) button.

The camcorder rewinds the tape, plays back the last few seconds, and returns to record pause mode.

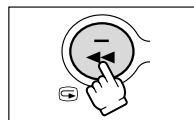

### Record Search

CAMERA

PLAY (VCR)

CARD CAMERA

CARD PLAY

In record pause mode, this function allows you to play back the tape (forward or reverse) to locate the point where you wish to begin recording.

#### Press and hold the REC SEARCH + button (forward) or - button (reverse).

- Release the button at the point you wish to begin recording.
- The camcorder returns to record pause mode.

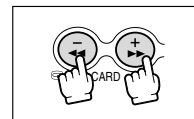

## Recording Still Images on a Tape

E

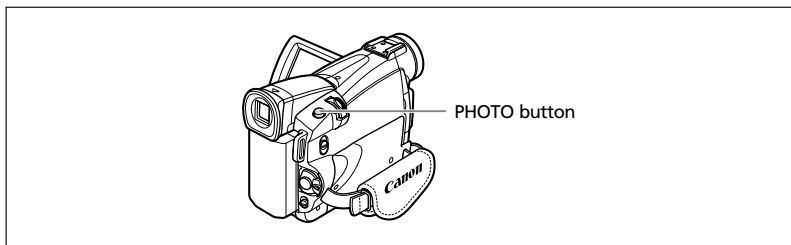

CAMERA

PLAY (VCR)

CARD CAMERA

CARD PLAY

1. **MV750i/MV730i** Open the menu and select [CAMERA SETUP]. Select [PHOTO REC], confirm that [TAPE ] is selected and close the menu.

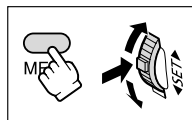

2. Press the PHOTO button halfway.

-  appears in green. If it does not appear in green, adjust the focus with the SET dial.
- Exposure is locked.
- **MV750i/MV730i** When you press the PHOTO button on the wireless controller, recording starts immediately.

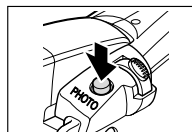

3. Press the PHOTO button fully.

-  disappears.
- The camcorder records the still image for approx. 6 seconds. During this time, the camcorder displays the still image and keeps recording the sound.
- The camcorder returns to record pause mode.

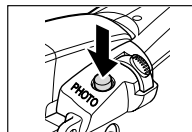

- You can also record a still image while you are recording a movie by pressing the PHOTO button fully.
- **MV750i/MV730i** Starting your recording with a still image allows you to easily locate the beginning of the recording with the Photo Search function ( 73).

Basic Functions -  
Recording

## Zooming

The camcorder automatically switches between optical zooming and digital zooming. Image resolution is slightly lower with the digital zoom.

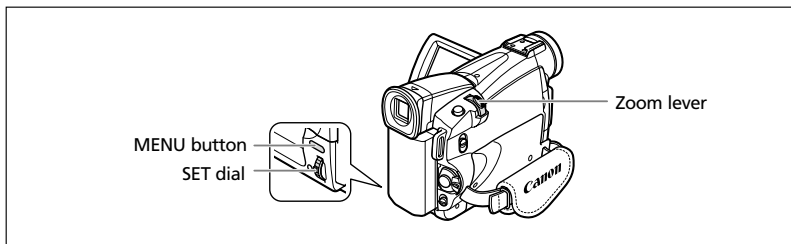
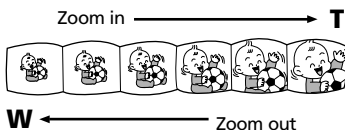

### Optical Zoom

<b>MV750i</b>	<b>MV730i</b>	<b>MV700i/MV700/MV690</b>
22× optical zoom	20× optical zoom	18× optical zoom

CAMERA

PLAY (VCR)

CARD CAMERA

CARD PLAY

Move the zoom lever toward **W** to zoom out (wide-angle). Move it toward **T** to zoom in (telephoto).

Press the zoom lever slightly for a slow zoom. Press harder for a faster zoom.

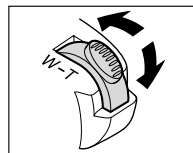

**MV750i/MV730i** You can also use the **T** and **W** buttons on the wireless controller. However, you cannot control the zoom speed.

## Digital Zoom

<b>MV750i</b>	<b>MV730i</b>	<b>MV700i/MV700/MV690</b>
88×/440× digital zoom (88× in CARD CAMERA mode)	80×/400× digital zoom (80× in CARD CAMERA mode)	72×/360× digital zoom

E



1. Press the **MENU** button to open the menu.

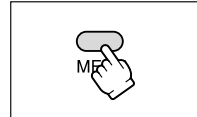

2. Turn the **SET** dial to select [**CAMERA SETUP**] and press the **SET** dial.

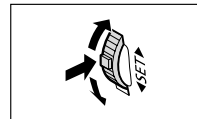

3. Turn the **SET** dial to select [**D.ZOOM**] and press the **SET** dial.

4. Turn the **SET** dial to select a setting option.

5. Press the **MENU** button to close the menu.

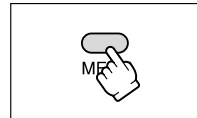

- Digital zoom cannot be used in the Night modes.
- Digital zoom cannot be used when the multi-image screen is selected.
- A zoom indicator appears for 4 seconds. It extends in light blue when the digital zoom is set to 88× (MV750i), 80× (MV730i) or 72× (MV700i/MV700/MV690), and extends further in dark blue when set to 440× (MV750i), 400× (MV730i) or 360× (MV700i/MV700/MV690).
- Keep at least 1 m to the subject. At wide-angle, you can focus on a subject as close as 1 cm.

# Tips for Making Better Videos

---

## **Holding the Camcorder**

For maximum stability, grip the camcorder in your right hand and keep your right elbow pressed against your body. If necessary, support the camcorder with your left hand. Be careful that your fingers do not touch the microphone or lens.



## **For More Stability**

Lean against a wall



Put the camcorder on a table

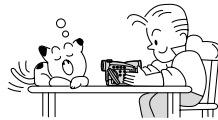

Lie on your elbow



Use a tripod



## **Lighting**

When recording outdoors, we recommend recording with the sun at your back.

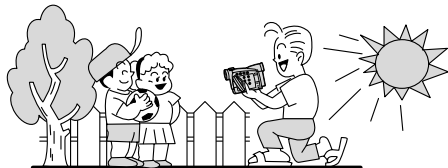

- When using a tripod, do not leave the viewfinder exposed to direct sunlight as it may melt (due to concentration of the light by the lens).
- Do not use tripods with fastening screws longer than 5.5 mm as it may damage the camcorder.

## Playing Back a Tape

If the playback picture is distorted, clean the video heads using a Canon Head Cleaning Cassette or a commercially available digital video head-cleaning cassette (□ 135).

E

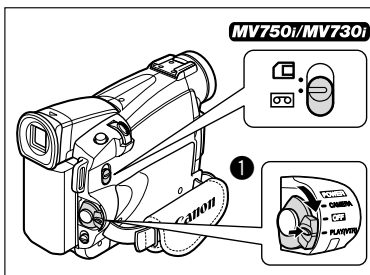

### 1. Set the camcorder to PLAY (VCR) mode.

- **MV750i/MV730i** Set the POWER switch to PLAY (VCR) and the TAPE/CARD switch to .
- **MV700i/MV700/MV690** Set the POWER switch to PLAY (VCR).



### 2. Open the LCD panel.

You can also close the LCD panel with the screen facing outward.

3. Press the  button to rewind the tape.
4. Press the  button to begin playback.
5. Press the  button to stop playback.

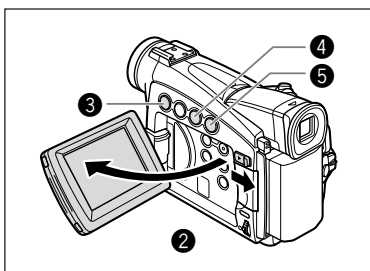

- To use the viewfinder, close the LCD panel. The built-in speaker does not sound. Use headphones when using the viewfinder.
- About the screen display: During playback, the time code gives the hours, minutes, seconds and frames. The remaining tape time may not appear when the time left is less than 15 seconds.

## Special Playback Modes

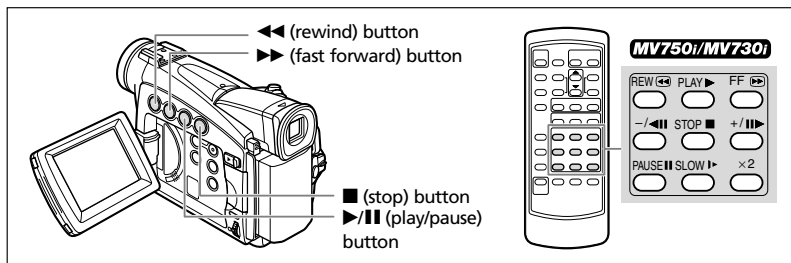

### ▶/|| (Playback Pause)

To pause playback, press the ▶/|| button during normal playback.

### ▶▶ (Fast Forward Playback) / ◀◀ (Rewind Playback)

Plays back the tape at 11.5 times normal speed (forward or reverse). Press and hold the button during normal playback or fast forward.

### MV750/MV730

### -/◀|| (Reverse Playback)

Press the button on the wireless controller during normal playback. Press the ▶ (play) button to return to normal playback.

### +/||▶ (Frame Advance) / -/◀|| (Frame Reverse)

Plays back frame-by-frame. Press the button on the wireless controller repeatedly during playback pause. Press and hold it to play back continuous frame advance/frame reverse.

### SLOW ▶ (Slow Forward)/(Slow Reverse)

Plays back at about 1/3 normal speed. Press the button on the wireless controller during normal or reverse playback. Press the ▶ (play) button to return to normal playback.

### × 2 (Forward ×2 Playback)/(Reverse ×2 Playback)

Plays back at 2 times normal speed. Press the button on the wireless controller during normal or reverse playback. Press the ▶ (play) button to return to normal playback.



- There is no sound during special playback.
- The picture may become distorted during some special playback modes.
- The camcorder stops the tape automatically after 5 minutes in playback pause mode to protect tape and video heads.



## Adjusting the Volume

When you use the LCD screen for playback, the camcorder plays back the sound via built-in speaker. The built-in speaker does not sound when you close the LCD panel.

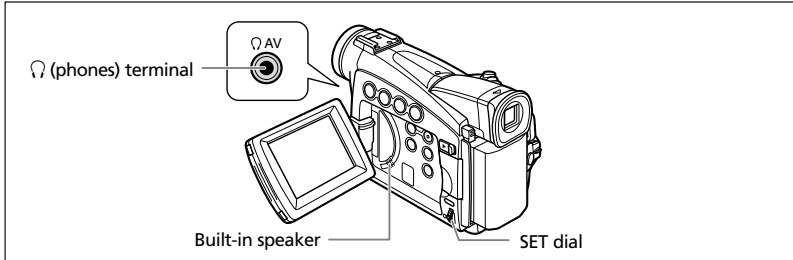

### When Using Headphones

The headphones terminal also serves as AV terminal. Headphones can only be used when "🎧" is displayed on the screen. If not, change the setting following the procedure below.



Open the menu and select [VCR SETUP]. Select [AV/PHONES 🎧], set it to [PHONES 🎧] and close the menu.



- The built-in speaker does not sound when "🎧" is displayed.
- Do not connect headphones unless "🎧" is displayed as it produces noise.

### Adjusting the Volume



Turn the SET dial up to increase the volume, and down to lower the volume.

- A volume bar appears for 2 seconds.
- You can turn off the volume completely by turning the SET dial down until [OFF] appears. Turn the SET dial up to increase the volume again.

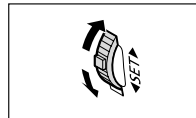

## Playing Back on a TV Screen

The AV terminal also serves as headphones terminal. When “🔊” is displayed on the screen, change the setting following the procedure below.



Open the menu and select [VCR SETUP]. Select [AV/PHONES 🔊], set it to [AV] and close the menu.

## TVs with SCART Terminal

Refer also to the TV or VCR instruction manual.

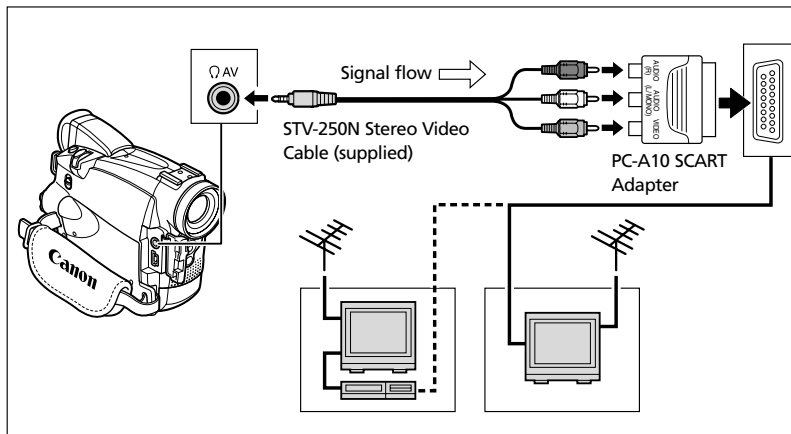

1. Turn off all devices before starting the connections.
2. Connect the PC-A10 SCART Adapter to the TV or VCR's SCART terminal.
3. Connect the STV-250N Stereo Video Cable to the camcorder's AV terminal and the audio/video terminals on the SCART Adapter.  
Connect the white plug to the white AUDIO terminal L (left), and the red plug to the red AUDIO terminal R (right) and the yellow plug to the yellow VIDEO terminal.
4. If connecting to a TV, set the input selector to VIDEO. If connecting to a VCR, set the input selector to LINE.



The supplied PC-A10 SCART Adapter is for output only. For analog line-in recording or analog-digital conversion, please use a SCART Adapter with input capability (commercially available).

## TVs with Audio/Video Terminals

Refer also to the TV or VCR instruction manual.

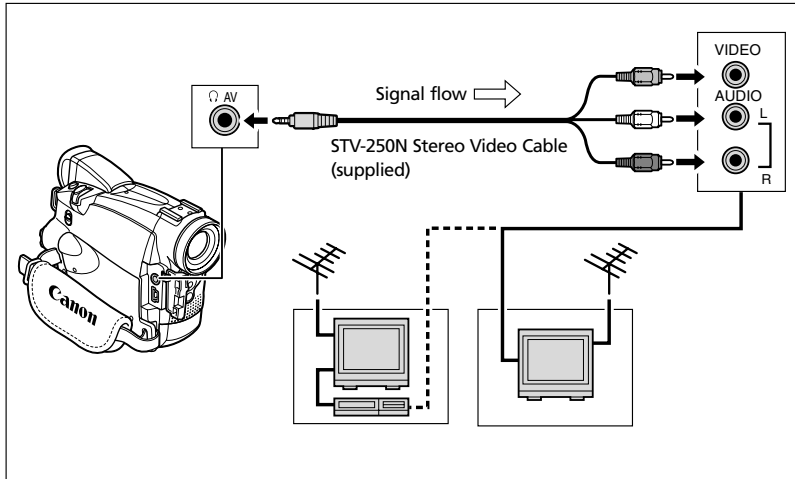

1. Turn off all devices before starting the connections.
2. Connect the STV-250N Stereo Video Cable to the camcorder's AV terminal and the audio/video terminals on the TV/VCR.  
Connect the white plug to the white audio terminal L (left), the red plug to the red audio terminal R (right) and the yellow plug to the yellow video terminal VIDEO.
3. If connecting to a TV, set the input selector to VIDEO. If connecting to a VCR, set the input selector to LINE.

E

Basic Functions -  
Playback

## **MV750** TVs with S (S1)-Video Input Terminal

Refer also to the TV or VCR instruction manual.

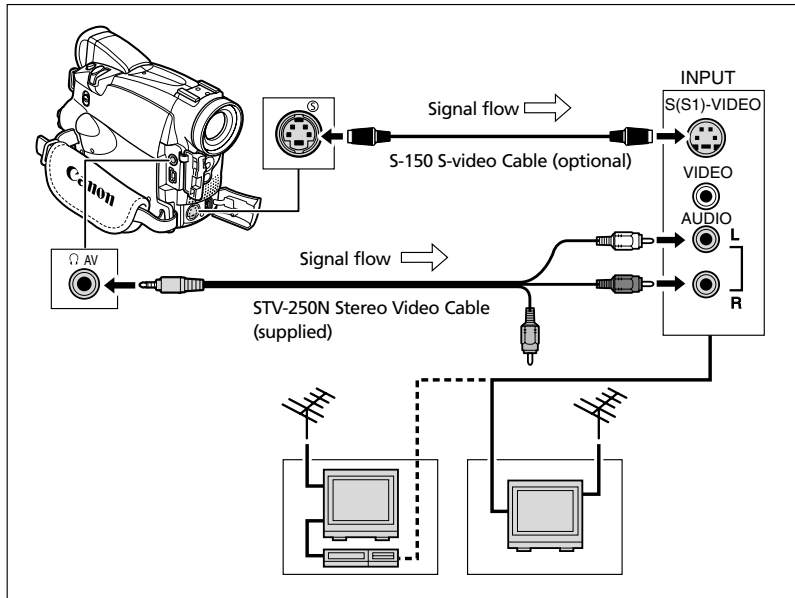

- 1. Turn off all devices before starting the connections.**
- 2. Connect the S-150 S-video Cable (optional) to the S-video terminals.**
- 3. Connect the STV-250N Stereo Video Cable to the camcorder's AV terminal and the audio terminals of the TV/VCR.**

Connect the white plug to the white AUDIO terminal L (left), and the red plug to the red AUDIO terminal R (right). Do not connect the yellow plug.

- 4. If connecting to a TV, set the input selector to VIDEO. If connecting to a VCR, set the input selector to LINE.**



- We recommend powering the camcorder from a household power source.
- **MV750** For high picture quality, we recommend using a TV with an S (S1) terminal.

## Selecting the Audio Output Channel

You can select the output channels when playing back a tape with audio recorded on two channels.



1. Press the MENU button to open the menu.

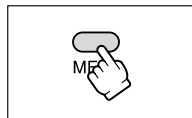

2. Turn the SET dial to select [AUTO SETUP] and press the SET dial.

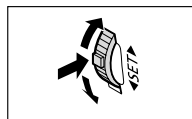

3. Turn the SET dial to select [OUTPUT CH] and press the SET dial.

4. Turn the SET dial to select a setting option.

- L/R: Stereo: L+R channels, Bilingual: Main+Sub.
- L/L: Stereo: L channel, Bilingual: Main.
- R/R: Stereo: R channel, Bilingual: Sub.

5. Turn the SET dial to select a setting option.

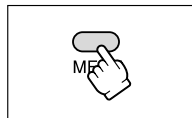

The setting resets to the L/R setting when you turn the camcorder off.

## Menus and Settings

Many of the camcorder's advanced functions are selected from menus that appear on the screen.

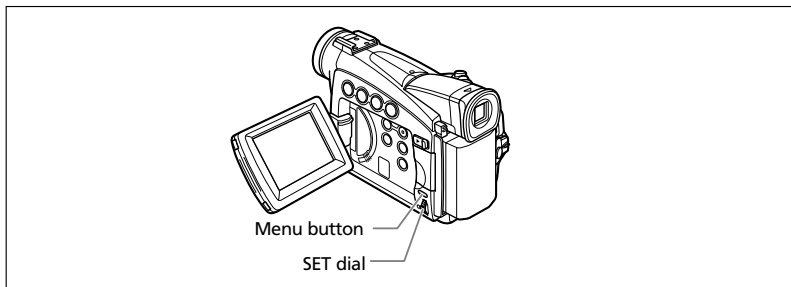

### Selecting Menus and Settings

1. Press the MENU button to open the menu.

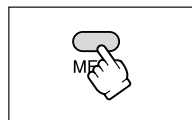

2. Turn the SET dial to select a submenu and press the SET dial.

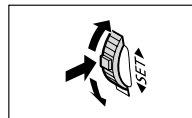

3. Turn the SET dial to select a menu item and press the SET dial.

4. Turn the SET dial to select a setting option.

5. Press the MENU button to close the menu.

When setting the white balance or shutter speed, press the SET dial first before pressing the MENU button.

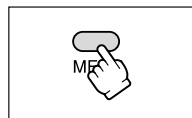

















- Pressing the MENU button at any time closes the menu.
- Items that are not available appear in purple.
- **MV750i/MV730i** You may find it more convenient to use the wireless controller to operate the menu. Press the MENU button on the wireless controller to open or close the menu. Use the select buttons in place of the SET dial and press the SET button in place of pressing the SET dial.

## Menu and Default Settings

Default settings are shown in boldface.

### CAMERA MENU

Submenu	Menu Item	Setting Options		
→CARD MIX*	MIX TYPE	<b>CARD CHROMA</b> , <b>CARD LUMI.</b> , <b>CAM. CHROMA</b> , <b>C. ANIMATION</b>	111	
	ANIMAT. TYPE	<b>CORNER</b> , <b>STRAIGHT</b> , <b>RANDOM</b>		
	MIX LEVEL			
CAMERA SETUP	SHUTTER	<b>AUTO</b> , 1/50, 1/120, 1/250, 1/500, 1/1000, 1/2000	55	
	D. ZOOM	MV750i	29	
		MV730i		
		OFF, <b>88x</b> , 440x	OFF, <b>80x</b> , 400x	OFF, <b>72x</b> , 360x
	A.SL SHUTTER	<b>ON</b> , OFF	56	
	IMG STAB (📷)	<b>ON</b> , OFF	78	
	16:9	<b>ON</b> , OFF	77	
	WHITE BAL.	<b>AUTO</b> , SET  , <b>INDOOR</b>  , <b>OUTDOOR</b> 	53	
	NIGHT MODE**	 <b>NIGHT</b> ,  <b>NIGHT+</b> ,  <b>S.NIGHT</b>	48	
	SKIN DETAIL	SOFT, <b>NORMAL</b>	49	
PHOTO REC*	<b>TAPE</b>  , <b>CARD</b> 	97		
VCR SETUP	REC MODE	<b>SP</b> , LP	58	
	AV/PHONES 	<b>AV</b> , PHONES 	60	
AUDIO SETUP	WIND SCREEN	<b>ON</b> , OFF	59	
	AUDIO MODE	16bit, <b>12bit</b>	59	
	 VOLUME		60	
DISPLAY SETUP/ 	BRIGHTNESS		24	
	LCD MIRROR	<b>ON</b> , OFF	23	
	TV SCREEN	<b>ON</b> , OFF	128	
	D/T DISPLAY	<b>ON</b> , OFF	21	
	LANGUAGE 	DEUTSCH, <b>ENGLISH</b> , ESPAÑOL, FRANÇAIS, ITALIANO, РУССКИЙ, 中文, 日本語	75	
	DATE FORMAT		75	
	DEMO MODE	<b>ON</b> , OFF	78	
SYSTEM	WL. REMOTE*	 <b>1</b> ,  <b>2</b> , OFF 	76	
	BEEP	<b>ON</b> , OFF	77	
	T.ZONE/DST	See list of time zones	19	
	D/TIME SET		19	

\* MV750i/MV730i only.

\*\* MV750i only.

E

Advanced Functions

Submenu	Menu Item	Setting Options	
MY CAMERA	S-UP IMAGE**	ON, OFF	74
	S-UP SOUND	MV750i/MV730i: OFF, <b>DEFAULT</b> , MY SOUND1, MY SOUND2  MV700i/MV700/MV690: OFF, <b>PATTERN1</b> , PATTERN2, PATTERN3	74
	SHTR SOUND*		
	OPER. SOUND		
	SELF-T SOUND		

\* MV750i/MV730i only.

\*\* MV700i/MV700/MV690 only.



## PLAY (VCR) MENU



Submenu	Menu Item	Setting Options	
VCR SETUP	REC MODE**	SP, LP	58
	AV/PHONES ( )	AV, PHONES ( )	33
	AV → DV OUT**	ON, OFF	84
AUDIO SETUP	OUTPUT CH	L/R, L/L, R/R	37
	AUDIO DUB.*	AUDIO IN, MIC. IN	88
	WIND SCREEN*	ON, OFF	59
	AUDIO MODE**	16bit, 12bit	59
	12bit AUDIO	STEREO1, STEREO2, MIX/FIXED, MIX/VARI.	89
	MIX BALLANCE		89
CARD SETUP*	IMG QUALITY	SUPER FINE, FINE, NORMAL	93
	MOVIE SIZE	320 × 240, 160 × 120	94
	FILE NOS.	RESET, CONTINUOUS	95
CARD OPERATIONS*	COPY ( ) → ( )	CANCEL, EXECUTE	115
DISPLAY SETUP/ ( )	BRIGHTNESS		24
	TV SCREEN	ON, OFF	128
	DISPLAYS	ON, OFF <PLAYBK>	128
	6SEC. DATE	ON, OFF	70
	DATA CODE	DATE/TIME, CAMERA DATA, CAM. & D/T	69
	D/TIME SEL.	DATE, TIME, DATE & TIME	69
	LANGUAGE ( )	DEUTSCH, ENGLISH, ESPAÑOL, FRANÇAIS, ITALIANO, РУССКИЙ, 中文, 日本語	75
	DATE FORMAT		75
SYSTEM	WL. REMOTE*	( ) 1, ( ) 2, OFF ( )	76
	BEEP	ON, OFF	77
	T.ZONE/DST	See list of time zones	19
	D/TIME SET		19

\* MV750i/MV730i only.

\*\* MV750i/MV730i/MV700i only.

E

Advanced Functions

Submenu	Menu Item	Setting Options	
MY CAMERA	S-UP IMAGE**	ON, OFF	74
	S-UP SOUND	MV750i/MV730i: OFF, <b>DEFAULT</b> , MY SOUND1, MY SOUND2  MV700i/MV700/MV690: OFF, <b>PATTERN1</b> , PATTERN2, PATTERN3	74
	SHTR SOUND*		
	OPER. SOUND		
	SELF-T SOUND		

\* MV750i/MV730i only.

\*\* MV700i/MV700/MV690 only.

## MV750i/MV730i CARD CAMERA MENU

CAMERA

PLAY (VCR)

CARD CAMERA

CARD PLAY

E

Submenu	Menu Item	Setting Options	
CAMERA SETUP	SHUTTER	AUTO, 1/50, 1/120, 1/250	55
	D.ZOOM	MV750i OFF, 88×	29
		MV730i OFF, 80×	
	WHITE BAL.	AUTO, SET  , INDOOR  , OUTDOOR	53
	FOCUS PRI.	ON, OFF	103
	NIGHT MODE	NIGHT,  NIGHT+,  S.NIGHT	48
	SKIN DETAIL	SOFT, NORMAL	49
REVIEW	OFF, 2sec, 4sec, 6sec, 8sec, 10sec	100	
CARD SETUP	IMG QUALITY	SUPER FINE, FINE, NORMAL	93
	IMAGE SIZE	1024 × 768, 640 × 480	93
	MOVIE SIZE	320 × 240, 160 × 120	94
	FILE NOS.	RESET, CONTINUOUS	95
VCR SETUP	AV/PHONES	AV, PHONES	60
AUDIO SETUP	WIND SCREEN	ON, OFF	59
	VOLUME		60
DISPLAY SETUP/ 	BRIGHTNESS		24
	LCD MIRROR	ON, OFF	23
	TV SCREEN	ON, OFF	128
	D/T DISPLAY	ON, OFF	21
	LANGUAGE	DEUTSCH, ENGLISH, ESPAÑOL, FRANÇAIS, ITALIANO, РУССКИЙ, 中文, 日本語	75
	DATE FORMAT		75
	DEMO MODE	ON, OFF	78
SYSTEM	WL. REMOTE	1, 2, OFF	76
	BEEP	ON, OFF	77
	T.ZONE/DST	See list of time zones	19
	D/TIME SET		19
MY CAMERA	S-UP SOUND	OFF, DEFAULT, MY SOUND1, MY SOUND2	74
	SHTR SOUND		
	OPER. SOUND		
	SELF-T SOUND		

Advanced Functions

**MV750i/MV730i** CARD PLAY MENU

CAMERA

PLAY (VCR)

CARD CAMERA

CARD PLAY

Submenu	Menu Item	Setting Options	
CARD OPERATIONS (Single Image Display)	COPY [  →  ]	CANCEL, EXECUTE	116
	PRINT ORDERS ALL ERASE	NO, YES	127
	IMAGE ERASE	CANCEL, SINGLE, ALL	110
	FORMAT	CANCEL, EXECUTE	117
CARD OPERATIONS (Index Screen)	→ PROTECT		109
	→  PRINT ORDER		126
VCR SETUP	REC MODE	SP, LP	58
	AV/PHONES	AV, PHONES	33
DISPLAY SETUP/ 	BRIGHTNESS		24
	TV SCREEN	ON, OFF	128
	DISPLAYS	ON, OFF <PLAYBK>	128
	D/TIME SEL.	DATE, TIME, DATE & TIME	69
	LANGUAGE	DEUTSCH, ENGLISH, ESPAÑOL, FRANÇAIS, ITALIANO, РУССКИЙ, 中文, 日本語	75
	DATE FORMAT		75
SYSTEM	WL. REMOTE	1, 2, OFF	76
	BEEP	ON, OFF	77
	T.ZONE/DST	See list of time zones	19
	D/TIME SET		19
MY CAMERA	CREATE START-UP IMAGE		119
	SEL. S-UP IMG	NO IMAGE, CANON LOGO, MY IMAGE1, MY IMAGE2	75
	S-UP SOUND	OFF, DEFAULT, MY SOUND1, MY SOUND2	75
	SHTR SOUND		
	OPER. SOUND		
SELF-T SOUND			
→  PRINT	Appears when connecting a printer with direct print function.		127

# Using the Recording Programs

## Easy Recording Program

The camcorder adjusts focus, exposure and other settings automatically, allowing you to just point and shoot.



## Program AE Modes

### **Auto**

The camcorder adjusts focus, exposure and other settings automatically. However, you have the option of adjusting the settings manually.



### **Sports**

Use this mode to record sports scenes (such as tennis or golf) or moving objects (such as roller coasters).



### **Portrait**

Use this mode to give accent to your subject by blurring the background or foreground. The blur effect increases the more you zoom to telephoto.



### **Spotlight**

Use this mode to record spotlit scenes or fireworks.



### **Sand & Snow**

Use this mode in bright places such as a sunny beach or ski resort. It prevents the subject from being underexposed.



### **Low Light**

Use this mode to record in dimly lit places.



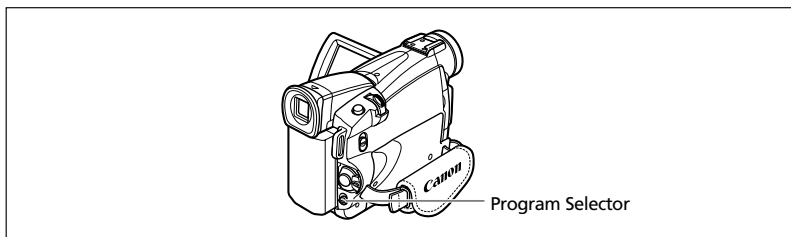

### Availability of Functions in Each Mode:

Recording Program	<input type="checkbox"/>	<b>A</b>					
Digital Zoom	<input type="radio"/>						<input type="radio"/>
Image Stabilizer	ON						<input type="radio"/>
Focus	A						<input type="radio"/>
White Balance	A						<input type="radio"/>
Shutter Speed	A	<input type="radio"/>				A	
AE Shift	×		<input type="radio"/>			×	<input type="radio"/>
Digital Effects	×						<input type="radio"/>
16:9	×						<input type="radio"/>
Card Mix*	×						<input type="radio"/>

A: Auto setting    : Available    : Not available

**Shaded area** : Can be used only in CAMERA mode.

\* MV750i/MV730i only.

### Selecting the Easy Recording Program



Set the program selector to .

appears.

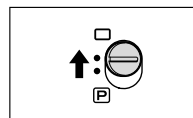

## Selecting the Program AE Mode

CAMERA

PLAY (VCR)

CARD CAMERA

CARD PLAY

E

### 1. Set the program selector to .

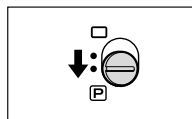

### 2. Press the SET dial.

A list of the program AE modes appears.

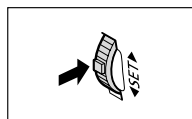

### 3. Select a mode and press the SET dial.

The symbol of the mode appears on the upper left corner of the screen.

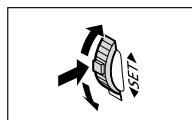

- The setting resets to the Auto mode when you change the position of the program selector.
- Do not change the mode during recording as the brightness of the image may change abruptly.
- Sports/Portrait mode:
  - The picture may not appear smooth when played back.
- Sand & Snow mode:
  - The subject may become overexposed in dark surroundings. Check the image on the screen.
  - The picture may not appear smooth when played back.
- Low Light mode:
  - Moving subjects may leave a trailing afterimage.
  - Picture quality may not be as good as in other modes.
  - The camcorder may have difficulty to focus automatically.

## Using the Night Modes

NIGHT	Allows you to record in dark places where lights cannot be used, without sacrificing color.
<b>MV750i</b> NIGHT+	The assist lamp (white LED) lights up and stays on.
<b>MV750i</b> SUPER NIGHT	Allows you to record in very dark places. The assist lamp (white LED) lights up automatically responding to the surrounding brightness.

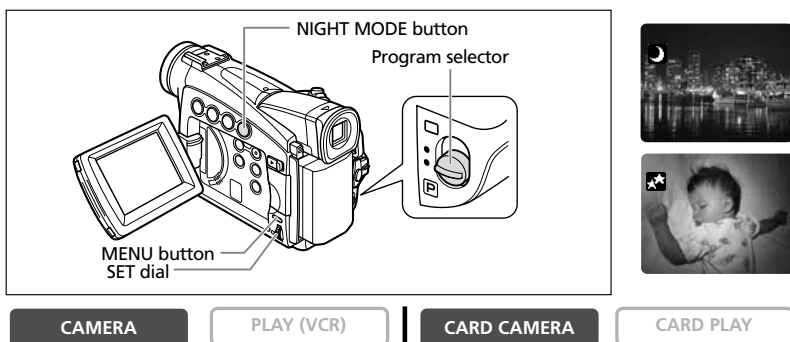

### **MV750i**

1. Set the program selector to **[P]**.
2. Open the menu and select **[CAMERA SETUP]**. Select **[NIGHT MODE]**, select a setting option and close the menu.
3. Press the **NIGHT MODE** button.
  - The symbol of the selected mode appears on the screen.
  - Pressing the NIGHT MODE button again resets the camcorder to the Auto mode.

### **MV730i/MV700i/MV700/MV690**

1. Set the program selector to **[P]**.
2. Press the **NIGHT MODE** button.
  - "**[Moon]**" appears.
  - Pressing the NIGHT MODE button again resets the camcorder to the Auto mode.



- Moving subjects may leave a trailing afterimage.
- Picture quality may not be as good as in other modes.
- White points may appear on the screen.
- Autofocus may not work as well as in other modes. In such case, adjust the focus manually.
- Digital zoom and multi-image screen cannot be used while a Night mode is activated.
- The program AE mode cannot be changed while a Night mode is activated.



## Skin Detail Function

---

The camcorder detects skin tones and adjusts the picture for a more smooth and natural appearance of the skin area.

E

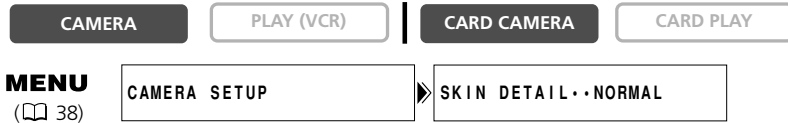

Open the menu and select [CAMERA SETUP]. Select [SKIN DETAIL], set it to [SOFT] and close the menu.



- Skin detail function cannot be used when the program selector is set to □.
- To obtain the best effect, use this function when recording a person in close-up. Note that areas similar to the skin color may lack in detail.

## Adjusting the AE Shift

You can adjust the AE (auto exposure) function to lighten or darken the image. This allows you to compensate for backlit or overexposed scenes. Available Levels: -2 to +2, in 0.25 intervals (excluding -1.75 and +1.75).

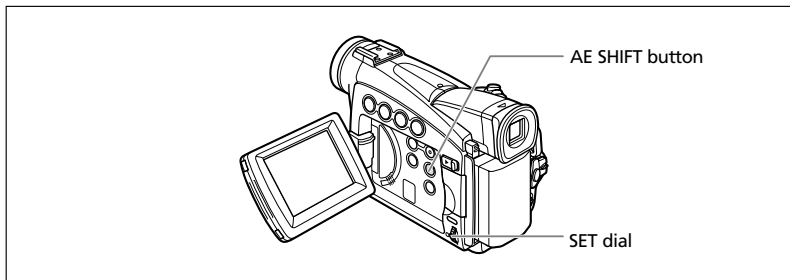

CAMERA

PLAY (VCR)

CARD CAMERA

CARD PLAY

1. Set the program selector to .

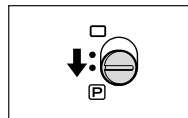

2. Set the program AE mode to  Auto,  Sports,  Portrait or  Low Light mode.

3. Press the AE SHIFT button.

"AE ±0" appears in light blue.

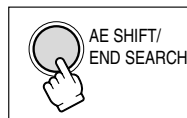

4. Turn the SET dial to adjust the AE shift level.

- Turn the SET dial up to lighten the image and down to darken image.
- If "MF" is displayed in light blue, AE shift cannot be adjusted. Press the AE SHIFT button again to display "AE ±0" in light blue.

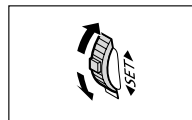

The camcorder retains the setting even if you turn it off or change the program AE mode.

# Adjusting the Focus Manually

Autofocus may not work well on the following subjects. In such case, focus manually.

E

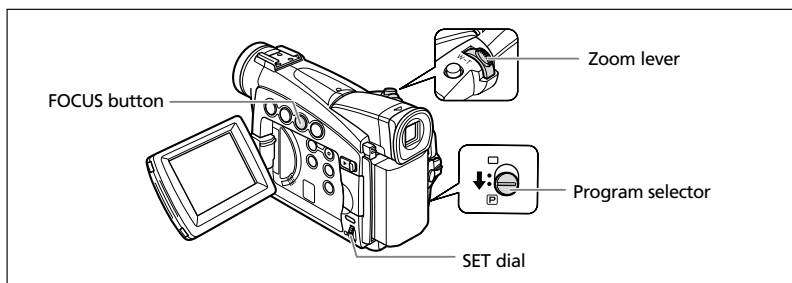
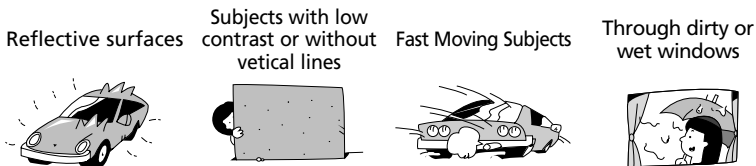

CAMERA

PLAY (VCR)

CARD CAMERA

CARD PLAY

1. Set the program selector to .

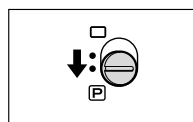

2. Adjust the zoom.

When you operate the zoom after adjusting the focus, the subject may not stay in focus. Adjust the zoom before the focus.

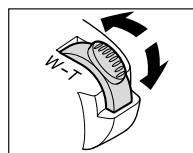

3. Press the FOCUS button.

"MF" appears.

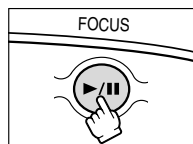

4. Turn the SET dial to adjust the focus.

- Turn the SET dial up or down until the image appears focused.
- Press the FOCUS button to return to autofocus.

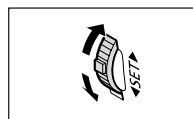



- The setting resets to autofocus when you switch the program selector to .
- Readjust the focus when you have turned off the camcorder.

## **Infinity Focus**

---

Use this function when you wish to focus on faraway subjects such as mountains or fireworks.

**Press the FOCUS button more than 2 seconds after step 2 in *Adjusting the Focus Manually*.**



"MF ∞" appears.





When you operate the zoom or turn the SET dial, "∞" disappears and the camcorder changes to manual focus.

## Setting the White Balance

You can use the preset modes to reproduce colours more accurately, or set a custom white balance to obtain the optimal setting.

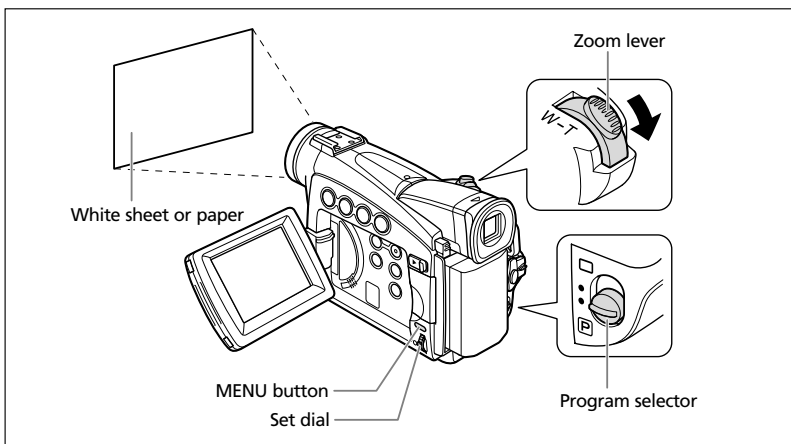
AUTO	Auto white balance
SET 	Custom white balance setting
INDOOR 	Use this mode for recording under changing lighting condition, video lights or sodium lamps.
OUTDOOR 	Use this mode for recording night scenes, fireworks, sunrise or sunset.



1. Set the program selector to **P**.
2. For custom white balance: Point the camcorder at a white object and zoom in until it fills the whole screen.  
Keep the camcorder zoomed at the white object until step 4 is completed.
3. Open the menu and select **[CAMERA SETUP]**. Select **[WHITE BAL.]**, select a setting option and close the menu.  
When you have selected **[SET **]: "****" flashes and stops flashing when settings is complete.
4. Close the menu.



- Use the auto setting for normal outdoor scenes.
- When the program selector is set to , white balance is preset to [AUTO].
- The camcorder retains the custom white balance setting even if you turn it off.  
MV750i/MV730i: However, it resets to [AUTO] when you change the position of the TAPE/CARD switch.
- When you have set the custom white balance:
  - Depending on the light source, “” may keep flashing. The result will still be better than with the auto setting.
  - Reset the white balance when the lighting condition changes.
  - Turn off the digital zoom.
- Custom white balance may provide better results in the following cases:
  - Changing lighting conditions
  - Close-ups
  - Subjects in a single colour (sky, sea or forest)
  - Under mercury lamps or certain types of fluorescent lights

# Setting the Shutter Speed

You can adjust the shutter speed manually to make stable shots of fast moving subjects.

E



1. Set the program selector to **P**.
2. Set the program AE mode to the **A** (Auto) mode.
3. Open the menu and select [CAMERA SETUP].
4. Select [SHUTTER].
5. Select the shutter speed and press the SET dial.

CAMERA Mode	<b>MV750i/MV730i</b> CARD CAMERA Mode
AUTO	AUTO
1/50	1/50
1/120	1/120
1/250	1/250
1/500	
1/1000	
1/2000	

## 6. Close the menu.



- **MV750i/MV730i** If the shutter speed is set to 1/500 or higher in CAMERA mode and you switch to CARD CAMERA mode, it automatically changes to 1/250.
- Do not point the camcorder directly at the sun when the shutter speed is set to 1/1000 or higher.
- The image may flicker when recording with high shutter speeds.
- The setting resets to the auto setting when you switch the program selector to **P**, or change the program AE mode.
- Guidelines for Recording with High Shutter Speeds:
  - Outdoor sports such as golf or tennis: 1/2000
  - Moving objects such as cars or roller coasters: 1/1000, 1/500 or 1/250
  - Indoor sports such as basketball: 1/120

## Auto Slow Shutter

---

In Easy Recording mode and when [SHUTTER] is set to [AUTO] in Auto mode, the camcorder uses shutter speeds down to 1/25. This allows you to record brightly in places with insufficient lighting. However, you can set the camcorder not to use the slow shutter speed of 1/25.



Open the menu and select [CAMERA SETUP]. Select [A.SL SHUTTER], set it to [OFF] and close the menu.



When set to [ON], moving subjects may leave a trailing afterimage.



# Using the Self-Timer

The self-timer can be used for recording movies and still images.

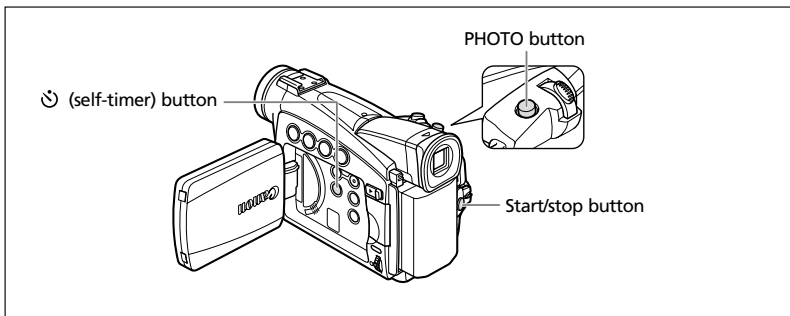

CAMERA

PLAY (VCR)

CARD CAMERA

CARD PLAY

## When recording movies

### 1. Press the (self-timer) button.

" (self-timer) " appears.

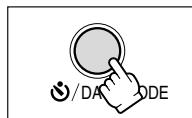

### 2. Press the start/stop button.

- The camcorder starts recording after a 10-second countdown (MV750i/MV7300i: 2 seconds when using the wireless controller). The count down appears on the screen.
- To record a still image, press the PHOTO button ( 27).

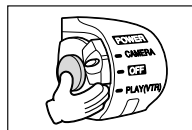

- To cancel the self-timer, press the (self-timer) button. Once the countdown has begun, you can also press the start/stop button (when recording movies) or the PHOTO button (when recording still image) to cancel the self-timer.
- The self-timer will be cancelled when you turn off the camcorder.

E

Advanced Functions -  
Recording

## Changing the Recording Mode (SP/LP)

You can choose between SP (standard play) and LP (long play). LP extends the tape usage by 1.5 times.

CAMERA

PLAY (VCR) \*

CARD CAMERA

CARD PLAY

\* MV750i/MV730i/MV700i only.

**MENU**



( 38)

VCR SETUP

▶ REC MODE.....SP

To change to LP mode, open the menu and select [VCR SETUP]. Select [REC MODE], set it to [LP] and close the menu.



- **MV750i/MV730i** Tapes recorded in LP mode cannot be used for audio dubbing ( 88) or AV insert ( 86).
- Depending on the nature and usage condition of the tape, picture and sound recorded in LP mode may be distorted. We recommend using the SP mode for important recordings.



- If you record in both SP and LP modes on the same tape, the playback picture may become distorted and the time code may not be written correctly.
- If you play back a tape that has been recorded in LP mode with another digital device on this camcorder, or vice versa, picture and sound may become distorted.

# Audio Recording

## Changing the Audio Mode

You can record sound in two audio modes—16-bit and 12-bit. The 12-bit mode records sound on two channels (stereo 1), leaving 2 channels free (stereo 2) for adding new sound later. Select the 16-bit mode for higher sound quality.



\* MV750i/MV730i/MV700i only.

**MENU**  
( 38)



Open the menu and select [AUDIO SETUP]. Select [AUDIO MODE], set it to [16bit] and close the menu.

“16bit” appears for approximately 4 seconds.

## Wind Screen

You can reduce the wind noise when recording in windy places.



\* MV750i/MV730i only.

**MENU**  
( 38)



Open the menu and select [AUDIO SETUP]. Select [WIND SCREEN], set it to [ON] and close the menu.

“WS ON” appears when you turn the wind screen on.



- Low sound may be reduced together with the wind noise. We recommend turning off the wind screen for normal recordings.
- **MV750i/MV730i** The wind screen function can also be used for audio dubbing (when [AUDIO DUB.] is set to [MIC. IN] in the [AUDIO SETUP] submenu).

## Using Headphones during Recording

The headphones terminal also serves as AV terminal. Headphones can only be used when "🎧" is displayed on the screen. If not, change the setting following the procedure below.



Open the menu and select [VCR SETUP]. Select [AV/PHONES 🎧], set it to [PHONES 🎧] and close the menu.

### Adjusting the Headphone Volume



Open the menu and select [AUDIO SETUP]. Select [🎧 VOLUME], adjust the volume with the SET dial and close the menu.





You can turn off the volume completely by turning the SET dial down until [OFF] appears. Turn the SET dial up to increase the volume again.

# Using Digital Effects

## Faders (📖 64)

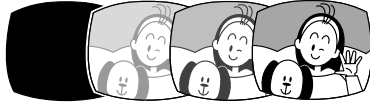
Begin or end scenes with a fade to or from black.

E





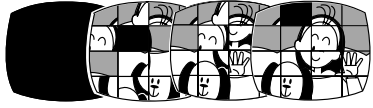
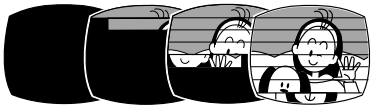
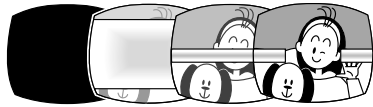
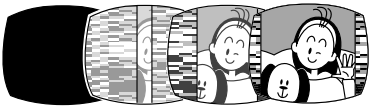

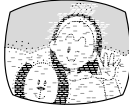

<p><b>Fade Trigger (FADE-T)</b></p> 	<p>The image gradually fades in.</p>
<p><b>Wipe (WIPE)</b></p> 	<p>The image gradually fades out.</p> <p>The image begins as a vertical line in the centre and expands sideways until it fills the whole screen.</p> <p>The image is wiped off from the sides of the screen.</p>
<p><b>Corner Wipe (CORNER)</b></p> 	<p>The image appears from the corners until it fills the whole screen.</p> <p>The image is wiped off from the corners.</p>
<p><b>Jump (JUMP)</b></p> 	<p>A small image appears from the left, jumps into the centre and enlarges until it fills the whole screen.</p> <p>The image shrinks, jumps from the centre to the left and disappears.</p>
<p><b>Flip (FLIP)</b></p> 	<p>The image flips into the screen.</p> <p>The image flips out of the screen.</p>

Advanced Functions -  
Recording

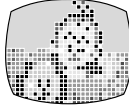
<p><b>Puzzle (PUZZLE)</b></p> 	<p>The image appears in 16 pieces. The pieces move around until the puzzle is solved.</p> <p>The image is divided into 16 pieces. The pieces move around and disappear.</p>
<p><b>Zigzag (ZIGZAG)</b></p> 	<p>The image appears in zigzag from the top of the screen.</p> <p>Black stripes appear in zigzag from the bottom of the screen until they cover the whole image.</p>
<p><b>Beam (BEAM)</b></p> 	<p>The screen turns yellow, forms a beam that becomes thinner and the image appears.</p> <p>A yellow beam appears in the centre of the screen and expands until it covers the whole image.</p>
<p><b>Tide (TIDE)</b></p> 	<p>The image appears from both sides like tides.</p> <p>The image disappears from both sides like tides.</p>

## Effects ( 65)

Add flavor to your recordings.

<p><b>Art (ART)</b> The image becomes like a paint (solarization).</p> 	<p><b>Black and White (BLK &amp; WHT)</b> The image becomes black and white.</p> 	<p><b>Sepia (SEPIA)</b> The image becomes monochrome with a brownish tint.</p> 
<p><b>Mosaic (MOSAIC)</b> The image is blurred through enlarging the size of some pixels.</p> 	<p><b>Ball (BALL)</b> The image becomes like a ball.</p> 	<p><b>Cube (CUBE)</b> The image becomes a cube and rotates.</p> 
<p><b>Wave (WAVE)</b> Both ends of the image sway in waves.</p> 	<p><b>Color Masking (COLOR M.)</b> The image becomes a rhombus surrounded by a masking frame that changes the colours.</p> 	<p><b>Mirror (MIRROR)</b> Creates a symmetrical image as if there would be a mirror in the centre of the screen.</p> 

E

Advanced Functions -  
Recording

## Multi-Image Screen ( 66)

Captures moving subjects in 4, 9 or 16 sequences of still images and displays them at one time. Sound will be recorded normally.

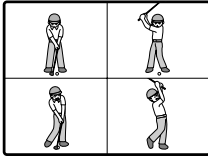
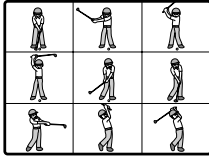
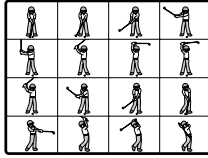
<p><b>4 Sequences</b></p> 	<p><b>9 Sequences</b></p> 	<p><b>16 Sequences</b></p> 
---	---	--

## Availability of Digital Effects by Operating Modes:

	CAMERA		PLAY (VCR)	<b>MV750i/MV730i</b>	<b>MV750i/MV730i</b>
	Movies	Still Images		CARD CAMERA	CARD PLAY
Faders	○	×	○	×	×
Effects	○	○	○	○*	×
Multi-image screen	○	○	○	×	×

○: Available    ×: Not available

\* : Black and White only.

## Selecting a Fader

In CAMERA mode, set the program selector to **P**.



### 1. Press the DIGITAL EFFECTS button.

[D.EFFECTS **OFF**], [FADER], [EFFECT] and [MULTI-S] appear.

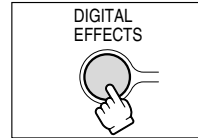

### 2. Select [FADER].

### 3. Select the fader option.

### 4. Press the DIGITAL EFFECTS button.

The name of the selected fader flashes.



CAMERA mode:

### 5. Fade in: In record pause mode, press the ON/OFF button and begin recording by pressing the start/stop button.

**Fade out:** During recording, press the ON/OFF button and pause recording by pressing the start/stop button.

The fader can be activated/deactivated by pressing the ON/OFF button.

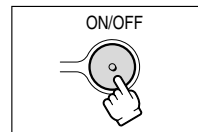

PLAY (VCR) mode:

### 5. Fade in: In playback pause mode, press the ON/OFF button and begin playback by pressing the ►/|| button.

**Fade out:** During playback, press the ON/OFF button and pause playback by pressing the ►/|| button.

The fader can be activated/deactivated by pressing the ON/OFF button.

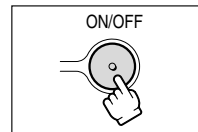



## Selecting an Effect

In CAMERA mode, set the program selector to **P**.

CAMERA

PLAY (VCR)

CARD CAMERA

CARD PLAY

E

### 1. Press the DIGITAL EFFECTS button.

[D.EFFECTS **OFF**], [FADER], [EFFECT] and [MULTI-S] appear.

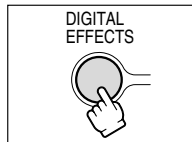

### 2. Select [EFFECT].

### 3. Select the effect.

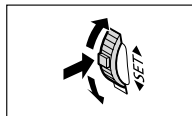

### 4. Press the DIGITAL EFFECTS button.

The name of the selected effect flashes.

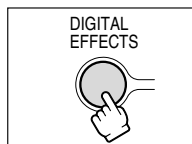

### 5. Press the ON/OFF button.

- The name of the selected effect stops flashing.
- The effect can be activated/deactivated by pressing the ON/OFF button.

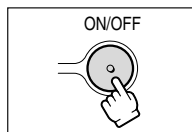

## **MV750i/MV730i** Selecting an Effect in CARD CAMERA Mode

CAMERA

PLAY (VCR)

CARD CAMERA

CARD PLAY

### 1. Press the DIGITAL EFFECTS button.

“BLK&WHT” flashes.

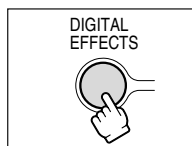

### 2. Press the ON/OFF button.

- “BLK&WHT” stops flashing.
- The effect can be activated/deactivated by pressing the ON/OFF button.

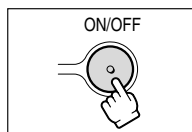

## Using the Multi-Image Screen

You can operate the multi-image screen only in the following playback modes:

- When [S.SPEED] is set to [MANUAL]: Playback pause, slow forward/reverse playback
- When [S.SPEED] is set to [FAST], [MOD.] or [SLOW]: Playback pause

In CAMERA mode, set the program selector to .

CAMERA

PLAY (VCR)

CARD CAMERA

CARD PLAY

### 1. Press the DIGITAL EFFECTS button.

[D.EFFECTS , [FADER], [EFFECT] and [MULTI-S] appear.

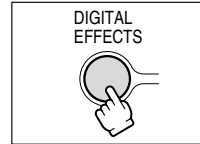

### 2. Select [MULTI-S].

[S.SPEED] and [S.SPLIT] appears.

### 3. Select [S.SPEED].

[MANUAL], [FAST], [MOD.] and [SLOW] appear.



### 4. Select the transition speed.

Following transition speeds can be selected: fast (every 4 frames), moderate (every 6 frames\*), slow (every 8 frames\*).

\* In Low Light mode: moderate (every 8 frames), slow (every 12 frames).

### 5. Select [MULTI-S] again.

[S.SPEED] and [S.SPLIT] appears.

### 6. Select [S.SPLIT].

[4], [9], [16] settings appear.

### 7. Select the number of sequences.

### 8. Press the DIGITAL EFFECTS button.

"MULTI-S" flashes.

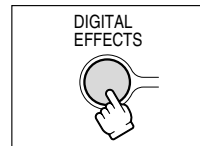

### 9. Press the ON/OFF button.

- MANUAL: Images will be captured each time you press the ON/OFF button. The blue frame indicating the next sequence disappears after the last image. To cancel the last captured image, press and hold the ON/OFF button. To cancel the multi-image screen, press and release the ON/OFF button.
- FAST, MODERATE, SLOW: The set number of images will be captured at the set speed. To cancel the multi-image screen, press the ON/OFF button.

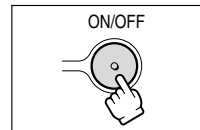

## 10. Press the start/stop button to begin recording.

The multi-image screen is recorded on the tape.



- Turn off the digital effect when you do not use it.  
Press the DIGITAL EFFECTS button to open the menu. Select [D.EFFECTS **OFF**] and press the DIGITAL EFFECTS button.
- The camcorder retains the setting even if you turn it off or change the program AE mode.
- Digital effects cannot be used when the program selector is set to .
- Digital effects cannot be used during DV dubbing and photo/date search.
- The digital effects can be operated in record or record pause mode.
- The multi-image screen cannot be used in the Night modes.
- The multi-image screen cannot be used when the 16:9 format is selected.
- **MV750/MV730** Faders and multi-image screen cannot be selected when Card Mix is activated.
- In PLAY (VCR) mode: Pressing any tape operation button (such as play or pause), or performing date/photo search cancels the multi-image screen.
- The image quality may be slightly lower with digital effects.

E

## Magnifying the Image

The playback image can be magnified up to 5 times.

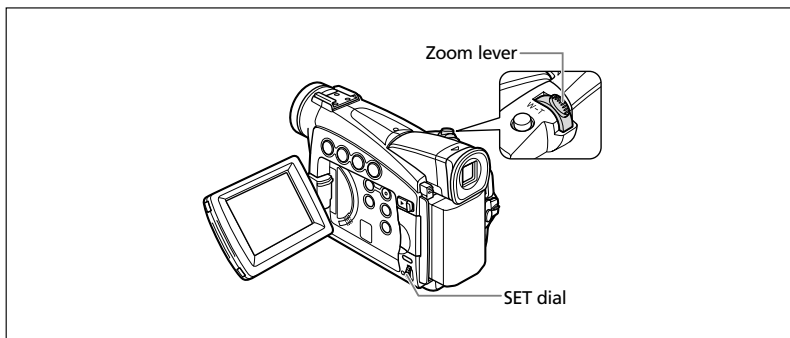

CAMERA

PLAY (VCR)

CARD CAMERA

CARD PLAY

### 1. Move the zoom lever toward **T**.

- The image is magnified by 2 times.
- A frame appears indicating the position of the magnified area.
- To further enlarge the image, move the zoom lever toward **T**.  
To shrink the image below 2 times magnification, move the zoom lever toward **W**.

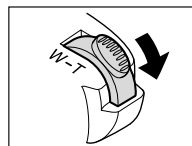

### 2. Selected the magnified area with the SET dial.

- Turn the SET dial to move the image to the right and left, or up and down. Pressing the SET dial switches between the directions.
- To cancel the magnification, move the zoom lever toward **W** until the frame disappears.

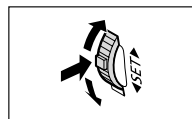

**MV750i/MV730i** Movies played back from a memory card cannot be magnified.

## Displaying the Data Code

The camcorder maintains a data code containing recording date and time and other camera data such as shutter speed and exposure (f-stop). When you play back a tape, you can display the data code and select the data code combination you wish to display.

E

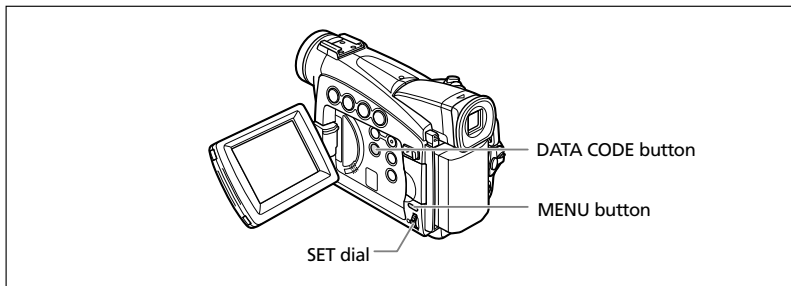

### Selecting the Date/Time Display Combination



Open the menu and select [DISPLAY SETUP/☺]. Select [D/TIME SEL.], set it to [DATE] or [TIME] and close the menu.

### Selecting the Data Code Display Combination



Open the menu and select [DISPLAY SETUP/☺]. Select [DATA CODE], set it to [CAMERA DATA] or [CAM. & D/T] and close the menu.

Advanced Functions -  
Playback

## Displaying the Data Code

---



Press the **DATA CODE** button.

---



- The data code display turns off when you turn the camcorder off.
- MV750i/MV730i** Only date and time appear in **CARD PLAY** mode.

## Six-Second Auto Date

---

Date and time appear for 6 seconds when you begin playback, or to indicate that date or time zone has changed.



**MENU**  
( 38)

DISPLAY SETUP /

▶▶ 6SEC.DATE . . . . OFF

Open the menu and select **[DISPLAY SETUP/ ]**. Select **[6SEC.DATE]**, set it to **[ON]** and close the menu.

## End Search

When you have played back a tape, you can use this function to locate the end of the last recorded scene.

E

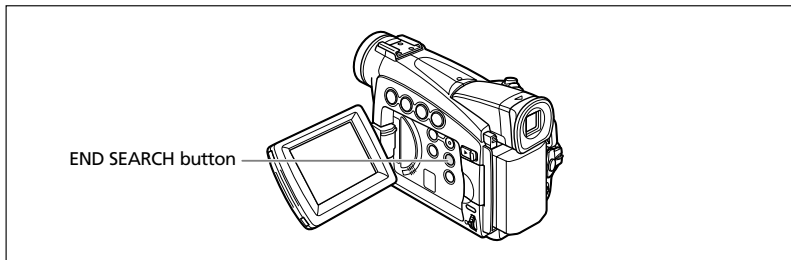

CAMERA

PLAY (VCR)

CARD CAMERA

CARD PLAY

**In stop mode, press the END SEARCH button.**

- "END SEARCH" appears.
- The camcorder rewinds/fast forwards the tape, plays back the last few seconds of the recording and stops the tape.
- Pressing the button again cancels the search.



- End search cannot be used once you unload the cassette.
- End search may not work properly if a blank section exists on the tape.
- **MV750i/MV730i** You cannot use end search to locate the editing end of AV insert or audio dubbing.

Advanced Functions -  
Playback

## **MV750i/MV730i** Returning to a Pre-marked Position

If you wish to return to a particular scene later, mark the point with the zero set memory and the tape will stop at that point when you rewind/fast forward the tape. This function is operated with the wireless controller.

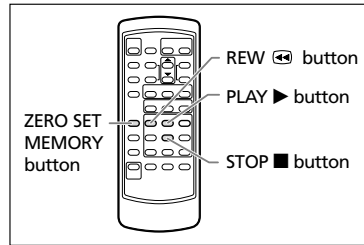

CAMERA

PLAY (VCR)

CARD CAMERA

CARD PLAY

### **1. Press the ZERO SET MEMORY button at the point you wish to return to later.**

- "0:00:00 **M**" appears.
- To cancel, press the ZERO SET MEMORY button again.

### **2. When you have finished playback, rewind the tape.**

- "◀◀ RTN" appears.
- The tape stops automatically at "0:00:00".
- The tape counter changes to time code.

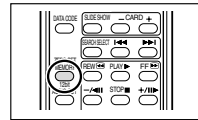

The zero set memory may not function correctly when the time code has not been recorded consecutively.



## MV750i/MV730i Photo Search/Date Search

You can search for a still image recorded anywhere on the tape with the photo search function, or locate the change of the date/time zone with the date search function. This function is operated with the wireless controller.

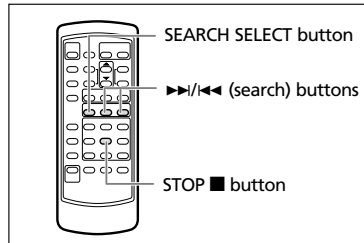

E

CAMERA

PLAY (VCR)

CARD CAMERA

CARD PLAY

### 1. Press the SEARCH SELECT button to choose between photo search and date search.

“PHOTO SEARCH” or “DATE SEARCH” appears.

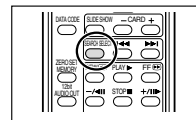

### 2. Press the ▶▶ or ◀◀ button to begin searching.

- Press more than once to search for further still images or date changes (up to 10 times).
- Press the STOP ■ button to stop searching.

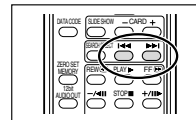

- Photo search: A still image recorded very close to the point you start the search may not be detected.
- Date search: A recording of longer than a minute per date/area is required.
- Date search may not function if the data code is not correctly displayed.

Advanced Functions -  
Playback

# Customizing the Camcorder

You can personalize your camcorder by customizing the start-up image and the sound it makes for start-up, shutter\*, operation and self-timer (collectively called the My Camera settings).

\* MV750i/MV730i only.

## Changing the My Camera Settings

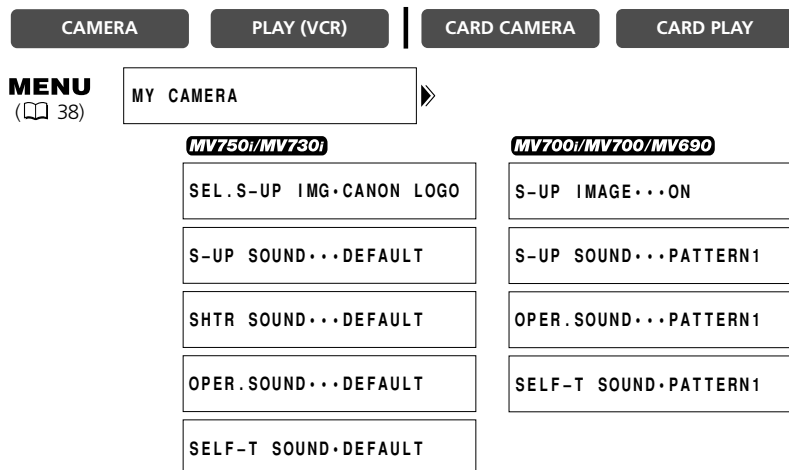

1. Open the menu and select [MY CAMERA].

2. Select the menu item you wish to change.

**MV750i/MV730i** When selecting a start-up image, set the camcorder to CARD PLAY mode.

3. Select a setting option and close the menu.



**MV750i/MV730i**

○ You can save your original images, or the images and sounds contained in the supplied software (ZoomBrowser EX for Windows or ImageBrowser for Macintosh) to the setting options [MY IMAGE1], [MY IMAGE2], [MY SOUND1] and [MY SOUND2]. For details, refer to the *Digital Video Software Instruction Manual*.

○ You can also create original start-up images (📖 119).

## Changing the Display Language

The language used in the camcorder displays and menu items can be changed to German, Spanish, French, Italian, Russian, Simplified Chinese or Japanese.

E



To change the display language, open the menu and select [DISPLAY SETUP/ [speech bubble icon]]. Select [LANGUAGE [speech bubble icon]], select a language and close the menu.



If you have mistakenly changed the language, follow the [speech bubble icon] mark next to the menu item to change the setting.

## Changing the Date Format

You can select between three date formats. For example, [1. JAN. 2004], [JAN. 1, 2004] and [2004. 1. 1].

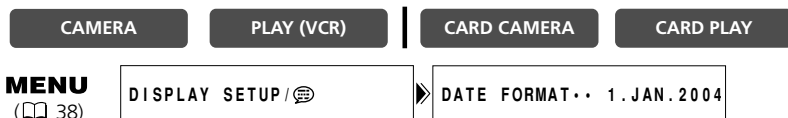

Open the menu and select [DISPLAY SETUP/ [speech bubble icon]]. Select [DATE FORMAT], select a format and close the menu.

## **MV750/MV730** Changing the Remote Sensor Mode

Two remote sensor modes and an off setting are available to prevent interference from other Canon wireless controllers being used nearby.

### Turning the Remote Sensor Off

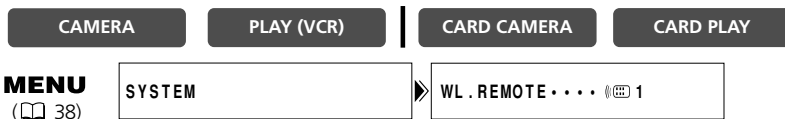

Open the menu and select [SYSTEM]. Select [WL. REMOTE], set it to [OFF (OFF)] and close the menu.

“(OFF)” appears.

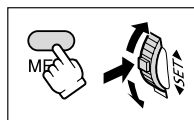

### Changing the Remote Sensor Mode

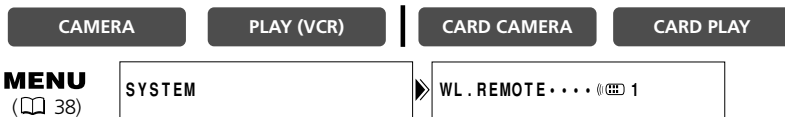

1. On the camcorder, open the menu and select [SYSTEM]. Select [WL. REMOTE], set it to [(1) 2] and close the menu.

The selected mode appears for a few seconds.

2. On the wireless controller, press and hold the REMOTE SET button. Press the ZOOM T button for mode 2. Keep the button pressed for over 2 seconds.

If you have set the camcorder to mode 1, press the ZOOM W button for mode 1.

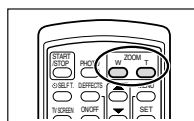
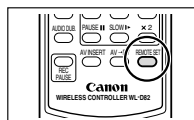
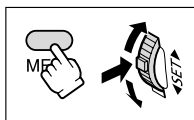

- The wireless controller returns to mode 1 when you replace the batteries. Change the mode if necessary.
- Make sure that camcorder and wireless controller are set to the same mode. Display the camcorder's mode by pressing any button on the wireless controller (except of the REMOTE SET button) and set the wireless controller's mode to the same mode. Change the batteries if the wireless controller still does not work.

## Other Camcorder Settings

E

### Beep

You will hear a beep upon camcorder operations such as power on/off, start/stop, self-timer countdown, and unusual conditions of the camcorder.

If you turn off the beep, all camcorder sounds including the ones of the My Camera settings will be turned off.

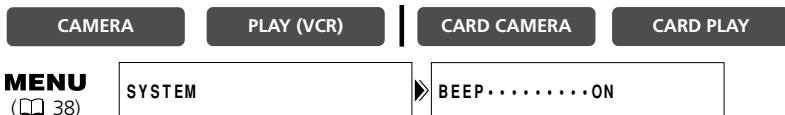

To turn the beep off, open the menu and select [SYSTEM]. Select [BEEP], set it to [OFF] and close the menu.

### Recording in 16:9 (Widescreen TV Recording)

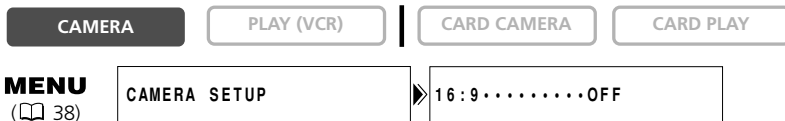

To switch 16:9 on, open the menu and select [CAMERA SETUP]. Select [16:9], set it to [ON] and close the menu.

“16:9” appears.



- The 16:9 mode is an electronically processed effect.
- The 16:9 mode cannot be selected in the Easy Recording mode.
- The multi-image screen cannot be used when the 16:9 format is selected.
- **MV750/MV730** Simultaneous recording on a memory card cannot be used when the 16:9 format is selected.
- If you play back a 16:9 recording on a normal TV, the image appears vertically “squashed” (compressed).

## Turning Off the Image Stabilizer

---

The image stabilizer compensates for camcorder shake even at full telephoto. The image stabilizer tries to compensate horizontal movements, therefore, we recommend turning off the image stabilizer when you mount the camcorder on a tripod.

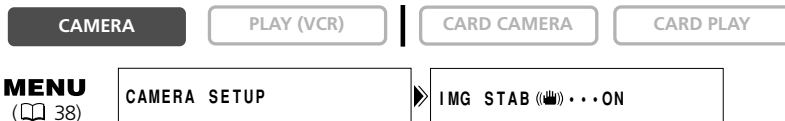

Open the menu and select [CAMERA SETUP]. Select [IMG STAB (👉)], set it to [OFF] and close the menu.

"(👉)" disappears.



- The image stabilizer cannot be turned off when the program selector is set to .
- The image stabilizer is designed to compensate a normal degree of camcorder shake.
- The image stabilizer might not be as effective when using the Night modes.

## Demonstration Mode

---

The demonstration mode displays the camcorder's main features. It starts automatically when you leave the camcorder turned on without loading a recording media for more than 5 minutes. However, you can set the camcorder not to start the demonstration mode.



Open the menu and select [DISPLAY SETUP/🗨️]. Select [DEMO MODE], set it to [OFF] and close the menu.



To cancel the demo mode once it has begun, press any button, turn off the camcorder or load a recording media.

## Recording to a VCR or Digital Video Device

You can copy your recordings by connecting the camcorder to a VCR or a digital video device. If you connect a digital video device, you can copy recordings with virtually no generation loss in image and sound quality.

E

### Connecting the Devices

#### ① Connecting a VCR

See *Playing Back on a TV Screen* ( 34).

#### ② Connecting a Digital Video Device

Refer also to the instruction manual of the digital video device.

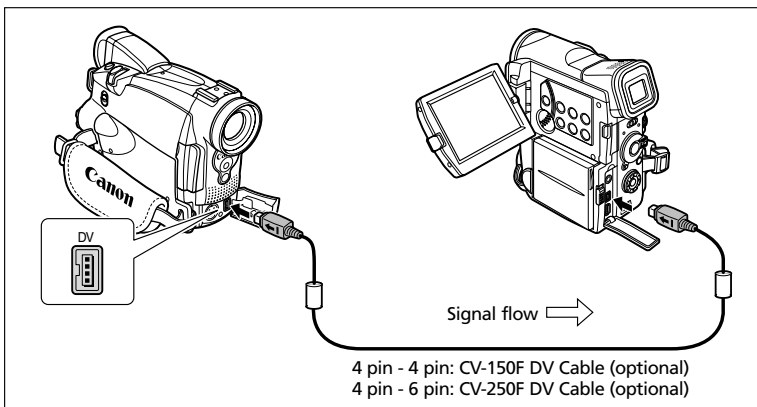

Editing

## Recording

CAMERA

PLAY (VCR)

CARD CAMERA

CARD PLAY

1. Set the camcorder to **PLAY (VCR)** mode and load a recorded cassette.  
If you are connecting via AV terminal, check the setting ( 34).
2. **Connected device:** Load a blank cassette and set the device to record pause mode.
3. Locate the scene you wish to copy and pause playback shortly before the scene.
4. Play back the tape.
5. **Connected device:** Begin recording when the scene you wish to copy appears. Stop recording when copying is complete.
6. Stop playback.



- When connecting a VCR, the quality of the edited tape will be slightly lower than that of the original.
- When connecting a digital video device:
  - If the picture does not appear, reconnect the DV cable or turn the camcorder off and back on again.
  - Proper operation cannot be guaranteed for all digital video devices equipped with a DV terminal. If operation does not work, use the S-video or AV terminal.



## **MV750i/MV730i/MV700i Recording from Analog Video Devices (VCR, TV or Camcorder)**

E

You can record videos or TV programs from a VCR or analog camcorder on the tape in the camcorder.

CAMERA

PLAY (VCR)

CARD CAMERA

CARD PLAY

### **1. Connect the camcorder to the analog video device.**

See *Playing Back on a TV Screen* (📖 34).

### **2. Set the camcorder to PLAY (VCR) mode and load a blank cassette.**

### **3. Connected device: Load the recorded cassette.**

### **4. Press the REC PAUSE button.**

In record pause mode and during recording, you can check the picture on the screen.

### **5. Connected device: Play back the tape.**

### **6. Press the ▶/|| button when the scene you wish to record appears.**

### **7. Press the ■ button to stop recording.**

- Press the ▶/|| button to pause recording.
- Press the ▶/|| button again to restart recording.

### **8. Connected device: Stop playback.**



- Headphones cannot be used during analog line-in recording.
- When connecting to a TV/video with SCART terminal, use a SCART adapter with input capability (commercially available). The supplied SCART Adapter PC-A10 is for output only.

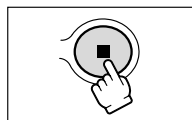
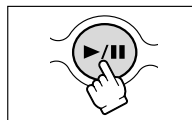
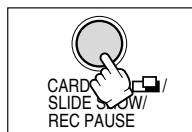

Editing

## **MV750i/MV730i/MV700i Recording from Digital Video Devices (DV Dubbing)**

You can record from other digital video devices equipped with a DV terminal with virtually no loss in picture and sound quality.

CAMERA

PLAY (VCR)

CARD CAMERA

CARD PLAY

### **1. Connect the camcorder to the digital video device.**

See *Connecting a Digital Video Device* (☞ 79).

### **2. Set the camcorder to PLAY (VCR) mode and load a blank cassette.**

Make sure that [AV→DV OUT] is set to [OFF] (☞ 85).

### **3. Connected device: Load the recorded cassette.**

### **4. Press the REC PAUSE button.**

In record pause mode and during recording, you can check the picture on the screen.

### **5. Connected Device: Play back the tape.**

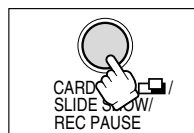

### **6. Press the ►/|| button when the scene you wish to record appears.**



### **7. Press the ■ button to stop recording.**

- Press the ►/|| button to pause recording.
- Press the ►/|| button again to restart recording.

### **8. Connected Device: Stop playback.**

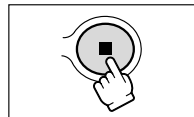

- Blank sections may be recorded as anomalous picture.
- If the picture does not appear, reconnect the DV cable or turn the camcorder off and back on again.
- You can only record signals from devices with the **DV** logo recording in SD system in SP or LP format.

## Concerning Copyright

---

### Copyright Precaution

Certain pre-recorded video tapes, films and other materials, as well as some television programmes are copyrighted. Unauthorised recording of these materials may violate copyright protection laws.

E

### Copyright Signals

During playback: If you try to play back a tape that contains copyright control signals for protection of software, "COPYRIGHT PROTECTED PLAYBACK IS RESTRICTED" appears for a few seconds and the camcorder displays a blank blue screen. You cannot playback the contents of the tape.

During recording: If you try to record from software that contains copyright control signals for protection of software, "COPYRIGHT PROTECTED DUBBING RESTRICTED" appears. You cannot record the contents of the software.

You cannot record copyright protection signals to a tape using this camcorder.

Editing

## **MV750/MV730/MV700** Converting Analog Signals into Digital Signals (Analog-Digital Converter)

By connecting the camcorder to a VCR or 8mm video camcorder, you can convert analog video/audio signals to digital signals and output the digital signals via the DV terminal. The DV terminal serves as output terminal only.

### **Connecting the Devices**

Turn off all devices before starting the connections. Unload the tape from the camcorder. Refer also to the instruction manual of the connected device.

**MV750** You can also connect a VCR with S (S1)-VIDEO terminal (□ 36).

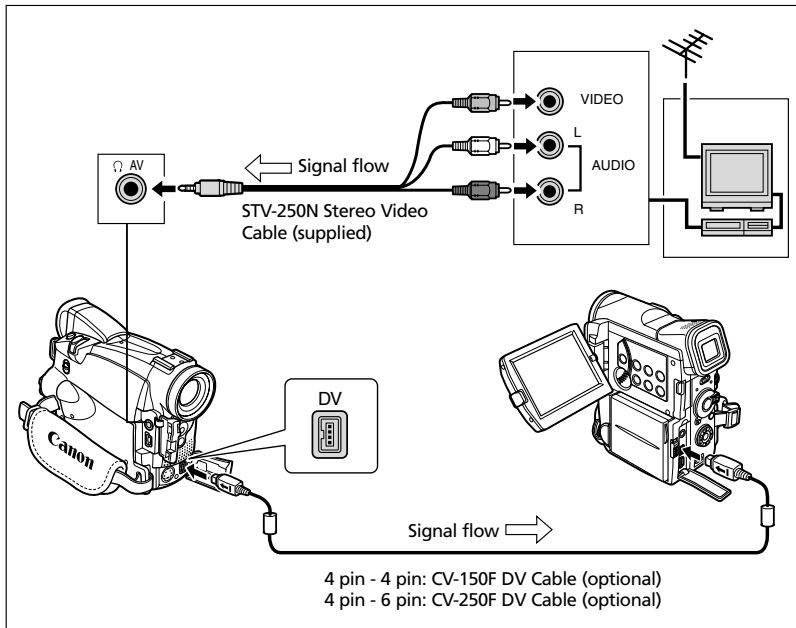

## Turning On the Analog-Digital Converter



E

Open the menu and select [VCR SETUP]. Select [AV→DV OUT], set it to [ON] and close the menu.



- Headphones cannot be used during analog-digital conversion.
- Depending on the signal sent from the connected device, the conversion from analog to digital signals might not work properly (e.g., signals that include copyright protective signals or anomalous signals such as ghost signals).
- When connecting to a TV/video with SCART terminal, use a SCART adapter with input capability (commercially available). The supplied SCART Adapter PC-A10 is for output only.
- For normal use, set [AV→DV OUT] to [OFF]. If it is set to [ON], digital signals cannot be input via the camcorder's DV terminal.
- Depending on the software and the specifications of your computer, you may not be able to transfer converted signals via the DV terminal.



- We recommend powering the camcorder from a household power source.
- **MV750i/MV730i** You can also press the AV→DV button on the wireless controller. The setting changes with each press of the button.

Editing

## **MV750/MV730** Replacing Existing Scenes (AV Insert)

You can insert and replace images and audio on the tape of the camcorder with images and audio from other video devices connected via AV terminal or DV terminal. This function is operated with the wireless controller.

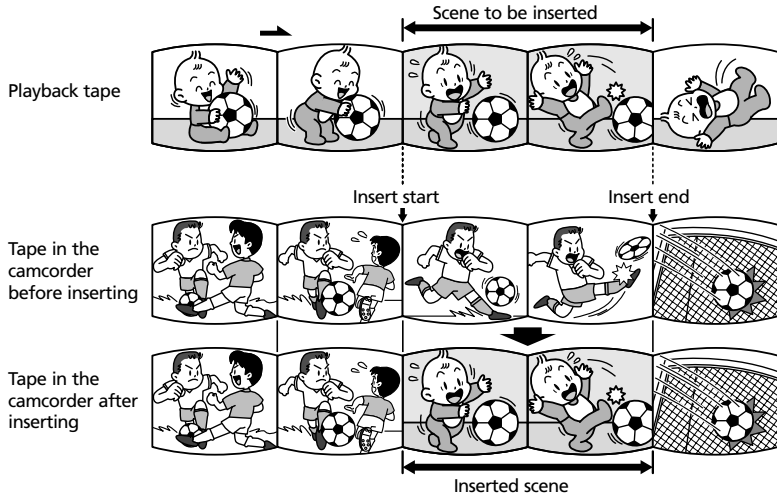

CAMERA

**PLAY (VCR)**

CARD CAMERA

CARD PLAY

### **1. Connect the camcorder to a video device.**

See *Playing Back on a TV Screen* (□ 34).

### **2. Connected device: Load a recorded cassette. Locate the scene you wish to insert and pause playback shortly before the scene.**

### **3. Set the camcorder to PLAY (VCR) mode and load a recorded cassette.**

Use a tape recorded in SP mode and make sure that the tape-protect switch is set to allow recording.

### **4. Locate the scene you wish to replace and pause playback shortly before the scene.**

### **5. Press the AV INSERT button on the wireless controller.**

“AV INSERT” and “●|||” appear.

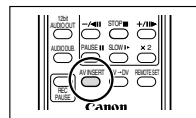

6. **Connected device: Play back the tape.**

7. **Press the PAUSE  button on the wireless controller when the scene you wish to insert appears.**

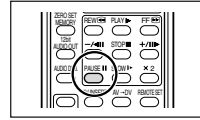

E

8. **Press the STOP  button on the wireless controller to stop inserting.**

Press the PAUSE  button on the wireless controller to pause inserting.

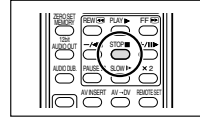

9. **Connected device: Stop playback.**



○ You cannot insert from a TV program when the synchronised signals are distorted.

Connected device:

- AV insert may not work correctly if the tape has a blank section or changes in the recording mode.
- AV insert cannot be performed when the quality of the recording is poor, or during special playback such as fast forward, rewind, playback pause, slow playback etc.



Set the zero set memory at the end of the scene you wish to replace. The camcorder will automatically stop AV insert at that point.

Editing

## MV750i/MV730i Audio Dubbing

You can add sound from audio devices (AUDIO IN) or with the built-in microphone (MIC. IN).

This function is operated with the wireless controller.

### Connecting an Audio Device

Refer also to the instruction manual of the connected device.

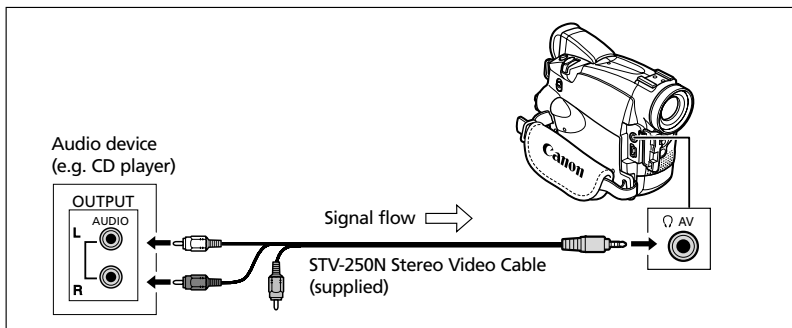

### Dubbing



**MENU**  
( 38)

AUDIO SETUP

AUDIO DUB...AUDIO IN

#### 1. Set the camcorder to **PLAY (VCR)** mode and load a recorded cassette.

Use a tape recorded in SP, 12-bit mode with this camcorder.

#### 2. Open the menu and select **[AUDIO SETUP]**. Select **[AUDIO DUB.]**, set it to **[AUDIO IN]** or **[MIC. IN]** and close the menu.

#### 3. Locate the scene you wish to start audio dubbing.

#### 4. Press the **PAUSE** button on the wireless controller.

#### 5. Press the **AUDIO DUB.** button on the wireless controller.

"AUDIO DUB." and " " appear.

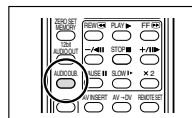

#### 6. Press the **PAUSE** button on the wireless controller to begin dubbing.

- Audio device: Begin playback.
- Microphone: Speak into the built-in microphone.

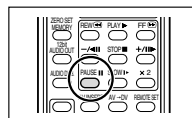



## 7. Press the STOP ■ button on the wireless controller to stop dubbing.

Audio device: Stop playback.

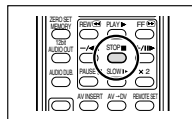

E



- Use only tapes recorded in SP mode 12-bit audio sound with this camcorder. Audio dubbing will stop if the tape has a blank section or a section recorded in LP mode or 16-bit mode.
- You cannot use the DV terminal for audio dubbing.
- If you add sound to a tape not recorded with this camcorder, sound quality may decrease.
- Sound quality may decrease when you add sound to the same scene for more than 3 times.



- When you connect an audio device, check the picture on the LCD screen and the sound via built-in speaker or audio device. MV750i: You can also connect a TV via S-video terminal.
- When you use the built-in microphone, you can either connect a TV via AV terminal to check the picture, or headphones to check the sound. MV750i: When you connect a TV via S-video terminal, you can check the picture on the TV screen and the sound with headphones connected to the camcorder.
- Set the zero set memory at the end of the scene you wish to dub audio. The camcorder will automatically stop audio dubbing at that point.

## Playing Back the Added Sound

You can select to play back Stereo 1 (original sound), Stereo 2 (added sound), or adjust the balance of both sounds.



Editing

### 1. Open the menu and select [AUDIO SETUP]. Select [12bit AUDIO], select a setting and close the menu.

- STEREO 1: Plays back the original sound.
- STEREO 2: Plays back the added sound.
- MIX/FIXED: Plays back Stereo 1 and Stereo 2 in the same level.
- MIX/VARI.: Plays back Stereo 1 and Stereo 2. The mix balance can be adjusted.

### 2. If you have selected [MIX/VARI.], adjust the mix level: Open the menu and select [AUDIO SETUP]. Select [MIX BALANCE], adjust the balance with the SET dial and close the menu.

Turn the SET dial down to increase the volume of Stereo 1 and up to increase the volume of Stereo 2.



- The camcorder resets to [STEREO 1] when you turn the camcorder off. However, the mix balance is memorised by the camcorder.
- You can also press the 12bit AUDIO OUT button on the wireless controller to select the audio output. However, the mix balance can only be adjusted in the menu.

## Connecting to a Computer Using a DV (IEEE1394) Cable

You can transfer recordings to a computer equipped with a DV (IEEE1394) terminal or IEEE1394 capture board. Optional software is required for transferring recordings from the tape to a computer. Refer to the instruction manual of the software. Use the optional CV-150F (4 pin-4 pin) or CV-250F (4 pin-6 pin) DV Cable.

E

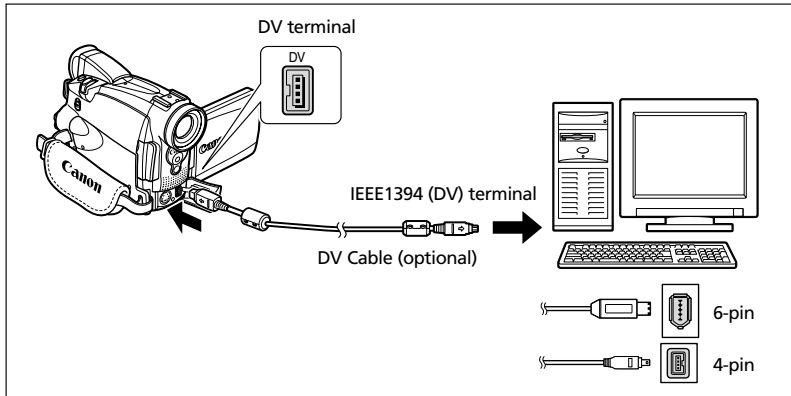

- Operation may not work correctly depending on the software and the specifications/settings of your computer.
- If the computer freezes while you have connected the camcorder, disconnect and reconnect the DV cable. If the problem persists, disconnect the interface cable, turn off camcorder and computer, turn camcorder and computer back on and reconnect them.
- **MV750i/MV730i** Do not disconnect the DV cable, open the memory card cover, remove the memory card, change the position of the POWER switch or turn off the camcorder and computer while data is being transferred to the computer (while the camcorder's card access indicator is flashing). Doing so may damage the memory card's data.
- **MV750i/MV730i** The image files on your memory card and the image files saved on the hard disk drive of your computer are valuable, original data files. If you wish to use image files on your computer, make copies of them first, and use the copied file, retaining the original.



- We recommend powering the camcorder from a household power source while it is connected to the computer.
- Refer also to the instruction manual of the computer.
- **MV750i/MV730i** Users of Windows XP can use the DV Network Software contained on the DIGITAL VIDEO SOLUTION DISK For Windows. For details, refer to the *DV Network Software Instruction Manual*.

Editing

# Inserting and Removing the Memory Card

You can use **SD** SD Memory Cards or commercially available MultiMediaCards with this camcorder. The SD Memory Card has a protect switch to prevent accidental erasure.

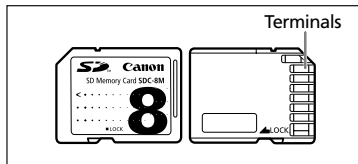

## Inserting the Card

1. Turn off the camcorder.
2. Open the cover.
3. Insert the memory card all the way into the memory card slot.
4. Close the cover.

Do not close the cover forcefully without having the card correctly inserted.

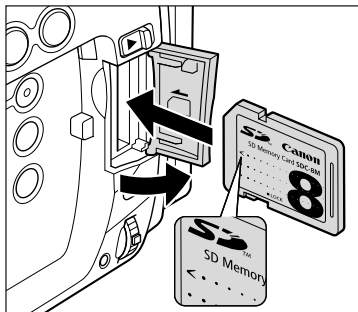

## Removing the Card

Do not forcefully remove the memory card without first pushing it in.

1. Turn off the camcorder.  
Make sure that the card access indicator is not flashing before you turn off the camcorder.
2. Open the cover.
3. Push the memory card to release it.  
Remove the memory card.
4. Close the cover.

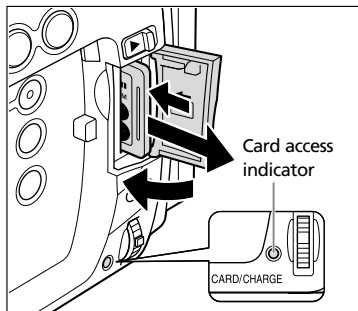

- This camcorder is compatible with SD Memory Cards or MultiMediaCards only. Do not use any other types of memory cards.
- Turn off the camcorder before inserting or removing the memory card. Otherwise, it may result in data damage.
- If you use memory cards other than the supplied one, make sure to format them with the camcorder (📖 117).

# Selecting the Image Quality/Size

## Changing the Still Image Quality

You can choose between Superfine, Fine and Normal.

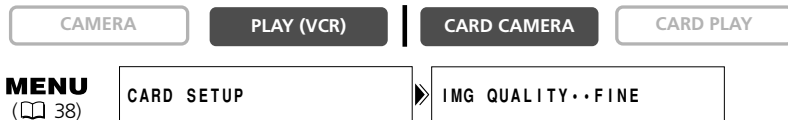

Open the menu and select [CARD SETUP]. Select [IMG QUALITY], set it to [SUPER FINE] or [NORMAL] and close the menu.

## Changing the Still Image Size

You can choose between 1024 × 768 pixels and 640 × 480 pixels.



Open the menu and select [CARD SETUP]. Select [IMAGE SIZE], set it to [640×480] and close the menu.



- Still images are compressed and recorded in the JPEG (Joint Photographic Experts Group) format.
- Estimated Capacity of an 8 MB Memory Card:

Image Size	1024 × 768		640 × 480	
	No. of Images	File Size per Image	No. of Images	File Size per Image
Superfine	13	440 KB	34	175 KB
Fine	20	300 KB	50	120 KB
Normal	38	160 KB	84	65 KB

These figures are approximate. They vary according to the recording condition and the subject. Sample images already recorded on the supplied SD Memory Card are to be included in the total number.

## Changing the Movie Size

You can choose between  $320 \times 240$  pixels and  $160 \times 120$  pixels.

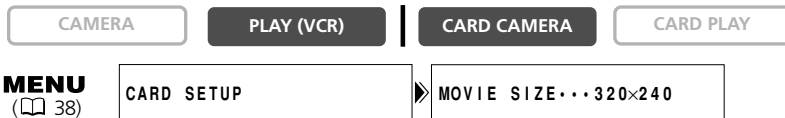

Open the menu and select [CARD SETUP]. Select [MOVIE SIZE], set it to [160x120] and close the menu.



- Movies are recorded in the Motion JPEG format.
- Maximum recording time on a 8MB SD Memory Card:

Image Size	Max. Recording Time (8 MB)	File Size per Second
$320 \times 240$	approx. 20 sec.	250 KB/sec.
$160 \times 120$	approx. 50 sec.	120 KB/sec.

## File Numbers

Images are automatically assigned file numbers from 0101 to 9900 and stored in folders containing up to 100 images. Folders are assigned numbers from 101 to 998. (The sample images on the supplied memory card are saved in the [100canon] folder.)

You can choose to use consecutive file numbers (CONTINUOUS) or to reset the file number each time a different memory card is inserted (RESET). We recommend setting the file numbers to CONTINUOUS.

<b>RESET</b>	The file number will be reset each time a new memory card is inserted, starting with 101-0101. If the memory card already contains image files, the consecutive file number will be assigned.
<b>CONTINUOUS</b>	The camcorder memorises the file number of the last image and assigns the consecutive file number to the next image, even when a new memory card is inserted. (If a higher file number already exists on the memory card, the consecutive number will be assigned.) There will be no duplication of file numbers. This is useful for organizing images on a computer.

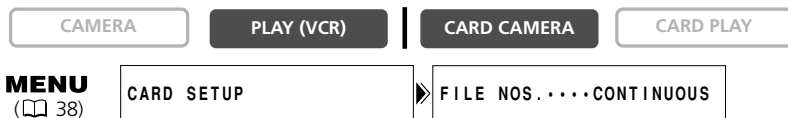
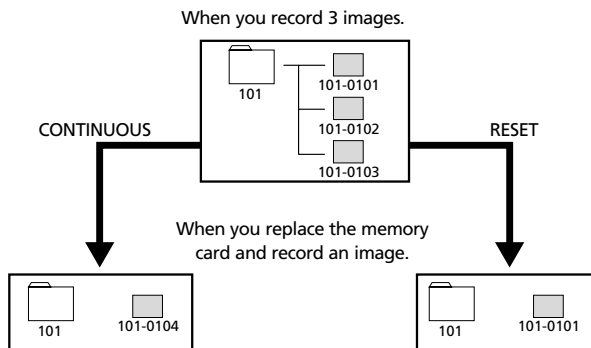

To change the setting, open the menu and select [CARD SETUP]. Select [FILE NOS.], set it to [RESET] and close the menu.

## Recording Still Images on a Memory Card

You can record still images with the camcorder, from a tape in the camcorder or from devices connected via the DV terminal or AV terminal. You can also record a still image on the memory card while you record a movie on the tape.

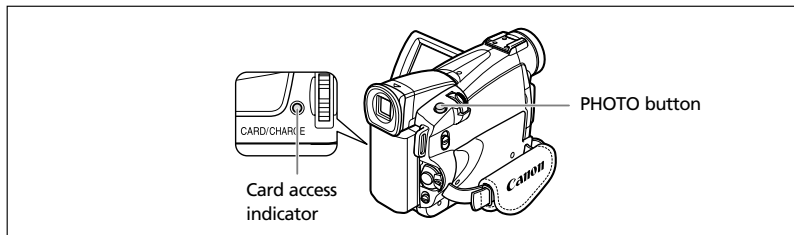

CAMERA

PLAY (VCR)

**CARD CAMERA**

CARD PLAY

### 1. Set the camcorder to **CARD CAMERA** mode.

A white focusing frame appears in the centre of the screen. The camcorder will focus on the subject in the centre of the screen. To change the focusing point, see *Selecting the Focusing Point* ( 103).

### 2. Press the **PHOTO** button halfway.

- **●** and focusing frame turn green when focus is adjusted. The beep sounds twice. The picture may appear out of focus for a moment while the camcorder is focusing.
- Exposure is locked.

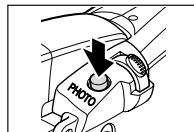

- When you press the PHOTO button on the wireless controller, recording starts immediately.

### 3. Press the **PHOTO** button fully.

- **●** and focusing frame disappear and you hear a shutter sound.
- The card access indicator flashes and the card access display appears.
- The still image shown on the screen will be recorded on the memory card.

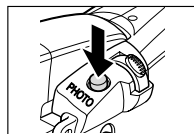

- Do not turn off the camcorder, change the position of the TAPE/CARD switch, disconnect the power source, open the memory card cover or remove the memory card while the card access indicator is flashing. Doing so could result in data damage.
- When you are using a SD Memory Card, make sure that the protect switch is set to allow recording.





- To use the self-timer (☰ 57), press the ⏸ (self-timer) button before step 2 and press the PHOTO button fully.
- When the subject is too bright (overexposed), use the optional FS-30.5U ND filter.
- **When the Focus-Priority mode is set to [ON]:**  
When you press the PHOTO button fully before ● and focusing frame turn green, it may take up to 2\* seconds until focus is adjusted and the still image can be recorded to the memory card.  
\* Up to 4 seconds in the Low Light and the Night modes.  
If the subject is not suitable for autofocus, the focusing frame turns yellow and locks the focus. Adjust the focus manually with the SET dial.
- **When the Focus-Priority mode is set to [OFF]:**  
No focusing frame appears.  
In step 2, ● turns green, and focus and exposure are locked.
- The camcorder shuts off when you do not operate it for 5 minutes to save power. "⚠️ AUTO POWER OFF" appears 20 seconds before shutoff. To continue recording, turn the POWER switch to OFF and then back to CAMERA.

## Recording a Still Image on a Memory Card While Recording Movies on a Tape

When you are recording a movie on a tape, you can record the same picture as a still image on the memory card.



1. Open the menu and select [CAMERA SETUP]. Select [PHOTO REC], set it to [CARD 📷] and close the menu.
2. While you are recording a movie, press the PHOTO button.



- The size of the still image will be 640 × 480.
- The quality of the still image is slightly lower than a still image recorded in CARD CAMERA mode.
- The still image cannot be recorded on a memory card when a fader, effect or the multi-image screen is activated.
- The still image cannot be recorded on a memory card when the 16:9 format is selected.
- Card mix cannot be used.

## Recording from a Tape in the Camcorder

---

CAMERA

PLAY (VCR)

CARD CAMERA

CARD PLAY

### 1. Play back the tape.

### 2. Press the PHOTO button halfway when the scene you wish to record appears.

- The camcorder pauses playback. The remaining image capacity and other information appear.
- When you press the PHOTO button on the wireless controller, recording starts immediately.

### 3. Press the PHOTO button fully.

- The card access indicator flashes.
- You can also record a still image by pressing the PHOTO button fully when the tape is in playback pause mode.

## Recording from Other Video Devices

---

You can record images from devices connected via the S-video terminal (MV750i) or AV terminal (analog line-in function), or via the DV terminal as still images on a memory card.

For connecting instructions, refer to page 34 and 79.

CAMERA

PLAY (VCR)

CARD CAMERA

CARD PLAY

### 1. Set the camcorder to PLAY (VCR) mode.

- If a cassette is loaded, make sure that the tape is stopped.
- When recording via the AV terminal, make sure that “AV→DV” is displayed on the screen. When recording via the DV terminal, make sure that “AV→DV” is not displayed. Change the setting as necessary (□ 85).

### 2. Connected device: Load a recorded cassette and play back the tape.

### 3. Press the PHOTO button halfway when the scene you wish to record appears.

- The still image, remaining image capacity and other information appear.
- When you press the PHOTO button on the wireless controller, recording starts immediately.

### 4. Press the PHOTO button fully.

The card access indicator flashes.



### When recording from a tape in the camcorder or other video devices:

- A still image recorded from an image in 16:9 format will be vertically compressed.
- The data code of the still image will reflect the date and time it has been recorded on the memory card.
- The size of the still image will be 640 × 480.

E

## Screen Displays during Still Image Recording



### ① Still Image Quality

Indicates the image quality of the still image.

### ② Remaining Card Capacity for Still Images

- flashing in red: No card
- in green: 6 or more images
- in yellow: 1 to 5 images
- in red: No more images
- The indication may not decrease even though a recording has been made, or may decrease by 2 images at once.
- All indicators are displayed in green when a memory card is played back.

### "▶" Card Access Display

Indicates that the camcorder is writing on the memory card.

### ③ Image Size

Indicates the still image size.

## ***Reviewing a Still Image Right after Recording***

You can select to display a still image for 2, 4, 6, 8 or 10 seconds after it has been recorded.



**MENU**  
( 38)

CAMERA SETUP

REVIEW.....2sec

Open the menu and select [CAMERA SETUP]. Select [REVIEW], select a setting option and close the menu.



- A still image is displayed as long as you hold the PHOTO button after recording.
- The FILE OPERATION menu appears when you press the SET dial while you are reviewing a still image, or when you press the SET dial right after recording. In this menu, you can protect ( 109) or erase ( 110) the image.

## Recording Motion JPEG Movies on a Memory Card

You can record Motion JPEG movies with the camcorder, from a tape in the camcorder or from devices connected via the DV terminal or the AV terminal. The sound of a movie recorded on a memory card will be monaural.

CAMERA

PLAY (VCR)

CARD CAMERA

CARD PLAY

### 1. Press the start/stop button to begin recording.

- You can keep recording until "CARD FULL" appears (max. 60 minutes).
- With MultiMediaCards, the recording time is limited to 10 sec. in 320 × 240 pixels and 30 sec. in 160 × 120 pixels.



### 2. Press the start/stop button to stop recording.



- Do not turn off the camcorder, change the position of the TAPE/CARD switch, disconnect the power source, open the memory card cover or remove the memory card while the card access indicator is flashing. Doing so could result in data damage.
- When you are using a SD Memory Card, make sure that the protect switch is set to allow recording.
- Do not load/unload a cassette during recording.



- We recommend using a SD Memory Card right after you have formatted it with this camcorder. Recording may be interrupted when you use memory cards with slow writing speed, or when recording and erasing has been repeatedly performed on a memory card.
- To use the self-timer (📖 57), press the ⏸ (self-timer) button before step 2 and press the start/stop button.
- You can select the focusing point when recording a movie on the memory card.

## Recording from a Tape in the Camcorder

CAMERA

PLAY (VCR)

CARD CAMERA

CARD PLAY

### 1. Play back the tape.

2. Press the start/stop button when the scene you wish to record appears.
3. Press the start/stop to stop recording.

E

MMZ150/MMZ300  
Using a Memory Card

## Recording from Other Video Devices

You can record movies from devices connected via the S-video terminal or AV terminal (analog line-in function), or via the DV terminal on a memory card.

For connecting instructions, refer to page 34 and 79.

CAMERA

PLAY (VCR)

CARD CAMERA

CARD PLAY

### 1. Set the camcorder to **PLAY (VCR)** mode.

- If a cassette is loaded, make sure the tape is stopped.
- When recording via the AV terminal, make sure that "AV→DV" is displayed on the screen. When recording via the DV terminal, make sure that "AV→DV" is not displayed. Change the setting as necessary (📖 85).

### 2. **Connected device: Load a recorded cassette and play back the tape.**

### 3. **Press the start/stop button when the scene you wish to record appears.**

### 4. **Press the start/stop button to stop recording.**



When recording from a tape in the camcorder or other video devices:

- A movie recorded from an image in 16:9 format will be vertically compressed.
- The data code of the movie will reflect the date and time it has been recorded on the memory card.
- Recording stops at blank sections or recordings in different audio mode (12bit/16bit).

## Screen Displays during Movie Recording

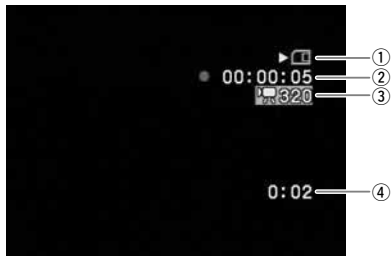

#### ① "▶" Card Access Display

Indicates that the camcorder is writing on the memory card.

#### ② Movie recording time

Indicates the recording time of the movie.

#### ③ Image Size

Indicates the movie size.

#### ④ Remaining Card Capacity for Movies

Indicates the remaining time in hours and minutes. At less than 1 minute, the remaining time will be displayed in 10 second-steps, at less than 10 seconds in 1 second-steps.

- The indication varies depending on the recording condition. The actual remaining time may be longer or shorter than indicated.

## Selecting the Focusing Point

The subject you wish to record is not always in the centre of the screen. In the Focus-Priority mode, you can choose from one of three focusing points to automatically put the subject you wish into sharp focus.

When the program selector is set to , the Focus-Priority becomes set to ON (only the centre focusing point is available).



1. Set the program selector to .
2. Turn the SET dial to display all focusing frames.

Three focusing frames appear on the screen, one of it in green.

3. Turn the SET dial to select the focusing point.

Turn the SET dial up to select the frame to the right, down to select the frame to the left.



- The focusing frame gives an indication of the focusing point. Depending on the size of the subject or the distance, the camcorder may focus outside the frame.
- When you operate the zoom lever, the frames other than the selected one disappear.
- The focusing point can be selected only when Focus-Priority is set to [ON] in CARD CAMERA mode.
- The focusing point returns to the centre if you turn off the camcorder, change from CARD CAMERA mode or move the program selector to .
- The focusing point cannot be selected in the following cases:
  - When using the digital zoom. When you zoom into the digital zoom range, the focusing frame flashes for 4 seconds and disappears. When you return to the optical zoom range, the focusing frame reappears.
  - In Stitch Assist mode.

## Turning Off the Focus-Priority Mode

Turn off the Focus-Priority mode if you wish to put timing ahead of focus.



**MENU**  
( 38)

CAMERA SETUP

FOCUS PRI...ON

Open the menu and select [CAMERA SETUP]. Select [FOCUS PRI.], set it to [OFF] and close the menu.

## Recording Panoramic Images (Stitch Assist Mode)

You can shoot a series of overlapping images and merge them into one large panoramic scene using the supplied software (PhotoStitch) on a computer.

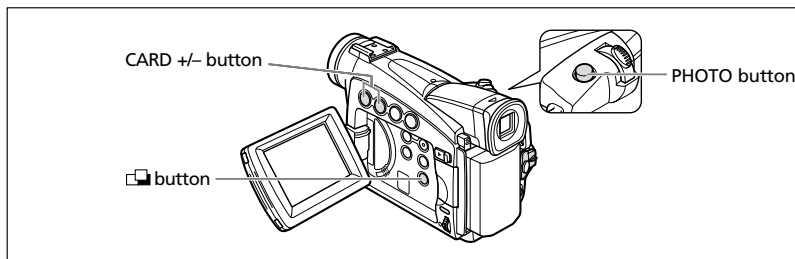

### When Recording in Stitch Assist Mode:

PhotoStitch detects the overlapping portion of adjoining images and merges them. Try to include a distinctive item (landmark, etc.) in the overlapping portion.



1. Press the  button.

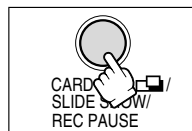

2. Select the direction with the **CARD +/-** button.

CARD + button: clockwise. CARD – button: anticlockwise.

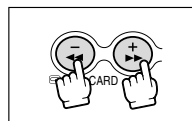

3. Select the program **AE** mode and zoom on the subject.

Adjust focus and AE shift manually as necessary. Once the sequence has started, you cannot change the program AE mode, AE shift, zoom or focus.

4. Press the **PHOTO** button to record the first image.

Direction and number of recorded images appear.

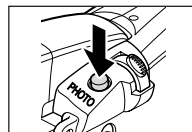



## 5. Record the second image so that it overlaps a portion of the first image.

- Minor discrepancies in the overlapped area can be corrected with the software.
- You can retake an image by pressing the CARD +/- button to return to the previous image.
- A maximum of 26 images can be recorded.

E

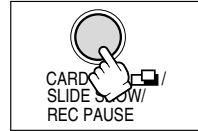

## 6. Press the button after the last image.

For details on how to merge these images, refer to the *Digital Video Software Instruction Manual*.



- Compose each image so that it overlaps 30 to 50% of the adjoining image. Try to keep the vertical misalignment within 10%.
- Do not include moving subject in the overlapping portion.
- Do not try to stitch images that include both distant and close subjects. They may appear warped or doubled up.

## Playing Back a Memory Card

You can display a single image, 6 at a time (index screen  107), or one after another (slide show  107). Use the Card Jump function to quickly locate an image without displaying them one by one ( 108).

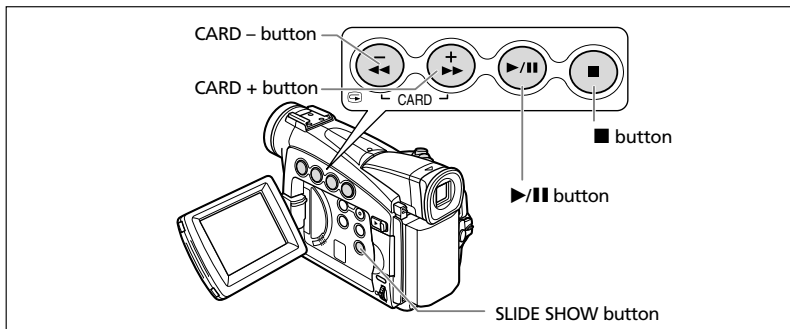

CAMERA

PLAY (VCR)



CARD CAMERA

CARD PLAY

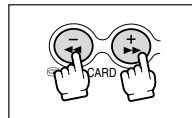
1. Set the camcorder to **CARD PLAY** mode.
2. Press the **CARD +/-** button to move between images.



3. To play back a movie, press the **▶/||** button.

- The first scene appears as a still image when playback is complete.
- Pressing the **▶/||** button during playback pauses the playback. Press the **▶/||** button again to restart playback.
- Pressing the **■** button displays the first scene of the movie.
- Press the **CARD +/-** button (or the **REW**  / **FF**  button on the wireless controller) for 8x fast forward/fast rewind playback.





- Images not recorded with this camcorder, uploaded from a computer (except the sample images 113), edited on a computer and images whose file names have been changed may not be played back correctly.
- Do not turn off the camcorder, change the position of the TAPE/CARD switch, disconnect the power source, open the memory card cover or remove the memory card while the card access indicator is flashing. Doing so could result in data damage.

## Slide Show

CAMERA

PLAY (VCR)

CARD CAMERA

CARD PLAY

### 1. Press the SLIDE SHOW button.

Images are played back one after another.

### 2. Press the SLIDE SHOW button to stop the slide show.

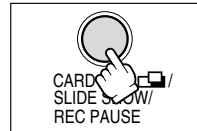

## Index Screen

CAMERA

PLAY (VCR)

CARD CAMERA

CARD PLAY

### 1. Move the zoom lever toward W.

Up to 6 images appear.

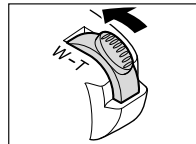

### 2. Turn the SET dial to select an image.

- Move the  to the image you wish to view.
- You can switch between the index pages by pressing the CARD + or CARD - button.

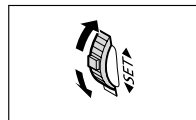

### 3. Move the zoom lever toward T.

The index screen is cancelled and the selected image is displayed.

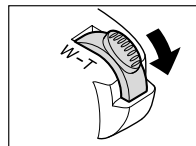

## Card Jump Function

---

You can locate images without displaying them one by one. The number in the upper right of the screen indicates the image number of the current image by the total number of images.



**Press and hold the CARD + or CARD – button.**

When you release the button, the image of the displayed image number appears.



## Protecting Images

You can protect important images from accidental erasure when displaying a single image or index screen.



If a memory card is formatted, all still images and movies, even protected ones, will be erased permanently.



- The sample images recorded on the supplied SD Memory Card are already protected.
- Movies can only be protected when the first scene is displayed as a still image.

CAMERA

PLAY (VCR)

CARD CAMERA

CARD PLAY

1. Select the image you wish to protect.
2. Press the SET dial to open the FILE OPERATION menu.

In CARD CAMERA mode, the menu appears when you press the SET dial while you are reviewing a still image, or when you press the SET dial right after recording.

3. Select [PROTECT  $\odot$ ].

- “ $\odot$ ” appears and now the image cannot be erased.
- To cancel the protection, press the SET dial.

4. Select [ $\leftarrow$  RETURN] to close the menu.

## Protecting during Index Screen Display

CAMERA

PLAY (VCR)

CARD CAMERA

CARD PLAY

MENU

(  $\square$  38)

CARD OPERATIONS

 $\rightarrow$ PROTECT  $\odot$ 

1. Move the zoom lever toward W.
  - Up to 6 images appear.
  - Select the image you wish to protect.
2. Open the menu and select [CARD OPERATIONS]. Select [ $\rightarrow$ PROTECT  $\odot$ ] and press the SET dial.
  - “ $\odot$ ” appears on the image.
  - To cancel the protection, press the SET dial.
3. Close the menu.

## Erasing Images

---

You can erase images singly or all at once.



Be careful when erasing images. Erased images cannot be recovered.



○ Protected images cannot be erased.

○ Movies can only be erased when the first scene is displayed as a still image.

### Erasing a Single Image

---

CAMERA

PLAY (VCR)

CARD CAMERA

CARD PLAY

1. Select the image you wish to erase.
2. Press the SET dial to open the FILE OPERATION menu.

In CARD CAMERA mode, the menu appears when you press the SET dial while you are reviewing a still image, or when you press the SET dial right after recording.

3. Select [IMAGE ERASE].

- “ERASE THIS IMAGE?”, [NO] and [YES] appears.
- If an image is protected, [YES] appears in purple.

4. Select [YES].

The image is erased and the previous image appears.

5. Select [← RETURN] to close the menu.

### Erasing a Single Image/All Images

---

CAMERA

PLAY (VCR)

CARD CAMERA

CARD PLAY

**MENU**  
( 38)

CARD OPERATIONS

▶ IMAGE ERASE

1. Open the menu and select [CARD OPERATIONS].
2. Select [IMAGE ERASE].
3. Select [SINGLE] or [ALL].

- When erasing a single image: “ERASE THIS IMAGE?” [NO] and [YES] appears. If an image is protected, [YES] appears in purple.
- When erasing all images: “ERASE ALL IMAGES? [EXCEPT FOR  IMAGES]”, [NO] and [YES] appears.

4. Select [YES] and close the menu.

- When erasing a single image: The image is erased and the previous image appears. To erase another image, select the image with the CARD +/- button and select [YES].
- When erasing all images: All still images or movies with exception of the protected ones are erased.

## Combining Images (Card Mix)

You can produce effects not possible with just a tape with the Card Mix function. Choose one of the sample images provided on the supplied SD Memory Card (such as picture frames, backgrounds and animations) and combine it with the live video recording.

E

### Card Chroma Key (CARD CHROMA)

Combines frames with your recordings. The live video recording will appear in place of the blue area of the card mix image.

Mix level adjustment: blue area of the still image.



### Card Luminance Key (CARD LUMI.)

Combines illustrations or title with your recordings. The live video recording will appear in place of the light area of the card mix image.

Mix level adjustment: light area of the still image.



### Camera Chroma Key (CAM. CHROMA)

Combines backgrounds with your recordings. Record your subject in front of a blue curtain, and the subject not blue will be superimposed on the card mix image.

Mix level adjustment: blue area of the live video recording.

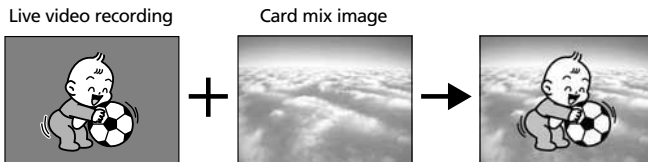

## Card Animation (C. ANIMATION)

Combines animations with your recordings. You can choose from 3 types of card animation effects.

- Corner: Animation appears on the upper left and the lower right corner of the screen.
- Straight: Animation appears on the top and bottom of the screen and moves to the right and left.
- Random: Animation moves randomly in the display.

Mix level adjustment: blue area of the card animation image.

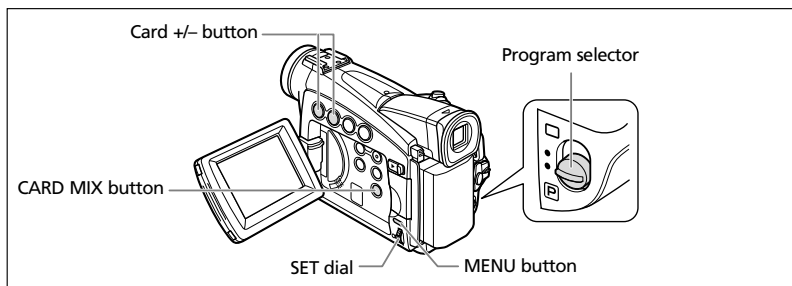
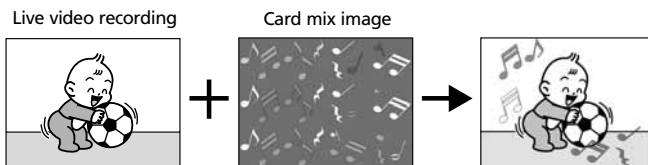

## Selecting the Card Mix Effect

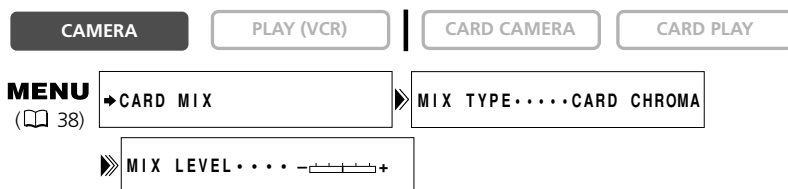

1. Set the program selector to **[P]**.
2. Open the menu and select **[M]CARD MIX**.  
The card mix menu appears.
3. Select the image you wish to combine with the **CARD +/-** button.
4. Select **[MIX TYPE]**.

[CARD CHROMA], [CARD LUMI.], [CAM. CHROMA] and [C. ANIMATION] appears.



### 5. Select the mix type matching the sample image you have selected.

- The screen shows the combined image.
- When you have selected [C. ANIMATION], select [ANIMAT. TYPE] and select between [CORNER], [STRAIGHT] and [RANDOM].

### 6. To adjust the mix level, select [MIX LEVEL] and adjust it with the SET dial.

### 7. Close the menu.

"CARD MIX" flashes.

### 8. Press the CARD MIX button.

- "CARD MIX" stops flashing.
- The combined image appears.



- Card mix cannot be used when [PHOTO REC] is set to [CARD .
- Movies recorded on a memory card cannot be combined with camcorder recordings.
- Additional sample images are provided on the supplied DIGITAL VIDEO SOLUTION DISK. Refer to *Adding Still Images from Your Computer to the Memory Card* in the *Digital Video Software Instruction Manual*.

## Sample Images

Following sample images are pre-recorded on the supplied SD Memory Card.

### Card Chroma Key



### Card Luminance Key



## Camera Chroma Key

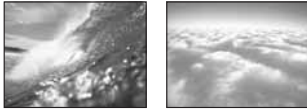

## Card Animation

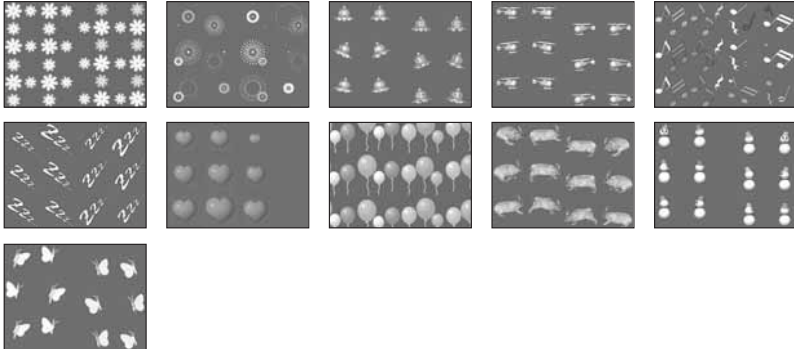

The sample images recorded on the supplied SD Memory Card are intended only for the personal use with this camcorder. Do not use these sample images for other purposes.



If you have mistakenly erased the sample images on the supplied SD Memory Card, they can be downloaded from the following homepages:

<http://www.canon-europe.com/products/products.html>

<http://www.canon-asia.com/>

<http://www.canon.com.au>

For details on how to add the downloaded images to the memory card, refer to *Adding Still Images from Your Computer to the Memory Card* in the *Digital Video Software Instruction Manual*.

PhotoEssentials – Royalty Free Stock Photography

The PhotoEssentials suite of royalty-free images on CD-ROM features premium quality assignment photography and is ideally suited for use in advertising, brochures, reports, multimedia, websites, books, packaging and more.

For more information, please visit their website [www.photoessentials.com](http://www.photoessentials.com)

# Copying Still Images

You can copy still images from tape to memory card, or from memory card to tape. All still images from the selected still image onward will be copied.

E

## Copying Still Images from Tape to Memory Card

Insert a memory card with enough remaining capacity, and load a recorded cassette.

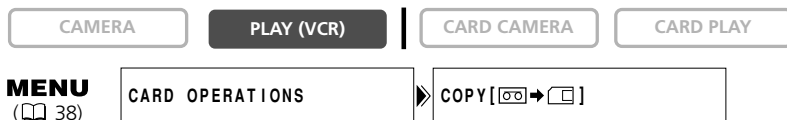

1. Locate the still image you wish to copy on the tape and stop the tape shortly before the still image.

To copy all still images from the tape, rewind the tape to the beginning.

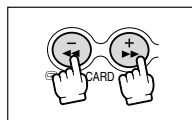

2. Open the menu and select [CARD OPERATIONS].

3. Select [COPY [Tape Icon] → [Card Icon]].

[CANCEL] and [EXECUTE] appears.

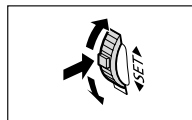

4. Select [EXECUTE].

- "NOW COPYING" appears.
- The still image being copied is shown on the screen.
- Copying stops when the tape reaches the end or the memory card is full ("CARD FULL" appears).

5. Press the ■ (stop) button to end copying.

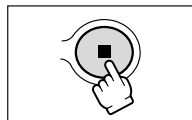

- The size of a still image copied from tape to memory card will be 640 × 480.
- The data code of the still image reflects the date and time it has been copied.

## Copying Still Images from Memory Card to Tape

Load a cassette with enough free space, and insert a recorded memory card. Make sure that the protect tab on the cassette is set to allow recording.

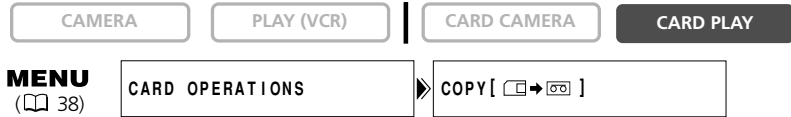

**1. Select the first still image you wish to copy with the CARD +/- buttons.**

To copy all still images from the memory card, select the first still image.

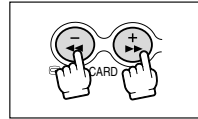

**2. Open the menu and select [CARD OPERATIONS].**

**3. Select [COPY [ ]].**

[CANCEL] and [EXECUTE] appears.

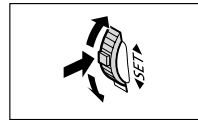

**4. Select [EXECUTE].**

- "NOW COPYING" appears.
- It takes about 6 seconds per still image to be copied to the tape.
- Copying stops when all still images are copied or the tape is full.

**5. Press the ■ (stop) button to end copying.**

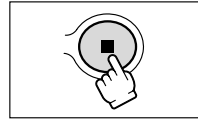

The data code of the still image reflects the date and time it has been copied.

## Formatting a Memory Card

Format new memory cards, or when you get the message "CARD ERROR". You can also format a memory card to erase all images recorded on it.

E



- Formatting a memory card erases all data, including protected images.
- Images erased by formatting cannot be recovered.
- If you use a memory card other than the supplied one, format it with the camcorder.



**1. Open the menu and select [CARD OPERATIONS].**

**2. Select [FORMAT].**

[CANCEL] and [EXECUTE] appears.

**3. Select [EXECUTE].**

[ALL DATA WILL BE ERASED. FORMAT THIS CARD?], [NO] and [YES] appears.

**4. Select [YES] and close the menu.**

- Formatting starts.
- Selecting [NO] brings you back to step 3.

## Connecting to a Computer Using a USB Cable

You can download images from the memory card to a computer using the supplied USB cable.

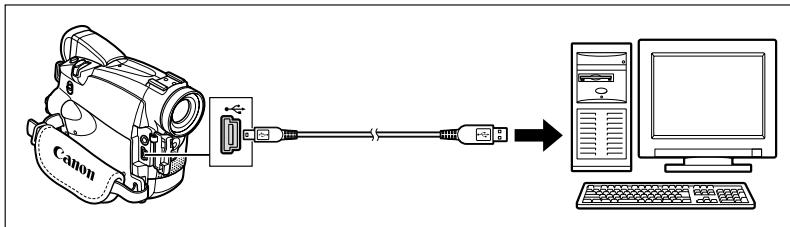

“PC CONNECT ” appears to indicate that the camcorder is connected to the computer via USB cable.

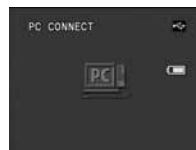

- Do not disconnect the USB cable, open the memory card cover, remove the memory card, change the position of the TAPE/CARD switch or turn off the camcorder and computer while data is being transferred to the computer (while the camcorder's card access indicator is flashing). Doing so may damage the memory card's data.
- Operation may not work correctly depending on the software and the specifications/settings of your computer.
- The image files on your memory card and the image files saved on the hard disk drive of your computer are valuable, original data files. If you wish to use image files on your computer, make copies of them first, and use the copied file, retaining the original.



- We recommend powering the camcorder from a household power source while it is connected to the computer.
- Refer also to the computer instruction manual.
- Images recorded on a tape cannot be transferred to a computer via USB interface.
- Users of Windows XP and Mac OS X:  
Your camcorder is equipped with the standard Picture Transfer Protocol (PTP) allowing you to download still images (JPEG only) by simply connecting the camcorder to a computer via USB cable without installing the software from the DIGITAL VIDEO SOLUTION DISK.

## Creating a Start-up Image

You can create 2 start-up images using still images on the memory card.

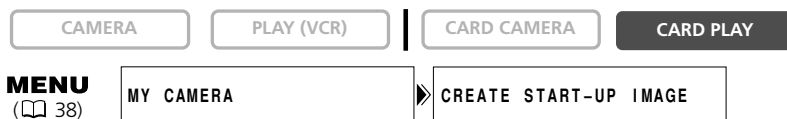

E

1. Select a still image with the **CARD +/-** buttons.
2. Open the menu and select **[MY CAMERA]**.
3. Select **[CREATE START-UP IMAGE]**.

[SET THIS AS START-UP IMAGE?], [YES] and [NO] appears.

4. Select **[YES]**.

[SAVE AS MY IMAGE1], [MY IMAGE2] and [CANCEL] appears.

5. Select **[MY IMAGE1]**.

[OVERWRITE MY IMAGE1?], [NO] and [YES] appears.

6. Select **[YES]**.

The still image will be saved, and the image that was saved to [MY IMAGE1] is erased.







Retain the original data of the still image you have set as the start-up image on your computer or removable disk.

## Printing Still Images

You can print still images by connecting the camcorder to a printer with Direct Print function. You can also use the print order settings for direct printing ( 126).

Following printers can be connected to your camcorder:

Canon Printers	PictBridge compliant CP Printer	 <b>PictBridge</b>
	Bubble Jet Direct compatible Printer	 <b>BUBBLE JET DIRECT</b>
	PictBridge compliant Bubble Jet Printer	 <b>PictBridge</b>
PictBridge compliant non-Canon Printer		 <b>PictBridge</b>



If your CP-300 is not PictBridge compliant (does not carry the PictBridge logo), upgrade the printer firmware following the instructions on below website to enable use with this camcorder.

[http://www.canon.co.jp/Imaging/cp300/cp300\\_firmware-e.html](http://www.canon.co.jp/Imaging/cp300/cp300_firmware-e.html)

If you cannot access the website, please contact:

- For Europe: A local Canon distributor listed in the Canon European Warranty System List included in the CP-300 kit.
- For other regions: Canon Customer Support Help Desk listed in the Canon Customer Support Leaflet included in the CP-300 kit.

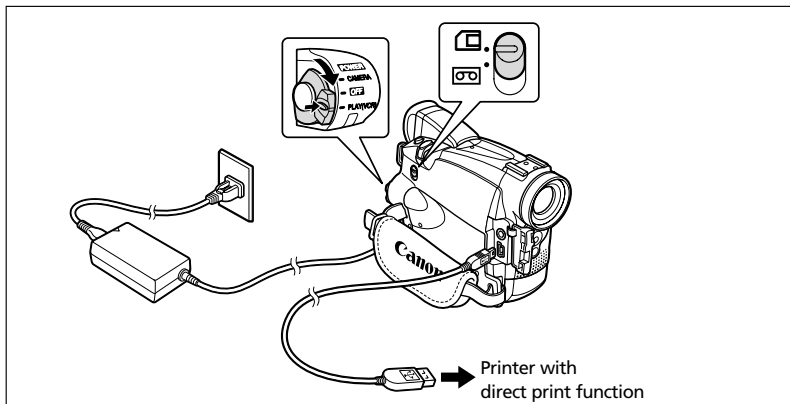

## Connecting the Printer to the Camcorder



1. Turn off the camcorder and insert a memory card that contains still images.
2. Turn on the printer.
3. Set the camcorder to CARD PLAY mode.



#### 4. Connect the camcorder to the printer using the cable.

 appears and changes to  or  when the printer is properly connected to the camcorder. (Does not appear with movies, or still images that cannot be played back with the camcorder.)



If  continues to flash (for more than 1 minute), the camcorder is not correctly connected to the printer. In such case, disconnect the cable from camcorder and printer, turn off camcorder and printer, turn both back on and reconnect the camcorder to the printer.



- Refer to the instruction manual of each printer for information on which interface cable to use with the camcorder.
- We recommend powering the camcorder from a household power source.
- Refer also to the instruction manual of the respective printer.
- The print setting menu may differ slightly depending on the connected printer.

### Printing



#### 1. During still image playback, select the still image you wish to print and press the SET dial.

- The print setting menu appears.
- Depending on the printer, the message "BUSY." may appear before the camcorder displays the print setting menu.

#### 2. Make sure that [PRINT] is selected and press the SET dial.

Printing starts. The print setting menu disappears when printing is complete.



- Observe the following precautions during printing, otherwise printing may not be performed correctly.
  - Do not turn off the camcorder or the printer.
  - Do not change the position of the TAPE/CARD switch.
  - Do not detach the cable.
  - Do not open the memory card cover or remove the memory card.
- Images not recorded with this camcorder, uploaded from a computer, edited on a computer and images whose file names have been changed may not be printed correctly.



### ○ **Cancel Printing**

Press the SET dial while "NOW PRINTING" is displayed. A confirmation dialog appears. Select [OK] and press the SET dial. Printing stops even if it is incomplete and the paper is fed through.

### ○ **Printing Errors**

If an error occurs during the printing process, an error message appears (□ 133).

- Canon printer: With most errors, printing resumes automatically after you correct the error. If the error persists, press the SET dial to cancel printing. Refer also to the printer manual for details.
- If the error still persists and printing does not restart, follow below procedure:
  1. Disconnect the cable.
  2. Turn the POWER switch of the camcorder to OFF and back to PLAY (VCR).
  3. Reconnect the cable.

### ○ **When you have finished printing:**

1. Disconnect the cable from the camcorder and printer.
2. Turn off the camcorder.

## Selecting the Number of Copies

---

A maximum of 99 copies can be selected for one still image.

1. In the print setting menu, turn the SET dial to select  (COPIES) and press the SET dial.







2. Turn the SET dial to select the number of copies and press the SET dial.



## Selecting the Print Settings (Paper/Style)

Check which print setting menu your camcorder displays and move to the respective section. The print setting options vary depending on the printer.

E

	Setting the Print Style ① (□□123)	Setting the Print Style ② (□□125)
Icon that appears when connecting the printer		
Print Setting Menu		
Paper Size	<input type="radio"/>	<input type="radio"/>
Paper Type	<input type="radio"/>	<input checked="" type="radio"/>
Borders	<input type="radio"/>	<input type="radio"/>
Multiple print (8-UP)	<input type="radio"/>	<input checked="" type="radio"/>
Print effect (Image Optimize)	<input type="radio"/>	<input checked="" type="radio"/>
Date	<input type="radio"/>	<input checked="" type="radio"/>

○: Available    ×: Not available



- Bordered: The image area remains relatively unchanged from the recorded image when it is printed.
- Borderless/multiple print: The centre portion of the recorded image is printed at an enlarged size. The image's top, bottom and sides may be cropped slightly.
- [8-UP] can be selected when using card size paper (5.3 × 8.6 cm) with PictBridge compliant CP Printers.
- Date print cannot be selected with the CP Printers CP-200 and CP-300.

### Setting the Print Style ①

The default setting and setting options vary depending on the printer. Refer to the instruction manual of the printer.

### Paper Settings

1. In the print setting menu, turn the SET dial to select [PAPER] and press the SET dial.



**MW50/MW300**  
 Direct Printing

- Turn the SET dial to select the paper size and press the SET dial.

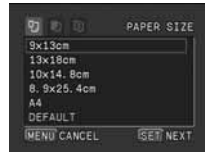

- Turn the SET dial to select the paper type and press the SET dial.



- Turn the SET dial to select a layout option and press the SET dial.

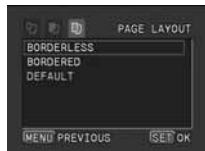

## Setting the Print Effect (Image Optimize)

This function uses the camcorder's recording information to optimize the image data, yielding high quality prints.

- In the print setting menu, turn the SET dial to select  (print effect) and press the SET dial.



- Turn the SET dial to select a setting and press the SET dial.



## Including the Date in the Print

- In the print setting menu, turn the SET dial to select  (date) and press the SET dial.



- Turn the SET dial to select a date print option and press the SET dial.

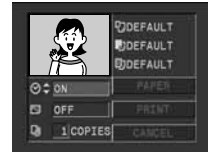

E

## Setting the Print Style ②

Paper Size	CARD #1*, CARD #2*, CARD #3*, LTR, A4 For details on paper type, refer to the Bubble Jet Printer User Guide.
Borders	Borderless Prints right to the edges of the page.
	Bordered Prints with a border.

\* Recommended paper size

- In the print setting menu, turn the SET dial to select [STYLE] and press the SET dial.



- Make sure that  (paper) is selected and press the SET dial.



- Turn the SET dial to select the paper size and press the SET dial.

Pressing the MENU button brings you back to the print settings menu.



- Turn the SET dial to select  (borders) and press the SET dial.



Direct Printing  
MZ50/MNZ30

- Turn the SET dial to select a borders option and press the SET dial.

Pressing the MENU button brings you back to the print settings menu.



## Printing with Print Order Settings

---

You can select still images for printing and set the number of copies. These print order settings are compatible with the Digital Print Order Format (DPOF) standards and can be used for printing on DPOF compatible printers (📖 120). A maximum of 200 still images can be selected.

### Selecting Still Images for Printing (Print Order)

---



1. Select the still image you wish to print.
2. Press the SET dial to open the FILE OPERATION menu.
3. Select [➡ PRINT ORDER].
4. Select the number of copies.
  - “👁” appears on the image.
  - To cancel the print order, set the number of copies to 0.
5. Select [⬅ RETURN] to close the menu.

### Selecting in Index Screen Display

---



1. Move the zoom lever toward W.
  - Up to 6 images appear.
  - Select the image you wish to print.
2. Open the menu and select [CARD OPERATIONS]. Select [➡ PRINT ORDER].
3. Press the SET dial and set the number of copies with the SET dial.
  - “👁” appears on the image.
  - To cancel the print order, set the number of copies to 0.
4. Close the menu.

## Erasing All Print Orders



E

1. Open the menu and select [CARD OPERATIONS].

2. Select [PRINT ORDERS ALL ERASE].

“ERASE ALL PRINT ORDERS?”, [NO] and [YES] appears.

3. Select [YES].

All “PRINT” disappear.

4. Close the menu.

## Printing



1. Connect the printer to the camcorder ( 120).

2. Open the menu and select [PRINT].

- The print setting menu appears.
- “SET PRINT ORDER” appears, when you connect a printer with direct print function and select [PRINT] without having set the print order.

3. Make sure that [PRINT] is selected and press the SET dial.

Printing starts. The print setting menu disappears when printing is complete.



- With PictBridge compliant printers, you can set paper settings, print effect and date print before step 3 ( 123).  
With Bubble Jet Direct compatible printers, you can set paper settings and date print before step 3 ( 125).

○ **Cancel Printing**

Press the SET dial while “NOW PRINTING” is displayed. A confirmation dialog appears. Select [OK] and press the SET dial. Printing stops even if it is incomplete and the paper is fed through.

○ **Restarting Printing**

Open the CARD PLAY menu and select [PRINT]. Select [RESUME] in the print setting menu and press the SET dial. The remaining images will be printed.

Printing cannot be restarted in the following cases:

- When you change the print order settings.
- When you delete a still image with print order settings.

MMZ50/MMZ300  
Direct Printing

## Screen Displays

---

### Hiding the Displays on the LCD Screen

---

You can hide the displays on the LCD screen to have a clear screen for playback.



Open the menu and select [DISPLAY SETUP/🌐]. Select [DISPLAYS], set it to [OFF <PLAYBK>] and close the menu.

- Warning messages still appear, and the data code appears if turned on.
- Tape operation displays appear for 2 seconds.
- **MV750/MV730** Displays cannot be hidden on the index screen.

### Hiding/Showing the Displays on the TV Screen

---

When you connect a TV for recording, you can select to show the camcorder displays on the TV screen. For playback, you can hide the camcorder displays on the TV screen.

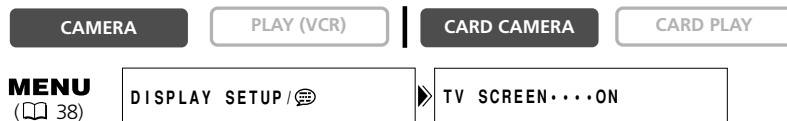

Open the menu and select [DISPLAY SETUP/🌐]. Select [TV SCREEN], set it to [OFF] and close the menu.

The displays disappear from the TV screen.

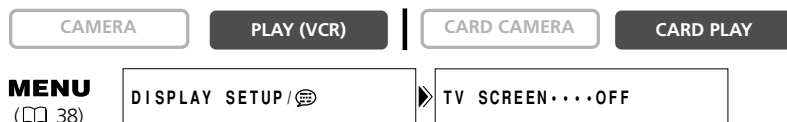

Open the menu and select [DISPLAY SETUP/🌐]. Select [TV SCREEN], set it to [ON] and close the menu.

The displays appear on the TV screen.



# Screen Displays during Recording/Playback

## CAMERA Mode

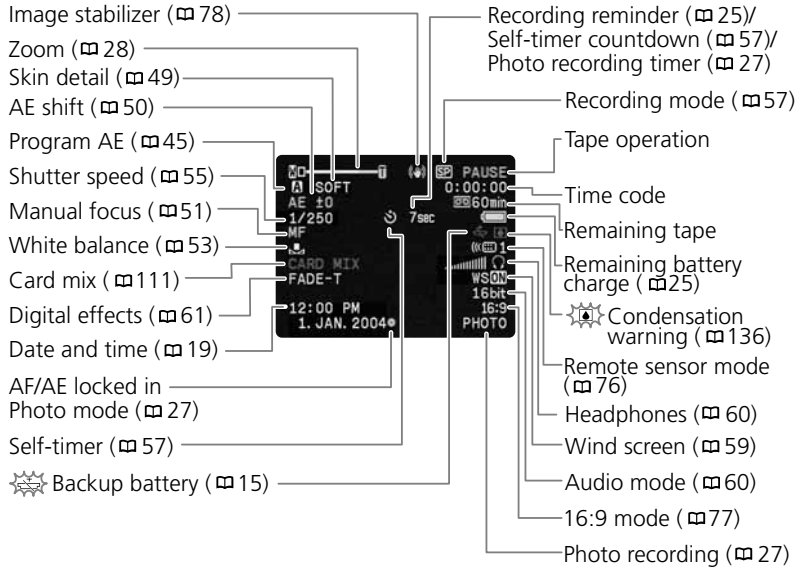

E

## PLAY (VCR) Mode

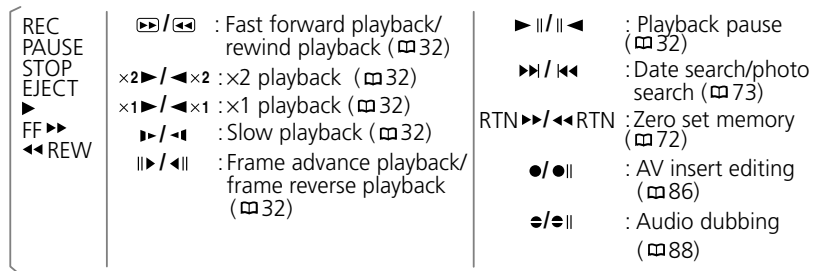

Additional Information

## **MV750i/MV730i** CARD CAMERA Mode

---

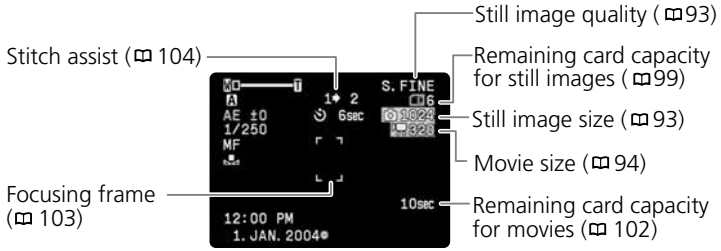

## **MV750i/MV730i** CARD PLAY Mode



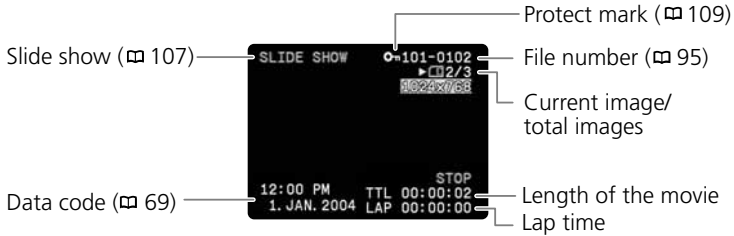

---





## List of Messages

Message	Explanation	
SET THE TIME ZONE, DATE AND TIME	You have not set the time zone, date and time. This message appears each time you turn the power on until you set the time zone, date and time.	19
CHANGE THE BATTERY PACK	Battery pack is exhausted. Replace or charge the battery pack.	11
THE TAPE IS SET FOR ERASURE PREVENTION	Cassette is protected. Replace the cassette or change the position of the protect switch.	138
REMOVE THE CASSETTE	Camcorder stopped operating to protect the tape. Unload and reload the cassette.	14
CHECK THE DV INPUT	DV cable is not connected, or the connected digital device is turned off.	79
CONDENSATION HAS BEEN DETECTED	Condensation has been detected in the camcorder.	136
TAPE END	Tape reached the end. Rewind the tape or replace the cassette.	–
CHECK THE CASSETTE [REC MODE]	You attempted to perform audio dubbing or AV insert on a tape recorded in a mode other than the SP mode.	86 88
CHECK THE CASSETTE [AUDIO MODE]	You attempted to perform audio dubbing on a tape recorded in 16-bit or 12-bit 4-channel sound.	88
CHECK THE CASSETTE [BLANK]	You attempted to perform audio dubbing or AV insert on a tape with a blank section.	86 88
COPYRIGHT PROTECTED PLAYBACK IS RESTRICTED	You attempted to play back a copyright protected tape.	82
COPYRIGHT PROTECTED DUBBING RESTRICTED	You attempted to dub a copyright protected tape. May also appear when an anomalous signal is received during analog line-in recording, or during analog-digital conversion of a copyright protected tape.	82

## **MV750i/MV730i** Memory Card Related Messages

Message	Explanation	
NO CARD	Memory card not inserted into the camcorder.	92
THE CARD IS SET FOR ERASURE PREVENTION	SD Memory Card is set for erasure prevention. Replace the card or change the position of the protect switch.	92
NO IMAGES	No images are recorded on the memory card.	–
CARD ERROR	A memory card error occurred. The camcorder cannot record or play back the image. The error may be temporary. If the message disappears after 4 seconds and  flashes red, turn the camcorder off, remove the card and reinsert the card. If  changes to green, you can continue recording/playback.	–
CARD FULL	No remaining capacity on the memory card. Replace with another card or erase images.	–
NAMING ERROR	File or folder number has reached the maximum value.	95
UNIDENTIFIABLE IMAGE	Image is recorded in a not compatible JPEG format or another format not compatible with the camcorder, or the image file is corrupted.	–
 PRINT ORDER ERROR	You attempted to set more than 200 still images in the print order.	126
THIS IMAGE CANNOT BE RECORDED	Some analog images cannot be recorded on the memory card depending on the signal.	–
THIS IMAGE CANNOT BE USED AS START-UP IMAGE	You attempted to use an image recorded with another camcorder, recorded in a format not compatible with this camcorder, or that has been edited on a computer.	119

**MV750i/MV730i Direct Print Related Messages****E**

Message	Explanation
PAPER ERROR	There is a problem with the paper. Wrong paper size is inserted, or the ink cannot be used with the selected paper.
NO PAPER	Paper is not correctly inserted or there is no paper.
PAPER JAM	The paper jammed during printing.
PAPER HAS BEEN CHANGED	Paper size has been changed between print setting and start of printing.
MEDIA TYPE ERROR	You attempted to use a paper size/type that is not supported by the printer.
INK ERROR	There is a problem with the ink.
NO INK	The ink cartridge is not inserted or is out of ink.
LOW INK LEVEL	The ink cartridge needs to be replaced soon.
WASTE TANK FULL	Waste tank is full. Refer to the instruction manual of your printer.
FILE ERROR	You attempted to print an image that was made with another camcorder, has a different format, or was edited on a computer.
CANNOT PRINT!	You attempted to print an image that was made with another camcorder, has a different format, or was edited on a computer.
COULD NOT PRINT X IMAGES	You attempted to use the print order settings to print X images that were made with another camcorder, have a different format or were edited on a computer.
SET  PRINT ORDER	You attempted to print an image from the CARD PLAY menu [   PRINT] without having set the print order.
PRINTER ERROR	Cancel printing. Turn off the printer and turn it back on. Check the printer status.
HARDWARE ERROR	Cancel printing. Turn off the printer and turn it back on. Check the printer status.
COMMUNICATION ERROR	The printer is experiencing a data transmission error. Or, you attempted to print from a memory card that contains a large number of images. Reduce the number of images.
PRINTER IN USE	The printer is in use. Check the printer status.
PRINTER WARMING UP	Printer is warming up. If the message does not disappear after a few seconds, check the printer status.
PAPER LEVER ERROR	Paper lever error occurred. Adjust the paper selection lever to the proper position.
PRINTER COVER OPEN	Close the printer cover securely.
NO PRINTHEAD	No print head is installed in the printer.

# **Maintenance/Others**

---

## **Camcorder Handling Precautions**

---

- Do not carry the camcorder by the LCD panel or viewfinder.
- Do not leave the camcorder in places subject to high temperatures, such as a sun-heated car, and high humidity.
- Do not use the camcorder in places subject to magnetic or electric fields such as near the TV transmitters or portable communication devices.
- Do not point the lens or viewfinder at strong light sources. Do not leave the camcorder pointed at a bright subject.
- Do not use the camcorder in dusty or sandy places. Dust or sand getting inside the cassette or camcorder may cause damage. Dust and sand can also damage the lens. Attach the lens cap after use.
- The camcorder is not waterproof. Water, mud or salt getting inside the cassette or camcorder may cause damage.
- Be careful of heat generated by lighting equipment.
- Do not disassemble the camcorder. If the camcorder does not function properly, consult qualified service personnel.
- Handle the camcorder with care. Do not subject the camcorder to shocks or vibration as this may cause damage.
- Avoid sudden changes in temperature. Moving the camcorder rapidly between hot and cold temperatures may cause condensation to form on its internal surfaces (📖 136).

## **Storage**

---

- If you do not intend to use the camcorder for a long time, store it in a place free of dust, in low humidity, and at temperatures not higher than 30 °C.
- After storage, check the functions of your camcorder to make sure that the camcorder is still working properly.

## **Cleaning**

---

### **Camcorder Body and Lens**

- Use a soft, dry cloth to clean the camcorder body and lens. Never use chemically treated cloth or volatile solvents such as paint thinner.

### **LCD Screen**

- Clean the LCD screen using a commercially available cleaning cloth for glasses.
- Condensation may form on the surface of the screen when the temperature changes suddenly. Wipe it with a soft dry cloth.

- At cold temperatures, the screen may be darker than usual. This is not a malfunction. The screen returns to normal when the camcorder warms up.

### Viewfinder

- Move the viewfinder upward. Remove the protect cover and clean the glass with a cotton swab. Reattach the protect cover when finished.
- Be careful not to scratch the glass when cleaning.

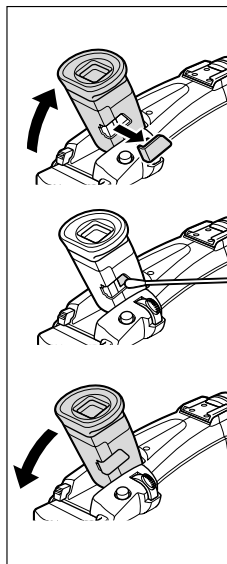

E

### Video Heads

- When the playback picture becomes distorted, the video heads need to be cleaned.
- To maintain the best picture quality, we recommend cleaning the video heads frequently with the Canon DVM-CL Digital Video Head Cleaning Cassette or a commercially available dry cleaning cassette.
- Do not use wet type cleaning cassettes as this may damage the camcorder.



## Condensation

Moving the camcorder rapidly between hot and cold temperature may cause condensation (water droplets) to form on its internal surfaces. Stop using the camcorder if condensation is detected. Continued use may damage the camcorder.

### Condensation may form in the following cases:

When the camcorder is moved from an air-conditioned room to a warm, humid place

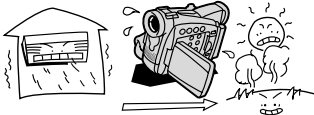

When the camcorder is moved from a cold place to a warm room

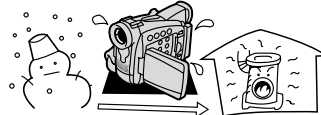

When the camcorder is left in a humid room

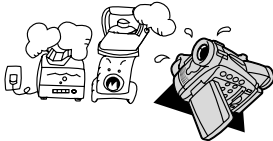



When a cold room is heated rapidly



### How to avoid condensation:

- Unload the cassette, place the camcorder in an airtight plastic bag and let it adjust to temperature changes slowly before removing it from the bag.

### When condensation is detected:

- The camcorder stops operating and the warning message "CONDENSATION HAS BEEN DETECTED" appears for approx. 4 seconds and  starts flashing.
- If a cassette is loaded, the warning message "REMOVE THE CASSETTE" appears and  starts flashing. Remove the cassette immediately and leave the cassette compartment open. Leaving the cassette in the camcorder may damage the tape.
- A cassette cannot be loaded when condensation is detected.

### Resuming use:

- It takes about 1 hour until the water droplets evaporate. After the condensation warning stops flashing, wait for 1 more hour before resuming use.



## Battery Pack Handling Precautions

### **DANGER!**

#### **Treat the battery pack with care.**

- Keep it away from fire (or it might explode).
  - Do not expose the battery pack to temperature higher than 60 °C. Do not leave it near a heater or inside a car in hot weather.
  - Do not try to disassemble or modify it.
  - Do not drop or knock it.
  - Do not get it wet.
- Charged battery packs continue to discharge naturally. Therefore, charge them on the day of use, or the day before, to ensure a full charge.
- Attach the terminal cover whenever a battery pack is not in use. Contact to metallic objects may cause a short circuit and damage the battery pack.
- Dirty terminals may cause a poor contact between the battery pack and the camcorder. Wipe the terminals with a soft cloth.
- Since storing a charged battery pack for a long time (about 1 year) can shorten its lifecycle or affect performance, we recommend to discharge the battery pack fully and to store it in a dry place at temperatures no higher than 30 °C. If you do not use the battery pack for long periods, charge and discharge it fully at least once a year. If you have more than 1 battery pack, perform these precautions at the same time for all battery packs.
- Although the battery pack's operating temperature range is from 0 °C to 40 °C, the optimal range is from 10 °C to 30 °C. At cold temperatures, performance will temporarily decline. Warm it in your pocket before use.
- Replace the battery pack if the usable time after full charge diminishes substantially at normal temperatures.

### **About the battery terminal cover**

The battery terminal cover has a [□]-shaped hole. This is useful when you wish to differentiate between charged and uncharged battery packs. For example, with charged battery packs, attach the terminal cover so that the [□]-shaped hole shows the blue label.

Back side of the battery pack

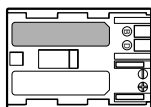

Terminal cover attached  
Charged



Uncharged

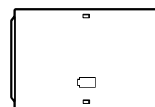

## Cassette Handling Precautions

- Rewind tapes after use. If the tape becomes slack and damaged, it may cause picture and sound distortion.
- Return cassettes in the case and store them upright.
- Do not leave the cassette in the camcorder after use.
- Do not use spliced tapes or nonstandard cassettes as they may damage the camcorder.
- Do not use tapes that have been jammed as video heads may become dirty.
- Do not insert anything into the small holes of the cassette, or cover them with cellophane tape.
- Handle cassettes with care. Do not drop or subject them to severe impact as this may damage the cassettes.
- Rewind tapes from time to time if they are stored for a long time.
- With cassettes equipped with a memory function, metal plated terminals may become dirty with use. Clean the terminals with a cotton swab after about 10 times of loading/unloading. The memory function is not supported by the camcorder.

## Protecting Tapes from Accidental Erasure

To protect your recordings from accidental erasure, slide the tab on the cassette to the left. (This switch position is usually labelled SAVE or ERASE OFF.)

If you load a protected cassette in CAMERA mode, the message "THE TAPE IS SET FOR ERASURE PREVENTION" appears for approx.

4 seconds and  starts flashing. If you wish to record on that cassette, slide the tab back to the right.

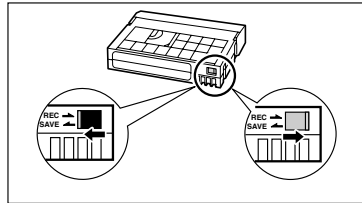

## **MV750i/MV730i** Memory Card Handling Precautions

- Format new memory cards with the camcorder. Memory cards formatted with other devices such as a computer may not operate correctly.
- We recommend saving backups of memory card images on your computer's hard drive or other external memory device. Image data may be corrupted or lost due to memory card defects or exposure to static electricity. Canon Inc. makes no warranties for corrupted or lost data.
- Do not turn off the camcorder, disconnect the power source, open the memory card cover or remove the memory card while the card access indicator is flashing.
- Do not use memory cards in places subject to strong magnetic fields.
- Do not leave memory cards in places subject to high humidity and high temperature.
- Do not disassemble memory cards.
- Do not bend, drop, or subject memory cards to shocks and do not expose them to water.

- Moving a memory card rapidly between hot and cold temperatures may cause condensation to form on its external and internal surfaces. If condensation forms on the card, put it aside until the droplets have evaporated completely.
- Do not touch or expose the terminals to dust or dirt.
- Check the direction before inserting the memory card. Forcing a memory card backwards into the slot may damage the memory card or the camcorder.
- Do not remove the label from the memory card, or affix other labels on the memory card.

## Using the Camcorder Abroad

---

### Power Sources

You can use the compact power adapter to operate the camcorder and to charge battery packs in any country with power supply between 100 and 240 V AC, 50/60 Hz. Consult the Canon Service Centre for information on plug adapters for overseas use.

### Playback on a TV Screen

You can only play back your recordings on TVs with PAL system. The PAL system is used in the following countries/areas:

Algeria, Australia, Austria, Bangladesh, Belgium, Brunei, China, Denmark, Finland, Germany, Hong Kong Special Administrative Region, Iceland, India, Indonesia, Ireland, Italy, Jordan, Kenya, Kuwait, Liberia, Malaysia, Malta, Mozambique, the Netherlands, New Zealand, North Korea, Norway, Oman, Pakistan, Portugal, Qatar, Sierra Leone, Singapore, South Africa, Spain, Sri Lanka, Swaziland, Sweden, Switzerland, Tanzania, Thailand, Turkey, Uganda, United Arab Emirates, United Kingdom, Yemen, former Yugoslavia, Zambia.



# Troubleshooting

If you have a problem with your camcorder, refer to this checklist. Consult your dealer or a Canon Service Centre if the problem persists.

## Power Source

Problem	Cause	Solution	
Camcorder will not turn on.	Battery pack is exhausted.	Replace or charge the battery pack.	11
	Battery pack is not correctly attached.	Attach the battery pack correctly.	11
The camcorder switches off by itself.	Battery pack is exhausted.	Replace or charge the battery pack.	11
	Power save function has been activated.	Turn on the camcorder.	23
Cassette compartment will not open.	Battery pack is exhausted.	Replace or charge the battery pack.	11
	Cassette compartment cover is not fully open.	Open the cassette compartment cover fully.	14
Cassette compartment stopped during loading/unloading.	Battery pack is exhausted.	Replace or charge the battery pack.	11
	The camcorder malfunctions.	Consult a Canon Service Centre.	–
LCD/viewfinder switches on and off.	Battery pack is exhausted.	Replace or charge the battery pack.	11



## Recording/Playback

Buttons will not work.	Camcorder is not turned on.	Turn on the camcorder.	22
	Cassette is not loaded.	Load a cassette.	14
 flashes on the screen.	Cassette is not loaded.	Load a cassette.	14
 flashes on the screen.	Battery pack is exhausted.	Replace or charge the battery pack.	11
 flashes on the screen.	Condensation is detected.	See reference page.	138
“Remove the cassette” appears on the screen.	Camcorder stopped operating to protect the tape.	Unload and reload the cassette.	14
The wireless controller will not work.	Camcorder and wireless controller are not set to the same remote sensor mode.	Change the remote sensor modes.	76
	Batteries of the wireless controller are exhausted.	Replace the batteries.	18

## Recording

Problem	Cause	Solution	
Image will not appear on the screen.	Camcorder is not set to CAMERA mode.	Set the camcorder to CAMERA mode.	22
“Set the time zone, date and time” appears on the screen.	Time zone, date and time are not set, or the backup battery is exhausted.	Set the time zone, date and time, or replace the backup battery and reset the date and time.	19
Pressing the start/stop button will not start recording.	Camcorder is turned off.	Turn on the power.	22
	Cassette is not loaded.	Load a cassette.	14
	Tape reached the end (END flashes on the screen).	Rewind the tape or replace the cassette.	14
	Cassette is protected (protect flashes on the screen).	Replace the tape or change the position of the protect switch.	138
	Camcorder is set to a mode other than the CAMERA mode.	Set the camcorder to CAMERA mode.	22
Camcorder will not focus.	Autofocus does not work on that subject.	Focus manually.	51
	Viewfinder is not adjusted.	Adjust the viewfinder with the diopter adjustment lever.	16
	Lens is dirty.	Clean the lens.	134
A vertical light bar appears on the screen.	Bright light in a dark scene may cause a vertical light bar (smear) to appear. This is not a malfunction.	---	—
Sound is distorted or recorded in a lower volume than the actual volume.	When recording near loud sound (such as fireworks, drums or concerts), sound may become distorted or may not be recorded in the actual sound level. This is not a malfunction.	---	—
Viewfinder picture is blurred.	Viewfinder is not adjusted.	Adjust the viewfinder with the diopter adjustment lever.	16

## Playback

Pressing the playback button does not start playback.	Camcorder is turned off, or is not set to PLAY (VCR) mode.	Set the camcorder to PLAY (VCR) mode.	31
	Cassette is not loaded.	Load a cassette.	14
	Tape reached the end (END flashes on the screen).	Rewind the tape.	31
Image will not appear on the TV screen.	[AV/PHONES{  }] is set to [PHONES{  }] in the menu.	Set [AV/PHONES{  }] to [AV] in the menu.	34
	[AV → DV OUT] is set to [ON].	Set [AV → DV OUT] to [OFF].	85
Tape is running, but image will not appear on the TV screen.	TV/VIDEO selector on the TV is not set to VIDEO.	Set the selector to VIDEO.	34
	Video heads are dirty.	Clean the video heads.	135
	You attempted to play back or dub copyright protected tape.	Stop playback/dubbing.	–
No sound from the built-in speaker.	Speaker volume is turned off.	Adjust the volume with the SET dial.	33

## **MV750/MV730** Memory Card Operation

Problem	Cause	Solution	
Memory card cannot be inserted.	Memory card was not facing the correct direction.	Turn the memory card over and reinsert it.	92
Memory card cannot be recorded.	Memory card is full.	Replace the memory card or erase images.	92
	Memory card is not formatted.	Format the memory card.	117
	Memory card is not inserted.	Insert a memory card.	92
	File number reached maximum value.	Set [FILE NUMBERS] to [RESET] and insert a new memory card.	95
	SD Memory Card is protected.	Change the position of the protect switch.	92
Memory card cannot be played back.	Camcorder is not set to CARD PLAY mode.	Set the camcorder to CARD PLAY mode.	106
	Memory card is not inserted.	Insert a memory card.	92
Image cannot be erased.	Image is protected.	Cancel the protection.	109
	SD memory card is protected.	Change the position of the protect switch.	92
 flashes red.	Card error occurred.	Turn off the camcorder. Remove and reinsert the memory card. Format the memory card if flashing persists.	117

# System Diagram (Availability differs from area to area)

E

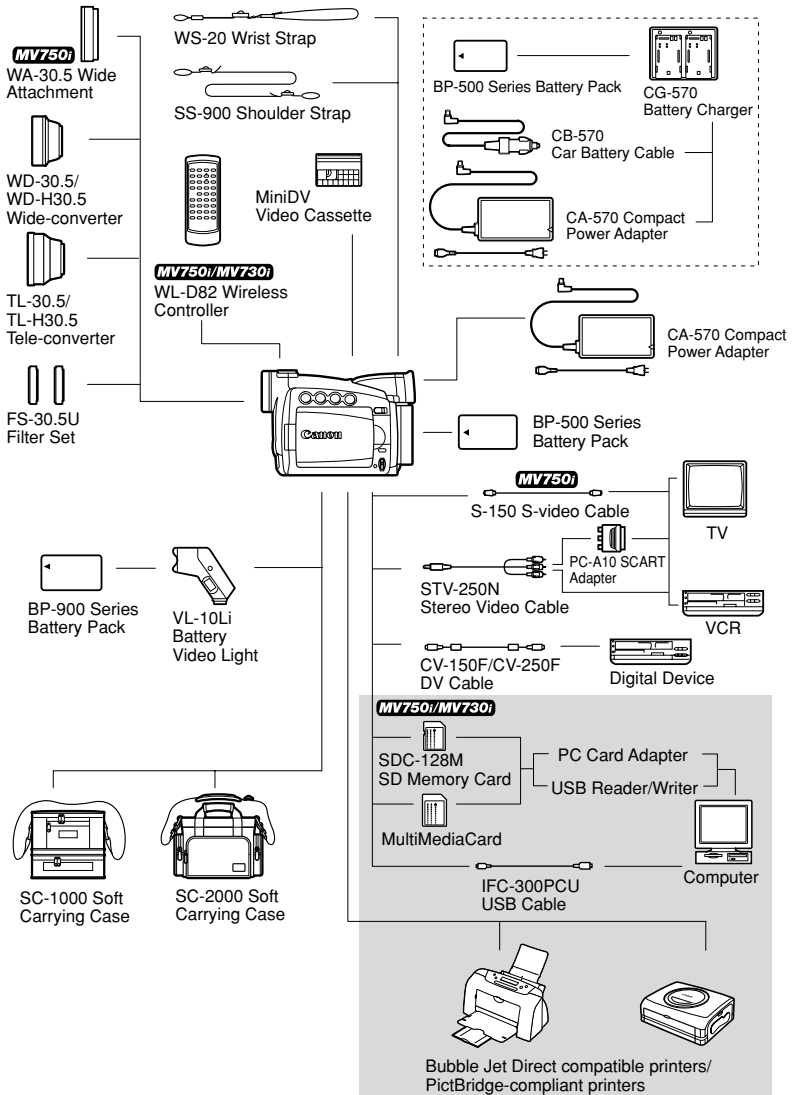

Additional Information

## Optional Accessories

### Use of genuine Canon accessories is recommended.

This product is designed to perform optimally when used with genuine Canon accessories. Canon shall not be liable for any damage to this product and/or accidents such as fire, etc., caused by the malfunction of non-genuine Canon accessories (e.g., a leakage and/or explosion of a battery pack). Please note that this warranty does not apply to repairs arising out of the malfunction of non-genuine Canon accessories, although you may request such repairs on a chargeable basis.

### BP-500 Series Battery Packs

When you need extra battery packs, select from the following: BP-511, BP-512, BP-514, BP-522 or BP-535.

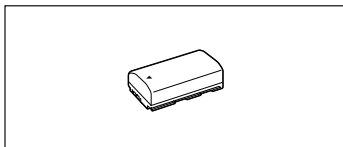

### CG-570 Battery Charger

The battery charger can be used with the supplied CA-570 Compact Power Adapter or the optional CB-570 Car Battery Cable to charge BP-500 series battery packs.

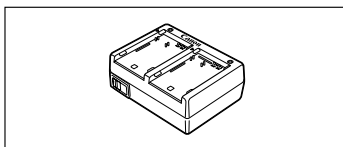

Battery Pack	Charging Time*
BP-508 (Supplied)	55 min.
BP-512/BP-511 (Optional)	95 min.
BP-514 (Optional)	95 min.
BP-522 (Optional)	140 min.
BP-535 (Optional)	205 min.

\* Charging time varies according to the charging condition.

### CB-570 Car Battery Cable

Use the car battery cable with the CG-570 Battery Charger to charge battery packs on the move. The car battery cable plugs into your car's cigarette lighter and runs off a 12-24 V DC negative ground battery.

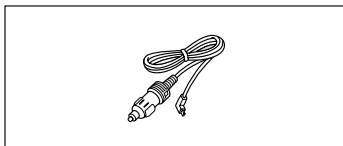



### TL-30.5/TL-H30.5 Tele-converter

This Tele-converter lens increases the focal length of the camcorder lens by a factor of 1.9 (TL-30.5) or 1.7 (TL-H30.5).

- The image stabilizer is not as effective when the Tele-converter is attached.
- The minimum focusing distance with the TL-30.5 is 4 m; 4 cm at maximum wide angle. With the TL-H30.5, it is 3 m; 3 cm at maximum wide angle.
- When the Tele-converter is attached, a shadow may appear in the picture when you record with video light (MV750i; or assist lamp).

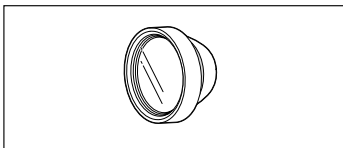

### WD-30.5/WD-H30.5 Wide-converter

This lens decreases focal length by a factor of 0.7, giving you a wide perspective for indoor shots or panoramic views.

- When the Wide-converter is attached, a shadow may appear in the picture when you record with video light (MV750i; or assist lamp).

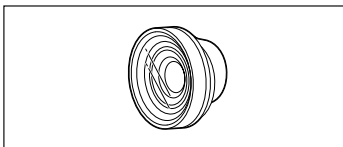

### FS-30.5U Filter Set

Neutral density and MC protector filters help you to control difficult lighting conditions.

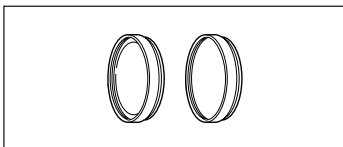

### VL-10Li Battery Video Light

This compact yet powerful video light can be used for both indoor and outdoor shooting. It attaches to the camcorder's accessory shoe and is powered by BP-900 series battery packs.

- Approximate usage time: BP-915: 60 min., BP-930: 120 min., BP-945: 170 min.
- BP-900 series battery packs are charged with the CA-920 Compact Power Adapter or CH-910 Dual Battery Charger/Holder.

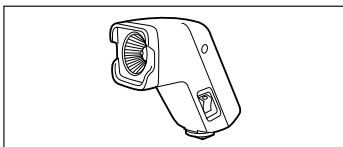

### WS-20 Wrist Strap

Use this for extra additional protection for active shooting.

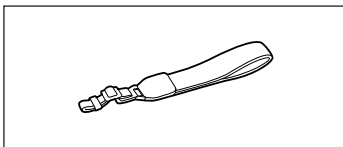

### SC-1000/SC-2000 Soft Carrying Case

A handy camcorder bag with padded compartments and plenty of space for accessories.

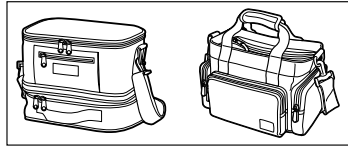

This mark identifies genuine Canon video accessories. When you use Canon video equipment, we recommend Canon-brand accessories or products bearing the same mark.



# Specifications

E

## MV750i/MV730i/MV700i/MV700/MV690

### System

<b>Video Recording System</b>	2 rotary heads, helical scanning DV system (consumer digital VCR SD system), digital component recording
<b>Audio Recording System</b>	PCM digital sound: 16 bit (48 kHz/2 ch); 12 bit (32 kHz/4 ch)
<b>Television System</b>	CCIR standard (625 lines, 50 fields) PAL colour signal
<b>Image Sensor</b>	1/6-inch CCD, approx. 800,000 pixels Effective pixels: tape: approx. 400,000 pixels card: approx. 528,000 pixels (MV750i/MV730i)
<b>Tape Format</b>	Videocassettes bearing the "MiniDV" mark
<b>Tape Speed</b>	SP: 18.83 mm/s, LP: 12.57 mm/s
<b>Maximum Recording Time (80 min. cassette)</b>	SP: 80 min., LP: 120 min.
<b>Fast Forward/Rewind Time</b>	Approx. 2 min. 20 sec. (with a 60 min. cassette)
<b>LCD Screen</b>	2.5-inch. TFT color, approx. 112,000 pixels
<b>Viewfinder</b>	0.33-inch. TFT color, approx. 113,000 pixels
<b>Microphone</b>	Stereo electret condenser microphone
<b>Lens</b>	MV750i: f=2.8-61.6 mm, F=1.6-3.6, 22x power zoom MV730i: f=2.8-56 mm, F=1.6-3.2, 20x power zoom MV700i/MV700/MV690: f=2.8-50.4 mm, F=1.6-2.9, 18x power zoom
<b>Lens Configuration</b>	11 elements in 8 groups
<b>Filter Diameter</b>	30.5 mm
<b>AF System</b>	TTL autofocus, manual focusing possible
<b>Minimum Focusing Distance</b>	1 m; 1 cm on maximum wide angle
<b>White Balance</b>	Auto white balance, pre-set white balance (indoor, outdoor) or custom white balance
<b>Minimum Illumination</b>	2 lx (using the Night mode)
<b>Recommended Illumination</b>	More than 100 lx
<b>Image Stabilization</b>	Electronic

### Memory Card (MV750i/MV730i)

<b>Recording Media</b>	SD Memory Card, MultiMediaCard
<b>Number of Recording Pixels</b>	Still image: 1024 × 768, 640 × 480 pixels Movie: 320 × 240, 160 × 120 pixels, 12.5 frames/sec.
<b>File Format</b>	Design rule for Camera File System (DCF), Exif 2.2* compliant, DPOF compliant (still images only)
	*This camcorder supports Exif 2.2 (also called "Exif Print"). Exif Print is a standard for enhancing the communication between camcorders and printers. By connecting to an Exif Print-compliant printer, the camcorder's image data at the time of shooting is used and optimized, yielding extremely high quality prints.
<b>Image Recording Format</b>	Still image: JPEG (compression: Super Fine, Fine, Normal) Movie: AVI (image data: Motion JPEG; audio data: WAVE (monaural))

Additional  
Information

## Input/Output Terminals (MV700/MV690: Output only)

<b>AV Terminal</b>	ø3.5 mm minijack Video: 1 Vp-p/75 ohms unbalanced Audio output: -10 dBV (47 kohm load)/3 kohms or less Audio input*: -10 dBV/40 kohms or more
<b>DV Terminal</b>	Special 4-pin connector (IEEE 1394 compliant)
<b>Headphone Terminal</b>	ø3.5 mm stereo mini-jack
<b>USB Terminal (MV750i/MV730i)</b>	mini-B
<b>S-video Terminal (MV750i)</b>	1 Vp-p/75 ohms (Y signal), 0.3 Vp-p/75 ohms (C signal)

\*MV750i/MV730i/MV700i only.

## Power/Others

<b>Power supply (rated)</b>	7.4 V DC
<b>Power consumption (AF on)</b>	2.3W (using viewfinder), 3.3W (using LCD screen)
<b>Operating temperature</b>	0 – 40 °C
<b>Dimensions (W × H × D)</b>	53 × 95 × 139 mm excluding protrusions
<b>Weight (camcorder body only)</b>	485 g

## CA-570 Compact Power Adapter

<b>Power supply</b>	100 – 240 V AC, 50/60 Hz
<b>Power consumption</b>	17W
<b>Rated output</b>	8.4 V DC, 1.5 A
<b>Operating temperature</b>	0 – 40 °C
<b>Dimensions</b>	52 × 90 × 29 mm
<b>Weight</b>	135 g

## BP-508 Battery Pack

<b>Battery type</b>	Rechargeable Lithium Ion Battery
<b>Rated voltage</b>	7.4 V DC
<b>Operating temperature</b>	0 – 40 °C
<b>Battery capacity</b>	800 mAh
<b>Dimensions</b>	38 × 21 × 55 mm
<b>Weight</b>	65 g

## SDC-8M SD Memory Card

<b>Capacity</b>	8 MB
<b>Interface</b>	SD Memory Card standard
<b>Operating temperature</b>	0 – 40 °C
<b>Dimensions</b>	32 × 24 × 2.1 mm
<b>Weight</b>	2 g

Weight and dimensions are approximate. Errors and omissions excepted. Subject to change without notice.

# Index

---

12bit audio . . . . . 89  
16:9 widescreen . . . . . 77  
6-second auto date . . . . . 70

## A

Abroad, using the camcorder . . . 139  
Accessories . . . . . 6, 144  
AE shift . . . . . 50  
Analog line-in . . . . . 81  
Analog-digital converter . . . . . 84  
Assist lamp . . . . . 48  
Audio dubbing . . . . . 88  
Audio mode . . . . . 59  
Auto . . . . . 45  
Autofocus . . . . . 51  
AV insert . . . . . 86  
AV → DV . . . . . 84  
AV/headphones terminal . . . . 33, 34

## B

Backup battery . . . . . 15  
Battery charger . . . . . 144  
Battery pack . . . . . 11  
Beep . . . . . 77  
Brightness . . . . . 24

## C

Card jump . . . . . 108  
Card mix . . . . . 111  
Computer . . . . . 91, 118  
Condensation . . . . . 136  
Connections - TV . . . . . 34  
Connections - VCR . . . . . 34  
Copying still images . . . . . 115  
Copyright signals . . . . . 83

## D

Data code . . . . . 69  
Date and time . . . . . 19  
Date format . . . . . 75  
Date search . . . . . 73  
Demo mode . . . . . 78  
Digital effects . . . . . 61  
Digital zoom . . . . . 29  
Direct print function . . . . . 120  
DV dubbing . . . . . 82

DV terminal . . . . . 79, 91

## E

Easy recording . . . . . 45  
Effects . . . . . 63  
End search . . . . . 71  
Erasing still images . . . . . 110

## F

Faders . . . . . 61  
Fast forward . . . . . 32  
File numbers . . . . . 95  
Focusing . . . . . 51  
Focusing point . . . . . 103  
Focus-Priority . . . . . 103  
Formatting . . . . . 117

## G

Grip belt . . . . . 16

## H

Headphones . . . . . 33, 60

## I

Image quality . . . . . 93  
Image stabilizer . . . . . 78  
Index screen . . . . . 107

## L

Language . . . . . 75  
LCD mirror mode . . . . . 23  
LCD screen . . . . . 22  
Lens cap . . . . . 16  
Low light mode . . . . . 45  
LP mode . . . . . 58

## M

Maintenance . . . . . 134  
Manual focus . . . . . 51  
Memory card . . . . . 92  
Menus . . . . . 38-44  
Movie size . . . . . 94  
MultiMediaCard . . . . . 92  
Multi-image screen . . . . . 63  
My Camera settings . . . . . 74

E

**N**

Night mode . . . . .	48
Night+ mode . . . . .	48

**O**

Operating mode . . . . .	3
Output channel . . . . .	37

**P**

Photo search . . . . .	73
Playback - Memory card . . . . .	106
Playback - Tape . . . . .	31
Playback pause . . . . .	32
Portrait mode . . . . .	45
Power adapter . . . . .	11
Print order . . . . .	126
Program AE . . . . .	45
Protect . . . . .	109

**R**

Record review . . . . .	26
Record search . . . . .	26
Recording Movies (memory card) . . . . .	101
Recording Movies (tape) . . . . .	22
Recording programs . . . . .	45
Recording Still Images (memory card) . . . . .	96
Recording Still Images (tape) . . . . .	27
Remote sensor . . . . .	76
Review . . . . .	100
Rewind . . . . .	31

**S**

S1 video terminal . . . . .	35
Sample images . . . . .	113
Sand & Snow mode . . . . .	45
Screen displays . . . . .	129
SD Memory Card . . . . .	92
Search select . . . . .	73
Self-timer . . . . .	57
Shoulder strap . . . . .	17
Shutter speed . . . . .	55
Skin detail . . . . .	49
Slide show . . . . .	107
SP mode . . . . .	58
Speaker . . . . .	33
Sports mode . . . . .	45

Spotlight mode . . . . .	45
Still image quality . . . . .	93
Still image size . . . . .	93
Stitch Assist mode . . . . .	104
Super Night mode . . . . .	48

**T**

Tape protection . . . . .	138
Time code . . . . .	25
Time zone . . . . .	19
Tripod . . . . .	30
Troubleshooting . . . . .	140
TV Screen . . . . .	34, 128

**U**

USB terminal . . . . .	118, 120
------------------------	----------

**V**

Video heads . . . . .	135
Video light . . . . .	145
Videocassettes . . . . .	14
Viewfinder . . . . .	16

**W**

White balance . . . . .	53
Wide attachment . . . . .	17
Widescreen . . . . .	77
Wind screen . . . . .	59
Wireless controller . . . . .	18

**Z**

Zero set memory . . . . .	72
Zooming . . . . .	28