

# Canon

# EOS *REBEL T6S* EOS 760D

EOS REBEL T6S (W)

EOS 760D (W)



Camera

Wi-Fi/NFC Function

## Basic Instruction Manual

This manual is the Basic Instruction Manual.

For more detailed instructions, refer to the Instruction Manuals included in the Camera Instruction Manual CD-ROM.





**Canon**

**EOS**                      **EOS**  
***REBEL T6s***      **760D** 

**EOS REBEL T6S (W)**

**EOS 760D (W)**

**Camera Basic Instruction Manual**

The Camera Basic Instruction Manual covers the most basic operations.

# Introduction

The EOS REBEL T6S or EOS 760D is a digital single-lens reflex camera featuring a fine-detail CMOS sensor with approx. 24.2 effective megapixels, DIGIC 6, high-precision and high-speed 19-point AF (cross-type AF point: max. 19 points), approx. 5.0 fps continuous shooting, Live View shooting, Full High-Definition (Full HD) movie shooting, and Wi-Fi/NFC function.

## **Before Starting to Shoot, Be Sure to Read the Following**

To avoid botched pictures and accidents, first read the “Safety Precautions” (p.16-18) and “Handling Precautions” (p.19-21).

## **Refer to This Manual while Using the Camera to Further Familiarize Yourself with the Camera**

While reading this manual, take a few test shots and see how they come out. You can then better understand the camera.

## **Testing the Camera Before Use and Liability**

After shooting, play images back and check whether they have been properly recorded. If the camera or memory card is faulty and the images cannot be recorded or downloaded to a computer, Canon cannot be held liable for any loss or inconvenience caused.

## **Copyrights**

Copyright laws in your country may prohibit the use of your recorded images or copyrighted music and images with music in the memory card for anything other than private enjoyment. Also be aware that certain public performances, exhibitions, etc., may prohibit photography even for private enjoyment.



## Item Check List

Before starting, check that all the following items are included with your camera. If anything is missing, contact your dealer.

---



**Camera**

(with eyecup and body cap)



**Battery Pack  
LP-E17**

(with protective cover)



**Battery Charger  
LC-E17/LC-E17E\***

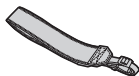

**Wide Strap**



**Interface Cable**

\* Battery Charger LC-E17 or LC-E17E is provided. (The LC-E17E comes with a power cord.)

- The Instruction Manuals and CD-ROMs provided are listed on the next page.
- If you purchased a Lens Kit, check that the lenses are included.
- Depending on the Lens Kit type, lens instruction manuals may also be included.
- Be careful not to lose any of the above items.

# Instruction Manual and CD-ROMs

The instruction manual consists of a booklet and electronic manuals (PDF files on the CD-ROM). **The booklet is the Basic Instruction Manual. For more detailed instructions, see the Camera Instruction Manual on the CD-ROM.**

---



**Camera and Wi-Fi/NFC Function  
Basic Instruction Manual**  
(This Manual)



## **Camera Instruction Manual CD-ROM**

Contains the following manuals (PDF files):

- Camera Instruction Manual
- Wi-Fi/NFC Function Instruction Manual
- Quick Reference Guide

Instructions for viewing the Camera Instruction Manual CD-ROM are on pages 162-163.



## **EOS DIGITAL Solution Disk** (Software CD-ROM)

Contains software such as image-editing software and Software Instruction Manuals (PDF files).

For more information and installation procedures of the software, see pages 166-167.

Instructions for viewing the Software Instruction Manual are on page 168.

## Compatible Cards

The camera can use the following cards regardless of capacity: **If the card is new or was previously formatted by another camera or computer, format the card with this camera (p.61).**

- SD memory cards
- SDHC memory cards\*
- SDXC memory cards\*

\* UHS-I cards supported.

### Cards that Can Record Movies

**When shooting movies, use a large-capacity SD card rated SD Speed Class 6 “CLASS 6” or higher.**

- If you use a slow-writing card when shooting movies, the movie may not be recorded properly. Also, if you play back a movie on a card with a slow reading speed, the movie may not play back properly.
- If you want to shoot still photos while shooting a movie, you will need an even faster card.
- To check the card's reading/writing speed, refer to the card manufacturer's Web site.



In this manual, “card” refers to SD memory cards, SDHC memory cards, and SDXC memory cards.

\* **The camera does not come with a card for recording images/movies.** Please purchase it separately.

# Quick Start Guide

1

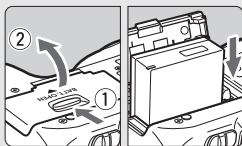

**Insert the battery** (p.34).

- To charge the battery, see page 32.

2

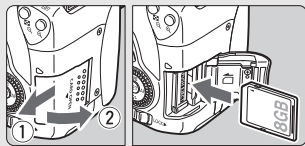

**Insert the card** (p.35).

- With the card's label facing toward the back of the camera, insert it into the card slot.

3

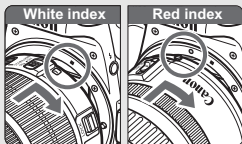

**Attach the lens** (p.43).

- Align the lens's white or red mount index with the camera's mount index of the same color.

4

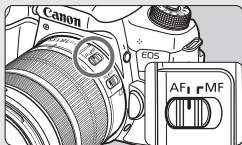

**Set the lens focus mode switch to <AF>** (p.43).

5

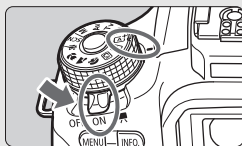

**Set the power switch to <ON>, then set the Mode Dial to <AI+> (Scene Intelligent Auto)** (p.70).

- Turn the Mode Dial while holding down the lock release button at the center.
- All the necessary camera settings will be set automatically.

6

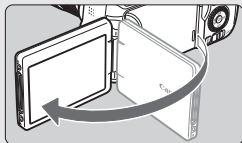
**Flip out the LCD monitor** (p.37).

- When the LCD monitor displays the date/time/zone setting screens, see page 40.

7

**Focus on the subject** (p.48).

- Look through the viewfinder and aim the viewfinder center over the subject.
- Press the shutter button halfway, and the camera will focus on the subject.
- If necessary, the built-in flash will be raised.

8

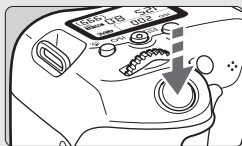
**Take the picture** (p.48).

- Press the shutter button completely to take the picture.





9

**Review the picture.**



- The captured image will be displayed for 2 sec. on the LCD monitor.
- To display the image again, press the <▶> button (p.94).
- To shoot while looking at the LCD monitor, see “Live View Shooting” (p.131).
- To view the images captured so far, see “Image Playback” (p.94).
- To delete an image, see “Erasing Images” (p.160).

# Conventions Used in this Manual

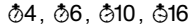
## Icons in this Manual

-  : Indicates the Main Dial.
-  : Indicates the Quick Control Dial.
-  : Indicates the direction of the shift or move when the key on the Quick Control Dial is pressed.
-  : Indicates the Setting button.
-  : Indicates that each function remains active for 4 sec., 6 sec., 10 sec., or 16 sec. after you let go of the button.

\* In this manual, the icons and markings indicating the camera's buttons, dials, and settings correspond to the icons and markings on the camera and on the LCD monitor.

- MENU** : Indicates a function that can be changed by pressing the <MENU> button to change its settings.
- ☆ : When shown on the upper right of a page, it indicates that the function is available only in the Creative Zone modes (p.27).
- (p.\*\*)
-  : Warning to prevent shooting problems.
-  : Supplemental information.
-  : Tips or advice for better shooting.
- ?

## Basic Assumptions

- All operations explained in this manual assume that the power switch is set to <ON> and the <LOCK▶> switch is set to the left (Multi function lock released) (p.51).
- It is assumed that all the menu settings, Custom Functions, etc. are set to their defaults.
- The illustrations in this manual show the camera attached with the EF-S18-135mm f/3.5-5.6 IS STM lens as an example.

# Chapters





	<b>Introduction</b>	<b>4</b>
<b>1</b>	<b>Getting Started</b>	<b>31</b>
<b>2</b>	<b>Basic Shooting and Image Playback</b>	<b>69</b>
<b>3</b>	<b>Setting the AF and Drive Modes</b>	<b>97</b>
<b>4</b>	<b>Image Settings</b>	<b>109</b>
<b>5</b>	<b>Advanced Operations</b>	<b>121</b>
<b>6</b>	<b>Shooting with the LCD Monitor (Live View Shooting)</b>	<b>131</b>
<b>7</b>	<b>Shooting Movies</b>	<b>145</b>
<b>8</b>	<b>Image Playback</b>	<b>153</b>
<b>9</b>	<b>Viewing the CD-ROM Instruction Manuals / Downloading Images to Your Computer</b>	<b>161</b>

# Contents

## Introduction 4

















Item Check List.....	5
Instruction Manual and CD-ROMs .....	6
Compatible Cards.....	7
Quick Start Guide .....	8
Conventions Used in this Manual.....	10
Chapters.....	11
Contents .....	12
Safety Precautions .....	16
Handling Precautions .....	19
Nomenclature .....	22

## 1 Getting Started 31



Charging the Battery .....	32
Installing and Removing the Battery.....	34
Installing and Removing the Card .....	35
Using the LCD Monitor .....	37
Turning on the Power .....	38
Setting the Date, Time, and Zone.....	40
Selecting the Interface Language.....	42
Attaching and Detaching a Lens.....	43
Lens Image Stabilizer .....	46
Basic Operation.....	47
 Quick Control for Shooting Functions .....	53
 Menu Operations.....	55
 Using the Touch Screen .....	58
Formatting the Card .....	61
Switching the LCD Monitor Display .....	63
 Displaying the Grid .....	65
 Displaying the Electronic Level.....	66
Feature Guide .....	68









## 2 Basic Shooting and Image Playback 69

 Fully Automatic Shooting (Scene Intelligent Auto) .....	70
 Full Auto Techniques (Scene Intelligent Auto).....	73
 Disabling Flash .....	75
 Creative Auto Shooting.....	76
 Shooting Portraits .....	80
 Shooting Landscapes .....	81
 Shooting Close-ups.....	82
 Shooting Moving Subjects .....	83
<b>SCN</b> : Special Scene Mode .....	84
 Shooting Children .....	85
 Shooting Food .....	86
 Shooting Candlelight Portraits .....	87
 Shooting Night Portraits (With a Tripod) .....	88
 Shooting Night Scenes (Handheld).....	89
 Shooting Backlit Scenes.....	90
 Quick Control.....	92
 Image Playback .....	94

## 3 Setting the AF and Drive Modes 97





AF: Changing the Autofocus Operation (AF operation) .....	98
 Selecting the AF Area and AF Point .....	101
AF Area Selection Modes .....	104
MF: Manual Focus .....	105
 Selecting the Drive Mode .....	106
 Using the Self-timer .....	107

<b>4</b>	<b>Image Settings</b>	<b>109</b>
	Setting the Image-Recording Quality .....	110
	<b>ISO</b> : Changing the ISO Speed to Suit the Light .....	112
	 Selecting a Picture Style .....	113
	<b>WB</b> : Matching the Light Source (White balance).....	114
	Auto Correction of Brightness and Contrast (Auto Lighting Optimizer) ...	115
	Setting Noise Reduction .....	116
	Correction of Lens Peripheral Illumination and Aberrations .....	118
	Reducing Flicker.....	120
<b>5</b>	<b>Advanced Operations</b>	<b>121</b>
	<b>P</b> : Program AE .....	122
	<b>Tv</b> : Conveying the Subject's Movement (Shutter priority AE).....	123
	<b>Av</b> : Changing the Depth of Field (Aperture priority AE) .....	124
	<b>M</b> : Manual Exposure .....	125
	 Changing the Metering Mode (Metering mode).....	126
	Setting Exposure Compensation (Exposure comp.) .....	127
	Auto Exposure Bracketing (AEB) .....	128
	 Locking the Exposure (AE Lock).....	129
	 Using the Built-in Flash.....	130
<b>6</b>	<b>Shooting with the LCD Monitor (Live View Shooting)</b>	<b>131</b>
	 Shooting with the LCD Monitor .....	132
	Changing the Autofocus Operation (AF operation) .....	135
	Using AF to Focus (AF Method).....	137
	 Shooting with the Touch Shutter.....	141
	<b>MF</b> : Focusing Manually .....	142

## 7 Shooting Movies 145

 Shooting Movies .....	146
Autoexposure Shooting .....	146
Manual Exposure Shooting .....	147
Setting the Movie Recording Size .....	150

## 8 Image Playback 153

 Searching for Images Quickly .....	154
 Magnified View .....	155
 Playing Back with the Touch Screen .....	156
 Playing Back Movies .....	158
 Erasing Images .....	160

## 9 Viewing the CD-ROM Instruction Manuals / Downloading Images to Your Computer 161

Viewing the Camera Instruction Manual CD-ROM .....	162
Downloading Images to a Computer .....	164
Software Overview .....	166
Installing the Software .....	167
Software Instruction Manual .....	168



### Certification Logo

Select [**F4: Certification Logo Display**] and press < > to display some of the logos of the camera's certifications. Other certification logos can be found in this Instruction Manual, on the camera body, and on the camera's package.

# Safety Precautions

The following precautions are provided to prevent harm or injury to yourself and others. Make sure to thoroughly understand and follow these precautions before using the product.

**If you experience any malfunctions, problems, or damage to the product, contact the nearest Canon Service Center or the dealer from whom you purchased the product.**



## Warnings

Follow the warnings below. Otherwise, death or serious injuries may result.

- To prevent fire, excessive heat, chemical leakage, explosions, and electrical shock, follow the safeguards below:
  - Do not use any batteries, power sources, or accessories not specified in the Instruction Manual. Do not use any home-made or modified batteries.
  - Do not short-circuit, disassemble, or modify the battery. Do not apply heat or solder to the battery. Do not expose the battery to fire or water. Do not subject the battery to strong physical shock.
  - Do not insert the battery's plus and minus ends incorrectly.
  - Do not recharge the battery in temperatures outside the allowable ambient temperature range. Also, do not exceed the recharging time indicated in the Instruction Manual.
  - Do not insert any foreign metallic objects into the electrical contacts of the camera, accessories, connecting cables, etc.
- When disposing of a battery, insulate the electrical contacts with tape to prevent contact with other metallic objects or batteries. This is to prevent a fire or an explosion.
- If excessive heat, smoke, or fumes are emitted when recharging the battery, immediately unplug the battery charger from the power outlet to stop recharging. Otherwise, it may cause a fire, heat damage, or electrical shock.
- If the battery leaks, changes color, deforms, or emits smoke or fumes, remove it immediately. Be careful not to get burned in the process. It may cause a fire, electrical shock or skin burn if you keep using it.
- Prevent any battery leakage from contacting your eyes, skin, and clothing. It can cause blindness or skin problems. If the battery leakage contacts your eyes, skin, or clothing, flush the affected area with lots of clean water without rubbing it. See a physician immediately.
- Do not leave any cords near a heat source. It can deform the cord or melt the insulation and cause a fire or electrical shock.
- Do not hold the camera in the same position for long periods of time. Even if the camera does not feel too hot, prolonged contact with the same body part may cause skin redness, blistering or low-temperature contact burns. Using a tripod is recommended for people with circulation problems or very sensitive skin, or when using the camera in very hot places.
- Do not fire the flash at anyone driving a car or other vehicle. It may cause an accident.

- When the camera or accessories are not in use, make sure to remove the battery and disconnect the power plug from the equipment before storing. This is to prevent electrical shock, excessive heat, fire, or corrosion.
- Do not use the equipment where there is flammable gas. This is to prevent an explosion or a fire.
- If you drop the equipment and the casing breaks open to expose the internal parts, do not touch the internal parts. There is a possibility of an electrical shock.
- Do not disassemble or modify the equipment. High-voltage internal parts can cause electrical shock.
- Do not look at the sun or an extremely bright light source through the camera or lens. Doing so may damage your vision.
- Keep equipment out of the reach of children and infants, including when in use. Straps or cords may accidentally cause choking, electrical shock, or injury. Choking or injury may also occur if a child or infant accidentally swallows a camera part or accessory. If a child or infant swallows a part or accessory, consult a physician immediately.
- Do not use or store the equipment in dusty or humid places. Likewise, store the battery with its protective cover attached to prevent short-circuit. This is to prevent a fire, excessive heat, electrical shock, or burn.
- Before using the camera inside an airplane or hospital, check if it is allowed. Electromagnetic waves emitted by the camera may interfere with the plane's instruments or the hospital's medical equipment.
- To prevent a fire and electrical shock, follow the safeguards below:
  - Always insert the power plug all the way in.
  - Do not handle a power plug with wet hands.
  - When unplugging a power plug, grasp and pull the plug instead of the cord.
  - Do not scratch, cut, or excessively bend the cord or put a heavy object on the cord. Also do not twist or tie the cords.
  - Do not connect too many power plugs to the same power outlet.
  - Do not use a cord whose wire is broken or insulation is damaged.
- Unplug the power plug periodically and clean off the dust around the power outlet with a dry cloth. If the surrounding is dusty, humid, or oily, the dust on the power outlet may become moist and short-circuit the outlet, causing a fire.
- Do not connect the battery directly to an electrical outlet or a car's cigarette lighter outlet. The battery may leak, generate excessive heat or explode, causing a fire, burns or injuries.
- A thorough explanation of how to use the product by an adult is required when the product is used by children. Supervise children while they are using the product. Incorrect usage may result in electrical shock or injury.
- Do not leave a lens or lens-attached camera in the sun without the lens cap attached. Otherwise, the lens may concentrate the sun's rays and cause a fire.
- Do not cover or wrap the product with a cloth. Doing so may trap heat within and cause the casing to deform or catch fire.
- Be careful not to get the camera wet. If you drop the product in the water or if water or metal get inside the product, promptly remove the battery. This is to prevent a fire and an electrical shock.
- Do not use paint thinner, benzene, or other organic solvents to clean the product. Doing so may cause fire or a health hazard.



### **Cautions**

Follow the cautions below. Otherwise, physical injury or property damage may result.

- Do not use or store the product inside a car under the hot sun or near a heat source. The product may become hot and cause skin burns. Doing so may also cause battery leakage or explosion, which will degrade the performance or shorten the life of the product.
- Do not carry the camera around when it is attached to a tripod. Doing so may cause injury. Also make sure the tripod is sturdy enough to support the camera and lens.
- Do not leave the product in a low-temperature environment for an extended period of time. The product will become cold and may cause injury when touched.
- Do not fire the flash near the eyes. It may hurt the eyes.
- Never play the provided CD-ROM in a drive that is not compatible with the CD-ROM. If you use it in a music CD player, you may damage the speakers and other components. When using headphones, there is also a risk of injury to your ears from excessively loud volume.

# Handling Precautions

## Camera Care

- This camera is a precision instrument. Do not drop it or subject it to physical shock.
- The camera is not waterproof and cannot be used underwater. If you accidentally drop the camera into water, promptly consult the nearest Canon Service Center. Wipe off any water droplets with a dry and clean cloth. If the camera has been exposed to salty air, wipe it with a well-wrung wet cloth.
- Never leave the camera near anything having a strong magnetic field such as a magnet or electric motor. Also avoid using or leaving the camera near anything emitting strong radio waves, such as a large antenna. Strong magnetic fields can cause camera misoperation or destroy image data.
- Do not leave the camera in excessive heat, such as in a car in direct sunlight. High temperatures can cause the camera to malfunction.
- The camera contains precision electronic circuitry. Never attempt to disassemble the camera yourself.
- Do not block the built-in flash, mirror operation with your finger, etc. Doing so may cause a malfunction.
- Use a blower to blow away dust on the lens, viewfinder, reflex mirror, and focusing screen. Do not use cleaners that contain organic solvents to clean the camera body or lens. For stubborn dirt, take the camera to the nearest Canon Service Center.
- Do not touch the camera's electrical contacts with your fingers. This is to prevent the contacts from corroding. Corroded contacts can cause camera misoperation.
- If the camera is suddenly brought in from the cold into a warm room, condensation may form on the camera and internal parts. To prevent condensation, first put the camera in a sealed plastic bag and let it adjust to the warmer temperature before taking it out of the bag.
- If condensation forms on the camera, do not use the camera. This is to avoid damaging the camera. If there is condensation, remove the lens, card and battery from the camera, and wait until condensation has evaporated before using the camera.
- If the camera will not be used for an extended period, remove the battery and store the camera in a cool, dry, well-ventilated location. Even while the camera is in storage, press the shutter button a few times once in a while to check that the camera is still working.

- Avoid storing the camera where there are chemicals that result in rust and corrosion such as in a chemical lab.
- If the camera has not been used for an extended period, test all its functions before using it. If you have not used the camera for some time or if there is an important shoot such as a foreign trip coming up, have the camera checked by your nearest Canon Service Center or check the camera yourself and make sure it is working properly.
- If you use continuous shooting, Live View shooting, or movie shooting for a prolonged period, the camera may become hot. This is not a malfunction.
- If there is a bright light source inside or outside the image area, ghosting may occur.

### LCD Panel and LCD Monitor

- Although the LCD monitor is manufactured with very high precision technology with over 99.99% effective pixels, there may be a few dead pixels displaying only black or red, etc. among the remaining 0.01% or less pixels. Dead pixels are not a malfunction. They do not affect the images recorded.
- If the LCD monitor is left on for a prolonged period, screen burn-in may occur where you see remnants of what was displayed. However, this is only temporary and will disappear when the camera is left unused for a few days.
- The LCD monitor display may seem slow in low temperatures, or look black in high temperatures. It will return to normal at room temperature.

### Cards

To protect the card and its recorded data, note the following:

- Do not drop, bend, or wet the card. Do not subject it to excessive force, physical shock, or vibration.
- Do not touch the card's electronic contacts with your fingers or anything metallic.
- Do not affix any stickers, etc., on the card.
- Do not store or use the card near anything that has a strong magnetic field, such as a TV set, speakers, or magnet. Also avoid places prone to having static electricity.
- Do not leave the card in direct sunlight or near a heat source.
- Store the card in a case.
- Do not store the card in hot, dusty, or humid locations.



### Smudges Adhering to the Front of the Sensor

Besides dust entering the camera from outside, in rare cases lubricant from the camera's internal parts may adhere to the front of the sensor. If visible spots remain on the image, having the sensor cleaned by a Canon Service Center is recommended.

### Lens

After detaching the lens from the camera, put down the lens with the rear end up and attach the rear lens cap to avoid scratching the lens surface and electrical contacts.



# Nomenclature

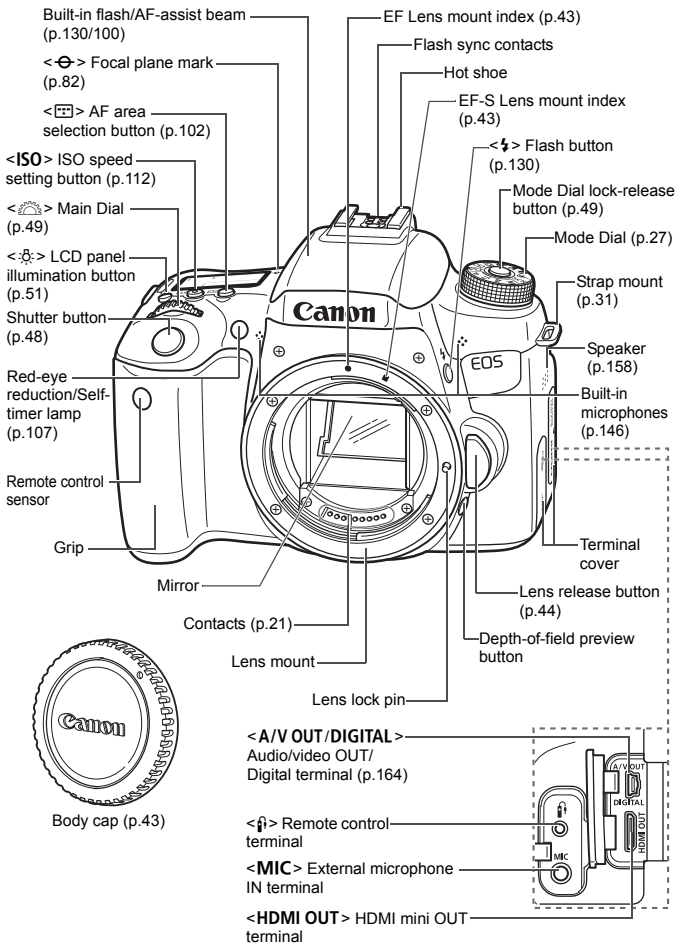

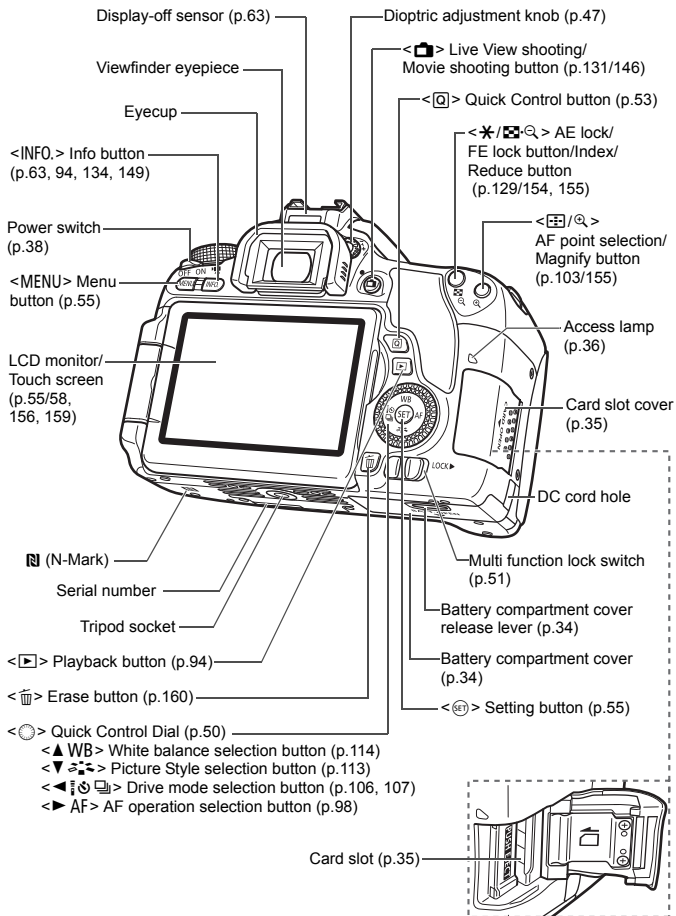

## Shooting Function Settings (in Creative Zone modes, p.27)

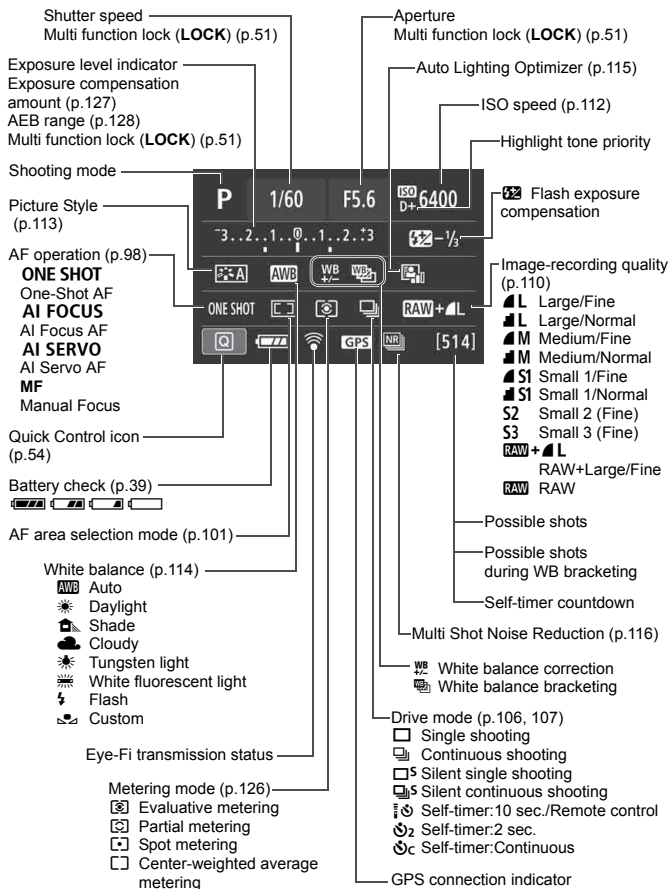

The display will show only the settings currently applied.

## LCD Panel

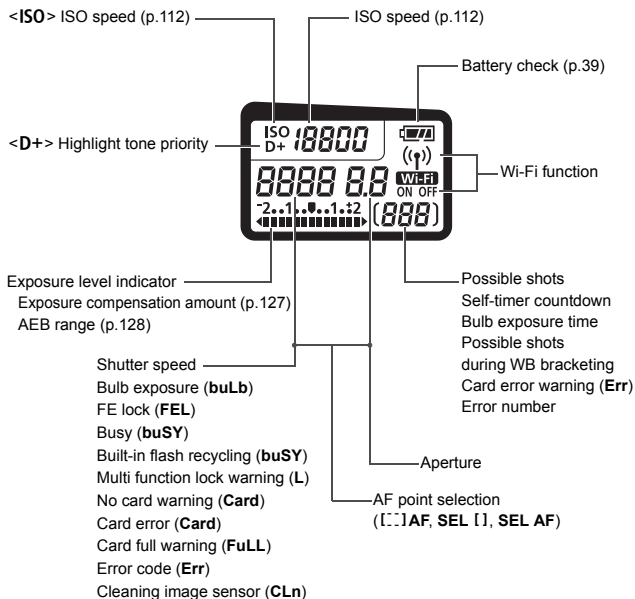

The display will show only the settings currently applied.

## Viewfinder Information

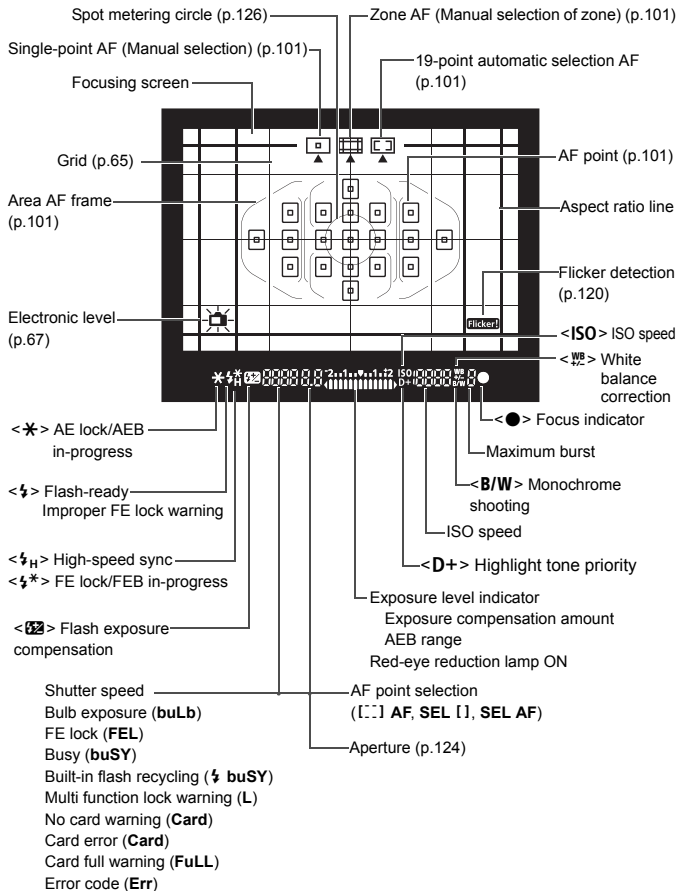

The display will show only the settings currently applied.

## Mode Dial

You can set the shooting mode. Turn the Mode Dial while holding down the Mode Dial center (Mode Dial lock release button).

### Creative Zone

These modes give you more control for shooting various subjects as desired.

**P** : Program AE (p.122)

**Tv** : Shutter-priority AE (p.123)

**Av** : Aperture-priority AE (p.124)

**M** : Manual exposure (p.125)

### Basic Zone

All you do is press the shutter button. The camera sets everything to suit the subject or scene for shooting.

**A+** : Scene Intelligent Auto (p.70)

 : Flash Off (p.75)

**CA** : Creative Auto (p.76)

 : Portrait (p.80)

 : Landscape (p.81)

 : Close-up (p.82)

 : Sports (p.83)

**SCN**: Special scene (p.84)

 : Kids (p.85)

 : Food (p.86)

 : Candlelight (p.87)

 : Night Portrait (p.88)

 : Handheld Night Scene (p.89)

 : HDR Backlight Control (p.90)

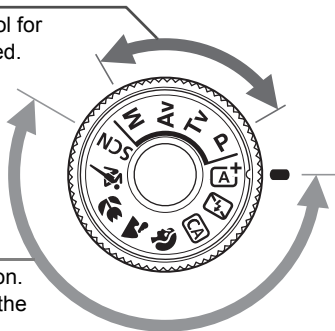

## Lens without a Distance Scale

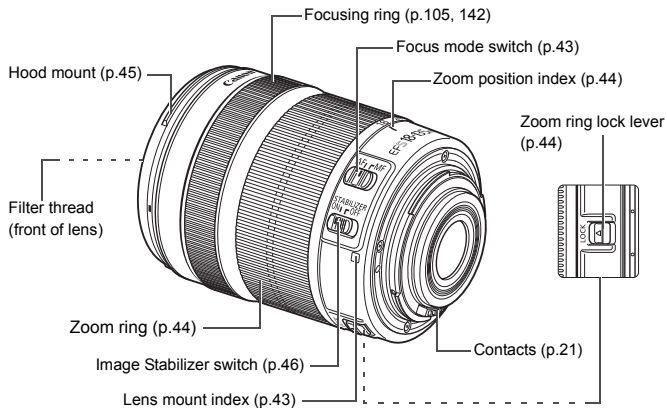



**Battery Charger LC-E17**

Charger for Battery Pack LP-E17 (p.32).

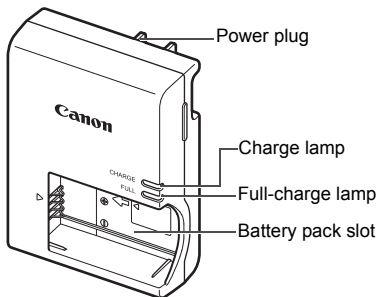

**IMPORTANT SAFETY INSTRUCTIONS-SAVE THESE INSTRUCTIONS.  
DANGER-TO REDUCE THE RISK OF FIRE OR ELECTRIC SHOCK,  
CAREFULLY FOLLOW THESE INSTRUCTIONS.**

For connection to a supply not in the U.S.A., use an attachment plug adapter of the proper configuration for the power outlet, if needed.

**Battery Charger LC-E17E**

Charger for Battery Pack LP-E17 (p.32).

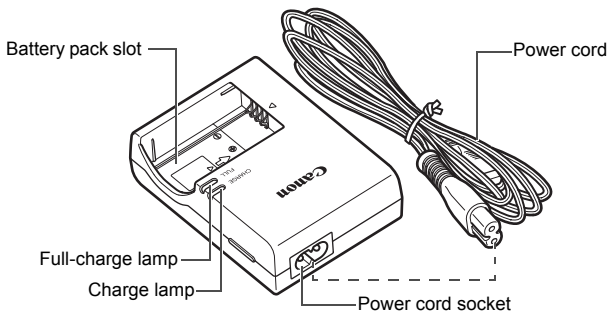



# 1

## Getting Started

This chapter explains preparatory steps before you start shooting and basic camera operations.

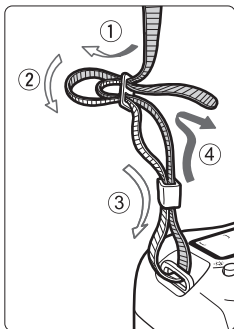

### Attaching the Provided Strap

Pass the end of the strap through the camera's strap mount eyelet from the bottom. Then pass it through the strap's buckle as shown in the illustration. Pull the strap to take up any slack and make sure the strap will not loosen from the buckle.

- The eyepiece cover is also attached to the strap.

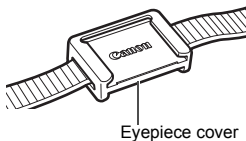

# Charging the Battery

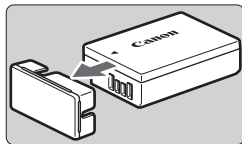

## 1 Remove the protective cover.

- Detach the protective cover provided with the battery.

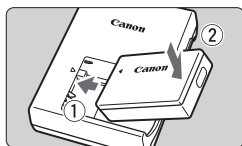

## 2 Attach the battery.

- As shown in the illustration, attach the battery securely to the charger.
- To detach the battery, follow the above procedure in reverse.

### LC-E17

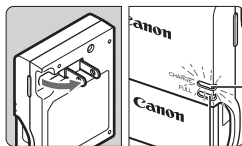

## 3 Recharge the battery.

### For LC-E17

- As shown by the arrow, flip out the battery charger's prongs and insert the prongs into a power outlet.

### For LC-E17E

- Connect the power cord to the charger and insert the plug into a power outlet.

Full-charge lamp

Charge lamp

### LC-E17E

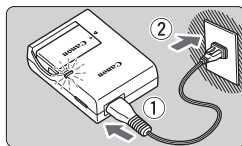

- ▶ Recharging starts automatically and the charge lamp lights up in orange.
- ▶ When the battery is fully recharged, the full-charge lamp will light up in green.

- It takes approx. 2 hours to fully recharge a completely exhausted battery at room temperature (23°C / 73°F). The time required to recharge the battery will vary greatly depending on the ambient temperature and the battery's remaining capacity.
- For safety reasons, recharging in low temperatures (5°C - 10°C / 41°F - 50°F) will take longer (up to approx. 4 hours).



## Tips for Using the Battery and Charger

- **Upon purchase, the battery is not fully charged.**  
Charge the battery before use.
  - **Recharge the battery on the day before or on the day it is to be used.**  
Even during storage, a charged battery will gradually drain and lose its capacity.
  - **After recharging the battery, detach it and disconnect the charger from the power outlet.**
  - **When not using the camera, remove the battery.**  
If the battery is left in the camera for a prolonged period, a small amount of power current is released, resulting in excess discharge and shorter battery life. Store the battery with the protective cover (provided) attached. Storing the battery when it is fully charged may lower the battery's performance.
  - **The battery charger can also be used in foreign countries.**  
The battery charger is compatible with a 100 V AC to 240 V AC 50/60 Hz power source. If necessary, attach a commercially-available plug adapter for the respective country or region. Do not attach any portable voltage transformer to the battery charger. Doing so can damage the battery charger.
  - **If the battery becomes exhausted quickly even after being fully charged, the battery has reached the end of its service life.**  
Check the battery's recharge performance and purchase a new battery.
- 
- After disconnecting the charger's power plug, do not touch the prongs for at least 5 sec.
  - Do not charge any battery other than a Battery Pack LP-E17.
  - Battery Pack LP-E17 is dedicated to Canon products only. Using it with an incompatible battery charger or product may result in malfunction or accidents for which Canon cannot be held liable.

# Installing and Removing the Battery

Load a fully charged Battery Pack LP-E17 into the camera. The camera's viewfinder becomes bright when a battery is installed, and darkens when the battery is removed.

## Installing the Battery

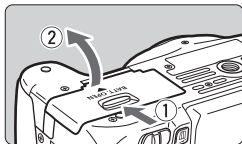

### 1 Open the cover.

- Slide the lever as shown by the arrows and open the cover.

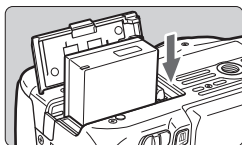

### 2 Insert the battery.

- Insert the end with the battery contacts.
- Insert the battery until it locks in place.

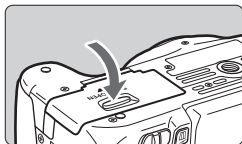

### 3 Close the cover.

- Press the cover until it snaps shut.

## Removing the Battery

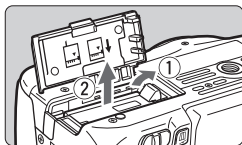

### Open the cover and remove the battery.

- Press the battery release lever as shown by the arrow and remove the battery.
- To prevent short circuiting of the battery contacts, be sure to attach the protective cover (provided, p.32) to the battery.

⚠ After opening the battery compartment cover, be careful not to forcefully swing it back further. Otherwise, the hinge may break.

# Installing and Removing the Card

The card (sold separately) can be an SD, SDHC, or SDXC memory card. SDHC and SDXC memory cards with UHS-I can also be used. The captured images are recorded onto the card.

- **Make sure the card's write-protect switch is set upward to enable writing and erasing.**

## Installing the Card

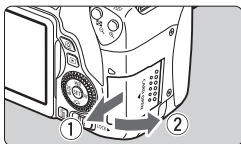

### 1 Open the cover.

- Slide the cover as shown by the arrows to open it.

Write-protect switch

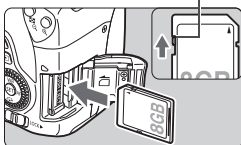

### 2 Insert the card.

- As shown by the illustration, face the card's label side toward you and insert it until it clicks in place.

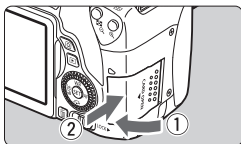

### 3 Close the cover.

- Close the cover and slide it in the direction shown by the arrows until it snaps shut.
- When you set the power switch to <ON>, the number of possible shots will be displayed on the LCD panel.



Possible shots



- The number of possible shots depends on the remaining capacity of the card, image-recording quality, ISO speed, etc.
- Setting [**1: Release shutter without card**] to [**Disable**] will prevent you from shooting without a card inserted.

## Removing the Card

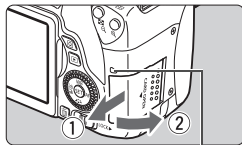

Access lamp

### 1 Open the cover.

- Set the power switch to <OFF>.
- **Make sure the access lamp is off, then open the cover.**
- If [**Recording...**] is displayed, close the cover.

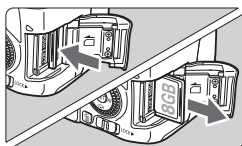

### 2 Remove the card.

- Gently push in the card, then let go to eject it.
- Pull the card straight out, then close the cover.

- !**
- **When the access lamp is lit or blinking, it indicates that images are being written to, read from, or erased from the card, or data is being transferred. Do not open the card slot cover during this time. Also, never do any of the following while the access lamp is lit or blinking. Otherwise, it can damage the image data, card, or camera.**
    - **Removing the card.**
    - **Removing the battery.**
    - **Shaking or banging the camera around.**
    - **Unplugging and connecting a power cord** (when household power outlet accessories are used).
  - If the card already contains recorded images, the image number may not start from 0001.
  - If a card-related error message is displayed on the LCD monitor, remove and reinsert the card. If the error persists, use a different card. If you can transfer all the images on the card to a computer, transfer all the images and then format the card with the camera (p.61). The card may then return to normal.
  - Do not touch the card's contacts with your fingers or metal objects. Do not expose the contacts to dust or water. If a smudge adheres to the contacts, contact failure may result.
  - Multimedia cards (MMC) cannot be used (card error will be displayed).



# Using the LCD Monitor

After you flip out the LCD monitor, you can set menu functions, use Live View shooting, shoot movies, and play back images and movies. You can change the direction and angle of the LCD monitor.

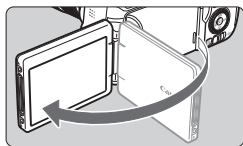

## 1 Flip out the LCD monitor.

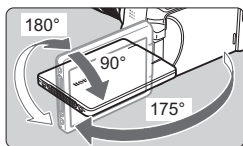

## 2 Rotate the LCD monitor.

- When the LCD monitor is swung out, you can rotate it up, down, or over 180° to face the subject.
- The indicated angle is only approximate.

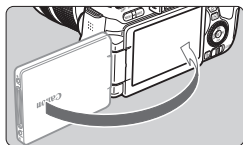

## 3 Face it toward you.

- Normally, use the camera with the LCD monitor facing you.



- Be careful not to force and break the hinge when rotating the LCD monitor.
- When Remote Switch RS-60E3 or an external microphone is connected to the camera, the rotation angle range of the flipped out LCD monitor will be limited.



- When not using the camera, close the LCD monitor with the screen facing inward. This will protect the screen.
- During Live View shooting or movie shooting, facing the LCD monitor toward the subject will display a mirror image on the screen.

## Turning on the Power

If you turn on the power switch and the date/time/zone setting screen appears, see page 40 to set the date/time/zone.

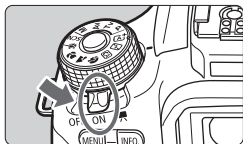

- < > : The camera turns on. You can shoot movies (p.146).
- < ON > : The camera turns on. You can shoot still photos.
- < OFF > : The camera is turned off and does not operate. Set to this position when not using the camera.

### Automatic Sensor Cleaning

- Whenever you set the power switch to <ON> or <OFF>, sensor cleaning will be executed automatically. (A small sound may be heard.) During the sensor cleaning, the LCD monitor will display < >.
- You can still shoot during sensor cleaning by pressing the shutter button halfway (p.48) to stop cleaning and take a picture.
- If you repeatedly turn the power switch <ON>/<OFF> at a short interval, the < > icon may not be displayed. This is normal and not a malfunction.

### **MENU** Auto Power Off





- To save battery power, the camera turns off automatically after approx. 30 seconds of non-operation. To turn on the camera again, just press the shutter button halfway (p.48).
- You can change the auto power off time with [**F2: Auto power off**].

If you set the power switch to <OFF> while an image is being recorded to the card, [**Recording...**] will be displayed and the power will turn off after the recording finishes.

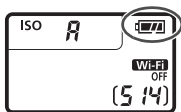
## Checking the Battery Level

When the power is turned on, the battery level will be indicated in one of the four levels.



-  : Battery level is sufficient.
-  : Battery level is low, but the camera can still be used.
-  : Battery will be exhausted soon. (Blinks)
-  : Recharge the battery.

## Number of Possible Shots (Approx. number of shots)

Temperature	Room Temperature (23°C / 73°F)	Low Temperatures (0°C / 32°F)
No Flash	550	470
50% Flash Use	440	400

- The figures above are based on a fully-charged Battery Pack LP-E17, no Live View shooting, and CIPA (Camera & Imaging Products Association) testing standards.
- Possible shots with Battery Grip BG-E18 (sold separately)
  - With LP-E17 x 2: approx, twice the shots without the battery grip.



- Doing any of the following will exhaust the battery sooner:
  - Pressing the shutter button halfway for a prolonged period.
  - Activating the AF frequently without taking a picture.
  - Using the lens Image Stabilizer.
  - Using the LCD monitor frequently.
- The number of possible shots may decrease depending on the actual shooting conditions.
- The lens operation is powered by the camera's battery. Depending on the lens used, the battery power may exhaust faster.
- For the number of possible shots with Live View shooting, see page 133.
- See [**43: Battery info.**] to check the battery's condition.

## **MENU** Setting the Date, Time, and Zone

When you turn on the power for the first time or if the date/time/zone are reset, the date/time/zone setting screen will appear. Follow the steps below, making sure to set the time zone first. Set the camera to the time zone in which you currently live so that, when you travel, you can simply change the setting to the correct time zone for your destination, and the camera will automatically adjust the date/time.

**Note that the date/time appended to recorded images will be based on this date/time setting. Be sure to set the correct date/time.**

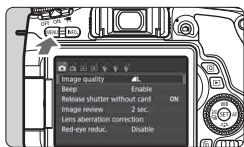

### **1** Display the menu screen.

- Press the <MENU> button to display the menu screen.

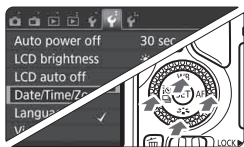

### **2** Under the [**📅**] tab, select [**Date/Time/Zone**].

- Press the <◀> <▶> keys to select the [**📅**] tab.
- Press the <▲> <▼> keys to select [**Date/Time/Zone**], then press <SET>.

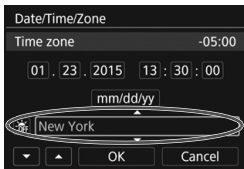

### **3** Set the time zone.

- [**London**] is set by default.
- Press the <◀> <▶> keys to select the time zone box.
- Press <SET> so <📍> is displayed.
- Press the <▲> <▼> keys to select the time zone, then press <SET>.  
(Returns to <□>.)

- The menu setting procedure is explained on pages 56-57.
- In step 3, the time displayed on the upper right of the screen is the time difference compared with Coordinated Universal Time (UTC). If you do not see your time zone, set the time zone while referring to the difference with UTC.

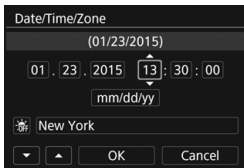

## 4 Set the date and time.

- Press the <◀> <▶> keys to select the number.
- Press <SET> so <⏏> is displayed.
- Press the <▲> <▼> keys to set the number, then press <SET>. (Returns to <□>.)

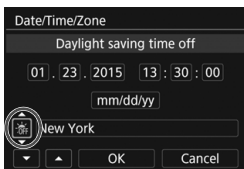

## 5 Set the daylight saving time.

- Set it if necessary.
- Press the <◀> <▶> keys to select [☀️].
- Press <SET> so <⏏> is displayed.
- Press the <▲> <▼> keys to select [☀️], then press <SET>.
- When the daylight saving time is set to [☀️], the time set in step 4 will advance by 1 hour. If [☀️] is set, the daylight saving time will be canceled and the time will go back by 1 hour.

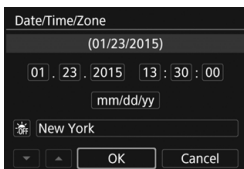

## 6 Exit the setting.

- Press the <◀> <▶> keys to select [OK], then press <SET>.
- ▶ The date/time/zone and daylight saving time will be set and the menu will reappear.



The date/time/zone settings may be reset in the following cases. If this happens, set the date/time/zone again.

- When the camera is stored without the battery.
- When the camera's battery becomes exhausted.
- When the camera is exposed to below freezing temperatures for a prolonged period.



- The date/time that were set will start when you select [OK] in step 6.
- After changing the time zone, check that the correct date and time are set.

## **MENU** Selecting the Interface Language



- 1** Display the menu screen.
- Press the <MENU> button to display the menu screen.

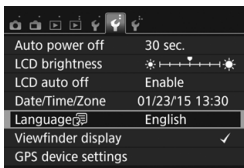

- 2** Under the [**2**] tab, select [Language].
- Press the <◀> <▶> keys to select the [**2**] tab.
  - Press the <▲> <▼> keys to select [Language], then press <SET>.



- 3** Set the desired language.
- Press the <▲> <▼> keys to select the language, then press <SET>.
  - ▶ The interface language will change.

# Attaching and Detaching a Lens

The camera is compatible with all Canon EF and EF-S lenses. **The camera cannot be used with EF-M lenses.**

## Attaching a Lens

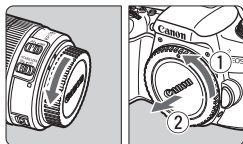

### 1 Remove the caps.

- Remove the rear lens cap and the body cap by turning them as shown by the arrows.

White index

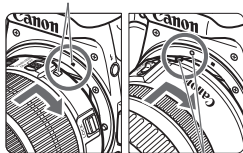

### 2 Attach the lens.

- Align the lens's red or white index with the camera's index matching the same color. Turn the lens as shown by the arrow until it clicks in place.

Red index

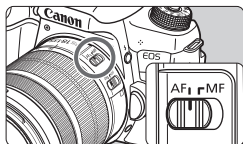

### 3 Set the lens's focus mode switch to <AF>.

- <AF> stands for autofocus.
- <MF> stands for manual focus.

### 4 Remove the front lens cap.

#### Minimizing Dust

- When changing lenses, do it quickly in a place with minimal dust.
- When storing the camera without a lens attached, be sure to attach the body cap to the camera.
- Remove dust on the body cap before attaching it.

## Zooming

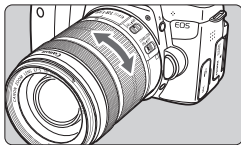

**Turn the zoom ring on the lens with your fingers.**

- If you want to zoom, do it before focusing. Turning the zoom ring after achieving focus may throw off the focus.

## Detaching the Lens

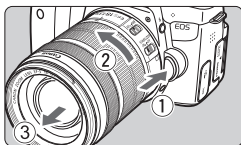

**While pressing the lens release button, turn the lens as shown by the arrow.**

- Turn the lens until it stops, then detach it.
- Attach the rear lens cap to the detached lens.

### ● To owners of the EF-S18-135mm f/3.5-5.6 IS STM lens or EF-S18-200mm f/3.5-5.6 IS lens:

You can prevent the lens from extending out while you are carrying it around. Set the zoom ring to the 18mm wide-angle end, then slide the zoom ring lock lever to <LOCK>. The zoom ring can be locked only at the wide-angle end.

- Do not look at the sun directly through any lens. Doing so may cause loss of vision.
- When attaching or detaching a lens, set the camera's power switch to <OFF>.
- If the front part (focusing ring) of the lens rotates during autofocus, do not touch the rotating part.



### Angle of View

Since the image sensor size is smaller than the 35mm film format, the angle of view of an attached lens will be equivalent to that of a lens with approx. 1.6x of the focal length indicated.

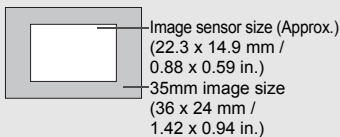



## Attaching a Lens Hood

A lens hood can block unwanted light and prevent rain, snow, dust, etc. adhering to the front of the lens. When storing the lens in a bag, etc., you can also attach the hood in reverse.

- **If there is no index mark on the lens and hood:**

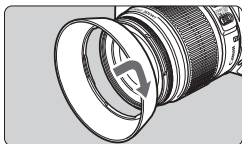

### Attach the lens hood.

- Turn the hood as shown by the arrow to attach it securely.

- **If there is an index mark on the lens and hood:**

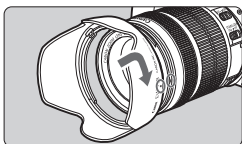

- 1 Align the red dots on the hood and lens edges, then turn the hood as shown by the arrow.**

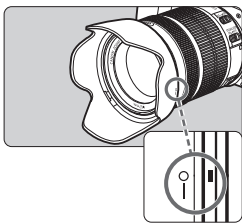

- 2 Turn the hood as shown in the illustration.**

- Turn the hood clockwise until it attaches securely.

- If the hood is not attached properly, it may obstruct the image's periphery, making the image look dark.
- When attaching or detaching the hood, grasp the base of the hood to turn it. Grasping the hood's edges to turn it may deform the hood, resulting in failure to turn.
- When using the camera's built-in flash, detach the hood. Otherwise, the hood will obstruct part of the flash.

# Lens Image Stabilizer

When you use the IS lens's built-in Image Stabilizer, camera shake is corrected to obtain a sharper shot. The procedure explained here is based on the EF-S18-135mm f/3.5-5.6 IS STM lens as an example.

\* IS stands for Image Stabilizer.

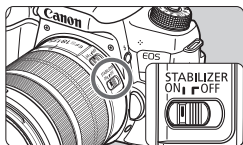

- 1 Set the IS switch to <ON>.**
  - Set also the camera's power switch to <ON>.
- 2 Press the shutter button halfway.**
  - ▶ The Image Stabilizer will operate.
- 3 Take the picture.**
  - When the picture looks steady in the viewfinder, press the shutter button completely to take the picture.

- The Image Stabilizer will not be effective if the subject moves during the exposure.
- For bulb exposures, set the IS switch to <OFF>. If <ON> is set, Image Stabilizer misoperation may occur.
- The Image Stabilizer may not be effective for excessive shaking such as on a rocking boat.

- The Image Stabilizer can operate with the lens's focus mode switch set to either <AF> or <MF>.
- When using a tripod, you can still shoot with the IS switch set to <ON> with no problem. However, to save battery power, setting the IS switch to <OFF> is recommended.
- The Image Stabilizer is effective even when the camera is mounted on a monopod.
- With the EF-S18-135mm f/3.5-5.6 IS STM lens, EF-S18-55mm f/3.5-5.6 IS STM lens, EF-S55-250mm f/4-5.6 IS STM lens, or EF-S18-200mm f/3.5-5.6 IS lens, the Image Stabilizer mode will be switched automatically to suit the shooting conditions.

# Basic Operation

## Adjusting the Viewfinder Clarity

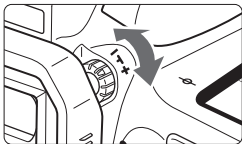

### Turn the dioptic adjustment knob.

- Turn the knob left or right so that the AF points in the viewfinder look the sharpest.



If the camera dioptic adjustment still cannot provide a sharp viewfinder image, using E-series Dioptic Adjustment Lenses (sold separately) is recommended.

## Holding the Camera

To obtain sharp images, hold the camera still to minimize camera shake.

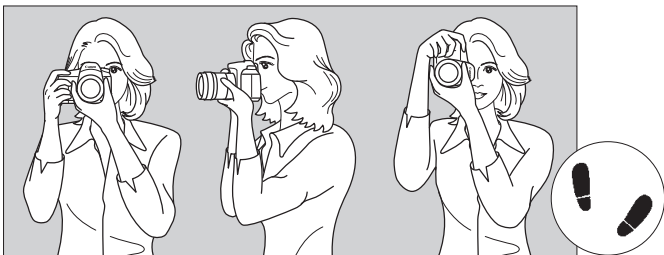

Horizontal shooting

Vertical shooting

1. Wrap your right hand around the camera grip firmly.
2. Hold the lens bottom with your left hand.
3. Rest your hand's right index finger lightly on the shutter button.
4. Press your arms and elbows lightly against the front of your body.
5. To maintain a stable stance, place one foot slightly ahead of the other.
6. Press the camera against your face and look through the viewfinder.



To shoot while looking at the LCD monitor, see page 131.

## Shutter Button

The shutter button has two steps. You can press the shutter button halfway. Then you can further press the shutter button completely.

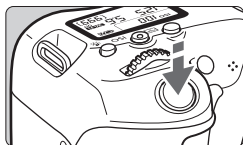

### Pressing Halfway

This activates autofocus and the automatic exposure system that sets the shutter speed and aperture.

The exposure setting (shutter speed and aperture) is displayed in the viewfinder and on the LCD panel (ⓘ4).

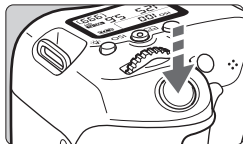

### Pressing Completely

This releases the shutter and takes the picture.

### Preventing Camera Shake

Hand-held camera movement during the moment of exposure is called camera shake. It can cause blurred pictures. To prevent camera shake, note the following:

- Hold and steady the camera as shown on the preceding page.
- Press the shutter button halfway to autofocus, then slowly press the shutter button completely.



- If you press the shutter button completely without pressing it halfway first, or if you press the shutter button halfway and then press it completely immediately, the camera will take a moment before it takes the picture.
- Even during menu display, image playback, or image recording, you can instantly go back to shooting-ready by pressing the shutter button halfway.

## Mode Dial

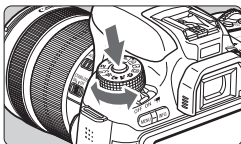

**Turn the dial while holding down the lock release button at the center of the dial.**

Use it to set the shooting mode.



## Main Dial

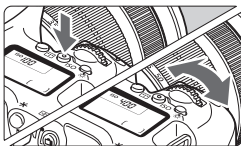

**(1) After pressing a button, turn the <Main Dial> dial.**

After pressing a button such as <ISO> <▲ WB> <▼ [ISO] > <◀ [WB] > <▶ AF>, turn the <Main Dial> dial to change the setting. For the <ISO> button, the function remains selected for 6 sec. (⓪6) after pressing the button.

When the function selection ends or if you press the shutter button halfway, the camera will be ready to shoot.

- Use this dial to select or set the ISO speed, white balance, Picture Style, drive mode, AF operation, AF point, etc.

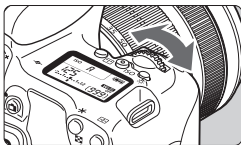

**(2) Turn the <Main Dial> dial only.**

While looking at the viewfinder or LCD panel, turn the <Main Dial> dial to change the setting.

- Use this dial to set the shutter speed, aperture, etc.



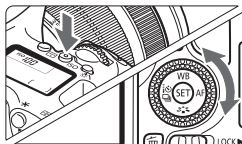

The operations in (1) are possible even when the <LOCK▶> switch is set to the right (Multi function lock, p.51).

## Quick Control Dial



### (1) After pressing a button, turn the <img alt="QCD icon" data-bbox="418 171 448 191"/> dial.

After pressing a button such as <ISO> <▲ WB> <▼ > <◀   > <▶ AF>, turn the <img alt="QCD icon" data-bbox="418 248 448 268"/> dial to change the setting. For the <ISO> button, the function remains selected for 6 sec. (6) after pressing the button.

When the function selection ends or if you press the shutter button halfway, the camera will be ready to shoot.

- Use this dial to select or set the ISO speed, white balance, Picture Style, drive mode, AF operation, AF point, etc.

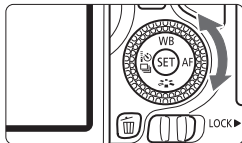

### (2) Turn the <img alt="QCD icon" data-bbox="568 518 598 538"/> dial only.

While looking at the viewfinder or LCD panel, turn the <img alt="QCD icon" data-bbox="568 574 598 594"/> dial to change the setting.

- Use this dial to set the exposure compensation amount, the aperture setting for manual exposures, etc.

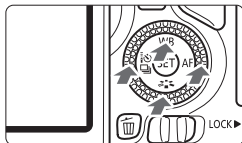

### (3) After pressing a button, press the <▲>, <▼>, <◀>, or <▶> key.

After pressing the <MENU> or <Q> button, press the <▲> <▼> or <◀> <▶> keys to set menus or Quick Control functions.

 The operations in (1) and (3) are possible even when the <LOCK▶> switch is set to the right (Multi function lock, p.51).

## LOCK▶ Multi Function Lock

By setting [13: Multi function lock] under [4: Custom Functions (C.Fn)] and moving the <LOCK▶> switch to the right, you can prevent the Main Dial and Quick Control Dial from moving and changing a setting inadvertently.

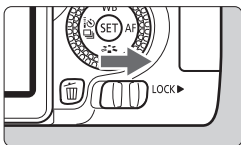

<LOCK▶> switch set to the left:

Lock released

<LOCK▶> switch set to the right:

Lock engaged



If the <LOCK▶> switch is set to the right and you try to use one of the locked camera controls, <L> will be displayed in the viewfinder and on the LCD panel. On the shooting settings display (p.52), [LOCK] will be displayed.

## ☼ LCD Panel Illumination

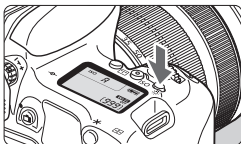

Turn on (☼6) or off the LCD panel illumination by pressing the <☼> button. During a bulb exposure, pressing the shutter button completely will turn off the LCD panel illumination.

## Displaying Shooting Function Settings

After you press the <INFO.> button a number of times, the shooting function settings will be displayed.

With the shooting function settings displayed, you can turn the Mode Dial to see the settings for each shooting mode.

Pressing the <Q> button enables Quick Control of the shooting function settings (p.53).

Press the <INFO.> button again to turn off the display.





## Q Quick Control for Shooting Functions

You can directly select and set the shooting functions displayed on the LCD monitor. This is called Quick Control.

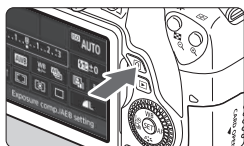

### 1 Press the <Q> button (10).

- ▶ The Quick Control screen will appear.



### 2 Set the desired functions.

- Press the <▲> <▼> or <◀> <▶> keys to select a function.
- ▶ The selected function and Feature guide (p.68) will appear.
- Turn the <☀> or <☾> dial to change the setting.

#### Basic Zone modes

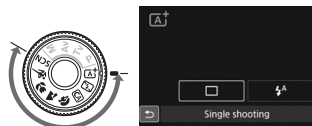

#### Creative Zone modes

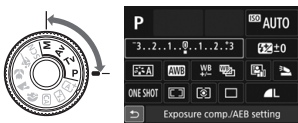

### 3 Take the picture.

- Press the shutter button completely to take the picture.
- ▶ The captured image will be displayed.



- For the functions settable in Basic Zone modes and their setting procedures, see page 93.
- In steps 1 and 2, you can also use the LCD monitor's touch screen (p.58).

## Sample Quick Control Screen

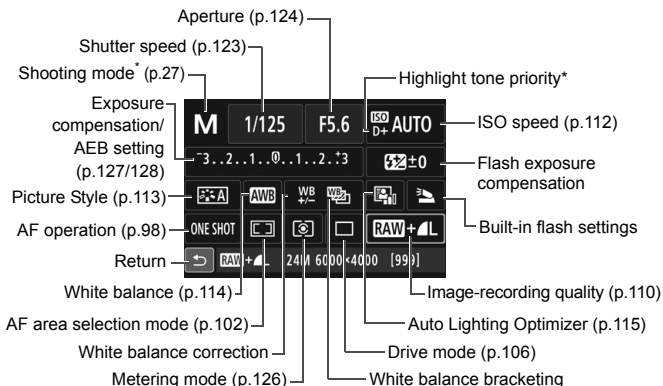

\* Functions marked with an asterisk cannot be set with the Quick Control screen.

## Function Setting Screen

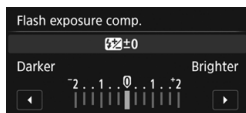
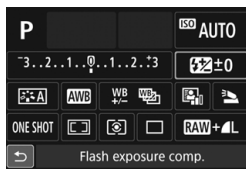

- Select the desired function and press  $\langle \text{SET} \rangle$ . The function's setting screen will appear.
- Turn the  $\langle \text{DIAL} \rangle$  or  $\langle \text{DIAL} \rangle$  dial or press the  $\langle \text{LEFT} \rangle$   $\langle \text{RIGHT} \rangle$  keys to change the settings. There are also some functions that are set by pressing the  $\langle \text{INFO.} \rangle$ ,  $\langle \text{INFO.} \rangle$ , or  $\langle \text{INFO.} \rangle$  button.
- Press  $\langle \text{SET} \rangle$  to finalize the setting and return to the Quick Control screen.
- When you select  $\langle \text{MENU} \rangle$  (p.101) and press the  $\langle \text{MENU} \rangle$  button, the previous screen will reappear.

# MENU Menu Operations

You can set various settings with the menus such as the image-recording quality, date and time, etc.

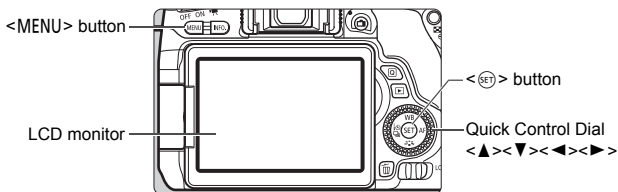

## Menu Screen

The menu tabs and items displayed will differ depending on the shooting mode.

### Basic Zone modes

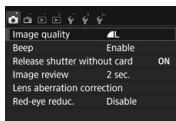

### Movie shooting

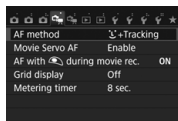

### Creative Zone modes

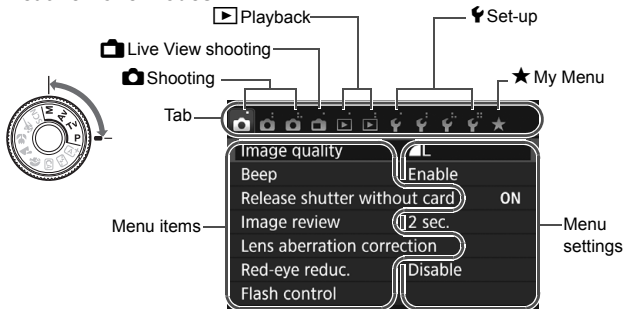

## Menu Setting Procedure

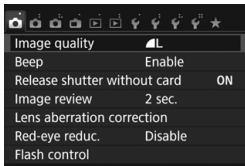
**1 Display the menu screen.**

- Press the <MENU> button to display the menu screen.

**2 Select a tab.**

- Press the Quick Control Dial's <◀> <▶> keys to select a tab (group of functions).
- For example, in this manual, “the [📷3] tab” refers to the screen displayed when the third 📷 (Shooting) tab from the left [📷+] is selected.

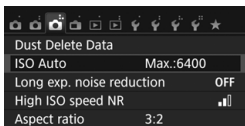
**3 Select the desired item.**

- Press the Quick Control Dial's <▲> <▼> keys to select the item, then press <SET>.

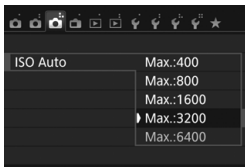
**4 Select the setting.**

- Press the Quick Control Dial's <▲> <▼> or <◀> <▶> keys to select the desired setting. (Some settings require you to press either the <▲> <▼> or <◀> <▶> keys to select those settings.)
- The current setting is indicated in blue.

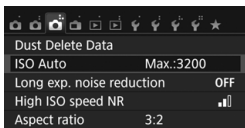
**5 Set the desired setting.**

- Press <SET> to set it.

**6 Exit the setting.**

- Press the <MENU> button to return to the shooting function settings display.



- In step 2, you can also turn the <☀> dial to select a menu tab. In step 4, you can also turn the <☉> dial to select certain settings.
- In steps 2 to 5, you can also use the LCD monitor's touch screen (p.58).
- The explanation of menu functions hereinafter assumes that you have pressed the <MENU> button to display the menu screen.
- To cancel, press the <MENU> button.

## Dimmed Menu Items

Example: When **[Multi Shot Noise Reduction]** is set

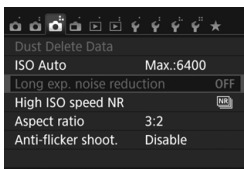

Dimmed menu items cannot be set. The menu item is dimmed if another function setting is overriding it.

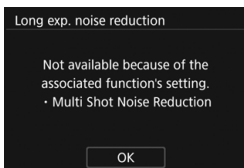

You can see the overriding function by selecting the dimmed menu item and pressing <Ⓢ(SET)>.

If you cancel the overriding function's setting, the dimmed menu item will become settable.



Some dimmed menu items will not show the overriding function.



With **[Clear all camera settings]** under **[4: Clear settings]**, you can reset the menu functions to the default settings.

## Using the Touch Screen

The LCD monitor is a touch-sensitive panel that you can operate with your fingers.

### Tap

#### Quick Control (Sample display)

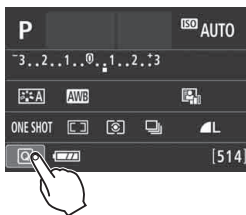

- Use your finger to tap on (touch briefly and then remove your finger from) the LCD monitor.
- By tapping, you can select menus, icons, etc., displayed on the LCD monitor.
- When touch-screen operation is possible, a frame will appear around the icon (except on menu screens). For example, when you tap on [Q], the Quick Control screen appears. By tapping on [↶], you can return to the preceding screen.

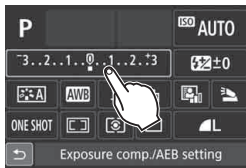

#### Operations possible by tapping on the screen

- Setting menu functions after pressing the <MENU> button
- Quick Control
- Setting functions after pressing the <[Q]>, <ISO>, <[Q]>, <▲WB>, <▼[WB]>, <◀[WB]>, or <▶AF> button
- Touch shutter during Live View shooting
- Setting functions during Live View shooting
- Setting functions during movie shooting
- Playback operations

## Drag

### Menu screen (Sample display)

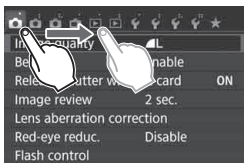

- Slide your finger while touching the LCD monitor.

### Scale display (Sample display)

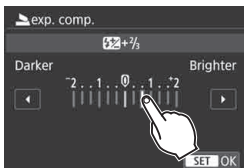

### Operations possible by dragging your finger on the screen

- Selecting a menu tab or item after pressing the <MENU> button
- Setting a scale control
- Quick Control
- Setting functions during Live View shooting
- Setting functions during movie shooting
- Playback operations

## MENU Silencing the Beep during Touch Operations

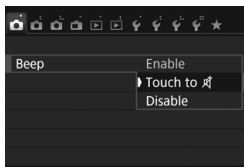

If [**1: Beep**] is set to [**Touch to** , the beep will not sound during touch operations.

## MENU Touch Control Settings

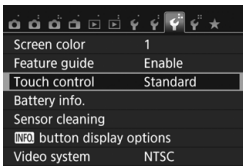

### 1 Select [Touch control].

- Under the [**3**] tab, select [**Touch control**], then press <SET>.

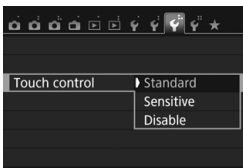

### 2 Set the touch control setting.

- Select the preferred setting, then press <SET>.
- [**Standard**] is the normal setting.
- [**Sensitive**] provides a more reactive touch response than [**Standard**]. Try using both settings and select the one you prefer.
- To disable touch-screen operations, select [**Disable**].

## ⚠ Cautions for Touch Screen Operations

- Since the LCD monitor is not pressure sensitive, do not use any sharp objects, such as your fingernail or a ballpoint pen, for touch operations.
- Do not use wet fingers for touch screen operations.
- If the LCD monitor has any moisture or if your fingers are wet, the touch screen may not respond or misoperation may occur. In such a case, turn off the power and wipe the LCD monitor with a cloth.
- Do not attach any protective sheet (commercially available) or sticker on the LCD monitor. It may make the touch operation response slow.
- If you quickly perform touch operation when [**Sensitive**] is set, the touch response may be slower.



## MENU Formatting the Card

If the card is new or was previously formatted by another camera or computer, format the card with this camera.

- 1 When the card is formatted, all images and data on the card will be erased. Even protected images will be erased, so make sure there is nothing you need to keep. If necessary, transfer the images and data to a computer, etc., before formatting the card.

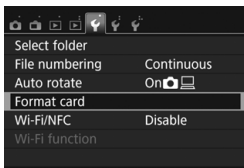

### 1 Select [Format card].

- Under the [**F1**] tab, select [**Format card**], then press <SET>.

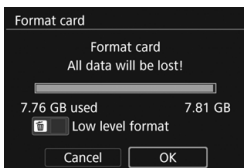

### 2 Format the card.

- Select [**OK**], then press <SET>.
- ▶ The card will be formatted.
- ▶ When the formatting is completed, the menu will reappear.

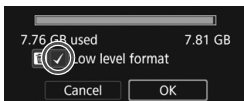

- For low-level formatting, press the <trash> button to append [**Low level format**] with a checkmark <✓>, then select [**OK**].



### Execute [Format card] in the following cases:

- The card is new.
- The card was formatted by a different camera or a computer.
- The card is full with images or data.
- A card-related error is displayed.

#### Low-level Formatting

- Perform low-level formatting if the card's recording or reading speed seems slow or if you want to totally erase data on the card.
- Since low-level formatting will format all recordable sectors on the card, the formatting will take slightly longer than normal formatting.
- You can stop the low-level formatting by selecting [**Cancel**]. Even in this case, normal formatting will be completed and you can use the card as usual.

- When the card is formatted or data is erased, only the file management information is changed. The actual data is not completely erased. Be aware of this when selling or discarding the card. When discarding the card, execute low-level formatting or destroy the card physically to prevent the personal data from being leaked.
- **Before using a new Eye-Fi card, the software on the card must be installed on your computer. Then format the card with the camera.**



- The card capacity displayed on the card format screen may be smaller than the capacity indicated on the card.
- This device incorporates exFAT technology licensed from Microsoft.

# Switching the LCD Monitor Display

The LCD monitor can display the shooting settings screen, menu screen, captured images, etc.

## Shooting Settings

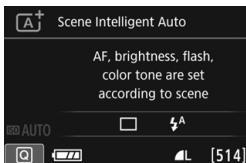

- When you turn on the power, the shooting settings will be displayed.
- When your eye is near the viewfinder eyepiece, the display-off sensor (p.23) will turn off the LCD monitor to prevent glare. When your eye leaves the viewfinder eyepiece, the LCD monitor will turn on again.
- By pressing the <INFO.> button, you can switch the LCD monitor screen as follows: Display the camera settings screen, display the electronic level, display the shooting settings screen, or turn off the LCD monitor screen.

## Menu Functions

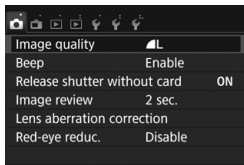

- Appears when you press the <MENU> button. Press the button again to return to the shooting settings screen.

## Captured Image



- Appears when you press the <▶> button. Press the button again to return to the shooting settings screen.



- Under [**2: LCD auto off**], you can prevent the LCD monitor from turning off automatically.
- Even when the menu screen or captured image is displayed, pressing the shutter button will enable you to shoot immediately.



- If you look through the viewfinder eyepiece while wearing sunglasses, the LCD monitor may not turn off automatically. If this occurs, press the <INFO.> button to turn off the LCD monitor.
- Nearby fluorescent lighting may cause the LCD monitor to turn off. If this occurs, take the camera away from the fluorescent lighting.

# # Displaying the Grid

You can display a grid in the viewfinder to help you check the camera tilt or compose the shot.

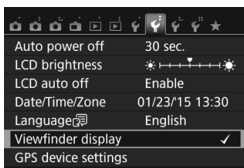

## 1 Select [Viewfinder display].

- Under the [**2**] tab, select **[Viewfinder display]**, then press **<SET>**.

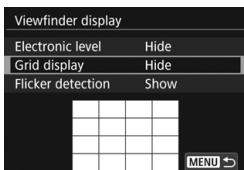

## 2 Select [Grid display].

- Select **[Grid display]**, then press **<SET>**.



## 3 Select [Show].

- Select **[Show]**, then press **<SET>**.
- ▶ When you exit the menu, the grid will appear in the viewfinder.

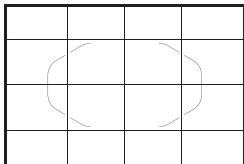

You can display a grid on the LCD monitor during Live View shooting and before you start shooting a movie.

## Displaying the Electronic Level

You can display the electronic level on the LCD monitor and in the viewfinder to help you correct the camera tilt. Note that you can check only the horizontal tilt and not the forward/backward tilt.

### Displaying the Electronic Level on the LCD Monitor

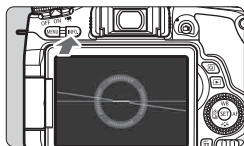

#### 1 Press the <INFO.> button.

- Each time you press the <INFO.> button, the screen display will change.
- Display the electronic level.
- If the electronic level does not appear, set [**4**3: **INFO** button display options] so that the electronic level can be displayed.

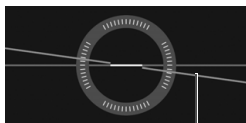
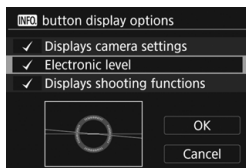

Horizontal level



#### 2 Check the camera's tilt.

- The horizontal tilt is displayed in 1° increments. The tilt scale is marked in 5° increments.
- When the red line turns green, it indicates that the tilt is almost corrected.

- Even when the tilt is corrected, there may be a margin of error of approx.  $\pm 1^\circ$ .
- If the camera is very tilted, the electronic level's margin of error will be larger.

 During Live View shooting and before movie shooting (except with **+** Tracking), you can also display the electronic level as described above.

## MENU Displaying the Electronic Level in the Viewfinder

A simple electronic level using a camera icon can be displayed in the viewfinder. Since this can be displayed while you shoot, you can correct any tilt during handheld shooting.

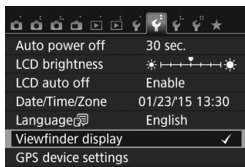

### 1 Select [Viewfinder display].

- Under the [F2] tab, select [Viewfinder display], then press <SET>.

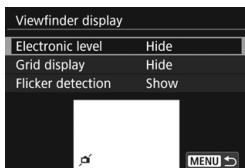

### 2 Select [Electronic level].

- Select [Electronic level], then press <SET>.



### 3 Select [Show].

- Select [Show], then press <SET>.

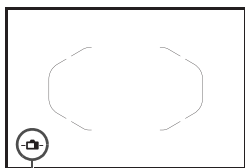

Electronic level

### 4 Press the shutter button halfway.

- ▶ The electronic level will appear as shown in the illustration.

Horizontal

Tilt 1°

Tilt 2° or higher

- This also works with vertical shooting.

Even when the tilt is corrected, there may be a margin of error of  $\pm 1^\circ$ .

# Feature Guide

The Feature guide appears when you change the shooting mode or set a shooting function, Live View shooting, movie shooting, or Quick Control for playback, and displays a brief description of that mode, function or option. It also displays a description when you select a function or option on the Quick Control screen. The Feature guide turns off when you tap on the description or proceed with the operation.

## ● Shooting mode (Sample)

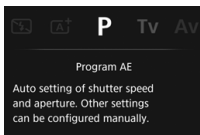
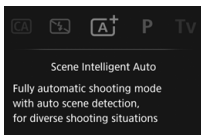

## ● Quick Control (Sample)

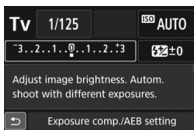

Shooting settings



Live View shooting



Playback

## **MENU** Disabling the Feature Guide

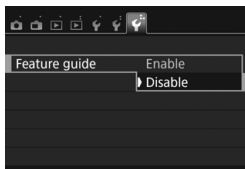

### Select [Feature guide].

- Under the [**F3**] tab, select [**Feature guide**], then press <[SET]>.
- Select [**Disable**], then press <[SET]>.



# 2

## Basic Shooting and Image Playback

This chapter explains how to use the Basic Zone modes on the Mode Dial for best results and how to play back images.

With Basic Zone modes, all you do is point and shoot while the camera sets everything automatically (p.93). Also, to prevent botched pictures due to mistaken operations, advanced shooting function settings cannot be changed.

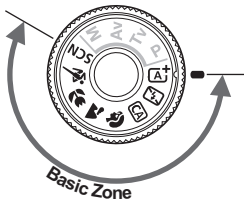

If you set the Mode Dial to <SCN> when the LCD monitor is off, press the <Q> button (p.23) to check the shooting mode before shooting (p.84).

## **[A<sup>+</sup>]** Fully Automatic Shooting (Scene Intelligent Auto) ■

**<[A<sup>+</sup>]>** is a fully automatic mode. The camera analyzes the scene and sets the optimum settings automatically. It also adjusts focus automatically by detecting whether the subject is still or moving (p.73).



### **1 Set the Mode Dial to <[A<sup>+</sup>]>.**

- Turn the Mode Dial while holding down the lock release button at the center.

Area AF frame



### **2 Aim the Area AF frame over the subject.**

- All the AF points will be used to focus, and the camera will focus on the closest object.
- Aiming the center of the Area AF frame over the subject will make focusing easier.

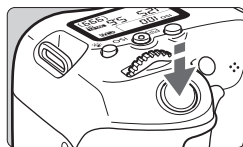

### **3 Focus on the subject.**

- Press the shutter button halfway. The lens elements will shift to focus.
  - ▶ The AF point(s) that achieve(s) focus will be displayed. At the same time, the beeper will sound and the focus indicator **<●>** in the viewfinder will light up.
  - ▶ In low light, the AF point(s) will light up briefly in red.
  - ▶ If necessary, the built-in flash will be raised automatically.



Focus indicator



## 4 Take the picture.

- Press the shutter button completely to take the picture.
- ▶ The captured image will be displayed for 2 sec. on the LCD monitor.
- After you finish shooting, push down the built-in flash with your fingers.



The **<A+>** mode makes the colors look more impressive in nature, outdoor, and sunset scenes. If you did not obtain the desired color tones, change the mode to a Creative Zone mode and select a Picture Style other than **<P-A>**, then shoot again (p.113).



## FAQ

- **The focus indicator <●> blinks and focus is not achieved.**  
Aim the Area AF frame over an area with good contrast, then press the shutter button halfway (p.48). If you are too close to the subject, move away and try again.
- **When focus is achieved, the AF points do not light up in red.**  
The AF points light up in red only when focus is achieved in low-light conditions.
- **Multiple AF points light up simultaneously.**  
Focus has been achieved at all those points. You can take the picture as long as an AF point covering the target subject is lighting up.

- **The beeper continues to beep softly. (The focus indicator <●> does not light up.)**



It indicates that the camera is focusing continuously on a moving subject. (The focus indicator <●> does not light up.) You can take sharp pictures of a moving subject.

Note that the focus lock (p.73) will not work in this case.

- **Pressing the shutter button halfway does not focus on the subject.**

If the focus mode switch on the lens is set to <MF> (manual focus), set it to <AF> (autofocus).

- **The flash fired even though it was daylight.**

For a backlit subject, the flash may fire to help lighten the subject's dark areas. If you do not want the flash to fire, use the Quick Control to set [Flash firing] to [>] (p.92) or set the <> (Flash Off) mode and shoot (p.75).

- **The flash fired and the picture came out extremely bright.**

Move further from the subject and shoot. When shooting flash photography, if the subject is too close to the camera, the picture may come out extremely bright (overexposure).

- **In low light, the built-in flash fired a series of flashes.**

Pressing the shutter button halfway may trigger the built-in flash to fire a series of flashes to assist autofocusing. This is called the AF-assist beam. Its effective range is approx. 4 meters/13.1 feet. The built-in flash will make a sound when firing continuously. This is normal and not a malfunction.

- **When flash was used, the bottom part of the picture came out unnaturally dark.**

The shadow of the lens barrel was captured in the picture because the subject was too close to the camera. Move further away from the subject and shoot. If a hood is attached to the lens, remove it before taking the flash picture.

## **[A+] Full Auto Techniques (Scene Intelligent Auto)**

### **Recomposing the Shot**



Depending on the scene, position the subject toward the left or right to create a balanced background and good perspective.

In the <[A+]> mode, pressing the shutter button halfway to focus on a still subject will lock the focus on that subject. Recompose the shot while keeping the shutter button pressed halfway, and then press the shutter button completely to take the picture. This is called “focus lock”. Focus lock is also possible in other Basic Zone modes (except <[A] > <[S] >).

### **Shooting a Moving Subject**



In the <[A+]> mode, if the subject moves (distance to camera changes) while or after you focus, AI Servo AF will take effect to focus on the subject continuously. (The beeper will continue beeping softly.) As long as you keep the Area AF frame positioned over the subject while pressing the shutter button halfway, the focusing will be continuous. When you want to take the picture, press the shutter button completely.

## Live View Shooting

You can shoot while viewing the image on the LCD monitor. This is called “Live View shooting”. For details, see page 131.



### 1 Display the Live View image on the LCD monitor.

- Press the <img alt="Live View button icon" data-bbox="598 251 628 271"/> button.
- ▶ The Live View image will appear on the LCD monitor.



### 2 Focus on the subject.

- Press the shutter button halfway to focus.
- ▶ When focus is achieved, the AF point will turn green and the beeper will sound.

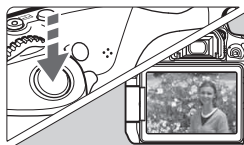

### 3 Take the picture.

- Press the shutter button completely.
- ▶ The picture is taken and the captured image is displayed on the LCD monitor.
- ▶ When the playback display ends, the camera will return to Live View shooting automatically.
- Press the <img alt="Live View button icon" data-bbox="598 691 628 711"/> button to end the Live View shooting.

You can also rotate the LCD monitor for different angles (p.37).



Normal angle



Low angle



High angle

## Disabling Flash

The camera analyzes the scene and sets the optimum settings automatically. In places where flash photography is prohibited such as in a museum or an aquarium, use the <> (Flash Off) mode.

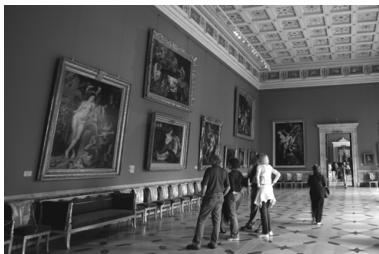
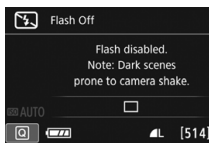

## Shooting Tips

- **Prevent camera shake if the numeric display in the viewfinder blinks.**  
Under low light when camera shake is prone to occur, the viewfinder's shutter speed display will blink. Hold the camera steady or use a tripod. When using a zoom lens, use the wide-angle end to reduce blur caused by camera shake even while handholding the camera.
- **Take portraits without flash.**  
In low-light conditions, tell the subject to keep still until the picture is taken. Any movement by the subject during shooting may result in the subject being blurred in the picture.

## **CA** Creative Auto Shooting

In the <CA> mode, you can set the following functions for shooting: (1) Extra Effect Shot, (2) Ambience-based shots, (3) Background blur, (4) Drive mode, and (5) Flash firing. The default settings are the same as the <A+> mode.

\* CA stands for Creative Auto.



### **1** Set the Mode Dial to <CA>.

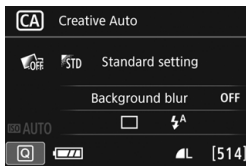

### **2** Press the <Q> button (10).

▶ The Quick Control screen will appear.

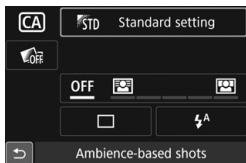

### **3** Set the desired function.

- Press the <▲> <▼> or <◀> <▶> keys to select a function.
- ▶ The selected function and Feature guide (p.68) will appear.
- Press <SET> to set the function.
- For the setting procedure and details on each function, see pages 77-79.

### **4** Take the picture.

- Press the shutter button completely to take the picture.



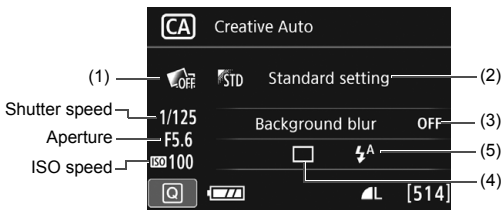

If you set (1), (2) or (3) when the camera is set for Live View shooting, you can see the effect on the screen before you start shooting.

### (1) Extra Effect Shot

- You can select any of the following effects for shooting: Creative filters, Picture Styles (p.113), and Ambience-based shots.
- Turn the <☉> dial to select [📷 : **Enable**]. Turn the <⚙️> dial to select a shooting effect and shoot.
- When you take a picture, two images will be recorded. One with the effect applied and one without. Both images will be displayed together immediately after you take the picture. The image without the effect is displayed on the left and the one with the effect on the right.

### Registering your favorite shooting effects

- During the image review immediately after shooting and during playback, the image applied with the effect will have the [SET 📷] icon. After you press the <SET> button and then the <INFO.> button, you can check which shooting effect is applied.
- You can register up to two shooting effects under [★ : **Favorite effect**].
- When you select the registered [★ : **Favorite effect**], you can shoot with that shooting effect applied. You can also overwrite the [★ : **Favorite effect**].











- If you are using an Eye-Fi card and have set it to erase images after their transfer, the image without the effect will not be displayed during the playback immediately after shooting.
- The Live View image displayed with Extra Effect Shot applied will not look exactly the same as the actual photo.

## (2) Ambience-based shots

- You can select and shoot with the ambience you want to convey in your images.
- Turn the <  > dial to select the ambience.

## (3) Background blur



- If [**OFF**] is set, the degree of background blur will change depending on the brightness.
- If it is set to any setting other than [**OFF**], you can adjust the background blur regardless of the brightness.
- If you turn the <  > or <  > dial to move the cursor to the right, the background will look sharper.
- Turning the <  > or <  > dial to move the cursor to the left will blur the subject's background. Note that depending on the lens's maximum aperture (smallest f/number), certain slider adjustments may not be selectable.
- If you use Live View shooting, you can see how the image is blurred in front of and behind the point of focus. When you turn the <  > or <  > dial, [**Simulating blur**] will be displayed on the LCD monitor.
- If you want to blur the background, see “Shooting Portraits” on page 80.
- Depending on the lens and shooting conditions, the background may not look so blurred.
- This function cannot be set if you use flash. If <  > has been set and you set background blur, <  > will be set automatically.



- If [**Simulating blur**] is effective during Live View shooting, the image displayed with <  > (p.134) blinking may have more noise than the actual image being recorded, or it may look dark.
- You cannot set both (1) Extra Effect Shot and (2) Ambience-based shots at the same time.
- You cannot set both (1) Extra Effect Shot and (3) Background blur at the same time.

(4) **Drive mode:** Use the or dial to make the selection.

<□> **Single shooting:**

Shoot one image at a time.

<□> **Continuous shooting:**

While you hold down the shutter button completely, shots will be taken continuously. You can shoot up to approx. 5.0 shots per second.

<□S> **Silent single shooting\*:**

Single shooting with less shooting sound than <□>.

<□> **Silent continuous shooting\*:**

Continuous shooting (max. approx. 3.0 shots per second) with less shooting sound than <□>.

<⏱> **Self-timer: 10sec./remote control:**

The picture is taken 10 seconds after you press the shutter button. A remote controller can also be used.

<⏱2> **Self-timer: 2 sec.:**

The picture is taken 2 seconds after you press the shutter button.

<⏱C> **Self-timer: Continuous:**

Press the <▲> <▼> keys to set the number of multiple shots (2 to 10) to be taken with the self-timer. 10 seconds after you press the shutter button, the set number of multiple shots will be taken.

\* Cannot be set during Live View shooting.

(5) **Flash firing:** Turn the or dial to select the desired setting.

<⚡> **Auto flash** : The flash fires automatically when necessary.

<⚡> **Flash on** : The flash fires at all times.

<⊕> **Flash off** : The flash is disabled.



- When using <⊕>, see “Disabling Flash” on page 75.
- If you have set Extra Effect Shot, **RAW** + **▲** **L**, **RAW**, and <□> <□S> <⏱C> cannot be set.
- If you have set background blur, you cannot use flash.

## Shooting Portraits

The <img alt="Portrait mode icon" data-bbox="128 91 151 114"/> (Portrait) mode blurs the background to make the human subject stand out. It also makes skin tones and hair look softer.

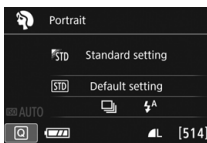

### Shooting Tips

- **Select the location where the distance between the subject and the background is the farthest.**

The further the distance between the subject and background, the more blurred the background will look. The subject will also stand out better against an uncluttered dark background.

- **Use a telephoto lens.**

If you have a zoom lens, use the telephoto end to fill the frame with the subject from the waist up. Move in closer if necessary.

- **Focus on the face.**

Check that the AF point covering the face lights up. For close-ups of the face, focus on the eyes.



The default setting is <img alt="Continuous shooting icon" data-bbox="348 884 371 907"/> (Continuous shooting). If you hold down the shutter button, you can shoot continuously to capture subtle changes in the subject's pose and facial expression (max. approx. 5.0 shots/sec.).

## Shooting Landscapes

Use the <> (Landscape) mode for wide scenery or to have everything in focus from near to far. For vivid blues and greens, and very sharp and crisp images.

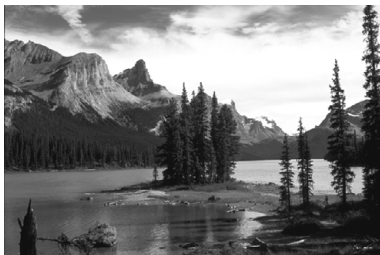
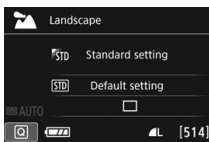

### Shooting Tips

- **With a zoom lens, use the wide-angle end.**  
When using the wide-angle end of a zoom lens, objects near and far will be in focus better than at the telephoto end. It also adds breadth to landscapes.
- **Shooting night scenes.**  
The <> mode is also good for night scenes because it disables the built-in flash. When shooting night scenes, use a tripod to prevent camera shake.



- The built-in flash will not fire even in backlit or low-light conditions.
- If you are using an external Speedlite, the Speedlite will fire.

## Shooting Close-ups

When you want to shoot flowers or small things up close, use the  (Close-up) mode. To make small things appear much larger, use a macro lens (sold separately).

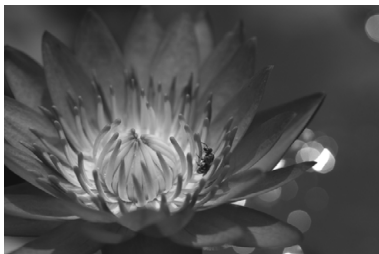
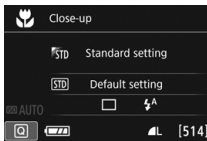

### Shooting Tips

- **Use a simple background.**

A simple background makes small objects such as flowers stand out better.

- **Move in as close as possible to the subject.**

Check the lens for its minimum focusing distance. Some lenses have indications such as **<MACRO 0.25m/0.8ft>** on them. The lens minimum focusing distance is measured from the **<⊖>** (focal plane) mark on the top of the camera to the subject. If you are too close to the subject, the focus indicator **<●>** will blink.

If you use flash and the bottom of the picture looks unusually dark, move away from the subject.

- **With a zoom lens, use the telephoto end.**

If you have a zoom lens, using the telephoto end will make the subject look larger.

## Shooting Moving Subjects

Use the < > (Sports) mode to shoot a moving subject, such as a running person or a moving vehicle.

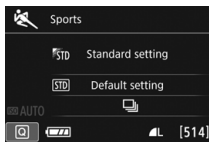



### Shooting Tips

- **Use a telephoto lens.**

The use of a telephoto lens is recommended for shooting from a distance.

- **Track the subject with the Area AF frame.**

Aim the center AF point over the subject, then press the shutter button halfway to start autofocusing in Area AF frame. During autofocusing, the beeper will continue beeping softly. If focus cannot be achieved, the focus indicator < > will blink.

The default setting is < > (Continuous shooting). When you want to take the picture, press the shutter button completely. If you hold down the shutter button, you will be able to maintain autofocusing during continuous shooting of the subject's movement (max. approx. 5.0 shots per sec.).



- Under low light when camera shake is prone to occur, the viewfinder's shutter speed display on the bottom left will blink. Hold the camera steady and shoot.
- If you are using an external Speedlite, the Speedlite will fire.

# SCN: Special Scene Mode

The camera will automatically choose the appropriate settings when you select a shooting mode for your subject or scene.



## 1 Set the Mode Dial to <SCN>.

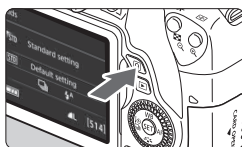

## 2 Press the <Q> button (10).

▶ The Quick Control screen will appear.

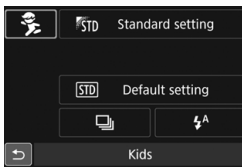

## 3 Select a shooting mode.

- Press the <▲> <▼> or <◀> <▶> keys to select the desired shooting mode's icon.
- Turn the <☀> or <☾> dial to select a shooting mode.
- You can also select the shooting mode icon and press <SET> to display a selection of shooting modes from which you can select one.

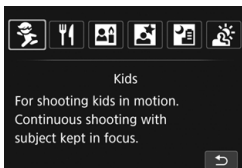

### Available Shooting Modes in the <SCN> Mode

Shooting Mode	Page
Kids	p.85
Food	p.86
Candlelight	p.87

Shooting Mode	Page
Night Portrait	p.88
Handheld Night Scene	p.89
HDR Backlight Control	p.90



## Shooting Children

When you want to continuously focus and shoot children running around, use <> (Kids). Skin tones will look healthy.

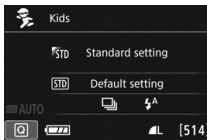

### Shooting Tips

- **Track the subject with the Area AF frame.**

Aim the center AF point over the subject, then press the shutter button halfway to start autofocusing in Area AF frame. During autofocusing, the beeper will continue beeping softly. If focus cannot be achieved, the focus indicator <> will blink.
- **Shoot continuously.**

The default setting is <> (Continuous shooting). When you want to take the picture, press the shutter button completely. If you hold down the shutter button, you will be able to maintain autofocusing during continuous shooting of the subject's changing facial expressions and movement (max. approx. 5.0 shots per sec.).



While the flash is recycling, “**buSY**” is displayed in the viewfinder and on the LCD panel, and a picture cannot be taken. Take the picture after this display turns off. During Live View shooting, “**BUSY**” is displayed on the LCD monitor, and you cannot view the subject.

## 🍴 Shooting Food

When shooting food, use <🍴> (Food). The photo will look bright and vivid.

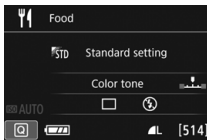
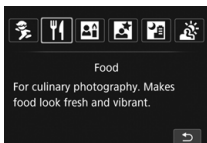

### 💡 Shooting Tips

- **Change the color tone.**

You can change [Color tone]. Food photos with a reddish tinge usually make the food look more vivid. To increase the food's reddish tinge, set it toward [Warm tone]. Set it toward [Cool tone] if it looks too red.

- **Shoot the subject in close-up.**

If you have a zoom lens, use the telephoto end to shoot the food in close-up.

- **Avoid using flash.**

If you use flash, the light may reflect off the dish or food and results in unnatural shadows. By default, <🚫> (Flash off) is set. Try to prevent camera shake when shooting in low-light conditions.

- Since this mode sets the color tone to make food look vivid, human subjects may be shot in an unsuitable skin tone.
- If you use flash, the [Color tone] setting will switch to the standard setting.

## Shooting Candlelight Portraits

When shooting a human subject in candlelight, use  (Candlelight). The candlelight color tones will be retained in the photo.

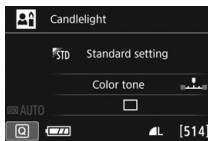
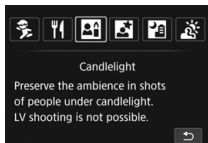

### Shooting Tips

- **Use the center AF point to focus.**  
Aim the center AF point in the viewfinder over the subject, then shoot.
- **Prevent camera shake if the shutter speed in the viewfinder blinks.**  
Under low light when camera shake is prone to occur, the viewfinder's shutter speed display will blink. Hold the camera steady or use a tripod. When using a zoom lens, use the wide-angle end to reduce blur caused by camera shake even while handholding the camera.
- **Change the color tone.**  
You can change [Color tone]. To increase the candlelight's reddish tinge, set it toward [Warm tone]. Set it toward [Cool tone] if it looks too red.



- Live View shooting cannot be used.
- The built-in flash will not fire. In low light, the AF-assist beam may be emitted (p.100).
- If you are using an external Speedlite, the Speedlite will fire.

## Shooting Night Portraits (With a Tripod) ■

To shoot people at night and obtain a natural-looking night scene in the background, use the  (Night Portrait) mode. Using a tripod is recommended.

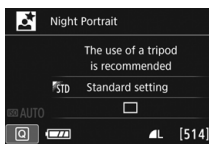
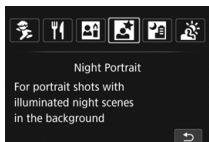

### Shooting Tips

- **Use a wide-angle lens and a tripod.**



When using a zoom lens, use the wide-angle end to obtain a wide night view. Also, use a tripod to prevent camera shake.

- **Check the subject's brightness.**

Under low light, the built-in flash will fire automatically to obtain a good exposure of the subject.

It is recommended to play back the image after shooting to check the image brightness. If the subject looks dark, move nearer and shoot again.

- **Also shoot in other shooting modes.**

Since camera shake is prone to occur with night shots, shooting also with  and  is recommended.



- Tell the subject to keep still even after the flash fires.
- If you use the self-timer together with flash, the self-timer lamp will light up briefly after the picture is taken.
- See the cautions on page 91.

## Shooting Night Scenes (Handheld)

Using a tripod when shooting a night scene gives the best results. However, the  (Handheld Night Scene) mode enables you to shoot night scenes even while handholding the camera. Four shots are taken continuously for each picture, and the resulting one image with reduced camera shake is recorded.

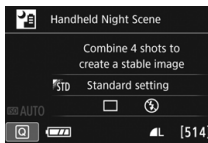
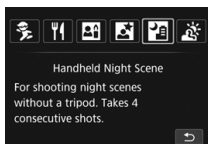



### Shooting Tips

- **Hold the camera firmly.**

While shooting, hold the camera firmly and steadily. In this mode, four shots are aligned and merged into a single image. However, if there is significant misalignment in any of the four shots due to camera shake, they may not align properly in the final image.

- **For shots of people, turn on the flash.**

If you want to include people in the night scene shot, press the  button to set  (Flash on). To take a nice portrait, the first shot will use flash. Tell the subject not to move until all four continuous shots are taken.



See the cautions on page 91.

## Shooting Backlit Scenes

When shooting a scene having both bright and dark areas, use the  (HDR Backlight Control) mode. When you take one picture in this mode, three continuous shots are taken at different exposures. This results in one image, with a wide tonal range, that has minimized the clipped shadows caused by backlighting.

---

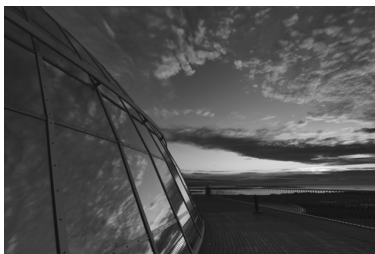
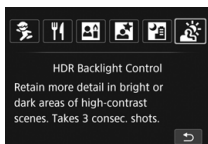

## Shooting Tips

### ● Hold the camera firmly.

While shooting, hold the camera firmly and steadily. In this mode, three shots are aligned and merged into a single image. However, if there is significant misalignment in any of the three shots due to camera shake, they may not align properly in the final image.

-  ● The flash will not fire. In low light, the AF-assist beam may be emitted (p.100).
- See the cautions on page 91.

 HDR stands for High Dynamic Range.



### Cautions for both <Fn> (Night Portrait) and <Fn> (Handheld Night Scene)

- During Live View shooting, it may be difficult to focus on dots of light such as in a night scene. In such a case, set the lens's focus mode switch to <MF> and focus manually.
- The Live View image displayed will not look exactly the same as the actual image shot.

### Cautions for <Fn> (Handheld Night Scene)

- When shooting flash photography, if the subject is too close to the camera, the picture may come out extremely bright (overexposure).
- If you use flash to shoot a night scene with few lights, the shots may not align correctly. This can result in a blurry picture.
- If you use flash and the human subject is close to the background that is also illuminated by the flash, the shots may not align correctly. This can result in a blurry picture. Unnatural shadows and unsuitable colors may also appear.
- External flash coverage:
  - When using a Speedlite with automatic flash coverage setting, the zoom position will be fixed to the wide end, regardless of the lens's zoom position.
  - If you have to set the flash coverage manually, set the light-emitting unit (flash head) to the wide-angle end before shooting.

### Cautions for <Fn> (Night Portrait)

- During Live View shooting, it may be difficult to focus when the face of the subject looks dark. In such a case, set the lens's focus mode switch to <MF> and focus manually.

### Cautions for both <Fn> (Handheld Night Scene) and <Fn> (HDR Backlight Control)

- Compared to other shooting modes, the shooting range will be smaller.
- **RAW** + **AF-L** or **RAW** cannot be selected. If **RAW** + **AF-L** or **RAW** has been set, **AF-L** will be set.
- If you shoot a moving subject, the subject's movement may leave afterimages, or the surrounding area of the subject may become dark.
- The image alignment may not function properly with repetitive patterns (lattice, stripes, etc.), flat or single-tone images, or images significantly misaligned due to camera shake.
- It takes some time to record images to the card since they are merged after shooting. During the processing of the images, "buSY" will be displayed in the viewfinder and on the LCD panel, and you cannot take another picture until the processing is completed.
- If the shooting mode is set to <Fn> or <Fn>, direct printing is not possible.

### ⚠ Cautions for <🌞> (HDR Backlight Control)

- Note that the image may not be rendered with a smooth gradation and may look irregular or have significant noise.
- HDR Backlight Control may not be effective for excessively backlit scenes or extremely high-contrast scenes.
- When shooting subjects that are sufficiently bright, for example for normally lit scenes, the image may look unnatural because of the applied HDR effect.

## Q Quick Control

In Basic Zone modes when the shooting function settings screen is displayed, you can press the <Q> button to display the Quick Control screen. The tables on the next page show the functions that can be set with the Quick Control screen in each Basic Zone mode.

### 1 Set the Mode Dial to a Basic Zone mode.

Example: Portrait mode

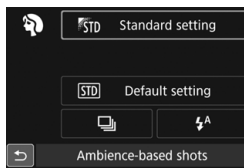

### 2 Press the <Q> button (📷10).

- ▶ The Quick Control screen will appear.



### 3 Set the functions.

- Press the <▲> <▼> or <◀> <▶> keys to select a function. (This step is not necessary in the 📷 mode.)
- ▶ The selected function and Feature guide (p.68) will appear.
- Turn the <🌞> or <🌑> dial to change the setting.
- You can also select from a list by selecting a function and pressing <SET>.



## Settable Functions in Basic Zone Modes

●: Default setting ○: User selectable □: Not selectable

Function							
Drive mode (p.106)	: Single shooting	●	●	●	○	●	○
	: Continuous shooting	○	○	○	●	○	●
	: Silent single shooting	○	○	○	○	○	○
	: Silent continuous shooting	○	○	○	○	○	○
	(10 sec.)	○	○	○	○	○	○
	(2 sec.)	○	○	○	○	○	○
	(Continuous)	○	○	○	○	○	○
Flash firing	: Automatic firing	●		●	●	●	
	: Flash on (Fires at all times)	○		○	○	○	
	: Flash off	○	●	○	○	●	●
Ambience-based shots				○	○	○	○
Light/scene-based shots					○	○	○
Background blur (p.78)				○			
Color tone (p.86, 87)							
Extra Effect Shot (p.77)				○			

Function		SCN					
Drive mode (p.106)	: Single shooting	○	●	●	●	●	●
	: Continuous shooting	●	○	○	○	○	○
	: Silent single shooting	○	○	○	○	○	○
	: Silent continuous shooting	○	○	○	○	○	○
	(10 sec.)	○	○	○	○	○	○
	(2 sec.)	○	○	○	○	○	○
	(Continuous)	○	○	○	○	○	○
Flash firing	: Automatic firing	●			●		
	: Flash on (Fires at all times)	○	○			○	
	: Flash off	○	●	●		●	●
Ambience-based shots		○	○	○	○	○	
Light/scene-based shots		○					
Background blur (p.78)							
Color tone (p.86, 87)			○	○			
Extra Effect Shot (p.77)							

\* If you change the shooting mode or set the power switch to <OFF>, all the functions will revert to the default settings (except the self-timer).

## ▶ Image Playback

The easiest way to play back images is explained below.



### 1 Play back the image.

- Press the <▶> button.
- ▶ The last image captured or played back will appear.



### 2 Select an image.

- To play back images starting with the last image captured, turn the <☀> dial counterclockwise. To play back images starting with the first captured image, turn the <☀> dial clockwise.
- Each time you press the <INFO.> button, the information display will change.



No information



Basic information display

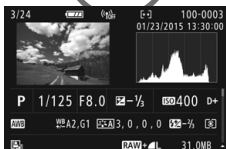

Shooting information display

### 3 Exit the image playback.

- Press the <▶> button to exit the image playback and return to shooting-ready state.

## Shooting Information Display

With the shooting information screen displayed (p.94), you can press the <▲> <▼> keys to change the shooting information displayed at the screen's bottom as follows.

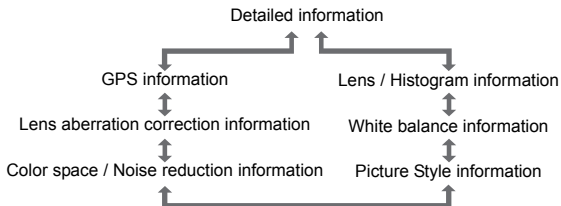

- The information displayed varies depending on the shooting mode and settings.
- If GPS information is not recorded for the image, the GPS information screen will not be displayed.



# 3

## Setting the AF and Drive Modes

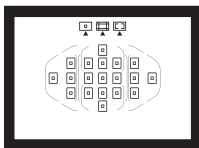

The 19 AF points in the viewfinder make AF shooting suitable for a wide variety of subjects and scenes.

You can also select the AF operation and drive mode that best match the shooting conditions and subject.

- The ☆ icon at the upper right of the page title indicates that the function is available only in Creative Zone modes (p.27).
- In Basic Zone modes, the AF operation and AF point (AF area selection mode) are set automatically.



<AF> stands for autofocus. <MF> stands for manual focus.

# AF: Changing the Autofocus Operation ☆

You can select the AF (autofocus) operation characteristics suiting the shooting conditions or subject. In Basic Zone modes, the optimum AF operation is set automatically for the respective shooting mode.

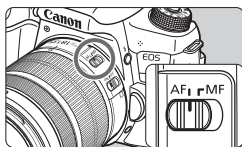

- 1 Set the lens's focus mode switch to <AF>.**

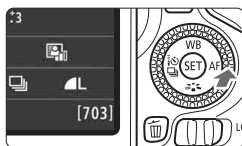

- 2 Press the <▶ AF> button.**
  - ▶ [AF operation] will appear.

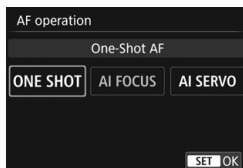

- 3 Select the AF operation.**
  - Press the <◀> <▶> keys to select the desired AF operation, then press <SET>.

- 4 Focus on the subject.**
  - Aim the AF point over the subject and press the shutter button halfway. The camera will then autofocus in the selected AF operation.

## One-Shot AF for Still Subjects

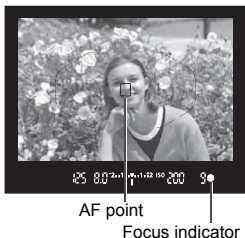

**Suited for still subjects. When you press the shutter button halfway, the camera will focus only once.**

- When focus is achieved, the AF point that achieved focus will be displayed, and the focus indicator <●> in the viewfinder will also light up.
  - With evaluative metering, the exposure setting will be set at the same time focus is achieved.
- While you hold down the shutter button halfway, the focus will be locked. You can then recompose the shot if desired.

## AI Servo AF for Moving Subjects

**This AF operation is suited for moving subjects when the focusing distance keeps changing. While you hold down the shutter button halfway, the subject will be focused on continuously.**

- The exposure is set at the moment the picture is taken.
- When the AF area selection mode is set to 19-point automatic selection AF (p.101), the camera first uses the manually-selected AF point to focus. During autofocusing, if the subject moves away from the manually-selected AF point, focus tracking continues as long as the subject is covered by the Area AF frame.

## AI Focus AF for Switching the AF Operation Automatically

**AI Focus AF switches the AF operation from One-Shot AF to AI Servo AF automatically if a still subject starts moving.**

- After the subject is focused on in One-Shot AF, if the subject starts moving, the camera will detect the movement, change the AF operation automatically to AI Servo AF, and start tracking the moving subject.

## **AF Points Lighting Up in Red**

By default, the AF points light up in red when focus is achieved in low-light conditions. In Creative Zone modes, you can set whether to have the AF points light up in red when focus is achieved.

## **AF-Assist Beam with the Built-in Flash**

Under low-light conditions, when you press the shutter button halfway, the built-in flash may fire a brief burst of flashes. This illuminates the subject to help autofocusing.



## **Selecting the AF Area and AF Point** <sup>☆</sup>

19 AF points are provided for autofocusing. You can select the AF area selection mode and AF point(s) suiting the scene or subject.

### **AF Area Selection Mode**

You can select one of three AF area selection modes. See the next page for the selection procedure.

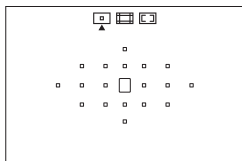

#### **: Single-point AF (Manual selection)**

Select one AF point to focus.

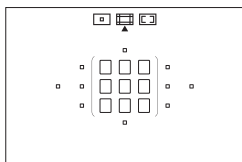

#### **: Zone AF (Manual selection of zone)**

The 19 AF points are divided into five zones for focusing.

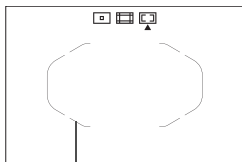



#### **: 19-point automatic selection AF**

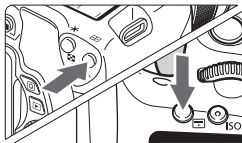

All the AF points are used to focus. **This mode is set automatically in Basic Zone modes** (except < >).

Area AF frame

## Selecting the AF Area Selection Mode



1 Press the  or  button (☐6).

- Look through the viewfinder and press the  or  button.

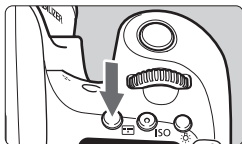

2 Press the  button.

- Each time you press the  button, the AF area selection mode changes.
- The AF area selection mode currently set is indicated on the top of the viewfinder.

AF area selection mode

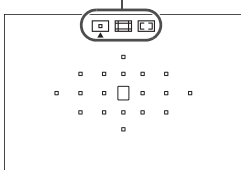

 : **Single-point AF**  
(Manual selection)

 : **Zone AF**  
(Manual selection of zone)

 : **19-point automatic selection AF**

## Selecting the AF Point Manually

You can manually select the AF point or zone. If 19-point automatic selection AF + AI Servo AF has been set, you can select any position where AI Servo AF is to start.

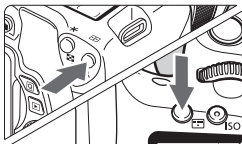

### 1 Press the **<☒>** or **<☒>** button (☒6).

- ▶ The AF points will be displayed in the viewfinder.
- In the Zone AF mode, the selected zone will be displayed.

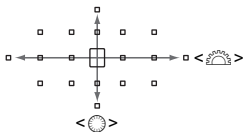

### 2 Select an AF point.

- You can select an AF point by shifting horizontally with the **<☒6>** dial or vertically with the **<☒6>** dial. If you press **<SET>**, the center AF point (or center zone) will be selected.
- In the Zone AF mode, turning the **<☒6>** or **<☒6>** dial will change the zone in a looping sequence.
- You can also select an AF point or zone by shifting horizontally with the **<◀>** **<▶>** keys or vertically with the **<▲>** **<▼>** keys.

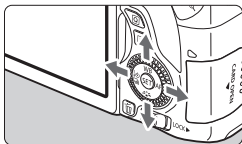

# AF Area Selection Modes ☆

## Single-point AF (Manual Selection)



Select one AF point <□> to be used for focusing.

## Zone AF (Manual Selection of Zone)

The 19 AF points are divided into five zones for focusing. All the AF points in the selected zone are used for the automatic selection of the focusing point(s). It is effective for moving subjects.

However, since it is inclined to focus the nearest subject, focusing a specific target is harder than with single-point AF.

The AF point(s) achieving focus is displayed as <□>.

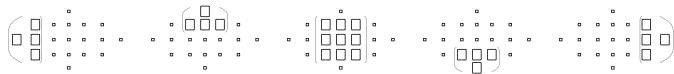

## 19-point Automatic Selection AF

All the AF points are used to focus. This mode is set automatically in Basic Zone modes (except <□>).



With One-Shot AF, pressing the shutter button halfway will display the AF point(s) <□> that achieved focus. If multiple AF points are displayed, it means they all have achieved focus.



With AI Servo AF, the manually-selected (p.103) AF point <□> is used first to achieve focus. The AF point(s) achieving focus is displayed as <□>.

## MF: Manual Focus

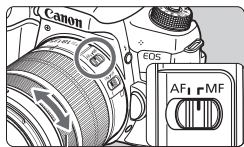

Focusing ring

**1** Set the lens focus mode switch to **<MF>**.

**2** Focus on the subject.

- Focus by turning the lens focusing ring until the subject looks sharp in the viewfinder.

## Selecting the Drive Mode

Single and continuous drive modes are provided.



### 1 Press the <◀[i]⊙▶> button.

▶ [Drive mode] will appear.

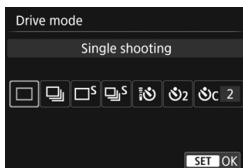

### 2 Select the drive mode.

- Press the <◀> <▶> keys to select the desired drive mode, then press <⊙(SET)>.

#### □ : **Single shooting**

When you press the shutter button completely, only one shot will be taken.

#### ▶ : **Continuous shooting** (Max. approx. 5.0 shots/sec.)

While you hold down the shutter button completely, shots will be taken continuously.

#### □<sup>S</sup> : **Silent single shooting**

Single shooting with less shooting sound than <□>.

#### ▶<sup>S</sup> : **Silent continuous shooting** (Max. approx. 3.0 shots/sec.)

Continuous shooting with less shooting sound than <▶>.

#### ⊙ : **Self-timer: 10sec./remote control**

#### ⊙<sub>2</sub> : **Self-timer: 2 sec.**

#### ⊙<sub>C</sub> : **Self-timer: Continuous**

For self-timer shooting, see page 107.

## Using the Self-timer



### 1 Press the **<◀▶i⌂▶>** button.

- ▶ [Drive mode] will appear.

### 2 Select the self-timer.

- Press the **<◀>** keys to select the self-timer, then press **<SET>**.

#### **i⌂**: 10-sec. self-timer

The remote controller can also be used.

#### **i⌂<sub>2</sub>**: 2-sec. self-timer (p.79)

#### **i⌂<sub>C</sub>**: 10-sec. self-timer plus continuous shots

Press the **<▲>** **<▼>** keys to set the number of multiple shots (2 to 10) to be taken with the self-timer.

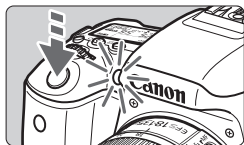
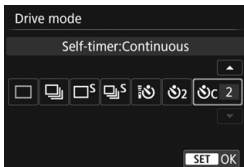

### 3 Take the picture.

- Look through the viewfinder, focus on the subject, then press the shutter button completely.
- ▶ You can check the self-timer operation with the self-timer lamp, beeper, and countdown display (in seconds) on the LCD panel.
- ▶ Two sec. before the picture is taken, the self-timer lamp will light up and the beeper will sound faster.





# 4

## Image Settings

This chapter explains image-related function settings: Image-recording quality, ISO speed, Picture Style, white balance, Auto Lighting Optimizer, noise reduction, lens aberration correction, anti-flicker shooting, and other functions.

- The ☆ icon at the upper right of the page title indicates that the function is available only in Creative Zone modes (p.27).

## MENU Setting the Image-Recording Quality

You can select the pixel count and the image quality. Ten image-recording quality settings are provided: **L**, **L**, **M**, **M**, **S1**, **S1**, **S2**, **S3**, **RAW** + **L**, **RAW**.

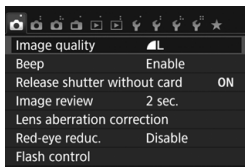

### 1 Select the image-recording quality.

- Under the [**1**] tab, select [**Image quality**], then press <SET>.
- ▶ [**Image quality**] will appear.

Pixels recorded (pixel count)

Possible shots



### 2 Set the image-recording quality.

- The respective quality's pixel count and number of possible shots will be displayed to help you select the desired quality. Then press <SET>.

## Guide to Image-recording Quality Settings

(Approx.)

Image Quality			Pixels Recorded (megapixels)	File Size (MB)	Possible Shots	Maximum Burst
L	High quality	JPEG	24 (24M)	7.6	940	180 (940)
				3.9	1810	1810 (1810)
M	Medium quality		10.6 (11M)	4.0	1770	1770 (1770)
				2.0	3500	3500 (3500)
S1	Low quality		5.9 (5.9M)	2.5	2830	2830 (2830)
				1.3	5320	5320 (5320)
S2			2.5 (2.5M)	1.3	5320	5320 (5320)
S3			0.35 (0.3M)	0.3	20180	20180 (20180)
RAW + L	High quality		24 (24M)	28.1+7.6	190	6 (6)
RAW				28.1	240	7 (8)

\* The file size, possible shots, and maximum burst during continuous shooting are based on Canon's testing standards (3:2 aspect ratio, ISO 100 and Standard Picture Style) using an 8 GB card. **These figures will vary by the subject, card brand, aspect ratio, ISO speed, Picture Style, Custom Functions, and other settings.**

\* Figures in parentheses apply to an UHS-I compatible 8 GB card based on Canon's testing standards.

# ISO: Changing the ISO Speed to Suit the Light <sup>☆</sup>

Set the ISO speed (image sensor's sensitivity to light) to suit the ambient light level. In Basic Zone modes, the ISO speed is set automatically.

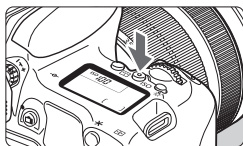

1 Press the <ISO> button (⚙️).

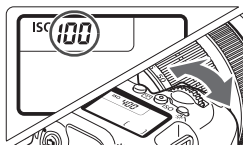

2 Set the ISO speed.

- While looking at the LCD panel or in the viewfinder, turn the <⚙️> or <⦿> dial.
- ▶ “A” indicates ISO Auto. The ISO speed will be set automatically.

## ISO Speed Guide

ISO Speed	Shooting Situation (No flash)	Flash Range
ISO 100 - ISO 400	Sunny outdoors	The higher the ISO speed, the farther the flash range will extend (p.130).
ISO 400 - ISO 1600	Overcast skies or evening time	
ISO 1600 - ISO 12800, H	Dark indoors or night	

\* High ISO speeds will result in grainier images.

## **Selecting a Picture Style** ☆

By selecting a Picture Style, you can obtain image characteristics matching your photographic expression or the subject.

In Basic Zone modes, [A] (Auto) is set automatically.

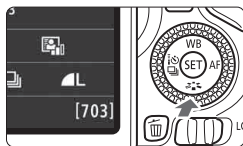

### 1 **Press the <▼ > button.**

- ▶ The Picture Style selection screen will appear.

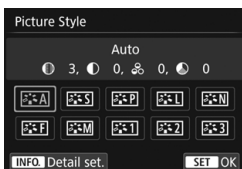

### 2 **Select a Picture Style.**

- Select a Picture Style, then press <SET>.
- ▶ The Picture Style will be set.

 You can also set the Picture Style with [2: Picture Style].

## WB: Matching the Light Source <sup>☆</sup>

The function adjusting the color tone so that white objects look white in the picture is called white balance (WB). Normally, the [AWB] (Auto) setting will obtain the correct white balance. If natural-looking colors cannot be obtained with [AWB], you can select the white balance to match the light source or set it manually by shooting a white object.

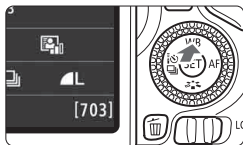

### 1 Press the <▲ WB> button.

▶ [White balance] will appear.

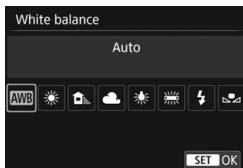

### 2 Select a white balance setting.

- Select the desired setting, then press <SET>.
- The “Approx. \*\*\*\*K” (K: Kelvin) displayed for the white balance settings <☀>, <🏠>, <☁>, <☀> or <☀> is the respective color temperature.

## **MENU** Auto Correction of Brightness and Contrast ☆

If the image comes out dark or the contrast is low, the brightness and contrast can be corrected automatically. This function is called Auto Lighting Optimizer. The default setting is [**Standard**]. With JPEG images, the correction is applied when the image is captured.

In Basic Zone modes, [**Standard**] is set automatically.

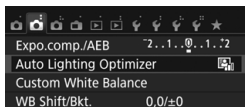

### **1** Select [**Auto Lighting Optimizer**].

- Under the [**2**] tab, select [**Auto Lighting Optimizer**], then press <SET>.



### **2** Select the setting.

- Select the desired setting, then press <SET>.

### **3** Take the picture.

- The image will be recorded with the brightness and contrast corrected if necessary.

# MENU Setting Noise Reduction ☆

## High ISO Speed Noise Reduction

This function reduces the noise generated in the image. Although noise reduction is applied at all ISO speeds, it is particularly effective at high ISO speeds. At low ISO speeds, the noise in the darker parts of the image (shadow areas) is further reduced. Change the setting to suit the noise level.

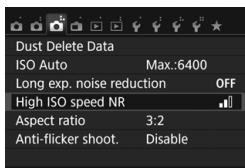

### 1 Select [High ISO speed NR].

- Under the [CAMERA] tab, select [High ISO speed NR], then press <SET>.

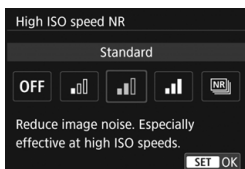

### 2 Set the level.

- Select the desired noise reduction level, then press <SET>.

### ● [NR]: Multi Shot Noise Reduction

This applies noise reduction with higher image quality than [High]. For a single photo, four shots are taken continuously and aligned and merged automatically into a single JPEG image.

### 3 Take the picture.

- The image will be recorded with noise reduction applied.



## Long Exposure Noise Reduction

Noise reduction is possible with images exposed for 1 sec. or longer.

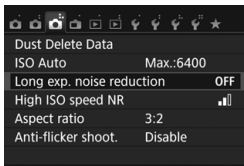

### 1 Select [Long exp. noise reduction].

- Under the [**3**] tab, select [**Long exp. noise reduction**], then press <SET>.

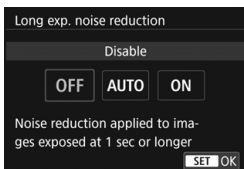

### 2 Set the desired setting.

- Select the desired setting, then press <SET>.

#### ● [Auto]

For exposures of 1 sec. or longer, noise reduction is performed automatically if noise typical of long exposures is detected. This [Auto] setting is effective in most cases.

#### ● [Enable]

Noise reduction is performed for all exposures of 1 sec. or longer. The [Enable] setting may reduce noise that cannot be detected with the [Auto] setting.

### 3 Take the picture.

- The image will be recorded with noise reduction applied.

## MENU Correction of Lens Peripheral Illumination and Aberrations

Peripheral light fall-off is a phenomenon that makes the image corners look darker due to the lens characteristics. Color fringing along subject outlines is called chromatic aberration. And image distortion due to lens characteristics is called distortion. These lens aberrations and light fall-off can be corrected. By default, Peripheral illumination and Chromatic aberration correction are set to **[Enable]**, and Distortion correction is set to **[Disable]**.

### Peripheral Illumination Correction

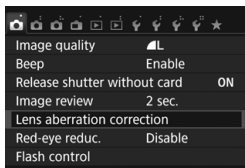

#### 1 Select **[Lens aberration correction]**.

- Under the [**1**] tab, select **[Lens aberration correction]**, then press **<SET>**.

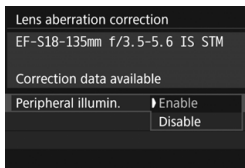

#### 2 Select the setting.

- Check that **[Correction data available]** is displayed for the attached lens.
- Select **[Peripheral illumin.]**, then press **<SET>**.
- Select **[Enable]**, then press **<SET>**.

#### 3 Take the picture.

- The image will be recorded with the peripheral illumination corrected.

### Chromatic Aberration Correction

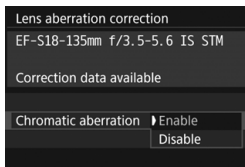

#### 1 Select the setting.

- Check that **[Correction data available]** is displayed for the attached lens.
- Select **[Chromatic aberration]**, then press **<SET>**.
- Select **[Enable]**, then press **<SET>**.

## 2 Take the picture.

- The image will be recorded with the chromatic aberration corrected.

### Distortion Correction

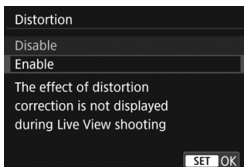

## 1 Select the setting.

- Check that [**Correction data available**] is displayed for the attached lens.
- Select [**Distortion**], then press <SET>.
- Select [**Enable**], then press <SET>.

## 2 Take the picture.

- The image will be recorded with the distortion corrected.

### Lens Correction Data

The camera already contains data for lens peripheral illumination correction, chromatic aberration correction, and distortion correction for approx. 30 lenses. If you select [**Enable**], the peripheral illumination correction, chromatic aberration correction, and distortion correction will be applied automatically for any lens whose correction data is registered in the camera.

With EOS Utility (EOS software), you can check which lenses have their correction data registered in the camera. You can also register the correction data for unregistered lenses. For details, refer to the EOS Utility Instruction Manual (p.168).

For lenses incorporating the correction data, it is not necessary to register the correction data to the camera.

## MENU Reducing Flicker ☆

If you shoot an image with a fast shutter speed under a light source such as fluorescent light, the blinking of the light source causes flicker and the image may be vertically unevenly exposed. If continuous shooting is used under these conditions, uneven exposures or colors across the images may result.

With anti-flicker shooting, the camera detects the frequency of the light source's blinking and takes the picture when the flicker causes less effect on exposure or color.

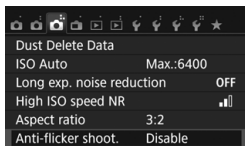

### 1 Select [Anti-flicker shoot.].

- Under the [📷3] tab, select [Anti-flicker shoot.], then press <SET>.

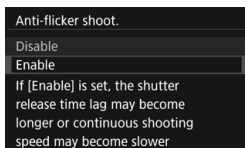

### 2 Select [Enable].

- Select [Enable], then press <SET>.

### 3 Take the picture.

- The image will be taken with reduced unevenness of exposure or color caused by the flicker.

# 5

## Advanced Operations

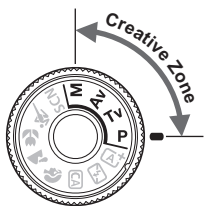

In Creative Zone modes, you can change various settings of the camera as you desire to obtain a wide variety of shooting results, by selecting the shutter speed and/or aperture, adjusting the exposure as you prefer, etc.

- The ☆ icon at the upper right of the page title indicates that the function is available only in Creative Zone modes.
- After you press the shutter button halfway and let go, the exposure values will remain displayed in the viewfinder and on the LCD panel for 4 sec. (ⓘ4) by the operation of metering timer.



Set the <LOCK> switch to the left.

# P: Program AE

The camera automatically sets the shutter speed and aperture to suit the subject's brightness. This is called Program AE.

\* <P> stands for Program.

\* AE stands for Auto Exposure.



## 1 Set the Mode Dial to <P>.



## 2 Focus on the subject.

- Look through the viewfinder and aim the AF point over the subject. Then press the shutter button halfway.
- ▶ When focus is achieved, the focus indicator <●> on the viewfinder's bottom right will light up (when in One-Shot AF mode).
- ▶ The shutter speed and aperture will be set automatically and displayed in the viewfinder and on the LCD panel.



## 3 Check the display.

- A standard exposure will be obtained as long as the shutter speed and aperture display do not blink.

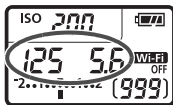

## 4 Take the picture.

- Compose the shot and press the shutter button completely.

## Tv: Conveying the Subject's Movement

You can either freeze the action or create motion blur with the **<Tv>** (Shutter-priority AE) mode on the Mode Dial.

\* **<Tv>** stands for Time value.



Blurred motion  
(Slow shutter speed: 1/30 sec.)



Frozen action  
(Fast shutter speed: 1/2000 sec.)



### 1 Set the Mode Dial to **<Tv>**.

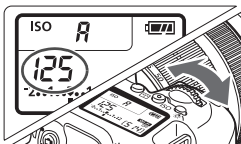

### 2 Set the desired shutter speed.

- While looking at the LCD panel or in the viewfinder, turn the **<Shutter Speed>** dial.
- Turning the **<Shutter Speed>** dial to the right sets a faster shutter speed, and turning it to the left sets a slower one.



### 3 Take the picture.

- When you focus and press the shutter button completely, the picture will be taken at the selected shutter speed.

# Av: Changing the Depth of Field

To blur the background or to make everything near and far look sharp, set the Mode Dial to <Av> (Aperture-priority AE) to adjust the depth of field (range of acceptable focus).

\* <Av> stands for Aperture value, which is the size of the diaphragm hole inside the lens.

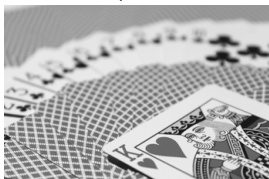

Blurred background  
(With a low aperture f/number: f/5.6)



Sharp foreground and background  
(With a high aperture f/number: f/32)



## 1 Set the Mode Dial to <Av>.

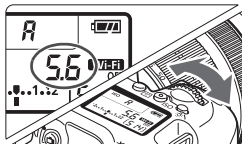

## 2 Set the desired aperture.

- While looking at the LCD panel or viewfinder, turn the <⚙> dial.
- The higher the f/number, the wider the depth of field where sharper focus is obtained in both the foreground and background.
- Turning the <⚙> dial to the right will set a higher f/number (smaller aperture opening), and turning it to the left will set a lower f/number (larger aperture opening).



## 3 Take the picture.

- Focus and press the shutter button completely. The picture will be taken with the selected aperture.



# M: Manual Exposure

You can set both the shutter speed and aperture manually as desired. While referring to the exposure level indicator in the viewfinder, you can set the exposure as desired. This method is called manual exposure.

\* <M> stands for Manual.



## 1 Set the Mode Dial to <M>.

## 2 Set the ISO speed (p.112).

## 3 Set the shutter speed and aperture.

- To set the shutter speed, turn the <⚙> dial.
- To set the aperture, turn the <⦿> dial.
- If it cannot be set, set the <LOCK▶> switch to the left, then turn the <⚙> or <⦿> dial.



Standard exposure index



Exposure level mark

## 4 Focus on the subject.

- Press the shutter button halfway.
- ▶ The exposure setting will be displayed in the viewfinder and on the LCD panel.
- The exposure level mark <↑> indicates how far the current exposure level is from the standard exposure level.

## 5 Set the exposure and take the picture.



- Check the exposure level indicator and set the desired shutter speed and aperture.
- If the exposure level exceeds  $\pm 2$  stops from the standard exposure, the end of the exposure level indicator will display <◀> or <▶> in the viewfinder and on the LCD panel. (On the LCD monitor, if the exposure level exceeds  $\pm 3$  stops, <◀> or <▶> will be displayed.)

## Changing the Metering Mode ☆

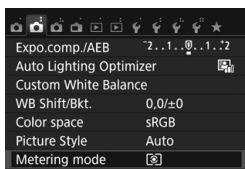
Four methods (metering modes) to measure the subject's brightness are provided. Normally, evaluative metering is recommended. In Basic Zone modes, metering mode is set automatically.



### 1 Select [Metering mode].

- Under the [2] tab, select [Metering mode], then press < >.

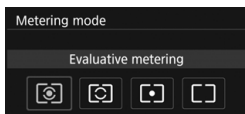

### 2 Set the metering mode.

- Select the desired metering mode, then press < >.

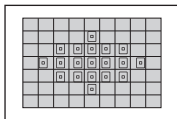

#### Evaluative metering

General-purpose metering mode suited even for backlit subjects. The camera sets the exposure automatically to suit the scene.



#### Partial metering

Effective where there are much brighter lights around the subject due to backlight, etc. The gray area in the left figure is where the brightness is metered to obtain the standard exposure.

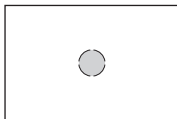

#### Spot metering

Effective when metering a specific part of the subject or scene. The gray area in the left figure is where the brightness is metered to obtain the standard exposure. This metering mode is for advanced users.



#### Center-weighted average metering

The brightness is metered at the image center and then averaged for the entire scene. This metering mode is for advanced users.

# Setting Exposure Compensation ☆

Set exposure compensation if the exposure (without flash) does not come out as desired. This feature can be used in Creative Zone modes (except <M>). You can set the exposure compensation up to  $\pm 5$  stops in 1/3-stop increments.

## 1 Check the exposure level indicator.

- Press the shutter button halfway (☉4) and check the exposure level indicator.

Increased exposure  
for a brighter image

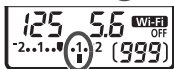

Decreased exposure  
for a darker image



## 2 Set the compensation amount.

- While looking in the viewfinder or at the LCD panel, turn the <☉> dial.
- If it cannot be set, set the <LOCK▶> switch to the left, then turn the <☉> dial.

## 3 Take the picture.

- To cancel the exposure compensation, set the exposure compensation amount back to <☉>.

## MENU Auto Exposure Bracketing ☆

This feature takes exposure compensation a step further by varying the exposure automatically (up to  $\pm 2$  stops in 1/3-stop increments) with three shots as shown below. You can then choose the best exposure. This is called AEB (Auto Exposure Bracketing).



Standard exposure



Darker exposure  
(Decreased exposure)



Brighter exposure  
(Increased exposure)

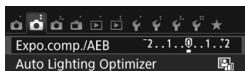

### 1 Select [Expo.comp./AEB].

- Under the [CAMERA] tab, select [Expo.comp./AEB], then press <SET>.

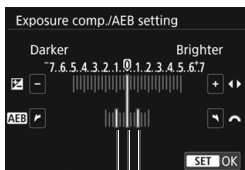

AEB range

### 2 Set the AEB range.

- Turn the <DIAL> dial to set the AEB range.
- Press the <LEFT> <RIGHT> keys to set the exposure compensation amount. If AEB is combined with exposure compensation, AEB will be applied centering on level of exposure compensation.
- Press <SET> to set it.
- When you press the <MENU> button to exit the menu, the AEB range will be displayed on the LCD panel.

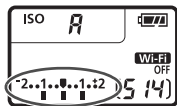

### 3 Take the picture.

- Focus and press the shutter button completely. The three bracketed shots will be taken in this sequence: standard exposure, decreased exposure, and increased exposure.

## ✳ Locking the Exposure ☆

You can lock the exposure when the area of focus is to be different from the exposure metering area or when you want to take multiple shots at the same exposure setting. Press the <✳> button to lock the exposure, then recompose and take the picture. This is called AE lock. It is effective for backlit subjects, etc.

### 1 Focus on the subject.

- Press the shutter button halfway.
- ▶ The exposure setting will be displayed.

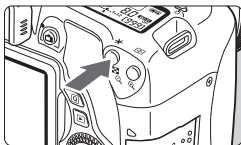

### 2 Press the <✳> button. (☺4)

- ▶ The <✳> icon lights up in the viewfinder to indicate that the exposure setting is locked (AE lock).
- Each time you press the <✳> button, the current autoexposure setting is locked.



### 3 Recompose and take the picture.

- If you want to maintain the AE lock while taking more shots, hold down the <✳> button and press the shutter button to take another shot.

## ⚡ Using the Built-in Flash

In indoor, low light, or backlit conditions in daylight, just raise the built-in flash and press the shutter button to take flash pictures. In the <P> mode, the shutter speed (1/60 sec. - 1/200 sec.) will be set automatically to prevent camera shake.

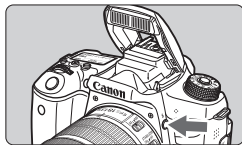

### 1 Press the <⚡> button.

- In Creative Zone modes, you can press the <⚡> button anytime to take flash pictures.
- While the flash is recycling, “buSY” is displayed in the viewfinder and on the LCD panel.



### 2 Press the shutter button halfway.

- In the bottom left of the viewfinder, check that the <⚡> icon is lit.



### 3 Take the picture.

- When focus is achieved and you press the shutter button completely, the flash will fire for the picture.

## Effective Range of Built-in Flash

(Approx. in meters/feet)

ISO Speed (p.112)	EF-S18-135mm f/3.5-5.6 IS STM, EF-S18-55mm f/3.5-5.6 IS STM, EF-S55-250mm f/4-5.6 IS STM, EF-S18-200mm f/3.5-5.6 IS		
	Wide Angle		Telephoto
	f/3.5	f/4	f/5.6
ISO 100	1 - 3.4 / 3.3 - 11.2	1 - 3 / 3.3 - 9.8	1 - 2.1 / 3.3 - 6.9
ISO 400	1 - 6.9 / 3.3 - 22.6	1 - 6 / 3.3 - 19.7	1 - 4.3 / 3.3 - 14.1
ISO 1600	1.7 - 13.7 / 5.6 - 44.9	1.5 - 12 / 4.9 - 39.4	1.1 - 8.6 / 3.6 - 28.2
ISO 6400	3.4 - 27.4 / 11.2 - 89.9	3 - 24 / 9.8 - 78.7	2.1 - 17.1 / 6.9 - 56.1

\* When a high ISO speed is set and focusing distance is long, appropriate exposure may not be obtained depending on the subject conditions, etc.

# 6

## Shooting with the LCD Monitor (Live View Shooting)

You can shoot while viewing the picture on the camera's LCD monitor. This is called "Live View shooting".

- If you handhold the camera and shoot while viewing the LCD monitor, camera shake can cause blurred images. Using a tripod is recommended.





### **Remote Live View Shooting**

With EOS Utility (EOS software, p.166) installed on your computer, you can connect the camera to the computer and shoot remotely while viewing the computer screen. For details, refer to the EOS Utility Instruction Manual (p.168).

## Shooting with the LCD Monitor



### 1 Display the Live View image.

- Press the  button.
- ▶ The Live View image will appear on the LCD monitor. In the  mode, the scene icon for the scene detected by the camera is displayed on the upper left.
- By default, Continuous AF will take effect.
- The Live View image will closely reflect the brightness level of the actual image you capture.



### 2 Focus on the subject.

- When you press the shutter button halfway, the camera will focus with the current AF method (p.137).

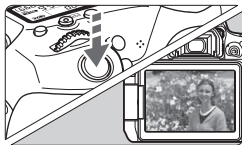

### 3 Take the picture.

- Press the shutter button completely.
- ▶ The picture will be taken and the captured image is displayed on the LCD monitor.
- ▶ When the playback display ends, the camera will return to Live View shooting automatically.
- Press the  button to exit the Live View shooting.



## Enabling Live View Shooting

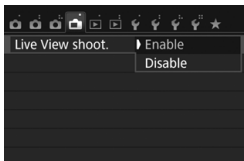

Set [: Live View shoot.] to [Enable].

### Number of Possible Shots with Live View Shooting (Approx. number of shots)

Temperature	Room Temperature (23°C / 73°F)	Low Temperatures (0°C / 32°F)
No Flash	200	170
50% Flash Use	180	150

- The figures above are based on a fully-charged Battery Pack LP-E17 and CIPA (Camera & Imaging Products Association) testing standards.
- With a fully-charged Battery Pack LP-E17, continuous Live View shooting is possible for approx. 1 hr. 30 min. at room temperature (23°C / 73°F).

**Do not hold the camera in the same position for long periods of time.** Even if the camera does not feel too hot, prolonged contact with the same body part may cause skin redness, blistering or low-temperature contact burns. Using a tripod is recommended for people with circulation problems or very sensitive skin, or when using the camera in very hot places.

Do not point the camera toward an intense light source, such as the sun or an intense artificial light source. Doing so may damage the image sensor or the camera's internal components.

## Information Display

- Each time you press the <INFO.> button, the information display will change.

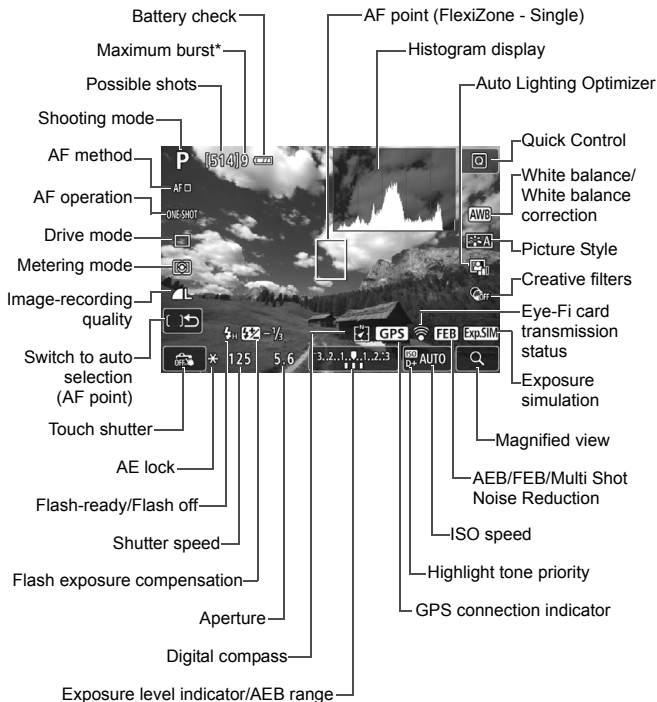

\* The number will be displayed when the maximum burst decreases to nine or lower.

# Changing the Autofocus Operation <sup>☆</sup>

You can select the AF (autofocus) operation characteristics suiting the shooting conditions or subject. In Basic Zone modes, the optimum AF operation is set for the respective shooting mode.

## 1 Press the **<Q>** button.

- ▶ The Quick Control screen will appear.

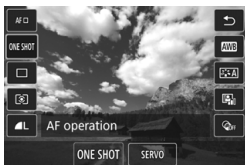

## 2 Select **[ONE SHOT]**.

- Press the **<▲>** **<▼>** keys to select **[ONE SHOT]** (AF operation) on the screen's left side.

## 3 Select the **AF operation**.

- Press the **<◀>** **<▶>** keys to select the desired AF operation, then press **<SET>**.

## 4 **Focus on the subject**

- Aim the AF point over the subject and press the shutter button halfway. The camera will then autofocus in the selected AF operation.

## One-Shot AF for Still Subjects

**Suited for still subjects. When you press the shutter button halfway, the camera will focus only once.**

- When focus is achieved, the AF point will turn green and the beeper will sound.
- While you hold down the shutter button halfway, the focus will be locked. You can then recompose the shot if desired.

## Servo AF for Moving Subjects

**This AF operation is suited for moving subjects. While you hold down the shutter button halfway, the camera will keep focusing on the subject continuously.**

- The exposure is set at the moment the picture is taken.
- The continuous shooting speed becomes slower since the camera keeps focusing and shooting continuously.
- Setting the [AF method] to [FlexiZone - Single] is recommended.
- Depending on the shooting conditions, it may take a moment until the shutter is released.
- Depending on the lens used, the distance to the subject and the subject's speed, the camera may not be able to achieve correct focus.
- If you operate the zoom during continuous shooting, the focus may be lost. Shoot after using the zoom to obtain the desired composition.
- When focus is achieved, the AF point will turn blue.

# Using AF to Focus (AF Method)

## Selecting the AF Method

You can select an AF method to suit the shooting conditions and your subject. The following AF methods are provided: [**☺ (face)+Tracking**], [**FlexiZone - Multi**] (p.138), and [**FlexiZone - Single**] (p.140).

If you want to achieve precise focus, set the lens focus mode switch to <MF>, magnify the image, and focus manually (p.142).

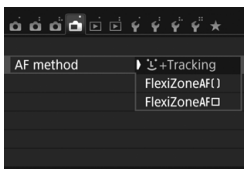

## Select the AF method.

- Under the [**📷**] tab, select [**AF method**].
- Select the desired AF method, then press <ⓈET>.
- While the Live View image is displayed, you can also press the <📷> button to select the AF method on the Quick Control screen.

## ☺ (face)+Tracking: AF ☺

The camera detects and focuses on human faces. If a face moves, the AF point <📷> also moves to track the face.



## 1 Display the Live View image.

- Press the <📷> button.
- ▶ The Live View image will appear on the LCD monitor.

## 2 Select an AF point.

- When a face is detected, the AF point <📷> will appear over the face to be focused on.
- If multiple faces are detected, <📷> will be displayed. Use the <◀> <▶> keys to move the <📷> frame over the face you want to focus on.

- You can also tap on the LCD monitor screen to select the face or subject. If the subject is not a face, <AF> will be displayed.
- If no faces can be detected, or if you tap on the LCD monitor but do not select any face or subject, the camera will switch to **[FlexiZone - Multi]** with automatic selection (p.138).

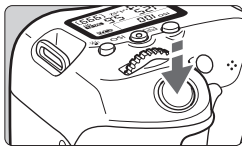

### 3 Focus on the subject.

- Press the shutter button halfway to focus.
- ▶ When focus is achieved, the AF point will turn green and the beeper will sound.
- ▶ If focus is not achieved, the AF point will turn orange.



### 4 Take the picture.

- Check the focus and exposure, then press the shutter button completely to take the picture (p.132).

## FlexiZone - Multi: AF ( )

You can use up to 49 AF points for wide-area focusing (automatic selection). This wide area can also be divided into 9 zones for focusing (zone selection).



Area frame

### 1 Display the Live View image.

- Press the <CAM> button.
- ▶ The Live View image will appear on the LCD monitor.



## 2 Select the AF point. ☆

- Pressing <SET> or the <🗑️> button will toggle between automatic selection and zone selection. In Basic Zone modes, automatic selection is set automatically.
- Use the <▲> <▼> or <◀> <▶> keys to select a zone. To return to the center zone, press <SET> or the <🗑️> button again.
- You can also tap on the LCD monitor screen to select a zone. When a zone is selected, tap [ ] on the screen to switch to automatic selection.

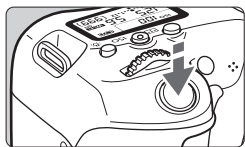

## 3 Focus on the subject.

- Aim the AF point over the subject and press the shutter button halfway.
- ▶ When focus is achieved, the AF point will turn green and the beeper will sound.
- ▶ If focus is not achieved, the area frame will turn orange.



## 4 Take the picture.

- Check the focus and exposure, then press the shutter button completely to take the picture (p.132).

## FlexiZone - Single: AF □

The camera focuses with a single AF point. This is effective when you want to focus on a particular subject.



AF point

### 1 Display the Live View image.

- Press the <img alt="camera icon" data-bbox="598 228 628 248"/> button.
- ▶ The Live View image will appear on the LCD monitor.
- ▶ The AF point <img alt="AF point icon" data-bbox="262 262 292 282"/> will appear.
- During movie shooting, if **[Movie Servo AF]** is set to **[Enable]**, the AF point will be displayed in a larger size.



### 2 Move the AF point.

- Press the <img alt="up arrow" data-bbox="458 433 488 453"/> <img alt="down arrow" data-bbox="518 433 548 453"/> or <img alt="left arrow" data-bbox="458 473 488 493"/> <img alt="right arrow" data-bbox="518 473 548 493"/> keys to move the AF point to where you want to focus. (It cannot go to the edge of the screen.)
- Pressing <img alt="SET button" data-bbox="528 523 558 543"/> or the <img alt="trash icon" data-bbox="528 523 558 543"/> button will return the AF point to the screen's center.
- You can also tap on the LCD monitor screen to move the AF point.

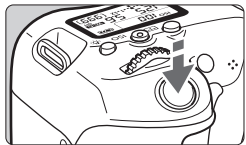

### 3 Focus on the subject.

- Aim the AF point over the subject and press the shutter button halfway.
- ▶ When focus is achieved, the AF point will turn green and the beeper will sound.
- ▶ If focus is not achieved, the AF point will turn orange.



### 4 Take the picture.

- Check the focus and exposure, then press the shutter button completely to take the picture (p.132).



# Shooting with the Touch Shutter

Just by tapping on the LCD monitor screen, you can focus and take the picture automatically. This works in all shooting modes.







## 1 Display the Live View image.

- Press the <> button.
- ▶ The Live View image will appear on the LCD monitor.



## 2 Enable the touch shutter.

- Tap [] on the screen's bottom left. Each time you tap on the icon, it will toggle between [] and [].
- [] (Touch shutter: Enable)  
You can tap on the spot to focus and shoot.
- [] (Touch shutter: Disable)  
You can tap on the spot to select where you want to focus. Press the shutter button completely to take the picture.



## 3 Tap on the screen to shoot.

- Tap on the face or subject on the screen.
- ▶ On the point you tap, the camera will focus in the AF method that was set (p.137-140). When [**FlexiZone - Multi**] is set, it will switch to [**FlexiZone - Single**].
- ▶ When focus is achieved, the AF point turns green and the picture is taken automatically.
- If focus is not achieved, the AF point turns orange and the picture cannot be taken. Tap on the face or subject on the screen again.

# MF: Focusing Manually

You can magnify the image and focus precisely with manual focus.

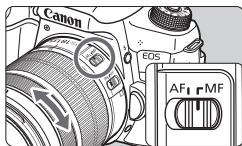

## 1 Set the lens focus mode switch to <MF>.

- Turn the lens focusing ring to focus roughly.

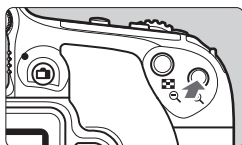

## 2 Display the magnifying frame.

- Press the <Q> button.
- ▶ The magnifying frame will appear.
- You can also tap [Q] on the screen to magnify the image.



## 3 Move the magnifying frame.

- Press the <▲> <▼> or <◀> <▶> keys to move the magnifying frame to the position where you want to focus.
- To return to the screen's center, press <SET> or the <🗑> button.

Magnifying frame

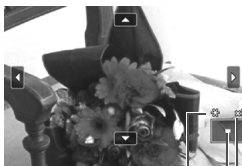

## 4 Magnify the image.

- Each time you press the <Q> button, the magnification of the image will change in the following sequence:

→ 1x → 5x → 10x → Normal view →

AE lock

Magnified area position

Magnification

## 5 Focus manually.

- While looking at the magnified image, turn the lens focusing ring to focus.
- After achieving focus, press the <Ⓚ> button to return to the normal view.

## 6 Take the picture.

- Check the focus and exposure, then press the shutter button to take the picture (p.132).



# 7

## Shooting Movies

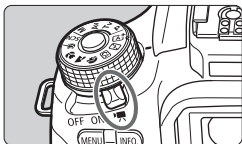

Movie shooting is enabled by setting the power switch to <img alt="movie icon" data-bbox="455 495 485 515"/>. The movie recording format will be MP4.

- For cards that can record movies, see page 7.
- If you handhold the camera and shoot movies, camera shake can cause blurred movies. Using a tripod is recommended.
- To shoot while handholding the camera, see page 74.



### Full HD 1080

Full HD 1080 indicates compatibility with High-Definition featuring 1080 vertical pixels (scanning lines).



# Shooting Movies

Connecting the camera to a TV set is recommended to play back the movies shot.

## Autoexposure Shooting

When the shooting mode is set to any mode other than <M>, autoexposure control will take effect to suit the scene's current brightness.

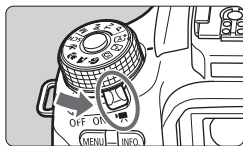

### 1 Set the power switch to <Movie icon>.

- ▶ The reflex mirror will make a sound, then the image will appear on the LCD monitor.

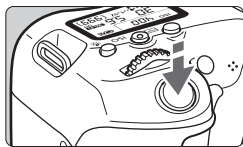

### 2 Set any shooting mode except <M>.

### 3 Focus on the subject.

- Before shooting a movie, focus with AF or manual focus (p.137-140, 142).
- By default, [Movie Servo AF: Enable] is set so that the camera will always focus.



### 4 Shoot the movie.

- Press the <Movie icon> button to start shooting a movie. To stop movie shooting, press <Movie icon> again.
- ▶ While the movie is being shot, the “●” mark will be displayed on the upper right of the screen.
- ▶ Sound will be recorded by the built-in microphones.

Recording movie

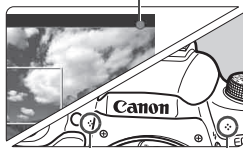

Built-in microphones

## Manual Exposure Shooting

In the <M> mode, you can freely set the shutter speed, aperture, and ISO speed for movie shooting. Using manual exposure to shoot movies is for advanced users.

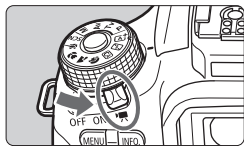

### 1 Set the power switch to <[Movie Icon]>.

- ▶ The reflex mirror will make a sound, then the image will appear on the LCD monitor.



### 2 Set the Mode Dial to <M>.

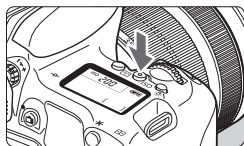

### 3 Set the ISO speed.

- Press the <ISO> button and turn the <[Gear Icon]> or <[Clock Icon]> dial to select the ISO speed.



### 4 Set the shutter speed and aperture.

- To set the shutter speed, turn the <[Gear Icon]> dial. The settable shutter speeds vary depending on the frame rate <[FPS Icon]>.
  - 29.97P 25.00P 23.98P: 1/4000 sec. - 1/30 sec.
  - 59.94P 50.00P: 1/4000 sec. - 1/60 sec.
- To set the aperture, turn the <[Clock Icon]> dial.
- If it cannot be set, set the <[LOCK Icon]> switch to the left, then turn the <[Gear Icon]> or <[Clock Icon]> dial.

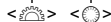

## **5 Focus and shoot the movie.**

- The procedure is the same as steps 3 and 4 for “Autoexposure Shooting” (p.146).



## Information Display

- Each time you press the <INFO.> button, the information display will change.

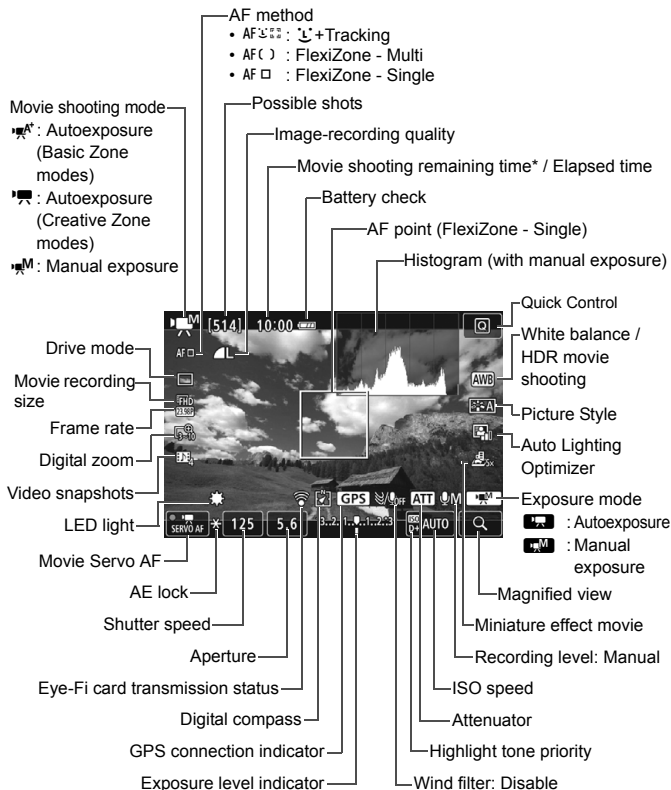

\* Applies to a single movie clip.

## MENU Setting the Movie Recording Size

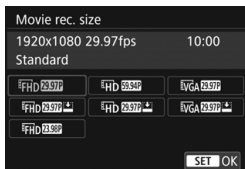

With [**2: Movie rec. size**], you can set the movie recording size (image size, frame rate, and compression method) and other functions.

- **Image Size**

- FHD 1920x1080**

- Full High-Definition (Full HD) recording quality. The aspect ratio is 16:9.

- FHD 1280x720**

- High-Definition (HD) recording quality. The aspect ratio is 16:9.

- EVGA 640x480**

- Standard-definition recording quality. The aspect ratio is 4:3.

- **Frame Rate** (fps: frames per second)

- 29.97P 29.97 fps/59.94P 59.94 fps**

- For areas where the TV format is NTSC (North America, Japan, South Korea, Mexico, etc.).

- 25.00P 25.00 fps/50.00P 50.00 fps**

- For areas where the TV format is PAL (Europe, Russia, China, Australia, etc.).

- 23.98P 23.98 fps**

- Mainly for motion pictures.

- **Compression Method**

- Standard**



- Compresses multiple frames at a time efficiently for recording.

- Light (L)**

- The movie is recorded at a low bit rate for playback on various devices, resulting in a smaller file size than with [**Standard**].

- Therefore, you can shoot longer than with [**Standard**].

**Total Movie Recording Time and File Size Per Minute** (Approx.)

Movie Recording Size			Total Recording Time on Card			File Size
			4 GB	8 GB	16 GB	
 [1920x1080]	29.97P 25.00P 23.98P	Standard	17 min.	35 min.	1 hr. 10 min.	216 MB/min.
	29.97P 25.00P	Light	43 min.	1 hr. 26 min.	2 hr. 53 min.	87 MB/min.
 [1280x720]	59.94P 50.00P	Standard	20 min.	40 min.	1 hr. 21 min.	187 MB/min.
	29.97P 25.00P	Light	2 hr. 5 min.	4 hr. 10 min.	8 hr. 20 min.	30 MB/min.
 [640x480]	29.97P 25.00P	Standard	57 min.	1 hr. 55 min.	3 hr. 50 min.	66 MB/min.
	29.97P 25.00P	Light	2 hr. 43 min.	5 hr. 26 min.	10 hr. 53 min.	23 MB/min.
HDR Movie Shooting [1280x720]			40 min.	1 hr. 20 min.	2 hr. 40 min.	94 MB/min.

● **Movie Files Exceeding 4 GB**

Even if you shoot a movie exceeding 4 GB, you can keep shooting without interruption.

During movie shooting, approx. 30 sec. before the movie reaches the 4 GB file size, the elapsed shooting time displayed in the movie shooting screen will start blinking. If you keep shooting until the movie file size exceeds 4 GB, a new movie file will be created automatically and the elapsed shooting time or time code will stop blinking.

When you play back the movie, you will have to play each movie file individually. Movie files cannot be played back automatically in consecutive order. After the movie playback ends, select the next movie to be played back.

● **Movie Shooting Time Limit**

The maximum recording time of one movie clip is 29 min. 59 sec. If the movie shooting time reaches 29 min. 59 sec., the movie shooting will stop automatically. You can start shooting a movie again by pressing the <  > button. (A new movie file starts being recorded.)

 **Do not hold the camera in the same position for long periods of time.** Even if the camera does not feel too hot, prolonged contact with the same body part may cause skin redness, blistering or low-temperature contact burns. Using a tripod is recommended for people with circulation problems or very sensitive skin, or when using the camera in very hot places.

# 8

## Image Playback

---

This chapter explains basic procedures to play back images and movies.

### **Images shot and saved with another device**

The camera may not be able to properly display images captured with a different camera, edited with a computer, or that have had their file names changed.

## ▶ Searching for Images Quickly

### ▣ Displaying Multiple Images on One Screen (Index Display)

Search for images quickly with the index display showing 4, 9, 36, or 100 images on one screen.



#### 1 Play back the image.

- When you press the <▶> button, the last image captured will be displayed.



#### 2 Switch to the index display.

- Press the <▣> button.
- ▶ The 4-image index display will appear. The selected image is highlighted with an orange frame.
- Pressing the <▣> button will switch the display as follows: 9 images → 36 images → 100 images.
- Pressing the <◂> button will switch the display as follows: 100 images → 36 images → 9 images → 4 images → 1 image.



#### 3 Select an image.



- Turn the <◂> dial to move the orange frame and select the image. You can also press the <▲> <▼> or <◀> <▶> keys to select the image.
- Turning the <◂> dial will display image(s) on the next or previous screen.
- Press <SET> in the index display to display the selected image in the single-image display.

## **Magnified View**

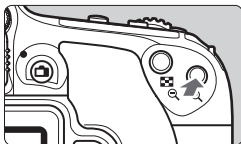
You can magnify a captured image by approx. 1.5x to 10x on the LCD monitor.







### **1 Magnify the image.**

- Press the  button during image playback.
- ▶ The image will be magnified.
- If you hold down the  button, the image will be magnified until it reaches the maximum magnification.
- Press the  button to reduce the magnification. If you hold down the button, the magnification will be reduced to the single-image display.



Magnified area position

### **2 Scroll around the image.**

- Press the   or   keys to scroll the magnified image in the direction pressed.
- To exit magnified view, press the  button and the single-image display will reappear.

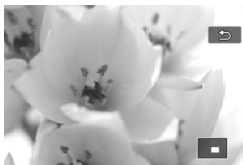



## Playing Back with the Touch Screen

The LCD monitor is a touch-sensitive panel that you can touch with your fingers for various playback operations. **First, press the <▶> button to play back images.**

### Browsing Images



#### Swipe with one finger.

- With single-image display, touch the LCD monitor with **one finger**. You can browse to the next or previous image by swiping your finger to the left or right.

Swipe to the left to see the next (newer) image, or swipe to the right to see the previous (older) image.

- With index display, also touch the LCD monitor with **one finger**. You can browse to the next or previous screen by swiping your finger up or down.

Swipe up to see the next (newer) images or swipe down to see the previous (older) images.

When you select an image, the orange frame will appear. Tap on the image again to display it as a single image.

### Jumping through Images (Jump Display)



#### Swipe with two fingers.

Touch the LCD monitor with **two fingers**. When you swipe two fingers to the left or right, you can jump through images with the method set in [Image jump w/ 



## Reducing Image (Index Display)



### Pinch two fingers.

Touch the screen with two fingers spread apart, and pinch your fingers together on the screen.

- Each time you pinch your fingers, the single-image display will change to the index display.
- When you select an image, the orange frame will appear. Tap on the image again to display it as a single image.

## Magnifying Image



### Spread two fingers apart.

Touch the screen with two fingers together, then spread your fingers apart on the screen.

- As you spread your fingers, the image will be magnified.
- The image can be magnified up to approx. 10x.
- You can scroll around the image by dragging your fingers.
- To reduce the image, pinch your fingers together on the screen.
- Tapping on the [↶] icon will return to the single-image display.

## ▶▶ Playing Back Movies



### 1 Play back the image.

- Press the <▶> button to display an image.

### 2 Select a movie.

- Turn the <⊙> dial to select the movie to be played back.
- In the single-image display, the <SET [▶]> icon displayed on the upper left of the screen indicates a movie. If the movie is a video snapshot, <SET [▶]> will be displayed.
- In the index display, perforations at the left edge of a thumbnail indicate a movie. **As movies cannot be played back from the index display, press <SET> to switch to the single-image display.**



### 3 In the single-image display, press <SET>.

- ▶ The movie playback panel will appear at the bottom of the screen.



### 4 Play back the movie.

- Select [▶] (Play), then press <SET>.
- ▶ The movie will start playing back.
- You can pause the movie playback by pressing <SET>.
- You can adjust the sound volume by turning the <⊙> dial even during movie playback.
- For more details on the playback procedure, see the next page.

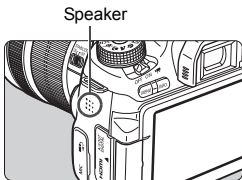

## Movie Playback Panel

Operation	Playback Description
▶ Play	Pressing <SET> toggles between play and stop.
▶ Slow motion	Adjust the slow motion speed by pressing the <◀> <▶> keys. The slow motion speed is indicated on the upper right of the screen.
◀◀ First frame	Displays the movie's first frame.
◀◀ Previous frame	Each time you press <SET>, the previous frame is displayed. If you hold down <SET>, it will rewind the movie.
▶▶ Next frame	Each time you press <SET>, the movie will play frame-by-frame. If you hold down <SET>, it will fast forward the movie.
▶▶ Last frame	Displays the movie's last frame.
🎵 Background music*	Plays back a movie with the selected background music.
✂ Edit	Displays the editing screen.
	Playback position
mm' ss"	Playback time (minutes:seconds)
🔊 Volume	Turn the <🔊> dial to adjust the volume of the built-in speaker (p.158).
MENU ↶	Press the <MENU> button to return to the single-image display.

\* When background music is set, the movie sound will not be played back.

## Playback with the Touch Screen

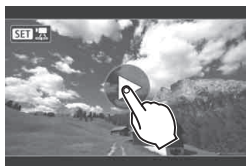

Tap [▶] on the center of the screen.

- ▶ The movie will start playing back.
- To display the movie playback panel, tap <SET ▶▶▶> on the upper left of the screen.
- To pause the movie while it is playing back, tap on the screen. The movie playback panel will also appear.

## Erasing Images

You can either select and erase unnecessary images one by one or erase them in one batch. Protected images will not be erased.

- ⓘ **Once an image is erased, it cannot be recovered. Make sure you no longer need the image before erasing it. To prevent important images from being erased accidentally, protect them. Erasing a RAW+JPEG image will erase both the RAW and JPEG images.**

### Erasing a Single Image



**1 Play back the image to be erased.**

**2 Press the  button.**

- ▶ The Erase menu will appear.



**3 Erase the image.**

- Select [**Erase**], then press . The image displayed will be erased.

# 9

## Viewing the CD-ROM Instruction Manuals / Downloading Images to Your Computer

This chapter explains how to view the Camera Instruction Manual CD-ROM on your computer, download images from the camera to your computer, gives an overview of the software in the EOS DIGITAL Solution Disk (CD-ROM), and explains how to install the software on your computer. It also explains how to view the Software Instruction Manuals.



**Camera Instruction  
Manual**



**EOS DIGITAL Solution Disk**  
(Software/Software Instruction Manuals)

# Viewing the Camera Instruction Manual CD-ROM ■



The Camera Instruction Manual CD-ROM contains instruction manuals (PDF files) related to this product.

## Viewing the Camera Instruction Manual CD-ROM

To view the instruction manuals (PDF files), Adobe Reader 6.0 or higher must be installed on your computer. Adobe Reader can be downloaded free from the Internet. After installing Adobe Reader, follow the procedure below.

**1 Insert the “CAMERA INSTRUCTION MANUAL” CD-ROM into your computer.**



**2 Double-click the CD-ROM.**

- With Windows, double-click on the CD-ROM icon in [(My) Computer]. With Macintosh, double-click on the CD-ROM icon on the desktop.
- The icon displayed will differ depending on your computer's operating system.



**3 Double-click the START file.**

- The icon displayed will differ depending on your computer's operating system.

**4 Click your language.**

**5 Click the instruction manual you want to read.**

▶ The manual will be displayed.



- You can save the PDF file to your computer.
- To learn how to use Adobe Reader, refer to Adobe Reader's Help section.

# Downloading Images to a Computer

You can use the EOS software to download the images in the camera to your computer. There are two ways to do this.

## Downloading by Connecting the Camera to the Computer

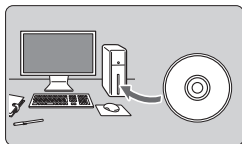

**1** Install the software (p.167).

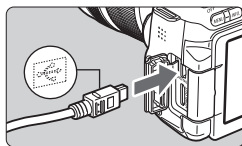

**2** Use the provided interface cable to connect the camera to your computer.

- Use the interface cable provided with the camera.
- Connect the cable to the camera's digital terminal with the cable plug's <↔> icon facing the front of the camera.
- Connect the cord's plug to the computer's USB terminal.

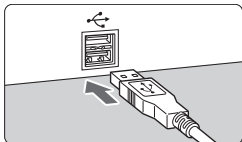

**3** Use EOS Utility to download the images.

- Refer to the EOS Utility Instruction Manual (p.168).

**!** If [**Wi-Fi/NFC**] is set to [**Enable**], the camera cannot be connected to a computer. Set [**Wi-Fi/NFC**] to [**Disable**], then reconnect the camera to a computer with an interface cable.



## Downloading Images with a Card Reader

You can also use a card reader to download images to your computer.

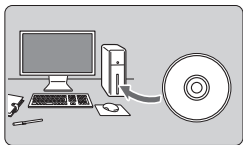

**1 Install the software** (p.167).

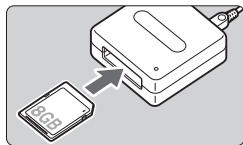

**2 Insert the card into the card reader.**

**3 Use Digital Photo Professional to download the images.**

- Refer to the Digital Photo Professional Instruction Manual (p.168).



When downloading images from the camera to your computer with a card reader without using EOS software, copy the DCIM folder on the card to your computer.

# Software Overview



## **EOS DIGITAL Solution Disk**

Various software for EOS DIGITAL cameras are contained on the EOS DIGITAL Solution Disk.

### **EOS Utility**

With the camera connected to a computer, EOS Utility enables you to transfer still photos and movies shot with the camera to the computer. You can use this software to set various camera settings and shoot remotely from the computer connected to the camera. Also, you can copy background music tracks, such as EOS Sample Music\*, to the card.

\* You can use the background music as the soundtrack for a video snapshot album, movie, or slide show played back with your camera.

### **Digital Photo Professional**

This software is recommended for users who shoot RAW images. You can view, edit, and print RAW images and JPEG images.

\* Some functions differ between the version to be installed on a 64-bit computer and that to be installed on a 32-bit computer.

### **Picture Style Editor**

You can edit Picture Styles, and create and save original Picture Style files. This software is aimed at advanced users who are experienced in processing images.

## Installing the Software



- **Do not connect the camera to your computer before you install the software. The software will not be installed correctly.**
- If a previous version is installed, follow the steps below to reinstall the software. (The newer version will overwrite the previous version.)

- 1 Insert the EOS DIGITAL Solution Disk into your computer.**
  - For Macintosh, double-click to open the CD-ROM icon displayed on the desktop, then double-click on [setup].
- 2 Click [Easy Installation] and follow the on-screen instructions to install.**
- 3 Remove the CD-ROM after the installation is complete.**

# Software Instruction Manual



Software Instruction Manuals are contained on the EOS DIGITAL Solution Disk. You can copy and view the software instruction manual (PDF files) as follows:

**1 Insert the EOS DIGITAL Solution Disk into your computer.**

**2 Close the install screen.**

- When the EOS DIGITAL Solution Disk install screen appears, close the install screen.

**3 Open the CD-ROM.**

**4 Open the [Manual] folder.**

**5 Copy the [English] folder to your computer.**

- Instruction Manual PDFs with the names below are copied.

	Windows	Macintosh
EOS Utility	EUx.xW_E_xx	EUx.xM_E_xx
Digital Photo Professional	DPPx.xW_E_xx	DPPx.xM_E_xx
Picture Style Editor	PSEx.xW_E_xx	PSEx.xM_E_xx

**6 Double-click the copied PDF file.**

- Adobe Reader (most recent version recommended) must be installed on your computer.
- Adobe Reader can be downloaded free from the Internet.

---

## Trademarks

- Adobe is a trademark of Adobe Systems Incorporated.
- Microsoft and Windows are trademarks or registered trademarks of Microsoft Corporation in the United States and/or other countries.
- Macintosh and Mac OS are trademarks of Apple Inc., registered in the U.S. and other countries.
- SDXC logo is a trademark of SD-3C, LLC.
- HDMI, HDMI logo, and High-Definition Multimedia Interface are trademarks or registered trademarks of HDMI Licensing LLC.
- All other trademarks are the property of their respective owners.

## About MPEG-4 Licensing

"This product is licensed under AT&T patents for the MPEG-4 standard and may be used for encoding MPEG-4 compliant video and/or decoding MPEG-4 compliant video that was encoded only (1) for a personal and non-commercial purpose or (2) by a video provider licensed under the AT&T patents to provide MPEG-4 compliant video. No license is granted or implied for any other use for MPEG-4 standard."

\* Notice displayed in English as required.

---

### **Use of genuine Canon accessories is recommended**

This product is designed to achieve excellent performance when used with genuine Canon accessories.

Canon shall not be liable for any damage to this product and/or accidents such as fire, etc., caused by the malfunction of non-genuine Canon accessories (e.g., a leakage and/or explosion of a battery pack). Please note that this warranty does not apply to repairs arising out of the malfunction of non-genuine Canon accessories, although you may request such repairs on a chargeable basis.

## **Digital Camera Model DS126481 Systems**

This device complies with Part 15 of the FCC Rules. Operation is subject to the following two conditions: (1) This device may not cause harmful interference, and (2) this device must accept any interference received, including interference that may cause undesired operation.

**Note:** This equipment has been tested and found to comply with the limits for class B digital devices, pursuant to Part 15 of the FCC Rules. These limits are designed to provide reasonable protection against harmful interference in a residential installation. This equipment generates, uses and can radiate radio frequency energy and, if not installed and used in accordance with the instructions, may cause harmful interference to radio communications. However, there is no guarantee that interference will not occur in a particular installation. If this equipment does cause harmful interference to radio or television reception, which can be determined by turning the equipment off and on, the user is encouraged to try to correct the interference by one or more of the following measures:

- Reorient or relocate the receiving antenna.
- Increase the separation between the equipment and receiver.
- Connect the equipment into an outlet on a circuit different from that to which the receiver is connected.
- Consult the dealer or an experienced radio/TV technician for help.

The cable with the ferrite core provided with the digital camera must be used with this equipment in order to comply with Class B limits in Subpart B of Part 15 of the FCC rules.

Do not make any changes or modifications to the equipment unless otherwise specified in the manual. If such changes or modifications should be made, you could be required to stop operation of the equipment.

Canon U.S.A. Inc.  
One Canon Park, Melville, NY 11747, U.S.A.  
Tel No. 1-800-OK-CANON (1-800-652-2666)

CAN ICES-3 (B) / NMB-3 (B)



USA and Canada only:

The Lithium ion/polymer battery that powers the product is recyclable. Please call 1-800-8-BATTERY for information on how to recycle this battery.

For CA, USA only

Included lithium battery contains Perchlorate Material – special handling may apply. See [www.dtsc.ca.gov/hazardouswaste/perchlorate/](http://www.dtsc.ca.gov/hazardouswaste/perchlorate/) for details.

### **CAUTION**

RISK OF EXPLOSION IF BATTERY IS REPLACED BY AN INCORRECT TYPE.  
DISPOSE OF USED BATTERIES ACCORDING TO LOCAL REGULATION.







# Canon

**EOS** **EOS**  
***REBEL T6s*** **760D**

**EOS REBEL T6S (W)**

**EOS 760D (W)**

## **Wi-Fi/NFC Function Basic Instruction Manual**

In the Wi-Fi/NFC Function Basic Instruction Manual, basic operation procedures for easy-to-use “Connect to a smartphone”, “Transfer images between cameras”, and “Save images to Connect Station” are explained.

# Introduction

## What You Can Do Using the Wireless LAN Functions

This camera's wireless LAN functions let you perform a range of tasks wirelessly, from sending images to Web services and other cameras to controlling the camera remotely, simply by connecting to a Wi-Fi® network or other device supporting this camera's wireless LAN functions.

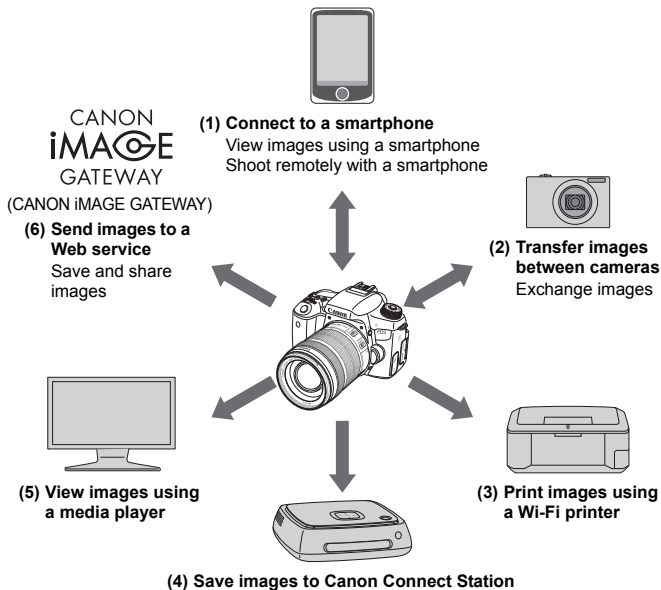

\* For the procedures to use functions (3), (5), and (6) or to connect via an access point for function (1), refer to the "Wi-Fi/NFC Function Instruction Manual" PDF file included in the CD-ROM.

- CANON iMAGE GATEWAY Web services are not supported in certain countries and areas. For information on countries and areas supporting CANON iMAGE GATEWAY services, refer to the Canon Web site (<http://www.canon.com/cig>).
- Settings for "Send images to a Web service" may not be performed from a computer in certain countries and areas.

**(1)  Connect to a smartphone** (p.W-17)

View saved images or operate the camera from a Wi-Fi-enabled smartphone or tablet. Install the dedicated application “Camera Connect” to use these functions.

In this manual and on the camera’s LCD monitor, “smartphone” refers to smartphones and tablets.

**(2)  Transfer images between cameras** (p.W-35)

Transfer images between this camera and other Canon cameras with built-in wireless LAN functions.

**(3)  Print images using a Wi-Fi printer** (CD-ROM)

Connect the camera to a wireless LAN compatible printer supporting PictBridge (Wireless LAN) to print images wirelessly.

**(4) Save images to Connect Station** (p.W-43)

Connect the camera to Connect Station (sold separately) via a wireless LAN to save images.

**(5)  View images using a media player** (CD-ROM)

View images on the camera’s memory card on your TV set, by using a media player supporting DLNA\* via a wireless LAN.

\* Digital Living Network Alliance

**(6)  Send images to a Web service** (CD-ROM)

Share images with family and friends or share images using a range of Web services via CANON iMAGE GATEWAY, an online photo service for Canon users (free registration required).

**Easy Connection Using the NFC Function**

This camera supports NFC which enables you to set up a connection between the camera and a smartphone or Connect Station (sold separately) easily. For details, see page W-11.

# Conventions Used in this Manual

- In this manual, the term “wireless LAN” is used as a general term for Wi-Fi and Canon’s original wireless communication functions.
- Brackets [ ] indicate button names, icon names, or other software elements displayed on the computer or other device’s screen. Brackets also indicate camera menu items.
- The \*\* (numbers) for “(p.\*\*)” in this manual indicate reference page numbers for more information.
- Sections of this manual labeled with the following symbols contain particular types of information as described below.

: Warnings to prevent potential problems during operation.

: Supplemental information.

## Trademarks

- Microsoft and Windows are trademarks or registered trademarks of Microsoft Corporation in the United States and/or other countries.
- Macintosh and Mac OS are trademarks of Apple Inc., registered in the U.S. and other countries.
- Wi-Fi is a registered trademark of the Wi-Fi Alliance.
- Wi-Fi Certified, WPA, WPA2, and the Wi-Fi Certified logo are trademarks of the Wi-Fi Alliance.
- WPS used on camera settings screens and in this manual stands for Wi-Fi Protected Setup.
- UPnP is a trademark of the UPnP Implementers Corporation.
- The N-Mark is a trademark or registered trademark of NFC Forum, Inc. in the United States and in other countries.
- All other trademarks are the property of their respective owners.

- Note that Canon cannot be held liable for any loss or damage from erroneous wireless LAN settings for using the camera. In addition, Canon cannot be held liable for any other loss or damage caused by use of the camera.
- When using Wi-Fi functions, establish appropriate security at your own risk and discretion. Canon cannot be held liable for any loss or damage caused by unauthorized access or other security breaches.

# Chapters

	<b>Introduction</b>	W-2
<b>1</b>	<b>Basic Operation and Settings</b>	W-7
<b>2</b>	<b>Registering a Nickname</b>	W-13
<b>3</b>	<b>Easy Connection to a Smartphone</b>	W-17
<b>4</b>	<b>Transferring Images Between Cameras</b>	W-35
<b>5</b>	<b>Easy Connection to Connect Station</b>	W-43

# Contents

<b>Introduction</b>	<b>W-2</b>
What You Can Do Using the Wireless LAN Functions .....	W-2
Conventions Used in this Manual .....	W-4
Chapters .....	W-5
Contents .....	W-6
<b>1 Basic Operation and Settings</b>	<b>W-7</b>
Basic Operation and Settings .....	W-8
<b>2 Registering a Nickname</b>	<b>W-13</b>
Registering a Nickname .....	W-14
<b>3 Easy Connection to a Smartphone</b>	<b>W-17</b>
Preparation .....	W-18
Connecting with the NFC Function .....	W-20
Using Camera Access Point Mode to Establish a Connection ...	W-23
Operating the Camera Using a Smartphone .....	W-27
Reconnecting .....	W-29
Easy Image Transfer Using the NFC Function .....	W-31
<b>4 Transferring Images Between Cameras</b>	<b>W-35</b>
Selecting the Connection Destination .....	W-36
Sending Images .....	W-38
Reconnecting .....	W-42
<b>5 Easy Connection to Connect Station</b>	<b>W-43</b>
Saving Images .....	W-44
Wi-Fi (Wireless LAN) Precautions .....	W-47



# 1

## Basic Operation and Settings

---

This chapter describes the basic operation and settings necessary for using the camera's wireless LAN functions.

# Basic Operation and Settings

The basic operation for setting the camera's wireless LAN functions is explained here. Follow the procedures below.

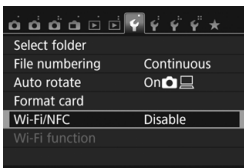

## 1 Select [Wi-Fi/NFC].

- Under the [**1**] tab, select [**Wi-Fi/NFC**], then press <SET>.

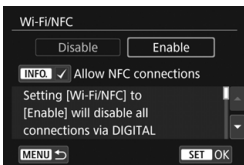

## 2 Select [Enable].

- Press the <▶> key to select [**Enable**], then press <SET>.
- **When this setting is selected for the first time, a screen to register a nickname (for identification) is displayed.** See page W-14 to register a nickname.
- ▶ [**Wi-Fi function**] under the [**1**] tab is now selectable.
- When it is set to [**Enable**], all connections via the DIGITAL and HDMI terminals will be disabled. [**Eye-Fi trans.**] will be set to [**Disable**].

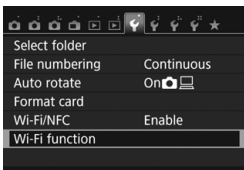

## 3 Select [Wi-Fi function].

- Under the [**1**] tab, select [**Wi-Fi function**], then press <SET>.

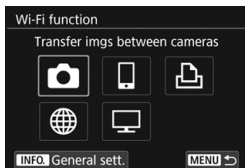

## 4 Select the Wi-Fi function to connect to.

- Press the <▲> <▼> or <◀> <▶> keys to select an item.
- The camera's wireless LAN settings are set from this screen. For further connection settings, see “Easy Connection” or “Advanced Connection”.

### [Wi-Fi/NFC]

- When it is set to **[Disable]**, you cannot select **[Wi-Fi function]** under the **[1]** tab.
- When using the NFC function, set **[Wi-Fi/NFC]** to **[Enable]**, then add **[✓]** to **[Allow NFC connections]**. Press the <INFO.> button to add or remove **[✓]**.
- When the use of electronic devices and wireless devices is prohibited, such as on board airplanes or in hospitals, set it to **[Disable]**.
- When it is set to **[Enable]**, you cannot use the camera by connecting it to a Connect Station, computer, printer, GPS receiver, TV set, or other device with a cable (p.W-12).

### Using the Camera While Wireless LAN Functions Are Active

When you want to prioritize wireless LAN functions, do not operate the power switch, Mode Dial, card slot cover, or battery compartment cover. Otherwise, shooting or playback operation may be prioritized and wireless LAN functions may be terminated during the process.

## Auto Power Off

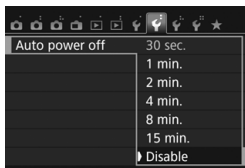

- If necessary, set **[Auto power off]** under the **[F2]** tab to **[Disable]**.
- If the camera's auto power off is activated during the wireless LAN connection, the connection will be terminated.

## Wireless LAN Connection Status

Wireless LAN connection status can be checked on the camera's LCD panel.

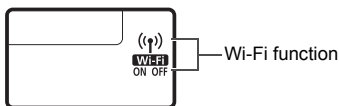

Connection Status	Wi-Fi Function Display
Not connected	(Off)
	Wi-Fi OFF
Connected/Sending data/ Receiving data	(Wi-Fi symbol)
	Wi-Fi ON
Waiting for connection/Waiting for reconnection	(Wi-Fi symbol) (Blinking)
	Wi-Fi ON
Connection error	(Wi-Fi symbol) (Blinking)
	Wi-Fi ON (Blinking)

## Touch Control

You can operate wireless LAN functions by touching the camera's screen as well.

## What You Can Do Using the NFC Function

Using the camera's NFC function enables you to do the following:

- Touch an NFC-enabled smartphone to the camera to connect them easily via a wireless LAN (p.W-20).
- While playing back images on the camera, touch an NFC-enabled smartphone to the camera to send a captured image to the smartphone (p.W-31).
- Hold the camera close to the Canon Connect Station (sold separately) to connect them easily via a wireless LAN (p.W-44).



With this camera, you cannot connect to other NFC-enabled cameras or printers using the NFC function.





### What is NFC?

NFC (Near Field Communication) is a function that can exchange information by simply bringing two NFC-enabled devices close together. This camera uses the NFC function to exchange information regarding wireless LAN connection.

## Cable Connection Cautions

- When [**1: Wi-Fi/NFC**] is set to [**Enable**], connection via interface cable, stereo AV cable, or HDMI cable is disabled. Set [**1: Wi-Fi/NFC**] to [**Disable**] before connecting a cable.
- When the camera is connected to a Connect Station, computer, printer, GPS receiver, TV set, or any other device with an interface cable, settings for [**Wi-Fi/NFC**] cannot be changed. Disconnect the interface cable before changing any settings.

### Cards

- If there is no card in the camera, it cannot be connected to a wireless LAN. Additionally, the camera cannot be connected to a wireless LAN to use the Wi-Fi functions [], [], or [] unless the card has images saved on it.

### Using an Eye-Fi Card

- When [**1: Wi-Fi/NFC**] is set to [**Enable**], image transfer using an Eye-Fi card is disabled.

# 2

## Registering a Nickname

---

This chapter describes how to set the camera's nickname (for identification).

# Registering a Nickname

Before setting up a connection, set the camera's nickname (for identification).

When the camera is connected to another device via a wireless LAN, the nickname will be displayed on the device. **Be sure to set a nickname as otherwise you cannot go to the wireless LAN settings screen.**

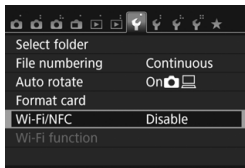

## 1 Select [Wi-Fi/NFC].

- Under the [**Wi-Fi/NFC**] tab, select [**Wi-Fi/NFC**], then press <SET>.

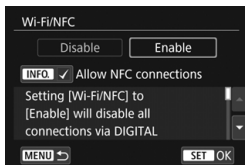

## 2 Select [Enable].

- Press the <▶> key to select [**Enable**], then press <SET>.

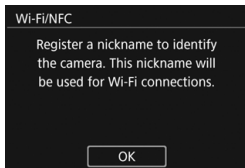

- ▶ When this setting is selected for the first time, a screen to register a nickname is displayed. Select [**OK**] and proceed on to step 3.





### 3 Enter a nickname.

- For instructions on entering characters, see “Virtual Keyboard Operation” on the next page.
- Enter any characters between 1 to 14 characters in length.

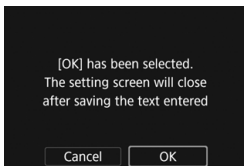

### 4 Exit the setting.

- When you are finished, press the <MENU> button.
- Select [OK] on the confirmation dialog and press <SET> to return to the menu screen.



The nickname can be changed later from the [General sett.] screen.

## Virtual Keyboard Operation



- **Changing the entry area**  
Press the <[Q]> button to toggle between the top and bottom entry areas.
- **Moving the cursor**  
Press the <◀> <▶> keys in the top area to move the cursor.
- **Entering text**  
In the bottom area, press the <▲> <▼> or <◀> <▶> keys to select a character, then press <[SET]> to enter it.  
You can check how many characters you have entered, and how many more can be entered, by referring to [\*/] on the upper right of the screen.
- **Changing the entry mode\***  
Select [Aa=1@] at the bottom right of the bottom entry area. Each time you press <[SET]>, the entry mode will change as follows: Lower case → Numerals / Symbols 1 → Numerals / Symbols 2 → Upper case.  
\* When [Touch control: Disable] is set, you can enter all characters on one screen.
- **Deleting a character**  
Press the <[ ]> button to delete one character.
- **Finishing the text entry**  
Press the <[MENU]> button to confirm what you have entered and exit. If a confirmation dialog is displayed, select [OK] to exit.
- **Canceling the text entry**  
Press the <[INFO]> button to cancel text entry and exit. If a confirmation dialog is displayed, select [OK] to exit.

# 3

## Easy Connection to a Smartphone

Connecting the camera to a smartphone enables you to do the following:

- View or manage images stored in the camera with the smartphone.
- Receive images stored in the camera with the smartphone.
- Operate the camera with the smartphone and take a picture.



The camera cannot be connected to a smartphone when the power switch is set to <img alt="Smartphone icon" data-bbox="395 932 415 948"/>.>.

# Preparation

## Install Camera Connect on a Smartphone



To communicate with a smartphone, the dedicated smartphone application Camera Connect (free of charge) is necessary.

- Camera Connect can be downloaded from the App Store or Google Play. Install Camera Connect on the smartphone and then perform the procedures to establish the connection.
- To use Camera Connect, a smartphone on which iOS or Android installed is necessary. For information on supported operating systems, refer to the download site of Camera Connect.
- When an NFC-enabled smartphone on which Camera Connect is not installed is touched to the camera, the download screen of Camera Connect will be displayed on the smartphone.
- Interface or functions of Camera Connect are subject to change, for application improvement or update. In such a case, features of Camera Connect may differ from sample screens or operation instructions in this manual.

## Connection Method

When using an Android smartphone, check if it is NFC-enabled.

- **When the smartphone is NFC-enabled: See p.W-20**  
You can easily set up a connection using the NFC function.
- **When the smartphone is not NFC-enabled: See p.W-23**  
Set up a connection in camera access point mode.

Smartphones labeled with the  mark are NFC-enabled. Some smartphones are not labeled with the  mark even if they are NFC-enabled; if you do not know whether your smartphone is NFC-enabled, contact the manufacturer of the smartphone.

# Connecting with the NFC Function

Connect the camera and a smartphone using the NFC function.  
The operation flow for connecting via NFC is as follows.

- (1) Turn on the camera and smartphone.
  - (2) Enable the NFC function on the camera and smartphone.
  - (3) Touch the smartphone to the camera so that they come into contact with each other (p.W-21).
- For the smartphone's NFC setting and its NFC antenna position, refer to the smartphone's instruction manual.
  - For the camera's NFC setting, follow the steps below.

## NFC Setting on the Camera

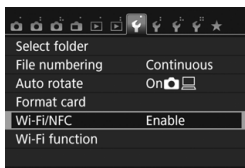

### 1 Select [Wi-Fi/NFC].

- Under the [**1**] tab, select [**Wi-Fi/NFC**], then press <SET>.

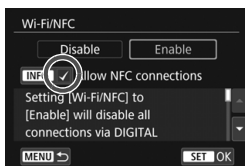

### 2 Add [✓] to [Allow NFC connections].

- Displayed when [**Wi-Fi/NFC**] is set to [**Enable**].
- Press the <INFO.> button to add or remove [✓]. With [✓] added, press <SET>.
- When this setting is selected for the first time, a screen to register a nickname (for identification) is displayed (p.W-14).
- For procedures to send images to a smartphone, see page W-31.

 When the smartphone is not NFC-enabled, see page W-23.

## Connecting to a Smartphone



### 1 Touch a smartphone to the camera.

- If an image is being played back on the camera, end the playback.
- Touch the **N** mark on the smartphone to that on the camera.

- **When a message indicating the connection is displayed on the camera's LCD monitor**, move the smartphone away from the camera.
- ▶ Camera Connect starts on the smartphone and establishes a connection.
- ▶ When the operation on the camera is completed in step 2, the Camera Connect Main window will appear.



The device name set on Camera Connect

### 2 Save the settings.

- When a connection is established, the screen on the left will appear on the camera's LCD monitor. When connection settings are already saved, this screen will not appear and the LCD monitor will turn off.
- Press the <▶> key to select [OK], then press <SET>.
- ▶ After a message is displayed, the camera's LCD monitor will turn off.

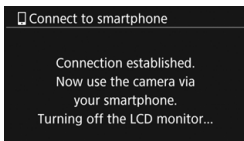

You can check or change the device name on the setting screen of Camera Connect.

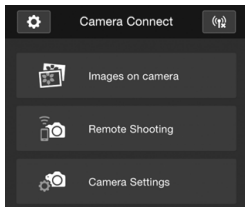



### 3 Operate the Camera using Camera Connect.

- Perform further operations using Camera Connect. For the operation procedure, see page W-27.

The settings for communicating with a smartphone are now complete.

#### NFC Function Cautions

- When touching the smartphone to the camera, be careful not to drop the camera or smartphone.
- Do not touch the smartphone to the camera with too much force. Doing so can scratch the camera or smartphone.
- Just holding the smartphone close to the mark may not establish a connection. Be sure to touch the mark with the smartphone so that they come into contact with each other.
- Recognition may be difficult depending on the smartphone. Touch slowly while changing the position or angle.
- Another application on the smartphone may start depending on how you touch. Check the position of the  mark, then touch again.
- A connection cannot be established via the NFC function while shooting with the camera, when the power switch is set to , when there is no card, or when the LCD monitor is closed with the screen facing inward.
- When touching the smartphone to the camera, do not leave anything between the camera and smartphone. In addition, when a case is attached to the camera or smartphone, communication may not be possible via NFC function.
- When Battery Grip BG-E18 (sold separately) is attached, a connection cannot be established via the NFC function.

-  The camera cannot be connected to two or more smartphones at the same time.
- By default, the connection settings via the NFC function are saved as the fourth setting (a setting dedicated to NFC connection) under the name **[SET4(NFC)]**. When you connect the camera to another smartphone via NFC, **[SET4(NFC)]** will be overwritten.
- A connection can be established even when the camera's power is in the auto power off state. However, if a connection cannot be established, cancel auto power off, then establish a connection.



# Using Camera Access Point Mode to Establish a Connection

Smartphones that are not NFC-enabled can be connected in camera access point mode.

To establish connection, operations on the smartphone are required. For details, refer to the smartphone's instruction manual.

## Operation on the Camera-1

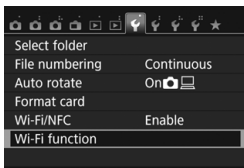

### 1 Select [Wi-Fi function].

- Under the [**1**] tab, set [Wi-Fi/NFC] to [Enable], then select [Wi-Fi function].



### 2 Select [].

- Select [] (Connect to smartphone) and press <SET>.

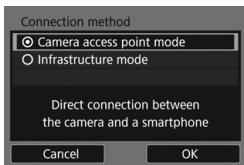

### 3 Select [Camera access point mode].

- Press the <▲> <▼> keys to select [Camera access point mode], then press <SET>.
- Select [OK] and press <SET> to go to the next screen.

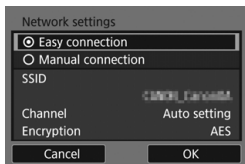

#### 4 Select [Easy connection].

- Press the <▲> <▼> keys to select [Easy connection], then press <SET>.
- Select [OK] and press <SET> to go to the next screen.

### Operation on the Smartphone-1

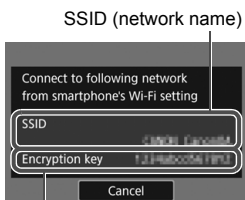

#### 5 Operate the smartphone and connect it to the camera.

- Activate the smartphone's Wi-Fi function, then select the SSID (network name) displayed on the camera's LCD monitor.
- For the password, enter the encryption key displayed on the camera's LCD monitor.

When connected by selecting [Easy connection] in camera access point mode, “\_Canon0A” is appended to the SSID of the camera.

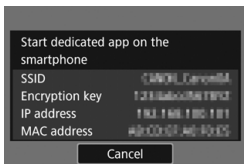

## 6 Start Camera Connect on the smartphone.

- When the smartphone's Wi-Fi settings are completed, start Camera Connect.

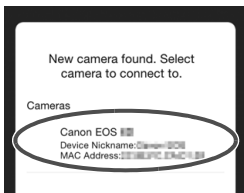

## 7 Select the camera to connect to on the smartphone.

- Select and touch the camera to connect to from [Cameras] on Camera Connect to establish a connection.
- ▶ When the operation on the camera is completed in step 8 on the next page, the Camera Connect Main window will appear.

## Operation on the Camera-2



The device name set on  
Camera Connect

### 8 Connect to the camera.

- When a connection is established, the screen on the left will appear on the camera's LCD monitor.
- Press the <▶> key to select [OK], then press <SET>.

▶ After a message is displayed, the camera's LCD monitor will turn off.

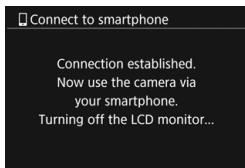

## Operation on the Smartphone-2

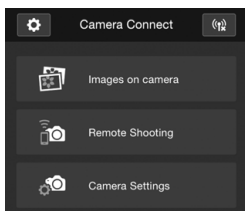

### 9 Operate the camera using Camera Connect.

- Perform further operations using Camera Connect. For the operation procedure, see page W-27.

The settings for communicating with a smartphone are now complete.

 You can check or change the device name on the setting screen of Camera Connect.

# Operating the Camera Using a Smartphone ■

You can use a smartphone with Camera Connect installed to view images stored in the camera and shoot remotely.

---

## Camera Connect Main Window

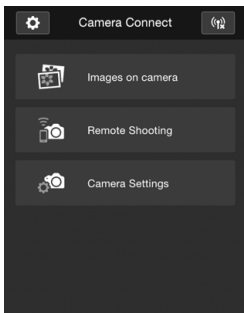

The main functions of Camera Connect are described below. Touch the screen to learn the operation procedures.

### [Images on camera]

- Images stored in the camera can be viewed.
- Images stored in the camera can be saved on a smartphone.
- Operations such as deletion can be performed on images stored in the camera.

### [Remote Shooting]

- The camera's Live View image can be viewed using a smartphone.
- You can shoot using remote operation.

### [Camera Settings]

- Camera settings can be changed.

### ⚙ (Settings button)

- Use this button to access various settings for Camera Connect.

## Terminating the Connection

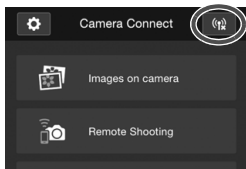

To terminate the connection, perform either of the following operations.

- Tap [] on the Camera Connect screen.
- Set the camera's power to <OFF>.

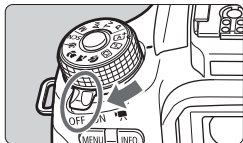

- While connected, a picture cannot be taken even if the camera's shutter button is pressed.
- In remote shooting, the AF speed may become slower.
- Depending on the connection status, image display or shutter release may become slower than usual.

- The connection will also be terminated if you set the power switch to <>, turn the Mode Dial, or open the card slot/battery compartment cover.
- When saving RAW images to a smartphone, they are saved as JPEG images.
- While connected, the camera's auto power off does not function.
- While connected, disabling the smartphone's power saving function is recommended.

# Reconnecting

The camera can reconnect to a smartphone for which connection settings have been registered.

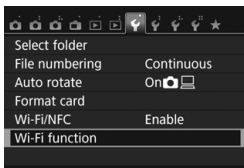

## 1 Select [Wi-Fi function].

- Under the [**1**] tab, set [**Wi-Fi/NFC**] to [**Enable**], then select [**Wi-Fi function**].



## 2 Select [**☎**].

- Select [**☎**] (Connect to smartphone) and press < **SET** >.

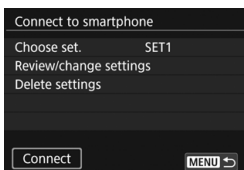

## 3 Establish a connection.

- Select [**Connect**] and press < **SET** >.
- On the confirmation dialog, select [**OK**].
- When settings for multiple connection destinations are registered, select [**Choose set.**], select the connection destination, then connect to the destination.

#### 4 **Activate the smartphone's Wi-Fi function.**

- If the connection destination has been changed, restore the setting to connect to the camera.

#### 5 **Start Camera Connect on the smartphone.**

- A connection will be established.



- If you do not know the SSID of the camera when reconnecting, select [**Review/change settings**] in step 3 to check it.
- With NFC connection or when connected by selecting [**Easy connection**] in camera access point mode, “**\_Canon0A**” is appended to the SSID of the camera.



# Easy Image Transfer Using the NFC Function ■

While playing back images on the camera, touch an NFC-enabled smartphone to the camera to send a captured image to the smartphone.

- If a connection has already been established via a wireless LAN, terminate the connection and then play back images on the camera.
- Set up the camera and smartphone to allow use of their NFC functions in advance (p.W-20).

## Sending Images Individually



### 1 Play back the image.

- Press the <▶> button to play back an image in the single-image display.

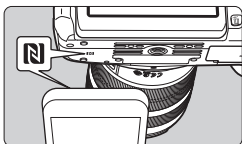

### 2 Touch a smartphone to the camera.

- Touch the **N** mark on the smartphone to that on the camera.
- When a message indicating the connection is displayed on the camera's LCD monitor, move the smartphone away from the camera.



### 3 Select an image to send.

- Turn the <⦿> dial to select an image to send.



**4** Press **<SET>**.

**5** Select **[Send img shown]**.

- Press the **<◀>** **<▶>** keys to select **[Send img shown]**, then press **<SET>**.
- When you select **[Send selected]**, the screen in step 2 on page W-33 is displayed.
  - ▶ The displayed image will be sent.
- When the transfer is complete, the screen for step 3 will reappear. To send another image, select an image and press **<SET>** (p.W-34).



**6** Terminate the connection.

- Press the **<MENU>** button to display the confirmation dialog. Press the **<▶>** key to select **[OK]**, then press **<SET>** to terminate the connection.

## Sending Multiple Images

When the index display is selected in step 1 on page W-31, the image selection screen will appear on the camera after a connection is established.



### 1 Connect the camera to the smartphone.

- Play back images in the index display.
- See step 2 on page W-31 to touch the smartphone to the camera and establish a connection.
- ▶ The image selection screen will appear.



### 2 Select the images to send.

- Turn the <DIAL> dial to select an image to send, then add [✓]. Press <SET> to add or remove [✓].
- By pressing the <Q> button, you can switch to the single-image display and select an image.

### 3 Send the images.

- After selecting the images to send, press the <Q> button to send them.

## Sending Another Image

On the screen to complete the process for sending the image, press **<SET>** to send another image.



- **[Send selected]**  
You can select the images to send in the image selection screen.
- **[Send img shown]**  
Sends the displayed image. Display the image to send in advance.

- **If necessary, also read “NFC Function Cautions” (p.W-22).**
- While connected, a picture cannot be taken even if the camera’s shutter button is pressed.
- Images cannot be sent using the NFC function while the camera is connected to another device via a wireless LAN. In addition, the camera cannot be connected to multiple smartphones at the same time.

- You can cancel the image transfer by selecting **[Cancel]** during the transfer.
- Images larger than S2 are resized to S2 when they are sent. S2 and S3 images are sent without resizing.
- While connected, disabling the smartphone’s power saving function is recommended.
- Settings for easy image transfer using the NFC function are not saved on the camera.

# 4

## Transferring Images Between Cameras

Images can be transferred between Canon cameras via the built-in wireless LAN functions.

- Wireless connection is possible for Canon cameras with built-in wireless LAN functions marketed in 2012 or later. Note that the camera cannot be connected to Canon camcorders, even if they have built-in wireless LAN functions.
- The camera cannot be connected to Canon cameras without built-in wireless LAN functions, even if they support Eye-Fi cards.
- Still photos can be transferred only if their file format is JPEG.
- For movies, a send error may occur or the sent movies may not be played back depending on the target camera's functionality. (Movies cannot be sent to cameras that are not compatible with playback of MP4-format movies.)

# Selecting the Connection Destination

Register the target camera to connect to via a wireless LAN. The camera can be connected to only one camera at a time.

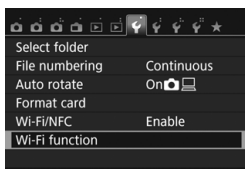

## 1 Select [Wi-Fi function].

- Under the [**1**] tab, set [**Wi-Fi/NFC**] to [**Enable**], then select [**Wi-Fi function**].

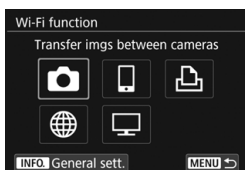

## 2 Select [**📷**].

- Select [**📷**] (Transfer imgs between cameras), then press <SET>.

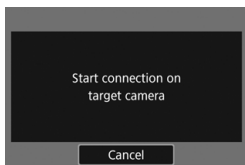

## 3 Start the connection on the target camera.

- When the screen on the left is displayed on the camera, start the connection on the target camera as well. For the operation procedure, refer to the instruction manual of the target camera.
- ▶ When a connection is established, the settings are saved and an image on the card is displayed.



## 4 Select the images to send.

- Select images on the camera sending the images (p.W-38).
- Do not operate the camera receiving the images.

 Note that GPS information is not displayed on the camera's playback screen even if GPS information is appended to the received image. Shooting locations can be viewed on a virtual map, using Map Utility (EOS software).

- 
- The connection settings are saved/registered with the nickname of the camera to which a connection was established.
  - While connected, auto power off does not function.

# Sending Images

## Sending Images Individually

Select and send images individually.



### 1 Select an image to send.

- Turn the <ⓘ> dial to select an image to send, then press <SET>.
- By pressing the <⏏> button, you can switch to the index display and select an image.



### 2 Select [Send img shown].

- To select a size at which to send the image, select [Resize image] and press <SET>.
- Press the <◀> <▶> keys to select [Send img shown], then press <SET>.
- ▶ The transfer progress screen will appear. When the transfer is complete, the screen for step 1 will reappear.
- To send another image, repeat steps 1 and 2.



### 3 Terminate the connection.

- Press the <MENU> button to display the confirmation dialog. Press the <▶> key to select [OK], then press <SET> to terminate the connection.
- ▶ The [Wi-Fi function] screen will reappear.



## Sending Multiple Images

Select multiple images and send them at once.



1 Press **<SET>**.



2 Select **[Send selected]**.

- To select a size at which to send the images, select **[Resize image]** and press **<SET>**.
- Press the **<◀>** **<▶>** keys to select **[Send selected]**, then press **<SET>**.



3 Select the images to send.

- Turn the **<DISP>** dial to select an image to send, then add **[✓]**. Press **<SET>** to add or remove **[✓]**.
- By pressing the **<Q>** button, you can switch to the three-image display and select an image.
- After selecting the images to send, press the **<Q>** button.

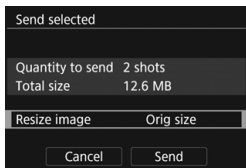

#### 4 Reduce the image size.

- Set it if necessary.
- On the next screen, press the <▲> <▼> keys to select an image size, then press <SET>.

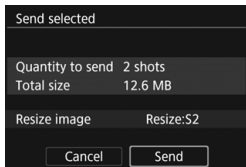
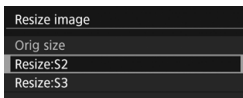

#### 5 Send the images.

- Press the <▲> <▼> keys to select [Send], then press <SET> to send the images.
- ▶ The transfer progress screen will appear. When the transfer is complete, the screen for step 1 will reappear.
- To send another image, repeat steps 1 to 5.



#### 6 Terminate the connection.

- Press the <MENU> button to display the confirmation dialog. Press the <▶> key to select [OK], then press <SET> to terminate the connection.
- ▶ The [Wi-Fi function] screen will reappear.



- While connected, a picture cannot be taken even if the camera's shutter button is pressed. When you want to terminate the connection to shoot or perform other operations, press the <MENU> button, then terminate the connection on the displayed screen. To terminate the connection during image transfer, select [**Cancel**] on the camera, then terminate the connection.
- When sending a large number of images or large files (total size), make sure that the battery is adequately charged so it does not run out during the process.
- Depending on the functionality of the target camera, the movie files will be converted when they are sent. Therefore, transfer may take longer than usual.



- RAW images cannot be sent.
- You can select up to 50 files at a time.
- When you reduce the image size, all images to be sent at the same time are resized except for movies and for images that are already smaller than the selected image size.
- [**Resize:S2**] and [**Resize:S3**] are enabled only for still photos shot with the EOS REBEL T6S/EOS 760D. Images shot with other cameras are sent without resizing.
- The file size (total size) is based on the file sizes before resizing the images.
- You can cancel the image transfer by selecting [**Cancel**] during the transfer. When [**Cancel**] is selected on the camera sending the images, the image selection screen will reappear. When [**Cancel**] is selected on the camera receiving the images, the connection will be terminated.

# Reconnecting

The camera can reconnect to another camera for which connection settings have been registered.

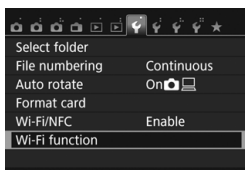

## 1 Select [Wi-Fi function].

- Under the [**1**] tab, set [**Wi-Fi/NFC**] to [**Enable**], then select [**Wi-Fi function**].

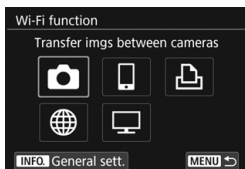

## 2 Select [**📷**].

- Select [**📷**] (Transfer imgs between cameras) and press <[**SET**]>.

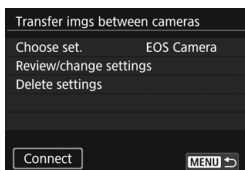

## 3 Establish a connection.

- Select [**Connect**] and press <[**SET**]>.
  - On the confirmation dialog, select [**OK**].
  - Perform the reconnection procedure on the target camera as well.
    - ▶ The images on the card are displayed and the images to send can be selected.
- 
- When settings for multiple connection destinations are registered, select [**Choose set.**], select the connection destination, then connect to the destination.
  - By default, settings are named after the nickname of the camera that was connected to.

# 5

## Easy Connection to Connect Station

Connect Station (sold separately) is a device that allows you to import captured still photos and movies for viewing on your TV set, smartphone, etc., or sharing them over a network.

You can easily save still photos and movies to Connect Station by holding this camera close to Connect Station.

# Saving Images

This section explains how to connect the camera and Connect Station (sold separately) via a wireless LAN. To save images in other ways, refer to the Connect Station instruction manual.

- Set up the camera to allow use of its NFC function in advance (p.W-20).

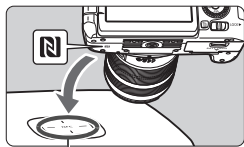

NFC connect point

## 1 Set up the camera to allow use of its NFC function (p.W-20).

## 2 Hold the camera close to Connect Station.

- Turn on the camera and Connect Station, then hold the camera's **N** mark close to the Connect Station's NFC connect point.
- ▶ A message indicating the connection is displayed on the camera's LCD monitor.
- When a connection is established, Connect Station checks the images on the memory card, then saves only the unsaved images.

## 3 Terminate the connection.

- After images are saved, the screen on the left will appear on the camera's LCD monitor. Press **<SET>** to terminate the connection.

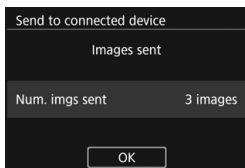



- Do not drop the camera on Connect Station or touch the camera to it with too much force. Doing so may damage Connect Station's internal hard disk.
- Since the camera may not be recognized readily, hold it carefully close to Connect Station while changing the camera's position or angle.
- Just holding the camera close to Connect Station may not establish a connection. In such a case, gently touch Connect Station with the camera.
- A connection cannot be established via the NFC function while shooting with the camera, when the power switch is set to <img alt="Power switch icon: a small black rectangle with a white 'P' and a white battery symbol." data-bbox="258 258 288 288"/>, when there is no card, or when the LCD monitor is closed with the screen facing inward.
- When holding the camera close to Connect Station, do not leave anything between the camera and Connect Station. In addition, when a case is attached to the camera, communication may not be possible via NFC function.
- When Battery Grip BG-E18 (sold separately) is attached, a connection cannot be established via the NFC function.
- If the camera and Connect Station are moved too far away from each other while importing images, import may take time or the connection may be terminated.
- If the camera's battery runs out during import, the import will stop. Charge the battery, then try importing again.



- A connection can be established even when the camera's power is in the auto power off state. However, if a connection cannot be established, cancel auto power off, then establish a connection.
- When all images are already imported, import does not start. In such a case, select [OK] to terminate the connection.
- When there are a large number of images on the memory card, it may take time to check and save the images.





# Wi-Fi (Wireless LAN) Precautions

## ■ Countries and Regions Permitting Wireless LAN Use

Use of wireless LAN is restricted in some countries and regions, and illegal use may be punishable under national or local regulations. To avoid violating wireless LAN regulations, visit the Canon Web site to check where use is allowed.

Note that Canon cannot be held liable for any problems arising from wireless LAN use in other countries and regions.

## ■ Model Number

EOS REBEL T6S (W)/EOS 760D (W): DS126481 (including WLAN module model: CH9-1346)

Complies with  
IDA Standards  
DB00671

This product is installed with the WLAN Module which is certified to standards set by IDA Singapore.

## FCC/IC NOTICE

**Model: DS126481 (including WLAN Module Model CH9-1346, FCC ID: AZD221)**

This device complies with Part 15 of FCC Rules and Industry Canada's licence-exempt RSSs. Operation is subject to the following two conditions:

- (1) this device may not cause harmful interference, and
- (2) this device must accept any interference received, including interference that may cause undesired operation.

This transmitter must not be co-located or operated in conjunction with any other antenna or transmitter except Canon accessories supplied or designated for this product.

The available scientific evidence does not show that any health problems are associated with using low power wireless devices. There is no proof, however, that these low power wireless devices are absolutely safe. Low power Wireless devices emit low levels of radio frequency energy (RF) in the microwave range while being used. Whereas high levels of RF can produce health effects (by heating tissue), exposure of low-level RF that does not produce heating effects causes no known adverse health effects. Many studies of low-level RF exposures have not found any biological effects. Some studies have suggested that some biological effects might occur, but such findings have not been confirmed by additional research. This model has been tested and found to comply with FCC/IC radiation exposure limits set forth for an uncontrolled environment and meets the FCC radio frequency (RF) Exposure Guidelines and RSS-102 of the IC radio frequency (RF) Exposure rules.

---

Hereby, Canon Inc., declares that this CH9-1346 is in compliance with the essential requirements and other relevant provisions of Directive 1999/5/EC.

Please contact the following address for the original Declaration of Conformity:

**CANON EUROPA N.V.**

Bovenkerkerweg 59, 1185 XB Amstelveen, The Netherlands

**CANON INC.**

30-2, Shimomaruko 3-chome, Ohta-ku, Tokyo 146-8501, Japan



# MEMO

---

---

---

---

---

---

---

---

---

---

---

---

---

---

---

---

---

---

---

---

---

---

---

---

---





# MEMO

---

---

---

---

---

---

---

---

---

---

---

---

---

---

---

---

---

---

---

---

---

---

---

---

---

---

---

---

---

---





The descriptions in this Instruction Manual are current as of March 2016. For information on the compatibility with any products introduced after this date, contact any Canon Service Center. For the latest version Instruction Manual, refer to the Canon Web site.