

Canon

EOS 5D^s

EOS 5D^sR



E

**INSTRUCTION
MANUAL**

Introduction

The EOS 5DS/EOS 5DS R is a digital single-lens reflex camera featuring a full-frame CMOS sensor (approx. 36.0 mm x 24.0 mm) with approx. 50.6 effective megapixels, Dual DIGIC 6, approx. 100% viewfinder coverage, high-precision and high-speed 61-point AF, approx. 5.0 fps continuous shooting, 3.2-inch LCD monitor, Live View shooting, and Full High-Definition (Full HD) movie shooting.

Before Starting to Shoot, Be Sure to Read the Following

To avoid botched pictures and accidents, first read the “Safety Precautions” (p.20-22) and “Handling Precautions” (p.23-25).

Refer to This Manual While Using the Camera to Further Familiarize Yourself with the Camera

While reading this manual, take a few test shots and see how they come out. You can then better understand the camera.

Testing the Camera Before Use and Liability

After shooting, play images back and check whether they have been properly recorded. If the camera or memory card is faulty and the images cannot be recorded or downloaded to a computer, Canon cannot be held liable for any loss or inconvenience caused.

Copyrights

Copyright laws in your country may prohibit the use of your recorded images of people and certain subjects for anything but private enjoyment. Also be aware that certain public performances, exhibitions, etc., may prohibit photography even for private enjoyment.

About the EOS 5DS R

The EOS 5DS R's optical low-pass filter is disabled, and the effect is eliminated to obtain a higher-looking resolution.

Since the optical low-pass filter is for reducing moire and false colors, images taken with the EOS 5DS R may show more moire and false colors than with the EOS 5DS depending on the subject and shooting conditions.

Item Check List

Before starting, check that all the following items are included with your camera. If anything is missing, contact your dealer.



Camera
(with body cap)



Eyecup Eg



**Battery Pack
LP-E6N**
(with protective cover)



**Battery Charger
LC-E6/LC-E6E***

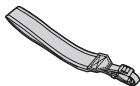

Wide Strap

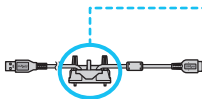

**Interface Cable
IFC-150U II**



**Cable
protector**

* Battery Charger LC-E6 or LC-E6E is provided. (The LC-E6E comes with a power cord.)

- The Instruction Manual and CD-ROMs provided are listed on the next page.
- Be careful not to lose any of the above items.

⚠ Connecting to Peripheral Devices

When connecting the camera to a computer or printer, use the provided interface cable or one from Canon. When connecting an interface cable, also use the provided cable protector (p.36).

Instruction Manual and CD-ROMs

The instruction manual consists of a booklet, a leaflet, and electronic manuals (PDF files on the CD-ROM).



**Camera Basic
Instruction Manual**



Quick Reference Guide



Camera Instruction Manual CD-ROM

Contains the following manuals (PDF files):

- Camera Instruction Manual (Detailed version)
- Quick Reference Guide

Instructions for viewing the Camera Instruction Manual CD-ROM are on pages 516-517.



EOS DIGITAL Solution Disk (Software CD-ROM)

Contains software such as image-editing software and Software Instruction Manuals (PDF files).

For more information and installation procedures of the software, see pages 520-521.

Instructions for viewing the Software Instruction Manual are on page 522.

Compatible Cards

The camera can use the following cards regardless of capacity: **If the card is new or was previously formatted (initialized) by another camera or computer, format the card with this camera (p.67).**

- **CF (CompactFlash) cards**
* Type I, UDMA mode 7-compatible.
- **SD/SDHC*/SDXC* memory cards**
* UHS-I cards supported.

Cards that Can Record Movies

When shooting movies, use a large-capacity card with a fast reading/writing speed as shown in the table.

Movie Recording Size (p.297)	CF card	SD card
ALL-I (I-only)	30 MB/sec. or faster	20 MB/sec. or faster
IPB	10 MB/sec. or faster	6 MB/sec. or faster

- If you use a slow-writing card when shooting movies, the movie may not be recorded properly. Also, if you play back a movie on a card with a slow reading speed, the movie may not play back properly.
- If you want to shoot still photos while shooting a movie, you will need an even faster card.
- To check the card's reading/writing speed, refer to the card manufacturer's Web site.



In this manual, "CF card" refers to CompactFlash cards and "SD card" refers to SD/SDHC/SDXC cards. "Card" refers to all memory cards used to record images or movies.

* **The camera does not come with a card for recording images/movies.** Please purchase it separately.

Quick Start Guide

1

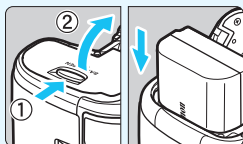

Insert the battery (p.42).

- To charge the battery, see page 40.

2

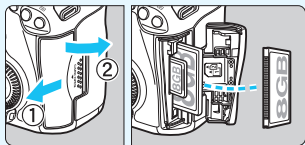

Insert the card (p.43).

- The camera-front side slot is for a CF card, and the camera-back side slot is for an SD card.

* Shooting is possible with either a CF card or an SD card in the camera.

3

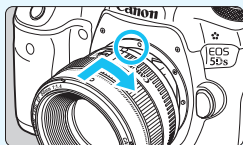

Attach the lens (p.52).

- Align it with the red dot.

4

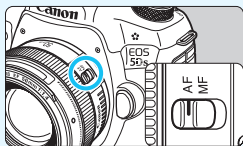

Set the lens's focus mode switch to <AF> (p.52).

5

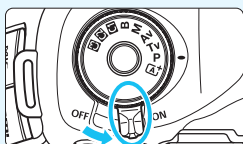

Set the power switch to <ON> (p.47).

6

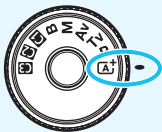

While holding down the center of the Mode Dial, set it to $\langle \text{Ai} \rangle$ (Scene Intelligent Auto) (p.33).

- All the necessary camera settings will be set automatically.

7



Focus on the subject (p.55).

- Look through the viewfinder and aim the viewfinder center over the subject.
- Press the shutter button halfway, and the camera will focus on the subject.

8



Take the picture (p.55).

- Press the shutter button completely to take the picture.

9







Review the picture.

- The image just captured will be displayed for 2 sec. on the LCD monitor.
- To display the image again, press the $\langle \text{▶} \rangle$ button (p.320).





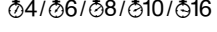

- To shoot while looking at the LCD monitor, see “Live View Shooting” (p.255).
- To view the images captured so far, see “Image Playback” (p.320).
- To delete an image, see “Erasing Images” (p.358).

Conventions Used in this Manual

Icons in this Manual

-  : Indicates the Main Dial.
-  : Indicates the Quick Control Dial.
-  : Indicates the Multi-controller.
-  : Indicates the Setting button.
-  : Indicates that each function remains active for 4 sec., 6 sec., 8 sec., 10 sec., or 16 sec. after you let go of the button.

* In this manual, the icons and markings indicating the camera's buttons, dials, and settings correspond to the icons and markings on the camera and on the LCD monitor.

-  : Indicates a function that can be changed by pressing the <MENU> button to change its settings.
-  : When shown on the upper right of a page, it indicates that the function is available only in the <P>, <Tv>, <Av>, <M>, or mode.
- (p.**)
-  : Warning to prevent shooting problems.
-  : Supplemental information.
-  : Tips or advice for better shooting.
-  : Troubleshooting advice.

Basic Assumptions

- All operations explained in this manual assume that the power switch is set to <ON> and the <LOCK▶> switch is set to the left (Multi function lock released) (p.47, 59).
- It is assumed that all the menu settings, Custom Functions, etc. are set to their defaults.
- The illustrations in this manual show the EOS 5DS attached with the EF50mm f/1.4 USM lens as an example.

Chapters

For first-time DSLR users, Chapters 1 and 2 explain the camera's basic operations and shooting procedures.



	Introduction	2
1	Getting Started	39
2	Basic Shooting	79
3	Setting the AF and Drive Modes	85
4	Image Settings	145
5	Advanced Operations	203
6	Flash Photography	243
7	Shooting with the LCD Monitor (Live View Shooting)	255
8	Shooting Movies	279
9	Image Playback	319
10	Post-Processing Images	363
11	Sensor Cleaning	373
12	Printing Images and Transferring Images to a Computer	379
13	Customizing the Camera	399
14	Reference	441
15	Viewing the CD-ROM Instruction Manuals / Downloading Images to Your Computer	515



Contents

Introduction 2



Item Check List.....	3
Instruction Manual and CD-ROMs	4
Compatible Cards.....	5
Quick Start Guide	6
Conventions Used in this Manual.....	8
Chapters.....	9
Index to Features	17
Safety Precautions	20
Handling Precautions	23
Nomenclature	26

1 Getting Started 39



Charging the Battery	40
Installing and Removing the Battery.....	42
Installing and Removing the Card	43
Turning on the Power	47
Setting the Date, Time, and Zone	49
Selecting the Interface Language.....	51
Attaching and Detaching a Lens	52
Basic Operation.....	54
 Quick Control for Shooting Functions	61
 Menu Operations.....	64
Before You Start.....	67
Formatting the Card.....	67
Disabling the Beeper	69
Setting the Power-off Time/Auto Power Off	69
Setting the Image Review Time	70
Reverting the Camera to the Default Settings	70

 Displaying the Grid.....	74
 Displaying the Electronic Level.....	75
Setting the Viewfinder Information Display.....	77
 Help.....	78



2 Basic Shooting 79





 Fully Automatic Shooting (Scene Intelligent Auto).....	80
 Full Auto Techniques (Scene Intelligent Auto).....	83

3 Setting the AF and Drive Modes 85







AF: Selecting the AF Operation.....	86
 Selecting the AF Area and AF Point.....	90
AF Area Selection Modes.....	95
AF Sensor.....	99
Lenses and Usable AF Points.....	100
Selecting AI Servo AF Characteristics.....	109
Customizing AF Functions.....	118
Fine Adjustment of AF's Point of Focus.....	134
When Autofocus Fails.....	140
MF: Manual Focus.....	141
 Selecting the Drive Mode.....	142
 Using the Self-timer.....	144



4 Image Settings 145

Selecting the Card for Recording and Playback.....	146
Setting the Image-Recording Quality.....	149
Setting Crop/aspect ratio.....	154
ISO: Setting the ISO Speed.....	158
 Selecting a Picture Style.....	164
 Customizing a Picture Style.....	168

 Registering a Picture Style	172
WB : Setting the White Balance	174
 Custom White Balance	176
 Setting the Color Temperature	178
 White Balance Correction	179
Auto Correction of Brightness and Contrast	182
Setting Noise Reduction	183
Highlight Tone Priority	187
Correction of Lens Peripheral Illumination and Aberrations	188
Reducing Flicker	191
Setting the Color Space	193
Creating and Selecting a Folder	194
Changing the File Name	196
File Numbering Methods	199
Setting Copyright Information	201

5 Advanced Operations 203

P : Program AE	204
Tv : Shutter-Priority AE	206
Av : Aperture-Priority AE	208
Depth-of-Field Preview	209
M : Manual Exposure	210
 Selecting the Metering Mode	212
 Setting Exposure Compensation	214
 Auto Exposure Bracketing (AEB)	215
 AE Lock	217
B : Bulb Exposures	218
HDR : HDR (High Dynamic Range) Shooting	221
 Multiple Exposures	226
 Mirror Lockup	234

Using the Eyepiece Cover	236
 Using a Remote Switch.....	237
 Remote Control Shooting.....	237
 Interval Timer Shooting	239



6 Flash Photography 243

 Flash Photography	244
Setting the Flash	247

7 Shooting with the LCD Monitor (Live View Shooting) 255

 Shooting with the LCD Monitor	256
Shooting Function Settings	262
Menu Function Settings	264
Using AF to Focus (AF Method)	268
MF: Focusing Manually	275

8 Shooting Movies 279





 Shooting Movies	280
Autoexposure Shooting	280
Shutter-priority AE	281
Aperture-priority AE	282
Manual Exposure Shooting	286
Shooting Still Photos	293
Shooting Function Settings	295
Setting the Movie Recording Size	297
Setting the Sound Recording	300
Silent Control	302
Setting the Time Code	303
 Shooting Time-lapse Movies	306
Menu Function Settings	313

9	Image Playback	319
	Image Playback	320
	INFO.: Shooting Information Display	322
	Searching for Images Quickly	327
	Display Multiple Images on One Screen (Index Display).....	327
	Jump through Images (Jump Display).....	328
	Magnifying Images.....	330
	Comparing Images (Two-Image Display).....	332
	Rotating the Image.....	333
	Protecting Images.....	334
	Setting Ratings	337
	Quick Control for Playback	340
	Enjoying Movies	342
	Playing Back Movies	344
	Editing a Movie's First and Last Scenes	346
	Slide Show (Auto Playback)	348
	Viewing Images on a TV Set	351
	Copying Images	354
	Erasing Images.....	358
	Changing Image Playback Settings	361
	Adjusting the LCD Monitor Brightness.....	361
	Auto Rotation of Vertical Images	362
10	Post-Processing Images	363
	Processing RAW Images with the Camera	364
	Resizing JPEG Images.....	369
	Cropping JPEG Images	371



11 Sensor Cleaning 373

 Automatic Sensor Cleaning.....	374
Appending Dust Delete Data	375
Manual Sensor Cleaning.....	377

12 Printing Images and Transferring Images to a Computer 379

Preparing to Print	380
 Printing	382
 Digital Print Order Format (DPOF).....	389
 Direct Printing of Print-Ordered Images.....	392
 Transferring Images to a Computer.....	393
 Specifying Images for a Photobook	397

13 Customizing the Camera 399

Custom Functions	400
Setting Custom Functions.....	402
C.Fn1: Exposure	402
C.Fn2: Exposure	408
C.Fn3: Others.....	409
 C: Custom Controls	413
Custom Quick Control	427
Registering My Menu	432
 C: Registering Custom Shooting Modes.....	437

14	Reference	441
	INFO. Button Functions	442
	Checking the Battery Information	446
	Using a Household Power Outlet	450
	📶 Using Eye-Fi Cards.....	451
	System Map	454
	Function Availability Table According to Shooting Mode	456
	Menu Settings	460
	Troubleshooting Guide	471
	Error Codes	487
	Specifications	488
15	Viewing the CD-ROM Instruction Manuals / Downloading Images to Your Computer	515
	Viewing the Camera Instruction Manual CD-ROM.....	516
	Downloading Images to a Computer	518
	Software Overview	520
	Installing the Software	521
	Software Instruction Manual.....	522
	Index.....	523

Index to Features

Power

- Charging the battery → p.40
- Battery level → p.48
- Battery information check → p.446
- Household power outlet → p.450
- Auto power off → p.69

Card

- Formatting → p.67
- Recording function → p.146
- Selecting card → p.148
- Release shutter without card → p.44

Lens

- Attaching → p.52

Basic Settings

- Language → p.51
- Date/Time/Zone → p.49
- Beeper → p.69
- Copyright information → p.201
- Clear all camera settings → p.70

Viewfinder

- Dioptic adjustment → p.54
- Eyepiece cover → p.236
- Grid display → p.74
- Electronic level → p.76
- Show/hide in viewfinder → p.77

LCD Monitor

- Brightness adjustment → p.361
- Electronic level → p.75
- Help → p.78

AF

- AF operation → p.86
- AF area selection mode → p.90
- AF point selection → p.93
- AF point registration → p.418
- Lens group → p.100
- AF points lighting up in red → p.132
- AI Servo AF characteristics → p.109
- AF Custom Functions → p.118
- AF Microadjustment → p.134
- Focusing manually → p.141

Metering

- Metering mode → p.212

Drive

- Drive mode → p.142
- Self-timer → p.144
- Maximum burst → p.153

Recording Images

- Recording function → p.146
- Creating/Selecting a folder → p.194
- File name → p.196
- File numbering → p.199

Image Quality

- Image-recording quality → p.149
- Crop/aspect ratio → p.154
- ISO speed → p.158
- Picture Style → p.164
- White balance → p.174
- Auto Lighting Optimizer → p.182
- Noise reduction for high ISO speeds → p.183
- Noise reduction for long exposures → p.185
- Highlight tone priority → p.187
- Lens aberration correction → p.188
- Anti-flicker → p.191
- Color space → p.193

Shooting

- Shooting mode → p.33
- HDR → p.221
- Multiple exposures → p.226
- Mirror lockup → p.234
- Bulb timer → p.219
- Interval timer → p.239
- Depth-of-field preview → p.209
- Remote control → p.237
- Quick Control → p.61

Exposure

- Exposure compensation → p.214
- Exposure compensation with M+Auto ISO → p.211
- AEB → p.215
- AE lock → p.217
- Safety shift → p.405

Flash

- External Speedlite → p.244
- Flash exposure compensation → p.244
- FE lock → p.244
- Flash function settings → p.247
- Flash Custom Function settings → p.253

Live View Shooting

- Live View shooting → p.255
- AF method → p.268
- Continuous AF → p.264
- Focusing manually → p.275
- Crop/aspect ratio → p.262
- Silent LV shooting → p.266

Movie Shooting

- Movie shooting → p.279
- AF method → p.268
- Movie Servo AF → p.313
- Movie recording quality → p.297
- Sound recording → p.300
- Time code → p.303
- Time-lapse movie → p.306
- Still photo shooting → p.293

Playback

- Image review time → p.70
- Single-image display → p.320
- Shooting information → p.322
- Index display → p.327
- Image browsing (Jump display) → p.328
- Magnified view → p.330
- Two-image display → p.332
- Image rotation → p.333
- Protect → p.334
- Rating → p.337
- Movie playback → p.344
- Slide show → p.348
- Viewing images on a TV set → p.351
- Copying → p.354
- Erasing → p.358
- Quick Control → p.340

Image Editing

- RAW image processing → p.364
- Resizing JPEGs → p.369
- Cropping JPEGs → p.371

Printing and Transferring Images

- PictBridge → p.379
- Print Order (DPOF) → p.389
- Image transfer → p.393
- Photobook Set-up → p.397

Customization

- Custom Functions (C.Fn) → p.400
- Custom Controls → p.413
- Custom Quick Control → p.427
- My Menu → p.432
- Custom shooting mode → p.437

Sensor Cleaning and Dust Reduction

- Sensor cleaning → p.374
- Append Dust Delete Data → p.375

Interface

- Cable protector → p.36

Software

- Overview → p.520
- Installation → p.521

Safety Precautions

The following precautions are provided to prevent harm or injury to yourself and others. Make sure to thoroughly understand and follow these precautions before using the product.

If you experience any malfunctions, problems, or damage to the product, contact the nearest Canon Service Center or the dealer from whom you purchased the product.



Warnings: Follow the warnings below. Otherwise, death or serious injuries may result.

- To prevent fire, excessive heat, chemical leakage, explosions, and electrical shock, follow the safeguards below:
 - Do not use any batteries, power sources, or accessories not specified in the Instruction Manual. Do not use any home-made or modified batteries.
 - Do not short-circuit, disassemble, or modify the battery. Do not apply heat or solder to the battery. Do not expose the battery to fire or water. Do not subject the battery to strong physical shock.
 - Do not insert the battery's plus and minus ends incorrectly.
 - Do not recharge the battery in temperatures outside the allowable charging (working) temperature range. Also, do not exceed the recharging time indicated in the Instruction Manual.
 - Do not insert any foreign metallic objects into the electrical contacts of the camera, accessories, connecting cables, etc.
- When disposing of a battery, insulate the electrical contacts with tape to prevent contact with other metallic objects or batteries. This is to prevent a fire or an explosion.
- If excessive heat, smoke, or fumes are emitted when recharging the battery, immediately unplug the battery charger from the power outlet to stop recharging. Otherwise, it may cause a fire, heat damage, or electrical shock.
- If the battery leaks, changes color, deforms, or emits smoke or fumes, remove it immediately. Be careful not to get burned in the process. It may cause a fire, electrical shock or skin burn if you keep using it.
- Prevent any battery leakage from contacting your eyes, skin, and clothing. It can cause blindness or skin problems. If the battery leakage contacts your eyes, skin, or clothing, flush the affected area with lots of clean water without rubbing it. See a physician immediately.
- Do not leave any cords near a heat source. It can deform the cord or melt the insulation and cause a fire or electrical shock.
- Do not hold the camera in the same position for long periods of time. Even if the camera does not feel too hot, prolonged contact with the same body part may cause skin redness, blistering or low-temperature contact burns. Using a tripod is recommended for people with circulation problems or very sensitive skin, or when using the camera in very hot places.
- Do not fire the flash at anyone driving a car or other vehicle. It may cause an accident.

- When the camera or accessories are not in use, make sure to remove the battery and disconnect the power plug from the equipment before storing. This is to prevent electrical shock, excessive heat, fire, or corrosion.
- Do not use the equipment where there is flammable gas. This is to prevent an explosion or a fire.
- If you drop the equipment and the casing breaks open to expose the internal parts, do not touch the internal parts. There is a possibility of an electrical shock.
- Do not disassemble or modify the equipment. High-voltage internal parts can cause electrical shock.
- Do not look at the sun or an extremely bright light source through the camera or lens. Doing so may damage your vision.
- Keep equipment out of the reach of children and infants, including when in use. Straps or cords may accidentally cause choking, electrical shock, or injury. Choking or injury may also occur if a child or infant accidentally swallows a camera part or accessory. If a child or infant swallows a part or accessory, consult a physician immediately.
- Do not use or store the equipment in dusty or humid places. Likewise, store the battery with its protective cover attached to prevent short-circuit. This is to prevent a fire, excessive heat, electrical shock, or burn.
- Before using the camera inside an airplane or hospital, check if it is allowed. Electromagnetic waves emitted by the camera may interfere with the plane's instruments or the hospital's medical equipment.
- To prevent a fire and electrical shock, follow the safeguards below:
 - Always insert the power plug all the way in.
 - Do not handle a power plug with wet hands.
 - When unplugging a power plug, grasp and pull the plug instead of the cord.
 - Do not scratch, cut, or excessively bend the cord or put a heavy object on the cord. Also do not twist or tie the cords.
 - Do not connect too many power plugs to the same power outlet.
 - Do not use a cord whose wire is broken or insulation is damaged.
- Unplug the power plug periodically and clean off the dust around the power outlet with a dry cloth. If the surrounding is dusty, humid, or oily, the dust on the power outlet may become moist and short-circuit the outlet, causing a fire.
- Do not connect the battery directly to an electrical outlet or a car's cigarette lighter outlet. The battery may leak, generate excessive heat or explode, causing a fire, burns or injuries.
- A thorough explanation of how to use the product by an adult is required when the product is used by children. Supervise children while they are using the product. Incorrect usage may result in electrical shock or injury.
- Do not leave a lens or lens-attached camera in the sun without the lens cap attached. Otherwise, the lens may concentrate the sun's rays and cause a fire.
- Do not cover or wrap the product with a cloth. Doing so may trap heat within and cause the casing to deform or catch fire.
- Be careful not to get the camera wet. If you drop the product in the water or if water or metal get inside the product, promptly remove the battery. This is to prevent a fire and an electrical shock.
- Do not use paint thinner, benzene, or other organic solvents to clean the product. Doing so may cause fire or a health hazard.



Cautions: Follow the cautions below. Otherwise, physical injury or property damage may result.

- Do not use or store the product inside a car under the hot sun or near a heat source. The product may become hot and cause skin burns. Doing so may also cause battery leakage or explosion, which will degrade the performance or shorten the life of the product.
- Do not carry the camera around when it is attached to a tripod. Doing so may cause injury. Also make sure the tripod is sturdy enough to support the camera and lens.
- Do not leave the product in a low-temperature environment for an extended period of time. The product will become cold and may cause injury when touched.
- Do not fire the flash near the eyes. It may hurt the eyes.
- Never play the provided CD-ROM in a drive that is not compatible with the CD-ROM. If you use it in a music CD player, you may damage the speakers and other components. When using headphones, there is also a risk of injury to your ears from excessively loud volume.

Handling Precautions

Camera Care

- This camera is a precision instrument. Do not drop it or subject it to physical shock.
- The camera is not waterproof and cannot be used underwater.
- To maximize the camera's dust- and drip- resistance, keep the terminal cover, battery compartment cover, card slot cover, and all other covers firmly closed.
- This camera is designed to be dust- and drip- resistant, in order to help prevent sand, dust, dirt, or water that falls on it unexpectedly from getting inside, but it is impossible to prevent dirt, dust, water, or salt from getting inside at all. As far as possible, do not allow dirt, dust, water, and salt to get on the camera.
- If water gets on the camera, wipe it off with a dry and clean cloth. If dirt, dust, or salt gets on the camera, wipe it off with a clean, well-wrung wet cloth.
- Using the camera in a location with large amounts of dirt or dust may cause a malfunction.
- Cleaning the camera after use is recommended. Allowing dirt, dust, water, or salt to remain on the camera may cause a malfunction.
- If you accidentally drop the camera into water or are concerned that moisture (water), dirt, dust, or salt may have gotten inside it, promptly consult the nearest Canon Service Center.
- Never leave the camera near anything having a strong magnetic field such as a magnet or electric motor. Also avoid using or leaving the camera near anything emitting strong radio waves, such as a large antenna. Strong magnetic fields can cause camera misoperation or destroy image data.
- Do not leave the camera in excessive heat, such as in a car in direct sunlight. High temperatures can cause the camera to malfunction.
- The camera contains precision electronic circuitry. Never attempt to disassemble the camera yourself.

- Do not block the mirror operation with your finger, etc. Doing so may cause a malfunction.
- Use a blower to blow away dust on the lens, viewfinder, reflex mirror, and focusing screen. Do not use cleaners that contain organic solvents to clean the camera body or lens. For stubborn dirt, take the camera to the nearest Canon Service Center.
- Do not touch the camera's electrical contacts with your fingers. This is to prevent the contacts from corroding. Corroded contacts can cause camera misoperation.
- If the camera is suddenly brought in from the cold into a warm room, condensation may form on the camera and internal parts. To prevent condensation, first put the camera in a sealed plastic bag and let it adjust to the warmer temperature before taking it out of the bag.
- If condensation forms on the camera, do not use the camera. This is to avoid damaging the camera. If there is condensation, remove the lens, card and battery from the camera, and wait until condensation has evaporated before using the camera.
- If the camera will not be used for an extended period, remove the battery and store the camera in a cool, dry, well-ventilated location. Even while the camera is in storage, press the shutter button a few times once in a while to check that the camera is still working.
- Avoid storing the camera where there are chemicals that result in rust and corrosion such as in a chemical lab.
- If the camera has not been used for an extended period, test all its functions before using it. If you have not used the camera for some time or if there is an important shoot such as a foreign trip coming up, have the camera checked by your nearest Canon Service Center or check the camera yourself and make sure it is working properly.
- If you use continuous shooting, Live View shooting, or movie shooting for a prolonged period, the camera may become hot. This is not a malfunction.
- If there is a bright light source inside or outside the image area, ghosting may occur.

LCD Panel and LCD Monitor

- Although the LCD monitor is manufactured with very high precision technology with over 99.99% effective pixels, there may be a few dead pixels displaying only black or red, etc. among the remaining 0.01% or less pixels. Dead pixels are not a malfunction. They do not affect the images recorded.
- If the LCD monitor is left on for a prolonged period, screen burn-in may occur where you see remnants of what was displayed. However, this is only temporary and will disappear when the camera is left unused for a few days.
- The LCD monitor display may seem slow in low temperatures, or look black in high temperatures. It will return to normal at room temperature.

Cards

To protect the card and its recorded data, note the following:

- Do not drop, bend, or wet the card. Do not subject it to excessive force, physical shock, or vibration.
- Do not touch the card's electronic contacts with your fingers or anything metallic.
- Do not affix any stickers, etc., on the card.
- Do not store or use the card near anything that has a strong magnetic field, such as a TV set, speakers, or magnet. Also avoid places prone to having static electricity.
- Do not leave the card in direct sunlight or near a heat source.
- Store the card in a case.
- Do not store the card in hot, dusty, or humid locations.

Lens

After detaching the lens from the camera, put down the lens with the rear end up and attach the rear lens cap to avoid scratching the lens surface and electrical contacts.



Nomenclature

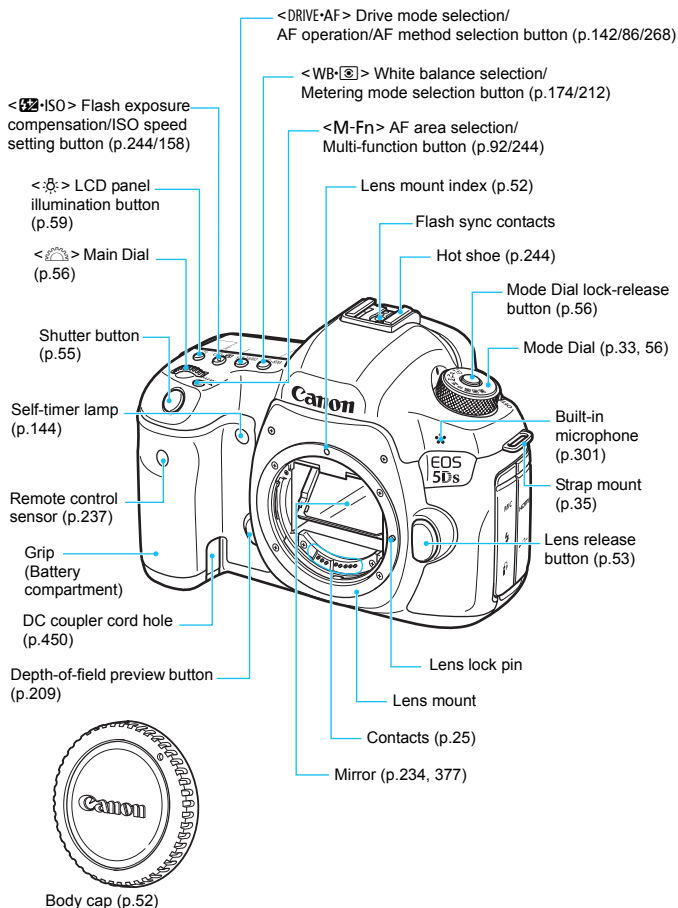

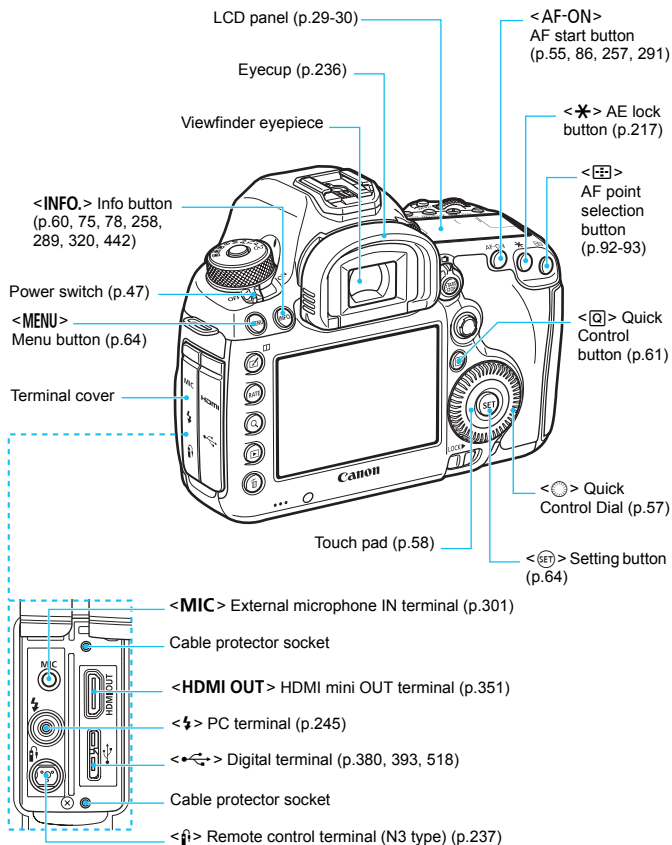

When connecting the interface cable to a digital terminal, you must use the provided cable protector (p.36).

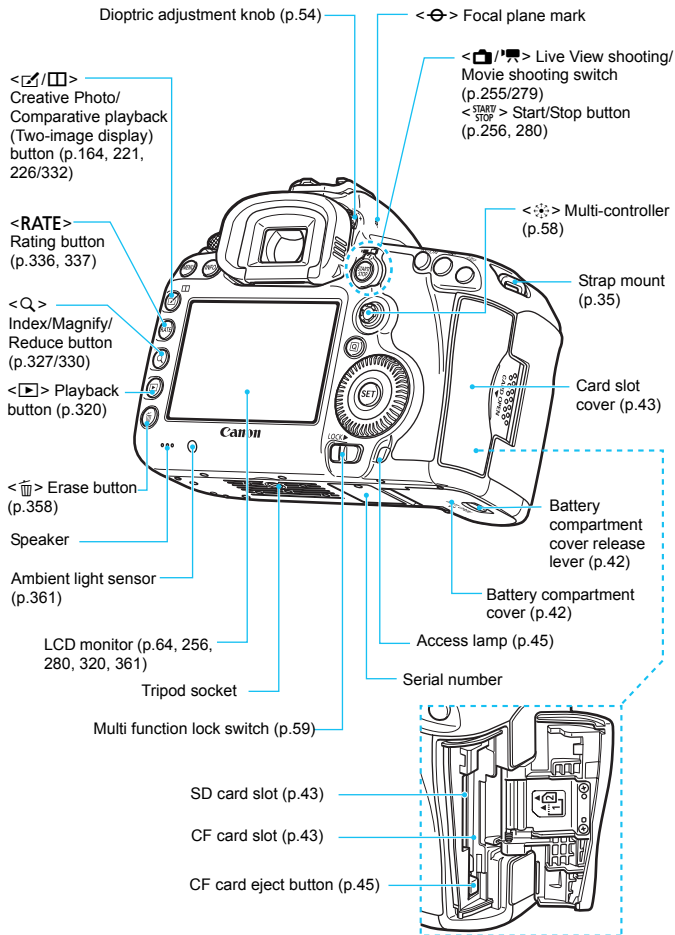

LCD Panel

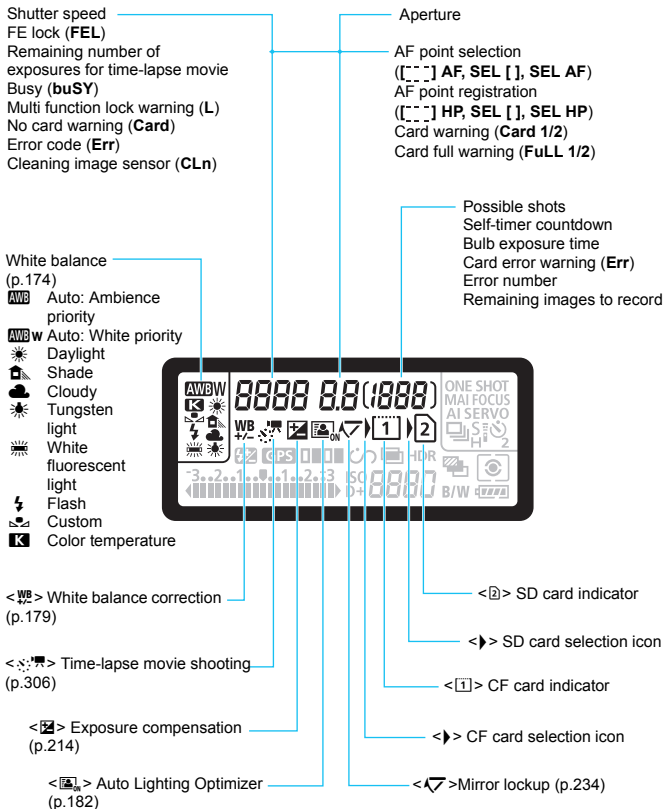

* The display will show only the settings currently applied.

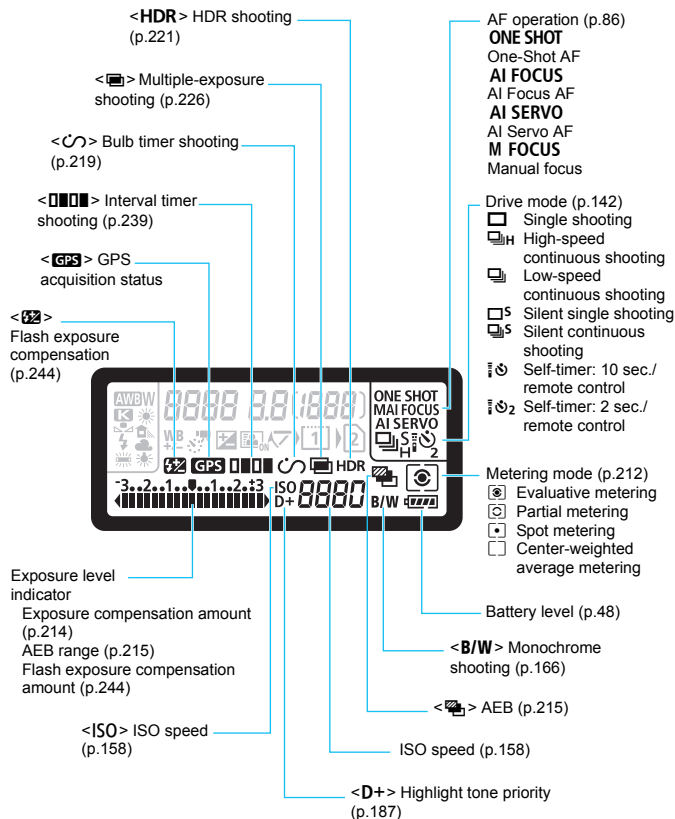

Viewfinder Information

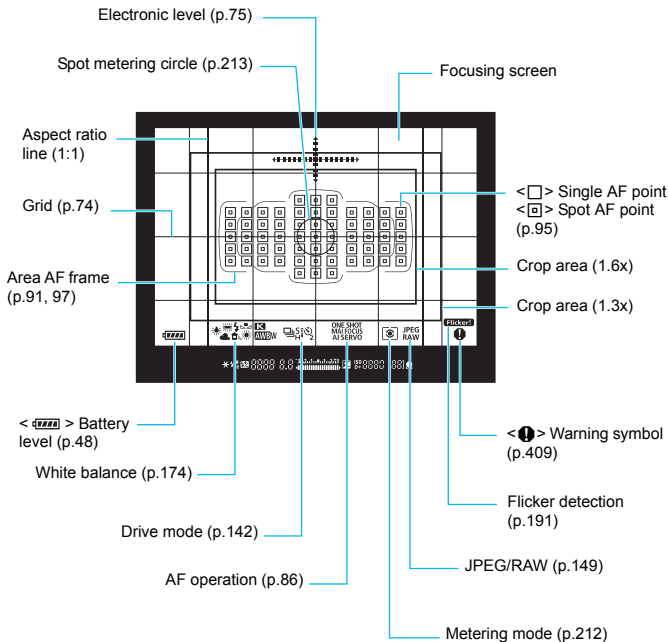

* The display will show only the settings currently applied.

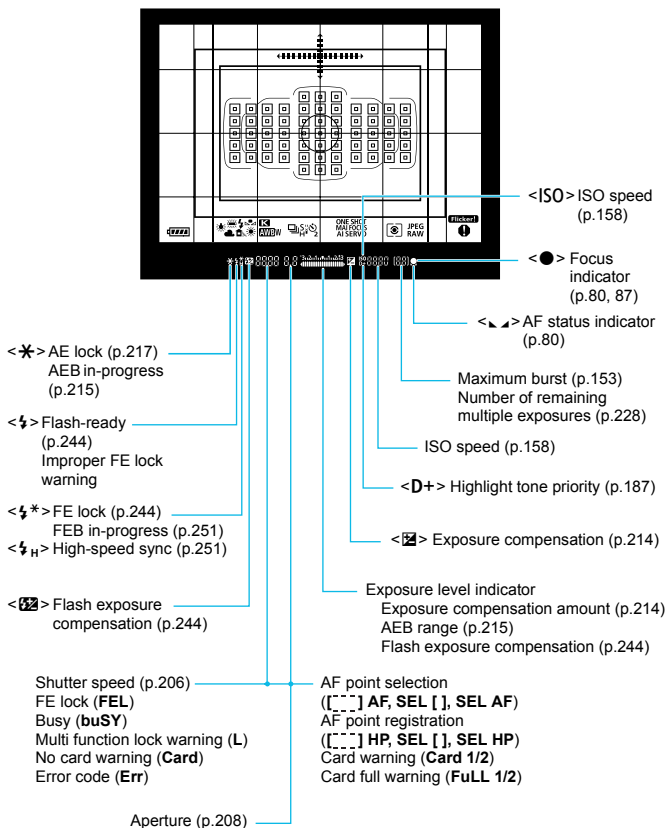

Mode Dial

You can set the shooting mode. Turn the Mode Dial while holding down the Mode Dial center (Mode Dial lock release button).

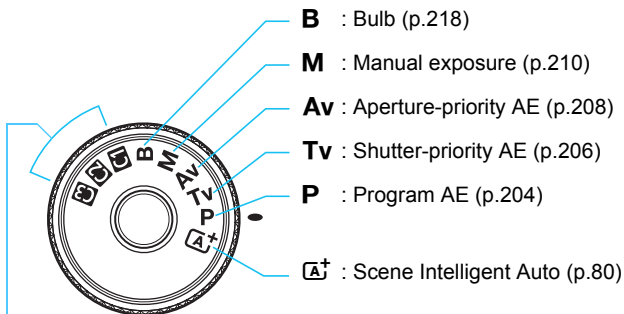

Custom shooting mode

You can register the shooting mode (**P/Tv/Av/M/B**), AF operation, menu settings, etc., to **1**, **2**, **3** Mode Dial positions (p.437).

Battery Charger LC-E6

Charger for Battery Pack LP-E6N/LP-E6 (p.40).

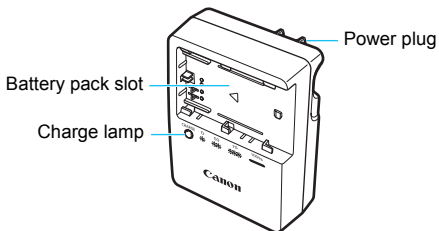

**IMPORTANT SAFETY INSTRUCTIONS-SAVE THESE INSTRUCTIONS.
DANGER-TO REDUCE THE RISK OF FIRE OR ELECTRIC SHOCK,
CAREFULLY FOLLOW THESE INSTRUCTIONS.**

For connection to a supply not in the U.S.A., use an attachment plug adapter of the proper configuration for the power outlet, if needed.

Battery Charger LC-E6E

Charger for Battery Pack LP-E6N/LP-E6 (p.40).

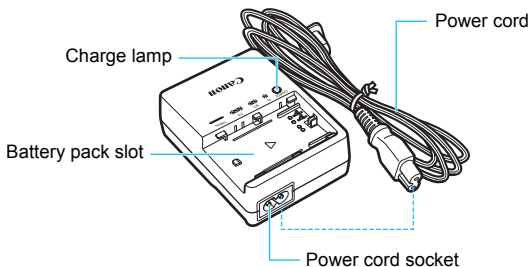

Attaching the Strap

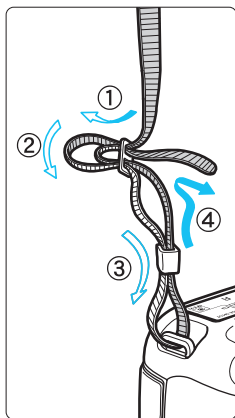

Pass the end of the strap through the camera's strap mount eyelet from the bottom. Then pass it through the strap's buckle as shown in the illustration. Pull the strap to take up any slack and make sure the strap will not loosen from the buckle.

- The eyepiece cover is also attached to the strap (p.236).

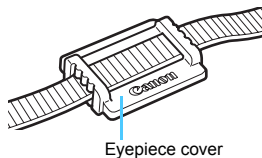

Using the Cable Protector

When connecting the camera to a computer, printer, Wireless File Transmitter or GPS Receiver, use the provided interface cable or one from Canon (shown in the System Map on page 454).

When connecting the interface cable, also use the provided cable protector. Using the cable protector prevents the cable from accidental disconnection and the terminal from getting damaged.

Using the Provided Interface Cable and a Genuine HDMI Cable (sold separately)

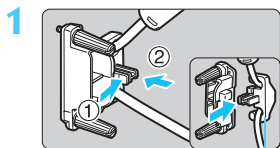

Clamp

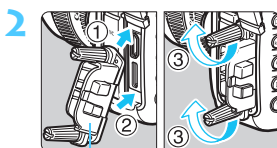

Cable protector

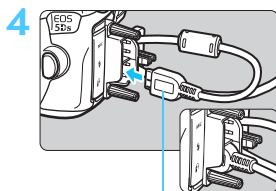
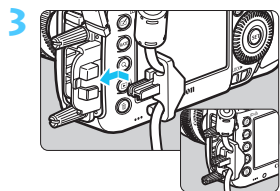

Provided interface cable

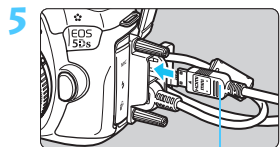

HDMI cable (sold separately)

Using a Genuine Interface Cable (sold separately)

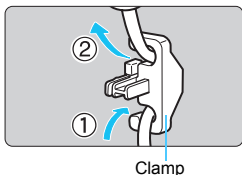

If you use a genuine interface cable (sold separately, p.454), run the cable through the clamp before attaching the clamp to the cable protector.



- Connecting interface cable without using the cable protector may damage the digital terminal.
- Do not use a USB 2.0 cable equipped with a Micro-B plug. It may damage the camera's digital terminal.
- As shown in the lower-right illustration for step 4, check that the interface cable is securely attached to the digital terminal.



To connect the camera to a TV set, using HDMI Cable HTC-100 (sold separately) is recommended. Using the cable protector is recommended even when connecting an HDMI cable.

MEMO

1

Getting Started

This chapter explains preparatory steps before you start shooting and basic camera operations.

Charging the Battery

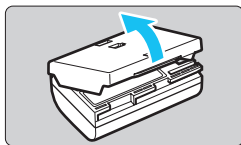

1 Remove the protective cover.

- Detach the protective cover provided with the battery.

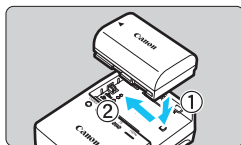

2 Attach the battery.

- As shown in the illustration, attach the battery securely to the charger.
- To detach the battery, follow the above procedure in reverse.

LC-E6

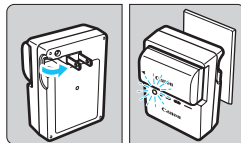

3 Recharge the battery.

For LC-E6

- As shown by the arrow, flip out the battery charger's prongs and insert the prongs into a power outlet.

LC-E6E

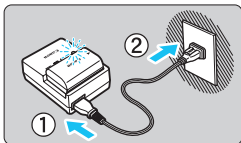

For LC-E6E

- Connect the power cord to the charger and insert the plug into a power outlet.
- ▶ Recharging starts automatically and the charge lamp blinks in orange.

Charge Level	Charge Lamp	
	Color	Display
0-49%	Orange	Blinks once per second
50-74%		Blinks twice per second
75% or higher		Blinks three times per second
Fully charged	Green	Lights up

- It takes approx. 2 hr. and 30 min. to fully recharge a completely exhausted battery at room temperature (23°C / 73°F). The time required to recharge the battery will vary greatly depending on the ambient temperature and the battery's remaining capacity.
- For safety reasons, recharging in low temperatures (5°C - 10°C / 41°F - 50°F) will take longer (up to approx. 4 hr.).



Tips for Using the Battery and Charger

- **Upon purchase, the battery is not fully charged.**
Charge the battery before use.
- **Recharge the battery on the day before or on the day it is to be used.**
Even during storage, a charged battery will gradually drain and lose its capacity.
- **After recharging the battery, detach it and disconnect the charger from the power outlet.**
- **You can attach the cover in a different orientation to indicate whether the battery has been recharged or not.**



If the battery has been recharged, attach the cover so that the battery-shaped hole is aligned over the blue sticker on the battery. If the battery is exhausted, attach the cover in the opposite orientation.

- **When not using the camera, remove the battery.**
If the battery is left in the camera for a prolonged period, a small amount of power current is released, resulting in excess discharge and shorter battery life. Store the battery with the protective cover attached. Storing the battery when it is fully charged may lower the battery's performance.
- **The battery charger can also be used in foreign countries.**
The battery charger is compatible with a 100 V AC to 240 V AC 50/60 Hz power source. If necessary, attach a commercially-available plug adapter for the respective country or region. Do not attach any portable voltage transformer to the battery charger. Doing so can damage the battery charger.
- **If the battery becomes exhausted quickly even after being fully charged, the battery has reached the end of its service life.**
Check the battery's recharge performance (p.446) and purchase a new battery.



- After disconnecting the charger's power plug, do not touch the prongs for approx. 10 sec.
- If the battery's remaining capacity (p.446) is 94% or higher, the battery will not be recharged.
- The charger cannot charge any battery other than Battery Pack LP-E6N/LP-E6.

Installing and Removing the Battery

Load a fully-charged Battery Pack LP-E6N (or LP-E6) into the camera. The camera's viewfinder becomes bright when a battery is installed, and darkens when the battery is removed.

Installing the Battery

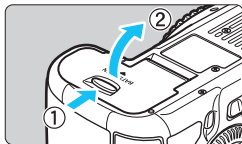

1 Open the cover.

- Slide the lever as shown by the arrows and open the cover.

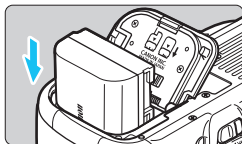

2 Insert the battery.

- Insert the end with the battery contacts.
- Insert the battery until it locks in place.

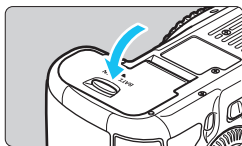

3 Close the cover.

- Press the cover until it snaps shut.

 Only Battery Pack LP-E6N/LP-E6 can be used.

Removing the Battery

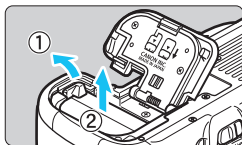

Open the cover and remove the battery.

- Press the battery lock lever as shown by the arrow and remove the battery.
- To prevent short circuiting of the battery contacts, be sure to attach the provided protective cover (p.40) to the battery.

Installing and Removing the Card

The camera can use a CF card and an SD card. **Images can be recorded when at least one card is installed in the camera.**

If both types of card are inserted, you can select which card to record images to, or simultaneously record images on both cards (p.146-148).

Cautions for Using an SD Card

If you use an SD card, be sure the card's write-protect switch is set upward to enable writing/erasing.

Installing the Card

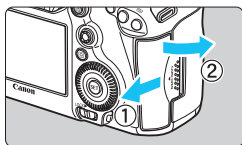

1 Open the cover.

- Slide the cover as shown by the arrows to open it.

CF card

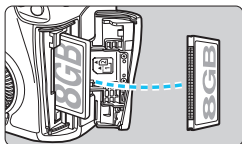

2 Insert the card.

- The camera-front side slot is for a CF card, and the camera-back side slot is for an SD card.

- **Face the CF card's label toward you and insert the end with the small holes into the camera.**

If the card is inserted in the wrong way, it may damage the camera.

- ▶ The CF card eject button will stick out.

- **With the SD card's label facing you, push in the card until it clicks in place.**

SD card

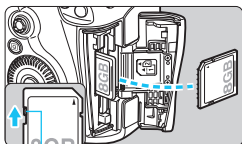

Write-protect switch

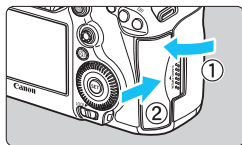

3 Close the cover.

- Close the cover and slide it in the direction shown by the arrows until it snaps shut.
- ▶ When you set the power switch to <ON> (p.47), the number of possible shots and the loaded card(s) will be displayed on the LCD panel.

The images will be recorded to the card indicated by the arrow < > icon.

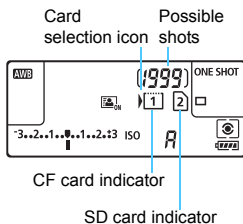

- The camera cannot use Type II CF cards, hard disk-type cards, or CFast cards.
- Multimedia cards (MMC) cannot be used (card error will be displayed).

- Ultra DMA (UDMA) CF cards can also be used with the camera. UDMA cards enable faster data writing.
- SD/SDHC/SDXC memory cards are supported. UHS-I SDHC or SDXC memory cards can also be used.
- The number of possible shots depends on the remaining capacity of the card, image-recording quality, ISO speed, etc.
- “Possible Shots” displays the number of shots based on the [CAMERA 4: Crop/aspect ratio] setting (p.154).
- Even if shooting 2,000 or more shots is possible, the indicator will display only up to 1999.
- Setting [CAMERA 1: Release shutter without card] to [Disable] will prevent you from forgetting to insert a card (p.460).

Removing the Card

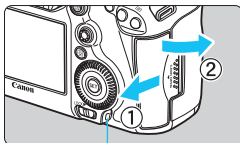

Access lamp

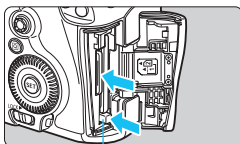

CF card eject button

1 Open the cover.

- Set the power switch to **<OFF>**.
- **Make sure the access lamp is off, then open the cover.**
- If [**Recording...**] is displayed on the LCD monitor, close the cover.

2 Remove the card.

- To remove the CF card, push the eject button.
- To remove the SD card, push it in gently and release it. Then pull it out.
- Pull the card straight out, then close the cover.

- **When the access lamp is lit or blinking, it indicates that images are being written to, read from, or erased from the card, or data is being transferred. Do not open the card slot cover during this time. Also, never do any of the following while the access lamp is lit or blinking. Otherwise, it can damage the image data, card, or camera.**
 - **Removing the card.**
 - **Removing the battery.**
 - **Shaking or banging the camera around.**
 - **Unplugging and connecting a power cord** (when household power outlet accessories (sold separately, p.450) are used).
- If the card already contains recorded images, the image number may not start from 0001 (p.199).
- If a card-related error message is displayed on the LCD monitor, remove and reinsert the card. If the error persists, use a different card. If you can transfer all the images on the card to a computer, transfer all the images and then format the card with the camera (p.67). The card may then return to normal.
- Do not touch the SD card's contacts with your fingers or metal objects. Do not expose the contacts to dust or water. If smudges adhere to the contacts, contact failure may result.

Turning on the Power

If you turn on the power switch and the date/time/zone setting screen appears, see page 49 to set the date/time/zone.

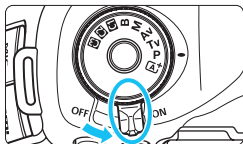

- <ON> : The camera turns on.
- <OFF> : The camera is turned off and does not operate. Set to this position when not using the camera.

Automatic Sensor Cleaning

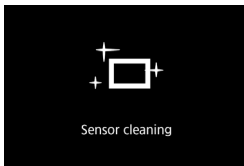

- Whenever you set the power switch to <ON> or <OFF>, sensor cleaning will be executed automatically. (A small sound may be heard.) During the sensor cleaning, the LCD monitor will display <+□+>.
- You can still shoot during sensor cleaning by pressing the shutter button halfway (p.55) to stop cleaning and take a picture.
- If you repeatedly turn the power switch <ON>/<OFF> at a short interval, the <+□+> icon may not be displayed. This is normal and not a malfunction.

MENU Auto Power Off

- To save battery power, the camera turns off automatically after 1 minute of non-operation. To turn on the camera again, just press the shutter button halfway.
- You can change the auto power off time with [F2: Auto power off] (p.69).









If you set the power switch to <OFF> while an image is being recorded to the card, [Recording...] will be displayed and the power will turn off after the recording finishes.

Battery Level Indicator

When the power switch is set to <ON>, the battery level will be indicated in one of six levels. A blinking battery icon < > indicates that the battery will be exhausted soon.



Display						
Level (%)	100 - 70	69 - 50	49 - 20	19 - 10	9 - 1	0



Number of Possible Shots

(Approx. number of shots)

Temperature	Room Temperature (23°C / 73°F)	Low Temperatures (0°C / 32°F)
Possible shots	700	660

- The figures above are based on a fully-charged Battery Pack LP-E6N, no Live View shooting, and CIPA (Camera & Imaging Products Association) testing standards.
- Possible shots with Battery Grip BG-E11 (sold separately)
 - With LP-E6N x 2: approx. twice the shots without the battery grip.
 - With AA/LR6 alkaline batteries at room temperature (23°C / 73°F): approx. 140 shots.



- Doing any of the following will exhaust the battery sooner:
 - Pressing the shutter button halfway for a prolonged period.
 - Activating the AF frequently without taking a picture.
 - Using the lens Image Stabilizer.
 - Using the LCD monitor frequently.
- The number of possible shots may decrease depending on the actual shooting conditions.
- The lens operation is powered by the camera's battery. Depending on the lens used, the battery may exhaust faster.
- For the number of possible shots with Live View shooting, see page 257.
- See [**3: Battery info.**] to check the battery's condition (p.446).
- With Battery Grip BG-E11 (sold separately) loaded with AA/R6 batteries, a four-level indicator will be displayed. (/) will not be displayed.)

MENU Setting the Date, Time, and Zone

When you turn on the power for the first time or if the date/time/zone are reset, the date/time/zone setting screen will appear. Follow the steps below, making sure to set the time zone first. Set the camera to the time zone in which you currently live so that, when you travel, you can simply change the setting to the correct time zone for your destination and the camera will automatically adjust the date/time.

Note that the date/time appended to recorded images will be based on this date/time setting. Be sure to set the correct date/time.

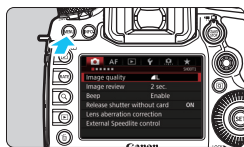

1 Display the menu screen.

- Press the <MENU> button to display the menu screen.

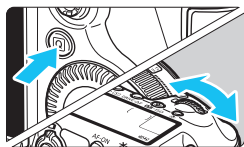

2 Under the [2] tab, select [Date/Time/Zone].

- Press the <Q> button and select the [2] tab.
- Turn the <MODE DIAL> dial to select the [2] tab.
- Turn the <SET> dial to select [Date/Time/Zone], then press <SET>.

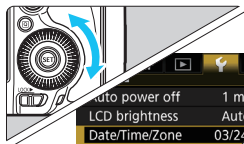

3 Set the time zone.

- [London] is set by default.
- Turn the <MODE DIAL> dial to select [Time zone].
- Press <SET> so <L> is displayed.
- Turn the <MODE DIAL> dial to select the time zone, then press <SET>.



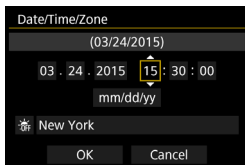

4 Set the date and time.

- Turn the <⊙> dial to select the number.
- Press <SET> so <⊙> is displayed.
- Turn the <⊙> dial to select the desired setting, then press <SET> (Returns to <□>).

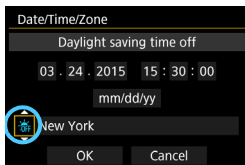

5 Set the daylight saving time.

- Set it if necessary.
- Turn the <⊙> dial to select [☀].
- Press <SET> so <⊙> is displayed.
- Turn the <⊙> dial to select [☀], then press <SET>.
- When the daylight saving time is set to [☀], the time set in step 4 will advance by 1 hr. If [☀] is set, the daylight saving time will be canceled and the time will go back by 1 hr.

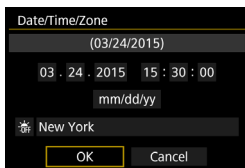

6 Exit the setting.

- Turn the <⊙> dial to select [OK], then press <SET>.
- ▶ The date/time/zone and daylight saving time will be set and the menu will reappear.

- ! The date/time/zone settings may be reset when the camera is stored without the battery, when its battery becomes exhausted, or when it is exposed to below freezing temperatures for a prolonged period. If this happens, set the date/time/zone again.
- After changing the time zone, check that the correct date/time are set.
- When performing [Sync time between cameras] via Wireless File Transmitter, using another EOS 5DS/EOS 5DS R is recommended. If you perform [Sync time between cameras] using different models, the time zone or time may not be set correctly.



- The date/time that were set will start from when you select [OK] in step 6.
- In step 3, the time displayed on the upper right of the screen is the time difference compared with Coordinated Universal Time (UTC). If you do not see your time zone, set the time zone while referring to the difference with UTC.

MENU Selecting the Interface Language



1 Display the menu screen.

- Press the <MENU> button to display the menu screen.

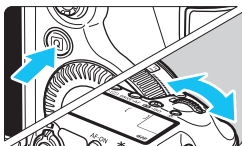

2 Under the [F2] tab, select [Language].

- Press the <Q> button and select the [F2] tab.
- Turn the <DIAL> dial to select the [F2] tab.
- Turn the <DIAL> dial to select [Language], then press <SET>.

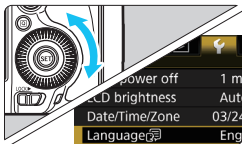

3 Set the desired language.

- Turn the <DIAL> dial to select the language, then press <SET>.
- ▶ The interface language will change.

English	Norsk	Română
Deutsch	Svenska	Türkçe
Français	Español	العربية
Nederlands	Ελληνικά	עברית
Dansk	Русский	繁體中文
Português	Polski	繁體中文
Suomi	Čeština	한국어
Italiano	Magyar	日本語
Українська		

Attaching and Detaching a Lens

The camera is compatible with all Canon EF lenses. **The camera cannot be used with EF-S or EF-M lenses.**

Attaching a Lens

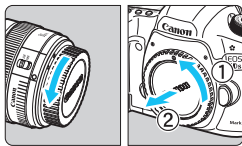

1 Remove the caps.

- Remove the rear lens cap and the body cap by turning them as shown by the arrows.

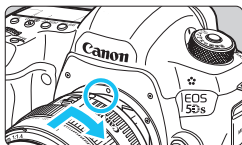

2 Attach the lens.

- Align the red dots on the lens and camera and turn the lens as shown by the arrow until it clicks in place.

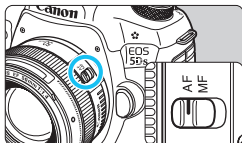

3 Set the lens's focus mode switch to <AF>.

- <AF> stands for autofocus.
- <MF> stands for manual focus. Autofocus will not operate.

4 Remove the front lens cap.

Detaching the Lens

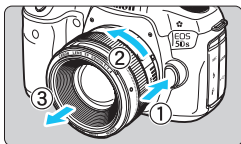

While pressing the lens release button, turn the lens as shown by the arrow.

- Turn the lens until it stops, then detach it.
- Attach the rear lens cap to the detached lens.



- Do not look at the sun directly through any lens. Doing so may cause loss of vision.
- When attaching or detaching a lens, set the camera's power switch to **<OFF>**.
- If the front part (focusing ring) of the lens rotates during autofocus, do not touch the rotating part.

Minimizing Dust

- When changing lenses, do it quickly in a place with minimal dust.
- When storing the camera without a lens attached, be sure to attach the body cap to the camera.
- Remove dust on the body cap before attaching it.

Basic Operation

Adjusting the Viewfinder Clarity

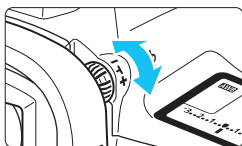

Turn the dioptic adjustment knob.

- Turn the knob left or right so that the AF points in the viewfinder look sharp.
- If the knob is difficult to turn, remove the eyecup (p.236).

 If the camera's dioptic adjustment still cannot provide a sharp viewfinder image, using Dioptic Adjustment Lens Eg (sold separately) is recommended.

Holding the Camera

To obtain sharp images, hold the camera still to minimize camera shake.

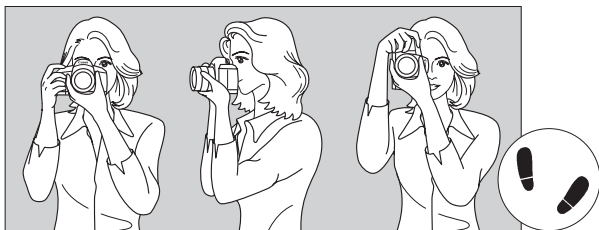

Horizontal shooting

Vertical shooting

1. Wrap your right hand around the camera grip firmly.
2. Hold the lens bottom with your left hand.
3. Rest your hand's right index finger lightly on the shutter button.
4. Press your arms and elbows lightly against the front of your body.
5. To maintain a stable stance, place one foot slightly ahead of the other.
6. Press the camera against your face and look through the viewfinder.

 To shoot while looking at the LCD monitor, see page 255.

Shutter Button

The shutter button has two steps. You can press the shutter button halfway. Then you can further press the shutter button completely.



Pressing Halfway

This activates autofocus and the automatic exposure system that sets the shutter speed and aperture.

The exposure setting (shutter speed and aperture) is displayed in the viewfinder and on the LCD panel for 4 sec. (metering timer/ \odot 4).



Pressing Completely

This releases the shutter and takes the picture.

Preventing Camera Shake

Hand-held camera movement during the moment of exposure is called camera shake. It can cause blurred pictures. To prevent camera shake, note the following:

- Hold and steady the camera as shown on the preceding page.
- Press the shutter button halfway to autofocus, then slowly press the shutter button completely.



- In the **<P>** **<Tv>** **<Av>** **<M>** **** shooting modes, pressing the **<AF-ON>** button will execute the same operation as pressing the shutter button halfway.
- If you press the shutter button completely without pressing it halfway first or if you press the shutter button halfway and then press it completely immediately, the camera will take a moment before it takes the picture.
- Even during menu display or image playback, you can go back to shooting-ready by pressing the shutter button halfway.

Mode Dial

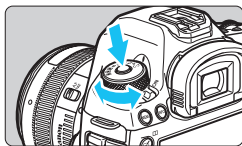



Turn the dial while holding down the lock release button at the center of the dial.



Use it to set the shooting mode.

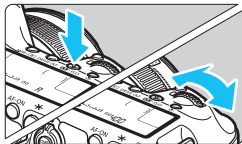

Main Dial





- (1) After pressing a button, turn the  dial.

When you press a button such as <WB>•> <DRIVE>•AF> <•ISO>, the respective function remains selected for 6 sec. (6). During this time, you can turn the  dial to change the setting. When the function selection ends or if you press the shutter button halfway, the camera will be ready to shoot.

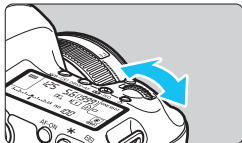
- Use this dial to select the metering mode, AF operation, ISO speed, AF point, etc.



- (2) Turn the  dial only.

While looking at the viewfinder or LCD panel, turn the  dial to change the setting.

- Use this dial to set the shutter speed, aperture, etc.

 The operations in (1) are possible even when the <LOCK> switch is set to the right (Multi function lock, p.59).

Quick Control Dial

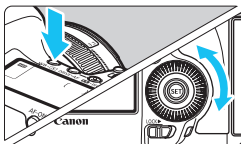

(1) After pressing a button, turn the dial.

When you press a button such as <WB> <DRIVE> <AF> <ISO>, the respective function remains selected for 6 sec. (6). During this time, you can turn the  dial to change the setting. When the function selection ends or if you press the shutter button halfway, the camera will be ready to shoot.

- Use this dial to select the white balance, drive mode, flash exposure compensation, AF point, etc.

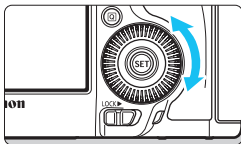

(2) Turn the dial only.



While looking at the viewfinder or LCD panel, turn the  dial to change the setting.

- Use this dial to set the exposure compensation amount, the aperture setting for manual exposures, etc.



The operations in (1) are possible even when the <LOCK> switch is set to the right (Multi function lock, p.59).

Multi-controller

The < > consists of an eight-direction key and a button at the center. Use your thumb to tilt the < > in the desired direction.

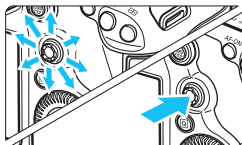



- Use it to select the AF point, correct the white balance, move the AF point or magnifying frame during Live View shooting, scroll around magnified images during playback, operate the Quick Control screen, etc.
- You can also use it to select and set menu items.
- For menus and Quick Control, the Multi-controller works only in the vertical and horizontal directions. It does not work in diagonal directions.

Touch Pad

During movie shooting, the touch pad provides a quiet way to adjust the shutter speed, aperture, exposure compensation, ISO speed, and sound recording level (p.302).

This function works when [ 5: Silent Control] is set to [Enable 

After pressing the < > button, tap the < > dial's inner ring at the top, bottom, left, or right.

LOCK▶ Multi Function Lock

By setting [**3: Multi function lock**] (p.410) and moving the <LOCK▶> switch to the right, you can prevent the Main Dial, Quick Control Dial, and Multi-controller from moving and changing a setting inadvertently.

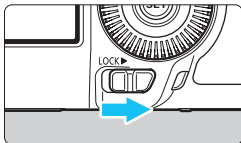

<LOCK▶> switch set to the left:

Lock released

<LOCK▶> switch set to the right:

Lock engaged

If the <LOCK▶> switch is set to the right and you try to operate any of the locked camera controls, <L> will appear in the viewfinder and on the LCD panel. Also, [LOCK] will appear on the Quick Control screen (p.60).

☼ LCD Panel Illumination



You can illuminate the LCD panel by pressing the <☼> button. Turn on (☼6) or off the LCD panel illumination by pressing the <☼> button.

During a bulb exposure, pressing the shutter button completely will turn off the LCD panel illumination.

Displaying Quick Control Screen

After you press the <INFO.> button a number of times (p.442), the Quick Control screen (p.62) or Custom Quick Control screen (p.427) will appear. You can then check the current shooting function settings. Pressing the <Q> button enables Quick Control of the shooting function settings (p.61). Then you can press the <INFO.> button to turn off the screen.

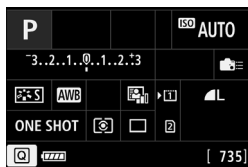
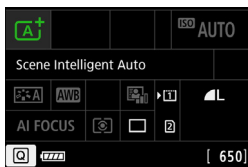

Q Quick Control for Shooting Functions

You can directly select and set the shooting functions displayed on the LCD monitor. This is called Quick Control.

The basic operating procedures are the same for the Quick Control screen (p.60) and the Custom Quick Control screen (p.427).

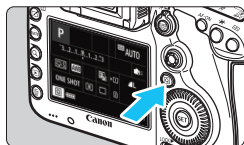

1 Press the <Q> button (10).

- ▶ The Quick Control screen will appear.

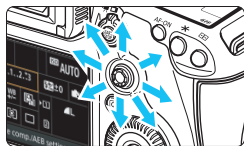

2 Set the desired functions.

- Use <Q> to select a function.
- ▶ The setting of the selected function is displayed.
- Turn the <Q> or <Q> dial to change the setting.

● <A+> mode

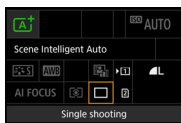

● <P/Tv/Av/M/B> modes

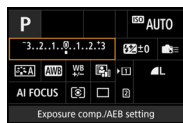
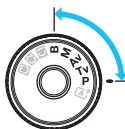

3 Take the picture.

- Press the shutter button completely to take the picture.
- ▶ The captured image will be displayed.



In the <A+> mode with the Quick Control screen displayed, you can only set recording function, card selection, image-recording quality, and drive mode.

Settable Functions on Quick Control Screen

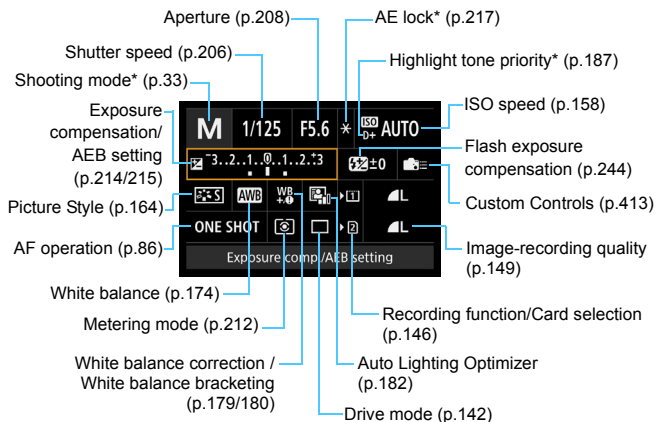

* Functions marked with an asterisk cannot be set with the Quick Control screen.

Custom Quick Control Screen

You can customize the layout of the Custom Quick Control screen. This feature lets you display and position the shooting functions on the Custom Quick Control screen as desired. For details, see page 427.

On the Custom Quick Control screen, if you press the $\langle \text{Q} \rangle$ button and there are no functions you can set with Quick Control, the Quick Control icon on the lower left of the screen will be displayed in orange.

Quick Control Screen

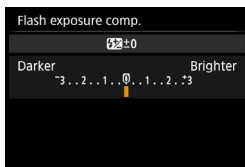
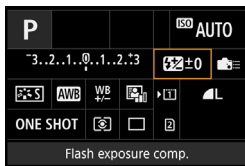

- Select a function and press **<SET>**. The function setting screen will appear.
- Turn the **<DIAL>** or **<DIAL>** dial to change some of the settings. There are also functions that are set by pressing the button.
- Press **<SET>** to finalize the setting and return to the previous screen.
- When you select **<MENU>** (p.413) and press the **<MENU>** button, the previous screen will reappear.

MENU Menu Operations

You can set various settings with the menus such as the image-recording quality, date/time, etc.

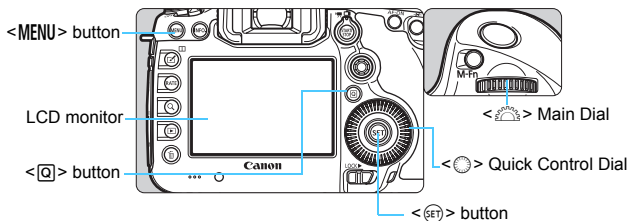

[A]⁺ Mode Menu Screen

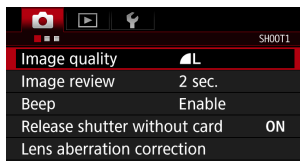

* Certain menu tabs and menu items are not displayed in the **[A]⁺** mode.

P/Tv/Av/M/B Mode Menu Screen

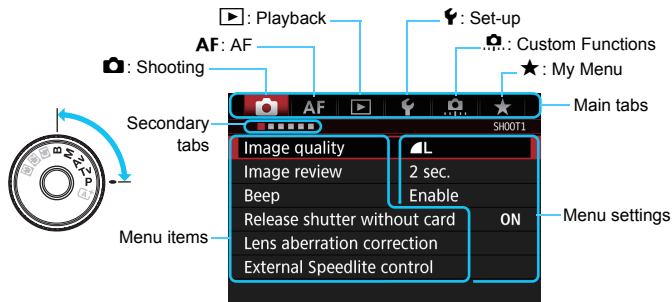

Menu Setting Procedure

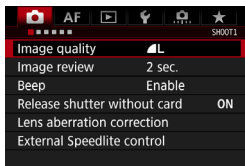

1 Display the menu screen.

- Press the <MENU> button to display the menu screen.

2 Select a tab.

- Each time you press the <Q> button, the main tab will switch.
- Turn the <return> dial to select a secondary tab.
- For example, the [5] tab refers to the screen displayed when the (Shooting) tab's fifth dot "■" from the left is selected.

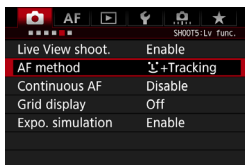

3 Select the desired item.

- Turn the <return> dial to select the item, then press <SET>.

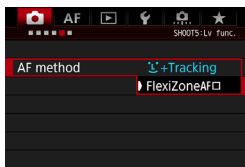

4 Select the setting.

- Turn the <return> dial to select the desired setting.
- The current setting is indicated in blue.

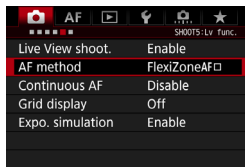

5 Adjust the setting.

- Press <SET> to set it.

6 Exit the setting.

- Press the <MENU> button to exit the menu and return to shooting-ready.

- The explanation of menu functions hereinafter assumes that you have pressed the <MENU> button to display the menu screen.
- You can also use <⏏> to operate and set menu functions. (Except for [▶1: Erase images] and [⚡1: Format card].)
- To cancel the operation, press the <MENU> button.
- For details about each menu item, see page 460.

Dimmed Menu Items

Example: When Multi Shot Noise Reduction is set

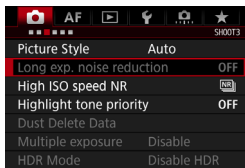

Dimmed menu items cannot be set. The menu item is dimmed if another function setting is overriding it.

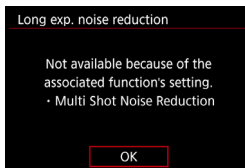

You can see the overriding function by selecting the dimmed menu item and pressing <ⓈET>. If you cancel the overriding function's setting, the dimmed menu item will become settable.

Some dimmed menu items will not show the overriding function.

With [⚡4: Clear all camera settings], you can reset the menu functions to the default settings (p.70).

Before You Start

MENU Formatting the Card

If the card is new or was previously formatted by another camera or computer, format the card with this camera.

⚠ Cautions for Formatting the Card

When the card is formatted, all images and data on the card will be erased. Even protected images will be erased, so make sure there is nothing you need to keep. If necessary, transfer the images and data to a computer, etc., before formatting the card.

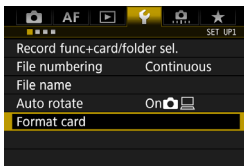

1 Select [Format card].

- Under the [**f**1] tab, select [**Format card**], then press <[SET]>.

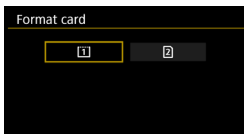

2 Select the card.

- [1] is the CF card, and [2] is the SD card.
- Select the card, then press <[SET]>.

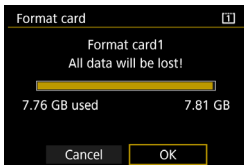

3 Select [OK].

- ▶ The card will be formatted.

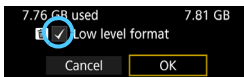

- When [2] is selected, low-level formatting is possible (p.68). For low-level formatting, press the <[]> button to append [**Low level format**] with a checkmark <✓>, then select [**OK**].



Format the card in the following cases:

- The card is new.
- The card was formatted by a different camera or a computer.
- The card is full with images or data.
- A card-related error is displayed (p.487).

Low-level Formatting

- Perform low-level formatting if the SD card's reading or writing speed seems slow or if you want to totally erase all data on the card.
- Since low-level formatting will erase all recordable sectors on the SD card, the formatting will take longer than normal formatting.
- You can stop the low-level formatting by selecting **[Cancel]**. Even in this case, normal formatting will be completed and you can use the SD card as usual.

- When the card is formatted or data is erased, only the file management information is changed. The actual data is not completely erased. Be aware of this when selling or discarding the card. When discarding the card, execute low-level formatting or destroy the card physically to prevent the personal data from being leaked.
- Before using a new Eye-Fi card (p.451), the software on the card must be installed on your computer. Then format the card with the camera.



- The card capacity displayed on the card format screen may be smaller than the capacity indicated on the card.
- This device incorporates exFAT technology licensed from Microsoft.

MENU Disabling the Beeper

You can prevent the beeper from sounding when focus is achieved or during self-timer operation.

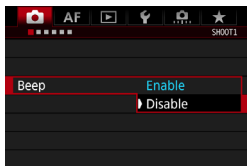

1 Select [Beep].

- Under the [**1**] tab, select [**Beep**], then press <SET>.

2 Select [Disable].

- Select [**Disable**], then press <SET>.
- The beeper will not sound.

MENU Setting the Power-off Time/Auto Power Off

To save battery power, the camera turns off automatically after a set time of idle operation elapses. The default setting is 1 min., but this setting can be changed. If you do not want the camera to turn off automatically, set this to [**Disable**]. After the power turns off, you can turn on the camera again by pressing the shutter button or other buttons.

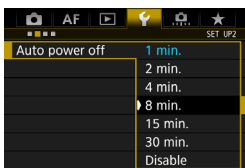

1 Select [Auto power off].

- Under the [**2**] tab, select [**Auto power off**], then press <SET>.

2 Set the desired time.

- Select the desired setting, then press <SET>.

Even if [**Disable**] is set, the LCD monitor will turn off automatically after 30 min. to save power. (The camera's power does not turn off.)

MENU Setting the Image Review Time

You can set how long the image is displayed on the LCD monitor just after shooting. To keep the image displayed, set **[Hold]**. To not have the image displayed, set **[Off]**.

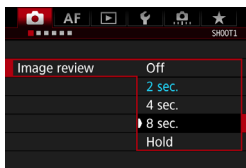

1 Select **[Image review]**.

- Under the **[1]** tab, select **[Image review]**, then press **<SET>**.

2 Set the desired time.

- Select the desired setting, then press **<SET>**.

If **[Hold]** is set, the image will be displayed until the auto power off time elapses.

MENU Reverting the Camera to the Default Settings [☆]

The camera's shooting function settings and menu settings can be reverted to their defaults.

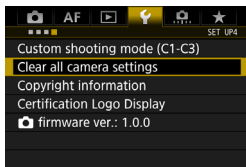

1 Select **[Clear all camera settings]**.

- Under the **[4]** tab, select **[Clear all camera settings]**, then press **<SET>**.

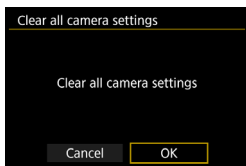

2 Select **[OK]**.

- Clearing all the camera settings will reset the camera to the default settings on pages 71-73.

Shooting Function Settings

AF operation	One-Shot AF
AF area selection mode	Single-point AF (Manual Selection)
AF point selection	Center
Registered AF point	Canceled
Metering mode	 (Evaluative metering)
ISO speed	Auto
ISO speed range	Minimum limit: 100 Maximum limit: 6400
Auto ISO range	Minimum limit: 100 Maximum limit: 3200
Minimum shutter speed	Auto
Drive mode	<input type="checkbox"/> (Single shooting)
Exposure compensation/AEB	Canceled
Flash exposure compensation	Canceled
Multiple exposure	Disable
HDR Mode	Disable HDR
Interval timer	Disable
Bulb timer	Disable
Anti-flicker shooting	Disable
Mirror lockup	Disable
Viewfinder display	
Electronic level	Hide
Grid display	Hide
Show/hide in viewfinder	Only Flicker selected
Custom Functions	Unchanged
External Speedlite control	
Flash firing	Enable
E-TTL II flash metering	Evaluative flash metering
Flash sync. speed in Av mode	Auto

AF Settings

Case 1 - 6	Case1/Parameter settings of all cases cleared
AI Servo 1st image priority	Equal priority
AI Servo 2nd image priority	Equal priority
Lens electronic MF	Enable after One-Shot AF
AF-assist beam firing	Enable
One-Shot AF release priority	Focus priority
Lens drive when AF impossible	Continue focus search
Selectable AF point	61 points
Select AF area selection mode	All items selected
AF area selection method	M-Fn button
Orientation linked AF point	Same for both vertical/horizontal
Initial AF point,  AI Servo AF	Auto
Automatic AF point selection: EOS iTR AF	Enable
Manual AF point selection pattern	Stops at AF area edges
AF point display during focus	Selected (constant)
VF display illumination	Auto
AF point during AI Servo AF	Non illuminated
AF Microadjustment	Disable/Adjustment amount retained

Image Recording Settings

Image quality	L
Crop/aspect ratio	Full-frame
Picture Style	Standard
Auto Lighting Optimizer	Standard
Lens aberration correction	
Peripheral illumination correction	Enable/Correction data retained
Chromatic aberration correction	Enable/Correction data retained
White balance	(Ambience priority)
Custom White Balance	Canceled
White balance shift	Canceled
White balance bracketing	Canceled
Color space	sRGB
Long exposure noise reduction	Disable
High ISO speed noise reduction	Standard
Highlight tone priority	Disable
Record function	Standard
File numbering	Continuous
File name	Preset code
Auto cleaning	Enable
Dust Delete Data	Erased









Camera Settings

Auto power off	1 min.
Beep	Enable
Release shutter without card	Enable
Image review time	2 sec.
Highlight alert	Disable
AF point display	Disable
Playback grid	Off
Histogram display	Brightness
Movie playback count	Unchanged
Magnification (Approx.)	2x (magnify from center)
Control over HDMI	Disable
Image jump w/	(10 images)
Auto rotate	On
LCD brightness	Auto
Date/Time/Zone	Unchanged
Eye-Fi settings	Disable
Language	Unchanged
Video system	Unchanged
button display options	All items selected
Custom Quick Control	Unchanged
button function	Rating
Custom shooting mode	Unchanged
Copyright information	Unchanged
Configure: MY MENU	Unchanged
Menu display	Normal display

Live View Shooting Settings

Live View shooting	Enable
AF method	 +Tracking
Continuous AF	Disable
Grid display	Off
Exposure simulation	Enable
Silent LV shooting	Mode 1
Metering timer	8 sec.

Movie Shooting Settings

Movie Servo AF	Disable
AF method	 +Tracking
Grid display	Off
Movie recording size	NTSC:   PAL:  
Sound recording	Auto
Wind filter	Disable
Attenuator	Disable
Silent LV shooting	Mode 1
Metering timer	8 sec.
Time code	
Count up	Unchanged
Start time setting	Unchanged
Movie recording count	Unchanged
Movie playback count	Unchanged
Drop frame	Unchanged
Silent control	Disable 
 button function	 AF / 
Time-lapse movie	Disable

⚡ Displaying the Grid

You can display a grid in the viewfinder to help you check the camera tilt or compose the shot.

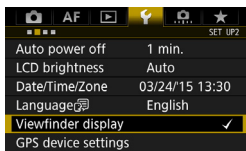

1 Select [Viewfinder display].

- Under the [**⚡**] tab, select [Viewfinder display], then press < (SET) >.



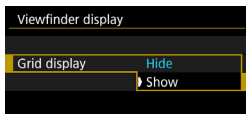

2 Select [Grid display].

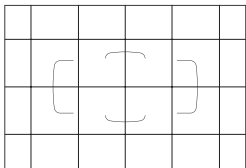

3 Select [Show].

- When you exit the menu, the grid will appear in the viewfinder.



 You can display a grid on the LCD monitor during Live View shooting and before you start shooting a movie (p.265, 315).

Displaying the Electronic Level

You can display the electronic level on the LCD monitor and in the viewfinder to help you correct camera tilt.

Displaying the Electronic Level on the LCD Monitor

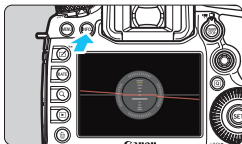

1 Press the <INFO.> button.

- Each time you press the <INFO.> button, the screen display will change.
- Display the electronic level.

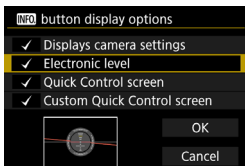

- If the electronic level does not appear, set [**43**: **INFO** button display options] so that the electronic level can be displayed (p.442).



Vertical level Horizontal level

2 Check the camera's tilt.

- The horizontal and vertical tilt are displayed in 1° increments.
- When the red line turns green, it indicates that the tilt is almost corrected.

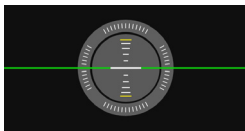

- Even when the tilt is corrected, there may be a margin of error of approx. $\pm 1^\circ$.
- If the camera is very tilted, the electronic level's margin of error will be larger.



During Live View shooting and before movie shooting, you can also display the electronic level as described above (except with **L** + Tracking).

MENU Displaying the Electronic Level in the Viewfinder

An electronic level can be displayed on the upper part of the viewfinder. Since this can be displayed while you shoot, you can correct the camera tilt while shooting.

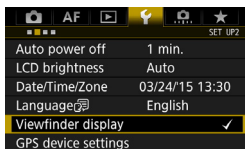

1 Select [Viewfinder display].

- Under the [📷] tab, select [Viewfinder display], then press < (SET) >.

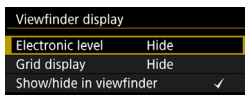

2 Select [Electronic level].



3 Select [Show].

4 Press the shutter button halfway.

- The electronic level will be displayed in the viewfinder.
- This also works with vertical shooting.

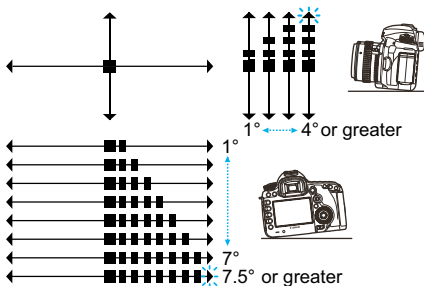

⚠ Even when the tilt is corrected, there may be a margin of error of approx. $\pm 1^\circ$.

MENU Setting the Viewfinder Information Display ☆

The shooting function settings (Battery, White balance, Drive mode, AF operation, Metering mode, Image quality: JPEG/RAW, Flicker detection) can be displayed in the viewfinder.

By default, only Flicker detection is checkmarked [✓].



1 Select [Viewfinder display].

- Under the [MENU] tab, select [Viewfinder display], then press <SET>.

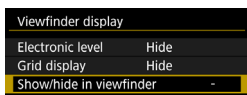

2 Select [Show/hide in viewfinder].

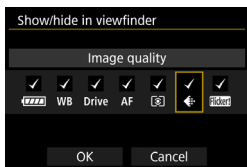

3 Checkmark [✓] the information to be displayed.

- Select the information to display and press <SET> to append a checkmark <✓>.
- Repeat this procedure to append a checkmark [✓] to all the information to be displayed. Then select [OK].
- When you exit the menu, the checkmarked information will appear in the viewfinder (p.31).



⚠ If no card is inserted in the camera, the image-recording quality will not be displayed.

- When you press the <WB•[WB]> or <DRIVE•AF> button, operate the lens's focus mode switch, or when a lens equipped with electronic manual focusing function is used and the AF/MF switches as the lens's focusing ring is turned (p.120), the respective information will appear in the viewfinder regardless of whether it is checkmarked.
- If [Battery] is not checkmarked, the battery check icon ([Battery] / [Battery]) will be displayed in the viewfinder when the battery level is low.

? Help

When [INFO Help] is displayed at the bottom of the menu screen, the feature's description (Help) can be displayed. The Help screen is displayed only while you hold down the <INFO.> button. If the Help fills more than one screen, a scroll bar will appear on the right edge. To scroll, hold down the <INFO.> button and turn the <DIAL> dial.

● Example: [AF1: Case2]

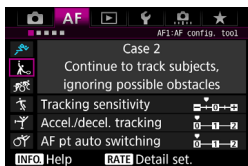

INFO.

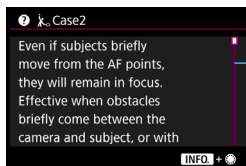

Scroll bar

● Example: [AF4: Orientation linked AF point]

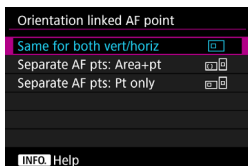

INFO.

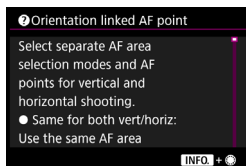

● Example: [AF3: Multi function lock]



INFO.

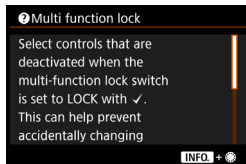

2

Basic Shooting

This chapter explains how to use the Mode Dial's <A⁺> (Scene Intelligent Auto) mode for easy picture taking.

In the <A⁺> mode, all you do is point and shoot and the camera sets everything automatically (p.456). Also, to prevent botched pictures due to mistaken operations, advanced shooting function settings cannot be changed.

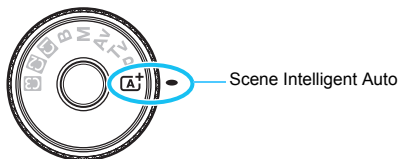

Auto Lighting Optimizer

In the <A⁺> mode, the Auto Lighting Optimizer (p.182) will adjust the image automatically to obtain the optimum brightness and contrast. It is also enabled by default in the <P>, <Tv>, or <Av> mode.

[A⁺] Fully Automatic Shooting (Scene Intelligent Auto) ■

<[A⁺]> is a fully automatic mode. The camera analyzes the scene and sets the optimum settings automatically. It also adjusts focus automatically by detecting whether the subject is still or moving (p.83).



1 Set the Mode Dial to <[A⁺]>.

- Turn the Mode Dial while holding down the lock release button at the center.

Area AF frame

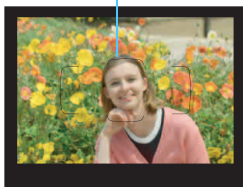

2 Aim the Area AF frame over the subject.

- All the AF points will be used to focus, and the camera will focus on the closest object.
- Aiming the center of the Area AF frame over the subject will make focusing easier.

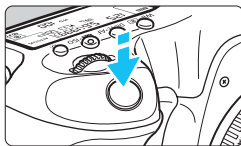

3 Focus on the subject.

- Press the shutter button halfway. The lens elements will shift to focus.
- ▶ During the autofocus operation, **<[AF]>** will be displayed.
- ▶ The AF point that achieves focus will be displayed. At the same time, the beeper will sound and the focus indicator **<●>** will light up.
- ▶ In low light, the AF point(s) will light up briefly in red.



Focus indicator

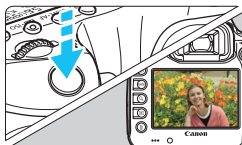

4 Take the picture.

- Press the shutter button completely to take the picture.
- ▶ The captured image will be displayed for 2 sec. on the LCD monitor.

 The **A⁺** mode makes the colors look more impressive in nature, outdoor, and sunset scenes. If you did not obtain the desired color tones, change the mode to **P**, **Tv**, **Av**, or **M**, set a Picture Style other than **StA**, then shoot again (p.164).

? FAQ

- **The focus indicator <●> blinks and focus is not achieved.**
Aim the Area AF frame over an area with good contrast, then press the shutter button halfway (p.55). If you are too close to the subject, move away and try again. If focus cannot be achieved, the AF status indicator <▲> will also blink.
- **When focus is achieved, the AF points do not light up in red.**
The AF points light up in red only when focus is achieved in low-light conditions.
- **Multiple AF points light up simultaneously.**
Focus has been achieved at all those points. You can take the picture as long as an AF point covering the target subject is lighting up.
- **The beeper continues to beep softly. (The focus indicator <●> does not light up.)**
It indicates that the camera is focusing continuously on a moving subject. (The AF status indicator <▲> lights up, but the focus confirmation light <●> does not light up.) You can take sharp pictures of a moving subject.
Note that focus lock (p.83) will not work in this case.

- **Pressing the shutter button halfway does not focus on the subject.**

If the focus mode switch on the lens is set to <MF> (manual focus), set it to <AF> (autofocus).

- **The shutter speed display is blinking.**

Since it is too dark, taking the picture may result in a blurred subject due to camera shake. Using a tripod or a Canon EX-series Speedlite (sold separately, p.244) is recommended.

- **When the external flash was used, the bottom part of the picture came out unnaturally dark.**

If a hood is attached to the lens, it can obstruct the flash light. If the subject is close, detach the hood before taking the picture with flash.

[A⁺] Full Auto Techniques (Scene Intelligent Auto) ■

Recomposing the Shot

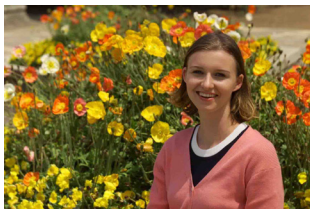

Depending on the scene, position the subject toward the left or right to create a balanced background and good perspective.

In the <[A⁺]> mode, pressing the shutter button halfway to focus on a still subject will lock the focus on that subject. Recompose the shot while keeping the shutter button pressed halfway, and then press the shutter button completely to take the picture. This is called “focus lock”.

Shooting a Moving Subject



In the <[A⁺]> mode, if the subject moves (distance to camera changes) while or after you focus, AI Servo AF will take effect to focus on the subject continuously. (The beeper will continue beeping softly.) As long as you keep the Area AF frame positioned over the subject while pressing the shutter button halfway, the focusing will be continuous. When you want to take the picture, press the shutter button completely.

Live View Shooting

You can shoot while viewing the image on the LCD monitor. This is called “Live View shooting”. For details, see page 255.

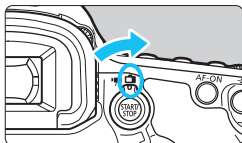

- 1 Set the Live View shooting/Movie shooting switch to .**

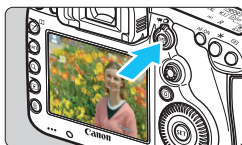

- 2 Display the Live View image on the LCD monitor.**

- Press the button.
- ▶ The Live View image will appear on the LCD monitor.

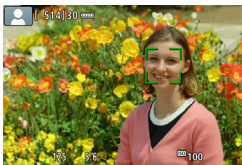

- 3 Focus on the subject.**

- Press the shutter button halfway to focus.
- ▶ When focus is achieved, the AF point will turn green and the beeper will sound.

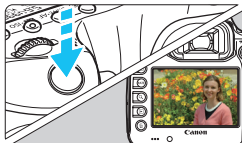

- 4 Take the picture.**

- Press the shutter button completely.
- ▶ The picture is taken and the captured image is displayed on the LCD monitor.
- ▶ When the playback display ends, the camera will return to Live View shooting automatically.
- Press the button to exit the Live View shooting.

3

Setting the AF and Drive Modes

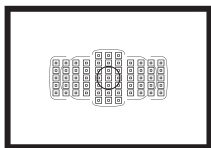

The AF points in the viewfinder are arranged to make AF shooting suitable for a wide variety of subjects and scenes.

You can also select the AF operation and drive mode that best match the shooting conditions and subject.

- A ☆ icon at the upper right of a page title indicates a function that can be used only in the following modes: <P> <Tv> <Av> <M> .
- In the <A+> mode, the AF operation and AF area selection mode are set automatically.



<AF> stands for autofocus. <MF> stands for manual focus.

AF: Selecting the AF Operation ☆

You can select the AF operation characteristics to suit the shooting conditions or subject. In the <A+> mode, "AI Focus AF" is set automatically.

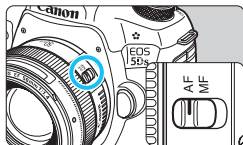

1 Set the lens's focus mode switch to <AF>.

2 Set the <P> <Tv> <Av> <M> mode.

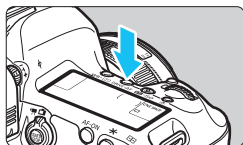

3 Press the <DRIVE·AF> button. (⊗6)

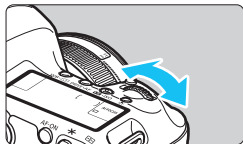

4 Select the AF operation.

- While looking at the LCD panel or in the viewfinder, turn the <⚙> dial.

ONE SHOT : One-Shot AF

AI FOCUS : AI Focus AF

AI SERVO : AI Servo AF

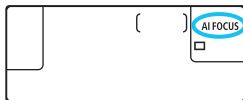

In the <P>, <Tv>, <Av>, <M>, or mode, AF is also possible by pressing the <AF-ON> button.

One-Shot AF for Still Subjects



AF point

Focus indicator

Suited for still subjects. When you press the shutter button halfway, the camera will focus only once.

- When focus is achieved, the AF point that achieved focus will be displayed, and the focus indicator <●> in the viewfinder will also light up.
 - With evaluative metering (p.212), the exposure setting will be set at the same time as focus is achieved.
- While you hold down the shutter button halfway, the focus will be locked. You can then recompose the shot if desired.



- If focus cannot be achieved, the focus indicator <●> in the viewfinder will blink. If this occurs, the picture cannot be taken even if the shutter button is pressed completely. Recompose the shot and try to focus again or see “When Autofocus Fails” (p.140).
- If [**1: Beep**] is set to [**Disable**], the beeper will not sound when focus is achieved.
- After achieving focus with One-Shot AF, you can lock the focus on a subject and recompose the shot. This is called “focus lock”. This is convenient when you want to focus on a peripheral subject not covered by the Area AF frame.

AI Servo AF for Moving Subjects

This AF operation is suited for moving subjects when the focusing distance keeps changing. While you hold down the shutter button halfway, the camera will keep focusing on the subject continuously.

- The exposure is set at the moment the picture is taken.
- When the AF area selection mode (p.90) is set to 61-point automatic selection AF, focus tracking will continue as long as the Area AF frame covers the subject.

 With AI Servo AF, the beeper will not sound even when focus is achieved. Also, the focus indicator <●> in the viewfinder will not light up.

AI Focus AF for Switching the AF Operation Automatically

AI Focus AF switches the AF operation from One-Shot AF to AI Servo AF automatically if a still subject starts moving.

- After the subject is focused in One-Shot AF, if the subject starts moving, the camera will detect the movement, change the AF operation automatically to AI Servo AF, and start tracking the moving subject.

 When focus is achieved with AI Focus AF with the Servo operation active, the beeper will continue beeping softly. However, the focus indicator <●> in the viewfinder will not light up. Note that focus will not be locked in this case.

AF Operation Indicator



While you press the shutter button halfway and the camera focuses with AF, the <▲> icon will appear under the focus indicator in the viewfinder.

In One-Shot AF mode, the icon also appears if you press the shutter button halfway after focus is achieved.

AF Points Lighting Up in Red

By default, the AF points light up in red in low-light conditions. In the <P>, <Tv>, <Av>, <M>, or mode, you can set whether to have the AF points light up in red (p.132).

Selecting the AF Area and AF Point [☆]

The camera has 61 AF points for autofocusing. You can select the AF area selection mode and AF point(s) suiting the scene or subject.

 Depending on the lens attached to the camera, the number of usable AF points and AF point patterns will differ. For details, see “Lenses and Usable AF Points” on page 100.

AF Area Selection Mode

You can select one of six AF area selection modes. For the setting procedure, see page 92.

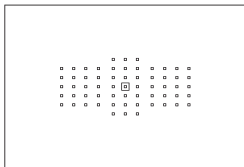

Single-point Spot AF (Manual selection)

For pinpoint focusing.

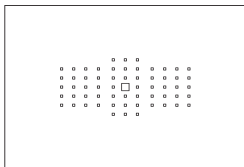

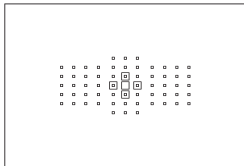

Single-point AF (Manual selection)

Select one AF point to focus.



AF point expansion (Manual selection)

The manually-selected AF point < > and four adjacent AF points < > (above, below, on the left, and on the right) are used to focus.

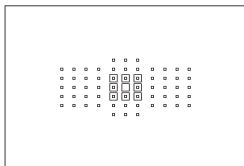

 **AF point expansion (Manual selection, surrounding points)**

The manually-selected AF point <□> and the surrounding AF points <▣> are used to focus.

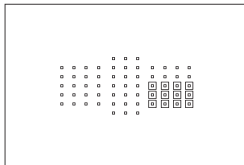

 **Zone AF (Manual selection of zone)**

One of nine zones is used to focus.

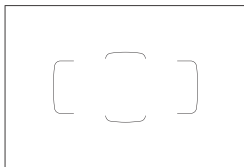

 **61-point automatic selection AF**

The Area AF frame (entire AF area) is used to focus. **This mode is set automatically in the <A+> mode.**

Selecting the AF Area Selection Mode

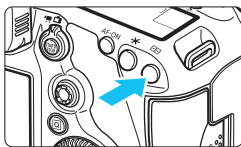



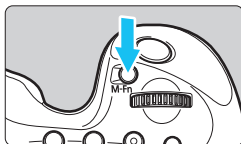

1 Press the  button. (ⓘ6)



2 Press the **<M-Fn>** button.

- Look through the viewfinder and press the **<M-Fn>** button.
- Each time you press the **<M-Fn>** button, the AF area selection mode changes.

- 
- With [**AF4: Select AF area selec. mode**], you can limit the selectable AF area selection modes (p.125).
 - If you set [**AF4: AF area selection method**] to [ → **Main Dial**], you can select the AF area selection mode by pressing the  button, then turning the  dial (p.126).

Selecting the AF Point Manually

You can manually select the AF point or zone.

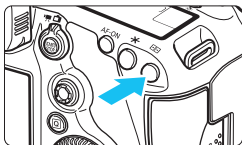

1 Press the <☰> button. (Ⓞ6)

- ▶ The AF points will be displayed in the viewfinder.
 - In AF point expansion modes, adjacent AF points will also be displayed.
 - In the Zone AF mode, the selected zone will be displayed.

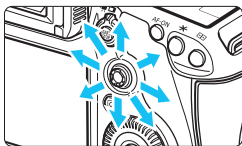

2 Select an AF point.

- The AF point selection will change in the direction you tilt <☰>. If you press <☰> straight down, the center AF point (or center zone) will be selected.
- You can also select a horizontal AF point by turning the <☰> dial and select a vertical AF point by turning the <☰> dial.
- In the Zone AF mode, turning the <☰> or <☰> dial will change the zone in a looping sequence.

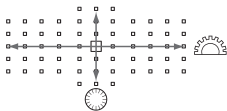

- When [AF4: Initial AF pt, Ⓞ AI Servo AF] is set to [Initial Ⓞ AF pt selected] (p.128), you can use this method to manually select the AI Servo's AF starting position.
- When you press the <☰> button, the LCD panel displays the following:
 - 61-point automatic selection AF and Zone AF: [☰] AF
 - Single-point Spot AF, Single-point AF, and AF point expansion: SEL [] (Center)/SEL AF (Off-center)

AF Point Display Indications

Pressing the <> button lights up the AF points that are cross-type AF points for high-precision autofocusing. The blinking AF points are horizontal-line or vertical-line sensitive. For details, see pages 99-104.

Registering the AF point

You can register a frequently-used AF point to the camera.

When you use the button set with the [ **3: Custom Controls**] (p.413) menu's detailed settings screens for [**Metering and AF start**], [**Switch to registered AF point**], [**Direct AF point selection**], or [**Register/recall shooting func**], you can instantly switch from the current AF point to the registered AF point.

For details on registering the AF point, see page 418.

AF Area Selection Modes ☆

▣ Single-point Spot AF (Manual selection)



For pinpoint focusing over a narrower area than with single-point AF (manual selection). Select one AF point <▣> to focus.

Effective for pinpoint focusing or focusing overlapping subjects such as an animal in a cage. Since Single-point Spot AF (manual selection) covers a very small area, focusing may be difficult during hand-held shooting or for a moving subject.

□ Single-point AF (Manual selection)



Select one AF point <□> to be used for focusing.

◻ AF point expansion (Manual selection ◻)

The manually-selected AF point <◻> and adjacent AF points <◻> (above, below, on the left, and on the right) are used to focus. Effective when it is difficult to track a moving subject with just one AF point. With AI Servo AF, the initial manually-selected AF point <◻> must focus-track the subject first. However, it is superior to Zone AF in focusing on the target subject.

With One-Shot AF, when focus is achieved with expanded AF points, the expanded AF points <◻> will also be displayed along with the manually-selected AF point <◻>.



AF point expansion (Manual selection, surrounding points)

The manually-selected AF point <□> and surrounding AF points <○> are used to focus. The AF point expansion is larger than with AF point expansion (manual selection «□»), so the focusing is executed over a wider area. Effective when it is difficult to track a moving subject with just one AF point.

AI Servo AF and One-Shot AF work in the same way as with AF point expansion (manual selection «□») mode (p.95).



Zone AF (Manual selection of zone)

The AF area is divided into nine focusing zones for focusing. All the AF points in the selected zone are used for the automatic AF point selection. It is superior to single-point AF or AF point expansion in achieving focus, and it is effective for moving subjects.

However, since it is inclined to focus on the nearest subject, focusing on a specific target may be more difficult than with single-point AF or AF point expansion.

The AF point(s) achieving focus is displayed as <□>.

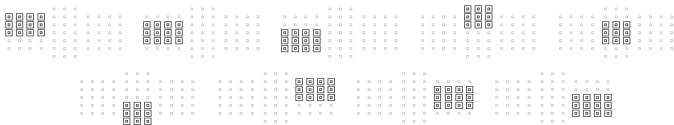

61-point automatic selection AF

The Area AF frame (entire AF area) is used to focus. This mode is set automatically in the < > mode.

The AF point(s) achieving focus is displayed as < >.



With One-Shot AF, pressing the shutter button halfway will display the AF point(s) < > that achieved focus. If multiple AF points are displayed, it means they all have achieved focus. This mode tends to focus on the nearest subject.

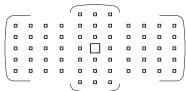

With AI Servo AF, you can set the AI Servo AF's starting position with **[Initial AF pt,  AI Servo AF]** (p.128). As long as the Area AF frame can track the subject during shooting, focusing will continue.

- When AI Servo AF mode is set with 61-point automatic selection AF, or Zone AF (manual selection of zone), the active AF point <□> will keep switching to track the subject. However, under certain shooting conditions (such as when the subject is small), it may not be able to track the subject. Also, in low temperatures, the tracking response may become slower.
- With Single-point Spot AF (manual selection), focusing with an EOS-dedicated, external Speedlite's AF-assist beam may be difficult.
- If a peripheral AF point or a wide-angle lens is used, achieving focus may be difficult with an EOS-dedicated, external Speedlite's AF-assist beam. In such a case, use an AF point closer to the center.
- When the AF point(s) light up, part or all of the viewfinder may light up in red. Also, if [**4: Crop/aspect ratio**] is set, the semi-transparent, masked area may light up in red. This is a characteristic of the AF point display (using liquid crystal).
- In low temperatures, the AF point's display may be difficult to see. This is a characteristic of AF point display (using liquid crystal).

- With [**AF4: Orientation linked AF point**], you can set the AF area selection mode + AF point (or only the AF point) separately for the horizontal and vertical orientations (p.126).
- With [**AF4: Selectable AF point**], you can change the number of manually selectable AF points (p.124).



AF Sensor

The camera's AF sensor has 61 AF points. The illustration below shows the AF sensor pattern corresponding to each AF point. With $f/2.8$ or larger maximum aperture lenses, high-precision AF is possible at the viewfinder center.

Depending on the lens attached to the camera, the number of usable AF points and AF pattern will differ. For details, see pages 100-108.

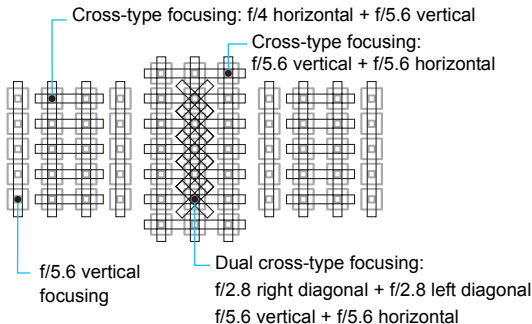
Diagram

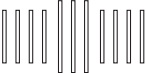

	<p>These focusing sensors are geared to obtain higher precision focusing with $f/2.8$ or larger maximum aperture lenses. A diagonal cross pattern makes it easier to focus subjects that may be difficult to focus. They cover the five AF points vertically aligned at the center.</p>
	<p>These focusing sensors are geared to obtain high-precision focusing with $f/4$ or larger maximum aperture lenses. Since they have a horizontal pattern, they can detect vertical lines.</p>
	<p>These focusing sensors are geared for $f/5.6$ or larger maximum aperture lenses. Since they have a horizontal pattern, they can detect vertical lines. They cover the three columns of AF points at the viewfinder's center. The center AF point and the adjacent AF points at the top and bottom are compatible with $f/8$ or larger maximum-aperture lenses.</p>
	<p>These focusing sensors are geared for $f/5.6$ or larger maximum aperture lenses. Since they have a vertical pattern, they can detect horizontal lines. They cover all 61 AF points. The center AF point and the adjacent AF points on the left and on the right are compatible with $f/8$ or larger maximum-aperture lenses.</p>

Lenses and Usable AF Points

- Although the camera has 61 AF points, the number of usable AF points and focusing patterns will differ depending on the lens. The lenses are thereby classified into nine groups from A to I.
- When using a lens in Groups F to H, fewer AF points will be usable.
- See which group each lens belongs to on pages 105-108. Check which group the lens in use belongs to.

- When you press the <AF-ON> button, the AF points indicated by the □ mark will blink. (The ■/▣/□ AF points will stay lit.) Regarding lighting up or blinking of the AF points, see page 94.
- Regarding new lenses marketed after the EOS 5DS/EOS 5DS R (in the first half of 2015), check the Canon Web site to see which group they belong to.
- Some lenses may not be available in certain countries or regions.

Group A

Autofocusing with 61 points is possible. All the AF area selection modes are selectable.

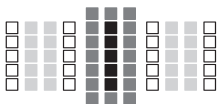

- : Dual cross-type AF point. Subject tracking is superior and the focusing precision is higher than with other AF points.
- ▣: Cross-type AF point. Subject tracking is superior and high-precision focusing is achieved.
- : AF points sensitive to horizontal lines.

Group B

Autofocusing with 61 points is possible. All the AF area selection modes are selectable.

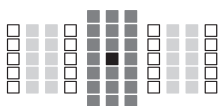

- : Dual cross-type AF point. Subject tracking is superior and the focusing precision is higher than with other AF points.
- : Cross-type AF point. Subject tracking is superior and high-precision focusing is achieved.
- : AF points sensitive to horizontal lines.

Group C

Autofocusing with 61 points is possible. All the AF area selection modes are selectable.

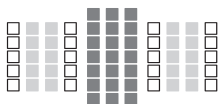

- : Cross-type AF point. Subject tracking is superior and high-precision focusing is achieved.
- : AF points sensitive to horizontal lines.

Group D

Autofocusing with 61 points is possible. All the AF area selection modes are selectable.

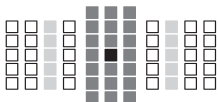

- : Dual cross-type AF point. Subject tracking is superior and the focusing precision is higher than with other AF points.
- : Cross-type AF point. Subject tracking is superior and high-precision focusing is achieved.
- : Cross-type AF point. Subject tracking is superior and high-precision focusing is achieved.
- : AF points sensitive to horizontal lines.

Group E

Autofocusing with 61 points is possible. All the AF area selection modes are selectable.

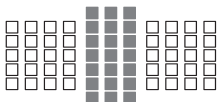

- : Cross-type AF point. Subject tracking is superior and high-precision focusing is achieved.
- : AF points sensitive to horizontal lines.

Group F

Autofocusing with only 47 points is possible. (Not possible with all 61 AF points.) All the AF area selection modes are selectable. During automatic AF point selection, the outer frame marking the AF area (Area AF frame) will be different from 61-point automatic selection AF.

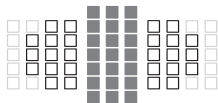

- : Cross-type AF point. Subject tracking is superior and high-precision focusing is achieved.
- : AF points sensitive to horizontal lines.
- : Disabled AF points (not displayed).

Group G

Autofocusing with only 33 points is possible. (Not possible with all 61 AF points.) All the AF area selection modes are selectable. During automatic AF point selection, the outer frame marking the AF area (Area AF frame) will be different from 61-point automatic selection AF.



- : Cross-type AF point. Subject tracking is superior and high-precision focusing is achieved.
- : AF points sensitive to horizontal lines.
- : Disabled AF points (not displayed).

Group H

AF is possible with the center AF point and the adjacent AF points above, below, on the left, and on the right. Only the following AF area selection modes are selectable: Single-point AF (manual selection), Single-point Spot AF (manual selection), and AF point expansion (manual selection AF^{EXP}). If an Extender is attached to the lens and the maximum aperture is $f/8$ (between $f/5.6$ and $f/8$), AF will be possible.

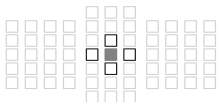

- : Cross-type AF point. Subject tracking is superior and high-precision focusing is achieved.
- : AF points sensitive to vertical lines (top and bottom AF points adjacent to the center AF point) or horizontal lines (left and right AF points adjacent to the center AF point). Not manually selectable. It works only when “AF point expansion (manual selection AF^{EXP})” is selected.
- : Disabled AF points (not displayed).



- If the maximum aperture is smaller than $f/5.6$ (maximum aperture number is between $f/5.6$ and $f/8$), focus may not be achieved with AF when shooting low-contrast or low-light subjects.
- When Extender EF2x is attached to the EF180mm $f/3.5L$ Macro USM lens, AF is not possible.
- If the maximum aperture is smaller than $f/8$ (maximum aperture number exceeds $f/8$), AF is not possible during viewfinder shooting.

Group I

Autofocusing with 61 points is possible. All the AF area selection modes are selectable.

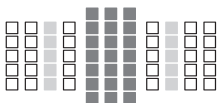

- : Cross-type AF point. Subject tracking is superior and high-precision focusing is achieved.
- : AF points sensitive to horizontal lines.

Lens Group Designations

EF14mm f/2.8L USM	B	EF200mm f/1.8L USM + Extender EF2x	C*
EF14mm f/2.8L II USM	B	EF200mm f/2L IS USM	A
EF15mm f/2.8 Fisheye	B	EF200mm f/2L IS USM + Extender EF1.4x	A
EF20mm f/2.8 USM	B	EF200mm f/2L IS USM + Extender EF2x	C
EF24mm f/1.4L USM	A	EF200mm f/2.8L USM	A
EF24mm f/1.4L II USM	A	EF200mm f/2.8L USM + Extender EF1.4x	C
EF24mm f/2.8	B	EF200mm f/2.8L USM	A
EF24mm f/2.8 IS USM	B	EF200mm f/2.8L USM + Extender EF2x	E
EF28mm f/1.8 USM	A	EF200mm f/2.8L II USM	A
EF28mm f/2.8	D	EF200mm f/2.8L II USM + Extender EF1.4x	C
EF28mm f/2.8 IS USM	B	EF200mm f/2.8L II USM + Extender EF2x	E
EF35mm f/1.4L USM	A	EF300mm f/2.8L USM	A
EF35mm f/1.4L II USM	A	EF300mm f/2.8L USM + Extender EF1.4x	C*
EF35mm f/2	A	EF300mm f/2.8L USM + Extender EF2x	E*
EF35mm f/2 IS USM	A	EF300mm f/2.8L IS USM	A
EF40mm f/2.8 STM	D	EF300mm f/2.8L IS USM + Extender EF1.4x	C
EF50mm f/1.0L USM	A	EF300mm f/2.8L IS USM + Extender EF2x	E
EF50mm f/1.2L USM	A	EF300mm f/2.8L IS II USM	A
EF50mm f/1.4 USM	A	EF300mm f/2.8L IS II USM + Extender EF1.4x	C
EF50mm f/1.8	A	EF300mm f/2.8L IS II USM + Extender EF2x	E
EF50mm f/1.8 II	A	EF300mm f/4L USM	C
EF50mm f/1.8 STM	A	EF300mm f/4L USM + Extender EF1.4x	E
EF50mm f/2.5 Compact Macro	C	EF300mm f/4L USM + Extender EF2x	H (f/8)
EF50mm f/2.5 Compact Macro + LIFE SIZE Converter	E	EF300mm f/4L IS USM	C
EF85mm f/1.2L USM	A	EF300mm f/4L IS USM + Extender EF1.4x	E
EF85mm f/1.2L II USM	A	EF300mm f/4L IS USM + Extender EF2x	E
EF85mm f/1.8 USM	A	EF300mm f/4L IS USM + Extender EF1.4x	E
EF100mm f/2 USM	A	EF300mm f/4L IS USM + Extender EF2x	H (f/8)
EF100mm f/2.8 Macro	C	EF300mm f/4L IS USM + Extender EF1.4x	E
EF100mm f/2.8 Macro USM	E	EF300mm f/4L IS USM + Extender EF2x	H (f/8)
EF100mm f/2.8L Macro IS USM	C	EF400mm f/2.8L USM	A
EF135mm f/2L USM	A	EF400mm f/2.8L USM + Extender EF1.4x	C*
EF135mm f/2L USM + Extender EF1.4x	A		
EF135mm f/2L USM + Extender EF2x	C		
EF135mm f/2.8 (Sofffocus)	A		
EF180mm f/3.5L Macro USM	G		
EF180mm f/3.5L Macro USM + Extender EF1.4x	G		
EF200mm f/1.8L USM	A		
EF200mm f/1.8L USM + Extender EF1.4x	A*		

Lenses and Usable AF Points

EF400mm f/2.8L USM + Extender EF2x	E*	EF600mm f/4L USM + Extender EF2x	H (f/8)*
EF400mm f/2.8L II USM	A	EF600mm f/4L IS USM	C
EF400mm f/2.8L II USM + Extender EF1.4x	C*	EF600mm f/4L IS USM + Extender EF1.4x	E
EF400mm f/2.8L II USM + Extender EF2x	E*	EF600mm f/4L IS USM + Extender EF2x	H (f/8)
EF400mm f/2.8L IS USM	A	EF600mm f/4L IS II USM	C
EF400mm f/2.8L IS USM + Extender EF1.4x	C	EF600mm f/4L IS II USM + Extender EF1.4x	E
EF400mm f/2.8L IS USM + Extender EF2x	E	EF600mm f/4L IS II USM + Extender EF2x	H (f/8)
EF400mm f/2.8L IS II USM	A	EF800mm f/5.6L IS USM	F
EF400mm f/2.8L IS II USM + Extender EF1.4x	C	EF800mm f/5.6L IS USM + Extender EF1.4x	H (f/8)
EF400mm f/2.8L IS II USM + Extender EF2x	E	EF1200mm f/5.6L USM	G
EF400mm f/4 DO IS USM	C	EF1200mm f/5.6L USM + Extender EF1.4x	H (f/8)*
EF400mm f/4 DO IS USM + Extender EF1.4x	E	EF8-15mm f/4L Fisheye USM	C
EF400mm f/4 DO IS USM + Extender EF2x	H (f/8)	EF11-24mm f/4L USM	I
EF400mm f/4 DO IS II USM	C	EF16-35mm f/2.8L USM	A
EF400mm f/4 DO IS II USM + Extender EF1.4x	E	EF16-35mm f/2.8L II USM	A
EF400mm f/4 DO IS II USM + Extender EF2x	H (f/8)	EF16-35mm f/2.8L III USM	A
EF400mm f/5.6L USM	E	EF16-35mm f/4L IS USM	C
EF400mm f/5.6L USM + Extender EF1.4x	H (f/8)	EF17-35mm f/2.8L USM	A
EF500mm f/4L IS USM	C	EF17-40mm f/4L USM	C
EF500mm f/4L IS USM + Extender EF1.4x	E	EF20-35mm f/2.8L	A
EF500mm f/4L IS II USM	C	EF20-35mm f/3.5-4.5 USM	E
EF500mm f/4L IS II USM + Extender EF1.4x	E	EF22-55mm f/4-5.6 USM	F
EF500mm f/4L IS II USM + Extender EF2x	H (f/8)	EF24-70mm f/2.8L USM	B
EF500mm f/4.5L USM	H (f/8)*	EF24-70mm f/2.8L II USM	A
EF600mm f/4L USM	C	EF24-70mm f/4L IS USM	C
EF600mm f/4L USM + Extender EF1.4x	E*	EF24-85mm f/3.5-4.5 USM	E
		EF24-105mm f/3.5-5.6 IS STM	E
		EF24-105mm f/4L IS USM	C
		EF24-105mm f/4L IS II USM	C
		EF28-70mm f/2.8L USM	A
		EF28-70mm f/3.5-4.5	F
		EF28-70mm f/3.5-4.5 II	F
		EF28-80mm f/2.8-4L USM	C
		EF28-80mm f/3.5-5.6	F
		EF28-80mm f/3.5-5.6 USM	F
		EF28-80mm f/3.5-5.6 II	F
		EF28-80mm f/3.5-5.6 II USM	F
		EF28-80mm f/3.5-5.6 III USM	F
		EF28-80mm f/3.5-5.6 IV USM	F

EF28-80mm f/3.5-5.6 V USM	F	EF70-200mm f/2.8L IS II USM + Extender EF2x	E
EF28-90mm f/4-5.6	E	EF70-200mm f/4L USM	C
EF28-90mm f/4-5.6 USM	E	EF70-200mm f/4L USM + Extender EF1.4x	E
EF28-90mm f/4-5.6 II	E	EF70-200mm f/4L USM + Extender EF2x	H (f/8)
EF28-90mm f/4-5.6 II USM	E	EF70-200mm f/4L IS USM	C
EF28-90mm f/4-5.6 III	E	EF70-200mm f/4L IS USM + Extender EF1.4x	E
EF28-105mm f/3.5-4.5 USM	E	EF70-200mm f/4L IS USM + Extender EF2x	H (f/8)
EF28-105mm f/3.5-4.5 II USM	E	EF70-210mm f/3.5-4.5 USM	E
EF28-105mm f/4-5.6	F	EF70-210mm f/4	C
EF28-105mm f/4-5.6 USM	F	EF70-300mm f/4-5.6 IS USM	E
EF28-135mm f/3.5-5.6 IS USM	E	EF70-300mm f/4-5.6 IS II USM	E
EF28-200mm f/3.5-5.6	E	EF70-300mm f/4-5.6L IS USM	E
EF28-200mm f/3.5-5.6 USM	E	EF70-300mm f/4-5.6L DO IS USM	E
EF28-300mm f/3.5-5.6L IS USM	E	EF75-300mm f/4-5.6	E
EF35-70mm f/3.5-4.5	F	EF75-300mm f/4-5.6 USM	E
EF35-70mm f/3.5-4.5A	F	EF75-300mm f/4-5.6 II	E
EF35-80mm f/4-5.6	F	EF75-300mm f/4-5.6 II USM	E
EF35-80mm f/4-5.6 PZ	F	EF75-300mm f/4-5.6 III	E
EF35-80mm f/4-5.6 USM	F	EF75-300mm f/4-5.6 III USM	E
EF35-80mm f/4-5.6 II	F	EF75-300mm f/4-5.6 IS USM	E
EF35-80mm f/4-5.6 III	F	EF80-200mm f/2.8L	A
EF35-105mm f/3.5-4.5	E	EF80-200mm f/4.5-5.6	E
EF35-105mm f/4.5-5.6	H	EF80-200mm f/4.5-5.6 USM	F
EF35-105mm f/4.5-5.6 USM	H	EF80-200mm f/4.5-5.6 II	F
EF35-135mm f/3.5-4.5	E	EF90-300mm f/4.5-5.6	E
EF35-135mm f/4-5.6 USM	E	EF90-300mm f/4.5-5.6 USM	E
EF35-350mm f/3.5-5.6L USM	F	EF100-200mm f/4.5A	E
EF38-76mm f/4.5-5.6	E	EF100-300mm f/4.5-5.6 USM	E
EF50-200mm f/3.5-4.5	E	EF100-300mm f/5.6	E
EF50-200mm f/3.5-4.5L	E	EF100-300mm f/5.6L	E
EF55-200mm f/4.5-5.6 USM	E	EF100-400mm f/4.5-5.6L IS USM	E
EF55-200mm f/4.5-5.6 II USM	E	EF100-400mm f/4.5-5.6L IS USM + Extender EF1.4x	H (f/8)
EF70-200mm f/2.8L USM	A	EF100-400mm f/4.5-5.6L IS II USM	E
EF70-200mm f/2.8L USM + Extender EF1.4x	C*	EF100-400mm f/4.5-5.6L IS II USM + Extender EF1.4x	H (f/8)
EF70-200mm f/2.8L USM + Extender EF2x	E*	EF200-400mm f/4L IS USM Extender 1.4x	I
EF70-200mm f/2.8L IS USM	A	EF200-400mm f/4L IS USM Extender 1.4x: With built-in Ext. 1.4x	E
EF70-200mm f/2.8L IS USM + Extender EF1.4x	C		
EF70-200mm f/2.8L IS USM + Extender EF2x	E		
EF70-200mm f/2.8L IS II USM	A		
EF70-200mm f/2.8L IS II USM + Extender EF1.4x	C		

EF200-400mm f/4L IS USM Extender 1.4x + Extender EF1.4x	E
EF200-400mm f/4L IS USM Extender 1.4x: With built-in Ext. 1.4x + Extender EF1.4x	H (f/8)
EF200-400mm f/4L IS USM Extender 1.4x + Extender EF2x	H (f/8)
TS-E17mm f/4L	C
TS-E24mm f/3.5L	C
TS-E24mm f/3.5L II	C
TS-E45mm f/2.8	A
TS-E90mm f/2.8	A

 When using a lens and an extender in the combination marked with *, precise focus may not be achieved with AF. Refer to the instruction manual of the lens or extender used.

- 
- Both “Extender EF1.4x” and “Extender EF2x” apply to all the I/II/III models (under this grouping).
 - If you use a TS-E lens, manual focusing will be required. The lens group designation of TS-E lenses applies only when you do not use tilt or shift function.

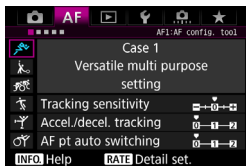

MENU Selecting AI Servo AF Characteristics ☆

You can easily fine-tune AI Servo AF to suit a particular subject or shooting scene just by selecting an option from case 1 to case 6. This feature is called the “AF Configuration Tool.”









1 Select the [AF1] tab.

2 Select a case.

- Turn the <  > dial to select a case icon, then press <  >.
- ▶ The selected case will be set. The selected case is indicated in blue.

Case 1 to 6

As explained on pages 114 to 116, case 1 to 6 are six setting combinations of “Tracking sensitivity”, “Acceleration/deceleration tracking”, and “AF point auto switching”. Refer to the table below to select the case applicable to the subject or shooting scene.

Case	Icon	Description	Applicable Subjects	Page
Case 1		Versatile multi purpose setting	For any moving subject.	110
Case 2		Continue to track subjects, ignoring possible obstacles	Tennis players, butterfly swimmers, freestyle skiers, etc.	110
Case 3		Instantly focus on subjects suddenly entering AF points	Starting line of a bicycle race, alpine downhill skiers, etc.	111
Case 4		For subjects that accelerate or decelerate quickly	Soccer, motor sports, basketball, etc.	111
Case 5		For erratic subjects moving quickly in any direction	Figure skaters, etc.	112
Case 6		For subjects that change speed and move erratically	Rhythm gymnastics, etc.	113

Case 1: Versatile multi purpose setting

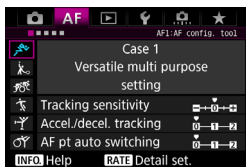

Standard setting suited for any moving subject. Works with many subjects and scenes.

Select [Case 2] to [Case 6] for the following: When an obstacle cuts across the AF points or the subject tends to stray from the AF points, when you want to focus on a subject appearing suddenly, when the speed of a moving subject changes suddenly, or when the subject dramatically moves horizontally or vertically.

Default settings

- Tracking sensitivity: 0
- Accel./decel. tracking: 0
- AF pt auto switching: 0

Case 2: Continue to track subjects, ignoring possible obstacles

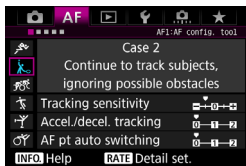

The camera will try to continue focusing on the subject even if an obstacle enters the AF points or if the subject strays from the AF points. Effective when there may be an obstacle blocking the subject or when you do not want to focus on the background.

Default settings

- Tracking sensitivity: Locked on: -1
- Accel./decel. tracking: 0
- AF pt auto switching: 0

If an obstacle gets in the way or if the subject moves away from the AF points for a prolonged period and the default setting is unable to track the target subject, setting [Tracking sensitivity] to [-2] may give better results (p.114).

Case 3: Instantly focus on subjects suddenly entering AF points

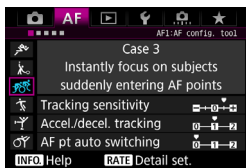

Once an AF point starts tracking the subject, this setting enables the camera to consecutively focus on subjects at different distances. If a new subject appears in front of the target subject, the camera will start focusing on the new subject. Also effective when you want to always focus on the closest subject.

Default settings

- Tracking sensitivity: Responsive: +1
- Accel./decel. tracking: +1
- AF pt auto switching: 0



If you want to quickly focus on a subject appearing suddenly, setting [**Tracking sensitivity**] to [+2] may give better results (p.114).

Case 4: For subjects that accelerate or decelerate quickly

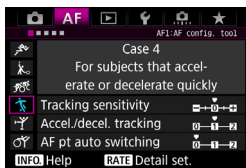

Geared for tracking moving subjects whose speed can change dramatically and suddenly.

Effective for subjects having sudden movements, sudden acceleration, sudden deceleration, or sudden stops.

Default settings

- Tracking sensitivity: 0
- Accel./decel. tracking: +1
- AF pt auto switching: 0



If the subject is in motion, and prone to sudden, dramatic changes in speed, setting [**Accel./decel. tracking**] to [+2] may give better results (p.115).

Case 5: For erratic subjects moving quickly in any direction

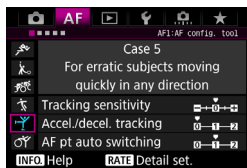

Default settings

- Tracking sensitivity: 0
- Accel./decel. tracking: 0
- AF pt auto switching: +1

Even if the target subject moves dramatically up, down, left, or right, the AF point will switch automatically to focus-track the subject. Effective for shooting subjects that move dramatically up, down, left, or right.

It is recommended to use this setting with the following modes; AF point expansion (manual selection $\text{AF} \cdot \text{EXP}$), AF point expansion (manual selection, surrounding points), Zone AF (manual selection of zone), and 61-point automatic selection AF.

With Single-point Spot AF (manual selection) or Single-point AF (manual selection) mode, the tracking action will be the same as with Case 1.

If the subject moves even more dramatically up, down, left, or right, setting **[AF pt auto switching]** to **[+2]** may give better results (p.116).

Case 6: For subjects that change speed and move erratically

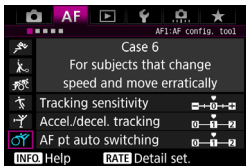

Default settings

- Tracking sensitivity: 0
- Accel./decel. tracking: +1
- AF pt auto switching: +1

Geared for tracking moving subjects whose speed can change dramatically and suddenly. Also, if the target subject moves dramatically up, down, left or right and it is difficult to focus, the AF point switches automatically to track the subject.

It is recommended to use this setting with the following modes; AF point expansion (manual selection $\square \square \square$), AF point expansion (manual selection, surrounding points), Zone AF (manual selection of zone), and 61-point automatic selection AF.

With Single-point Spot AF (manual selection) or Single-point AF (manual selection) mode, the tracking action will be the same as with Case 4.



- If the subject is in motion, and prone to sudden, dramatic changes in speed, setting **[Accel./decel. tracking]** to **[+2]** may give better results (p.115).
- If the subject moves even more dramatically up, down, left, or right, setting **[AF pt auto switching]** to **[+2]** may give better results (p.116).

Parameters

● Tracking sensitivity

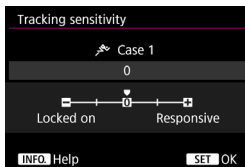

Sets the subject-tracking sensitivity during AI Servo AF when an obstacle enters the AF points or when the AF points stray from the subject.

0
Default setting. Suitable for moving subjects in general.

Locked on: -2 / Locked on: -1

The camera will try to continue focusing on the subject even if an obstacle enters the AF points or if the subject strays from the AF points. The -2 setting makes the camera track the target subject longer than with the -1 setting.

However, if the camera focuses on a wrong subject, it may take slightly longer to switch and focus on the target subject.

Responsive: +2 / Responsive: +1

The camera can focus consecutively on subjects at different distances that are covered by the AF points. Also effective when you want to always focus on the closest subject. The +2 setting is more responsive when focusing on the next subject than +1.

However, the camera will be more prone to focus on the wrong subject.

 [Tracking sensitivity] is the feature named [AI Servo tracking sensitivity] in the EOS-1D Mark III/IV, EOS-1Ds Mark III, and EOS 7D.

● Acceleration/deceleration tracking

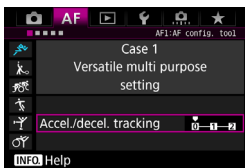

This sets the tracking sensitivity for moving subjects whose speed can suddenly change dramatically by starting or stopping suddenly, etc.

0

Suited for subjects that move at a steady speed (minimal change in moving speed).

+2 / +1

Effective for subjects having sudden movements, sudden acceleration/deceleration, or sudden stops. Even if the moving subject's speed suddenly changes dramatically, the camera continues to focus on the target subject. For example, for an approaching subject, the camera becomes less prone to focus behind it to avoid subject blur. For a subject stopping suddenly, the camera becomes less prone to focus in front of it. Setting +2 can track dramatic changes in the moving subject's speed better than with +1.

However, since the camera will be sensitive even to the slight movements of the subject, the focusing may momentarily become unstable.

● AF point auto switching

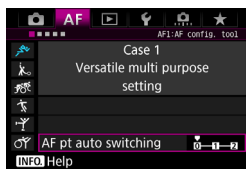

This sets the switching sensitivity of the AF points as they track the subject moving dramatically up, down, left, or right.

This setting takes effect when the AF area selection mode is set to AF point expansion (manual selection \square), AF point expansion (manual selection, surrounding points), Zone AF (manual selection of zone), or 61-point automatic selection AF.

0

Standard setting for gradual AF point switching.

+2 / +1

Even if the target subject moves dramatically up, down, left, or right and moves away from the AF point, the camera switches its focus to neighboring AF points to continue focusing on the subject. The camera switches to the AF point deemed most likely to focus on the subject based on the subject's continual movement, contrast, etc. Setting +2 makes the camera more prone to switch the AF point than with +1.

However, with a wide-angle lens having a wide depth of field or if the subject is too small in the frame, the camera may focus with the wrong AF point.

Changing Cases' Parameter Settings

You can manually adjust each case's three parameters: 1. Tracking sensitivity, 2. Acceleration/deceleration tracking, and 3. AF point auto switching.

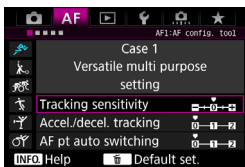

- 1 **Select a case.**
 - Turn the <DIAL> dial to select the icon of the case you want to adjust.

- 2 **Press the <RATE> button.**
 - The selected parameter will have a purple frame.

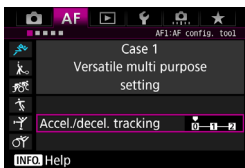

- 3 **Select the parameter to adjust.**
 - Select the parameter to adjust, then press <SET>.
 - When Tracking sensitivity is selected, the setting screen will appear.

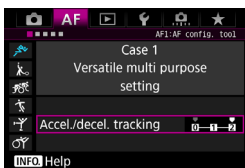

- 4 **Make the adjustment.**
 - Adjust the setting, then press <SET>.
 - ▶ The adjustment is saved.
 - The default setting is indicated by the light gray [■] mark.
 - To return to the screen in step 1, press the <RATE> button.



- In step 2, if you press the <RATE> button and then press the <TRASH> button, you can revert the 1, 2 and 3 parameter settings above for each case.
- You can also register the 1, 2, and 3 parameter settings to My Menu (p.432). Doing so will change the selected case's settings.
- When shooting with a case whose parameters you adjusted, select the adjusted case and then take the picture.

MENU Customizing AF Functions ☆

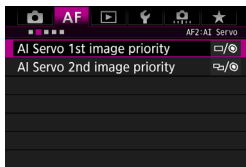

With the [**AF2**] to [**AF5**] menu tabs, you can set the AF functions to suit your shooting style or subject.

AF2: AI Servo

AI Servo 1st image priority

You can set the AF operation characteristics and shutter-release timing for the first shot with AI Servo AF.

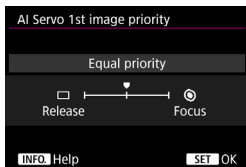

□/⊕: Equal priority

Equal priority is given to focusing and shutter release.

□: Release priority

Pressing the shutter button takes the picture immediately even if focus has not been achieved. It is effective when you want to give priority to capturing the image rather than achieving focus.

⊕: Focus priority

Pressing the shutter button does not take the picture until focus is achieved. Effective when you want to achieve focus before capturing the image.

AI Servo 2nd image priority

You can set the AF operation characteristics and shutter-release timing during continuous shooting after the first shot with AI Servo AF.

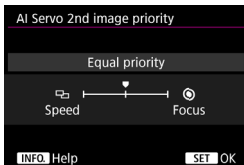

/ : Equal priority

Equal priority is given to focusing and continuous shooting speed. In low light or with low-contrast subjects, shooting speed may slow down.

: Shooting speed priority

Priority is given to the continuous shooting speed instead of achieving focus.

: Focus priority

Priority is given to achieving focus instead of the continuous shooting speed. The picture will not be taken until focus is achieved.

 Under shooting conditions which activate anti-flicker shooting (p.191), even if **[Shooting speed priority]** is set, the continuous shooting speed may become slightly slower or the shooting interval may become irregular.

AF3: One Shot

Lens electronic MF

With the following USM and STM lenses equipped with an electronic manual focusing function, you can set whether to use electronic manual focusing.

EF50mm f/1.0L USM	EF300mm f/2.8L USM	EF600mm f/4L USM
EF85mm f/1.2L USM	EF400mm f/2.8L USM	EF1200mm f/5.6L USM
EF85mm f/1.2L II USM	EF400mm f/2.8L II USM	EF28-80mm f/2.8-4L USM
EF200mm f/1.8L USM	EF500mm f/4.5L USM	EF70-300mm f/4-5.6 IS II USM
EF40mm f/2.8 STM	EF50mm f/1.8 STM	EF24-105mm f/3.5-5.6 IS STM

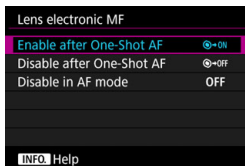

ON: Enable after One-Shot AF

After AF operates, if you keep pressing the shutter button halfway, you can adjust the focus manually.

OFF: Disable after One-Shot AF

After AF operates, manual focusing adjustment is disabled.

OFF: Disable in AF mode

When the lens's focus mode switch is set to <AF>, manual focusing is disabled.

AF-assist beam firing

Enables or disables the AF-assist beam from the EOS-dedicated external Speedlite.

AF-assist beam firing	
Enable	ON
Disable	OFF
IR AF assist beam only	IR
INFO Help	

ON: Enable

The external Speedlite emits the AF-assist beam when necessary.

OFF: Disable

The external Speedlite will not emit the AF-assist beam. Prevents the AF-assist beam from disturbing others.

IR: IR AF assist beam only

When an external Speedlite is attached, only the infrared AF-assist beam will be emitted. This prevents the AF-assist light from firing as a burst of small flashes.

With an EX-series Speedlite equipped with an LED light, the LED light will not automatically turn on for AF-assist.



If an external Speedlite's **[AF-assist beam firing]** Custom Function is set to **[Disabled]**, the Speedlite will not emit the AF-assist beam regardless of this setting.

One-Shot AF release priority

You can set the AF operation characteristics and shutter-release timing for One-Shot AF.

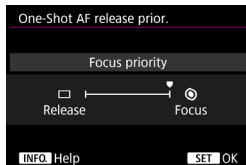

: **Focus priority**

The picture will not be taken until focus is achieved. Effective when you want to achieve focus before capturing the shot.

: **Release priority**

Priority is given to the timing of shutter release instead of achieving focus. This gives priority to capturing the image rather than achieving correct focus.

Note that the picture will be taken even if focus has not been achieved.

AF4

Lens drive when AF impossible

If focus cannot be achieved with autofocus, you can have the camera keep searching for the correct focus or have it stop searching.

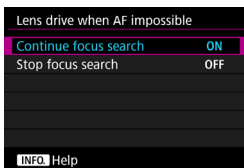
**ON: Continue focus search**

If focus cannot be achieved with autofocus, the lens is driven to search for the correct focus.

OFF: Stop focus search

If autofocus starts and the focus is far off or if focus cannot be achieved, the lens drive will not be performed. This prevents the lens from becoming grossly out of focus due to focus searching.



Super telephoto lenses, etc., with a wide focusing drive range can become grossly out of focus during focus search, taking more time to achieve focus next time. Setting [**Stop focus search**] is recommended.

Selectable AF point

You can change the number of manually selectable AF points. If 61-point automatic selection AF is set, the Area AF frame (entire AF area) will be used for AF regardless of the setting below.

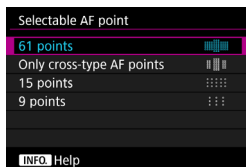

: **61 points**

All AF points will be manually selectable.

: **Only cross-type AF points**

Only cross-type AF points will be manually selectable. The number of selectable cross-type AF points will differ depending on the lens.



: **15 points**

Fifteen major AF points will be manually selectable.

: **9 points**

Nine major AF points will be manually selectable.

 With a lens from Groups F to H (p.103-104), the number of manually selectable AF points will be fewer.

-  • Even with settings other than **[61 points]**, AF point expansion (manual selection ) , AF point expansion (manual selection, surrounding points) and Zone AF (manual selection of zone) are still possible.
- When you press the  button, the AF points which are not manually selectable will not be displayed in the viewfinder.

Select AF area selection mode

You can limit the selectable AF area selection modes to suit your shooting preferences. Select the desired selection mode and press **<SET>** to append a checkmark **<✓>**. Then select **[OK]** to register the setting.

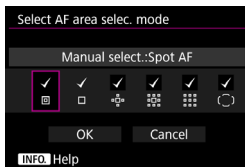

Manual select.:Spot AF

For pinpoint focusing with a narrower area than single-point AF (manual selection).

Manual selection:1 pt AF

One of the AF points set by **[Selectable AF point]** setting can be selected.

Expand AF area:

The camera will focus with the manually-selected AF point and the adjacent AF points (above, below, on the left, and on the right).

Expand AF area:Surround

The camera will focus with the manually-selected AF point and the surrounding AF points.

Manual select.:Zone AF

The AF area is divided into nine focusing zones for focusing.

Auto selection:61 pt AF

The Area AF frame (entire AF area) is used for focusing.



- The **<✓>** mark cannot be removed from **[Manual selection:1 pt AF]**.
- If the attached lens belongs to group H (p.104), you can only select **[Manual select.:Spot AF]**, **[Manual selection:1 pt AF]**, and **[Expand AF area: **].

AF area selection method

You can set the method for changing the AF area selection mode.

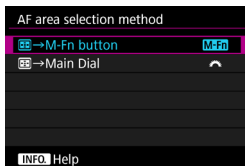

M-Fn : → **M-Fn button**

After you press the button, pressing the <M-Fn> button, the AF area selection mode changes.

: → **Main Dial**

After you press the button, turning the dial changes the AF area selection mode.

When → **Main Dial** is set, use the to move the AF point horizontally.

Orientation linked AF point

You can set the AF point or the AF area selection mode + AF point separately for vertical shooting and horizontal shooting.

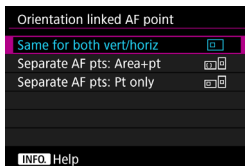

: **Same for both vert/horiz**

The same AF area selection mode and manually-selected AF point (or zone) are used for both vertical shooting and horizontal shooting.

: **Separate AF pts: Area+pt**

The AF area selection mode and AF point (or zone) can be set separately for each camera orientation (1. Horizontal, 2. Vertical with the camera grip at the top, 3. Vertical with the camera grip at the bottom).

When you manually select the AF area selection mode and AF point (or zone) for each of the three camera orientations, they will be set for the respective orientation. Whenever you change the camera orientation during shooting, the camera will switch to the AF area selection mode and manually-selected AF point (or zone) set for that orientation.

: **Separate AF pts: Pt only**

The AF point can be set separately for each camera orientation (1. Horizontal, 2. Vertical with the camera grip at the top, 3. Vertical with the camera grip at the bottom). While using the same AF area selection mode, the AF point will switch automatically for the respective camera orientation.

When you manually select the AF point for each of the three camera orientations, it will be recorded for the respective orientation. During shooting, the manually-selected AF point will switch to match the respective camera orientation. Even if you change the AF area selection mode to Manual select.:Spot AF, Manual selection:1 pt AF, Expand AF area:, or Expand AF area:Surround, the AF point set for the respective orientation will be retained.

If you change the AF area selection mode to Zone AF (manual selection of zone), the zone will switch to match the respective camera orientation.



- If you clear the camera settings to their defaults (p.70), the setting will be **[Same for both vert/horiz]**. Also, your settings for the three camera orientations (1, 2 and 3) will be cleared and all three will revert to Single-point AF (Manual selection) with the center AF point selected.
- If you set this and later attach a lens from a different AF group (p.100-104, particularly Group H), the setting may be cleared.

Initial AF Point, (C) AI Servo AF

You can set the AI Servo AF's starting AF point for when the AF area selection mode is set to Auto selection: 61 pt AF.

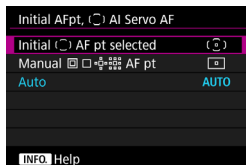

(C): Initial (C) AF pt selected

AI Servo AF will start with the manually-selected AF point when the AF operation is set to AI Servo AF and the AF area selection mode is set to Auto selection: 61 pt AF.

[AF pt] : Manual [AF pt] AF pt

If you switch from Manual select.:Spot AF, Manual selection:1 pt AF, Expand AF area: [AF pt], or Expand AF area:Surround to Auto selection: 61 pt AF, AI Servo AF will start with the AF point that was manually selected before the switch. Convenient if you want AI Servo AF to start with the AF point which was selected before the AF area selection mode was switched to Auto selection: 61 pt AF.

After you set the AF area selection mode to Auto selection: 61 pt AF with the [3: Custom Controls] menu's [Metering and AF start] (p.418), [Switch to registered AF func.] (p.420), or [Register/recall shooting func] (p.425), you can press the assigned button during Manual select: Spot AF, Manual selection: 1 pt AF, Expand AF area: [AF pt], or Expand AF area: Surround to switch to AI Servo AF using Auto selection: 61 pt AF instead of the AF point used immediately before.

AUTO: Auto

The AF point which AI Servo AF starts with is set automatically to suit the shooting conditions.

 When [Manual [AF pt] AF pt] is set, AI Servo AF will start with the zone that corresponds to the manually selected AF point, even if you switch AF area selection mode to Zone AF (manual selection of zone).

Auto AF point selection: EOS iTR AF

EOS iTR* AF executes autofocus by recognizing faces and subject colors. EOS iTR AF works when the AF area selection mode is set to 61-point automatic selection AF or Zone AF (manual selection of zone).

* intelligent Tracking and Recognition: The function that the metering sensor identifies the subject to make the AF points tracking it.



ON: Enable

The AF point is automatically selected based not only on AF information, but also faces and other details.

In AI Servo AF mode, the camera remembers the color at the position it focused on first, then continues to track and focus on the subject by switching AF points to track that color. This makes it easier to keep track of the subject than when only AF information is available. In One-Shot AF mode, EOS iTR AF makes focusing on people easier, so you can perform shooting with priority on composition.

OFF: Disable

AF points are automatically selected based only on AF information. (The AF will not use information about faces, subject colors and other details.)



- If **[Enable]** is set, the camera may take longer to focus than when **[Disable]** is set.
- Even if you set **[Enable]**, expected result may not be obtained depending on the shooting conditions and subject.
- Under light so low that the EOS-dedicated, external Speedlite emits the AF-assist beam automatically, AF points are selected automatically based only on AF information.
- Face detection may not work if the face is small or under low-light conditions.

AF5

Manual AF point selection pattern

During manual AF point selection, the selection can either stop at the outer edge or it can cycle around to the opposite side. This function works in AF area selection modes other than Zone AF (manual selection of zone), and 61-point automatic selection AF (works with AI Servo AF).

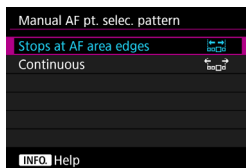
 : **Stops at AF area edges**

Convenient if you often use an AF point at the periphery.

 : **Continuous**

Instead of stopping at the outer edge, the selection of AF point continues to the opposite side.

AF point display during focus

You can set whether or not to display the AF point(s) in the following cases: 1. When selecting the AF point(s), 2. When the camera is ready to shoot (before AF operation), 3. During AF operation, and 4. When focus is achieved.

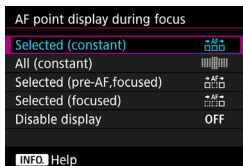

: **Selected (constant)**

The selected AF point(s) is always displayed.

: **All (constant)**

All AF points are always displayed.

: **Selected (pre-AF, focused)**

The selected AF point(s) is displayed for 1, 2, and 4.

: **Selected (focused)**



The selected AF point(s) is displayed for 1 and 4 and for when AF starts.

OFF: Disable display

For 2, 3, and 4, the selected AF point(s) will not be displayed.

VF display illumination

You can set whether the AF points in the viewfinder are to light up in red when focus is achieved.

VF display illumination	
Auto	AUTO
Enable	ON
Disable	OFF
AF point during AI Servo AF OFF	
 AF point during AI Servo AF	
 Help	

AUTO: Auto

The AF points automatically light up in red under low light.

ON: Enable

The AF points light up in red regardless of the ambient light level.

OFF: Disable

The AF points do not light up in red.

With [**Auto**] or [**Enable**] set, you can set whether the AF point lights up in red (blink) when you press the < > button during AI Servo AF.

AF point during AI Servo AF	
Non illuminated	OFF
Illuminated	ON

OFF: Non illuminated

The AF point will not light up during AI Servo AF.

ON: Illuminated

AF points used for focusing light up in red during AI Servo AF. This will not work if [**VF display illumination**] is set to [**Disable**].

- When you press the < > button, the AF points will light up in red regardless of this setting.
- The electronic level and grid in the viewfinder and the information set with [**Show/hide in viewfinder**] (p.77) will also light up in red.

AF Microadjustment

You can make fine adjustments for the AF's point of focus. For details, see "Fine Adjustment of AF's Point of Focus" on the next page.

MENU Fine Adjustment of AF's Point of Focus ☆

Fine adjustment of the AF's point of focus is possible for viewfinder shooting. This is called "AF Microadjustment". Before making the adjustment, read "General Cautions for AF Microadjustment" on page 139.

ⓘ Cautions for AF Microadjustment

Normally, this adjustment is not required. Perform this adjustment only if necessary. Note that performing this adjustment may prevent accurate focusing from being achieved.

Adjust All by Same Amount

Set the adjustment manually by adjusting, shooting, and checking the result. Repeat this until appropriate adjustment is made. During AF, regardless of the lens used, the point of focus will always be shifted by the adjustment amount.

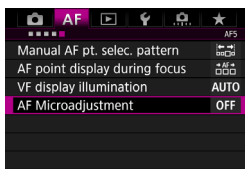

1 Select [AF Microadjustment].

- Under the [AF5] tab, select [AF Microadjustment], then press <SET>.

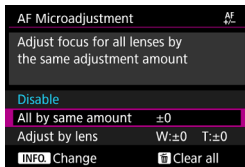

2 Select [All by same amount].

3 Press the <INFO.> button.

- ▶ The [All by same amount] screen will appear.

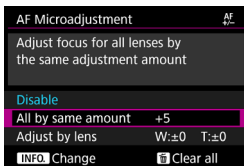
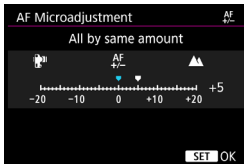

4 Make the adjustment.

- Set the adjustment amount. The adjustable range is ± 20 steps.
- Setting it toward “-: ” will shift the point of focus in front of the standard point of focus.
- Setting it toward “+: ” will shift the point of focus to the rear of the standard point of focus.
- After making the adjustment, press \langle (SET) \rangle .
- Select [All by same amount], then press \langle (SET) \rangle .

5 Check the result of the adjustment.

- Take a picture and play back the image (p.320) to check the adjustment result.
- If the shooting result comes out with focus in front of the targeted point, adjust toward the “+: ” side. If it comes out with focus behind the targeted point, adjust toward the “-: ” side.
- If necessary, repeat the adjustment.

If [All by same amount] is selected, separate AF adjustment will not be possible for the wide-angle and telephoto ends of zoom lenses.

Adjust by Lens

You can make the adjustment for each lens and register the adjustment in the camera. You can register the adjustment for up to 40 lenses. When you autofocus with a lens whose adjustment is registered, the point of focus will always be shifted by the adjustment amount. Set the adjustment manually by adjusting, shooting, and checking the result. Repeat this until the desired adjustment is made. If you use a zoom lens, make the adjustment for the wide-angle (W) and telephoto (T) ends.

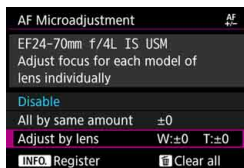

1 Select **[Adjust by lens]**.

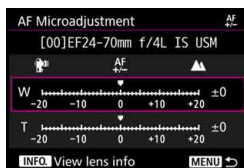

2 Press the **<INFO.>** button.

▶ The **[Adjust by lens]** screen will appear.

3 Check and change the lens information.

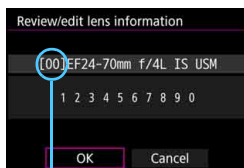

Registered number

Checking the Lens Information

- Press the **<INFO.>** button.
- ▶ The screen will show the lens name and a 10-digit serial number. When the serial number is displayed, select **[OK]** and go to step 4.
- If the lens's serial number cannot be confirmed, "0000000000" will be displayed. In this case, enter the number by following the instructions on the next page.
- Regarding the asterisk "*" displayed in front of some lens serial numbers, see the next page.

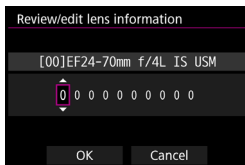

Entering the Serial Number

- Select the digit to be entered, then press < (SET) > so < () > is displayed.
- Enter the number, then press < (SET) >.
- After entering all the digits, select [OK].

Lens Serial Number

- **In step 3, if “ * ” appears in front of the 10-digit lens serial number, you can register only one unit of the same lens model. Even if you enter the serial number, “ * ” will remain displayed.**
- **The serial number on the lens may differ from the serial number displayed on the screen in step 3. This is not a malfunction.**
- If the lens serial number includes letters, enter only the numbers.
- If the lens serial number is eleven digits or longer, enter only the last ten digits.
- The location of the serial number varies depending on the lens.
- Some lenses may not have a serial number inscribed. To register a lens that has no serial number inscribed, enter any serial number.



- If [Adjust by lens] is selected and an Extender is used, the adjustment will be registered for the lens and Extender combination.
- If 40 lenses have already been registered, a message will appear. After you select a lens whose registration is to be erased (overwritten), you can register another lens.

Single focal length lens

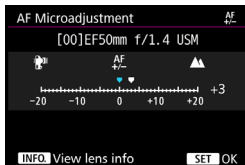

Zoom lens

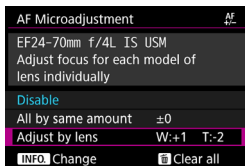
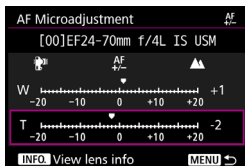

4 Make the adjustment.

- For a zoom lens, select the wide-angle (W) or telephoto (T) end. Pressing **<SET>** will turn off the purple frame and make the adjustment possible.
- Set the adjustment amount, then press **<SET>**. The adjustable range is ± 20 steps.
- Setting it toward “-: ” will shift the point of focus in front of the standard point of focus.
- Setting it toward “+: ” will shift the point of focus to the rear of the standard point of focus.
- For a zoom lens, repeat this procedure and adjust it for the wide-angle (W) and telephoto (T) ends.
- After completing the adjustment, press the **<MENU>** button to return to the screen in step 1.
- Select **[Adjust by lens]**, then press **<SET>**.

5 Check the result of the adjustment.

- Take a picture and play back the image (p.320) to check the adjustment result.
- If the shooting result comes out with focus in front of the targeted point, adjust toward the “+: ” side. If it comes out with focus behind the targeted point, adjust toward the “-: ” side.
- If necessary, repeat the adjustment.



When shooting with the intermediate range (focal length) of a zoom lens, the AF's point of focus is corrected automatically relative to the adjustments made for the wide-angle and telephoto ends. Even if only the wide-angle or telephoto end is adjusted, a correction will be made automatically for the intermediate range.

Clearing All AF Microadjustments

When [Clear all] appears at the bottom of the screen, pressing the button will clear all the adjustments made for [All by same amount] and [Adjust by lens].



General Cautions for AF Microadjustment

- The AF's point of focus will vary slightly depending on the subject conditions, brightness, zoom position, and other shooting conditions. Therefore, even if you perform AF Microadjustment, focus may still not be achieved at the suitable position.
- The adjustment amount of one stop varies depending on the maximum aperture of the lens. Keep adjusting, shooting, and checking the focus repeatedly to adjust the AF's point of focus.
- The adjustment will not be applied to AF during Live View shooting or movie shooting.
- The adjustments will be retained even if you clear all the camera settings (p.70). However, the setting itself will be [Disable].



Notes for AF Microadjustment

- It is best to make the adjustment at the actual location where you will shoot. This will make the adjustment more precise.
- Using a tripod when making the adjustment is recommended.
- For making adjustments, shooting at the  L image-recording quality is recommended.

When Autofocus Fails

Autofocus can fail to achieve focus (viewfinder's focus indicator <●> blinks) with certain subjects such as the following:

Subjects Difficult to Focus

- Subjects with very low contrast
(Example: Blue skies, solid-color flat surfaces, etc.)
- Subjects in very low light
- Strongly backlit or reflective subjects
(Example: Cars with highly reflective bodies, etc.)
- Near and distant subjects framed close to an AF point
(Example: Animals in cages, etc.)
- Subjects such as dots of light framed close to an AF point
(Example: Night scenes, etc.)
- Repetitive patterns
(Example: Skyscraper windows, computer keyboards, etc.)

In such cases, focus by doing either of the following:

- (1) With One-Shot AF, focus on an object at the same distance as the subject and lock the focus, then recompose the shot (p.83).
- (2) Set the lens's focus mode switch to <MF> and focus manually (p.141).



- Depending on the subject, focus may be achieved by slightly recomposing the shot and performing AF operation again.
- For conditions where AF can fail to achieve focus with [**L**+Tracking]/[FlexiZone - Single] during Live View shooting or movie shooting, see page 273.

MF: Manual Focus

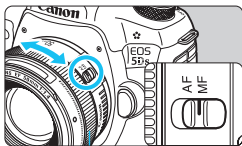

Focusing ring

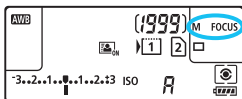

1 Set the lens's focus mode switch to <MF>.

- ▶ <M FOCUS> will be displayed on the LCD panel.

2 Focus on the subject.

- Focus by turning the lens's focusing ring until the subject looks sharp in the viewfinder.



- If you press the shutter button halfway while focusing manually, the focus indicator <●> will light up when focus is achieved.
- With 61-point automatic selection AF, when the center AF point achieves focus, the focus indicator <●> will light up.

Selecting the Drive Mode

Single and continuous drive modes are provided. You can select the drive mode suiting the scene or subject.

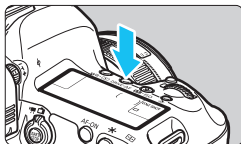

1 Press the <DRIVE·AF> button. (ⓘ6)

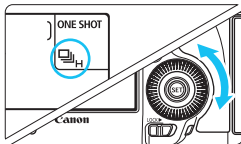

2 Select the drive mode.

- While looking at the LCD panel or in the viewfinder, turn the <DISP> dial.

: **Single shooting**

When you press the shutter button completely, only one shot will be taken.

H: **High-speed continuous shooting**

While you hold down the shutter button completely, the camera will shoot continuously at a **maximum of approx. 5.0 shots/sec.**

: **Low-speed continuous shooting**



While you hold down the shutter button completely, the camera will shoot continuously at a **maximum of approx. 3.0 shots/sec.**

S : **Silent single shooting**

Single shooting with less shooting sound than <> during viewfinder shooting.

S : **Silent continuous shooting**

Continuous shooting with less shooting sound than <> during viewfinder shooting. The camera will shoot continuously at a **maximum of approx. 3.0 shots/sec.**

 During Live View shooting and movie shooting, shooting will not be silent even if <S> or <S> is set.

 : **10-sec. self-timer/remote control**







 : **2-sec. self-timer/remote control**

For self-timer shooting, see page 144. For remote control shooting, see page 237.



- : The maximum continuous shooting speed of approx. 5.0 shots/sec. is attained under the following conditions*: 1/500 sec. or faster shutter speed, maximum aperture (varies depending on the lens), Anti-flicker shooting set to Disable, with a fully-charged Battery Pack LP-E6N, and at room temperature (23°C/73°F). The continuous shooting speed may become slower depending on the shutter speed, aperture, subject conditions, brightness, lens, flash use, temperature, battery type, remaining battery level, etc.

* With the AF mode set to One-Shot AF and the Image Stabilizer turned off when using the following lenses: EF300mm f/4L IS USM, EF28-135mm f/3.5-5.6 IS USM, EF75-300mm f/4-5.6 IS USM, EF100-400mm f/4.5-5.6L IS USM.

- In AI Servo AF operation, the continuous shooting speed may become slower depending on the subject and the lens used.
- If you use Battery Pack LP-E6 and shoot in low temperatures (battery temperature is low), the high-speed continuous shooting speed may become slower.
- The continuous shooting speed may become slower if the remaining battery level is low or if you shoot under low-light conditions.
- If you use Battery Grip BG-E11 (sold separately) with AA/R6 batteries, the maximum continuous shooting speed will be approx. 3.0 fps for high-speed continuous shooting.
- If you set [ 4: **Anti-flicker shoot.**] to [**Enable**] (p.191) and shoot under a flickering light source, the continuous shooting speed may decrease slightly, the shooting interval may become irregular, or the release timelag may become longer.
- If < S> or < S> is set, the time lag from when you press the shutter button completely until the picture is shot will be longer than standard.
- If the [ 1: **Record func+card/folder sel.**] menu's [**Record func.**] is set to [**Rec. separately**] (p.146) and the recording quality setting for the CF card [ 1] and SD card [ 2] is different, the maximum burst (p.151) will decrease.
- When internal memory becomes full during continuous shooting, the continuous shooting speed may drop during shooting since shooting will be temporarily disabled (p.153).

🕒 Using the Self-timer

Use the self-timer when you want to be in the picture.

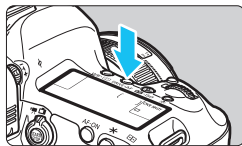

1 Press the <DRIVE·AF> button. (🕒6)

2 Select the self-timer.

- While looking at the LCD panel or in the viewfinder, turn the <🕒> dial.

🕒 : **10-sec. self-timer**

🕒₂ : **2-sec. self-timer**

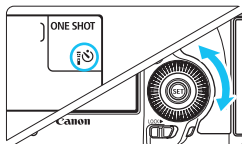

3 Take the picture.

- Look through the viewfinder, focus on the subject, then press the shutter button completely.
- ▶ You can check the self-timer operation with the self-timer lamp, beeper, and countdown display (in seconds) on the LCD panel.
- ▶ 2 sec. before the picture is taken, the self-timer lamp will light up and the beeper will sound faster.

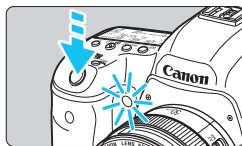

🚫 If you do not look through the viewfinder when you press the shutter button, attach the eyepiece cover (p.236). If stray light enters the viewfinder when the picture is taken, it may throw off the exposure.

- The <🕒> enables you to shoot while not touching the camera mounted on a tripod. This prevents camera shake when you shoot still lifes or long exposures.
- After taking self-timer shots, playing back the image (p.320) to check focus and exposure is recommended.
- When using the self-timer to shoot yourself, use focus lock (p.83) on an object at the same distance as where you will stand.
- To cancel the self-timer, press the <DRIVE·AF> button.

4

Image Settings

This chapter explains image-related function settings: Image-recording quality, Crop/aspect, ISO speed, Picture Style, white balance, Auto Lighting Optimizer, noise reduction, highlight tone priority, lens aberration correction, anti-flicker shooting, and other functions.

- A ☆ icon at the upper right of a page title indicates a function that can be used only in the following modes: <P> <Tv> <Av> <M> .

MENU Selecting the Card for Recording and Playback

If either a CF card or SD card is already inserted in the camera, you can start recording captured images. When only one card is inserted, you do not have to follow the procedures described on pages 146-148.

If you insert both a CF card and SD card, you can select the recording method and select which card to use for recording and playing back images.

[1] indicates the CF card, and [2] the SD card.

Recording Method with Two Cards Inserted

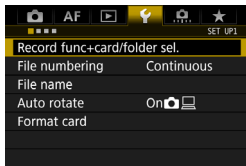

1 Select [Record func+card/folder sel.].

- Under the [1] tab, select [Record func+card/folder sel.], then press <SET>.

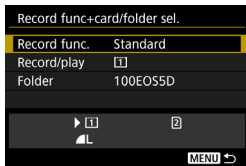

2 Select [Record func.].

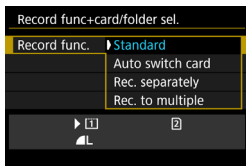

3 Select the recording method.

- Select the recording method, then press <SET>.

- **Standard**

Images will be recorded to the card selected with **[Record/play]**.

- **Auto switch card**

Same as with the **[Standard]** setting, but if the card becomes full, the camera will automatically switch to the other card to record images. When the card is automatically switched, a new folder will be created.

- **Rec. separately**

You can set the image-recording quality for each card (p.149). Each image is recorded to both the CF and SD cards at the image-recording quality you set. You can freely set the image-recording quality, such as to **L** and **RAW**, or **S3** and **M RAW**.

- **Rec. to multiple**

Each image is recorded to both the CF and SD cards simultaneously at the same image size. You can also select RAW+JPEG.



- If **[Rec. separately]** is set and different recording qualities are set for the CF card and SD card, the maximum burst for continuous shooting will decrease (p.151).
- Even if **[Record func.]** is set to **[Rec. to multiple]**, movies cannot be recorded to both the CF card and SD card at the same time. If **[Rec. separately]** or **[Rec. to multiple]** is set, the movie will be recorded to the card which is set for **[Playback]**.



[Rec. separately] and [Rec. to multiple]

- The same file number is used for recording to both the CF card and SD card.
- The LCD panel will display the number of possible shots of the card having the lower number.
- If one of the cards becomes full, **[Card* full]** will be displayed and shooting will be disabled. If this happens, either replace the card or set **[Record func.]** to **[Standard]** or **[Auto switch card]**, and select the card with remaining capacity to continue shooting.

Selecting the CF or SD Card for Recording and Playback

If **[Record func.]** is set to **[Standard]** or **[Auto switch card]**, select the card for recording and playing back images.

If **[Record func.]** is set to **[Rec. separately]** or **[Rec. to multiple]**, select the card for playing back images.

Standard / Auto switch card

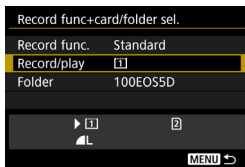

Select **[Record/play]**.

- Select **[Record/play]**, then press **< (SET) >**.
 - 1 : Record images to and play images back from the CF card.
 - 2 : Record images to and play images back from the SD card.
- Select the card, then press **< (SET) >**.

Rec. separately / Rec. to multiple

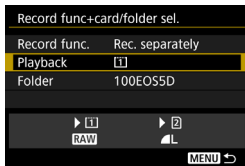

Select **[Playback]**.

- Select **[Playback]**, then press **< (SET) >**.
 - 1 : Play back the CF card's images.
 - 2 : Play back the SD card's images.
- Select the card, then press **< (SET) >**.

MENU Setting the Image-Recording Quality

You can select the pixel count and the image quality. There are ten JPEG image-recording quality settings: **L**, **L**, **M1**, **M1**, **M2**, **M2**, **S1**, **S1**, **S2**, **S3**. There are three RAW image quality settings: **RAW**, **M RAW**, **S RAW** (p.152).

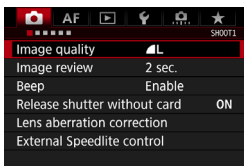

1 Select [Image quality].

- Under the [**1**] tab, select [**Image quality**], then press <SET>.

Standard / Auto switch card / Rec. to multiple

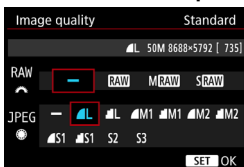

2 Select the image-recording quality.

- To select a RAW quality, turn the <DIAL> dial. To select a JPEG quality, turn the <DIAL> dial.
- On the upper right, the “**M (megapixels) ***x***” number indicates the recorded pixel count, and [***] is the number of possible shots (displayed up to 9999).
- Press <SET> to set it.

Rec. separately

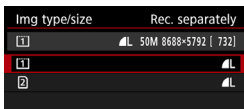

- Under [**1**: Record func+card/ folder sel.], if [**Record func.**] is set to [**Rec. separately**], select CF card [1] or SD card [2], then press <SET>.

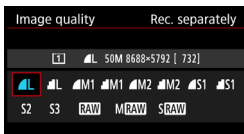

- Select the desired image-recording quality, then press <SET>.

Image-recording Quality Setting Examples

L only

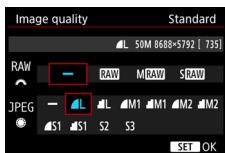

RAW only

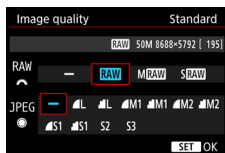

RAW + L

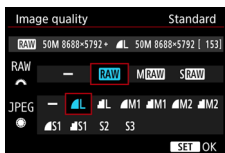

S RAW + M1

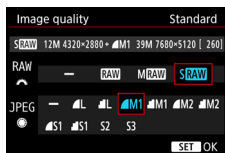

i The image size [****x****] and number of possible shots [****] displayed on the Image-recording quality setting screen always apply to the **[Full-frame]** setting regardless of the **[4: Crop/aspect ratio]** setting (p.154). The number of possible shots displayed on the LCD panel and Live View shooting screen during shooting is based on the **[4: Crop/aspect ratio]** setting.

- i** If [-] is set for both RAW and JPEG, **L** will be set.
- i** The number of possible shots will be displayed up to 1999 on the LCD panel.



Guide to Image-Recording Quality Settings (Approx.)

Image Quality		Pixels Recorded	Print Size	File Size (MB)	Possible Shots	Maximum Burst
JPEG	L	50M	A1	14.1	510	31 (510)
	L			7.0	1030	1030 (1030)
	M1	39M		10.9	660	45 (660)
	M1			5.5	1310	1310 (1310)
	M2	22M	A2	7.1	1010	1010 (1010)
	M2			3.5	2030	2030 (2030)
	S1	12M	A3	4.5	1590	1590 (1590)
	S1			2.3	3120	3120 (3120)
	S2 ^{*1}	2.5M	9x13 cm	1.2	5600	5600 (5600)
	S3 ^{*2}	0.3M	-	0.3	20380	20380 (20380)
RAW	RAW	50M	A1	60.5	100	12 (14)
	M RAW	28M	A2	44.0	140	12 (14)
	S RAW	12M	A3	29.8	190	14 (15)
RAW + JPEG	RAW	50M	A1	60.5+14.1	87	12 (12)
	L		A1			
	M RAW	28M	A2	44.0+14.1	110	11 (12)
	L	50M	A1			
	S RAW	12M	A3	29.8+14.1	140	14 (14)
L	50M	A1				

*1: S2 is suitable for playing back the images on a digital photo frame.

*2: S3 is suitable for emailing the image or using it on a Web site.

- S2 and S3 will be in (Fine) quality.
- The file size, possible shots, and maximum burst during continuous shooting are based on Canon's testing standards (Crop/aspect ratio: Full-frame, ISO 100 and Standard Picture Style) using an 8 GB CF card. **These figures will vary by the subject, card brand, crop/aspect ratio, ISO speed, Picture Style, Custom Functions, and other settings.**
- The maximum burst applies to high-speed continuous shooting. Figures in parentheses apply to an Ultra DMA (UDMA) 7 CF card, based on Canon's testing standards.

-  • Even if you use a UDMA card, the maximum burst indicator remains the same. However, the maximum burst in parentheses on the preceding page will be applied during continuous shooting.
- If you select both RAW and JPEG, the same image will be recorded simultaneously to the card in both RAW and JPEG at the image-recording qualities that were set. The two images will be recorded with the same file numbers (file extension: .JPG for JPEG and .CR2 for RAW).
- The image-recording quality icons are as follows: **RAW** (RAW), **M RAW** (Medium RAW), **S RAW** (Small RAW), JPEG (JPEG),  (Fine),  (Normal), **L** (Large), **M** (Medium), and **S** (Small).

RAW Images

A RAW image is raw data output by the image sensor converted to digital data. It is recorded to the card as is, and you can select the quality as follows: **RAW**, **M RAW**, or **S RAW**.

A **RAW** image can be processed with [] **1: RAW image processing** (p.364) and saved as a JPEG image. (**M RAW** and **S RAW** images cannot be processed with the camera.) As the RAW image itself does not change, you can process the RAW image according to different processing conditions to create any number of JPEG images from it. You can use Digital Photo Professional (EOS software, p.520) to process RAW images. You can make various adjustments as desired and generate a JPEG, TIFF, etc., image incorporating those adjustments.

RAW Image Processing Software

- To display RAW images on a computer, using Digital Photo Professional (DPP, EOS software) is recommended.
- Previous DPP Ver.4.x cannot process RAW images taken with this camera. If your computer has the previous DPP Ver.4.x, update it with the EOS DIGITAL Solution Disk (p.521). (The previous version will be overwritten.) Note that DPP Ver.3.x or earlier cannot process RAW images taken with this camera.
- Commercially-available software may not be able to display RAW images taken with this camera. For compatibility information, contact the software manufacturer.

One-touch Image Quality Setting

With Custom Controls, you can assign the image-recording quality to the <M-Fn> button or depth-of-field preview button so you can switch to it momentarily. If you assign [**One-touch image quality setting**] or [**One-touch image quality (hold)**] to the <M-Fn> button or depth-of-field preview button, you can quickly switch to the desired image-recording quality and shoot.

For details, see Custom Controls (p.413).

- Under [**1: Record func+card/folder sel.**], if [**Record func.**] is set to [**Rec. separately**], you cannot switch to the One-touch image quality setting.

Maximum Burst for Continuous Shooting



The approximate maximum burst is displayed in the viewfinder, Quick Control screen, and on the bottom right of the Custom Quick Control screen. If the maximum burst for continuous shooting is 99 or higher, “99” will be displayed.

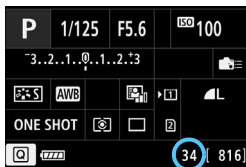

- The maximum burst is displayed even when a card is not inserted in the camera. Make sure that a card is inserted before taking a picture.

- If the maximum burst is displayed as “99”, it indicates that you can shoot 99 or more shots continuously. If the maximum burst decreases to 98 or lower and the internal buffer memory becomes full, “buSY” will be displayed in the viewfinder and on the LCD panel. Shooting will then be disabled temporarily. If you stop continuous shooting, the maximum burst will increase. After all the captured images are written to the card, you can resume continuous shooting and shoot up to the maximum burst listed on page 151.

Setting Crop/Aspect Ratio ☆

Normally, images are recorded at the sensor size of approx. 36.0 mm x 24.0 mm (full-frame shooting). You can record only the center of the image magnified approx. 1.3x (equivalent to APS-H size) or approx. 1.6x (equivalent to APS-C size) as if you were using a telephoto lens (crop shooting) or set the desired aspect ratio before you shoot.

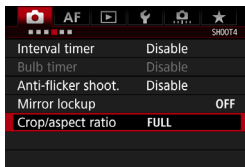

1 Select [Crop/aspect ratio].

- Under the [**4**] tab, select [**Crop/aspect ratio**], then press <SET>.

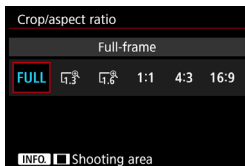

2 Select the desired setting.

Viewfinder shooting

- Select any of the following: [**Full-frame**], [**1.3x (crop)**], [**1.6x (crop)**], or [**1:1 (aspect ratio)**].
- If you set [**4:3 (aspect ratio)**] or [**16:9 (aspect ratio)**] and use the viewfinder to shoot, the shooting result will be the same as with [**Full-frame**].

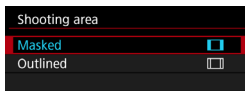

Live View shooting (p.256)

- You can select any setting.
- If you will not change the shooting area display, press <SET> and go to step 4.



3 Select the shooting area display.

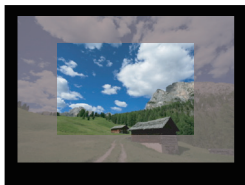
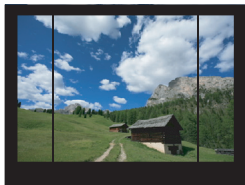

- With the screen in step 2 displayed, press the <INFO.> button.
- Select either [**Masked**] or [**Outlined**], then press <SET>.

Example settingsWith 4:6 With 1:1 With 1.3x With 4:3 **4 Take the picture.****Viewfinder shooting**

- The shooting area in the viewfinder will be masked or have frame lines.
- The area surrounded by the semi-transparent masking or frame lines will be recorded as an image.

Live View shooting

- When [1.3x (crop)] or [1.6x (crop)] is set, the displayed image will be magnified by approx. 1.3x or 1.6x respectively.
- Regardless of the [Shooting area] setting, the area shown by the displayed image will be recorded.
- If you select [1:1 (aspect ratio)], [4:3 (aspect ratio)], or [16:9 (aspect ratio)], the area surrounded by the masking or frame lines will be recorded as an image.

- The [ 4: **Crop/aspect ratio**] setting does not work with movie shooting and multiple exposures.
- The 4:3 and 16:9 aspect ratios cannot be used with viewfinder shooting.
- [ 3: **Add cropping information**] can be set only when [**Full-frame**] has been set for Crop/aspect ratio.
- An external Speedlite's flash zoom (automatic flash coverage) will not work in tandem with the [ 4: **Crop/aspect ratio**] setting.

- The image coverage with viewfinder shooting will be as follows:
 - With [**1.3x (crop)**]: Approx. 99% vertical/horizontal coverage.
 - With [**1.6x (crop)**]: Approx. 98% vertical/horizontal coverage.
 - With [**1:1 (aspect ratio)**]: Approx. 100% vertical and approx. 99% horizontal coverage.
- When the image-recording quality is RAW, the image will be recorded in full-frame and the Crop/aspect ratio setting will be appended. During RAW image playback, the shooting area will be indicated by frame lines on the full-frame display. However, in a slide show (p.348), only the shooting area will appear.
- If you use [ 3: **Custom Controls**] to assign [**Switch between crop/aspect**] to the <M-Fn> button (p.413), you can press the <M-Fn> button during viewfinder shooting or Live View shooting to switch the Crop/aspect ratio shooting area (p.423).
- During Live View shooting, you can use the Quick Control screen to set [**Crop/aspect ratio**] (p.263).

Pixels Recorded in Crop/Aspect Ratio Settings

(Approx.)

Image Quality	Full-frame (3:2)	1.3x (crop)	1.6x (crop)
L	8688x5792 (50.3 megapixels)	6768x4512 (30.5 megapixels)	5424x3616 (19.6 megapixels)
M1	7680x5120 (39.3 megapixels)	6016x4000* (24.1 megapixels)	4800x3200 (15.4 megapixels)
M2	5760x3840 (22.1 megapixels)	4512x3008 (13.6 megapixels)	3616x2408* (8.7 megapixels)
S1	4320x2880 (12.4 megapixels)	3376x2256* (7.6 megapixels)	2704x1808* (4.9 megapixels)
S2	1920x1280 (2.5 megapixels)	1920x1280 (2.5 megapixels)	1920x1280 (2.5 megapixels)
S3	720x480 (350,000 pixels)	720x480 (350,000 pixels)	720x480 (350,000 pixels)

(Approx.)

Image Quality	1:1 (aspect ratio)	4:3 (aspect ratio)	16:9 (aspect ratio)
L	5792x5792 (33.5 megapixels)	7712x5792* (44.7 megapixels)	8688x4888* (42.5 megapixels)
M1	5120x5120 (26.2 megapixels)	6816x5120* (34.9 megapixels)	7680x4320 (33.2 megapixels)
M2	3840x3840 (14.7 megapixels)	5120x3840 (19.7 megapixels)	5760x3240 (18.7 megapixels)
S1	2880x2880 (8.3 megapixels)	3840x2880 (11.1 megapixels)	4320x2432* (10.5 megapixels)
S2	1280x1280 (1.6 megapixels)	1712x1280* (2.2 megapixels)	1920x1080 (2.1 megapixels)
S3	480x480 (230,000 pixels)	640x480 (310,000 pixels)	720x408* (290,000 pixels)



- The items marked with an asterisk do not exactly match the indicated aspect ratio.
- For JPEG image file sizes, see the figures for full-frame shooting on page 370. The file size of an image taken with the [4: Crop/aspect ratio] set will be smaller than an identical image taken with [Full-frame] set.
- The file size and maximum burst of RAW images are the same as those of full-frame shooting. See page 151.

ISO: Setting the ISO Speed [☆]

Set the ISO speed (image sensor's sensitivity to light) to suit the ambient light level. With the $\langle \text{A}^+ \rangle$ mode selected, the ISO speed will be set automatically (p.160).

Regarding the ISO speed during movie shooting, see pages 283 and 287.

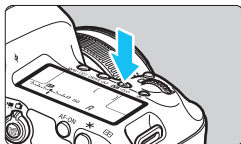

1 Press the $\langle \text{ISO} \rangle$ button. (06)

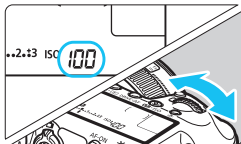

2 Set the ISO speed.

- While looking at the LCD panel or in the viewfinder, turn the $\langle \text{gear} \rangle$ dial.
- ISO speed can be set within ISO 100 - ISO 6400 in 1/3-stop increments.
- "A" indicates Auto ISO. The ISO speed will be set automatically (p.160).

ISO Speed Guide

ISO speed	Shooting Situation (No flash)	Flash Range
L, ISO 100 - ISO 400	Sunny outdoors	The higher the ISO speed, the farther the flash range will be.
ISO 400 - ISO 1600	Overcast skies or evening time	
ISO 1600 - ISO 6400, H	Dark indoors or night	

* High ISO speeds will result in grainier images.



- As H (equivalent to ISO 12800) is an expanded ISO speed setting, noise (dots of light, banding, etc.) and irregular colors will be more noticeable, and the resolution lower than usual.
- As L (equivalent to ISO 50) is an expanded ISO speed setting, the dynamic range will be somewhat narrower than usual.
- If [**☑3: Highlight tone priority**] is set to [**Enable**] (p.187), L (equivalent to ISO 50), ISO 100/125/160, and H (equivalent to ISO 12800) cannot be selected.
- Shooting in high temperatures may result in images that look grainier. Long exposures can also cause irregular colors in the image.
- When you shoot at high ISO speeds, noise (such as dots of light and banding) may become noticeable.
- When shooting in conditions that produce an extreme amount of noise, such as a combination of high ISO speed, high temperature, and long exposure, images may not be recorded properly.
- If you use a high ISO speed and flash to shoot a close subject, overexposure may result.



Under [**☑2: ISO speed settings**], you can use [**ISO speed range**] to expand the settable ISO speed range from L (equivalent to ISO 50) to H (equivalent to ISO 12800) (p.161).

Auto ISO

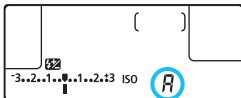

If the ISO speed is set to “A” (Auto), the actual ISO speed to be set will be displayed when you press the shutter button halfway.

As indicated below, the ISO speed will be set automatically to suit the shooting mode.

Shooting Mode	ISO Speed Setting	
	No Flash	With Flash
A ⁺	ISO 100 - ISO 3200	ISO 100 - ISO 1600
P/Tv/Av/M	ISO 100 - ISO 6400 ^{*1}	ISO 400 ^{*1*2*3}
B	ISO 400 ^{*1}	

*1: The actual ISO speed range depends on the [Minimum] and [Maximum] settings set in [Auto ISO range].

*2: If fill flash will cause overexposure, ISO speed may be reduced, down to a possible minimum of ISO 100 (except in the <M> and modes).

*3: In the <P> mode, if the external Speedlite is set for bounce flash, ISO 400 - ISO 1600 will be set automatically.

MENU Setting the Manually-Settable ISO Speed Range

You can set the manually-settable ISO speed range (minimum and maximum limits). You can set the minimum limit within L (equivalent to ISO 50) to ISO 6400, and the maximum limit within ISO 100 to H (equivalent to ISO 12800).

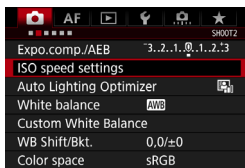

1 Select [ISO speed settings].

- Under the [CAMERA] tab, select [ISO speed settings], then press <SET>.

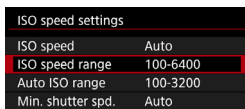

2 Select [ISO speed range].

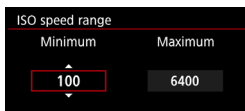

3 Set the minimum limit.

- Select the minimum limit box, then press <SET>.
- Select the ISO speed, then press <SET>.

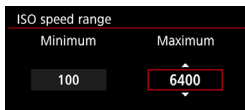

4 Set the maximum limit.

- Select the maximum limit box, then press <SET>.
- Select the ISO speed, then press <SET>.

5 Select [OK].

MENU Setting the ISO Speed Range for Auto ISO

You can set the automatic ISO speed range for Auto ISO within ISO 100 - ISO 6400. You can set the minimum limit within ISO 100 - ISO 3200, and the maximum limit within ISO 200 - ISO 6400 in 1-stop increments.

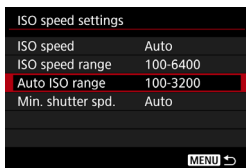
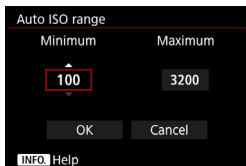
**1** Select [Auto ISO range].**2** Set the minimum limit.

- Select the minimum limit box, then press < (SET) >.
- Select the ISO speed, then press < (SET) >.

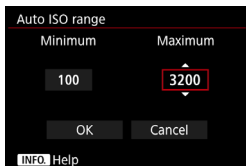
**3** Set the maximum limit.

- Select the maximum limit box, then press < (SET) >.
- Select the ISO speed, then press < (SET) >.

4 Select [OK].

The [Minimum] and [Maximum] settings will also be applied to the ISO speed safety shift's minimum and maximum ISO speeds (p.405).

MENU Setting the Minimum Shutter Speed for Auto ISO

You can set the minimum shutter speed so that the shutter speed set automatically will not be too slow when Auto ISO is set.

This is convenient in the <P> and <Av> modes when you use a wide-angle lens to shoot a moving subject or when you use a telephoto lens. It helps to reduce camera shake and blurred subjects.

ISO speed settings	
ISO speed	Auto
ISO speed range	100-6400
Auto ISO range	100-3200
Min. shutter spd.	Auto

1 Select [Min. shutter spd.].

Automatically set

Min. shutter spd.	
Auto(Standard)	
Auto	
Manual	
Slower	Faster

2 Set the desired minimum shutter speed.

- Select [Auto] or [Manual].
- If you select [Auto], turn the < > dial to set the desired speed, slower or faster, compared to the standard speed, then press < >.
- If you select [Manual], turn the < > dial to select the shutter speed, then press < >.

Manually set

Min. shutter spd.				
Manual(1/125)				
Auto				
Manual				
1/8000	1/4000	1/2000	1/1000	1/500
1/250	1/125	1/60	1/30	1/15
1/8	1/4	0.5	1"	





- If a correct exposure cannot be obtained with the maximum ISO speed limit set with [Auto ISO range], a shutter speed slower than the [Min. shutter spd.] will be set to obtain a standard exposure.
- This function will not be applied to flash and movie shooting.





When [Auto: 0] is set, the minimum shutter speed will be the reciprocal of the lens focal length. A single step from [Slower] to [Faster] is equivalent to a single shutter speed stop.

Selecting a Picture Style ☆

By selecting a Picture Style, you can obtain image characteristics matching your photographic expression or the subject.

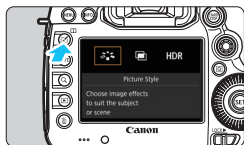
The Picture Style is set automatically to [A] (Auto) in the <A+> mode.



1 Press the < > button.

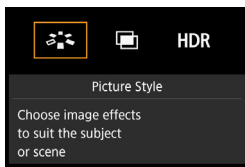

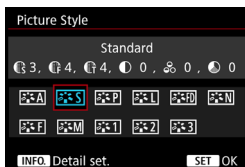

2 Select [].

▶ The Picture Style selection screen will appear.



3 Select a Picture Style.

▶ The Picture Style will be set and the camera will be ready to shoot.

 You can also select the Picture Style with [3: Picture Style].

Picture Style Characteristics

Auto

The color tone will be adjusted automatically to suit the scene. The colors will look vivid, especially for blue skies, greenery and sunsets, and in nature, outdoor and sunset scenes.



If the desired color tone is not obtained with **[Auto]**, use another Picture Style.

Standard

The image looks vivid, sharp, and crisp. This is a general-purpose Picture Style suitable for most scenes.

Portrait

For nice skin tones. The image looks softer. Suited for close-up portraits.

By changing the **[Color tone]** (p.168), you can adjust the skin tone.

Landscape

For vivid blues and greens, and very sharp and crisp images. Effective for impressive landscapes.

Fine Detail

Suited for detailed outline and fine texture description of the subject. The colors will be slightly vivid.

Neutral

Suited for processing the image with a computer. For natural colors and subdued images with modest brightness and color saturation.



Faithful

Suited for processing the image with a computer. The color of a subject that is captured in sunlight at a color temperature of 5200K will be adjusted to match the subject's colorimetric color. For subdued images with modest brightness and color saturation.

Monochrome

Creates black-and-white images.

 Black-and-white images shot in JPEG cannot be turned into color. If you want to later shoot pictures in color, make sure the **[Monochrome]** setting is canceled.

 You can display  in the viewfinder when **[Monochrome]** is set (p.409).

User Def. 1-3









You can register a basic style such as **[Portrait]**, **[Landscape]**, a Picture Style file, etc., and adjust it as desired (p.172). Any User Defined Picture Style that is not set will have the same settings as the **[Standard]** Picture Style.

Symbols

The Picture Style selection screen has icons for **[Strength]**, **[Fineness]**, or **[Threshold]** of **[Sharpness]**, **[Contrast]**, and other parameters. The numerals indicate the set values for these parameters as set by the respective Picture Style.



Symbols

	Sharpness	
		Strength
		Fineness
		Threshold
	Contrast	
	Saturation	
	Color tone	
	Filter effect (Monochrome)	
	Toning effect (Monochrome)	

 **[Fineness]** and **[Threshold]** for **[Sharpness]** will not be applied to movies.

Customizing a Picture Style ☆

You can customize the Picture Styles. You can change or adjust the parameter settings of Picture Styles such as [**Strength**], [**Fineness**], or [**Threshold**] of [**Sharpness**], and [**Contrast**], and other parameters from the default settings. To see the resulting effects, take test shots. To customize [**Monochrome**], see page 171.

1 Press the  button.

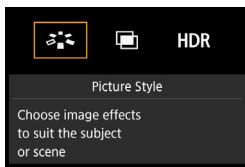

2 Select [].

- ▶ The Picture Style selection screen will appear.

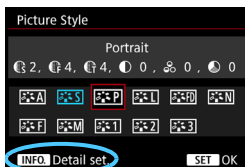

3 Select a Picture Style.

- Select a Picture Style, then press <INFO.> button.

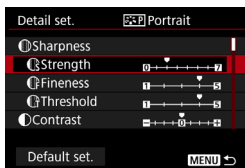

4 Select a parameter.

- Select the parameter (such as [**Sharpness**] - [**Strength**]) to be set, then press <SET>.
- The settings and effects are explained on page 170.

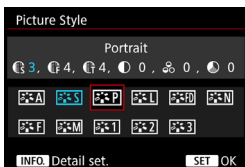







5 Set the parameter.

- Adjust the parameter as desired, then press $\langle \text{SET} \rangle$.
- Press the $\langle \text{MENU} \rangle$ button to save the adjusted parameters. The Picture Style selection screen will reappear.
- ▶ Any parameter settings different from the default will be displayed in blue.



- By selecting [**Default set.**] in step 4, you can revert the parameter settings of the respective Picture Style to its default.
- To shoot with the Picture Style you adjusted, first select the adjusted Picture Style, then shoot.

Parameter Settings and Effects

	Sharpness			
		Strength	0: Less sharp outline	7: Sharp outline
		Fineness ^{*1}	1: Fine	5: Coarse
		Threshold ^{*2}	1: Low	5: High
	Contrast	-4: Low contrast	+4: High contrast	
	Saturation	-4: Low saturation	+4: High saturation	
	Color tone	-4: Reddish skin tone	+4: Yellowish skin tone	

*1: Indicates the fineness of the outlines to be emphasized. The smaller the number, the finer the outlines can be emphasized.

*2: Sets how much the outline is emphasized based on the difference in contrast between the subject and the surrounding area. The smaller the number, the more the outline will be emphasized when the contrast difference is low. However, noise at high ISO speeds tends to be more noticeable when the number is smaller.

Monochrome Adjustment

Besides **[Strength]**, **[Fineness]**, or **[Threshold]** of **[Sharpness]** and **[Contrast]**, you can also set **[Filter effect]** and **[Toning effect]**.

Filter effect

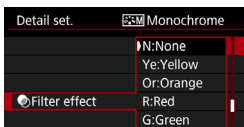

With a filter effect applied to a monochrome image, you can make white clouds or green trees stand out more.

Filter	Sample Effects
N: None	Normal black-and-white image with no filter effects.
Ye: Yellow	The blue sky will look more natural, and the white clouds will look crisper.
Or: Orange	The blue sky will look slightly darker. The sunset will look more brilliant.
R: Red	The blue sky will look quite dark. Fall leaves will look crisper and brighter.
G: Green	Skin tones and lips will appear muted. Green tree leaves will look crisper and brighter.

 Increasing the **[Contrast]** will make the filter effect more pronounced.

Toning effect

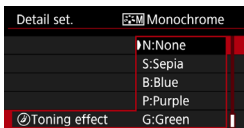

By applying a toning effect, you can create a monochrome image in that color. It can make the image look more impressive.

The following can be selected: **[N:None]**, **[S:Sepia]**, **[B:Blue]**, **[P:Purple]** or **[G:Green]**.

Registering a Picture Style ☆

You can select a base Picture Style such as [Portrait] or [Landscape], adjust its parameters as desired and register it under [User Def. 1], [User Def. 2], or [User Def. 3]. You can create multiple Picture Styles with different settings for parameters such as sharpness and contrast. You can also adjust the parameters of a Picture Style that is registered to the camera with EOS Utility (EOS software, p.520).

1 Press the  button.

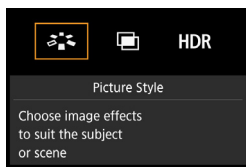

2 Select .

▶ The Picture Style selection screen will appear.

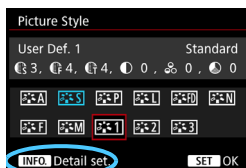

3 Select [User Def. *].

- Select [User Def. *], then press <INFO.> button.



4 Press <SET>.

- With [Picture Style] selected, press <SET>.

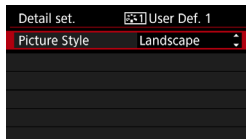

5 Select the base Picture Style.

- Select the base Picture Style, then press <SET>.
- To adjust the parameters of a Picture Style that is registered to the camera with EOS Utility (EOS software), select the Picture Style here.



6 Select a parameter.

- Select the parameter (such as **[Sharpness]** - **[Strength]**) to be set, then press **<SET>**.

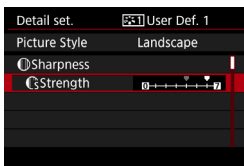

7 Set the parameter.

- Adjust the parameter as desired, then press **<SET>**.
For details, see “Customizing a Picture Style” (p.168).
- Press the **<MENU>** button to register the modified Picture Style. The Picture Style selection screen will then reappear.
- ▶ The base Picture Style will be indicated on the right of **[User Def. *]**.

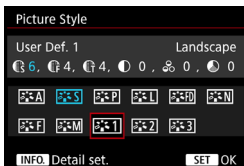

- If a Picture Style has already been registered under **[User Def. *]**, changing the base Picture Style in step 5 will nullify the parameter settings of the registered Picture Style.
- If you perform **[Clear all camera settings]** (p.70), all the **[User Def. *]** styles and settings will revert to their defaults. Any Picture Style registered via EOS Utility (EOS software) will have only its modified parameters reverted to the default setting.



- To shoot with the Picture Style you adjusted, select the registered **[User Def. *]**, then shoot.
- Regarding the procedure to register a Picture Style file to the camera, refer to the EOS Utility Instruction Manual (p.520).

WB: Setting the White Balance ☆

White balance (WB) is for making the white areas look white. Normally, the Auto [AWB] (Ambience priority) or [AWBw] (White priority) setting will obtain the correct white balance. If natural-looking colors cannot be obtained with Auto, you can select the white balance to match the light source or set it manually by shooting a white object.

<A+> is automatically set in the [AWB] (Ambience priority) mode.

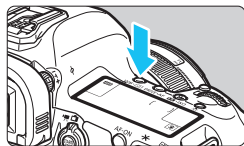

1 Press the <WB> button. (⓪6)

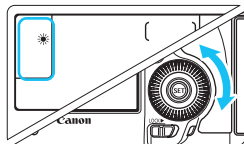

2 Select a white balance setting.

- While looking at the LCD panel or in the viewfinder, turn the <WB> dial.

(Approx.)

Display	Mode	Color Temperature (K: Kelvin)
[AWB]	Auto (Ambience priority, p.175)	3000-7000
[AWBw]	Auto (White priority, p.175)	
[☀]	Daylight	5200
[🏠]	Shade	7000
[☁]	Cloudy, twilight, sunset	6000
[💡]	Tungsten light	3200
[💡]	White fluorescent light	4000
[⚡]	Flash use	Automatically set*
[📷]	Custom (p.176)	2000-10000
[K]	Color temperature (p.178)	2500-10000

* Applicable with Speedlites having a color temperature transmission function. Otherwise, it will be fixed to approx. 6000 K.

📖 You can also set this with [📷2: White balance].

White Balance

To the human eye, a white object looks white regardless of the type of lighting. With a digital camera, the white for color correction basis is decided depending on the color temperature of the illumination, and then the color is adjusted with software to make the white areas look white. With this function, pictures with natural color shades can be taken.

AWB Auto White Balance

With the standard [AWB] (Ambience priority), you can increase the intensity of the image's warm color cast when shooting a tungsten-light scene. If you select [AWBw] (White priority), you can reduce the intensity of the image's warm color cast.

If you want to match the Auto white balance of previous EOS DIGITAL camera models, select [AWB] (Ambience priority).

1 Select [White balance].

- Under the [CAM2] tab, select [White balance], then press <SET>.

2 Select <AWB>.

- Select <AWB>, then press <INFO.> button.

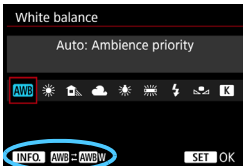

3 Select the desired item.

- Select [Auto: Ambience priority] or [Auto: White priority], then press <SET>.

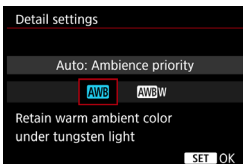

AWB : Auto: Ambience priority

AWBw : Auto: White priority

⚠ Cautions for Setting [AWB w] (White priority)

- The reddish color cast of subjects may fade.
- When multiple light sources are included on the screen, the red color cast of the picture may not be lessened.
- When using flash, the color tone will be the same as [AWB] (Ambience priority).

📷 Custom White Balance

Custom white balance enables you to manually set the white balance for a specific light source for better accuracy. Perform this procedure under the actual light source to be used.

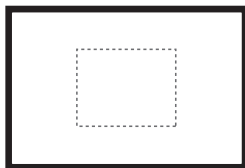

1 Shoot a white object.

- Look through the viewfinder and aim the entire dotted line box (shown in the illustration) over a plain, white object.
- Focus manually and shoot with the standard exposure set for the white object.
- You can use any white balance setting.

2 Select [Custom White Balance].

- Under the [CAM2] tab, select [Custom White Balance], then press <SET>.
- ▶ The custom white balance selection screen will appear.

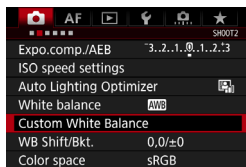



3 Import the white balance data.

- Turn the <⦿> dial to select the image captured in step 1, then press <SET>.
- ▶ On the dialog screen that appears, select [OK] and the data will be imported.
- Press the <MENU> button to exit the menu.

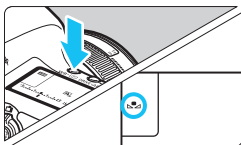

4 Press the <WB·[camera icon]> button. (⦿6)

5 Select the custom white balance.

- Look at the LCD panel and turn the <⦿> dial to select <[camera icon]>.



- If the exposure obtained in step 1 differs greatly from the standard exposure, a correct white balance may not be obtained.
- In step 3, the following images cannot be selected: Images captured while the Picture Style was set to [Monochrome], multiple-exposure images, and images shot with another camera.



- Instead of a white object, a gray chart or 18% gray reflector (commercially available) can produce a more accurate white balance.
- The personal white balance registered with the EOS software will be registered under <[camera icon]>. If you perform step 3, the data for the registered personal white balance will be erased.

K Setting the Color Temperature

You can set the white balance's color temperature numerically. This is for advanced users.

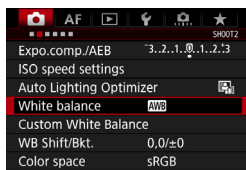

1 Select [White balance].

- Under the [**2**] tab, select [White balance], then press <SET>.

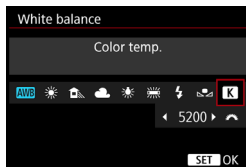

2 Set the color temperature.

- Select [**K**].
- Turn the <DIAL> dial to set the color temperature, then press <SET>.
- The color temperature can be set from approx. 2500 K to 10000 K in 100 K increments.



- When setting the color temperature for an artificial light source, set white balance correction (magenta or green) as necessary.
- If you set [**K**] to the reading taken with a commercially-available color temperature meter, take test shots and adjust the setting to compensate for the difference between the color temperature meter's reading and the camera's color temperature reading.

WB \pm White Balance Correction [☆]

You can correct the white balance that is set. This adjustment will have the same effect as using a commercially-available color temperature conversion filter or color compensating filter. Each color can be corrected to one of nine levels.

This function is for advanced users who are familiar with using color temperature conversion or color compensating filters.

White Balance Correction

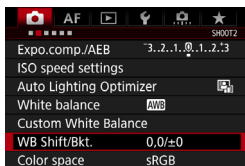

1 Select [WB Shift/Bkt.].

- Under the [**2**] tab, select **[WB Shift/Bkt.]**, then press **<SET>**.

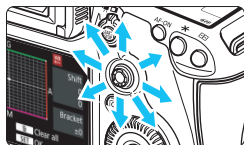

2 Set the white balance correction.

- Use **<⦿>** to move the “■” mark to the appropriate position.
- B is for blue, A for amber, M for magenta, and G for green. The image's color balance will be adjusted towards the color in the direction of the move.
- On the right of the screen, “**Shift**” indicates the direction and correction amount, respectively.
- Pressing the **<⏏>** button will cancel all the **[WB Shift/Bkt.]** settings.
- Press **<SET>** to exit the setting.

Sample setting: A2, G1

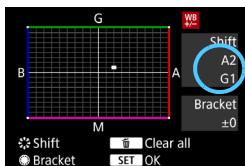

- During the white balance correction, **<WB>** will be displayed on the LCD panel.
- You can display **<!>** in the viewfinder when white balance correction is set (p.409).
- One level of the blue/amber correction is equivalent to approx. 5 mireds of a color temperature conversion filter. (Mired: Measuring unit indicating the density of a color temperature conversion filter.)

White Balance Auto Bracketing

With just one shot, three images with different color tones can be recorded simultaneously. Based on the color temperature of the current white balance setting, the image will be bracketed with a blue/amber bias or magenta/green bias. This is called white balance bracketing (WB-BKT). White balance bracketing is possible up to ± 3 levels in single-level increments.

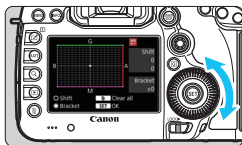

B/A bias ± 3 levels

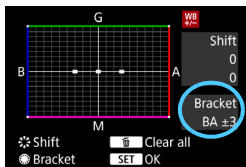

Set the white balance bracketing amount.

- In step 2 for “White Balance Correction”, when you turn the $\langle \odot \rangle$ dial, the “■” mark on the screen will change to “■■■” (3 points). Turning the dial to the right sets the B/A bracketing, and turning it to the left sets the M/G bracketing.
- ▶ On the right, “**Bracket**” indicates the bracketing direction and correction amount.
- Pressing the $\langle \text{WB Shift/Bkt.} \rangle$ button will cancel all the [WB Shift/Bkt.] settings.
- Press $\langle \text{SET} \rangle$ to exit the setting.

Bracketing Sequence

The images will be bracketed in the following sequence: 1. Standard white balance, 2. Blue (B) bias, and 3. Amber (A) bias, or 1. Standard white balance, 2. Magenta (M) bias, and 3. Green (G) bias.



- During WB bracketing, the maximum burst for continuous shooting will be lower.
- Since three images are recorded for one shot, it takes longer to record the image to the card.



- You can also set white balance correction and AEB together with white balance bracketing. If you set AEB in combination with white balance bracketing, a total of nine images will be recorded for a single shot.
- When white balance bracketing is set, the white balance icon will blink.
- You can change the number of shots for white balance bracketing (p.404).
- “**Bkt.**” stands for bracketing.

MENU Auto Correction of Brightness and Contrast [☆]

If the image comes out dark or the contrast is low, the brightness and contrast can be corrected automatically. This function is called Auto Lighting Optimizer. The default setting is [Standard]. With JPEG images, the correction is applied when the image is captured.

[Standard] is automatically set in the <[A+]> mode.

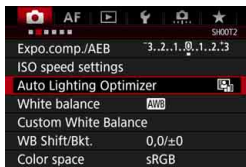

1 Select [Auto Lighting Optimizer].

- Under the [CAMERA] tab, select [Auto Lighting Optimizer], then press <[SET]>.

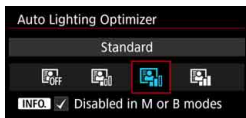

2 Select the setting.

- Select the desired setting, then press <[SET]>.

3 Take the picture.

- The image will be recorded with the brightness and contrast corrected if necessary.

- Depending on the shooting conditions, noise may increase.
- If the Auto Lighting Optimizer is too strong and the image is too bright, set [Low] or [Disable].
- If a setting other than [Disable] is set and you use exposure compensation or flash exposure compensation to darken the exposure, the image may still come out bright. If you want a darker exposure, set this function to [Disable].
- If [CAMERA 3: Highlight tone priority] is set to [Enable], [Auto Lighting Optimizer] will be set automatically to [Disable].

In step 2, if you press the <[INFO]> button and uncheck <[✓]> the [Disabled in M or B modes] setting, the [Auto Lighting Optimizer] can also be set in the <[M]> and <[B]> modes.

MENU Setting Noise Reduction ☆

High ISO Speed Noise Reduction

This function reduces the noise generated in the image. Although noise reduction is applied at all ISO speeds, it is particularly effective at high ISO speeds. At low ISO speeds, the noise in the darker parts of the image (shadow areas) is further reduced.

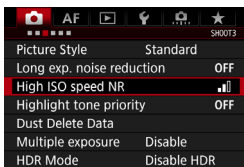

1 Select [High ISO speed NR].

- Under the [**3**] tab, select [**High ISO speed NR**], then press <SET>.

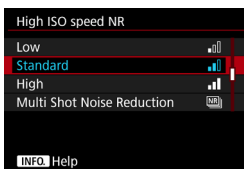

2 Set the level.

- Select the desired noise reduction level, then press <SET>.

• **NR**: Multi Shot Noise Reduction

This applies noise reduction with higher image quality than [**High**]. For a single photo, four shots are taken continuously and aligned and merged automatically into a single JPEG image.

If the image-recording quality is set to RAW or RAW+JPEG, you cannot set [**Multi Shot Noise Reduction**].





3 Take the picture.

- The image will be recorded with noise reduction applied.



When Multi Shot Noise Reduction is set, you can display <NR> in the viewfinder (p.409).

Cautions for Setting Multi Shot Noise Reduction

- If there is significant misalignment in the image due to camera shake, the noise reduction effect may be minimal.
- If you are handholding the camera, keep it steady to prevent camera shake. Using a tripod is recommended.
- If you shoot a moving subject, the moving subject may leave afterimages.
- The image alignment may not function properly with repetitive patterns (lattice, stripes, etc.) or flat, single-tone images.
- If the subject's brightness changes as the four consecutive shots are taken, irregular exposure in the image may result.
- After shooting, it may take some time to record an image to the card for noise reduction and merging the images. During the processing of the images, "buSY" will be displayed in the viewfinder and on the LCD panel, and you cannot take another picture until the processing is completed.
- You cannot use AEB and WB bracketing.
- If [ 3: Long exp. noise reduction], [ 3: Multiple exposure], [ 3: HDR Mode], AEB, or WB bracketing is set, [**Multi Shot Noise Reduction**] cannot be set.
- You cannot set [**Multi Shot Noise Reduction**] for bulb exposures and movie shooting.
- Flash shooting is not possible. The EOS-dedicated, external Speedlite's AF-assist beam will be emitted according to the [**AF3: AF-assist beam firing**] setting.
- Doing any of the following will automatically switch the setting to [**Standard**]: Set the power switch to <OFF>, replace the battery, replace the card, select the < > or < > shooting mode, set or switch the image-recording quality to RAW or RAW+JPEG, or switch to movie shooting.

Long Exposure Noise Reduction

Noise reduction is possible with images exposed for 1 sec. or longer.

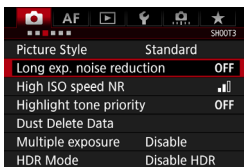

1 Select [Long exp. noise reduction].

- Under the [**3**] tab, select [**Long exp. noise reduction**], then press **<SET>**.

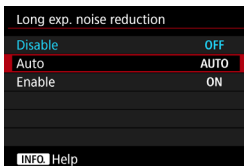

2 Set the desired setting.

- Select the desired setting, then press **<SET>**.

• Auto

For exposures of 1 sec. or longer, noise reduction is performed automatically if noise typical of long exposures is detected. This [**Auto**] setting is effective in most cases.

• Enable

Noise reduction is performed for all exposures of 1 sec. or longer. The [**Enable**] setting may reduce noise that cannot be detected with the [**Auto**] setting.

3 Take the picture.

- The image will be recorded with noise reduction applied.

- With **[Auto]** and **[Enable]**, the noise reduction process after the picture is taken may take the same amount of time as that for the exposure. During noise reduction, shooting is still possible as long as the maximum burst indicator in the viewfinder shows “1” or higher.
- Images taken at ISO 1600 or higher may look grainier with the **[Enable]** setting than with the **[Disable]** or **[Auto]** setting.
- With **[Enable]**, if a long exposure is shot with the Live View image displayed, “**BUSY**” will be displayed during the noise reduction process. The Live View display will not appear until the noise reduction is completed. (You cannot take another picture.)

MENU Highlight Tone Priority ☆

You can reduce overexposed, clipped highlights.

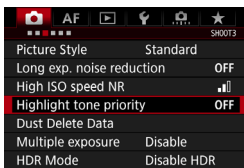

1 Select [Highlight tone priority].

- Under the [**3**] tab, select [Highlight tone priority], then press <SET>.

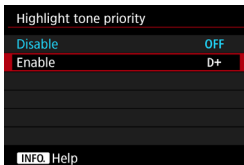

2 Select [Enable].

- Highlight details are improved. The dynamic range is expanded from the standard 18% gray to bright highlights. The gradation between the grays and highlights becomes smoother.

3 Take the picture.

- The image will be recorded with highlight tone priority applied.



When [Enable] is set, noise may increase slightly.



With [Enable], the settable range will be ISO 200 - ISO 6400. Also, the <D+> icon will be displayed in the viewfinder and on the LCD panel when highlight tone priority is enabled.

MENU Correction of Lens Peripheral Illumination and Aberration

Peripheral light fall-off is a phenomenon that makes the image corners look darker due to the lens characteristics. Color fringing along subject outlines is called chromatic aberration. This lens aberration and light fall-off can be corrected. By default, Peripheral illumination and Chromatic aberration correction are set to **[Enable]**.

If **[Cannot correct - no data]** is displayed, see “Lens Correction Data” on the next page.

Peripheral Illumination Correction

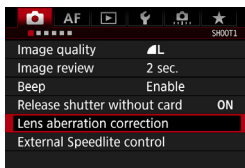

1 Select [Lens aberration correction].

- Under the [**1**] tab, select [**Lens aberration correction**], then press **<SET>**.

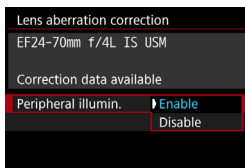

2 Select the setting.

- Check that [**Correction data available**] is displayed for the attached lens.
- Select [**Peripheral illumin.**], then press **<SET>**.
- Select [**Enable**], then press **<SET>**.

3 Take the picture.

- The image will be recorded with the peripheral illumination corrected.

Depending on shooting conditions, noise may appear on the image periphery.

- The correction amount applied will be lower than the maximum correction amount settable with Digital Photo Professional (EOS software, p.520).
- The higher the ISO speed, the lower the correction amount will be.

Chromatic Aberration Correction

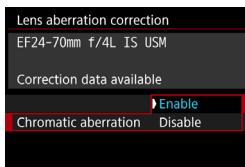

1 Select the setting.

- Check that [**Correction data available**] is displayed for the attached lens.
- Select [**Chromatic aberration**], then press < (SET) >.
- Select [**Enable**], then press < (SET) >.

2 Take the picture.

- The image will be recorded with the chromatic aberration corrected.

Lens Correction Data

The camera already contains data for lens peripheral illumination correction and chromatic aberration correction for approx. 30 lenses. If you select [**Enable**], the peripheral illumination correction and chromatic aberration correction will be applied automatically for any lens whose correction data is registered in the camera.

With EOS Utility (EOS software), you can check the lenses of which correction data is registered in the camera. You can also register the correction data for unregistered lenses. For details, refer to the EOS Utility Instruction Manual (p.522).

For lenses incorporating the correction data, it is not necessary to register the correction data to the camera.

Cautions for Lens Correction

- Peripheral illumination correction and chromatic aberration correction cannot be applied to JPEG images already taken.
- When using a non-Canon lens, setting the corrections to **[Disable]** is recommended, even if **[Correction data available]** is displayed.
- If you use magnified view during Live View shooting, the peripheral illumination correction and chromatic aberration correction will not be reflected in the image shown on the screen.
- The correction amount will be less if the lens used does not have distance information.

Notes for Lens Correction

- If the effect of the correction is not visible, magnify the image after shooting and check it again.
- Corrections can be applied even when an Extender or Life-size Converter is attached.

MENU Reducing Flicker ☆

If you shoot an image with a fast shutter speed under a light source such as fluorescent light, the blinking of the light source causes flicker and the image may be vertically unevenly exposed. If continuous shooting is used under these conditions, uneven exposures or colors across the images may result.

With anti-flicker shooting, the camera detects the frequency of the light source's blinking and takes the picture when the flicker causes less effect on exposure or color.

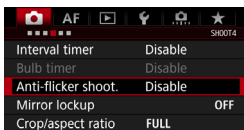

1 Select [Anti-flicker shoot.].

- Under the [**4**] tab, select [**Anti-flicker shoot.**], then press < **SET** >.

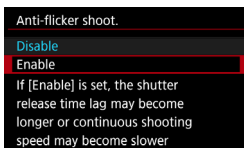

2 Select [Enable].

3 Take the picture.

- The image will be taken with reduced unevenness of exposure or color caused by the flicker.



- When [**Enable**] is set and you shoot under a flickering light source, the shutter-release time lag may become longer. Also, the continuous shooting speed may become slightly slower, and the shooting interval may become irregular.
- This function does not work with Live View shooting and movie shooting.
- In the <**P**> or <**Av**> mode, if the shutter speed changes during continuous shooting or if you shoot multiple shots of the same scene at different shutter speeds, the color tone may be inconsistent. To avoid inconsistent color tones, use the <**Tv**> or <**M**> mode at a fixed shutter speed.
- The color tone of images shot when [**Anti-flicker shoot.**] is set to [**Enable**] may look different from when [**Disable**] is set.
- Flicker at a frequency other than 100 Hz or 120 Hz cannot be detected. Also, if the light's flicker frequency changes during continuous shooting, effects of the flicker cannot be reduced.

- 
 - If the subject is against a dark background or if there is a bright light in the image, flicker may not be detected.
 - Under certain special types of lighting, the camera may not be able to reduce the effects of the flicker even when < **Flicker!** > is displayed.
 - Depending on the light source, flicker may not be detected properly.
 - If you recompose a shot, < **Flicker!** > may appear and disappear intermittently.
 - Depending on the light sources or shooting conditions, expected result may not be obtained even if you use this function.

- 
 - Taking test shots is recommended.
 - If < **Flicker!** > is not displayed in the viewfinder, checkmark **[Flicker detection]** in **[Show/hide in viewfinder]** (p.77). When the camera reduces the effects of the flicker when you shoot, < **Flicker!** > will light. Under a light source which does not flicker, or if no flicker is detected, < **Flicker!** > will not be displayed.
 - If **[Flicker detection]** is checkmarked and **[CAMERA 4: Anti-flicker shoot.]** is set to **[Disable]**, metering under a flickering light source will cause < **Flicker!** > to blink in the viewfinder as a warning. Setting **[Enable]** before shooting is recommended.
 - In the < **[A+]** > mode, the effects of flickering light will be reduced when you shoot, but < **Flicker!** > will not be displayed.
 - Anti-flicker shooting also works with flash. However, the expected result may not be obtained during wireless flash shooting.

MENU Setting the Color Space ☆

The range of reproducible colors is called “color space”. With this camera, you can set the color space for captured images to sRGB or Adobe RGB. For normal shooting, sRGB is recommended. The color space is set automatically to [sRGB] in the <[A]⁺> mode.

1 Select [Color space].

- Under the [CAMERA 2] tab, select [Color space], then press <[SET]>.

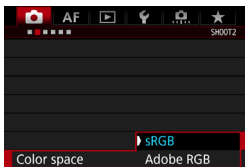

2 Set the desired color space.

- Select [sRGB] or [Adobe RGB], then press <[SET]>.

Adobe RGB

This color space is mainly used for commercial printing and other industrial uses. This setting is not recommended if you are not familiar with image processing, Adobe RGB, and Design rule for Camera File System 2.0 (Exif 2.21 or higher). The image will look very subdued in a sRGB computer environment and with printers not compatible with Design rule for Camera File System 2.0 (Exif 2.21 or higher). Post-processing of the image with computer software will therefore be required.



- If the captured still photo was shot in the Adobe RGB color space, the first character in the file name will be an underscore “_”.
- The ICC profile is not appended. For explanations about the ICC profile, refer to the Digital Photo Professional Instruction Manual (p.522).

MENU Creating and Selecting a Folder

You can freely create and select the folder where the captured images are to be saved.

This operation is optional since a folder will be created automatically for saving captured images.

Creating a Folder

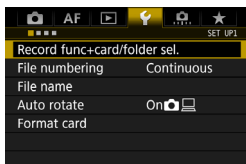

1 Select [Record func+card/folder sel.].

- Under the [**⚡**1] tab, select [**Record func+card/folder sel.**], then press < **SET** >.

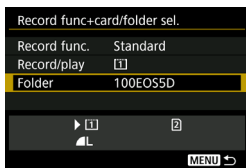

2 Select [Folder].

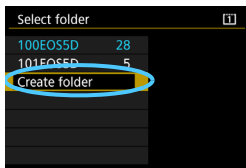

3 Select [Create folder].

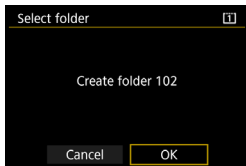

4 Select [OK].

- A new folder with the folder number increased by one is created.

Selecting a Folder

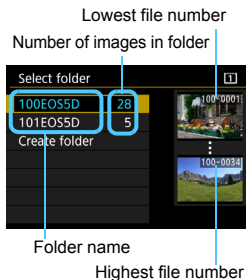

- Select a folder on the folder selection screen, then press < (SET) >.
- ▶ The folder where the captured images will be saved is selected.
- Subsequently captured images will be recorded into the selected folder.



Folders

As with “100EOS5D” for example, the folder name starts with three digits (the folder number) followed by five alphanumeric characters. A folder can contain up to 9999 images (file number 0001 - 9999). When a folder becomes full, a new folder with the folder number increased by one is created automatically. Also, if manual reset (p.200) is executed, a new folder will be created automatically. Folders numbered from 100 to 999 can be created.

Creating Folders with a Computer

With the card open on the screen, create a new folder named “DCIM”. Open the DCIM folder and create as many folders as necessary to save and organize your images. The folder name must follow the format “100ABC_D”. The first three digits are the folder number, from 100 to 999. The last five characters can be any combination of upper- and lower-case letters from A to Z, numerals, and the underscore “_”. The space cannot be used. Also note that two folder names cannot share the same three-digit folder number (for example, “100ABC_D” and “100W_XYZ”), even if the remaining five characters in each name are different.

MENU Changing the File Name

The file name has four alphanumeric characters followed by a four-digit image number (p.199) and extension. (Example) BE3B0001.JPG
The first four alphanumeric characters are set upon factory shipment and unique to the camera. However, you can change them.

With “User setting1”, you can change and register the four characters as desired. With “User setting2”, if you register three characters, the fourth character from the left will be appended automatically to indicate the image size.

Registering or Changing the File Name

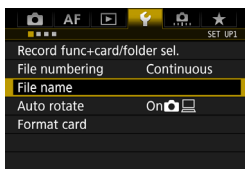

1 Select [File name].

- Under the [**1**] tab, select [**File name**], then press <SET>.

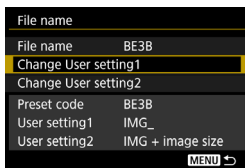

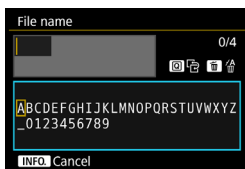

2 Select [Change User setting*].

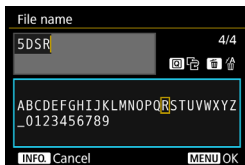

3 Enter any alphanumeric characters.

- For User setting1, enter four characters. For User setting2, enter three characters.
- Press the <[trash]> button to delete any unnecessary characters.
- Press the <[Q]> button. The text palette will be highlighted with a color frame, and text can be entered.



- Operate the <⊙> dial or <⊙> to move the  and select the desired character. Then press <⊙> to enter it.

4 Exit the setting.

- After entering the correct number of characters, press the <MENU> button, then select **[OK]**.
- ▶ The registered file name will be saved.

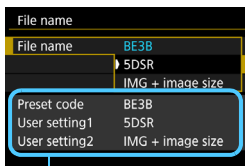

Settings

5 Select the registered file name.

- Select **[File name]**, then press <⊙>.
- Select the registered file name, then press <⊙>.
- If User setting2 is registered, select "*** (the 3 characters registered) + image size".



The first character cannot be an underscore “_”.



User setting2

When you select the “*** + image size” registered with User setting2 and take pictures, the image-recording quality character will be automatically appended as the file name’s fourth character from the left. The meaning of the image-recording quality characters is as follows:

“***L” = L / L / RAW	“***M” = M1 / M1 / M RAW
“***N” = M2 / M2	“***S” = S1 / S1 / S RAW
“***T” = S2	“***U” = S3

When the image is transferred to a computer, the automatically appended fourth character will be included. You can then see the image size without having to open the image. RAW or JPEG images can be distinguished with the extension.



- The extension will be “.JPG” for JPEG images, “.CR2” for RAW images, and “.MOV” for movies.
- When you shoot a movie with User setting2, the file name’s fourth character will be an underscore “_”.

MENU File Numbering Methods

The four-digit file number is like the frame number on a roll of film. The captured images are assigned a sequential file number from 0001 to 9999 and saved in one folder. You can change how the file number is assigned. (Example) **BE3B0001.JPG**

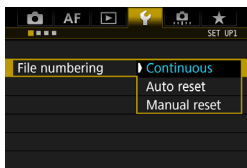

- 1 **Select [File numbering].**
 - Under the [**1**] tab, select [**File numbering**], then press <SET>.
- 2 **Select the file numbering method.**
 - Select the desired setting, then press <SET>.

Continuous

Continues the file numbering sequence even after the card is replaced or a new folder is created.

Even after you replace the card, create a folder, or switch the target card (such as [1] → [2]), the file numbering continues in sequence up to 9999 for the images saved. This is convenient when you want to save images numbered anywhere between 0001 to 9999 on multiple cards or in multiple folders into one folder on your computer.

If the replacement card or existing folder already contains images recorded previously, the file numbering of the new images may continue from the file numbering of the existing images on the card or in the folder. If you want to use continuous file numbering, it is recommended that you use a newly-formatted card each time.

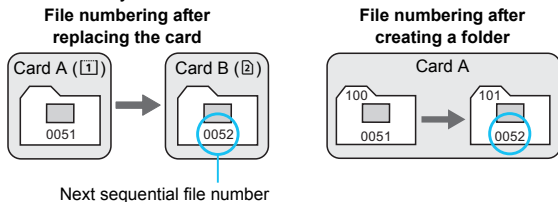

Auto Reset

Restarts the file numbering from 0001 each time the card is replaced or a new folder is created.

When you replace the card, create a folder, or switch the target card (such as ① → ②), the file numbering continues in sequence from 0001 for the images saved. This is convenient if you want to organize images according to cards or folders.

If the replacement card or existing folder already contains images recorded previously, the file numbering of the new images may continue from the file numbering of the existing images on the card or in the folder. If you want to save images with the file numbering starting from 0001, use a newly formatted card each time.

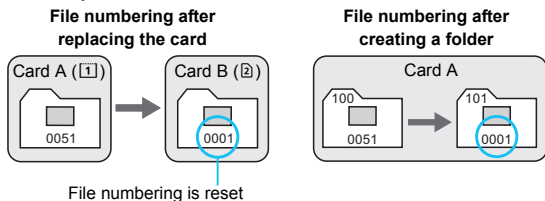

Manual Reset

Resets the file numbering to 0001 or to start from file number 0001 in a new folder.

When you reset the file numbering manually, a new folder is created automatically and the file numbering of images saved to that folder starts from 0001.

This is convenient if you want to use different folders for the images taken yesterday and the ones taken today, for example. After the manual reset, the file numbering returns to continuous or auto reset. (There will be no manual reset confirmation dialog.)

! If the file number in folder 999 reaches 9999, shooting will not be possible even if the card still has storage capacity. The LCD monitor will display a message telling you to replace the card. Replace it with a new card.

MENU Setting Copyright Information ☆

When you set the copyright information, it will be recorded to the image as Exif information.

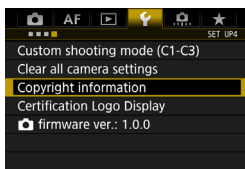

1 Select [Copyright information].

- Under the [**4**] tab, select [**Copyright information**], then press <SET>.



2 Select the option to be set.

- Select [**Enter author's name**] or [**Enter copyright details**], then press <SET>.

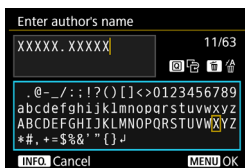

3 Enter text.

- Press the <Q> button. The text palette will be highlighted with a color frame, and text can be entered.
- Operate the <DIAL> or <DIAL> to move the cursor and select the desired character. Then press <SET> to enter it.
- You can enter up to 63 characters.
- To delete a character, press the <DELETE> button.
- To cancel the text entry, press the <INFO.> button, then select [OK].

4 Exit the setting.

- After entering the text, press the <MENU> button, then select [OK].
- ▶ The information is saved.

Checking the Copyright Information

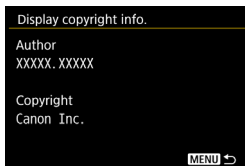

When you select [**Display copyright info.**] in step 2, you can check the [**Author**] and [**Copyright**] information that you entered.

Deleting the Copyright Information

When you select [**Delete copyright information**] in step 2 on the preceding page, you can delete the [**Author**] and [**Copyright**] information.

 If the entry for “Author” or “Copyright” is long, it may not be displayed entirely when you select [**Display copyright info.**].

 You can also set or check the copyright information with EOS Utility (EOS software, p.520).

5

Advanced Operations

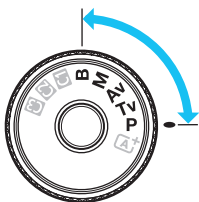

In the **<P>** **<Tv>** **<Av>** **<M>** **** shooting modes, you can select the shutter speed, aperture, and other camera settings to change the exposure and obtain the desired result.

- A ☆ icon at the upper right of a page title indicates a function that can be used only in the following modes: **<P>** **<Tv>** **<Av>** **<M>** ****.
- After you press the shutter button halfway and let go, the exposure values will remain displayed in the viewfinder and on the LCD panel for 4 sec. (ⓘ4).
- For the functions settable in each shooting mode, see page 456.



Set the **<LOCK▶>** switch to the left.

P: Program AE

The camera automatically sets the shutter speed and aperture to suit the subject's brightness. This is called Program AE.

* <P> stands for Program.

* AE stands for Auto Exposure.



1 Set the Mode Dial to <P>.



2 Focus on the subject.

- Look through the viewfinder and aim the AF point over the subject. Then press the shutter button halfway.
- ▶ When focus is achieved, the focus indicator <●> in the viewfinder will light up (in One-Shot AF mode).
- ▶ The shutter speed and aperture will be set automatically and displayed in the viewfinder and on the LCD panel.



3 Check the display.

- A standard exposure will be obtained as long as the shutter speed and aperture displays do not blink.



4 Take the picture.

- Compose the shot and press the shutter button completely.



- If the "30"" shutter speed and the lowest f/number blink, it indicates underexposure. Increase the ISO speed or use flash.



- If the "8000" shutter speed and the highest f/number blink, it indicates overexposure. Lower the ISO speed or use an ND filter (sold separately) to reduce the amount of light entering the lens.



Differences Between <P> and <A+> Modes

In the <A+> mode, many functions, such as the AF operation and metering mode, are set automatically to prevent spoiled shots. The functions you can set are limited. With <P> mode, only the shutter speed and aperture are set automatically. You can freely set the AF operation, metering mode, and other functions (p.456).

Program Shift

- In the Program AE mode, you can freely change the shutter speed and aperture combination (Program) set automatically by the camera while maintaining the same exposure. This is called Program shift.
- To shift the program, press the shutter button halfway, then turn the <A+> dial until the desired shutter speed or aperture is displayed.
- Program shift will be canceled automatically when the metering timer (4) ends (exposure setting display turns off).
- Program shift cannot be used with flash.

Tv: Shutter-Priority AE

In this mode, you set the shutter speed and the camera automatically sets the aperture to obtain the standard exposure matching the brightness of the subject. This is called shutter-priority AE. A faster shutter speed can freeze the action of a moving subject. A slower shutter speed can create a blurred effect, giving the impression of motion.

* <Tv> stands for Time value.



Blurred motion
(Slow shutter speed: 1/30 sec.)



Frozen action
(Fast shutter speed: 1/2000 sec.)



1 Set the Mode Dial to <Tv>.

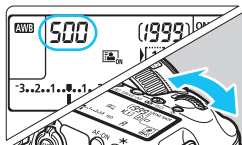

2 Set the desired shutter speed.

- While looking at the LCD panel or in the viewfinder, turn the <⚙> dial.

3 Focus on the subject.

- Press the shutter button halfway.
- ▶ The aperture is set automatically.



4 Check the viewfinder display and shoot.

- As long as the aperture is not blinking, a standard exposure will be obtained.



- If the lowest f/number blinks, it indicates underexposure. Turn the $\langle \text{aperture} \rangle$ dial to set a slower shutter speed until the aperture stops blinking or set a higher ISO speed.



- If the highest f/number blinks, it indicates overexposure. Turn the $\langle \text{aperture} \rangle$ dial to set a faster shutter speed until the aperture stops blinking or set a lower ISO speed.



Shutter Speed Display

The shutter speeds from “8000” to “4” indicate the denominator of the fractional shutter speed. For example, “125” indicates 1/125 sec., “0”5” indicates 0.5 sec. and “15” is 15 sec.

Av : Aperture-Priority AE

In this mode, you set the desired aperture and the camera sets the shutter speed automatically to obtain the standard exposure suiting the subject brightness. This is called aperture-priority AE. A higher f/number (smaller aperture hole) will make more of the foreground and background fall within acceptable focus. On the other hand, a lower f/number (larger aperture hole) will make less of the foreground and background fall within acceptable focus.

* <Av> stands for Aperture value (aperture opening).

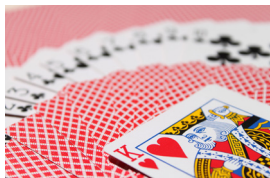

Blurred background
(With a low aperture f/number: f/5.6)



Sharp foreground and background
(With a high aperture f/number: f/32)

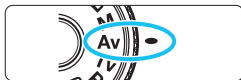

1 Set the Mode Dial to <Av>.

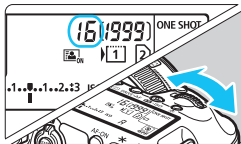

2 Set the desired aperture.

- While looking at the LCD panel or in the viewfinder, turn the <☀> dial.

3 Focus on the subject.

- Press the shutter button halfway.
- ▶ The shutter speed is set automatically.



4 Check the viewfinder display and shoot.

- As long as the shutter speed is not blinking, a standard exposure will be obtained.



- If the “30” shutter speed blinks, it indicates underexposure. Turn the dial to set a larger aperture (lower f/number) until the shutter speed blinking stops or set a higher ISO speed.

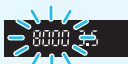

- If the “8000” shutter speed blinks, it indicates overexposure. Turn the dial to set a smaller aperture (higher f/number) until the shutter speed blinking stops or set a lower ISO speed.



Aperture Display

The higher the f/number, the smaller the aperture opening will be. The f/number displayed will differ depending on the lens. If no lens is attached to the camera, “00” will be displayed for the aperture.

Depth-of-Field Preview ☆

The aperture opening (diaphragm) changes only at the moment when the picture is taken. Otherwise, the aperture remains fully open. Therefore, when you look at the scene through the viewfinder or on the LCD monitor, the depth of field will look narrow.

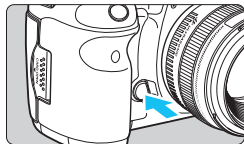

Press the depth-of-field preview button to stop down the lens to the current aperture setting and check the depth of field (range of acceptable focus).



- A higher f/number will make more of the foreground and background fall within acceptable focus. However, the viewfinder will look darker.
- While looking at the Live View image (p.256), you can change the aperture and press the depth-of-field preview button to see how the depth of field changes.
- The exposure will be locked (AE lock) while the depth-of-field preview button is pressed.

M: Manual Exposure

In this mode, you set both the shutter speed and aperture as desired. To determine the exposure, refer to the exposure level indicator in the viewfinder or use a commercially-available exposure meter. This method is called manual exposure.

* <M> stands for Manual.



1 Set the Mode Dial to <M>.

2 Set the ISO speed (p.158).

3 Set the shutter speed and aperture.

- To set the shutter speed, turn the <☀> dial.
- To set the aperture, turn the <☉> dial.
- If it cannot be set, set the <LOCK▶> switch to the left, then turn the <☀> or <☉> dial.

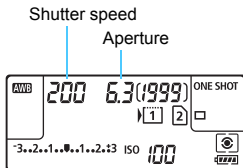

Standard exposure index



Exposure level mark

4 Focus on the subject.

- Press the shutter button halfway.
- ▶ The exposure setting will be displayed in the viewfinder and on the LCD panel.
- The exposure level mark <▶> indicates how far the current exposure level is from the standard exposure level.

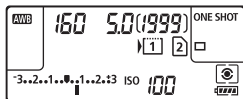

5 Set the exposure and take the picture.

- Check the exposure level indicator and set the desired shutter speed and aperture.
- If the exposure level exceeds ± 3 stops from the standard exposure, the end of the exposure level indicator will display <◀> or <▶>.

Exposure Compensation with Auto ISO

If the ISO speed is set to **A** (AUTO), you can set exposure compensation (p.214) as follows:

- [2: Expo.comp./AEB]
- Under [3: Custom Controls], use [**SET**: Expo comp (hold btn, turn)] (p.423).
- Quick Control (p.61)



- If Auto ISO is set, the ISO speed setting will change to suit the shutter speed and aperture in order to obtain a standard exposure. Therefore, you may not obtain the desired exposure effect. In such a case, set the exposure compensation.
- If flash is used when Auto ISO is set, exposure compensation will not be applied even if an exposure compensation amount is set.



- Under [2: Auto Lighting Optimizer], if the checkmark <✓> for [Disabled in M or B modes] is removed, Auto Lighting Optimizer can be set even in the <M> mode (p.182).
- When Auto ISO is set, you can press the <✳> button to lock the ISO speed.
- If you press the <✳> button and recompose the shot, you can see the exposure level difference on the exposure level indicator compared to when you pressed the <✳> button.
- If exposure compensation (p.214) was applied in <P>, <Tv>, or <Av> mode, and then the shooting mode is switched to <M> with Auto ISO set, the exposure compensation amount already set will be maintained.
- With Auto ISO set and [1: ISO speed setting increments] set to [1/2-stop], any 1/2-stop exposure compensation will be implemented with the ISO speed (1/3 stop) and shutter speed. However, the shutter speed displayed will not change.

Selecting the Metering Mode [☆]

You can select one of four methods to measure the subject brightness. In the <A+> mode, evaluative metering is set automatically.

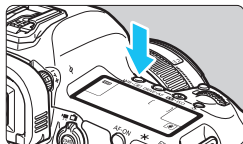

1 Press the <WB>  button. (ⓘ6)

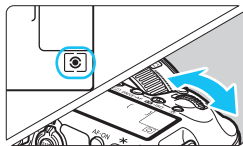



2 Select the metering mode.

- While looking at the LCD panel or in the viewfinder, turn the <METERING> dial.

 : Evaluative metering

 : Partial metering

 : Spot metering

 : Center-weighted average metering

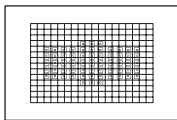

 **Evaluative metering**

This is a general-purpose metering mode suited even for backlit subjects. The camera sets the exposure automatically to suit the scene.

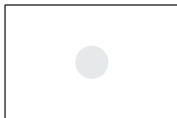

 **Partial metering**

Effective when the background is much brighter than the subject due to backlighting, etc. Partial metering covers approx. 6.1% of the viewfinder area at the center.

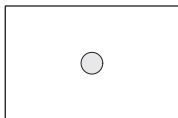

☑ **Spot metering**

This is for metering a specific spot of the subject or scene. Spot metering covers approx. 1.3% of the viewfinder area at the center. The spot metering circle will be displayed in the viewfinder.



☐ **Center-weighted average metering**

The metering is weighted at the center and then averaged for the entire scene.



- With ☒ (Evaluative metering), the exposure setting will be locked when you press the shutter button halfway and focus is achieved (in One-Shot AF mode). In the ☒ (Partial metering), ☑ (Spot metering), and ☐ (Center-weighted average metering) modes, the exposure is set at the moment the picture is taken. (Pressing the shutter button halfway does not lock the exposure.)
- When <☑> (Spot metering) is set, you can display <ⓘ> in the viewfinder (p.409).

☑ Setting Exposure Compensation ☆

Exposure compensation can brighten (increased exposure) or darken (decreased exposure) the standard exposure set by the camera. Exposure compensation can be set in the <P>, <Tv>, and <Av> shooting modes. Although you can set the exposure compensation up to ± 5 stops in 1/3-stop increments, the exposure compensation indicator in the viewfinder and on the LCD panel can only display the setting up to ± 3 stops. If you want to set the exposure compensation setting beyond ± 3 stops, use the Quick Control (p.61) or follow the instructions for [📷2: Expo.comp./AEB] on the next page. If the <M> mode and the Auto ISO are both set, see page 211 to set the exposure compensation.

1 Check the exposure.

- Press the shutter button halfway (📷4) and check the exposure level indicator.

2 Set the exposure compensation amount.

- While looking at the viewfinder or LCD panel, turn the <📷> dial.
- If it cannot be set, set the <LOCK▶> switch to the left, then turn the <📷> dial.

3 Take the picture.

- To cancel exposure compensation, set the exposure level indicator <📷/▶> to the standard exposure index (<📷> or <▶>).

Increased exposure for a brighter image

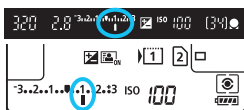

Decreased exposure for a darker image



📷 If [📷2: Auto Lighting Optimizer] (p.182) is set to any setting other than [Disable], the image may still look bright even if a decreased exposure compensation for a darker image is set.

- The exposure compensation amount will remain in effect even after you set the power switch to <OFF>.
- After setting the exposure compensation amount, you can prevent the exposure compensation amount from changing accidentally by setting the <LOCK▶> switch to the right.
- If the exposure compensation amount exceeds ± 3 stops, the end of the exposure level indicator will display <◀> or <▶>.

Auto Exposure Bracketing (AEB) [☆]

By changing the shutter speed or aperture automatically, the camera brackets the exposure up to ± 3 stops in 1/3-stop increments for three successive shots. This is called AEB.

* AEB stands for Auto Exposure Bracketing.

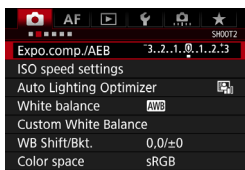

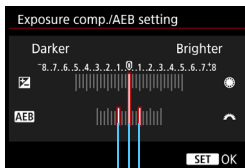

1 Select [Expo.comp./AEB].

- Under the [2] tab, select [Expo.comp./AEB], then press <SET>.



AEB range

2 Set the AEB range.

- Turn the < > dial to set the AEB range. If you turn < >, you can set the exposure compensation.
- Press <SET> to set it.
- When you exit the menu, < > and the AEB range will be displayed on the LCD panel.

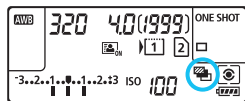

3 Take the picture.

- Three bracketed shots will be taken according to the drive mode set in this sequence: Standard exposure, decreased exposure, and increased exposure.
- AEB will not be automatically canceled. To cancel AEB, follow step 2 to turn off the AEB range display.

Standard exposure











Decreased exposure



Increased exposure



-  ● During AEB, <✳> in the viewfinder and < > on the LCD panel will blink.
- If the drive mode is set to < > or < S >, press the shutter button three times for each shot. When < H >, < >, or < S > is set and you hold down the shutter button completely, the three bracketed shots will be taken continuously and the camera will automatically stop shooting. When < S > or < S₂ > is set, the three bracketed shots will be taken continuously after a 10-sec. or 2-sec. delay.
- You can set AEB in combination with exposure compensation.
- If the AEB range exceeds ± 3 stops, the end of the exposure level indicator will display <◀> or <▶>.
- AEB cannot be used with flash, bulb exposures, or when [**Multi Shot Noise Reduction**] or [**HDR Mode**] is set.
- AEB will be canceled automatically when you set the power switch to <**OFF**> or when the flash is ready to fire.

* AE Lock ☆

Use AE lock when the area of focus is to be different from the exposure metering area or when you want to take multiple shots at the same exposure setting. Press the < * > button to lock the exposure, then recompose and take the picture. This is called AE lock. It is effective for backlit subjects, etc.

1 Focus on the subject.

- Press the shutter button halfway.
- ▶ The exposure setting will be displayed.

2 Press the < * > button. (ⓘ4)

- ▶ The < * > icon lights up in the viewfinder to indicate that the exposure setting is locked (AE lock).
- Each time you press the < * > button, the current exposure setting is locked.

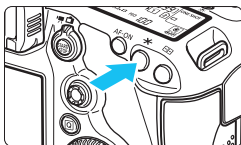



3 Recompose and take the picture.

- If you want to maintain the AE lock while taking more shots, hold down the < * > button and press the shutter button to take another shot.



AE Lock Effects

Metering Mode (p.212)	AF Point Selection Method (p.93)	
	Automatic Selection	Manual Selection
 *	AE lock is applied at the AF point that achieved focus.	AE lock is applied at the selected AF point.
	AE lock is applied at the center AF point.	

* When the lens's focus mode switch is set to <MF>, AE lock is applied at the center AF point.

 AE lock is not possible with bulb exposures.

B: Bulb Exposures

In this mode, the shutter stays open as long as you hold down the shutter button completely, and closes when you let go of the shutter button. This is called bulb exposure. Use bulb exposures for night scenes, fireworks, the heavens, and other subjects requiring long exposures.



1 Set the Mode Dial to .

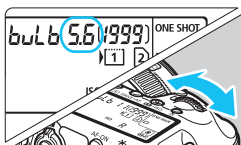

2 Set the desired aperture.

- While looking at the LCD panel or the viewfinder, turn the <☀> or <⊙> dial.

Elapsed exposure time

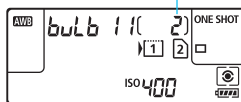

3 Take the picture.

- The exposure will continue for as long as you keep the shutter button pressed completely.
- ▶ The elapsed exposure time will be displayed on the LCD panel.

- ⚠ Do not point the camera toward an intense light source, such as the sun or an intense artificial light source. Doing so may damage the image sensor or the camera's internal components.
- Long exposures produce more noise than usual.
- If Auto ISO is set, the ISO speed will be ISO 400 (p.160).
- For a bulb exposure, if you use both the self-timer and mirror lockup instead of the bulb timer, keep pressing the shutter button completely (self-timer delay time + bulb exposure time). If you let go of the shutter button during the self-timer countdown, there will be a shutter-release sound, but no picture will be taken. If you use the bulb timer under the same shooting conditions, you need not hold down the shutter button completely.



- With [**3**: Long exp. noise reduction], you can reduce the noise generated during long exposures (p.185).
- For bulb exposures, using a tripod and bulb timer is recommended. Using mirror lockup (p.234) with bulb exposures is also possible.
- You can also shoot bulb exposures by using Remote Switch RS-80N3 or Timer Remote Controller TC-80N3 (both sold separately, p.237).
- You can also use Remote Controller RC-6 (sold separately, p.237) for bulb exposures. When you press the remote controller's transmit button, the bulb exposure will start immediately or 2 sec. later. Press the button again to stop the bulb exposure.

Bulb Timer ☆

You can preset the bulb exposure's exposure time. With the bulb timer, you need not hold down the shutter button during the bulb exposure. This reduces camera shake.

The bulb timer can be set only in the <**B**> (Bulb) shooting mode. It cannot be set (or will not function) in any other shooting mode.

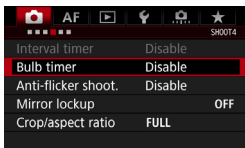

1 Select [**Bulb timer**].

- Under the [**4**] tab, select [**Bulb timer**], then press <SET>.



2 Select [**Enable**].

- Select [**Enable**], then press <INFO.> button.

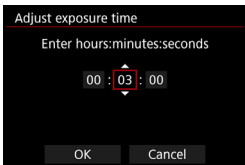

3 Set the desired exposure time.

- Select the hour, minute, or second.
- Press <SET> so <⏱> is displayed.
- Set the desired number, then press <SET> (Returns to <□>).

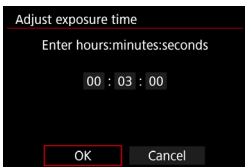

4 Select [OK].

- ▶ The set time will be displayed on the menu screen.
- ▶ When you exit the menu, <⏱> will be displayed on the LCD panel.

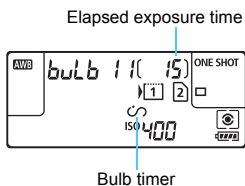

5 Take the picture.

- ▶ Press the shutter button completely, and the bulb exposure will start and continue until the set time elapses.
- To cancel the timer setting, set **[Disable]** in step 2.

- If you press the shutter button completely while the bulb timer is operating, the bulb exposure will stop.
- Doing any of the following will cancel the bulb timer (reverts to **[Disable]**): Set the power switch to **<OFF>**, replace the battery, replace the card, switch to movie shooting, or change the shooting mode to other than ****.

HDR : HDR (High Dynamic Range) Shooting ☆

Clipped highlights and shadows will be reduced for a high dynamic range of tones even with high-contrast scenes. HDR shooting is effective for landscape and still-life shots.

With HDR shooting, three images of different exposures (standard exposure, underexposure, and overexposure) are captured continuously for each shot and then merged together automatically. The HDR image is recorded as a JPEG image.

* HDR stands for High Dynamic Range.



1 Press the button.

2 Select the HDR mode.

- Select [HDR], then press .
- ▶ The HDR mode screen will appear.

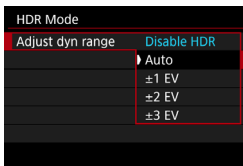

3 Set [Adjust dyn range].

- Select the desired dynamic range setting, then press .
- Selecting [**Auto**] will have the dynamic range set automatically depending on the image's overall tonal range.
- The higher the number, the wider the dynamic range will be.
- To exit HDR shooting, select [**Disable HDR**].

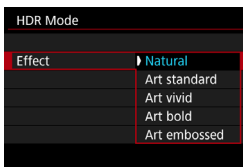

4 Set [Effect].

- Select the desired effect, then press .



- You can also set HDR shooting with [3: HDR Mode].

Effects

- **Natural**

For images preserving a wide tonal range where the highlight and shadow details would otherwise be lost. Clipped highlights and shadows will be reduced.

- **Art standard**

While the clipped highlights and shadows will be reduced more than with **[Natural]**, the contrast will be lower, and the gradation flatter to have the picture look like a painting. The subject outlines will have bright (or dark) edges.

- **Art vivid**

The colors are more saturated than with **[Art standard]**, and the low contrast and flat gradation create a graphic art effect.

- **Art bold**

The colors are the most saturated, making the subject pop out, and the picture look like an oil painting.

- **Art embossed**

The color saturation, brightness, contrast and gradation are decreased to make the picture look flat. The picture looks faded and old. The subject outlines will have bright (or dark) edges.

	Art standard	Art vivid	Art bold	Art embossed
Saturation	Standard	High	Higher	Low
Bold outline	Standard	Weak	Strong	Stronger
Brightness	Standard	Standard	Standard	Dark
Tone	Flat	Flat	Flat	Flatter

 Each effect will be applied based on the characteristics of the Picture Style currently set (p.164).

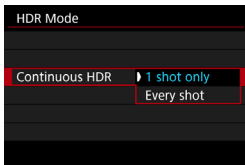

5 Set [Continuous HDR].

- Select either [**1 shot only**] or [**Every shot**], then press <ⓈET>.
- With [**1 shot only**], HDR shooting will be canceled automatically after the shooting ends.
- With [**Every shot**], HDR shooting continues until the setting in step 3 is set to [**Disable HDR**].

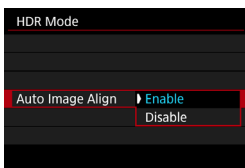

6 Set [Auto Image Align].

- For handheld shooting, select [**Enable**]. When using a tripod, select [**Disable**], then press <ⓈET>.

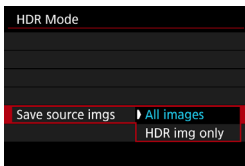

7 Set the images to be saved.

- To save all three images and the merged HDR image, select [**All images**], then press <ⓈET>.
- To save only the HDR image, select [**HDR img only**], then press <ⓈET>.

8 Take the picture.

- HDR shooting is possible with viewfinder shooting and Live View shooting.
- ▶ <HDR> will be displayed on the LCD panel.
- When you press the shutter button completely, three consecutive images will be captured, and the HDR image will be recorded to the card.

- If the image-recording quality is set to RAW, the HDR image will be recorded in **L** quality. If the image-recording quality is set to RAW+JPEG, the HDR image will be recorded in the JPEG quality set.
- HDR shooting is not possible with ISO expansion (L, H). HDR shooting is possible within ISO 100 - ISO 6400.
- The flash will not fire during HDR shooting.
- During HDR shooting, the settings of [**2: Auto Lighting Optimizer**], [**3: Highlight tone priority**], and [**5: Expo. simulation**] will be automatically switched to [**Disable**].
- AEB cannot be set.
- If you shoot a moving subject, the subject's movement may leave afterimages.
- In HDR shooting, three images are captured with different shutter speeds set automatically. Therefore, even in <**Tv**> and <**M**> shooting modes, the shutter speed will be shifted based on the shutter speed you set.
- To prevent camera shake, a high ISO speed may be set.



- When shooting HDR images with [**Auto Image Align**] set to [**Enable**], AF point display information (p.325) and Dust Delete Data (p.375) will not be appended to the image.
- If you perform handheld HDR shooting while [**Auto Image Align**] is set to [**Enable**], image periphery will be slightly cropped and resolution will be slightly lowered (except when shooting with [**1.3x (crop)**] or [**1.6x (crop)**]). Also, if the images cannot be aligned properly due to camera shake, etc., auto image alignment may not take effect. Note that when shooting with excessively bright (or dark) exposure settings, auto image alignment may not work properly.
- If you perform handheld HDR shooting while [**Auto Image Align**] is set to [**Disable**], the three images may not be properly aligned and the HDR effect may be minimal. Using a tripod is recommended.
- Auto image alignment may not work properly with repetitive patterns (lattice, stripes, etc.) or flat, single-tone images.
- The color gradation of the sky or white walls may not be reproduced correctly. Irregular colors, irregular exposure or noise may appear.
- HDR shooting under fluorescent or LED lighting may result in unnatural color reproduction of the illuminated areas.
- With HDR shooting, the images will be merged, then saved to the card, so it may take some time. Therefore, it will take a longer time to record the HDR image to the card than with normal shooting. During the processing of the images, “**buSY**” will be displayed in the viewfinder and on the LCD panel, and you cannot take another picture until the processing is completed.
- If you change the shooting mode or switch to movie shooting after setting HDR shooting, HDR shooting setting may be cleared ([**Adjust dyn range**] setting may be switched to [**Disable HDR**]).

Multiple Exposures ☆

You can shoot two to nine exposures to be merged into one image. If you shoot multiple-exposure images with Live View shooting (p.255), you can see how the single exposures are being merged while shooting.

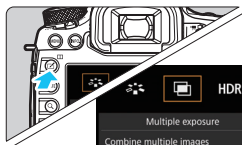

1 Press the **< [] >** button.

2 Select **Multiple exposure**.

- Select **[]**, then press **< (SET) >**.
- ▶ The multiple exposure setting screen will appear.

3 Set **[Multiple exposure]**.

- Select **[On:Func/Ctrl]** or **[On:ContShtng]**, then press **< (SET) >**.
- To exit shooting multiple exposures, select **[Disable]**.

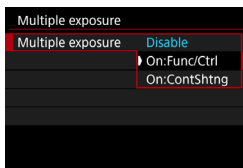

- **On: Func/Ctrl (Function and control priority)**

Convenient when you want to shoot multiple exposures while checking the result as you proceed. During continuous shooting, the continuous shooting speed will decrease greatly.

- **On: ContShtng (Continuous shooting priority)**

Geared for continuous multiple-exposure shooting of a moving subject. Continuous shooting is possible, but the following operations are disabled during shooting: menu viewing, Live View display, image review after image capture, image playback, and undo last image (p.232).

Also, only the multiple-exposure image will be saved. (The single exposures merged in the multiple-exposure image will not be saved.)

 You can also set multiple exposure with **[]3: Multiple exposure**.

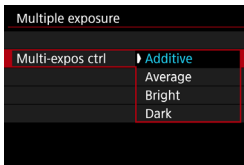

4 Set [Multi-expos ctrl].

- Select the desired multiple-exposure control method, then press <SET>.

● Additive

The exposure of each single exposure is added cumulatively. Based on the [No. of exposures], set a negative exposure compensation. Refer to the basic guide below to set a negative exposure compensation.

Exposure Compensation Setting Guide for Multiple Exposures

Two exposures: -1 stop, three exposures: -1.5 stop, four exposures: -2 stops

● Average

Based on the [No. of exposures], negative exposure compensation is set automatically as you shoot multiple exposures. If you shoot multiple exposures of the same scene, the exposure of the subject's background will be automatically controlled to obtain a standard exposure.

● Bright/Dark

The brightness (or darkness) of the base image and the images to be added are compared at the same position, and then the bright (or dark) part will be left in the picture. Depending on the overlapping colors, the colors may be mixed depending on the brightness (or darkness) ratio of the compared images.

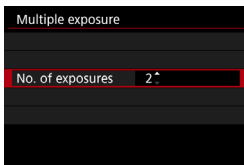

5 Set the [No. of exposures].

- Select the number of exposures, then press <SET>.
- You can set it from 2 to 9 exposures.

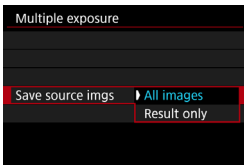

6 Set the images to be saved.

- To save all the single exposures and the merged multiple-exposure image, select [**All images**], then press <SET>.
- To save only the merged multiple-exposure image, select [**Result only**], then press <SET>.

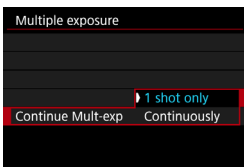

7 Set [Continue Mult-exp].

- Select either [**1 shot only**] or [**Continuously**], then press <SET>.
- With [**1 shot only**], multiple-exposure shooting will be canceled automatically after the shooting ends.
- With [**Continuously**], multiple-exposure shooting continues until the setting in step 3 is set to [**Disable**].

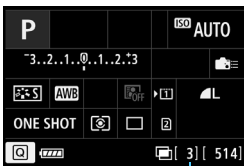

Remaining number of exposures

8 Take the first exposure.

- When [**On:Func/Ctrl**] is set, the captured image will be displayed.
- The <[]> icon will blink.
- The number of remaining exposures is displayed in brackets [] in the viewfinder or on the screen.
- Pressing the <[]> button enables you to view the captured image (p.232).

9 Shoot subsequent exposures.

- ▶ When [**On:Func/Ctrl**] is set, the merged multiple-exposure image will be displayed.
- With Live View shooting, the multiple-exposure images merged so far will be displayed. By pressing the <**INFO.**> button, you can display only the Live View image.
- After you shoot the set number of exposures, multiple-exposure shooting will exit. With continuous shooting, after you finish shooting the set number of exposures while holding down the shutter button, the shooting will stop.



- The image-recording quality, ISO speed, Picture Style, high ISO speed noise reduction and color space, etc. set for the first single exposure will also be set for the subsequent exposures.
- You cannot use crop shooting or shoot with a set aspect ratio for multiple exposures. [**Full-frame**] will be applied for [**4: Crop/aspect ratio**] for shooting.
- During multiple exposure shooting, the settings of [**1: Lens aberration correction**], [**2: Auto Lighting Optimizer**], and [**3: Highlight tone priority**] will be automatically switched to [**Disable**].
- If [**3: Picture Style**] is set to [**Auto**], [**Standard**] will be applied for shooting.
- If [**On:Func/Ctrl**] and [**Additive**], [**Bright**], or [**Dark**] are both set, the image displayed during shooting may look noisy. However, when you finish shooting the set number of exposures, noise reduction will be applied and the final multiple-exposure image will be less noisy.
- If you perform Live View shooting while [**On:ContShtng**] is set, the Live View function will stop automatically after the first shot is taken. From the second shot onward, shoot while looking through the viewfinder.



When [**On:Func/Ctrl**] is set, you can press the <**▶**> button to view the multiple exposures taken so far or delete the last single exposure (p.232).

- With multiple exposures, the more exposures there are, the more noticeable the noise, irregular colors, and banding will be. Also, as noise increases with higher ISO speeds, shooting at low ISO speeds is recommended.
- If **[Additive]**, **[Bright]**, or **[Dark]** is set, the image processing after taking the multiple exposures will take time. (The access lamp will light up longer.)
- If you perform Live View shooting while **[On:Func/Ctrl]** and **[Additive]**, **[Bright]**, or **[Dark]** are both set, the Live View function will stop automatically when the multiple-exposure shooting ends.
- In step 9, the brightness and noise of the multiple-exposure image displayed during Live View shooting will be different from the final multiple-exposure image recorded.
- If **[On:ContShtng]** is set, let go of the shutter button after shooting the set number of exposures.
- Doing any of the following will cancel the multiple-exposure shooting: Set the power switch to **<OFF>**, replace the battery, replace the card, or switch to movie shooting.
- If you switch the shooting mode to **<A⁺>** or **<C1/C2/C3>** while shooting, multiple-exposure shooting will end.
- If you connect the camera to a computer or printer, multiple-exposure shooting will not be possible. If you connect the camera to a computer or printer during shooting, multiple-exposure shooting will stop.

Merging Multiple Exposures with an Image Recorded on the Card

You can select a **RAW** image recorded on the card as the first single exposure. The image data of the selected **RAW** image will remain intact.



You can only select RAW images. You cannot select **M RAW/S RAW** or JPEG images.

Multiple exposure	
Multiple exposure	On:Func/Ctrl
Multi-expos ctrl	Additive
No. of exposures	3
Save source imgs	All images
Continue Multi-exp	1 shot only
Select image for multi. expo.	
Deselect img	

1 Select [Select image for multi. expo.].

- ▶ The images on the card will be displayed.





2 Select an image.

- Turn the <  > dial to select the image to be used as the first single exposure, then press <  >.
- Select [OK].
- ▶ The file number of the selected image will be displayed at the bottom of the screen.

3 Take the picture.

- When you select the first image, the number of remaining exposures as set with [No. of exposures] will decrease by 1. For example, if [No. of exposures] is 3, you can shoot two exposures.



- The following cannot be selected as the first single exposure: Images shot with [ 3: Highlight tone priority] set to [Enable], images whose [ 4: Crop/aspect ratio] is set to any setting other than [Full-frame] (p.154), and images having cropping information (p.411).
- [Disable] will be applied for [ 1: Lens aberration correction] and [ 2: Auto Lighting Optimizer] regardless of the settings of the **RAW** image selected as the first single exposure.
- The ISO speed, Picture Style, high ISO speed noise reduction, and color space, etc. set for the first **RAW** image will also be applied for the subsequent images.
- If [ 3: Picture Style] is Auto for the RAW image selected as the first **RAW** image, Standard will be applied for shooting.
- You cannot select an image taken with another camera.

- You can also select a **RAW** multiple-exposure image as the first single exposure.
- If you select [**Deselect img**], the selected image will be canceled.

Checking and Deleting Multiple Exposures During Shooting

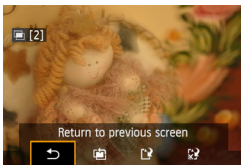

When [**On:Func/Ctrl**] is set and you have not finished shooting the set number of exposures, you can press the <▶> button to view the merged multiple-exposure image so far. You can check how it looks and the exposure. (Not possible when [**On:ContShtng**] is set.)

If you press the <⏮> button, the operations possible during multiple-exposure shooting will be displayed.

Operation	Description
Undo last image	Deletes the last image you shot (shoot another image). The number of remaining exposures will increase by 1.
Save and exit	If [Save source imgs: All images] is set, all of the single exposures and the merged multiple-exposure image will be saved before exiting. If [Save source imgs: Result only] is set, only the multiple-exposure image merged so far will be saved before exiting.
Exit without saving	None of the images will be saved before exiting.
Return to previous screen	The screen before you pressed the <⏮> button will reappear.

- During multiple-exposure shooting, you can only play back multiple-exposure images.

? FAQ

• Are there any restrictions on the image-recording quality?

All JPEG image-recording quality settings can be selected. If **M RAW** or **S RAW** is set, the merged multiple-exposure will be a **RAW** image.

Image-Recording Quality Setting	Single Exposures	Merged Multiple-Exposure
JPEG	JPEG	JPEG
RAW	RAW	RAW
M RAW/S RAW	M RAW/S RAW	RAW
RAW+JPEG	RAW+JPEG	RAW+JPEG
M RAW/S RAW+JPEG	M RAW/S RAW+JPEG	RAW+JPEG

• Can I merge images recorded on the card?

With [**Select image for multi. expo.**], you can select the first single exposure from the images recorded on the card (p.231). Note that you cannot merge multiple images already recorded on the card.

• Are multiple exposures possible with Live View shooting?

With [**On:Func/Ctrl**] set, you can shoot multiple exposures with Live View shooting (p.255). Note that [**Full-frame**] will be applied for [**4: Crop/aspect ratio**] for shooting.

• What file numbers are used for saving merged multiple-exposures?

If all images are set to be saved, the merged multiple-exposure image file number will be the serial number coming after the file number of the final single exposure used to create the merged multiple-exposure image.

• Will auto power off take effect during multiple-exposure shooting?

As long as [**2: Auto power off**] is set to any setting other than [**Disable**], the power will turn off automatically after 30 min. of non-operation. If the auto power off takes effect, multiple-exposure shooting will end, and multiple-exposure settings will be canceled. Before starting the multiple-exposure shooting, the auto power off will take effect as set with the camera, and multiple-exposure settings will be canceled.

Mirror Lockup [☆]

Camera vibrations caused by the mirror's reflex action when the picture is taken is called "mirror shock". Mirror lockup keeps the mirror up before and while shooting to reduce blur caused by camera vibrations. Useful when shooting closeups (macro photography), using a super telephoto lens, and shooting at slow shutter speeds.

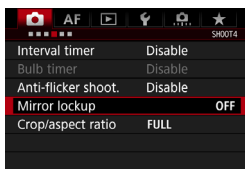

1 Select [Mirror lockup].

- Under the [4] tab, select [Mirror lockup], then press >.

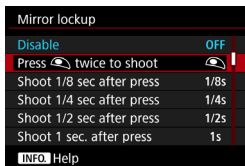

2 Select the desired setting.

- ▶ When you exit the menu, > will be displayed on the LCD panel.



3 Take the picture.

- If you select [**Press twice to shoot**], press the shutter button completely to lock up the mirror, then press it completely again to take a picture.
- If you select [**Shoot * sec. after press**], press the shutter button completely to lock up the mirror. A picture will be taken after the set time elapses. You can select 1/8 sec. after, 1/4 sec. after, 1/2 sec. after, 1 sec. after, or 2 sec. after.

Minimizing Blurred Photos

- Use a sturdy tripod suited for the camera weight. Mount the camera securely on the tripod.
- Using a remote switch or a remote controller is recommended (p.237).
- In addition to mirror lockup, Silent LV shooting (p.266) and Silent single shooting (p.142) are also effective.
- When using mirror lockup, setting [**Shoot * sec. after press**] is recommended. Selecting a longer time, such as [**Shoot 2 sec. after press**], will increase time before the shot, reducing mirror shock.



- Do not point the camera toward an intense light source, such as the sun or an intense artificial light source. Doing so may damage the image sensor or the camera's internal components.
- In very bright light, such as at the beach or a ski slope on a sunny day, take the picture promptly after mirror lockup is stabilized.
- When [**Press  twice to shoot**] is set, single shooting will take effect even if the drive mode is set to continuous shooting.
- If [**4: Interval timer**] or [**4: Bulb timer**] is set to [**Enable**], you cannot select [**Press  twice to shoot**].
- If you use [**Shoot *sec. after press**] for Multi Shot Noise Reduction shooting or HDR shooting, the [**Shoot *sec. after press**] setting will be applied only to the first shot. (Continuous shooting will apply for the second and subsequent shots.)
- During mirror lockup, shooting function settings and menu are disabled.



- When [**Shoot * sec. after press**] is set, you can also use the self-timer or bulb timer with mirror lockup.
- If 30 sec. elapse after the mirror has locked up, it will go back down automatically. Pressing the shutter button completely locks up the mirror again.
- For mirror lockup, using a tripod and Remote Switch RS-80N3 (sold separately) or Timer Remote Controller TC-80N3 (sold separately) is recommended (p.237).
- You can also use a remote controller (sold separately, p.237) with mirror lockup. Setting the remote controller to a 2-sec. delay is recommended.

Using the Eyepiece Cover

When you use the self-timer, bulb, or a remote switch and do not look through the viewfinder, stray light entering the viewfinder can cause the picture to look dark. To prevent this, use the eyepiece cover (p.35) attached to the camera strap.

During Live View shooting and movie shooting, it is not necessary to attach the eyepiece cover.

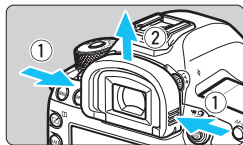

1 Detach the eyecup.

- While grasping both sides of the eyecup, slide it upward to detach it.

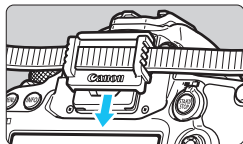

2 Attach the eyepiece cover.

- Slide the eyepiece cover down into the eyepiece groove to attach it.
- After you finish shooting, detach the eyepiece cover and attach the eyecup.

Using a Remote Switch

You can connect the Remote Switch RS-80N3 (sold separately) or Timer Remote Controller TC-80N3 (sold separately) or any EOS accessory equipped with an N3-type terminal to the camera for shooting (p.454).

To operate the accessory, refer to its instruction manual.

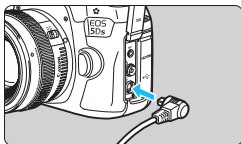

- 1 **Open the terminal cover.**
- 2 **Connect the plug to the remote control terminal.**
 - Connect the plug as shown in the illustration.
 - To disconnect the plug, grasp the silver part and pull.

Remote Control Shooting



With Remote Controller RC-6 (sold separately), you can shoot remotely up to approx. 5 meters/16.4 feet from the camera. You can either shoot immediately or use a 2-sec. delay.

You can also use Remote Controller RC-1 and RC-5.

- 1 **Focus on the subject.**
- 2 **Set the lens's focus mode switch to <MF>.**
 - You can also shoot with <AF>.
- 3 **Press the <DRIVE>AF> button. (ⓘ6)**

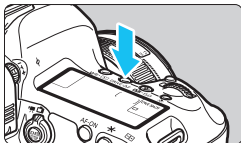

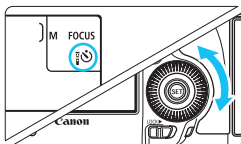

4 Select the self-timer.

- While looking at the LCD panel or in the viewfinder, turn the dial to select or .

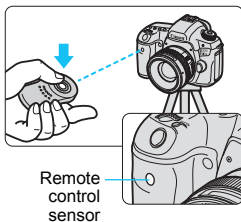

5 Press the remote controller's transmit button.

- Point the remote controller toward the camera's remote control sensor, and press the transmit button.
- ▶ The self-timer lamp lights up and the picture is taken.

- Fluorescent or LED lighting may cause camera misoperation by triggering the shutter inadvertently. Try to keep the camera away from such light sources.
- If you point a remote controller for a TV set toward the camera and operate it, it may cause camera misoperation by triggering the shutter inadvertently.
- If flash light is emitted from a flash on another camera around this camera, it may cause camera misoperation by triggering the shutter inadvertently. Do not expose the remote control sensor to flash light from a flash on another camera.

Remote control shooting is also possible with devices such as an EX-series Speedlite equipped with a remote-release function (sold separately).

Interval Timer Shooting

With the interval timer, you can set the shooting interval and the number of shots. The camera will repeat taking one shot with the set interval until the set number of shots are taken.

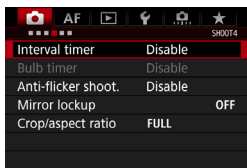

1 Select [Interval timer].

- Under the [CAMERA 4] tab (the [CAMERA 2] tab in <[A+]>), select [Interval timer], then press <[SET]>.

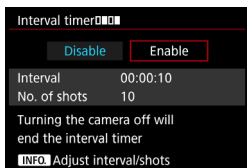

2 Select [Enable].

- Select [Enable], then press <INFO.> button.

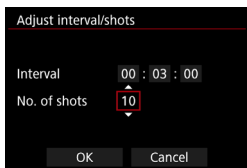

3 Set the interval and number of shots.

- Select the hour, minute, second, or number of shots.
- Press <[SET]> so <[UP]> is displayed.
- Set the desired number, then press <[SET]> (Returns to <[OK]>).

● Interval

Settable from [00:00:01] to [99:59:59].

● No. of shots

Settable from [01] to [99]. If you set [00], the camera will keep shooting until you stop the interval timer.

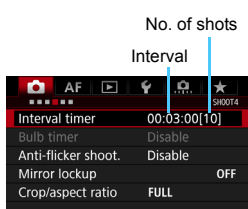

4 Select [OK].

- ▶ The interval timer settings will be displayed on the menu screen.
- ▶ When you exit the menu, <[]> will be displayed on the LCD panel.

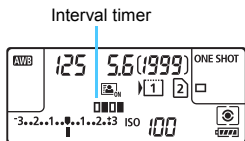

5 Take the picture.

- ▶ Shooting will start according to the interval timer settings.
- During interval timer shooting, <[]> will blink.
- After the set number of shots are taken, the interval timer shooting will stop and be automatically canceled.

- Using a tripod is recommended.
- Taking test shots is recommended.
- After the interval timer shooting starts, you can still press the shutter button completely to take a picture as usual. However, from 5 sec. before the next interval timer shooting, the shooting function settings, menu operation, image playback, and other operations will be suspended, and the camera will be ready to shoot.
- If a picture is taken or an image is being processed as the next interval timer shooting, that interval timer shooting will be canceled. This will make the number of interval timer images captured lower than the set number of shots.
- Auto power off operates with the interval timer. The power will automatically turn on approx. 1 min. before the next shot.
- Interval timer shooting can be combined with AEB, WB bracketing, multiple exposures, and HDR mode.
- You can stop the interval timer shooting by selecting [Disable] or turning the power switch to <OFF>.



- Do not point the camera toward an intense light source, such as the sun or an intense artificial light source. Doing so may damage the image sensor or the camera's internal components.
- If the lens's focus mode switch is set to <AF>, the camera will not shoot when focus is not achieved. Setting it to <MF> and focusing manually is recommended.
- Live View shooting, movie shooting, or bulb exposures cannot be performed with interval timer.
- For prolonged interval timer shooting, using the DC Coupler DR-E6 (sold separately) and AC Adapter AC-E6N (sold separately) to power the camera is recommended.
- If a long exposure or shutter speed longer than the shooting interval is set, the camera cannot shoot at the set interval. The camera will thereby shoot fewer shots than the number set for interval timer shooting. Also, the number of shots may decrease when the shutter speed and the shooting interval are nearly the same.
- If card recording time is longer than the set shooting interval, due to card performance or shooting settings, etc., the camera may not shoot at the set shooting interval.
- If you use flash with interval timer shooting, set an interval longer than the flash's recycling time. Otherwise, if the interval is too short, the flash may not fire.
- If the shooting interval is too short, the camera may not take a picture or may capture an image without autofocusing.
- Interval timer shooting will be canceled and reset to [Disable] if you do any of the following: Set the power switch to <OFF>, display the Live View or movie shooting screen, set the shooting mode to or a Custom shooting mode, or use EOS Utility (EOS software, p.520).
- After interval timer shooting starts, you cannot use remote control shooting (p.237) or remote-release shooting with an EOS-dedicated, external Speedlite.
- During interval timer shooting, if your eye will not remain on the viewfinder eyepiece, attach the eyepiece cover (p.236). Stray light entering the viewfinder can throw off the exposure.

MEMO

6

Flash Photography

This chapter explains how to shoot with external EX-series Speedlites (sold separately) and how to set Speedlite settings with the camera's menu screen.



- Flash cannot be used with movie shooting. It will not fire.
- AEB cannot be used with flash.

⚡ Flash Photography

EOS-dedicated, EX-series Speedlites

An EX-series Speedlite (sold separately) makes flash photography as easy as normal shooting.

For detailed instructions, refer to the EX-series Speedlite's instruction manual. This camera is a Type-A camera that can use all the features of EX-series Speedlites.

To set the flash functions and flash Custom Functions with the camera's menu, see pages 247-253.



Shoe-mount Speedlites

Macro Lites

● Flash exposure compensation

In the same way as normal exposure compensation, flash exposure compensation can be set. You can set flash exposure compensation up to ± 3 stops in 1/3-stop increments.

Press the camera's **< ISO >** button, then turn the **< >** dial while looking in the viewfinder or at the LCD panel.

● FE lock

This enables you to attain a proper flash exposure for a specific part of the subject. Aim the viewfinder center over the subject, press the camera's **< M-Fn >** button, then compose the shot and take the picture.

If [**2: Auto Lighting Optimizer**] (p.182) is set to any setting other than [**Disable**], the image may still look bright even if a decreased exposure compensation for a darker image is set.

If it is difficult to achieve focus with autofocus, the EOS-dedicated, external Speedlite will automatically emit the AF-assist beam as necessary.

Canon Speedlites Other Than the EX-series

- With an EZ/E/EG/ML/TL-series Speedlite set to A-TTL or TTL autoflash mode, the flash can be fired at full output only. Set the camera's shooting mode to <M> (manual exposure) or <Av> (aperture-priority AE) and adjust the aperture setting before shooting.
- When using a Speedlite that has manual flash mode, shoot in the manual flash mode.

Non-Canon Flash Units

Sync Speed

The camera can synchronize with non-Canon compact flash units at 1/200 sec. and slower speeds. With large studio flash units, be sure to test the flash synchronization before shooting with the sync speed set within approx. 1/60 sec. to 1/30 sec. The flash duration of such units is longer than that of compact flash units and varies depending on the model.

PC Terminal

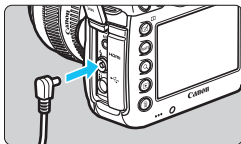

- The camera's PC terminal can be used with flash units having a sync cord. The PC terminal is threaded to prevent inadvertent disconnection.
- The camera's PC terminal has no polarity. You can connect any sync cord regardless of its polarity.

Cautions for Live View Shooting

If you use a non-Canon flash unit with Live View shooting, set [**6**: Silent LV shoot.] to [**Disable**] (p.266). The flash will not fire if it is set to [**Mode 1**] or [**Mode 2**].

- ⚠ If the camera is used with a flash unit or flash accessory dedicated to another camera brand, the camera may not operate properly and malfunction may result.
- Do not connect to the camera's PC terminal any flash unit with an output voltage of 250 V or more.
- Do not attach a high-voltage flash unit on the camera's hot shoe. It may not fire.

 A flash unit attached to the camera's hot shoe and a flash unit connected to the PC terminal can both be used at the same time.

MENU Setting the Flash ☆

With an EX-series Speedlite having compatible flash function settings, you can use the camera's menu screen to set the Speedlite's functions and Custom Functions. **Attach the Speedlite to the camera and turn on the Speedlite before setting the flash functions.**

For details on the Speedlite's functions, refer to the Speedlite's instruction manual.

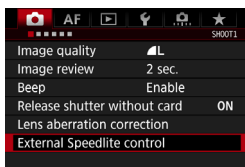

1 Select [External Speedlite control].

- Under the [📷 1] tab, select [External Speedlite control], then press <ⓈET>.
- ▶ The external Speedlite control screen will appear.

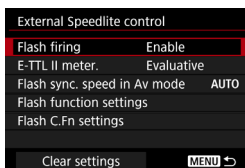

2 Select the desired item.

- Select the menu option to be set, then press <ⓈET>.

Flash Firing

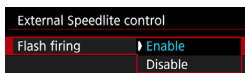

To enable flash photography, set [Enable]. To enable only the AF-assist beam to be emitted, set [Disable].

E-TTL II Metering

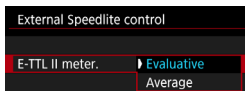

For normal flash exposures, set it to [Evaluative]. If [Average] is set, the flash exposure will be averaged for the entire metered scene. Depending on the scene, flash exposure compensation may be necessary. This setting is for advanced users.

Flash Sync. Speed in Av Mode

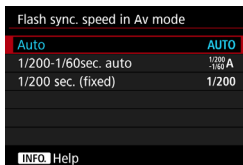

You can set the flash-sync speed for flash photography in the aperture-priority AE (**Av**) mode.

- **AUTO: Auto**

The flash sync speed is set automatically within a range of 1/200 sec. to 30 sec. to suit the scene's brightness. High-speed sync is also possible.

- ^{1/200}/_{-1/60} **A: 1/200-1/60sec. auto**

Prevents a slow shutter speed from being set in low-light conditions. It is effective for preventing subject blur and camera shake. However, while the subject will be properly exposed with the flash, the background may come out dark.

- 1/200: **1/200 sec. (fixed)**

The flash-sync speed is fixed at 1/200 sec. This more effectively prevents subject blur and camera shake than with [**1/200-1/60sec. auto**]. However, in low light, the subject's background will come out darker than with [**1/200-1/60sec. auto**].

 If [**1/200-1/60sec. auto**] or [**1/200 sec. (fixed)**] is set, high-speed sync is not possible in the <**Av**> mode.

Flash Function Settings

The screen display and setting options will vary depending on the Speedlite model, current flash mode, Speedlite's Custom Function settings, etc.

To see which functions your Speedlite (sold separately) provides, refer to the Speedlite's instruction manual.

Sample display

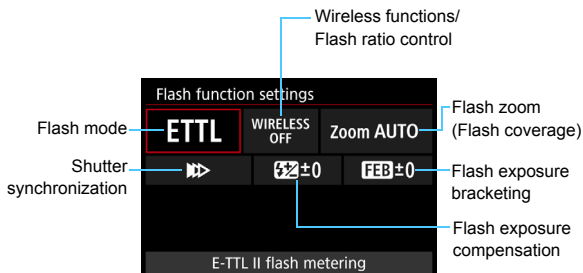

● Flash mode

You can select the flash mode to suit your desired flash shooting.

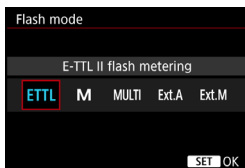

[E-TTL II flash metering] is the standard mode of EX-series Speedlites for automatic flash shooting.

[Manual flash] is for setting the Speedlite's [Flash output level] yourself.

Regarding other flash modes, refer to the instruction manual of a Speedlite compatible with the functions.

● **Wireless functions / Flash ratio control**

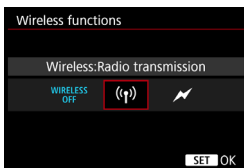

Wireless (multiple) flash shooting is possible with radio or optical transmission.

For details on wireless flash, refer to the instruction manual of a Speedlite compatible with wireless flash shooting.



With a macro flash (MR-14EX II, etc.) compatible with flash function settings, you can set the flash ratio between flash tubes or flash heads A and B, or use wireless flash with slave units.

For details on flash ratio control, refer to the macro flash's instruction manual.

● **Flash zoom (Flash coverage)**

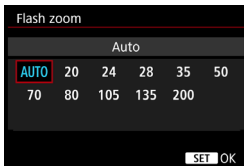

With Speedlites having a zooming flash head, you can set the flash coverage.

Normally, set this to [AUTO] so that the camera will automatically set the flash coverage to match the lens focal length.

● Shutter synchronization

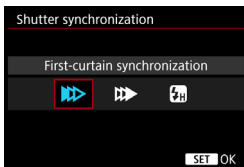

Normally, set this to [**First-curtain synchronization**] so that the flash fires immediately after the exposure starts.

If [**Second-curtain synchronization**] is set, the flash will fire right before the shutter closes. When this is combined with a slow shutter speed, you can create a trail of light such as from car headlights at night with a more natural feel. With second-curtain synchronization, two flashes will be fired: once when you press the shutter button completely, and once immediately before the exposure ends.

If [**High-speed synchronization**] is set, the flash can be used at all shutter speeds. This is convenient when you want to shoot with background blur (open aperture) in locations such as outdoors in daylight.

● Flash exposure compensation

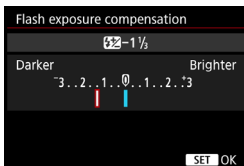

You can set flash exposure compensation up to ± 3 stops in 1/3-stop increments.

For details, refer to the Speedlite's instruction manual.

● Flash exposure bracketing

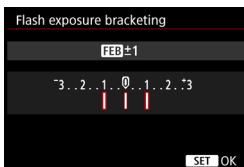

While changing the flash output automatically, three shots will be taken. For details, refer to the instruction manual of a Speedlite equipped with flash exposure bracketing.

 When using second-curtain synchronization, set the shutter speed to 1/25 sec. or slower. If the shutter speed is 1/30 sec. or faster, first-curtain synchronization will be applied automatically even if [**Second-curtain synchronization**] is set.

- 
- With an EX-series Speedlite not compatible with flash function settings, you can only set the following: [**Flash firing**], [**E-TTL II meter.**], and [**Flash exposure compensation**] under [**Flash function settings**]. ([**Shutter synchronization**] can also be set with certain EX-series Speedlites.)
 - If flash exposure compensation is set with the Speedlite, you cannot set the flash exposure compensation with the camera. If it is set with both the camera and Speedlite, the Speedlite's setting overrides the camera's.

Flash Custom Function Settings

For details on the Speedlite's Custom Functions, refer to the Speedlite's (sold separately) instruction manual.

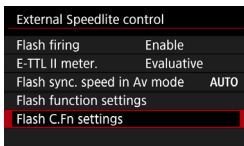

1 Select [Flash C.Fn settings].

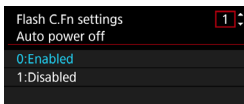

2 Set the desired functions.

- Select the number, then press <SET>.
- Select the setting, then press <SET>.



With an EX-series Speedlite, if the [Flash metering mode] Custom Function is set to [TTL flash metering] (autoflash), the Speedlite will always fire at full output.

Clear Settings

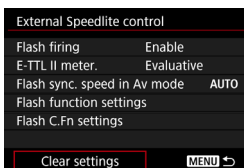

1 Select [Clear settings].

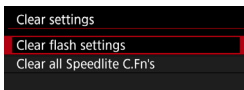

2 Select the settings to be cleared.

- Select [Clear flash settings] or [Clear all Speedlite C.Fn's], then press <SET>.
- On the confirmation dialog, select [OK]. Then the flash settings or Custom Function settings will all be cleared.



The Speedlite's Personal Function (P.Fn) cannot be set or canceled with the camera's [External Speedlite control] screen. Set it with the Speedlite.

MEMO

7

Shooting with the LCD Monitor (Live View Shooting)



You can shoot while viewing the picture on the camera's LCD monitor. This is called "Live View shooting".

Live View shooting is enabled by setting the Live View shooting/Movie shooting switch to .

- If you handhold the camera and shoot while viewing the LCD monitor, camera shake can cause blurred images. Using a tripod is recommended.



Remote Live View Shooting

With EOS Utility (EOS software, p.520) installed on your computer, you can connect the camera to the computer and shoot remotely while viewing the computer screen. For details, refer to the EOS Utility Instruction Manual (p.522).

Shooting with the LCD Monitor

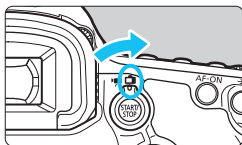

- 1** Set the Live View shooting/Movie shooting switch to .

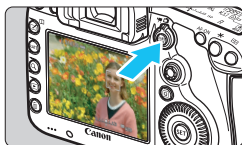

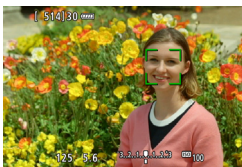

- 2** Display the Live View image.
- Press the .
 - ▶ The Live View image will appear on the LCD monitor.
 - The Live View image will closely match the brightness level of the actual image you capture.

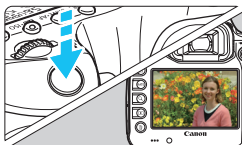

- 3** Focus on the subject.
- When you press the shutter button halfway, the camera will focus with the current AF method (p.268).



- 4** Take the picture.
- Press the shutter button completely.
 - ▶ The picture is taken and the captured image is displayed on the LCD monitor.
 - ▶ When the playback display ends, the camera will return to Live View shooting automatically.
 - Press the  to exit the Live View shooting.

-  The image's field of view is approx. 100% (when the image-recording quality is set to JPEG  with full-frame).
- In the **<P>** **<Tv>** **<Av>** **<M>** **** shooting mode, you can check the depth of field by pressing the depth-of-field preview button.
 - During continuous shooting, the exposure set for the first shot will also be applied to subsequent shots.
 - You can also use a remote controller (sold separately, p.237) for Live View shooting.

Enabling Live View Shooting

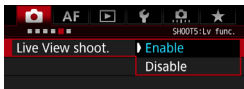

Set [**5: Live View shoot.**] (the [**3**] tab in <[**A**]>) to [**Enable**].

Number of Possible Shots with Live View Shooting

(Approx. number of shots)

Temperature	Room Temperature (23°C / 73°F)	Low Temperatures (0°C / 32°F)
Possible shots	220	210

- The figures above are based on a fully-charged Battery Pack LP-E6N and CIPA (Camera & Imaging Products Association) testing standards.
- With a fully-charged Battery Pack LP-E6N, total continuous Live View shooting time will be as follows: At room temperature (23°C/73°F): Approx. 1 hr. 45 min., At low temperatures (0°C/32°F): Approx. 1 hr. 40 min.



- Do not point the camera toward an intense light source, such as the sun or an intense artificial light source. Doing so may damage the image sensor or the camera's internal components.
- **General Live View Shooting Cautions are on pages 277-278.**





- You can also focus by pressing the <AF-ON> button.
- When flash is used, there will be two shutter sounds, but only one shot will be taken. Also, the time it takes to take the picture after you press the shutter button completely will be slightly longer than with viewfinder shooting.
- If the camera is not operated for a prolonged period, the power will turn off automatically after the time set in [**2: Auto power off**] (p.69). If [**2: Auto power off**] is set to [**Disable**], Live View shooting will end automatically after 30 min. (camera power remains on).
- With the HDMI cable HTC-100 (sold separately), you can display the Live View image on a TV screen (p.351). Note that no sound will be output. If the picture does not appear on the TV screen, set the [**3: Video system**] correctly to [**For NTSC**] or [**For PAL**] (depending on the video system of your TV set).

Information Display

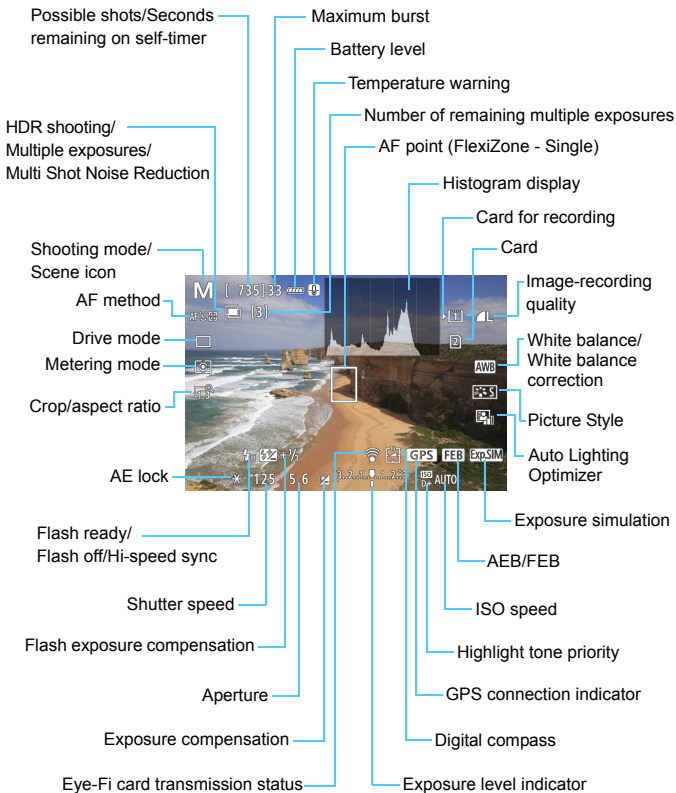
- Each time you press the <INFO.> button, the information display will change.





- The histogram can be displayed when [ **5: Expo. simulation: Enable**] (p.265) is set.
- You can display the electronic level by pressing the <INFO.> button (p.75). Note that if the AF method is set to [ **+Tracking**] or the camera is connected to a TV set with an HDMI cable, the electronic level cannot be displayed.
- When <Exp.SIM> is displayed in white, it indicates that the Live View image brightness is close to what the captured image will look like.
- If <Exp.SIM> is blinking, it indicates that the Live View image is displayed at a brightness that differs from the actual shooting result because of low- or bright-light conditions. However, the actual image recorded will reflect the exposure setting. Note that the noise may be more noticeable than the actual image recorded.
- If Multi Shot Noise Reduction, bulb exposure, or flash is used, the <Exp.SIM> icon and histogram will be displayed in gray (just as reference). The histogram may not be properly displayed in low- or bright-light conditions.



Do not hold the camera in the same position for long periods of time.

Even if the camera does not feel too hot, prolonged contact with the same body part may cause skin redness, blistering or low-temperature contact burns. Using a tripod is recommended for people with circulation problems or very sensitive skin, or when using the camera in very hot places.

Scene Icons

In the <A+> shooting mode, the camera detects the scene type and sets everything automatically to suit the scene. The detected scene type is indicated on the upper left of the screen. For certain scenes or shooting conditions, the icon displayed may not match the actual scene.

Subject Background	Portrait* ¹		Non-portrait			Background Color
		Movement	Nature and Outdoor Scene	Movement	Close* ²	
Bright						Gray
Backlit						
Blue Sky Included						Light blue
Backlit						
Sunset	* ³			* ³		Orange
Spotlight						Dark blue
Dark						
With Tripod	* ⁴ * ⁵	* ³	* ⁴ * ⁵	* ³		

*1: Displayed only when the AF method is set to [+Tracking]. If another AF method is set, the “Non-portrait” icon will be displayed even if a person is detected.

*2: Displayed when the attached lens has distance information. With an Extension Tube or Close-up Lens, the icon displayed may not match the actual scene.

*3: The icon suiting the scene detected will be displayed.

*4: Displayed when all the following conditions apply: The shooting scene is dark, it is a night scene, and the camera is mounted on a tripod.

*5: Displayed with any of the lenses below:

- EF300mm f/2.8L IS II USM
- EF400mm f/2.8L IS II USM
- EF500mm f/4L IS II USM
- EF600mm f/4L IS II USM
- Image Stabilizer lenses marketed in 2012 or later.

*4+*5: If the conditions in both *4 and *5 are met, the shutter speed will slow down.

Final Image Simulation

The final image simulation shows the results of the current settings for Picture Style, white balance and other functions in the Live View image, so you can see what the captured image will look like.

The Live View image will automatically show the effects of the settings listed below.

Final Image Simulation During Live View Shooting

- Picture Style
 - * Sharpness (Strength), contrast, color saturation, and color tone will be reflected.
- White balance
- White balance correction
- Metering mode
- Exposure (with [📷5: Expo. simulation: Enable] set)
- Depth of field (with depth-of-field preview button ON)
- Auto Lighting Optimizer
- Peripheral illumination correction
- Chromatic aberration correction
- Highlight tone priority
- Crop/aspect ratio (shooting area confirmation)

Shooting Function Settings

Crop/Aspect

You can perform crop shooting, or shoot with the set aspect ratio for Live View shooting. To set them with the menu, see page 154. To set them with the Quick Control screen, see the next page.

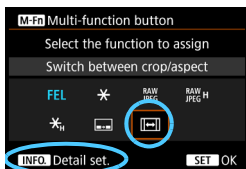

If you use [..3: **Custom Controls**] to assign [**Switch between crop/aspect**] to the <M-Fn> button, you can just press the <M-Fn> button while displaying Live View image to switch the Crop/aspect setting. For details, see page 423.

If Crop/aspect is set for Live View shooting, the image's field of view will be approx. 100% (when the image-recording quality is set to JPEG **L**).

WB/[WB] / DRIVE / AF / [WB] / ISO / [WB] Settings

When the Live View image is displayed, if you press the <WB>[WB]>, <DRIVE•AF>, <[WB]•ISO>, or <[WB]> button, the setting screen will appear on the LCD monitor and you can turn the <[WB]> or <[WB]> dial to set the respective shooting function.

- By pressing the <WB>[WB]> button and then the <INFO.> button, you can set WB shift and WB bracketing.

When you set [WB] (Partial metering) or [WB] (Spot metering), a metering circle will be displayed in the center.

Q Quick Control

In the <P> <Tv> <Av> <M> modes, the **AF method**, **Drive mode**, **Metering mode**, **Crop/aspect ratio**, **Recording/playing back card and image quality**, **White balance**, **Picture Style**, and **Auto Lighting Optimizer** can be set.

In the <A+> mode, only the functions in bold above can be set.



1 Press the <Q> button (10).

- ▶ The settable functions will be displayed.

2 Select a function and set it.

- Use <DISP> to select a function.
- ▶ The setting of the selected function is displayed on the screen.
- Turn the <WB/ASPECT> or <QUALITY> dial to set it.
- To set the RAW image-recording quality, press <SET>.
- To select the card for recording/playing back, WB shift/bracketing, or Picture Style parameters, press the <INFO.> button.
- To set Auto white balance, select [AWB], then press <SET>.
- Press <SET> to finalize the setting and return to Live View shooting.



If [Crop/aspect ratio] is set, [Shooting area] (p.154) cannot be set.

MENU Menu Function Settings

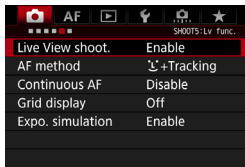

When the Live View shooting/Movie shooting switch is set to <📷>, the Live View shooting menu options will appear under the [📷5] and [📷6] tabs (the [📷3] tab in <[A+]>).

The settable functions on this menu screen apply only to Live View shooting. They do not work with viewfinder shooting (settings become invalid).

- **Live View shooting**

You can set Live View shooting to [Enable] or [Disable].

- **AF method**

You can select [L+Tracking] or [FlexiZone - Single]. See pages 268-272 for the AF method.

- **Continuous AF**

The default setting is [Disable].

When [Enable] is set, the camera attains rough focus on the subject continuously. This makes it quicker to achieve focus when you press the shutter button halfway. If [Enable] is set, the lens will operate constantly and consume more battery power. This will reduce the number of possible shots due to shorter battery life.

If you want to set the lens's focus mode switch to <MF> during Continuous AF, first stop Live View shooting.

- **Grid display**

With [3x3 

- **Exposure simulation** [☆]

Exposure simulation simulates and displays how the brightness of the actual image (exposure) will look.

- **Enable** ()

The displayed image brightness will be close to the actual brightness (exposure) of the resulting image. If you set exposure compensation, the image brightness will change accordingly.

- **During** ( (/Exp.SIM))

Normally, the image is displayed at the standard brightness to make the Live View image easy to see. The image will be displayed close to the actual brightness (exposure) of the resulting image only while you hold down the depth-of-field preview button.

- **Disable** ()

The image is displayed at the standard brightness to make the Live View image easy to see. Even if you set exposure compensation, the image is displayed at the standard brightness.

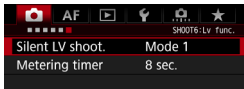

● Silent LV shooting [★]

• Mode 1

You can suppress the camera noise when shooting. Continuous shooting is also possible. If <[H]> is set, you can shoot at a maximum continuous shooting speed of approx. 5.0 fps.

• Mode 2

When the shutter button is pressed completely, only one shot will be taken. While you keep holding down the shutter button, the camera operation will be suspended. Then when you return to the shutter button's halfway position, the camera operation will resume. The shooting noise is thereby minimized. Even if continuous shooting is set, only a single shot will be taken.

• Disable

Be sure to set it to **[Disable]** if you use a TS-E lens (other than those listed in [H] below) **for shifting or tilting the lens** or if you use an Extension Tube. If **[Mode 1]** or **[Mode 2]** is set, the standard exposure may not be obtained, or an irregular exposure may result.

- If you use **[Mode 1]** with continuous shooting, the **[Disable]** setting will be applied to the second and subsequent shots.
- When shooting with flash, the **[Disable]** setting will be applied regardless of the **[Silent LV shoot.]** setting. (Silent shooting cannot be performed.)
- When using a non-Canon flash unit, set it to **[Disable]**. The flash will not fire if it is set to **[Mode 1]** or **[Mode 2]**.
- If **[Mode 2]** is set and you use a Remote Controller (p.237), the operation will be the same as with **[Mode 1]**.

[H] With the TS-E17mm f/4L or TS-E24mm f/3.5L II lens, you can use **[Mode 1]** or **[Mode 2]**.

- **Metering timer** [☆]

You can change how long the exposure setting is displayed (AE lock time).



Performing any of the following operations will stop Live View shooting. To start Live View shooting again, press the < $\frac{\text{START}}{\text{STOP}}$ > button.

- Selecting [**3: Dust Delete Data**], [**3: Sensor cleaning**], [**4: Clear all camera settings**], or [**4: firmware ver.**].

Using AF to Focus (AF Method)

Selecting the AF Method

You can set the AF method to [**L**] (**face**)+Tracking] (p.269) or [**FlexiZone - Single**] (p.271) to suit the shooting conditions or subject. If you want to achieve precise focus, set the lens's focus mode switch to <MF>, magnify the image, and focus manually (p.275).

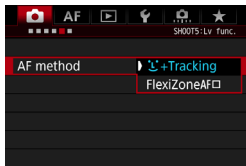

Select the AF method.

- Under the [**5**] tab (the [**3**] tab in <A+>), select [**AF method**].
- Select the desired AF method, then press <SET>.
- When the Live View image is displayed, you can press the <DRIVE•AF> button to select the AF method.

☺ (face)+Tracking: AF ☺

The camera detects and focuses on human faces. If a face moves, the AF point <☺> also moves to track the face.

1 Display the Live View image.

- Press the <START/STOP> button.
- ▶ The Live View image will appear on the LCD monitor.



2 Select an AF point.

- When a face is detected, the <☺> frame will appear over the face to be focused on.
- If multiple faces are detected, <☺> will be displayed. Use <☺> to move the <☺> frame over the face you want to focus on.
- If no faces are detected, the camera will switch to FlexiZone - Single (p.271).



3 Focus on the subject.



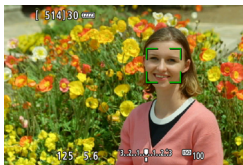

- Press the shutter button halfway to focus.
- ▶ When focus is achieved, the AF point will turn green and the beeper will sound.
- ▶ If focus is not achieved, the AF point will turn orange.







4 Take the picture.

- Check the focus and exposure, then press the shutter button completely to take the picture (p.256).

- **Focusing on a subject other than a human face**

Press <  > or <  > and the AF frame <  > will appear in the center. Then use <  > to move the AF frame over the desired subject. Once the AF frame <  > achieves focus, it will track the subject even if the subject moves or if you change the composition.

- If the subject's face is significantly out of focus, face detection will not be possible. Adjust the focus manually (p.275) so that the face can be detected, then perform AF.
- An object other than a human face may be detected as a face.
- Face detection will not work if the face is very small or large in the picture, too bright or too dark, or partially hidden.
- The <  > may cover only part of the face.

- Since AF is not possible with a face or a subject detected near the edge of the picture, the <  > or <  > will be grayed out. If you press the shutter button halfway in this situation, the subject will be focused on with the FlexiZone - Single method.
- The size of the AF frame varies depending on the subject or the setting of [ 4: Crop/aspect ratio].

FlexiZone - Single: AF □

The camera focuses with a single AF point. This is effective when you want to focus on a particular subject.



AF point

1 Display the Live View image.

- Press the <START/STOP> button.
- ▶ The Live View image will appear on the LCD monitor.
- ▶ The AF point <□> will appear.

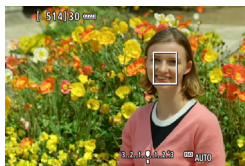

2 Move the AF point.

- Use <⊗> to move the AF point to where you want to focus. (It cannot be moved to the edge of the screen.)
- Pressing <⊗>, <SET>, or <🗑️> button will return the AF point to the screen's center.



3 Focus on the subject.

- Aim the AF point over the subject and press the shutter button halfway.
- ▶ When focus is achieved, the AF point will turn green and the beeper will sound.
- ▶ If focus is not achieved, the AF point will turn orange.

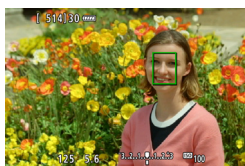

4 Take the picture.

- Check the focus and exposure, then press the shutter button completely to take the picture (p.256).



- The size of the AF point varies depending on the setting of [**4: Crop/aspect ratio**].
- During movie shooting, if [**Movie Servo AF**] is set to [**Enable**], the AF point will be displayed in a larger size.

Notes for AF

AF Operation

- Even when focus is achieved, pressing the shutter button halfway will focus again.
- The image brightness may change during and after the AF operation.
- If the light source changes while the Live View image is displayed, the screen may flicker and focusing may be difficult. If this happens, exit Live View shooting and execute AF under the actual light source.



- If you cannot achieve focus with AF, set the lens's focus mode switch to **<MF>** and focus manually (p.275).
- If you shoot the subject at the periphery and it is slightly out of focus, aim the center AF point over the subject you want to focus on, focus again, and then take the picture.
- The external Speedlite will not emit the AF-assist beam. However, if an EX-series Speedlite (sold separately) equipped with an LED light is used, the LED light will turn on for AF-assist when necessary.

Shooting Conditions that Make Focusing Difficult

- Subject with low-contrast such as the blue sky, solid-color flat surfaces or when highlight or shadow details are clipped.
- Subjects in low light.
- Stripes and other patterns where there is contrast only in the horizontal direction.
- Subjects with repetitive patterns (Example: Skyscraper windows, computer keyboards, etc.).
- Fine lines and subject outlines.
- Under a light source whose brightness, color, or pattern keeps changing.
- Night scenes or dots of light.
- Under fluorescent or LED lighting when the image flickers.
- Extremely small subjects.
- Subjects at the edge of the picture.
- Strongly backlit or reflective subjects (Example: Car with a highly reflective body, etc.)
- Near and distant subjects covered by an AF point (Example: Animal in a cage, etc.)
- Subjects that keep moving within the AF point and will not stay still due to camera shake or subject blur.
- A subject approaching or moving away from the camera.
- Performing AF while the subject is very far out of focus.
- Soft focus effect is applied with a soft focus lens.
- A special effect filter is used.
- Noise (spots, banding, etc.) appears on the screen during AF.



Using AF with any of the following lenses may take longer to achieve focus, or the correct focus may not be achieved.

EF50mm f/1.4 USM, EF50mm f/1.8 II, EF50mm f/2.5 Compact Macro,
EF75-300mm f/4-5.6 III, EF75-300mm f/4-5.6 III USM

For information on discontinued lenses, refer to the Canon Web site.

Magnified View for FlexiZone - Single

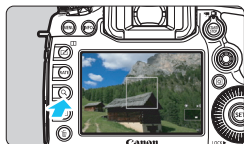

With [**FlexiZone - Single**], pressing the <Q> button will magnify the image to check the focus in the following sequence: approx. 6x, then approx. 16x.

- The image will be magnified at the AF point.
- If you press the shutter button halfway, AF will be performed in the magnified view.
- If focusing is difficult in the magnified view, return to the normal view and perform AF.

- Magnified view is not possible with [**⏏ +Tracking**].
- If AF is performed in the normal view and then magnify the view, accurate focus may not be achieved.
- AF speed differs between normal view and magnified view.
- Continuous AF (p.264) or Movie Servo AF (p.313) does not work during the magnified view.
- The [**x6**] and [**x16**] views are always displayed in magnification of the view with [**Full-frame**] setting, regardless of the [**4: Crop/aspect ratio**] setting.
- During magnified view, achieving focus becomes more difficult due to camera shake. Using a tripod is recommended.

- If [**4: Crop/aspect ratio**] is set to [**1.3x (crop)**] or [**1.6x (crop)**], [**X1.3**] or [**X1.6**] will be displayed when starting the magnified view.
- In magnified view, the exposure is locked. (Shutter speed and aperture will be displayed in red.)

MF: Focusing Manually

You can magnify the image and focus precisely with MF (manual focus).

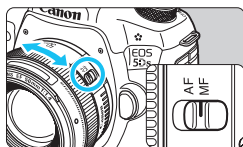

1 Set the lens's focus mode switch to <MF>.

- Turn the lens's focusing ring to focus roughly.

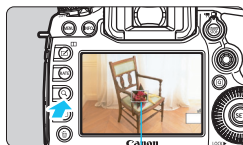

Magnifying frame

2 Display the magnifying frame.

- Press the <Q> button.
- ▶ The magnifying frame will appear.

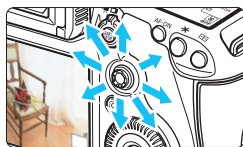

3 Move the magnifying frame.

- Use <⦿> to move the magnifying frame to the position where you want to focus.
- Pressing <⦿>, <SET>, or <⌫> button will return the magnifying frame to the screen's center.



AE lock
Magnified area position
Magnification (Approx.)

4 Magnify the image.

- Each time you press the <Q> button, the magnification within the frame will change in the following sequence:

→ Normal view → 1x → 6x → 16x →

- While in magnified view, you can use <⦿> to scroll around the magnified image.

5 Focus manually.

- While looking at the magnified image, turn the lens's focusing ring to focus.
- After achieving focus, press the <Q> button to return to the normal view.

6 Take the picture.

- Check the exposure, then press the shutter button completely to take the picture (p.256).



- If [**4: Crop/aspect ratio**] is set to [**1.3x (crop)**] or [**1.6x (crop)**], [**X1.3**] or [**X1.6**] will be displayed when starting the magnified view.
- When [**1.3x (crop)**] or [**1.6x (crop)**] is set, the magnifying frame will be displayed larger than usual.
- In magnified view, the exposure is locked. (Shutter speed and aperture will be displayed in red.)



General Live View Shooting Cautions

Image Quality

- When you shoot at high ISO speeds, noise (such as dots of light and banding) may become noticeable.
- Shooting in high temperatures may cause noise and irregular colors in the image.
- If Live View shooting is used continuously for a prolonged period, the camera's internal temperature may rise, and image quality may deteriorate. Always exit Live View shooting when you are not shooting.
- If you shoot a long exposure while the camera's internal temperature is high, image quality may deteriorate. Exit Live View shooting and wait a few minutes before shooting again.

White <[Icon]> and Red <[Icon]> Internal Temperature Warning Icons

- If the camera's internal temperature increases due to prolonged Live View shooting or under a high ambient temperature, a white <[Icon]> or red <[Icon]> icon will appear.
- The white <[Icon]> icon indicates that the image quality of still photos will deteriorate. It is recommended that you temporarily exit Live View shooting and allow the camera to cool down before shooting again.
- The red <[Icon]> icon indicates that the Live View shooting will soon stop automatically. If this happens, you will not be able to shoot again until the camera's internal temperature decreases. Exit the Live View shooting or turn off the power and let the camera rest for a while.
- Using Live View shooting at a high temperature for a prolonged period will cause the <[Icon]> or <[Icon]> icon to appear earlier. When you are not shooting, always turn off the camera.
- If the camera's internal temperature is high, the quality of images shot with high ISO speed or long exposure may deteriorate even before the white <[Icon]> icon is displayed.

Shooting Results

- In magnified view, the shutter speed and aperture will be displayed in red. If you take the picture in magnified view, the exposure may not come out as desired. Return to the normal view before taking the picture.
- Even if you take the picture in magnified view, the image will be captured in the normal view range.

General Live View Shooting Cautions

Live View Image

- Under low- or bright-light conditions, the Live View image may not reflect the brightness of the captured image.
- Even if a low ISO speed is set, noise may be noticeable in the displayed Live View image under low light. However, when you shoot, the image recorded will have less noise. (The image quality of the Live View image is different from that of the recorded image.)
- If the light source (illumination) within the image changes, the screen may flicker. If this happens, exit Live View shooting and resume Live View shooting under the actual light source.
- If you point the camera in a different direction, it may throw off the Live View image's correct brightness momentarily. Wait until the brightness level stabilizes before shooting.
- If there is a very bright light source in the image, the bright area may appear black on the LCD monitor. However, the actual captured image will correctly show the bright area.
- In low light, if you set the [**F2: LCD brightness**] to a bright setting, noise or irregular colors may appear in the Live View image. However, the noise or irregular colors will not be recorded in the captured image.
- When you magnify the image, the image sharpness may look more pronounced than in the actual image.

Custom Functions

- During Live View shooting, some Custom Functions will not work (settings become invalid). For details, see p.400-401.

Lens and Flash

- If the attached lens has an Image Stabilizer and you set the Image Stabilizer (IS) switch to **<ON>**, the Image Stabilizer will operate at all times even if you do not press the shutter button halfway. The Image Stabilizer consumes battery power and may decrease the number of possible shots. If you use a tripod or if the Image Stabilizer is not necessary, it is recommended that you set the IS switch to **<OFF>**.
- The focus preset function is possible for Live View shooting only when using a (super) telephoto lens equipped with the focus preset mode, available since the second half of 2011.
- FE lock and modeling flash will not work if an external Speedlite is used.

8

Shooting Movies



Movie shooting is enabled by setting the Live View shooting/Movie shooting switch to <  >.

- For cards that can record movies, see page 5.
- If you handhold the camera and shoot movies, camera shake can cause blurred movies. Using a tripod is recommended.



Full HD 1080

Full HD 1080 indicates compatibility with High-Definition featuring 1080 vertical pixels (scanning lines).



Shooting Movies

Autoexposure Shooting

When the shooting mode is set to $\langle \text{A}^+ \rangle$, $\langle \text{P} \rangle$, or $\langle \text{B} \rangle$, autoexposure control will take effect to suit the scene's current brightness. Exposure control will be the same for all the shooting modes.

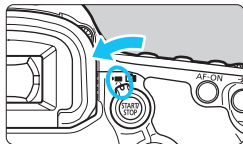

1 Set the Mode Dial to $\langle \text{A}^+ \rangle$, $\langle \text{P} \rangle$, or $\langle \text{B} \rangle$.

2 Set the Live View shooting/Movie shooting switch to $\langle \text{Movie} \rangle$.

- ▶ The reflex mirror will make a sound, then the image will appear on the LCD monitor.

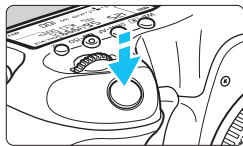

3 Focus on the subject.

- Before shooting a movie, focus with AF or manual focus (p.268-276).
- When you press the shutter button halfway, the camera will focus with the current AF method.

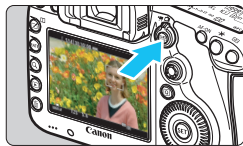

4 Shoot the movie.

- Press the $\langle \text{START/STOP} \rangle$ button to start shooting a movie.
- ▶ While the movie is being shot, the “●” mark will be displayed on the upper right of the screen.
- ▶ Sound will be recorded by the built-in microphone.
- To stop shooting the movie, press the $\langle \text{START/STOP} \rangle$ button again.

Recording movies

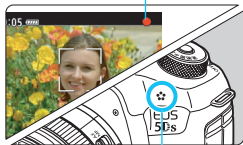

Built-in microphone

Shutter-priority AE

When the shooting mode is <Tv>, you can manually set the shutter speed for movie shooting. The ISO speed and aperture will be set automatically to suit the brightness and obtain a standard exposure.



1 Set the Mode Dial to <Tv>.

2 Set the Live View shooting/Movie shooting switch to <Movie>.

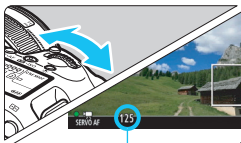

Shutter speed

3 Set the desired shutter speed.

- While looking at the LCD monitor, turn the <Sun> dial. The settable shutter speeds depend on the frame rate.

• **29.97P** **25.00P** **23.98P** :

1/4000 sec. - 1/30 sec.

• **59.94P** **50.00P** : 1/4000 sec. - 1/60 sec.

4 Focus and shoot the movie.

- The procedure is the same as steps 3 and 4 for “Autoexposure Shooting” (p.280).



- Changing the shutter speed during movie shooting is not recommended since the changes in the exposure will be recorded.
- When shooting a movie of a moving subject, a shutter speed of 1/30 sec. to 1/125 sec. is recommended. The faster the shutter speed, the less smooth the subject's movement will look.
- If you change the shutter speed while shooting under fluorescent or LED lighting, image flicker may be recorded.

Av Aperture-priority AE

When the shooting mode is <Av>, you can manually set the aperture for movie shooting. The ISO speed and shutter speed will be set automatically to suit the brightness and obtain a standard exposure.

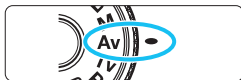

1 Set the Mode Dial to <Av>.

2 Set the Live View shooting/Movie shooting switch to <Movie>.

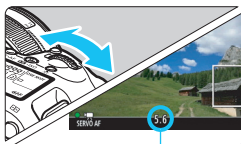

Aperture

3 Set the desired aperture.

- While looking at the LCD monitor, turn the <Aperture> dial.



4 Focus and shoot the movie.

- The procedure is the same as steps 3 and 4 for “Autoexposure Shooting” (p.280).

Changing the aperture during movie shooting is not recommended since variations in the exposure, due to the drive of the lens aperture, will be recorded.

ISO Speed in the <A+> Mode

- The ISO speed will be set automatically within ISO 100 - ISO 6400.

ISO Speed in the <P>, <Tv>, <Av>, and Modes

- The ISO speed will be set automatically within ISO 100 - ISO 6400.
- Under [**2: ISO speed settings**], if you set the [**ISO speed range**]'s [**Maximum**] setting to [**H (12800)**] in the <P>, <Av>, or mode (p.161), the automatic ISO range will be expanded to H (equivalent to ISO 12800). Even if you set the [**Maximum**] and [**Minimum**] to a narrower range than the default ISO range (ISO 100 - ISO 6400), it will not take effect.
- If [**3: Highlight tone priority**] is set to [**Enable**] (p.187), the automatic ISO range will be ISO 200 - ISO 6400.
- Under [**2: ISO speed settings**], [**Auto ISO range**] and [**Min. shutter spd.**] cannot be set (p.162-163) for movie shooting. [**2: ISO speed settings**] cannot be selected in the <Tv> mode.

 If [**Minimum**] is set to [**L(50)**] in [**ISO speed range**], and you switch from still photo shooting to movie shooting, the minimum setting for automatic ISO range for movie shooting will be ISO 100. It cannot be expanded to ISO 50.



Notes for <A>, <P>, <Tv>, <Av>, and Modes

- In the <A> mode, the scene icon for the scene detected by the camera is displayed on the upper left of the screen (p.285).
- You can lock the exposure (AE lock) by pressing the <A> button (except in the <A> mode, p.217). The exposure setting will be displayed for the time length set with [6: Metering timer]. After applying AE lock during movie shooting, you can cancel it by pressing the <A> button. (AE lock setting is retained until you press the <A> button.)
- You can set exposure compensation up to ± 3 stops by setting the <LOCK> switch to the left and turning the <DIAL> dial (except in the <A> mode).
- Pressing the shutter button halfway displays the ISO speed and shutter speed at the screen bottom. This is the exposure setting for taking a still photo (p.289). The exposure setting for movie shooting is not displayed. Note that the exposure setting for movie shooting may differ from that for still photo shooting.
- In the <A>, <P>, and modes, the shutter speed and aperture will not be recorded in the movie's Exif information.

Using an EX-series Speedlite (Sold Separately) Equipped with an LED Light

During movie shooting in the <A>, <P>, <Tv>, <Av>, and modes, this camera supports the function that turns on the Speedlite's LED light automatically in low-light conditions. **For detailed instructions, refer to the EX-series Speedlite's instruction manual.**

Scene Icons

During movie shooting in the <A+> mode, an icon representing the scene detected by the camera will be displayed, and the shooting will be adapted to that scene. For certain scenes or shooting conditions, the icon displayed may not match the actual scene.

Subject \ Background	Portrait ^{*1}	Non-Portrait		Background Color
		Nature and Outdoor Scene	Close ^{*2}	
Bright				Gray
Backlit				
Blue Sky Included				Light blue
Backlit				
Sunset	*3		*3	Orange
Spotlight				Dark blue
Dark				

*1: Displayed only when the AF method is set to [+Tracking]. If another AF method is set, the “Non-portrait” icon will be displayed even if a person is detected.

*2: Displayed when the attached lens has distance information. With an Extension Tube or Close-up Lens, the icon displayed may not match the actual scene.

*3: The icon suiting the scene detected will be displayed.

Manual Exposure Shooting

You can manually set the shutter speed, aperture, and ISO speed for movie shooting. Using manual exposure to shoot movies is for advanced users.



1 Set the Mode Dial to <M>.

2 Set the Live View shooting/Movie shooting switch to <[Movie icon]>.

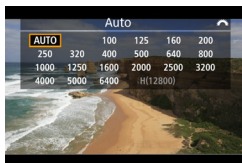

3 Set the ISO speed.

- Press the <[ISO icon]> button.
- ▶ The ISO speed setting screen will appear on the LCD monitor.
- Turn the <[ISO dial]> dial to set the ISO speed.
- For details on the ISO speed, see the next page.

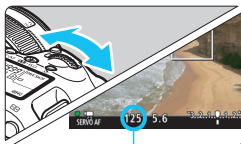

Shutter speed

4 Set the shutter speed and aperture.

- Press the shutter button halfway and check the exposure level indicator.
- To set the shutter speed, turn the <[Shutter speed dial]> dial. The settable shutter speeds vary depending on the frame rate.

- **29.97P 25.00P 23.98P** :
1/4000 sec. - 1/30 sec.
- **59.94P 50.00P** : 1/4000 sec. - 1/60 sec.

- To set the aperture, turn the <[Aperture dial]> dial.
- If it cannot be set, set the <[LOCK]> switch to the left, then turn the <[Aperture dial]> or <[Aperture dial]> dial.

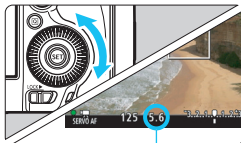

Aperture

5 Focus and shoot the movie.

- The procedure is the same as steps 3 and 4 for “Autoexposure Shooting” (p.280).

ISO Speed in the <M> Mode

- With [**Auto**] (**A**), the ISO speed will be set automatically within ISO 100 - ISO 6400. Under [**2: ISO speed settings**], if you set [**ISO speed range**]’s [**Maximum**] setting to [**H (12800)**] (p.161), the automatic ISO range will not expand to the H maximum. Even if you set the [**Maximum**] and [**Minimum**] to a narrower range than the default ISO range (ISO 100 - ISO 6400), it will not take effect.
- You can set the ISO speed manually within ISO 100 - ISO 6400 in 1/3-stop increments. Under [**2: ISO speed settings**], if you set [**ISO speed range**]’s [**Maximum**] setting to [**H (12800)**], the manual ISO speed setting range’s maximum will be expanded to H (equivalent to ISO 12800). You can also set the [**Maximum**] and [**Minimum**] to a range narrower than the default range (ISO 100 - ISO 6400).
- If [**3: Highlight tone priority**] is set to [**Enable**] (p.187), the auto or manual ISO setting range will be ISO 200 or higher.
- Under [**2: ISO speed settings**], [**Auto ISO range**] and [**Min. shutter spd.**] cannot be set (p.162-163) for movie shooting.

- If **[Minimum]** is set to **[L(50)]** in **[ISO speed range]**, and you switch from still photo shooting to movie shooting, the minimum setting for manual ISO range for movie shooting will be ISO 100. It cannot be expanded to ISO 50.
- Changing the shutter speed or aperture during movie shooting is not recommended since the changes in the exposure will be recorded.
- When shooting a movie of a moving subject, a shutter speed of 1/30 sec. to 1/125 sec. is recommended. The faster the shutter speed, the less smooth the subject's movement will look.
- If you change the shutter speed while shooting under fluorescent or LED lighting, image flicker may be recorded.

- Under **[.📷:3: Custom Controls]**, if **[SET: Expo comp (hold btn, turn 🌞)]** is set (p.423), you can set exposure compensation while Auto ISO is set.
- When Auto ISO is set, you can press the **<★>** button to lock the ISO speed.
- If you press the **<★>** button and recompose the shot, you can see the exposure level difference on the exposure level indicator (p.289) compared to when the **<★>** button was pressed.
- By pressing the **<INFO.>** button, you can display the histogram.

Information Display

- Each time you press the <INFO.> button, the information display will change.

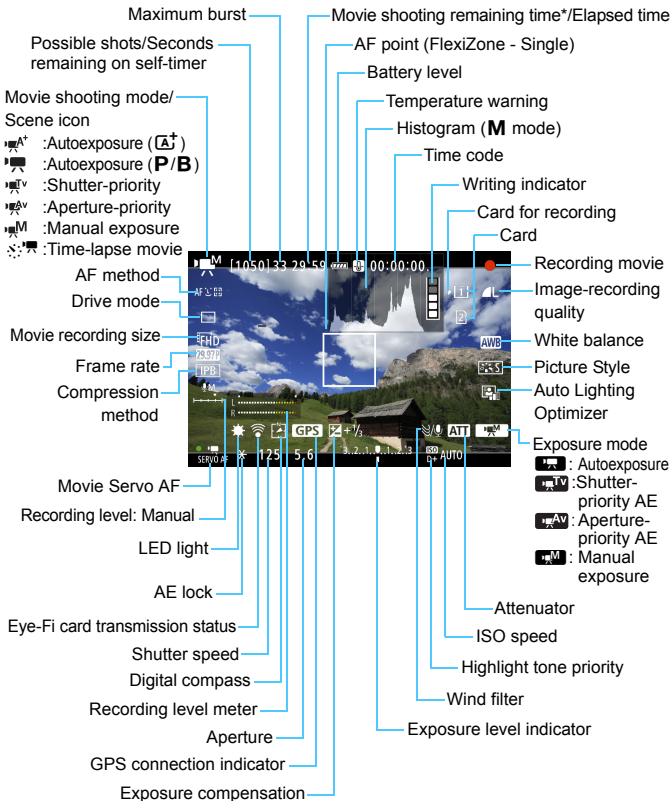

* Applies to a single movie clip.

- 
- You can display the electronic level by pressing the <INFO.> button (p.75).
 - Note that if the AF method is set to [L +Tracking] or the camera is connected to a TV set with an HDMI cable (p.351), the electronic level cannot be displayed.
 - The electronic level, grid lines, or histogram cannot be displayed during movie shooting. (The display will disappear when you start shooting a movie.)
 - When movie shooting starts, the movie shooting remaining time will change to the elapsed time.

🚫 Cautions for Movie Shooting

- Do not point the camera toward an intense light source, such as the sun or an intense artificial light source. Doing so may damage the image sensor or the camera's internal components.
- If you shoot something that has fine detail, moire or false colors may result.
- Under [📷1: Record func+card/folder sel.], even if [Record func.] is set to [Rec. to multiple] (p.147), the movie cannot be recorded to both the CF card [1] and SD card [2]. If [Rec. separately] or [Rec. to multiple] is set, the movie will be recorded to the card which is set for [Playback].
- If <AWB> or <AWB w> is set and the ISO speed or aperture changes during movie shooting, the white balance may also change.
- If you shoot a movie under fluorescent or LED lighting, the movie may flicker.
- Shooting a few test movies is recommended where you will perform zooming during movie shooting. Zooming during movie shooting may result in recording of changes in exposure or mechanical sound of the lens, or images may be out of focus.
- When an SD card is selected as a card to record images and you cannot shoot movies even if the card still has storage capacity, transfer the images recorded on the card to a computer, etc. then format the card.
- During movie shooting, you cannot magnify the image even if you press the <Q> button.
- Be careful not to cover the built-in microphone (p.280) with your finger, etc.
- [Multi Shot Noise Reduction] (p.183) cannot be set.
- If you connect or disconnect the HDMI cable during movie shooting, the movie shooting will end.
- **General Movie Shooting Cautions are on pages 317-318.**
- **If necessary, also read General Live View Shooting Cautions on pages 277-278.**



Notes for Movie Shooting

- Movie-related settings are under the [CAMERA 4] and [CAMERA 5] tabs (p.313). In the <[AF+]> mode, they are under the [CAMERA 2] and [CAMERA 3] tabs.
- A movie file is recorded each time you shoot a movie. If the file size exceeds 4 GB, a new file will be created for every subsequent approx. 4 GB.
- The movie image's field of view is approx. 100% (when the movie recording size is set to [FHD]).
- You can also focus on the image by pressing the <AF-ON> button.
- Under [CAMERA 5:  button function], if [AF/AF-ON] [AF/AF-ON] is selected, you can press the shutter button completely to start or stop the movie shooting (p.316).
- Monaural sound is recorded by the camera's built-in microphone (p.280).
- Stereo sound recording is also possible by connecting the Directional Stereo Microphone DM-E1 (sold separately) to the camera's external microphone IN terminal (p.27) as the external microphone is given the priority.
- You can use Remote Controller RC-6 (sold separately, p.237) to start and stop the movie shooting if the drive mode is <[i]i> or <[i]i2>. Set the shooting timing switch to <2> (2-sec. delay), then press the transmit button. If the switch is set to <●> (immediate shooting), still photo shooting will take effect.
- With a fully-charged Battery Pack LP-E6N, the total movie recording time will be as follows: At room temperature (23°C/73°F): Approx. 1 hr. 30 min., At low temperatures (0°C/32°F): Approx. 1 hr. 25 min. (with [CAMERA 4: **Movie Servo AF: Disable**] set).
- The focus preset function is possible for movie shooting when using a (super) telephoto lens equipped with the focus preset mode, available since the second half of 2011.



Do not hold the camera in the same position for long periods of time.

Even if the camera does not feel too hot, prolonged contact with the same body part may cause skin redness, blistering or low-temperature contact burns. Using a tripod is recommended for people with circulation problems or very sensitive skin, or when using the camera in very hot places.

Final Image Simulation

The final image simulation shows the results of the current settings for Picture Style, white balance and other functions in the image so you can see what the captured image will look like.

During movie shooting, the image displayed will automatically show the effects of the settings listed below.

Final Image Simulation for Movie Shooting

- Picture Style
 - * Sharpness (Strength), contrast, color saturation, and color tone will be reflected.
- White balance
- White balance correction
- Exposure
- Depth of field (except during time-lapse movie shooting)
- Auto Lighting Optimizer
- Peripheral illumination correction
- Chromatic aberration correction
- Highlight tone priority

Shooting Still Photos













While shooting a movie, you can also take a still photo by pressing the shutter button completely.

Taking Still Photos During Movie Shooting

- If you take a still photo during movie shooting, the movie will record a still moment lasting approx. 1 sec.
- The captured still photo will be recorded to the card, and the movie shooting will resume automatically when the Live View image is displayed.
- The movie and still photo will be recorded as separate files on the card.
- Under [**F1: Record func+card/folder sel.**], if [**Record func.**] (p.146) is set to [**Standard**] or [**Auto switch card**], the movies and still photos will be recorded to the same card. If [**Rec. separately**] or [**Rec. to multiple**] is set, the movies will be recorded to the card set for [**Playback**] (p.148). The still photos will be recorded at the image-recording quality set for the respective card.
- Functions particular to still photo shooting are shown below.

Function	Settings
Image-recording Quality	As set in [Q1: Image quality]. When the movie recording size is [1920x1080] or [1280x720], the aspect ratio will be 16:9. When the size is [640x480], the aspect ratio will be 4:3.
ISO Speed*	<ul style="list-style-type: none"> • <[A+]>: ISO 100 - ISO 3200 • <[P>, <[Av>, and <[B>: ISO 100 - ISO 3200 • <[Tv>: ISO 100 - ISO 6400 • <[M>: See "ISO Speed in the <[M> mode" on page 287.
Exposure Setting	<ul style="list-style-type: none"> • <[A+]>, <[P>, and <[B>: Automatically-set shutter speed and aperture. • <[Tv>: Manually-set shutter speed and automatically-set aperture. • <[Av>: Manually-set aperture and automatically-set shutter speed. • <[M>: Manually-set shutter speed and aperture.





* If highlight tone priority is set, the ISO speed range will start from ISO 200.





- 🔊 If [ 5:  button function] is set to [ AF / ] or [ / ] (p.316), you cannot take still photos.
- Still photo shooting during movie shooting will have approx. 100% coverage with , , and  (when the image-recording quality is set to JPEG ).
- AEB cannot be used.
- Even if a flash is used, it will not fire.
- Continuous still photo shooting is possible during movie shooting. However, the captured images will not be displayed on the screen. Depending on the still photo's image-recording quality, number of shots during continuous shooting, card performance, etc., movie shooting may stop automatically.
- AF is possible during movie shooting. However, the following may occur:
 - Focus may become far off momentarily.
 - The brightness of the recorded movie may change.
 - The recorded movie may be momentarily still.
 - The movie may record the lens operation noise.
 - If focus cannot be achieved, you cannot shoot still photos.

- 📄 Exposure compensation up to ± 3 stops can be applied for still photo shooting during movie shooting.
- If you want to shoot still photos continuously during movie shooting, using a high-speed card is recommended. Setting a smaller image-recording quality for still photos and shooting fewer continuous still photos are also recommended.
- You can shoot still photos in all drive modes.
- The self-timer can be set before you start shooting a movie. During movie shooting, the camera will switch to single-image shooting.

Shooting Function Settings

WB/DRIVE/AF/ISO/ Settings

If you press the <WB•>, <DRIVE•AF>, <•ISO>, or <•> button while the image is displayed on the LCD monitor, the setting screen will appear on the LCD monitor and you can turn the < > or < > dial to set the respective function.

- During manual-exposure shooting (p.286), you can press the <•ISO> button to set the ISO speed.
- By pressing the <WB•> button and then the <INFO.> button, you can set WB shift and WB bracketing.
- Note that the following cannot be set: <> Metering mode, <•> Flash exposure compensation, <HDR> HDR mode, and <•> Multiple exposures.

Q Quick Control

In the <P>, <Tv>, <Av>, <M>, and modes, the **AF method**, **Drive mode**, **Movie recording size**, Recording level (set manually only), **Recording/playing back card and image quality** (still photos), White balance, Picture Style, and Auto Lighting Optimizer can be set. **In the <A+> mode, only the functions in bold above can be set.**

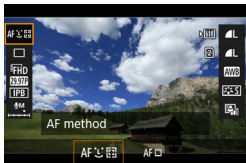

1 Press the <Q> button (ⓘ10).

- ▶ The settable functions will be displayed.

2 Select a function and set it.

- Use <⬇️> to select a function.
- ▶ The setting of the selected function is displayed on the screen.
- Turn the <⚙️> or <⚙️> dial to set it.
- To set the image quality to RAW, press <ⓈET>.
- To select the card for recording/playing back, WB shift/bracketing, or Picture Style parameters, press the <INFO.> button.
- To set Auto white balance, select [AWB], then press <ⓈET>.
- Pressing <ⓈET> will return the camera to movie shooting.

⚠️ If you press the <Q> button before starting the time-lapse movie shooting (p.306), recording-level will not be displayed.

MENU Setting the Movie Recording Size

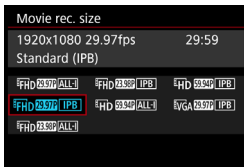

With [**4**: **Movie rec. size**] (the [**2**] tab in <[**A**]⁺>), you can set the movie's image size, frame rate (frames per sec.), and compression method.

The frame rate displayed on the [**Movie rec. size**] screen switches automatically depending on the [**3**: **Video system**] setting (p.467).

- **Image Size**

- **FHD 1920x1080**

- Full High-Definition (Full HD) recording quality. The aspect ratio is 16:9.

- **HD 1280x720**

- High-Definition (HD) recording quality. The aspect ratio is 16:9.

- **VGA 640x480**

- Standard-definition recording quality. The aspect ratio is 4:3.

- **Frame Rate** (fps: frames per second)

- **29.97P 29.97 fps / 59.94P 59.94 fps**

- For areas where the TV format is NTSC (North America, Japan, South Korea, Mexico, etc.).

- **25.00P 25.00 fps / 50.00P 50.00 fps**

- For areas where the TV format is PAL (Europe, Russia, China, Australia, etc.).

- **23.98P 23.98 fps**

- Mainly for motion pictures.



If you change the [**3**: **Video system**] setting, set the movie recording size again.

- **Compression Method**

[ALL-I] **ALL-I** (For editing/I-only)

Compresses one frame at a time for recording. Although the file size is larger than with IPB (Standard), the movie is more suited for editing.

[IPB] **IPB** (Standard)

Compresses multiple frames at a time efficiently for recording. Since the file size is smaller than with ALL-I (For editing), you can shoot longer (with a card of the same capacity).

Total Movie Recording Time and File Size Per Minute

(Approx.)

Movie Recording Quality				Total Recording Time on Card			File Size
				4 GB	8 GB	16 GB	
4K FHD	29.97P	25.00P	[ALL-I]	5 min.	11 min.	23 min.	654MB/min.
	23.98P						
4K FHD	29.97P	25.00P	[IPB]	16 min.	33 min.	67 min.	225MB/min.
	23.98P						
1080p HD	59.94P	50.00P	[ALL-I]	6 min.	13 min.	26 min.	583MB/min.
	59.94P	50.00P	[IPB]	19 min.	38 min.	1 hr. 17 min.	196MB/min.
720p VGA	29.97P	25.00P	[IPB]	48 min.	1 hr. 37 min.	3 hr. 14 min.	78MB/min.

 An increase of the camera's internal temperature (p.317) may cause movie shooting to stop before the maximum recording time shown in the table.

- **Movie Files Exceeding 4 GB**

Even if you shoot a movie exceeding 4 GB, you can keep shooting without interruption.

During movie shooting, approx. 30 sec. before the movie reaches the 4 GB file size, the elapsed shooting time or time code displayed in the movie-shooting screen will start blinking. If you keep shooting until the movie file size exceeds 4 GB, a new movie file will be created automatically and the elapsed shooting time or time code will stop blinking.

When you play back the movie, you will have to play each movie file individually. Movie files cannot be played back automatically in consecutive order. After the movie playback ends, select the next movie and play it back.

- **Movie Shooting Time Limit**

The maximum recording time of one movie clip is 29 min. 59 sec. If the movie shooting time reaches 29 min. 59 sec., the movie shooting will stop automatically. You can start shooting a movie again by pressing the < START/STOP > button. (A new movie file starts being recorded.)



When shooting movies, if the file size exceeds 4 GB, “**buSY**” may be displayed on the LCD panel for a while. Still photo shooting is not possible while “**buSY**” is displayed on the screen.

MENU Setting the Sound Recording

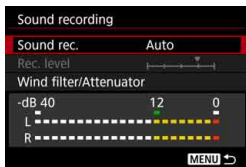

You can shoot movies while recording sound with the built-in monaural microphone or the Directional Stereo Microphone DM-E1 (sold separately). You can also freely adjust the sound-recording level.

Sound-recording settings are under [**4**: Sound recording] (the [**2**] tab in <[A]⁺>).

Sound Recording/Sound-Recording Level

- Auto** : The sound-recording level is adjusted automatically. Auto level control will operate automatically in response to the sound level.
- Manual** : For advanced users. You can adjust the sound-recording level to one of 64 levels. Select [**Rec. level**] and look at the level meter while turning the <⦿> dial to adjust the sound-recording level. Look at the peak hold indicator, and adjust so that the level meter sometimes lights up on the right of the "12" (-12 dB) mark for the loudest sounds. If it exceeds "0", the sound will be distorted.
- Disable** : Sound will not be recorded.

Wind Filter/Attenuator

- Wind filter** : When [**Enable**] is set, it reduces the wind noise when recording outdoors. This feature takes effect only with the built-in microphone. Note that [**Enable**] reduces low bass sounds, so set it to [**Disable**] when there is no wind. It will record a more natural sound than with [**Enable**].
- Attenuator** : Automatically suppresses sound distortion caused by loud noises. Even if [**Sound rec.**] is set to [**Auto**] or [**Manual**] before shooting, sound distortion may still result if there is a very loud sound. In such a case, setting it to [**Enable**] is recommended.

● Using a microphone

Normally, the built-in microphone will record monaural sound. Stereo sound recording is also possible by connecting the Directional Stereo Microphone DM-E1 (sold separately) to the camera's external microphone IN terminal (p.27) as the external microphone is given the priority.



- In the <[A]⁺> mode, [**Sound recording**] can be set to [**On**] or [**Off**]. If [**On**] is set, the sound-recording level will be adjusted automatically (same as with [**Auto**]), but the wind filter function will not take effect.
- The sound volume balance between L (left) and R (right) cannot be adjusted.
- Audio is recorded at a 48 kHz/16-bit sampling rate.
- If [**5: Silent Control**] is set to [**Enable**  > touch pad with less operation noise during movie shooting.

MENU Silent Control ☆

You can change the settings of the ISO speed, sound-recording level, etc. without making too much noise while shooting a movie.



When [**5: Silent Control**] is set to [**Enable (on)**], you can use the touch pad <⊕> on the inner ring of the Quick Control Dial.



You can just touch the top, bottom, left, or right of <⊕> for silent operation. During movie shooting, you can press the <Q> button to display the Quick Control screen and change the functions below with <⊕>.



Settable Functions	Shooting Mode			
	P/B	Tv	Av	M
Shutter speed	-	○	-	○
Aperture	-	-	○	○
Exposure compensation	○	○	○	○*1
ISO speed	-	-	-	○
Recording level*2	○	○	○	○

*1: With Auto ISO set.

*2: With [**Sound recording: Manual**] set.

- ⓘ If [**5: Silent Control**] is set to [**Enable (on)**], you cannot change Quick Control settings with the <⊕> Quick Control dial during movie shooting.
- Even if you change the aperture silently with <⊕>, the movie will still record the lens aperture-driving sound.
- If there is water or dirt on the <⊕>, the touch operation may not work. In such a case, use a clean cloth to clean the <⊕>. If it still does not work, wait a while and try again.

📄 Before shooting a movie, you can use <⊕> with the [**Rec. level**] setting to adjust the sound-recording level.

MENU Setting the Time Code

Time code	
Count up	Rec run
Start time setting	
Movie rec count	Rec time
Movie play count	Rec time
Drop frame	Enable
MENU →	

The time code is a time reference recorded automatically to synchronize the movie during movie shooting. It is recorded at all times in the following units: hours, minutes, seconds, and frames. It is mainly used during movie editing.

Use [**5: Time code**] (the [**3**] tab in <[A+]>) to set the time code.

Count Up

- Rec run** : The time code counts up only while you are shooting a movie. The time code will continue in the sequence of the movie files captured.
- Free run** : The time code counts up whether you are shooting a movie or not.

Start Time Setting

You can set the time code's start time.

Manual input setting : You can freely set the hour, minute, second, and frames.

Reset : The time set with [**Manual input setting**] and [**Set to camera time**] is reset to "00:00:00." or "00:00:00." (p.305).

Set to camera time : Sets hours, minutes, and seconds to match the camera's internal clock. "Frames" will be set to 00.

- Shooting still photos during movie shooting will cause a discrepancy between the actual time and time code.
- If [**Free run**] is set and you change the time, zone, or daylight saving time (p.49), the time code will be affected.

Movie Recording Count

You can select what to display on the movie shooting screen.

Rec time : Indicates the elapsed time from the start of the movie shooting.

Time code : Indicates the time code during movie shooting.

Movie Playback Count

You can select what to display on the movie playback screen.

Rec time : Displays the recording time and playback time during movie playback.

Time code : Displays the time code during movie playback.

With [Time code] set:



During movie shooting



During movie playback



- Regardless of the [Movie rec count] setting, the time code will always be recorded to the movie file (except during time-lapse movie shooting).
- The [Movie play count] setting under [5: Time code] switches in tandem with the [3: Movie play count] setting. Changing either setting will automatically change the other.
- “Frames” are not displayed for movie shooting or during movie playback.

Drop Frame

If the frame rate setting is **29.97P** (29.97 fps) or **59.94P** (59.94 fps), the time code's frame count causes a discrepancy between the actual time and time code. This discrepancy can be corrected automatically. This correction function is called "drop frame."

Enable : The discrepancy is corrected automatically by skipping time code numbers (DF: Drop frame).

Disable : The discrepancy is not corrected (NDF: Non-drop frame).

The time code will be displayed as follows:

Enable (DF)	: 00:00:00. (Playback time: 00:00:00.00)
Disable (NDF)	: 00:00:00: (Playback time: 00:00:00:00)



If the frame rate is **23.98P** (23.98 fps), **25.00P** (25.00 fps), or **50.00P** (50.00 fps), drop frame is not used. (If **23.98P** is set or if [**3: Video system**] is set to [**For PAL**], [**Drop frame**] will not be displayed.)

Shooting Time-lapse Movies

Still photos shot at a set interval can be stitched together automatically to create a time-lapse movie. A time-lapse movie shows how a subject changes in a much shorter period of time than the actual time it took. It is effective for a fixed-point observation of changing scenery, growing plants, celestial motion, etc.

Time-lapse movies are recorded in **FHD 29.97P** **[ALL-I]** (NTSC) or **FHD 25.00P** **[ALL-I]** (PAL). The frame rate will be switched automatically according to the **[Y3: Video system]** setting (p.467).

1 Select the shooting mode.

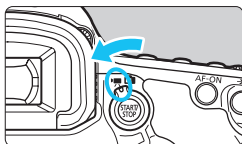

2 Set the Live View shooting/Movie shooting switch to <[Movie icon]>.

- ▶ The image will appear on the LCD monitor.

3 Select [Time-lapse movie].



- Under the **[CAMERA 5]** tab, select **[Time-lapse movie]** (the **[CAMERA 3]** tab in **<[A+]>**), then press **<[SET]>**.
- If **[Time-lapse movie]** is grayed out, press the **<[START/STOP]>** button to enable movie shooting. Then perform step 3 again.

4 Select [Enable].



- Select **[Enable]**, then press **<[INFO]>**.

⚠ Do not point the camera toward an intense light source, such as the sun or an intense artificial light source. Doing so may damage the image sensor or the camera's internal components.

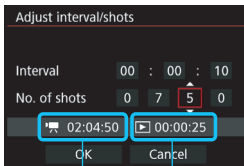

Time required Playback time

5 Set the shooting interval and number of shots.

- Check the [**⏱**: Time required] and [**▶**: Playback time] displayed at the bottom of the screen to set the shooting interval and number of shots.
- Select the number to be set (hours: minutes: seconds / Number of shots).
- Press <SET> so <⏱> is displayed.
- Set the desired number, then press <SET>. (Returns to <□>).

• Shooting interval

Settable from [00:00:01] to [99:59:59].

• Number of shots

Settable from [0002] to [3600]. Set one digit at a time. If 3600 is set, the time-lapse movie will be approx. 2 min. for NTSC and approx. 2 min. 24 sec. for PAL.

6 Select [OK].

- ▶ The screen in step 3 will reappear.



7 Check the settings.

- With [Time-lapse movie] selected on the screen in step 3, press <SET>.
- ▶ The current settings will be displayed.

• Time required

Indicates the time required to shoot the set number of shots at the set interval. If it exceeds 24 hours, “**** days” will be displayed.

• Playback time

Indicates the playback time (time required to play back the movie) of the time-lapse movie that will be created from the still photos taken at the set interval and recorded in **FHD** **29.97P** **ALL-I** (NTSC) or **FHD** **25.00P** **ALL-I** (PAL).

● **Card- time left**

The total length of a time-lapse movie that can be recorded on the card based on its remaining capacity.

8 Exit the menu.

- Press the <MENU> button to turn off the menu screen.

9 Read the message.

- Read the message and select [OK].

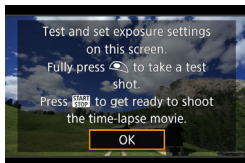

10 Take test shots.

- Set the exposure and shooting functions, and press the shutter button halfway to focus as you do with Live View shooting.
- Press the shutter button completely to start taking test shots. The test images will be recorded to the card.
- If there are no problems with the test shots, go to the next step.
- To take test shots again, repeat this step.

11 Press the <START/STOP> button.

- ▶ The camera will be ready to start shooting a time-lapse movie.
- To return to step 9, press the <START/STOP> button again.



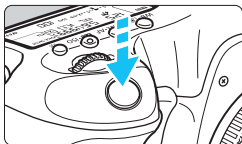

12 Shoot the time-lapse movie.

- Press the shutter button halfway to check the focus and exposure.
- Press the shutter button completely to start shooting the time-lapse movie.
- AF will not work during time-lapse movie shooting. The exposure setting for the first shot will be applied to subsequent shots.
- During time-lapse movie shooting, nothing will be displayed on the LCD monitor. <START/STOP> will blink on the LCD panel.
- Since the electronic shutter is used for shooting, the reflex mirror and shutter make no operation noise during time-lapse movie shooting.
- When the set number of shots are taken, the time-lapse movie shooting will stop and be automatically canceled.

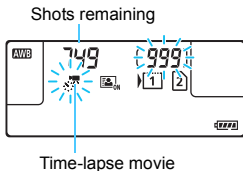

- Using a tripod is recommended.
- Taking test shots is recommended.
- Regardless of the [CAMERA 1: Image quality] setting, the time-lapse movie will be recorded in [FHD 29.97P ALL-I] (NTSC) or [FHD 25.00P ALL-I] (PAL).
- To cancel the time-lapse movie shooting before it is completed, either press the shutter button completely or press the <START/STOP> button ([Disable] is set). The time-lapse movie shot so far will be recorded on the card.
- You can play back the shot time-lapse movie with this camera the same way that you play back normal movies.
- If the time required for shooting is 24 hours to 48 hours, “2 days” will be indicated. If three or more days are required, the number of days will be indicated in 24-hour increments.
- Even if the time-lapse movie’s playback time is less than 1 sec., a movie file will still be created. For [Playback time], “00:00:00” will be displayed.
- If the shooting time is long, using the DC Coupler DR-E6 (sold separately) and AC Adapter AC-E6N (sold separately) to power the camera is recommended.

- 
 - With time-lapse movie set to [Enable], you cannot set [M4: Movie rec. size] and [F3: Video system].
 - If the camera is connected to a computer or printer with the interface cable, or if an HDMI cable is connected to the camera, you cannot select [Enable].
 - The maximum ISO speed will be ISO 3200 in the <P>, <Tv>, <Av>, and modes, and <M> mode with Auto ISO set.
 - Bulb exposure cannot be performed. If the shooting mode is , the operation will be the same as the <P> mode.
 - Movie Servo AF will not function.
 - If the shutter speed is 1/30 sec. or slower, the exposure of the movie displayed may not reflect the exposure of the resulting movie.
 - Do not zoom the lens during time-lapse movie shooting. Zooming the lens may cause the image to be out of focus, the exposure to change, and the lens aberration correction not to function properly.
 - When shooting a time-lapse movie under a flickering light, noticeable image flickering, horizontal stripes (noise), or irregular exposures may be recorded.
 - The image displayed during time-lapse movie shooting and the resulting movie may look different (in terms of flicker, depth of field, etc.).
 - If you move the camera from left to right (panning) or shoot a moving subject while shooting a time-lapse movie, the image may look extremely distorted.
 - During time-lapse movie shooting, auto power off will not operate. Also, you cannot adjust the shooting function and menu function settings, or play back images.
 - Sound and time code are not recorded for time-lapse movies.
 - Single shooting setting is applied to time-lapse movie shooting regardless of the drive mode setting.
 - The shooting function settings for the first shot will be applied to subsequent shots.
 - If a long exposure or shutter speed longer than the shooting interval is set, the camera cannot shoot with the set interval. Also, shooting may not be performed when the shutter speed and the shooting interval are nearly the same.
 - If the next scheduled shot is not possible, it will be skipped. This may make the time-lapse movie's recording time shorter.





- If the time it takes to record to the card exceeds the interval between shots due to the shooting functions set or card performance, some of the shots may not be taken with the set intervals.
- The captured images are not recorded as still photos. Even if you cancel the time-lapse movie shooting after only one shot is taken, it will be recorded as a movie file.
- If the card does not have enough free space to record the set number of shots, **[Playback time]** will be displayed in red. Although the camera can continue shooting, the shooting will stop when the card becomes full.
- If you connect the camera to a computer with the interface cable provided with the camera and use EOS Utility (EOS software), set **[CAM5: Time-lapse movie]** to **[Disable]**. If it is set to **[Enable]**, the camera cannot communicate with the computer.
- During time-lapse movie shooting, the lens's Image Stabilizer will not operate.
- If the power switch is set to **<OFF>** or the Live View shooting/Movie shooting switch is operated, time-lapse movie shooting will be terminated and the setting is switched to **[Disable]**.
- Even if a flash is used, it will not fire.
- Shooting-ready state of the time-lapse movie is canceled and the setting is switched to **[Disable]** with any of the following operations:
 - Selecting **[CAM3: Dust Delete Data]**, **[CAM3: Sensor cleaning]**, **[CAM4: Clear all camera settings]**, or **[CAM4: Firmware ver.]**.
 - Selecting **<CAM1>**, **<CAM2>**, or **<CAM3>** shooting modes.
- When time-lapse movie shooting ends, the settings are cleared automatically, and you return to normal movie shooting. Note that if you have set the shutter speed slower than 1/60 sec. or faster than 1/4000 sec. for time-lapse movie shooting and the settings are automatically cleared, the shutter speed may be automatically changed to a speed within the settable range for normal movie shooting.
- If you start time-lapse movie shooting while the white **<WB>** (p.317) is displayed, the image quality of the time-lapse movie may deteriorate.

 You can perform time-lapse movie shooting with a fully-charged Battery Pack LP-E6N for the durations (from start of shooting until the battery is exhausted) listed in the table below.

Total Possible Time for Time-lapse Movie Shooting

	Room Temperature (23°C / 73°F)	Low Temperatures (0°C / 32°F)
Shooting interval: 1sec.	2 hr. 15 min.	2 hr. 10 min.
Shooting interval: 10sec.	4 hr. 5 min.	3 hr. 55 min.

 If you use Remote Controller RC-6 (sold separately, p.237), you can start or stop the time-lapse movie shooting with the drive mode set to  or .

When Using Remote Controller RC-6

Camera Status/Remote Control Setting	<2> (2-sec. delay)	<●> (Immediate shooting)
Test-shooting screen	To shooting-ready	Shoots still photo
Shooting-ready	To test-shooting screen	Starts shooting
During time-lapse movie shooting	Ends shooting	Ends shooting

MENU Menu Function Settings

4

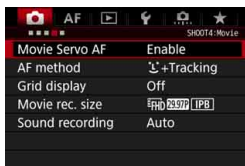

When the Live View shooting/Movie shooting switch is set to <M>, the movie shooting menu options will appear under the [4] and [5] tabs (the [2] and [3] tabs in <A+>).

● Movie Servo AF

During movie shooting, the camera focuses on the subject continuously. The default setting is [Disable].

When [Enable] is set:

- The camera focuses on the subject continuously even when you are not pressing the shutter button halfway.
- Since this drives the lens continuously, it will consume battery power and shorten the total possible movie shooting time (p.291).
- With certain lenses, the lens mechanical sound during focusing may be recorded. If this happens, use the Directional Stereo Microphone DM-E1 (sold separately) to reduce the lens mechanical sound in the movie.
- If you want to set the lens's focus mode switch to <MF> during Movie Servo AF, first set the Live View shooting/Movie shooting switch to <M>.

- If you want to keep the focus at a specific point or you do not want the lens operation noise to be recorded, you can temporarily stop Movie Servo AF by pressing the button assigned to **[Pause Movie Servo AF]** or **[AF stop]** under **[. 3: Custom controls]**. When you stop Movie Servo AF, the AF point will turn gray.
 - Under **[. 3: Custom controls]**, if a button is assigned to **[Pause Movie Servo AF]** (p.421), Movie Servo AF will stop while holding down that button. When you press the button again, Movie Servo AF will resume.
 - If a button is assigned to **[AF stop]** (p.419), Movie Servo AF will stop while holding down that button. When you let go of the button, Movie Servo AF will resume.
- When Movie Servo AF is paused, if you return to movie shooting after pressing the **<MENU>** or **<▶>** button or performing other operations such as changing the AF method, Movie Servo AF will resume automatically.

When **[Disable]** is set:

- Press the shutter button halfway or press the **<AF-ON>** button to focus.

Cautions When **[Movie Servo AF]** is Set to **[Enable]**

- **Shooting Conditions that Make Focusing Difficult**
 - A fast-moving subject approaching or moving away from the camera.
 - A subject moving at a close distance in front of the camera.
 - Also see “Shooting Conditions that Make Focusing Difficult” on page 273.
- Movie Servo AF will pause during zooming or magnified view.
- During movie shooting, if a subject approaches or moves away or if the camera is moved vertically or horizontally (panning), the recorded movie image may momentarily expand or contract (change in image magnification).

- **AF method**

You can select [**┐+Tracking**] or [**FlexiZone - Single**] (p.269-272).

- **Grid display**

With [**3x3** 卍] or [**6x4** 卐], you can display grid lines to help you level the camera vertically or horizontally. Also, with [**3x3+diag** 卐], the grid is displayed together with diagonal lines to help you compose with better balance by aligning the intersections over the subject.

Note that the grid is not displayed during movie shooting.

- **Movie recording size**

You can set the movie recording size (image size, frame rate, and compression method). For details, see page 297.

- **Sound recording**

You can set sound-recording settings. For details, see page 300.

5

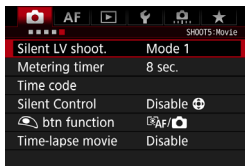

- **Silent LV shooting[☆]**

This function applies to still photo shooting. For details, see page 266.

- **Metering timer** ☆

You can change how long the exposure setting is displayed (AE lock time).

- **Time code**





You can set the time code. For details, see pages 303-305.





- **Silent Control** ☆



When [Enable  > and Quick Control screen to change settings silently during movie shooting. For details, see page 302.

-  **button function** ☆

You can set the functions performed by pressing the shutter button halfway or completely during movie shooting.

Setting	Pressed Halfway	Pressed Completely
	Metering and AF	Still photo shooting
	Metering only	Still photo shooting
	Metering and AF	Starts/stops movie shooting
	Metering only	Starts/stops movie shooting

If [] or [] is set, besides pressing the < > button, you can start/stop the movie shooting by pressing the shutter button completely or by using Remote Switch RS-80N3 or Timer Remote Controller TC-80N3 (both sold separately, p.237). However, with [] or [] set, still photo shooting (p.293) is not possible.

 During movie shooting, the [ **button function**] setting overrides any function assigned to the shutter button with [ **3: Custom Controls**].



General Movie Shooting Cautions

White <🔥> and Red <🔥> Internal Temperature Warning Icons

- If the camera's internal temperature increases due to prolonged movie shooting or under a high ambient temperature, a white <🔥> or red <🔥> icon will appear.
- The white <🔥> icon indicates that the image quality of still photos will deteriorate. It is recommended that you stop still photo shooting for a while and allow the camera to cool down. Since movie image quality will hardly be affected, you can still shoot movies.
- The red <🔥> icon indicates that movie shooting will soon be terminated automatically. If this happens, you will not be able to shoot again until the camera's internal temperature decreases. Turn off the power and let the camera rest for a while.
- Shooting a movie at a high temperature for a prolonged period will cause the <🔥> or <🔥> icon to appear earlier. When you are not shooting, always turn off the camera.

Recording and Image Quality

- If the attached lens has an Image Stabilizer and you set the Image Stabilizer (IS) switch to <ON>, the Image Stabilizer will operate at all times even if you do not press the shutter button halfway. The Image Stabilizer consumes battery power and may shorten the total movie shooting time or decrease the number of possible shots. If you use a tripod or if the Image Stabilizer is not necessary, it is recommended that you set the IS switch to <OFF>.
- The camera's built-in microphone will also pick up the operation sound and mechanical sound of the camera during shooting. Use the Directional Stereo Microphone DM-E1 (sold separately) to reduce these sounds in the movie.
- Do not connect anything other than an external microphone to the camera's external microphone IN terminal.
- With autoexposure shooting or shutter-priority AE, if the brightness changes during movie shooting, the movie may freeze temporarily. In such cases, shoot movies with aperture-priority AE or manual exposure.
- If there is a very bright light source in the image, the bright area may appear black on the LCD monitor. The movie will be recorded almost exactly as it appears on the LCD monitor.
- In low light, noise or irregular colors may appear in the image. The movie will be recorded almost exactly as it appears on the LCD monitor.
- If you play back a movie with other devices, image or sound quality may deteriorate or playback may not be possible (even if the devices support MOV format).

General Movie Shooting Cautions

Recording and Image Quality

- If you use a card with a slow writing speed, a five-level indicator may appear on the right of the screen during movie shooting. It indicates how much data has not yet been written to the card (remaining capacity of the internal buffer memory). The slower the card, the faster the indicator will climb upward. If the indicator becomes full, movie shooting will stop automatically. If the card has a fast writing speed, the indicator will either not appear or the level (if displayed) will hardly go upward. First, shoot a few test movies to see if the card can write fast enough.
- If the indicator indicates that the card is full and movie shooting stops automatically, the sound near the end of the movie may not be recorded properly.
- If the card's writing speed decreases (due to fragmentation) and the indicator appears, formatting the CF card (p.67) or low-level formatting of the SD card (p.67-68) may resolve the problem.

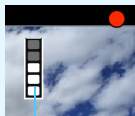

Indicator

Still Photo Shooting during Movie Shooting

- Regarding the image quality of still photos, see “Image Quality” on page 277.

9

Image Playback

This chapter explains how to play back or erase photos and movies, how to display them on a TV screen, and other playback-related functions.

Images shot and saved with another device

The camera may not be able to properly display images captured with a different camera, edited with a computer, or that have had their file names changed.

▶ Image Playback

Single-Image Display



1 Play back the image.

- Press the <▶> button.
- ▶ The last image captured or played back will appear.



2 Select an image.

- To play back images starting with the last image captured, turn the <◀> dial counterclockwise. To play back images starting with the first captured image, turn the dial clockwise.
- Each time you press the <INFO.> button, the information display will change.

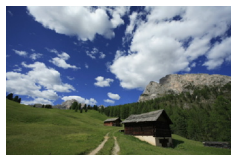

No information



Basic information display

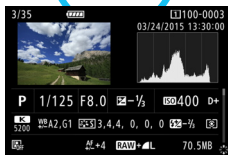

Shooting information display

When you play back RAW images shot with the [CAMERA: Crop/aspect ratio] (p.154) set, lines indicating the shooting area will be displayed.

3 Exit the image playback.

- Press the <▶> button to exit the image playback and return to shooting-ready state.

Shooting Information Display

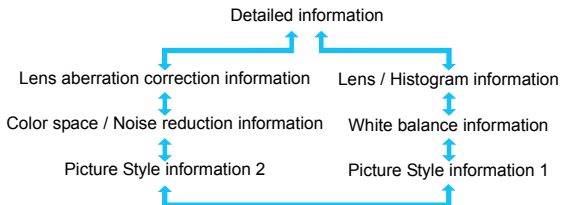

With the shooting information screen displayed (p.320), you can tilt <◀▶> up or down to change the shooting information displayed at the screen's bottom as follows. For details, see pages 323-324.

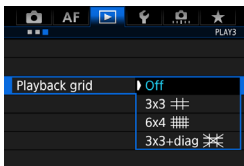

MENU Grid Display



In single-image display and two-image display (p.332), you can overlay the grid on the image playback.

With [**▶3: Playback grid**], you can select [**3x3** , [**6x4** , or [**3x3+diag** ].

This function is convenient for checking the image's vertical or horizontal tilt as well as composition.

 The grid is not displayed during movie playback.

INFO.: Shooting Information Display

Sample Information for Still Photos

● Basic information display

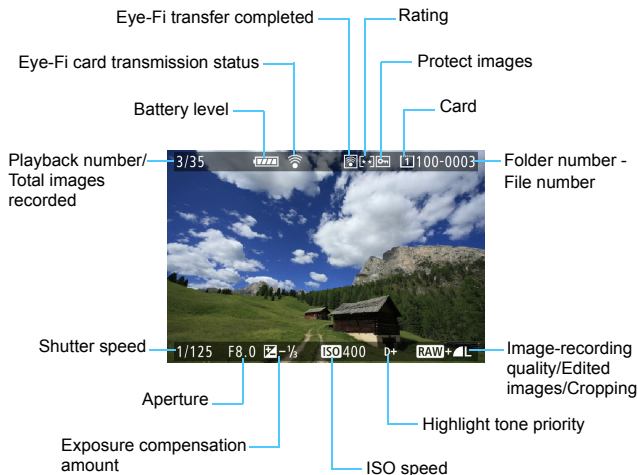

- If the image was taken by another camera, certain shooting information may not be displayed.
- It may not be possible to play back images taken with the EOS 5DS/EOS 5DS R on other cameras.

● Shooting information display

● Detailed information

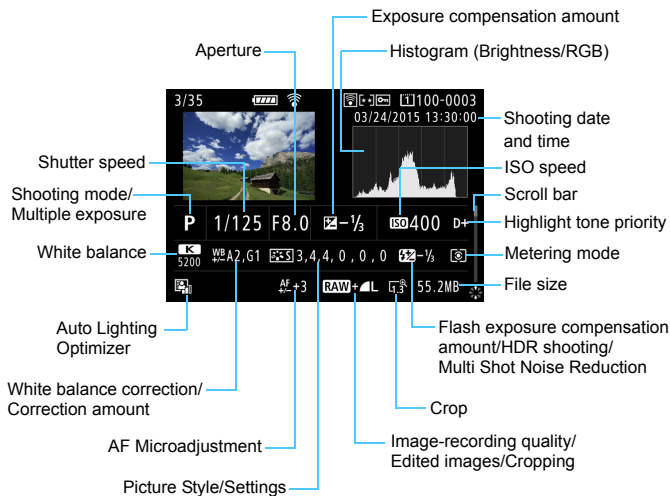

- * When you shoot in RAW+JPEG image quality, the RAW image file size will be displayed.
- * Lines indicating the shooting area will be displayed for images taken with the crop/aspect ratio set and with RAW or RAW+JPEG set for image quality.
- * Lines indicating the shooting area will be displayed for images with cropping information appended (p.411).
- * During flash photography without flash exposure compensation, <f> will be displayed.
- * <HDR> and the dynamic range adjustment amount will be displayed for images shot with HDR shooting.
- * <M> will be displayed for multiple-exposure photos.
- * <NR> will be displayed for images shot with Multi Shot Noise Reduction.
- * For still photos taken during movie shooting, <M> will be displayed.
- * For images that are processed (RAW processing function, resized, or cropped) and then saved, <C> will be displayed.
- * For images cropped and then saved, <T> will be displayed.

• **Lens/Histogram information**

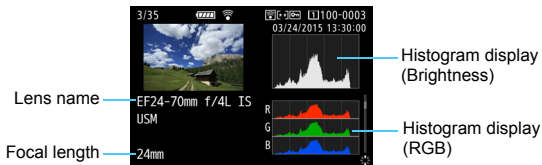

• **White balance information**

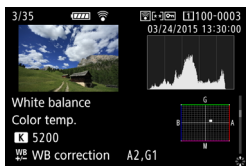

• **Picture Style information 1**



• **Picture Style information 2**

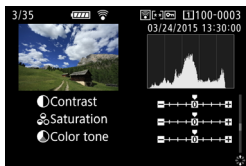

• **Color space / Noise reduction information**



• **Lens aberration correction information**

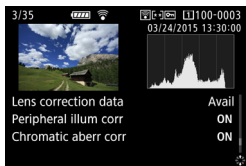

If you used GPS Receiver GP-E2 to record GPS information for the image, tilt \llcorner up or down to view the "GPS information" screen.

Sample Movie Information Display

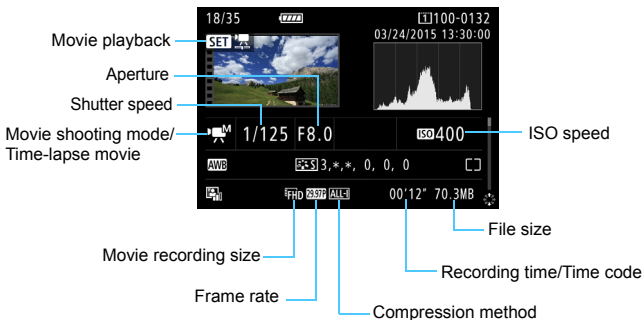

- <M> and <M> modes: Shutter speed, aperture and ISO speed are not displayed.
- <Tv> mode: Aperture and ISO speed are not displayed.
- <Av> mode: Shutter speed and ISO speed are not displayed.
- <M> mode + Auto ISO: ISO speed is not displayed.

● Highlight Alert

When [▶3: Highlight alert] is set to [Enable], overexposed, clipped highlights will blink. To obtain more image detail in the overexposed, blinking areas, set the exposure compensation to a negative amount and shoot again.

● AF Point Display

When [▶3: AF point disp.] is set to [Enable], the AF point that achieved focus will be displayed in red. If automatic AF point selection is set, multiple AF points may be displayed.

● Histogram

The brightness histogram shows the exposure level distribution and overall brightness. The RGB histogram is for checking the color saturation and gradation. The display can be switched with [▶] 3: **Histogram disp.**].

[Brightness] Display

This histogram is a graph showing the distribution of the image's brightness level. The horizontal axis indicates the brightness level (darker on the left and brighter on the right), while the vertical axis indicates how many pixels exist for each brightness level. The more pixels there are toward the left, the darker the image. The more pixels there are toward the right, the brighter the image. If there are too many pixels on the left, the shadow detail will be lost. If there are too many pixels on the right, the highlight detail will be lost. The gradation in-between will be reproduced. By checking the image and its brightness histogram, you can see the exposure level inclination and the overall gradation.

Sample Histograms



Dark image



Normal brightness



Bright image

[RGB] Display

This histogram is a graph showing the distribution of each primary color's brightness level in the image (RGB or red, green, and blue). The horizontal axis indicates the color's brightness level (darker on the left and brighter on the right), while the vertical axis indicates how many pixels exist for each color brightness level. The more pixels there are toward the left, the darker and less prominent the color. The more pixels there are toward the right, the brighter and denser the color. If there are too many pixels on the left, the respective color information will be lacking. If there are too many pixels on the right, the color will be too saturated with no gradation. By checking the image's RGB histogram, you can see the color's saturation and gradation condition, as well as white balance inclination.

▶ Searching for Images Quickly

❑ Display Multiple Images on One Screen (Index Display)

You can search for images quickly with the index display showing 4, 9, 36, or 100 images on one screen.





1 Press the <Q> button.

- During image playback or when the camera is ready to shoot, press the <Q> button.
- ▶ [ Q] will be displayed on the lower right of the screen.





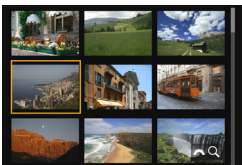

2 Switch to the index display.

- Turn the < > dial counterclockwise.
- ▶ The 4-image index display will appear. The selected image is highlighted with an orange frame.
- Turning the < > dial further counterclockwise will switch the display from 9 images, 36 images and to 100 images. If you turn the dial clockwise, it will rotate through 100, 36, 9, 4, and single-image display.



3 Select an image.



- Operate < > or the < > dial to move the orange frame and select the image.
- Press the <Q> button to turn off the [ Q] icon, then turn the < > dial to go to the next screen or previous image.
- Press <SET> in the index display to display the selected image in the single-image display.

Jump through Images (Jump Display)

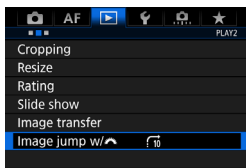
In the single-image display, you can turn the < > dial to jump through the images forward or backward according to the jump method set.



1 Select [Image jump w/].

- Under the [ 2] tab, select [Image jump w/ ], then press < >.

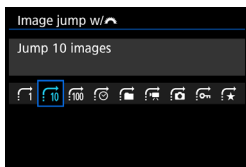

2 Select the jump method.

- Select the jump method, then press < >.

: Display images one by one

: Jump 10 images

: Jump 100 images

: Display by date

: Display by folder

: Display movies only

: Display stills only

: Display protected images only

: Display by image rating (p.337)

Turn the < > dial to select.

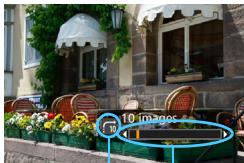

Jump method

Playback position

3 Browse by jumping.

- Press the <▶> button to play back images.
- In the single-image display, turn the <⚙> dial.
- ▶ You can browse by the method that was set.



- To search images by shooting date, select [**Date**].
- To search images by folder, select [**Folder**].
- If the card contains both movies and still photos, select [**Movies**] or [**Stills**] to display one or the other.
- If no images match the [**Protect**] or [**Rating**] setting, you cannot browse through images with the <⚙> dial.

Q Magnifying Images

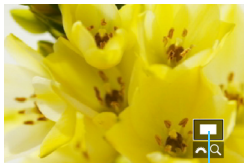

You can magnify a captured image by approx. 1.5x to 16x on the LCD monitor.



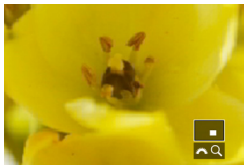
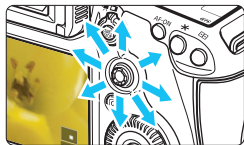

Magnified area position



1 Magnify the image.

- The image can be magnified as follows: 1. During image playback (single-image display), 2. During the image review after image capture, and 3. From the shooting-ready state.
- Press the **<Q>** button.
- ▶ The magnified view will appear. The magnified area and [ **Q**] will be displayed on the lower right of the screen.
- The image magnification increases as you turn the **< >** dial clockwise. You can magnify the image up to approx. 16x.
- The image magnification decreases as you turn the **< >** dial counterclockwise. In the case of 1 and 3 only, turning the dial further will display the index display (p.327).

2 Scroll around the image.

- Use **< >** to scroll around the magnified image.
- To exit the magnified view, press the **<Q>** button or **< >** button and the single-image display will return.

- In the case of 1 and 3 only, you can turn the **< >** dial to view another image while the magnification is maintained.
- A movie cannot be magnified.

MENU Magnification Settings

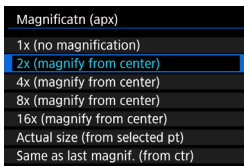
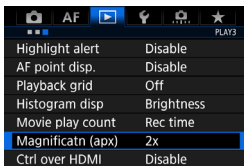

Under the [] 3 tab, when you select [Magnificatn (apx)], you can set the starting magnification and initial position for the magnified view.

- **1x (no magnification)**

The image is not magnified. The magnified view will start with the single-image display.

- **2x, 4x, 8x, 16x (magnify from center)**

The magnified view starts at the image center at the selected magnification.

- **Actual size (from selected point)**

The recorded image's pixels will be displayed at approx. 100%. The magnified view starts at the AF point that achieved focus. If the photo is taken with manual focus, the magnified view starts at the image center.

- **Same as last magnification (from center)**

The magnification will be the same as the last time you exited the magnified view with the <▶> or <Q> button. The magnified view starts at the image center.



For images taken with [L]+Tracking] or [FlexiZone - Single] (p.268), the magnified view will start at the image center even if [Actual size (from selected pt)] is set.

Comparing Images (Two-Image Display)

You can compare two images side by side on the LCD monitor. In the two-image display, you can use magnified view or jump display as well as protection, rating and erasure of images.









1 Set the two-image display.

- During image playback, press the  button.
- ▶ The two-image index display will appear. The currently-selected image will be highlighted with an orange frame.



2 Select the images to be compared.

- Pressing  switches the orange frame between the two images.
- Turn the  dial to select an image.
- Repeat this procedure to select the other image to be compared.
- If the left and right images are the same, the  icon will appear on the upper left of both images.
- By pressing the , you can set the same magnification and magnified area for both images. (The magnification settings will match those of the image not highlighted with an orange frame.)
- By holding the , you can display the image highlighted with the orange frame as a single image.
- To return to the previous display, press the .



-  • By pressing the **<INFO.>** button, you can change the information display.
- You cannot play back movies in the two-image display.

Rotating the Image

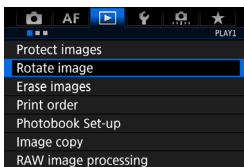
You can rotate the displayed image to the desired orientation.



1 Select [Rotate image].

- Under the [ 1] tab, select [Rotate image], then press < >.

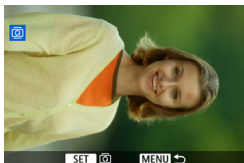

2 Select an image.



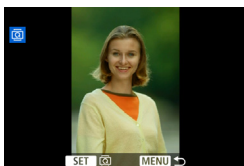



- Turn the < > dial to select the image to be rotated.
- You can also select an image in the index display (p.327).



3 Rotate the image.

- Each time you press < >, the image will rotate clockwise as follows: 90° → 270° → 0°.
- To rotate another image, repeat steps 2 and 3.



- If you set [ 1: Auto rotate] to [On  ] (p.362) before taking vertical shots, you need not rotate the image as described above.
- If the rotated image is not displayed in the rotated orientation during image playback, set [ 1: Auto rotate] to [On  ].
- A movie cannot be rotated.

Protecting Images

You can protect important images from being accidentally erased by the camera's erase function.

MENU Protecting a Single Image

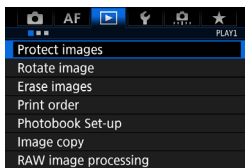

1 Select [Protect images].

- Under the [▶] 1 tab, select [Protect images], then press <SET>.

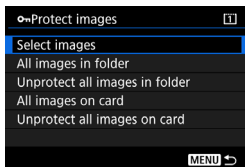

2 Select [Select images].

- ▶ An image will be displayed.

Image protection icon



3 Select an image.

- Turn the <DISP> dial to select the image to be protected.
- You can also select an image or movie on the index display (p.327).

4 Protect the image.

- Press <SET> to protect the selected image. The <Protect icon> will appear at the top of the screen.
- To cancel the image protection, press <SET> again. The <Protect icon> will disappear.
- To protect another image, repeat steps 3 and 4.

MENU Protecting All Images in a Folder or on a Card

You can protect all the images in a folder or on a card at once.

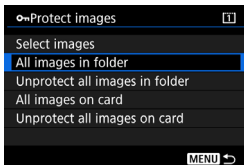

When you select **[All images in folder]** or **[All images on card]** in [**▶** 1: **Protect images**], all the images in the folder or on the card will be protected. To cancel the image protection, select **[Unprotect all images in folder]** or **[Unprotect all images on card]**.

 **If you format the card (p.67), the protected images will also be erased.**

-  ● Movies can also be protected.
- Once an image is protected, it cannot be erased by the camera's erase function. To erase a protected image, you must first cancel the protection.
- If you erase all the images (p.360), only the protected images will remain. This is convenient when you want to erase unnecessary images all at once.
- When **[All images on card]** or **[Unprotect all images on card]** is selected, the images will be protected or unprotected on the card selected for **[Record/play]** or **[Playback]** under [**▶** 1: **Record func+card/folder sel.**].

Protecting Images with the <RATE> Button

During image playback, you can use the <RATE> button to protect an image.

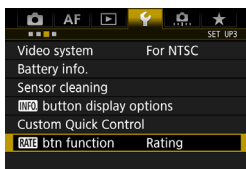

1 Select [**RATE** btn function].

- Under the [**3**] tab, select [**RATE** button function], then press <SET>.

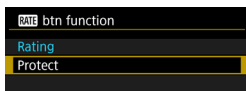

2 Select [Protect].



3 Select an image.

- Press the <▶> button to play back images.
- Turn the <DIAL> dial to select the image to be protected.
- You can also select an image or movie on the index display (p.327).

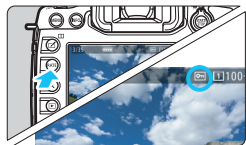

4 Protect the image.

- When you press the <RATE> button, the image will be protected and the <L100> icon will appear.
- To cancel the image protection, press the <RATE> button again. The <L100> icon will disappear.

Setting Ratings

You can rate images (still photos and movies) with one of the five rating marks: [★]/[★★]/[★★★]/[★★★★]/[★★★★★]. This function is called rating.

Rating Images with the <RATE> Button



1 Select an image.

- During image playback, turn the <◉> dial to select an image or movie to be rated.
- You can also select an image or movie on the index display (p.327).

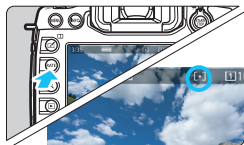

2 Rate the image.

- Each time you press the <RATE> button, the rating mark will change: [★]/[★★]/[★★★]/[★★★★]/[★★★★★]/None.
- To rate another image, repeat steps 1 and 2.

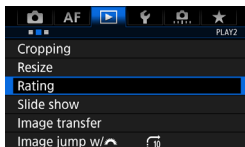

- If [☛3: RATE btn function] is set to [Protect], change it to [Rating].
- If you press the <Q> button when [Rating] is selected in [☛3: RATE btn function], you can set the rating marks that can be selected when you press the <RATE> button.

MENU Setting Ratings with the Menu**1** Select [Rating].

- Under the [▶] 2 tab, select [Rating], then press <SET>.

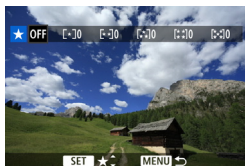
**2** Select an image.

- Turn the <◉> dial to select an image or movie to be rated.
- If you press the <Q> button and turn the <☀> dial counterclockwise, you can select an image from a three-image display. To return to the single-image display, turn the <☀> dial clockwise.

**3** Rate the image.

- Press <SET> and a blue highlight frame will appear as shown in the screenshot.
- Turn the <◉> dial to select a rating, then press <SET>.
- ▶ When you set a rating mark to the image, the total number of the images displayed beside the rating mark will be counted up.
- To rate another image, repeat steps 2 and 3.



A total of up to 999 images of a given rating can be displayed. If there are more than 999 images with a given rating, [###] will be displayed.



Taking Advantage of Ratings

- With [▶2: **Image jump w/** ], you can display only images having the specified rating.
- With [▶2: **Slide show**], you can play back only images with a specific rating.
- With Digital Photo Professional (EOS software, p.520), you can select only the image with a specific rating (still photos only).
- With Windows 8.1, Windows 8, Windows 7, etc., you can see each file's rating as part of the file information display or in the provided image viewer (JPEG images only).

Q Quick Control for Playback

During playback, you can press the <Q> button to set the following: [**On** : **Protect images**], [**Q** : Rotate image], [**★** : **Rating**], [**RAW**↓ : RAW image processing (RAW images only)], [**⌂** : Resize (JPEG image only)], [**⌂** : Cropping (JPEG images only)], [**ON** : **Highlight alert**], [**ON** : **AF point display**], and [**⌂** : **Image jump w/** ].

For movies, **only the functions in bold above can be set.**

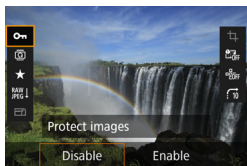

1 Press the <Q> button.

- During image playback, press the <Q> button.
- ▶ The Quick Control options will appear.

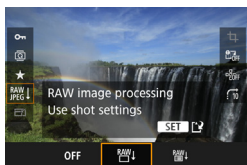







2 Select an item and set it.

- Tilt <Q> up or down to select a function.
- ▶ The setting of the selected function is displayed at the bottom.
- Turn the <Q> dial to set it.
- For RAW image processing, Resize, and Cropping, press <SET> and set the function. For details, see page 364 for RAW image processing, page 369 for Resize, and page 371 for Cropping. To cancel, press the <MENU> button.

3 Exit the setting.

- Press the <Q> button to exit the Quick Control screen.

 To rotate an image, set [**1: Auto rotate**] to [**On**  ]. If [**On** ] or [**Off**] is set, the [**Rotate image**] setting will be recorded to the image, but the camera will not rotate the image for display.

- 
- Pressing the <> button during the index display will switch to the single-image display and the Quick Control screen will appear. Pressing the <> button again will return to the index display.
 - For images taken with another camera, the options you can select may be restricted.

Enjoying Movies

You can play back movies in the following three ways:

Playback on a TV Set (p.351)



By connecting the camera to a TV set with HDMI Cable HTC-100 (sold separately), you can play back the camera's still photos and movies on the TV set.

- Since hard disk recorders do not have an HDMI IN port, the camera cannot be connected to a hard disk recorder with an HDMI cable.
- Even if the camera is connected to a hard disk recorder with a USB cable, movies and still photos cannot be played back or saved.

Playback on the Camera's LCD Monitor (p.344-345)

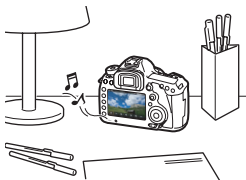

You can play back movies on the camera's LCD monitor. You can also edit out the movie's first and last scenes, and play back the still photos and movies on the card in an automatic slide show.

- A movie edited with a computer cannot be rewritten to the card and played back with the camera.

Playback and Editing with a Computer



To play back or edit a movie, use pre-installed or general-purpose software, compatible with the movie's recording format.



If you play back or edit a movie with commercially-available software, use software compatible with MOV-format movies. For details on commercially-available software, contact the software manufacturer.

▶▶ Playing Back Movies



1 Play back the image.

- Press the <▶> button to display an image.



2 Select a movie.

- Turn the <☉> dial to select the movie to be played.
- With the single-image display, the <SET ▶▶> icon displayed on the upper left indicates a movie.
- In the index display, perforations at the left edge of a thumbnail indicate a movie. **As movies cannot be played from the index display, press <SET> to switch to the single-image display.**



3 In the single-image display, press <SET>.

- ▶ The movie playback panel will appear at the bottom of the screen.







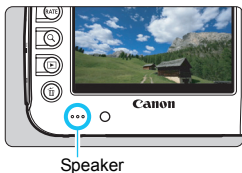





4 Play back the movie.

- Select [▶] (Play), then press <SET>.
- ▶ The movie will start playing back.
- You can pause the movie playback by pressing <SET>.
- You can adjust the sound volume during movie playback by turning the <☉> dial.
- For more details on the playback procedure, see the next page.



⚠ The camera may not be able to play back movies shot with another camera.

Movie Playback Panel

Operation	Playback Description
 Play	Pressing <SET> toggles between play and stop.
 Slow motion	Adjust the slow motion speed by turning the <DIAL> dial. The slow motion speed is indicated on the upper right of the screen.
 First frame	Displays the movie's first frame.
 Previous frame	Each time you press <SET>, the previous frame is displayed. If you hold down <SET>, it will rewind the movie.
 Next frame	Each time you press <SET>, the movie will play frame-by-frame. If you hold down <SET>, it will fast forward the movie.
 Last frame	Displays the movie's last frame.
 Edit	Displays the editing screen (p.346).
	Playback position
mm' ss"	Playback time (minutes:seconds with [Movie play count: Rec time] set)
hh:mm:ss.ff (DF) hh:mm:ss:ff (NDF)	Time code (hours:minutes:seconds:frames with [Movie play count: Time code] set)
 Volume	Turn the <DIAL> dial to adjust the volume of the built-in speaker (p.344).
MENU 	To return to the single-image display, press the <MENU> button.



- With a fully-charged Battery Pack LP-E6N, the continuous playback time at room temperature (23°C/73°F) will be approx. 3 hr. 20 min.
- If you connect the camera to a TV set to play back a movie (p.351), adjust the sound volume with the TV set. (Turning the <DIAL> dial will not change the sound volume.) If there is audio feedback, place the camera farther away from the TV set or turn down the TV sound volume.
- If you take a still photo during movie shooting, the still photo will be displayed for approx. 1 sec. during the movie playback.

✂ Editing a Movie's First and Last Scenes

You can edit out the first and last scenes of a movie in approx. 1-sec. increments. You can also edit time-lapse movies.



1 On the movie playback screen, select [✂].

- ▶ The movie editing panel will be displayed at the bottom of the screen.

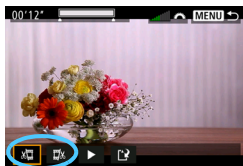

2 Specify the part to be edited out.

- Select either [✂] (Cut beginning) or [✂] (Cut end), then press <SET>.
- Tilt <◀▶> to the left or right to see the previous or next frames. Holding down the key will fast forward or fast rewind the frames. Turn the <⊙> dial for frame-by-frame playback.
- After deciding which part to edit out, press <SET>. The portion highlighted in white on the top of the screen is what will remain.



3 Check the edited movie.

- Select [▶] and press <SET> to play back the edited movie.
- To change the editing, go back to step 2.
- To cancel the editing, press the <MENU> button, then select [OK] on the confirmation dialog.

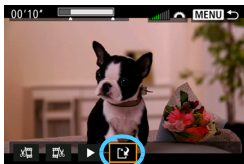

4 Save the edited movie.

- Select [**X**], then press < (SET) >.
- ▶ The save screen will appear.
- To save it as a new movie, select [**New file**]. To save it and overwrite the original movie file, select [**Overwrite**], then press < (SET) >.
- On the confirmation dialog, select [**OK**] to save the edited movie and return to the movie playback screen.



- Since the editing is performed in approx. 1-sec. increments (position indicated by [**X**] on the top of the screen), the actual position where the movie is edited may differ from the position you specified.
- If the card does not have enough free space, [**New file**] will not be available.
- When the battery level is low, movie editing is not possible. Use a fully-charged battery.
- Movies shot with another camera cannot be edited with this camera.

MENU Slide Show (Auto Playback)

You can play back the images on the card as an automatic slide show.

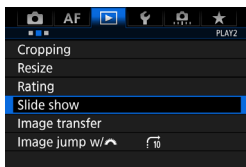

1 Select [Slide show].

- Under the [▶] 2 tab, select [Slide show], then press <SET>.

Number of images to be played back

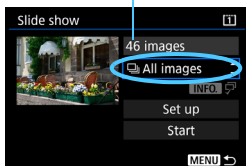

2 Select the images to be played back.

- Select the desired option on the screen, then press <SET>.

All images/Movies/Stills/Protect

- Select one of the following: [All images] [Movies] [Stills] [Protect]. Then press <SET>.

Date/Folder/Rating

- Select one of the following: [Date] [Folder] [Rating].
- When <INFO. [right arrow]> is highlighted, press the <INFO.> button.
- Select the desired setting, then press <SET>.

Date

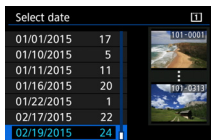

Folder

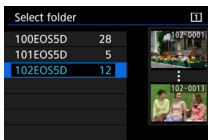

Rating



Item	Playback Description
All images	All the still photos and movies on the card will be played back.
Date	Still photos and movies taken on the selected shooting date will be played back.
Folder	Still photos and movies in the selected folder will be played back.
Movies	Only the movies on the card will be played back.
Stills	Only the still photos on the card will be played back.
Protected	Only the protected still photos and movies on the card will be played back.
Rating	Only the still photos and movies with the selected rating will be played back.

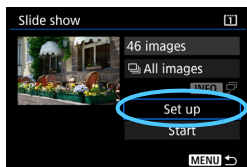

3 Configure [Set up] as desired.

- Select [Set up], then press <SET>.
- Set the [Display time] and [Repeat] settings for still photos.
- After completing the settings, press the <MENU> button.

Display time

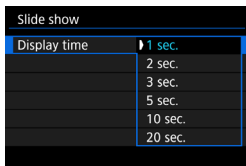

Repeat

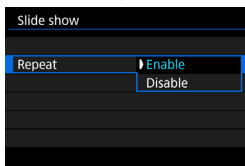

The images on the card selected for [Record/play] or [Playback] under [**1**: Record func+card/folder sel.] will be played back.

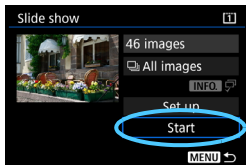

4 Start the slide show.

- Select [**Start**], then press <SET>.
- ▶ After [**Loading image...**] is displayed, the slide show will start.

5 Exit the slide show.

- To exit the slide show and return to the setting screen, press the <MENU> button.

- To pause the slide show, press <SET>. During pause, [||] will be displayed on the upper left of the image. Press <SET> again to resume the slide show.
- During auto playback, you can press the <INFO.> button to change the still photo display format (p.320).
- During movie playback, you can adjust the sound volume by turning the <SOUND> dial.
- During auto playback or pause, you can turn the <DIAL> dial to view another image.
- During auto playback, auto power off will not take effect.
- The display time may vary depending on the image.
- To view the slide show on a TV set, see page 351.

Viewing Images on a TV Set

By connecting the camera to a TV set with an HDMI cable (sold separately), you can play the camera's still photos and movies on the TV set. For the HDMI cable, HDMI Cable HTC-100 (sold separately) is recommended.

If the picture does not appear on the TV screen, set the **[F3: Video system]** correctly to **[For NTSC]** or **[For PAL]** (depending on the video system of your TV set).

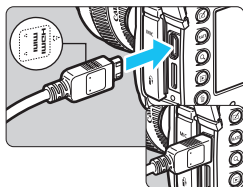

1 Connect the HDMI cable to the camera.

- With the plug's <▲HDMI MINI> logo facing the front of the camera, insert it into the <HDMI OUT> terminal.

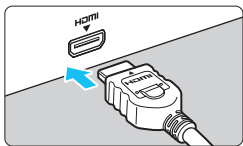

2 Connect the HDMI cable to the TV set.

- Connect the HDMI cable to the TV set's HDMI IN port.

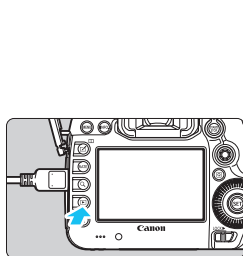

3 Turn on the TV set and switch the TV set's video input to select the connected port.

4 Set the camera's power switch to <ON>.

5 Press the <▶> button.

- ▶ The image will appear on the TV screen. (Nothing will be displayed on the camera's LCD monitor.)
- The images will automatically be displayed at the optimum resolution matching the connected TV set.
- By pressing the <INFO.> button, you can change the information display.
- To play back movies, see page 344.

- Adjust movie sound volume with the TV set. The sound volume cannot be adjusted with the camera.
- Before connecting or disconnecting the cable between the camera and TV set, turn off the camera and TV set.
- Depending on the TV set, part of the image displayed may be cut off.
- Do not connect any other device's output to the camera's <HDMI OUT> terminal. Doing so may cause a malfunction.
- Certain TV sets may not be able to display the captured movies.

Using HDMI CEC TV Sets

If the TV set connected to the camera with an HDMI cable is compatible with HDMI CEC*, you can use the TV set's remote control for playback operations.

* An HDMI-standard function enabling HDMI devices to control each other so that you can control them with one remote control unit.

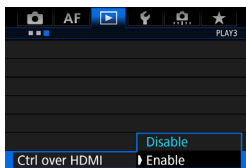

- 1 **Set [Ctrl over HDMI] to [Enable].**
 - Under the [▶3] tab, select [Ctrl over HDMI], then press <SET>.
 - Select [Enable], then press <SET>.

- 2 **Connect the camera to a TV set.**
 - Use an HDMI cable to connect the camera to the TV set.
 - ▶ The TV set's input will switch automatically to the HDMI port connected to the camera. If it does not switch automatically, use the TV set's remote control to select the HDMI IN port the cable is connected to.

3 Press the camera's button.

- ▶ An image will appear on the TV screen and you can use the TV set's remote control to play back images.

4 Select an image.





- Point the remote control toward the TV set and press the \leftarrow/\rightarrow button to select an image.

Still photo playback menu **5 Press the remote control's Enter button.**





Movie playback menu



-  : Return
-  : 9-image index
-  : Play movie
-  : Slide show
- INFO.** : Display shooting info
-  : Rotate

- ▶ The menu appears and you can perform the playback operations shown on the left.
- Press the remote control's \leftarrow/\rightarrow button to select the desired option, then press the Enter button. For a slide show, press the \uparrow/\downarrow button to select an option, then press the Enter button.
- If you select [**Return**] and press the Enter button, the menu will disappear and you can use the \leftarrow/\rightarrow button to select an image.

 During the two-image display (p.332), playback with the TV's remote control is not possible. To use the TV's remote control for playback, first press the \leftarrow/\rightarrow button to return to the single-image display.

-  ● Some TV sets require you to first enable the HDMI CEC connection. For details, refer to the TV set's instruction manual.
- Certain TV sets, even those compatible with HDMI CEC, may not operate properly. In such a case, set [ **3: Ctrl over HDMI**] to [**Disable**], and use the camera to control the playback operation.

Copying Images

The images recorded on one card can be copied to another card.

MENU Copying a Single Image

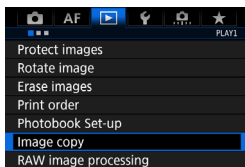

1 Select [Image copy].

- Under the [▶ 1] tab, select [Image copy], then press <SET>.

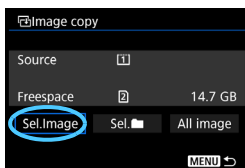

2 Select [Sel. Image].

- Check the copy source and target cards' number, and remaining capacity.
- Select [Sel. Image], then press <SET>.

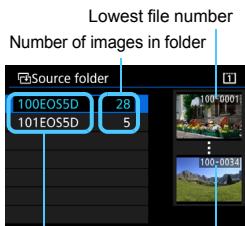

3 Select the folder.

- Select the folder containing the image you want to copy, then press <SET>.
- Check the images displayed on the right to select the desired folder.
- ▶ The images in the selected folder will be displayed.

 The copy source is the card selected for [Record/play] or [Playback] under [▼ 1: Record func+card/folder sel.].

Total images selected



4 Select the images to be copied.

- Turn the <DISP> dial to select an image to be copied, then press <SET>.
- ▶ The [✓] icon will appear on the upper left of the screen.
- If you press the <Q> button and turn the <DISP> dial counterclockwise, you can select an image from a three-image display. To return to the single-image display, turn the <DISP> dial clockwise.
- To select other images to be copied, repeat step 4.

5 Press the <RATE> button.

- After selecting all the images to be copied, press the <RATE> button.

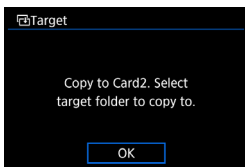

6 Select [OK].

- Check the card where the images will be copied to, then select [OK].

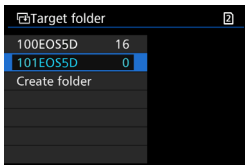

7 Select the target folder.

- Select the target folder to which you want to copy the images, then press <SET>.
- To create a new folder, select [Create folder].

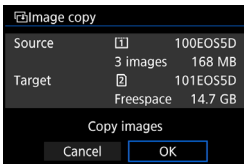

8 Select [OK].

- Check the information of the source card and target card, then select [OK].

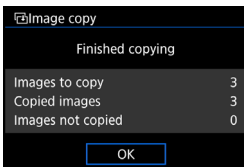

- ▶ The copying will start and the progress will be displayed.
- When the copying is completed, the result will be displayed. Select [OK] to return to the screen in step 2.

MENU Copying All Images in a Folder or on a Card

You can copy all the images in a folder or on a card at once.

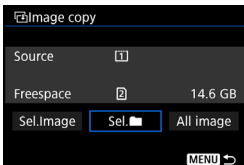

Under [**▶ 1: Image copy**], when you select [**Sel. [Folder]**] or [**All image**], you can copy all the images in the folder or on a card.



- The file name of the copied image will be the same as the source image's file name.
- If **[Sel.Image]** is set, you cannot copy images in multiple folders at once. Select images in each folder to copy them folder by folder.
- If an image is being copied to a target folder/card which has an image with the same file number, the following will be displayed: **[Skip image and continue]** **[Replace existing image]** **[Cancel copy]**. Select the copying method, then press <SET>.
 - **[Skip image and continue]**: Any images in the source folder having the same file number as images in the target folder will be skipped and not copied.
 - **[Replace existing image]**: Any images in the target folder having the same file number as the source images (including protected images) will be overwritten.

If an image with a print order (p.389) is overwritten, you will have to set the print order again.

- The image's print order information, image transfer information, and photo book order information will not be retained when the image is copied.
- Shooting is not possible during the copying operation. Select **[Cancel]** before shooting.

Erasing Images

You can either select and erase unnecessary images one by one or erase them in one batch. Protected images (p.334) will not be erased.

- ⚠ **Once an image is erased, it cannot be recovered. Make sure you no longer need the image before erasing it. To prevent important images from being erased accidentally, protect them. Erasing a RAW+JPEG image will erase both the RAW and JPEG images.**

Erasing a Single Image



1 Play back the image to be erased.

2 Press the  button.

- ▶ The Erase menu will appear.

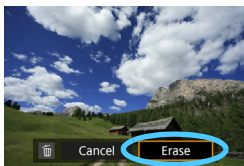

3 Erase the image.

- Select **[Erase]**, then press . The image displayed will be erased.

 Setting **[.3: Default Erase option]** to **[[Erase] selected]** makes it faster to erase images (p.412).

MENU Checkmarking [✓] Images to Be Erased in a Batch

By appending checkmarks <✓> to the images to be erased, you can erase multiple images at once.

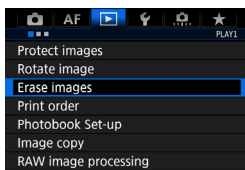

1 Select [Erase images].

- Under the [▶1] tab, select [Erase images], then press <SET>.

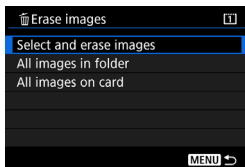

2 Select [Select and erase images].

- An image will be displayed.
- If you press the <Q> button and turn the <⌚> dial counterclockwise, you can select an image from a three-image display. To return to the single-image display, turn the <⌚> dial clockwise.

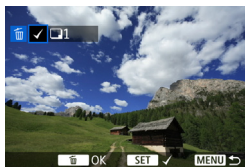

3 Select the images to be erased.

- Turn the <⌚> dial to select the image to be erased, then press <SET>.
- A checkmark [✓] will be displayed on the upper left of the screen.
- To select other images to be erased, repeat step 3.

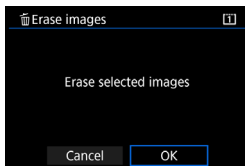



4 Erase the image.

- Press the <🗑️> button, then press [OK].
- The selected images will be erased in one batch.

MENU Erasing All Images in a Folder or on a Card

You can erase all the images in a folder or on a card at once. When [ **1: Erase images**] is set to [**All images in folder**] or [**All images on card**], all the images in the folder or on the card will be erased.

-  To erase all images, including protected images, format the card (p.67).
- The images on the card selected for [**Record/play**] or [**Playback**] under [ **1: Record func+card/folder sel.**] will be erased.

Changing Image Playback Settings

MENU Adjusting the LCD Monitor Brightness

The LCD monitor's brightness is adjusted automatically for optimum viewing depending on the ambient light level. You can also set the automatic adjustment's brightness level (brighter or darker), or adjust the brightness manually.



1 Select [LCD brightness].

- Under the [**2**] tab, select [**LCD brightness**], then press <SET>.

2 Select [Auto] or [Manual].

- Turn the <DIAL> dial to make the selection.

3 Adjust the brightness.

- While referring to the gray chart, turn the <DIAL> dial, then press <SET>.
- You can adjust [**Auto**] to one of three levels, and [**Manual**] to one of seven levels.

Automatic adjustment



Manual adjustment



⚠ While [**Auto**] is set, be careful not to obstruct the round, ambient light sensor (p.28) under the LCD monitor with your finger, etc.

- To check the image's exposure, looking at the histogram is recommended (p.326).
- During playback, pressing the <DIAL> button will display the screen in step 2.

MENU Auto Rotation of Vertical Images

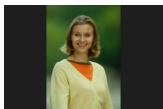

Vertical images are rotated automatically so they are displayed vertically on the camera's LCD monitor and on the computer instead of horizontally. You can change the setting for this feature.

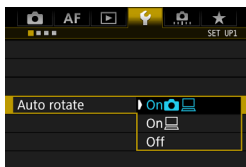

1 Select [Auto rotate].

- Under the [**1**] tab, select [**Auto rotate**], then press <SET>.

2 Set the auto rotation.

- Select the desired setting, then press <SET>.

- On**  

The vertical image is automatically rotated during playback on both the camera's LCD monitor and on the computer.

- On** 

The vertical image is automatically rotated only on the computer.

- Off**

The vertical image is not automatically rotated.

 Auto rotation will not work with vertical images captured while auto rotation was [**Off**]. They will not rotate even if you later switch it to [**On**] for playback.

-  The vertical image will not be automatically rotated for the image review just after shooting.
- If the vertical image is taken while the camera is pointed up or down, the image may not be rotated automatically for playback.
- If the vertical image is not automatically rotated on the computer screen, it means the software you are using is unable to rotate the image. Using the EOS software is recommended.

10

Post-Processing Images

You can process RAW images and resize or crop JPEG images.

- A ☆ icon at the upper right of a page title indicates a function that can be used only in the following modes: <P> <Tv> <Av> <M> .



- The camera may not be able to process images taken with another camera.
- Post-processing images as described in this chapter cannot be performed while the camera is connected to a computer via an interface cable.

RAW↓ JPEG↓ Processing RAW Images with the Camera ☆

You can process **RAW** images with the camera and save them as JPEG images. As the RAW image itself does not change, you can apply different processing conditions to create any number of JPEG images from it.

Note that **M RAW** and **S RAW** images cannot be processed with the camera. Use Digital Photo Professional (EOS software, p.520) to process those images.

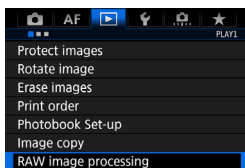

1 Select [RAW image processing].

- Under the [▶] 1 tab, select [**RAW image processing**], then press <SET>.
- RAW** images will be displayed.

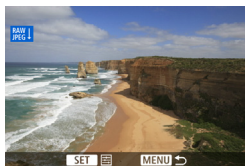

2 Select an image.

- Turn the <⊙> dial to select the image you want to process.
- If you press the <Q> button and turn the <⊙> dial counterclockwise, you can select an image from the index display.



3 Process the image.

- Press <SET> to make the RAW-processing options appear (p.366).
- Use <⊙> to select an option, then turn the <⊙> dial to switch the setting.
- The displayed image will reflect such settings as “Brightness adjustment”, “White balance”, etc.
- To return to the image settings at the time of shooting, press the <INFO.> button.

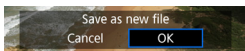
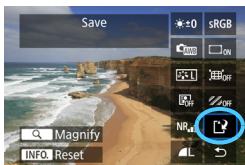

Displaying the setting screen

- Press <SET> to display the setting screen. Turn the <DISP.> or <DISP.> dial to change the setting. Press <SET> to finalize the setting and return to the previous screen.

4 Save the image.

- Select [Q] (Save), then press <SET>.
- Select [OK] to save the image.
- Check the destination folder and image file number, then select [OK].
- To process another image, repeat steps 2 to 4.

Magnified View







You can magnify the image by pressing the <Q> button in step 3. The magnification will differ depending on the pixel count of **[Image quality]** set in **[RAW image processing]**. With <DISP.>, you can scroll around the magnified image.

To cancel magnified view, press the <Q> button again.

Crop/Aspect Ratio

Frame lines indicating the shooting area will be displayed on images shot when **[4: Crop/aspect ratio]** (p.154) is set to an option other than **[Full-frame]**. JPEG images generated from RAW images will be saved with the cropping area or aspect ratio that was set.

RAW Image Processing Options

-  **Brightness adjustment**
You can adjust the image brightness up to ± 1 stop in 1/3-stop increments. The displayed image will reflect the setting's effect.
-  **White balance** (p.174)
You can select the white balance. If you select [**AWB**] and press the <INFO.> button, you can select [**Auto: Ambience priority**] or [**Auto: White priority**]. If you select [**K**] and press the <INFO.> button, you can set the color temperature. The displayed image will reflect the setting's effect.
-  **Picture Style** (p.164)
You can select the Picture Style. By pressing the <INFO.> button, you can adjust the sharpness and other parameters. The displayed image will reflect the setting's effect.
-  **Auto Lighting Optimizer** (p.182)
You can set the Auto Lighting Optimizer. The displayed image will reflect the setting's effect.
-  **High ISO speed noise reduction** (p.183)
You can set the noise reduction for high ISO speeds. The displayed image will reflect the setting's effect. If the effect is difficult to discern, magnify the image (p.365).
-  **Image quality** (p.149)
You can set the image quality when generating an image in JPEG format.

- sRGB **Color space** (p.193)

You can select either sRGB or Adobe RGB. Since the camera's LCD monitor is not compatible with Adobe RGB, the image will not look very different when either color space is set.

- OFF **Peripheral illumination correction** (p.188)

If [**Enable**] is set, the corrected image will be displayed. If the effect is difficult to discern, magnify the image (p.365) and check the four corners. The peripheral illumination correction applied with the camera will be less pronounced than with Digital Photo Professional (EOS software) and may be less apparent. In such a case, use Digital Photo Professional to apply the peripheral illumination correction.

- OFF **Distortion correction**

Image distortion due to lens characteristics can be corrected. If [**Enable**] is set, the corrected image will be displayed. The image periphery will be trimmed in the corrected image. Since the image resolution may look slightly lower, adjust the sharpness with the Picture Style's [**Sharpness**] parameter setting as necessary.

- OFF **Chromatic aberration correction** (p.189)

Chromatic aberrations (color fringing along the subject's outline) due to the lens characteristics can be corrected. If [**Enable**] is set, the corrected image will be displayed. If the effect is difficult to discern, magnify the image (p.365).

Peripheral Illumination Correction, Distortion Correction, and Chromatic Aberration Correction

To execute peripheral illumination correction, distortion correction, and chromatic aberration correction, the correction data of the lens used is necessary. If you cannot apply correction when processing RAW images in the camera, use EOS Utility (EOS software, p.520) to register the correction data to the camera.

-  ● Processing RAW images in the camera will not produce the same results as processing RAW images with Digital Photo Professional.
- When processing images with **[Distortion]** set to **[Enable]**, AF point display information (p.325) and Dust Delete Data (p.375) will not be appended to the image.

Resizing JPEG Images

You can resize a JPEG image to make the pixel count lower and save it as a new image. Resizing an image is possible only with JPEG L/M1/M2/S1/S2 images. **JPEG S3 and RAW images cannot be resized.**

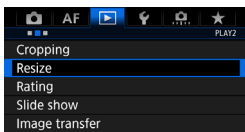

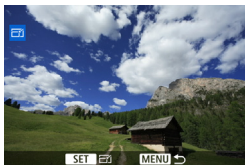

1 Select [Resize].

- Under the [ 2] tab, select [Resize], then press <SET>.
- ▶ An image will be displayed.



2 Select an image.

- Turn the < > dial to select the image you want to resize.
- If you press the <Q> button and turn the < > dial counterclockwise, you can select an image from the index display.



Target sizes

3 Select the desired image size.

- Press <SET> to display the image sizes.
- Select the desired image size, then press <SET>.

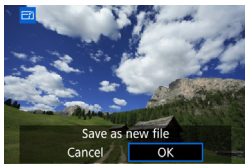

4 Save the image.

- Select [OK] to save the resized image.
- Check the destination folder and image file number, then select [OK].
- To resize another image, repeat steps 2 to 4.

Resize Options by Original Image Size

Original Image Size	Available Resize Settings				
	M1	M2	S1	S2	S3
L	<input type="radio"/>	<input type="radio"/>	<input type="radio"/>	<input type="radio"/>	<input type="radio"/>
M1		<input type="radio"/>	<input type="radio"/>	<input type="radio"/>	<input type="radio"/>
M2			<input type="radio"/>	<input type="radio"/>	<input type="radio"/>
S1				<input type="radio"/>	<input type="radio"/>
S2					<input type="radio"/>

Image Sizes

Sizes for resized images are shown below.

(Approx.)

Image Quality	Full-frame (3:2)	1.3x (crop)	1.6x (crop)
M1	7680x5120 (39.3 megapixels)	6016x4000* (24.1 megapixels)	4800x3200 (15.4 megapixels)
M2	5760x3840 (22.1 megapixels)	4512x3008 (13.6 megapixels)	3616x2408* (8.7 megapixels)
S1	4320x2880 (12.4 megapixels)	3376x2256* (7.6 megapixels)	2704x1808* (4.9 megapixels)
S2	1920x1280 (2.5 megapixels)	1920x1280 (2.5 megapixels)	1920x1280 (2.5 megapixels)
S3	720x480 (350,000 pixels)	720x480 (350,000 pixels)	720x480 (350,000 pixels)

Image Quality	1:1 (aspect ratio)	4:3 (aspect ratio)	16:9 (aspect ratio)
M1	5120x5120 (26.2 megapixels)	6816x5120* (34.9 megapixels)	7680x4320 (33.2 megapixels)
M2	3840x3840 (14.7 megapixels)	5120x3840 (19.7 megapixels)	5760x3240 (18.7 megapixels)
S1	2880x2880 (8.3 megapixels)	3840x2880 (11.1 megapixels)	4320x2432* (10.5 megapixels)
S2	1280x1280 (1.6 megapixels)	1712x1280* (2.2 megapixels)	1920x1080 (2.1 megapixels)
S3	480x480 (230,000 pixels)	640x480 (310,000 pixels)	720x408* (290,000 pixels)

 The items marked with an asterisk do not exactly match the indicated aspect ratio. The image will be cropped slightly.

🔗 Cropping JPEG Images

You can crop a JPEG image and save it as another image. You can crop L, M1, M2, S1 and S2 JPEG images. JPEG S3 and RAW images cannot be cropped.

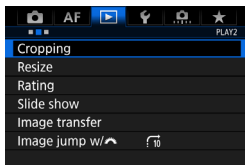

1 Select [Cropping].

- Under the [▶2] tab, select [Cropping], then press <SET>.
- ▶ An image is displayed.

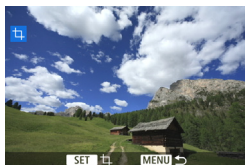

2 Select an image.

- Turn the <☉> dial to select the image you want to crop.
- If you press the <Q> button and turn the <☉> dial counterclockwise, you can select an image from the index display.



3 Set the cropping frame size, aspect ratio, position, and orientation.

- Press <SET> to display the cropping frame.
- The image area within the cropping frame will be cropped.

Changing the Cropping Frame Size

Turn the <☉> dial to change the cropping frame size. The smaller the cropping frame, the more magnified the cropped image will look.

Changing the Aspect Ratio

Turn the <☉> dial to change the cropping frame's aspect ratio. You can select the aspect ratio as follows: [3:2], [16:9], [4:3], or [1:1].

Moving the Cropping Frame

Use <⬆> to move the frame over the image vertically or horizontally. Move the cropping frame until it covers the desired image area.

Switching the Cropping Frame Orientation

Pressing the <INFO.> button will toggle the cropping frame between the vertical and horizontal orientations. This enables you to create a vertically oriented image from a horizontal image.

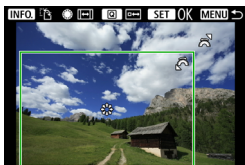

4 Check the image area to be cropped.

- Press the <Q> button.
- ▶ The image area to be cropped will be displayed.
- Press the <Q> button again to return to the original image.

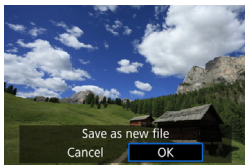

5 Save the cropped image.

- Press <SET> and select [OK] to save the cropped image.
- Check the destination folder and image number, then select [OK].
- To crop another image, repeat steps 2 to 4.

- Once a cropped image is saved, it cannot be cropped again or resized.
- AF point display information (p.325) and Dust Delete Data (p.375) will not be appended to the cropped images.

11

Sensor Cleaning

The camera has a Self Cleaning Sensor Unit to automatically shake off dust adhered to the image sensor's front layer (low pass filter). The Dust Delete Data can also be appended to the image so that the dust spots remaining can be deleted automatically by Digital Photo Professional (EOS software, p.520).

Smudges adhering to the front of the sensor

Besides dust entering the camera from outside, in rare cases, lubricant from the camera's internal parts may adhere to the front of the sensor. If visible spots still remain after the automatic sensor cleaning, having the sensor cleaned by a Canon Service Center is recommended.



Even while the Self Cleaning Sensor Unit is operating, you can press the shutter button halfway to interrupt the cleaning and start shooting immediately.

Automatic Sensor Cleaning

Whenever you set the power switch to <ON> or <OFF>, the Self Cleaning Sensor Unit operates to automatically shake off the dust on the front of the sensor. Normally, you need not pay attention to this operation. However, you can choose to perform sensor cleaning manually, or disable it.

Cleaning the Sensor Now

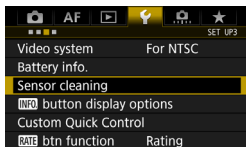

1 Select [Sensor cleaning].

- Under the [ 3] tab, select [**Sensor cleaning**], then press <SET>.

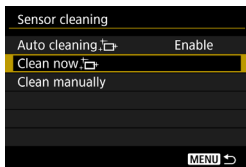

- Select [**Clean now ]**, then press <SET>.
- Select [**OK**].
- ▶ The screen will indicate that the sensor is being cleaned. (A small sound may be heard.) Although there will be a shutter sound, no picture is taken.



- For best results, perform the sensor cleaning with the camera placed upright and stable on a table or other flat surface.
- Even if you repeat the sensor cleaning, the result will not improve much. Immediately after the sensor cleaning is finished, the [**Clean now ]** option remains disabled temporarily.

Disabling Automatic Sensor Cleaning

- In step 2, select [**Auto cleaning ]** and set it to [**Disable**].
- ▶ The sensor cleaning will no longer be executed when you set the power switch to <ON> or <OFF>.

MENU Appending Dust Delete Data ☆

Normally, the Self Cleaning Sensor Unit will eliminate most of the dust that may be visible on captured images. However, in case visible dust still remains, you can append the Dust Delete Data to the image for erasing the dust spots later. The Dust Delete Data is used by Digital Photo Professional (EOS software, p.520) to erase the dust spots automatically.

Preparation

- Prepare a solid white object such as a sheet of paper.
- Set the lens focal length to 50 mm or longer.
- Set the lens's focus mode switch to <MF> and set the focus to infinity (∞). If the lens has no distance scale, rotate the camera to face towards you and turn the focusing ring clockwise all the way.

Obtaining the Dust Delete Data

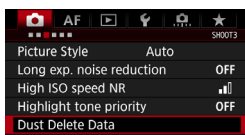

1 Select [Dust Delete Data].

- Under the [**3**] tab, select [**Dust Delete Data**], then press <SET>.

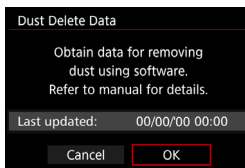

2 Select [OK].

- ▶ After the automatic self-cleaning of the sensor is performed, a message will appear. Although there will be a shutter sound during the cleaning, no picture is taken.

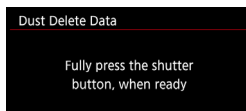
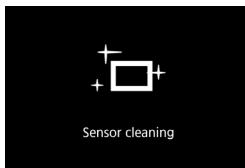



3 Shoot a solid-white object.

- At a distance of 20 cm - 30 cm (0.7 ft. - 1.0 ft.), fill the viewfinder with a patternless, solid-white object and take a picture.
- ▶ The picture will be taken in aperture-priority AE mode at an aperture of f/22.
- Since the image will not be saved, the data can still be obtained even if there is no card in the camera.
- ▶ When the picture is taken, the camera will start collecting the Dust Delete Data. When the Dust Delete Data is obtained, a message will appear.
- If the data is not obtained successfully, an error message will appear. Follow the "Preparation" procedure on the preceding page, then select [OK]. Take the picture again.

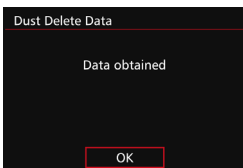

Dust Delete Data

After the Dust Delete Data is obtained, it is appended to all the JPEG and RAW images captured thereafter. Before an important shoot, it is recommended that you update the Dust Delete Data by obtaining it again.

For details about using Digital Photo Professional (EOS software, p.520) to erase dust spots, refer to the Digital Photo Professional Instruction Manual (p.522).

The Dust Delete Data appended to the image is so small that it hardly affects the image file size.

 Be sure to use a solid-white object such as a new sheet of white paper. If the object has any pattern or design, it may be recognized as dust data and affect the accuracy of the dust deletion with the EOS software.

MENU Manual Sensor Cleaning [☆]

Dust that could not be removed by the automatic sensor cleaning can be removed manually with a commercially-available blower, etc. Before cleaning the sensor, detach the lens from the camera.

The image sensor is extremely delicate. If the sensor needs to be cleaned directly, having it done by a Canon Service Center is recommended.

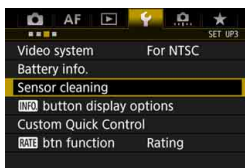

1 Select [Sensor cleaning].

- Under the [**3**] tab, select [**Sensor cleaning**], then press <SET>.

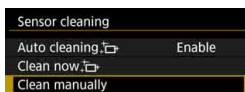

2 Select [Clean manually].



3 Select [OK].

- ▶ In a moment, the reflex mirror will lock up and the shutter will open.
- “CLn” will blink on the LCD panel.

4 Clean the sensor.

5 End the cleaning.

- Set the power switch to <OFF>.



- If you use a battery, make sure it is fully charged.
- If you use Battery Grip BG-E11 (sold separately) with AA/R6 batteries, manual sensor cleaning will not be possible.



For the power source, using the DC Coupler DR-E6 (sold separately) and AC Adapter AC-E6N (sold separately) is recommended.

- **While cleaning the sensor, never do any of the following. If the power is cut off, the shutter will close and the shutter curtains and image sensor may get damaged.**
 - **Setting the power switch to <OFF>.**
 - **Removing or inserting the battery.**
- The surface of the image sensor is extremely delicate. Clean the sensor with care.
- Use a plain blower without any brush attached. A brush can scratch the sensor.
- Do not insert the blower tip inside the camera beyond the lens mount. If the power is turned off, the shutter will close and the shutter curtains or reflex mirror may get damaged.
- Never use pressurized air or gas to clean the sensor. The blowing force can damage the sensor, or the spray gas can freeze on the sensor and scratch it.
- If the battery level becomes low while you clean the sensor, the beeper will sound as a warning. Stop cleaning the sensor.
- If a smudge that cannot be removed with a blower remains, having the sensor cleaned by a Canon Service Center is recommended.

12

Printing Images and Transferring Images to a Computer

- **Printing** (p.382)
You can connect the camera directly to a printer and print out the images on the card. The camera is compliant with “PictBridge”, which is the standard for direct printing.
- **Digital Print Order Format (DPOF)** (p.389)
DPOF (Digital Print Order Format) enables you to print images recorded on the card according to your printing instructions such as the image selection, quantity to print, etc. You can print multiple images in one batch or create a print order for a photofinisher.
- **Transferring Images to a Computer** (p.393)
You can connect the camera to a computer and operate the camera to transfer images recorded on the card to the computer.
- **Specifying Images for a Photobook** (p.397)
You can specify images on the card for printing in a photobook.

Preparing to Print

The direct printing procedure can be performed entirely with the camera while you look at the camera's LCD monitor.

Connecting the Camera to a Printer

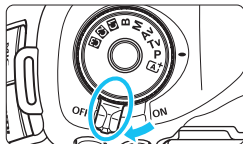

1 Set the camera's power switch to **<OFF>**.

2 Set up the printer.

- For details, refer to the printer's instruction manual.

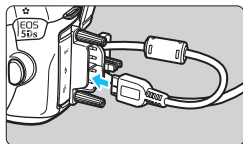

3 Connect the camera to a printer.

- Use the interface cable provided with the camera.
- When connecting the cable to the camera, use the cable protector (p.36). Connect the cable to the digital terminal with the plug's **<SS>>** icon facing the back of the camera.
- To connect to the printer, refer to the printer's instruction manual.

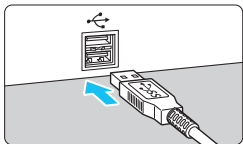

4 Turn on the printer.

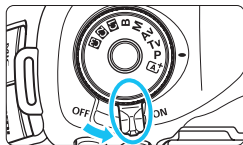

5 Set the camera's power switch to **<ON>**.

- ▶ Some printers may make a beeping sound.





6 Play back the image.

- Press the <  > button.
- ▶ The image will appear with the <  > icon on the upper left of the screen to indicate that the camera is connected to a printer.



- Make sure the printer has a PictBridge connection port.
- Use the provided interface cable or one from Canon (p.454). When connecting the interface cable, use the provided cable protector (p.36).
- Movies cannot be printed.
- The camera cannot be used with printers conforming only to CP Direct or Bubble Jet Direct.
- If there is a long beeping sound in step 5, it indicates a problem with the printer. Resolve the problem displayed in the error message (p.388).
- Printing is not possible if Multi Shot Noise Reduction or the HDR Mode is set.



- You can also print RAW images taken with this camera.
- You can also print JPEG/RAW images shot when [**4: Crop/aspect ratio**] (p.154) is set.
- If you use a battery to power the camera, make sure it is fully charged. With a fully-charged battery, printing up to approx. 3 hr. is possible.
- Before disconnecting the cable, first turn off the camera and printer. Hold the plug (not the cord) to pull out the cable.
- For direct printing, using the DC Coupler DR-E6 (sold separately) and AC Adapter AC-E6N (sold separately) to power the camera is recommended.

☞ Printing

The screen display and setting options will differ depending on the printer. Some settings may not be available. For details, refer to the printer's instruction manual.

Printer-connected icon



1 Select the image to be printed.

- Check that the <☞> icon is displayed on the upper left of the LCD monitor.
- Turn the <⦿> dial to select the image to be printed.

2 Press <SET>.

- ▶ The print setting screen will appear.

Print setting screen

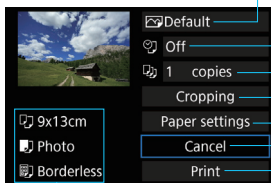

Sets printing effects (p.384).

Sets date or file number imprinting to on or off (p.385).

Sets quantity to be printed (p.385).

Sets print area (p.387).

Sets paper size, type, and layout (p.383).

Returns to the screen in step 1.

Starts printing.

The paper size, type, and layout you set are displayed.

* Depending on the printer, certain settings such as the date and file number imprinting and cropping may not be selectable.

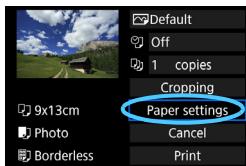

3 Select [Paper settings].

- ▶ The paper settings screen will appear.

Setting the Paper Size

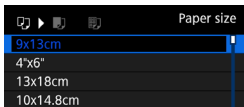

- Select the size of the paper loaded in the printer, then press **<SET>**.
- ▶ The paper type screen will appear.

Setting the Paper Type

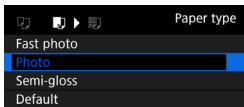

- Select the type of the paper loaded in the printer, then press **<SET>**.
- ▶ The page layout screen will appear.

Setting the Page Layout

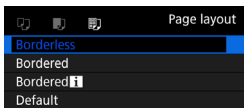

- Select the page layout, then press **<SET>**.
- ▶ The print setting screen will reappear.

Borderless	Prints with no borders. If your printer cannot print borderless prints, the print will have borders.
Bordered	Prints with white borders along the edges.
Bordered [i]	Imprints the shooting information* ¹ on the border on 9x13 cm or larger prints.
xx-up	Option to print 2, 4, 8, 9, 16, or 20 images on one sheet.
20-up [i] 35-up [i]	Prints 20 or 35 images as thumbnails on A4 or Letter size paper* ² . • Imprints the shooting information* ¹ with [20-up [i]] .
Default	The page layout varies depending on the printer model or its settings.

*1: From the Exif data, the camera name, lens name, shooting mode, shutter speed, aperture, exposure compensation amount, ISO speed, white balance, etc., will be imprinted.

*2: After ordering the prints with "Digital Print Order Format (DPOF)" (p.389), printing by following "Direct Printing of Print-Ordered Images" (p.392) is recommended.

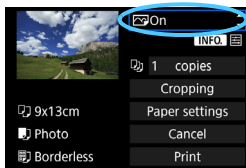

4 Set the printing effects.

- Set them if necessary. If you do not need to set any printing effects, go to step 5.
- **Contents displayed on the screen differ depending on the printer.**
- Select the setting, then press <SET>.
- Select the desired printing effect, then press <SET>.
- If the <INFO [INFO] > icons are displayed brightly, you can also adjust the printing effects (p.386).

Printing Effect	Description
Off	No automatic correction is applied.
On	Print with the printer's standard colors. The image's Exif data is used to make automatic corrections.
VIVID	Print with higher saturation to produce more vivid blues and greens.
NR	Image noise is reduced before printing.
B/W B/W	Prints in black-and-white with true blacks.
B/W Cool tone	Prints in black-and-white with cool, bluish blacks.
B/W Warm tone	Prints in black-and-white with warm, yellowish blacks.
Natural	Prints the image in the actual colors and contrast. No automatic color adjustments are applied.
Natural M	Printing characteristics are the same as the "Natural" setting. However, this setting enables finer printing adjustments than with "Natural."
Default	Printing differs depending on the printer. For details, refer to the printer's instruction manual.

* When you change the printing effects, changes are reflected in the image displayed on the upper left of the screen. Note that the printed image may look slightly different from the displayed image, which is only an approximation. This also applies to [Brightness] and [Adjust levels] on page 386.

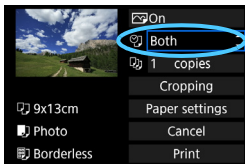

5 Set the date and file number imprinting.

- Set them if necessary.
- Select <Ⓞ>, then press <SET>.
- Set the print settings as desired, then press <SET>.



6 Set the number of copies.

- Set it if necessary.
- Select <Ⓞ>, then press <SET>.
- Select the number of copies, then press <SET>.

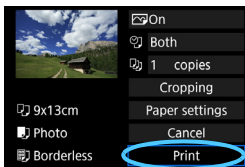

7 Start printing.

- Select [Print], then press <SET>.



- The [Default] setting for printing effects and other options are the printer's own default settings as set by the printer's manufacturer. Refer to the printer's instruction manual to find out what the [Default] settings are.
- Depending on the image's file size and image-recording quality, it may take some time for the printing to start after you select [Print].
- If image tilt correction (p.387) is applied, it may take longer to print the image.
- To stop the printing, press <SET> while [Stop] is displayed, then select [OK].
- If you execute [4: Clear all camera settings] (p.70), all the settings will revert to their defaults.

Adjusting Printing Effects

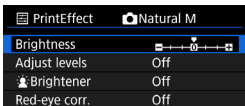
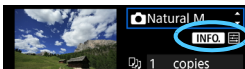

In step 4 on page 384, select the printing effect. When the <INFO> icons are displayed brightly, you can press the <INFO.> button. You can then adjust the printing effects. What can be adjusted or what is displayed will depend on the selection made in step 4.

Brightness

The image brightness can be adjusted.

Adjust levels

When you select [Manual], you can change the histogram's distribution and adjust the image's brightness and contrast.

With the Adjust levels screen displayed, press the <INFO.> button to change the position of the <↑>. Turn the <⦿> dial to freely adjust the shadow level (0 - 127) or highlight level (128 - 255).

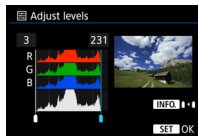

Brightener

Effective in backlit conditions where the subject's face looks dark. When [On] is set, the face will be brightened for printing.

Red-eye corr.

Effective in flash images where the subject has red eyes. When [On] is set, the red eye will be corrected for printing.

- The [Brightener] and [Red-eye corr.] effects will not be reflected on the screen.
- When [Detail set.] is selected, you can adjust the [Contrast], [Saturation], [Color tone], and [Color balance]. To adjust the [Color balance], use <←>. B is for blue, A for amber, M for magenta, and G for green. The image's color balance will be adjusted towards the color in the direction of the move.
- If you select [Clear all], all the printing effect settings will be reverted to their defaults.

Cropping the Image

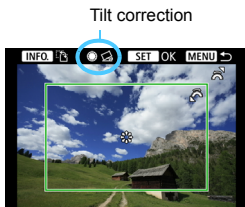

You can crop the image and print only an enlarged version of the cropped portion, as if the image is recomposed.

Set the cropping right before printing.

If you change the print settings after setting the cropping, you may have to set the cropping again before printing.

1 On the print setting screen, select [Cropping].

2 Set the cropping frame size, position, and aspect ratio.

- The image area within the cropping frame will be printed. The cropping frame's aspect ratio can be changed with [**Paper settings**].

Changing the Cropping Frame Size

Turn the <  > dial to change the cropping frame size. The smaller the cropping frame, the larger the image magnification will be for printing.



Moving the Cropping Frame

Use <  > to move the frame over the image vertically or horizontally. Move the cropping frame until it covers the desired image area.

Switching the Orientations of the Cropping Frame

Pressing the < **INFO.** > button will toggle the cropping frame between the vertical and horizontal orientations. This enables you to create a vertically oriented print from a horizontal image.

Image Tilt Correction

By turning the <  > dial, you can tilt the image between -10 and +10 degrees in 0.5-degree increments. When you adjust the image tilt, the <  > icon on the screen will turn blue.

3 Press <  > to exit the cropping.

- ▶ The print setting screen will reappear.
- You can check the cropped image area on the print setting screen.

- Depending on the printer, you may not be able to print an image with a large image size. In such a case, resize the image (p.369), then print.
- If the image's aspect ratio is different from the printing paper's aspect ratio, the image may be cropped significantly when you print it as a borderless print. If the image is cropped, the print may look grainier due to the fewer number of pixels.
- If you imprint shooting information on an image shot at an expanded ISO speed (H), the correct ISO speed may not be imprinted.
- Depending on the printer, the cropped image area may not be printed as you specified.
- The smaller you make the cropping frame, the grainier the picture will look in the print.
- Check the camera's LCD monitor while cropping the image. If you look at the image on a TV screen, the cropping frame may not be displayed accurately.



Handling Printer Errors

If printing does not resume after you resolve a printer error (no ink, no paper, etc.) and select [**Continue**], operate the buttons on the printer to resume printing. For details on resuming the printing, refer to the printer's instruction manual.

Error Messages

If a problem occurs during printing, an error message will appear on the camera's LCD monitor. Press <  > to stop printing. After fixing the problem, resume printing. For details on how to fix a printing problem, refer to the printer's instruction manual.

Paper Error

Check whether the paper is properly loaded in the printer.

Ink Error

Check the printer's ink level and the waste ink tank.

Hardware Error

Check for any printer problems other than paper and ink problems.

File Error

The selected image cannot be printed via PictBridge. Images taken with a different camera or images edited with a computer may not be printable.

Digital Print Order Format (DPOF)

You can set the print settings such as print type, date imprinting, file number imprinting, etc. The print settings will be applied to all print-ordered images. (They cannot be set individually for each image.)

Setting the Printing Options

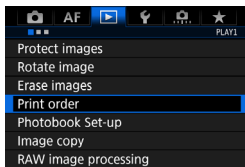

1 Select [Print order].

- Under the [▶1] tab, select [Print order], then press <SET>.

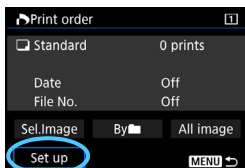

2 Select [Set up].

3 Set the options as desired.

- Set the [Print type], [Date], and [File No.].
- Select the option to be set, then press <SET>. Select the desired setting, then press <SET>.

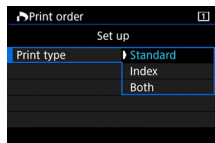

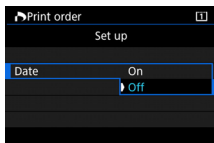

Print type

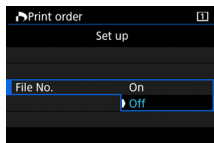

Date



File No.

Print type		Standard	Prints one image on one sheet.
		Index	Multiple thumbnail images are printed on one sheet.
		Both	Prints both the standard and index prints.
Date	On	[On] imprints the recorded date on the print.	
	Off		
File number	On	[On] imprints the file number on the print.	
	Off		

4 Exit the setting.

- Press the <MENU> button.
- ▶ The print order screen will reappear.
- Next, select [**Sel. Image**], [**By ■■**], or [**All image**] to order the images to be printed.

- RAW images and movies cannot be print ordered. You can print RAW images with PictBridge (p.379).
- If you print an image with a large image size using the [**Index**] or [**Both**] setting (p.392), the index print may not be printed with some printers. In such a case, resize the image (p.369), then print the index print.
- Even if [**Date**] and [**File No.**] are set to [**On**], the date or file number may not be imprinted, depending on the print type setting and printer model.
- With [**Index**] prints, the [**Date**] and [**File No.**] cannot both be set to [**On**] at the same time.
- When printing with DPOF, use the card whose print order specifications are set. It cannot be printed with the specified print order if you just extract images from the card and try to print them.
- Certain DPOF-compatible printers and photofinishers may not be able to print the images as you specified. Refer to the printer's instruction manual before printing, or check with your photofinisher about compatibility when ordering prints.
- Do not specify a new print order for a card containing images whose print order was set by a different camera. The print order may be overwritten. Also, the print order may not be possible, depending on the image type.

Print Ordering

Sel.Image

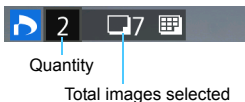
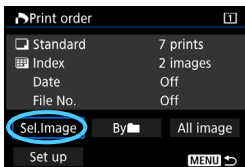

Select and order images one by one. If you press the <Q> button and turn the <DIAL> dial counterclockwise, you can select an image from a three-image display. To return to the single-image display, turn the <DIAL> dial clockwise. Press the <MENU> button to save the print order to the card.

Standard / Both

Press <SET>, and a print order for one copy of the displayed image will be placed. By turning the <DIAL> dial, you can set the number of copies to be printed up to 99.

Index

Press <SET> to add a checkmark to the box [✓]. The image will be included in the index print.

By folder

Select **[Mark all in folder]** and select the folder. A print order for one copy of all the images in the folder will be specified. If you select **[Clear all in folder]** and select the folder, the print order for all the images in the folder will be canceled.

All image

If you select **[Mark all on card]**, one copy of all the images on the card will be set for printing. If you select **[Clear all on card]**, the print order will be cleared for all the images on the card.



- Note that RAW images and movies will not be included in the print order even if you set **[By folder]** or **[All image]**.
- When using a PictBridge printer, print no more than 400 images for one print order. If you specify more than this, all the images may not be printed.

Direct Printing of Print-Ordered Images

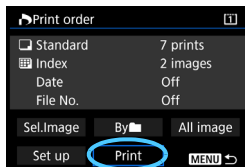

With a PictBridge printer, you can easily print images with DPOF.

1 Prepare to print.

- See page 380.

Follow the “Connecting the Camera to a Printer” procedure up to step 5.

2 Under the [▶ 1] tab, select [Print order].

3 Select [Print].

- [Print] will be displayed only if the camera is connected to a printer and printing is possible.

4 Set the [Paper settings] (p.382).

- Set the printing effects (p.384) if necessary.

5 Select [OK].

- Before printing, be sure to set the paper size.
- Certain printers may not imprint the file number.
- If [Bordered] is set, certain printers may imprint the date on the border.
- Depending on the printer, the date may appear faint if it is imprinted on a bright background or on the border.
- Under [Adjust levels], [Manual] cannot be selected.

- If you stopped the printing and want to resume printing of the remaining images, select [Resume]. Note that printing will not resume if any of the following are the case:
 - You changed the print order or deleted any of the print ordered images before resuming the printing.
 - When index is set, you changed the paper setting before resuming the printing.
 - The card's remaining capacity was low when you paused the printing.
- If a problem occurs during printing, see page 388.

➡ Transferring Images to a Computer

You can connect the camera to a computer and operate the camera to transfer images on the card to the computer. This is called direct image transfer.

The direct image transfer can be performed with the camera while you look at the LCD monitor.

The images transferred to the computer will be saved in the **[Pictures]** or **[My Pictures]** folder and organized in folders by shooting date.

⚠ Caution for Image Transfer

Before connecting the camera to a computer, install the EOS Utility (p.521) on your computer.

Preparing Image Transfer

1 Set the camera's power switch to <OFF>.

2 Connect the camera to a computer.

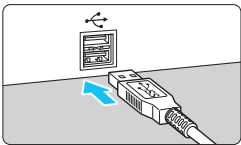
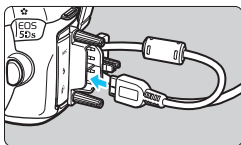

- Use the interface cable provided with the camera.
- When connecting the cable to the camera, use the cable protector (p.36). Connect the cable to the digital terminal with the plug's <SS←→> icon facing the back of the camera.
- Connect the cord's plug to the computer's USB terminal.

⚠ Use the provided interface cable or one from Canon (p.454). When connecting the interface cable, use the provided cable protector (p.36).

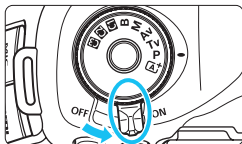

3 Set the camera's power switch to <ON>.

- When the computer displays a screen to select the program, select [**EOS Utility**].
- ▶ The EOS Utility screen will appear on the computer.

⚠ **After the EOS Utility screen appears, do not operate EOS Utility.** If any screen other than EOS Utility's main window is displayed, [**Direct transfer**] in step 5 on page 396 will not be displayed. (The image transfer function will not be available.)

- If the EOS Utility screen does not appear, refer to the EOS Utility Instruction Manual (p.522).
- Before disconnecting the cable, turn off the camera. Hold the plug (not the cord) to pull out the cable.

MENU Transferring RAW+JPEG Images

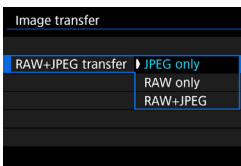

For RAW+JPEG images, you can specify which image to transfer.

On the next page in step 2, select [**RAW+JPEG transfer**], and select the image to be transferred: [**JPEG only**], [**RAW only**], or [**RAW+JPEG**].

MENU Selecting the Images to be Transferred

Sel.Image

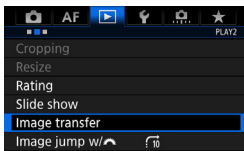

- 1 Select [Image transfer].
 - Under the [▶2] tab, select [Image transfer], then press <SET>.

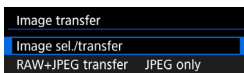

- 2 Select [Image sel./transfer].

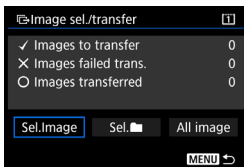

- 3 Select [Sel.Image].

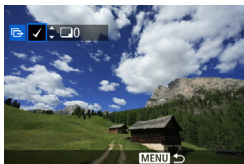

- 4 Select the images to be transferred.
 - Turn the <DISP> dial to select the image to be transferred, then press <SET>.
 - Turn the <DISP> dial to display the [✓] on the screen's upper left, then press <SET>.
 - If you press the <Q> button and turn the <DISP> dial counterclockwise, you can select an image from a three-image display. To return to the single-image display, turn the <DISP> dial clockwise.
 - To select other images to be transferred, repeat step 4.



- When [Sel.Image] is selected, you can check the image's transfer status on the upper left of the screen: No mark: Not selected. ✓: Selected for transfer. ×: Transfer failed. ○: Transfer succeeded.
- The procedures for [RAW+JPEG transfer] (p.394) and above steps 1 to 4 can also be performed while the camera is not connected to a computer.

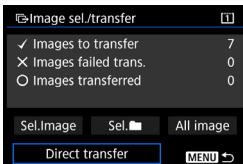

5 Transfer the image.

- On the computer screen, check that EOS Utility's main window is displayed.
- Select [**Direct transfer**], then press < (SET) >.
- On the confirmation dialog, select [**OK**], and the images will be transferred to the computer.
- Images selected with [**Sel. [Folder]**] and [**All image**] can also be transferred in this way.

• Sel. [Folder]

Select [**Sel. [Folder]**] and select [**Folder images not transfer'd**]. When you select a folder, all the images in that folder not yet transferred to the computer will be selected.

Selecting [**Folder images failed transf.**] will select the selected folder's images that failed to transfer.

Selecting [**Clear folder transf. history**] will clear the transfer history of the images in the selected folder. After clearing the transfer history, you can select [**Folder images not transfer'd**] and again transfer all the images in the folder.

• All image

If [**All image**] is selected and you select [**Card images not transferred**], all the images on the card not yet transferred to a computer will be selected.

For a description of [**Card images failed transfer**] and [**Clear card's transf. history**], see "Sel. [Folder]" above.

- If any screen other than EOS Utility's main window is displayed on the computer, [**Direct transfer**] is not displayed.
- During the image transfer, certain menu options cannot be used.

- You can also transfer movies.
- Up to 9,999 images can be transferred in one batch.
- Shooting is possible during the image transfer.

☑ Specifying Images for a Photobook

You can specify up to 998 images to be printed in a photobook. When you use EOS Utility (EOS software) to transfer images to a computer, the specified images will be copied to a dedicated folder. This function is useful for ordering photobooks online.

Specifying One Image at a Time

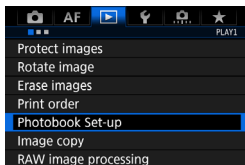

1 Select [Photobook Set-up].

- Under the [▶ 1] tab, select [Photobook set-up], then press <SET>.

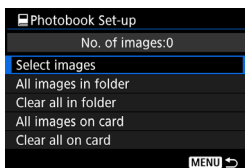

2 Select [Select images].

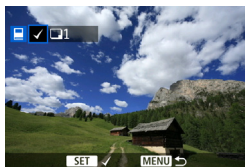

3 Select the image to be specified.

- Turn the <◉> dial to select the image to be specified, then press <SET>.
- If you press the <Q> button and turn the <☀> dial counterclockwise, you can select an image from a three-image display. To return to the single-image display, turn the <☀> dial clockwise.
- To select other images to be transferred, repeat step 3. The number of specified images will be displayed.

Specifying All Images in a Folder or on a Card

You can specify all the images in a folder or on a card at once.

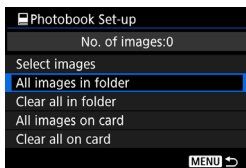

When [▶ 1: **Photobook Set-up**] is set to [**All images in folder**] or [**All images on card**], all the images in the folder or on the card will be specified.

To clear your selections, select [**Clear all in folder**] or [**Clear all on card**].

- ⓘ RAW images and movies cannot be specified.
- Do not specify images already specified for a photobook in another camera for another photobook with this camera. The photobook settings may be overwritten.

13

Customizing the Camera

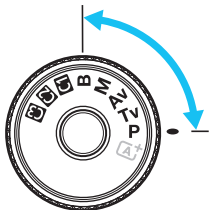

You can customize various camera functions to suit your picture-taking preferences with Custom Functions. Also, current camera settings can be saved under <C1> <C2> <C3> positions of the Mode Dial.

The features explained in this chapter can be set and used in the following shooting modes: <P> <Tv> <Av> <M> .



MENU Custom Functions ☆

☛ 1: Exposure



		 LV Shooting	 Movie Shooting
Exposure level increments	p.402	<input type="radio"/>	<input type="radio"/>
ISO speed setting increments		<input type="radio"/>	In M
Bracketing auto cancel	p.403	<input type="radio"/>	(Still photo, with WB bracketing)
Bracketing sequence		<input type="radio"/>	
Number of bracketed shots	p.404	<input type="radio"/>	
Safety shift	p.405	<input type="radio"/>	
Same exposure for new aperture	p.406	<input type="radio"/>	

☛ 2: Exposure

Set shutter speed range	p.408	<input type="radio"/>	<input type="radio"/>
Set aperture range		<input type="radio"/>	<input type="radio"/>

 The shaded Custom Functions do not function during Live View (LV) shooting or movie shooting. (Settings are ineffective.)

☰.3: Others

		 LV Shooting	 Movie Shooting
Warnings  in viewfinder	p.409		
Dial direction during Tv/Av	p.410	<input type="radio"/>	<input type="radio"/>
Multi function lock		<input type="radio"/>	<input type="radio"/>
Custom Controls	p.411	Depends on setting	
Add cropping information		<input type="radio"/>	
Default Erase option	p.412	(During playback)	
Retract lens on power off		<input type="radio"/>	<input type="radio"/>

☰.4: Clear

Selecting [**☰.4: Clear all Custom Func. (C.Fn)**] will clear all the Custom Function settings.



Even if [**☰.4: Clear all Custom Func.(C.Fn)**] is executed, the settings for [**☰.3: Custom Controls**] will remain unchanged.

MENU Custom Function Settings ☆

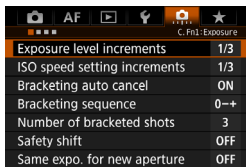

Setting	Value
Exposure level increments	1/3
ISO speed setting increments	1/3
Bracketing auto cancel	ON
Bracketing sequence	0→+
Number of bracketed shots	3
Safety shift	OFF
Same expo. for new aperture	OFF

Under the [] tab, you can customize various camera features to suit your picture-taking preferences. Any settings different from the default will be displayed in blue.



C.Fn1: Exposure

Exposure level increments

1/3: 1/3-stop

1/2: 1/2-stop

Sets 1/2-stop increments for the shutter speed, aperture, exposure compensation, AEB, flash exposure compensation, etc. This is effective when you prefer to control the exposure in less fine increments than 1/3-stop.

 When [] is set, the exposure level will be displayed as shown below.





ISO speed setting increments

1/3: 1/3-stop

1/1: 1-stop

You can change the manual ISO speed setting increments to 1-stop.

 Even if [] is set, ISO speed will be automatically set in 1/3-stop increments when Auto ISO is set.

Bracketing auto cancel

ON: Enable

When you set the power switch to <OFF>, the AEB and white balance bracketing settings will be canceled. AEB will also be canceled when the flash is ready to fire or if you switch to movie shooting.

OFF: Disable

The AEB and white balance bracketing settings will not be canceled even if you set the power switch to <OFF>. (If the flash is ready to fire or if you switch to movie shooting, AEB will be canceled temporarily, but the AEB range will be retained.)

Bracketing sequence

The AEB shooting sequence and white balance bracketing sequence can be changed.

0-+: 0, -, +

-0+: -, 0, +

+0-: +, 0, -

AEB	White Balance Bracketing	
	B/A Direction	M/G Direction
0 : Standard exposure	0 : Standard white balance	0 : Standard white balance
- : Decreased exposure	- : Blue bias	- : Magenta bias
+ : Increased exposure	+ : Amber bias	+ : Green bias

Number of bracketed shots

The number of shots taken with AEB and white balance bracketing can be changed from the default, 3 shots, to 2, 5, or 7 shots.

When [**Bracketing sequence: 0, -, +**] is set, the bracketed shots will be taken as shown in the table below.

3: 3 shots

2: 2 shots

5: 5 shots

7: 7 shots

(1-stop increments)

	1st Shot	2nd Shot	3rd Shot	4th Shot	5th Shot	6th Shot	7th Shot
3: 3 shots	Standard (0)	-1	+1				
2: 2 shots	Standard (0)	±1					
5: 5 shots	Standard (0)	-2	-1	+1	+2		
7: 7 shots	Standard (0)	-3	-2	-1	+1	+2	+3

 If [**2 shots**] is set, you can select the + or - side when setting the AEB range. Setting WB bracketing will result in a decreased exposure in the B/A or M/G direction.

Safety shift

OFF: Disable

Tv/Av: Shutter speed/Aperture

This takes effect in the shutter-priority AE (**Tv**) and aperture-priority AE (**Av**) modes. If the subject brightness changes and the standard exposure cannot be obtained within the autoexposure range, the camera will automatically change the manually-selected setting to obtain a standard exposure.

ISO: ISO speed

This works in the Program AE (**P**), shutter-priority AE (**Tv**), and aperture-priority AE (**Av**) modes. If the subject brightness changes and the standard exposure cannot be obtained within the autoexposure range, the camera will automatically change the manually set ISO speed to obtain a standard exposure.



- Under [**☑2: ISO speed settings**], even if [**ISO speed range**] or [**Min. shutter spd.**] is changed from the default setting, safety shift will override it if a standard exposure cannot be obtained.
- The minimum and maximum ISO speeds of the safety shift using the ISO speed will be determined by the [**Auto ISO range**] setting (p.162). However, if the manually set ISO speed exceeds the [**Auto ISO range**], the safety shift will take effect up or down to the manually set ISO speed.
- Safety shift will take effect if necessary even when flash is used.

Same exposure for new aperture

If the <M> mode (manual exposure shooting) is set and the ISO speed is set manually (other than Auto ISO or H (12800) is set), the maximum aperture's f/number may change to a higher number (smaller aperture) if you do any of the following: 1. Change the lens, 2. Attach or detach an Extender, or 3. Use a zoom lens whose maximum aperture f/number changes. If you then shoot at the exposure setting as is, the image will be underexposed by the amount the maximum aperture f/number changes to a higher number. However, by changing the ISO speed or shutter speed (Tv) automatically, you can obtain the same exposure that would be obtained before you did 1, 2, or 3.

OFF: Disable

Automatic changes in settings to maintain the specified exposure will not be applied. The ISO speed, shutter speed, and aperture already set will be used for shooting. If you do 1, 2, or 3 and the maximum aperture f/number increases, adjust the ISO speed and shutter speed before you shoot.

ISO: ISO speed

If you do 1, 2, or 3, the ISO speed will automatically increase to compensate for the amount that the maximum aperture f/number increases by. The same exposure that would be obtained before you did 1, 2, or 3 is thereby obtained.

Tv: Shutter speed

If you do 1, 2, or 3, a slower shutter speed will automatically be set to compensate for the amount that the maximum aperture f/number increases by. The same exposure that would be obtained before you did 1, 2, or 3 is thereby obtained.



- This function does not work with macro lenses whose actual aperture f/number changes when the magnification changes.
- This function does not work with movies.
- If **[ISO speed]** is set and the exposure cannot be maintained within the range set with **[ISO speed range]**, the ISO speed will be automatically switched within the specified range.
- If **[Shutter speed]** is set and the exposure cannot be maintained within the range set with **[2: Set shutter speed range]**, the shutter speed will be automatically switched within the specified range.
- If you do 1, 2, or 3 and the camera turns off (power switch is set to <OFF>, etc.) while the exposure is being maintained, the standard exposure will be updated to the exposure at the moment the camera turns off.



- This function also works with changes in the highest f/number (minimum aperture).
- If you set **[ISO speed]** or **[Shutter speed]**, do 1, 2, or 3, and then undo 1, 2, or 3 without manually changing the ISO speed, shutter speed, or aperture, so that the camera is back to its original state, the original exposure setting will be restored.
- If **[ISO speed]** is set and the ISO speed increases to an expanded ISO speed, the shutter speed may change to maintain the exposure.

C.Fn2: Exposure

Set shutter speed range

You can set the shutter speed range. In the <Tv> <M> modes, you can set the shutter speed manually within the shutter speed range that you have set. In the <P> <Av> modes, the shutter speed will be set automatically within the shutter speed range that you have set.

Highest speed

You can set it from 1/8000 sec. to 15 sec.

Lowest speed

You can set it from 30 sec. to 1/4000 sec.

Set aperture range

You can set the aperture range. In the <Av> <M> modes, you can set the aperture manually within the aperture range that you have set. In the <P> <Tv> modes, the aperture will be set automatically within the aperture range that you have set.

Min. aperture (Max. f/)

You can set it from f/91 to f/1.4.

Max. aperture (Min. f/)



You can set it from f/1.0 to f/64.

 The settable aperture range will differ depending on the lens's maximum and minimum apertures.

C.Fn3: Others

Warnings in viewfinder

When any of the following functions are set, the  icon can be displayed in the viewfinder (p.31).

Select the function for which you want the warning icon to appear, and press  to append a . Then select [OK] to register the setting.

When monochrome is set

If the Picture Style is set to [Monochrome] (p.166), the warning icon will appear.

When WB is corrected

If white balance correction is set (p.179), the warning icon will appear.

When one-touch image quality is set

If you change the image-recording quality with the one-touch image quality function (p.424), the warning icon will appear.



When is set

If [ 3: High ISO speed NR] is set to [Multi Shot Noise Reduction] (p.183), the warning icon will appear.

When spot metering is set

If the metering mode is set to [Spot metering] (p.213), the warning icon will appear.







If you set any of the checkmarked  functions,  will also appear for the respective setting displayed on the Quick Control screen (p.60) and Custom Quick Control screen (p.427).

Dial direction during Tv/Av



 : **Normal**

 : **Reverse direction**

Dial turning direction when setting the shutter speed and aperture can be reversed.

In the <M> shooting mode, the turning direction of the < > and < > dials will be reversed. In other shooting modes, the turning direction of only the < > dial will be reversed. The < > dial's turning direction in the <M> mode and the turning direction to set the exposure compensation in the <P>, <Tv>, and <Av> mode will be the same.

Multi function lock





When the <LOCK▶> switch is set to the right, it can prevent the < >, < >, and < > from accidentally changing a setting.

Select the camera control you want to lock, then press <SET> to append a checkmark [✓]. Select [OK] to register the setting.

 **Main Dial**

 **Quick Control Dial**

 **Multi-controller**

-  ● If the <LOCK▶> switch is set and you try to use any of the locked camera controls, <L> will appear in the viewfinder and on the LCD panel. Also, [LOCK] will appear on the Quick Control screen (p.60) and Custom Quick Control screen (p.427).
- By default, when locked, the < > dial will be locked.
- Even if the < > dial is appended with a [✓] checkmark, you can still use the touch pad < >.

Custom Controls

You can assign often-used functions to camera buttons or dials according to your preferences. For details, see page 413.

Add cropping information

If you set cropping information, vertical lines for the aspect ratio you have set will appear on the Live View image. You can then compose the shot as if you were shooting with a medium- or large-format camera (6x6 cm, 4x5 inch, etc.).

When you take a picture, the aspect ratio information for cropping the image with the EOS software will be appended to the image. (The image is recorded to the card without being cropped.)

After the image is transferred to a computer, you can use Digital Photo Professional (EOS software, p.520) to easily crop the image to the aspect ratio that was set.

OFF : Off

6:6 : Aspect ratio 6:6

3:4 : Aspect ratio 3:4

4:5 : Aspect ratio 4:5

6:7 : Aspect ratio 6:7

5:6 : Aspect ratio 10:12

5:7 : Aspect ratio 5:7



- If [**4: Crop/aspect ratio**] is set to any setting other than [**Full-frame**], the cropping information cannot be set.
- Cropping information will also be appended for viewfinder shooting. However, the cropping range will not be displayed.
- Even if a RAW image with cropping information added is processed with the camera (p.364), the JPEG image cannot be saved as the cropped image.

Default Erase option

During image playback and image review after image capture, when you press the <  > button, the erase menu appears (p.358). You can set which option, [**Cancel**] or [**Erase**], is to be preselected on this screen.

If [**Erase**] is set, you can just press <  > to quickly erase the image.

 : [**Cancel**] selected

 : [**Erase**] selected



If [**Erase**] is set, be careful not to erase an image accidentally.

Retract lens on power off

This is to set the lens retraction mechanism for when a gear-driven STM lens (such as EF40mm f/2.8 STM) is attached to the camera. You can set it to retract the extended lens automatically when the camera's power switch is set to < **OFF** >.

ON: Enable

OFF: Disable



- With auto power off, the lens will not retract regardless of the setting.
- Make sure that the lens has been retracted before detaching it.



When [**Enable**] is set, this function takes effect regardless of the lens's focus mode switch setting (AF or MF).

3: Custom Controls ☆

You can assign often-used functions to camera buttons or dials according to your preferences.

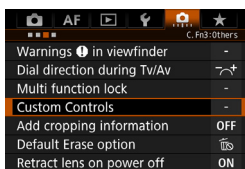

1 Select [3: Custom Controls].

- Under the [3] tab, select [Custom Controls], then press <SET>.
- ▶ The Custom Controls screen to select control buttons and dials will appear.



2 Select a camera button or dial.

- Select a camera button or dial, then press <SET>.
- ▶ The name of the camera control and the assignable functions will be displayed.

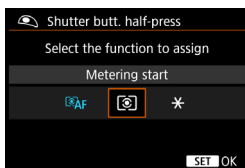

3 Assign a function.













- Select a function, then press <SET>.
- If the [INFO] icon appears on the bottom left, you can press the <INFO.> button and set other related options.





4 Exit the setting.

- When you press <SET> to exit the setting, the screen in step 2 will reappear.
- Press the <MENU> button to exit.

With the screen in step 2 displayed, you can press the <MENU> button to revert the Custom Control settings to their defaults. Note that the [3: Custom Controls] settings will not be canceled even if you select [4: Clear all Custom Func. (C.Fn)].

Assignable Functions to Camera Controls



















Function		Page		AF-ON	☆
AF	 AF Metering and AF start	418	<input type="radio"/>	<input type="radio"/> *1	<input type="radio"/> *1
	AF-OFF AF stop	419	<input type="radio"/>	<input type="radio"/>	<input type="radio"/>
	AF-- Switch to registered AF function	420	<input type="radio"/>	<input type="radio"/>	<input type="radio"/>
	 ONE SHOT ↔ AI SERVO		<input type="radio"/>	<input type="radio"/>	
	 Switch to registered AF point		<input type="radio"/>	<input type="radio"/>	
	 AF point direct selection	421	<input type="radio"/>	<input type="radio"/>	<input type="radio"/>
	 Direct AF point selection: Vertical		<input type="radio"/>	<input type="radio"/>	
 Pause Movie Servo AF	<input type="radio"/>		<input type="radio"/>		
Exposure	 Metering start	421	<input type="radio"/>	<input type="radio"/>	<input type="radio"/>
	☆ AE lock		<input type="radio"/>	<input type="radio"/>	
	☆ AE lock (while button pressed)	422	<input type="radio"/>	<input type="radio"/>	<input type="radio"/>
	☆H AE lock (hold)		<input type="radio"/>	<input type="radio"/>	
	☆AF-OFF AE lock, AF stop		<input type="radio"/>	<input type="radio"/>	
	FEL FE lock		<input type="radio"/>	<input type="radio"/>	
	ISO ↓ Set ISO speed (hold button, turn )		<input type="radio"/>	<input type="radio"/>	
	ISO  Set ISO speed ( during metering)	<input type="radio"/>	<input type="radio"/>		
	 Exposure compensation (hold button, turn )	423	<input type="radio"/>	<input type="radio"/>	<input type="radio"/>
	Tv Shutter speed setting in M mode		<input type="radio"/>	<input type="radio"/>	
Av Aperture setting in M mode	<input type="radio"/>		<input type="radio"/>		





	LENS	M-Fn	SET			
	<input type="radio"/>					
<input type="radio"/>	<input type="radio"/>					
<input type="radio"/> *2	<input type="radio"/> *2					
<input type="radio"/>	<input type="radio"/>					
<input type="radio"/> *3	<input type="radio"/> *3					
					<input type="radio"/>	<input type="radio"/> *4
					<input type="radio"/>	
<input type="radio"/>			<input type="radio"/>			
<input type="radio"/>	<input type="radio"/>	<input type="radio"/>				
<input type="radio"/>	<input type="radio"/>	<input type="radio"/>				
<input type="radio"/>		<input type="radio"/>				
			<input type="radio"/>			
					<input type="radio"/>	
			<input type="radio"/>			
				<input type="radio"/>	<input type="radio"/>	
				<input type="radio"/>	<input type="radio"/>	



<LENS> stands for "AF stop button" provided on super telephoto lenses equipped with Image Stabilizer.

Assignable Functions to Camera Controls

Function		Page		AF-ON	
Images	 Switch between crop/aspect	423			
	 One-touch image quality setting	424			
	 One-touch image quality (hold)				
	 Image quality				
	 Picture Style	425			
Operation	 Depth-of-field preview	425			
	 IS start				
	MENU Menu display				
	 Register/recall shooting function			○*7	○*7
	 Image playback	426			
	 Magnify/Reduce (press SET, turn )				
	 Cycle:  • ISO /Drive • AF/WB • 				
	UNLOCK  Unlock while button pressed				
	 Flash function settings				
	OFF No function (disabled)				○

	LENS	M-Fn	SET			
		<input type="radio"/> *5				
<input type="radio"/> *6		<input type="radio"/> *6				
<input type="radio"/> *6		<input type="radio"/> *6				
			<input type="radio"/>			
			<input type="radio"/>			
<input type="radio"/>						
<input type="radio"/>	<input type="radio"/>					
			<input type="radio"/>			
			<input type="radio"/>			
			<input type="radio"/>			
		<input type="radio"/>				
<input type="radio"/>						
			<input type="radio"/>			
<input type="radio"/>			<input type="radio"/>	<input type="radio"/>	<input type="radio"/>	<input type="radio"/>



<LENS> stands for "AF stop button" provided on super telephoto lenses equipped with Image Stabilizer.

AF: Metering and AF start

When you press the button assigned to this function, metering and AF are executed.

*1: When assigned to the <AF-ON> or <★> button, pressing the <INFO.> button while the setting screen is displayed will enable you to set the detailed AF settings. When shooting, pressing the <AF-ON> or <★> button will execute AF as it was set.



● AF start position

When [Registered AF point] is set, you can press the <AF-ON> or <★> button to switch to the registered AF point.

Registering the AF Point

1. Set the AF area selection mode to one of the following: Single-point Spot AF (manual selection), Single-point AF (manual selection), AF point expansion (manual selection $\square \square \square$), AF point expansion (manual selection, surrounding points), or 61-point automatic selection AF. Zone AF (manual selection of zone) cannot be selected.
2. Select an AF point manually.
3. Hold down the <[INFO.]> button and press the <[AF-ON]> button. A beep will sound and the AF point will be registered. If the AF area selection mode is set to any setting other than 61-point automatic selection AF, the registered AF point will blink.



- When the AF point is registered, the following will be displayed:
 - 61-point automatic selection AF: [] HP (HP: Home Position)
 - Spot AF, 1 pt AF, Expand AF Area: **SEL []** (Center), **SEL HP** (Off center)
- To cancel the registered AF point, hold down the <[INFO.]> button and press the <[ISO]> button. The registered AF point will also be canceled if you select [4: Clear all camera settings].

- **AI Servo AF characteristics** (p.109)
Press the <AF-ON> or <✳> button to perform AF with the set case from [Case1] to [Case6].
- **AF operation** (p.86)
Press the <AF-ON> or <✳> button to perform AF with the set AF operation.
- **AF area selection mode** (p.90)
Press the <AF-ON> or <✳> button to perform AF with the set AF area selection mode.

If you want to keep using currently selected AF point when you press the <AF-ON> or <✳> button, set [AF start position] to [Manually selected AF point]. If you want to keep the currently set AI Servo AF characteristics, AF operation, and AF area selection mode, select [Maintain current setting].



- If [AF4: Orientation linked AF point] is set to [Separate AF pts: Area+pt] or [Separate AF pts: Pt only], you can register the AF points to be used separately for vertical (grip up or down) and horizontal shooting.
- If [AF start position: Registered AF point] and [AF area selection mode] are both set, [Registered AF point] will take effect.

AF-OFF: AF stop

The AF will stop while you hold down the button assigned to this function. Convenient when you want to stop the AF during AI Servo AF.

AF-- : Switch to registered AF function

After setting and assigning this function to a button, you can apply the following settings by holding down the assigned button for AF: AF area selection mode (p.90), Tracking sensitivity (p.114), Acceleration/ deceleration tracking (p.115), AF point auto switching (p.116), Servo 1st image priority (p.118), and Servo 2nd image priority (p.119). Convenient when you want to change the AF characteristics during AI Servo AF.

*2: On the setting screen, press the <INFO.> button to display the detailed settings screen. Turn the <☉> or <☀> dial to select the parameter to be registered, then press <SET> to append a checkmark [✓]. When you select a parameter and press <SET>, you can adjust the parameter. By pressing the <☰> button, you can revert the settings to their defaults.

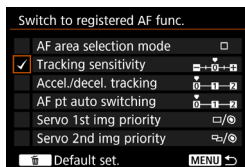

ONESHOT AI SERVO : ONE SHOT ↔ AI SERVO





You can switch the AF operation. In One-Shot AF mode, when you hold down the button to which this function is assigned, the camera switches to AI Servo AF mode. In the AI Servo AF mode, the camera switches to One-Shot AF mode only while you hold down the button. Convenient when you need to keep switching between One-Shot AF and AI Servo AF for a subject that keeps moving and stopping.

☐☐ HP : Switch to registered AF point

During metering, when you press the button assigned to this function, focusing point can be switched to the registered AF point.



*3: On the setting screen, when you press the <INFO.> button, you can select [**Switch only when btn is held**] or [**Switch each time btn is pressed**]. To register the AF point, see page 418.

 **Direct AF point selection**

During metering, you can select an AF point directly with the < > dial or < > without pressing the < > button. With the < > dial, you can select a left or right AF point. (Looping sequence for Zone AF.)

*5: On the Multi-controller setting screen, when you press the <INFO.> button, you can press the center of < > to select [**Switch to center AF point**] or [**Switch to registered AF point**]. To register the AF point, see page 418.

 **Direct AF point selection: Vertical**

During metering, you can turn the < > dial to directly select an upper or lower AF point without pressing the < > button. (Looping sequence for Zone AF.)

 **Pause Movie Servo AF**





During Movie Servo AF, you can pause the AF by pressing the Depth-of-field preview button or < >. Press the button again to resume Movie Servo AF.

 **Metering start**

When you press the shutter button halfway, exposure metering is performed (AF is not performed).

 **AE lock**

When you press the button assigned to this function, you can lock the exposure (AE lock) during metering. Convenient when you want to focus and meter the shot at different areas or when you want to take multiple shots at the same exposure setting.

 To change the aperture in <M> mode when [**Direct AF point selection**], [**Direct AF pt select: Vertical**], or [**Set ISO speed (● during metering)**] (p.422) is assigned to < >, turn the < > dial while holding down the < > button.

: AE lock (while button pressed)

The exposure will be locked (AE lock) while you press the shutter button.

H: AE lock (hold)

When you press the button assigned to this function, you can lock the exposure (AE lock). The AE lock will be maintained until you press the button again. Convenient when you want to focus and meter the shot at different areas or when you want to take multiple shots at the same exposure setting.



*AF-OFF: AE lock, AF stop

When you press the button assigned to this function, you can lock the exposure (AE lock) and the AF will stop. Convenient during AI Servo AF if you want AE lock at the same time when AF stops.

FEL: FE lock



During flash photography, pressing the button assigned to this function will fire a preflash and record the required flash output (FE lock).

ISO : Set ISO speed (hold button, turn)

You can set the ISO speed by holding down < > and turning the < > dial.

If this control is used while Auto ISO is set, manual ISO speed setting will take effect. Auto ISO cannot be set. If you use this function in the <**M**> mode, you can adjust the exposure with the ISO speed while maintaining the current shutter speed and aperture.

ISO : Set ISO speed (during metering)



During metering, you can set the ISO speed by turning the < > dial. The settable range is the same as with ISO .

 If you assign [AE lock (while button pressed)] to the shutter button, any buttons assigned to [AE lock] or [AE lock (hold)] will also work as [AE lock (while button pressed)].



☰ : Exposure compensation (hold button, turn )

You can set the exposure compensation by holding down <SET> and turning the <> dial. Convenient when you want to set exposure compensation while <M> manual exposure and Auto ISO are set.

Tv : Shutter speed setting in M mode

In manual exposure <M>, you can set the shutter speed with the <> or <> dial.

Av : Aperture setting in M mode



In manual exposure <M>, you can set the aperture with the <> or <> dial.

☰ : Switch between crop/aspect

When you press the <M-Fn> button, you can switch from full-frame shooting to crop shooting (approx. 1.3x or 1.6x) or shooting with the set aspect ratio (1:1, 4:3, or 16:9). Pressing the <M-Fn> button switches the setting.

*5: On the setting screen, press the <INFO.> button to display the detailed settings screen. Turn the <> dial to select the setting to be switched to, then press <SET> to append a checkmark [✓].



 The operations for [Set ISO speed (hold btn, turn )] (p.422) and [Expo comp (hold btn, turn )] are possible even when the <LOCK▶> switch is set to the right (Multi function lock, p.59).

**RAW
JPEG** : One-touch image quality setting

Pressing the button assigned to this function will switch to the image-recording quality set here. While this change is in effect, the image-recording quality (JPEG/RAW) will blink in the viewfinder (with [**Show/hide in viewfinder**]'s [**Image quality**] checkmarked). After the shooting ends, the One-touch image quality setting will be canceled and the image-recording quality will be switched back to the previous quality.

*6: On the setting screen, by pressing the <**INFO.**> button, you can select the image-recording quality for this function.

**RAW
JPEG H** : One-touch image quality (hold)

Pressing the button assigned to this function will switch to the image-recording quality set here. While this change is in effect, the image-recording quality (JPEG/RAW) will blink in the viewfinder (with [**Show/hide in viewfinder**]'s [**Image quality**] checkmarked). Even after shooting, the One-touch image quality setting will not be canceled. To revert to the previous image-recording quality setting, press the button assigned to this function again.

*6: You can select the image-recording quality for this function by pressing the <**INFO.**> button in the setting screen.

⇐ : Image quality

Press <**SET**> to display the image-recording quality setting screen (p.149) on the LCD monitor.

! If RAW or RAW+JPEG is set for the image-recording quality to be switched to with [**One-touch image quality setting**] and [**One-touch image quality (hold)**], [**Multi Shot Noise Reduction**] (p.183) will not work after the switch. For [**3: High ISO speed noise reduct'n**], [**Standard**] will be applied for shooting.

! When the image-recording quality is switched with the One-touch image quality setting, you can display <**!**> in the viewfinder (p.409).

📷: Picture Style

Press <SET> to display the Picture Style selection setting screen on the LCD monitor (p.164).

🔍: Depth-of-field preview

When you press the depth-of-field preview button, the aperture will stop down and you can check the depth of field (p.209).

👉: IS start

If you press the button assigned to this function when the lens's IS switch is set to <ON>, lens's Image Stabilizer will operate (p.55).

MENU: Menu display

Press <SET> to display the menu on the LCD monitor.

📷: Register/recall shooting function



You can manually set the main shooting functions such as the shutter speed, aperture, ISO speed, metering mode and AF area selection mode, and register them to the camera. Only while you hold down the button assigned to this function, you can recall and use the registered shooting function settings and shoot.

*7: On the setting screen, press the <INFO,> button to display the detailed settings. Turn the <🔍> or <📷> dial to select the function to be registered, then press <SET> to append a checkmark [✓] to it. When you select a function and press <SET>, you can adjust the setting. By pressing the <🔍> button, you can revert the settings to their defaults. By selecting **[Register current settings]**, the camera's current settings will be registered. To register the AF point, see page 418.







: **Image playback**

Pressing <SET> will play back images.

: **Magnify/Reduce (press SET, turn )**

Press <SET> to magnify or reduce the images recorded on the card. See page 330 for the operation procedure. During Live View or movie shooting (except  + Tracking), you can also magnify the image (p.274, 275).

: **Cycle:  • ISO/Drive • AF/WB • **

Pressing the <M-Fn> button changes the settable function in this sequence:  • ISO → DRIVE • AF → WB • .

UNLOCK : Unlock while button pressed

Even when the <LOCK > switch is set to the right, only while you hold down the depth-of-field preview button, you can use the camera control buttons and dials restricted by [**☰.3: Multi function lock**].

: **Flash function settings**

Pressing <SET> will display the flash function setting screen.

OFF: No function (disabled)

Use this setting when you do not want to assign any function to the button.

Custom Quick Control

On the standard Quick Control screen (p.60), pre-determined shooting functions are displayed in the default layout. On the Custom Quick Control screen, you can customize the screen with your preferred shooting functions and layout. This feature is called “Custom Quick Control”.

This page explains how to change the layout of the Custom Quick Control screen. Page 61 explains how to use the Quick Control screen, and page 442 explains how to display the Custom Quick Control screen.

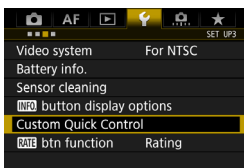

1 Select [Custom Quick Control].

- Under the [CUSTOM] tab, select [Custom Quick Control], then press <SET>.

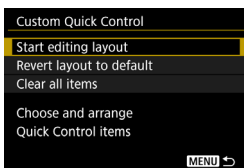

2 Select [Start editing layout].

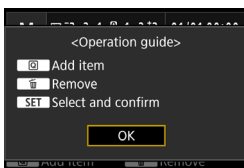

3 Read the operation procedure and select [OK].

- : Add item
 - : Remove
 - **SET** : Select and confirm
- Items displayed on the default screen are shown on the left.

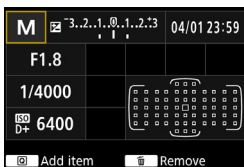

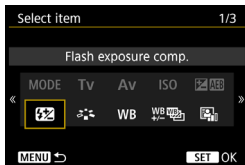

4 Add an item.

- Press the $\langle \text{Q} \rangle$ button.
- Turn the $\langle \odot \rangle$ dial or use $\langle \odot \rangle$ to select the item to be added, then press $\langle \text{SET} \rangle$.
- To remove an item, select the item, then press the $\langle \text{trash} \rangle$ button. Otherwise, select **[Clear all items]** in step 2.
- For items that let you select the icon size, turn the $\langle \odot \rangle$ dial or use $\langle \odot \rangle$ to select the size, then press $\langle \text{SET} \rangle$.
- For items which can be positioned and for display sizes, see page 430.

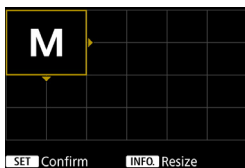

5 Position the item.

- Use $\langle \text{directional} \rangle$, $\langle \odot \rangle$ or $\langle \odot \rangle$ to move the item (framed with directional wedges) to the desired position.
- If you want to change the size, press the $\langle \text{INFO} \rangle$ button to change it.
- Press $\langle \text{SET} \rangle$ to place the item. If there is already an item on that position, it will be overwritten (deleted).
- To move an item to another position, select the item and press $\langle \text{SET} \rangle$ to move it.

 If you first want to delete all the items displayed by default, select **[Clear all items]** in step 2 and then go to step 4.

Sample layout

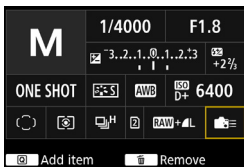

- Repeat steps 4 and 5 to position other items as desired.
- To delete an item already in position, select it and press the $\langle \text{trash} \rangle$ button.

6 Exit the setting.

- Press the $\langle \text{MENU} \rangle$ button to exit the setting. The screen in step 2 will reappear.

Sample screen

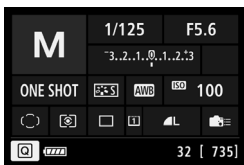

7 Check the setting screen.

- Under [**43: INFO** button display options], check that [**Custom Quick Control screen**] is checkmarked (p.442).
- Press the $\langle \text{INFO} \rangle$ button to display the Custom Quick Control screen (p.442) and check the layout.
- Press the $\langle \text{Q} \rangle$ button to use the Quick Control screen (p.61).

Resetting the Custom Quick Control Screen or Clearing All Items

In step 2, selecting [**Revert layout to default**] will revert the Custom Quick Control screen to the default layout of Custom Quick Control screen (p.427).

Selecting [**Clear all items**] will delete all the items set. The screen will then be blank.

Available Items and Display Sizes for the Screen Layout

(Vertical x horizontal cells)

Item and Size	1x1	1x2	1x3	2x2	2x3
Shooting mode	<input type="radio"/>			<input type="radio"/>	
Shutter speed	<input type="radio"/>	<input type="radio"/>			
Aperture	<input type="radio"/>	<input type="radio"/>			
ISO speed	<input type="radio"/>	<input type="radio"/>			
Exposure compensation/ AEB setting	<input type="radio"/>	<input type="radio"/>	<input type="radio"/>		
Flash exposure compensation	<input type="radio"/>	<input type="radio"/>	<input type="radio"/>		
Picture Style	<input type="radio"/>		<input type="radio"/>		
White balance	<input type="radio"/>	<input type="radio"/>			
White balance shift/ bracketing	<input type="radio"/>	<input type="radio"/>			
Auto Lighting Optimizer	<input type="radio"/>				
Custom Controls	<input type="radio"/>				
AF operation	<input type="radio"/>	<input type="radio"/>			
AF point selection	<input type="radio"/>				<input type="radio"/>
Metering mode	<input type="radio"/>				
Drive mode	<input type="radio"/>				
Recording function/ card selection	<input type="radio"/>	<input type="radio"/>		<input type="radio"/>	
Date/Time/Zone	<input type="radio"/>	<input type="radio"/>			<input type="radio"/>
External Speedlite control	<input type="radio"/>				
Highlight tone priority	<input type="radio"/>				
Viewfinder grid	<input type="radio"/>				
Sensor cleaning	<input type="radio"/>				

- Depending on the items, the amount of displayable information and settable functions for Quick Control may vary due to their display sizes.
- The same item cannot be placed in multiple positions on the screen.

<A⁺> Mode Settings and Display Conditions

You can also set Custom Quick Control and display the Custom Quick Control screen in the <A⁺> mode.

However, functions such as [Expo.comp./AEB] that are not displayed on the menu screen for <A⁺> mode will not appear on the Custom Quick Control screen. Also, [ISO speed] and other functions that cannot be set with the Quick Control screen in the <A⁺> mode will be grayed out.

- **Not displayed**

Exposure compensation/AEB, Flash exposure compensation, White balance shift/bracketing, Custom Controls, External Speedlite control, Highlight tone priority

- **Grayed out** (not settable with the Quick Control screen)

Shutter speed, Aperture, ISO speed, Picture Style, White balance, Auto Lighting Optimizer, AF operation, AF point selection, Metering mode

MENU Registering My Menu ☆

Under My Menu tab, you can register menu items and Custom Functions whose settings you change frequently. You can also name the registered menu tabs and press the <MENU> button to display the My Menu tab first.

Adding My Menu Tab

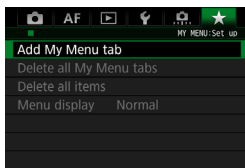

- 1 Select [Add My Menu tab].
 - Under the [★] tab, select [Add My Menu tab], then press <SET>.

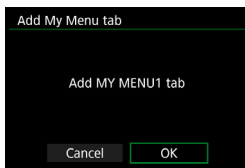

- 2 Select [OK].
 - ▶ The [MY MENU1] tab is created.
 - You can create up to five menu tabs by repeating steps 1 and 2.

Registering Menu Items under the My Menu Tab(s)

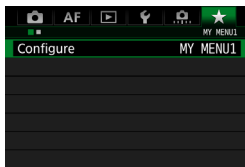

- 1 Select [Configure: MY MENU*].
 - Turn the <☀> dial to select [Configure: MY MENU*] (tab for registering menu items), then press <SET>.

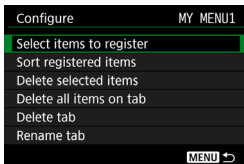

2 Select [Select items to register].

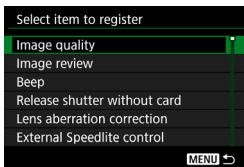

3 Register the desired items.

- Select the desired item, then press <SET>.
- Select [OK] on the confirmation dialog.
- You can register up to six items.
- To return to the screen in step 2, press the <MENU> button.

My Menu Tab Settings

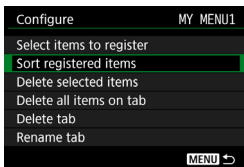

You can sort and delete items under the menu tab, and rename or delete the menu tab.

• Sort registered items

You can change the order of the registered items in My Menu. Select [**Sort registered items**] and select the item whose order you want to change. Then press <SET>. With [◆] displayed, turn the <DIAL> dial to change the order, then press <SET>.

• Delete selected items / Delete all items on tab

You can delete any of the registered items. [**Delete selected items**] deletes one item at a time, and [**Delete all items on tab**] deletes all registered items.

- **Delete tab**

You can delete the My Menu tab currently displayed. Select [**Delete tab**] to delete the [**MY MENU***] tab.

- **Rename tab**

You can rename the My Menu tab from [**MY MENU***].

1 Select [Rename tab].

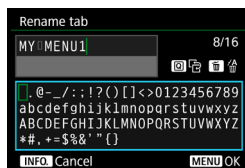

2 Enter text.

- Press the <[trash]> button to delete any unnecessary characters.
- Press the <[Q]> button. The text palette will be highlighted with a color frame, and text can be entered.
- Operate the <[dial]> or <[directional pad]> to move the [] and select the desired character. Then press <[SET]> to enter it.
- You can enter up to 16 characters.

3 Exit the setting.

- After entering the text, press the <MENU> button, then select [**OK**].
- ▶ The name is saved.

Deleting all My Menu tabs / Deleting all items

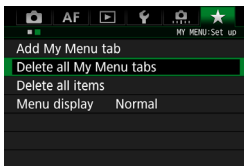

You can delete all My Menu tabs and delete all My Menu items.

- **Delete all My Menu tabs**

You can delete all My Menu tabs. When you select [**Delete all My Menu tabs**], all the tabs from [**MY MENU1**] to [**MY MENU5**] will be deleted and the [**★**] tab will revert to its default.

- **Delete all items**

You can delete all the items registered under the [**MY MENU1**] to [**MY MENU5**] tabs and keep the tabs. The menu tab(s) will remain. When [**Delete all items**] is selected, all the items registered under all the created tabs will be deleted.



If you do [**Delete tab**] or [**Delete all My Menu tabs**], tab names renamed with [**Rename tab**] will also be deleted.

Menu Display Settings

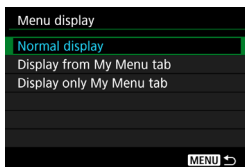

You can select [**Menu display**] to set the menu screen that is to appear first when you press the <MENU> button.

- **Normal display**
Displays the last displayed menu screen.
- **Display from My Menu tab**
Displays with the [★] tab selected.
- **Display only My Menu tab**
Only the [★] tab is displayed. (The 📷, AF, ▶, 📺, and 📶 tabs will not be displayed.)

C1: Registering Custom Shooting Modes ☆

You can register current camera settings, such as the shooting mode, menu functions, and Custom Function settings, as Custom shooting modes under the Mode Dial's <**C1**>, <**C2**>, and <**C3**> positions.

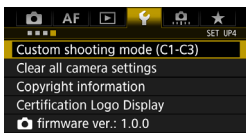

1 Select [Custom shooting mode (C1-C3)].

- Under the [**4**] tab, select [Custom shooting mode (C1-C3)], then press <**SET**>.

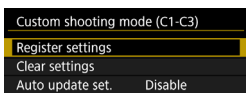

2 Select [Register settings].

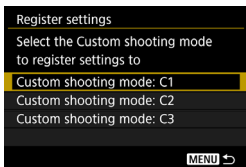

3 Register the Custom shooting mode.

- Select the Custom shooting mode to be registered, then press <**SET**>.
- Select [**OK**] on the confirmation dialog.
- ▶ The current camera settings (p.438-439) will be registered under the Mode Dial's C* position.

Automatic Updating

If you change a setting while you shoot in the <**C1**>, <**C2**>, or <**C3**> mode, the respective Custom shooting mode can be automatically updated to reflect the changes in settings. To enable this automatic update, in step 2, set [**Auto update set.**] to [**Enable**].

Canceling Registered Custom Shooting Modes

In step 2, if you select [**Clear settings**], the settings of respective modes will revert to the default settings with no Custom shooting modes registered.

Settings To Be Registered

● Shooting functions

Shooting mode, Shutter speed, Aperture, ISO speed, AF operation, AF area selection mode, AF point, Drive mode, Metering mode, Exposure compensation amount, Flash exposure compensation amount

● Menu functions

[1] Image quality, Image review time, Beep, Release shutter without card, Lens aberration correction, Flash firing, E-TTL II flash metering, Flash sync speed in Av mode

[2] Exposure compensation/AEB, ISO speed settings, Auto Lighting Optimizer, White balance, Custom White Balance, White balance shift/bracketing, Color space

[3] Picture Style, Long exposure noise reduction, High ISO speed noise reduction, Highlight tone priority, Multiple exposure (settings), HDR Mode (settings)

[4] Interval timer, Bulb timer, Anti-flicker shooting, Mirror lockup, Crop/aspect ratio

[5 (Live View shooting)]

Live View shooting, AF method, Continuous AF, Grid display, Exposure simulation

[6 (Live View shooting)]

Silent LV shooting, Metering timer

[4 (Movie)]











Movie Servo AF, AF method, Grid display, Movie recording size, Sound recording

[5 (Movie)]

Silent LV shooting, Metering timer, Movie recording count, Movie play count, Silent control,  button function, Time-lapse movie (settings)

[AF1] Case 1, Case 2, Case 3, Case 4, Case 5, Case 6

[AF2] AI Servo 1st image priority, AI Servo 2nd image priority

- [**AF3**] Lens electronic MF, AF-assist beam firing, One-Shot AF release priority
- [**AF4**] Lens drive when AF impossible, Selectable AF point, Select AF area selection mode, AF area selection method, Orientation linked AF point, Initial AF point,  AI Servo AF, Auto AF point selection: EOS iTR AF
- [**AF5**] Manual AF point selection pattern, AF point display during focus, VF display illumination, AF Microadjustment
- [2] Slide show (settings), Image jump with 
- [3] Highlight alert, AF point display, Playback grid, Histogram display, Movie play count, Magnification (approx.)
- [1] File numbering, Auto rotate, Eye-Fi settings
- [2] Auto power off, LCD brightness, Viewfinder display
- [3] Auto cleaning, **INFO** button display options, **RATE** button function
- [1] Exposure level increments, ISO speed setting increments, Bracketing auto cancel, Bracketing sequence, Number of bracketed shots, Safety shift, Same exposure for new aperture
- [2] Set shutter speed range, Set aperture range
- [3] Dial direction during Tv/Av, Multi function lock, Custom Controls, Add cropping information, Default Erase option, Retract lens on power off



My Menu settings will not be registered under Custom shooting modes.



- Even when the Mode Dial is set to **<G1>**, **<G2>**, or **<G3>**, you can still change shooting function settings and menu settings.
- By pressing the **<INFO.>** button, you can check which shooting mode is registered under **<G1>**, **<G2>**, and **<G3>** (p.442-444).

14

Reference

This chapter provides reference information for camera features, system accessories, etc.



Certification Logo

Select [**F4: Certification Logo Display**] and press <SET> to display some of the logos of the camera's certifications. Other certification logos can be found in this Instruction Manual, on the camera body, and on the camera's package.

INFO. Button Functions



When the camera is ready to shoot, pressing the <INFO.> button can switch the display as follows: Camera settings, Electronic level (p.75), Quick Control screen (p.60), and Custom Quick Control screen (p.427).

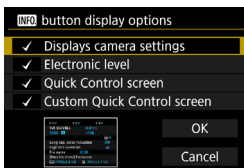

Under the [Fn] tab, [INFO button display options] enables you to select the options displayed when the <INFO.> button is pressed.

- Select the desired display option and press <SET> to append a checkmark [✓].
- After completing the selections, select [OK].

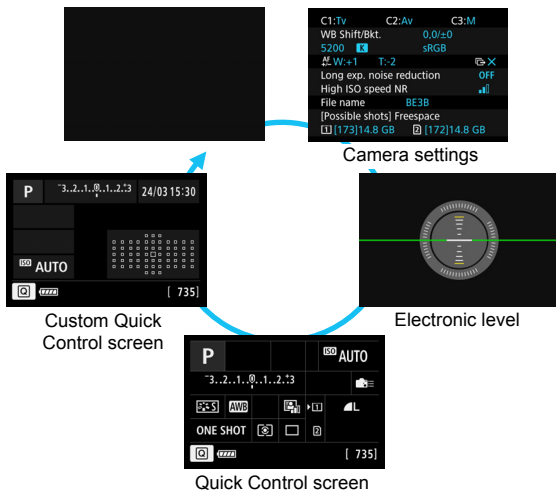



- If you turn off the power while the Electronic level, Quick Control screen, or Custom Quick Control screen is displayed, the same screen will be displayed when you turn on the power again. To cancel this function, press the <INFO.> button a number of times until the screen is blank, then turn off the power switch.
- Note that you cannot remove the [✓] for all four display options.
- The [Displays camera settings] sample screen is displayed in English for all languages.
- Even if you uncheck the [Electronic level] so it does not appear, it will still appear for Live View shooting and movie shooting when you press the <INFO.> button.
- While the Quick Control screen or Custom Quick Control screen is displayed, pressing the <Q> button enables you to set a function with Quick Control (p.61).

Camera Settings

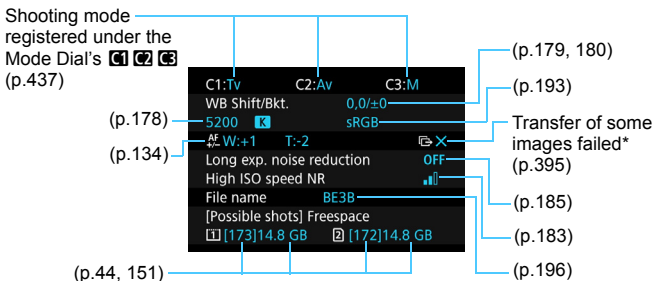

* This icon is displayed when the transfer of some images failed.

Quick Control Screen

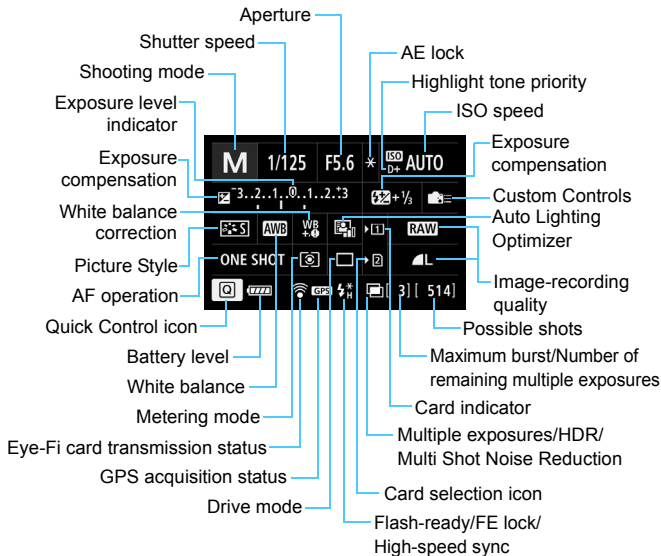

Custom Quick Control Screen

For the Custom Quick Control screen, see page 427.

Button Functions for the Quick Control and Custom Quick Control Screens

When you press the <WB> [WB], <DRIVE> [DRIVE], <ISO> [ISO], or <AF-ON> [AF-ON] button, the setting screen appears and you can use <DISP> [DISP], <Q/SET> [Q/SET], <M-Fn> [M-Fn], or <M-Fn> to set the functions.

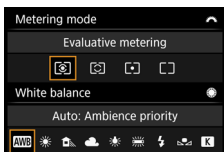

Metering mode / White balance

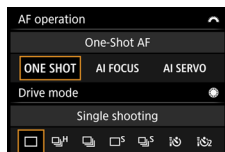

AF operation / Drive mode



ISO speed /
Flash exposure compensation

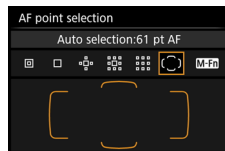

AF point selection

MENU Checking the Battery Information

You can check the battery's condition on the LCD monitor. Each Battery Pack LP-E6N/LP-E6 has a unique serial number, and you can register multiple batteries to the camera. When you use this feature, you can check the registered batteries' approximate remaining capacity and operation history.

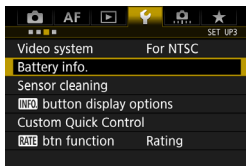

Select [Battery info.].

- Under the [**F**] tab, select [**Battery info.**], then press <[SET]>.
- ▶ The battery info. screen will appear.

Battery position

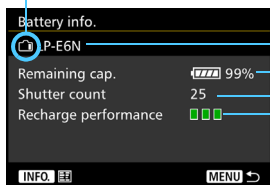

Battery model or household power source being used.

The battery level indicator (p.48) is displayed together with the remaining battery level shown in 1% increments.

The number of shots taken with the current battery. The number is reset when the battery is recharged.

Battery's recharge performance level is displayed in one of three levels.

■■■ (Green): Battery's recharge performance is fine.

■■□ (Green): Battery's recharge performance is slightly degraded.

■□□ (Red): Purchasing a new battery is recommended.

! Using a genuine Canon Battery Pack LP-E6N/LP-E6 is recommended. If you use batteries that are not genuine Canon products, the camera's full performance may not be attained or malfunction may result.

- The shutter count is the number of still photos taken. (Movies are not counted.)
- The battery information will also be displayed when Battery Pack LP-E6N/LP-E6 is used with Battery Grip BG-E11 (sold separately). If AA/R6 batteries are used, only the remaining battery level will be displayed.



If a battery communication error message is displayed, follow the instructions in the message.

Registering Batteries to the Camera

You can register up to six LP-E6N/LP-E6 batteries to the camera. To register multiple batteries to the camera, follow the procedure below for each battery.

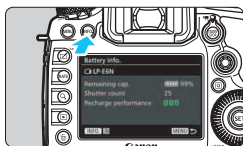

1 Press the <INFO.> button.

- With the battery info. screen displayed, press the <INFO.> button.
- ▶ The battery history screen will appear.
- ▶ If the battery is not registered, it will be grayed out.

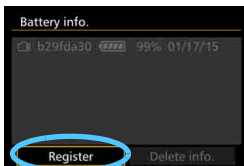

2 Select [Register].

- ▶ The confirmation dialog will appear.

3 Select [OK].

- ▶ The battery will be registered and the battery history screen will reappear.
- ▶ The grayed out battery number will now be displayed in white.
- Press the <MENU> button. The battery info. screen will reappear.



- The battery cannot be registered if Battery Grip BG-E11 (sold separately) using AA/R6 batteries is attached or the camera is powered by the DC Coupler DR-E6 (sold separately) and AC Adapter AC-E6N (sold separately).
- If six batteries are already registered, [Register] cannot be selected. To delete unnecessary battery information, see page 449.

Labeling Serial Numbers on Batteries

It is convenient to label each registered Battery Pack LP-E6N/LP-E6 with their serial numbers, using commercially-available labels.

Serial number

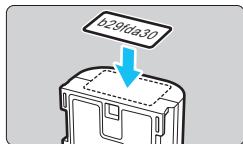
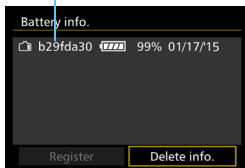

1 Write the serial number on a label.

- Write the serial number displayed on the battery history screen on a label approx. 25 mm x 15 mm / 1.0 in. x 0.6 in. in size.

2 Remove the battery and affix the label.

- Set the power switch to **<OFF>**.
- Open the battery compartment cover and remove the battery.
- Affix the label as shown in the illustration (on the side with no electrical contacts).
- Repeat this procedure for all of your batteries so you can easily see the serial number.

- Do not affix the label on any part other than as shown in the illustration in step 2. Otherwise, the misplaced label may make it difficult to insert the battery or impossible to turn on the camera.
- If you use Battery Grip BG-E11 (sold separately), the label may peel off as you repeatedly insert and remove the battery. If it peels off, affix a new label.

Checking the Remaining Capacity of a Registered Battery

You can check the remaining capacity of any battery (even when not installed) and also when it was last used.

Serial number Date last used

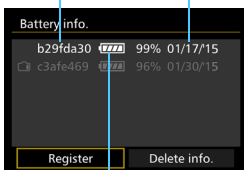

Remaining capacity
of a battery

Look for the serial number.

- Refer to the battery's serial number label and look for the battery's serial number on the battery history screen.
- ▶ You can check the respective battery's remaining capacity and the date when it was last used.

Deleting the Registered Battery Information

1 Select [Delete info.].

- Follow step 2 on page 447 to select [**Delete info.**], then press $\langle \text{SET} \rangle$.

2 Select the battery information to be deleted.

- Select the battery information to be deleted, then press $\langle \text{SET} \rangle$.
- ▶ [✓] will appear.
- To delete information for another battery, repeat this procedure.

3 Press the $\langle \text{trash} \rangle$ button.

- ▶ The confirmation dialog will appear.

4 Select [OK].

- ▶ The battery information will be deleted and the screen in step 1 will reappear.

Using a Household Power Outlet

You can power the camera with a household power outlet by using the DC Coupler DR-E6 and AC Adapter AC-E6N (both sold separately).

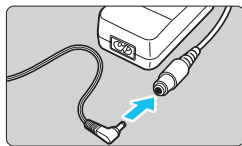

1 Connect the DC Coupler's plug.

- Connect the DC Coupler's plug to the AC Adapter's socket.

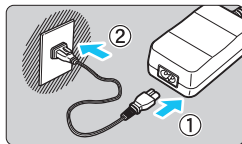

2 Connect the power cord.

- Connect the power cord as shown in the illustration.
- After using the camera, unplug the power plug from the power outlet.

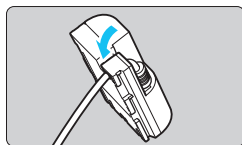

3 Place the cord in the groove.

- Insert the DC Coupler's cord to the groove carefully without damaging the cord.

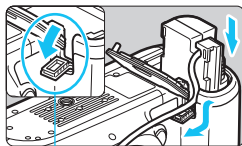

DC Coupler cord hole

4 Insert the DC Coupler.

- Open the battery compartment cover and open the DC Coupler cord hole cover.
- Insert the DC Coupler securely until it locks and put the cord through the hole.
- Close the cover.

 Do not connect or disconnect the power cord or DC Coupler while the camera's power switch is set to **<ON>**.

Using Eye-Fi Cards

With a commercially-available Eye-Fi card already set up, you can automatically transfer captured images to a computer or upload them to an online service via a wireless LAN.



The image transfer is a function of the Eye-Fi card. For instructions on how to set up and use the Eye-Fi card or to troubleshoot any image transfer problems, refer to the Eye-Fi card's instruction manual or contact the card manufacturer.

 **The camera is not guaranteed to support Eye-Fi card functions (including wireless transfer). In case of a problem with an Eye-Fi card, please check with the card manufacturer. Also note that approval is required to use Eye-Fi cards in many countries or regions. Without approval, use of the card is not permitted. If it is unclear whether the card has been approved for use in your area, please check with the card manufacturer.**

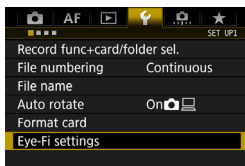

1 Insert an Eye-Fi card (p.43).



2 Select [Eye-Fi settings].

- Under the [ 1] tab, select [**Eye-Fi settings**], then press < >.
- This menu is displayed only when an Eye-Fi card is inserted into the camera.

3 Enable Eye-Fi transmission.

- Select [**Eye-Fi trans.**], then press < >.
- Select [**Enable**], then press < >.
- If you set [**Disable**], there will be no automatic transmission even with the Eye-Fi card inserted (transmission status icon ).

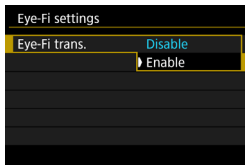

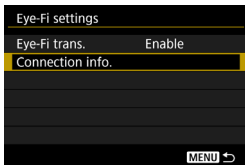

4 Display the connection information.

- Select [**Connection info.**], then press <SET>.



5 Check the [**Access point SSID:**].

- Check that an access point is displayed for [**Access point SSID:**].
- You can also check the Eye-Fi card's MAC address and firmware version.
- Press the <MENU> button to exit the menu.



Transmission status

6 Take the picture.

- ▶ The picture is transferred and the [Wi-Fi] icon switches from gray (not connected) to one of the icons below.
- For transferred images, [Wi-Fi] is displayed in the shooting information display (p.323).

- Wi-Fi (Gray) **Not connected** : No connection with access point.
- Wi-Fi (Blinking) **Connecting...** : Connecting to access point.
- Wi-Fi (Illuminated) **Connected** : Connection to access point established.
- Wi-Fi (↑) **Transferring...** : Image transfer to access point in progress.

Cautions for Using Eye-Fi Cards

- If “ > will not appear.

System Map

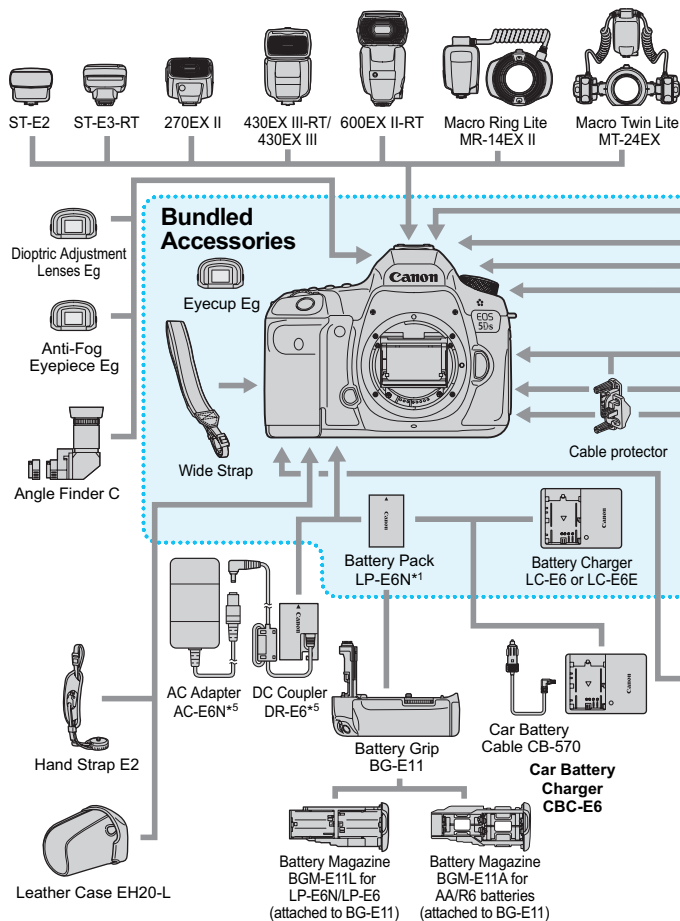

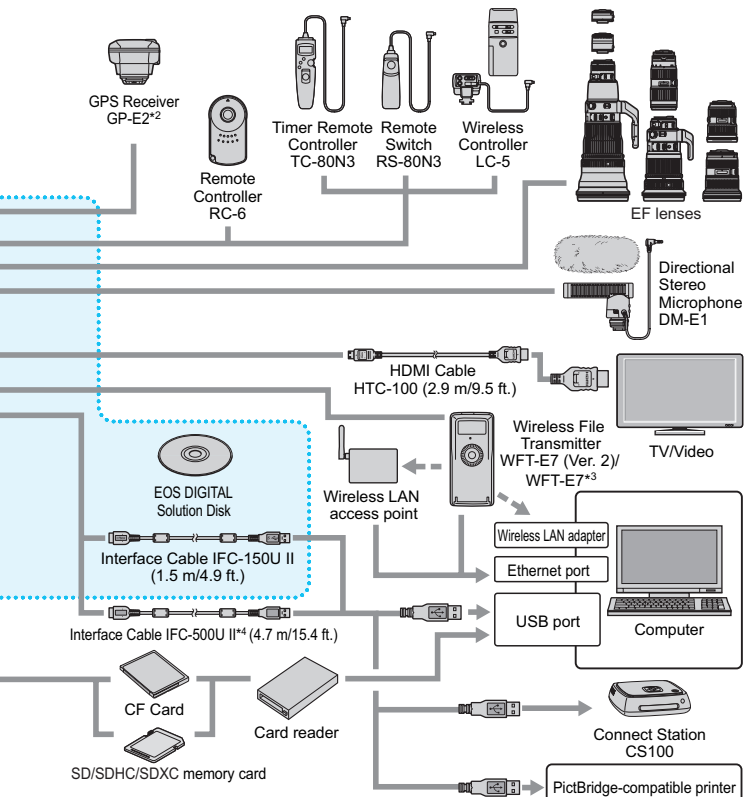

*1: Battery Pack LP-E6 can also be used.

*2: To use the GP-E2 with a cable, the GP-E2's firmware must be updated to Version 2.0.0 or later and Interface Cable IFC-40AB II or IFC-150AB II must be used.

*3: To use the older model WFT-E7 (not Version 2), the WFT-E7's firmware must be updated and Interface Cable IFC-40AB II or IFC-150AB II must be used.

*4: With IFC-500U II, the communication speed will be equivalent to Hi-Speed USB (USB 2.0).

*5: AC Adapter Kit ACK-E6 can also be used.

* All cable lengths given are approximate figures.

Function Availability Table According to Shooting Mode

Still Photo Shooting

● : Set automatically ○ : User selectable □ : Not selectable/Disabled

Function		A ⁺	P	Tv	Av	M	B
All image quality settings selectable		○	○	○	○	○	○
Crop/aspect ratio		□	○	○	○	○	○
ISO speed	Automatically set/Auto ISO	●	○	○	○	○	○
	Manually set	□	○	○	○	○	○
Picture Style	Automatically set/Auto	●	○	○	○	○	○
	Manual selection	□	○	○	○	○	○
White balance	Auto	●	○	○	○	○	○
	Preset	□	○	○	○	○	○
	Custom	□	○	○	○	○	○
	Color temperature setting	□	○	○	○	○	○
	Correction/Bracketing	□	○	○	○	○	○
Auto Lighting Optimizer		●	○	○	○	○	○
Long exposure noise reduction		□	○	○	○	○	○
High ISO speed noise reduction		●	○	○	○	○	○
Highlight tone priority		□	○	○	○	○	○
Lens aberration correction	Peripheral illumination correction	○	○	○	○	○	○
	Chromatic aberration correction	○	○	○	○	○	○
Anti-flicker shooting ^{*1}		●	○	○	○	○	○
Color space	sRGB	●	○	○	○	○	○
	Adobe RGB	□	○	○	○	○	○
AF	One-Shot AF ^{*1}	□	○	○	○	○	○
	AI Servo AF ^{*1}	□	○	○	○	○	○
	AI Focus AF ^{*1}	●	○	○	○	○	○
	AF area selection mode ^{*1}	□	○	○	○	○	○
	AF point	●	○	○	○	○	○
	Manual focusing (MF)	○	○	○	○	○	○
	AF Microadjustment ^{*1}	□	○	○	○	○	○
	⌂ (face)+Tracking ^{*2}	○	○	○	○	○	○
	FlexZone - Single ^{*2}	○	○	○	○	○	○
	Continuous AF ^{*2}	○	○	○	○	○	○

Function			P	Tv	Av	M	B
Metering	Evaluative metering	●	○	○	○	○	○
	Partial metering		○	○	○	○	○
	Spot metering		○	○	○	○	○
	Center-weighted average metering		○	○	○	○	○
Exposure	Program shift		○				
	Exposure compensation		○	○	○	○ ^{*3}	
	AEB		○	○	○	○	
	AE lock		○	○	○	^{*4}	
	Depth-of-field preview		○	○	○	○	○
	HDR shooting		○	○	○	○	
	Multiple exposures		○	○	○	○	○
	Interval timer ^{*1}	○	○	○	○	○	
	Bulb timer						○
	Mirror Lockup ^{*1}		○	○	○	○	○
Drive	Single shooting	○	○	○	○	○	○
	High-speed continuous shooting	○	○	○	○	○	○
	Low-speed continuous shooting	○	○	○	○	○	○
	Silent single shooting	○	○	○	○	○	○
	Silent continuous shooting	○	○	○	○	○	○
	10-sec. self-timer/Remote control	○	○	○	○	○	○
	2-sec. self-timer/Remote control	○	○	○	○	○	○
External Speedlite	Flash exposure compensation		○	○	○	○	○
	FE lock ^{*1}		○	○	○	○	○
	Function settings		○	○	○	○	○
	Custom Function settings		○	○	○	○	○
Live View shooting		○	○	○	○	○	
Quick Control		○	○	○	○	○	

*1: Settable only with viewfinder shooting.

*2: Settable only during Live View shooting.

*3: Settable only when Auto ISO is set.

*4: With Auto ISO, you can set a fixed ISO speed.

Movie Shooting

● : Set automatically ○ : User selectable □ : Not selectable/Disabled

Function		Movies					Still Photos ⁻¹			
All image quality settings selectable (movie)		○	○	○	○	○				
All image quality settings selectable (still photos)							○			○
Time-lapse movie		○	○	○	○	○				
ISO speed	Automatically set/Auto ISO	●	●	●	●	○	●	●		○
	Manually set					○				○
Picture Style	Automatically set/Auto	●	○	○	○	○	●	○		○
	Manual selection		○	○	○	○		○		○
White balance	Auto	●	○	○	○	○	●	○		○
	Preset		○	○	○	○		○		○
	Custom		○	○	○	○		○		○
	Color temperature setting		○	○	○	○		○		○
	Correction		○	○	○	○		○		○
	Bracketing							○		○
Auto Lighting Optimizer		●	○	○	○	○	●	○		○
Long exposure noise reduction										
High ISO speed noise reduction ⁻²		●	○	○	○	○	●	○		○
Highlight tone priority			○	○	○	○		○		○
Lens aberration correction	Peripheral illumination correction	○	○	○	○	○	○	○		○
	Chromatic aberration correction	○	○	○	○	○	○	○		○
Color space	sRGB	●	●	●	●	●	●	○		○
	Adobe RGB							○		○
AF	┌+Tracking	○	○	○	○	○	○	○		○
	FlexiZone - Single	○	○	○	○	○	○	○		○
	Manual focusing (MF)	○	○	○	○	○	○	○		○
	Movie Servo AF	○	○	○	○	○	○	○		○

Function		Movies					Still Photos ^{*1}				
Metering		●	●	●	●	●	●	●	●	●	
Exposure	Program shift										
	AE lock		○	○	○	*3		○		*3	
	Exposure compensation		○	○	○	○ ^{*4}		○		○ ^{*4}	
	AEB										
	Depth-of-field preview										
Drive	Single shooting						○	○		○	
	High-speed continuous shooting						○	○		○	
	Low-speed continuous shooting						○	○		○	
	Silent single shooting						○	○		○	
	Silent continuous shooting						○	○		○	
	10-sec. self-timer/ Remote control ^{*5}						○	○		○	
	2-sec. self-timer/Remote control ^{*5}						○	○		○	
External Speedlite											
Sound recording		○	○	○	○	○					
Time code		○	○	○	○	○					
Quick Control		○	○	○	○	○	○	○		○	

*1: Indicates still photo shooting during movie shooting.

*2: Multi Shot Noise Reduction cannot be set.

*3: With Auto ISO, you can set a fixed ISO speed.

*4: Settable only when Auto ISO is set.









*5: Works only before you start shooting a movie.





Menu Settings

Viewfinder Shooting and Live View Shooting

: Shooting 1 (Red)

Page

Image quality	RAW / M RAW / S RAW	149
	 L /  L /  M1 /  M1 /  M2 /  M2 /  S1 /  S1 / S2 / S3	
Image review time	Off / 2 sec. / 4 sec. / 8 sec. / Hold	70
Beep	Enable / Disable	69
Release shutter without card	Enable / Disable	44
Lens aberration correction	Peripheral illumination: Enable / Disable	188
	Chromatic aberration: Enable / Disable	
External Speedlite control	Flash firing / E-TTL II metering / Flash sync. speed in Av mode / Flash function settings / Flash C.Fn settings / Clear settings	247

-  Shaded menu options are not displayed in the <[A+]> mode.
- What is displayed under [ 1: Image quality] depends on the [Record func.] (p.146) setting under [ 1: Record func+card/folder sel.]. If [Rec. separately] is set, set the image quality for each card.
- With movie shooting, certain menu items are not displayed. Also, the [ 6] tab will not appear.

📷: Shooting 2 (Red)

Page

Exposure compensation/ AEB setting*	1/3- and 1/2-stop increments, ± 5 stops	214
	(AEB ± 3 stops)	215
ISO speed settings	ISO speed / ISO speed range / Auto ISO range / Minimum shutter speed	158
Auto Lighting Optimizer	Disable / Low / Standard / High	182
	Disabled in M or B modes	
White balance	AWB (Ambience priority) / AWB w (White priority) / ☀️/🏠/☁️/🌅/🌄/🌧️/⚡/🌋/🏔️/🏰 (Approx. 2500 - 10000)	174
Custom White Balance	Manual setting of white balance	176
White Balance Shift/ Bracketing	White balance correction: B/A/M/G bias, 9 levels each	179
	White balance bracketing: B/A and M/G bias, single-level increments, ± 3 levels	
Color space	sRGB / Adobe RGB	193

* During movie shooting, [Expo.comp./AEB] will be [Exposure comp.].

📷: Shooting 3 (Red)

Picture Style	📷A Auto / 📷S Standard / 📷P Portrait / 📷L Landscape / 📷FD Fine Detail / 📷N Neutral / 📷F Faithful / 📷M Monochrome / 📷1 User Def. 1-3	164
Long exposure noise reduction	Disable / Auto / Enable	185
High ISO speed noise reduction	Disable / Low / Standard / High / Multi Shot Noise Reduction	183
Highlight tone priority	Disable / Enable	187
Dust Delete Data	Obtain data to be used by EOS software to delete dust spots	375
Multiple exposure	Multiple exposure / Multiple exposure control / Number of exposures / Save source images / Continue multiple exposure	226
HDR Mode	Adjust dynamic range / Effect / Continuous HDR / Auto Image Align / Save source images	221





📷: Shooting 4* (Red)

Page

Interval timer	Disable / Enable (Interval / Number of shots)	239
Bulb timer	Disable / Enable (Exposure time)	219
Anti-flicker shooting	Disable / Enable	191
Mirror lockup	Disable / Press  twice to shoot / Shoot 1/8 sec after press / Shoot 1/4 sec after press / Shoot 1/2 sec after press / Shoot 1 sec. after press / Shoot 2 sec. after press	234
Crop/aspect ratio	Full-frame / 1.3x (crop) / 1.6x (crop) / 1:1 (aspect ratio) / 4:3 (aspect ratio) / 16:9 (aspect ratio)	154

* In the <[A]⁺> mode, these menu options are displayed under [**📷2**].

📷: Shooting 5* (Red)

Live View shooting	Enable / Disable	257
AF method	 +Tracking / FlexiZone - Single	268
Continuous AF	Disable / Enable	264
Grid display	Off / 3x3  / 6x4  / 3x3+diag 	265
Exposure simulation	Enable / During  / Disable	265

* In the <[A]⁺> mode, these menu options are displayed under [**📷3**].

📷: Shooting 6 (Red)

Silent LV shooting	Mode 1 / Mode 2 / Disable	266
Metering timer	4 sec. / 8 sec. / 16 sec. / 30 sec. / 1 min. / 10 min. / 30 min.	267

AF: AF1 (Purple)

Page

Case 1	Versatile multi purpose setting	110
Case 2	Continue to track the subjects, ignoring possible obstacles	110
Case 3	Instantly focus on subjects suddenly entering AF points	111
Case 4	For subjects that accelerate or decelerate quickly	111
Case 5	For erratic subjects moving quickly in any direction	112
Case 6	For subjects that change speed and move erratically	113

AF: AF2 (Purple)









AI Servo 1st image priority	Release priority / Equal priority / Focus priority	118
AI Servo 2nd image priority	Shooting speed priority / Equal priority / Focus priority	119

AF: AF3 (Purple)

Lens electronic MF	Enable after One-Shot AF / Disable after One-Shot AF / Disable in AF mode	120
AF-assist beam firing	Enable / Disable / IR AF assist beam only	121
One-Shot AF release priority	Release priority / Focus priority	122

AF: AF4 (Purple)

Page

Lens drive when AF impossible	Continue focus search / Stop focus search	123
Selectable AF point	61 points / Only cross-type AF points / 15 points / 9 points	124
Select AF area selection mode	Manual selection: Spot AF / Manual selection: 1 point AF / Expand AF area:  / Expand AF area: Surround / Manual selection: Zone AF / Auto selection: 61 point AF	125
AF area selection method	 → M-Fn button /  → Main Dial	126
Orientation linked AF point	Same for both vertical/horizontal / Separate AF points: Area+point / Separate AF points: Point only	126
Initial AF point,  AI Servo AF	Initial  AF point selected / Manual     AF point / Auto	128
Auto AF point selection: EOS iTR AF	Enable / Disable	129

AF: AF5 (Purple)

Manual AF point selection pattern	Stops at AF area edges / Continuous	130
AF point display during focus	Selected (constant) / All (constant) / Selected (pre-AF, focused) / Selected (focused) / Disable display	131
VF display illumination	Auto / Enable / Disable	132
	AF point during AI Servo AF: Non illuminated / Illuminated	
AF Microadjustment	Disable / All by same amount / Adjust by lens	134

▶: Playback 1 (Blue)



Page

Protect images	Protect images	334
Rotate image	Rotate images	333
Erase images	Erase images	358
Print order	Specify images to be printed (DPOF)	392
Photobook Set-up	Specify images for a photobook	397
Image copy	Copy images between cards	354
RAW image processing	Process RAW images	364

▶: Playback 2 (Blue)

Cropping	Partially crop JPEG images	371
Resize	Downsize JPEG image's pixel count	369
Rating	[OFF] / [.] / [·] / [∗] / [∗∗] / [∗∗∗]	337
Slide show	Set playback description / Display time / Repeat, and start auto playback	348
Image transfer	Image selection/transfer / RAW+JPEG transfer	395
Image jump w/ 	1 image / 10 images / 100 images / Date / Folder / Movies / Stills / Protect / Rating	328





▶: Playback 3 (Blue)

Highlight alert	Disable / Enable	325
AF point display	Disable / Enable	325
Playback grid	Off / 3x3  / 6x4  / 3x3+diag 	321
Histogram display	Brightness / RGB	326
Movie playback count*	Rec time / Time code	304
Magnification (approx.)	1x (no magnification) / 2x (magnify from center) / 4x (magnify from center) / 8x (magnify from center) / 16x (magnify from center) / Actual size (from selected point) / Same as last magnification (from center)	331
Control over HDMI	Disable / Enable	352

* The setting is linked to the [Time code]'s [Movie play count] under the [Movie] tab.

☛: Set-up 1 (Yellow)

Page



Record function+card/ folder selection	Recording function: Standard / Auto switch card / Record separately / Record to multiple	146
	Record/playback / Playback:  / 	148
	Folder: Selecting and creating a folder	194
File numbering	Continuous / Auto reset / Manual reset	199
File name	Preset code / User setting 1 / User setting 2	196
Auto rotate	On   / On  / Off	362
Format card	Erase data on the card by formatting	67
Eye-Fi settings	Displayed when a commercially-available Eye- Fi card is inserted	451

☛: Set-up 2 (Yellow)

Auto power off	1 min. / 2 min. / 4 min. / 8 min. / 15 min. / 30 min. / Disable	69
LCD brightness	Auto: Adjustable to one of three brightness levels	361
	Manual: Adjustable to one of seven brightness levels	
Date/Time/Zone	Date (year, month, day) / Time (hr., min., sec.) / Daylight saving time / Time zone	49
Language 	Select the interface language	51
Viewfinder display	Electronic level: Hide / Show	75
	Grid display: Hide / Show	74
	Show/hide in viewfinder: Battery / White balance / Drive mode / AF operation / Metering mode / Image quality / Flicker detection	77
GPS device settings	Settable when the GPS Receiver GP-E2 (sold separately) is attached	-

☛: Set-up 3 (Yellow)

Page

Video system	For NTSC / For PAL	297 351
Battery information	Power source / Remaining capacity / Shutter count / Recharge performance / Battery registration / Serial number / Battery history	446
Sensor cleaning	Auto cleaning  : Enable / Disable	374
	Clean now 	
	Clean manually	377
INFO button display options	Displays camera settings / Electronic level / Quick Control screen / Custom Quick Control screen	442
Custom Quick Control	Customize the functions and layout for Quick Control screen	427
RATE button function	Rating / Protect	337 336
Communication settings	Displayed when Wireless File Transmitter WFT-E7 (Ver. 2, sold separately) is attached.	-







- When using GPS device or a Wireless File Transmitter, be sure to check the countries and areas of use, and use the device in accordance with the laws and regulations of the country or region.
- Note that when connecting GPS Receiver GP-E2 (sold separately) with a cable, preparations as below are necessary.
 - Update the GP-E2's firmware to Version 2.0.0 or later. (Using the cable for connection is not possible with the firmware version earlier than Version 2.0.0.)
 - Interface Cable IFC-40AB II or IFC-150AB II (both sold separately) must be used.

When using the GP-E2 attached to the hot shoe, preparations as above are not necessary. For how to update the GP-E2's firmware, refer to the Canon Web site.

Set-up 4 (Yellow)

Page

Custom shooting mode (C1-C3)	Register current camera settings to the Mode Dial's  ,  , and  positions	437
Clear all camera settings	Resets the camera to the default settings	70
Copyright information	Display copyright information / Enter author's name / Enter copyright details / Delete copyright information	201
Certification Logo Display	Some of the camera's certification logos are displayed	441
 firmware ver.	Select to update the firmware of the camera, lens, Speedlite, or Wireless File Transmitter	-

Custom Functions (Orange)

C.Fn1: Exposure	Customize camera functions as desired	402
C.Fn2: Exposure		408
C.Fn3: Others		409
C.Fn4: Clear		401

My Menu (Green)

Add My Menu tab	Add My Menu tabs 1-5	432
Delete all My Menu tabs	Delete all My Menu tabs	435
Delete all items	Delete all items under My Menu tabs 1-5	435
Menu display	Normal display / Display from My Menu tab / Display only My Menu tab	436

Movie Shooting

Shooting 4*¹ (Movie) (Red)

Page











Movie Servo AF	Enable / Disable	313
AF method	⤴+Tracking / FlexiZone - Single	315
Grid display	Off / 3x3 田 / 6x4 田田 / 3x3+diag 田田	315
Movie recording size	<ul style="list-style-type: none"> • 1920x1080 / 1280x720 / 640x480 • NTSC: 59.94p / 29.97p / 23.98p • PAL: 50.00p / 25.00p • ALL-I (For editing) / IPB (Standard) 	297
Sound recording * ²	Sound recording: Auto / Manual / Disable	300
	Recording level	
	Wind filter: Disable / Enable	
	Attenuator: Disable / Enable	

*1: In the <[A+]> mode, these menu options are displayed under [2].

*2: In the <[A+]> mode, [Sound recording] settings will be [On] [Off].

 **Shooting 5*¹ (Movie) (Red)**

Page

Silent LV shooting	Mode 1 / Mode 2 / Disable	315
Metering timer	4 sec. / 8 sec. / 16 sec. / 30 sec. / 1 min. / 10 min. / 30 min.	316
Time code	Count up / Start time setting / Movie recording count / Movie play count ^{*2} / Drop frame ^{*3}	303
Silent Control	Enable  / Disable 	302
button function	 /  /  /  /  /  /  / 	316
Time-lapse movie	Disable / Enable (Interval / No. of shots / Time required / Playback time/ Card- time left)	306

*1: In the <[A+]> mode, these menu options are displayed under [3].

*2: The setting is linked to [Movie play count] under the [3] tab.

*3: Displayed when 59.94P (59.94 fps) or 29.97P (29.97 fps) is set.

Troubleshooting Guide

If a problem occurs with the camera, first consult this Troubleshooting Guide. If this Troubleshooting Guide does not resolve the problem, contact your dealer or nearest Canon Service Center.

Power-Related Problems

The battery does not recharge.

- If the battery's remaining capacity is 94% or higher, the battery will not be recharged (p.446).
- Do not use any battery other than genuine Battery Pack LP-E6N/LP-E6.

The charger's lamp blinks at high speed.

- If (1) the battery charger or battery has a problem or (2) communication with the battery failed (with a non-Canon battery pack), the protection circuit will stop charging, and the charge lamp will blink in orange at a high speed. In the case of (1), unplug the charger's power plug from the power outlet. Detach and reattach the battery to the charger. Wait a few minutes, then reconnect the power plug to the power outlet. If the problem persists, contact your dealer or nearest Canon Service Center.

The charger's lamp does not blink.

- If the internal temperature of the battery attached to the charger is high, the charger will not charge the battery for safety reasons (lamp off). During charging, if the battery's temperature becomes high for any reason, charging will stop automatically (lamp blinks). When the battery temperature goes down, charging will resume automatically.

The camera does not operate even when the power switch is set to <ON>.

- Make sure the battery compartment cover is closed (p.42).
- Make sure the battery is installed properly in the camera (p.42).
- Recharge the battery (p.40).
- Make sure the card slot cover is closed (p.43).

The access lamp still lights or blinks even when the power switch is <OFF>.

- If the power is turned off while an image is being recorded to the card, the access lamp will remain on or continue to blink for a few seconds. When the image recording is completed, the power will turn off automatically.

[Does this battery/do these batteries display the Canon logo?] is displayed.

- Do not use any battery other than a genuine Battery Pack LP-E6N/LP-E6.
- Remove and install the battery again (p.42).
- If the battery contacts are dirty, use a soft cloth to clean them.

The battery becomes exhausted quickly.

- Use a fully-charged battery (p.40).
- The battery performance may have degraded. See [**43: Battery info.**] to check the battery's recharge performance level (p.446). If the battery performance is poor, replace the battery with a new one.
- The number of possible shots will decrease with any of the following operations:
 - Pressing the shutter button halfway for a prolonged period.
 - Activating the AF frequently without taking a picture.
 - Using the lens's Image Stabilizer.
 - Using the LCD monitor frequently.
 - Continuing Live View shooting or movie shooting for a prolonged period.
 - The Eye-Fi card's communication function is operating.

The camera turns off by itself.

- Auto power off is in effect. If you do not want auto power off to take effect, set [**42: Auto power off**] to [**Disable**] (p.69).
- Even if [**42: Auto power off**] is set to [**Disable**], the LCD monitor will still turn off after the camera is left idle for 30 min. (The camera's power does not turn off.)

Shooting-Related Problems

The lens cannot be attached.

- The camera cannot be used with EF-S or EF-M lenses (p.52).

The viewfinder is dark.

- Install a recharged battery in the camera (p.40).

No images can be shot or recorded.

- Make sure the card is properly inserted (p.43).
- If you are using an SD card, slide the card's write-protect switch to the Write/Erase setting (p.43).
- If the card is full, replace the card or delete unnecessary images to make space (p.43, 358).
- If you try to focus in the One-Shot AF mode and the focus indicator <●> in the viewfinder blinks, a picture cannot be taken. Press the shutter button halfway again to refocus automatically, or focus manually (p.55, 141).



The card cannot be used.

- If a card error message is displayed, see page 46 or 487.

I cannot lock the focus and recompose the shot.

- Set the AF operation to One-Shot AF (p.87). Focus lock is not possible in the AI Servo AF, or when servo takes effect in AI Focus AF (p.83).

I have to press the shutter button twice completely to take a picture.

- If [4: Mirror lockup] is set to [Press  twice to shoot], set it to [Disable].

The image is out of focus or blurred.

- Set the lens's focus mode switch to <AF> (p.52).
- Press the shutter button gently to prevent camera shake (p.54-55).
- If the lens has an Image Stabilizer, set the IS switch to <ON>.
- In low light, the shutter speed may become slow. Use a faster shutter speed (p.206), set a higher ISO speed (p.158), use flash (p.244), or use a tripod.
- See “Minimizing Blurred Photos” on page 235.

There are fewer AF points.

- Depending on the attached lens, the number of usable AF points and patterns will differ. The lenses are categorized into nine groups from A to I. Check which group your lens belongs to. Using a lens in Groups F to H will have fewer usable AF points (p.103-104).

The AF point is blinking or two AF points are displayed.

- Regarding lighting up or blinking of the AF points when you press the < > button, see page 94.
- The AF point at the registered area is blinking (p.94, 418).
- The manually-selected AF point (or zone) and the registered AF point are displayed (p.93, 418).

The AF points do not light up in red.

- The AF points light up in red when focus is achieved in low-light conditions.
- In the <P>, <Tv>, <Av>, <M>, and modes, you can set whether to have the AF points light in red when focus is achieved (p.132).

The continuous shooting speed is slow.

- The continuous shooting speed may become slower depending on the shutter speed, aperture, subject conditions, brightness, lens, flash use, temperature, battery type, remaining battery level, etc. (p.143).
- In AI Servo AF operation, the continuous shooting speed may become slower depending on the subject conditions and lens used (p.143).
- If you use Battery Pack LP-E6 and shoot in low temperatures (battery temperature is low), the high-speed continuous shooting speed may become slower (p.143).
- The continuous shooting speed may become slower if the remaining battery level is low or if you shoot under low-light conditions (p.143).
- If you use Battery Grip BG-E11 (sold separately) with AA/R6 batteries, the maximum continuous shooting speed will be approx. 3.0 fps for high-speed continuous shooting.
- If you set [**4: Anti-flicker shoot.**] to [**Enable**] and shoot under a flickering light source, the continuous shooting speed may decrease slightly, the shooting interval may become irregular, or the release time lag may become longer (p.191).

The maximum burst during continuous shooting is lower.

- If you shoot something that has fine detail such as a field of grass, the file size will be larger, and the actual maximum burst may be lower than the number mentioned on page 151.

I cannot shoot in the 4:3 or 16:9 aspect ratio.

- During viewfinder shooting, you cannot shoot in either the 4:3 or the 16:9 aspect ratio even when the aspect ratio is set. During Live View shooting, you can shoot images in the 4:3 and 16:9 aspect ratios (p.154).

ISO 100 cannot be set. ISO speed expansion cannot be selected.

- If [**3: Highlight tone priority**] is set to [**Enable**], the settable ISO speed range will be ISO 200 - ISO 6400. Even if you expand the settable ISO speed range with [**ISO speed range**], you cannot select the L (equivalent to ISO 50) or H (equivalent to ISO 12800). When [**3: Highlight tone priority**] is set to [**Disable**], ISO 100/125/160, L, or H can be set (p.187).

Even if I set a decreased exposure compensation, the image comes out bright.

- Set [**2: Auto Lighting Optimizer**] to [**Disable**]. When [**Low**], [**Standard**], or [**High**] is set, even if you set a decreased exposure compensation or flash exposure compensation, the image may come out bright (p.182).

I cannot set the exposure compensation while both manual exposure and Auto ISO are set.

- See page 211 to set the exposure compensation.
- Even if an exposure compensation is performed, it will not be applied for flash photography.

Multi Shot Noise Reduction cannot be set.

- If the image-recording quality is set to RAW or RAW+JPEG, [**Multi Shot Noise Reduction**] cannot be set.

The Live View image or movie shooting image is not displayed during multiple-exposure shooting.

- If [**On:ContShtng**] is set, Live View display, image review after image capture, or image playback is not possible during shooting (p.226).

Live View shooting ends when multiple exposure shooting is performed.

- If you perform Live View shooting with [**On:ContShtng**], Live View function will end automatically when the first exposure is taken. Take the second and subsequent exposures while looking through the viewfinder.

The multiple-exposure image is shot in **RAW** quality.

- When the image-recording quality is set to **M RAW** or **S RAW**, the multiple-exposure image will be recorded in **RAW** quality (p.233).

When I use the <Av> mode with flash, the shutter speed becomes slow.

- If you shoot at night when the background is dark, the shutter speed automatically becomes slow (slow-sync shooting) so that both the subject and background are properly exposed. To prevent a slow shutter speed, under [**1: External Speedlite control**], set [**Flash sync. speed in Av mode**] to [**1/200-1/60sec. auto**] or [**1/200 sec. (fixed)**] (p.248).

The flash does not fire.

- Make sure the flash (or PC sync cord) is securely attached to the camera.
- If you use a non-Canon flash unit with Live View shooting, set [**Ⓜ6: Silent LV shoot.**] to [**Disable**] (p.266).

The flash always fires at full output.

- If you use a flash unit other than an EX-series Speedlite, the flash will always be fired at full output (p.245).
- When the flash Custom Function setting for [**Flash metering mode**] is set to [**TTL flash metering**] (autoflash), the flash will always be fired at full output (p.253).

Flash exposure compensation cannot be set.

- If flash exposure compensation is already set with the Speedlite, flash exposure compensation cannot be set with the camera. When the external Speedlite's flash exposure compensation is canceled (set to 0), flash exposure compensation can be set with the camera.



High-speed sync cannot be set in the <Av> mode.

- Under [**Ⓜ1: External Speedlite control**], set [**Flash sync. speed in Av mode**] to [**Auto**] (p.248).

The shutter makes two shooting sounds during Live View shooting.

- If you use flash, the shutter will make two sounds each time you shoot (p.257).

During Live View or movie shooting, a white or red icon is displayed.

- It indicates that the camera's internal temperature is high. If the white  icon is displayed, the still photo's image quality may deteriorate. If the red  icon is displayed, it indicates that the Live View or movie shooting will soon stop automatically (p.277, 317).

Movie shooting stops by itself.

- If the card's writing speed is slow, movie shooting may stop automatically. For cards that can record movies, see page 5. To find out the card's writing speed, refer to the card manufacturer's Web site.
- If the movie shooting time reaches 29 min. 59 sec., the movie shooting will stop automatically.

The ISO speed cannot be set for movie shooting.

- If the shooting mode is , **P**, **Tv**, **Av**, or **B**, the ISO speed will be set automatically. In the **M** mode, you can freely set the ISO speed (p.287).

The manually set ISO speed changes when switching to movie shooting.

- If you shoot a movie with manual exposure set to L (equivalent to ISO 50), the ISO speed setting will switch to ISO 100. Even if you switch back to still photo shooting, the ISO speed will not revert to L.

The exposure changes during movie shooting.

- If you change the shutter speed or aperture during movie shooting, the changes in the exposure may be recorded.
- Zooming the lens during movie shooting can cause changes in the exposure regardless of whether the lens's maximum aperture changes or not. The changes in the exposure may be recorded as a result.

The image flickers or horizontal stripes appear during movie shooting.

- Flickering, horizontal stripes (noise), or irregular exposures can be caused by fluorescent lighting, LED lighting, or other light sources during movie shooting. Also, changes in the exposure (brightness) or color tone may be recorded. In the <M> or <Tv> mode, a slow shutter speed may reduce the problem. The problem may be more noticeable in time-lapse movie shooting.

The subject looks distorted during movie shooting.

- If you move the camera to the left or right (panning) or shoot a moving subject, the image may look distorted. The problem may be more noticeable in time-lapse movie shooting.

When I shoot still photos during movie shooting, the movie shooting stops.

- To shoot still photos during movie shooting, using a CF card capable of UDMA transfer or a UHS-I SD card is recommended.
- Setting a lower image quality for still photos or shooting fewer continuous still photos may resolve the problem.

Time code is off.

- Shooting still photos during movie shooting will cause a discrepancy between the actual time and time code. When you want to edit a movie using time code, it is recommended not to shoot still photos during movie shooting.

Operation Problems

I cannot change the setting with the < >, < > or < >.

- Set the <LOCK▶> switch to the left (lock release, p.59).
- Check the [.3: Multi function lock] setting (p.410).

A camera button or dial does not work as expected.

- Check the [.3: Custom Controls] setting (p.413).

Display Problems

The menu screen shows fewer tabs and options.

- In the <[A+]> mode, only certain menu tabs and options are displayed. Set the shooting mode to <P>, <Tv>, <Av>, <M> or (p.64).
- Under the [★] tab, [Menu display] is set to [Display only My Menu tab] (p.436).

The file name's first character is an underscore (“_”).

- Set the color space to sRGB. If Adobe RGB is set, the first character will be an underscore (p.193).

The fourth character in the file name changes.

- With [📁1: File name], select the camera's unique file name or the file name registered under User setting 1 (p.196).

The file numbering does not start from 0001.

- If the card already contains recorded images, the image number may not start from 0001 (p.199).

The shooting date and time displayed is incorrect.

- Check that the correct date and time are set (p.49).
- Check the time zone and daylight saving time (p.49-50).

The date and time are not in the picture.

- The shooting date and time do not appear in the picture. The date and time are recorded in the image data as shooting information. When printing, you can imprint the date and time in the picture, using the date and time recorded in the shooting information (p.385, 389).

[###] is displayed.

- If the number of images recorded on the card exceeds the number the camera can display, [###] will be displayed (p.339).

In the viewfinder, the AF point display speed is slow.

- In low temperatures, the display speed of the AF points may become slower due to the AF point display device's (liquid crystal) characteristics. The display speed will return to normal at room temperature.

The LCD monitor does not display a clear image.

- If the LCD monitor is dirty, use a soft cloth to clean it.
- In low or high temperatures, the LCD monitor display may seem slow or may look black. It will return to normal at room temperature.

[Eye-Fi settings] does not appear.

- [Eye-Fi settings] will appear only when an Eye-Fi card is inserted in the camera. If the Eye-Fi card has a write-protect switch set to the **LOCK** position, you will not be able to check the card's connection status or disable Eye-Fi transmission (p.451).

Playback Problems

Part of the image blinks in black.

- [▶3: Highlight alert] is set to [Enable] (p.325).

A red box is displayed on the image.

- [▶3: AF point disp.] is set to [Enable] (p.325).

The image cannot be erased.

- If the image is protected, it cannot be erased (p.334).

The movie cannot be played back.

- Movies edited with a computer cannot be played back with the camera.

Camera operation noise can be heard when the movie is played back.

- If you operate the camera's dials or lens during movie shooting, the operation noise will also be recorded. Using the Directional Stereo Microphone DM-E1 (sold separately) is recommended (p.301).

The movie has still moments.

- During autoexposure movie shooting, if there is a drastic change in the exposure level, the recording will stop momentarily until the brightness stabilizes. In such cases, shoot in the <M> mode (p.286).

No picture on the TV set.

- Check if the [**3: Video system**] is correctly set to [**For NTSC**] or [**For PAL**] (depending on the video system of your TV set).
- Check that the HDMI cable's plug is inserted all the way in (p.351).

There are multiple movie files for a single movie shoot.

- If the movie file size reaches 4 GB, another movie file will be created automatically (p.299).

My card reader does not recognize the card.

- Depending on the card reader and computer OS used, large-capacity CF cards or SDXC cards may not be correctly recognized. In such a case, connect your camera to the computer with the interface cable, then transfer the images to your computer, using EOS Utility (EOS software, p.520).

I cannot process the RAW image.

- **M RAW** and **S RAW** images cannot be processed with the camera. Use the EOS software, Digital Photo Professional to process the image (p.520).

I cannot resize or crop the image.

- JPEG **S3**, **RAW**, **M RAW**, and **S RAW** images cannot be resized or cropped with the camera (p.369, 371).

Sensor Cleaning Problems

The shutter makes a noise during sensor cleaning.

- If you selected [**Clean now** ], the shutter will make a noise, but no picture is taken (p.374).

Automatic sensor cleaning does not work.

- If you repeatedly turn the power switch <**ON**> / <**OFF**> at a short interval, the < > icon may not be displayed (p.47).

Printing-Related Problems

There are fewer printing effects than listed in the instruction manual.

- Contents displayed on the screen vary depending on the printer. This instruction manual lists all the printing effects available (p.384).

Computer Connection Problems

Communication between the connected camera and computer does not work.

- When using EOS Utility (EOS software), set [ **5: Time-lapse movie**] to [**Disable**] (p.306).

I cannot transfer images to a computer.

- Install the EOS software (EOS DIGITAL Solution Disk CD-ROM) on the computer (p.520).
- Check that EOS Utility's main window is displayed.

Error Codes

Error number

If there is a problem with the camera, an error message will appear. Follow the on-screen instructions.

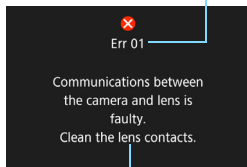

Cause and countermeasures

Number	Error Message and Solution
01	Communications between the camera and lens is faulty. Clean the lens contacts.
	→ Clean the electrical contacts on the camera and lens, use a Canon lens, or remove and install the battery again (p.25, 26, 42).
02	Card* cannot be accessed. Reinsert/change card* or format card* with camera.
	→ Remove and insert the card again, replace the card, or format the card (p.43, 67).
04	Cannot save images because card* is full. Replace card*.
	→ Replace the card, erase unnecessary images, or format the card (p.43, 67, 358).
06	Sensor cleaning could not be performed. Turn the camera off and on again.
	→ Operate the power switch (p.47).
10, 20 30, 40 50, 60 70, 80 99	An error prevented shooting. Turn the camera off and on again or re-install the battery.
	→ Operate the power switch, remove and install the battery again, or use a Canon lens (p.42, 47).

* If the error still persists, write down the error number and contact your nearest Canon Service Center.

Specifications

• Type

Type:	Digital, single-lens reflex, AF/AE camera
Recording media:	CF cards (Type I, UDMA 7 supported) SD/SDHC*/SDXC* memory cards * UHS-I cards compatible.
Image sensor size:	Approx. 36.0 x 24.0 mm
Compatible lenses:	Canon EF lenses * Excluding EF-S and EF-M lenses (35mm-equivalent lens focal length is as indicated on the lens)
Lens mount:	Canon EF mount

• Image Sensor

Type:	CMOS sensor
Effective pixels:	Approx. 50.6 megapixels * Rounded off to the nearest 10,000th.
Aspect ratio:	3:2
Dust delete feature:	Auto/Manual, Appending Dust Delete Data

• Recording System

Recording format:	Design rule for Camera File System (DCF) 2.0
Image type:	JPEG, RAW (14-bit Canon original), RAW+JPEG simultaneous recording possible
Pixels recorded (With full-frame):	L (Large) : Approx. 50.3 megapixels (8688 x 5792) M1 (Medium 1) : Approx. 39.3 megapixels (7680 x 5120) M2 (Medium 2) : Approx. 22.1 megapixels (5760 x 3840) S1 (Small 1) : Approx. 12.4 megapixels (4320 x 2880) S2 (Small 2) : Approx. 2.5 megapixels (1920 x 1280) S3 (Small 3) : Approx. 0.35 megapixels (720 x 480) RAW : Approx. 50.3 megapixels (8688 x 5792) M-RAW : Approx. 28.0 megapixels (6480 x 4320) S-RAW : Approx. 12.4 megapixels (4320 x 2880)
Crop/aspect ratio:	Crop shooting and shooting with the set aspect ratio possible. Full-frame / Approx. 1.3x (crop) / Approx. 1.6x (crop) / 1:1 (aspect ratio) / 4:3 (aspect ratio) / 16:9 (aspect ratio)

Recording function:	Standard, Auto switch card, Record separately, Record to multiple
Create/select a folder:	Possible
File name:	Preset code / User setting 1 / User setting 2
File numbering:	Continuous, Auto reset, Manual reset

• Image Processing During Shooting

Picture Style:	Auto, Standard, Portrait, Landscape, Fine Detail, Neutral, Faithful, Monochrome, User Defined 1 - 3
White balance:	Auto (Ambience priority), Auto (White priority), Preset (Daylight, Shade, Cloudy, Tungsten light, White fluorescent light, Flash), Custom, Color temperature setting (approx. 2500-10000 K), White balance correction, and White balance bracketing provided * Flash color temperature information transmission possible
Noise reduction:	Applicable to long exposures and high ISO speed shots
Automatic image brightness correction:	Auto Lighting Optimizer provided
Highlight tone priority:	Provided
Lens aberration correction:	Peripheral illumination correction, Chromatic aberration correction

• Viewfinder

Type:	Eye-level pentaprism
Coverage:	Vertical/Horizontal approx. 100% (with Eye point approx. 21 mm, full-frame)
Magnification:	Approx. 0.71x (-1 m ⁻¹ with 50mm lens at infinity)
Eye point:	Approx. 21mm (from eyepiece lens center at -1 m ⁻¹)
Built-in dioptic adjustment:	Approx. -3.0 - +1.0 m ⁻¹ (dpt)
Focusing screen:	Fixed
Grid display:	Provided
Electronic level:	Provided
Function setting display:	Battery, White balance, Drive mode, AF operation, Metering mode, Image quality: JPEG/RAW, Flicker detection, Warning symbol !
Mirror:	Quick-return type
Depth-of-field preview:	Provided

• Autofocus

Type:	TTL secondary image-registration, phase-difference detection with the dedicated AF sensor
AF points:	61 (Cross-type AF point: Max. 41 points) * Number of available AF points, cross-type points, and Dual cross-type points vary depending on the lens. * Dual cross-type focusing at f/2.8 with 5 AF points vertically aligned at the center. (AF group: When Group A lenses are used)
Focusing brightness range:	EV -2 - 18 (Conditions: f/2.8-sensitive center AF point, One-Shot AF, room temperature, ISO 100)
Focus operation:	One-Shot AF, AI Servo AF, AI Focus AF, Manual focusing (MF)
AF area selection mode:	Single-point Spot AF (manual selection), Single-point AF (manual selection), AF point expansion (manual selection: up, down, left, and right), AF point expansion (manual selection: surround), Zone AF (manual selection of zone), 61-point automatic selection AF
AF point automatic selection conditions:	Based on EOS iTR AF setting (Enables AF incorporating human face/color information) * iTR: Intelligent Tracking and Recognition
AF Configuration Tool:	Case 1 - 6
AI Servo AF characteristics:	Tracking sensitivity, Acceleration/deceleration tracking, AF point auto switching
AF Custom Functions:	16 functions
AF fine adjustment:	AF Microadjustment (All lenses by the same amount, Adjust by lens)
AF-assist beam:	Emitted by the EOS-dedicated external Speedlite

• Exposure Control

Metering mode:	Approx. 150,000-pixel RGB+IR metering sensor and 252-zone TTL metering at max. aperture EOS iSA (Intelligent Subject Analysis) system • Evaluative metering (linked to all AF points) • Partial metering (approx. 6.1% of viewfinder at center) • Spot metering (approx. 1.3% of viewfinder at center) • Center-weighted average metering
Brightness metering range:	EV 0 - 20 (at room temperature, ISO 100)

Exposure control:	Program AE (Scene Intelligent Auto, Program), Shutter-priority AE, Aperture-priority AE, Manual exposure, Bulb exposure
ISO speed (Recommended exposure index):	Scene Intelligent Auto: ISO 100 - ISO 3200 set automatically P, Tv, Av, M, B: Auto ISO, ISO 100 - ISO 6400 (in 1/3- or whole-stop increments), or ISO expansion to L (equivalent to ISO 50) or H (equivalent to ISO 12800)
ISO speed settings:	ISO speed range, Auto ISO range, and Auto ISO minimum shutter speed settable
Exposure compensation:	Manual: ± 5 stops in 1/3- or 1/2-stop increments AEB: ± 3 stops in 1/3- or 1/2-stop increments (can be combined with manual exposure compensation)
AE lock:	Auto: Applied in One-Shot AF mode with evaluative metering when focus is achieved Manual: By AE lock button
Anti-flicker:	Possible
Interval timer:	Shooting interval and shot count settable
Bulb timer:	Bulb exposure time settable

• HDR Shooting

Dynamic range adjustment:	Auto, ± 1 , ± 2 , ± 3
Effects:	Natural, Art standard, Art vivid, Art bold, Art embossed
Auto image align:	Provided

• Multiple Exposures

Shooting method:	Function/control priority, Continuous shooting priority
Number of multiple exposures:	2 to 9 exposures
Multiple-exposure control:	Additive, Average, Bright, Dark

• Shutter

Type:	Electronically-controlled, focal-plane shutter
Shutter speed:	1/8000 sec. to 30 sec. (total shutter speed range; available range varies by shooting mode), Bulb, X-sync at 1/200 sec.

• Drive System

Drive mode:	Single shooting, High-speed continuous shooting, Low-speed continuous shooting, Silent single shooting, Silent continuous shooting, 10-sec. self-timer/remote control, 2-sec. self-timer/remote control
-------------	---

Continuous shooting speed:	High-speed continuous shooting: Max. approx. 5.0 shots/sec. Low-speed continuous shooting: Max. approx. 3.0 shots/sec. Silent continuous shooting: Max. approx. 3.0 shots/sec.
Max. burst (With full-frame):	JPEG Large/Fine: Approx. 31 shots (approx. 510 shots) RAW: Approx. 12 shots (approx. 14 shots) RAW+JPEG Large/Fine: Approx. 12 shots (approx. 12 shots) * Figures are based on Canon's testing standards (ISO 100 and Standard Picture Style) and an 8 GB CF card. * Figures in parentheses apply to an UDMA mode 7, with a CF card based on Canon's testing standards.

• External Speedlite

Compatible Speedlites:	EX-series Speedlites
Flash metering:	E-TTL II autoflash
Flash exposure compensation:	±3 stops in 1/3- or 1/2-stop increments
FE lock:	Provided
PC terminal:	Provided
Flash control:	Flash function settings, Flash C.Fn settings

• Live View Shooting

Focus method:	Contrast-detection AF system (Face+Tracking, FlexiZone-Single) Manual focus (approx. 6x and 16x magnified view possible for focus check)
Continuous AF:	Provided
Focusing brightness range:	EV 0 - 18 (at room temperature, ISO 100)
Metering mode:	Evaluative metering (315 zones), Partial metering (approx. 6.4% of Live View screen), Spot metering (approx. 2.8% of Live View screen), Center-weighted average metering
Brightness metering range:	EV 0 - 20 (at room temperature, ISO 100)
Silent shooting:	Provided (Mode 1 and 2)
Grid display:	3 types

• Movie Shooting

Recording format:	MOV
Movie:	MPEG-4 AVC / H.264 Variable (average) bit rate
Audio:	Linear PCM
Recording size and frame rate:	Full HD (1920x1080): 29.97p/25.00p/23.98p HD (1280x720) : 59.94p/50.00p VGA (640x480) : 29.97p/25.00p
Compression method:	ALL-I (For editing/I-only), IPB (Standard)
File size:	Full HD (29.97p/25.00p/23.98p)/ALL-I : Approx. 654 MB/min. Full HD (29.97p/25.00p/23.98p)/IPB (Standard) : Approx. 225 MB/min. HD (59.94p/50.00p)/ALL-I : Approx. 583 MB/min. HD (59.94p/50.00p)/IPB (Standard): Approx. 196 MB/min. VGA (29.97p/25.00p)/IPB (Standard): Approx. 78 MB/min.
Card requirements (Writing/reading speed):	[CF card] ALL-I: 30 MB/sec. or faster, IPB: 10 MB/sec. or faster [SD card] ALL-I: 20 MB/sec. or faster, IPB: 6 MB/sec. or faster
Focus method:	Contrast-detection AF system (Face+Tracking, FlexiZone-Single) Manual focus (approx. 6x and 16x magnified view possible for focus check)
Movie servo AF:	Possible
Focusing brightness range:	EV 0 - 18 (at room temperature, ISO 100)
Metering mode:	Center-weighted average and Evaluative metering with the image sensor * Automatically set by the focus method.
Brightness metering range:	EV 0 - 20 (at room temperature, ISO 100)
Exposure control:	Autoexposure shooting (Program AE for movie shooting), Shutter-priority AE, Aperture-priority AE, Manual exposure
Exposure compensation:	±3 stops in 1/3-stop or 1/2-stop increments
ISO speed (Recommended exposure index):	Scene Intelligent Auto, Tv: Automatically set within ISO 100 - ISO 6400 P, Av, B: Automatically set within ISO 100 - ISO 6400, expandable to H (equivalent to ISO 12800) M: Auto ISO (automatically set within ISO 100 - ISO 6400), ISO 100 - ISO 6400 set manually (in 1/3- or whole-stop increments), expandable to H (equivalent to ISO 12800)
Time code:	Supported
Drop frames:	Compatible with 59.94p/29.97p

Specifications

Sound recording:	Built-in monaural microphone, external stereo microphone terminal provided Sound-recording level adjustable, wind filter provided, attenuator provided
Grid display:	3 types
Time-lapse movie:	Shooting interval and number of shots settable Required shooting time period, playback length, and remaining card capacity viewable
Still photo shooting:	Possible

• LCD Monitor

Type:	TFT color, liquid-crystal monitor
Monitor size and dots:	Wide 8.1 cm (3.2-in) (3:2) with approx. 1.04 million dots
Brightness adjustment:	Auto (Dark, Standard, Bright), Manual (7 levels)
Electronic level:	Provided
Interface languages:	25
Help display:	Possible

• Playback

Image display format:	Single-image display (without shooting information), Single-image display (with simple information), Single-image display (Shooting information displayed: Detailed information, Lens/histogram, White balance, Picture Style 1, Picture Style 2, Color space/noise reduction, Lens aberration correction), Index display (4/9/36/100 images), Two-image display
Highlight alert:	Overexposed highlights blink
AF point display:	Provided
Grid display:	3 types
Magnified view:	Approx. 1.5x-16x, initial magnification and position settable
Image browsing method:	Single image, Jump by 10 or 100 images, By shooting date, By folder, By movies, By stills, By protected images, By rating
Image rotation:	Provided
Rating:	Provided
Movie playback:	Enabled (LCD monitor, HDMI) Built-in speaker
Slide show:	All images, By date, By folder, By movies, By stills, By protected images, By rating
Image protection:	Possible
Copying images:	Possible

• Post-Processing of Images

In-camera RAW image processing:	Brightness correction, White balance, Picture Style, Auto Lighting Optimizer, High ISO speed noise reduction, JPEG image-recording quality, Color space, Peripheral illumination correction, Distortion correction, Chromatic aberration correction
Resize:	Provided
Cropping:	Provided

• Direct Printing

Compatible printers:	PictBridge-compatible printers
Printable images:	JPEG and RAW images
Print ordering:	DPOF Version 1.1 compliant

• Image Transfer

Transferrable files:	Still photos (JPEG, RAW, RAW+JPEG images), Movies
----------------------	---

• Custom Functions

Custom Functions:	16
Custom Quick Control:	Provided
My Menu:	Up to 5 screens can be registered
Custom shooting mode:	Register under Mode Dial's C1, C2, or C3
Copyright information:	Text entry and inclusion enabled

• Interface

DIGITAL terminal:	SuperSpeed USB (USB 3.0) Computer communication, direct printing, Wireless File Transmitter WFT-E7 (Ver. 2), GPS Receiver GP-E2, Connect Station CS100 connection
HDMI mini OUT terminal:	Type C (Auto switching of resolution), CEC-compatible
External microphone IN terminal:	3.5 mm diameter stereo mini-jack
Remote control terminal:	For N3-type remote control units
Wireless remote control:	Compatible with Remote Controller RC-6
Eye-Fi card:	Supported

• Power

Battery:	Battery Pack LP-E6N/LP-E6, quantity 1 * AC power usable with household power outlet accessories. * With Battery Grip BG-E11 attached, AA/R6 batteries can be used.
Battery information:	Remaining capacity, Shutter count, Recharge performance, and Battery registration possible
Number of possible shots:	With viewfinder shooting: Approx. 700 shots at room temperature (23°C/73°F), approx. 660 shots at low temperatures (0°C/32°F) With Live View shooting: Approx. 220 shots at room temperature (23°C/73°F), approx. 210 shots at low temperatures (0°C/32°F) * With a fully-charged Battery Pack LP-E6N.
Movie shooting time:	Total approx. 1 hr. 30 min. at room temperature (23°C/73°F) Total approx. 1 hr. 25 min. at low temperatures (0°C/32°F) * With a fully-charged Battery Pack LP-E6N.

• Dimensions and Weight

Dimensions (W x H x D):	Approx. 152.0 x 116.4 x 76.4 mm / 5.98 x 4.58 x 3.01 in.
Weight:	Approx. 930 g / 32.80 oz. (Based on CIPA Guidelines) Approx. 845 g / 29.80 oz. (Body only)

• Operation Environment

Working temperature range:	0°C - 40°C / 32°F - 104°F
Working humidity:	85% or less

- All the specifications listed above are common between EOS 5DS and EOS 5DS R.
- All the data above is based on Canon's testing standards and CIPA (Camera & Imaging Products Association) testing standards and guidelines.
- Dimensions and weight listed above are based on CIPA Guidelines (except weight for camera body only).
- Product specifications and the exterior are subject to change without notice.
- If a problem occurs with a non-Canon lens attached to the camera, consult the respective lens manufacturer.

Trademarks

- Adobe is a trademark of Adobe Systems Incorporated.
- Microsoft and Windows are trademarks or registered trademarks of Microsoft Corporation in the United States and/or other countries.
- Macintosh and Mac OS are trademarks of Apple Inc., registered in the U.S. and other countries.
- CompactFlash is a trademark of SanDisk Corporation.
- SDXC logo is a trademark of SD-3C, LLC.
- HDMI, HDMI logo, and High-Definition Multimedia Interface are trademarks or registered trademarks of HDMI Licensing LLC.
- All other trademarks are the property of their respective owners.

About MPEG-4 Licensing

"This product is licensed under AT&T patents for the MPEG-4 standard and may be used for encoding MPEG-4 compliant video and/or decoding MPEG-4 compliant video that was encoded only (1) for a personal and non-commercial purpose or (2) by a video provider licensed under the AT&T patents to provide MPEG-4 compliant video. No license is granted or implied for any other use for MPEG-4 standard."

* Notice displayed in English as required.

Use of Genuine Canon Accessories Is Recommended

This product is designed to achieve excellent performance when used with genuine Canon accessories.

Canon shall not be liable for any damage to this product and/or accidents such as fire, etc., caused by the malfunction of non-genuine Canon accessories (e.g., a leakage and/or explosion of a battery pack). Please note that this warranty does not apply to repairs arising out of the malfunction of non-genuine Canon accessories, although you may request such repairs on a chargeable basis.



Battery Pack LP-E6N/LP-E6 is dedicated to Canon products only. Using it with an incompatible battery charger or product may result in malfunction or accidents for which Canon cannot be held liable.

Digital Camera Model DS126521 / DS126611 Systems

This device complies with Part 15 of the FCC Rules. Operation is subject to the following two conditions: (1) This device may not cause harmful interference, and (2) this device must accept any interference received, including interference that may cause undesired operation.

Note: This equipment has been tested and found to comply with the limits for class B digital devices, pursuant to Part 15 of the FCC Rules. These limits are designed to provide reasonable protection against harmful interference in a residential installation. This equipment generates, uses and can radiate radio frequency energy and, if not installed and used in accordance with the instructions, may cause harmful interference to radio communications. However, there is no guarantee that interference will not occur in a particular installation. If this equipment does cause harmful interference to radio or television reception, which can be determined by turning the equipment off and on, the user is encouraged to try to correct the interference by one or more of the following measures:

- Reorient or relocate the receiving antenna.
- Increase the separation between the equipment and receiver.
- Connect the equipment into an outlet on a circuit different from that to which the receiver is connected.
- Consult the dealer or an experienced radio/TV technician for help.

The cable with the ferrite core provided with the digital camera must be used with this equipment in order to comply with Class B limits in Subpart B of Part 15 of the FCC rules.

Do not make any changes or modifications to the equipment unless otherwise specified in the manual. If such changes or modifications should be made, you could be required to stop operation of the equipment.

Canon U.S.A. Inc.
One Canon Park, Melville, NY 11747, U.S.A.
Tel No. 1-800-OK-CANON (1-800-652-2666)

CAN ICES-3 (B) / NMB-3 (B)



USA and Canada only:

The Lithium ion/polymer battery that powers the product is recyclable. Please call 1-800-8-BATTERY for information on how to recycle this battery.

For CA, USA only

Included lithium battery contains Perchlorate Material – special handling may apply. See www.dtsc.ca.gov/hazardouswaste/perchlorate/ for details.

CAUTION

RISK OF EXPLOSION IF BATTERY IS REPLACED BY AN INCORRECT TYPE.
DISPOSE OF USED BATTERIES ACCORDING TO LOCAL REGULATION.

15

Viewing the CD-ROM Instruction Manuals / Downloading Images to Your Computer

This chapter explains how to view the Camera Instruction Manual CD-ROM on your computer, download images from the camera to your computer, gives an overview of the software in the EOS DIGITAL Solution Disk (CD-ROM), and explains how to install the software on your computer. It also explains how to view the Software Instruction Manuals.



**Camera
Instruction Manual**



EOS DIGITAL Solution Disk
(Software/Software Instruction Manuals)

Viewing the Camera Instruction Manual CD-ROM



The Camera Instruction Manual CD-ROM contains the following electronic manuals (PDF files):

- **Camera Instruction Manual**

Explains all the camera functions and procedures, including basic content.

- **Quick Reference Guide**

Simple and portable guide covering basic function settings, shooting instructions, and playback instructions.

Viewing the Camera Instruction Manual CD-ROM

To view the instruction manuals (PDF files), Adobe Reader 6.0 or higher must be installed on your computer. Adobe Reader can be downloaded free from the Internet. After installing Adobe Reader, follow the procedure below.

- 1 Insert the “CAMERA INSTRUCTION MANUAL” CD-ROM into your computer.**

- 2 Double-click the CD-ROM icon.**



- With Windows, double-click on the CD-ROM icon in **[(My) Computer]**. With Macintosh, double-click on the CD-ROM icon on the desktop.
- The icon displayed will differ depending on your computer's operating system.



3 Double-click the **START** file.

- ▶ The screen shown in step 4 will appear.
- The icon displayed will differ depending on your computer's operating system.

4 Click your language.



5 Click the instruction manual you want to read.

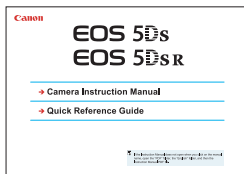

- ▶ The instruction manual will be displayed.



- You can save the PDF file to your computer.
- To learn how to use Adobe Reader, refer to Adobe Reader's Help section.

Downloading Images to a Computer

You can use EOS software to download the images in the camera to your computer. There are two ways to do this.

Downloading by Connecting the Camera to the Computer

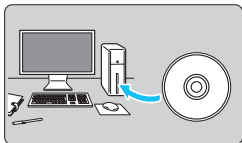

1 Install the software (p.521).

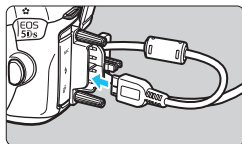

2 Use the provided interface cable to connect the camera to your computer.

- Use the interface cable provided with the camera.
- When connecting the cable to the camera, use the cable protector (p.36). Connect the cable to the digital terminal with the plug's icon facing the back of the camera.
- Connect the cord's plug to the computer's USB terminal.

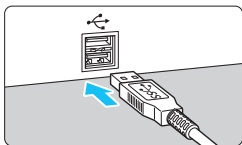

3 Use EOS Utility to transfer the images.

- For details, refer to the EOS Utility Instruction Manual (p.522).

 Use the provided interface cable or one from Canon (p.454). When connecting the interface cable, use the provided cable protector (p.36).

Downloading Images with a Card Reader

You can use a card reader to download images to your computer.

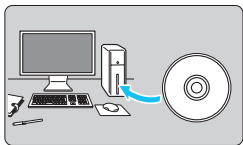

1 Install the software (p.521).

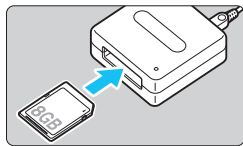

2 Insert the card into the card reader.

3 Use Digital Photo Professional to download the images.

- For details, refer to the Digital Photo Professional Instruction Manual (p.522).



When downloading images from the camera to your computer with a card reader without using EOS software, copy the DCIM folder on the card to your computer.

Software Overview



EOS DIGITAL Solution Disk

Various software for EOS DIGITAL cameras are contained on the EOS DIGITAL Solution Disk.

EOS Utility

With the camera connected to a computer, EOS Utility enables you to transfer still photos and movies shot with the camera to the computer. You can also use this software to set various camera settings and shoot remotely from the computer connected to the camera.

Digital Photo Professional

This software is recommended for users who shoot RAW images. You can view, edit, and print RAW and JPEG images.

* Some functions differ between the version to be installed on a 64-bit computer and that to be installed on a 32-bit computer.

Picture Style Editor

You can edit Picture Styles, and create and save original Picture Style files. This software is aimed at advanced users who are experienced in processing images.

Installing the Software



- **Do not connect the camera to your computer before you install the software. The software will not be installed correctly.**
- If there is a previous version of the software already installed on your computer, follow the procedure below to install the latest version. (The previous version will be overwritten.)

- 1 Insert the EOS DIGITAL Solution Disk into your computer.**
 - For Macintosh, double-click to open the CD-ROM icon displayed on the desktop, then double-click on **[setup]**.
- 2 Click [Easy Installation] and follow the on-screen instructions to install.**
- 3 Click [Restart] and remove the CD-ROM after the computer restarts.**
 - When the computer has restarted, the installation is complete.

Software Instruction Manual



Software Instruction Manuals are contained on the EOS DIGITAL Solution Disk. You can copy and view the software instruction manual (PDF files) as follows:

1 Insert the EOS DIGITAL Solution Disk into your computer.

2 Close the install screen.

- When the EOS DIGITAL Solution Disk install screen appears, close the install screen.

3 Open the CD-ROM.

4 Open the [Manual] folder.

5 Copy the [English] folder to your computer.

- Instruction Manual PDFs with the names below are copied.

	Windows	Macintosh
EOS Utility	EUx.xW_E_xx	EUx.xM_E_xx
Digital Photo Professional	DPPx.xW_E_xx	DPPx.xM_E_xx
Picture Style Editor	PSEx.xW_E_xx	PSEx.xM_E_xx

6 Double-click the copied PDF file.

- Adobe Reader (most recent version recommended) must be installed on your computer.
- Adobe Reader can be downloaded free from the Internet.

Index

Numerics

1:1 (aspect ratio).....	154, 262
1.3x (crop).....	154, 262
1.6x (crop).....	154, 262
10- or 2-sec. self-timer	144
1280x720 (movie).....	297
16:9 (aspect ratio).....	154, 262
1920x1080 (movie).....	297
4:3 (aspect ratio).....	154, 262
61-point automatic selection	
AF	91, 97
640x480 (movie).....	297

A

 (Scene Intelligent Auto).....	80
AC Adapter	450
Acceleration/ deceleration tracking.....	115
Access lamp.....	45, 46
Accessories.....	3
Adjust all by same amount.....	134
Adjust by lens.....	136
Adobe RGB.....	193
AE lock.....	217
AEB (Auto Exposure Bracketing) ..	215, 403
AF	85
AF area selection mode.....	90, 92, 95
AF-assist beam.....	121
AF Configuration Tool.....	109
AF group.....	100
AF method.....	268, 315
AF Microadjustment.....	134
AF-ON (AF start) button.....	55, 414, 416
AF operation.....	86
AF point	90, 93, 95, 99
AF point expansion.....	90, 95

AF point registration.....	418
AF point selection	93, 421
Area AF frame.....	91, 97
Beeper	69
Color information.....	129
Cross-type focusing	99
Customization	118
Direct AF point selection	421
Dual cross-type focusing.....	99
f/8 AF limit.....	99, 104
Facial information.....	129
Manual focusing (MF)	141, 275
Out of focus.....	54, 55, 474
Recomposing.....	83, 217
Spot AF point	31, 95
Subjects difficult for AF ...	140, 273
AI FOCUS (AI Focus AF)	88
AI SERVO (AI Servo AF).....	88
Acceleration/ deceleration tracking.....	115
AF Operation indicator	89, 132
AF point auto switching.....	116
AF points light up in red	89, 132
AF sensor.....	99
Tracking sensitivity.....	114
ALL-I (For editing/I-only).....	298
Ambience priority (AWB)	175
Ambient light sensor.....	28, 361
Anti-flicker shooting	191
Aperture-priority AE.....	208, 282
Area AF frame	91, 97
Aspect ratio	154, 262
Attenuator	301
Auto ()	165
Auto Lighting Optimizer	79, 182
Auto playback.....	348
Auto power off	47, 69
Auto reset.....	200
Auto rotate vertical images.....	362

Auto switch card 147
 Autofocus → AF
 Automatic selection (AF)..... 91, 97
 Av (Aperture-priority AE)..... 208, 282

B

B (Bulb)..... 218, 280
 Battery 40, 42, 48, 446
 Battery Grip..... 48, 446, 454
 Beeper 69, 81, 144
 Black-and-white
 images 166, 171, 384
 Bracketing
 AEB (Auto exposure
 bracketing)..... 215, 403
 FEB
 (Flash exposure bracketing)..... 251
 WB-BKT (White balance
 bracketing)..... 180, 403
 Bulb exposures 218
 Bulb timer 219
 buSY (BUSY)..... 153

C

C (Custom shooting)..... 437
 Cable 3, 351, 380, 393, 454, 518
 Protector 36
 Camera
 Camera shake 54
 Clearing the camera settings..... 70
 Holding the camera 54
 Settings display 443
 Cards 5, 25, 43, 67
 Card reminder 44
 Formatting 67
 Low-level formatting 68
 Troubleshooting 46, 68
 Write protection 43
 Case 109

Center-weighted average
 metering 213
 CF card → Cards
 Charger 34, 40
 Chromatic aberration correction... 189
 Cleaning (image sensor) 373
 Clearing the camera settings 70
 AI Servo AF characteristics 117
 Camera function settings 70
 Custom Controls
 (buttons & dials)..... 413
 Custom Function settings 401
 Custom Quick Control settings 428
 Flash Custom Function
 settings 253
 My menu 435
 Clipped highlights 325
 CLn..... 377
 Color saturation..... 170
 Color space 193
 Color temperature 174, 178
 Color tone..... 170
 Continuous AF 264
 Continuous file numbering 199
 Continuous shooting 142
 Contrast..... 170, 182
 Copyright information 201
 Creative photo 164, 221, 226
 ☆ (Creative Zone) icon 8
 Crop (when shooting)..... 154, 262
 Cropping (for printing) 387
 Cropping (images)..... 371
 Cropping information 411
 Cross-type focusing 99
 Custom Controls 413
 Custom functions 400, 402
 Custom Quick Control 427
 Custom shooting mode 437
 Custom WB 176

D



D+	187
Date/time	49
Daylight saving time	50
DC Coupler	450
Default settings tables	70, 71, 72, 73
Depth-of-field preview	209
Detailed information (shooting)	323
Dials	
Main Dial	56
Quick Control Dial	57
Digital	
terminal	27, 36, 380, 393, 518
Dimmed menu items	66
Dioptric adjustment	54
Direct printing	379
Direct selection of AF point	421
Downloading images	
(to a computer)	518
DPOF	
(Digital Print Order Format)	389
Drive mode	142
Dual cross-type focusing	99
Dust Delete Data	375

E

Electronic level	75, 76
Erasing images	358
Err	29, 487
Error codes	487
Evaluative metering	212
exFAT	68
Exposure compensation	214
Exposure compensation with	
Auto ISO	211
Exposure level increments	402
Exposure level	
indicator	30, 32, 258, 289

Exposure maintained for	
new aperture	406
Exposure simulation	265
External Speedlite → Flash	
Eyecup	236
Eye-Fi cards	451
Eyepiece cover	35, 236

F

Faithful ()	166
FE lock	244
Feature guide	78
FEB	251
File extension	198
File name	196
Underscore “_”	193, 198
File size	151, 298, 323
Filter effects	171
Final image simulation	261, 292
Fine (image-recording	
quality)	149, 151
Fine Detail ()	165
Fineness (Sharpness)	170
Firmware	468
First-curtain synchronization	251
Flash (Speedlite)	243
Custom Functions	253
External flash	244
FEB	
(Flash exposure bracketing)	251
FE lock	244
Flash control	247
Flash exposure	
compensation	244, 251
Flash mode	249
Flash sync contacts	26
Flash sync speed	245, 248
Flash sync. speed in Av	
mode	248

Manual flash	249
Shutter synchronization (1st/2nd curtain)	251
Focus indicator	80
Focus lock.....	83
Focus mode switch.....	6, 52, 141, 275
Focusing → AF, Manual Focusing (MF)	
Focusing point (AF point).....	90, 93, 95, 99
Folder creation/selection.....	194, 195
For editing (ALL-I).....	298
Formatting (card initialization).....	67
Frame rate	297
Free run	303
Full Auto mode.....	80
Full High-Definition (Full HD) (movie)	279, 297
Full-frame (3:2)	154, 262
Functions settable by shooting mode	456

G

Grid.....	74, 265, 315, 321
-----------	-------------------

H



HD (movie).....	297
HDMI.....	36, 342, 351
HDMI CEC	352
HDR.....	221
Help	78
High ISO speed noise reduction ...	183
High-Definition (HD) movies	297
Highlight alert.....	325
Highlight tone priority	187
High-speed continuous shooting ..	142
Histogram (Brightness/RGB).....	258, 289, 326
Hot shoe	26, 244





Household power	450
-----------------------	-----

I

ICC profile	193
Icon	8
Illumination (AF point)	132
Illumination (LCD panel).....	59
Image dust prevention.....	373
Image-recording quality.....	149, 297
Image review time	70
Images	
AF point display	325
Auto playback	348
Auto reset	200
Auto rotation	362
Continuous numbering.....	199
Copying.....	354
Downloading images (to a computer)	518
Erase	358
Highlight alert.....	325
Histogram	326
Image file numbering	199
Index display.....	327
Jump display (image browsing)	328
Magnification.....	330
Manual reset	200
Manual rotation	333
Playback	319
Protection.....	334
Rating	337
Shooting information.....	322
Size.....	151, 298, 323
Slide show	348
Transfer.....	393
Two-image display	332
Viewing on a TV set.....	342, 351
Index display	327
INFO. button... 60, 258, 289, 320, 442	

- Initial AF Point..... 128
Interval timer 239
IPB (Standard) 298
ISO speed 158, 283, 287
 Automatic setting (Auto) 160
 Automatic setting range 162
 ISO expansion 161
 Manual setting range 161
 Minimum shutter speed 163
 Setting increments 402
iTR AF 129
- J**
- JPEG 149, 151
Jump display 328
- L**
- Landscape () 165
Language 51
Large
(image-recording quality) 151, 369
LCD monitor 24
 Brightness adjustment 361
 Electronic level 75, 76
 Image playback 319
 Menu display 64, 460
 Shooting function settings .. 60, 444
LCD panel 29
 Illumination 59
Lens 25, 52
 Chromatic aberration
 correction 189
 Focus mode
 switch 6, 52, 141, 275
 Group for usable AF points 100
 Lock release 53
 Peripheral illumination
 correction 188
Live View shooting 84, 255
 Crop/aspect ratio 262
 Exposure simulation 265
 Face+Tracking 269
 FlexiZone - Single 271
 Grid display 265
 Information display 258
 Manual focusing (MF) 275
 Metering timer 267
 Possible shots 257
 Quick Control 263
 Silent shooting 266
LOCK 59, 410
Long exposure noise reduction 185
Long exposures 218
Low-speed continuous shooting... 142
- M**
- M (Manual exposure) 210, 286
Magnification 274, 275, 330
 Initial position 331
Main Dial 56
Malfunction 471
Manual exposure 210, 286
Manual focusing (MF) 141, 275
Manual reset 200
Manual selection
(AF point) 90, 93, 95
Maximum burst 151, 153
Medium
(image-recording quality) 151, 369
Memory cards → Cards
Menu 64
 My Menu 432
 Setting procedure 65
 Settings 460
MENU icon 8
Metering mode 212
Metering timer 55, 267, 316
M-Fn 92, 126, 415, 417
Microadjustment 134

- Microphone 280, 301
- Mirror lockup 234
- Mode Dial 33, 56
- Monochrome () 166
- Monochrome images 384
- Movies 279
- AE lock 284
 - AF method 295, 315
 - Aperture-priority AE 282
 - Attenuator 301
 - Autoexposure shooting 280
 - Compression method 298
 - Count up 303
 - Drop frame 305
 - Editing out first and last scenes 346
 - Enjoying movies 342
 - File size 298, 299
 - Frame rate 297
 - Free run 303
 - Grid 315
 - Information display 289
 - Manual exposure shooting 286
 - Metering timer 316
 - Microphone 280, 301
 - Movie shooting button 280, 316
 - Playback 342, 344
 - Quick Control 296
 - Rec run 303
 - Recording size 297
 - Recording time 298
 - Recording/playback count 304
 - Servo AF 313
 - Shutter-priority AE 281
 - Silent control 302
 - Silent shooting 315
 - Sound recording 300
 - Start time setting 303
 - Stills 293
 - Time code 303
 - Time-lapse 306
 - Viewing on a TV set 342, 351
 - Wind filter 301
- M-RAW
(Medium RAW) 149, 151, 152
- Multi function 92, 126, 415, 417
- Multi function lock 59, 410
- Multi Shot Noise Reduction 183
- Multi-controller 58
- Multiple exposures 226
- My Menu 432
- ## N
- Neutral () 165
- Noise reduction
- High ISO speed 183
 - Long exposures 185
- Nomenclature 26
- Non-Canon flash units 245
- Normal
(image-recording quality) 149, 151
- NTSC 297, 351, 467
- ## O
- ONE SHOT (One-Shot AF) 87
- One-Shot AF 87
- One-touch image
quality setting 153, 424
- ## P
- P (Program AE) 204, 280
- PAL 297, 351, 467
- Partial metering 212
- PC terminal 245
- Peripheral illumination correction . 188
- Personal white balance 177
- Photobook set-up 397
- PictBridge 379
- Picture Style 164, 168, 172

- Pixels 149, 151, 157
 Playback 319
 Portrait () 165
 Possible recording time
 (movie) 291, 298
 Possible shots 48, 151, 257
 Power 47
 Auto power off 47, 69
 Battery information 446
 Battery level 48, 446
 Household power 450
 Possible shots 48, 151, 257
 Recharge performance 446
 Recharging 40
 Pressing completely 55
 Pressing halfway 55
 Printing 379
 Cropping 387
 Direct printing 379
 Page layout 383
 Paper settings 383
 Photobook set-up 397
 Print order (DPOF) 389
 Printing effects 384
 Tilt correction 387
 Program AE 204, 280
 Program shift 205
 Protecting images 334
- ## Q
-  (Quick Control) 61, 263, 296, 340
 Quick Control Dial 57
- ## R
- Rating mark 337
 RAW 149, 151, 152
 RAW image processing 364
 RAW+JPEG 149, 151
 Rec run 303
 Recharging 40
 Record function 146
 Record separately (CF and SD) ... 147
 Record to multiple 147
 Recording level 300
 Reduced display 327
 Release shutter without card 44
 Remote control shooting 237
 Remote switch 237
 Resizing 369
 Rotation (image) 333, 362
- ## S
- Safety precautions 20
 Safety shift 405
 Scene icons 260, 285
 Scene Intelligent Auto 80
 SD (VGA/movie) 297
 SD, SDHC, SDXC cards → Cards
 Second-curtain synchronization ... 251
 Self-timer 144, 238
 Sensitivity → ISO speed
 Sensor cleaning 373
 Sepia (Monochrome) 171
 Servo AF 83, 88, 313
 Sharpness 170
 Shooting area 154
 Shooting function settings 60, 444
 Shooting information display 322
 Shooting modes 33
 Av (Aperture-priority AE) 208
 B (Bulb) 218
  (Custom shooting) 437
 M (Manual exposure) 210
 P (Program AE) 204
 Tv (Shutter-priority AE) 206
  (Scene Intelligent Auto) 80
 Shooting orientation registration... 126
 Shutter button 55

Shutter synchronization 251
 Shutter-priority AE 206, 281
 Silent shooting
 Silent continuous shooting 142
 Silent LV shooting 266, 315
 Silent single shooting 142
 Single shooting 142
 Single-image display 320
 Single-point AF 90, 95, 271
 Single-point Spot AF 90, 95
 Slide show 348
 Small
 (image-recording quality) 151, 369
 Software 520
 Speaker 28, 344
 Specifications 488
 Spot AF point 31, 95
 Spot metering 213
 S-RAW (Small RAW) 149, 151, 152
 sRGB 193
 Standard (IPB) 298
 Standard () 165
 Stop down aperture 209
 Strap 35
 Strength (Sharpness) 170
 System map 454

T

Temperature warning 277, 317
 Threshold (Sharpness) 170
 Time code 303
 Time zone 49
 Time-lapse movie 306
 Tone priority 187
 Toning effect (Monochrome) 171
 Touch pad 58, 302
 Tracking sensitivity 114
 Tripod socket 28
 Troubleshooting guide 471

Tv (Shutter-priority AE) 206, 281
 Two-image display 332

U

Ultra DMA (UDMA) 44
 Underscore “_” 193, 198
 USB (DIGITAL)
 terminal 27, 36, 380, 393, 518
 User Def. () 166

V

VGA (movie) 297
 Video system 297, 351, 467
 Viewfinder 31
 Dioptic adjustment 54
 Electronic level 76
 Grid 74
 Information display 77
 Viewing on a TV set 342, 351
 Volume (movie playback) 345

W

Warning icon 409
 White balance (WB) 174
 Auto 175
 Bracketing 180
 Color temperature setting 178
 Correction 179
 Custom 176
 Personal 177
 White priority (AWB) 175
 Wind filter 301

Z

Zone AF 91, 96

Canon

The descriptions in this Instruction Manual are current as of February 2017. For information on the compatibility with any products introduced after this date, contact any Canon Service Center. For the latest version Instruction Manual, refer to the Canon Web site.