

ENGLISH



**Canon**

**PowerShot SD630**  
DIGITAL ELPH

**DIGITAL  
IXUS 65**



Preparations

Shooting

Playback/Erasing

Menus and Settings

Printing

Downloading Images  
to a Computer

**Canon**

**Basic**

## **Camera User Guide**

**Please Read This First**

This guide explains how to prepare the camera and use its basic features.

## Flowchart and Reference Guides

The following guides are available. Refer to them as necessary according to the flowchart below.

For information on included items and items sold separately



System Map

### Preparations

- Charging the battery
- Installing the battery and memory card
- Setting the date, time and language

### Shooting

### Playback/Erasing

### Menus and Settings



Basic Camera User Guide (This Guide)  
• Read this first.

Handling precautions, references to the various shooting and playback functions



Advanced Camera User Guide

### Printing



Direct Print User Guide

- Installing the software
- Downloading images to a computer
- Using the software



Basic Camera User Guide (This Guide)



Software Starter Guide



ZoomBrowser EX/  
ImageBrowser  
Software User Guide  
• PDF manuals available on the Canon website.  
<http://web.canon.jp/Imaging/information-e.html>

In this guide, the *Basic Camera User Guide* is called the *Basic Guide*, and the *Advanced Camera User Guide* is called the *Advanced Guide*. Also, "battery" refers to the battery pack.

# Preparations

## 1. Charging the Battery.

Charge the battery before use under the following circumstances.

- When using the battery for the first time.
- When the "Change the battery pack" message displays.

### 1. Insert the battery into the battery charger.

### 2. Plug the battery charger (CB-2LV) into a power outlet, or attach the power cord to the battery charger (CB-2LVE) and plug it into a power outlet.

- Battery charger model names and types vary by region.
- The charge indicator will light orange while the battery is charging. It will change to green when the charge is complete. Charging takes approximately 1 hour 30 minutes.

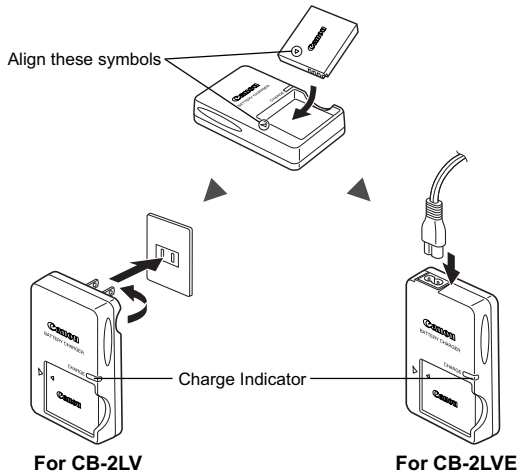

To protect the battery and prolong its life, do not charge it for longer than 24 hours continuously.

➔ See the *Advanced Guide: Battery Handling* (p. 113).

## 2. Installing the Battery.

1. Slide the memory card slot/battery cover and open it (①, ②).
2. Push the battery lock in the direction of the arrow (③) and insert the battery until it locks.  
To remove the battery, push the battery lock in the direction of the arrow (③) and hold it while pulling the battery out.

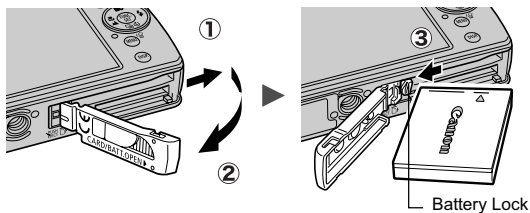

## 3. Inserting the Memory Card.

1. Insert the memory card until it clicks into place.
2. Close the memory card slot/battery cover (①, ②).

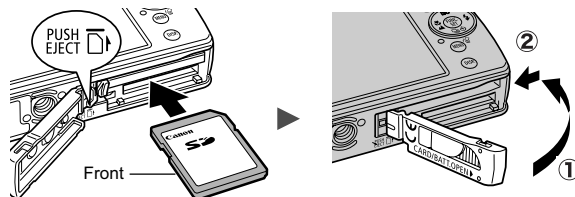

Ensure that the memory card is correctly oriented before inserting it in the camera. It may damage the camera if inserted incorrectly.

- ➔ See the *Advanced Guide: Handling the Memory Card* (p. 115).
- ➔ See the *Advanced Guide: Formatting Memory Cards* (p. 32).

■ **To Remove the Memory Card**

Push the memory card with your finger or the toggle on the wrist strap until the memory card clicks and then release it.

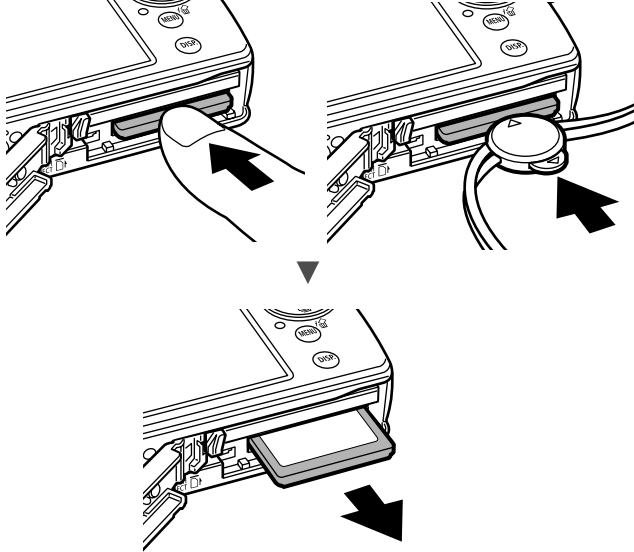

You can use SD\* memory cards and MultiMediaCards with this camera. These cards are collectively called memory cards in this guide.  
\*SD stands for Secure Digital, a copyright protection system.

## First Time Settings

### ■ Setting the Date/Time

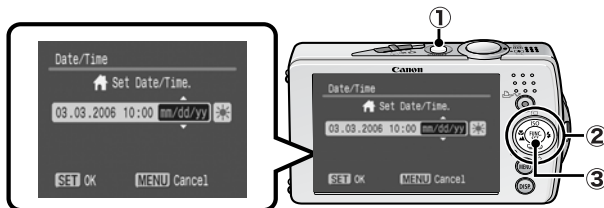

1. Press the power button ( ① ).
2. Use the ◀ or ▶ button to select an item and the ▲ or ▼ button to change its value ( ② ).  
To set the daylight saving option, use the ▲ or ▼ button to display .
3. Confirm that the correct time is displayed and press the FUNC./SET button ( ③ ).

The date and time can also be set in the Set up menu (p. 14).



- A rechargeable lithium battery is built into the camera to save such settings as the date/time. This battery charges when the main battery is in the camera. When you purchase the camera, place the main battery in it for approximately four hours or use AC Adapter Kit ACK-DC10 (sold separately) to charge the lithium battery. It will charge even if the camera is turned off.
- The date/time settings may be lost after approximately three weeks if you remove the main battery. Reset the date/time settings if this occurs.

➡ See the *Advanced Guide*: Setting the World Clock (p. 23).

### ■ Setting the Display Language

1. Slide the mode switch to  (playback).
2. Hold down the FUNC./SET button and press the MENU button.
3. Use the ▲, ▼, ◀ or ▶ button to select a language and press the FUNC./SET button.

The display language can also be set in the Set up menu (p. 14).

# Shooting

## 1. Press the power button.

The start-up sound will play and the start-up image will display in the LCD monitor.

- Pressing the power button again turns the power off.
- To switch to the setting that mutes all sounds (except for the warning sound), press and hold the **MENU** button while pressing the power button.

Power button

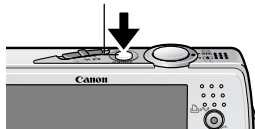

➔ See the *Advanced Guide: Using the LCD Monitor* (p. 16).



➔ See the *Advanced Guide: Power Saving Function* (p. 22).

➔ See the *Advanced Guide: Set up Menu* (p. 28).

➔ See the *Advanced Guide: My Camera Menu* (p. 30).

## 2. Set the shooting mode to (Auto).

1. Slide the mode switch to  (Rec.) (①).

2. Press the FUNC./SET button (②) and use the  or  button (③) to select  (auto).

3. Press the FUNC./SET button (④).

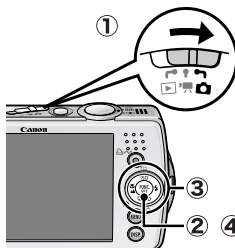

## 3. Aim the camera at the subject.

## 4. Focus and shoot.

1. Press the shutter button halfway to focus.

When the camera focuses, the camera beeps twice and the indicator lights green.

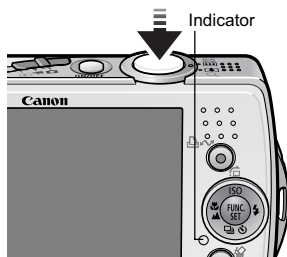

## 2. Press the shutter button fully to shoot.

The shutter sound will play and the image will record. The indicator will blink green while the image is recorded to the memory card.

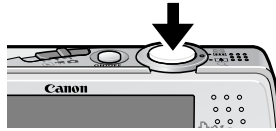

- ➔ See Basic Shooting Functions (p. 6).
- ➔ See the *Advanced Guide: Indicator* (p. 22).
- ➔ See the *Advanced Guide* for the various shooting methods available.

## Reviewing an Image Right After Shooting

After a shot is taken, the image appears in the LCD monitor for approximately 2 seconds.

You can continue to display images regardless of the review duration setting with the following procedures.





- Keeping the shutter button pressed after a shot.
- Pressing the **FUNC./SET** or **DISP.** button while the image is displayed in the LCD monitor.

To stop displaying the image, press the shutter button halfway.

- ➔ See the *Advanced Guide: Review* (p. 27).
- ➔ See Basic Erasing (p. 12).

## Basic Shooting Functions

### ■ Selecting a Shooting Mode

1. Slide the mode switch to  (Rec.) or  (Movie) ( ① ).
2. Press the **FUNC./SET** button ( ② ) and use the  or  button ( ③ ) to select a shooting mode.

For a scene mode (p. 7), select the  mode (default setting) and press the **MENU** button to select the desired mode.



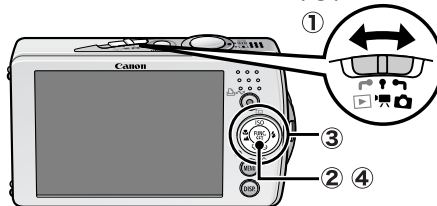













3. Press the **FUNC./SET** button ( ④ ).













## ■ Shooting Modes

### 📷 Still Images

<p> <b>Auto</b> The camera automatically selects settings.</p>	
<p> <b>Manual</b> Allows you to select settings yourself, such as the exposure compensation, white balance, my colors or ISO speed.</p>	
<p> <b>Stitch Assist</b> Allows you to shoot overlapping images that can later be merged (stitched) to create one panoramic image on a computer. Select [Stitch Assist] from the [📷 (Rec.)] menu. ➔ See the <i>Advanced Guide</i> (p. 44).</p>	
<p> <b>Digital Macro</b> Allows you to shoot when the distance from the lens (at maximum wide angle) to the subject is within 3 – 10 cm (1.2 – 3.9 in.). The subject can be shown larger than in standard macro mode because the camera trims the image edges and zooms in with the digital zoom. ➔ See the <i>Advanced Guide</i> (p. 34).</p>	
<p> <b>Portrait</b> Produces a soft effect when photographing people.</p>	
	<p> <b>Night Snapshot</b> Allows you to take snapshots of people against twilight or night backgrounds by reducing the effects of camera shake even without using a tripod.</p>
<p></p>	
<p><b>Scene Mode</b> You can shoot with the most appropriate settings for a scene.</p>	
<p> <b>Kids&amp;Pets</b> Allows you to capture subjects that move around, such as children and pets, without missing photo opportunities.</p>	
	<p> <b>Indoor</b> Prevents camera shake and maintains the subject's true color when shooting under fluorescent or tungsten lighting.</p>
	
<p> <b>Foliage</b> Shoots trees and leaves—such as new growth, autumn leaves or blossoms—in vivid colors.</p>	
	<p> <b>Snow</b> Shoots without a blue tinge and without making people appear dark against a snowy background.</p>
	

 <b>Beach</b> Shoots without making people appear dark near water or sand where reflected sunlight is strong.	 <b>Fireworks</b> Captures fireworks in the sky sharply and at optimal exposure.
 <b>Underwater</b> Appropriate for shooting images with Waterproof Case WP-DC3 (sold separately). This mode uses an optimal white balance setting to reduce bluish tones and record images with a natural hue.	
 <b>Color Accent</b> Use this option to have only the color specified in the LCD monitor remain and to transform all others to black and white.	 <b>Color Swap</b> Use this option to transform a color specified in the LCD monitor into another.
 See the <i>Advanced Guide</i> (p. 60).	 See the <i>Advanced Guide</i> (p. 61).

## Movie

 **Movie**  
 Shoots a movie when you press the shutter button. You can select from the following modes: [Standard] suitable for sports or fast motion; [Fast Frame Rate] suitable for sports or fast motion; [Compact] convenient for email attachments; [Color Accent] for recording all colors in black and white except for the selected color; and [Color Swap] for recording a selected color as a different color.  See the *Advanced Guide* (p. 40).

-  The shutter speed is slow in [Standard] mode. Always use a tripod to avoid camera shake.
- In [Standard], [Fast Frame Rate], [Compact], [Color Accent], [Color Swap], [A], [S], [A/S], or [S/A] mode, the ISO speed may increase and cause noise in the image depending on the scene being shot.
- In [Standard] mode, shoot with the subject 1 m (3.3 ft.) or more from the end of the lens.

-  To shoot underwater, install the camera in Waterproof Case WP-DC3 (sold separately).
- We recommend you use Waterproof Case WP-DC3 for shooting at ski resorts or beaches.

## ■ Using the Zoom

### 1. Press the zoom lever toward or .

The zoom can be adjusted from 35 – 105 mm (focal length) in 35mm film equivalent terms.



 **Wide Angle:** Zooms out from the subject.

 **Telephoto:** Zooms in on the subject.





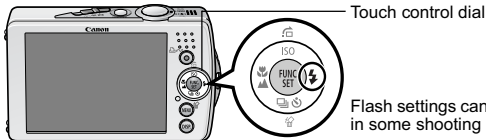

## ■ Using the Flash

### 1. Press the button to cycle through flash settings.

Placing a finger on the touch control dial displays the touch icons on the LCD monitor.



Flash settings cannot be used in some shooting modes.

- ▶  **Auto**
- ▶  **Auto Red-eye Reduction**
- ▶  **Red-eye Reduction On**
- ▶  **On**
- ▶  **Off**
- ▶  **Slow synchro**

#### Red-eye reduction

This feature reduces the effect of light reflecting back from the eyes and making them appear red.

#### Slow synchro

The flash timing is adjusted to a slow shutter speed, allowing you to shoot night scenes.





You are recommended to shoot with the camera attached to a tripod or other device if the camera shake warning icon  appears.

▶ See the *Advanced Guide: Functions Available in Each Shooting Mode* (p. 136).

▶ See the *Advanced Guide: Touch Control Dial* (p. 15).

## ■ Shooting Close-Ups/Infinity Shots

### 1. Press the button to switch modes.

To cancel the macro/infinity mode: press the  button to remove  or  from the display.

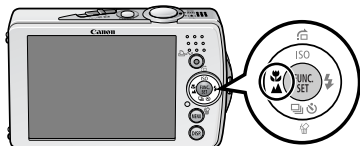

These settings cannot be set in some shooting modes.

#### Macro

Use this mode to shoot close-ups of flowers or small items.



Image Area at Minimum Shooting Distance from End of Lens to Subject

- Maximum wide angle setting: 37 × 27 mm (1.5 × 1.1 in.)  
Minimum shooting distance: 3 cm (1.2 in.)
- Maximum telephoto setting: 108 × 81 mm (4.3 × 3.2 in.)  
Minimum shooting distance: 30 cm (12 in.)



#### Infinity

Use this mode to record subjects 3 m (9.8 ft.) or more from the end of the lens.



The exposure may not be optimal when the flash is used in macro mode.

➔ See the *Advanced Guide: Touch Control Dial* (p. 15).

➔ See the *Advanced Guide: Functions Available in Each Shooting Mode* (p. 136).



## Playback

### 1. Slide the mode switch to (playback) (①).

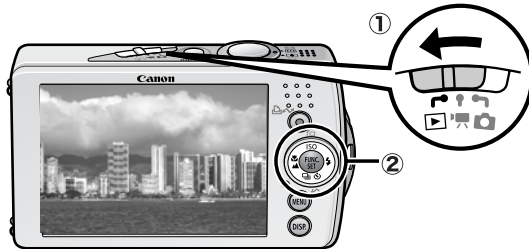
The last recorded image will appear in the LCD monitor.



### 2. Use the or button to display the image you wish to view (②).

- Use the  button to move to the previous image and the  button to move the next image. Holding the button down advances the images more rapidly, but shows them less clearly.
- Placing a finger on the touch control dial displays the touch icons on the LCD monitor.
- Circling a fingertip to the left or right on the touch control dial selects an image as follows. Moving fingertip in a counterclockwise direction displays the previous image, and clockwise displays the next image.

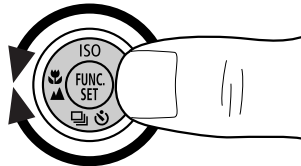

 See the *Advanced Guide* for the various playback methods available.

 See the *Advanced Guide: Touch Control Dial* (p. 15).

## Erasing

1. In the playback mode, use the **←** or **→** button to select an image to erase (1) and press the **⏏** button (2).

You can also select an image with the touch control dial.



2. Confirm that [Erase] is selected and press the **FUNC./SET** button (3).

To exit instead of erasing, select [Cancel].



**Please note that erased images cannot be recovered.  
Exercise adequate caution before erasing an image.**

➔ See the *Advanced Guide: Erasing All Images* (p. 89).

## Menus and Settings

Settings for the shooting or playback modes or such camera settings as the print settings, date/time and sounds are set using the FUNC. menu or the Rec., Play, Print, Set up or My Camera menu.

### FUNC. Menu

This menu sets many of the common shooting functions.

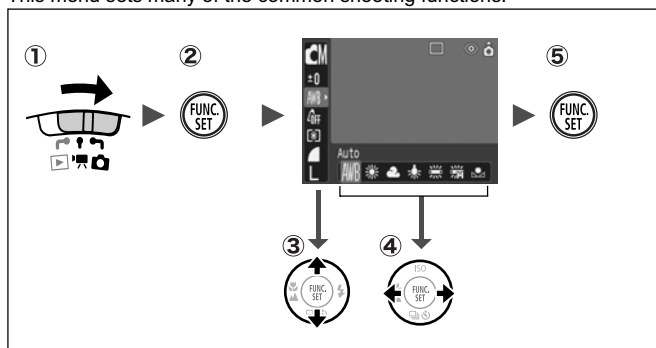

- 1 Slide the mode switch to or .
- 2 Press the FUNC./SET button.
- 3 Use the or button to select a menu item.
  - Some items may not be selectable in some shooting modes.
- 4 Use the or button to select an option for the menu item.
  - You can select further options with the MENU button for some options.
  - After selecting an option, you can press the shutter button to shoot immediately. After shooting, this menu will appear again, allowing you to adjust the settings easily.
- 5 Press the FUNC./SET button.

See the *Advanced Guide: Menu List* (p. 27).

## Rec., Play, Print, Set up and My Camera Menus

Convenient settings for shooting, playback or printing can be set with these menus.

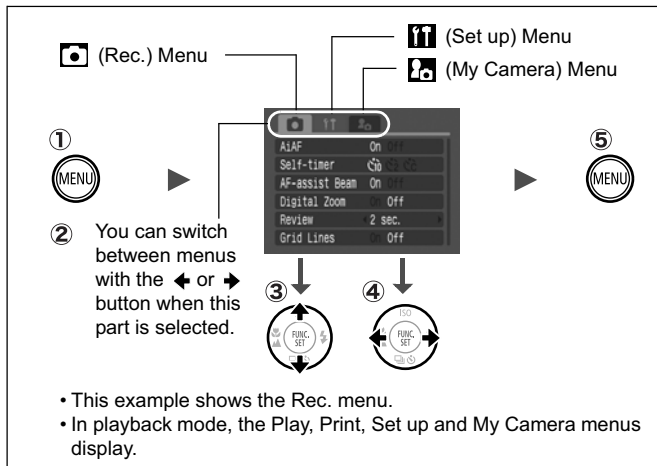

① **Press the MENU button.**

② **Use the ← or → button to switch between menus.**

- You can also use the zoom lever to switch between menus.

③ **Use the ↑ or ↓ button to select a menu item.**

- Some items may not be selectable in some shooting modes.

④ **Use the ← or → button to select an option.**

- Menu items followed by an ellipsis (...) can only be set after pressing the **FUNC./SET** button to display the next menu.

Press the **FUNC./SET** button again to confirm the setting.

⑤ **Press the MENU button.**

➡ See the *Advanced Guide: Menu List* (p. 27).



## Printing

You can easily print by connecting the camera to a direct print compatible printer\*<sup>1</sup> with a cable and simply pressing the  button on the camera.

- 1. Connect the camera to a *Direct Print* compatible printer and turn on the printer's power.**

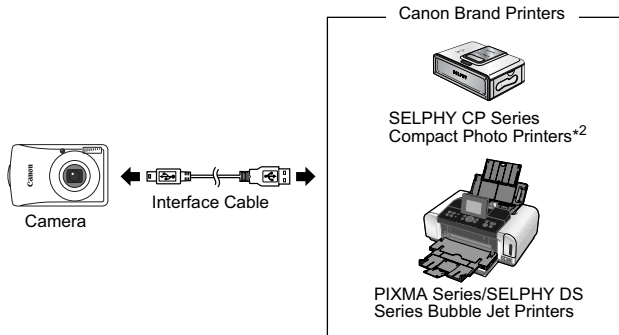



\*<sup>1</sup> Since this camera uses a standard protocol (PictBridge), you can use it with other PictBridge-compliant printers in addition to Canon-brand printers.

\*<sup>2</sup> You can also use card photo printers such as the CP-10/CP-100/CP-200/CP-300.

---

**2. Set the camera to the playback mode, turn on the power and confirm that ,  or  is displayed in the upper left of the LCD monitor (1).**

- The  button will light blue.
- The displayed icon will vary according to the printer model.

**3. Use the  or  button to select an image to print (2) and press the  button (3).**

- You can also select an image with the touch control dial.
- The  button will blink blue and printing will start.



 See the *Advanced Guide: Setting the DPOF Print Settings* (p. 90).

 See the *Direct Print User Guide*.

 See the user guide for your printer.

## Downloading Images to a Computer

The following methods can be used to download images recorded by the camera to a computer. Some methods, depending on the OS used, may not be available. Please read *System Requirements* (p. 18) in advance.

### ■ Camera to Computer Connection

Supplied Software	Install It		Do Not Install It
	Computer Procedure	Camera Procedure	Computer Procedure
OS Windows 98 Second Edition (SE)	●	●	—
Windows 2000	●	●	—
Windows Me	●	●	—
Windows XP	●	●	●
Mac OS X	●	●	●

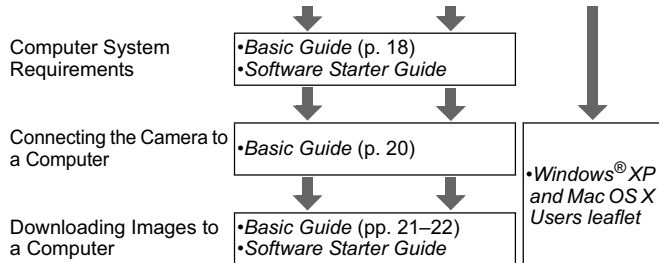

### ■ Using a Memory Card Reader

A memory card reader can be used with all the operating systems listed above. See the *Software Starter Guide* for details.

## System Requirements

Please install the software on a computer meeting the following minimum requirements.

### ■ Windows

OS	Windows 98 Second Edition (SE) Windows Me Windows 2000 Service Pack 4 Windows XP (including Service Pack 1 and Service Pack 2)	
Computer Model	The above OS should be pre-installed on computers with built-in USB ports.	
CPU	Pentium 500 MHz or higher processor	
RAM	Windows 98 SE/Windows Me	128 MB or more
	Windows 2000/Windows XP	256 MB or more
Interface	USB	
Free Hard Disk Space	<ul style="list-style-type: none"> <li>• Canon Utilities</li> <li>- ZoomBrowser EX                      200 MB or more</li> <li>- PhotoStitch                              40 MB or more</li> <li>• Canon Camera TWAIN Driver        25 MB or more</li> <li>• Canon Camera WIA Driver            25 MB or more</li> <li>• ArcSoft PhotoStudio                  50 MB or more</li> </ul>	
Display	1,024 x 768 pixels/High Color (16 bit) or better	

### ■ Macintosh

OS	Mac OS X (v10.2–v10.4)	
Computer Model	The above OS should be pre-installed on computers with built-in USB ports.	
CPU	PowerPC G3/G4/G5	
RAM	256 MB or more	
Interface	USB	
Free Hard Disk Space	<ul style="list-style-type: none"> <li>• Canon Utilities</li> <li>- ImageBrowser                          200 MB or more</li> <li>- PhotoStitch                              40 MB or more</li> <li>• ArcSoft PhotoStudio                  50 MB or more</li> </ul>	
Display	1,024 x 768 pixels/32,000 Colors or better	

---

## Preparing to Download Images

**Ensure that you install the software first before connecting the camera to the computer.**

### ■ Items to Prepare

- Camera and computer
- Canon Digital Camera Solution Disk supplied with the camera
- Interface cable supplied with the camera

### 1. Install the software.

1. Place the Canon Digital Camera Solution Disk in the computer's CD-ROM drive.

**Macintosh** Double-click the [Canon Digital Camera Installer] icon in the CD-ROM window. When the installer panel appears, click [Install].



2. Click [Easy Installation].

**Macintosh** Select [Easy Installation] as the setup type and click [Next].

Proceed with the installation while reviewing installation settings.

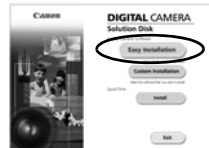

3. When the installation is finished, the [Finish] or [Restart] button appears. Click the one that appears.

**Macintosh** When the installation is finished, click [Exit].

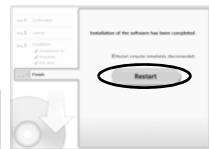

4. When the screen returns to the desktop display, remove the Canon Digital Camera Solution Disk from the CD-ROM drive.

## 2. Connecting the camera to a computer.

### 1. Connect the supplied interface cable to the computer's USB port and to the camera's DIGITAL terminal.

1. Slip your fingernail under the upper end of the camera's terminal cover and pull it open.
2. With the  facing in the direction shown, insert the interface cable all the way.

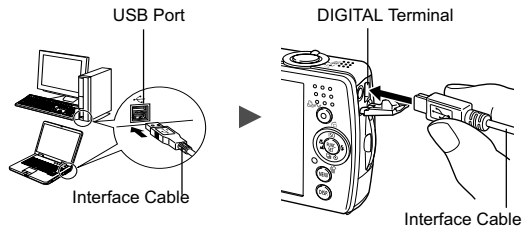

### 2. Slide the camera's mode switch to (playback) and turn on the power.

The camera and computer will be able to communicate.

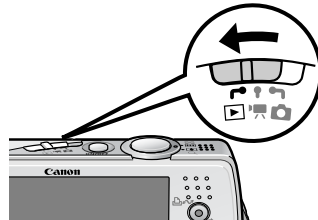

Always grasp the sides of the connector when disconnecting the interface cable from the camera's DIGITAL terminal.

**Windows** If the Digital Signature Not Found window appears, click [Yes]. The USB driver will automatically finish installing onto the computer when you attach the camera and open a connection.

## Windows Downloading Images to a Computer

A window allowing you to set the preferences will appear when a connection is established between the camera and computer.

### 1. Select [Canon CameraWindow] and click [OK] (first time only).



If the window to the right does not appear, click the [Start] menu and select [All Programs] or [Programs], followed by [Canon Utilities], [CameraWindow], [PowerShot - IXY - IXUS - DV 6] and [CameraWindow].



### 2. Download the images.

- Download the images using the camera or the computer.
- By default, the downloaded images are saved into the [My Pictures] folder.

Downloading Images Using the Camera (p. 23).

Downloading Images Using a Computer. By default, all images that have yet to be downloaded will download.

You can set the type of image to download and the destination folder.



Thumbnails (small versions) of the downloaded images will display in the ZoomBrowser EX Main Window. By default, the downloaded images are saved into subfolders according to their shooting dates.



## Macintosh Downloading Images to a Computer

The following window will appear when you establish a connection between the camera and computer. If it fails to appear, click the [Canon CameraWindow] icon on the Dock (the bar which appears at the bottom of the desktop).

### 1. Download the images.

- Download the images using the camera or the computer.
- By default, the downloaded images are saved into the [Pictures] folder.

Downloading Images Using the Camera (p. 23).

Downloading Images Using a Computer.

By default, all images that have yet to be downloaded will download.

You can set the type of image to download and the destination folder.







Thumbnails (small versions) of the downloaded images will display in the ImageBrowser Browser Window. By default, the downloaded images are saved into folders according to their shooting dates.





## Downloading Images Using the Camera (Direct Transfer)

Use this method to download images using camera operations. Install the supplied software and adjust the computer settings before using this method for the first time (p. 19).

	<b>All Images</b>	Transfers and saves all images to the computer.
	<b>New Images</b>	Transfers and saves to the computer only the images that have not been previously transferred.
	<b>DPOF Trans. Images</b>	Transfers and saves to the computer only the images with DPOF Transfer Order settings ( <i>Advanced Guide</i> , p.94).
	<b>Select &amp; Transfer</b>	Transfers and saves single images to the computer as you view and select them.
	<b>Wallpaper</b>	Transfers and saves single images to the computer as you view and select them. The transferred images display on the computer desktop.

### 1. Confirm that the Direct Transfer menu is displayed on the camera's LCD monitor.

- The  button will light blue.
- Press the **MENU** button if the Direct Transfer menu fails to appear.

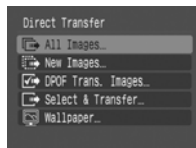

Direct Transfer Menu

### ■ All Images/New Images/DPOF Trans. Images

### 2. Select , , or and press the button.

- The images will download. The  button will blink blue while downloading is in progress. The display will return to the Direct Transfer menu when the download is complete.
- To cancel the download, press the **FUNC./SET** button.



---

## ■ Select & Transfer/Wallpaper

2. Select  or  and press the  button (or the FUNC./SET button).

3. Select images to download and press the  button (or the FUNC./SET button).

- The images will download. The  button will blink blue while downloading is in progress.
- Images can also be selected during index playback (*Advanced Guide* p.72).
- Press the **MENU** button to return to the Direct Transfer menu.



Only JPEG images can be downloaded as wallpaper for a computer. On the Windows platform, the files are automatically created as BMP images.



The option selected with the  button is retained even when the camera's power is turned off. The previous setting will be in effect the next time the Direct Transfer menu is displayed. The image selection screen will appear directly when the [Select & Transfer] or the [Wallpaper] option was last selected.

---

## Safety Precautions

Be sure to read, understand and follow the safety precautions below when using the camera, in order to prevent injury, burns or electrical shock to yourself and others.

**Be sure to also read the safety precautions listed in the *Advanced Camera User Guide*.**



### Warnings

- Do not trigger the flash in close proximity to human or animal eyes.
- Store this equipment out of the reach of children and infants.
- Avoid dropping or subjecting the camera to severe impacts. Do not touch the flash portion of the camera if it has been damaged.
- Stop operating the equipment immediately if it emits smoke or noxious-fumes.
- Do not handle the power cord if your hands are wet.
- Use only recommended batteries and accessories.
- The battery charger and compact power adapter are designed for exclusive use with your camera. Do not use it with other products or batteries.



### Caution

- Do not sit with the camera in a back pocket as it may cause the camera to malfunction or damage the LCD monitor.
-