



Large Format Printer

# iPF750

## User's Guide

Basic Printing Workflow	1	1
Enhanced Printing Options	20	2
Windows Software	206	3
Mac OS X Software	431	4
Handling Paper	567	5
Adjustments for Better Print Quality	618	6
Printer Parts	638	7
Control Panel	648	8
Network Setting	692	9
Maintenance and Consumables	730	10
Troubleshooting	768	11
Error Message	808	12
Specifications	834	13
Appendix	839	14

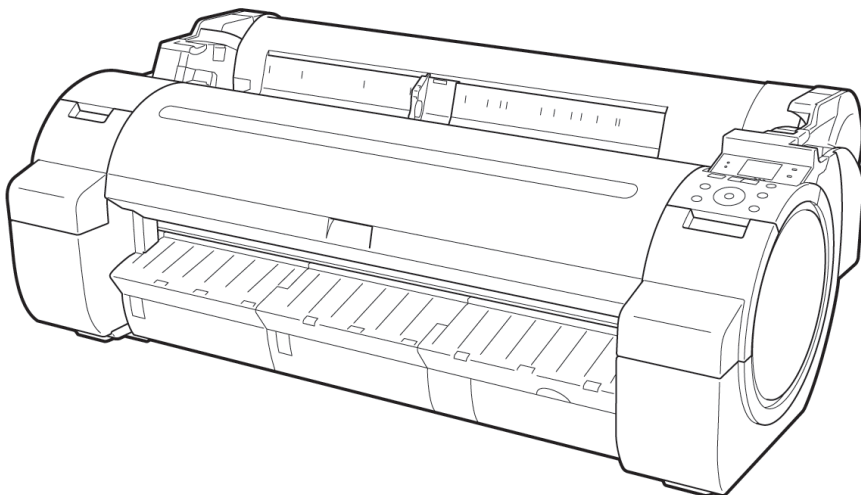

imagePROGRAF

## Note

In order to be printed easily, this PDF-format manual is converted from the HTML-format instruction manual included on the "User Manuals CD-ROM" supplied with the printer. Thus, there are descriptions that are applied only in HTML format, and functions (video display function, etc.) that cannot be used. We appreciate your understanding.



# Contents

## Basic Printing Workflow 1

### Printing procedure 2

Printing Options Using Rolls and Sheets .....	2
Turning the Printer On and Off .....	3
Loading and Printing on Rolls .....	6
Loading and Printing on Sheets .....	9
Printing in Windows .....	11
Printing from Mac OS X .....	12

### Canceling print jobs 14

Canceling Print Jobs from the Control Panel .....	14
Canceling Print Jobs from Windows .....	15
Canceling Print Jobs from Mac OS X .....	16

### Pausing Printing 19

Pausing Printing .....	19
------------------------	----

## Enhanced Printing Options 20

### Choosing Paper for Printing 21

Choosing a Paper for Printing .....	21
Specifying Paper in the Printer Driver .....	21

### Printing Photos and Office Documents 22

Printing Photos and Images .....	22
Printing Photos and Images (Windows) .....	23
Printing Photos and Images (Mac OS X) .....	25
Printing Office Documents .....	29
Printing Office Documents (Windows) .....	30
Printing Office Documents (Mac OS X) .....	32
Using PosterArtist to Compose Originals .....	36

### Printing CAD Drawings 39

Printing CAD Drawings .....	39
Printing Line Drawings and Text .....	39
Printing Line Drawings and Text (Windows) .....	40
Printing Line Drawings and Text (Mac OS X) .....	42
Printing from AutoCAD .....	46
Specifying Colors and Printing CAD Drawings .....	47
Specifying Colors and Printing CAD Drawings (Windows) .....	48
HP-GL/2 Printing .....	50

### Adjusting Images 51

Adjusting the Color in the Printer Driver .....	51
Fine-Tuning Colors of Photos and Images (Windows) .....	53
Fine-Tuning Colors of Photos and Images (Mac OS X) .....	57
Giving Priority to Particular Graphic Elements and Colors for Printing .....	60
Choosing the Document Type and Printing Conditions (Windows) .....	63
Choosing the Document Type and Printing Conditions (Mac OS X) .....	66

<b>Printing enlargements or reductions</b>	<b>69</b>
Resizing Originals to Match the Paper Size	69
Resizing Originals to Match the Paper Size (Windows)	69
Resizing Originals to Match the Paper Size (Mac OS X)	72
Resizing Originals to Fit the Roll Width	75
Resizing Originals to Fit the Roll Width (Windows)	76
Resizing Originals to Fit the Roll Width (Mac OS X)	78
Resizing Originals by Entering a Scaling Value	81
Resizing Originals by Entering a Scaling Value (Windows)	82
Resizing Originals by Entering a Scaling Value (Mac OS X)	85
<b>Printing at full size</b>	<b>89</b>
Printing on Oversized Paper	89
Printing at Full Size (Windows)	90
Printing at Full Size (Mac OS X)	92
Borderless Printing at Actual Size	95
Borderless Printing at Actual Size (Windows)	97
Borderless Printing at Actual Size (Mac OS X)	99
<b>Borderless Printing</b>	<b>104</b>
Borderless Printing on Paper of Equivalent Size	104
Borderless Printing by Resizing Originals to Match the Paper Size (Windows)	105
Borderless Printing by Resizing Originals to Match the Paper Size (Mac OS X)	108
Borderless Printing by Resizing Originals to Fit the Roll Width	111
Borderless Printing by Resizing Originals to Fit the Roll Width (Windows)	113
Borderless Printing by Resizing Originals to Fit the Roll Width (Mac OS X)	115
<b>Printing banners or at other non-standard sizes</b>	<b>120</b>
Printing Vertical or Horizontal Banners (Large-Format Printing)	120
Printing Vertical or Horizontal Banners (Large-Format Printing; Windows)	121
Printing Vertical or Horizontal Banners (Large-Format Printing; Mac OS X)	126
Printing on Non-Standard Paper Sizes	130
Printing on Non-Standard Paper Sizes (Windows)	131
Printing on Non-Standard Paper Sizes (Mac OS X)	135
<b>Tiling and multiple pages per sheet</b>	<b>139</b>
Printing Multiple Originals Next to Each Other	139
Printing Multiple Originals Next to Each Other (Windows)	140
Printing Multiple Originals Next to Each Other (Mac OS X)	142
Printing Multiple Pages Continuously	144
Printing Multiple Pages Continuously (Windows)	145
Printing Multiple Pages Continuously (Mac OS X)	147
Printing Multiple Pages Per Sheet	149
Printing Multiple Pages Per Sheet (Windows)	150
Printing Multiple Pages Per Sheet (Mac OS X)	153
Printing Posters in Sections	157
Printing Large Posters (Windows)	158
<b>Centering originals</b>	<b>161</b>
Printing Originals Centered on Rolls	161
Printing Originals Centered on Rolls (Windows)	161
Printing Originals Centered on Rolls (Mac OS X)	163
Printing Originals Centered on Sheets	167
Printing Originals Centered on Sheets (Windows)	167
Printing Originals Centered on Sheets (Mac OS X)	170

<b>Conserving roll paper</b>	<b>174</b>
Conserving Roll Paper by Rotating Originals 90 Degrees	174
Conserving Roll Paper by Rotating Originals 90 Degrees (Windows)	174
Conserving Roll Paper by Rotating Originals 90 Degrees (Mac OS X)	176
Conserving Roll Paper by Printing Originals Without Top and Bottom Margins	180
Conserving Roll Paper by Printing Originals Without Top and Bottom Margins (Windows)	180
Conserving Roll Paper by Printing Originals Without Top and Bottom Margins (Mac OS X)	183

<b>Checking Images Before Printing</b>	<b>188</b>
Checking the Layout in a Preview Before Printing	188

<b>Other useful settings</b>	<b>190</b>
Printing With Watermarks	190
Printing with Watermarks— COPY, FILE COPY, and so on (Windows)	191
Making the Original Orientation Match the Paper Orientation	194
Making the Original Orientation Match the Paper Orientation (Windows)	194
Making the Original Orientation Match the Paper Orientation (Mac OS X)	196
Using Favorites	200
Cutting Roll Paper After Printing	200
Cutting Roll Paper After Printing (Windows)	200
Cutting Roll Paper After Printing (Mac OS X)	202

## **Windows Software** **206**

<b>Printer Driver</b>	<b>207</b>
Printer Driver Settings	207
Specifying Paper in the Printer Driver	209
Confirming Print Settings	212
Checking the Layout in a Preview Before Printing	213
Using Favorites	214
Accessing the Printer Driver Dialog Box from Applications	217
Accessing the Printer Driver Dialog Box from the Operating System Menu	218
Main Sheet	220
Paper Information on Printer Dialog Box	224
Paper Detailed Settings Dialog Box	225
View Settings Dialog Box for the Printing Application	226
Color Adjustment Sheet: Color	226
Object Adjustment dialog box: Color	228
Matching Sheet	229
Color Adjustment Sheet: Monochrome	231
Object Adjustment dialog box: Monochrome	232
Page Setup Sheet	233
Paper Size Options Dialog Box	235
Layout Sheet	237
Page Options Dialog Box	238
Special Settings Dialog Box	239
Favorites Sheet	240
Utility Sheet	242
Support Sheet	243
Settings Summaries Dialog Box	244
Device Settings Sheet	245

<b>Preview</b>	<b>246</b>
The Features of Preview	246
Operating Environment	246

Starting Preview .....	247
Preview Main Window .....	248
Dialog Area .....	251
Enlarge/Reduce the screen display .....	252
Moving a Page .....	252
Using the ruler .....	253
Priority setting for rotating 90 degrees .....	253
Printing with Selecting the Layout .....	255
Print on the Center .....	257
Not Print Spaces at the Top/Bottom .....	258

## **Free Layout** **259**

The Features of Free Layout .....	259
Operating Environment .....	260
Starting Free Layout .....	260
Free Layout Main Window .....	262
Detailed Settings .....	264
Preferences Dialog Box .....	265
Page Options Dialog Box .....	266
Zoom Dialog Box .....	267
Format Dialog Box .....	268
Laying out a Multiple-File Document on One Page .....	270
Laying out a Document Created with Multiple Application Programs on One Page .....	273
Selecting an Object .....	276
Changing the Object Size .....	277
Moving an Object .....	277
Rotating an Object .....	278
Laying out Objects Automatically .....	279
Aligning Objects .....	279
Changing the Object Overlapping Order .....	281
Pasting a Copied or Cut Object .....	283
Folded Duplex Window .....	284
Finished Size Settings Dialog Box .....	285
Binding Settings Dialog Box .....	286
Prints using Folded Duplex .....	287

## **Color imageRUNNER Enlargement Copy** **289**

The Features of Color imageRUNNER Enlargement Copy .....	289
Operating Environment .....	289
Starting Color imageRUNNER Enlargement Copy .....	290
Color imageRUNNER Enlargement Copy Dialog Box .....	291
Hot Folder .....	292
Creating a New Hot Folder .....	293
Specifying an Existing Shared Folder as a Hot Folder .....	297
Setting the Print Parameters .....	300
Printing Enlargements of Scanned Originals from a Color imageRUNNER .....	301

## **Print Plug-In for Office** **303**

Print Plug-In for Office features .....	303
Operating Environment .....	303
Steps to install .....	304
Steps to uninstall .....	308
When Print Plug-In for Office is not displayed .....	309
To start from Microsoft Word .....	314
Print Matching Roll Width (Word) .....	316
Borderless Printing (Word) .....	319

Multi-Page Printing (Word) .....	322
Register the settings (Word) .....	324
Print Using Registered Settings (Word) .....	325
Portrait Orientation / Landscape Orientation (Word) .....	328
To start from Microsoft PowerPoint .....	330
Print Matching Roll Width (PowerPoint) .....	332
Borderless Printing (PowerPoint) .....	335
Multi-Page Printing (PowerPoint) .....	338
Register the settings (PowerPoint) .....	340
Print Using Registered Settings (PowerPoint) .....	341
Portrait Orientation / Landscape Orientation (PowerPoint) .....	344
To start from Microsoft Excel .....	346
Print Entire Sheet (Excel) .....	348
Print Selected Area (Excel) .....	351
Configuring Binding (Excel) .....	355
Configuring Special Settings .....	356

## **HDI Driver** **358**

The Features of HDI Driver .....	358
Operating Environment .....	358
Installation Procedure .....	359
Installing with the Canon Installer .....	359
Installing with the Add-A-Plotter Wizard .....	367
Opening the Plotter Configuration Dialog Box .....	371
Opening from the AutoCAD File Menu .....	372
Opening from the Start Menu .....	373
Plotter Configuration Editor Dialog Box .....	375
Media Source and Media Size Settings .....	376
Graphics Settings .....	377
Opening the Custom Properties Dialog Box .....	380
Custom Properties dialog box .....	382
Paper Detailed Settings .....	384
Color Compatibility Dialog Box .....	386
Printing .....	386

## **Status Monitor** **390**

The Features of imagePROGRAF Status Monitor .....	390
Job Management Using imagePROGRAF Status Monitor .....	391

## **Accounting** **393**

Accounting Manager .....	393
Launching the Accounting Manager .....	394
Accounting Manager Main Window .....	394
Job List Area .....	397
Accounting Manager Basic Procedures .....	397
Configuring Unit Costs in Accounting Manager .....	398
Setting the Unit Cost for Ink .....	399
Setting the Unit Cost for Paper .....	400
Setting the Unit Cost for Items Other Than Ink and Paper .....	401
Configuring Units and Display Settings in Accounting Manager .....	402
Automatically Acquiring Print Job Logs at Regular Intervals .....	403
Canceling Regular Print Job Log Acquisition .....	403
Switching Between Displaying Jobs on Printer and Regularly Acquired Jobs .....	404
Exporting Print Job Data as a CSV File .....	404
Showing Job Properties .....	405
Showing, Saving and Loading Selected Unit Cost Data .....	405

Showing the Total Amount of Ink and Paper Consumed .....	405
----------------------------------------------------------	-----

## Digital Photo Front-Access 406

Digital Photo Front-Access .....	406
----------------------------------	-----

## Device Setup Utility 407

imagePROGRAF Device Setup Utility .....	407
Installing imagePROGRAF Device Setup Utility .....	407
Configuring the IP Address Using imagePROGRAF Device Setup Utility .....	408

## Media Configuration Tool 412

The Features of Media Configuration Tool .....	412
Operating Environment .....	412
Installation Procedures .....	413
Starting the Media Configuration Tool .....	416
Media Configuration Tool Main Window .....	417
Editing Media Type Information .....	418
Adding Media Types .....	418
Changing Media Names .....	421
Deleting Media Types You Have Added .....	423
Switching Media Types Display Show/Hide .....	425
Changing the Display Order of Media Types .....	426
Updating Media Types .....	428

## Mac OS X Software 431

### Printer Driver 432

Printer Driver Settings .....	432
Specifying Paper in the Printer Driver .....	434
Confirming Print Settings .....	436
Checking the Layout in a Preview Before Printing .....	437
Using Favorites .....	439
Accessing the Printer Driver Dialog Box from Applications .....	439
Main Pane .....	440
Paper Information on Printer Dialog Box .....	443
Paper Detailed Settings Dialog Box .....	444
View settings Dialog Box for the Printing Application .....	445
Matching pane .....	446
Color Settings Pane: Color .....	448
Object Adjustment dialog box: Color .....	449
Color Settings Pane: Monochrome .....	450
Object Adjustment dialog box: Monochrome .....	451
Page Setup Pane .....	452
Utility Pane .....	454
Additional Settings Pane .....	455
Support Pane .....	455

### Preview 457

The Features of Preview .....	457
Operating Environment .....	457
Starting Preview .....	458
Preview Main Window .....	459
Paper Settings Panel .....	462
Easy Settings .....	464
Advanced Settings .....	466
Output Settings Panel .....	467

Color Settings Panel .....	469
Color Adjustment .....	470
Matching .....	473
Driver Matching Mode .....	475
ICC Matching Mode .....	476
ColorSync .....	477
Preferences Dialog Box .....	477
Zoom Dialog Box .....	478
Go to Page Dialog Box .....	478
Print with No Borders .....	479
Print on the Center .....	479
Not Print Spaces at the Top/Bottom .....	480
Print Page Rotated 90 Degrees .....	481
Display with Fitting to the Width of the Paper .....	482
Display with All .....	483
Display with Actual Size .....	484
Moving a Page .....	484

## Free Layout 486

The Features of Free Layout .....	486
Operating Environment .....	486
Starting Free Layout .....	487
Free Layout Main Window .....	488
Paper Settings Panel .....	491
Easy Settings .....	493
Advanced Settings .....	495
Color Settings Panel .....	496
Color Adjustment .....	497
Matching .....	500
Driver Matching Mode .....	502
ICC Matching Mode .....	503
ColorSync .....	504
Preferences Dialog Box .....	505
Page Setup Dialog Box .....	506
Zoom Dialog Box .....	507
Format Dialog Box .....	508
Laying out a Multiple-File Document on One Page .....	509
Laying out a Document Created with Multiple Application Programs on One Page .....	509
Selecting an Object .....	510
Changing the Object Size .....	510
Moving an Object .....	511
Rotating an Object .....	512
Laying out Objects Automatically .....	513
Aligning Objects .....	513
Changing the Object Overlapping Order .....	515
Pasting a Copied or Cut Object .....	517

## Color imageRUNNER Enlargement Copy 518

The Features of Color imageRUNNER Enlargement Copy .....	518
Operating Environment .....	518
Starting Color imageRUNNER Enlargement Copy .....	519
Color imageRUNNER Enlargement Copy Dialog Box .....	520
Hot Folder .....	521
Creating a New Hot Folder .....	522
Editing a Hot Folder (Setting Print Conditions) .....	525
Deleting a Hot Folder .....	528

Setting the Print Parameters .....	528
Paper Settings Panel .....	529
Easy Settings .....	531
Advanced Settings .....	532
Output Settings Panel .....	534
Color Settings Panel .....	536
Driver Matching Mode .....	537
ICC Matching Mode .....	538
ColorSync .....	539
Printing Enlargements of Scanned Originals from a Color imageRUNNER .....	539

## **Printmonitor** **541**

The Features of imagePROGRAF Printmonitor .....	541
Job Management Using imagePROGRAF Printmonitor .....	542

## **Media Configuration Tool** **543**

The Features of Media Configuration Tool .....	543
Operating Environment .....	543
Procedures for Installing .....	544
Procedures for Uninstalling .....	547
Starting the Media Configuration Tool .....	551
Media Configuration Tool main window .....	552
Editing Media Type Information .....	553
Adding Media Types .....	553
Changing Media Names .....	556
Deleting Media Types You Have Added .....	558
Switching Media Types Display Show/Hide .....	560
Changing the Display Order of Media Types .....	562
Updating Media Types .....	564

# **Handling Paper** **567**

## **Paper** **568**

Types of Paper .....	568
Paper Sizes .....	569
Displaying the Paper Reference Guide .....	571
Updating paper information .....	573
Adding Custom Paper .....	574

## **Handling rolls** **575**

Attaching the Roll Holder to Rolls .....	575
Loading Rolls in the Printer .....	579
Changing the Type of Paper .....	583
Specifying the Paper Length .....	585
Removing the Roll from the Printer .....	585
Removing the Roll Holder from Rolls .....	589
Feeding Roll Paper Manually .....	590
Keeping Track of the Amount of Roll Paper Left .....	591
Specifying the Ink Drying Time for Rolls .....	592
Specifying the Cutting Method for Rolls .....	594
Cutting the Leading Edge of Roll Paper Automatically .....	599
Reducing Dust from Cutting Rolls .....	601

## **Handling sheets** **602**

Loading Sheets in the Printer .....	602
Printing From a Desired Starting Point .....	606



Removing Sheets .....	609
<b>Output Stacker</b> .....	<b>611</b>
Using the Output Stacker .....	611

## **Adjustments for Better Print Quality** **618**

### **Adjusting the Printhead** **619**

Adjusting the Printhead .....	619
Automatic Adjustment to Straighten Lines and Colors (Head Posi. Adj.) .....	619
Manual Adjustment to Straighten Lines and Colors (Head Posi. Adj.) .....	621
Adjusting Line Misalignment (Head Inc. Adj.) .....	623
Troubleshooting Paper Abrasion and Blurry Images (Head Height) .....	626

### **Adjusting the feed amount** **628**

Adjusting the Feed Amount .....	628
Selecting a Feed Amount Adjustment Method (Feed Priority) .....	628
Automatic Banding Adjustment (Adj. Quality) .....	630
Manual Banding Adjustment (Adj. Quality) .....	631
Fine-Tuning the Paper Feed Amount (Adj. Fine Feed) .....	633
Adjusting Line Length (Adjust Length) .....	634
Adjusting the Vacuum Strength (VacuumStrngth) .....	636

## **Printer Parts** **638**

### **Printer parts** **639**

Front .....	639
Side .....	641
Top Cover (Inside) .....	642
Roll Cover (Inside) .....	643
Carriage .....	644
Ink Tank Cover (Inside) .....	644
Stand .....	645

### **Optional accessories** **647**

Roll Holder Set .....	647
-----------------------	-----

## **Control Panel** **648**

### **Operations and Display Screen** **649**

Control Panel .....	649
Control Panel Display .....	651
How to View Instructions With Navigate .....	655
Checking Instructions During Printer Operations .....	656

### **Printer Menu** **659**

Printer Menu Operations .....	659
Menu Operations .....	660
Menu Structure .....	663
Menu Settings .....	673
Menu Settings (During Printing) .....	684
Status Print .....	686
Printing Interface Setting Reports .....	688

## Network Setting 692

### Network Environment 693

Network Environment ..... 693

### Using RemoteUI 696

Using RemoteUI ..... 696

### Initial Settings 699

Configuring the IP Address on the Printer ..... 699

    Configuring the IP Address Using the Printer Control Panel ..... 700

    Configuring the IP Address Using ARP and PING Commands ..... 701

Configuring TCP/IPv6 Network Settings ..... 702

Configuring the Printer Driver Destination (Windows) ..... 703

Configuring the Printer Driver Destination (Mac OS X) ..... 704

Configuring the Printer's TCP/IP Network Settings With RemoteUI ..... 704

### NetWare Settings 708

Configuring NetWare Network Settings ..... 708

Specifying the Printer's Frame Type ..... 709

Specifying NetWare Print Services ..... 713

Configuring the Printer's NetWare Network Settings With RemoteUI ..... 716

### Mac OS X Settings 719

Configuring the Destination in TCP/IP Networks ..... 719

Configuring the Destination for Bonjour Network ..... 721

Configuring the Destination for AppleTalk Networks ..... 723

Configuring the Printer's AppleTalk Network Settings ..... 725

### Other Settings 726

Specifying Printer-Related Information ..... 726

Configuring the Communication Mode Manually ..... 727

Email Notification When Printing is Finished or Errors Occur ..... 728

Initializing the Network Settings ..... 729

## Maintenance and Consumables 730

### Ink Tanks 731

Ink Tanks ..... 731

Replacing Ink Tanks ..... 731

Checking Ink Tank Levels ..... 736

When to Replace Ink Tanks ..... 737

### Printheads 739

Printhead ..... 739

Checking for Nozzle Clogging ..... 739

Cleaning the Printhead ..... 740

Replacing the Printhead ..... 741

### Maintenance Cartridge 749

Maintenance Cartridge ..... 749

Replacing the Maintenance Cartridge ..... 749

Checking the Remaining Maintenance Cartridge Capacity ..... 754

When to Replace the Maintenance Cartridge ..... 755

<b>Cleaning the Printer</b>	<b>756</b>
Cleaning the Printer Exterior .....	756
Cleaning Inside the Top Cover .....	756
<b>Other Maintenance</b>	<b>762</b>
Preparing to Transfer the Printer .....	762
Updating the Firmware .....	766
<b>Consumables</b>	<b>767</b>
<b>Troubleshooting</b>	<b>768</b>
<b>Frequently Asked Questions</b>	<b>769</b>
Frequently Asked Questions .....	769
<b>Problems Regarding Paper</b>	<b>771</b>
Clearing Jammed Paper (Paper Feed Slot) .....	771
Clearing Jammed Roll Paper .....	773
Clearing a Jammed Sheet .....	777
Roll paper cannot be inserted into the paper feed slot .....	780
Cannot load sheets .....	780
Paper is not cut neatly .....	781
Paper is not cut .....	781
Depression on the leading edge is left .....	781
The size of clear film cannot be detected .....	781
Roll Paper is Continuously Ejected .....	782
<b>Printing does not start</b>	<b>783</b>
The Data lamp on the Control Panel does not light up .....	783
The printer does not respond even if print jobs are sent .....	783
Ink Filling.. is displayed .....	783
The display screen indicates Agitating .....	784
<b>The printer stops during a print job</b>	<b>785</b>
An error message is shown on the Display Screen .....	785
The printer ejects blank, unprinted paper .....	785
<b>Problems with the printing quality</b>	<b>786</b>
Printing is faint .....	786
Paper rubs against the Printhead .....	787
The edges of the paper are dirty .....	788
The surface of the paper is dirty .....	788
The back side of the paper is dirty .....	789
Printed colors are inaccurate .....	789
Banding in different colors occurs .....	790
Colors in printed images are uneven .....	790
Image edges are blurred or white banding occurs .....	791
The contrast becomes uneven during printing .....	792
The length of printed images is inaccurate in the feeding direction .....	792
Images are printed crooked .....	792
Documents are printed in monochrome .....	793
Line thickness is not uniform .....	793
Lines are misaligned .....	793
Problems with the printing quality caused by the type of paper .....	794

<b>Cannot print over a network</b>	<b>795</b>
Cannot connect the printer to the network .....	795
Cannot print over a TCP/IP network .....	795
Cannot print over a NetWare network .....	796
Cannot print over AppleTalk or Bonjour networks .....	796

<b>Installation problems</b>	<b>797</b>
Removing Installed Printer Drivers .....	797

<b>HP-GL/2 problems</b>	<b>799</b>
With HP-GL/2, printing is misaligned .....	799
Lines or images are missing in printed HP-GL/2 jobs. ....	799
Lines are printed too thick or thin in HP-GL/2 print jobs .....	799
HP-GL/2 jobs are printed in monochrome (or color) .....	800
Printed colors of lines are inaccurate during HP-GL/2 printing .....	800
HP-GL/2 jobs are printed 6 mm larger than specified .....	800
HP-GL/2 jobs are printed at maximum size, even if a standard size is specified .....	800
HP-GL/2 printing takes a long time .....	800
Replotting with HP-GL/2 jobs is not possible. ....	801
The printer stops when printing a HP-GL/2 job (the carriage stops moving) .....	801

<b>Other problems</b>	<b>802</b>
The printer does not go on .....	802
If the Printer Makes a Strange Sound .....	803
Messages advising to check the maintenance cartridge are not cleared .....	803
The printer consumes a lot of ink .....	803
Ink Level Detection .....	804

## **Error Message** **808**

<b>Error Messages</b>	<b>809</b>
-----------------------	------------

<b>Messages regarding paper</b>	<b>811</b>
MediaType Mismatch .....	811
The paper is too small. ....	812
The paper is too small. ....	812
PaprWidth Mismatch .....	813
Paper size not detected. ....	814
Insufficient paper for job .....	815
This paper cannot be used. ....	815
Roll printing is selected. ....	815
Roll printing is selected, but sheets are loaded. ....	816
The roll is empty. ....	816
Sheet printing is selected. ....	817
Regular printing is selected, but a roll is loaded. ....	817
Paper jam .....	817
Paper is crooked. ....	818
Paper not aligned with right guide. ....	819
Cannot detect paper .....	819
Paper cutting failed. ....	819
End of paper feed. ....	820
Rel lever is in wrong position. ....	820
Borderless printng not possible. ....	820
Paper position not suitable for borderless printing. ....	821
Roll paper is not securely in contact with roll holder. ....	821

## Messages regarding ink 822

Ink insufficient. ....	822
No ink left. ....	822
Remaining level of the ink cannot be correctly detected. ....	822
Unable to detect ink level correctly. ....	822
Close Ink Tank Cover ....	823
Ink tank is empty. ....	823
Not much ink is left. ....	823
No ink tank loaded. ....	824
Wrong ink tank. ....	824
Do not pull out ink tank. ....	824

## Messages regarding printing or adjustment 825

Cannot adjust paper feed. ....	825
Check printed document. ....	825

## Messages regarding printheads 826

Cannot adjust printhead. ....	826
Wrong printhead. ....	826
Printhead error ....	826
No printhead ....	827
Execute printhead cleaning. ....	827

## Messages regarding the maintenance cartridge 828

Insert the maintenance cartridge. ....	828
Wrong maintenance cartridge. ....	828
Maint. cart. The level is low ....	828
No Maintenance Cartridge capacity. ....	828
Maintenance cartridge full. ....	828
Maintenance cartridge problem. ....	829

## Messages regarding HP-GL/2 830

This type of paper is not compatible with HP-GL/2. ....	830
GL2: Wxxxx The memory is full. (xxxx is 0501, 0903, or 0904) ....	830
GL2: W0502 The parameter is out of range. ....	830
GL2: W0504 This command is not supported. ....	830

## Other Messages 831

GARO Wxxxx (x represents a number) ....	831
ERROR Exxx-xxxx (x represents a letter or number) ....	831
Hardware error. xxxxxxxx-xxxx (x represents a letter or number) ....	831
Top cover is open. ....	832
Prepare for parts replacement. ....	832
Parts replacement time has passed. ....	832
Unknown file. ....	832
Multi-sensor error ....	833
Error in cutter position. ....	833

## Specifications 834

### Printer Specifications 835

Specifications ....	835
Print Area ....	837

## Appendix

839

### How to use this manual

840

About This User Manual .....	840
Searching Topics .....	841
HTML Version of the Manual for Printing .....	843

### Disposal of the product

850

WEEE Directive .....	851
----------------------	-----

## Basic Printing Workflow

Printing procedure	2
Canceling print jobs	14
Pausing Printing	19

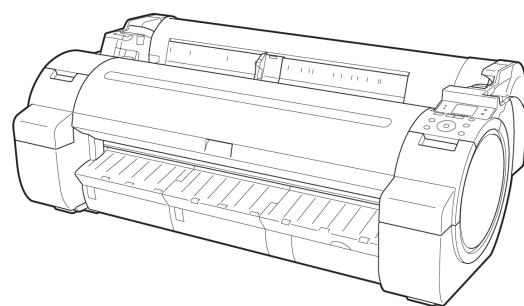

## Printing procedure

Printing Options Using Rolls and Sheets .....	2
Turning the Printer On and Off .....	3
Loading and Printing on Rolls .....	6
Loading and Printing on Sheets .....	9
Printing in Windows .....	11
Printing from Mac OS X .....	12

# 1

## Printing Options Using Rolls and Sheets

The printer supports both rolls and sheets.

This section introduces the main features of each, as well as the main printing methods available. Select rolls or sheets to suit your particular printing application.



### Note

- For information on the types of paper the printer supports, refer to the Paper Reference Guide. (See "Types of Paper.") →P.568
- A variety of other ways to print are available besides those introduced here. Choose the printing method that suits your particular printing application, referring to "Working with Various Print Jobs" and "Enhanced Printing Options" from the table of contents.

## Roll printing

Media in spooled rolls is generally called Roll Media. Rolls are loaded on the Roll Holder, which are in turn loaded in the printer.

Rolls can be used to print large photos or create posters or banners that cannot be printed on regular sheets.

- Large-format printing  
Easily print vertical or horizontal banners from familiar applications such as Microsoft Office applications. (See "Printing Vertical or Horizontal Banners (Large-Format Printing).") →P.120
- Borderless printing  
Print without a margin (border) around posters or photos.  
(See "Borderless Printing on Paper of Equivalent Size.") →P.104  
(See "Borderless Printing by Resizing Originals to Fit the Roll Width.") →P.111  
(See "Borderless Printing at Actual Size.") →P.95
- Banner printing  
You can print multiple pages as a single continuous image, without margins between pages. (See "Printing Multiple Pages Continuously.") →P.144
- 90-degree rotation before printing  
Originals in portrait orientation are rotated 90 degrees when possible to use paper more efficiently. (See "Conserving Roll Paper by Rotating Originals 90 Degrees.") →P.174
- Enlarged/reduced printing  
You can freely adjust the size of originals by enlarging or reducing originals before printing.  
(See "Resizing Originals to Match the Paper Size.") →P.69  
(See "Resizing Originals to Fit the Roll Width.") →P.75  
(See "Resizing Originals by Entering a Scaling Value.") →P.81
- Free Layout function

# 2



Print multiple documents from multiple applications (such as word-processing programs, spreadsheet programs, and so on) next to each other.

(See "Printing Multiple Originals Next to Each Other.") →P.139

## Sheet printing

Sheets refer to individual sheets of paper.

Insert the sheet between the Platen and the Paper Retainer.

- Enlarged/reduced printing  
You can freely adjust the size of originals by enlarging or reducing originals before printing.  
(See "Resizing Originals to Match the Paper Size.") →P.69  
(See "Resizing Originals by Entering a Scaling Value.") →P.81
- Free Layout function  
Print multiple documents from multiple applications (such as word-processing programs, spreadsheet programs, and so on) next to each other.  
(See "Printing Multiple Originals Next to Each Other.") →P.139

1

## Turning the Printer On and Off

### Turning the printer on

1. Press the **Power** button to turn on the printer.  
The printer will now start up.  
After the Display Screen shows the Canon logo, "**Starting up... Please wait.**" is displayed.



3

**2.** The **Power Lamp** is lit when the printer finishes starting up, and the printer is now in **Standby**.

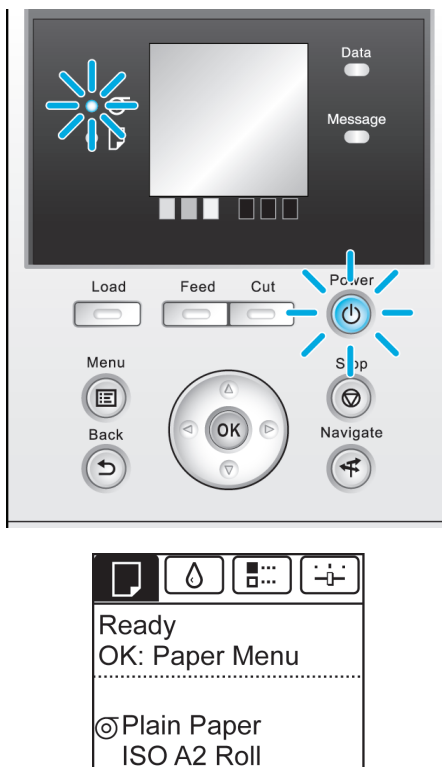

The printer will not go into **Standby** in the following situations. Take the appropriate action.

- **The Top Cover is open**  
Close the Top Cover.
- **The Ink Tank Cover is open**  
Close the Ink Tank Cover.
- **The Printhead is not installed**  
see "Replacing the Printhead." →P.741
- **An Ink Tank is not installed**  
see "Replacing Ink Tanks." →P.731
- **If ERROR is shown on the Display Screen**  
see "Error Messages." →P.809
- **The Power Lamp and Message Lamp are not lit (even once), and nothing appears on the Display Screen**  
Make sure the printer is plugged in correctly. Check the connection at the plug and electrical outlet.
- **No paper is loaded**  
Load paper. (See "Loading and Printing on Rolls." →P.6 (See "Loading and Printing on Sheets.")) →P.9

**Important**

- Starting the printer when it is connected via the USB cable to a Macintosh computer that is off may cause the computer to start up at the same time. To prevent this, disconnect the USB cable before starting the printer. Connecting the printer to the computer via a USB hub may solve this issue.

## Turning the printer off

**Important**

- Never disconnect the printer's power supply or unplug it during a print job. This may damage the printer.

1. Make sure no print jobs are in progress.

If the **Message Lamp** is flashing, check the message on the Display Screen and take action as necessary. (See "Error Messages.") →P.809



If the **Data Lamp** is flashing, the printer is receiving a print job. Turn off the printer only after printing is finished.



2. Hold down the **Power** button for more than a second.



After "Shut Down.. Please Wait.." is shown on the Display Screen, the printer shuts off.

## Loading and Printing on Rolls

These are the basic steps for loading and printing on rolls.  
Follow these steps to load and print on rolls.



### Note

- For details on supported sizes and types of rolls, see **Paper Sizes** or the Paper Reference Guide. (See "Paper Sizes.") →P.569 (See "Types of Paper.") →P.568
- If you prefer to wait for the ink to dry after printing and simply eject the document, you can deactivate automatic cutting and cut the paper manually. (See "Specifying the Cutting Method for Rolls.") →P.594

1. Turn the printer on. (See "Turning the Printer On and Off.") →P.3



**2.** Load the roll on the Roll Holder. (See "Attaching the Roll Holder to Rolls.") →P.575

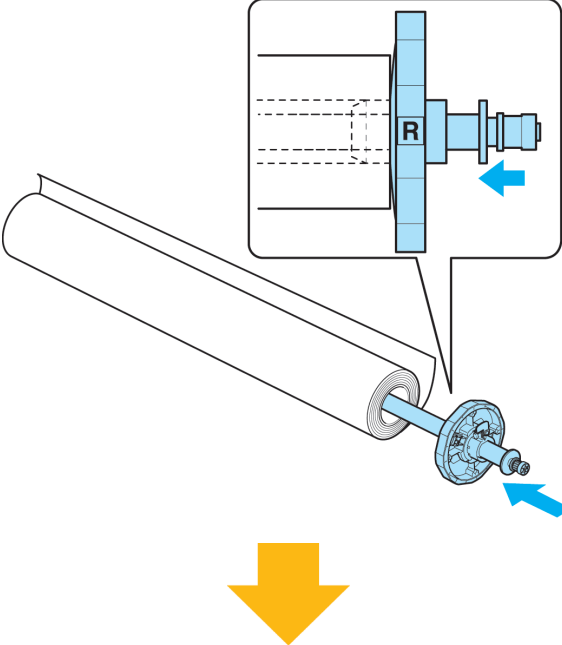

**3.** Load the roll in the printer. (See "Loading Rolls in the Printer.") →P.579

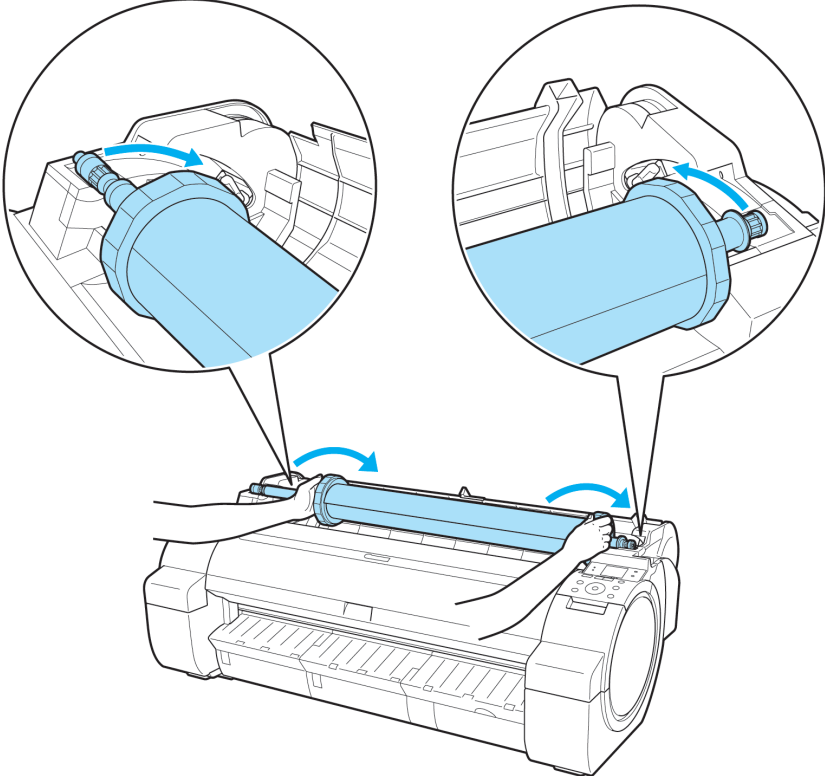

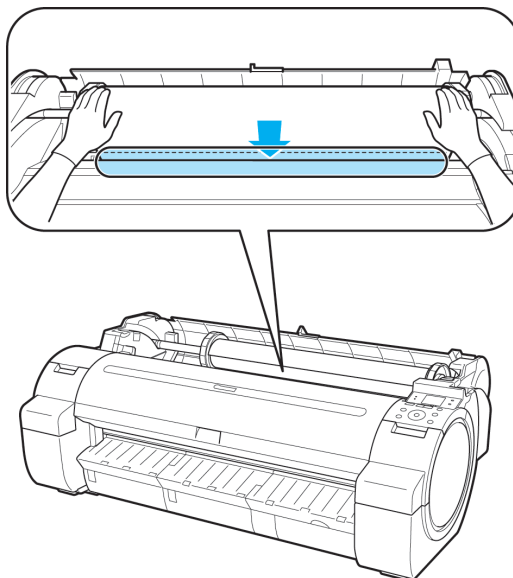

**1**

**4.** Select the type of paper. (See "Changing the Type of Paper.") →P.583



 **Note**

- If no barcode has been printed on the roll and you have set **ManageRemainRoll** to **On**, specify the roll length after the type of paper. (See "Specifying the Paper Length.") →P.585

**8**

**5.** Complete settings in the printer driver for the type of paper and other details.

- Specifying Paper in the Printer Driver(Windows) →P.209
- Specifying Paper in the Printer Driver(Mac OS X) →P.434

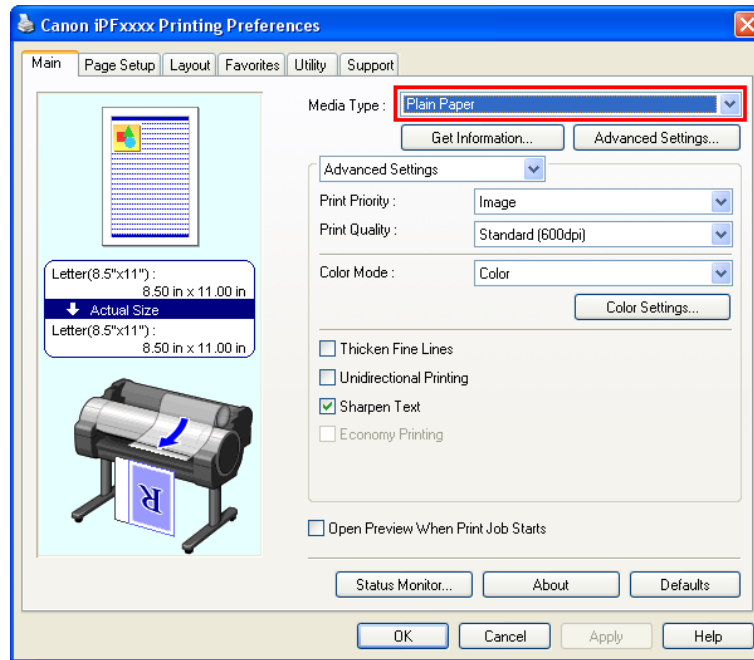

## 6. Send the print job.

- Printing in Windows →P.11
- Printing from Mac OS X →P.12

The printer now starts printing the print job.

## Loading and Printing on Sheets

These are the basic steps for loading sheets and then printing.  
Follow the steps below to load and print on sheets.



### Note

- For details on supported types and sizes of paper, see **Paper Sizes** or the Paper Reference Guide. (See "Paper Sizes." →P.569 (See "Types of Paper." →P.568

**1.** Turn the printer on. (See "Turning the Printer On and Off.") →P.3



**2.** Complete settings in the printer driver for the type of paper and other details.

- Specifying Paper in the Printer Driver(Windows) →P.209
- Specifying Paper in the Printer Driver(Mac OS X) →P.434

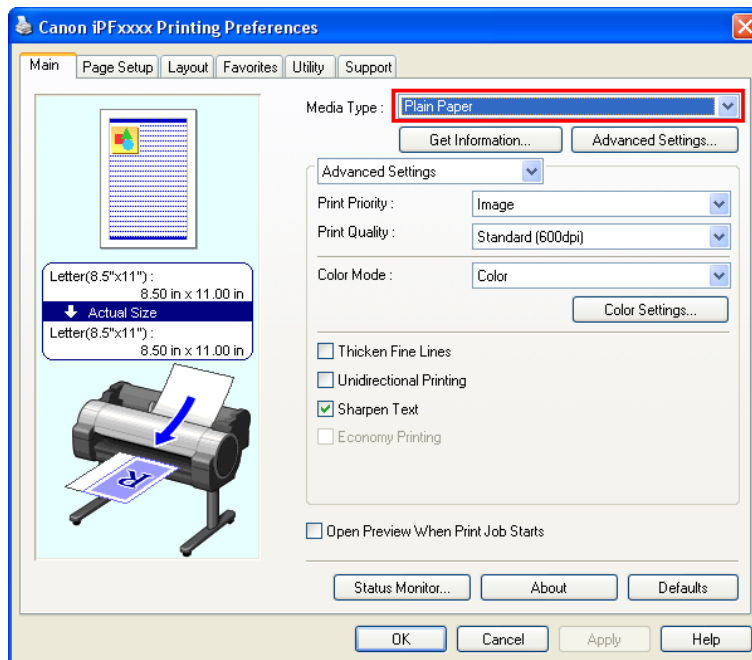

**3.** Send the print job.

- Printing in Windows →P.11
- Printing from Mac OS X →P.12





## 4. Load the sheet. (See "Loading Sheets in the Printer.") →P.602

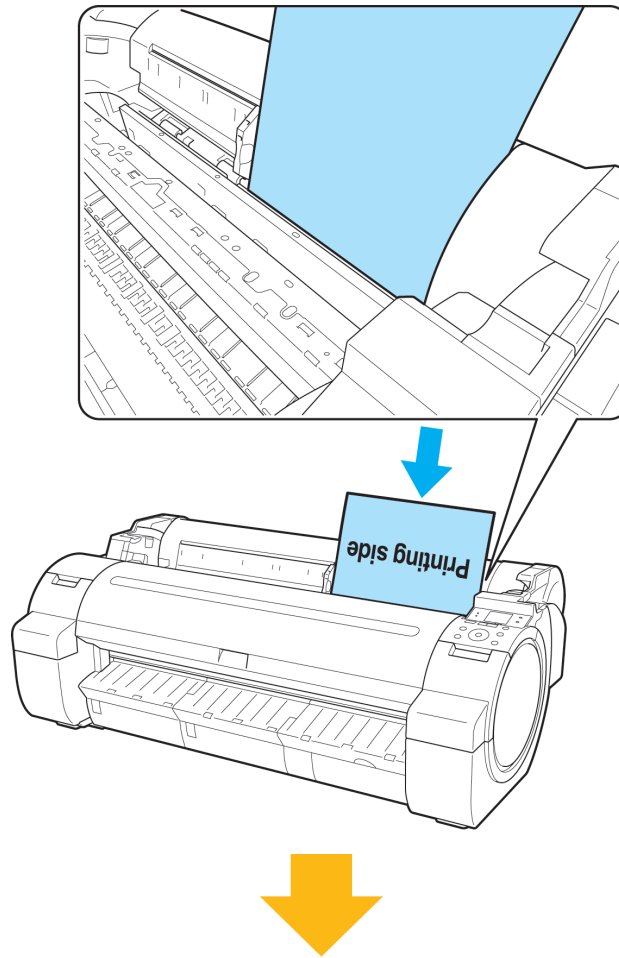

The printer now starts printing the print job.

### Printing in Windows

Print from the application menu.



#### Important

- We recommend exiting unnecessary applications before printing. Running several applications while printing may interrupt the transfer of print data and affect printing quality.

1. In the source application, select **Print** from the **File** menu to display the dialog box for printing conditions.

2. After confirming that the printer is selected in the dialog box, click **Print** or **OK** to start printing.



#### Note

- The appearance of the dialog box varies depending on the software application. In most cases, the dialog box includes basic printing options and enables you to choose the printer, specify the range of pages, number of copies, and so on.

Example: Print dialog box displayed by the application

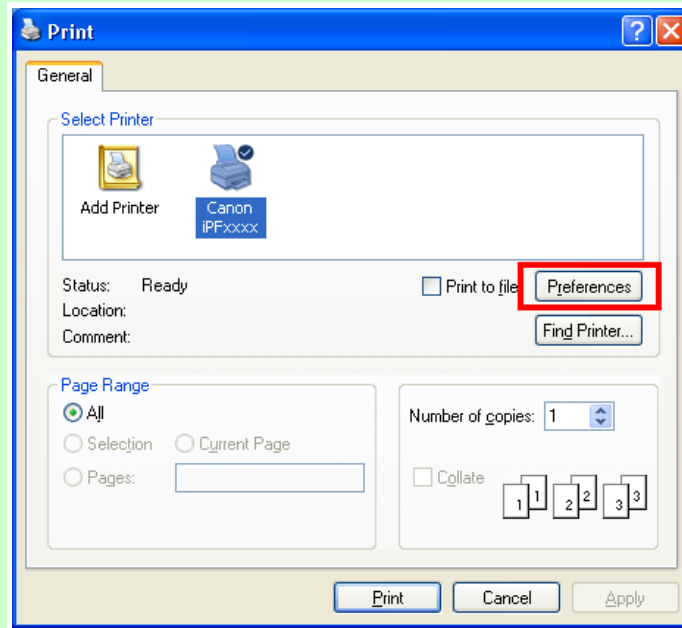

- If another printer is selected, select the printer you want to use under **Select Printer** or in the dialog box displayed after clicking **Printer**.

Settings for many printing methods (including enlarged or reduced printing, borderless printing, and so on) are displayed in the printer driver dialog box. There are two ways to access the printer driver dialog box, as follows.

- From the application  
(See "Accessing the Printer Driver Dialog Box from Applications(Windows).") →P.217
- From the operating system menu  
(See "Accessing the Printer Driver Dialog Box from the Operating System Menu(Windows).") →P.218

## Printing from Mac OS X

Print from the application menu after registering the printer.



#### Important

- We recommend exiting unnecessary applications before printing. Running several applications while printing may interrupt the transfer of print data and affect printing quality.

## Registering the printer

Before printing, you must register the printer in **imagePROGRAF PrinterSetup.app**.

For instructions on registering the printer, see "Configuring the Printer Driver Destination (Mac OS X)." →P.704

**Important**

- During this setup process, the printer will not be listed among available printers if it is off or disconnected.

Printing from the application software

1. In the application software, select **Print** from the **File** menu to display the dialog box for printing conditions.

**Note**

- This dialog box includes basic printing options and enables you to choose the printer, specify the range of pages, number of copies, and so on.

2. Select the printer in the **Printer** list.

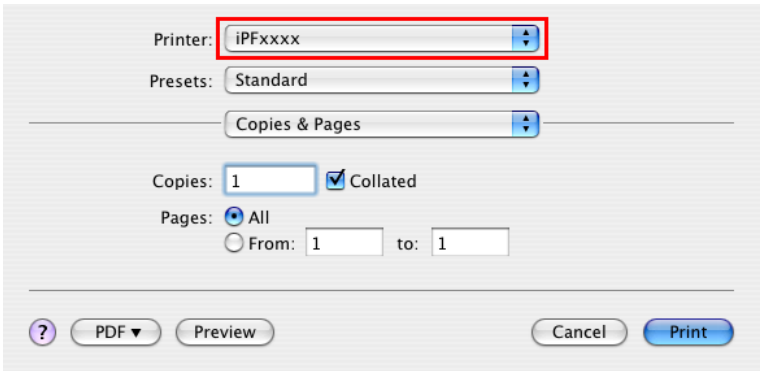

3. Click **Print** to start printing. As shown in the following illustration, you can switch to other panes in this dialog box to complete settings for various methods of printing, including enlarged and reduced printing, borderless printing, and so on.

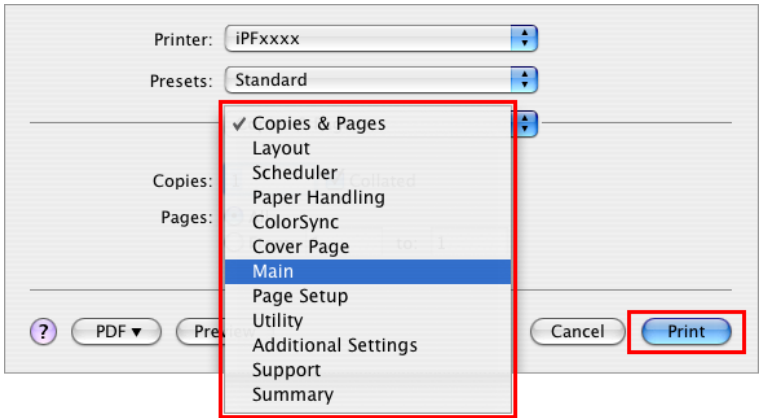

## Canceling print jobs

Canceling Print Jobs from the Control Panel .....	14
Canceling Print Jobs from Windows .....	15
Canceling Print Jobs from Mac OS X .....	16

### Canceling Print Jobs from the Control Panel

To cancel printing or reception of print jobs, press the **Stop** button on the Control Panel.



When you press the **Stop** button during printing, printer operation varies depending on the current status.

- If you press the **Stop** button before printing starts

Pressing the **Stop** button before printing starts will display a confirmation message. To cancel the print job, select **Yes**.

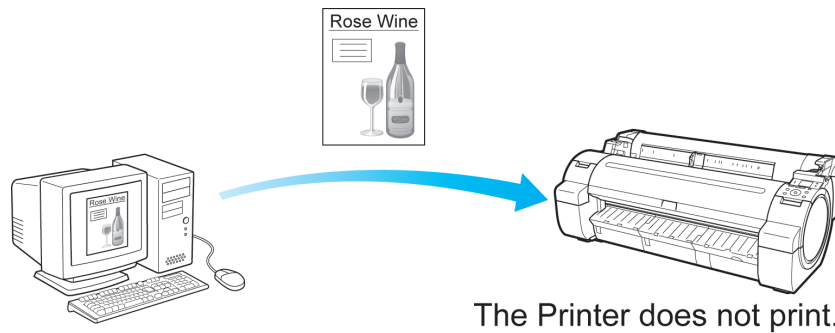

- If you press the **Stop** button during printing

Pressing the **Stop** button during printing will display a confirmation message. To cancel the print job immediately, select **Yes**.

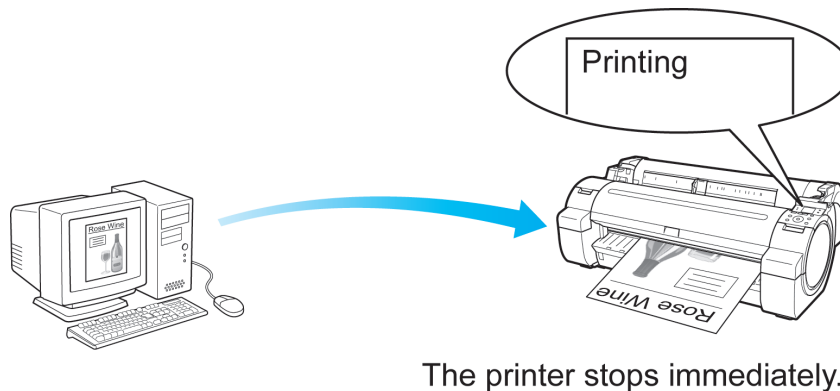

## Canceling Print Jobs from Windows

In the printer window, you can cancel jobs that are being sent to the printer.

Using imagePROGRAF Status Monitor, you can cancel print jobs that have already been received by the printer or that are currently being printed.

1. Click the printer icon in the taskbar to display the printer window.



### Note

- You can also display this window by double-clicking the printer icon in the **Printers and Faxes** (or **Printers**) folder, accessible through the Windows **start** menu.

2. Right-click the job to cancel and select **Cancel**.

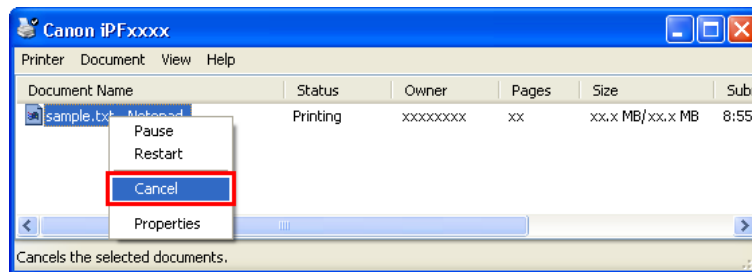

3. If the job to cancel is not shown in the printer window (that is, if the print data has already been received by the printer), double-click the taskbar icon to display imagePROGRAF Status Monitor.

4. On the **Printer Status** sheet, click **Cancel Job**.

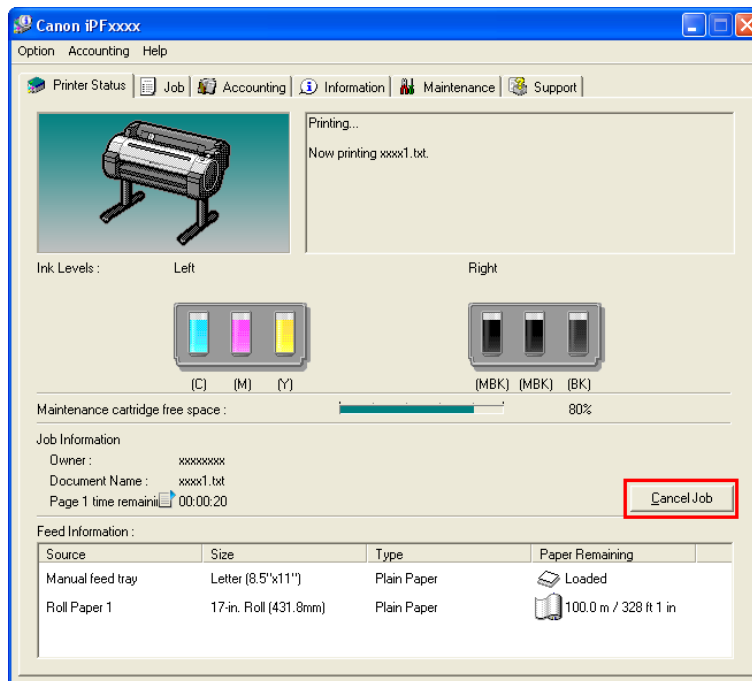



Note

- The screen may differ slightly depending on the model you are using.

## Canceling Print Jobs from Mac OS X

In the printer window, you can cancel jobs that are being sent to the printer. Otherwise, you can cancel jobs from imagePROGRAF Printmonitor if they have been received by the printer or are currently being printed.



Note

- Print jobs are shown in the printer window while they are being sent from the computer. After transmission, jobs are not displayed even during printing.
- Print jobs are displayed in the imagePROGRAF Printmonitor window from the moment the printer starts receiving the print data until the moment printing is finished. They are not displayed before print data is sent to the printer, even if the computer has started preparing the print data.

1. Click the printer icon in the **Dock** to display the printer window.
2. Click **Pause Printer** to stop printing.

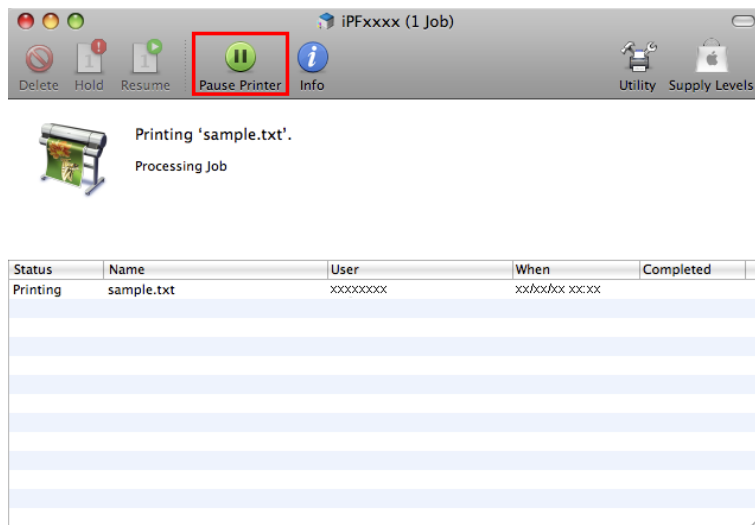

3. If there are no jobs in the printer window that can be canceled, (that is, if the print data has already been sent to the printer), click **Utility** to display imagePROGRAF Printmonitor.

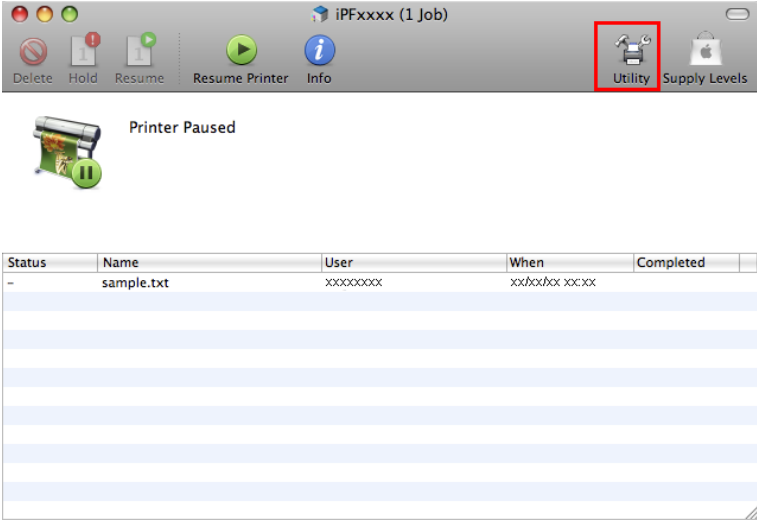

4. Select the print job to cancel and click  to delete the print job.

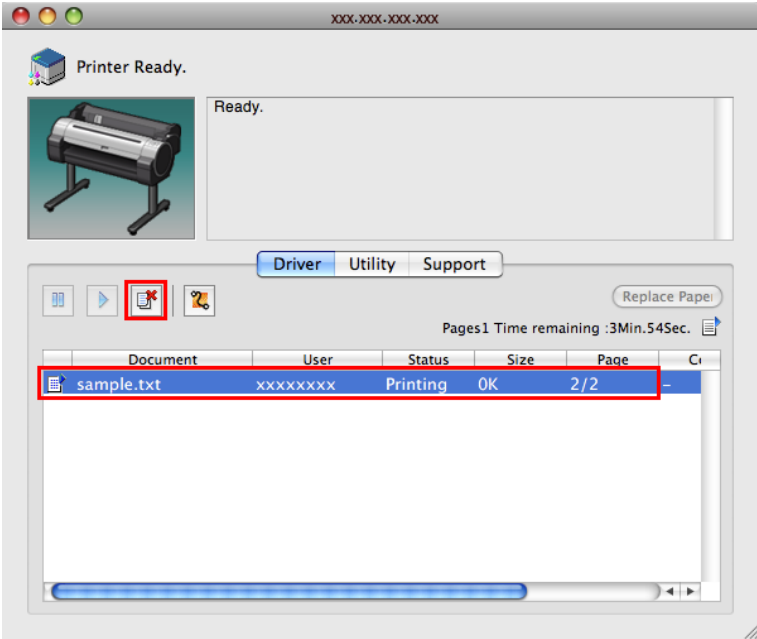

 **Note**  
• The screen may differ slightly depending on the model you are using.

The job sent to the printer is canceled.

**5.** Exit imagePROGRAF Printmonitor. In the printer window, click **Resume Printer**.



**Important**

- Always follow these steps if you cancel print jobs from imagePROGRAF Printmonitor. If you do not restart job processing, the next job cannot be printed.



## Pausing Printing

Pausing Printing ..... 19

### Pausing Printing

During printing, if you set **Pause Print** in the Control Panel menu to **On**, printing is stopped at that point and the printer enters a state in which printing is paused. (See "Control Panel Display.") →P.651

Printing from the job queue is not possible in this state.

To restore normal operation after this state, set **Pause Print** to **Off**.



#### Note

- In the following cases, the status is cleared even if you do not set **Pause Print** to **Off**, and printing from the job queue resumes.
  - When paper is advanced
  - When you execute **Chg. Paper Type** in the **Paper Menu**

1. During printing, on the **Tab Selection screen** of the Control Panel, press ◀ or ▶ to select the Job tab ().

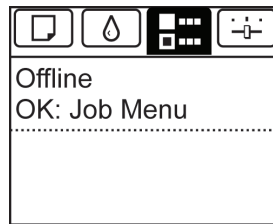

#### Note

- If the **Tab Selection screen** is not displayed, press the **Menu** button.

2. Press the **OK** button.  
The **Job Menu** is displayed.
3. Press ▲ or ▼ to select **Pause Print**, and then press the **OK** button.
4. Press ▲ or ▼ to select **On** or **Off**, and then press the **OK** button.

## Enhanced Printing Options

Choosing Paper for Printing	21
Printing Photos and Office Documents	22
Printing CAD Drawings	39
Adjusting Images	51
Printing enlargements or reductions	69
Printing at full size	89
Borderless Printing	104
Printing banners or at other non-standard sizes	120
Tiling and multiple pages per sheet	139
Centering originals	161
Conserving roll paper	174
Checking Images Before Printing	188
Other useful settings	190

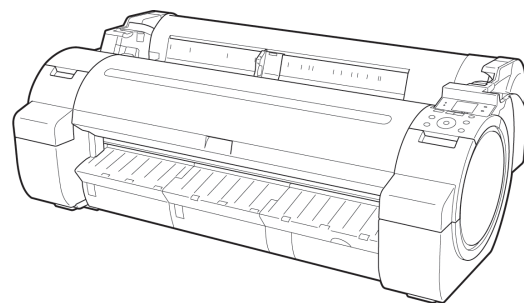

## Choosing Paper for Printing

Choosing a Paper for Printing .....	21
Specifying Paper in the Printer Driver .....	21

### Choosing a Paper for Printing

Choosing the right paper for your particular printing application will give you the best printing results.

- **Media Type**

The printer and printer driver offer print settings optimized for various paper characteristics.



**Note**

- For information on the types of paper the printer supports, refer to the Paper Reference Guide. (See "Types of Paper →P.568 ")
- The types of paper indicated in the printer driver and related software (as well as on the Control Panel) are updated when you install the Media Configuration Tool from the User Software CD-ROM or if you change paper information by using the Media Configuration Tool. For information about the Media Configuration Tool, see the Media Configuration Tool →P.412 (Windows) or Media Configuration Tool →P.543 (Macintosh).
- An error message may be displayed on the printer Control Panel if the type of paper as specified in the printer driver does not match the type specified on the printer. Although you can print under these conditions, the printing results may not be suitable.

- If the paper type is not listed for selection

If the type of paper loaded is not listed among the options for selection, try printing on Special 1, Special 2, and so on. Note that higher numbers in this setting enable more vivid colors but may also cause colors to run together.

For instructions on specifying the paper type before printing, refer to the following topics.

- Changing the Type of Paper →P.583

### Specifying Paper in the Printer Driver

If you replace the paper, complete the printer driver settings for the paper type and size.

For instructions on configuring paper settings in the printer driver, refer to the following topics, as appropriate for your computer and operating system.

- Specifying Paper in the Printer Driver(Windows) →P.209
- Specifying Paper in the Printer Driver(Mac OS X) →P.434

## Printing Photos and Office Documents

Printing Photos and Images ..... 22  
 Printing Photos and Images (Windows) ..... 23  
 Printing Photos and Images (Mac OS X) ..... 25  
 Printing Office Documents ..... 29  
 Printing Office Documents (Windows) ..... 30  
 Printing Office Documents (Mac OS X) ..... 32  
 Using PosterArtist to Compose Originals ..... 36

## Printing Photos and Images

2

Printing is easy when you simply choose the print target.



- **Easy Settings**

Simply choose the printing application in the list for optimal printing results.

- **Print Target**

Choose presets that match the type of document to be printed.

### Print targets for photos and images

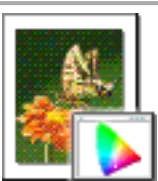
	Print Target	Description
	<b>Poster</b>	The best setting for posters. Prints using vivid and high impact colors.
	<b>Photo (Color)</b>	Suitable for printing photographic images captured with a digital camera.
	<b>Faithful Color Reproduction</b>	Prints by minimizing color differences. Suitable for when the printing results are too vivid or when printing scanned images.

22



**Important**

- Depending on the **Media Type** setting, some **Print Target** options may not be available.



**Note**

- You can check the settings values for each print target by clicking **View Settings**.
- You can also fine-tune these values as needed. ( **Advanced Settings** )  
 For details on **Advanced Settings**, see "Giving Priority to Particular Graphic Elements and Colors for Printing →P.60 "

## • Print Quality

Choose the print quality.

The printing mode is determined by a combination of the print quality and resolution.

Print Quality	Description
<b>Highest</b>	A setting for printing at the highest resolution when quality is most important. Printing takes longer and consumes more ink than in other modes, but this mode offers superior printing quality.
<b>High</b>	Choose this setting to print at high resolution when quality is most important. Printing takes longer and consumes more ink than in <b>Standard</b> or <b>Draft</b> modes, but this mode offers exceptional printing quality.
<b>Standard</b>	Choose this setting to print at standard resolution when quality and speed are both important. Printing takes less time than in <b>Highest</b> or <b>High</b> mode.
<b>Draft</b>	Choose this setting to print faster. Printing in draft mode can help you work more efficiently when checking layouts.

For instructions on printing photos and images, refer to the following topics, as appropriate for your computer and operating system.

- Printing Photos and Images (Windows) →P.23
- Printing Photos and Images (Mac OS X) →P.25

2

## Printing Photos and Images (Windows)

This topic describes how to print photos based on the following example.

- Document: Photo image from a digital camera
- Page size: 10×12 inches (254.0×304.8 mm)
- Paper: Roll
- Paper type: Premium Glossy Paper 200
- Roll paper width: 10 inches (254.0 mm)

1. Choose **Print** in the application menu.
2. Select the printer in the dialog box, and then display the printer driver dialog box. (See "Accessing the Printer Driver Dialog Box from Applications(Windows) →P.217 ")

23

### 3. Make sure the **Main** sheet is displayed.

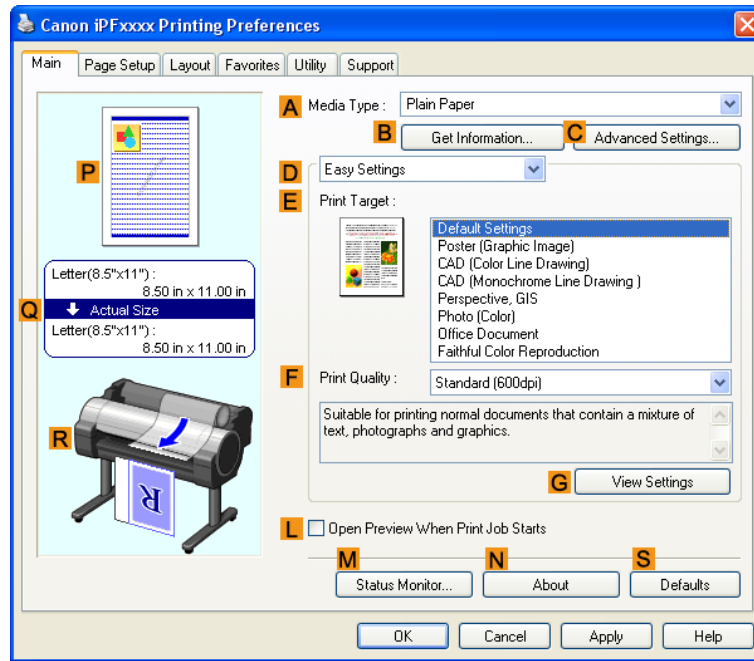

4. In the **A Media Type** list, select the type of paper that is loaded. In this case, click Premium Glossy Paper 200. In the **A Media Type**, choose the type of paper used for printing, such as Glossy Paper, Coated Paper, and so on. Make sure the paper you select is loaded in the printer.



#### Note

- The paper type setting in the printer driver and related software (as well as on the Control Panel) is updated when you install the Media Configuration Tool from the User Software CD-ROM or if you change paper information by using the Media Configuration Tool. For details, see Media Configuration Tool →P.412 .

5. After confirming that **D Easy Settings** is selected, click **Photo (Color)** in the **E Print Target** list.



#### Note

- You can check the settings values selected in the **E Print Target** list by clicking **G View Settings**.

6. Click the **Page Setup** tab to display the **Page Setup** sheet.

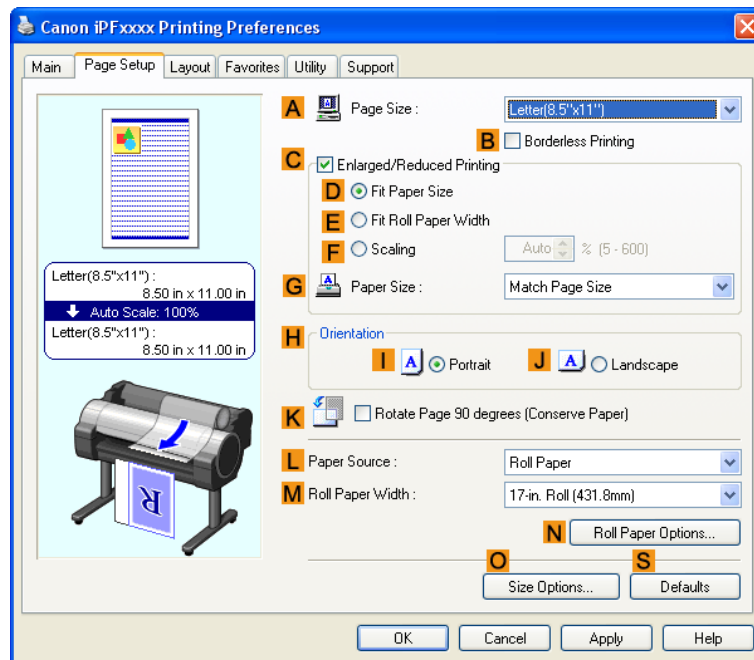

2

7. In the **A Page Size** list, click the size of the original as specified in the application. In this case, click **10"x12"**.
8. Select and click a roll paper in the **L Paper Source** list.
9. Select the width of the loaded roll in the **M Roll Paper Width** list—in this case, **10-in. Roll (254.0mm)**.
10. Specify additional printing conditions.  
For details on available printing conditions, see "Printer Driver Settings(Windows) →P.207 "
11. Confirm the print settings and print as desired.



#### Note

- For instructions on confirming print settings, see "Confirming Print Settings(Windows)

→P.212 "

25

## Printing Photos and Images (Mac OS X)

This topic describes how to print photos based on the following example.

- Document: Photo image from a digital camera
- Page size: 10×12 inches (254.0×304.8 mm)
- Paper: Roll paper
- Paper type: Premium Glossy Paper 200
- Roll paper width: 10 inches (254.0 mm)

1. This sets the **B Format for** and **C Paper Size**.



**Note**

- The configuration method varies depending on the OS and application software you are using. If **Page Setup** is displayed in the application menu, the settings are configured by opening the **Page Attributes** dialog box from **Page Setup**.

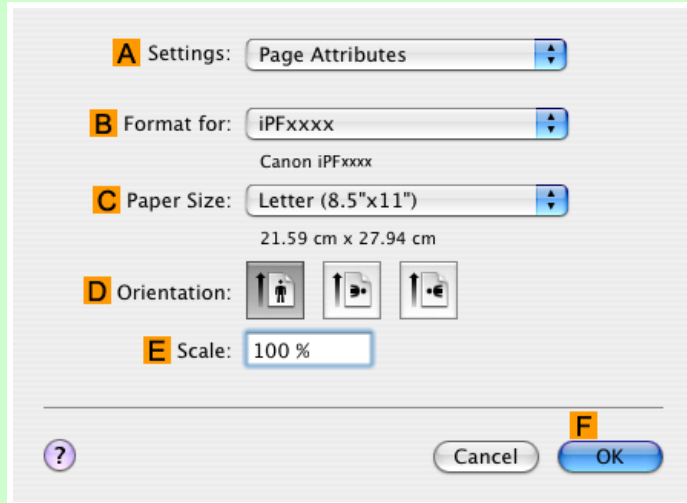

If it is not displayed, the settings are configured in the upper part of the printer driver displayed when you select **Print** from the application software menu.

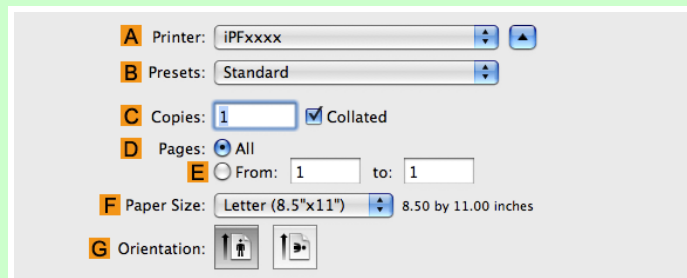

2. Select the printer in the **A Printer** list.

3. In the **F Paper Size** list, click the size of the original. In this case, click **10"x12"**.

4. If you configured the settings using the **Page Attributes** dialog box, click **F OK** to close the dialog box, and then select **Print** from the application software menu.



## 5. Access the **Main** pane.

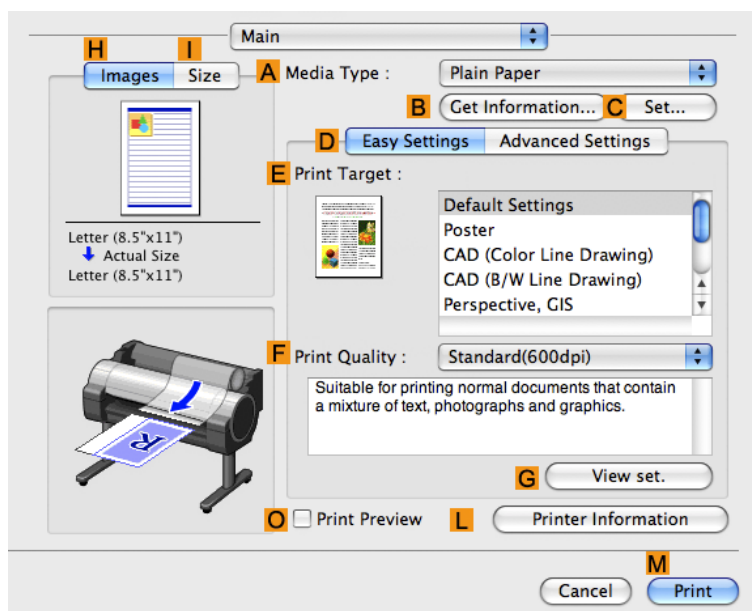

## 6. In the **A Media Type** list, select the type of paper that is loaded. In this case, click Premium Glossy Paper 200. Make sure the paper you select is loaded in the printer.



### Note

- The types of paper indicated in the printer driver and related software (as well as on the Control Panel) are updated when you install the Media Configuration Tool from the User Software CD-ROM or if you change paper information by using the Media Configuration Tool. For details, see [Media Configuration Tool](#) →P.543 .

## 7. After confirming that **D Easy Settings** is selected, click **Photo (Color)** in the **E Print Target** list.



### Note

- For information on settings optimized for printing photos and images, see "Printing Photos and Images" →P.22 "
- You can check the settings values selected in the **E Print Target** list by clicking **G View set..**

## 8. Make your selection in the **F Print Quality** list.

9. Access the **Page Setup** pane.

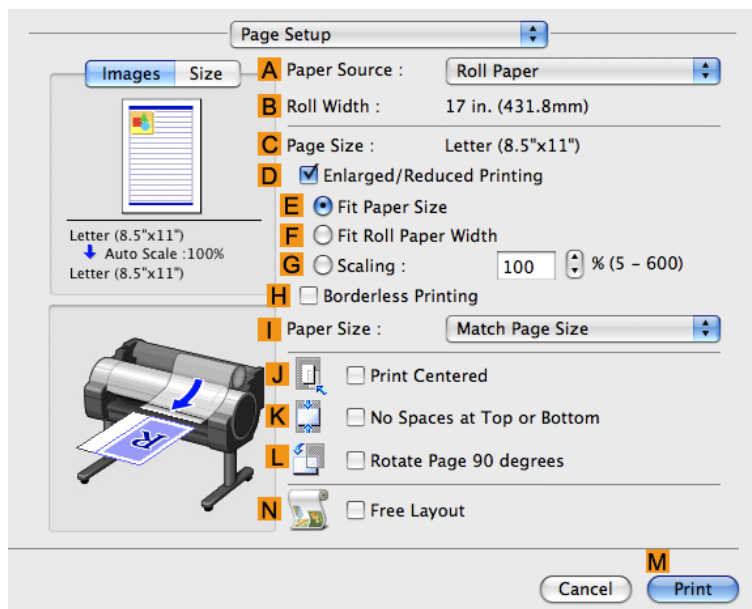

2

10. Select and click a roll paper in the **A Paper Source** list.

11. Make sure the width of the loaded roll is displayed in the **B Roll Width** list—in this case, **10 in. (254.0mm)**.

 **Note**  
• If the width of the roll loaded in the printer is not shown in **B Roll Width**, click **L Printer Information** on the **Main** pane to update the printer information.

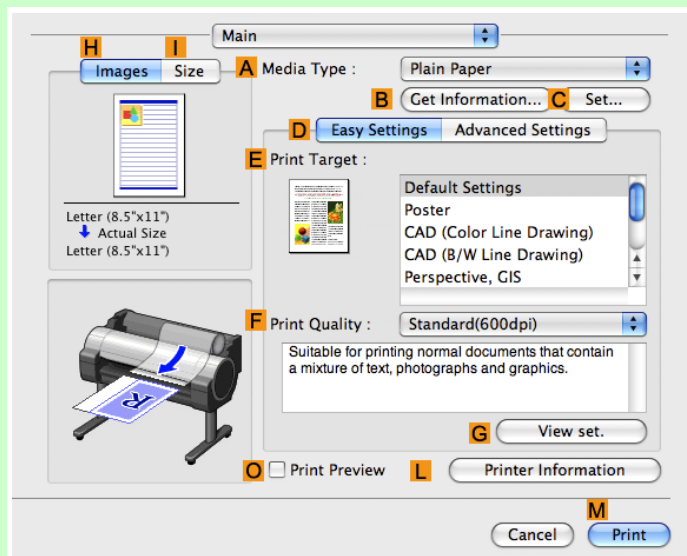

28

- 12.** Make sure **C Page Size** on the **Page Setup** pane shows the original size as specified in **C Paper Size** in the **Page Attributes** dialog box—in this case, **10"x12"**.

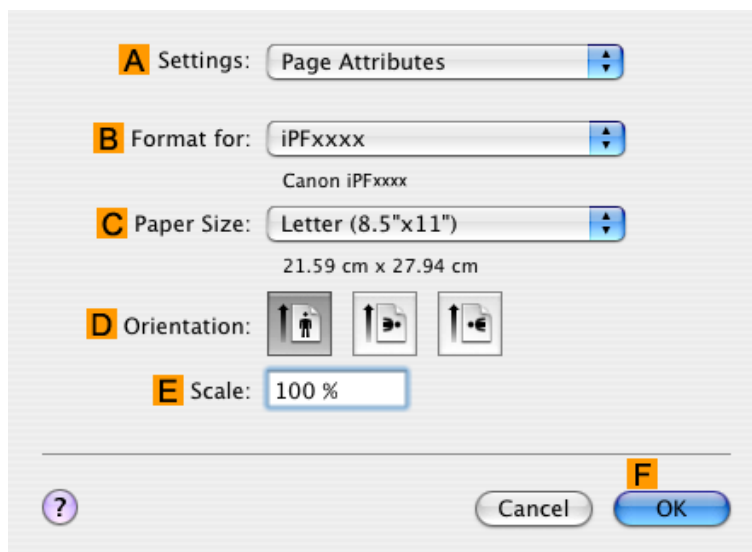

- 13.** Specify additional printing conditions.  
For details on available printing conditions, see "Printer Driver Settings(Mac OS X) →P.432 "

- 14.** Confirm the print settings, and then click **M Print** to start printing.



**Note**

- For tips on confirming print settings, see "Confirming Print Settings(Mac OS X) →P.436 "

## Printing Office Documents

Printing is easy when you simply choose the type of original to print.

- **Easy Settings**

Simply choose the printing application in the list for optimal printing results.

- **Print Target**

Choose presets that match the type of document to be printed.

### Print targets for office documents

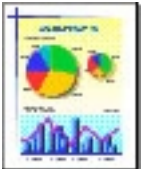
	Print Target	Description
	Office Document	Settings optimized for clear printing of office documents such as handouts.

**Note**

- You can check the settings values for each print target by clicking **View Settings**.
- You can also fine-tune these values as needed. (Advanced Settings)  
For details on Advanced Settings, see "Giving Priority to Particular Graphic Elements and Colors for Printing →P.60 "

## • Print Quality

Choose the print quality.

The printing mode is determined by a combination of the print quality and resolution.

Print Quality	Description
<b>Highest</b>	A setting for printing at the highest resolution when quality is most important. Printing takes longer and consumes more ink than in other modes, but this mode offers superior printing quality.
<b>High</b>	Choose this setting to print at high resolution when quality is most important. Printing takes longer and consumes more ink than in <b>Standard</b> or <b>Draft</b> modes, but this mode offers exceptional printing quality.
<b>Standard</b>	Choose this setting to print at standard resolution when quality and speed are both important. Printing takes less time than in <b>Highest</b> or <b>High</b> mode.
<b>Draft</b>	Choose this setting to print faster. Printing in draft mode can help you work more efficiently when checking layouts.

For instructions on printing office documents, refer to the following topics, as appropriate for your computer and operating system.

- Printing Office Documents (Windows) →P.30
- Printing Office Documents (Mac OS X) →P.32

## Printing Office Documents (Windows)

This topic describes how to print office documents based on the following example.

- Document: Office document created using word-processing or spreadsheet programs
- Page size: A4 (210.0 × 297.0 mm [8.3 × 11.7 in])
- Paper: Sheets
- Paper type: Plain Paper
- Paper size: A4 (210.0 × 297.0 mm [8.3 × 11.7 in])

1. Choose **Print** in the application menu.
2. Select the printer in the dialog box, and then display the printer driver dialog box. (See "Accessing the Printer Driver Dialog Box from Applications(Windows) →P.217 ")

3. Make sure the **Main** sheet is displayed.

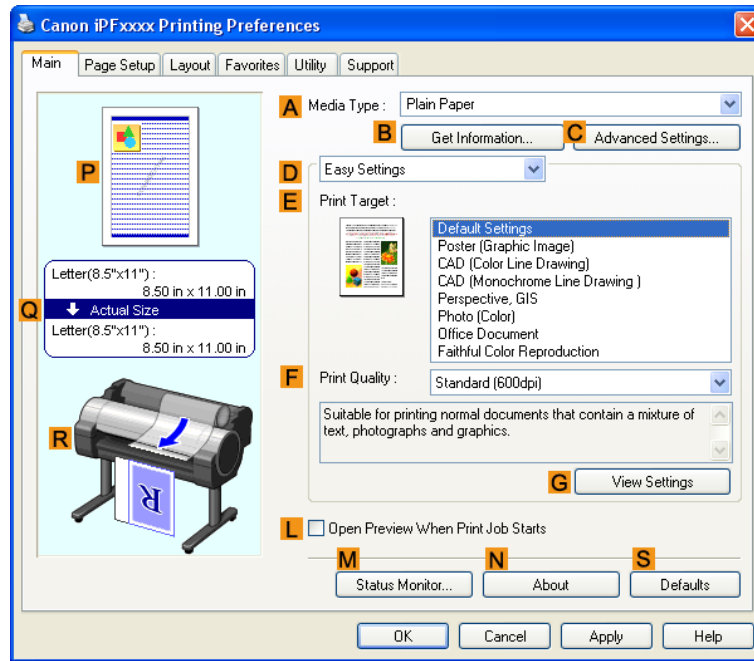

4. In the **A Media Type** list, select the type of paper that is loaded. In this case, click Plain Paper.

5. After confirming that **D Easy Settings** is selected, click **Office Document** in the **E Print Target** list.



**Note**

- You can check the settings values selected in the **E Print Target** list by clicking **G View Settings**.

6. Click the **Page Setup** tab to display the **Page Setup** sheet.

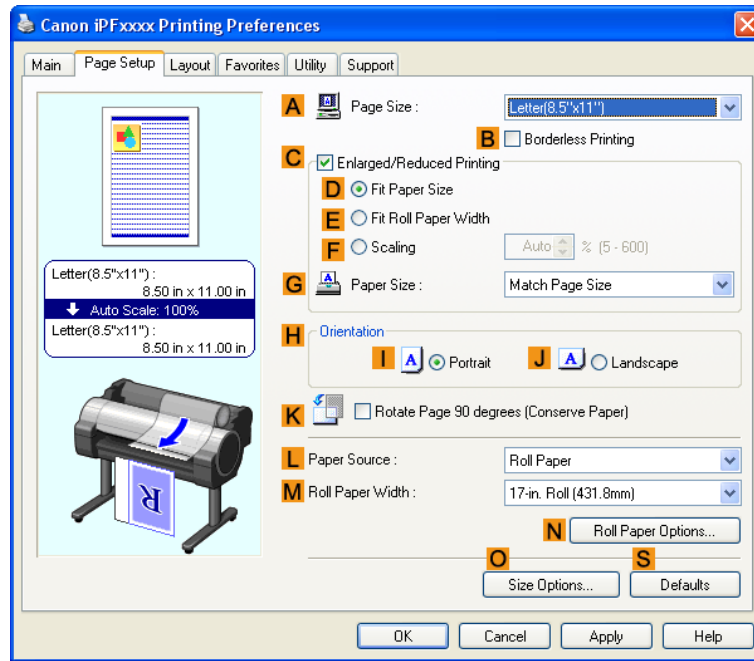

7. In the **A Page Size** list, click the size of the original as specified in the application. In this case, click **ISO A4**.

8. Click **Manual** in the **L Paper Source** list.

9. Specify additional printing conditions.  
 For details on available printing conditions, see "Printer Driver Settings(Windows) →P.207 "

10. Confirm the print settings and print as desired.

**Note**  
 • For tips on confirming print settings, see "Confirming Print Settings(Windows) →P.212 "

## Printing Office Documents (Mac OS X)

This topic describes how to print office documents based on the following example.

- Document: Office document created using word-processing or spreadsheet programs
- Page size: A4 (210.0 × 297.0 mm [8.3 × 11.7 in])
- Paper: Sheets
- Paper type: Plain Paper
- Paper size: A4 (210.0 × 297.0 mm [8.3 × 11.7 in])

1. This sets the **B Format for** and **C Paper Size**.

**Note**

- The configuration method varies depending on the OS and application software you are using. If **Page Setup** is displayed in the application menu, the settings are configured by opening the **Page Attributes** dialog box from **Page Setup**.

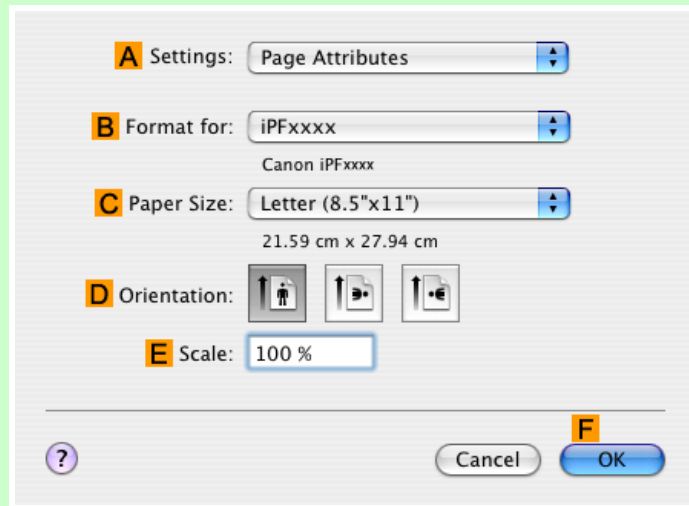

If it is not displayed, the settings are configured in the upper part of the printer driver displayed when you select **Print** from the application software menu.

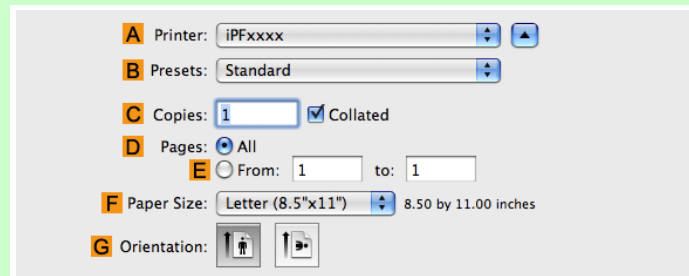

2. Select the printer in the **A Printer** list.
3. In the **F Paper Size** list, click the size of the original. In this case, click **ISO A4 - for Paper Tray (Large Margins)**.
4. If you configured the settings using the **Page Attributes** dialog box, click **F OK** to close the dialog box, and then select **Print** from the application software menu.

5. Access the **Main** pane.

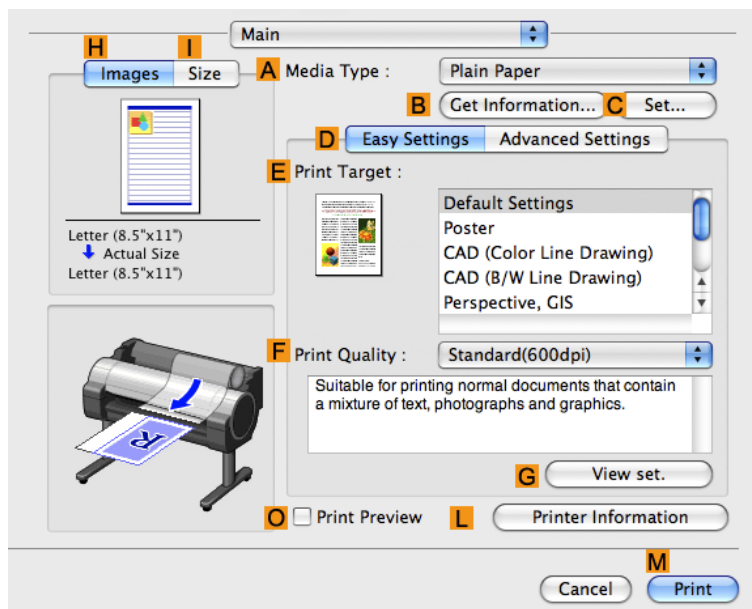

6. In the **A Media Type** list, select the type of paper that is loaded. In this case, click Plain Paper.

7. After confirming that **D Easy Settings** is selected, click **Office Document** in the **E Print Target** list.

**Note**

- You can check the settings values selected in the **E Print Target** list by clicking **G View set.**

8. Make your selection in the **F Print Quality** list.



## 9. Access the **Page Setup** pane.

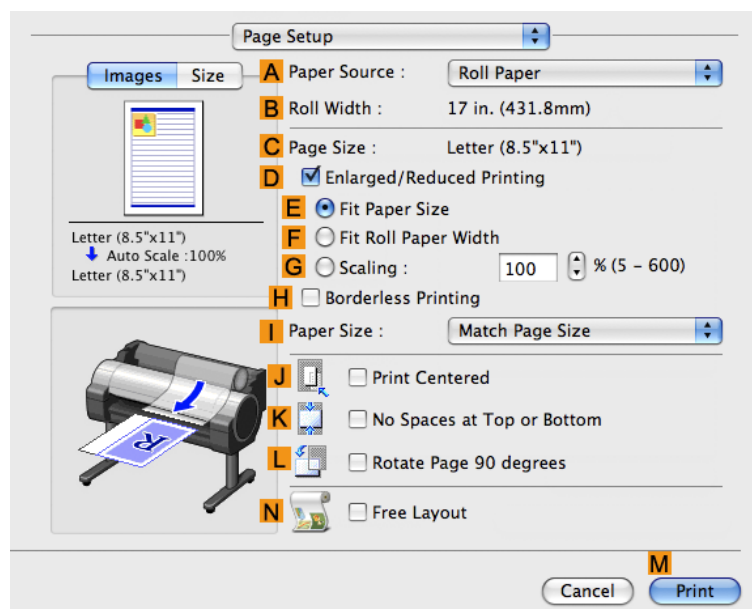

## 10. Click **Manual** in the **A Paper Source** list.

## 11. Make sure the **C Page Size** setting matches the original size as selected in **C Paper Size** in the **Page Attributes** dialog box—in this case, **ISO A4 - for Paper Tray (Large Margins)**.

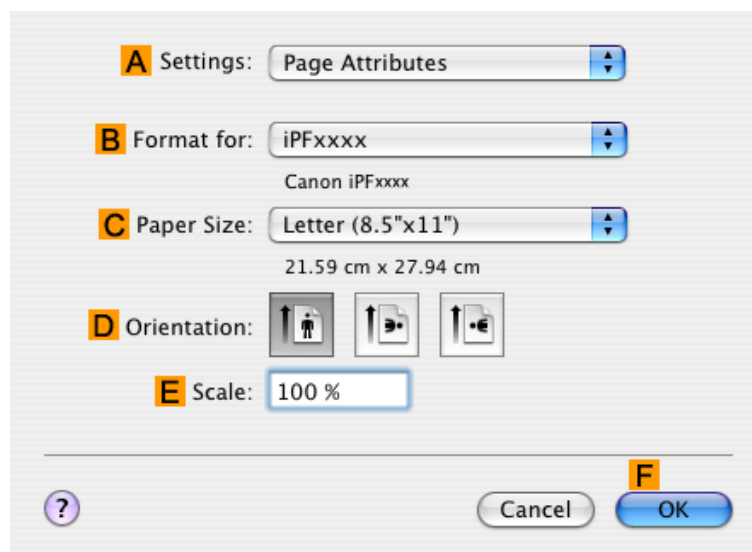

## 12. Specify additional printing conditions.

For details on available printing conditions, see "Printer Driver Settings(Mac OS X) →P.432 "

- 13.** Confirm the print settings, and then click **M Print** to start printing.

**Note**

- For tips on confirming print settings, see "Confirming Print Settings(Mac OS X) →P.436 "

## Using PosterArtist to Compose Originals

You can print a variety of source documents from word-processing or spreadsheet programs or screen shots from web browsers after composing an original with them using PosterArtist.

This topic describes how to use PosterArtist to compose originals from multiple applications, creating a poster layout for printing.

**Important**

- This function is only supported in Windows.
- PosterArtist (sold separately) must be installed to use this function.

1. Choose **Print** in the application menu.
2. Select the printer in the dialog box, and then open the printer driver dialog box. (See "Accessing the Printer Driver Dialog Box from Applications(Windows).") →P.217
3. Make sure the **Main** sheet is displayed.

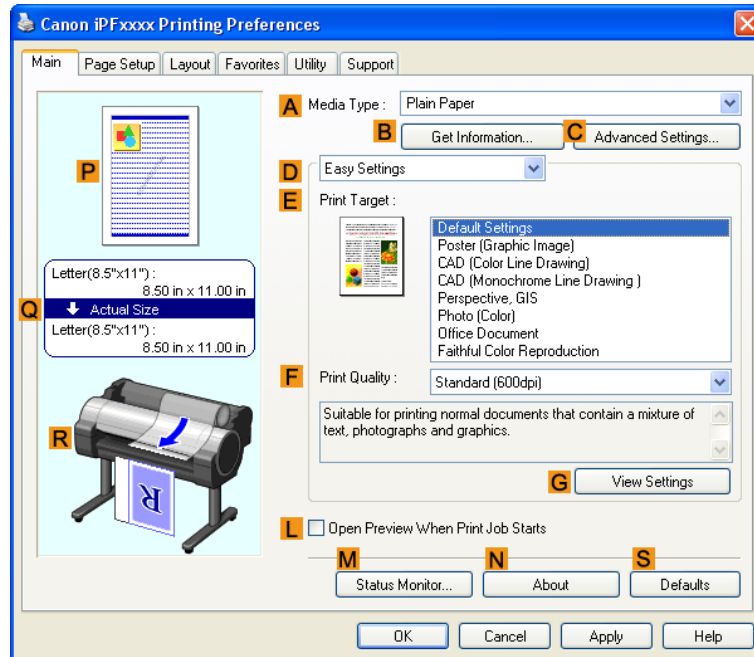

- Click the **Layout** tab to display the **Layout** sheet.

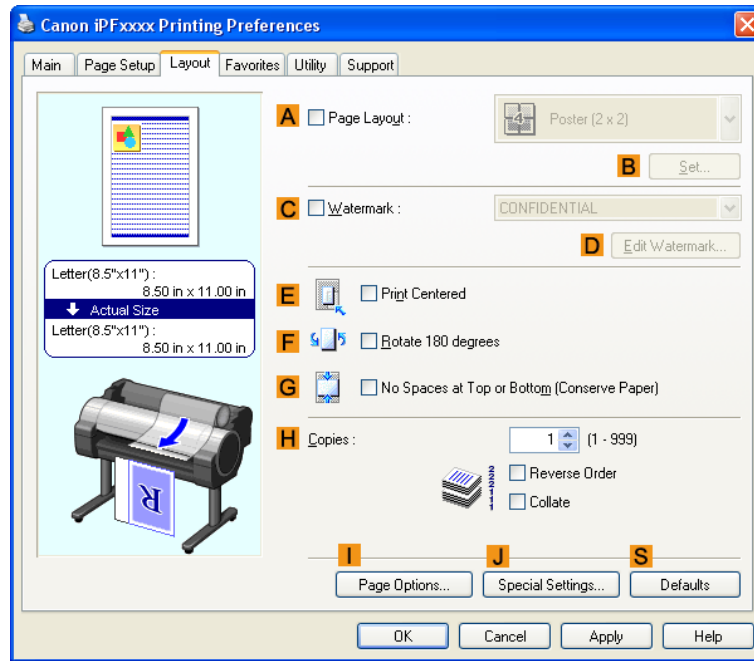

- Select the **A Page Layout** check box.
- Click in the **Edit Using PosterArtist** in the **A Page Layout** list.
- When you attempt to print, PosterArtist starts up and the PageCapture window is displayed. (At this point, the document will not be printed yet.)

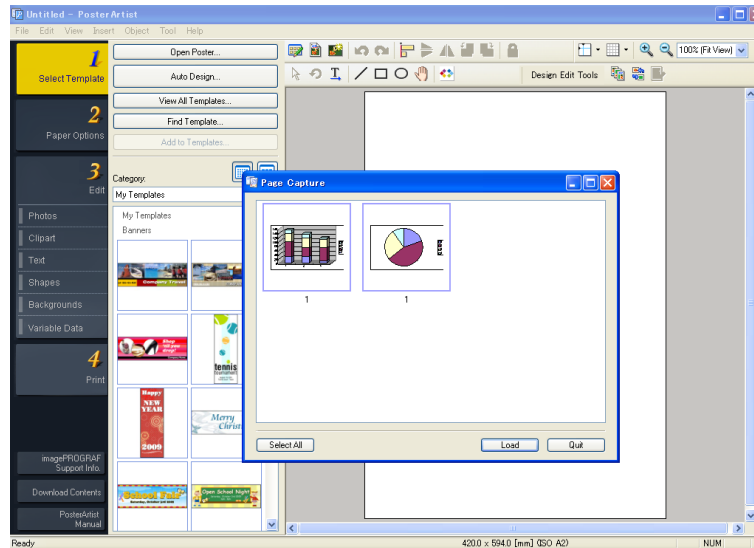

- Choose the page to load in PosterArtist.

**9.** Edit and rearrange the image in the PosterArtist window as desired.



**Important**

- Without closing the PosterArtist window, repeat steps 1-8 to arrange originals from multiple applications on the same page.



**Note**

- For instructions on editing and rearranging images, refer to the PosterArtist Manual.

**10.** Print from the PosterArtist menu.

## Printing CAD Drawings

Printing CAD Drawings .....	39
Printing Line Drawings and Text .....	39
Printing Line Drawings and Text (Windows) .....	40
Printing Line Drawings and Text (Mac OS X) .....	42
Printing from AutoCAD .....	46
Specifying Colors and Printing CAD Drawings .....	47
Specifying Colors and Printing CAD Drawings (Windows) .....	48
HP-GL/2 Printing .....	50

## Printing CAD Drawings

Using this printer, you can print fine lines and text clearly and sharply. It's easy to produce highly precise drawings from CAD applications.



### Note

- In Windows, you can print highly precise drawings using the provided imagePROGRAF HDI Driver for AutoCAD/AutoCAD LT.  
For details on the HDI driver, see the HDI Driver [→P.358](#).

For instructions on CAD printing, refer to the following topics, as appropriate for your computer and operating system.

- Printing Line Drawings and Text (Windows) [→P.40](#)
- Printing Line Drawings and Text (Mac OS X) [→P.42](#)

## Printing Line Drawings and Text

Printing is easy when you simply choose the type of original to print.

### • Easy Settings



Simply choose the printing application in the list for optimal printing results.

### • Print Target

Choose presets that match the type of document to be printed.

## Print targets for line drawings and text

	Print Target	Description
	<b>CAD (Color Line Drawing)</b>	Settings optimized to print intricate lines in CAD drawings clearly.

	Print Target	Description
	<b>CAD (Monochrome Line Drawing)</b>	Settings optimized to print black lines in CAD drawings clearly.
	<b>Perspective, GIS</b>	Settings optimized for printing 3D CAD drawings, perspective drawings, and maps, including GIS maps.



**Note**

- You can check the settings values for each print target by clicking **View Settings**.
- You can also fine-tune these values as needed. ( **Advanced Settings** )  
For details on **Advanced Settings**, see "Giving Priority to Particular Graphic Elements and Colors for Printing →P.60 "

**• Print Quality**

Choose the print quality.

The printing mode is determined by a combination of the print quality and resolution.

Print Quality	Description
<b>Highest</b>	A setting for printing at the highest resolution when quality is most important. Printing takes longer and consumes more ink than in other modes, but this mode offers superior printing quality.
<b>High</b>	Choose this setting to print at high resolution when quality is most important. Printing takes longer and consumes more ink than in <b>Standard</b> or <b>Draft</b> modes, but this mode offers exceptional printing quality.
<b>Standard</b>	Choose this setting to print at standard resolution when quality and speed are both important. Printing takes less time than in <b>Highest</b> or <b>High</b> mode.
<b>Draft</b>	Choose this setting to print faster. Printing in draft mode can help you work more efficiently when checking layouts.

For instructions on printing line drawings and text, refer to the following topics, as appropriate for your computer and operating system.

- Printing Line Drawings and Text (Windows) →P.40
- Printing Line Drawings and Text (Mac OS X) →P.42

**Printing Line Drawings and Text (Windows)**

This topic describes how to print line drawings based on the following example.

- Document: CAD drawing
- Page size: A3 (297.0 × 420.0 mm [11.7 × 16.5 in])
- Paper: Roll paper
- Paper type: Plain Paper
- Roll paper width: A2/A3 roll (420.0 mm [16.5 in])

1. Choose **Print** in the application menu.
2. Select the printer in the dialog box, and then display the printer driver dialog box. (See "Accessing the Printer Driver Dialog Box from Applications(Windows) (→P.217)")
3. Make sure the **Main** sheet is displayed.

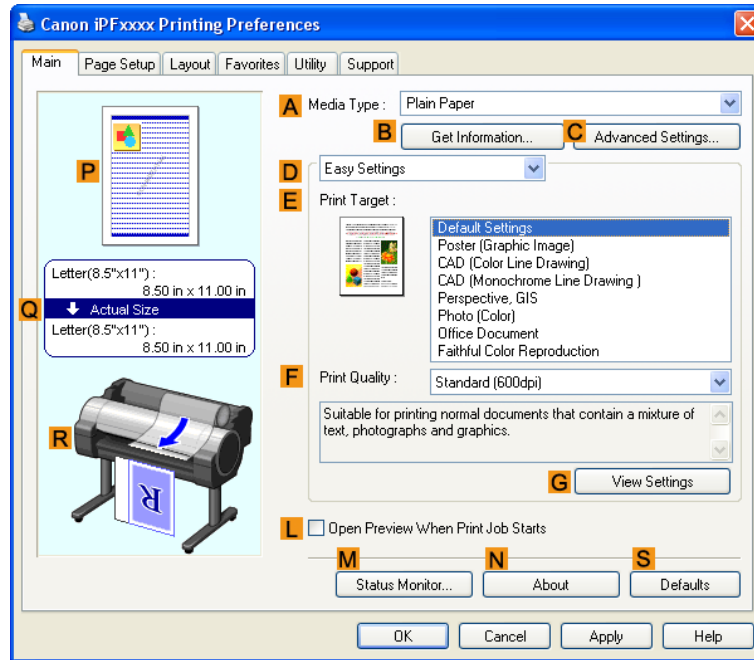

4. In the **A Media Type** list, select the type of paper that is loaded. In this case, click Plain Paper.
5. After confirming that **D Easy Settings** is selected, click **CAD (Color Line Drawing)** or **CAD (Monochrome Line Drawing)** in the **E Print Target** list.

**Note**

- You can check the settings values selected in the **E Print Target** list by clicking **G View Settings**.

6. Click the **Page Setup** tab to display the **Page Setup** sheet.

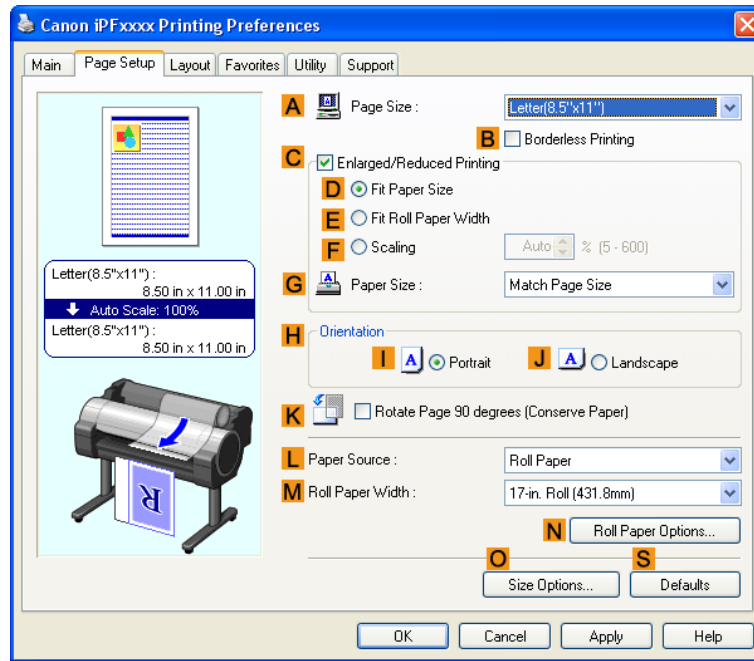

7. In **A Page Size**, click the size of the original as specified in the application. In this case, click **ISO A3**.
8. Select and click a roll paper in the **L Paper Source** list.
9. Select the width of the loaded roll in the **M Roll Paper Width** list—in this case, **ISO A2/A3 Roll (420.0mm)**.
10. Specify additional printing conditions.  
For details on available printing conditions, see "Printer Driver Settings(Windows) →P.207 "
11. Confirm the print settings and print as desired.



**Note**

- For tips on confirming print settings, see "Confirming Print Settings(Windows) →P.212 "

## Printing Line Drawings and Text (Mac OS X)

This topic describes how to print line drawings based on the following example.

- Document: CAD drawing
- Page size: A3 (297.0 × 420.0 mm [11.7 × 16.5 in])
- Paper: Roll
- Paper type: Plain Paper
- Roll paper width: A2/A3 roll (420.0 mm [16.5 in])



1. This sets the **B Format for** and **C Paper Size**.



**Note**

- The configuration method varies depending on the OS and application software you are using. If **Page Setup** is displayed in the application menu, the settings are configured by opening the **Page Attributes** dialog box from **Page Setup**.

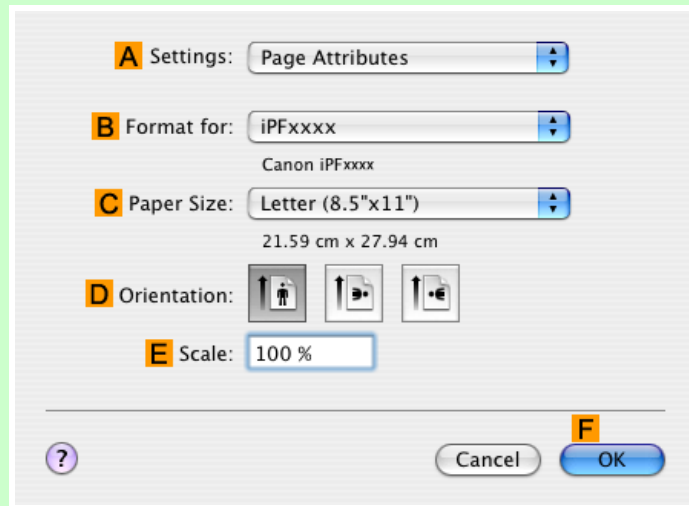

If it is not displayed, the settings are configured in the upper part of the printer driver displayed when you select **Print** from the application software menu.

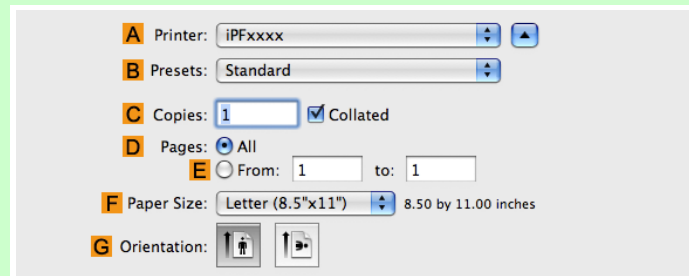

2. Select the printer in the **A Printer** list.
3. In the **F Paper Size** list, click the size of the original. In this case, click **ISO A3**.
4. If you configured the settings using the **Page Attributes** dialog box, click **F OK** to close the dialog box, and then select **Print** from the application software menu.

5. Access the **Main** pane.

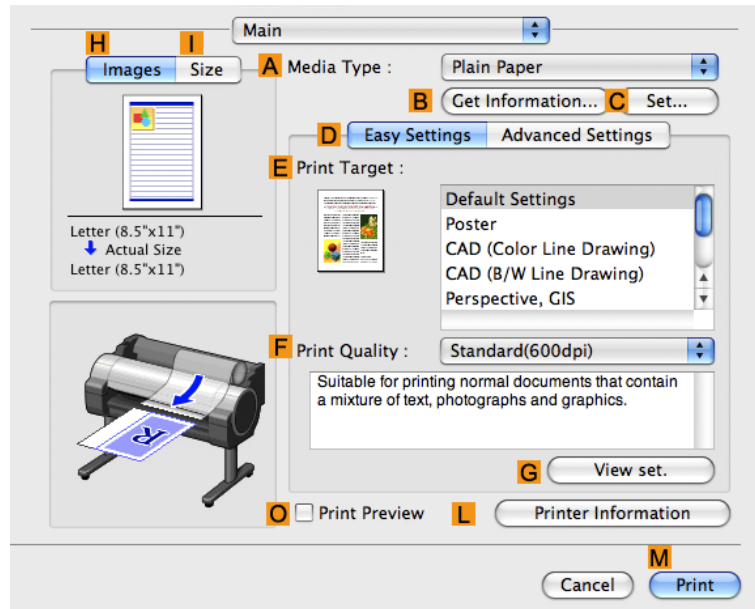

6. In the **A Media Type** list, select the type of paper that is loaded. In this case, click Plain Paper.

7. After confirming that **D Easy Settings** is selected, click **CAD (Color Line Drawing)** or **CAD (Monochrome Line Drawing)** in the **E Print Target** list.



Note

- You can check the settings values selected in the **E Print Target** list by clicking **G View set..**

8. Make your selection in the **F Print Quality** list.

## 9. Access the **Page Setup** pane.

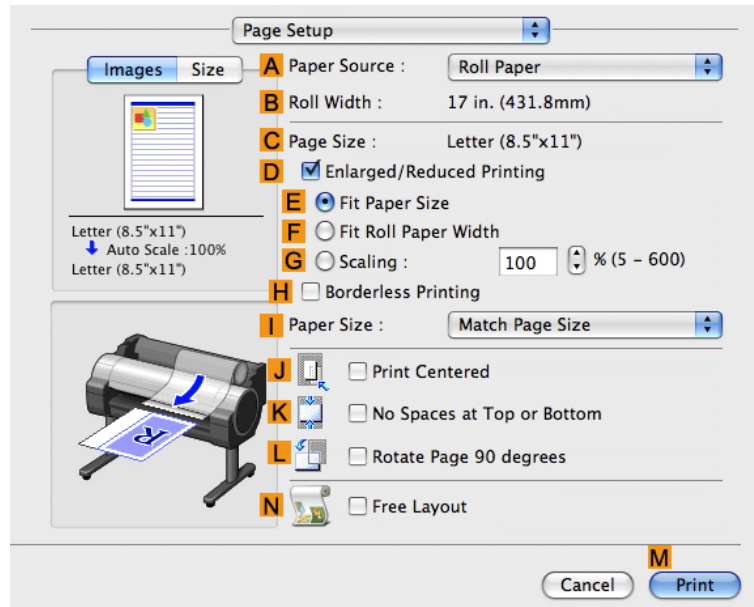

2

## 10. Select and click a roll paper in the **A Paper Source** list.

## 11. Make sure the width of the loaded roll is displayed in the **B Roll Width** list—in this case, **ISO A2/A3 (420.0mm)**.



### Note

- If the width of the roll loaded in the printer is not shown in **B Roll Width**, click **L Printer Information** on the **Main** pane to update the printer information.

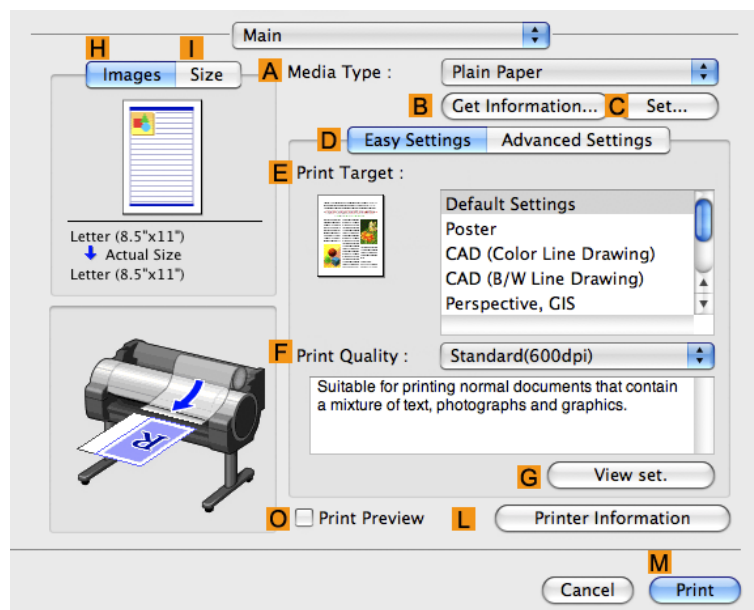

45

- 12.** Make sure **C Page Size** on the **Page Setup** pane shows the original size as specified in **C Paper Size** in the **Page Attributes** dialog box—in this case, **ISO A3**.

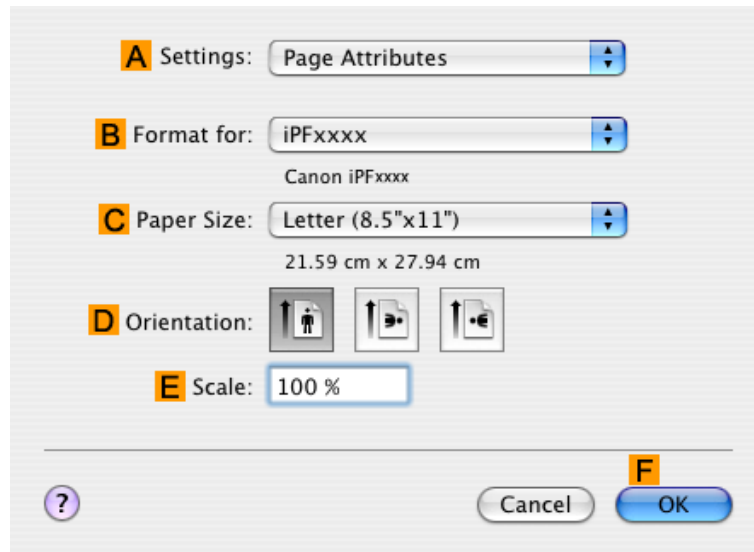

- 13.** Specify additional printing conditions.  
For details on available printing conditions, see "Printer Driver Settings(Mac OS X) →P.432 "

- 14.** Confirm the print settings, and then click **M Print** to start printing.



**Note**

- For tips on confirming print settings, see "Confirming Print Settings(Mac OS X) →P.436 "

## Printing from AutoCAD

Printer Driver Optimization Module for AutoCAD is software for printing optimally from AutoCAD with the printer driver. By optimally controlling the processing resolution of raster data and the memory to be used in image processing of AutoCAD, printing superior in reliability and productivity is realized.

If you install Printer Driver Optimization Module for AutoCAD on a computer on which supported AutoCAD is installed, it will be installed automatically.



**Note**

- Printer Driver Optimization Module for AutoCAD is applied automatically when you print from AutoCAD, and optimal printing is performed.

## Confirming the Installation of Printer Driver Optimization Module for AutoCAD

You can confirm whether Printer Driver Optimization Module for AutoCAD is installed by the following method.

- 1.** From the **File** menu of AutoCAD, select **Print**.

- The **Printing** dialog box is displayed.  
Printer Driver Optimization Module for AutoCAD is installed if in **Plotter** of **Printer/plotter** this is displayed: **iPFxxxx - Optimized driver - by Canon Inc.**

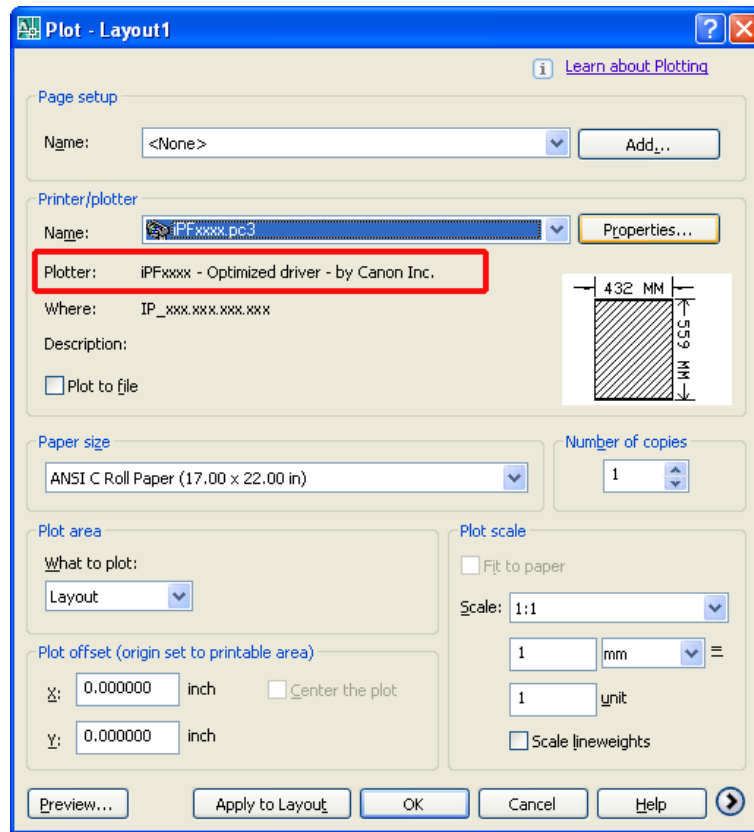

2

## Installation of Printer Driver Optimization Module for AutoCAD

If Printer Driver Optimization Module for AutoCAD is not installed, install it by the following method.

- Insert User Software CD-ROM in the CD-ROM drive and start the installer.
- In the **Setup Menu** window, click **Install Individual Software**.
- Click **Install** of Printer Driver Optimization Module for AutoCAD.
- Follow the instructions on the screen.

47

## Specifying Colors and Printing CAD Drawings

You can complete color settings when **Color (CAD)** is selected in **Color Mode**.  
Colors can be adjusted before printing as follows when **Color Compatibility** is selected.

**Note**

- **Color (CAD)** is displayed when you select **Advanced Settings** on the **Main** sheet and set **Print Priority** to **Line Drawing/Text**.

## Color Compatibility

Color Setting Item

Color Setting	Description
<b>Color (CAD) 1</b>	Print in standard colors.
<b>Color (CAD) 2</b>	Print in brighter colors.
<b>Color (CAD) 3</b>	Print with approximate colors emulating Canon iPF500, iPF600, iPF700, iPF510, iPF610, iPF710, iPF605, iPF720, iPF810, iPF820.
<b>Color (CAD) 4</b>	Print emulating the HP Designjet 500/800, in colors resembling colors produced by these printers.
<b>Color (CAD) 5</b>	Print emulating the HP Designjet 1000, in colors resembling colors produced by this printer.

**Important**

- If you have selected **Color (CAD) 3**, **Color (CAD) 4**, or **Color (CAD) 5**, it is not possible to match the colors and image quality produced by the specified printer exactly.

For instructions on configuring **Color Compatibility**, refer to the following topics.

- Specifying Colors and Printing CAD Drawings (Windows) →P.48

## Specifying Colors and Printing CAD Drawings (Windows)

You can complete color settings when **Color (CAD)** is selected in **Color Mode**.

**Note**

- **Color (CAD)** is displayed when you select **Advanced Settings** on the **Main** sheet and set **Print Priority** to **Line Drawing/Text**.

1. Click **start** > **Printers and Faxes** (or **Printers**).

2. Select the printer, and then display the printer properties dialog box.

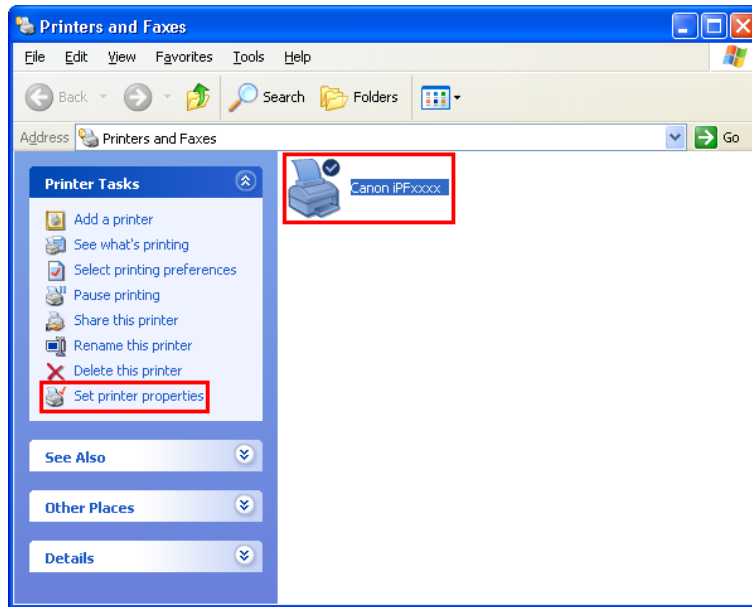

2

3. Click the **Device Settings** tab to display the **Device Settings** sheet.

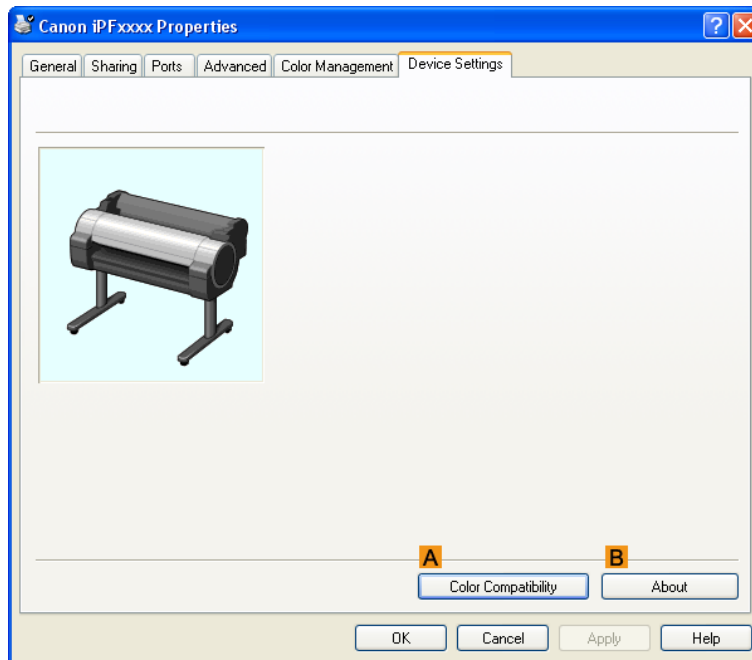

49

4. Click **A Color Compatibility** to display the **Color Compatibility** dialog box.

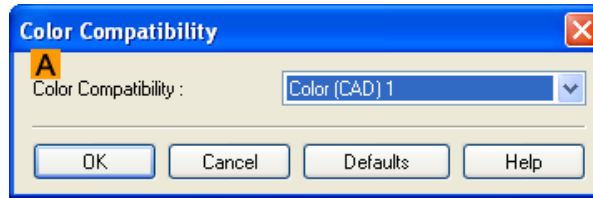

5. Select the desired color settings in the **A Color Compatibility** list.



**Note**

- For details on color settings, see "Specifying Colors and Printing CAD Drawings →P.47 "

2

For printing instructions, refer to the following topic.

- Choosing the Document Type and Printing Conditions (Windows) →P.63

## HP-GL/2 Printing

This printer supports the original Canon GARO printer control language as well as HP-GL/2 and HP RTL(\*1 →P.50 ) emulation.(\*2 →P.50 ) When printing from applications that support HP-GL/2 output, specify HP-GL/2 in the application's plotter output settings.



**Note**

- For instructions on configuring these settings, refer to the software documentation.

The printer automatically switches to the corresponding processing depending on whether a GARO, HP-GL/2, or HP RTL job is received. Configure the optional settings for HP-GL/2 emulation on the printer control panel. (See "Menu Settings.")

→P.673

This printer can emulate the following printers using HP-GL/2 emulation.

Emulated Printers	
Canon	iPF500, iPF600, iPF700, iPF510, iPF610, iPF710, iPF605, iPF720, iPF810 and iPF820
Hewlett-Packard	Designjet 500, Designjet 800 and Designjet 1000

\*1: HP-GL/2: Hewlett-Packard Graphics Language 2; HP RTL: Hewlett-Packard Raster Transfer Language

\*2: It may not be possible to print jobs with excessively large amounts of data correctly.



## Adjusting Images

Adjusting the Color in the Printer Driver .....	51
Fine-Tuning Colors of Photos and Images (Windows) .....	53
Fine-Tuning Colors of Photos and Images (Mac OS X) .....	57
Giving Priority to Particular Graphic Elements and Colors for Printing .....	60
Choosing the Document Type and Printing Conditions (Windows) .....	63
Choosing the Document Type and Printing Conditions (Mac OS X) .....	66

## Adjusting the Color in the Printer Driver

Color settings specified in the application for your documents are essentially given priority over other settings for each print job, but further color adjustment is possible in the printer driver.

### • Color Mode

Choose how the printer driver processes color, as desired.

The available options vary depending on the color mode.

Color Mode	Description	Color Adjustment
<b>Color</b>	Print in color.	You can adjust the color balance and color-matching method.
<b>Monochrome</b>	Print in grayscale.	You can adjust the color balance.
<b>Color (CAD)</b>	A color mode optimized for line drawings (2D-CAD). Lines in red, yellow, and other colors are printed especially clearly.	You can adjust the color balance.
<b>Monochrome (BK ink)</b>	A color mode for printing line drawings. Only Black ink is used.	You can adjust the color balance.
<b>Monochrome Bitmap</b>	Print in a color mode for CAD, using Color Ink, with all non-white portions printed in black.	No color adjustment is supported.
<b>No color correction (*1)</b>	Prints without performing color-matching in the printer driver.	You can adjust the color balance.

\*1: If **No color correction** is selected, the **Matching** sheet / **Matching** pane is not displayed.

### • Color Adjustment

You can adjust colors separately for images, graphics, and text documents.

Adjustment Item	Description
<b>Cyan</b>	Fine-tune color tones by adjusting the levels of <b>Cyan</b> , <b>Magenta</b> , and <b>Yellow</b> .
<b>Magenta</b>	
<b>Yellow</b>	
<b>Gray Tone</b>	Adjust the grayscale, in a range from cool, blue tones to warm, red tones.
<b>Brightness</b>	Adjust the brightness of printed images while keeping the darkest and lightest portions intact.
<b>Contrast</b>	Adjust the contrast of the darkest and lightest portions relative to each other. For soft gradation, decrease the contrast. For hard gradation, increase the contrast.

Adjustment Item	Description
<b>Saturation</b>	Adjust the level of color saturation, in a range from subdued to vivid.



**Note**

- Click **Object Adjustment** to open the **Object Adjustment** dialog box, which allows you to select the color adjustment target from **Image**, **Graphics**, and **Text**.

• **Matching**

You can choose the color-matching mode and method.

By adjusting the color-matching mode and method, you can make printed colors match the colors of on-screen images more closely.

Matching Mode	Description	Remarks
<b>Driver Matching Mode</b>	Enables printing of optimal color tones using a driver specific color profile.	You should normally select this mode.
<b>ICC Matching Mode</b>	Enables color matching using ICC profiles. Select this if you want to print by specifying the input profile, printer profile, and matching method in detail.	This allows you to use ICC profiles for digital cameras and scanners, ICC profiles created using the profile creation tool, etc.
<b>Driver ICM Mode</b>	Enables color matching by the printer driver using the ICM function of printer driver. Select this if you want to print by only specifying the matching method.	Available when using Windows.
<b>Host ICM Mode</b>	Enables color matching by the host computer using the ICM function of Windows. Select this if you want to print from an application that supports the ICM function.	
<b>ColorSync</b>	Enables color matching by using the ColorSync function of Mac OS. Select this if you want to perform soft proofing using ColorSync before printing.	Available when using Mac OS.

Matching Method	Description	Remarks
<b>Auto</b>	Color-matching optimized for images, graphics, or text.	The available options and their display order vary depending on your selected color-matching mode, as well as the operating system.
<b>Perceptual</b>	Color-matching optimized for printing typical photos attractively. Smooth gradation is a feature. This is also an easy-to-use mode when performing color adjustment using application software.	

Matching Method	Description	Remarks
<b>Colorimetric</b>	Color-matching optimized for printing image data with accurate colors in input color space. This is the easiest-to-use mode when you want to adjust the color and print. However, gradation may be lost for colors of wider range than the color reproduction range of the printer. Generally, this is also called relative colorimetric.	The available options and their display order vary depending on your selected color-matching mode, as well as the operating system.
<b>Colorimetric (No Wht-pnt Corr)</b>	The processing method of color-matching is identical to Colorimetric. Use this when you want to further reproduce the target paper material color of the image data. Generally, this also is called absolute colorimetric.	
<b>Saturation</b>	Color-matching optimized for printing posters, etc., vividly.	

**Note**

- Be sure to calibrate your monitor colors correctly if you adjust the colors for printing. If monitor colors are not calibrated correctly, you may not obtain the desired printing results. For instructions on monitor calibration, refer to the documentation for your monitor and operating system. For instructions on color adjustment, refer to the following topics, as appropriate for your computer and operating system.

- Fine-Tuning Colors of Photos and Images (Windows) →P.53
- Fine-Tuning Colors of Photos and Images (Mac OS X) →P.57

## Fine-Tuning Colors of Photos and Images (Windows)

You can specify your own print settings instead of using the **Print Target** presets. This topic describes how to fine-tune the color tone of photos before printing.

1. Choose **Print** in the application menu.
2. Select the printer in the dialog box, and then display the printer driver dialog box.(See "Accessing the Printer Driver Dialog Box from Applications(Windows) →P.217 ")

**3.** Make sure the **Main** sheet is displayed.

2

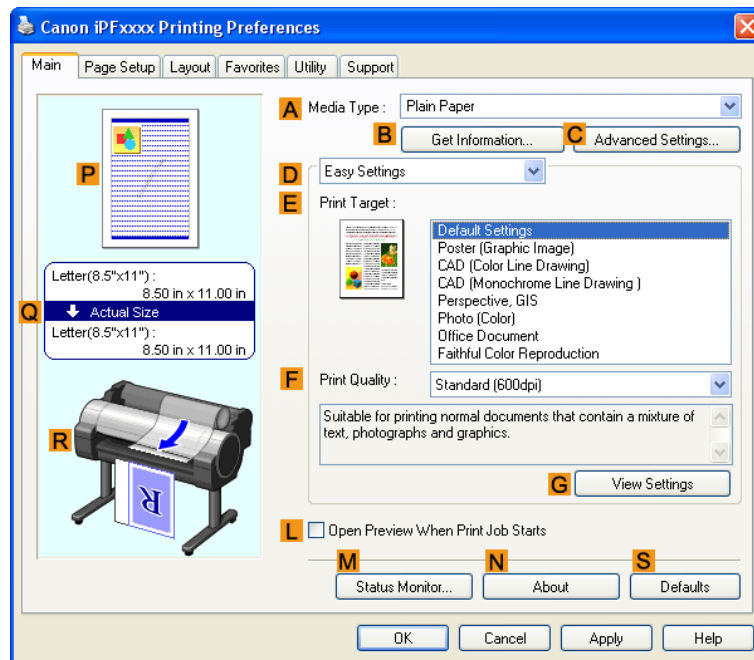

**4.** In the **A Media Type** list, select the type of paper that is loaded.

**5.** Click **D Advanced Settings** to switch the print mode.

54

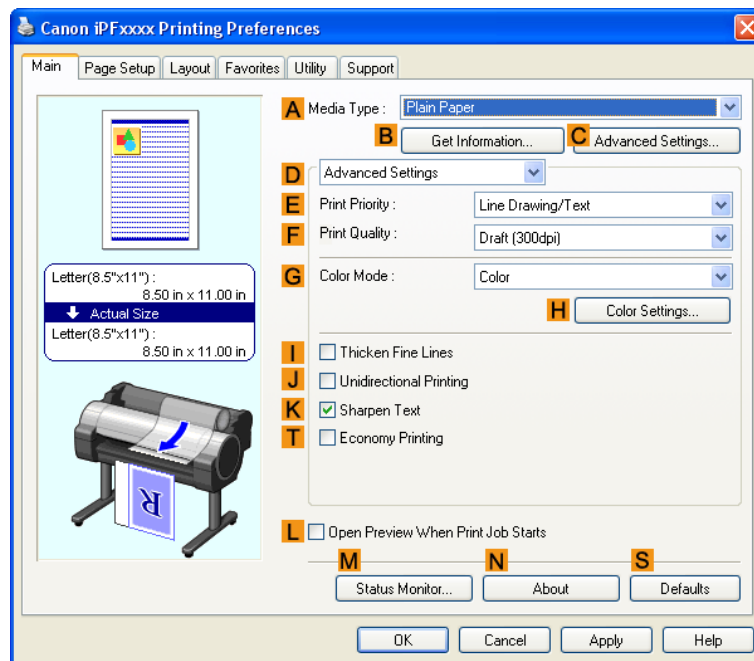

**6.** Click **Color** in the **G Color Mode** list.

7. Click **H Color Settings** to display the **Color Settings** dialog box.

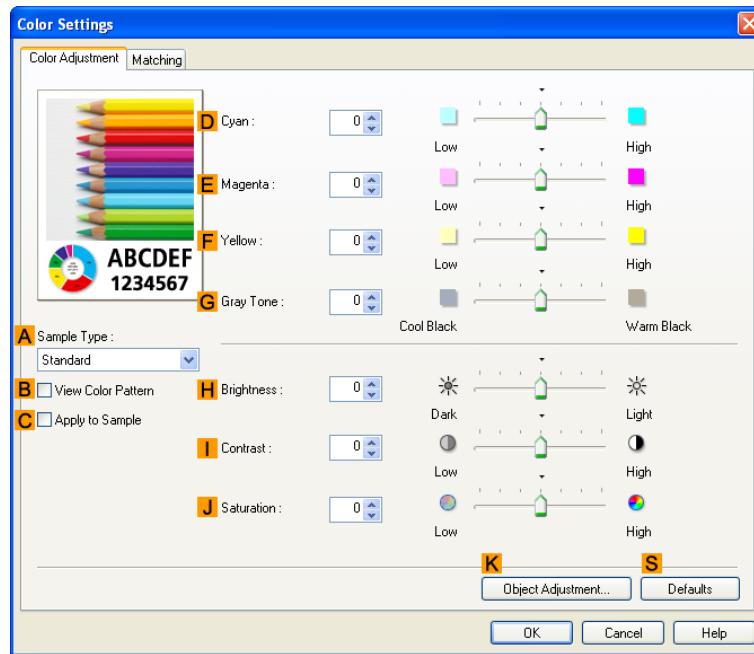

8. On the **Color Adjustment** sheet, adjust the color tones, brightness, and so on as desired.

Adjustment Item	Description
<b>D Cyan</b>	Fine-tune color tones by adjusting the levels of Cyan, Magenta, and Yellow.
<b>E Magenta</b>	
<b>F Yellow</b>	
<b>G Gray Tone</b>	Adjust the gray tone to suit the images of monochrome photos. Choose cool black (tinged with blue), pure black (neutral), warm black (tinged with red), and so on. Select the color tone in the color region or from the list.
<b>H Brightness</b>	Adjust the brightness of printed images while keeping the darkest and lightest portions intact.
<b>I Contrast</b>	Adjust the contrast of the darkest and lightest portions relative to each other. For soft gradation, decrease the contrast. For hard gradation, increase the contrast.
<b>J Saturation</b>	Adjust the level of color saturation, in a range from subdued to vivid.



**Note**

- Click **Object Adjustment** to open the **Object Adjustment** dialog box, which allows you to select the color adjustment target from **Image**, **Graphics**, and **Text**.

9. Close the **Color Settings** dialog box.

**10.** Click the **Page Setup** tab to display the **Page Setup** sheet.

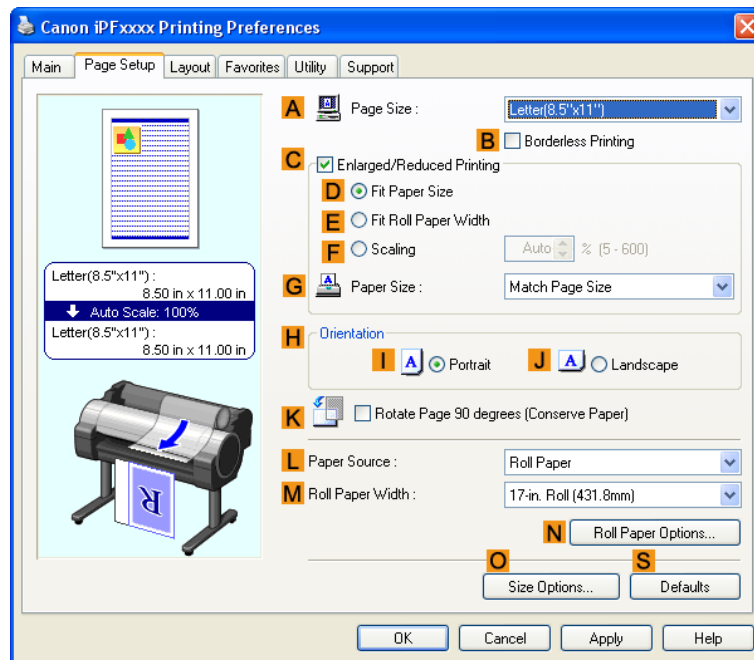

2

**11.** Confirm the settings of **A Page Size**, **L Paper Source**, and so on.

**12.** Confirm the print settings and print as desired.



Note

• For tips on confirming print settings, see "Confirming Print Settings(Windows) →P.212 "

## Fine-Tuning Colors of Photos and Images (Mac OS X)

You can specify your own print settings instead of using the **Print Target** presets. This topic describes how to fine-tune the color tone of photos before printing.

1. This sets the **B Format for** and **C Paper Size**.



### Note

- The configuration method varies depending on the OS and application software you are using. If **Page Setup** is displayed in the application menu, the settings are configured by opening the **Page Attributes** dialog box from **Page Setup**.

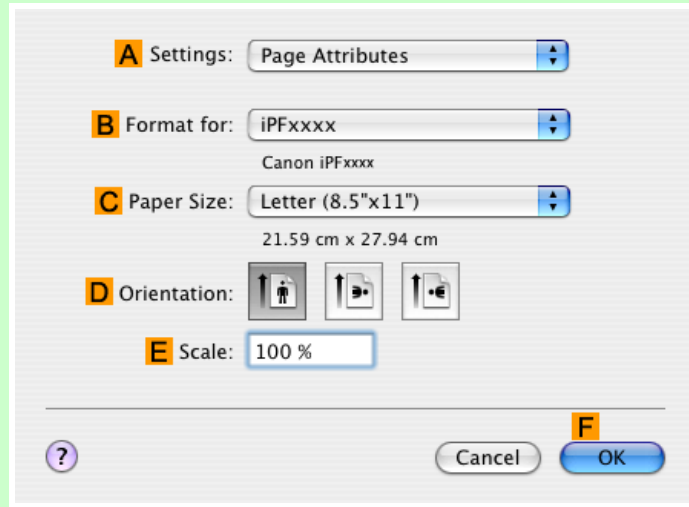

If it is not displayed, the settings are configured in the upper part of the printer driver displayed when you select **Print** from the application software menu.

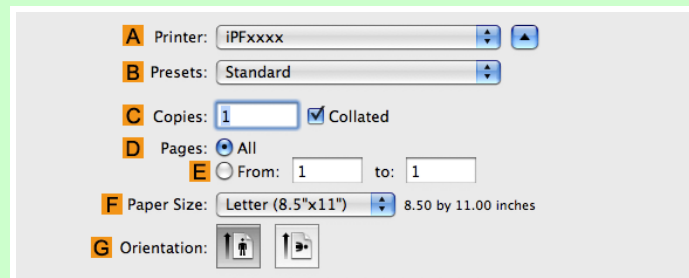

2. Select the printer in the **A Printer** list.
3. Choose the original size in the **F Paper Size** list.
4. If you configured the settings using the **Page Attributes** dialog box, click **F OK** to close the dialog box, and then select **Print** from the application software menu.

**5.** Access the **Main** pane.

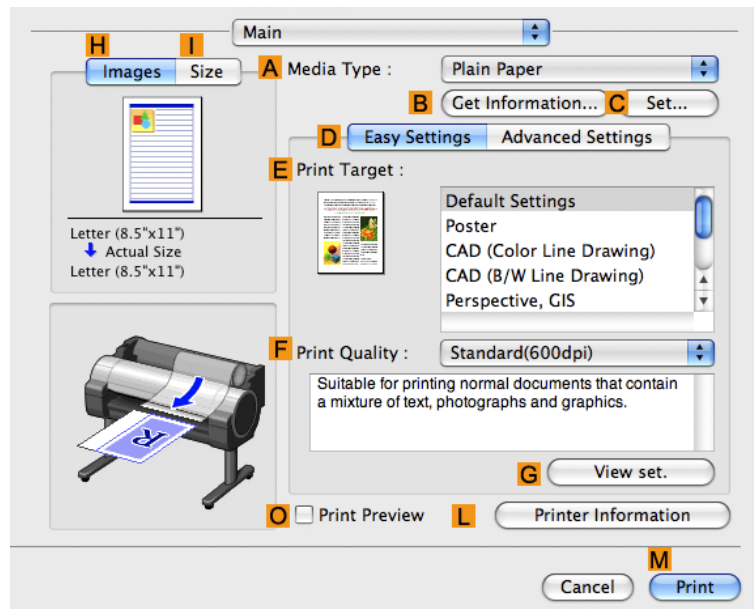

**6.** In the **A Media Type** list, select the type of paper that is loaded.

**7.** Click **D Advanced Settings** to switch the print mode.

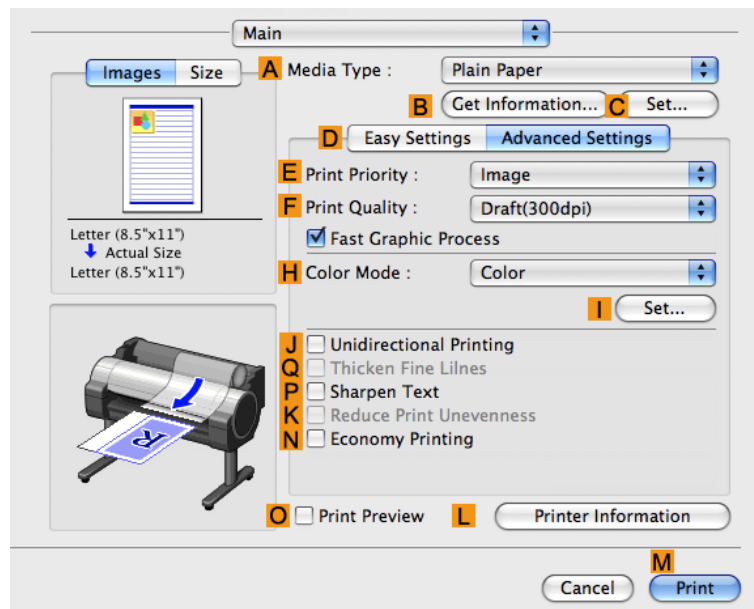

**8.** Click **Color** in the **H Color Mode** list.



9. Click **I** Set to display the **Color Settings** dialog box.

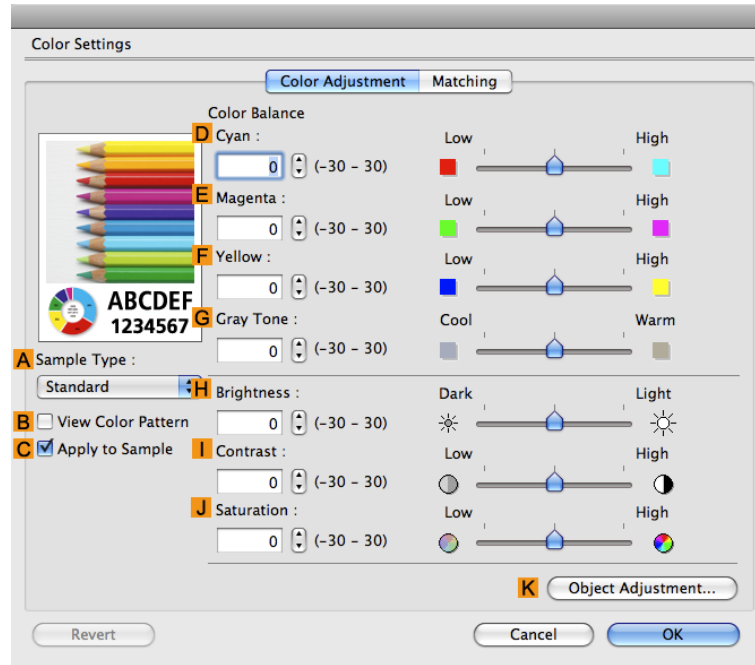

10. On the **Color Adjustment** pane, adjust the color tones, brightness, and so on as desired.

Adjustment Item	Description
<b>D</b> Cyan	Fine-tune color tones by adjusting the levels of Cyan, Magenta, and Yellow.
<b>E</b> Magenta	
<b>F</b> Yellow	
<b>G</b> Gray Tone	Adjust the gray tone to suit the images of monochrome photos. Choose cool black (tinged with blue), pure black (neutral), warm black (tinged with red), and so on. Select the color tone in the color region or from the list.
<b>H</b> Brightness	Adjust the brightness of printed images while keeping the darkest and lightest portions intact.
<b>I</b> Contrast	Adjust the contrast of the darkest and lightest portions relative to each other. For soft gradation, decrease the contrast. For hard gradation, increase the contrast.
<b>J</b> Saturation	Adjust the level of color saturation, in a range from subdued to vivid.



**Note**

- Click **Object Adjustment** to open the **Object Adjustment** dialog box, which allows you to select the color adjustment target from **Images**, **Graphics**, and **Text**.

11. Click **OK** to close the **Color Settings** dialog box.

## 12. Access the **Page Setup** pane.

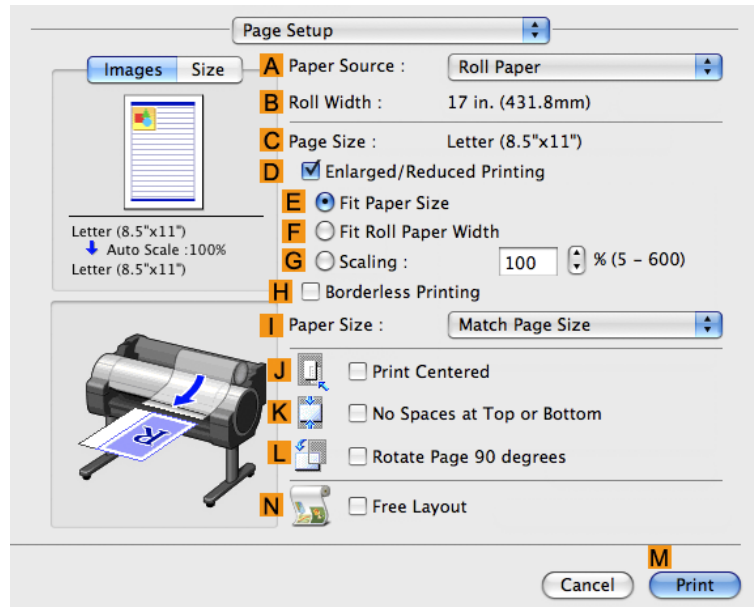

## 13. Confirm the settings of **A Paper Source** and **C Page Size**.

## 14. Confirm the print settings, and then click **M Print** to start printing.



### Note

- For tips on confirming print settings, see "Confirming Print Settings(Mac OS X) →P.436 "

## Giving Priority to Particular Graphic Elements and Colors for Printing

You can specify detailed print settings as desired for the quality level, colors, and other criteria.

### • **Advanced Settings**

For printing results that appear just as expected for your original, you can specify which graphic elements and colors to prioritize for printing.



### Note

- **Easy Settings** are also available, providing convenient presets. To use the presets, simply choose the printing application.  
For details on **Easy Settings**, refer to the following topics.
  - Printing Photos and Images →P.22
  - Printing Line Drawings and Text →P.39
  - Printing Office Documents →P.29

### • **Print Priority**

Choose the graphic elements that you want to emphasize for printing.

Print Priority (*1)	Description
<b>Image</b>	A setting for posters or other documents made up mainly of photos or images, or for emphasizing photos or images in printed documents.
<b>Line Drawing/Text</b>	Choose this setting for CAD drawings made up mainly of intricate lines, or wall newspapers and other notices with a large amount of text. Suitable for emphasizing detailed text in printed documents. However, the quality may not be sufficient when printing photos or images that require a lot of color coverage. In this case, choose <b>Image</b> instead.
<b>Office Document</b>	Choose this setting for better legibility of documents combining text and graphics, such as documents and presentation material created with typical office applications.

\*1: Options suitable for the selected type of paper are listed under Print Priority.

### • Print Quality

Choose the print quality.

The printing mode is determined by a combination of the print quality and resolution.

Print Quality (*1)	Description	Print Priority
<b>Highest</b>	A setting for printing at the highest resolution when quality is most important. Printing takes longer and consumes more ink than in other modes, but this mode offers superior printing quality.	<b>Image</b>
<b>High</b>	Choose this setting to print at high resolution when quality is most important. Printing takes longer and consumes more ink than in <b>Standard</b> or <b>Draft</b> modes, but this mode offers exceptional printing quality.	<b>Image</b> <b>Line Drawing/Text</b>
<b>Standard</b>	Choose this setting to print at standard resolution when quality and speed are both important. Printing takes less time than in <b>Highest</b> or <b>High</b> mode.	<b>Image</b> <b>Line Drawing/Text</b> <b>Office Document</b>
<b>Draft</b>	Choose this setting to print faster. Printing in draft mode can help you work more efficiently when checking layouts.	<b>Image</b> <b>Line Drawing/Text</b>

\*1: Options suitable for the selected Print Priority are listed under Print Quality.

### • Color Settings

Setting Item	Options	Description
<b>Color Mode (*1)</b>	<b>Color</b> <b>Monochrome</b> <b>Color (CAD)</b> <b>Monochrome (BK ink)</b> <b>Monochrome Bitmap</b> <b>No color correction</b>	Choose whether to print in color or monochrome. (See "Adjusting the Color in the Printer Driver →P.51 ")
<b>Color Adjustment</b>	<b>Cyan</b> <b>Magenta</b> <b>Yellow</b> <b>Gray Tone</b>	You can adjust the levels of cyan, magenta, and yellow as well as the brightness, contrast, saturation, and gray tones.

Setting Item	Options	Description
<b>Color Adjustment</b>	<b>Brightness</b> <b>Contrast</b> <b>Saturation</b>	If you choose <b>Monochrome</b> or <b>Monochrome (BK ink)</b> in <b>Color Mode</b> only <b>Brightness</b> and <b>Contrast</b> can be adjusted. <b>Image</b> , <b>Graphics</b> , and <b>Text</b> are available as <b>Object Adjustment</b> options.
Color-Matching Modes	<b>Driver Matching Mode</b> <b>ICC Matching Mode</b> <b>Driver ICM Mode (Windows)</b> <b>Host ICM Mode (Windows)</b> <b>ColorSync (Mac OS X)</b>	Choose the color-matching mode.
Color-Matching Method (*2)	<b>Auto</b> <b>Perceptual</b> <b>Colorimetric</b> <b>Colorimetric (No Wht-pnt Corr)</b> <b>Saturation</b>	Choose the color-matching method. The available options vary depending on your selection in <b>Color-Matching Mode</b> .

\*1: Options suitable for the selected Print Priority are listed under Color Mode.

\*2: The order of options displayed varies depending on the operating system.

• Enhancing printing quality

Setting Item	Description
<b>Unidirectional Printing</b>	Choosing unidirectional printing can improve printing results if lines are printed crooked or images are uneven. However, this takes more time than regular printing.
<b>Thicken Fine Lines</b>	Choose this option to make fine lines clearer in CAD drawings or similar documents.
<b>Sharpen Text</b>	Choose this option to print intricate text more distinctly.
<b>Reduce Print Unevenness (*1)</b>	Choose this option to counteract uneven printing.
<b>Economy Printing</b>	When this mode is selected, less ink is consumed than in regular printing, but the quality is diminished. Select this mode if you want to conserve ink when checking drawings, for example. Depending on the <b>Media Type</b> and <b>Print Quality</b> settings, this mode may not be available.

\*1: Displayed in Mac OS X.



Note

- To print at a higher level of quality, in the printer driver, choose **High** or **Highest** in **Print Quality**, and choose **Unidirectional Printing** as the direction of printing.

For instructions on specifying the print quality and color settings before printing, refer to the following topics, as appropriate for your computer and operating system.

- Choosing the Document Type and Printing Conditions (Windows) →P.63
- Choosing the Document Type and Printing Conditions (Mac OS X) →P.66

## Choosing the Document Type and Printing Conditions (Windows)

You can specify your own print settings instead of using the **Print Target** presets. As an example, this topic describes how to print CAD drawings as clearly as possible, with sharp lines and text.

1. Choose **Print** in the application menu.
2. Select the printer in the dialog box, and then display the printer driver dialog box. (See "Accessing the Printer Driver Dialog Box from Applications(Windows) →P.217 ")
3. Make sure the **Main** sheet is displayed.

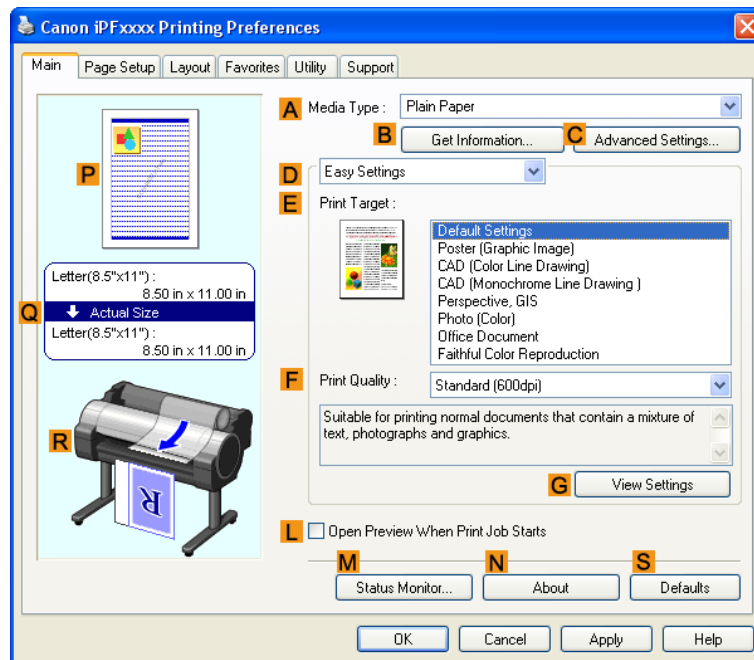

4. In the **A Media Type** list, select the type of paper that is loaded.

5. Click **D Advanced Settings** to switch the print mode.

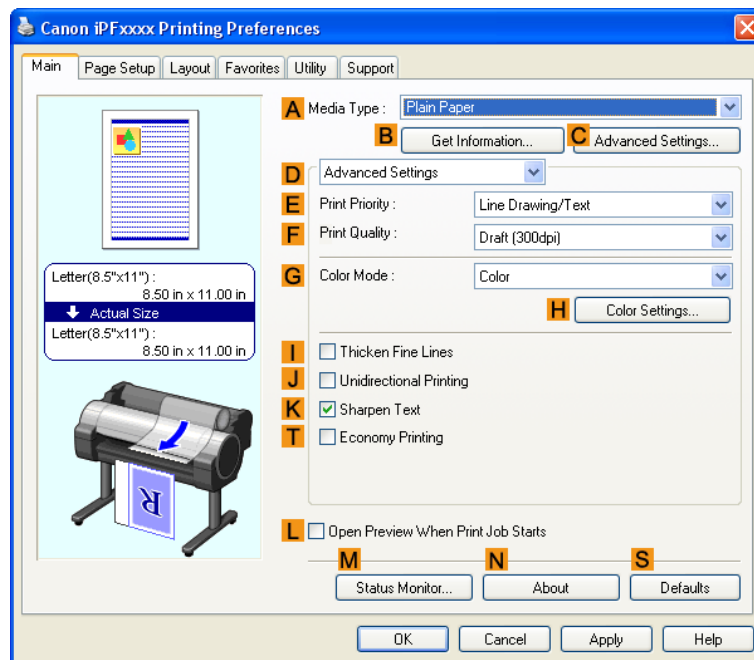

6. Click **Line Drawing/Text** in the **E Print Priority** list.

7. Click **High (1200dpi)** in the **F Print Quality** list.



Note

- Options displayed in the **F Print Quality** list vary depending on the paper type.

8. Click **Color (CAD)** in the **G Color Mode** list.

9. To adjust the color, click **H Color Settings**.



Note

- For instructions on adjusting color, see "Adjusting the Color in the Printer Driver →P.51 "

10. Select the **K Sharpen Text** check box.

- 11.** Click the **Page Setup** tab to display the **Page Setup** sheet.

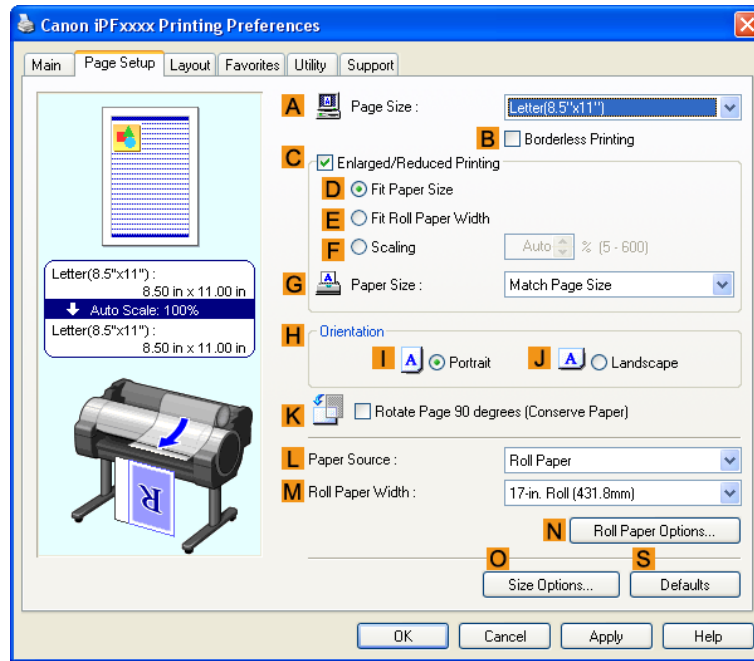

- 12.** Confirm the settings of **A Page Size**, **L Paper Source**, and so on.

- 13.** Confirm the print settings and print as desired.



**Note**

- For tips on confirming print settings, see "Confirming Print Settings(Windows) →P.212 "

## Choosing the Document Type and Printing Conditions (Mac OS X)

You can specify your own print settings instead of using the **Print Target** presets. As an example, this topic describes how to print CAD drawings as clearly as possible, with sharp lines and text.

1. This sets the **B Format for** and **C Paper Size**.



### Note

- The configuration method varies depending on the OS and application software you are using. If **Page Setup** is displayed in the application menu, the settings are configured by opening the **Page Attributes** dialog box from **Page Setup**.

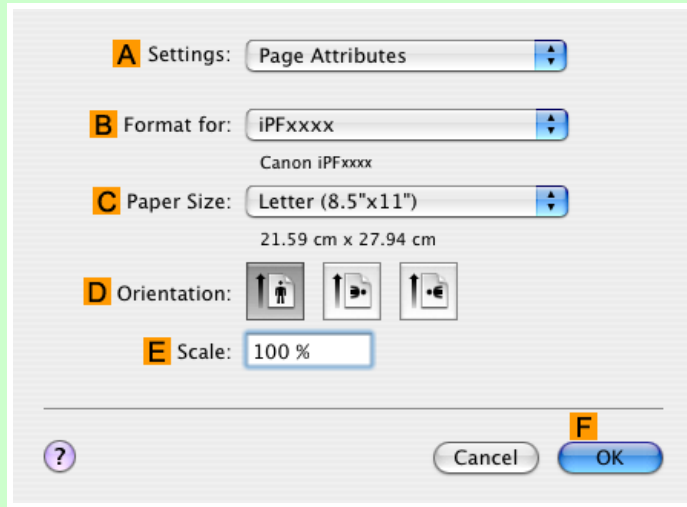

If it is not displayed, the settings are configured in the upper part of the printer driver displayed when you select **Print** from the application software menu.

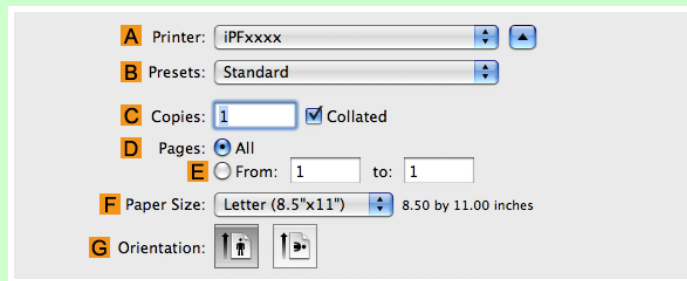

2. Select the printer in the **A Printer** list.

3. Choose the original size in the **F Paper Size** list.

4. If you configured the settings using the **Page Attributes** dialog box, click **F OK** to close the dialog box, and then select **Print** from the application software menu.



5. Access the **Main** pane.

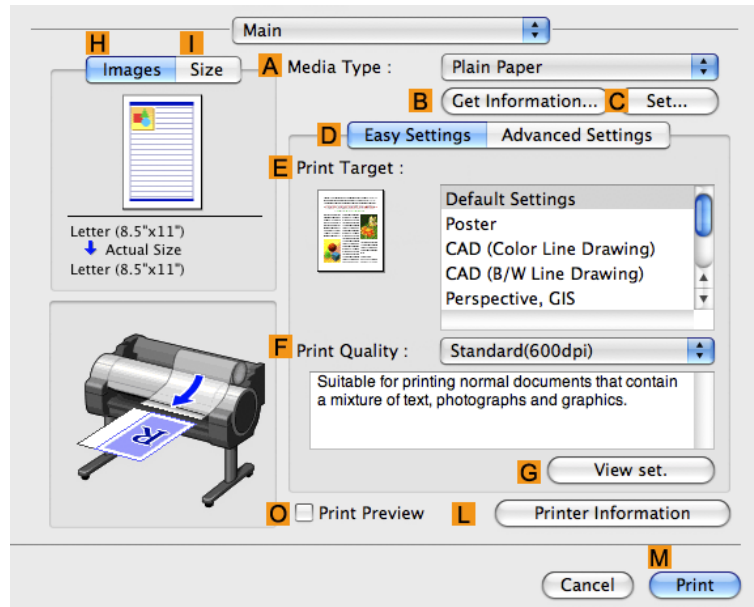

6. In the **A Media Type** list, select the type of paper that is loaded.

7. Click **D Advanced Settings** to switch the print mode.

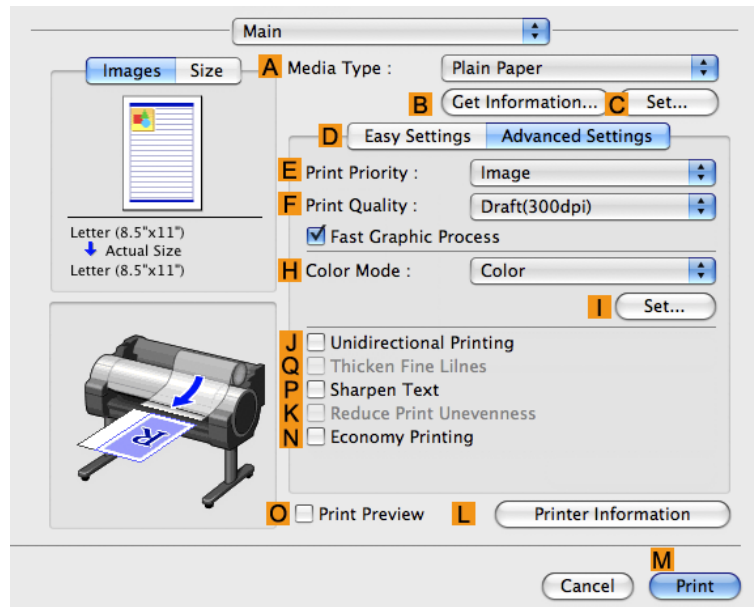

8. Click **Line Drawing** in the **E Print Priority** list.

9. Click **High(1200dpi)** in the **F Print Quality** list.



Note

- Options displayed in the **F Print Quality** list vary depending on the type of paper.

10. Click **Color (CAD)** in the **H Color Mode** list.

11. To adjust the color, click **I Set**.



Note

- For instructions on adjusting color, see "Adjusting the Color in the Printer Driver →P.51 "

2

12. Access the **Page Setup** pane.

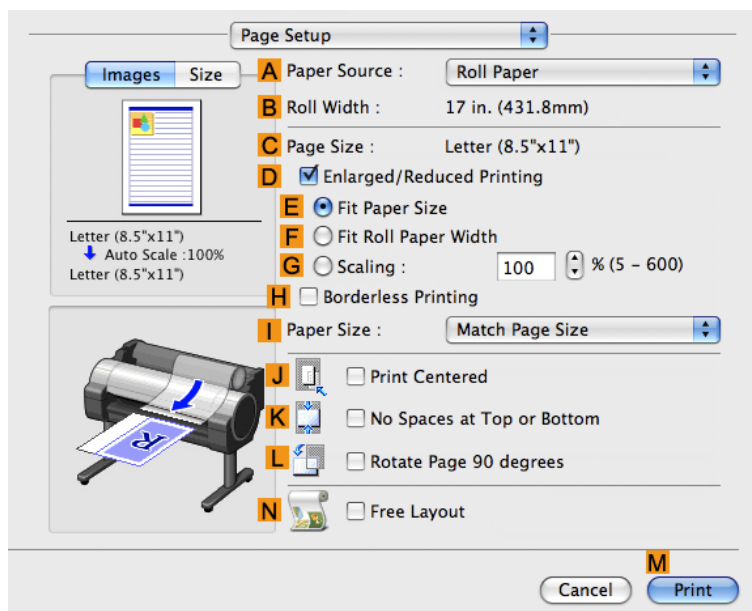

13. Confirm the settings of **A Paper Source** and **C Page Size**.

14. Confirm the print settings, and then click **M Print** to start printing.



Note

- For tips on confirming print settings, see "Confirming Print Settings(Mac OS X) →P.436 "

68

## Printing enlargements or reductions

Resizing Originals to Match the Paper Size .....	69
Resizing Originals to Match the Paper Size (Windows) .....	69
Resizing Originals to Match the Paper Size (Mac OS X) .....	72
Resizing Originals to Fit the Roll Width .....	75
Resizing Originals to Fit the Roll Width (Windows) .....	76
Resizing Originals to Fit the Roll Width (Mac OS X) .....	78
Resizing Originals by Entering a Scaling Value .....	81
Resizing Originals by Entering a Scaling Value (Windows) .....	82
Resizing Originals by Entering a Scaling Value (Mac OS X) .....	85

### Resizing Originals to Match the Paper Size

You can freely adjust the size of originals by enlarging or reducing them as desired.

- **Enlarged/Reduced Printing**

Enlarge or reduce the original in the printer driver, as desired.

- **Fit Paper Size**

Enlarge or reduce the original to match the size of the paper you are using.

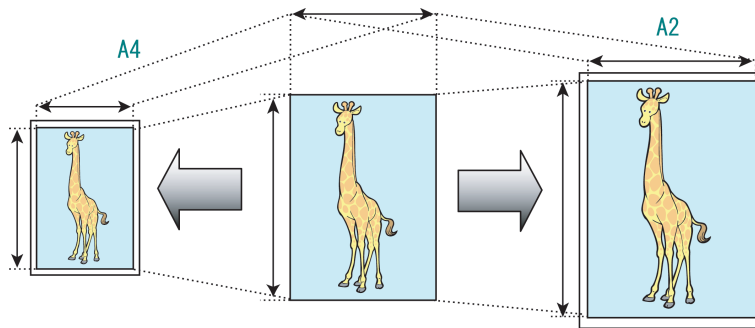

For instructions on resizing originals to match the paper size, refer to the following topics, as appropriate for your computer and operating system.

- Resizing Originals to Match the Paper Size (Windows) →P.69
- Resizing Originals to Match the Paper Size (Mac OS X) →P.72



#### Note

- For better printing results when enlarging photos from a digital camera in TIFF or JPEG format, use an image-editing application software such as Adobe Photoshop to specify an image resolution of 150 dpi or more at actual size.

### Resizing Originals to Match the Paper Size (Windows)

This topic describes how to enlarge originals before printing to match the paper size, based on the following example.

- Document: Any Type
- Page size: A4 (210.0×297.0mm)/Letter (8.3 × 11.7 in)
- Paper: Roll
- Paper type: Plain Paper

- Roll paper width: A2/A3 roll (420.0 mm [16.5 in])

1. Choose **Print** in the application menu.
2. Select the printer in the dialog box, and then open the printer driver dialog box. (See "Accessing the Printer Driver Dialog Box from Applications (Windows) → P.217 ")
3. Make sure the **Main** sheet is displayed.

2

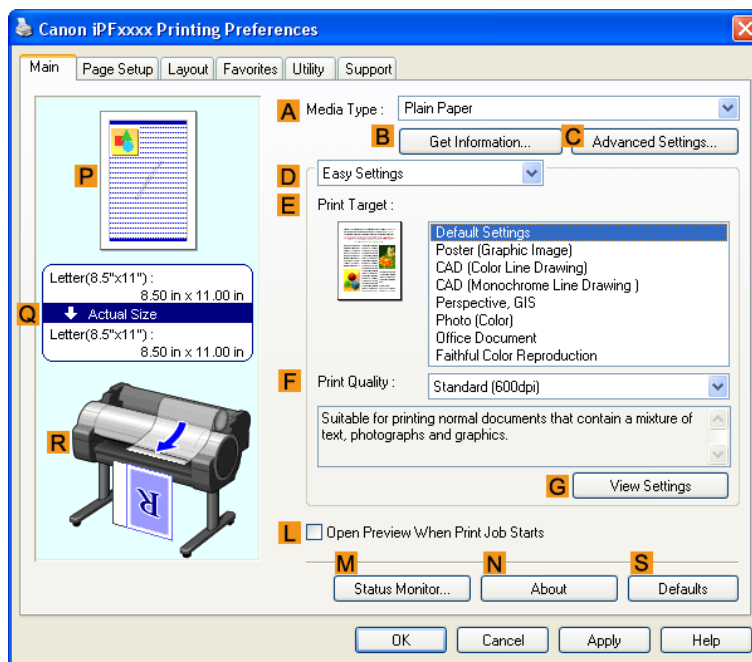

4. In the **A Media Type** list, select the type of paper that is loaded. In this case, click Plain Paper.
5. Select the printing application in the **E Print Target** list.

6. Click the **Page Setup** tab to display the **Page Setup** sheet.

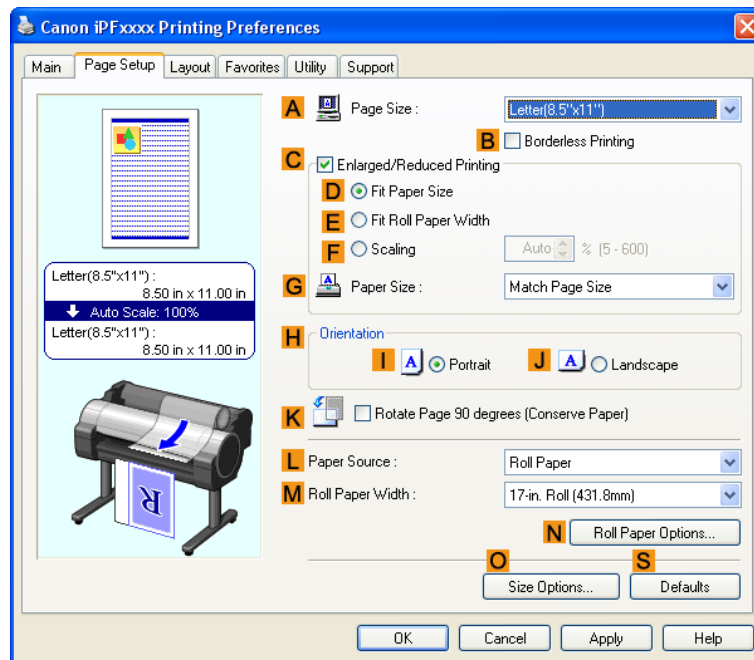

7. Select and click a roll paper in the **L Paper Source** list.
8. Select the width of the loaded roll in the **M Roll Paper Width** list—in this case, **ISO A2/A3 Roll (420.0mm)**.
9. In the **A Page Size** list, click the size of the original as specified in the application. In this case, click **ISO A4**.
10. Select the **C Enlarged/Reduced Printing** check box.
11. Select the **D Fit Paper Size** check box.
12. Click **ISO A3** in the **G Paper Size** list.
13. Confirm the print settings and print as desired.



**Note**

- For tips on confirming print settings, see "Confirming Print Settings(Windows) →P.212 "

## Resizing Originals to Match the Paper Size (Mac OS X)

This topic describes how to enlarge originals before printing to match the paper size, based on the following example.

- Document: Any Type
- Page size: A4 (210.0 × 297.0 mm [8.3 × 11.7 in])
- Paper: Roll paper
- Paper type: Plain Paper
- Roll paper width: A2/A3 roll (420.0 mm [16.5 in])

1. This sets the **B Format for** and **C Paper Size**.



### Note

- The configuration method varies depending on the OS and application software you are using. If **Page Setup** is displayed in the application menu, the settings are configured by opening the **Page Attributes** dialog box from **Page Setup**.

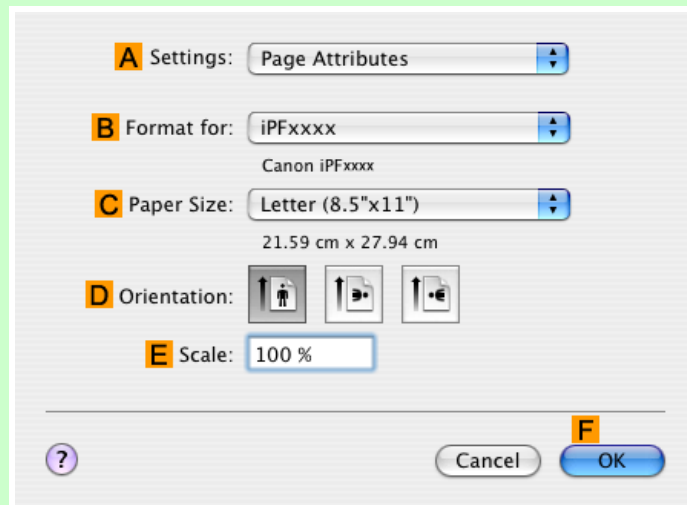

If it is not displayed, the settings are configured in the upper part of the printer driver displayed when you select **Print** from the application software menu.

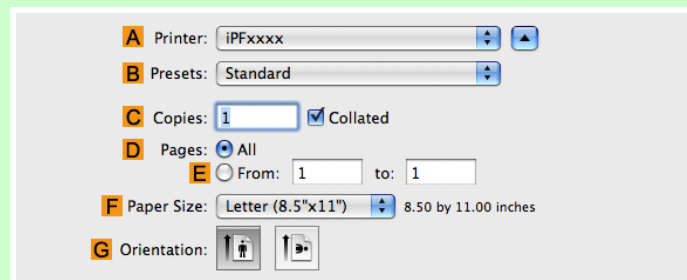

2. Select the printer in the **A Printer** list.

3. In the **F Paper Size** list, click the size of the original. In this case, click **ISO A4**.

4. If you configured the settings using the **Page Attributes** dialog box, click **F OK** to close the dialog box, and then select **Print** from the application software menu.

5. Access the **Main** pane.

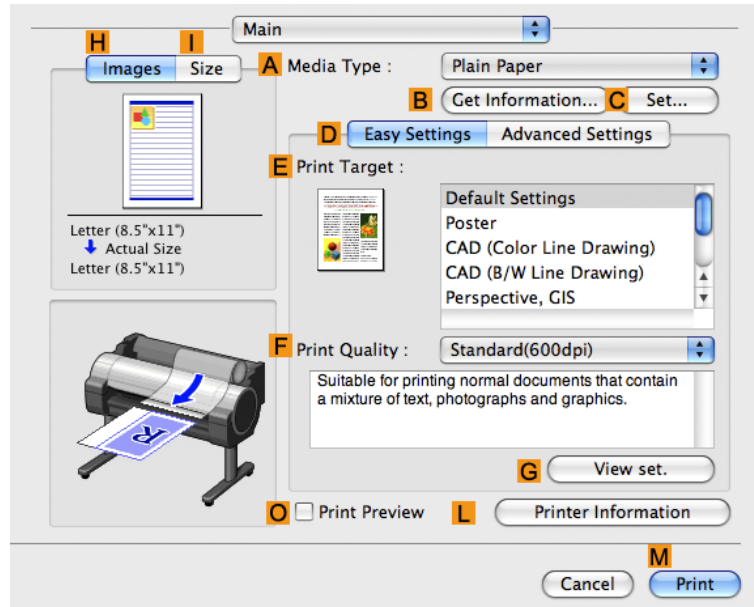

6. In the **A Media Type** list, select the type of paper that is loaded. In this case, click Plain Paper.

7. Make your selection in the **E Print Target** list.

8. Make your selection in the **F Print Quality** list.

9. Access the **Page Setup** pane.

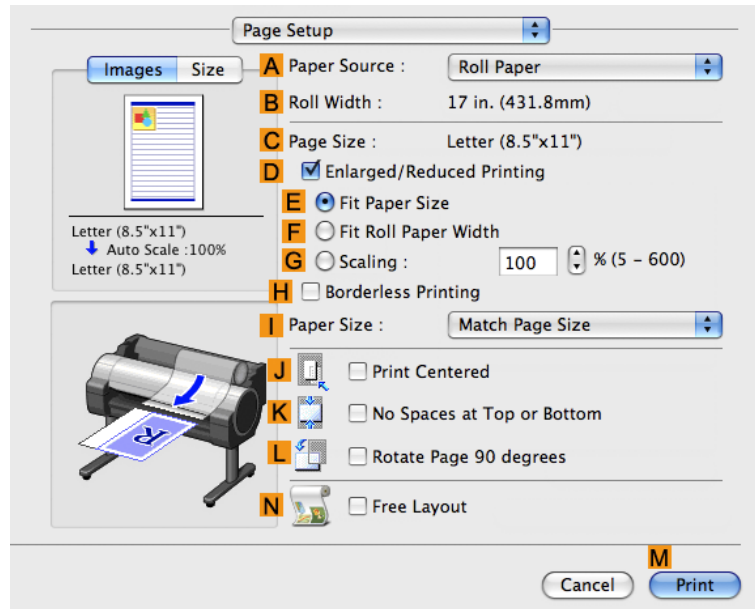

2

10. Select and click a roll paper in the **A Paper Source** list.

11. Make sure the width of the loaded roll is displayed in the **B Roll Width** list—in this case, **ISO A2/A3 (420.0mm)**.



Note

- If the width of the roll loaded in the printer is not shown in **B Roll Width**, click **L Printer Information** on the **Main** pane to update the printer information.

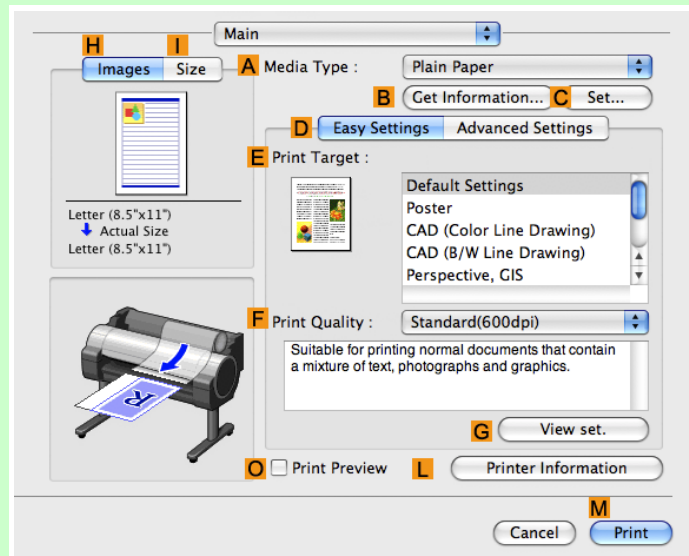

74



- 12.** Make sure **C Page Size** on the **Page Setup** pane shows the original size as specified in **C Paper Size** in the **Page Attributes** dialog box—in this case, **ISO A4**.

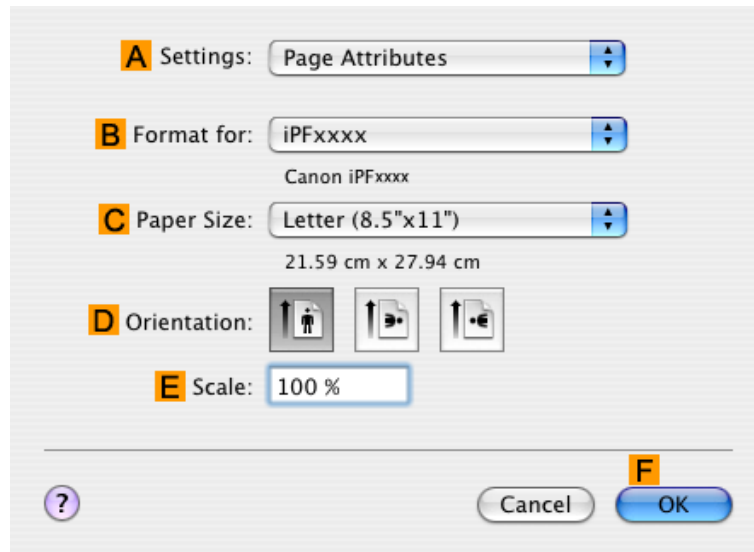

- 13.** Select the **D Enlarged/Reduced Printing** check box.

- 14.** Make sure **E Fit Paper Size** is selected.

- 15.** Click **ISO A3** in the **I Paper Size** list.

- 16.** Confirm the print settings, and then click **M Print** to start printing.



**Note**

- For tips on confirming print settings, see "Confirming Print Settings(Mac OS X) →P.436 "

## Resizing Originals to Fit the Roll Width

You can freely adjust the size of originals by enlarging or reducing them as desired.

- **Enlarged/Reduced Printing**

Enlarge or reduce the original in the printer driver, as desired.

**• Fit Roll Paper Width**

Enlarge or reduce the original as a whole to match the roll paper width, as desired.

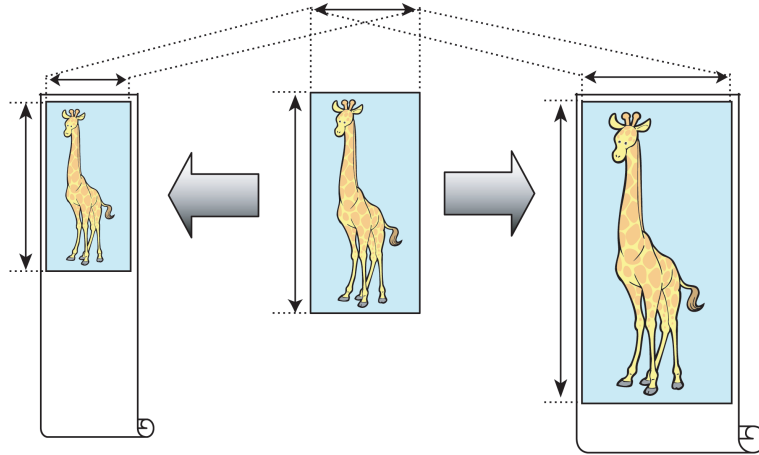

For instructions on resizing originals to match the roll paper width, refer to the following topics, as appropriate for your computer and operating system.

- Resizing Originals to Fit the Roll Width (Windows) →P.76
- Resizing Originals to Fit the Roll Width (Mac OS X) →P.78



**Note**

- For better printing results when enlarging photos from a digital camera in TIFF or JPEG format, use an image-editing application software such as Adobe Photoshop to specify an image resolution of 150 dpi or more at actual size.

**Resizing Originals to Fit the Roll Width (Windows)**

This topic describes how to enlarge originals before printing to match the roll width, based on the following example.

- Document: Any type
- Page size: A4 (210.0×297.0 mm)/Letter (8.3 × 11.7 in)
- Paper: Roll
- Paper type: Plain Paper
- Roll paper width: 16 inches (406.4 mm)

1. Choose **Print** in the application menu.
2. Select the printer in the dialog box, and then display the printer driver dialog box. (See "Accessing the Printer Driver Dialog Box from Applications(Windows) →P.217 ")

3. Make sure the **Main** sheet is displayed.

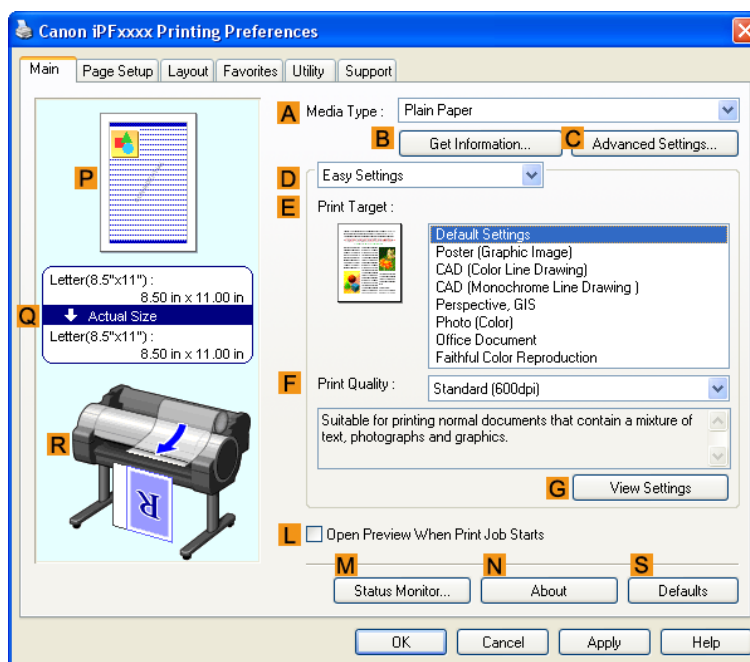

4. In the **A Media Type** list, select the type of paper that is loaded. In this case, click Plain Paper.

5. Select the printing application in the **E Print Target** list.

6. Click the **Page Setup** tab to display the **Page Setup** sheet.

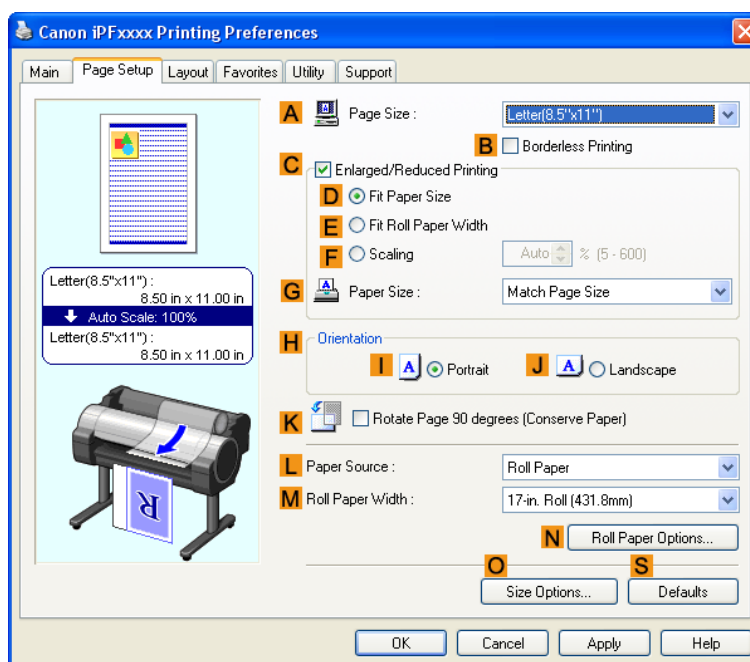

7. Select and click a roll paper in the **L Paper Source** list.
8. In the **A Page Size** list, click the size of the original as specified in the application. In this case, click **ISO A4** or **Letter (8.5"x11")**.
9. Select the **C Enlarged/Reduced Printing** check box.



**Note**

- If the **C Enlarged/Reduced Printing** check box is not displayed on the **Page Setup** sheet, clear the **B Borderless Printing** check box.

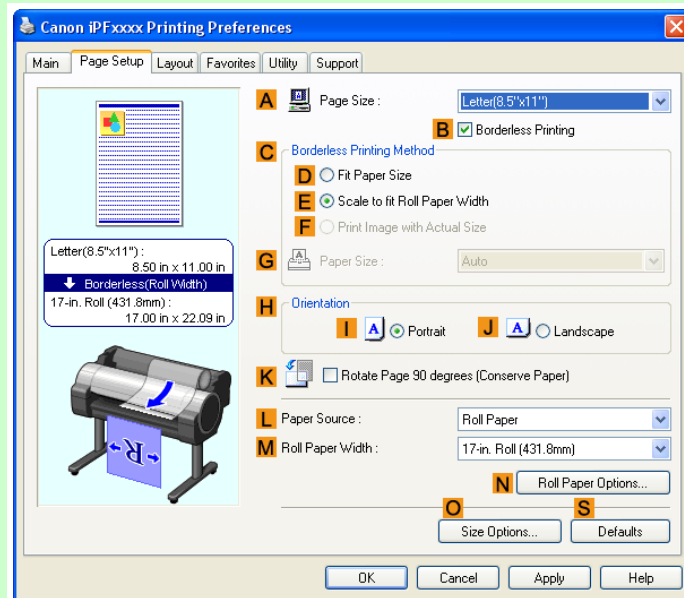

2

10. Click **E Fit Roll Paper Width**.



**Note**

- After you click **E Fit Roll Paper Width**, the **Information** dialog box is displayed. Select the width of the loaded roll in the **Roll Paper Width** list and click **OK**.
- Make sure the roll paper width you specify matches the width of the loaded roll.

11. Confirm the print settings and print as desired.



**Note**

- For tips on confirming print settings, see "Confirming Print Settings(Windows) →P.212 "

78

## Resizing Originals to Fit the Roll Width (Mac OS X)

This topic describes how to enlarge originals before printing to match the roll width, based on the following example.

- Document: Any Type

- Page size: A4 (210.0 × 297.0 mm [8.3 × 11.7 in])
- Paper: Roll paper
- Paper type: Plain Paper
- Roll paper width: 16 inches (406.4 mm)

1. This sets the **B Format for** and **C Paper Size**.



**Note**

- The configuration method varies depending on the OS and application software you are using. If **Page Setup** is displayed in the application menu, the settings are configured by opening the **Page Attributes** dialog box from **Page Setup**.

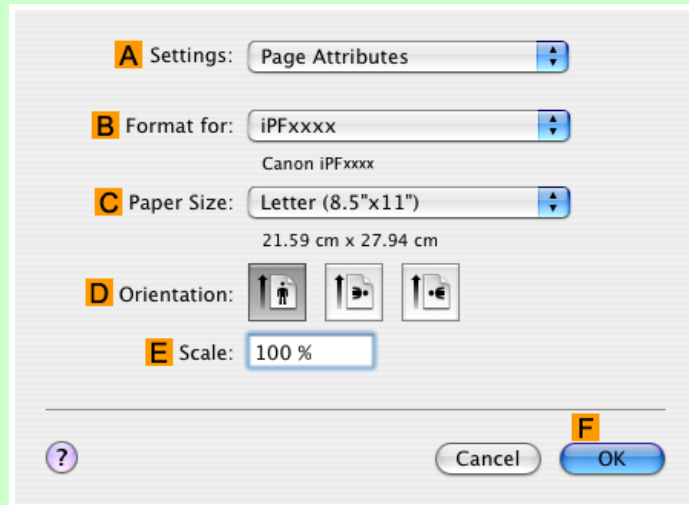

If it is not displayed, the settings are configured in the upper part of the printer driver displayed when you select **Print** from the application software menu.

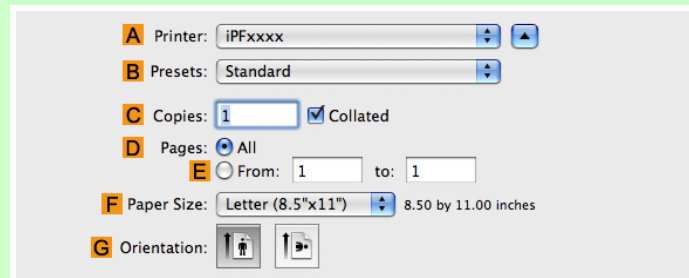

2. Select the printer in the **A Printer** list.

3. In the **F Paper Size** list, click the size of the original. In this case, click **ISO A4**.

4. If you configured the settings using the **Page Attributes** dialog box, click **F OK** to close the dialog box, and then select **Print** from the application software menu.

5. Access the **Main** pane.

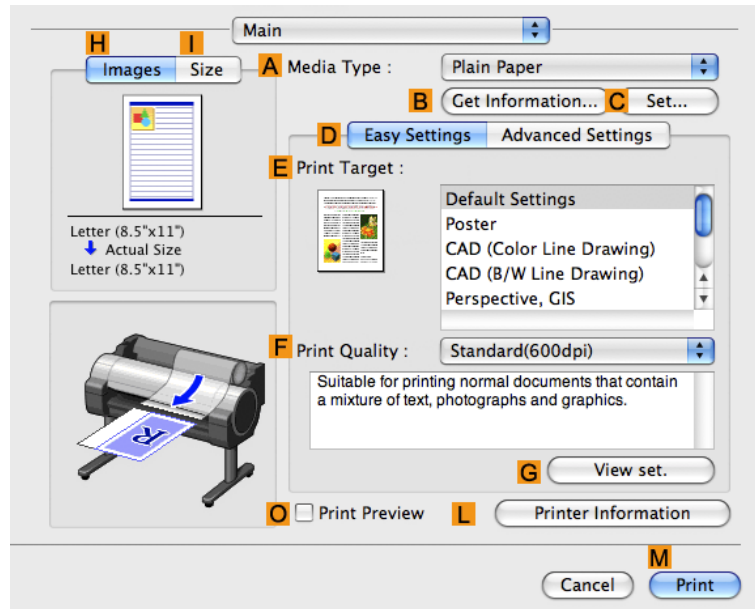

6. In the **A Media Type** list, select the type of paper that is loaded. In this case, click Plain Paper.

7. Make your selection in the **E Print Target** list.

8. Make your selection in the **F Print Quality** list.

9. Access the **Page Setup** pane.

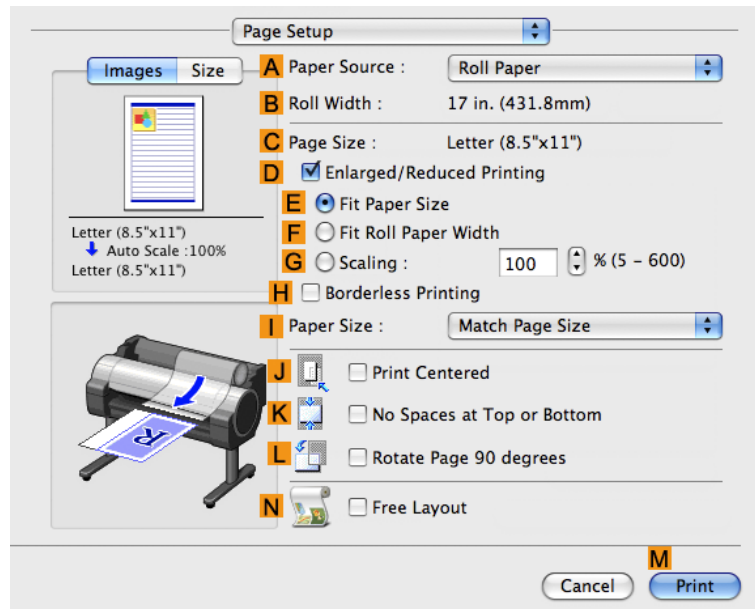

- 10.** Select and click a roll paper in the **A Paper Source** list.
- 11.** Make sure the width of the loaded roll is displayed in the **B Roll Width** list—in this case, **16 in. (406.4mm)**.

**Note**

- If the width of the roll loaded in the printer is not shown in **B Roll Width**, click **L Printer Information** on the **Main** pane to update the printer information.

- 12.** Make sure the **C Page Size** setting matches the original size as selected in **C Paper Size** in the **Page Attributes** dialog box—in this case, **ISO A4**.

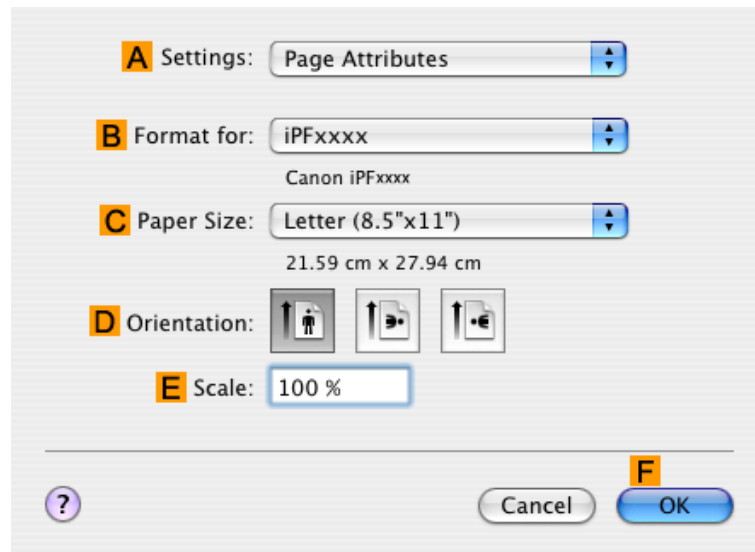

- 13.** Select the **D Enlarged/Reduced Printing** check box.

- 14.** Click **F Fit Roll Paper Width**.

- 15.** Confirm the print settings, and then click **M Print** to start printing.

**Note**

- For tips on confirming print settings, see "Confirming Print Settings(Mac OS X) →P.436 "

## Resizing Originals by Entering a Scaling Value

You can freely adjust the size of originals by enlarging or reducing them as desired.

- **Enlarged/Reduced Printing**

Enlarge or reduce the original in the printer driver, as desired.

## • Scaling

Enlarge or reduce originals by a particular amount, as desired.

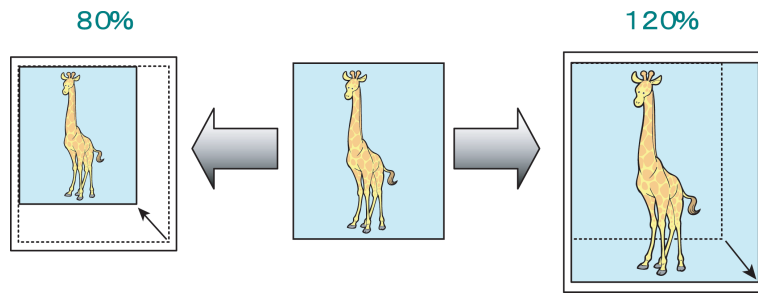

For instructions on entering a scaling value to resize originals, refer to the following topics, as appropriate for your computer and operating system.

- Resizing Originals by Entering a Scaling Value (Windows) →P.82
- Resizing Originals by Entering a Scaling Value (Mac OS X) →P.85



### Note

- For better printing results when enlarging photos from a digital camera in TIFF or JPEG format, use an image-editing application software such as Adobe Photoshop to specify an image resolution of 150 dpi or more at actual size.

## Resizing Originals by Entering a Scaling Value (Windows)

This topic describes how to enlarge originals before printing by entering a scaling value, based on the following example.

- Document: Any Type
- Page size: A4 (210.0 × 297.0 mm [8.3 × 11.7 in])
- Paper: Roll paper
- Paper type: Plain Paper
- Roll paper width: A2/A3 roll (420.0 mm [16.5 in])



### Important

- In borderless printing, you cannot resize originals by entering a scaling value.

1. Choose **Print** in the application menu.
2. Select the printer in the dialog box, and then display the printer driver dialog box. (See "Accessing the Printer Driver Dialog Box from Applications(Windows) →P.217 ")



### 3. Make sure the **Main** sheet is displayed.

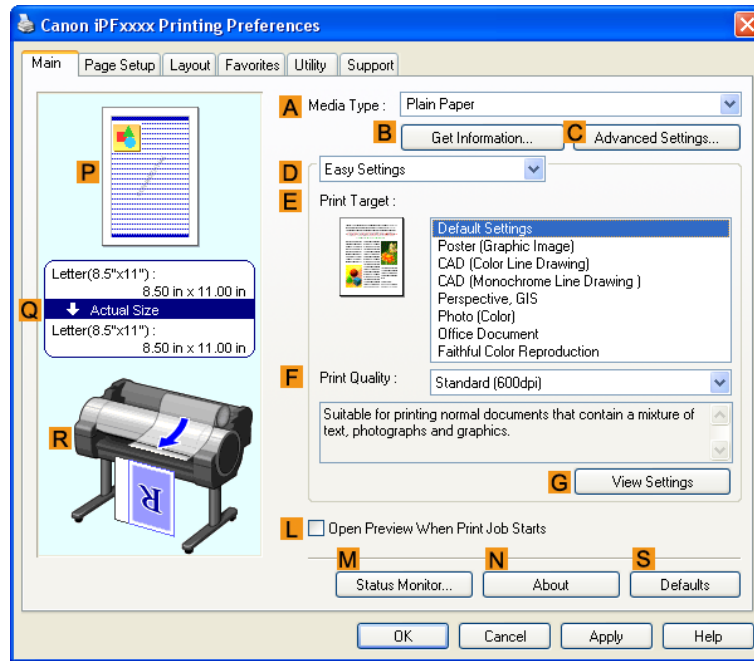

### 4. In the **A Media Type** list, select the type of paper that is loaded. In this case, click Plain Paper.

### 5. Select the printing application in the **E Print Target** list.

### 6. Click the **Page Setup** tab to display the **Page Setup** sheet.

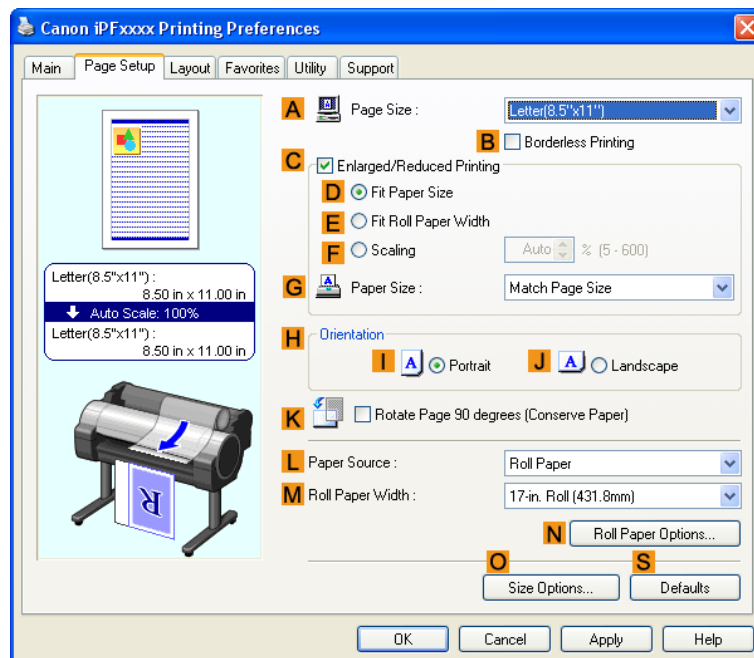

7. Select and click a roll paper in the **L Paper Source** list.
8. Select the width of the loaded roll in the **M Roll Paper Width** list—in this case, **ISO A2/A3 Roll (420.0mm)**.
9. In the **A Page Size** list, click the size of the original as specified in the application. In this case, click **ISO A4**.
10. Select the **C Enlarged/Reduced Printing** check box.
11. Click **ISO A4** in the **G Paper Size** list.
12. Click **F Scaling** and enter **120**.



**Note**

- You can specify enlargement that exceeds the paper size, but in this case, the portions off the bottom and right edges of the paper will not be printed.
- If the original size after enlargement or reduction is smaller than the paper size, the original is printed in the upper-left corner. In this case, you can center originals by selecting **E Print Centered** on the **Layout** sheet.

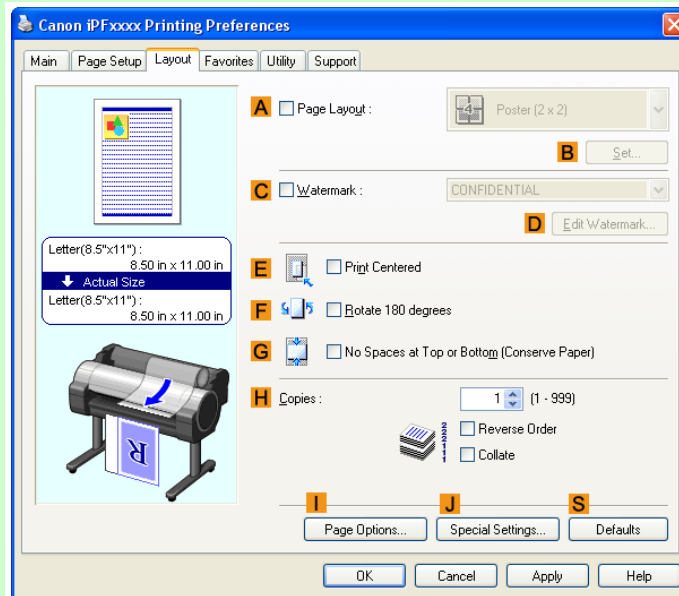

13. Confirm the print settings and print as desired.



**Note**

- For tips on confirming print settings, see "Confirming Print Settings(Windows) →P.212 "

## Resizing Originals by Entering a Scaling Value (Mac OS X)

This topic describes how to enlarge originals before printing by entering a scaling value, based on the following example.

- Document: Any Type
- Page size: A4 (210.0 × 297.0 mm [8.3 × 11.7 in])
- Paper: Roll paper
- Paper type: Plain Paper
- Roll paper width: A2/A3 roll (420.0 mm [16.5 in])

1. This sets the **B Format for** and **C Paper Size**.



### Note

- The configuration method varies depending on the OS and application software you are using. If **Page Setup** is displayed in the application menu, the settings are configured by opening the **Page Attributes** dialog box from **Page Setup**.

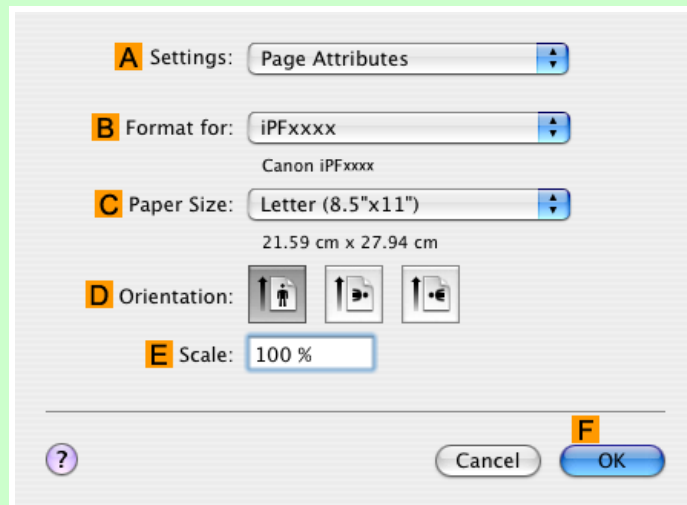

If it is not displayed, the settings are configured in the upper part of the printer driver displayed when you select **Print** from the application software menu.

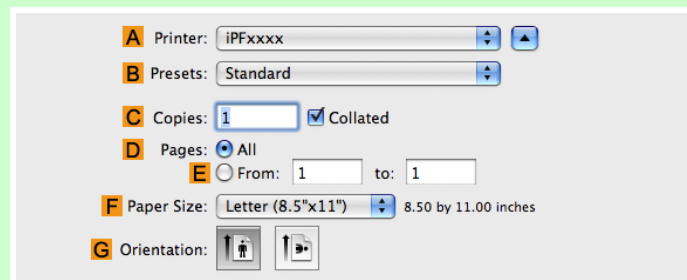

2. Select the printer in the **A Printer** list.

3. In the **F Paper Size** list, click the size of the original. In this case, click **ISO A4**.

4. If you configured the settings using the **Page Attributes** dialog box, click **OK** to close the dialog box, and then select **Print** from the application software menu.

5. Access the **Main** pane.

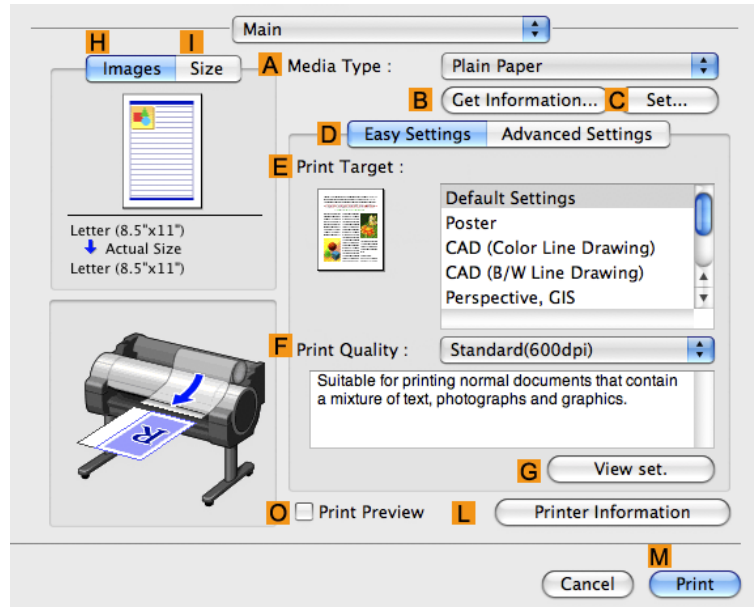

6. In the **Media Type** list, select the type of paper that is loaded. In this case, click Plain Paper.

7. Make your selection in the **Print Target** list.

8. Make your selection in the **Print Quality** list.

## 9. Access the **Page Setup** pane.

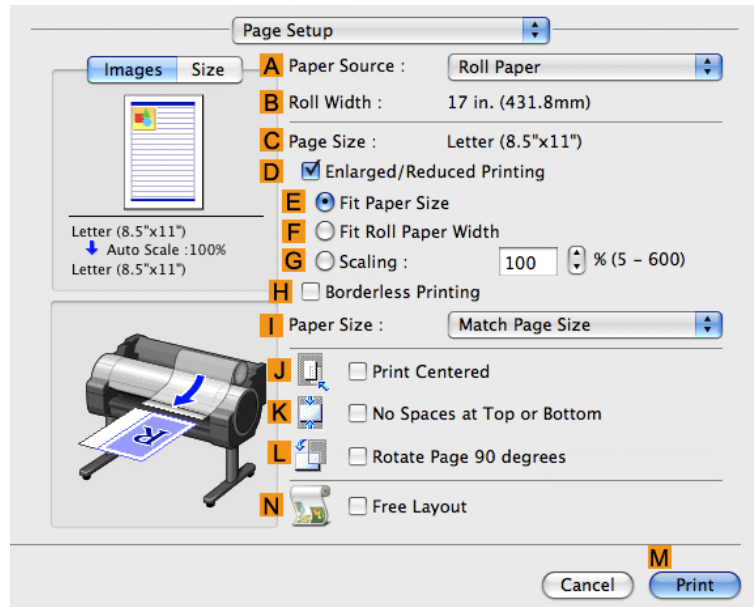

2

## 10. Select and click a roll paper in the **A Paper Source** list.

## 11. Make sure the width of the loaded roll is displayed in the **B Roll Width** list—in this case, **ISO A2/A3 (420.0mm)**.



### Note

- If the width of the roll loaded in the printer is not shown in **B Roll Width**, click **L Printer Information** on the **Main** pane to update the printer information.

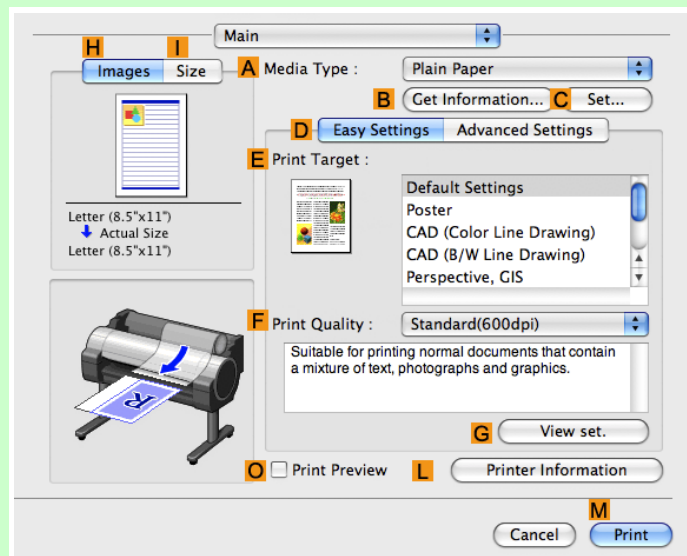

87

- 12.** Make sure the **C Page Size** setting matches the original size as selected in **C Paper Size** in the **Page Attributes** dialog box—in this case, **ISO A4**.

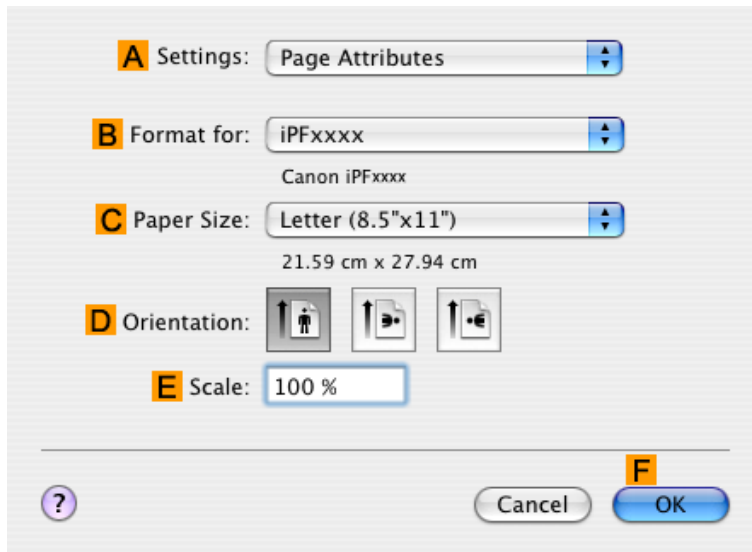

2

- 13.** Select the **D Enlarged/Reduced Printing** check box.

- 14.** Click **G Scaling** and enter **120**.



**Note**

- You can specify enlargement that exceeds the paper size, but in this case, the portion off the edge of the paper will not be printed.
- If the original size after enlargement or reduction is smaller than the paper size, the original is printed in the upper-left corner. In this case, you can center originals by selecting the **J Print Centered** check box.

- 15.** Confirm the print settings, and then click **M Print** to start printing.



**Note**

- For tips on confirming print settings, see "Confirming Print Settings(Mac OS X) [→P.436](#) "

## Printing at full size

Printing on Oversized Paper .....	89
Printing at Full Size (Windows) .....	90
Printing at Full Size (Mac OS X) .....	92
Borderless Printing at Actual Size .....	95
Borderless Printing at Actual Size (Windows) .....	97
Borderless Printing at Actual Size (Mac OS X) .....	99

## Printing on Oversized Paper

Except in borderless printing, the actual printing area corresponds to your selected paper size minus the space for a margin (See "Print Area →P.837"). To print documents or images you prepare without a margin at actual size, use an oversized paper size.

For example, to print a A4-sized original without a margin at A4 size, print it on paper larger than A4 size and cut away the excess margin.



### Note

- If you prepare an original for printing without a margin and print it on paper of regular size, the image near the edge will not be printed.

### • Oversize

The margin required by the printer is added around the **outside** of a regular paper size. For example, when printing a A4-sized original (210×297 mm), you have the following options.

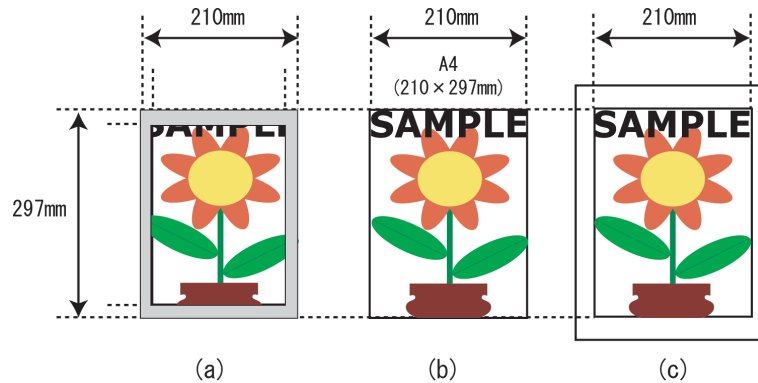

- (a) Regular paper size: Gray area not printed
- (b) Page Size
- (c) Oversized paper size: Print area matches the page size (b)



### Important

- When printing on oversized paper, load paper larger than the page size—a size that includes the margin required by the printer.
  - Sheets: Load paper that is at least 6 mm (0.24 in) wider and 26 mm (1 in) higher than the page size
  - Rolls: Load paper that is at least 6 mm (0.24 in) wider and 6 mm (0.24 in) higher than the page size



**Note**

- Paper larger than the maximum size supported by the printer cannot be used as paper for oversized printing. (See "Paper Sizes →P.569 ")
- To specify a non-standard paper size in oversized printing, register the paper size as a Custom Paper Size. Oversized printing is not available with **Custom Size**. (See "Printing on Non-Standard Paper Sizes →P.130 ")

For instructions on oversized printing, refer to the following topics, as appropriate for your computer and operating system.

- Printing at Full Size (Windows) →P.90
- Printing at Full Size (Mac OS X) →P.92

## 2 Printing at Full Size (Windows)

This topic describes how to print at full size based on the following example. (Oversized Printing)

- Document: Any Type
- Page Size: A4 (210.0×297.0 mm)/Letter (8.3 × 11.7 in)
- Paper: Roll
- Paper type: Plain Paper
- Roll paper width: A2/A3 roll (420.0 mm [16.5 in])

1. Choose **Print** in the application menu.
2. Select the printer in the dialog box, and then display the printer driver dialog box. (See "Accessing the Printer Driver Dialog Box from Applications(Windows) →P.217 ")
3. Make sure the **Main** sheet is displayed.

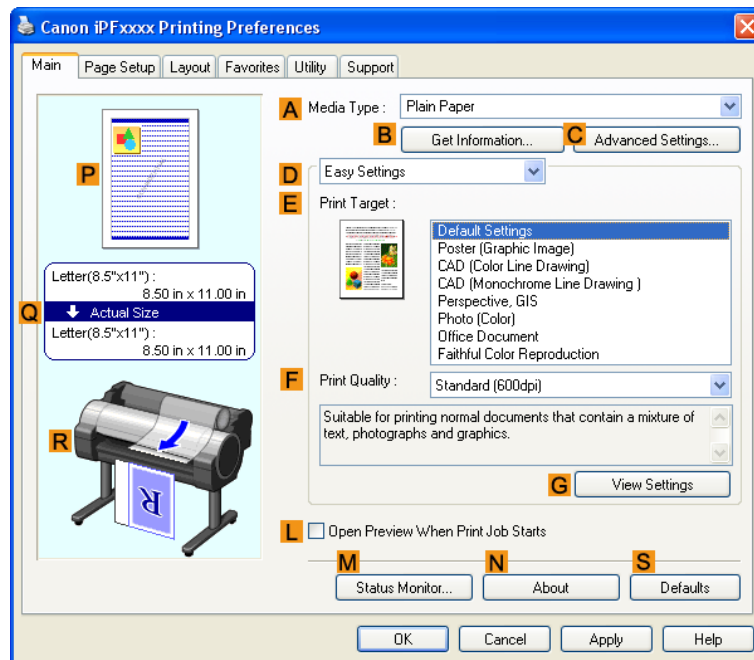



4. In the **A Media Type** list, select the type of paper that is loaded. In this case, click Plain Paper.

5. Click the **Page Setup** tab to display the **Page Setup** sheet.

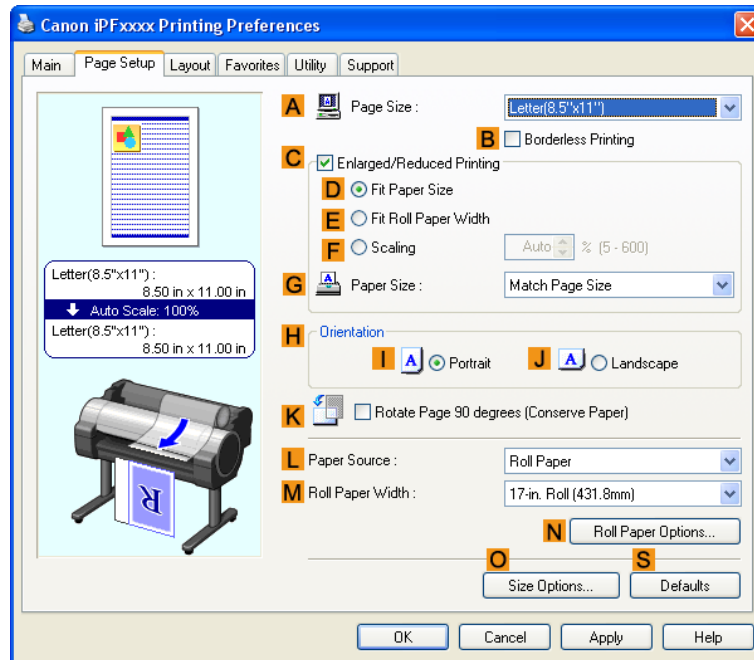

6. Click **O Size Options** to display the **Paper Size Options** dialog box.

7. In the **Paper Size Options** dialog box, select the **Oversize** check box in **Display Series**.

8. Click **OK** to close the **Paper Size Options** dialog box.

9. Click **Oversize - ISO A4** in the **A Page Size** list.

10. Select and click a roll paper in the **L Paper Source** list.

11. Select the width of the loaded roll in the **M Roll Paper Width** list—in this case, **ISO A2/A3 Roll (420.0mm)**.

12. Confirm the print settings and print as desired.



**Note**

- For tips on confirming print settings, see "Confirming Print Settings(Windows) →P.212 "

## Printing at Full Size (Mac OS X)

This topic describes how to print at full size based on the following example. (Oversized Printing)

- Document: Any Type
- Page size: A4 (210.0 × 297.0 mm [8.3 × 11.7 in])
- Paper: Roll paper
- Paper type: Plain Paper
- Roll paper width: A2/A3 roll (420.0 mm [16.5 in])

1. This sets the **B Format for** and **C Paper Size**.



**Note**

- The configuration method varies depending on the OS and application software you are using. If **Page Setup** is displayed in the application menu, the settings are configured by opening the **Page Attributes** dialog box from **Page Setup**.

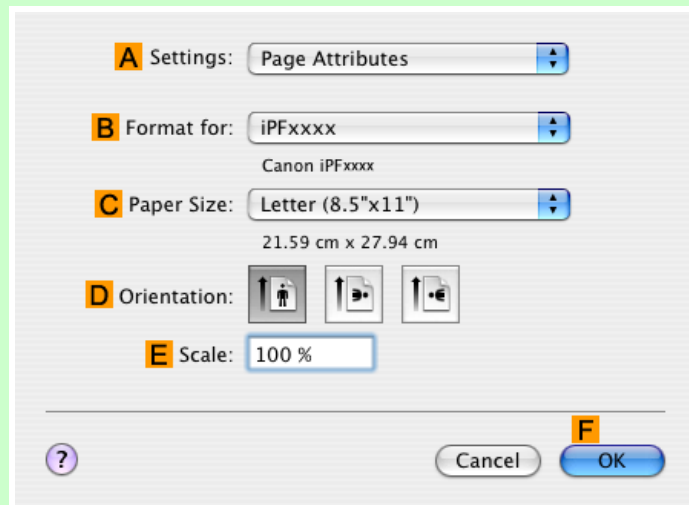

If it is not displayed, the settings are configured in the upper part of the printer driver displayed when you select **Print** from the application software menu.

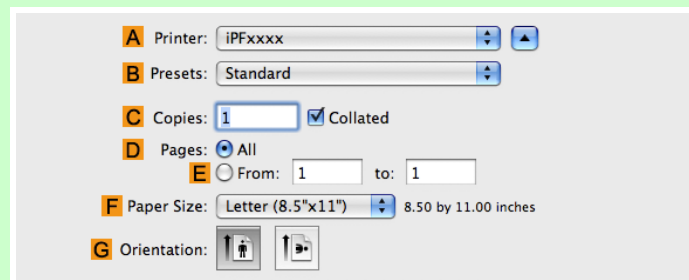

2. Select the printer in the **A Printer** list.

3. In **F Paper Size**, click the size of the original. In this case, click **ISO A4 - Oversize**.

4. If you configured the settings using the **Page Attributes** dialog box, click **OK** to close the dialog box, and then select **Print** from the application software menu.

5. Access the **Main** pane.

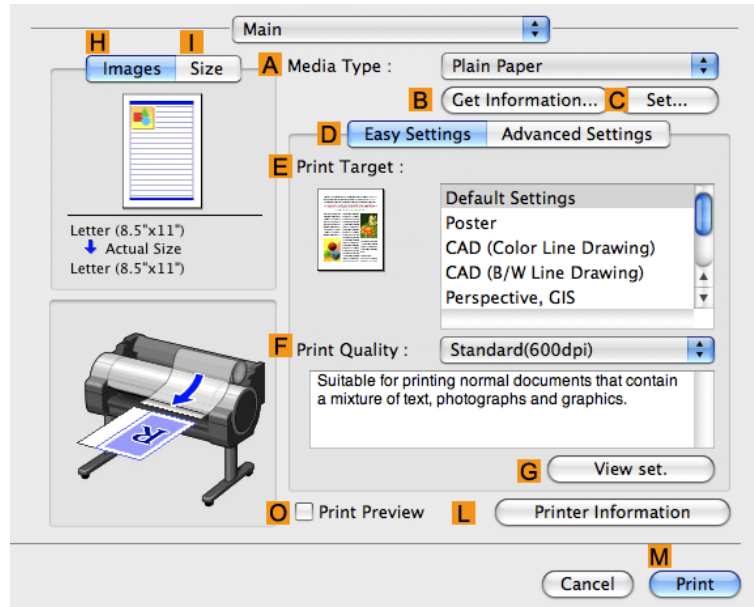

6. In the **A Media Type** list, select the type of paper that is loaded. In this case, click Plain Paper.

7. Make your selection in the **E Print Target** list.

8. Make your selection in the **F Print Quality** list.

**9.** Access the **Page Setup** pane.

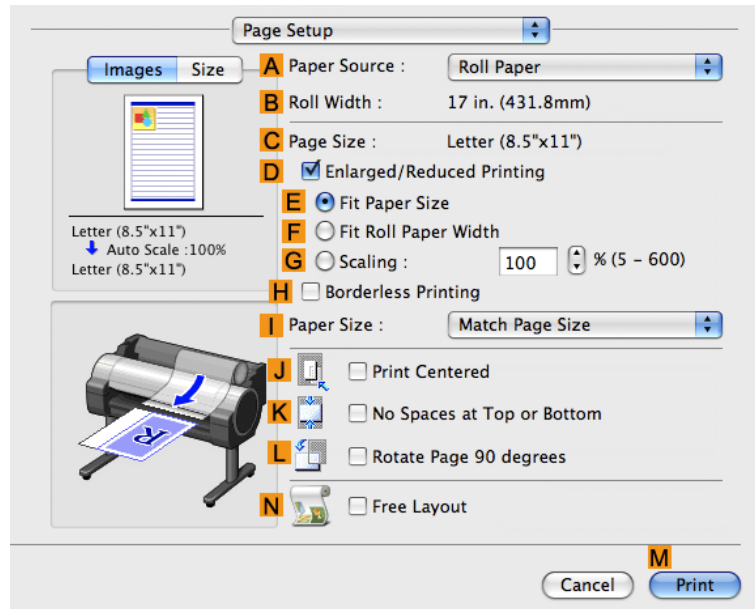

2

**10.** Select and click a roll paper in the **A Paper Source** list.

**11.** Make sure the width of the loaded roll is displayed in the **B Roll Width** list—in this case, **ISO A2/A3 (420.0mm)**.



**Note**

- If the width of the roll loaded in the printer is not shown in **B Roll Width**, click **L Printer Information** on the **Main** pane to update the printer information.

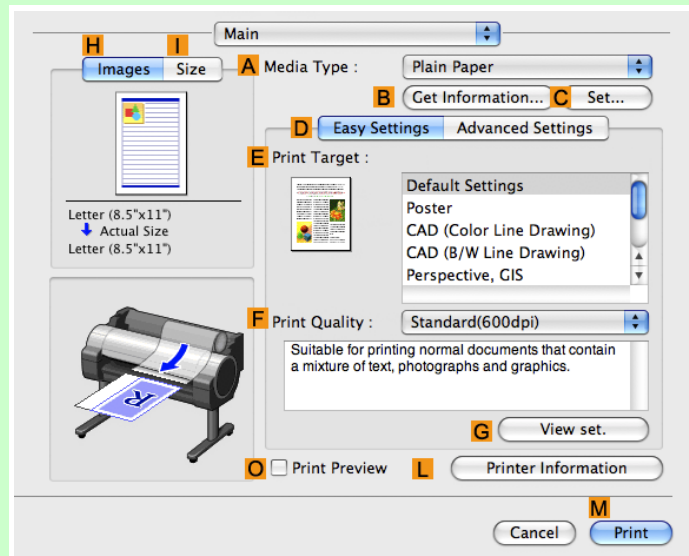

94

12. Make sure **C Page Size** shows the original size as specified in **C Paper Size** in the **Page Attributes** dialog box—in this case, **ISO A4 - Oversize**.

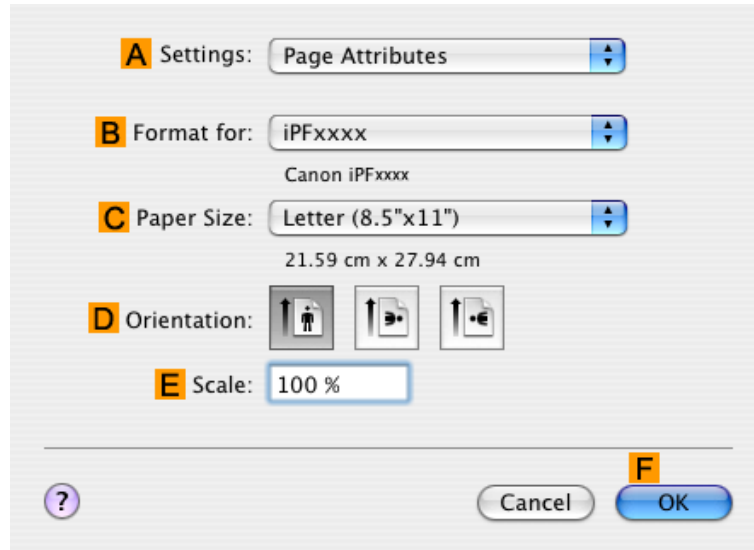

13. Confirm the print settings, and then click **M Print** to start printing.



**Note**

- For tips on confirming print settings, see "Confirming Print Settings(Mac OS X) →P.436 "

## Borderless Printing at Actual Size

Take advantage of borderless printing to print documents such as posters (made up mainly of photos or images) without a surrounding margin, or border.

### • Borderless Printing

In regular printing, a margin required by the printer is added around the original. With borderless printing, you can print documents without the margin, so that the printed image covers the entire surface of the paper.

**Important**

- Borderless printing is only available with rolls.
- Paper you can use for borderless printing is restricted to particular types of paper and rolls of particular widths. For information on types of paper compatible with borderless printing, refer to the Paper Reference Guide. (See "Types of Paper →P.568 ")
- Paper incompatible with the printer's auto cut function can be printed without borders on the left and right sides only.
- These features cannot be used in combination with borderless printing: special page layouts, centering originals, and printing cut lines on rolls.
- If **Fit Paper Size** or **Print Image with Actual Size** (Windows only) is selected when performing borderless printing, **Rotate Page 90 degrees (Conserve Paper)** cannot be selected.
- When borderless printing is used, the edge of the paper is cut during printing. Thus, ink density may be uneven at the edges. If you require higher image quality, specify **No** in **Auto Cut** in the printer driver. In this case, the paper can be printed without borders on the left and right sides only. After ejecting and cutting the printed document, use scissors to cut away the top and bottom edges.
- By factory default, the ink drying time is disabled for all paper. When you are using paper that takes longer for ink to adhere for borderless printing and the Cutter Unit touches printing surfaces that are not dry yet, it may damage the paper or the edge of the document that is cut, depending on frequency of use. In this case, follow these steps to change the ink drying time.
  - On the **Main** sheet of the printer driver, click **Settings** in **Media Type**.
  - Select the ink drying time in the **Between Pages** list of **Drying Time**.

**• Borderless Printing Method**

Choose the method of borderless printing that suits the original, as desired.

**• Print Image with Actual Size**

Prints originals at actual size, without enlarging or reducing them. Originals must be prepared in a size that exceeds the dimensions of the paper by 3 mm (0.12 in) on each side.

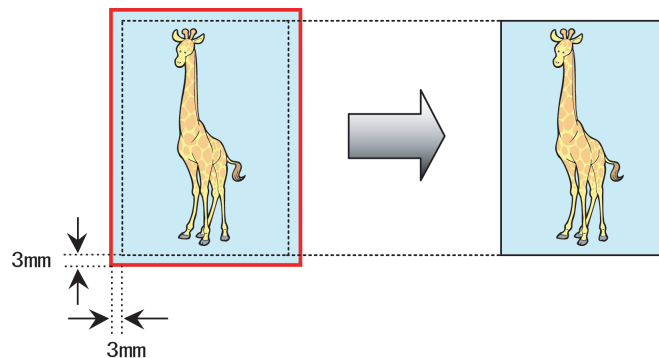
**Note**

- Not all page sizes are available.
- Even if you prepare originals of the same size as the paper size, the originals are automatically enlarged when you print borderlessly in combination with resizing originals to match the paper size. This may affect image quality. When image quality is most important, make the original 3 mm longer on each side than the paper size so that the image can be printed at actual size in borderless printing.

For instructions on borderless printing of photos and images at actual size, refer to the following topics, as appropriate for your computer and operating system.

- Borderless Printing at Actual Size (Windows) →P.97
- Borderless Printing at Actual Size (Mac OS X) →P.99

## Borderless Printing at Actual Size (Windows)

This topic describes how to print borderlessly at actual size based on the following example.

- Document: Any type
- Page size: 10×12 inches (254.0×304.8 mm)
- Paper: Roll
- Paper type: Heavyweight Coated Paper
- Roll paper width: 10 inches (254.0 mm)

1. Create the original in the source application 3 mm (0.12 in) larger on each side than 254.0×304.8 mm (10 × 12 in)—that is, 260.0×310.8 mm (10.2 × 12.2 in)



### Note

- If you can specify the margin, as in Microsoft Word, set the margin at 0 mm. For instructions on specifying the margin, refer to the software documentation.
- The extra 3 mm (0.12 in) on each side will not be printed. Create the original so that it fits inside the paper area to be printed on.

2. Choose **Print** in the application menu.
3. Select the printer in the dialog box, and then display the printer driver dialog box. (See "Accessing the Printer Driver Dialog Box from Applications(Windows) →P.217 ")
4. Make sure the **Main** sheet is displayed.

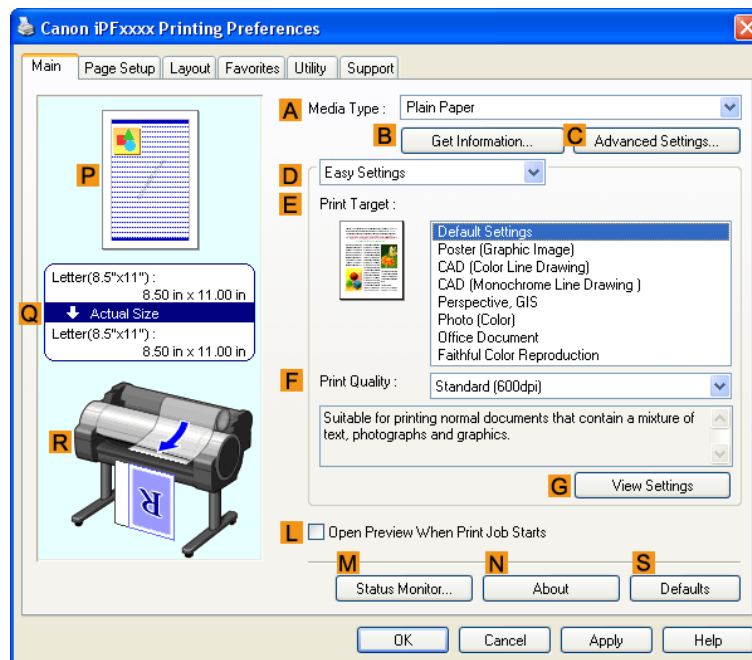

5. In the **A Media Type** list, select the type of paper that is loaded. In this case, click Heavyweight Coated Paper.
6. Select the print target in the **E Print Target** list.
7. Click the **Page Setup** tab to display the **Page Setup** sheet.

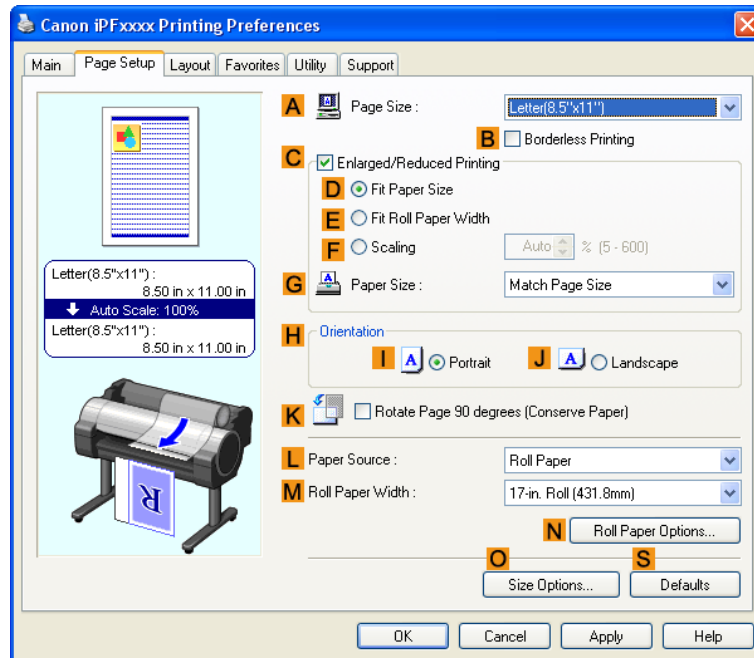

8. In the **A Page Size** list, click the size of the original as specified in the source application. In this case, click 10"x12".
9. Select and click a roll paper in the **L Paper Source** list.



- 10.** Select the **B Borderless Printing** check box to display the **Information** dialog box.

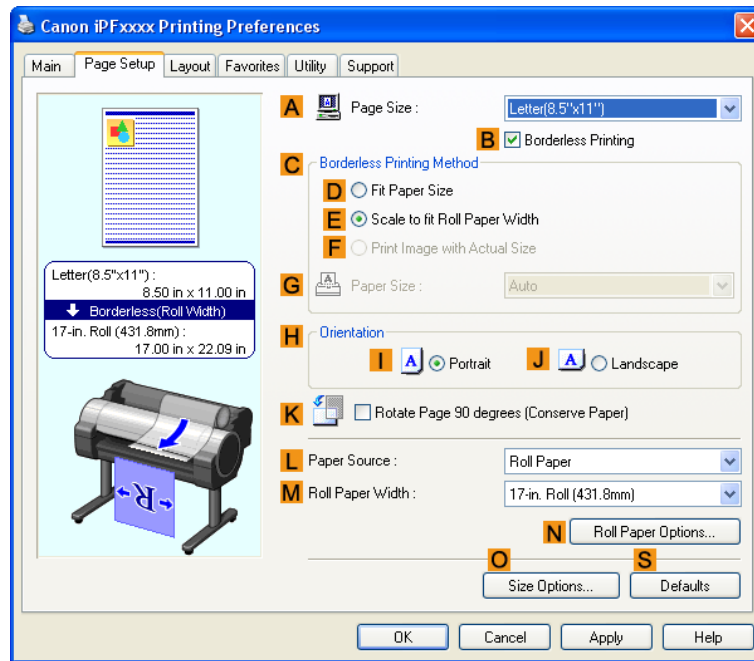

- 11.** Select the width of the loaded roll in the **Roll Paper Width** list—in this case, click **10-in. Roll (254.0mm)**.

- 12.** Click **OK** to close the **Information** dialog box.

- 13.** In **C Borderless Printing Method**, click **F Print Image with Actual Size**.

- 14.** Confirm the print settings and print as desired.



**Note**

- For tips on confirming print settings, see "Confirming Print Settings(Windows) →P.212 "

## Borderless Printing at Actual Size (Mac OS X)

This topic describes how to print borderlessly at actual size based on the following example.

- Document: Any Type
- Page size: 10 × 12 inches (254.0×304.8 mm)—Borderless
- Paper: Roll paper
- Paper type: Heavyweight Coated Paper
- Roll paper width: 10 inches (254.0 mm)

1. This sets the **B Format for** and **C Paper Size**.



**Note**

- The configuration method varies depending on the OS and application software you are using. If **Page Setup** is displayed in the application menu, the settings are configured by opening the **Page Attributes** dialog box from **Page Setup**.

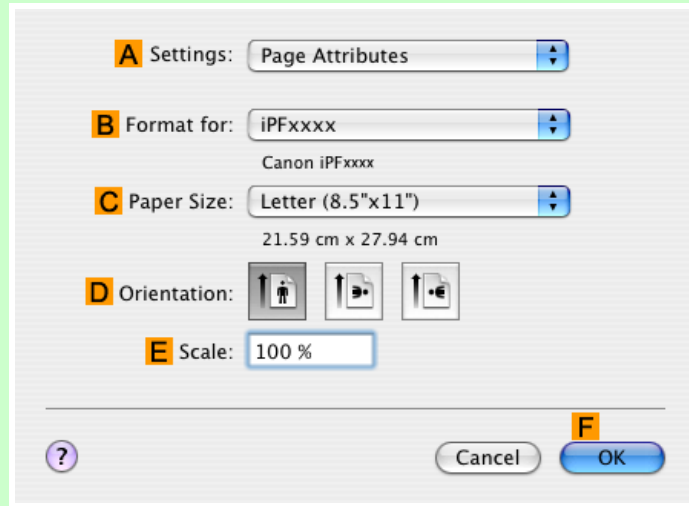

If it is not displayed, the settings are configured in the upper part of the printer driver displayed when you select **Print** from the application software menu.

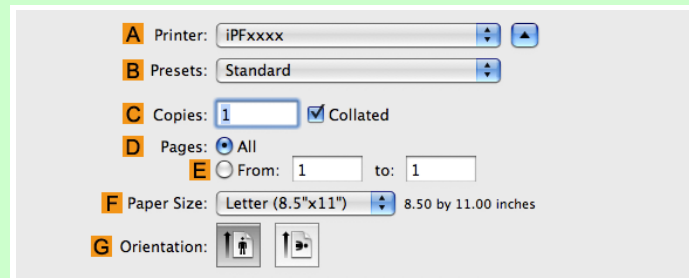

2. Select the printer in the **A Printer** list.

3. In the **F Paper Size** list, choose a paper size supported for borderless printing. Here, click **10"x12" - Borderless**.



**Note**

- Paper sizes supported for borderless printing are indicated by **—Borderless**.

4. If you configured the settings using the **Page Attributes** dialog box, click **F OK** to close the dialog box, and then select **Print** from the application software menu.

2

100

5. Access the **Main** pane.

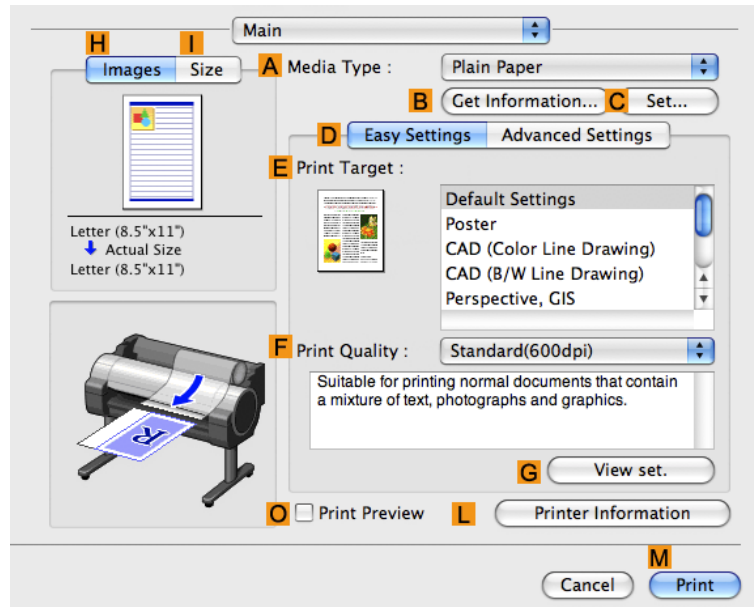

6. In the **A Media Type** list, select the type of paper that is loaded. In this case, click Heavyweight Coated Paper.

7. Make your selection in the **E Print Target** list.

8. Make your selection in the **F Print Quality** list.

9. Access the **Page Setup** pane.

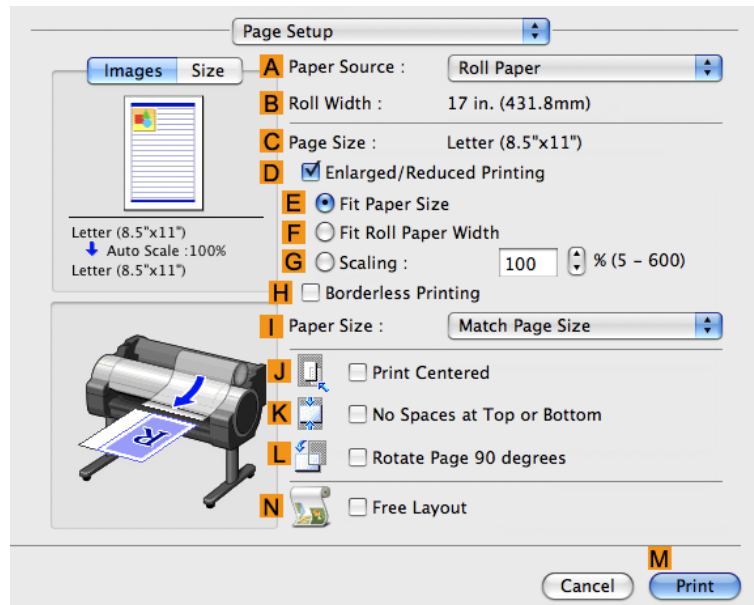

10. Select and click a roll paper in the **A Paper Source** list.

11. Confirm that the roll paper width matches the paper size.  
Make sure the width of the loaded roll is displayed in the **B Roll Width** list—in this case, **10 in. (254.0mm)**.

 **Note**

- If the width of the roll loaded in the printer is not shown in **B Roll Width**, click **L Printer Information** on the **Main** pane to update the printer information.

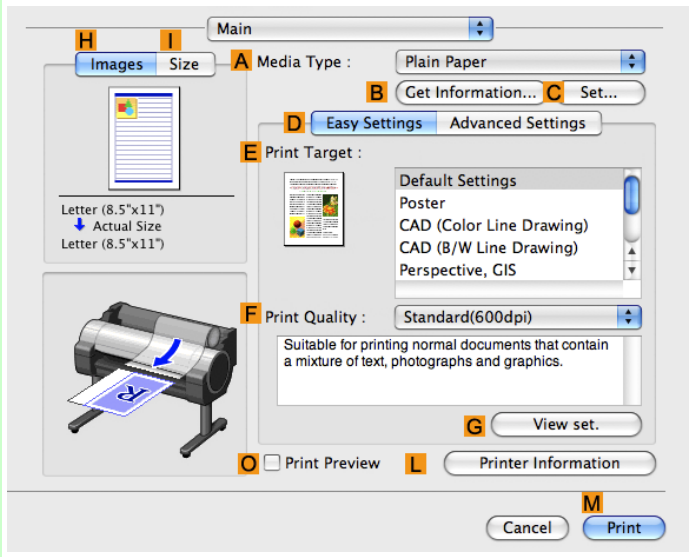

12. Make sure the **C Page Size** setting matches the original size as selected in **C Paper Size** in the **Page Attributes** dialog box—in this case, **10" x 12" - Borderless**.

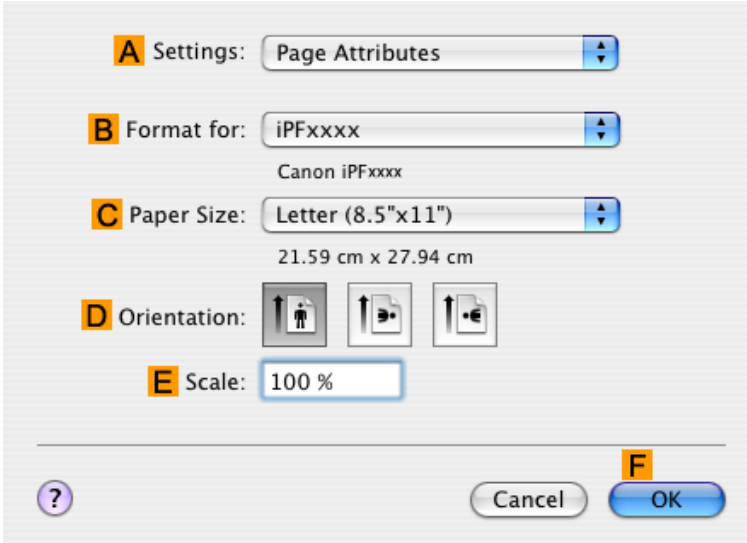

**13.** Confirm the print settings, and then click **Print** to start printing.



Note

- For tips on confirming print settings, see "Confirming Print Settings(Mac OS X) →P.436 "

## Borderless Printing

Borderless Printing on Paper of Equivalent Size .....	104
Borderless Printing by Resizing Originals to Match the Paper Size (Windows) .....	105
Borderless Printing by Resizing Originals to Match the Paper Size (Mac OS X) .....	108
Borderless Printing by Resizing Originals to Fit the Roll Width .....	111
Borderless Printing by Resizing Originals to Fit the Roll Width (Windows) .....	113
Borderless Printing by Resizing Originals to Fit the Roll Width (Mac OS X) .....	115

### Borderless Printing on Paper of Equivalent Size

2

Take advantage of borderless printing to print documents such as posters (made up mainly of photos or images) without a surrounding margin, or border.

#### • Borderless Printing

In regular printing, a margin required by the printer is added around the original. With borderless printing, you can print documents without the margin, so that the printed image covers the entire surface of the paper.



#### Important

- Borderless printing is only available with rolls.
- Paper you can use for borderless printing is restricted to particular types of paper and rolls of particular widths. For information on types of paper compatible with borderless printing, refer to the Paper Reference Guide. (Refer to "Types of Paper →P.568 ")
- Paper incompatible with the printer's auto cut function can be printed without borders on the left and right sides only.
- These features cannot be used in combination with borderless printing: special page layouts, centering originals, and printing cut lines on rolls.
- If **Fit Paper Size** or **Print Image with Actual Size** (Windows only) is selected when performing borderless printing, **Rotate Page 90 degrees (Conserve Paper)** cannot be selected.
- When borderless printing is used, the edge of the paper is cut during printing. Thus, ink density may be slightly uneven at the edges. If you require higher image quality, specify **No** in **Auto Cut** in the printer driver. In this case, the paper can be printed without borders on the left and right sides only. Cut the printed document ejected from the printer, then use scissors to cut away the edges on the top and bottom.
- By factory default, the ink drying time is disabled for all paper. When you are using paper that takes longer for ink to adhere for borderless printing and the Cutter Unit touches printing surfaces that are not dry yet, it may damage the paper or the edge of the document that is cut, depending on frequency of use. In this case, follow these steps to change the ink drying time.
  - On the **Main** sheet of the printer driver, click **Settings** in **Media Type**.
  - Select the ink drying time in the **Between Pages** list of **Drying Time**.

#### • Borderless Printing Method

Choose the method of borderless printing that suits the original, as desired.

### • Fit Paper Size

Enlarge or reduce the original to match the size of the paper you are using.

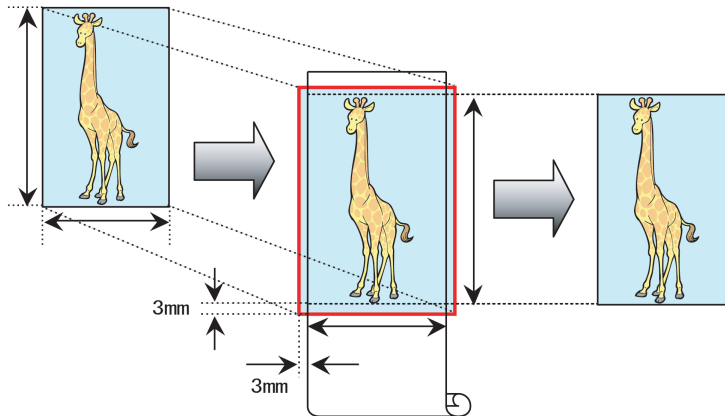

#### Note

- The printer driver automatically enlarges originals 3 mm (0.12 in) past the dimensions of the paper on each side. The 3 mm portion beyond the edge on each side is not printed.

For instructions on borderless printing of photos, images, and other documents to match the paper size, refer to the following topics, as appropriate for your computer and operating system.

- Borderless Printing by Resizing Originals to Match the Paper Size (Windows) [→P.105](#)
- Borderless Printing by Resizing Originals to Match the Paper Size (Mac OS X) [→P.108](#)

## Borderless Printing by Resizing Originals to Match the Paper Size (Windows)

This topic describes how to enlarge originals before borderless printing to match the paper size, based on the following example.

- Document: Any type
- Page size: 10×12 inches (254.0×304.8 mm)
- Paper: Roll
- Paper type: Heavyweight Coated Paper
- Roll paper width: 10 inches (254.0 mm)

1. In the application, create an original that takes up the entire space of the paper size.



#### Note

- If you can specify the margin, as in Microsoft Word, set the margin at 0 mm. For instructions on specifying the margin, refer to the software documentation.

2. Choose **Print** in the application menu.
3. Select the printer in the dialog box, and then display the printer driver dialog box. (See "Accessing the Printer Driver Dialog Box from Applications(Windows) [→P.217](#) ")

**4.** Make sure the **Main** sheet is displayed.

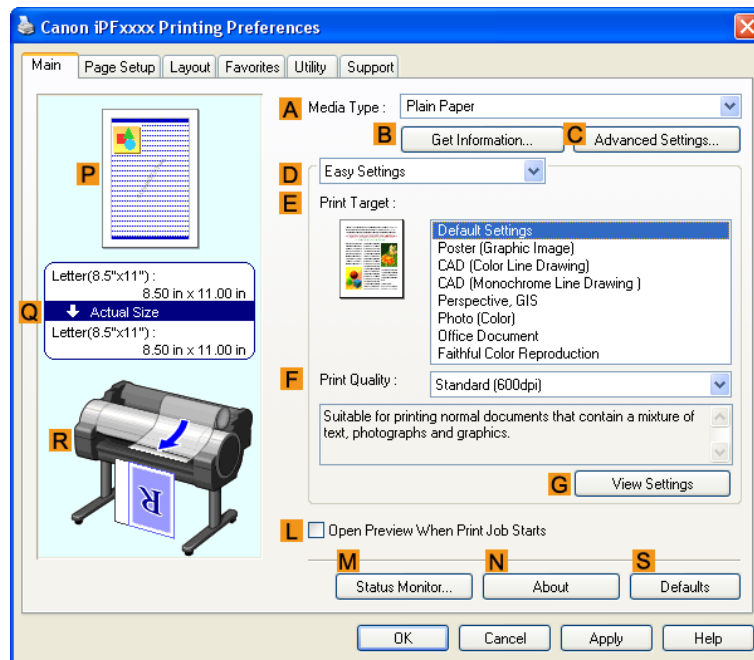

**5.** In the **A Media Type** list, select the type of paper that is loaded. In this case, click Heavyweight Coated Paper.

**6.** Select the print target in the **E Print Target** list.

**7.** Click the **Page Setup** tab to display the **Page Setup** sheet.

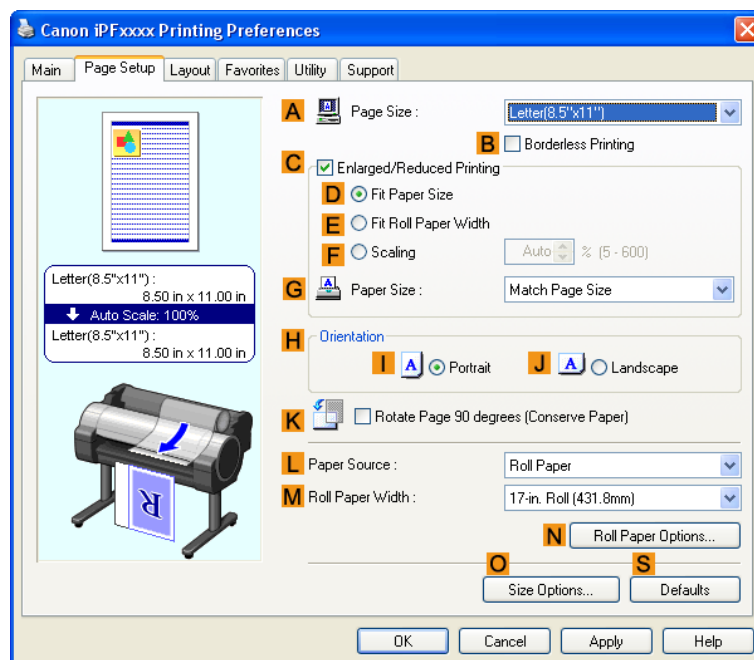



8. In the **A Page Size** list, click the size of the original as specified in the application. In this case, click **10"x12"**.
9. Select and click a roll paper in the **L Paper Source** list.
10. Select the **B Borderless Printing** check box to display the **Information** dialog box.

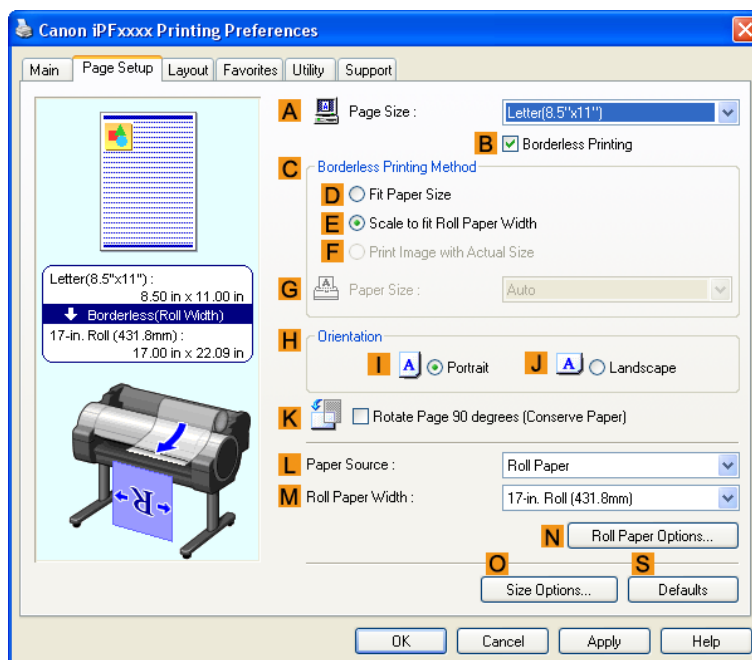

11. Select the width of the loaded roll in the **Roll Paper Width** list—in this case, click **10-in. Roll (254.0mm)**.
12. Click **OK** to close the **Information** dialog box.
13. In **C Borderless Printing Method**, click **D Fit Paper Size**.
14. Click **Match Page Size** in the **G Paper Size** list.
15. Confirm the print settings and print as desired.

**Note**

- For tips on confirming print settings, see "Confirming Print Settings(Windows) →P.212 "

## Borderless Printing by Resizing Originals to Match the Paper Size (Mac OS X)

This topic describes how to enlarge originals before borderless printing to match the paper size, based on the following example.

- Document: Any Type
- Page size: 10×12 inches (254.0×304.8 mm)
- Paper: Roll paper
- Paper type: Heavyweight Coated Paper
- Roll paper width: 10 inches (254.0 mm)

**1.** This sets the **B Format for** and **C Paper Size**.

2

Note

- The configuration method varies depending on the OS and application software you are using. If **Page Setup** is displayed in the application menu, the settings are configured by opening the **Page Attributes** dialog box from **Page Setup**.

A

Settings: Page Attributes

B

Format for: iPFxxxx  
Canon iPFxxxx

C

Paper Size: Letter (8.5"x11")  
21.59 cm x 27.94 cm

D

Orientation: Portrait

E

Scale: 100 %

?
Cancel
OK

If it is not displayed, the settings are configured in the upper part of the printer driver displayed when you select **Print** from the application software menu.

A

Printer: iPFxxxx

B

Presets: Standard

C

Copies: 1  Collated

D

Pages:  All

E

From: 1 to: 1

F

Paper Size: Letter (8.5"x11") 8.50 by 11.00 inches

G

Orientation: Portrait

**2.** Select the printer in the **A Printer** list.

3. In the **F Paper Size** list, click the size of the original. In this case, click **10"x12"**.

**Note**

- All sizes are available in borderless printing if you resize originals to match the paper size.

4. If you configured the settings using the **Page Attributes** dialog box, click **F OK** to close the dialog box, and then select **Print** from the application software menu.

5. Access the **Main** pane.

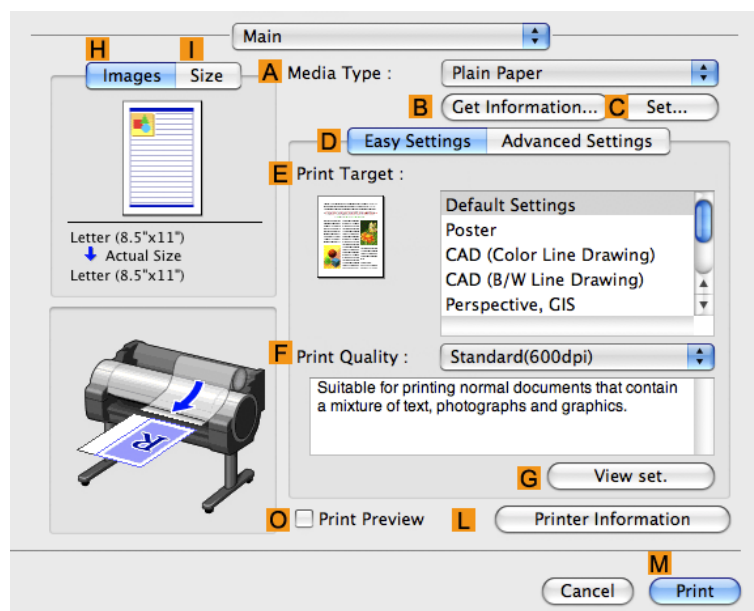

6. In the **A Media Type** list, select the type of paper that is loaded. In this case, click Heavyweight Coated Paper.

7. Make your selection in the **E Print Target** list.

8. Make your selection in the **F Print Quality** list.

9. Access the **Page Setup** pane.

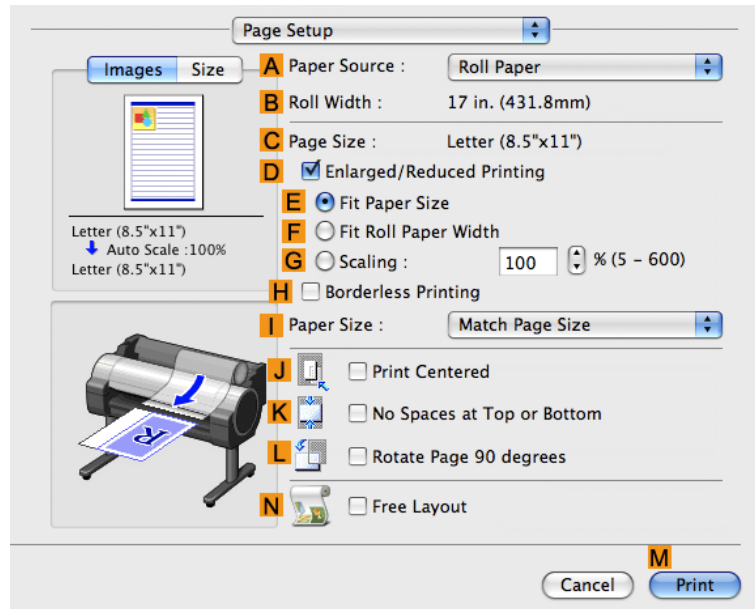

2

10. Select and click a roll paper in the **A Paper Source** list.

11. Make sure the width of the loaded roll is displayed in the **B Roll Width** list—in this case, **10 in. (254.0mm)**.



Note

- If the width of the roll loaded in the printer is not shown in **B Roll Width**, click **L Printer Information** on the **Main** pane to update the printer information.

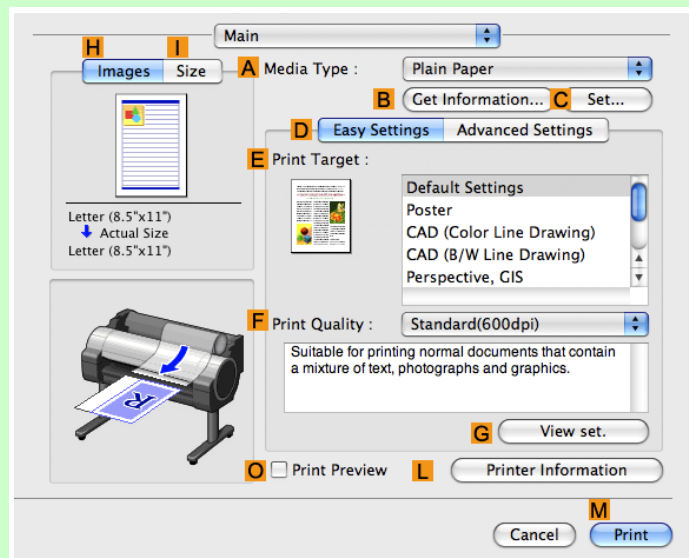

110

12. Make sure the **C Page Size** setting matches the original size as selected in **C Paper Size** in the **Page Attributes** dialog box—in this case, **10"x12"**.

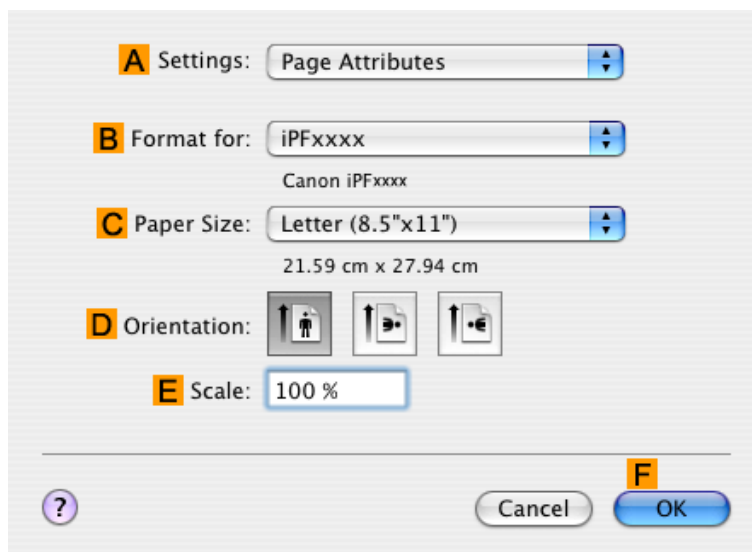

13. On the **Page Setup** pane, select the **D Enlarged/Reduced Printing** check box.

14. Select the **H Borderless Printing** check box.

15. Click **E Fit Paper Size** under **D Enlarged/Reduced Printing**.

16. In **I Paper Size**, click the paper size. In this case, click **10"x12" - Borderless**.

17. Confirm the print settings, and then click **M Print** to start printing.



**Note**

- For tips on confirming print settings, see "Confirming Print Settings(Mac OS X) →P.436 "

## Borderless Printing by Resizing Originals to Fit the Roll Width

Take advantage of borderless printing to print documents such as posters (made up mainly of photos or images) without a surrounding margin, or border.

### • Borderless Printing

In regular printing, a margin required by the printer is added around the original. With borderless printing, you can print documents without the margin, so that the printed image covers the entire surface of the paper.

**Important**

- Borderless printing is only available with rolls.
- Paper you can use for borderless printing is restricted to particular types of paper and rolls of particular widths. For information on types of paper compatible with borderless printing, refer to the Paper Reference Guide. (See "Types of Paper →P.568 ")
- Paper incompatible with the printer's auto cut function can be printed without borders on the left and right sides only.
- These features cannot be used in combination with borderless printing: special page layouts, centering originals, and printing cut lines on rolls.
- If **Fit Paper Size** or **Print Image with Actual Size** (Windows only) is selected when performing borderless printing, **Rotate Page 90 degrees (Conserve Paper)** cannot be selected.
- When borderless printing is used, the edge of the paper is cut during printing. Thus, ink density may be uneven at the edges. If you require higher image quality, specify **No in Auto Cut** in the printer driver. In this case, the paper can be printed without borders on the left and right sides only. After ejecting and cutting the printed document, use scissors to cut away the top and bottom edges.
- By factory default, the ink drying time is disabled for all paper. When you are using paper that takes longer for ink to adhere for borderless printing and the Cutter Unit touches printing surfaces that are not dry yet, it may damage the paper or the edge of the document that is cut, depending on frequency of use. In this case, follow these steps to change the ink drying time.
  - On the **Main** sheet of the printer driver, click **Settings in Media Type**.
  - Select the ink drying time in the **Between Pages** list of **Drying Time**.

**• Borderless Printing Method**

Choose the method of borderless printing that suits the original, as desired.

**• Scale to fit Roll Paper Width**

Enlarge or reduce the original as a whole to match the roll paper width.

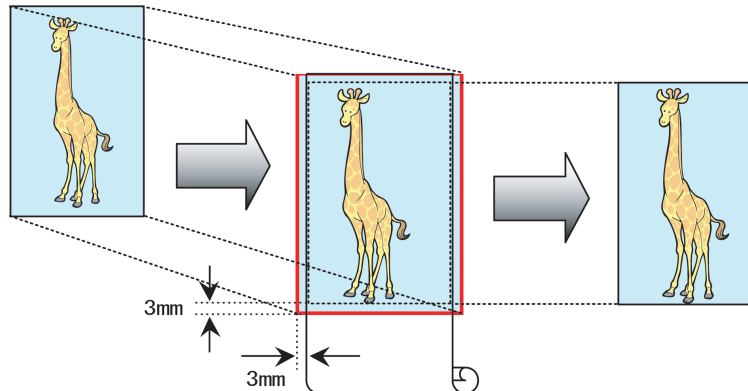
**Note**

- You can combine this function with rotating pages 90 degrees before printing so that the original width (relative to portrait orientation) matches the roll paper width in borderless printing.

For instructions on borderless printing of photos, images, and other documents to match the roll paper width, refer to the following topics, as appropriate for your computer and operating system.

- Borderless Printing by Resizing Originals to Fit the Roll Width (Windows) →P.113
- Borderless Printing by Resizing Originals to Fit the Roll Width (Mac OS X) →P.115

## Borderless Printing by Resizing Originals to Fit the Roll Width (Windows)

This topic describes how to enlarge originals before borderless printing to match the roll width, based on the following example.

- Document: Any type
- Page size: A4 (210.0×297.0 mm)/Letter (8.3 × 11.7 in)
- Paper: Roll
- Paper type: Heavyweight Coated Paper
- Roll paper width: 10 inches (254.0 mm)

1. In the application, create an original that takes up the entire space of the paper size.



### Note

- If you can specify the margin, as in Microsoft Word, set the margin at 0 mm. For instructions on specifying the margin, refer to the software documentation.

2. Choose **Print** in the application menu.
3. Select the printer in the dialog box, and then display the printer driver dialog box. (See "Accessing the Printer Driver Dialog Box from Applications(Windows) →P.217 ")
4. Make sure the **Main** sheet is displayed.

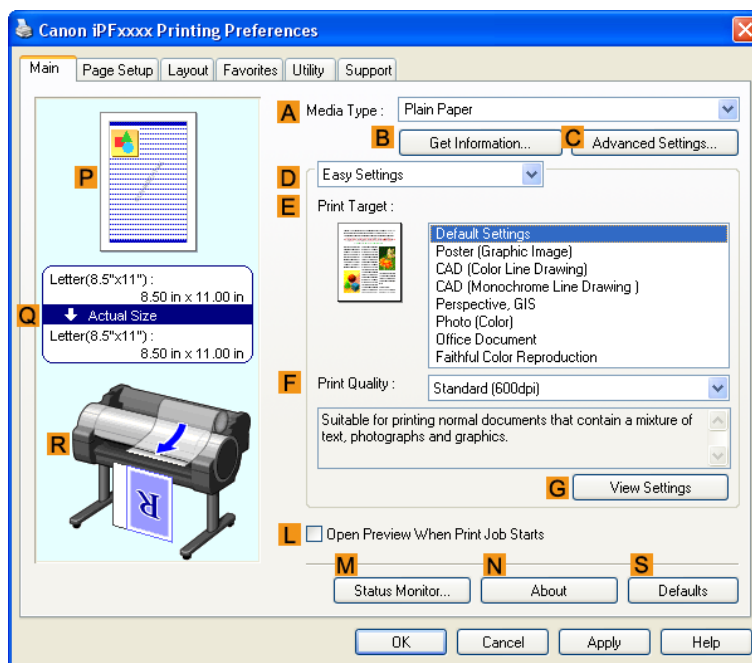

5. In the **A Media Type** list, select the type of paper that is loaded. In this case, click Heavyweight Coated Paper.
6. Select the print target in the **E Print Target** list.

- Click the **Page Setup** tab to display the **Page Setup** sheet.

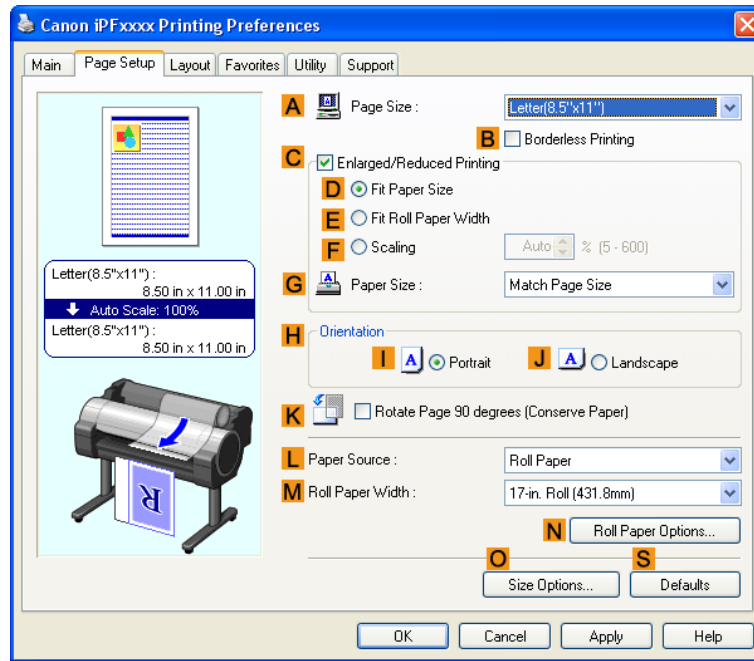

- In the **A Page Size** list, click the size of the original as specified in the application. In this case, click **ISO A4** or **Letter (8.5"x11")**.
- Select and click a roll paper in the **L Paper Source** list.
- Select the **B Borderless Printing** check box to display the **Information** dialog box.

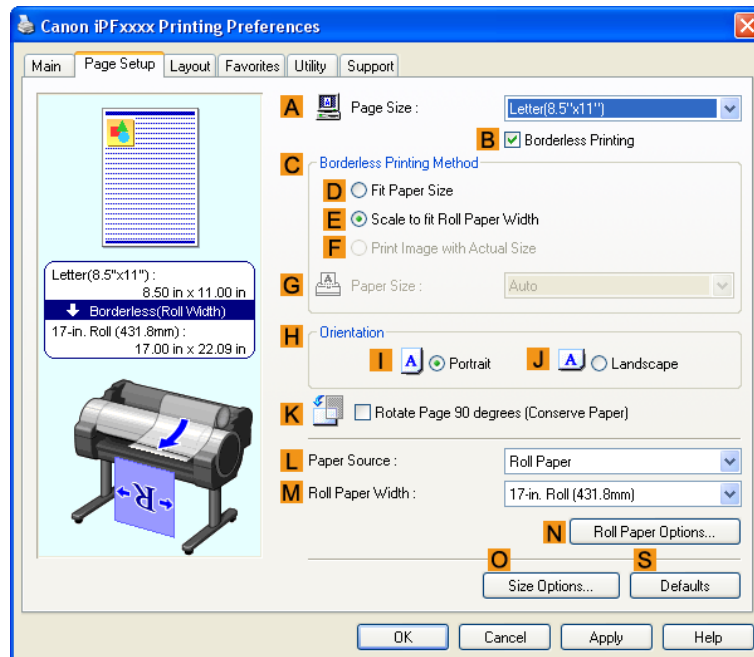



11. Select the width of the loaded roll in the **Roll Paper Width** list—in this case, click **10-in. Roll (254.0mm)**.
12. Click **OK** to close the **Information** dialog box.
13. In **C Borderless Printing Method**, make sure **E Scale to fit Roll Paper Width** is selected.
14. Confirm the print settings and print as desired.

**Note**

- For tips on confirming print settings, see "Confirming Print Settings(Windows) →P.212 "

## Borderless Printing by Resizing Originals to Fit the Roll Width (Mac OS X)

This topic describes how to enlarge originals before borderless printing to match the roll width, based on the following example.

- Document: Any Type
- Page size: A4 (210.0 × 297.0 mm [8.3 × 11.7 in])
- Paper: Roll paper
- Paper type: Heavyweight Coated Paper
- Roll paper width: 10 inches (254.0 mm)

1. This sets the **B Format for** and **C Paper Size**.

**Note**

- The configuration method varies depending on the OS and application software you are using. If **Page Setup** is displayed in the application menu, the settings are configured by opening the **Page Attributes** dialog box from **Page Setup**.

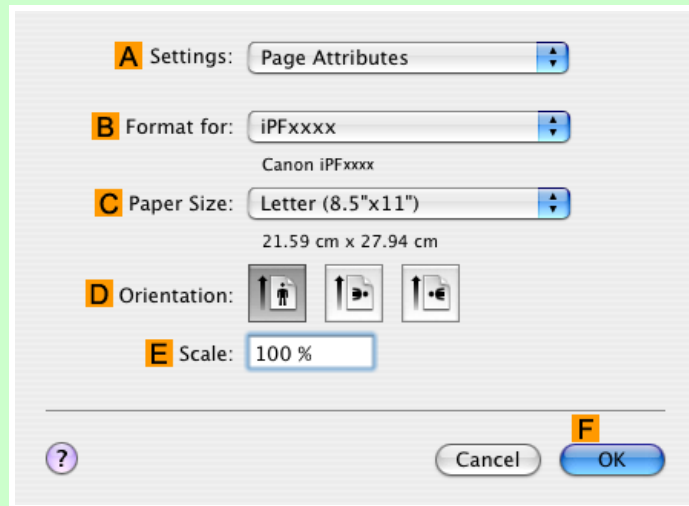

If it is not displayed, the settings are configured in the upper part of the printer driver displayed when you select **Print** from the application software menu.

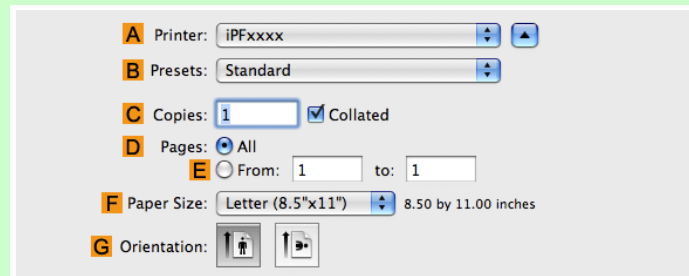

2. Select the printer in the **A Printer** list.
3. In the **F Paper Size** list, click the size of the original. In this case, click **ISO A4**.

**Note**

- All sizes are available in borderless printing if you resize originals to fit the roll width.

4. If you configured the settings using the **Page Attributes** dialog box, click **F OK** to close the dialog box, and then select **Print** from the application software menu.

5. Access the **Main** pane.

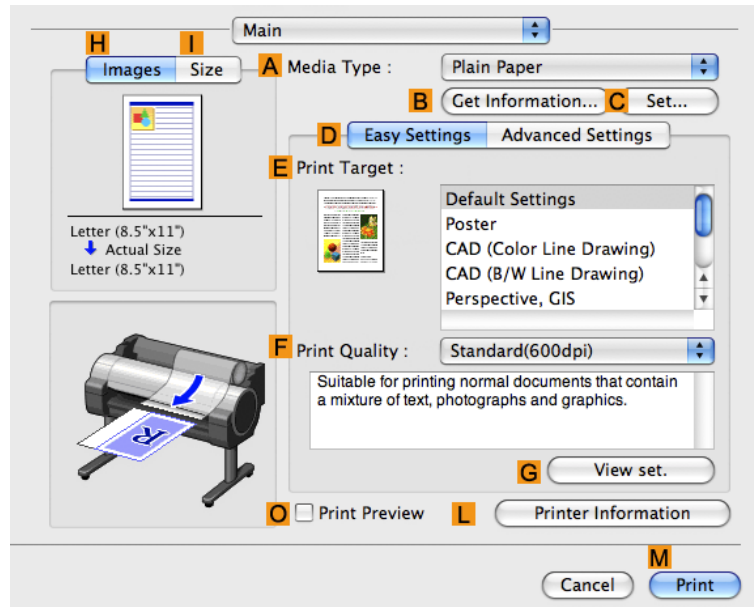

6. In the **A Media Type** list, select the type of paper that is loaded. In this case, click Heavyweight Coated Paper.

7. Make your selection in the **E Print Target** list.

8. Make your selection in the **F Print Quality** list.

9. Access the **Page Setup** pane.

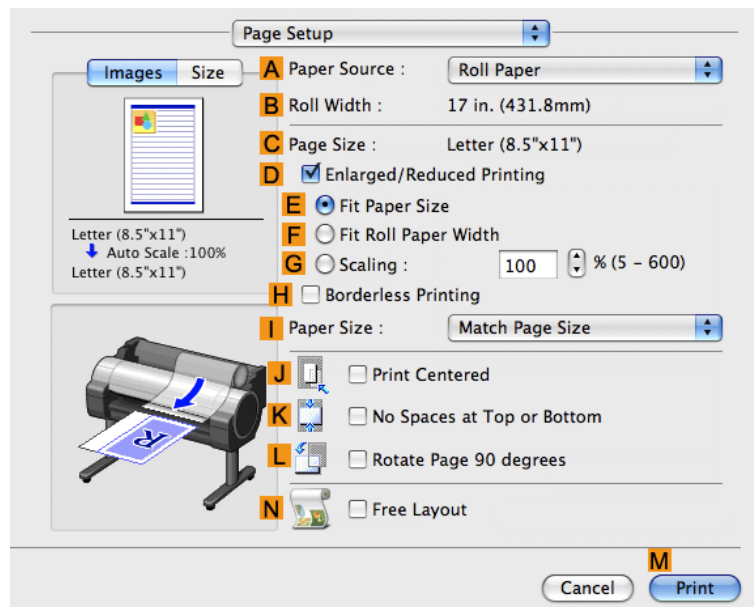

**10.** Select and click a roll paper in the **A Paper Source** list.

**11.** Make sure the width of the loaded roll is displayed in the **B Roll Width** list—in this case, **10 in. (254.0mm)**.

 **Note**

- If the width of the roll loaded in the printer is not shown in **B Roll Width**, click **L Printer Information** on the **Main** pane to update the printer information.

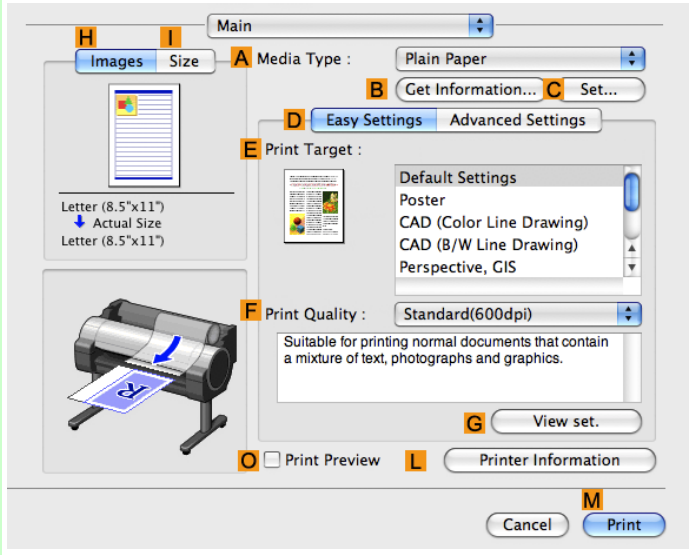

**12.** Make sure the **C Page Size** setting matches the original size as selected in **C Paper Size** in the **Page Attributes** dialog box—in this case, **ISO A4**.

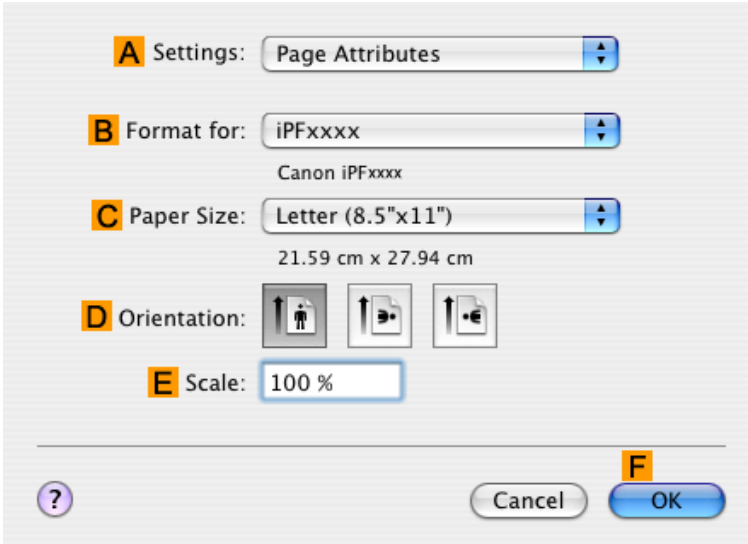

**13.** Select the **D Enlarged/Reduced Printing** check box.

14. Select the **H Borderless Printing** check box.  
This ensures that **F Fit Roll Paper Width** is automatically selected in **D Enlarged/Reduced Printing**.
15. Confirm the print settings, and then click **M Print** to start printing.

**Note**

- For tips on confirming print settings, see "Confirming Print Settings(Mac OS X) →P.436 "

## Printing banners or at other non-standard sizes

Printing Vertical or Horizontal Banners (Large-Format Printing) .....	120
Printing Vertical or Horizontal Banners (Large-Format Printing; Windows) .....	121
Printing Vertical or Horizontal Banners (Large-Format Printing; Mac OS X) .....	126
Printing on Non-Standard Paper Sizes .....	130
Printing on Non-Standard Paper Sizes (Windows) .....	131
Printing on Non-Standard Paper Sizes (Mac OS X) .....	135

### Printing Vertical or Horizontal Banners (Large-Format Printing)

On this printer, large-format printing of up to 18.0 m is available using rolls. If you use Print Plug-In for Office or PosterArtist, you can easily print maximum 18.0 m vertical or horizontal banners. (Refer to "Print Plug-In for Office features →P.303" and "Using PosterArtist to Compose Originals →P.36".) However, you may not be able to print 18.0 m due to restrictions in the settable document size according to the application software.

#### Fit Roll Paper Width

To match the width of vertical and horizontal banners with the width of rolls, use the printer driver function for automatically enlarging/reducing and printing. For example, if you automatically enlarge a document created with application software such as Microsoft Word, you can print the full width of the roll easily.

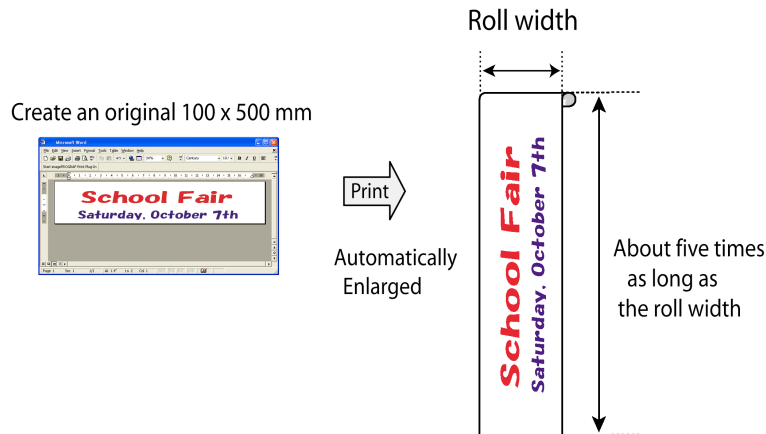

For instructions on printing vertical or horizontal banners, refer to the following topics, as appropriate for your computer and operating system.

- Printing Vertical or Horizontal Banners (Large-Format Printing; Windows) →P.121
- Printing Vertical or Horizontal Banners (Large-Format Printing; Mac OS X) →P.126



#### Important

- Before printing, check how much of the roll paper is left. If you have activated automatic detection of the remaining roll paper, a warning message is displayed when there is not enough roll paper left.
- If not much ink is left, prepare replacement ink tanks.
- To print at a higher level of quality, in the printer driver, choose **High** or **Highest** in Print Quality, and choose **Unidirectional Printing** as the direction of printing.

## Printing Vertical or Horizontal Banners (Large-Format Printing; Windows)

By automatic enlargement of a document created with an application software by the printer driver, you can print maximum 18.0 m vertical or horizontal banners.

However, you may not be able to print 18.0 m due to restrictions in the settable document size according to the application software.

This topic describes how to print a banner about five times as long as the roll width based on the following example.

- Document: A horizontal banner created in Microsoft Word
- Page size: Non-standard (100×500 mm [3.9×19.7 in])
- Paper: Roll
- Paper type: Plain Paper
- Roll paper width: 16 in (406.4 mm)

The print procedure is as follows.

1. Register a Custom Paper Size in the printer driver.  
Call a non-standard paper size registered in the printer driver with Custom Paper Size.  
Once you register Custom Paper Size, you then can select it repeatedly from the paper size list.  
Custom Paper Size can be set up to 18.0 m.
2. In the application, create an original in the size you registered.
3. Print the banner, using the settings that correspond to banners.

### Registering a Custom Paper Size

This example describes how to register a paper size that is horizontally elongated and suitable for banners in either horizontal or vertical format.

1. Display the printer driver dialog box. (See "Accessing the Printer Driver Dialog Box from the Operating System Menu(Windows) →P.218 ")

**2.** Click the **Page Setup** tab to display the **Page Setup** sheet.

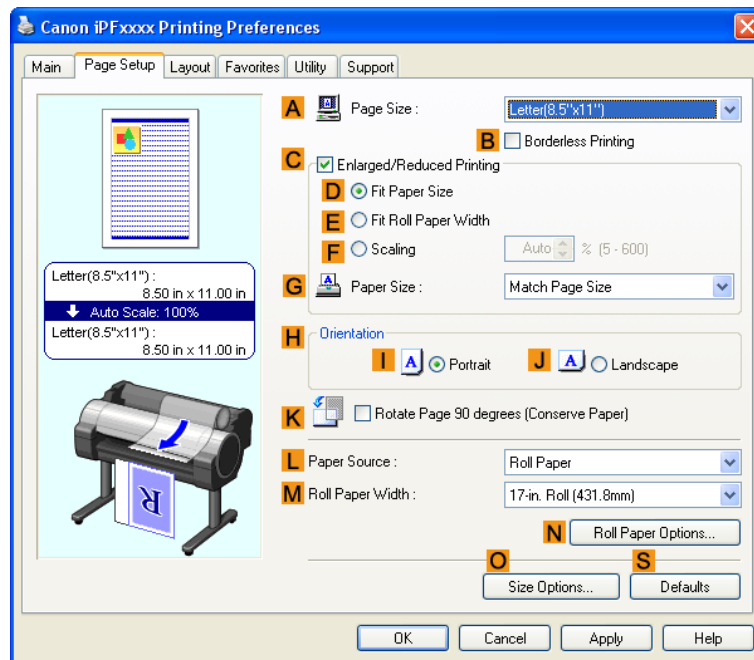

**3.** Select and click a roll paper in the **L Paper Source** list.

**4.** Click **O Size Options** to display the **Paper Size Options** dialog box.

**5.** Enter a desired paper name in **Custom Paper Size Name**. **My Horizontal Banner** is used in this example.

**6.** In **Units**, click **mm**.

**7.** Under **Paper Size**, enter **100** in **Width** and **500** in **Height**.

**8.** Click **Add** to add the paper size of **My Horizontal Banner**.

**9.** Click **OK** to close the **Paper Size Options** dialog box.

**10.** Close the printer driver dialog box.



**Note**

- Although you can even set **Custom Size** for the paper size, the maximum settable size is 3.2 m. The setting of **Custom Size** is disabled when you exit the application software. For more information, see "Printing on Non-Standard Paper Sizes (Windows) →P.131 "



## Creating the banner in the application

Follow the steps below to create the banner in Microsoft Word using the Custom Paper Size you registered.

1. Start Microsoft Word.
2. Choose **Page Setup** from the **File** menu to display the **Page Setup** dialog box.
3. Under **Paper Size**, click the Custom Paper Size you registered—**My Horizontal Banner** in this example.



### Important

- If **My Horizontal Banner** is not listed, make sure this printer is selected as the printer to use.
- In applications such as Microsoft PowerPoint that do not enable you to choose registered paper sizes, use the custom paper size setting in **Custom** and specify 100×500 mm (3.9×19.7 in)

4. Set the printing orientation to horizontal.
5. Create the banner.

## Printing the banner

Follow these steps to print the banner using the corresponding banner settings.

1. Choose **Print** in the Microsoft Word menu.
2. Select the printer in the dialog box, and then display the printer driver dialog box. (See "Accessing the Printer Driver Dialog Box from Applications(Windows) →P.217 ")

**3.** Make sure the **Main** sheet is displayed.

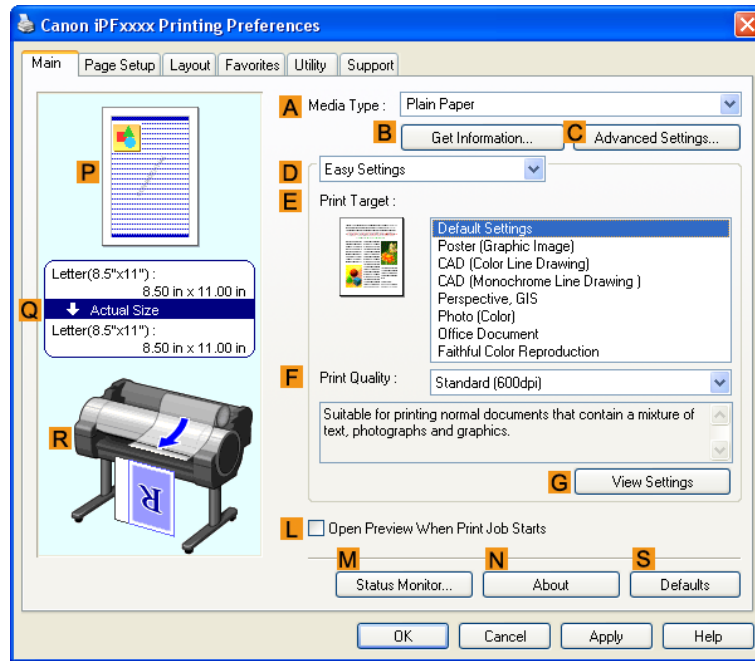

**4.** In the **A Media Type** list, select the type of paper that is loaded. In this case, click Plain Paper.

**5.** After confirming that **D Easy Settings** is selected, click **Poster** in the **E Print Target** list.

**6.** Click the **Page Setup** tab to display the **Page Setup** sheet.

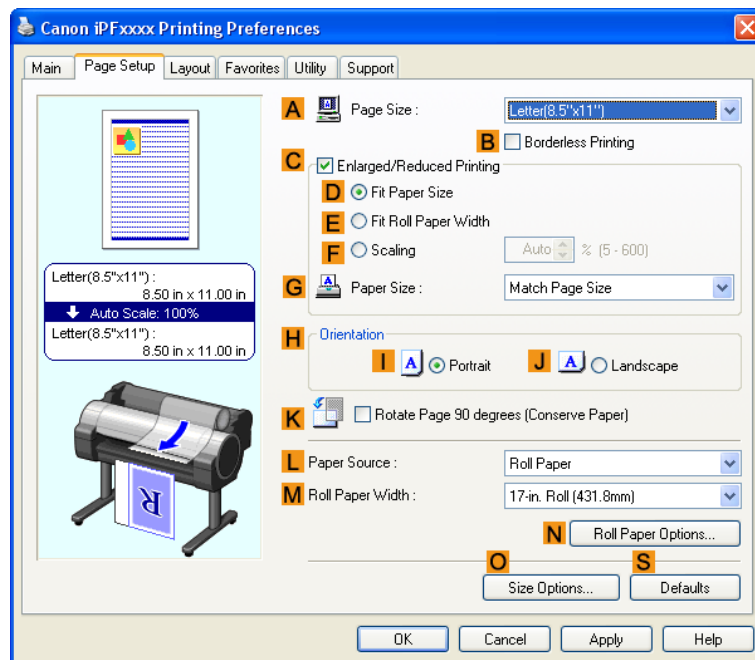

7. In the **A Page Size** list, click the size you registered, **My Horizontal Banner**.

8. Select the **C Enlarged/Reduced Printing** check box.



Note

- If the **C Enlarged/Reduced Printing** check box is not displayed on the **Page Setup** sheet, clear the **B Borderless Printing** check box.

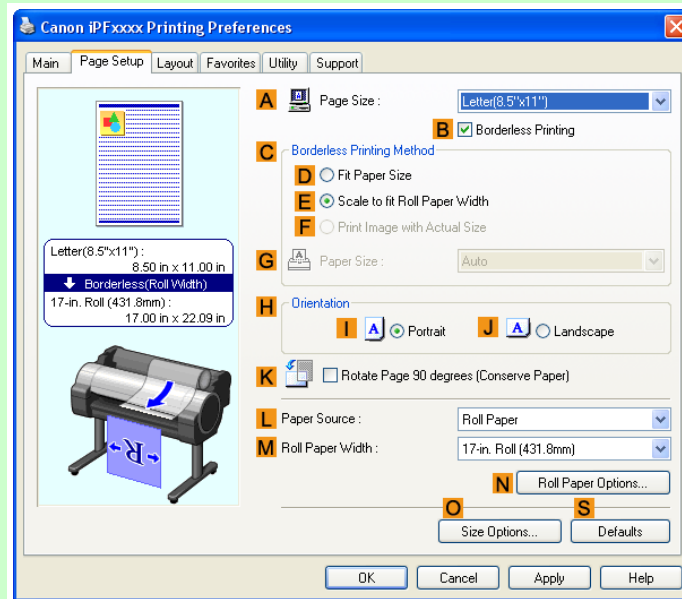

9. Select and click a roll paper in the **L Paper Source** list.

10. After you click **E Fit Roll Paper Width**, the **Information** dialog box is displayed.

11. Select the width of the loaded roll in the **Roll Paper Width** list. In this case, click **16-in. Roll (406.4mm)**, and then click **OK**.

12. Confirm the print settings and print as desired.



Note

- For tips on confirming print settings, see "Confirming Print Settings(Windows) →P.212 "

If printing is unsuccessful, you may be able to print after completing the following setting.

1. On the **Layout** sheet, click **J Special Settings** to display the **Special Settings** dialog box.

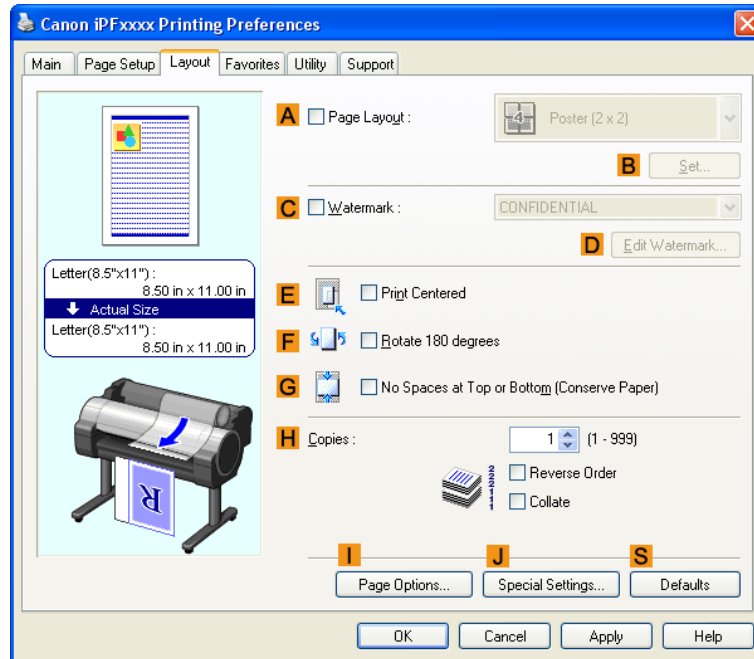

2. In the **FineZoom Settings** list, click **Yes**.

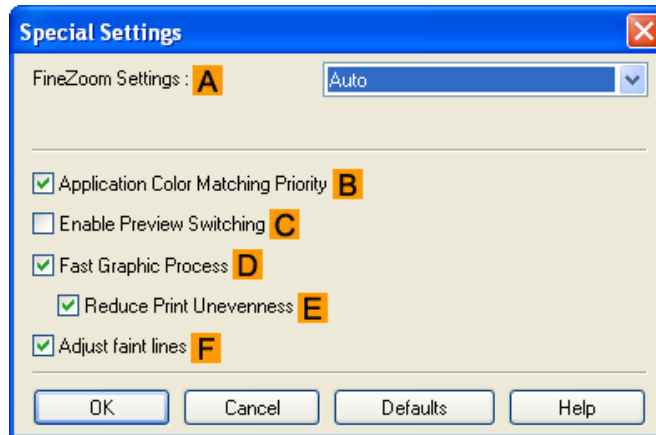

## Printing Vertical or Horizontal Banners (Large-Format Printing; Mac OS X)

By automatic enlargement of a document created with an application software by the printer driver, you can print maximum 18.0 m vertical or horizontal banners.

This topic describes how to print a banner about five times as long as the roll width based on the following example.

- Document: An original designed for a horizontal banner
- Page Size: Non-standard (100×500 mm [3.9×19.7 in])
- Paper: Roll
- Paper type: Plain Paper
- Roll paper width: 16 inches (406.4 mm)

The print procedure is as follows.

1. In the application, create an original in the format of a horizontal or vertical banner.
2. In **Page Setup**, register **Custom Page Sizes** (Mac OS X 10.3.9–10.5) / **Custom Paper Sizes** (Mac OS X 10.6).  
Once you register **Custom Page Sizes** / **Custom Paper Sizes**, you then can select it repeatedly from the paper size list.  
**Custom Page Sizes** / **Custom Paper Sizes** can be set up to 18.0 m.
3. Print the banner, using the settings that correspond to banners.



**Note**

- The following procedures are based on Mac OS X 10.5. The method of setting up non-standard paper sizes varies depending on the version of Mac OS X.

## Register a Custom Page Sizes

This example describes how to register and print using a page size that is horizontally elongated and suitable for banners in either horizontal or vertical format.

1. Create the document in the application.
2. Choose **Print** in the application menu.

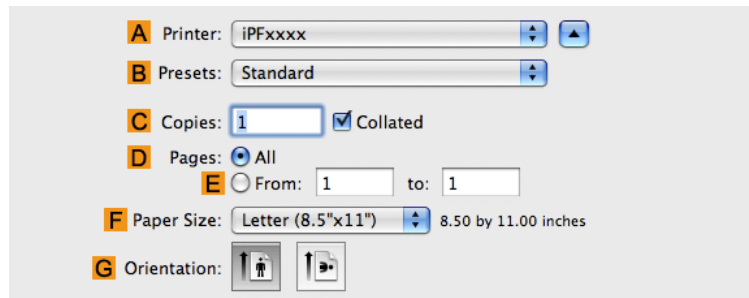

3. Select the printer in the **A Printer** list.

- Click **Manage Custom Sizes** in the **F Paper Size** list to display the **Custom Page Sizes** dialog box.

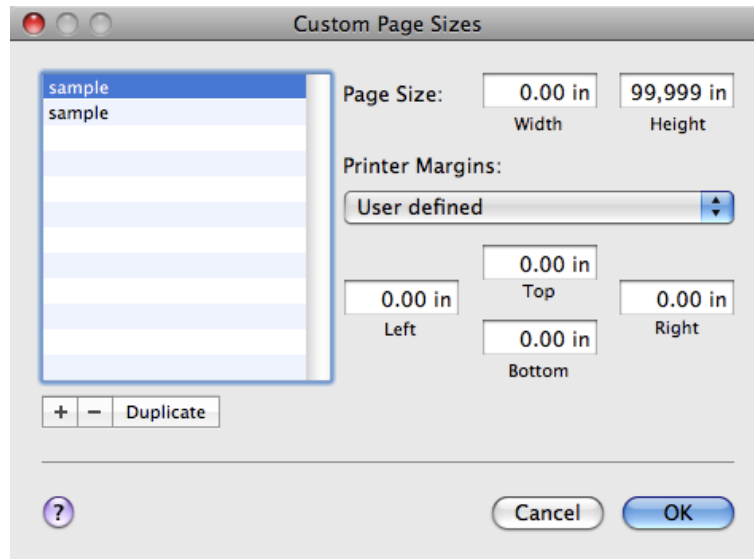

- Double-click **Untitled** in the list at left, and then enter a name for the page size you want to register. Here, enter **100\*500**.  
If the **Untitled** size is not listed at left, click + below the list.

- Under **Page Size**, enter **10** in **Width** and **50** in **Height**. Here, measurements are entered in centimeters.

- Specify the margins by entering **0.3** in **Printer Margins**. Here, too, measurements are entered in centimeters.

- Click **OK** to close the **Custom Page Sizes** dialog box.

- In the **F Paper Size** list, click the size of the original. In this case, click **100\*500**, the size you registered.

- In **G Orientation**, click the icon of the document in landscape orientation.

- Click **OK** to close the dialog box.

### Print the banner

Follow the steps below to print the banner using the corresponding banner settings.

- Choose **Print** in the application menu.

2. Access the **Main** pane.

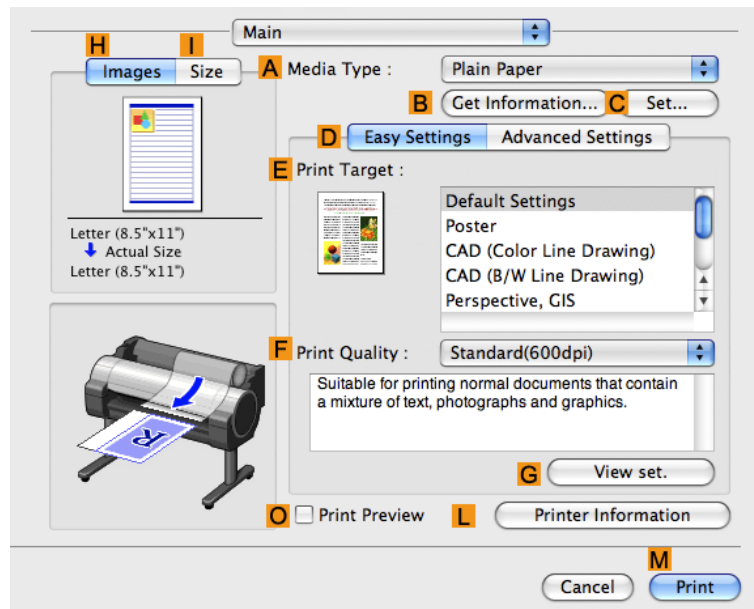

3. In the **A Media Type** list, select the type of paper that is loaded. In this case, click Plain Paper.

4. Make your selection in the **E Print Target** list.

5. Make your selection in the **F Print Quality** list.

6. Access the **Page Setup** pane.

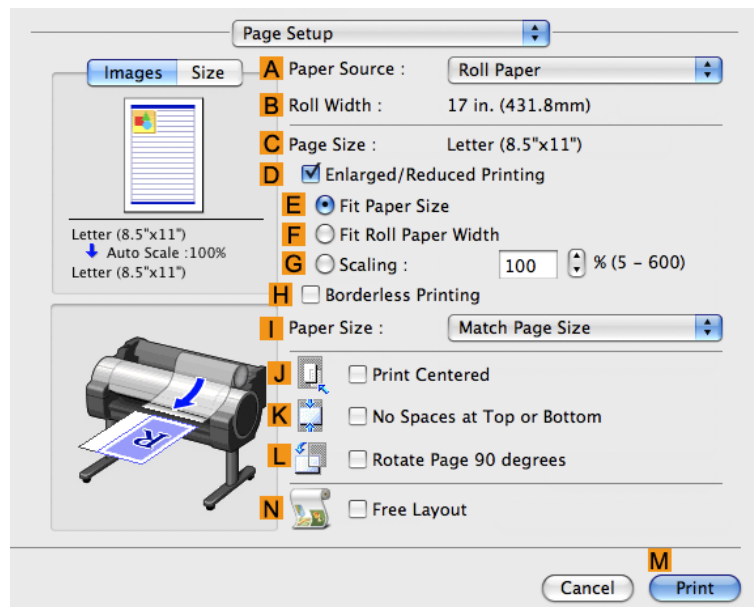

7. Select and click a roll paper in the **A Paper Source** list.
8. Make sure the width of the loaded roll is displayed in the **B Roll Width** list—in this case, **16 in. (406.4mm)**.



**Note**

- If the width of the loaded roll is not displayed in **B Roll Width**, click **L Printer Information** on the **Main** pane and update the printer information.

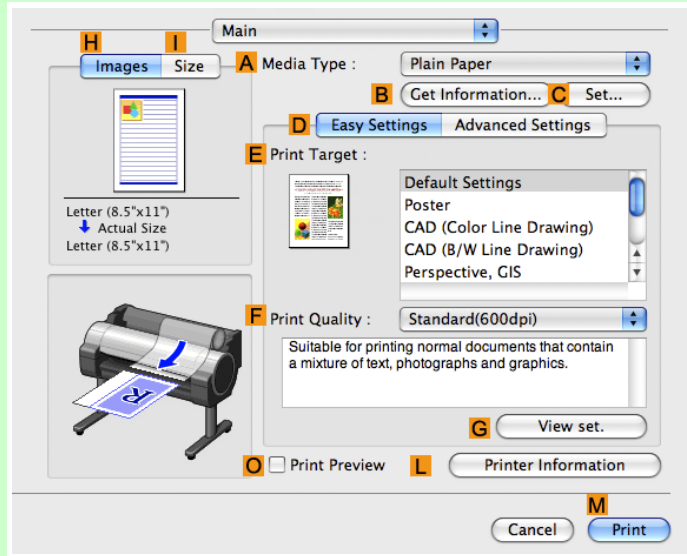

9. In **C Page Size**, make sure **100\*500** is displayed, as registered in **Page Setup**.

10. Select the **D Enlarged/Reduced Printing** check box.

11. Click **F Fit Roll Paper Width**.

12. Confirm the print settings, and click **M Print** to start printing.



**Note**

- For tips on confirming print settings, see "Confirming Print Settings(Mac OS X) →P.436 "

## Printing on Non-Standard Paper Sizes

For printing on non-standard size paper, first register the paper size in the printer driver. Once you register a paper size, you then can select it repeatedly from the paper size list. The paper size can be set up to 18.0 m.



**Note**

- In Windows, although you can even set **Custom Size** for the paper size, the maximum settable size is 3.2 m. The setting of **Custom Size** is disabled when you exit the application software.



For instructions on specifying non-standard paper sizes for printing, refer to the following topics, as appropriate for your computer and operating system.

- Printing on Non-Standard Paper Sizes (Windows) →P.131
- Printing on Non-Standard Paper Sizes (Mac OS X) →P.135

## Printing on Non-Standard Paper Sizes (Windows)

For printing on non-standard size paper, first register the paper size in the printer driver. Call a non-standard paper size registered in the printer driver with Custom Paper Size. Once you register Custom Paper Size, you then can select it repeatedly from the paper size list. Custom Paper Size can be set up to 18.0 m.



### Note

- Although you also can set **Custom Size** for the paper size temporarily, the maximum settable size is 3.2 m. Also, the setting of **Custom Size** is disabled when you exit the application software.

2

## Registering and Printing With a Custom Paper Size

This topic describes how to register a non-standard paper size by the name of **430 mm Square** and print based on the following example.

- Document: Any Type
- Page Size: A square sheet (430 × 430 mm [16.9 × 16.9 in])
- Paper: Sheets
- Media Type: Any type
- Paper Size: A square sheet (430 × 430 mm [16.9 × 16.9 in])

1. Load the square paper (430 × 430 mm [16.9 × 16.9 in]) in the printer.
2. Choose **Print** in the application menu.
3. Select the printer in the dialog box, and then display the printer driver dialog box. (See "Accessing the Printer Driver Dialog Box from Applications(Windows) →P.217 ")

4. Make sure the **Main** sheet is displayed.

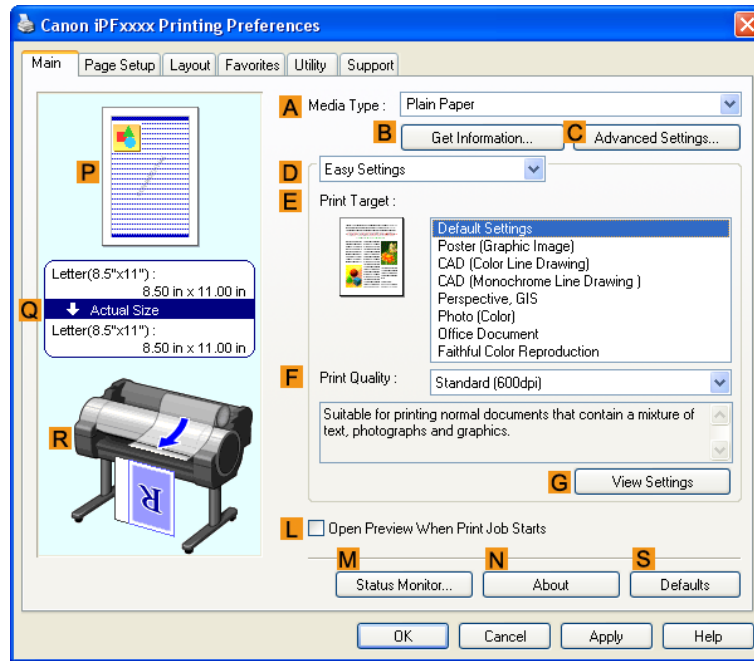

5. In the **A Media Type** list, select the type of paper that is loaded.
6. After confirming that **D Easy Settings** is selected, select from the **E Print Target** list.
7. Click the **Page Setup** tab to display the **Page Setup** sheet.

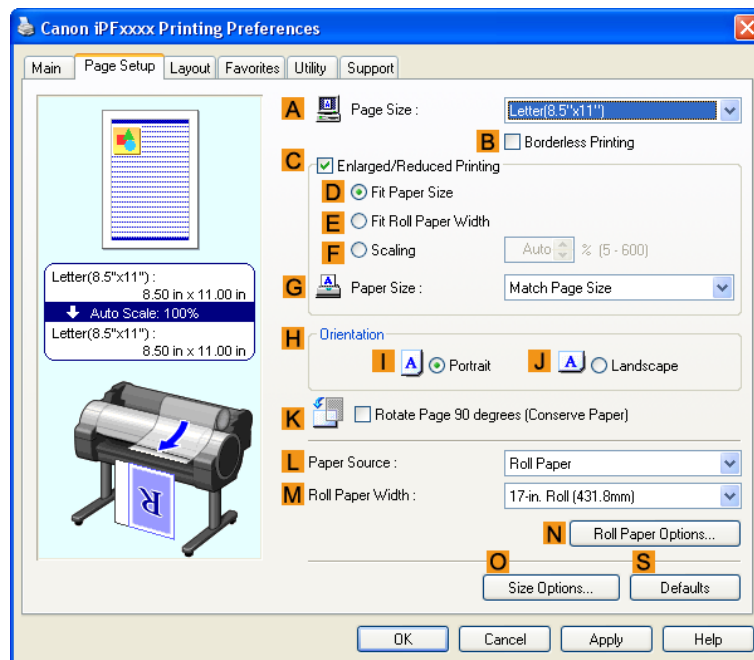

2

132

8. Click **Size Options** to display the **Paper Size Options** dialog box.
9. Enter a desired paper name in **Custom Paper Size Name**. **430 mm Square** is used in this example.
10. Select **mm** in **Units**.
11. Enter **430** (16.9 in) in both **Width** and **Height**.

**Note**

- If you select the **Fix the Ratio of the Width to Height** check box, after you enter a value in either **Width** or **Height**, the other value will be automatically applied based on the original aspect ratio.

12. Click **Add** to register **430 mm Square**.
13. Click **OK** to close the **Paper Size Options** dialog box.
14. Click **Cut Sheet** in the **Paper Source** list.
15. In the **Page Size** list, click the size you added, **430 mm Square**.
16. Confirm the print settings and print as desired.

**Note**

- For tips on confirming print settings, see "Confirming Print Settings(Windows) →P.212 "

### Printing by using **Custom Size**

This section describes how to print using **Custom Size** based on the following example.

- Document: Any Type
- Page size: Square of non-standard dimensions (430×430 mm [16.9×16.9 in])
- Paper: Sheets
- Paper type: Any type
- Paper Size: A square sheet (430 × 430 mm [16.9 × 16.9 in])

1. Load the square paper (430 × 430 mm [16.9 × 16.9 in]) in the printer.
2. Choose **Print** in the application menu.
3. Select the printer in the dialog box, and then display the printer driver dialog box.(See "Accessing the Printer Driver Dialog Box from Applications(Windows) →P.217 ")

4. Make sure the **Main** sheet is displayed.

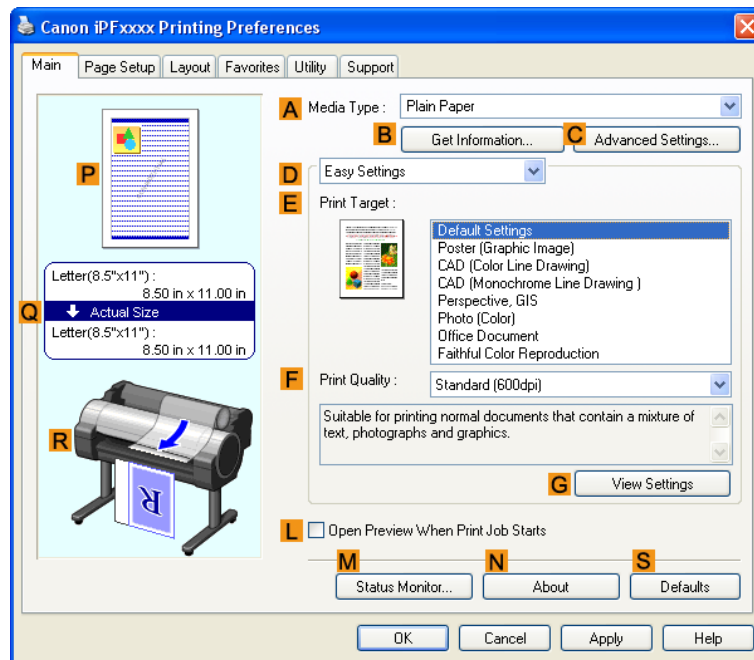

5. In the **A Media Type** list, select the type of paper that is loaded.

6. After confirming that **D Easy Settings** is selected, select from the **E Print Target** list.

7. Click the **Page Setup** tab to display the **Page Setup** sheet.

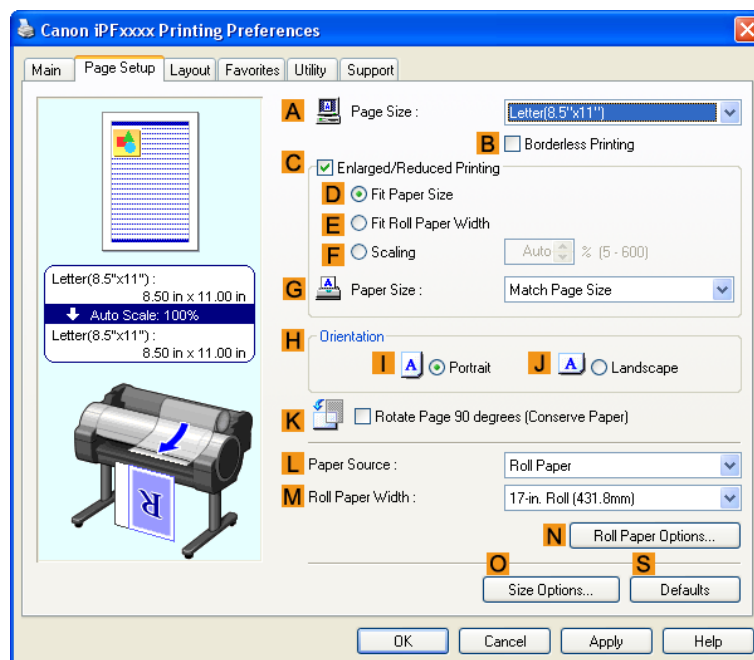

8. Click **Manual** in the **L Paper Source** list.
9. Click **Custom Size** in the **A Page Size** list to display the **Custom Size Settings** dialog box.
10. Confirm that **mm** is selected in **Units**.
11. Enter **430** (16.9 in) in both **Width** and **Height**.
12. Click **OK** to close the **Custom Size Settings** dialog box.
13. Confirm the print settings and print as desired.

**Note**

- For tips on confirming print settings, see "Confirming Print Settings(Windows) →P.212 "

## Printing on Non-Standard Paper Sizes (Mac OS X)

For printing on non-standard size paper, first register the paper size in the printer driver.

Call a non-standard paper size registered in the printer driver with **Custom Page Sizes** (Mac OS X 10.3.9-10.5)/ **Custom Paper Sizes** (Mac OS X 10.6).

Once you register **Custom Page Sizes** / **Custom Paper Sizes**, you then can select it repeatedly from the paper size list. **Custom Page Sizes** / **Custom Paper Sizes** can be set up to 18.0 m.

This topic describes how to register a non-standard paper size by the name of **430\*430** and print based on the following example.

- Document: Any Type
- Page Size: A square sheet (430 × 430 mm [16.9 × 16.9 in])
- Paper: Sheets
- Media Type: Any type
- Paper Size: A square sheet (430 × 430 mm [16.9 × 16.9 in])

**Note**

- The following procedures are based on Mac OS X 10.5. The method of setting up non-standard paper sizes varies depending on the version of Mac OS X.

1. Create the document in the application.
2. Load the square paper (430 × 430 mm [16.9 × 16.9 in]) in the printer.

**3.** Choose **Print** in the application menu.

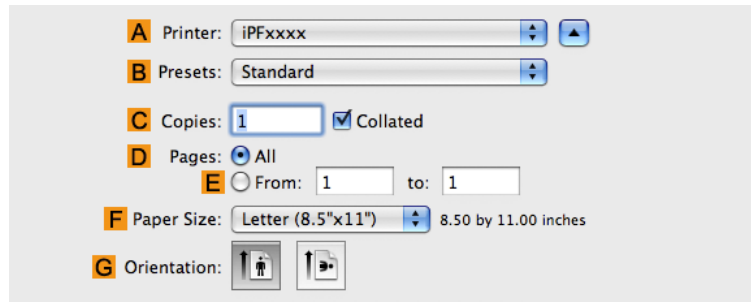

**4.** Select the printer in the **A Printer** list.

**5.** Click **Manage Custom Sizes** in the **F Paper Size** list to display the **Custom Page Sizes** dialog box.

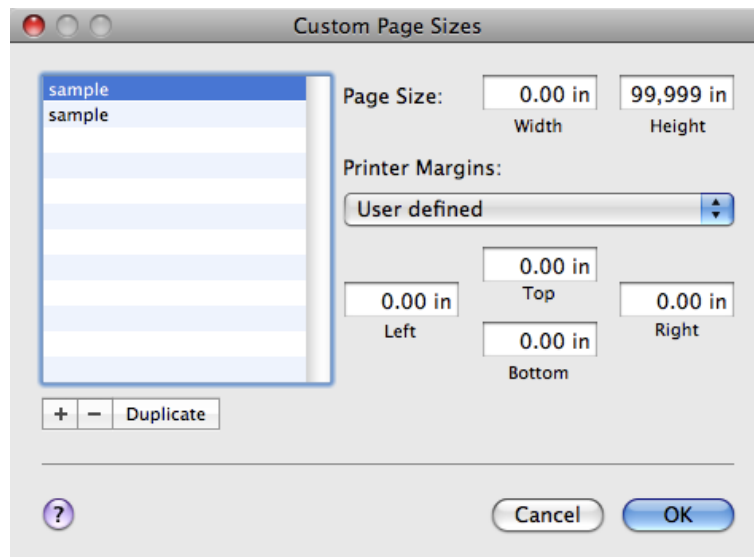

**6.** In **Page Size**, enter the height and width of the original. Here, enter **43.00 cm** in **Height** and **Width**.

**7.** In **Printer Margins**, enter **0.5** for the top and side margins and **2.3** for the bottom margin. Here, measurements are entered in centimeters.

**8.** Double-click **Untitled** in the list at left in the **Custom Page Sizes** dialog box and enter the paper name—in this case, **430\*430**.

**9.** Click **OK** to close the **Custom Page Sizes** dialog box.

**10.** In the **F Paper Size** list, click the size of the original. In this case, click **430\*430**, the size you registered.

2

136

**11.** If you configured the settings using the **Page Attributes** dialog box, click **OK** to close the dialog box, and then select **Print** from the application software menu.

**12.** Access the **Main** pane.

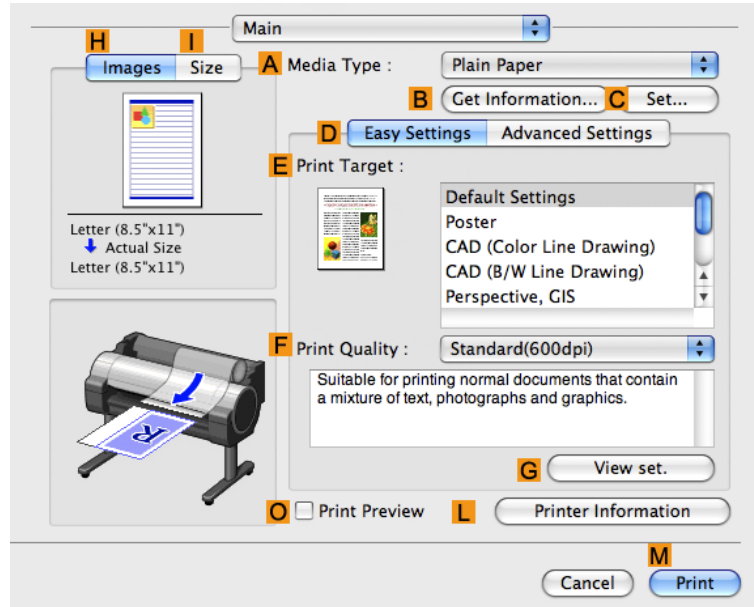

**13.** In the **A Media Type** list, select the type of paper that is loaded.

**14.** After confirming that **D Easy Settings** is selected, select from the **E Print Target** list.

**15.** Make your selection in the **F Print Quality** list.

**16.** Access the **Page Setup** pane.

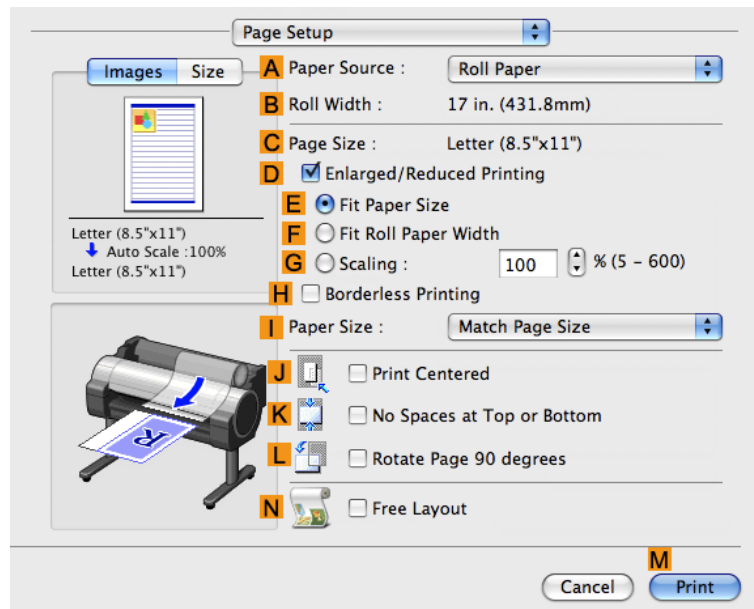

2

**17.** Click **Cut Sheet** in the **A Paper Source** list.

**18.** In **C Page Size**, make sure **430\*430** is displayed, as registered in **Page Setup**.

**19.** Confirm the print settings, and then click **M Print** to start printing.

 **Note**  
• For tips on confirming print settings, see "Confirming Print Settings(Mac OS X) →P.436 "



## Tiling and multiple pages per sheet

Printing Multiple Originals Next to Each Other .....	139
Printing Multiple Originals Next to Each Other (Windows) .....	140
Printing Multiple Originals Next to Each Other (Mac OS X) .....	142
Printing Multiple Pages Continuously .....	144
Printing Multiple Pages Continuously (Windows) .....	145
Printing Multiple Pages Continuously (Mac OS X) .....	147
Printing Multiple Pages Per Sheet .....	149
Printing Multiple Pages Per Sheet (Windows) .....	150
Printing Multiple Pages Per Sheet (Mac OS X) .....	153
Printing Posters in Sections .....	157
Printing Large Posters (Windows) .....	158

## Printing Multiple Originals Next to Each Other

By arranging originals from word-processing or spreadsheet programs or web browser screen shots next to each other on single sheets, you can create highly expressive presentation materials, easy-to-understand meeting materials, and a variety of other printed documents.

### • Free Layout (Windows)

Besides combining multiple pages in a single-page layout, you can combine originals from multiple files—even multiple source applications—in a single-page layout.

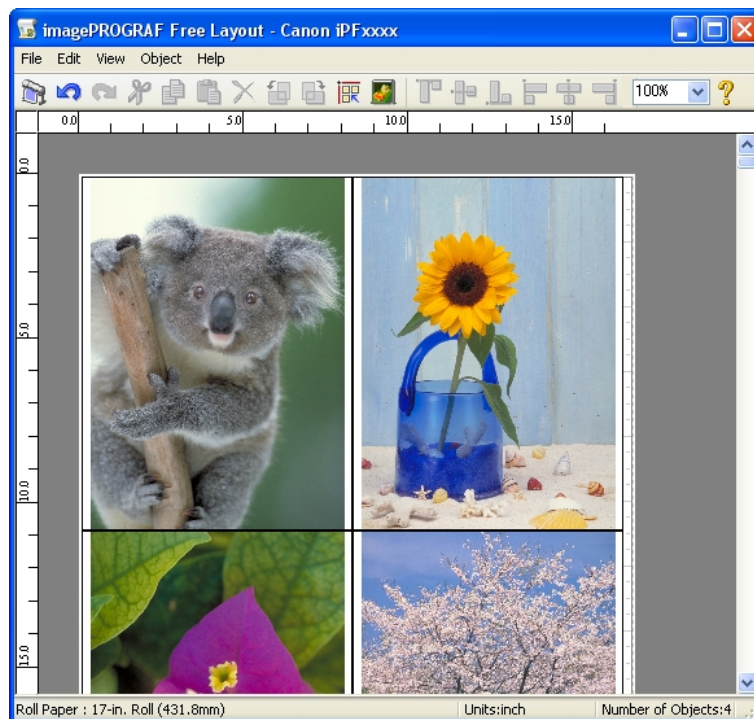

### Note

- Free Layout cannot be used in 64-bit version of Windows.

• **imagePROGRAF Free Layout (Macintosh)**

Besides combining multiple pages in a single-page layout, you can combine originals from multiple files—even multiple source applications—in a single-page layout.

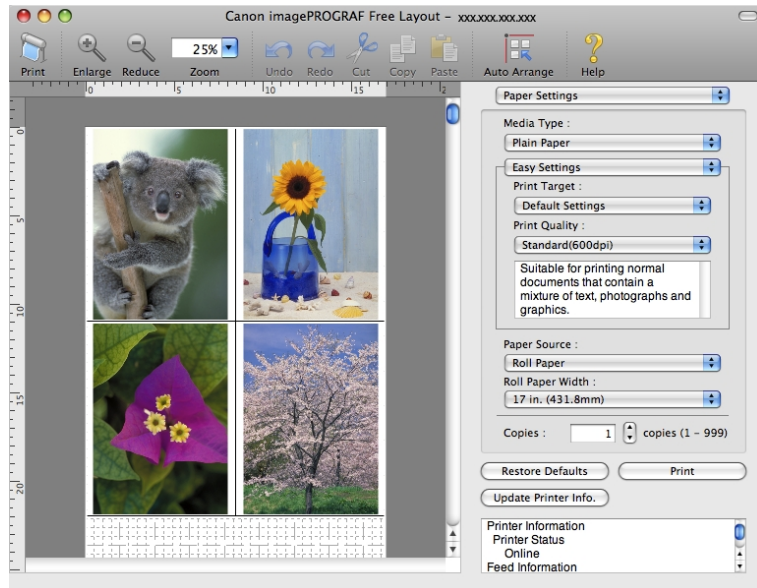

For instructions on arranging originals from multiple applications, refer to the following topics.

- Printing Multiple Originals Next to Each Other (Windows) →P.140
- Printing Multiple Originals Next to Each Other (Mac OS X) →P.142

## Printing Multiple Originals Next to Each Other (Windows)

This topic describes how to arrange multiple originals using the Free Layout function.



**Note**

- Free Layout cannot be used in 64-bit version of Windows.

1. Choose **Print** in the application menu.
2. Select the printer in the dialog box, and then display the printer driver dialog box.(See "Accessing the Printer Driver Dialog Box from Applications(Windows) →P.217 ")

3. Make sure the **Main** sheet is displayed.

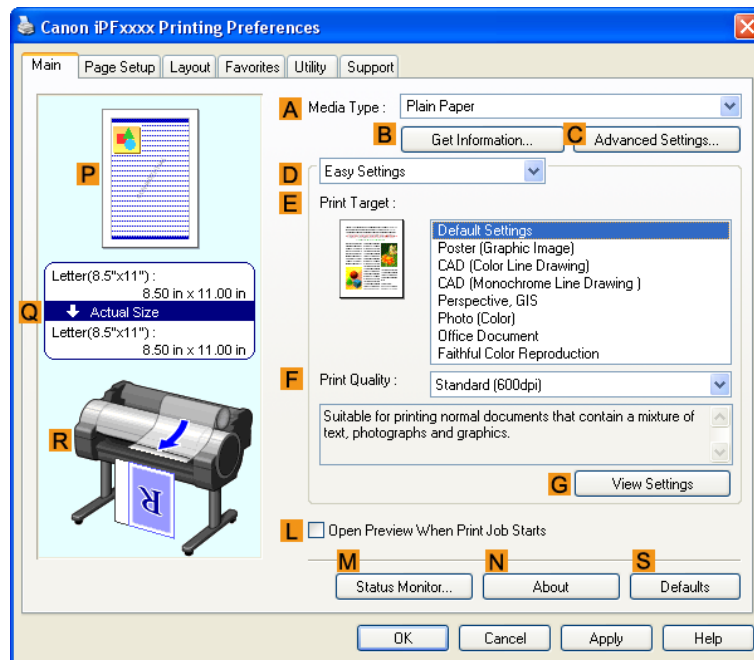

4. Click the **Layout** tab to display the **Layout** sheet.

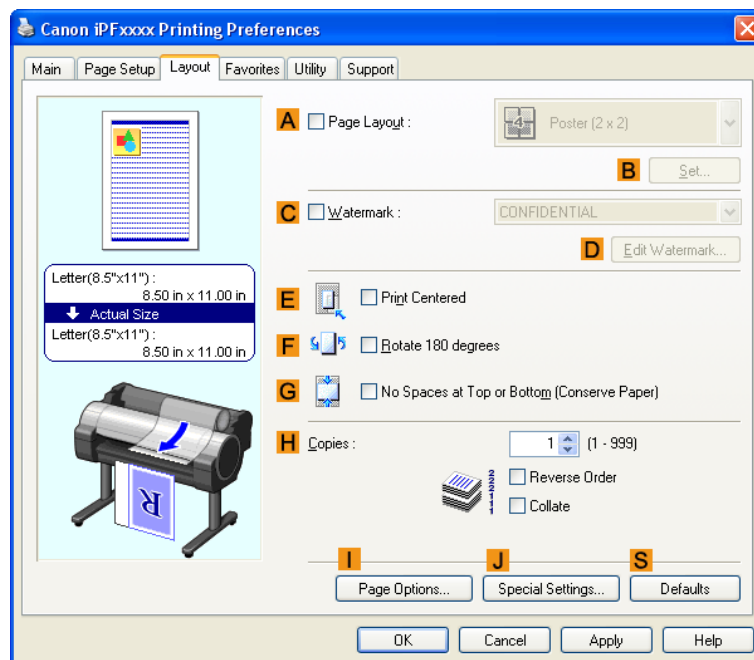

5. Select the **A Page Layout** check box.

6. Click **Free Layout** in the **A Page Layout** list.

7. When you attempt to print, the imagePROGRAF Free Layout window is displayed. (At this point, the document will not be printed yet.)

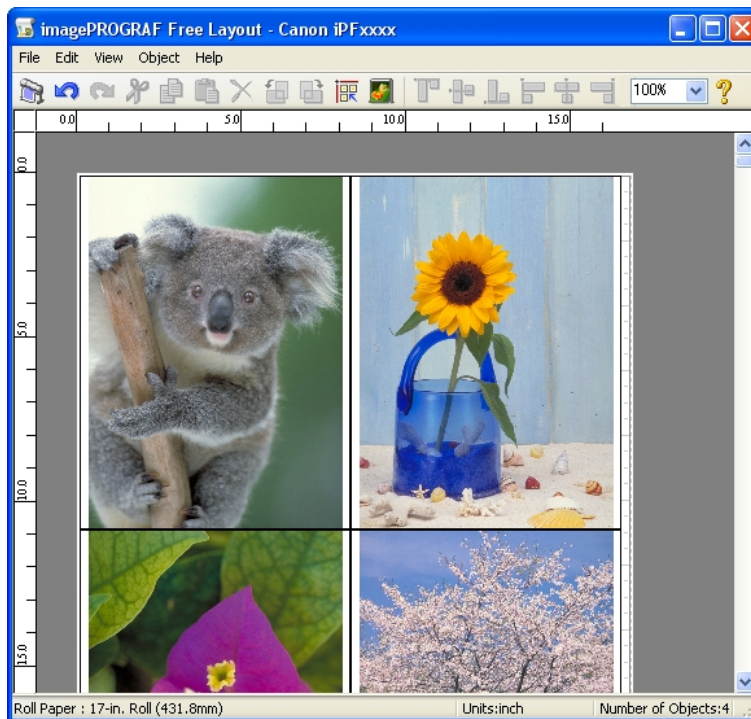

8. Edit and rearrange the image in the imagePROGRAF Free Layout window as desired.



**Note**

- Without closing the imagePROGRAF Free Layout window, repeat steps 1–7 to arrange originals from multiple applications on the same page.
- For instructions on editing and rearranging images, refer to the imagePROGRAF Free Layout help topic.

9. Print from the imagePROGRAF Free Layout menu.



**Note**

- For details on imagePROGRAF Free Layout functions, refer to **Free Layout** →P.259 .

## Printing Multiple Originals Next to Each Other (Mac OS X)

This topic describes how to use the **Free Layout** function to arrange multiple originals next to each other before printing.

1. Choose **Print** in the application menu.

## 2. Access the **Page Setup** pane.

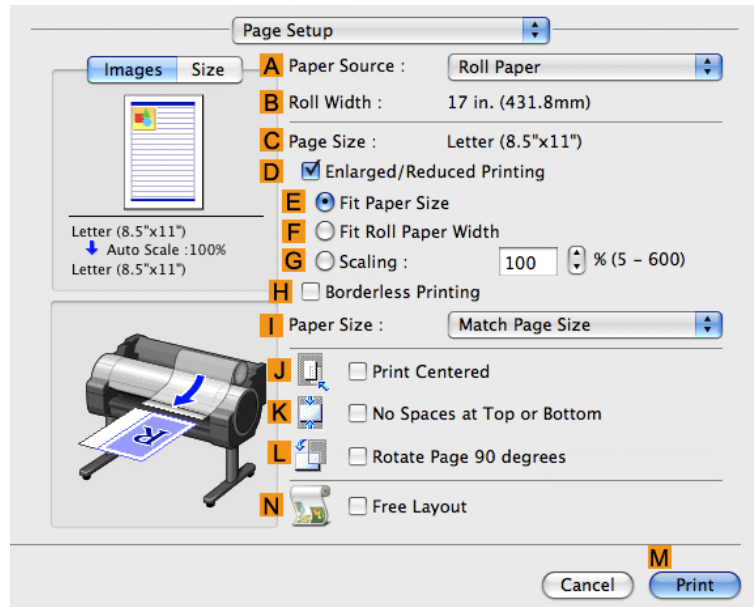

## 3. Select the **N Free Layout** check box.

## 4. Click **M Print**.

## 5. The **Canon imagePROGRAF Free Layout** window is displayed.

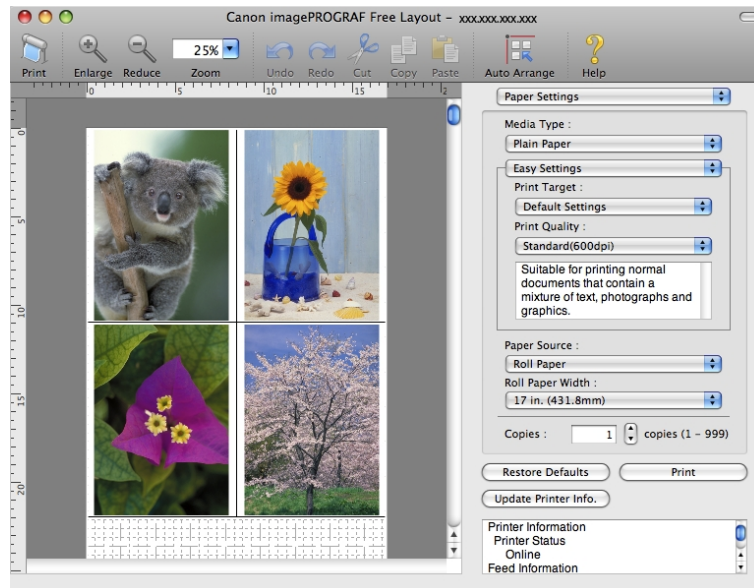

**6.** Edit and rearrange the image in the **Canon imagePROGRAF Free Layout** window as desired.



**Note**

- Without closing the **Canon imagePROGRAF Free Layout** window, repeat steps 1 to 4 to arrange originals from multiple applications on the same page.
- For instructions on editing and rearranging images, refer to the **Canon imagePROGRAF Free Layout** help topic.

**7.** Print from the **Canon imagePROGRAF Free Layout** menu.



**Note**

- For details on **Canon imagePROGRAF Free Layout** functions, refer to Free Layout →P.486 .

## Printing Multiple Pages Continuously

You can print multiple pages as a single continuous image, without margins between pages.

- Roll paper (banner)

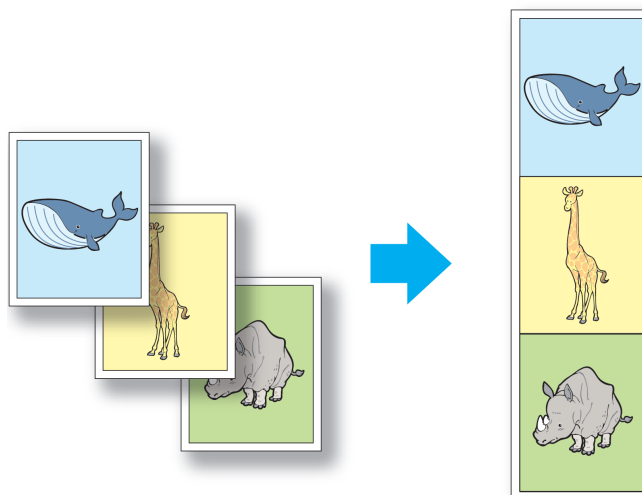

**Important**

- This feature is only available with rolls. It cannot be used when printing on sheets.
- During banner printing, settings for conserving paper, number of copies, borderless printing, enlargement or reduction, and other layout-related settings are disregarded.

For instructions on borderless printing of photos and images at actual size, refer to the following topics, as appropriate for your computer and operating system.

- Printing Multiple Pages Continuously (Windows) →P.145
- Printing Multiple Pages Continuously (Mac OS X) →P.147

## Printing Multiple Pages Continuously (Windows)

This topic describes how to print multiple pages as a single continuous image, without margins between pages.



### Important

- This feature is only available with rolls. It cannot be used when printing on sheets.
- During banner printing, settings for conserving paper, number of copies, borderless printing, enlargement or reduction, and other layout-related settings are disregarded.

1. Choose **Print** in the application menu.
2. Select the printer in the dialog box, and then display the printer driver dialog box. (See "Accessing the Printer Driver Dialog Box from Applications(Windows) →P.217 ")
3. Make sure the **Main** sheet is displayed.

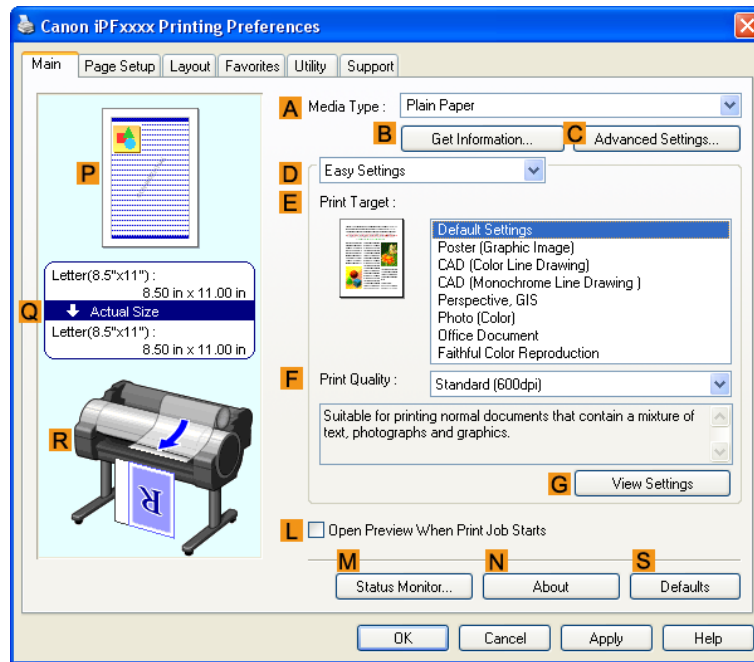

4. In the **A Media Type** list, click the type of paper that is loaded.



5. Click the **Page Setup** tab to display the **Page Setup** sheet.

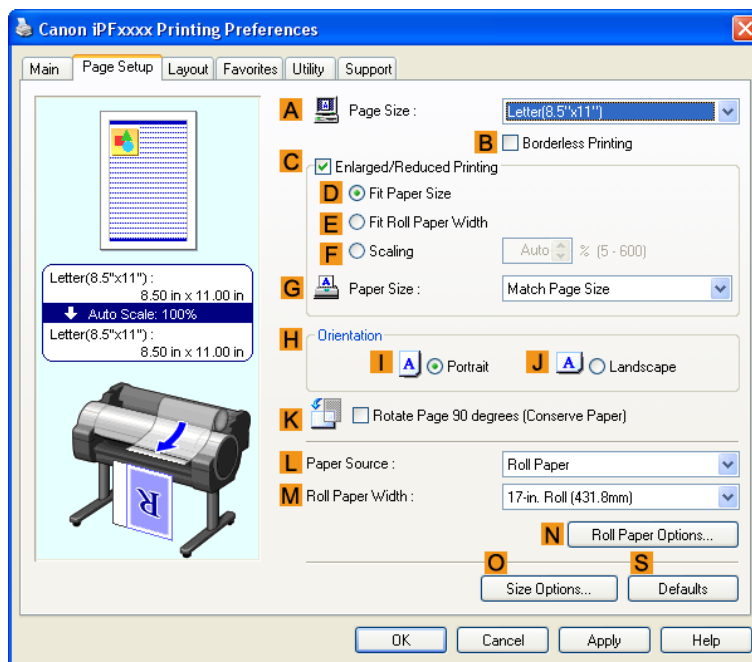

6. Select and click a roll paper in the **L Paper Source** list.

7. Click **N Roll Paper Options** to display the **Roll Paper Options** dialog box.

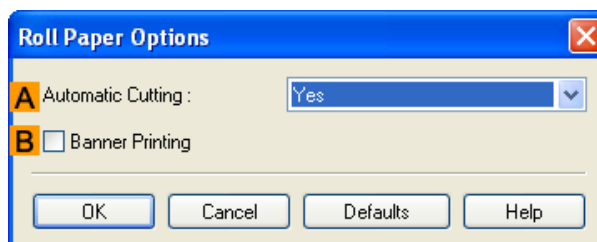

8. Select the **B Banner Printing** check box.

9. Click **OK**.

10. Confirm the print settings and print as desired.

**Note**  
 • For tips on confirming print settings, see "Confirming Print Settings(Windows) →P.212 "

2

146



## Printing Multiple Pages Continuously (Mac OS X)

This topic describes how to print multiple pages as a single continuous image, without margins between pages.



### Important

- This feature is only available with rolls. It cannot be used when printing on sheets.
- During banner printing, settings for conserving paper, number of copies, borderless printing, enlargement or reduction, and other layout-related settings are disregarded.

1. This sets the **B Format for** and **C Paper Size**.



### Note

- The configuration method varies depending on the OS and application software you are using. If **Page Setup** is displayed in the application menu, the settings are configured by opening the **Page Attributes** dialog box from **Page Setup**.

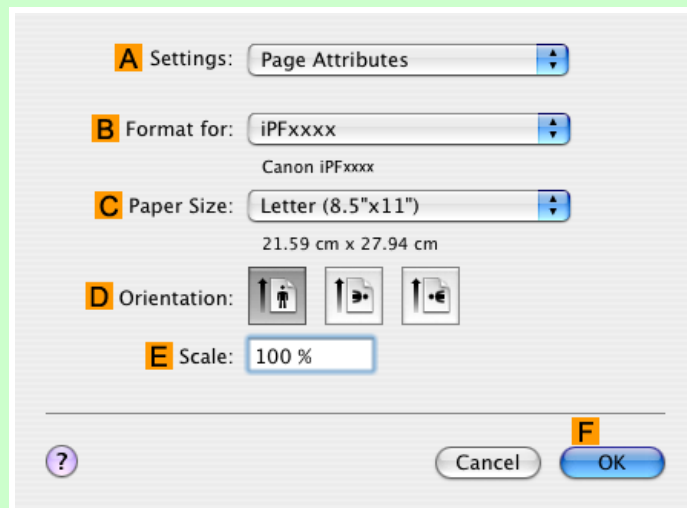

If it is not displayed, the settings are configured in the upper part of the printer driver displayed when you select **Print** from the application software menu.

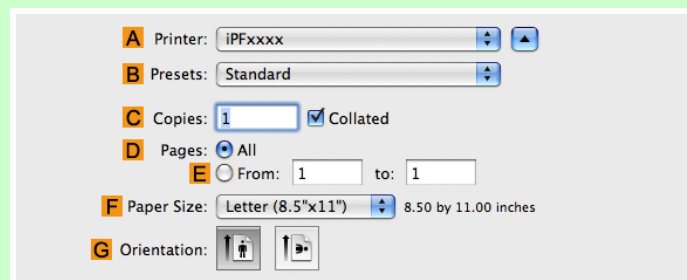

2. Select the printer in the **A Printer** list.
3. Click the original size in the **F Paper Size** list.

4. If you configured the settings using the **Page Attributes** dialog box, click **OK** to close the dialog box, and then select **Print** from the application software menu.

5. Access the **Main** pane.

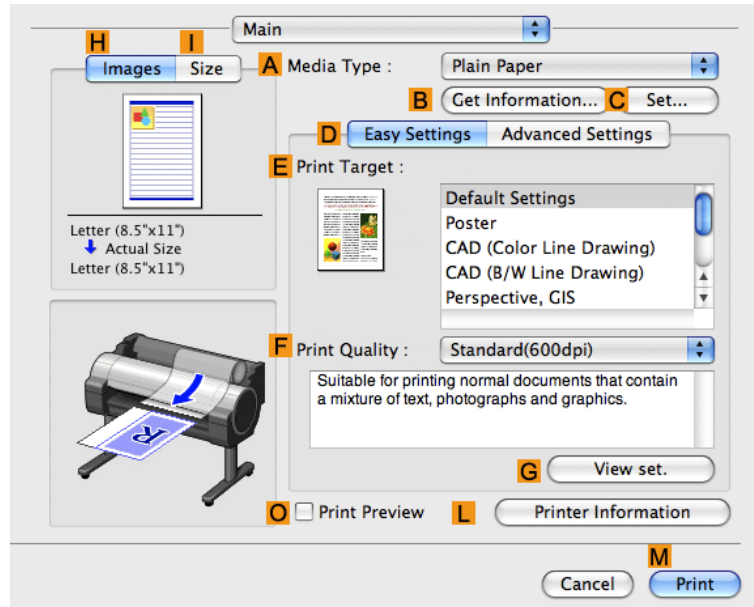

6. In the **A Media Type** list, click the type of paper that is loaded.

7. Make your selection in the **E Print Target** list.

8. Make your selection in the **F Print Quality** list.

2

## 9. Access the **Page Setup** pane.

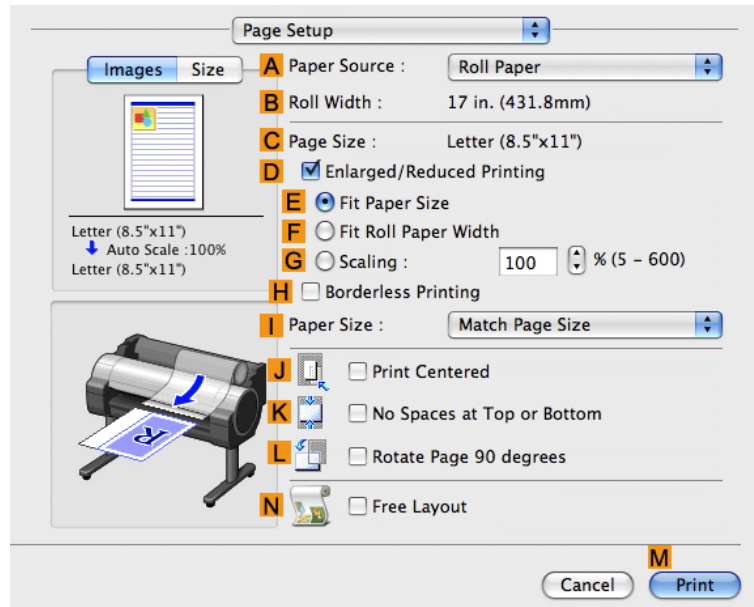

## 10. Click **Roll Paper (Banner)** in the **A Paper Source** list.

## 11. Confirm the print settings, and then click **M Print** to start printing.



### Note

- For tips on confirming print settings, see "Confirming Print Settings(Mac OS X) →P.436 "

## Printing Multiple Pages Per Sheet

To conserve paper, you can print several pages of the original on a single sheet by reducing the original and dividing the sheet into areas for each page.

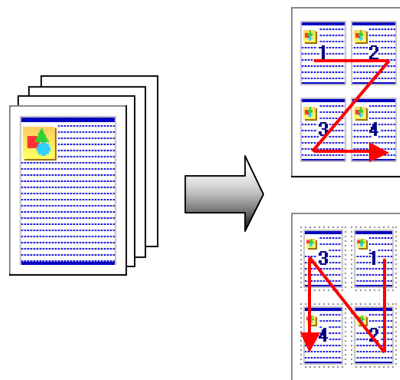

### • Page Layout

Specify a number of pages of the original to print on a single sheet, in a layout of multiple pages per sheet.



#### Important

- This function cannot be combined with the following options.
  - Borderless Printing
  - Scaling Originals (Windows)
  - Banner Printing (Windows)
- When printing using this function, the **Print Centered** setting is disabled.



#### Note

- You can print up to 16 pages of the original on a single sheet.
- You can also change the page layout order and print page boundary lines, as desired.

For instructions on printing multiple pages per sheet, refer to the following topics, as appropriate for your computer and operating system.

- Printing Multiple Pages Per Sheet (Windows) →P.150
- Printing Multiple Pages Per Sheet (Mac OS X) →P.153

## Printing Multiple Pages Per Sheet (Windows)

This topic describes how to print four pages of originals together on a single sheet based on the following example.

- Document: Any Type
- Page size: A3 (297.0×420.0 mm [11.7×16.5 in])
- Paper: Roll
- Paper type: Plain Paper
- Roll paper width: A2/A3 roll (420.0 mm [16.5 in])

1. Choose **Print** in the application menu.
2. Select the printer in the dialog box, and then open the printer driver dialog box.(See "Accessing the Printer Driver Dialog Box from Applications(Windows) →P.217 ")

3. Make sure the **Main** sheet is displayed.

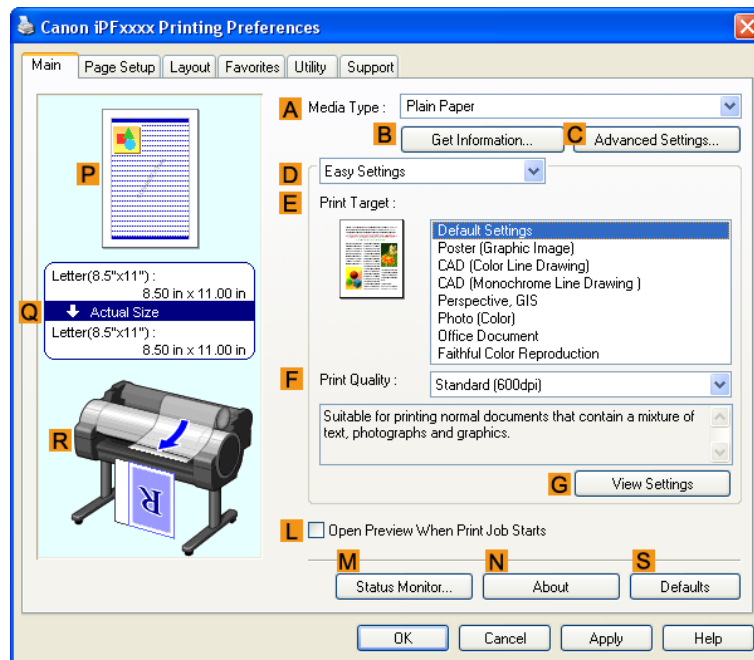

4. In the **A Media Type** list, select the type of paper that is loaded. In this case, click Plain Paper.
5. Make your selection in the **E Print Target** list.
6. Make your selection in the **F Print Quality** list.

7. Click the **Page Setup** tab to display the **Page Setup** sheet.

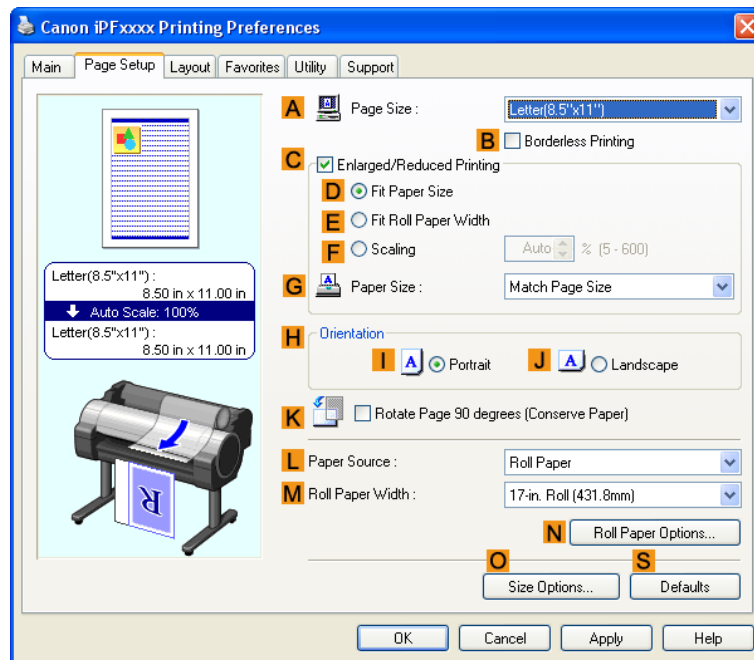

8. In **A** **Page Size**, click the size of the original as specified in the application software. In this case, click **ISO A3** or **Letter (8.5"x11")**.
9. Select and click a roll paper in the **L** **Paper Source** list.
10. Select the width of the loaded roll in the **M** **Roll Paper Width** list—in this case, **ISO A2/A3 Roll (420.0mm)**.

2

**11.** Click the **Layout** tab to display the **Layout** sheet.

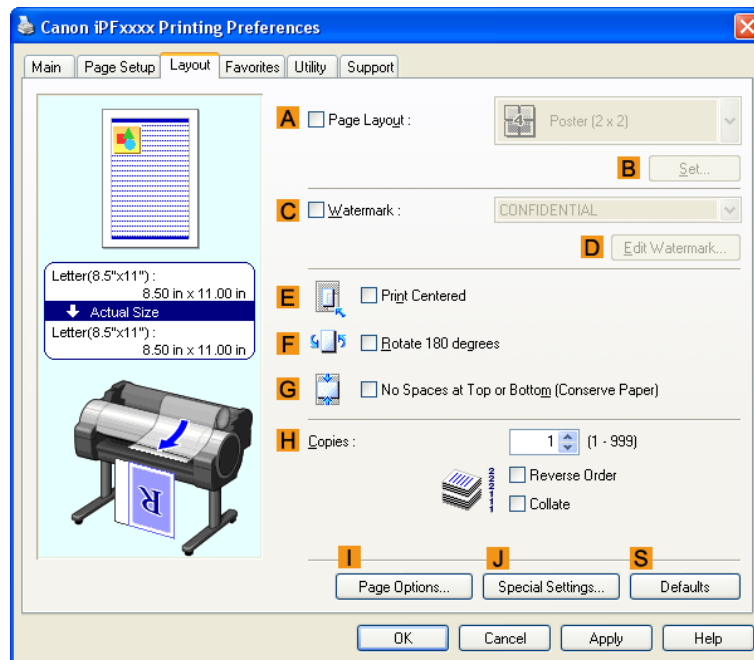

**12.** Select the **A Page Layout** check box.

**13.** Click **4 Pages/Sheet** in the **A Page Layout** list.



**Note**

- You can select the layout order for placing four pages on a sheet and a frame border in the **Page Layout Printing** dialog box by clicking **B Set**.

**14.** Confirm the print settings and print as desired.



**Note**

- For tips on confirming print settings, see "Confirming Print Settings(Windows) →P.212 "

## Printing Multiple Pages Per Sheet (Mac OS X)

This topic describes how to print four pages of an original on a single sheet, based on the following example.

- Document: Any Type
- Page size: A3 (297.0 × 420.0 mm [11.7 × 16.5 in])
- Paper: Roll paper
- Paper type: Plain Paper
- Roll paper width: A2/A3 roll (420.0 mm [16.5 in])

1. This sets the **B Format for** and **C Paper Size**.



**Note**

- The configuration method varies depending on the OS and application software you are using. If **Page Setup** is displayed in the application menu, the settings are configured by opening the **Page Attributes** dialog box from **Page Setup**.

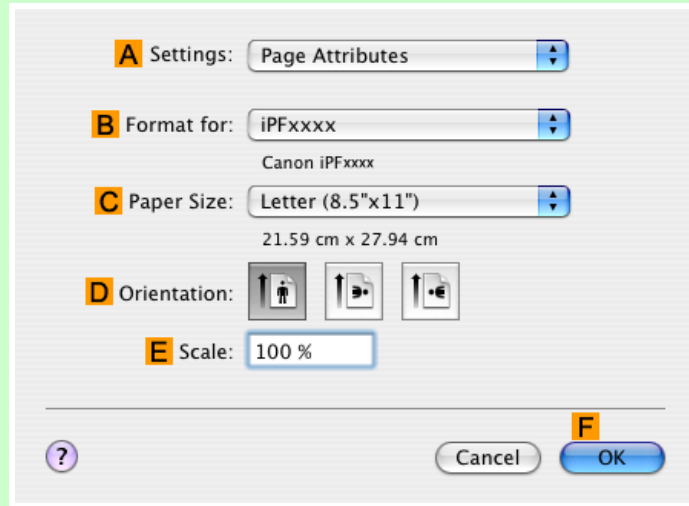

If it is not displayed, the settings are configured in the upper part of the printer driver displayed when you select **Print** from the application software menu.

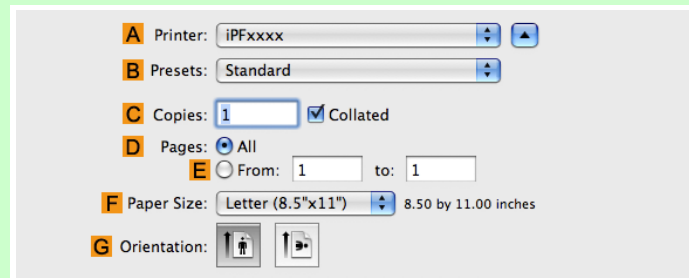

2. Select the printer in the **A Printer** list.
3. In the **F Paper Size** list, click the size of the original. In this case, click **ISO A3**.
4. If you configured the settings using the **Page Attributes** dialog box, click **F OK** to close the dialog box, and then select **Print** from the application software menu.



## 5. Access the **Layout** pane.

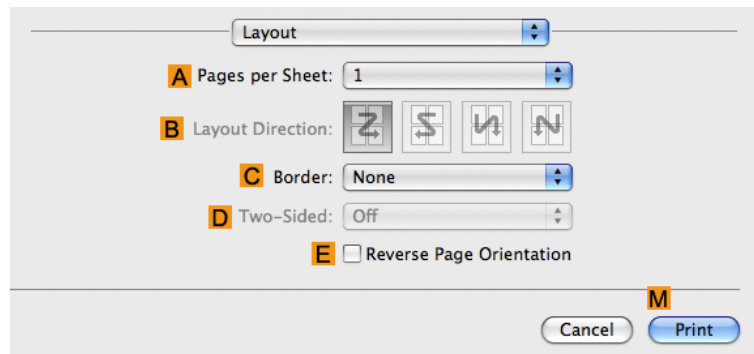

## 6. Click 4 in the **A Pages per Sheet** list.



### Note

- You can choose the layout order and specify a boundary line for the four pages in **B Layout Direction** and **C Border**.

## 7. Access the **Main** pane.

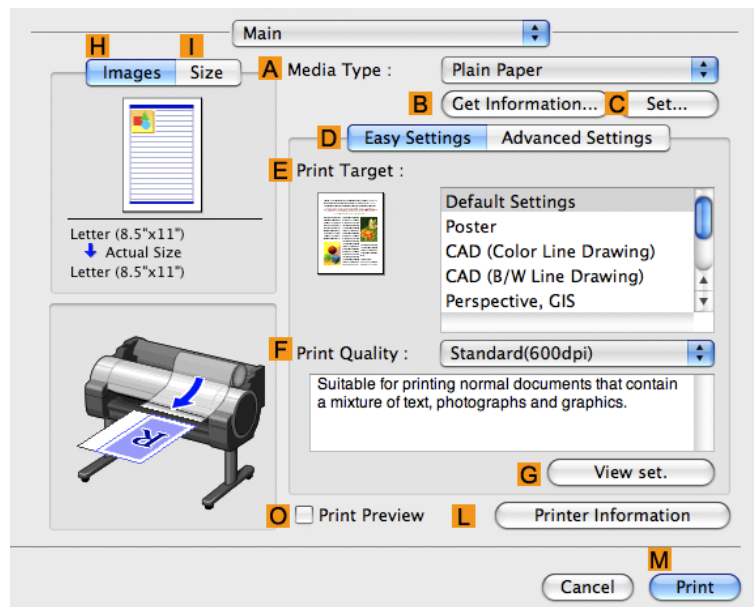

## 8. In the **A Media Type** list, select the type of paper that is loaded. In this case, click Plain Paper.

## 9. Make your selection in the **E Print Target** list.

## 10. Make your selection in the **F Print Quality** list.

**11.** Access the **Page Setup** pane.

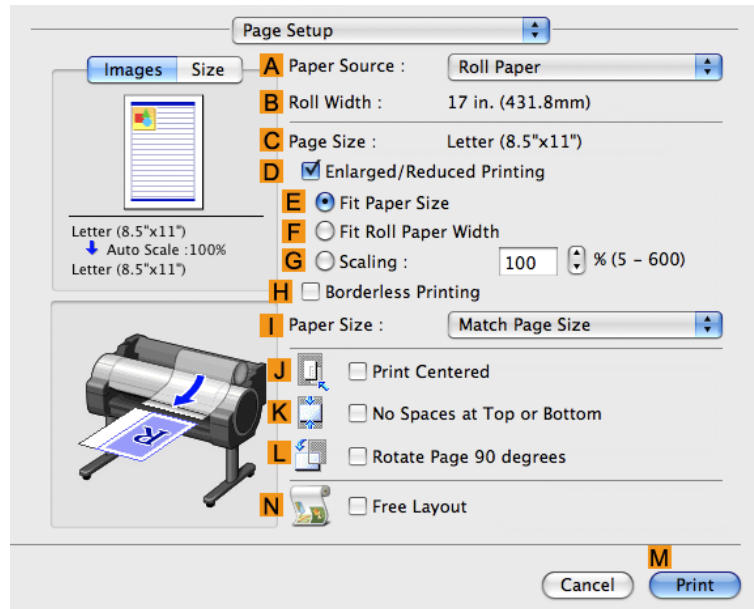

2

**12.** Select and click a roll paper in the **A Paper Source** list.

**13.** Make sure the width of the loaded roll is displayed in the **B Roll Width** list—in this case, **ISO A2/A3 (420.0mm)**.



**Note**

- If the width of the roll loaded in the printer is not shown in **B Roll Width**, click **L Printer Information** on the **Main** pane to update the printer information.

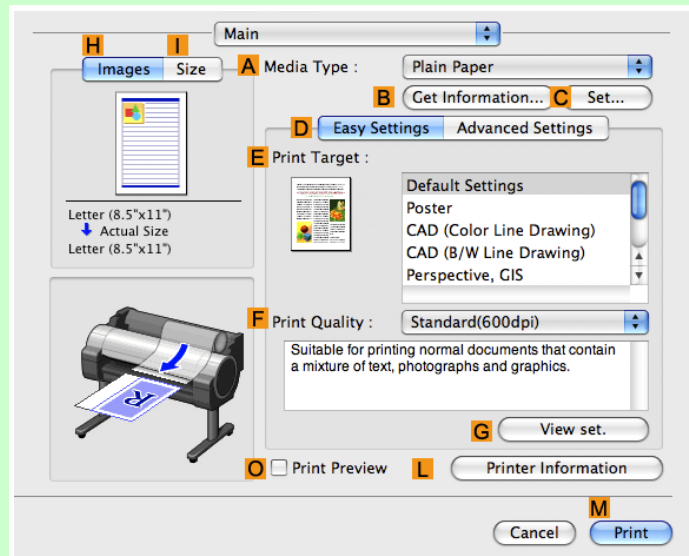

156

14. Make sure **C Page Size** shows the original size as specified in **C Paper Size** in the **Page Attributes** dialog box—in this case, **ISO A3**.

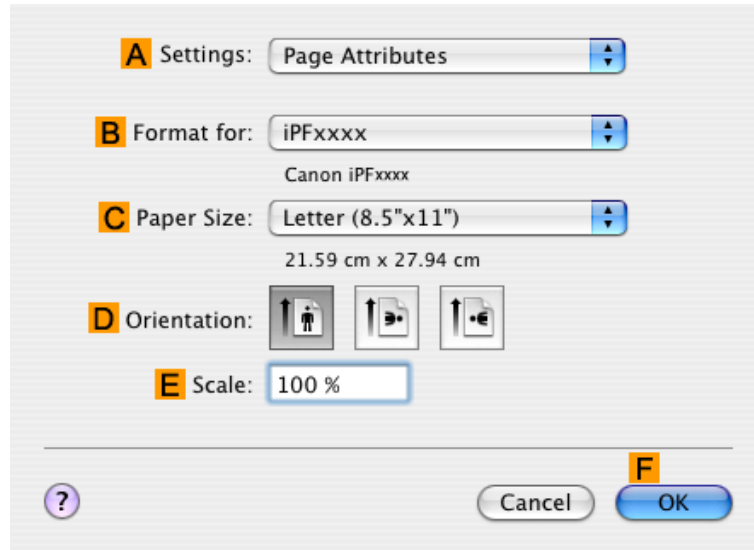

15. Confirm the print settings, and then click **M Print** to start printing.



#### Note

- For tips on confirming print settings, see "Confirming Print Settings(Mac OS X) →P.436 "

## Printing Posters in Sections

You can enlarge an original to print it in sections on several sheets. By assembling the printed sheets, you can create a poster larger than the maximum supported paper size of the printer.

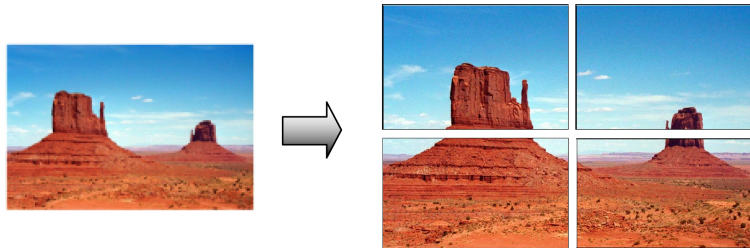

### • Page Layout

Choose poster printing.



#### Important

- When printing using this function, the **Print Centered**, **Watermark**, **No Spaces at Top or Bottom (Conserve Paper)**, and **Page Options** settings are disabled.

For instructions on printing large posters, refer to the following topics, as appropriate for your computer and operating system.

- Printing Large Posters (Windows) →P.158

**Note**

- This method of poster printing is supported in Windows.

## Printing Large Posters (Windows)

You can enlarge an original to print it in sections on several sheets. By assembling the printed sheets, you can create a poster larger than the maximum supported paper size of the printer. This topic describes how to enlarge an A2 original for printing it in sections on four sheets, based on the following example.

- Document: Poster
- Page size: A2 (420.0×594.0 mm [16.5 × 23.4 in])
- Paper: Sheets
- Paper Size: A2 (420.0 × 594.0 mm [16.5 × 23.4 in])

1. Choose **Print** in the application menu.
2. Select the printer in the dialog box, and then display the printer driver dialog box. (See "Accessing the Printer Driver Dialog Box from Applications(Windows) → P.217 ")
3. Make sure the **Main** sheet is displayed.

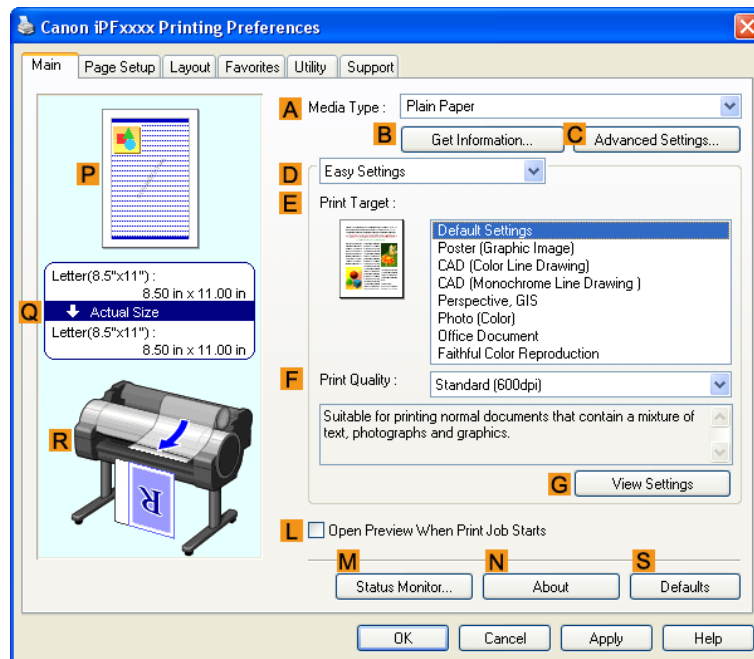

4. In the **A Media Type** list, select the type of paper that is loaded.
5. Click **Poster** in the **E Print Target** list.

6. Click the **Page Setup** tab to display the **Page Setup** sheet.

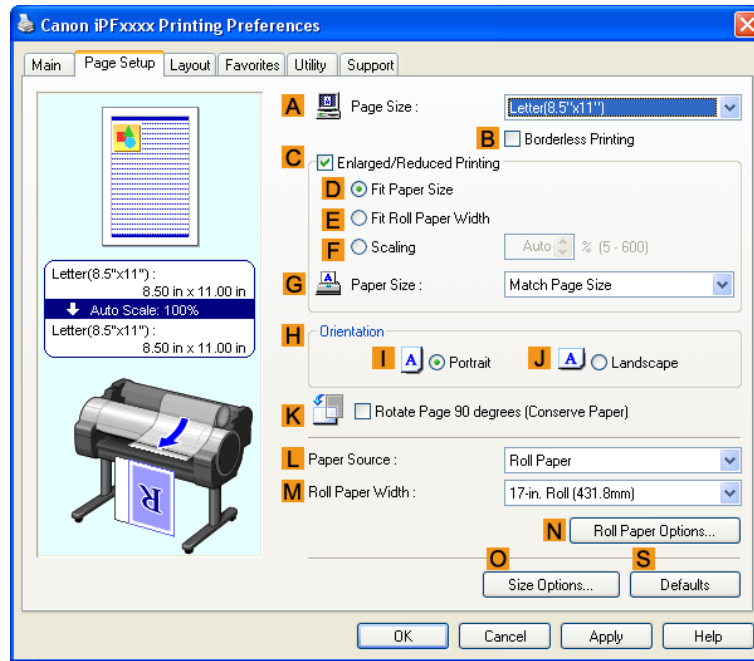

7. In **A Page Size**, click the size of the original as specified in the application. In this case, click **ISO A2**.

8. Click **Manual** in the **L Paper Source** list.

9. Click the **Layout** tab to display the **Layout** sheet.

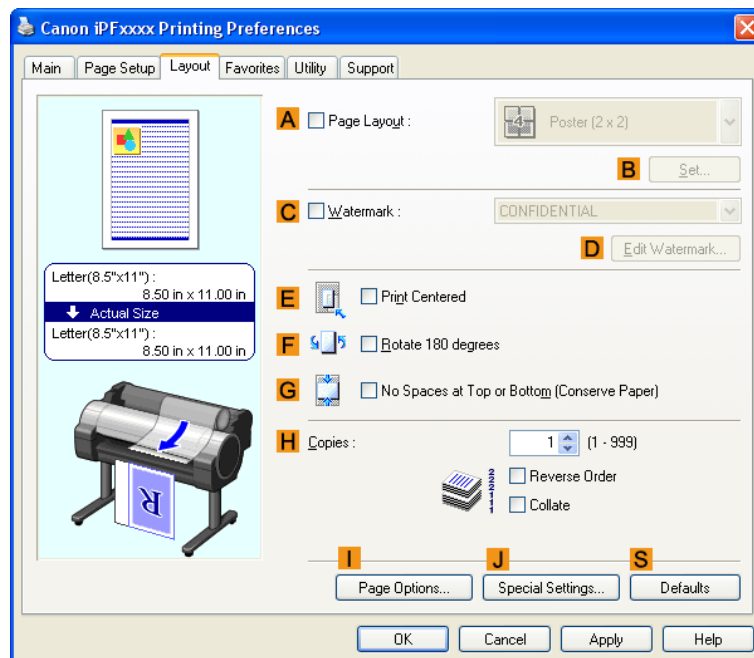

**10.** Select the **A Page Layout** check box.

**11.** Click **Poster (2 x 2)** in the **A Page Layout** list.



**Note**

- Follow the steps below to print only a portion of the poster as divided for printing.
  - Click **B Set** under **A Page Layout** to display the **Pages to Print** dialog box.
  - On the **Pages to Print** dialog box, clear the check boxes of the portion you do not want to print.
  - Click **OK** to close the **Pages to Print** dialog box.

**12.** Confirm the print settings and print as desired.



**Note**

- For tips on confirming print settings, see "Confirming Print Settings(Windows) →P.212 "

## Centering originals

Printing Originals Centered on Rolls .....	161
Printing Originals Centered on Rolls (Windows) .....	161
Printing Originals Centered on Rolls (Mac OS X) .....	163
Printing Originals Centered on Sheets .....	167
Printing Originals Centered on Sheets (Windows) .....	167
Printing Originals Centered on Sheets (Mac OS X) .....	170

### Printing Originals Centered on Rolls

You can print originals centered on a page—for example, if the paper is larger than the original, or if you are reducing the original.

- **Centering originals relative to roll paper width**

If you use originals smaller than the roll paper width, you can center them relative to the width when printing.

**Print Centered**

Aligns the center of the original with the center of the roll, relative to the width.

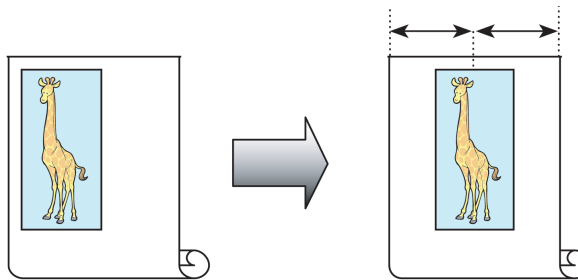

For instructions on centering originals when printing on rolls, refer to the following topics, as appropriate for your computer and operating system.

- Printing Originals Centered on Rolls (Windows) →P.161
- Printing Originals Centered on Rolls (Mac OS X) →P.163

### Printing Originals Centered on Rolls (Windows)

This topic describes how to center originals before printing on rolls based on the following example.

- Document: Any type
- Page size: A4 (210.0×297.0 mm)/Letter (8.3 × 11.7 in)
- Paper: Roll
- Paper type: Plain Paper
- Roll width: A3/A4 roll (297.0 mm [11.7 in])

1. Choose **Print** in the application menu.
2. Select the printer in the dialog box, and then display the printer driver dialog box. (See "Accessing the Printer Driver Dialog Box from Applications(Windows) →P.217 ")

**3.** Make sure the **Main** sheet is displayed.

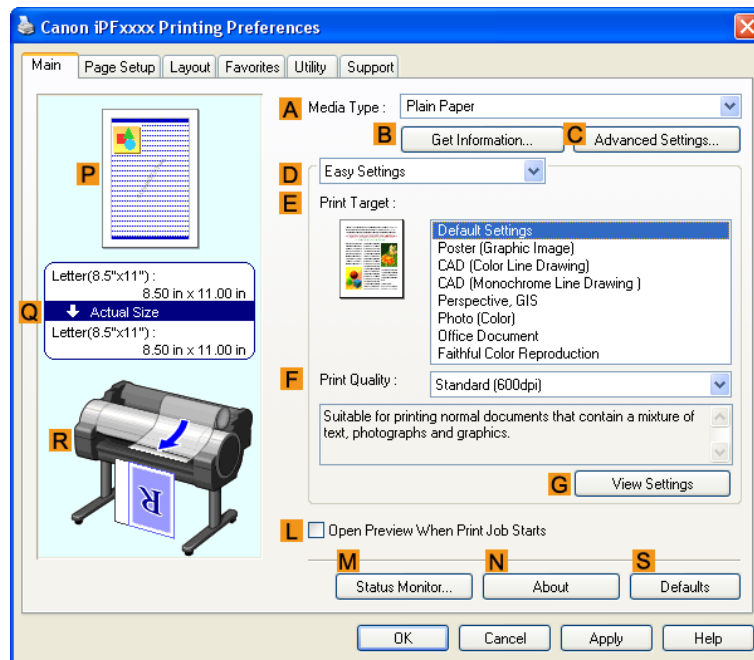

**4.** In the **A Media Type** list, select the type of paper that is loaded. In this case, click Plain Paper.

**5.** Select the print target in the **E Print Target** list.

**6.** Click the **Page Setup** tab to display the **Page Setup** sheet.

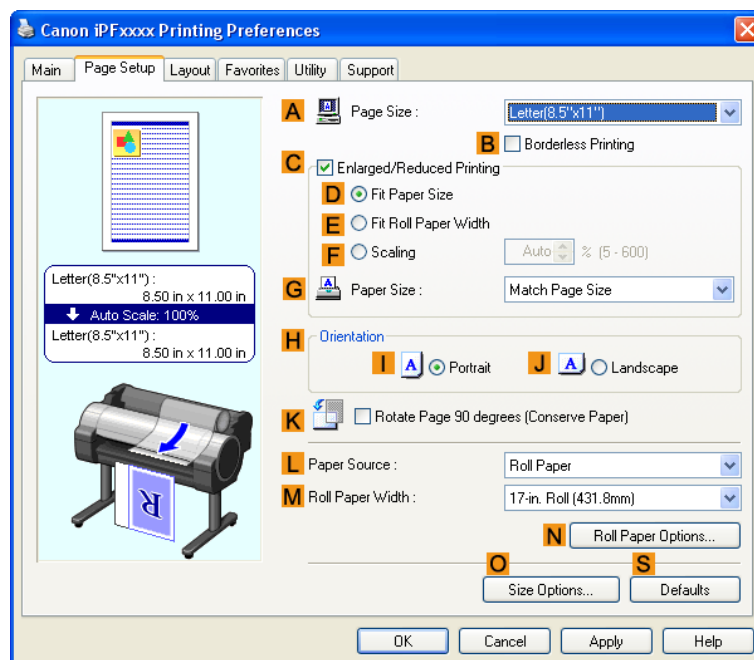



7. In the **A Page Size** list, click the size of the original as specified in the application. In this case, click **ISO A4** or **Letter (8.5"x11")**.
8. Select and click a roll paper in the **L Paper Source** list.
9. Select the width of the loaded roll in the **M Roll Paper Width** list—in this case, **ISO A3/A4 Roll (297.0mm)**.
10. Click the **Layout** tab to display the **Layout** sheet.

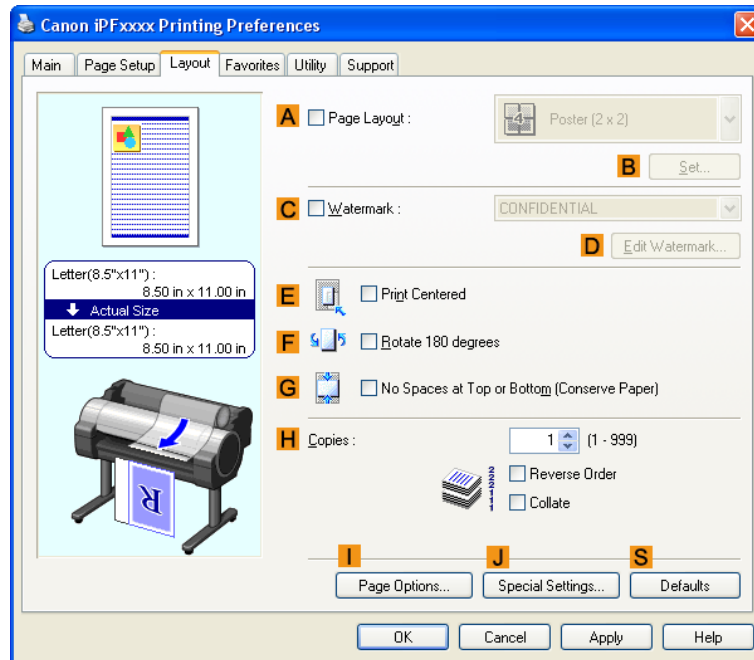

11. Select the **E Print Centered** check box.
12. Confirm the print settings and print as desired.

**Note**

- For tips on confirming print settings, see "Confirming Print Settings(Windows) →P.212 "

## Printing Originals Centered on Rolls (Mac OS X)

This topic describes how to center originals before printing on rolls based on the following example.

- Document: Any Type
- Page size: A4 (210.0 × 297.0 mm [8.3 × 11.7 in])
- Paper: Roll paper
- Paper type: Plain Paper
- Roll paper width: A3/A4 roll (297.0 mm [11.7 in])

1. This sets the **B Format for** and **C Paper Size**.

**Note**

- The configuration method varies depending on the OS and application software you are using. If **Page Setup** is displayed in the application menu, the settings are configured by opening the **Page Attributes** dialog box from **Page Setup**.

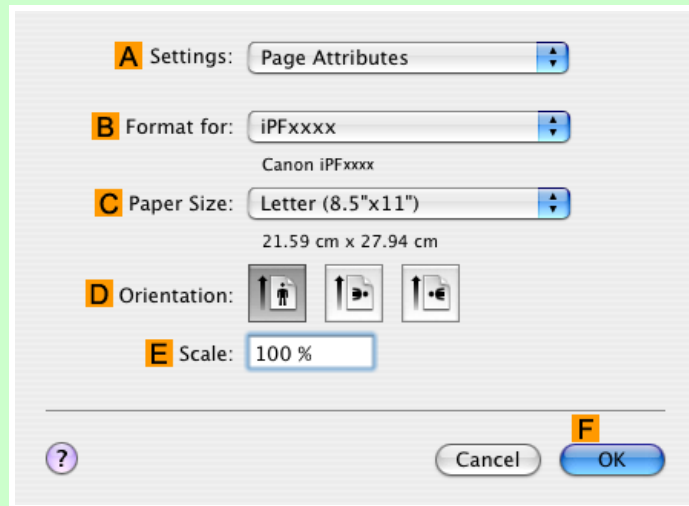

If it is not displayed, the settings are configured in the upper part of the printer driver displayed when you select **Print** from the application software menu.

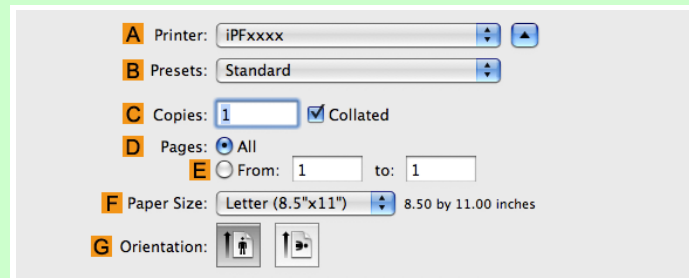

2. Select the printer in the **A Printer** list.
3. In the **F Paper Size** list, click the size of the original. In this case, click **ISO A4**.
4. If you configured the settings using the **Page Attributes** dialog box, click **F OK** to close the dialog box, and then select **Print** from the application software menu.

5. Access the **Main** pane.

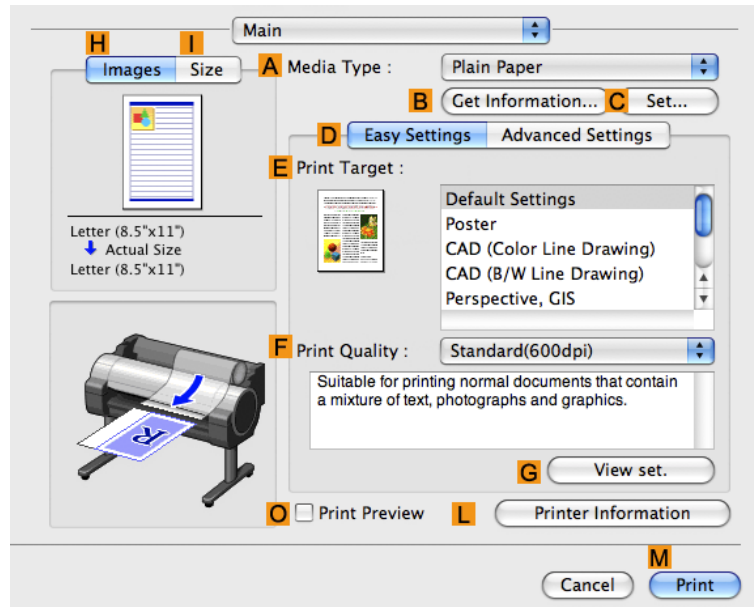

6. In the **A Media Type** list, select the type of paper that is loaded. In this case, click Plain Paper.

7. Make your selection in the **E Print Target** list.

8. Make your selection in the **F Print Quality** list.

9. Access the **Page Setup** pane.

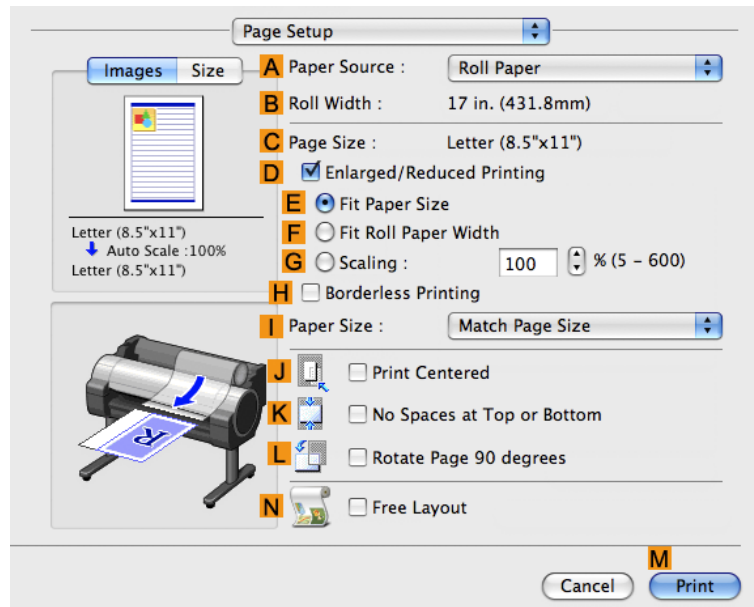

**10.** Select and click a roll paper in the **A Paper Source** list.

**11.** Make sure the width of the loaded roll is displayed in **B Roll Width**—in this case, **ISO A3/A4 (297.0mm)**.



**Note**

- If the width of the roll loaded in the printer is not shown in **B Roll Width**, click **L Printer Information** on the **Main** pane to update the printer information.

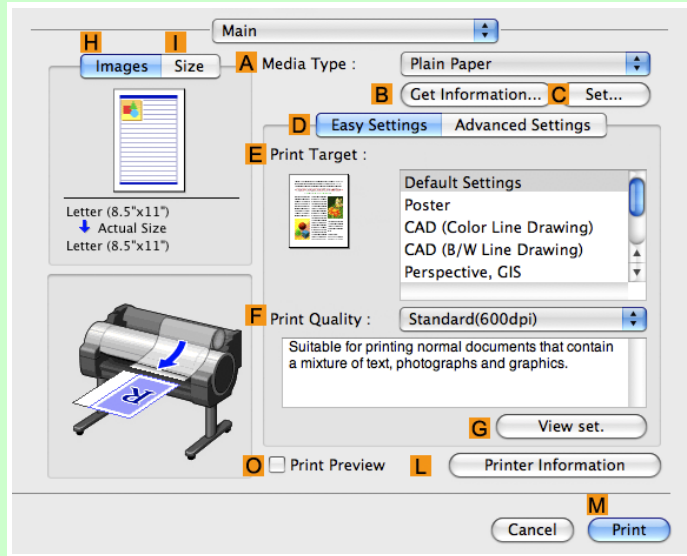

**12.** Make sure the **C Page Size** setting matches the original size as selected in **C Paper Size** in the **Page Attributes** dialog box—in this case, **ISO A4**.

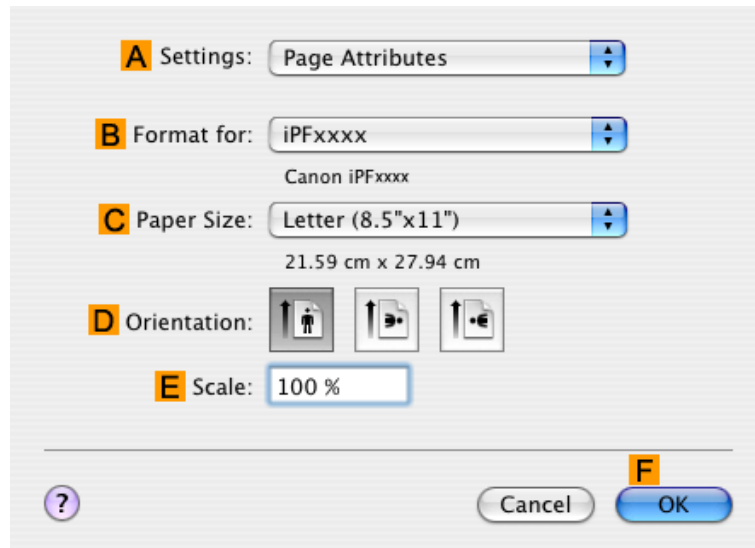

**13.** Select the **J Print Centered** check box.

- 14.** Confirm the print settings, and then click **Print** to start printing.



Note

- For tips on confirming print settings, see "Confirming Print Settings(Mac OS X) →P.436 "

## Printing Originals Centered on Sheets

You can print originals centered on a page—for example, if the paper is larger than the original, or if you are reducing the original.

### • Centering originals on sheets

If you use paper larger than the original size or print originals after reduction, the printed images may be aligned in the upper-left corner of the paper. In this case, you can center originals on sheets when printing.

#### Print Centered

Aligns the center of the original with the center of the sheet.

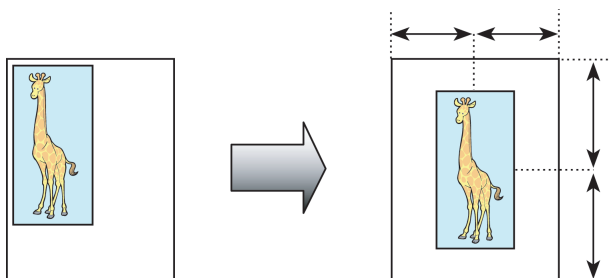

For instructions on centering originals when printing on sheets, refer to the following topics, as appropriate for your computer and operating system.

- Printing Originals Centered on Sheets (Windows) →P.167
- Printing Originals Centered on Sheets (Mac OS X) →P.170

## Printing Originals Centered on Sheets (Windows)

This topic describes how to reduce an original 50% for printing centered on a sheet.

- Document: Any Type
- Page size: A4 (210.0 × 297.0 mm [8.3 × 11.7 in])
- Paper: Sheets
- Paper type: Plain Paper
- Paper size: A4 (210.0 × 297.0 mm [8.3 × 11.7 in])

**1.**

Choose **Print** in the application menu.

**2.**

Select the printer in the dialog box, and then display the printer driver dialog box.(See "Accessing the Printer Driver Dialog Box from Applications(Windows) →P.217 ")

**3.** Make sure the **Main** sheet is displayed.

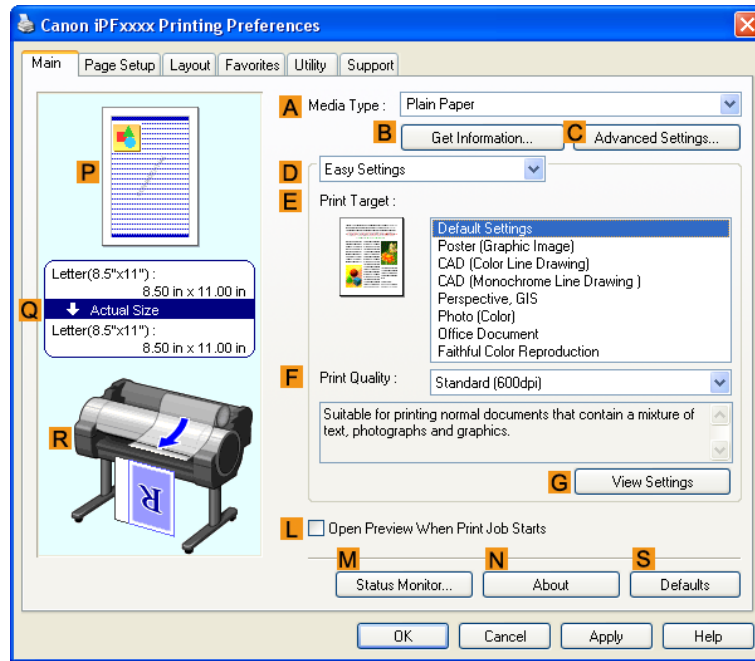

**4.** In the **A Media Type** list, select the type of paper that is loaded. In this case, click Plain Paper.

**5.** Make your selection in the **E Print Target** list.

**6.** Click the **Page Setup** tab to display the **Page Setup** sheet.

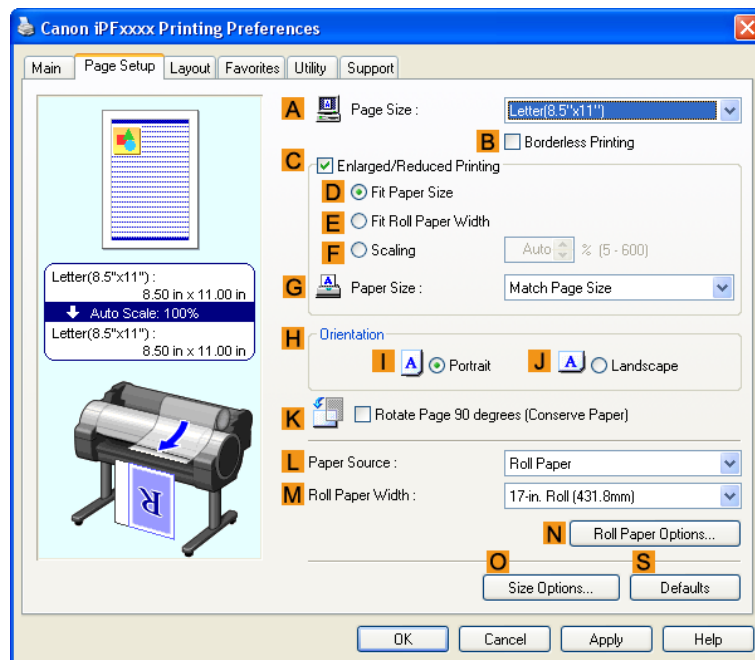

7. In the **A Page Size** list, click the size of the original as specified in the application. In this case, click **ISO A4**.
8. Select the **C Enlarged/Reduced Printing** check box.
9. Click **Match Page Size** in the **G Paper Size** list.
10. Click **F Scaling** and enter 50.
11. Click **Manual** in the **L Paper Source** list.
12. Click the **Layout** tab to display the **Layout** sheet.

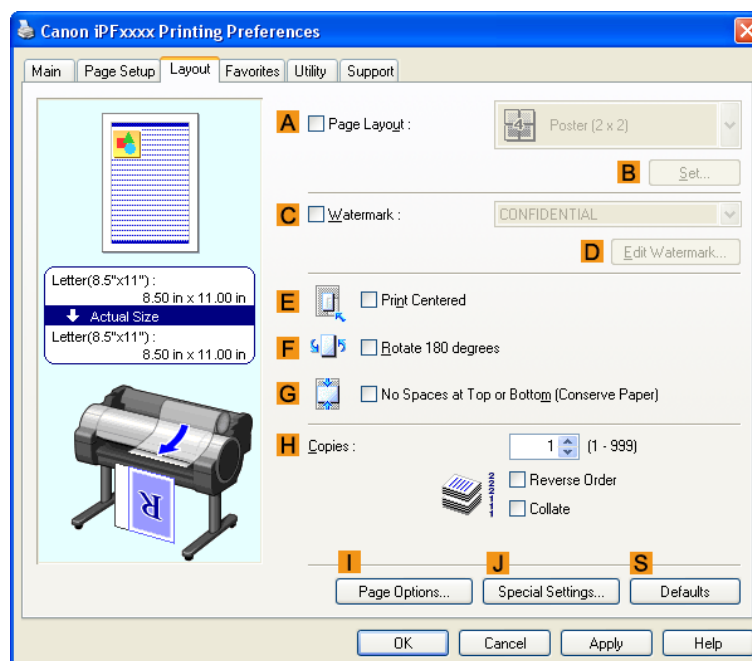

13. Select the **E Print Centered** check box.
14. Confirm the print settings and print as desired.



#### Important

- If you have selected **Manual** as the paper source, follow the instructions on the printer control panel to enter the paper size.



#### Note

- For tips on confirming print settings, see "Confirming Print Settings(Windows) →P.212 "

## Printing Originals Centered on Sheets (Mac OS X)

This topic describes how to center originals for printing on sheets, based on the following example.

- Document: Any Type
- Page size: A4
- Paper: Sheets
- Paper type: Plain Paper
- Paper size: Non-standard

1. This sets the **B Format for** and **C Paper Size**.



### Note

- The configuration method varies depending on the OS and application software you are using. If **Page Setup** is displayed in the application menu, the settings are configured by opening the **Page Attributes** dialog box from **Page Setup**.

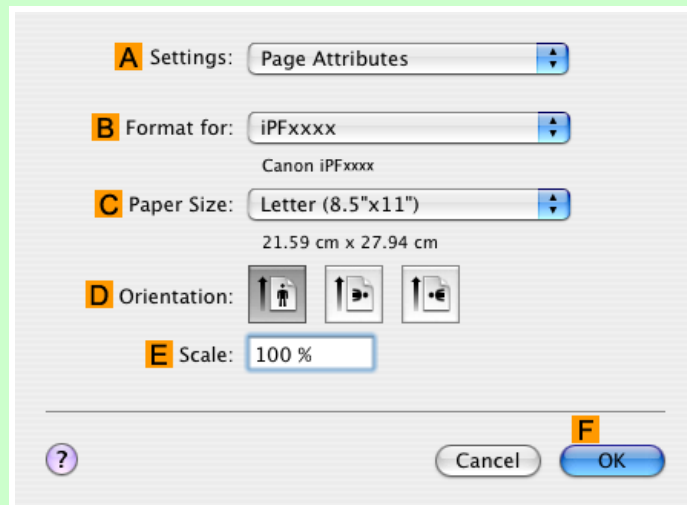

If it is not displayed, the settings are configured in the upper part of the printer driver displayed when you select **Print** from the application software menu.

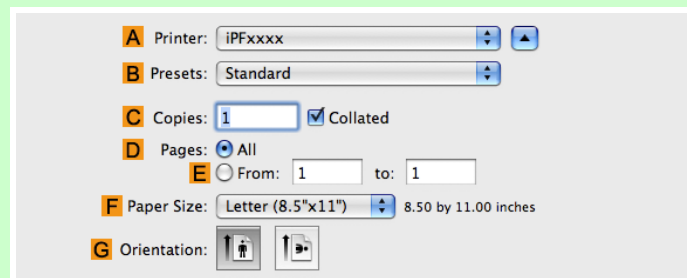

2. Select the printer in the **A Printer** list.

3. In the **F Paper Size** list, click the size of the original. In this case, click **ISO A4 - for Paper Tray (Large Margins)**.



4. If you configured the settings using the **Page Attributes** dialog box, click **OK** to close the dialog box, and then select **Print** from the application software menu.

5. Access the **Main** pane.

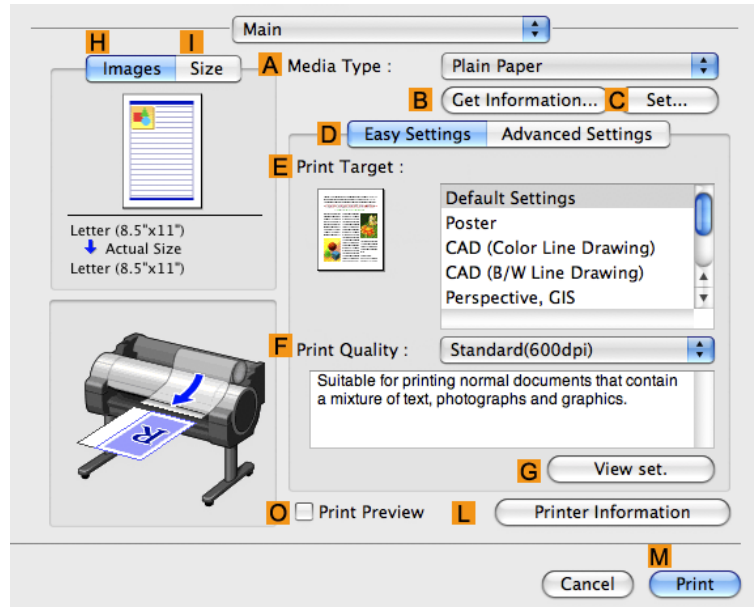

6. In the **Media Type** list, select the type of paper that is loaded. In this case, click Plain Paper.

7. Make your selection in the **Print Target** list.

8. Make your selection in the **Print Quality** list.

**9.** Access the **Page Setup** pane.

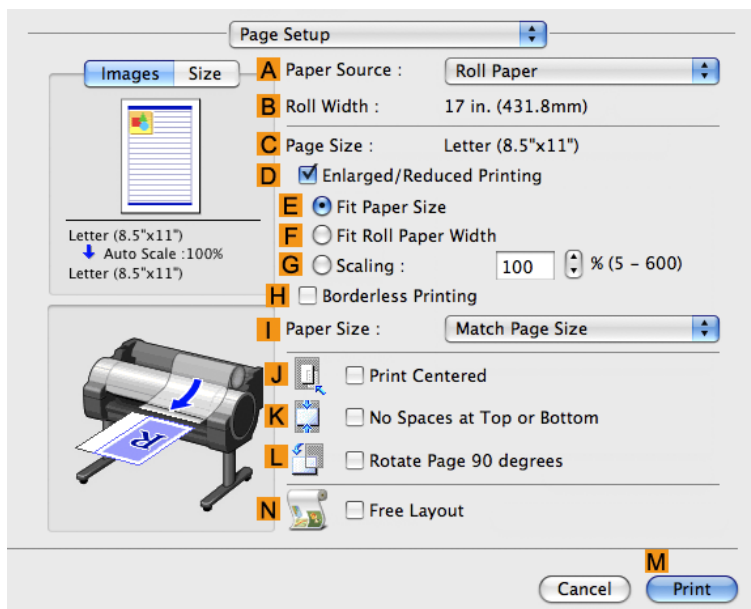

2

**10.** Click **Manual** in the **A Paper Source** list.

**11.** Make sure the **C Page Size** setting matches the original size as selected in **C Paper Size** in the **Page Attributes** dialog box—in this case, **ISO A4 - for Paper Tray (Large Margins)**.

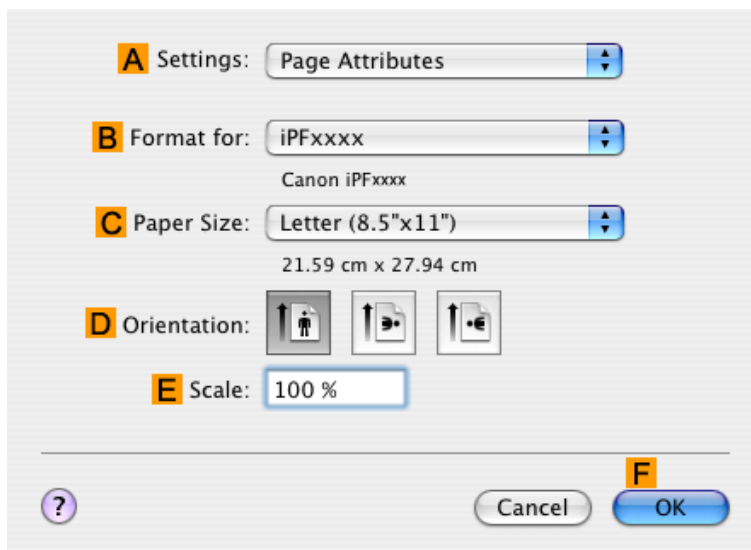

172

**12.** Select the **J Print Centered** check box.

**13.** Confirm the print settings, and then click **Print** to start printing.

**Note**

- For tips on confirming print settings, see "Confirming Print Settings(Mac OS X) →P.436 "

**Important**

- If you have selected **Manual** as the paper source, follow the instructions on the printer control panel to enter the paper size.

## Conserving roll paper

Conserving Roll Paper by Rotating Originals 90 Degrees .....	174
Conserving Roll Paper by Rotating Originals 90 Degrees (Windows) .....	174
Conserving Roll Paper by Rotating Originals 90 Degrees (Mac OS X) .....	176
Conserving Roll Paper by Printing Originals Without Top and Bottom Margins .....	180
Conserving Roll Paper by Printing Originals Without Top and Bottom Margins (Windows) .....	180
Conserving Roll Paper by Printing Originals Without Top and Bottom Margins (Mac OS X) .....	183

### Conserving Roll Paper by Rotating Originals 90 Degrees

You can conserve roll paper by specifying particular settings as suitable for your original.

#### • Rotate Page 90 degrees (Conserve Paper)

When originals are printed in portrait orientation, the original is rotated 90 degrees before printing if it fits within the roll width. This enables you to conserve paper.

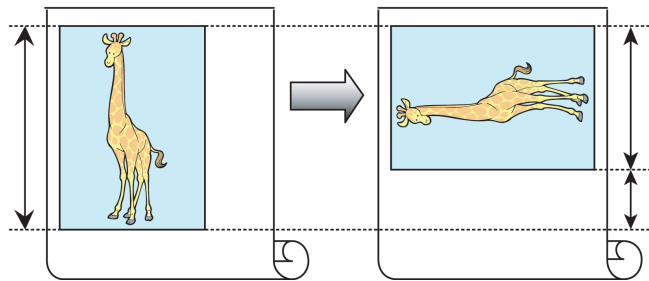

#### Important

- If the page would exceed the roll paper width after rotation, use this function with Scale to fit Roll Paper Width to print rotated pages.

For tips on conserving roll paper, refer to the following topics, as appropriate for your computer and operating system.

- Conserving Roll Paper by Rotating Originals 90 Degrees (Windows) →P.174
- Conserving Roll Paper by Rotating Originals 90 Degrees (Mac OS X) →P.176

### Conserving Roll Paper by Rotating Originals 90 Degrees (Windows)

This topic describes how to conserve paper by rotating originals 90 degrees before printing, based on the following example.

- Document: Any type
- Page size: A4 (210.0×297.0 mm)/Letter (8.3×11.7 in)
- Paper: Roll
- Paper type: Plain Paper
- Roll paper width: A3/A4 roll (297.0 mm [11.7 in])

This example illustrates how to rotate an A4 (210.0×297.0 mm)/Letter (8.3×11.7 in) original in portrait orientation 90 degrees to fit within the width of A3/A4 roll paper (297.0 mm [11.7 in]), which enables you to conserve paper.

1. Choose **Print** in the application menu.

2. Select the printer in the dialog box, and then open the printer driver dialog box. (See "Accessing the Printer Driver Dialog Box from Applications (Windows) → P.217 ")
3. Make sure the **Main** sheet is displayed.

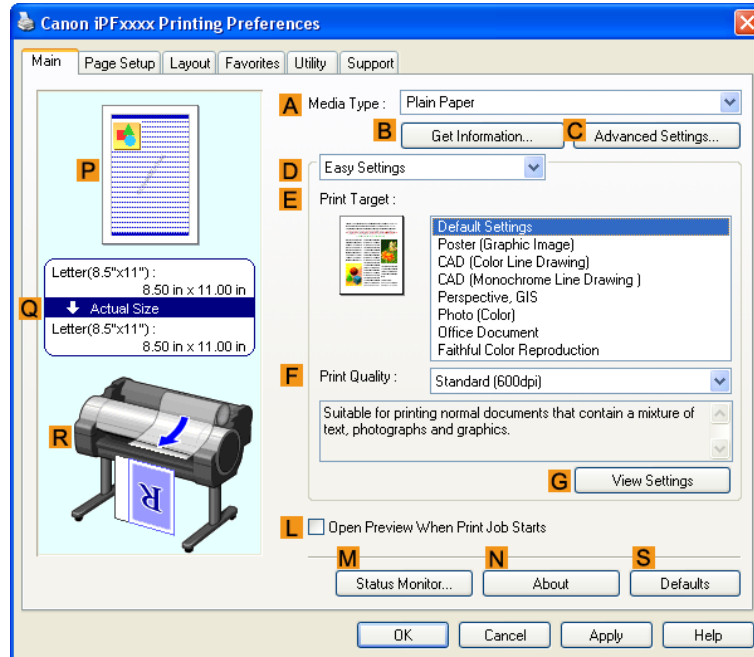

4. In the **A Media Type** list, select the type of paper that is loaded. In this case, click Plain Paper.
5. Click the **Page Setup** tab to display the **Page Setup** sheet.

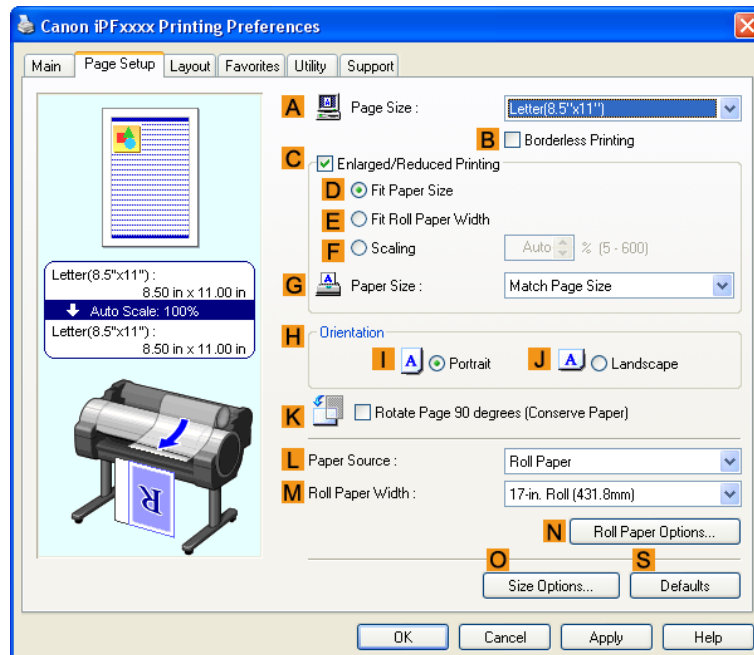

**6.** In the **A Page Size** list, click the size of the original as specified in the application. In this case, click **ISO A4** or **Letter (8.5"x11")**.

**7.** Select and click a roll paper in the **L Paper Source** list.

**8.** Select the width of the loaded roll in the **M Roll Paper Width** list—in this case, **ISO A3/A4 Roll (297.0mm)**.

**9.** Select the **K Rotate Page 90 degrees (Conserve Paper)** check box.

**10.** Confirm the print settings and print as desired.



**Note**

- For tips on confirming print settings, see "Confirming Print Settings(Windows) →P.212 "

## Conserving Roll Paper by Rotating Originals 90 Degrees (Mac OS X)

This topic describes how to conserve roll paper by rotating originals 90 degrees before printing, based on the following example.

- Document: Any Type
- Page size: A4 (210.0 × 297.0 mm [8.3 × 11.7 in])
- Paper: Roll paper
- Paper type: Plain Paper
- Roll paper width: A3/A4 roll (297.0 mm [11.7 in])

This example illustrates how to rotate an A4 (210.0×297.0 mm)/Letter (8.3 × 11.7 in) original in portrait orientation 90 degrees to fit within the width of A3/A4 roll (297.0 mm [11.7 in]), which enables you to conserve paper.

1. This sets the **B Format for** and **C Paper Size**.



**Note**

- The configuration method varies depending on the OS and application software you are using. If **Page Setup** is displayed in the application menu, the settings are configured by opening the **Page Attributes** dialog box from **Page Setup**.

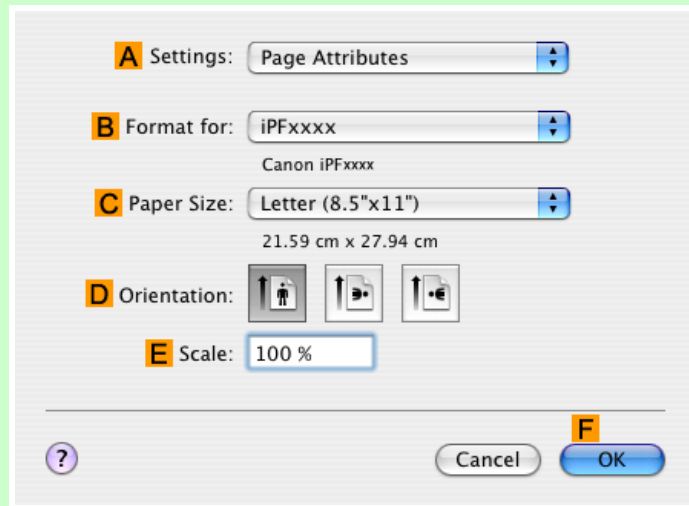

If it is not displayed, the settings are configured in the upper part of the printer driver displayed when you select **Print** from the application software menu.

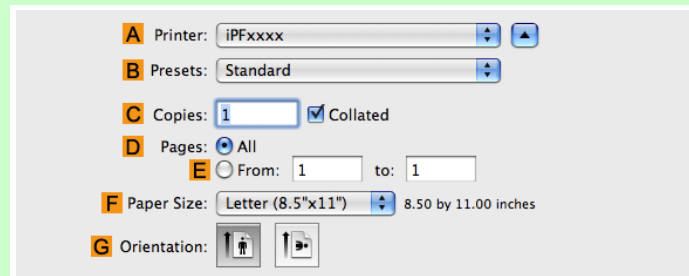

2. Select the printer in the **A Printer** list.
3. In the **F Paper Size** list, click the size of the original. In this case, click **ISO A4**.
4. If you configured the settings using the **Page Attributes** dialog box, click **F OK** to close the dialog box, and then select **Print** from the application software menu.

5. Access the **Main** pane.

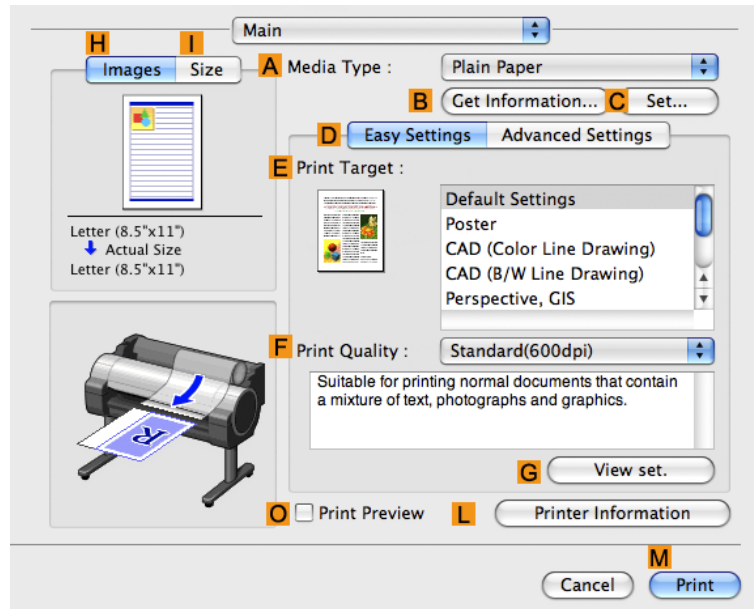

6. In the **A Media Type** list, select the type of paper that is loaded. In this case, click Plain Paper.

7. Access the **Page Setup** pane.

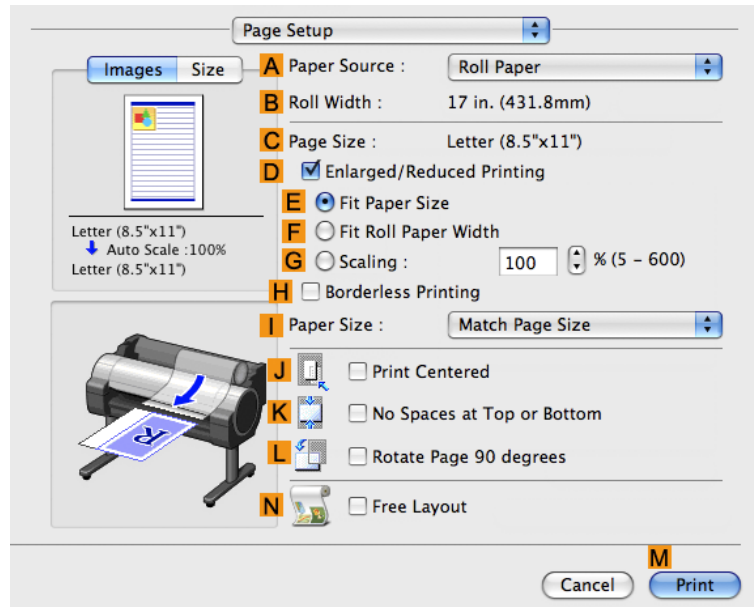

8. Select and click a roll paper in the **A Paper Source** list.



9. Make sure the width of the loaded roll is displayed in **B Roll Width**—in this case, **ISO A3/A4 (297.0mm)**.



**Note**

- If the width of the roll loaded in the printer is not shown in **B Roll Width**, click **L Printer Information** on the **Main** pane to update the printer information.

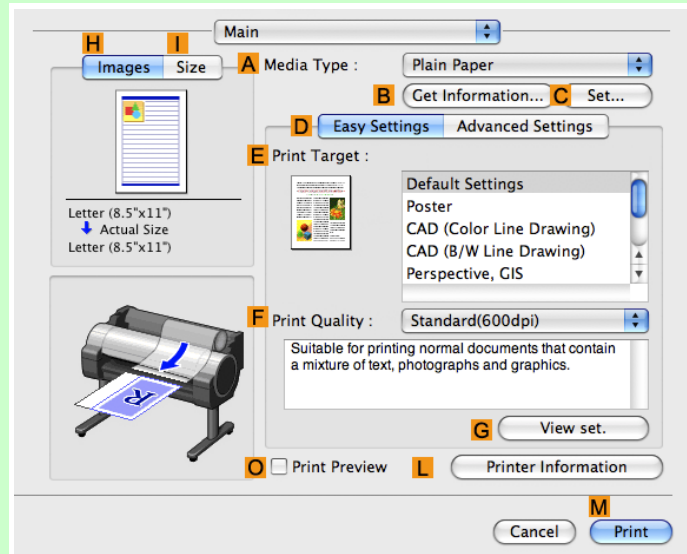

10. Make sure the **C Page Size** setting matches the original size as selected in **C Paper Size** in the **Page Attributes** dialog box—in this case, **ISO A4**.

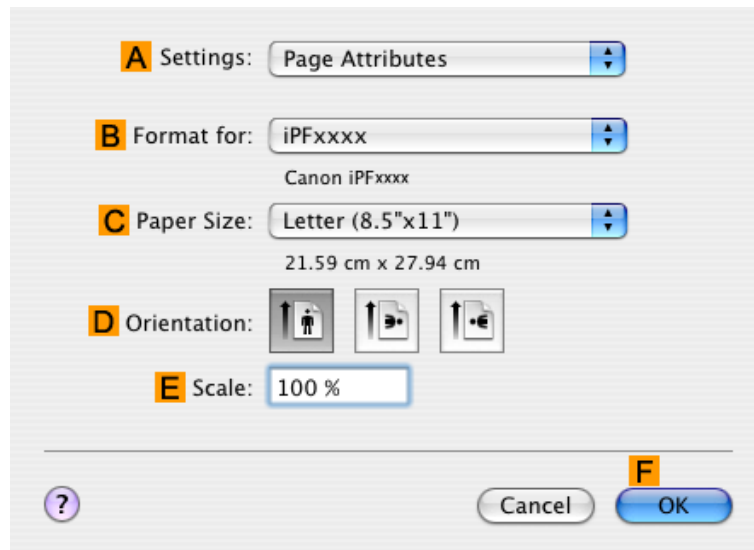

11. Select the **L Rotate Page 90 degrees** check box.

**12.** Confirm the print settings, and then click **Print** to start printing.



**Note**

- For tips on confirming print settings, see "Confirming Print Settings(Mac OS X) →P.436 "

## Conserving Roll Paper by Printing Originals Without Top and Bottom Margins

You can conserve roll paper by specifying particular settings as suitable for your original.

### • No Spaces at Top or Bottom (Conserve Paper)

You can print without feeding the paper for blank portions of originals if there are top and bottom margins in originals. This enables you to conserve as much paper as the size of the margins.

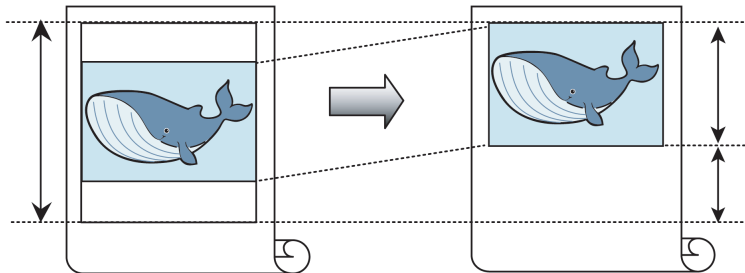

**Important**

- Printing without the top and bottom margins is not supported in the following cases.
  - Banner printing
  - If you have chosen poster as the type of page layout



**Note**

- Even during borderless printing, you can print without the top and bottom margins.
- Printing without the top and bottom margins may cause inconsistency in the size of printed documents, depending on the layout of images or text in your originals.

For tips on conserving roll paper, refer to the following topics, as appropriate for your computer and operating system.

- Conserving Roll Paper by Printing Originals Without Top and Bottom Margins (Windows) →P.180
- Conserving Roll Paper by Printing Originals Without Top and Bottom Margins (Mac OS X) →P.183

## Conserving Roll Paper by Printing Originals Without Top and Bottom Margins (Windows)

This topic describes how to conserve roll paper when printing originals that have a top and bottom margin, based on the following example.

- Document: Any type
- Page size: A4 (210.0×297.0mm)/Letter (8.3 × 11.7 in)
- Paper: Roll
- Paper type: Plain Paper
- Roll paper width: A3/A4 roll (297.0 mm [11.7 in])

1. Choose **Print** in the application menu.
2. Select the printer in the dialog box, and then display the printer driver dialog box. (See "Accessing the Printer Driver Dialog Box from Applications(Windows) (→P.217)")
3. Make sure the **Main** sheet is displayed.

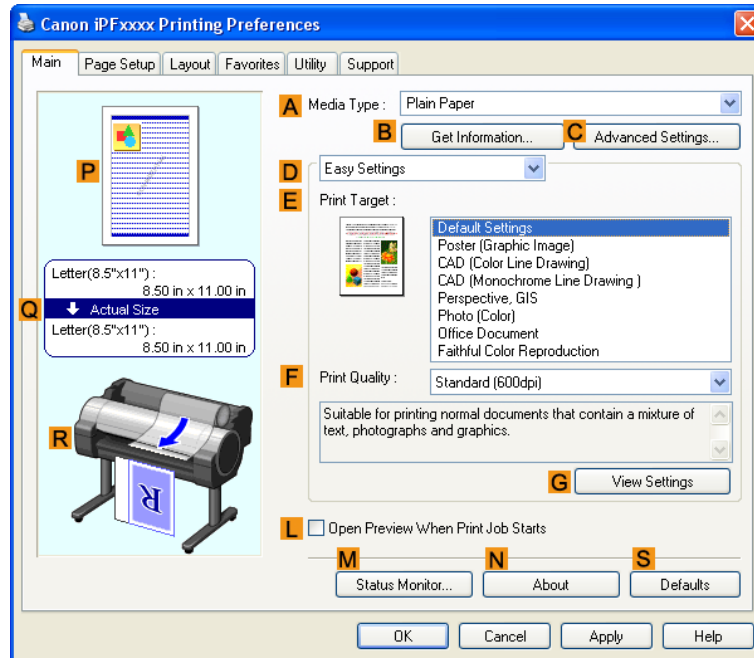

4. In the **A Media Type** list, select the type of paper that is loaded. In this case, click Plain Paper.

5. Click the **Page Setup** tab to display the **Page Setup** sheet.

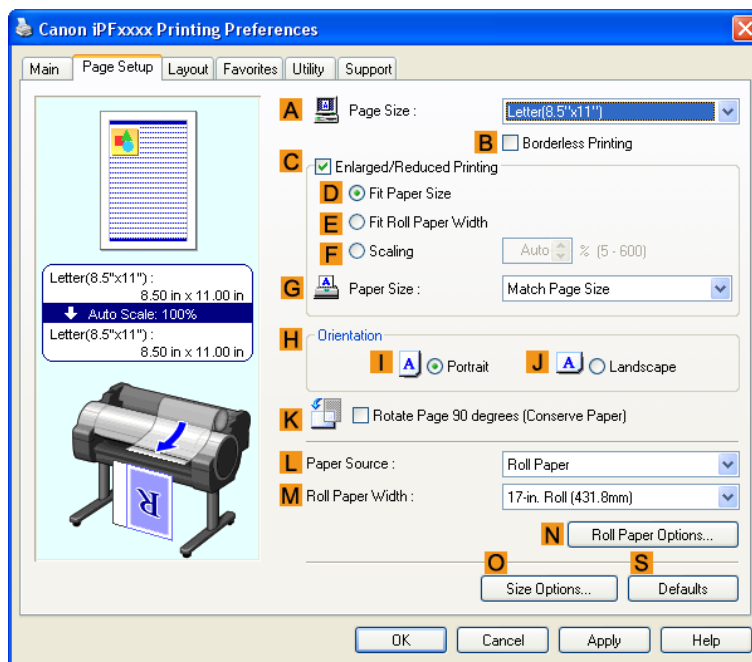

6. In the **A Page Size** list, click the size of the original as specified in the application. In this case, click **ISO A4** or **Letter (8.5"x11")**.

7. Select and click a roll paper in the **L Paper Source** list.

8. Select the width of the loaded roll in the **M Roll Paper Width** list—in this case, **ISO A3/A4 Roll (297.0mm)**.

9. Click the **Layout** tab to display the **Layout** sheet.

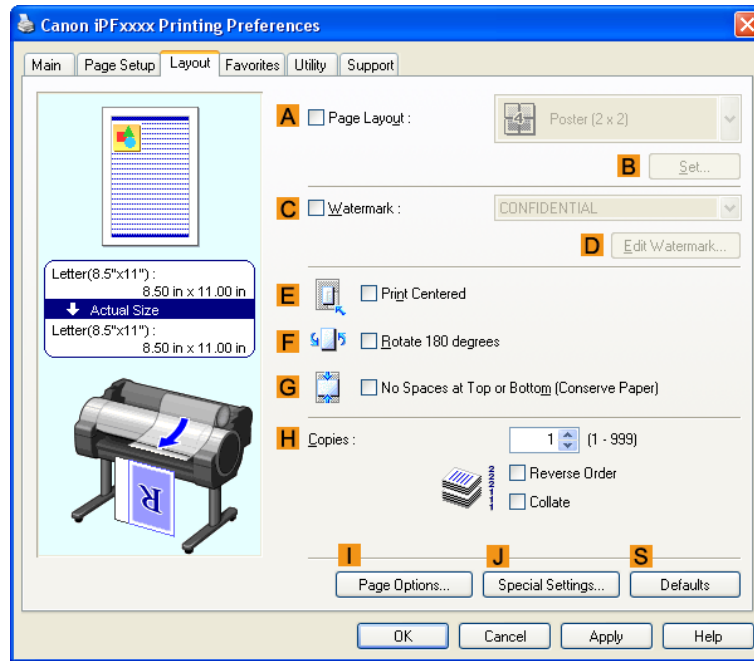

2

10. Select the **G No Spaces at Top or Bottom (Conserve Paper)** check box.

11. Confirm the print settings and print as desired.



**Note**

- For tips on confirming print settings, see "Confirming Print Settings(Windows) →P.212 "

## Conserving Roll Paper by Printing Originals Without Top and Bottom Margins (Mac OS X)

This topic describes how to conserve roll paper when printing originals that have a top and bottom margin, based on the following example.

- Document: Any Type
- Page size: A4 (210.0 × 297.0 mm [8.3 × 11.7 in])
- Paper: Roll paper
- Paper type: Plain Paper
- Roll paper width: A3/A4 roll (297.0 mm [11.7 in])

183

1. This sets the **B Format for** and **C Paper Size**.

**Note**

- The configuration method varies depending on the OS and application software you are using. If **Page Setup** is displayed in the application menu, the settings are configured by opening the **Page Attributes** dialog box from **Page Setup**.

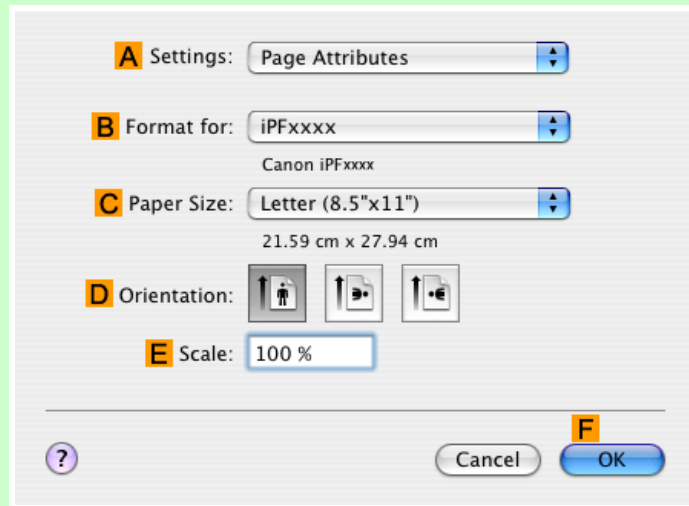

If it is not displayed, the settings are configured in the upper part of the printer driver displayed when you select **Print** from the application software menu.

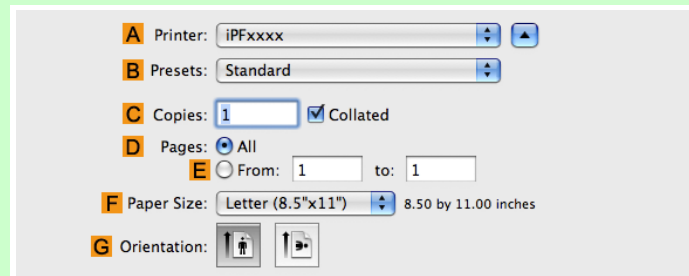

2. Select the printer in the **A Printer** list.
3. In the **F Paper Size** list, click the size of the original. In this case, click **ISO A4**.
4. If you configured the settings using the **Page Attributes** dialog box, click **F OK** to close the dialog box, and then select **Print** from the application software menu.

5. Access the **Main** pane.

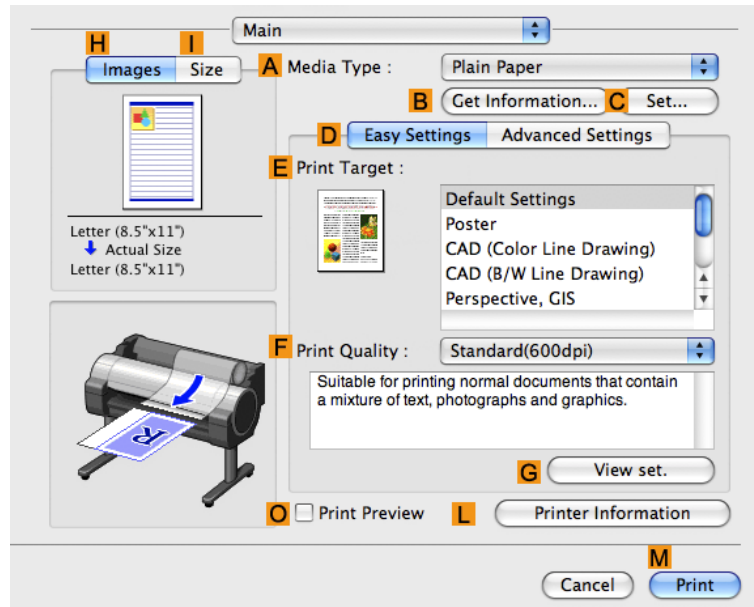

6. In the **A Media Type** list, select the type of paper that is loaded. In this case, click Plain Paper.

7. Access the **Page Setup** pane.

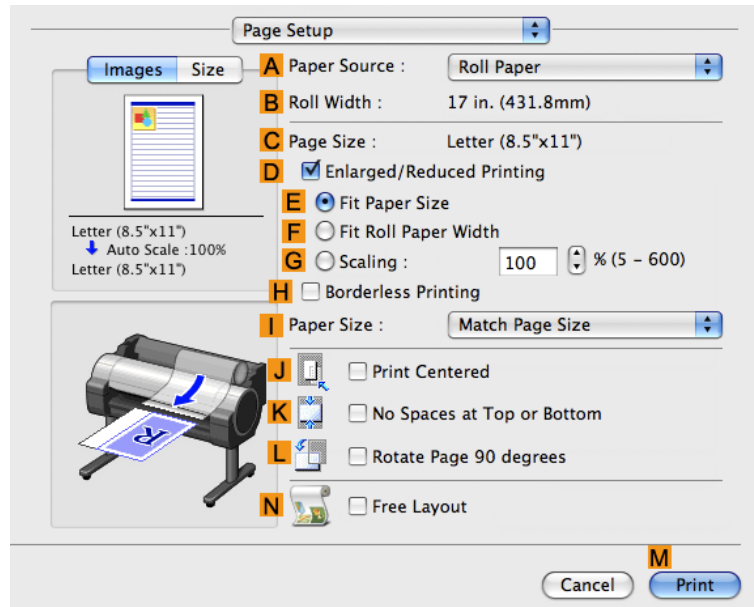

8. Select and click a roll paper in the **A Paper Source** list.

- Make sure the width of the loaded roll is displayed in **B Roll Width**—in this case, **ISO A3/A4 (297.0mm)**.



Note

- If the width of the roll loaded in the printer is not shown in **B Roll Width**, click **L Printer Information** on the **Main** pane to update the printer information.

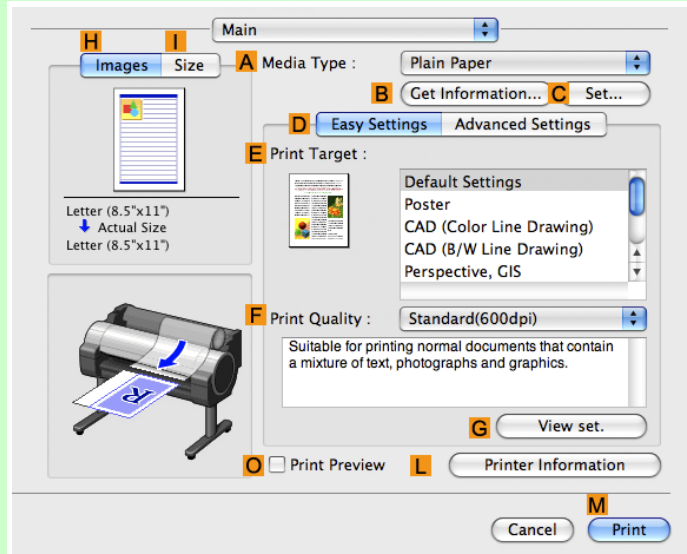

2

- Make sure the **C Page Size** setting matches the original size as selected in **C Paper Size** in the **Page Attributes** dialog box—in this case, **ISO A4**.

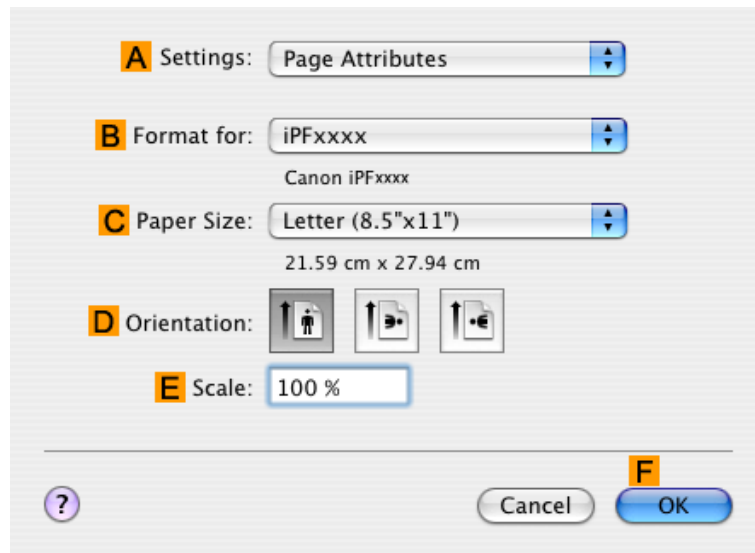

186

- Select the **K No Spaces at Top or Bottom** check box.



**12.** Confirm the print settings, and then click **Print** to start printing.



Note

- For tips on confirming print settings, see "Confirming Print Settings(Mac OS X) →P.436 "

## Checking Images Before Printing

Checking the Layout in a Preview Before Printing ..... 188

### Checking the Layout in a Preview Before Printing

You can check the print layout on the preview screen.

- **Open Preview When Print Job Starts (Windows)**

While viewing the preview screen, you can also adjust orientation or other settings, and your changes will be instantly applied on the preview screen.

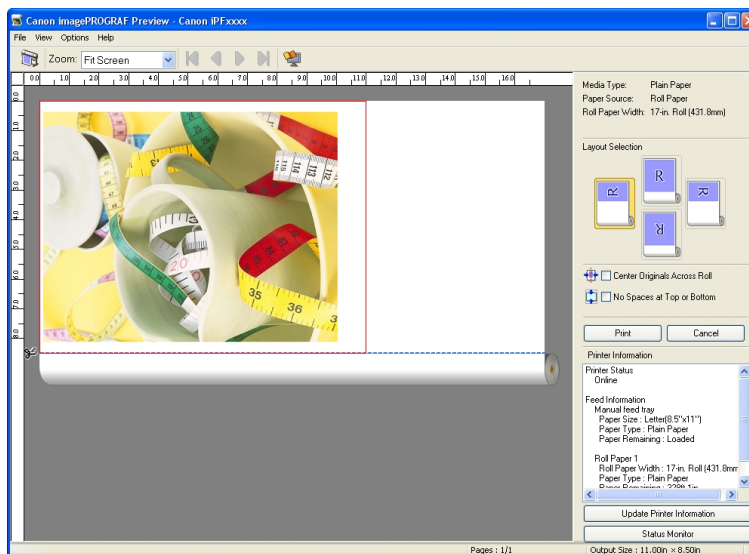

**Note**

- Under some settings and in some environments, PageComposer may be started.

- **Preview (Macintosh)**

While viewing the preview screen, you can also adjust layout or size settings, and your changes will be instantly applied on the preview screen.

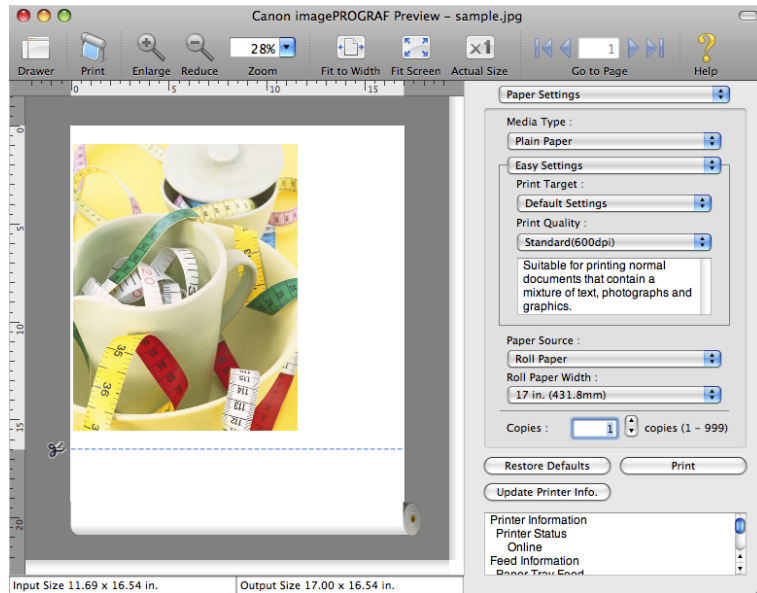

For instructions on how to check the layout before printing, refer to the following topics:

- Checking the Layout in a Preview Before Printing(Windows) →P.213
- Checking the Layout in a Preview Before Printing(Mac OS X) →P.437

## Other useful settings

Printing With Watermarks .....	190
Printing with Watermarks— COPY, FILE COPY, and so on (Windows) .....	191
Making the Original Orientation Match the Paper Orientation .....	194
Making the Original Orientation Match the Paper Orientation (Windows) .....	194
Making the Original Orientation Match the Paper Orientation (Mac OS X) .....	196
Using Favorites .....	200
Cutting Roll Paper After Printing .....	200
Cutting Roll Paper After Printing (Windows) .....	200
Cutting Roll Paper After Printing (Mac OS X) .....	202

## Printing With Watermarks

You can add watermarks (background images) to documents that require special handling.

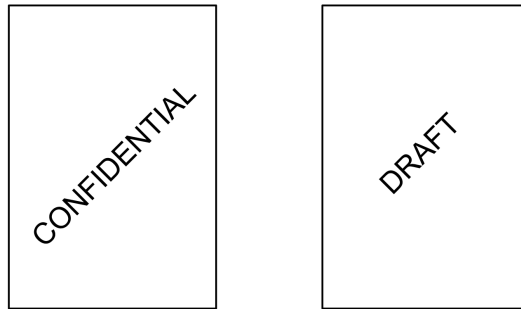

### • Watermark

Watermarks are applied to all pages of your document.



#### Important

- Watermarks are not printed if you select poster as the type of page layout.

The following watermarks are provided:

- CONFIDENTIAL
- COPY
- DRAFT
- FILE COPY
- FINAL
- PRELIMINARY
- PROOF
- TOP SECRET

You can also create your own watermarks. Specify the following options to customize your watermark.

- Watermark string: Specify the font, size, color, and so on. Surround the watermark with a frame, if desired.
- Watermark position: Specify the position on the page, the angle, and so on.
- Watermark printing method: Specify whether to print the watermark superimposed or under the document image. You can also print the watermark only on the first page, if desired.

**Note**

- Watermarks are supported in Windows.
- In addition to the provided watermarks, you can create up to 50 original watermarks.

For detailed instructions on printing with watermarks, refer to the following topics:

- Printing with Watermarks— COPY, FILE COPY, and so on (Windows) →P.191

## Printing with Watermarks— COPY, FILE COPY, and so on (Windows)

This topic describes how to print with watermarks, based on the following example of printing with a **FILE COPY** watermark.

- Document: Any type
- Page size: A2 (420.0×594.0 mm [16.5 × 23.4 in])
- Paper: Roll paper
- Paper type: Plain Paper
- Roll paper width: A2/A3 roll (420.0 mm [16.5 in])

1. Choose **Print** in the application menu.
2. Select the printer in the dialog box, and then display the printer driver dialog box. (See "Accessing the Printer Driver Dialog Box from Applications(Windows) →P.217 ")
3. Make sure the **Main** sheet is displayed.

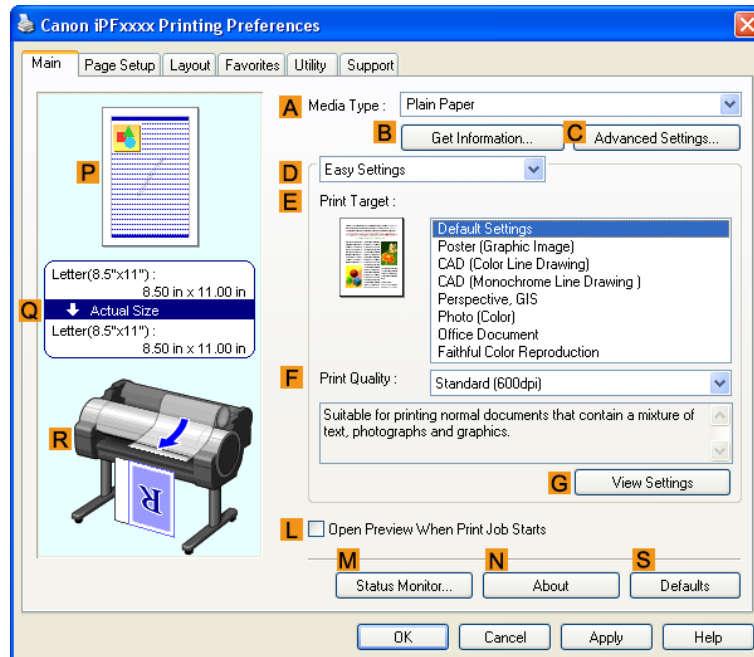

4. In the **A Media Type** list, select the type of paper that is loaded. In this case, click Plain Paper.

5. Make your selection in the **E Print Target** list.



Note

- You can check the settings values selected in the **E Print Target** list by clicking **G View Settings**.

6. Click the **Page Setup** tab to display the **Page Setup** sheet.

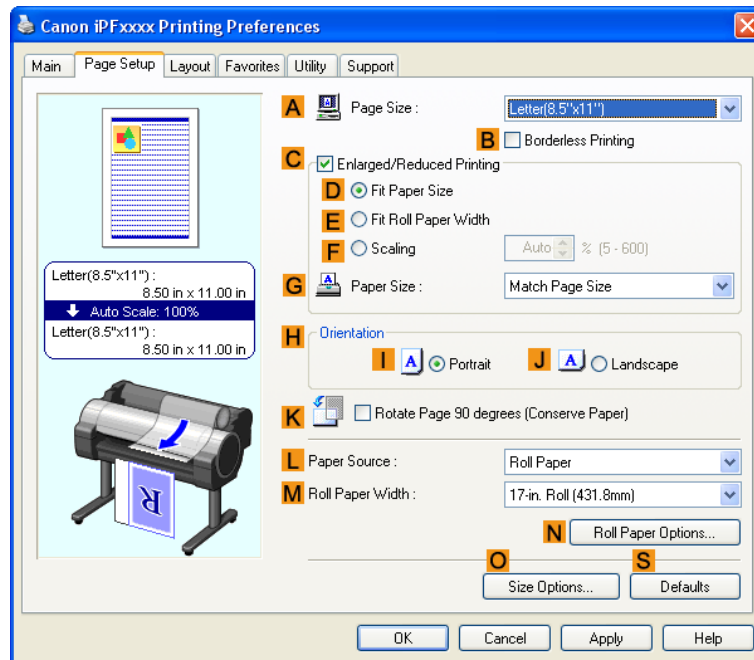

7. In **A Page Size**, click the size of the original as specified in the application software. In this case, click **ISO A2**.

8. Select and click a roll paper in the **L Paper Source** list.

9. Select the width of the loaded roll in the **M Roll Paper Width** list—in this case, **ISO A2/A3 Roll (420.0mm)**.

**10.** Click the **Layout** tab to display the **Layout** sheet.

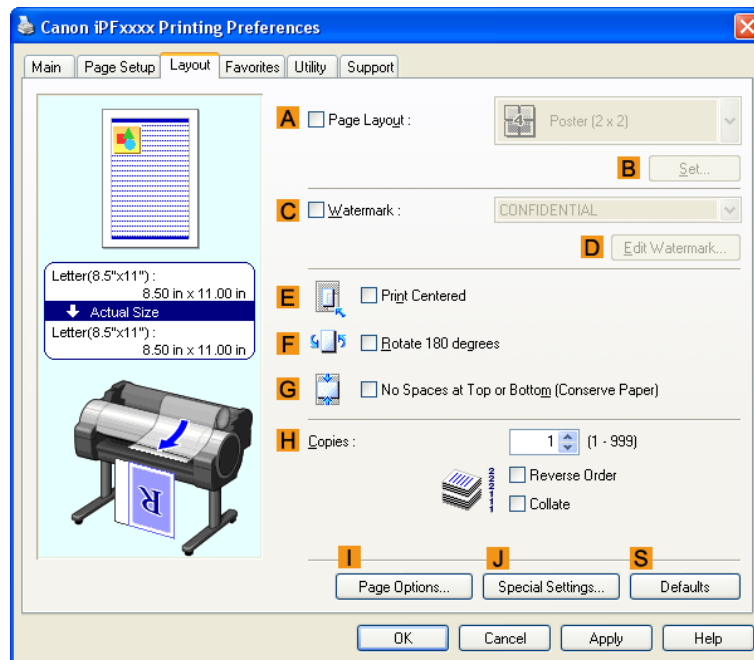

**11.** Select the **C Watermark** check box.

**12.** Click **FILE COPY** in the **Watermarks** list.



**Note**

- Click **D Edit Watermark** to open the **Edit Watermark** dialog box. In the **Edit Watermark** dialog box, you can create custom watermarks and change the position and angle of watermarks.

**13.** Confirm the print settings and print as desired.



**Note**

- For tips on confirming print settings, see "Confirming Print Settings(Windows) →P.212 "

## Making the Original Orientation Match the Paper Orientation

You can specify the original orientation to match the orientation of the paper for printing.

### • Orientation

Paper is usually loaded in the printer in portrait orientation. When you have an original in landscape orientation, you can specify the printing orientation so that the original is printed in landscape orientation.

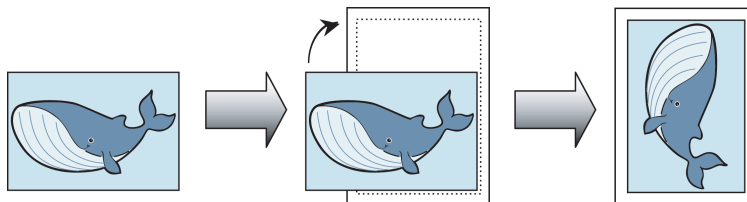

### • Rotate 180 degrees

The original is rotated 180 degrees to print it upside down.

### • Mirror

A mirror image of the original is printed.

For instructions on specifying the original orientation before printing, refer to the following topics, as appropriate for your computer and operating system.

- Making the Original Orientation Match the Paper Orientation (Windows) →P.194
- Making the Original Orientation Match the Paper Orientation (Mac OS X) →P.196

## Making the Original Orientation Match the Paper Orientation (Windows)

This topic describes how to print an original in landscape orientation after matching the paper orientation, based on the following example.

- Document: An original in landscape orientation
- Page size: A4 (210.0 × 297.0 mm)/Letter (8.3 × 11.7 in)
- Paper: Roll
- Paper type: Plain Paper
- Roll paper width: A2/A3 roll (420.0 mm [16.5 in])

1. Choose **Print** in the application menu.
2. Select the printer in the dialog box, and then open the printer driver dialog box. (See "Accessing the Printer Driver Dialog Box from Applications(Windows) →P.217 ")



3. Make sure the **Main** sheet is displayed.

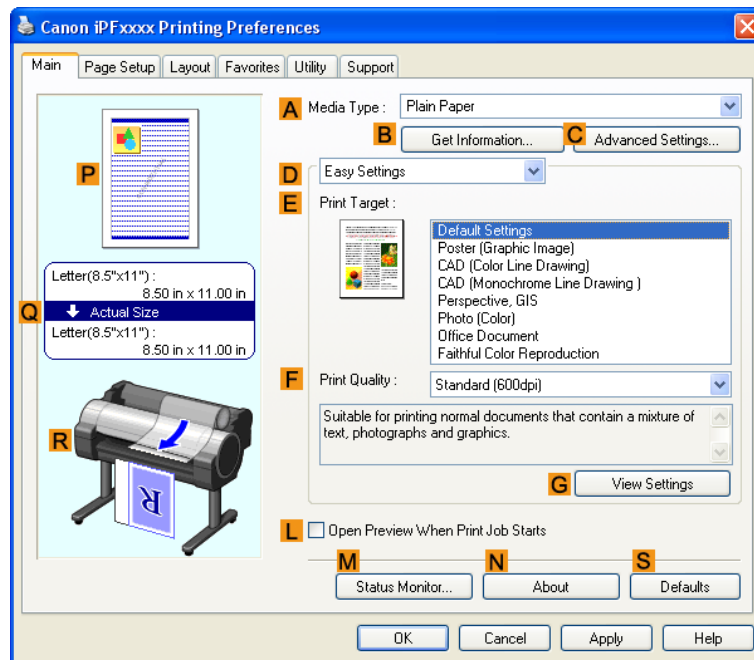

4. In the **A Media Type** list, select the type of paper that is loaded. In this case, click Plain Paper.
5. Make your selection in the **E Print Target** list.
6. Make your selection in the **F Print Quality** list.

7. Click the **Page Setup** tab to display the **Page Setup** sheet.

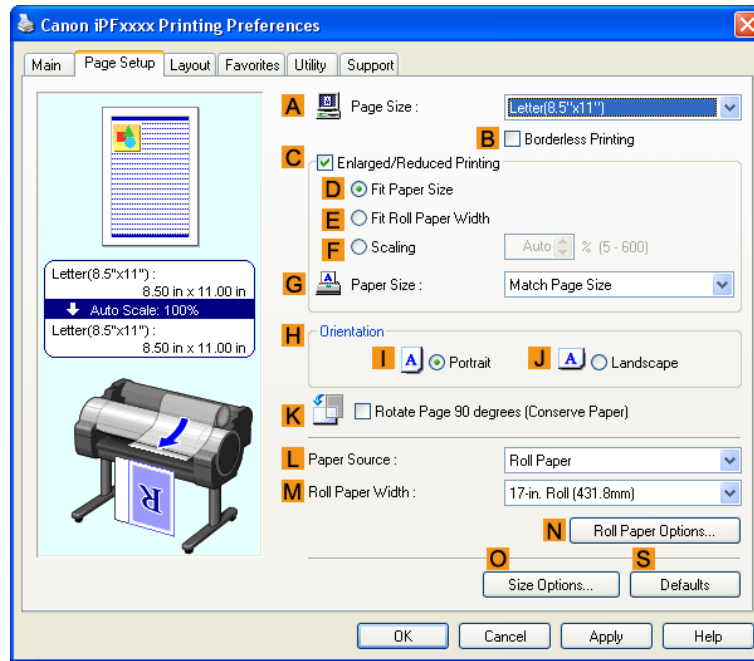

8. In the **A Page Size** list, click the size of the original as specified in the application. In this case, click **ISO A4** or **Letter (8.5\"x11\")**.

9. In **H Orientation**, click **J Landscape**.

10. Select and click a roll paper in the **L Paper Source** list.

11. Select the width of the loaded roll in the **M Roll Paper Width** list—in this case, **ISO A2/A3 Roll (420.0mm)**.

12. Confirm the print settings and print as desired.

 **Note**  
 • For tips on confirming print settings, see "Confirming Print Settings(Windows) →P.212 "

### Making the Original Orientation Match the Paper Orientation (Mac OS X)

This topic describes how to print an original in landscape orientation after matching the paper orientation, based on the following example.

- Document: An original in landscape orientation
- Page size: A4 (210.0 × 297.0 mm [8.3 × 11.7 in])
- Paper: Roll paper
- Paper type: Plain Paper
- Roll paper width: A2/A3 roll (420.0 mm [16.5 in])

1. This sets the **B Format for** and **C Paper Size**.



**Note**

- The configuration method varies depending on the OS and application software you are using. If **Page Setup** is displayed in the application menu, the settings are configured by opening the **Page Attributes** dialog box from **Page Setup**.

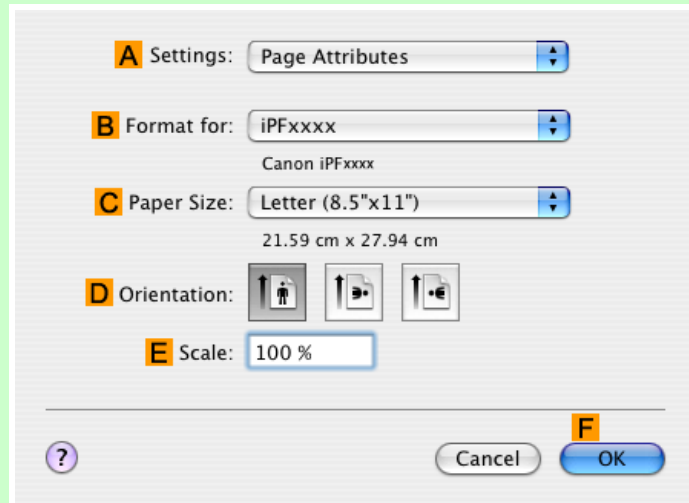

If it is not displayed, the settings are configured in the upper part of the printer driver displayed when you select **Print** from the application software menu.

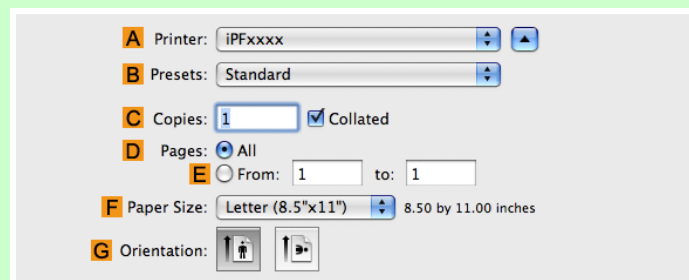

2. Select the printer in the **A Printer** list.
3. In the **F Paper Size** list, click the size of the original. In this case, click **ISO A4**.
4. In **G Orientation**, click the icon of the document in landscape orientation.
5. If you configured the settings using the **Page Attributes** dialog box, click **F OK** to close the dialog box, and then select **Print** from the application software menu.

6. Access the **Main** pane.

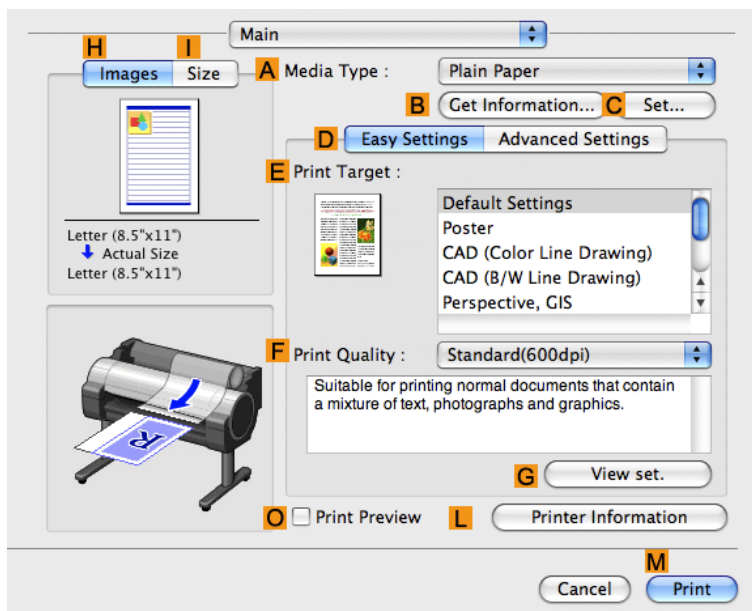

7. In the **A Media Type** list, select the type of paper that is loaded. In this case, click Plain Paper.

8. Make your selection in the **E Print Target** list.

9. Make your selection in the **F Print Quality** list.

10. Access the **Page Setup** pane.

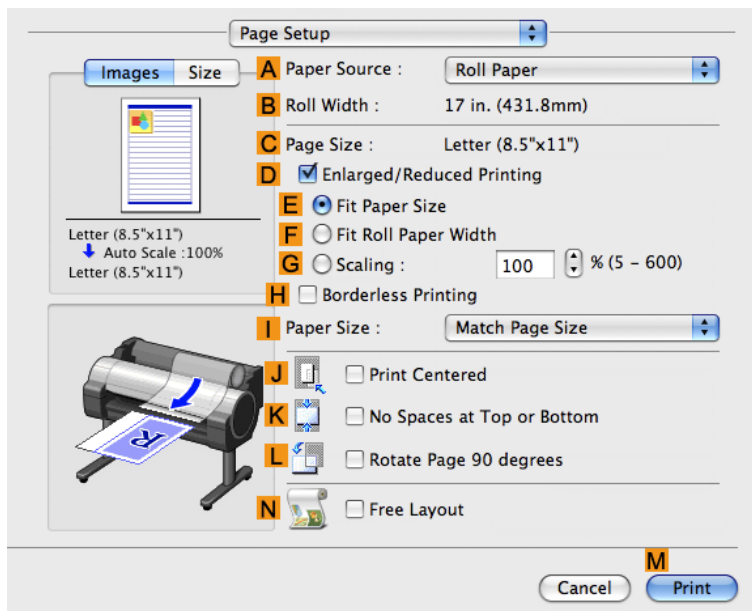

11. Select and click a roll paper in the **A Paper Source** list.
12. Make sure the width of the loaded roll is displayed in the **B Roll Width** list—in this case, **ISO A2/A3 (420.0mm)**.

**Note**

- If the width of the roll loaded in the printer is not shown in **B Roll Width**, click **L Printer Information** on the **Main** pane to update the printer information.

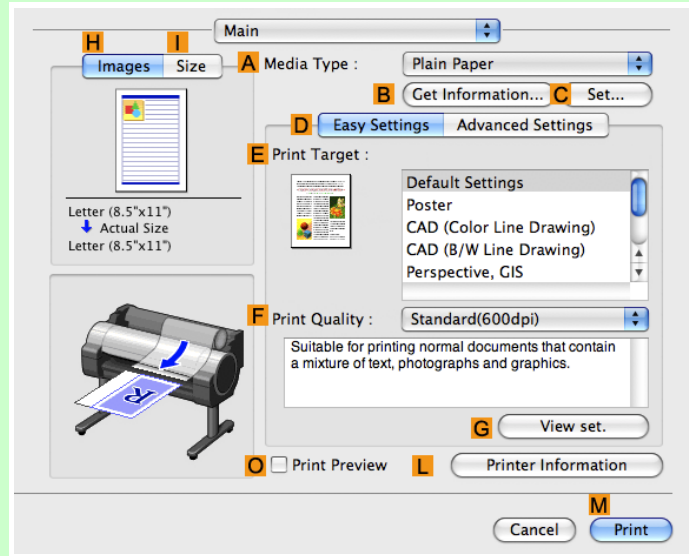

13. Make sure the **C Page Size** setting matches the original size as selected in **C Paper Size** in the **Page Attributes** dialog box—in this case, **ISO A4**.

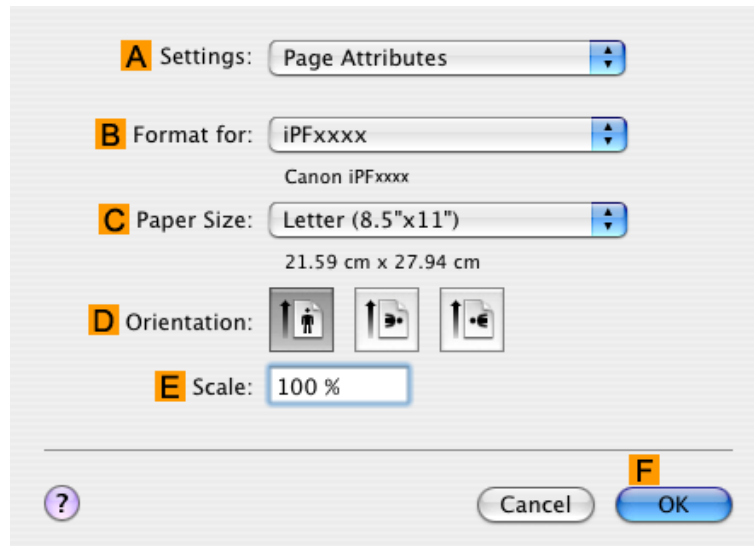

## 14. Confirm the print settings, and then click **M Print** to start printing.



### Note

- For tips on confirming print settings, see "Confirming Print Settings(Mac OS X) →P.436 "

## Using Favorites

You can register print settings as **Favorites** to reuse settings from a particular job that met your expectations, or settings for a particular page size that you will use repeatedly.

### • Favorites

Registering a favorite for later use. You can choose the settings you have registered from a list before printing, and you can check the settings details.



### Note

- You can also save the favorite settings as files. Using these files is a convenient way to print under the same conditions on another computer. (In Windows.)

For instructions on using favorites to print, refer to the following topics, as appropriate for your computer and operating system.

- Using Favorites(Windows) →P.214
- Using Favorites(Mac OS X) →P.439

## Cutting Roll Paper After Printing

Roll paper can be automatically cut after printing.



### Note

- It may not be possible to cut certain types of paper, such as adhesive paper. For details on types of paper that cannot be used with the auto cut feature, see the Paper Reference Guide. (See "Types of Paper →P.568 ")

### • Automatic Cutting

Roll paper is cut automatically after printing. If you prefer, you can print continuously without cutting the roll, or you can print a cut line.

For instructions on cutting roll paper after printing, refer to the following topics, as appropriate for your computer and operating system.

- Cutting Roll Paper After Printing (Windows) →P.200
- Cutting Roll Paper After Printing (Mac OS X) →P.202

## Cutting Roll Paper After Printing (Windows)

This topic describes how to cut roll paper automatically after printing (using the auto cut function), as well as how to print a cut line for manual cutting.



### Note

- The auto cut function is activated on the printer by default and when the printer driver is installed. Follow the steps below to reactivate the function if it is disabled, or to select the setting for printing a cut line instead.

1. Choose **Print** in the application menu.
2. Select the printer in the dialog box, and then display the printer driver dialog box. (See "Accessing the Printer Driver Dialog Box from Applications(Windows) (→P.217)")
3. Click the **Page Setup** tab to display the **Page Setup** sheet.

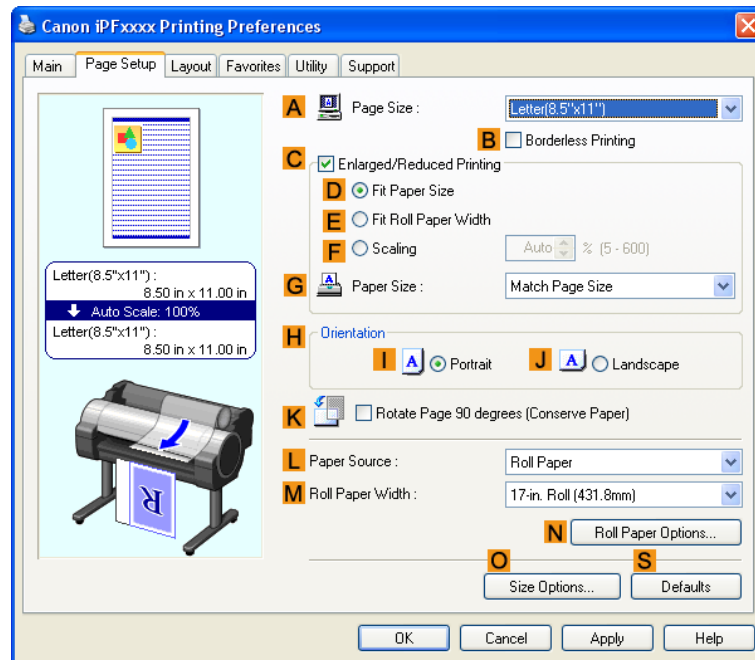

4. Select and click a roll paper in the **L Paper Source** list.
5. Click **N Roll Paper Options** to display the **Roll Paper Options** dialog box.

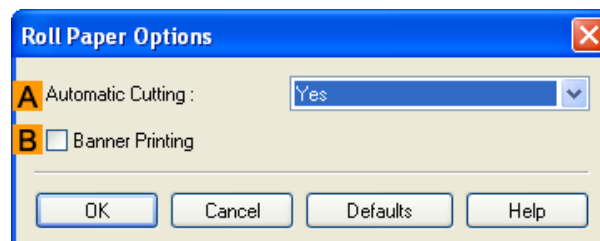

6. To enable automatic cutting, click **Yes** in the **A Automatic Cutting** list. If you prefer to cut the paper later yourself, click **Print Cut Guideline**.
7. Click **OK** to close the **Roll Paper Options** dialog box.

## 8. Confirm the print settings and print as desired.



**Note**

- For tips on confirming print settings, see "Confirming Print Settings(Windows) →P.212 "

Roll paper will be automatically cut after printing.

## Cutting Roll Paper After Printing (Mac OS X)

This topic describes how to cut roll paper automatically after printing (using the auto cut function), as well as how to print a cut line for manual cutting.



**Note**

- The auto cut function is activated on the printer by default and when the printer driver is installed. Follow the steps below to reactivate the function if it is disabled, or to select the setting for printing a cut line instead.

### 1. This sets the **B** Format for and **C** Paper Size.



**Note**

- The configuration method varies depending on the OS and application software you are using. If **Page Setup** is displayed in the application menu, the settings are configured by opening the **Page Attributes** dialog box from **Page Setup**.

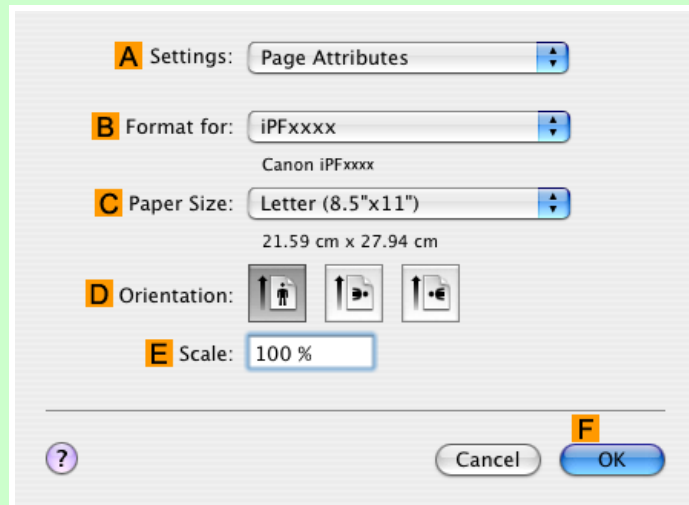

If it is not displayed, the settings are configured in the upper part of the printer driver displayed when you select **Print** from the application software menu.

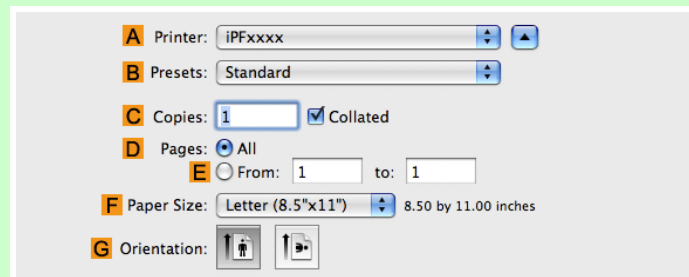



2. Select the printer in the **A Printer** list.
3. Choose the original size in the **F Paper Size** list.
4. If you configured the settings using the **Page Attributes** dialog box, click **F OK** to close the dialog box, and then select **Print** from the application software menu.
5. Access the **Page Setup** pane.

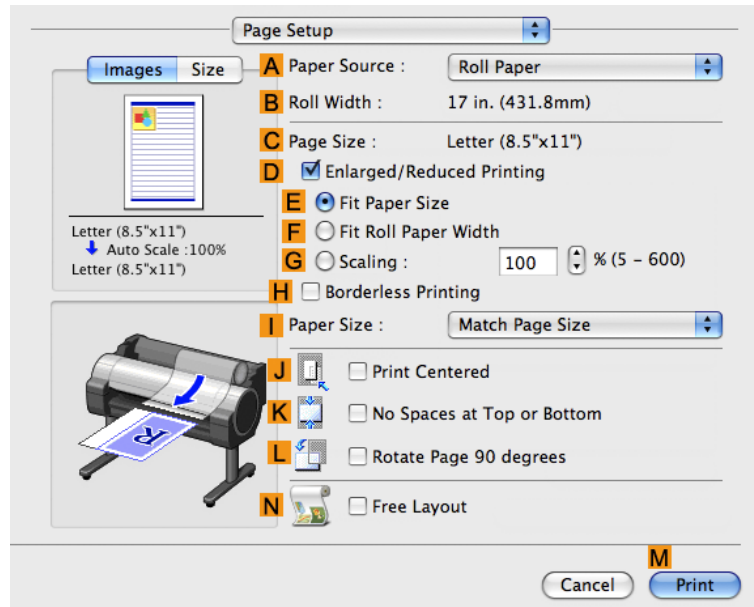

6. Select and click a roll paper in the **A Paper Source** list.

7. Access the **Main** pane.

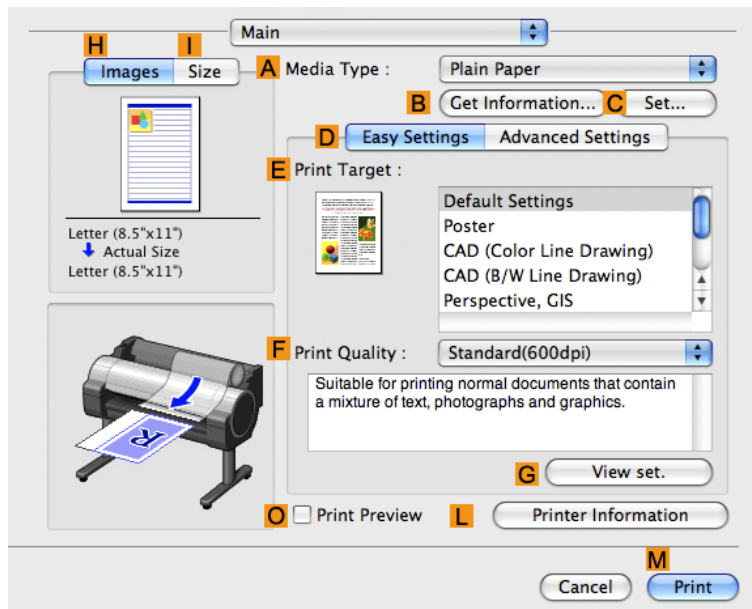

8. In the **A Media Type** list, select the type of paper that is loaded.

9. Click **C Set** to display the **Paper Detailed Settings** dialog box.

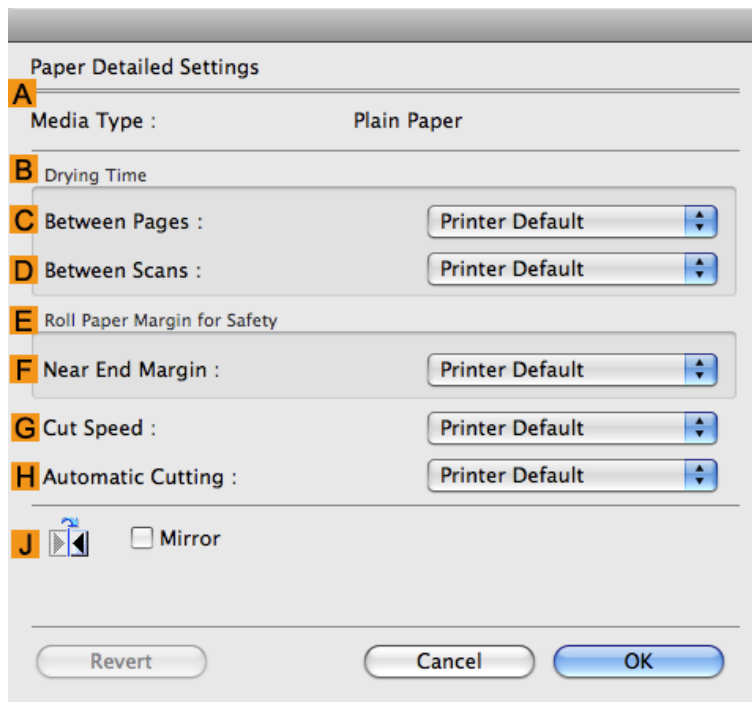

2

204

- 10.** To enable automatic cutting, click **Printer Default** in the **H Automatic Cutting** list. If you prefer to cut the paper later yourself, click **Print Cut Guideline**.

**Important**

- If the automatic cut function has been deactivated on the printer, change the auto cut setting on the printer Control Panel.

- 11.** Click **OK** to close the **Paper Detailed Settings** dialog box.

- 12.** Confirm the print settings, and then click **M Print** to start printing.

**Note**

- For tips on confirming print settings, see "Confirming Print Settings(Mac OS X) →P.436 "

## Windows Software

Printer Driver	207
Preview	246
Free Layout	259
Color imageRUNNER Enlargement Copy	289
Print Plug-In for Office	303
HDI Driver	358
Status Monitor	390
Accounting	393
Digital Photo Front-Access	406
Device Setup Utility	407
Media Configuration Tool	412

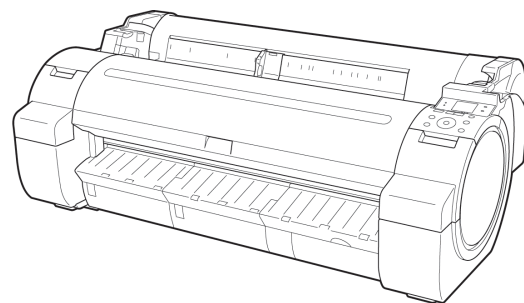

## Printer Driver

Printer Driver Settings .....	207
Specifying Paper in the Printer Driver .....	209
Confirming Print Settings .....	212
Checking the Layout in a Preview Before Printing .....	213
Using Favorites .....	214
Accessing the Printer Driver Dialog Box from Applications .....	217
Accessing the Printer Driver Dialog Box from the Operating System Menu .....	218
Main Sheet .....	220
Paper Information on Printer Dialog Box .....	224
Paper Detailed Settings Dialog Box .....	225
View Settings Dialog Box for the Printing Application .....	226
Color Adjustment Sheet: Color .....	226
Object Adjustment dialog box: Color .....	228
Matching Sheet .....	229
Color Adjustment Sheet: Monochrome .....	231
Object Adjustment dialog box: Monochrome .....	232
Page Setup Sheet .....	233
Paper Size Options Dialog Box .....	235
Layout Sheet .....	237
Page Options Dialog Box .....	238
Special Settings Dialog Box .....	239
Favorites Sheet .....	240
Utility Sheet .....	242
Support Sheet .....	243
Settings Summaries Dialog Box .....	244
Device Settings Sheet .....	245

## Printer Driver Settings

For instructions on accessing the Windows printer driver, refer to the following topics.

- Accessing the Printer Driver Dialog Box from Applications →P.217
- Accessing the Printer Driver Dialog Box from the Operating System Menu →P.218

For information on the Windows printer driver settings, refer to the following topics.

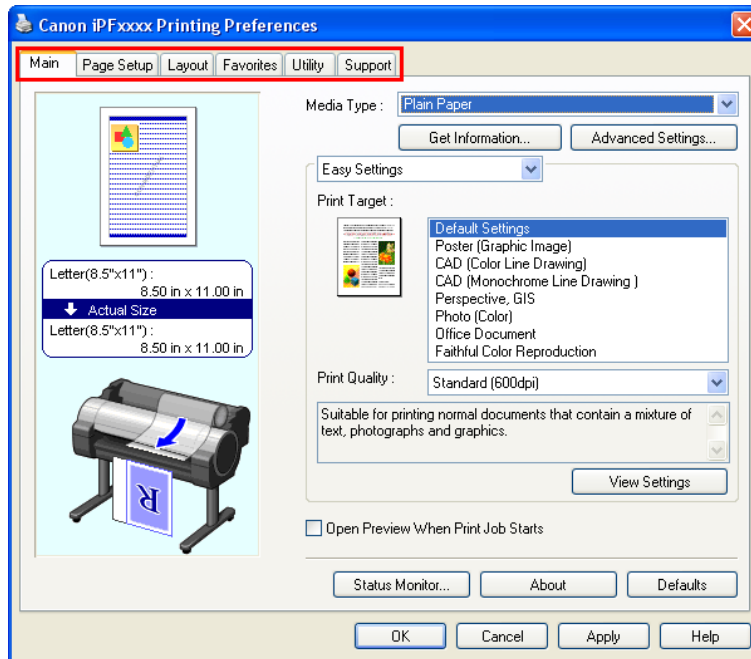

- Main Sheet →P.220

You can specify the type of paper, color processing, print quality, print preview, and other settings. Choose **Easy Settings** to specify basic print settings based on the printing application or **Advanced Settings** to complete more detailed settings as desired.

- Paper Detailed Settings Dialog Box →P.225
- View Settings Dialog Box for the Printing Application →P.226
- Color Adjustment Sheet: Color →P.226
- Matching Sheet →P.229
- Color Adjustment Sheet: Monochrome →P.231

- Page Setup Sheet →P.233

You can specify the page size of the original, borderless printing, enlargement or reduction, the orientation, the paper size and feed source, and automatic cutting.

- Paper Size Options Dialog Box →P.235

- Layout Sheet →P.237

You can specify the page layout, watermarks, the orientation, the number of copies, and print processing options.

- Page Options Dialog Box →P.238
- Special Settings Dialog Box →P.239

- Favorites Sheet →P.240

Groups of print settings you select on each sheet can be saved as a favorite. Favorites you have added can be edited or used at the time of printing as desired.

- Utility Sheet →P.242

You can specify settings related to maintenance for the Printhead and feed amount, as well as settings for **Color imageRUNNER Enlargement Copy**.

- Support Sheet →P.243

You can view support information and the user manual.

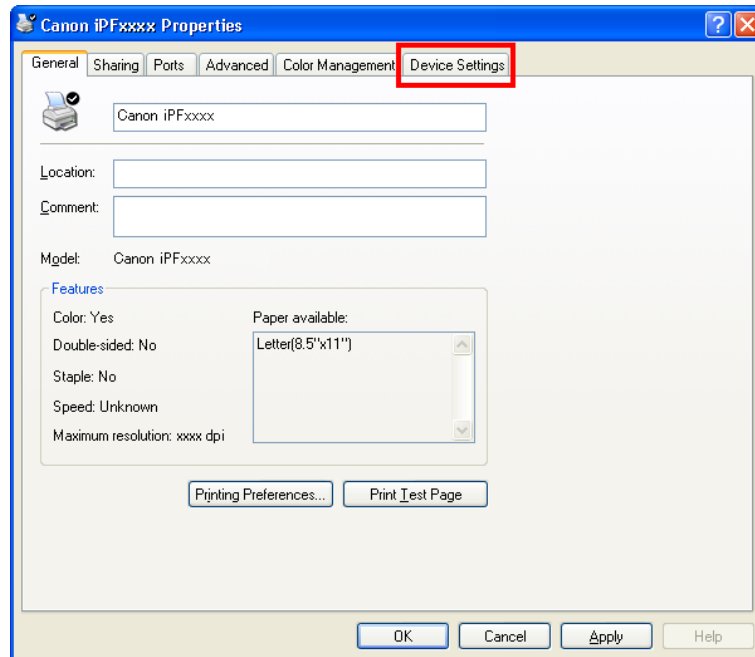

- **Device Settings Sheet** →P.245

You can display settings for optional equipment installed on the printer and see the version information for the printer driver.

**imagePROGRAF Free Layout** is a feature for freely arranging originals from various source applications on a single page as desired before printing. For details, see **Free Layout** →P.259 .

**Color imageRUNNER Enlargement Copy** is a feature for automatic enlargement and printing of scanned originals from a **Color imageRUNNER**. For details, see **Color imageRUNNER Enlargement Copy** →P.289 .



**Important**

- **Color imageRUNNER Enlargement Copy** and **imagePROGRAF Free Layout** cannot be used on 64-bit version of Windows.

## Specifying Paper in the Printer Driver

If you have replaced the paper, you must complete the following settings in the printer driver.



**Important**

- Always specify the same type and size of paper in the printer menu and printer driver.

1. Choose **Print** in the application menu.
2. Select the printer in the dialog box, and then display the printer driver dialog box. (See "Accessing the Printer Driver Dialog Box from Applications →P.217 ")

### 3. Make sure the **Main** sheet is displayed.

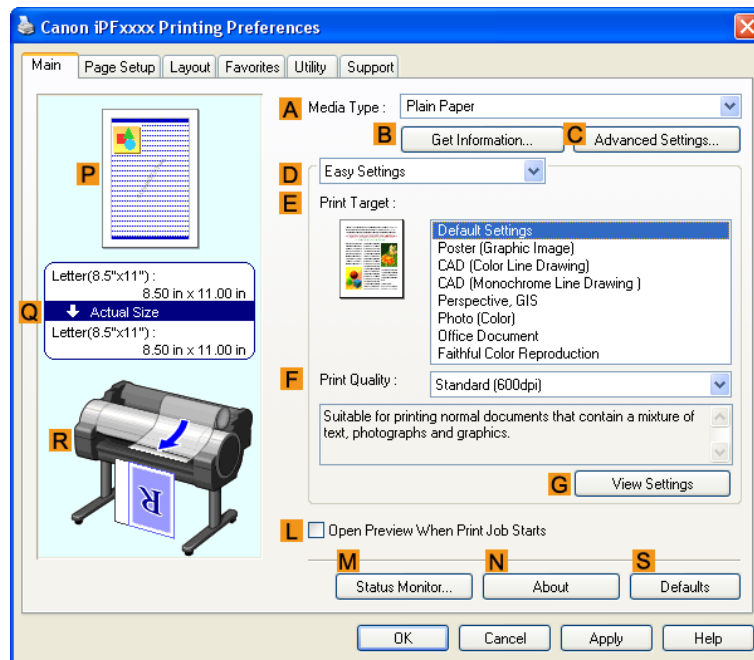

### 4. In the **A Media Type** list, select the type of paper that is loaded.



#### Note

- Click the **B Get Information** button to display the **Paper Information on Printer** dialog box. On the **Paper Information on Printer** dialog box, you can obtain information on the paper in the printer and configure printer driver settings for the feed source and type of paper. This function requires that the **Status Monitor** be installed.



5. Click the **Page Setup** tab to display the **Page Setup** sheet.

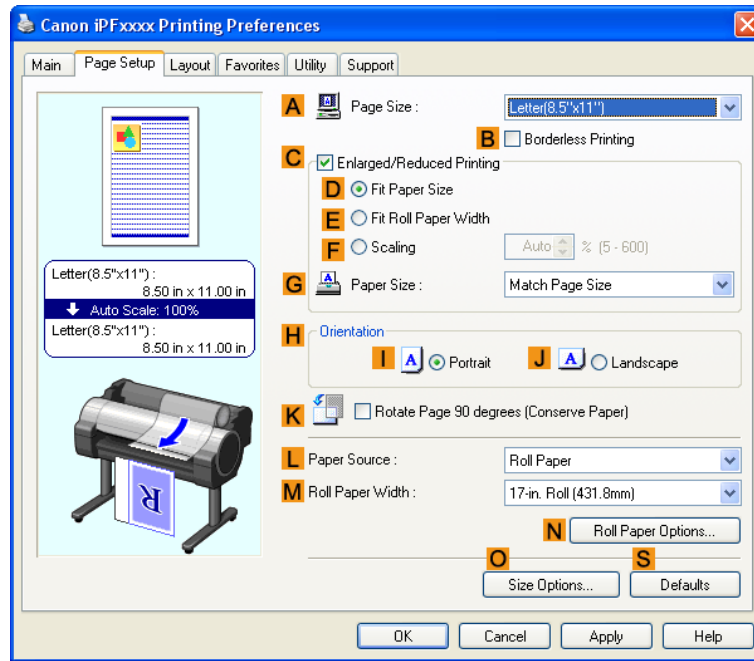

6. In the **A Page Size** list, select the size of the original as specified in the application.
7. In the **L Paper Source** list, select how paper is supplied.
8. If you have selected roll paper in **L Paper Source**, select the width of the loaded roll in **M Roll Paper Width**.



**Note**

- A variety of settings are available in the printer driver to suit different printing applications. For details on available printing conditions, see "Printer Driver Settings →P.207 "

## Confirming Print Settings

There are two ways to confirm the print settings, as follows.

- **Checking a preview of the settings**

A preview of the settings is displayed on the left side of the **Main**, **Page Setup**, and **Layout** sheets. By checking illustrations and numerical values in the preview, you can confirm current settings for the page size, orientation, paper source, layout, and so on.

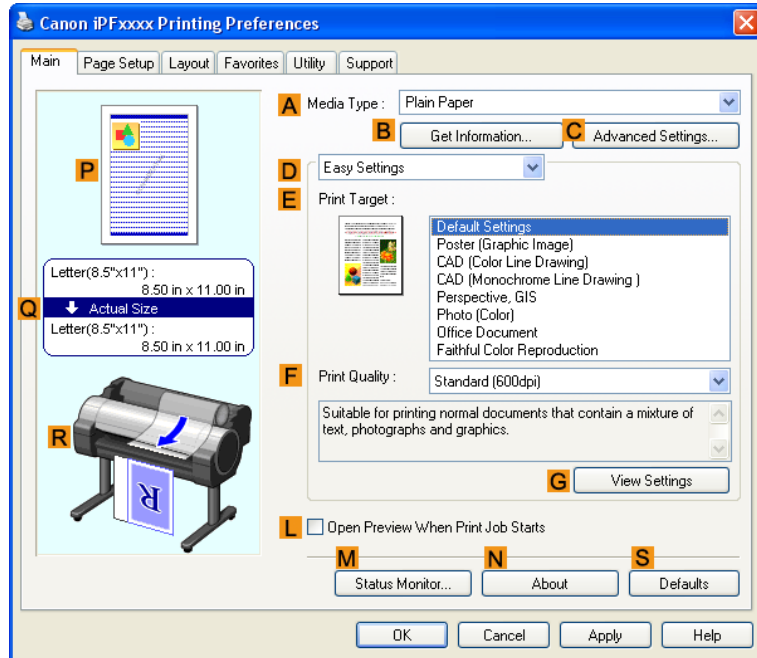

Display Area	Information Displayed
<b>P Top illustrations</b>	Illustrations indicate the orientation, page layout, borderless printing selection, color mode, and other settings information.
<b>Q Middle, bordered area</b>	The page size, paper size, and method and percentage of enlargement or reduction are indicated.
<b>R Bottom illustrations</b>	Illustrations indicate the feed source, orientation, borderless printing selection, and other settings information.



**Note**

- To confirm the **Print Target** specified in **Easy Settings**, click **G View Settings** on the **Main** sheet to display the **View Settings** dialog box.

- **Checking a print preview**

You can check an image of the original just as it will be printed.

When you activate this feature, imagePROGRAF Preview or PageComposer is started before printing. Confirming how documents will be printed this way helps prevent printing errors.

For details on print previews, see "Checking the Layout in a Preview Before Printing **→P.188** "

## Checking the Layout in a Preview Before Printing

This topic describes how to preview images of print jobs before actually printing them.

1. Choose **Print** in the application menu.
2. Select the printer in the dialog box, and then display the printer driver dialog box. (See "Accessing the Printer Driver Dialog Box from Applications →P.217 ")
3. Make sure the **Main** sheet is displayed.

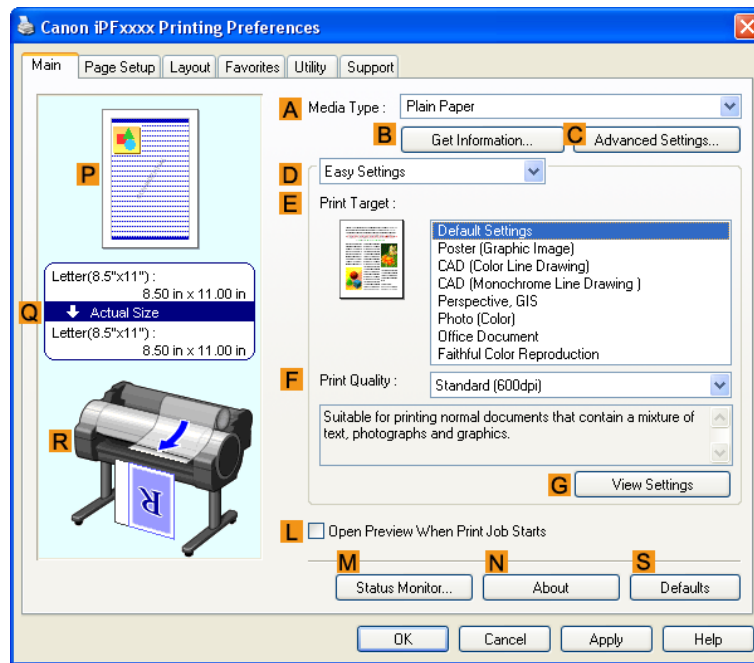

4. Select the **L Open Preview When Print Job Starts** check box.

5. After you click **OK**, when you print a job, the **imagePROGRAF Preview** window will be displayed.

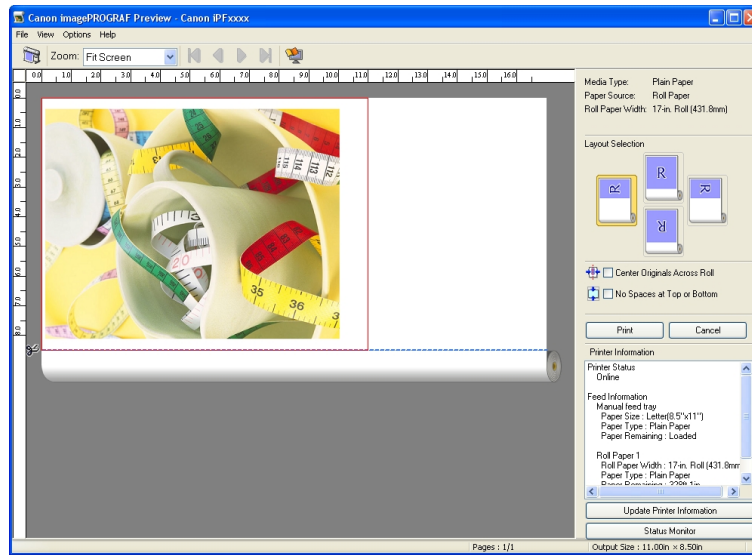

#### Note

- If PageComposer is running, access the **Special Settings** dialog box from the **Layout** sheet and clear **Enable Preview Switching**.

6. On the main window, you can check the layout and change settings as needed.

7. To print, click **Print** in the **File** menu.



#### Note

- For details on **imagePROGRAF Preview** functions, see **Preview** →P.246 .

## Using Favorites

This topic describes how to register favorites and print using favorite settings.

### Registering a favorite

This section describes the procedure for registering printing settings that have been changed in the driver as **Favorites**.

1. Choose **Print** in the application menu.
2. Select the printer in the dialog box, and then display the printer driver dialog box. (Refer to "Accessing the Printer Driver Dialog Box from Applications" →P.217 )
3. Perform normal printing settings.  
The favorite is registered from here.

4. Click the **Favorites** tab to display the **Favorites** sheet.

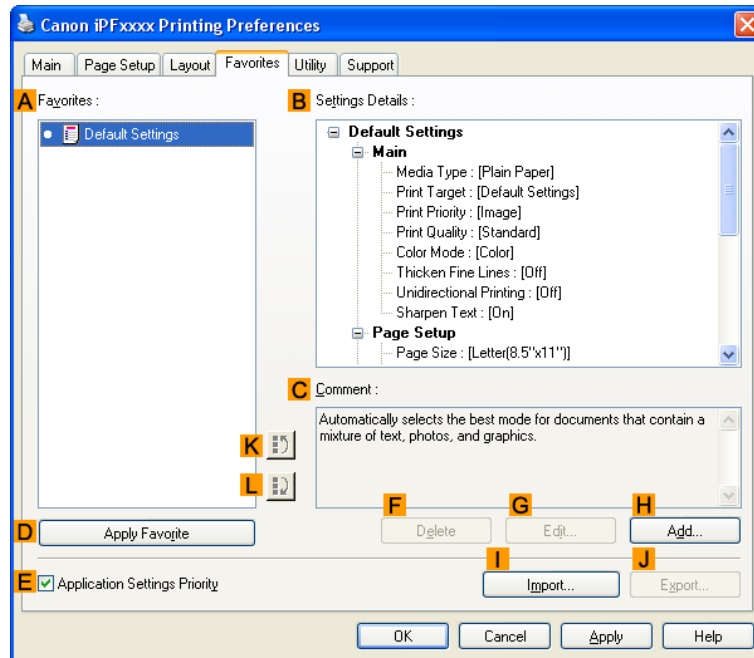

5. Click **H Add** to display the **Add** dialog box.

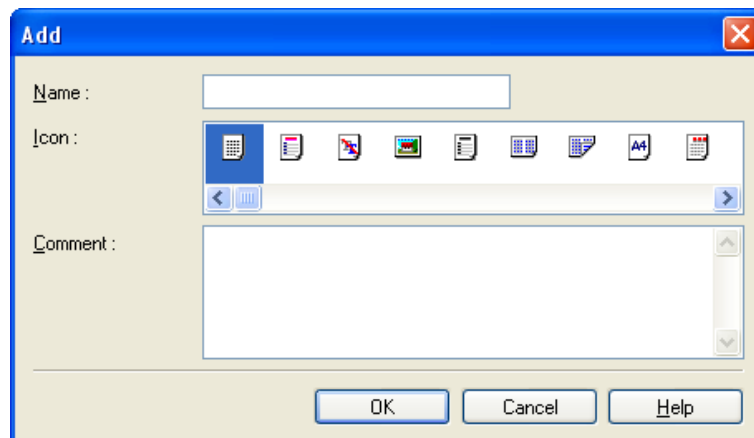

6. Enter a desired name in **Name**, such as **Photos for Presentations** or **Monthly Report**.

7. Choose a fitting icon for these print settings in the **Icon** list.

8. In **Comment**, enter a description of the favorite to be added, as desired.

- Click **OK** to close the **Add** dialog box.  
The favorite you have added is now displayed in **A Favorites**.

**Note**

- To save a favorite as a file, click **J Export** and specify the file to save.

## Printing using the favorite

Follow the steps below to print using the favorite you have registered.

- Choose **Print** in the application menu.
- Select the printer in the dialog box, and then display the printer driver dialog box. (See "Accessing the Printer Driver Dialog Box from Applications →P.217 ")
- Click the **Favorites** tab to display the **Favorites** sheet.

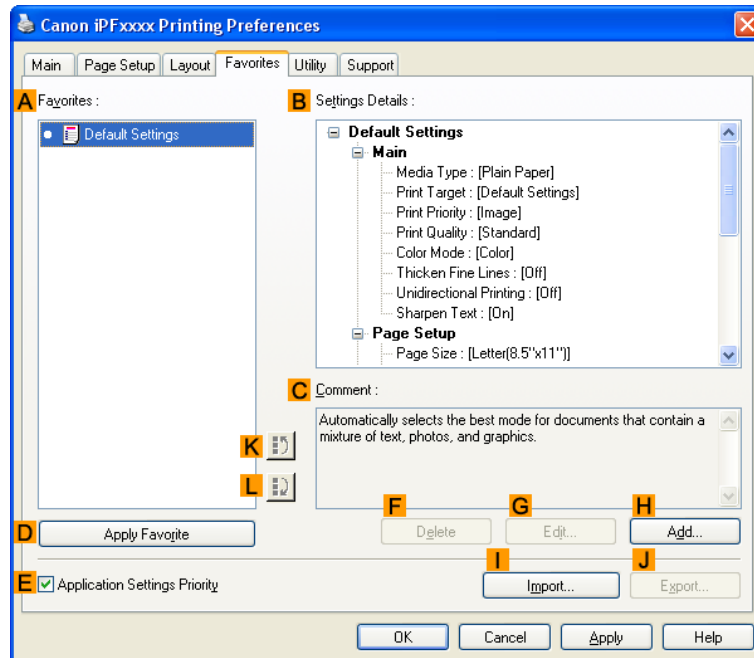

- In the **A Favorites**, choose the favorite you registered.

**Note**

- To import a favorite, click **I Import** and specify the favorite file.

- Click **D Apply Favorite** to replace the favorite settings with the current print settings.

## 6. Confirm the print settings and print as desired.



### Note

- For instructions on confirming print settings, see "Confirming Print Settings →P.212 "

## Accessing the Printer Driver Dialog Box from Applications

### 1. Choose **Print** from the **File** menu to display the dialog box for printing conditions.

### 2. Select the printer, and then display the printer driver dialog box.



### Note

- The dialog box for specifying printing conditions varies depending on the source application. In some cases, when you select the printer, a sheet for configuring the printer driver is added to the dialog box.  
In the following case, click **Preferences**.

- Example: **Print** dialog box displayed by the application software

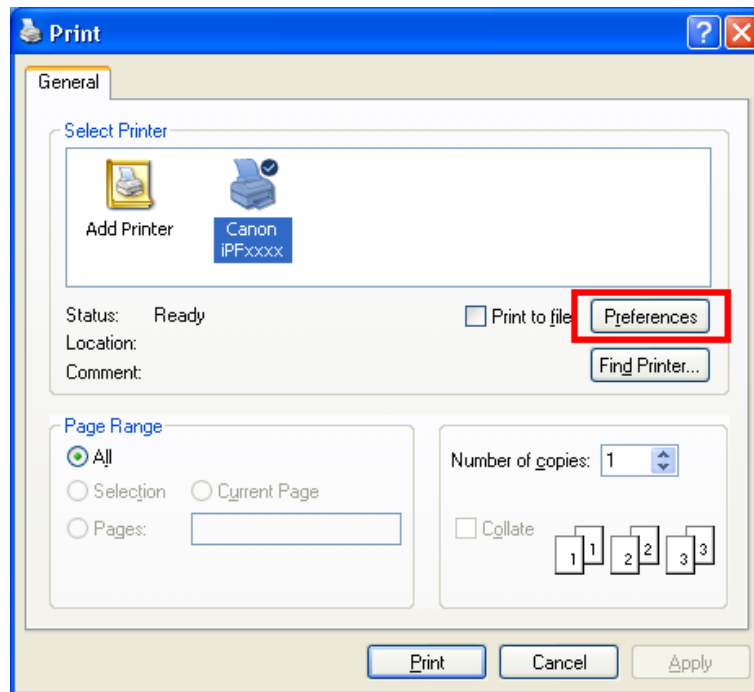

Six sheets of print settings are displayed by the printer driver: **Main**, **Page Setup**, **Layout**, **Favorites**, **Utility**, and **Support**.

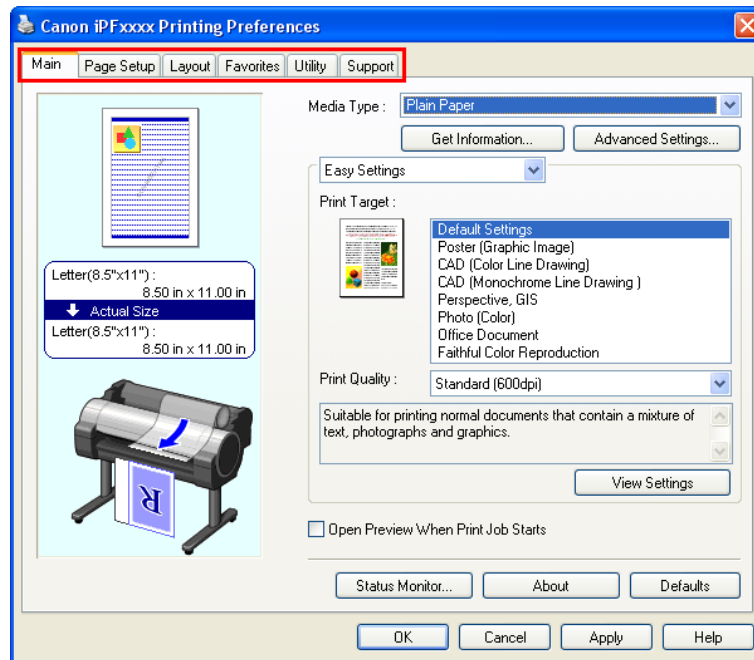

#### Note

- The titles of dialog boxes may vary depending on the application, and sheets other than these six sheets may be displayed.



#### Important

- If you access the printer driver dialog box from the source application, changes you make to the settings will only apply temporarily to that application. Because these are sizes you specify temporarily in the printer driver, the sizes will not be available after you exit the application.
- You can also access the printer driver dialog box from the Windows system menu. To use the settings continuously in all applications, open the printer driver from the system menu to make the settings. See "Accessing the Printer Driver Dialog Box from the Operating System Menu **→P.218**".

## Accessing the Printer Driver Dialog Box from the Operating System Menu

1. Click **start > Printers and Faxes** (or **Printers**).



2. Select the printer, and then display the printer properties dialog box.

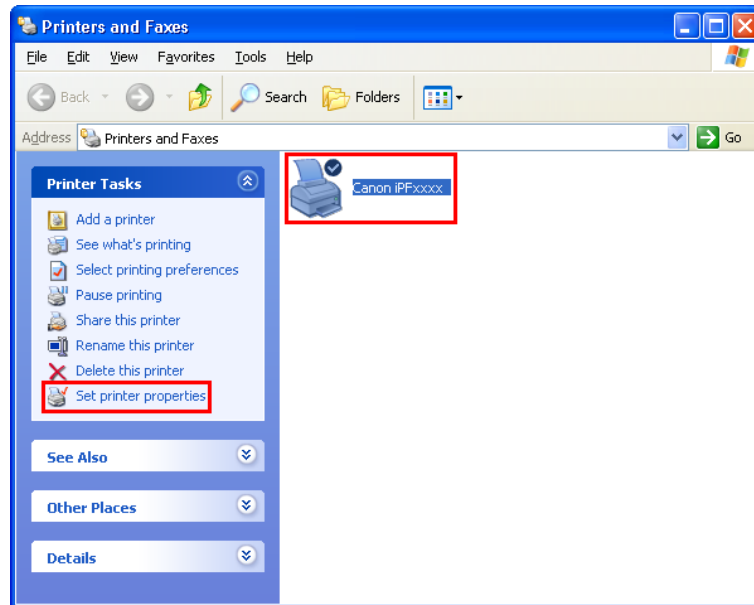

3

3. Click **Printing Preferences** to display the **Printing Preferences** dialog box, titled with the name of this printer.

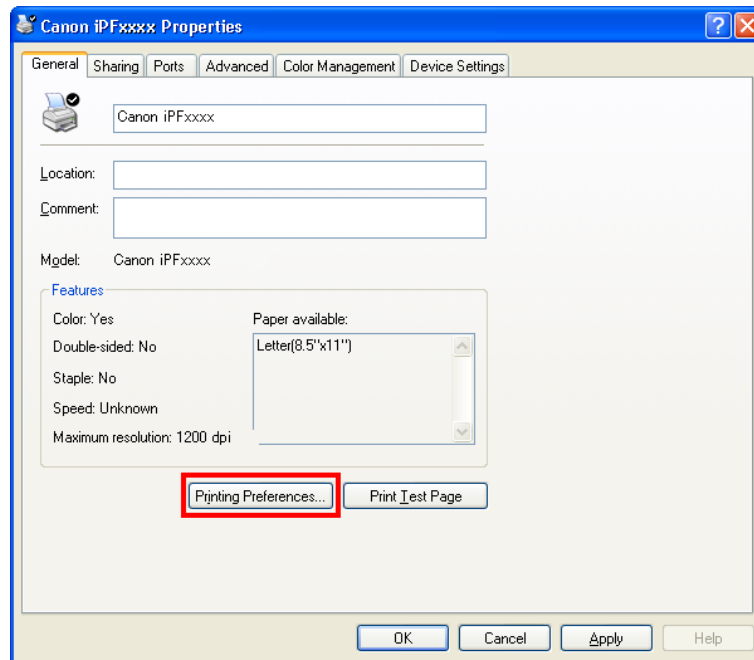

219



**Note**

- The **Device Settings** sheet is also an extension of the printer driver. (See "Device Settings Sheet →P.245 ")

Six sheets of print settings are displayed by the printer driver: **Main**, **Page Setup**, **Layout**, **Favorites**, **Utility**, and **Support**.

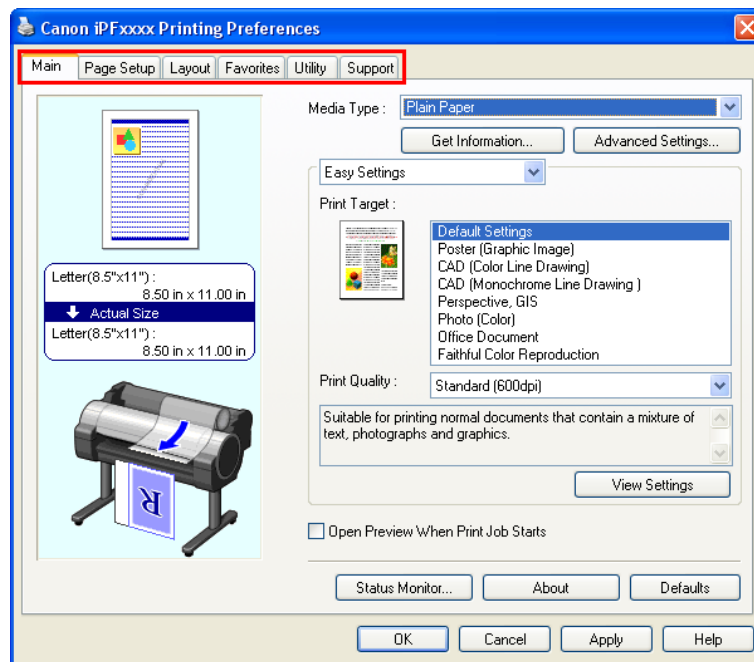

#### Important

- If you access the printer driver dialog box from the operating system menu, changes you make to the settings will apply to all applications you use for printing.
- You can also access the printer driver dialog box from applications.  
See "Accessing the Printer Driver Dialog Box from Applications →P.217".

## Main Sheet

The following settings are available on the **Main** sheet. For details on settings items, refer to the printer driver help file.



#### Note

- On the **Main** sheet, choose **Easy Settings** to specify basic print settings based on the particular printing application, or switch to **Advanced Settings** to complete more detailed settings as desired.

## Common Items

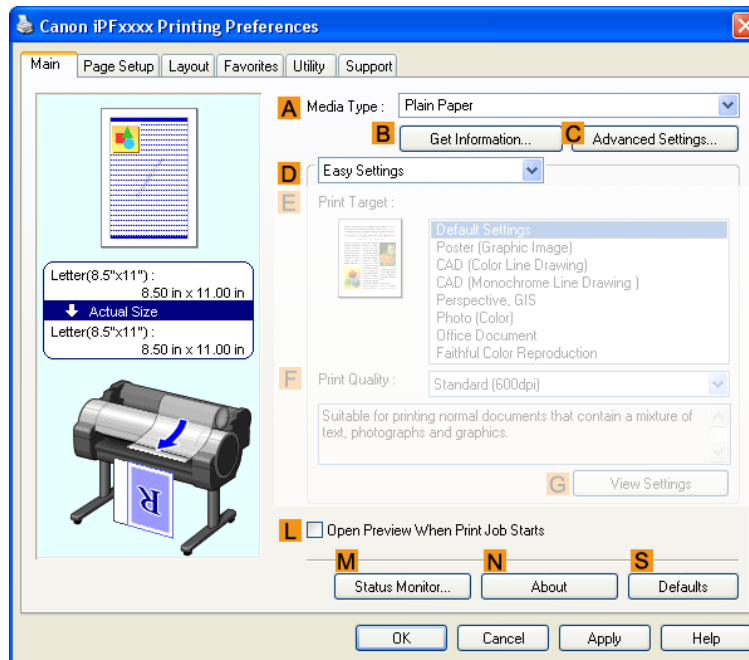

- **A Media Type**

Select the type of paper.

For information on the types of paper the printer supports, refer to the Paper Reference Guide. (See "Types of Paper" →P.568 ")

- **B Get Information**

Displays **Paper Information on Printer**. You can update the printer driver settings for the feed source, media type, and roll width by selecting the feed source.

- Paper Information on Printer Dialog Box →P.224

- **C Advanced Settings**

Displays **Paper Detailed Settings**. You can configure the printing settings to match the type of media, such as the ink drying time.

- Paper Detailed Settings Dialog Box →P.225

- **L Open Preview When Print Job Starts**

If you turn this on, **imagePROGRAF Preview** starts before printing.

This allows you to check on-screen previews of documents before printing.

- Checking the Layout in a Preview Before Printing →P.188

- **M Status Monitor**

Starts imagePROGRAF Status Monitor.

You can check the printer status, job status, and other conditions.

You can also set up email notification if printer errors occur by completing the **Email Notice** settings.

For details, refer to the **Status Monitor** help file.

- **N About**

Displays version information for the printer driver.

- **S Defaults**

Restores all settings on the sheet to the default values.

## Configuration using **Easy Settings**

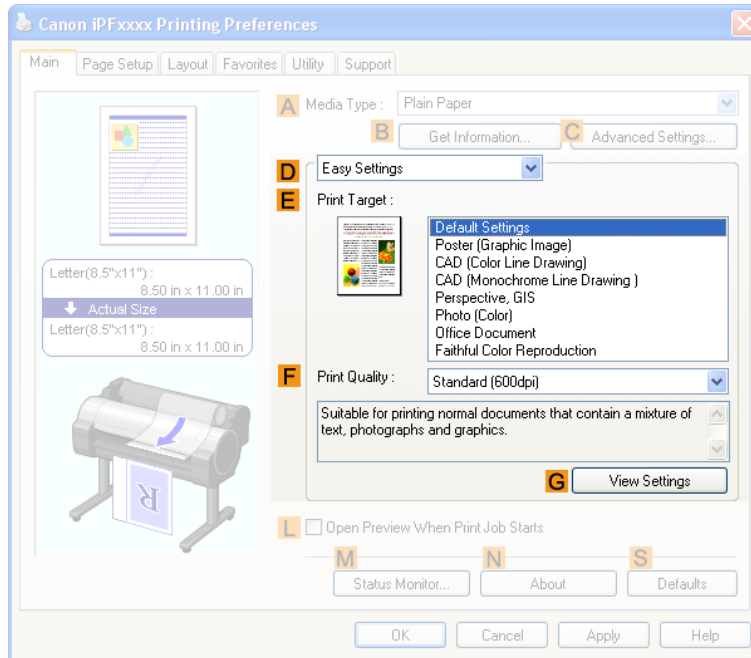

- **E Print Target**

Choose presets that match the type of document to be printed.

- Printing Photos and Images →P.22
- Printing Line Drawings and Text →P.39
- Printing Office Documents →P.29

Depending on the **A Media Type** setting, some **E Print Target** options may not be available.

- **F Print Quality**

Choose the level of print quality.

- Giving Priority to Particular Graphic Elements and Colors for Printing →P.60

- **G View Settings**

Displays the **E Print Target** setting values.

You can view and change the order of **E Print Target** setting values.

- View Settings Dialog Box for the Printing Application →P.226

## Configuration using **Advanced Settings**

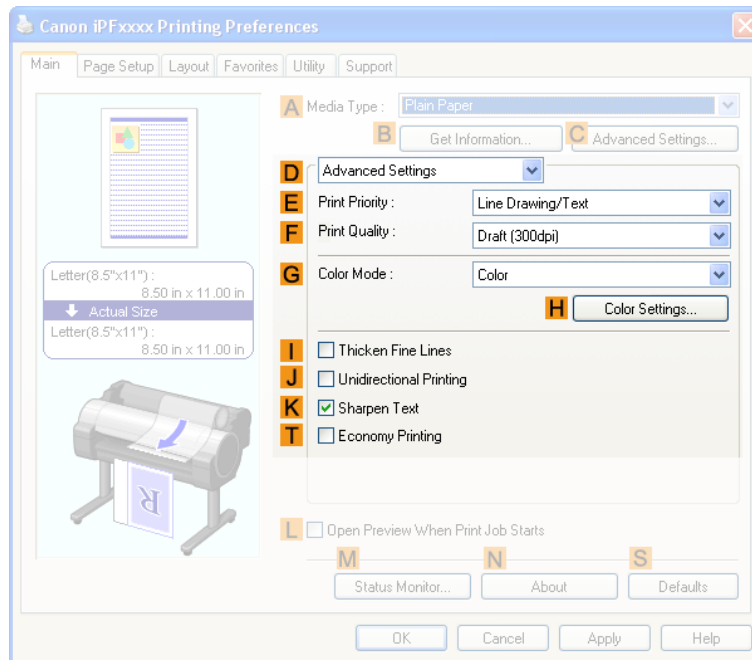

### • **E Print Priority**

Choose the graphic elements that you want to emphasize for printing.

- Giving Priority to Particular Graphic Elements and Colors for Printing →P.60

### • **F Print Quality**

Choose the level of print quality.

- Giving Priority to Particular Graphic Elements and Colors for Printing →P.60

### • **G Color Mode**

Choose the color mode.

- Giving Priority to Particular Graphic Elements and Colors for Printing →P.60



Note

- Depending on the **A Media Type** setting, some **G Color Mode** options may not be available.

### • **H Color Settings**

Click to display the **Color Settings** dialog box for more advanced color settings.

- Adjusting the Color in the Printer Driver →P.51

### • **I Thicken Fine Lines**

Activate this option to print fine lines more distinctly.

### • **J Unidirectional Printing**

Select this checkbox to prevent problems such as misaligned lines and improve the print quality. However, the printing speed becomes slower.

- **K Sharpen Text**

Activate this option to print text more sharply.

- **T Economy Printing**

Select this checkbox to reduce the amount of ink consumed during printing. However, the print quality is worse than for normal printing.

Select this mode if you want to conserve ink when checking drawings, for example. Depending on the **A Media Type** and **F Print Quality** settings, this mode may not be available.

## Paper Information on Printer Dialog Box

On the **Paper Information on Printer** dialog box, you can obtain information on the paper in the printer and configure printer driver settings for the paper source and media type.

3

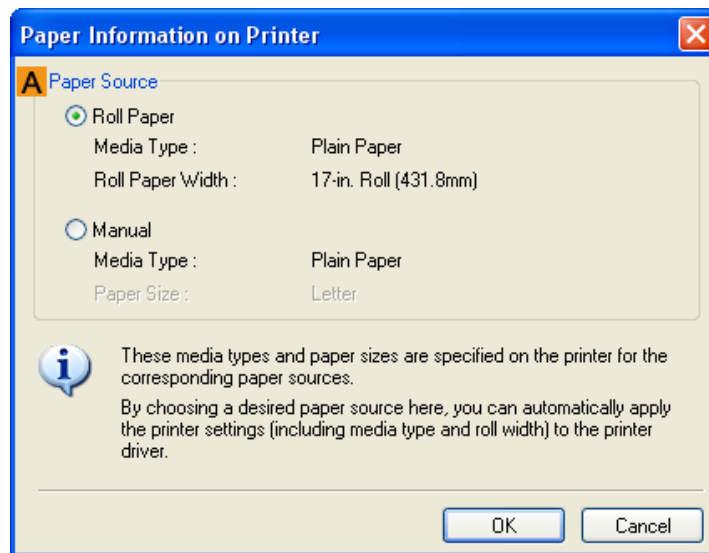

### Note

- To display the **Paper Information on Printer** dialog box, on the **Main** sheet, click **Get Information by Media Type**. (See "Main Sheet →P.220")

- **A Paper Source**

Shows the paper source supported by the printer, as well as information about the loaded paper. To update the paper source and media type settings in the printer driver, select the desired **Paper Source** option and click **OK**.

## Paper Detailed Settings Dialog Box

The **Paper Detailed Settings** dialog box offers the following settings. For details on settings items, refer to the printer driver help.

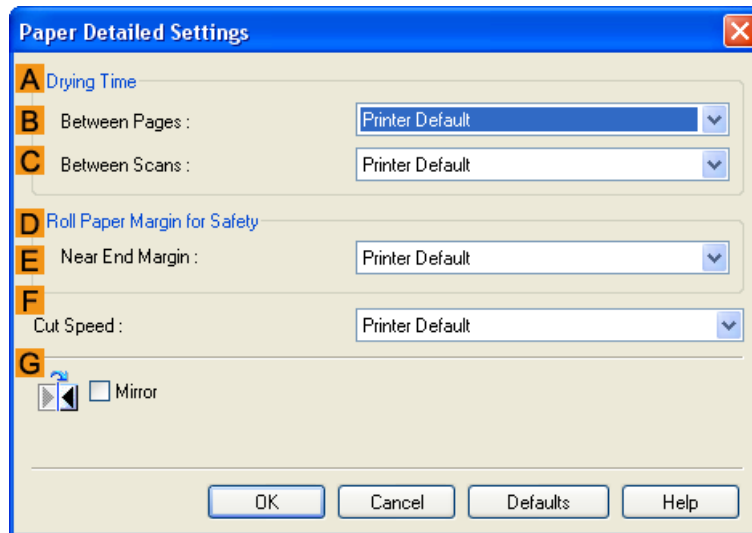

### Note

- To display the **Paper Detailed Settings** dialog box, on the **Main** sheet, click **Settings** by **Media Type**. (See "Main Sheet →P.220 ")

### • A Drying Time

Specify the time that the printer waits for ink to dry, as needed. The **Drying Time** setting is only valid for rolls.

- (See "Specifying the Ink Drying Time for Rolls →P.592 ")

### • B Between Pages

Specify the time the printer waits after printing a page until ejecting the paper, as needed.

### • C Between Scans

Specify the time the printer waits after printing a line on the page until printing the next line, as needed.

### • D Roll Paper Margin for Safety

You can specify the length of a margin on the leading edge of paper to ensure that paper susceptible to curling is held firmly against the Platen.

### • E Near End Margin

Specify the length of the **Near End Margin** (the leading edge margin) of the roll, as needed.

### • F Cut Speed

Select the speed of automatic cutting, as needed. You can adjust this setting if paper is not cut well when automatic cutting is used.

### • G Mirror

Specify whether to print a mirror image, as needed. Select this option to print a version of the document or image with the left and right sides inverted.

## View Settings Dialog Box for the Printing Application

In the **View Settings** dialog box, you can check details of the selected printing application.

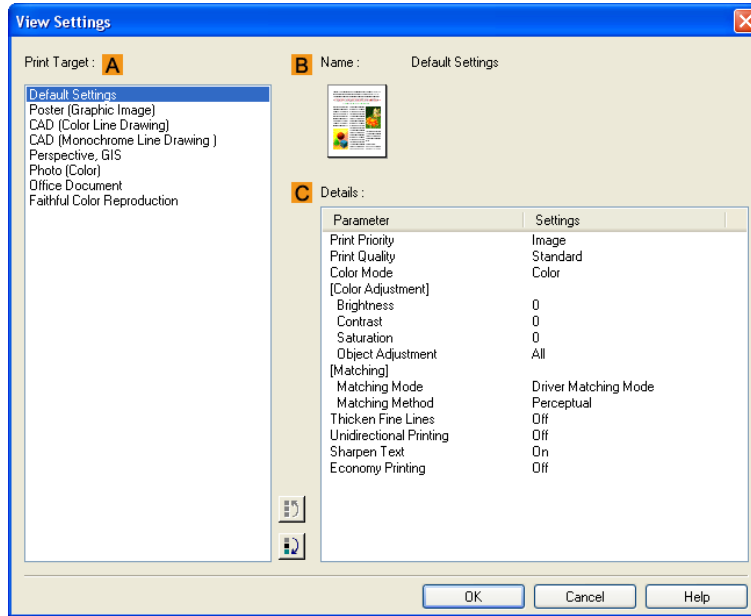

### Note

- To display the **View Settings** dialog box, on the **Main** sheet, click **View Settings by Print Target**. (See "Main Sheet →P.220 ")

#### • **A Print Target**

Shows all **Print Target** options (settings items for the printing application).

#### • **B Name**

Identifies the item selected in **Print Target** by its name and an icon.

#### • **C Details**

Here, you can confirm detailed settings values for each listed item for the selected **Print Target**.

## Color Adjustment Sheet: Color

If the color tone as printed is not as you expected, you can adjust it on the **Color Adjustment** sheet.



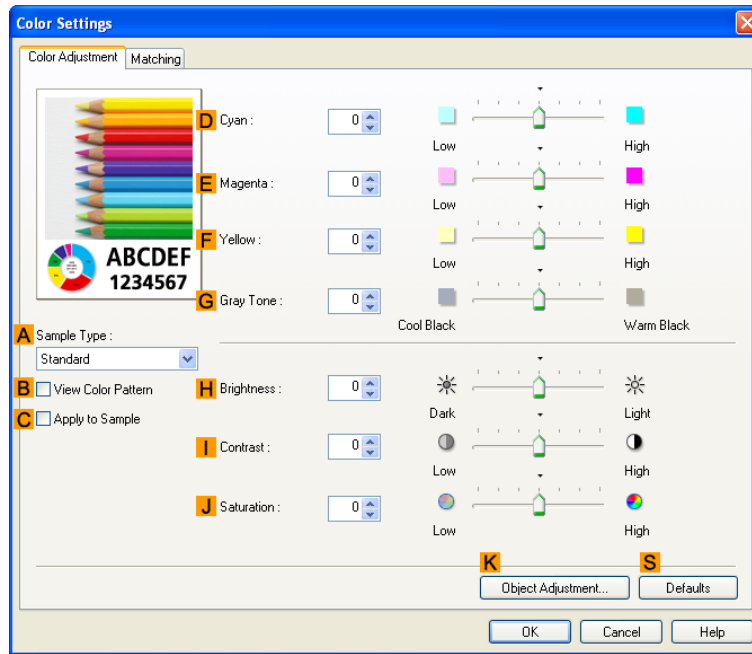

#### Note

- To display the **Color Adjustment** sheet, on the **Main** sheet, click **Color Settings** by **Color Mode** in **Advanced Settings**. (See "Main Sheet →P.220 ")

#### • **A Sample Type**

Choose a sample image from **Standard**, **Portrait**, **Landscape**, or **Graphics**.

#### • **B View Color Pattern**

Select this checkbox to display the color pattern.

#### • **C Apply to Sample**

Select this checkbox to apply the changed settings to the sample image.

#### • **D Cyan / E Magenta / F Yellow**

Fine-tune color tones by adjusting the levels of each color.

#### • **G Gray Tone**

Adjust the color tone of grays as desired. Choose **Cool Black** (tinged with blue) or **Warm Black** (tinged with red).

#### • **H Brightness**

Adjust the overall image brightness as desired. You can adjust the brightness if the printed document is lighter or darker than the original image (that is, the original photo that was scanned or the original graphic as it appears on the computer screen).

#### • **I Contrast**

Adjust the contrast of the darkest and lightest portions relative to each other, as desired. Increasing the **Contrast** makes images sharper, and reducing the **Contrast** softens images.

#### • **J Saturation**

Adjust the color intensity as desired. Increasing the **Saturation** setting makes colors more vivid, and reducing the **Saturation** makes colors more subdued.

- **K Object Adjustment**

Select this option to display the **Object Adjustment** dialog box, in which you can specify objects subject to color adjustment.

- Object Adjustment dialog box: Color →P.228

- **S Defaults**

Click to restore all settings on the sheet to the default values.



Note

- For details on settings items, see "Adjusting the Color in the Printer Driver →P.51 "

## Object Adjustment dialog box: Color

In the **Object Adjustment** dialog box, you can specify what type of print jobs to apply color adjustment to. If an original comprises images, graphics, and text, you can specify which portion to apply color adjustment to.

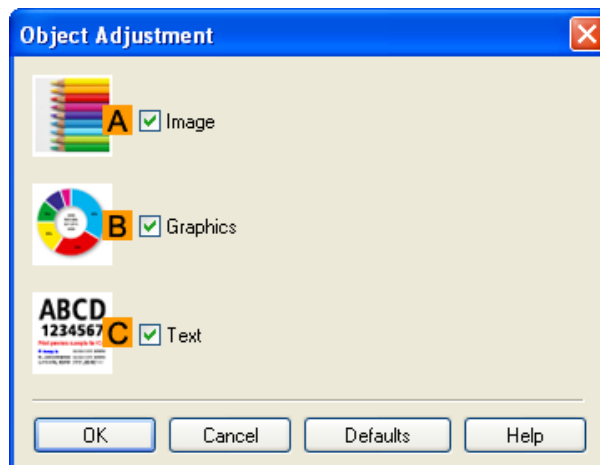

Note

- To display the **Object Adjustment** dialog box, click **Object Adjustment** on the **Color Adjustment** sheet.

- **A Image**

Select this option to apply color adjustment to image areas, such as photos.

- **B Graphics**

Select this option to apply color adjustment to graphics, such as lines and circles.

- **C Text**

Select this option to apply color adjustment to text.

## Matching Sheet

On the **Matching** sheet, you can specify color matching to compensate for differences in the appearance of colors on various devices.



### Important

- If **No color correction** is selected under **Color Mode**, the **Matching** sheet is not displayed.



### Note

- To display the **Matching** sheet, on the **Main** sheet, click **Color Settings** in **Color Mode** in **Advanced Settings**, and then click the **Matching** sheet. (Refer to "Main Sheet →P.220 ")

## Driver Matching Mode

The following options are available when you select **Driver Matching Mode** in the **A Matching Mode** list.

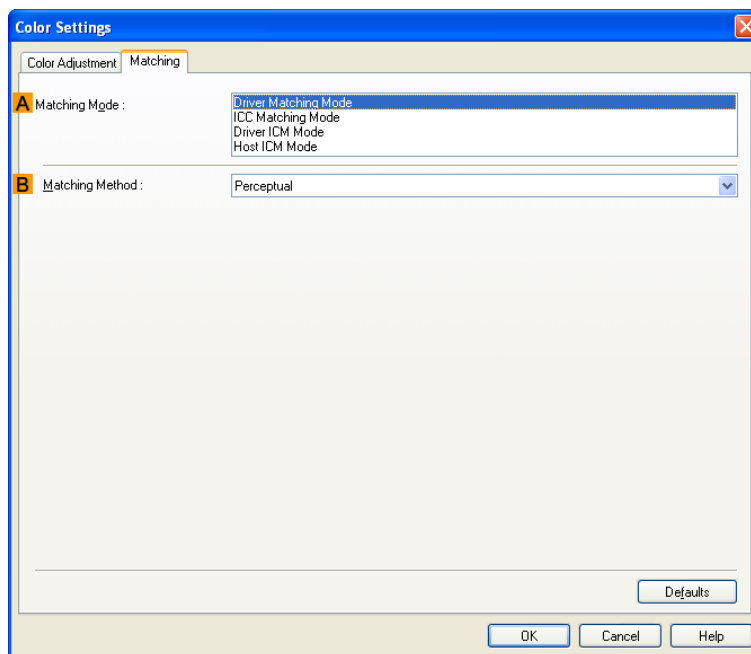

### • A Matching Mode

Select the color matching mode to use, as desired.

Normally, select **Driver Matching Mode**. For color matching based on ICC profiles, select **ICC Matching Mode**, **Driver ICM Mode**, or **Host ICM Mode**, depending on your color matching system.

### • B Matching Method

Select the color matching method that suits the document to be printed. Various **Matching Method** options are available depending on your selection in **Matching Mode**.

## ICC Matching Mode, Driver ICM Mode and Host ICM Mode

The following options are available when you select **ICC Matching Mode**, **Driver ICM Mode**, or **Host ICM Mode** in the **A Matching Mode** list.

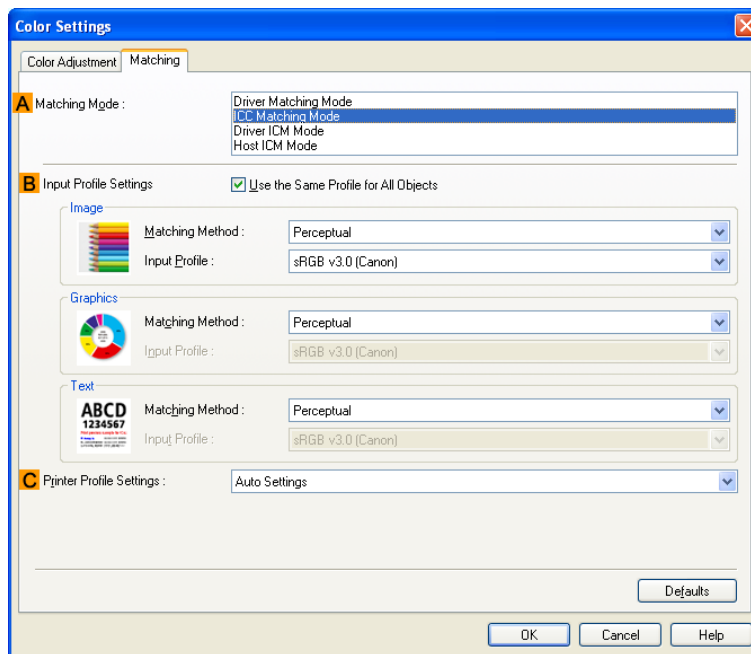

- **A Matching Mode**

Select the color matching mode to use, as desired.

- **B Input Profile Settings**

You can select **Image**, **Graphics**, or **Text**. You can choose **Matching Method** and **Input Profile**.

Various options are available depending on your selected **Matching Mode**.

To apply the same input profile automatically for **Graphics** and **Text**, select **Use the Same Profile for All Objects**. To apply separate input profiles to **Graphics** and **Text**, clear **Use the Same Profile for All Objects** and specify the individual settings.

- **C Printer Profile Settings**

Specify the printer profile as desired. Normally, select **Auto Settings**.



**Note**

- For details on settings items, see "Adjusting the Color in the Printer Driver →P.51 "

## Color Adjustment Sheet: Monochrome

On the **Color Adjustment** sheet for monochrome printing, you can adjust the brightness and contrast.

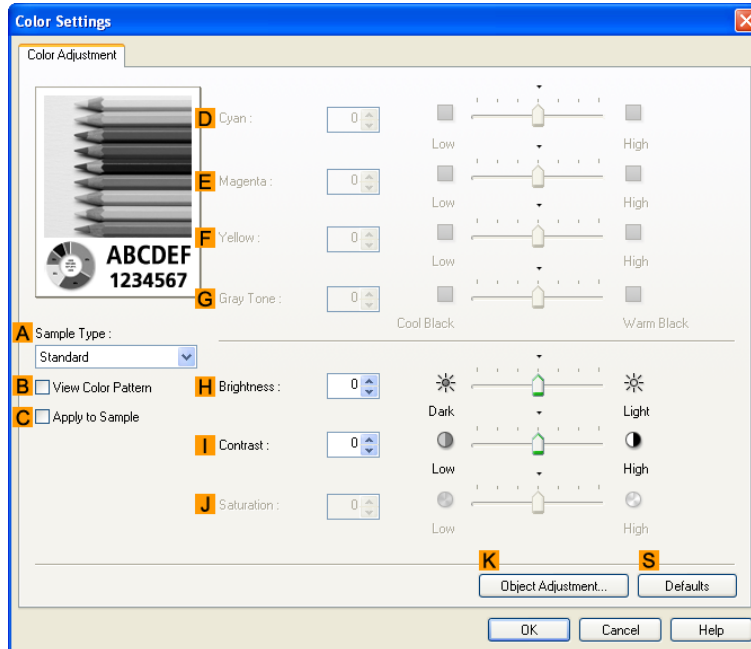

### Note

- To display the **Color Adjustment** sheet, on the **Main** sheet, click **Color Settings** by **Color Mode** in **Advanced Settings**. (See "Main Sheet →P.220 ")

### • **A Sample Type**

Choose a sample image from **Standard**, **Portrait**, **Landscape**, or **Graphics**.

### • **B View Color Pattern**

Select this checkbox to display the color pattern.

### • **C Apply to Sample**

Select this checkbox to apply the changed settings to the sample image.

### • **D Cyan / E Magenta / F Yellow**

Not available.

### • **G Gray Tone**

Not available.

### • **H Brightness**

Adjust the overall image brightness as desired. You can adjust the brightness if the printed document is lighter or darker than the original image (that is, the original photo that was scanned or the original graphic as it appears on the computer screen).

### • **I Contrast**

Adjust the contrast of the darkest and lightest portions relative to each other, as desired. Increasing the **Contrast** makes images sharper, and reducing the **Contrast** softens images.

- **J Saturation**

Not available.

- **K Object Adjustment**

Select this option to display the **Object Adjustment** dialog box, in which you can specify objects subject to color adjustment.

- Object Adjustment dialog box: Monochrome →P.232

- **S Defaults**

Click to restore all settings on the sheet to the default values.



**Note**

- For details on settings items, see "Adjusting the Color in the Printer Driver →P.51 "

### 3

## Object Adjustment dialog box: Monochrome

In the **Object Adjustment** dialog box, you can specify what type of print jobs to apply color adjustment to. If an original comprises images, graphics, and text, you can specify which portion to apply color adjustment to.

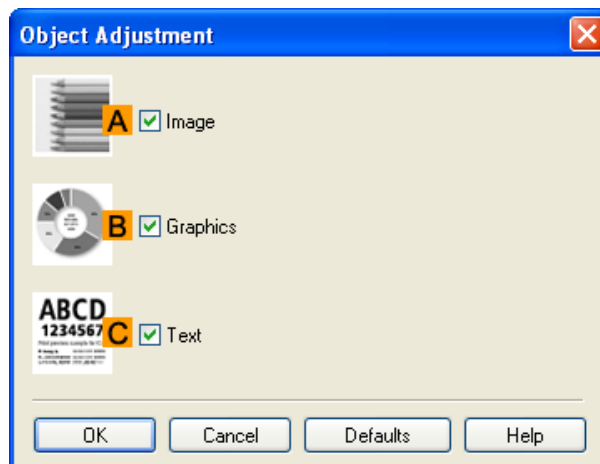

**Note**

- To display the **Object Adjustment** dialog box, click **Object Adjustment** on the **Color Adjustment** sheet.

- **A Image**

Select this option to apply color adjustment to image areas, such as photos.

- **B Graphics**

Select this option to apply color adjustment to graphics, such as lines and circles.

- **C Text**

Select this option to apply color adjustment to text.

## Page Setup Sheet

The following settings are available on the **Page Setup** sheet. For details on settings items, refer to the printer driver help file.

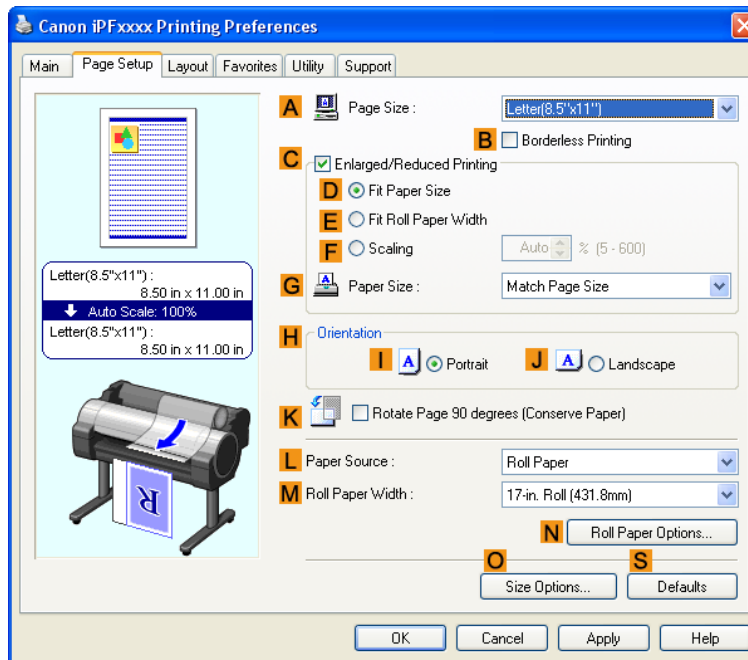

### • A Page Size

Select the page size as specified in the source application.

For details on available page sizes, see "Paper Sizes →P.569 "

### • B Borderless Printing

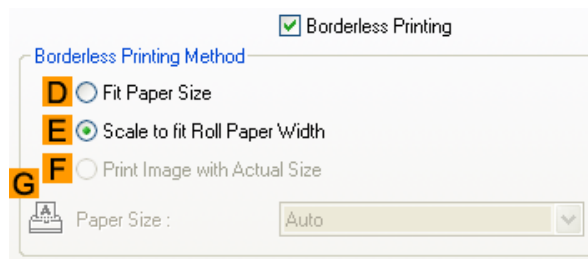

Borderless printing is available if roll paper is selected in the **L Paper Source** list. Choose from the following options when this setting is activated.

- Borderless Printing on Paper of Equivalent Size →P.104
- Borderless Printing by Resizing Originals to Fit the Roll Width →P.111
- Borderless Printing at Actual Size →P.95

### • D Fit Paper Size

Scales the document image to match the paper size.

### • E Scale to fit Roll Paper Width

Scales the document image to match the roll width.

### • **F Print Image with Actual Size**

Prints documents at their actual size. This function is available when you have selected the size same as the width of **Roll Paper** for either the length or width of the document from the **A Page Size** list.

### • **G Paper Size**

Available when **D Fit Paper Size** is selected.

Choose the size of the paper you will print on.

For details on available paper sizes, see "Paper Sizes →P.569 "

Paper sizes compatible with borderless printing are shown in the list.

### • **C Enlarged/Reduced Printing**

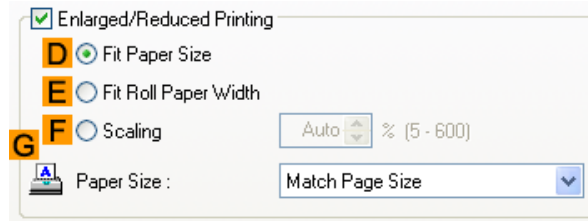

Choose from the following options when this setting is activated.

- Resizing Originals to Match the Paper Size →P.69
- Resizing Originals to Fit the Roll Width →P.75
- Resizing Originals by Entering a Scaling Value →P.81

### • **D Fit Paper Size**

Scales the document image to match the paper size.

### • **E Fit Roll Paper Width**

Scales the document image to match the roll width.

### • **F Scaling**

Resizes the document image based on a specified scaling value. Enter a value in a range of **5–600**.

### • **G Paper Size**

Choose the size of the paper you will print on.

For details on available paper sizes, see "Paper Sizes →P.569 "

### • **H Orientation**

Choose the printing orientation.

- Making the Original Orientation Match the Paper Orientation →P.194

### • **K Rotate Page 90 degrees (Conserve Paper)**

Activate this setting to rotate the document image by 90 degrees before printing.

- Conserving Roll Paper by Rotating Originals 90 Degrees →P.174

### • **L Paper Source**

Choose the feed source, as desired.

Options displayed in the list vary depending on the selection in **Media Type** on the **Main** sheet.

### • **M Roll Paper Width**

Choose the roll width.

For details on available roll widths, see "Paper Sizes →P.569 "



### • **N** Roll Paper Options

Complete optional roll paper settings. Click to display the **Roll Paper Options** dialog box.

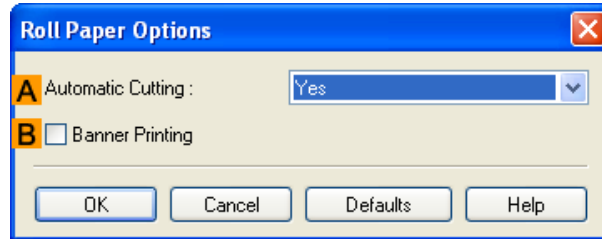

Under **A Automatic Cutting**, you can specify **Yes** or **No** and **Print Cut Guideline**.

- Cutting Roll Paper After Printing →P.200

Select **B Banner Printing** when printing multiple pages continuously.

- Printing Multiple Pages Continuously →P.144

### • **O** Size Options

Click to display the **Paper Size Options** dialog box, which enables you to register additional paper sizes or select the size system for use.

- Paper Size Options Dialog Box →P.235

### • **S** Defaults

Restores all settings on the sheet to the default values.

## Paper Size Options Dialog Box

In the **Paper Size Options** dialog box, you can create and register your own Custom Paper Size. The sizes you define are listed with standard paper sizes for selection later as needed.

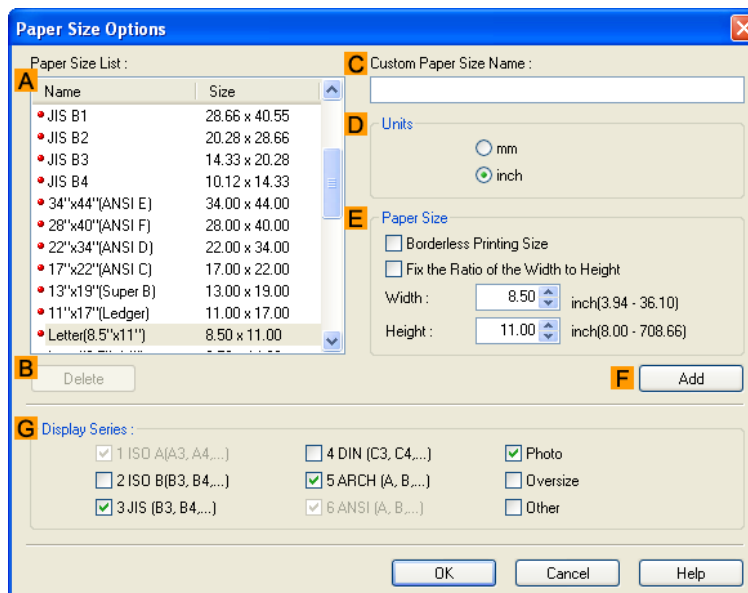

**Note**

- To display the **Paper Size Options** dialog box, on the **Page Setup** sheet, click **Paper Size Options**.(See "Page Setup Sheet →P.233 ")

**A Paper Size List**

Shows the names and sizes of paper that can be used with the printer driver.

**B Delete**

Custom paper sizes created by users can be deleted from the **A Paper Size List**, as needed.

However, they cannot be deleted in the following situations.

- If a standard paper size of the printer driver is selected.
- If an oversized paper size is selected.
- If a paper size marked with a red circle is selected.

**C Custom Paper Size Name**

You can name Custom Paper Size as desired.

**D Units**

Specify the desired unit of measure for the Custom Paper Size height and width.

**E Paper Size**

Specify the desired **Width** and **Height**. You can make your selection from sizes that are compatible with **Borderless Printing** by selecting **Borderless Printing Size**. To maintain the aspect ratio of the **Width** and **Height** as you resize the paper, select **Fix the Ratio of the Width to Height**.

**F Add**

Enables you to register the custom paper size you have specified or overwrite an existing custom paper size.

**G Display Series**

You can limit the number of options shown in **Page Size**, **Paper Size**, and **Paper Size List**.

## Layout Sheet

The following settings are available on the **Layout** sheet. For details on settings items, refer to the printer driver help.

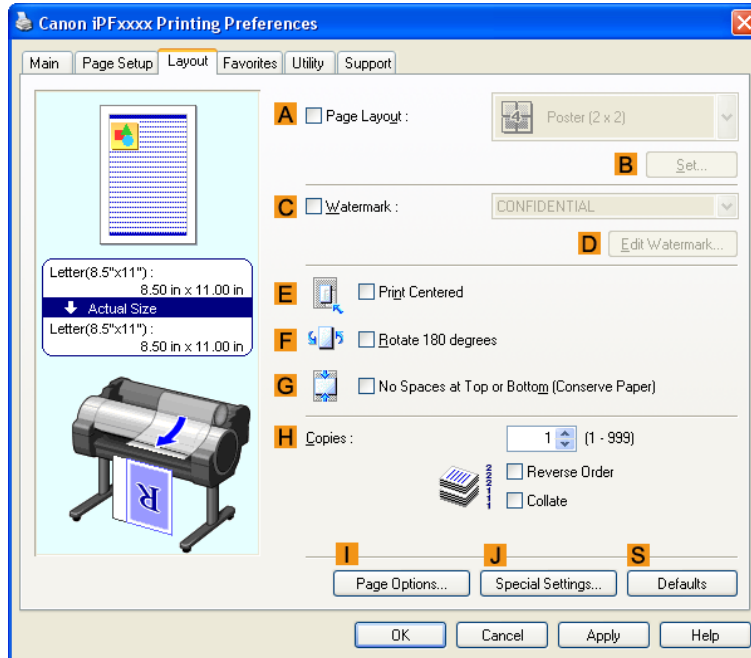

### • A Page Layout

Activate this setting to select a particular page layout.

- Printing Multiple Pages Per Sheet →P.149
- Printing Posters in Sections →P.157
- Printing Multiple Originals Next to Each Other →P.139
- Using PosterArtist to Compose Originals →P.36

### • B Set

Click to display one of the following dialog boxes depending on the selection in **A Page Layout**. In these dialog boxes, you can specify layout details and which pages to print, as well as other settings.

- Page Layout Printing
- Pages to Print
- Free Layout Settings

### • C Watermark

Activating this option makes two settings available, **Watermarks** and **D Edit Watermark**.

- Printing With Watermarks →P.190
- Watermarks  
Lists the provided watermarks. Choose the watermark to print.

### • D Edit Watermark

Click to display the **Edit Watermark** dialog box for creating your own, original watermark.

### • E Print Centered

Activate this setting to print document images in the center of the paper.

- Printing Originals Centered on Rolls →P.161

- Printing Originals Centered on Sheets →P.167

- **F Rotate 180 degrees**

Activate this option to rotate document images by 180 degrees before printing.

- **G No Spaces at Top or Bottom (Conserve Paper)**

Activate this setting to print the next image skipping blank areas above and below printable data in documents, which enables you to conserve the paper.

- Conserving Roll Paper by Printing Originals Without Top and Bottom Margins →P.180

- **H Copies**

Enter the number of copies to print, in a range of 1–999.

- **Reverse Order**

Activate this option to print pages in reverse order.

- **Collate**

Activate this option to print complete sets in the specified quantity.

- **I Page Options**

Click to display the **Page Options** dialog box, which enables you to complete settings for printing the user name, date, or page number in the header or footer.

- Page Options Dialog Box →P.238

- **J Special Settings**

If the printing results are not as you expected, click this option to change how printing is processed.

- Special Settings Dialog Box →P.239

- **S Defaults**

Click to restore all settings on the sheet to the default values.

## Page Options Dialog Box

The **Page Options** dialog box offers the following settings.

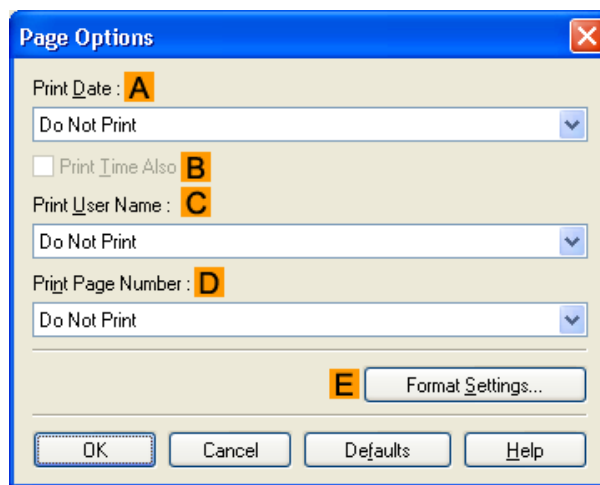

### Note

- To display the **Page Options** dialog box, on the **Layout** sheet, click **Page Options**. (See "Layout Sheet →P.237 ")

- **A Print Date**

Select where the date is printed, as desired. To print the time as well, select **B Print Time Also**.

- **C Print User Name**

Select where the user name is printed, as desired.

- **D Print Page Number**

Select where the page number is printed, as desired.

- **E Format Settings**

Click to display the **Format Settings** dialog box, which enables you to complete format-related settings.

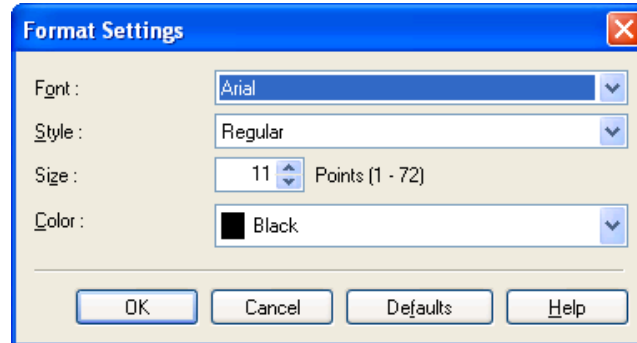

**Note**

- If you specify the same position for multiple items, the items are printed from left to right in this order: date, user name, and page number.
- When you print multiple pages per sheet using **Page Layout Printing** or similar functions, these items will be printed for each page.

## Special Settings Dialog Box

If the printing results are not as you expected, you can change how printing is processed in the **Special Settings** dialog box.

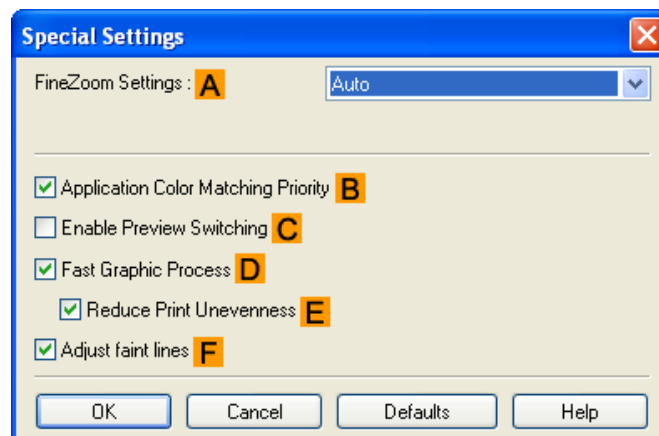

**Note**

- To display the **Special Settings** dialog box, on the **Layout** sheet, click **Special Settings**. (See "Layout Sheet →P.237")

- **A FineZoom Settings**

This function is used in large-format printing. Normally, choose **Auto**. If documents are not printed correctly on large-format paper, it may help to select **Yes**, and if fine lines are not visible or if images are distorted when printed, it may help to select **No**.

- **B Application Color Matching Priority**

You can give applications priority in color management.

- **C Enable Preview Switching**

When this option is selected, PageComposer starts if you print with **Open Preview When Print Job Starts** selected on the **Main** sheet.

- **D Fast Graphic Process**

If image colors are inconsistent in printed documents or if lines are printed in varying thicknesses, clearing this option may help produce the expected results.



**Note**

- This function cannot be used on 64-bit version of Windows.

- **E Reduce Print Unevenness**

If you are concerned about print unevenness, the printing results can be improved by selecting this option. However, printing may take longer for some images.

- **F Adjust faint lines**

If fine lines are printed in colors that do not match the colors of other shapes, clearing this option may help produce the expected results. However, lines in some colors may appear broken.

## Favorites Sheet

The following settings are available on the **Favorites** sheet. For details on settings items, refer to the printer driver help.

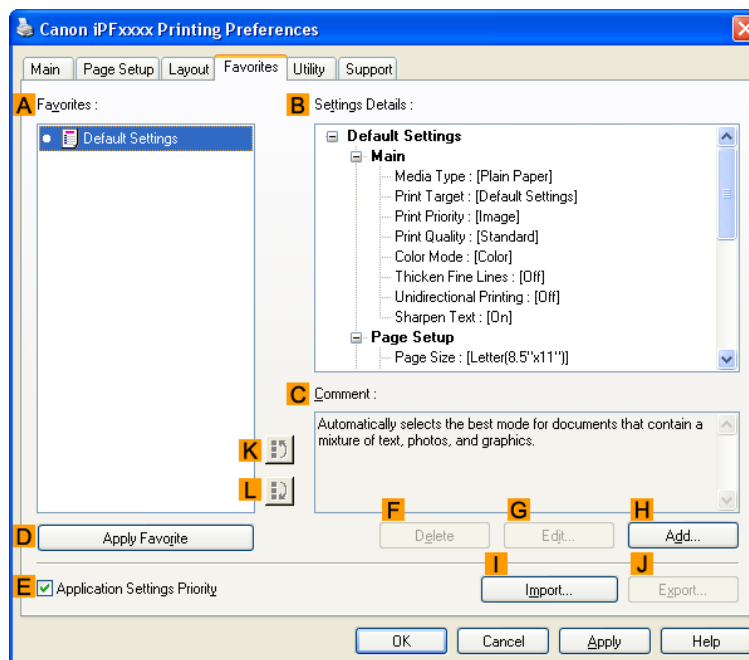

- **A Favorites**

Printing favorites you have created are listed with **Default Settings** favorites.

- Using Favorites →P.200

- **B Settings Details**

Displays details of the favorite selected in the **A Favorites**.

- **C Comment**

Displays notes registered in the favorite.

- **D Apply Favorite**

Click to change the current print settings to those of the favorite selected in the **A Favorites**.

- **E Application Settings Priority**

Activate this setting to use settings values specified in the source application in preference to favorite settings selected in the **A Favorites**, when clicking **D Apply Favorite**. For details on the settings items used in preference, refer to the printer driver help.

- **F Delete**

Click to delete the selected favorite from the **A Favorites** list.

- **G Edit**

Click to display the **Edit** dialog box, which enables you to change the name and icon for the favorite selected in the **A Favorites** list.

- **H Add**

Click to display the **Add** dialog box, which enables you to add the current print settings as a favorite.

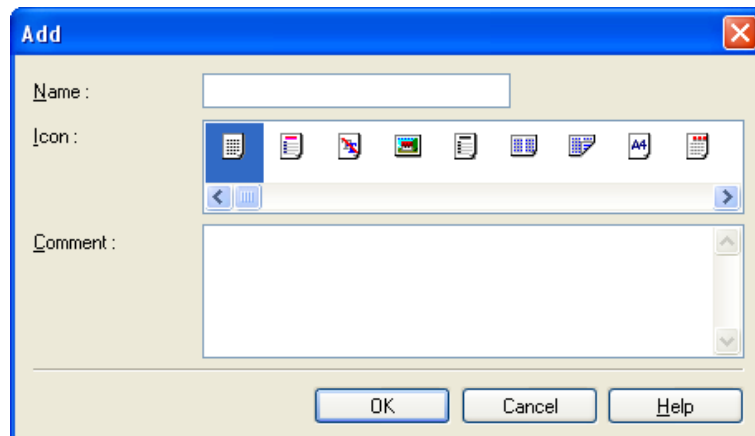

- **I Import**

Click to display the **Open** dialog box, which enables you to import favorite settings saved as a file.

- **J Export**

Click to display the **Save As** dialog box, which enables you to save the favorite settings as a file.

- **K Up**

Click to move the selected favorite up in the **A Favorites** list.

- **L Down**

Click to move the selected favorite down in the **A Favorites** list.

## Utility Sheet

The following items can be executed on the **Utility** sheet. For details on the utilities, refer to the relevant utility help.

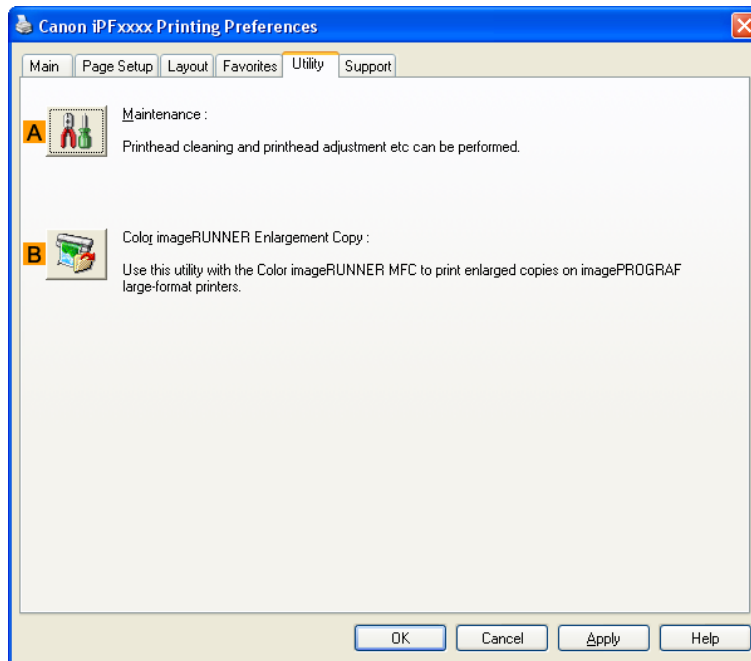

### • **A Maintenance**

Click to start the imagePROGRAF Status Monitor, which offers the following maintenance for the printer.

- Nozzle (ink ejecting outlet) check
- Nozzle (ink ejecting outlet) cleaning
- Head alignment adjustment
- Feed amount adjustment

### • **B Color imageRUNNER Enlargement Copy**

Click to launch Color imageRUNNER Enlargement Copy (iR enlargement copy), which enables you to create hot folders used for Color imageRUNNER Enlargement Copy and assign print settings to hot folders.

- Printing Enlargements of Scanned Originals from a Color imageRUNNER [→P.301](#)

For details, see Color imageRUNNER Enlargement Copy [→P.289](#) .



#### Note

- This function is not available on 64-bit version of Windows.



## Support Sheet

On the **Support** sheet, you can view support information and the user's manual.

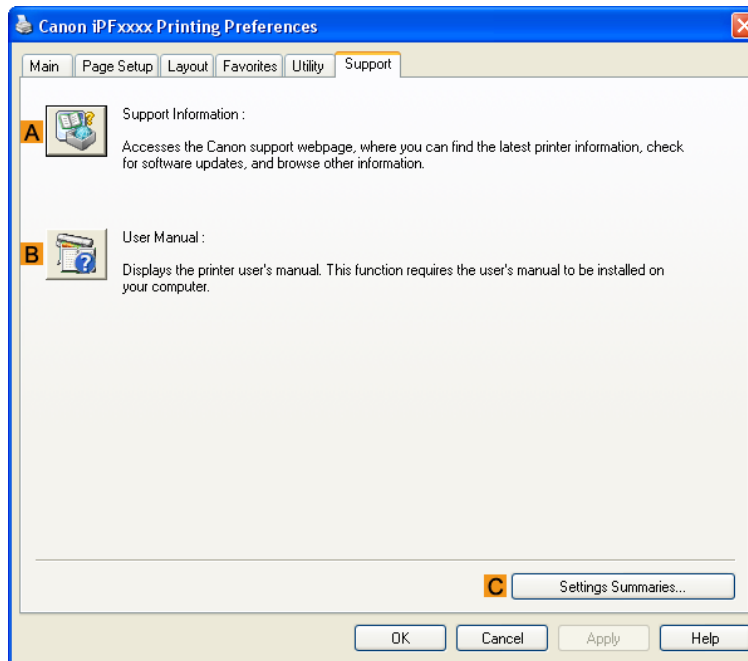

- **A Support Information**

Click to access the Canon support webpage, where you can find the latest information on the printer and consumables, check for printer driver updates, and browse other information.

- **B User Manual**

Click to view the printer user's manual. This function requires the user's manual to be installed on your computer.

- **C Settings Summaries**

Click to display the **View Settings** dialog box, which enables you to confirm the settings for the **Main**, **Page Setup**, **Layout**, and **Favorites** sheets.

## Settings Summaries Dialog Box

The **Settings Summaries** dialog box enables you to confirm the settings for the **Main**, **Page Setup**, **Layout**, and **Favorites** sheets.

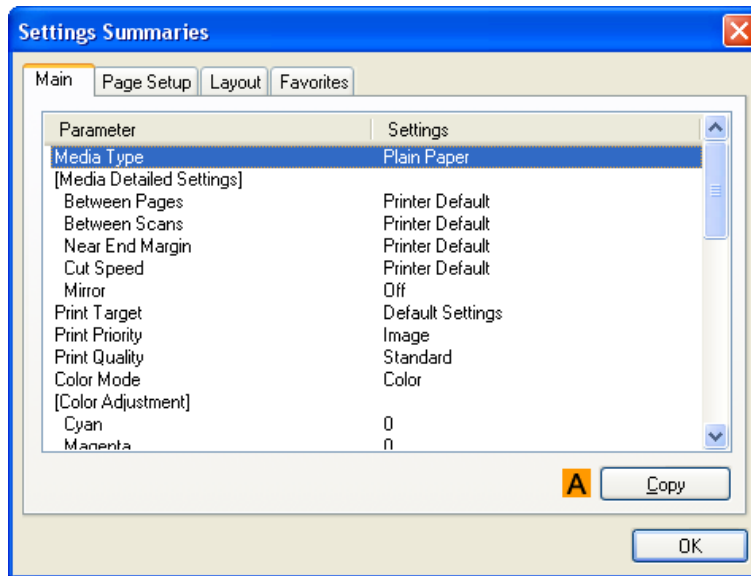

- **A Copy**

Click to copy the settings information to the clipboard. You can paste the settings information into a file created with a text editor or similar application.

## Device Settings Sheet

Many settings items on the printer properties sheets are controlled by Windows applications. However, the **Device Settings** sheet is for configuring the printer, and it is an extension of the printer driver. The following settings are available on the **Device Settings** sheet.

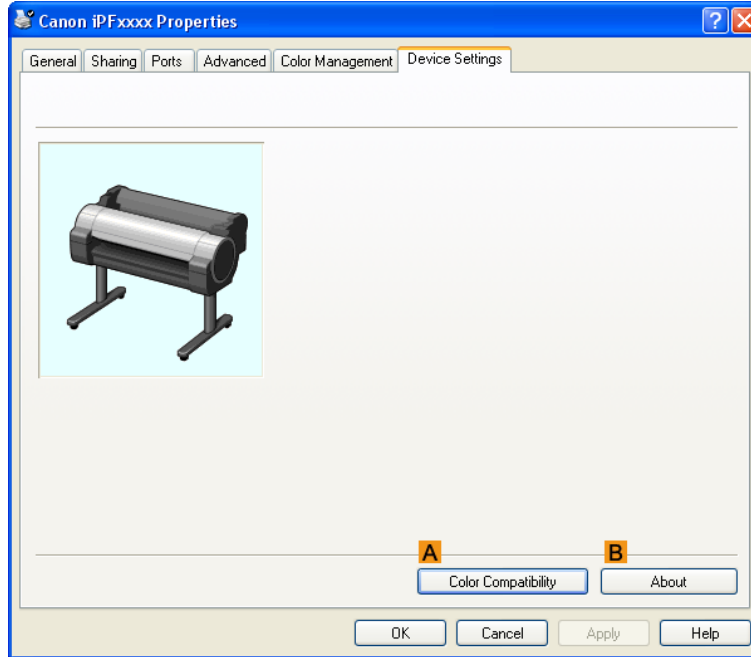

- **A Color Compatibility**

Click to display the **Color Compatibility** dialog box, which enables you to adjust colors if you have selected **Color Mode > Color (CAD)**.

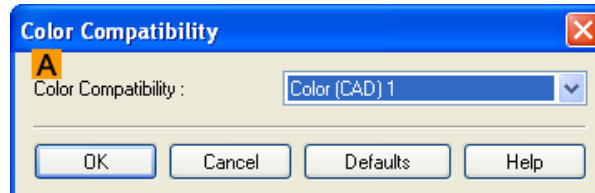

- For details on color settings, see [Specifying Colors and Printing CAD Drawings](#) →P.47 .

- **B About**

You can display version information for the printer driver.

## Preview

The Features of Preview .....	246
Operating Environment .....	246
Starting Preview .....	247
Preview Main Window .....	248
Dialog Area .....	251
Enlarge/Reduce the screen display .....	252
Moving a Page .....	252
Using the ruler .....	253
Priority setting for rotating 90 degrees .....	253
Printing with Selecting the Layout .....	255
Print on the Center .....	257
Not Print Spaces at the Top/Bottom .....	258

### 3

## The Features of Preview

The main features of Preview are as follows.

- While viewing this screen, you can adjust layout settings of a document created with application software.
- You can not only adjust layout settings but also your changes will be instantly applied on the preview screen, and you can print the preview screen as it is seen.



### Note

- The media type, image size, detailed media settings, and the printer settings can cause the actual print output to differ from the Preview settings.

## Operating Environment

You can use the Preview in the following environments.

- Compatible Operating System
  - 32 bit edition Windows OS  
Windows 2000, Windows XP, Windows Server 2003, Windows Server 2003 R2, Windows Vista, Windows Server 2008, Windows 7
  - 64 bit edition Windows OS  
Windows XP, Windows Server 2003, Windows Server 2003 R2, Windows Vista, Windows Server 2008, Windows Server 2008 R2, Windows 7



### Note

- For the Windows OS, use the latest version of Service Pack.

- Software that requires installation  
imagePROGRAF Printer Driver

## Starting Preview

Follow the procedure below to start the Preview.

1. Start the application software which you use.
2. From the application software's **File** menu, select the printer setup menu to open the **Print** dialog box.



### Note

- Normally, select **Print** from the **File** menu.

3. On the **Main** sheet, click on the **Open Preview When Print Job Starts** check box. Click the **OK** button to save the settings.

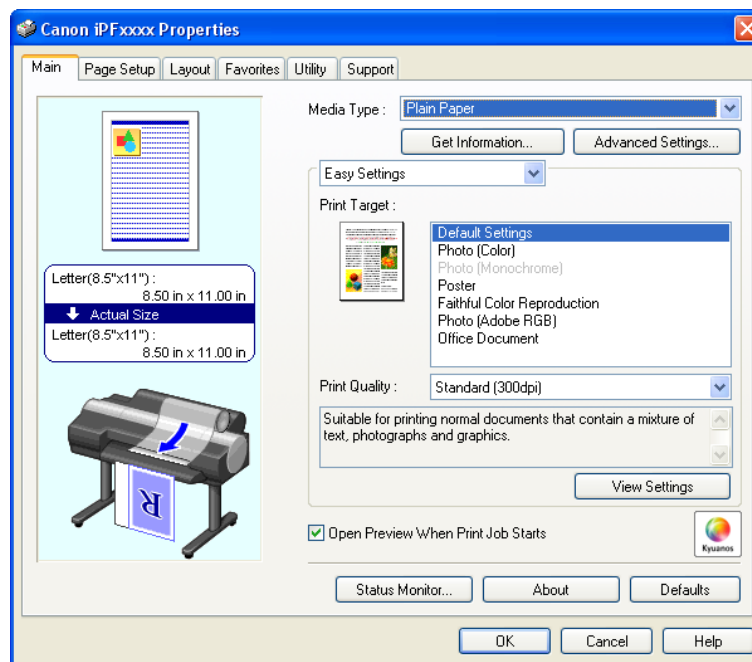

### Note

- Your printer is depicted in the lower-left area of this screen.

4. On the **Print** dialog box in the application software, click the **Print** button.

## 5. Preview main window is displayed.

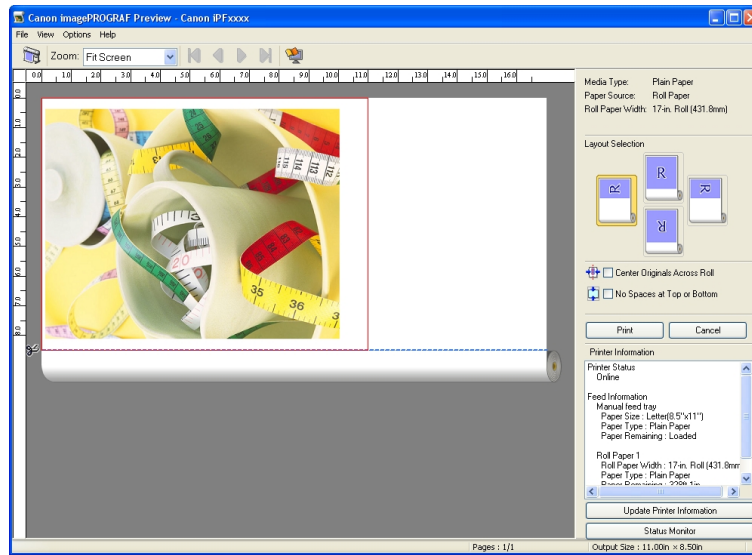

### Preview Main Window

The Preview main window consists of the menu and tool bars, preview and dialog area and status bar.

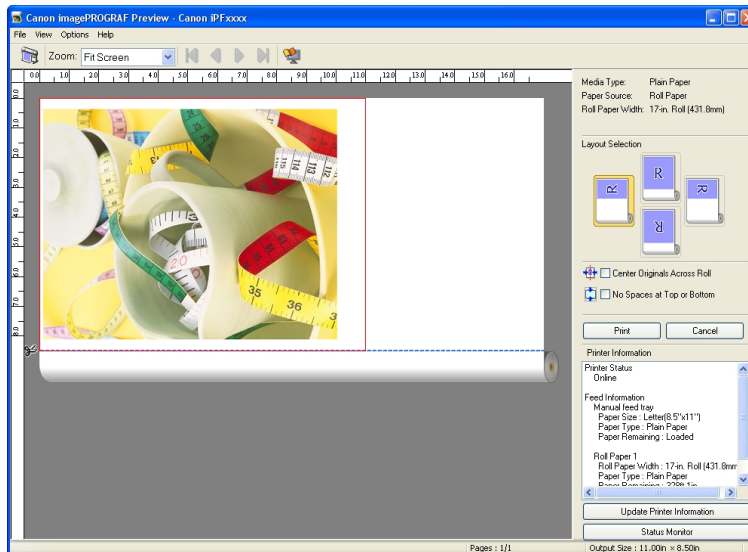

#### Note

- You can use the **View** menu to show or hide the tool bar.

#### • Menu Bar

This allows you to select menus required for operations.

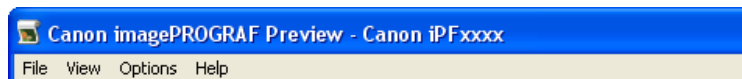

- Tool Bar

This allows you to select tool buttons required for major operations.



- Preview Area

You can check the settings you made in this area.

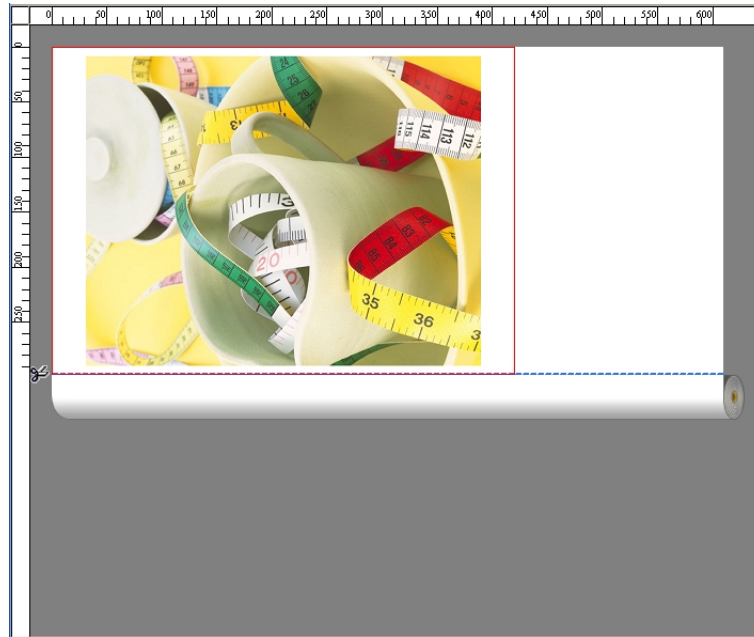

- Dialog Area

This allows you to set the print conditions and perform a print job.

For more information about Dialog Area, see "Dialog Area." →P.251

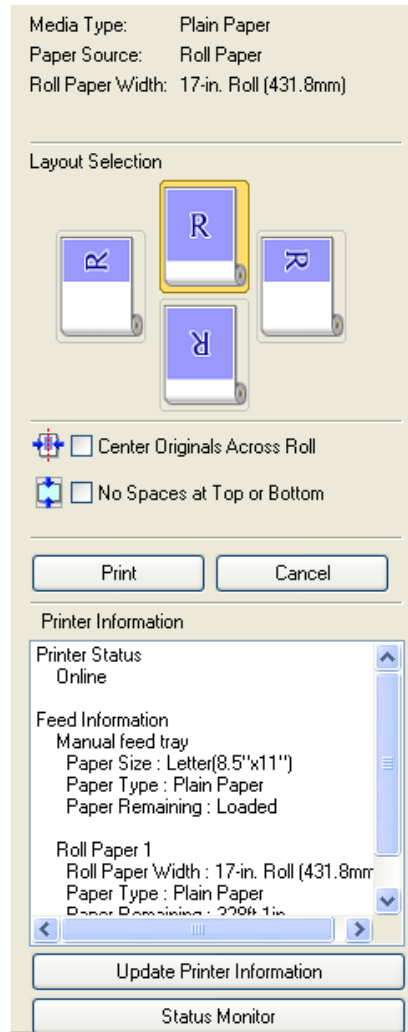

- Status Bar

This shows the message, **Pages** and **Output Size**.

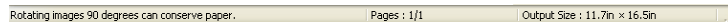



## Dialog Area

You can select the layout and print on the center.

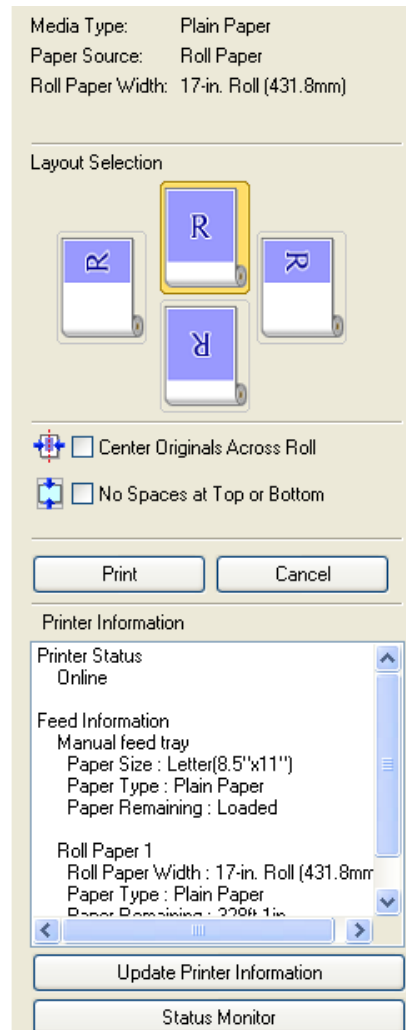

- **Media Type / Paper Source / Paper Size**

You can confirm the information that is set.

- **Layout Selection**

You can print which conserves paper by selecting the layout.

For more information about **Layout Selection**, see "Printing with Selecting the Layout." →P.255

- **Center Originals Across Roll**

You can print on the center of the media loaded in the printer.

For more information about **Center Originals Across Roll**, see "Print on the Center." →P.257



### Note

- Available only if rolls are selected in **Paper Source**.

### • No Spaces at Top or Bottom

You can save paper on not to feed roll paper for the empty spaces when the print data contains spaces at the top or bottom.

For more information about **No Spaces at Top or Bottom**, see "Not Print Spaces at the Top/Bottom." →P.258



#### Note

- Available only if rolls are selected in **Paper Source**.

### • Print Button

Click the button to start printing.

### • Cancel Button

Click the button to stop printing.

### • Printer Information

You can confirm the information acquired from the printer.

### • Update Printer Information Button

Click the button to update the printer information with connecting to the printer.

### • Status Monitor Button

Click the button to start **Status Monitor**.

## Enlarge/Reduce the screen display

You can enlarge or reduce the screen display when you select **Zoom** from the **View** menu.

Setting	Details
<b>Fit Screen</b>	Display all.
<b>Fit to Width</b>	Display to the width of the paper.
<b>Reduce</b>	Display at half of the standard size.
<b>Standard</b>	Display at the standard size.
<b>Enlarge</b>	Display with the double of the standard size.
<b>Enlarge More</b>	Display with the triple of the standard size.



#### Note

- This item can be selected even if you have clicked the ▼ button in the toolbar **Zoom**.

## Moving a Page

You can move a page to display when you select **Go to Page** from the **View** menu.

Setting	Details
<b>First Page</b>	Go to the first page.
<b>Previous Page</b>	Go to the previous page.

Setting	Details
<b>Next Page</b>	Go to the next page.
<b>Last Page</b>	Go to the last page.
<b>Go To Page</b>	Go to the specified page.

**Note**

- You can also move a page by clicking  on the tool bar.

## Using the ruler

You can confirm the layout with using the ruler.

- Switching the ruler Show/Hide  
In the **View** menu, select **Ruler** to switch the ruler Show/Hide.
- Changing the ruler unit  
You can set the ruler unit when you select **Units** from the **View** menu.

Setting	Details
<b>mm</b>	Use mm as the ruler unit.
<b>inch</b>	Use inches as the ruler unit.

## Priority setting for rotating 90 degrees

You can select **Rotate 90 Degrees If Possible** or **Use Driver Settings** from the **Options** menu.

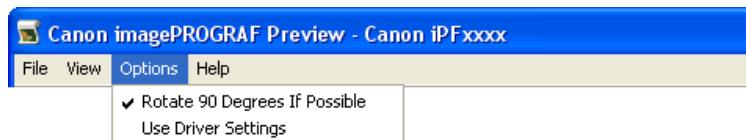

Setting	Details
<b>Rotate 90 Degrees If Possible</b>	Rotates pages in portrait orientation 90 degrees before printing. Pages are only rotated if they can fit lengthwise across the roll.
<b>Use Driver Settings</b>	Follows printer driver settings when determining whether to rotate pages.

Selecting **Rotate 90 Degrees If Possible** or Placing a checkmark for **Rotate Page 90 degrees (Conserve Paper)** on the printer driver

3

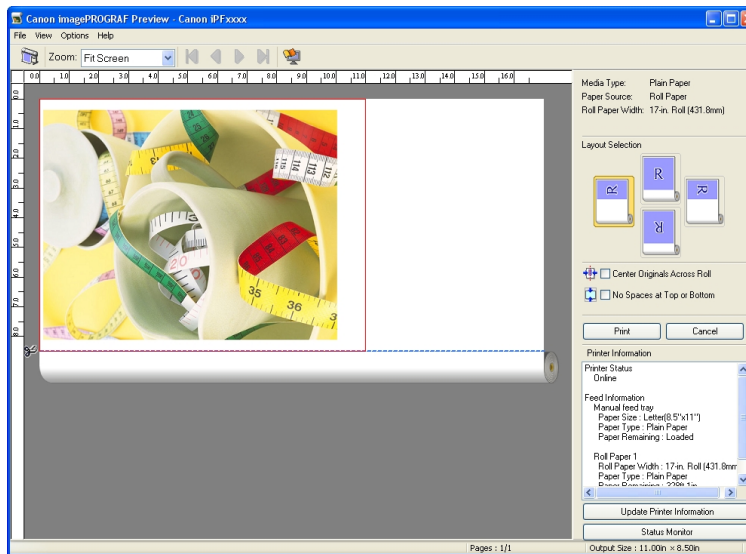

Selecting **Use Driver Settings**

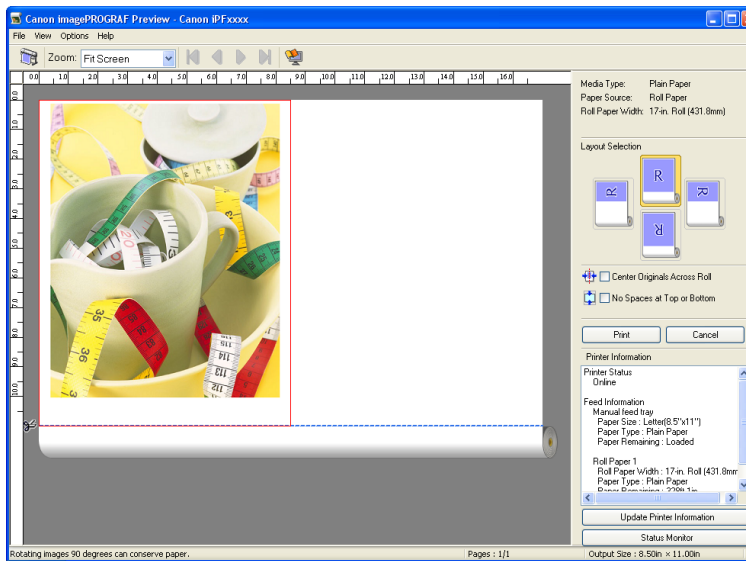

254



## Printing with Selecting the Layout

You can print which conserves paper by selecting the layout.

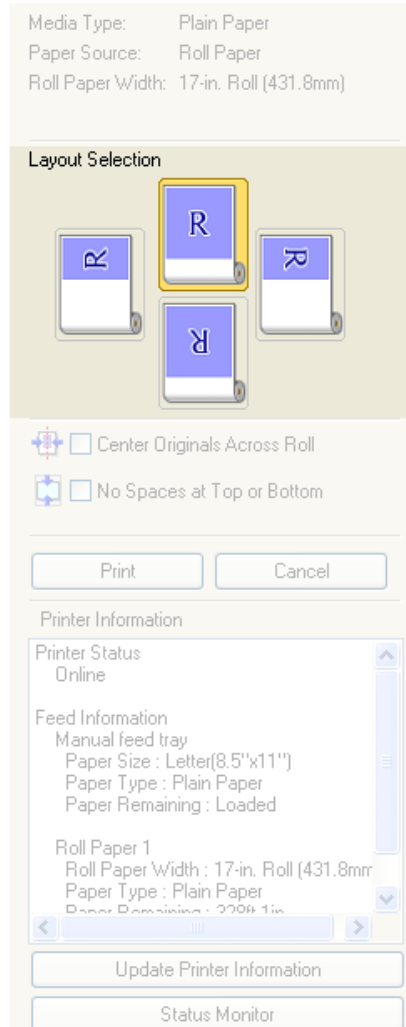
1. In **Layout Selection**, click the layout button to use.



3

Button	Details
<b>Upper Button</b>	Turn at the position of  .
<b>Right Button</b>	Turn at the position of  .
<b>Left Button</b>	Turn at the position of  .

255



Button	Details
<b>Lower Button</b>	 <p>Turn at the position of</p>

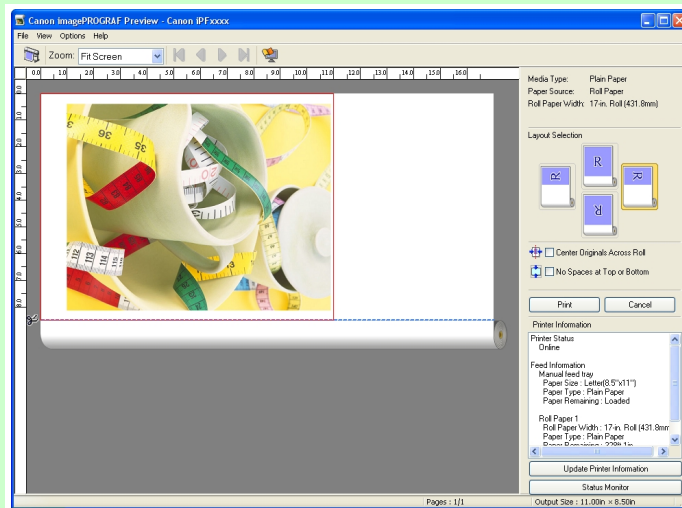

**Note**

- **Right Button** or **Left Button** can be selected only when the rotated pages can fit lengthwise across the roll.
- By clicking **Right Button** or **Left Button**, you can save paper by printing in landscape orientation on roll paper.
- You can select only **Upper Button** or **Lower Button** if **Cut Sheet** is selected.



Button	Details
	The button is selected currently.
	The button can be selected.
	The button can not be selected.

**2.** Click the **Print Button**.

Printing on the selected layout begins.

## Print on the Center

You can print on the center of the media loaded in the printer.

1. Click the **Center Originals Across Roll** check box on.

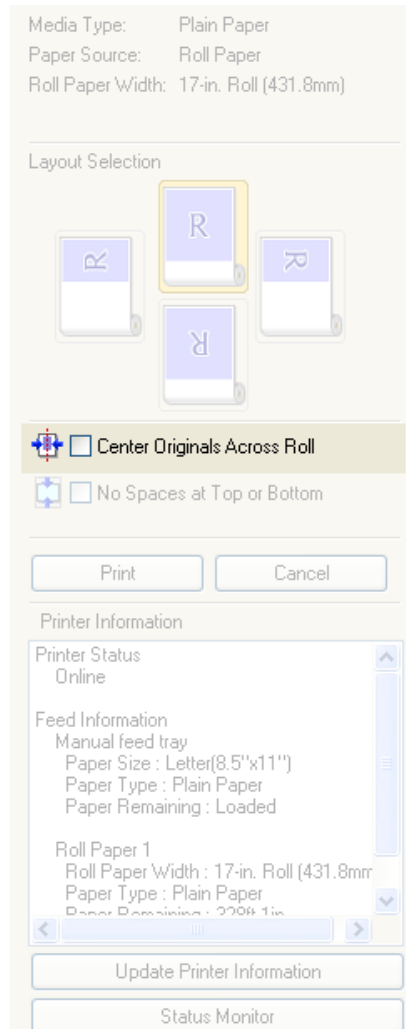

2. Click the **Print** button

Printing on the center begins.



### Note

- Available only if rolls are selected in **Paper Source**.

## Not Print Spaces at the Top/Bottom

You can save paper on not to feed roll paper for the empty spaces when the print data contains spaces at the top or bottom.

1. Click the **No Spaces at Top or Bottom** check box on.

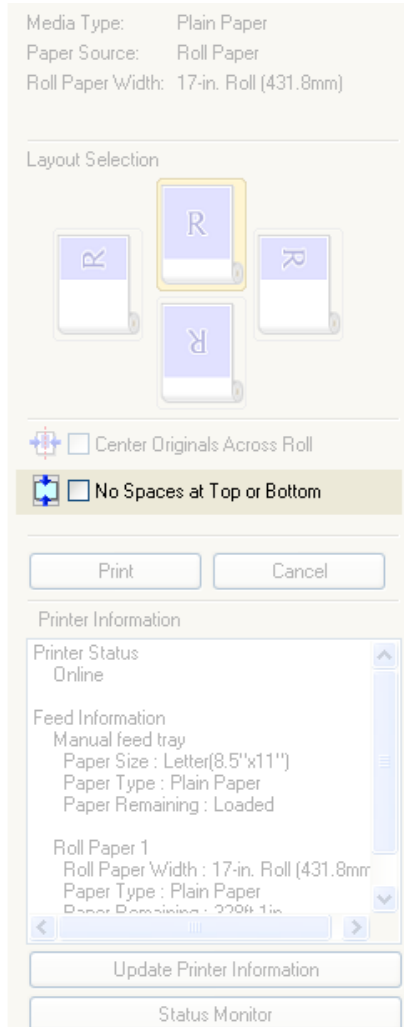

2. Click the **Print** button.

Printing on the settings with no spaces at top or bottom begins.

3

258



## Free Layout

The Features of Free Layout .....	259
Operating Environment .....	260
Starting Free Layout .....	260
Free Layout Main Window .....	262
Detailed Settings .....	264
Preferences Dialog Box .....	265
Page Options Dialog Box .....	266
Zoom Dialog Box .....	267
Format Dialog Box .....	268
Laying out a Multiple-File Document on One Page .....	270
Laying out a Document Created with Multiple Application Programs on One Page .....	273
Selecting an Object .....	276
Changing the Object Size .....	277
Moving an Object .....	277
Rotating an Object .....	278
Laying out Objects Automatically .....	279
Aligning Objects .....	279
Changing the Object Overlapping Order .....	281
Pasting a Copied or Cut Object .....	283
Folded Duplex Window .....	284
Finished Size Settings Dialog Box .....	285
Binding Settings Dialog Box .....	286
Prints using Folded Duplex .....	287

## The Features of Free Layout

The main features of Free Layout are as follows.

- Allows you to lay out at will and print a document created with application software.
- You can not only lay out multiple pages on one page but also lay out and print a multiple-file document on one page, or lay out and print a document created with multiple application programs on one page.
- Any two pages can be arranged and printed in a layout that becomes duplex on folding. This can be used such as for advertising posters that are suspended from the ceiling.

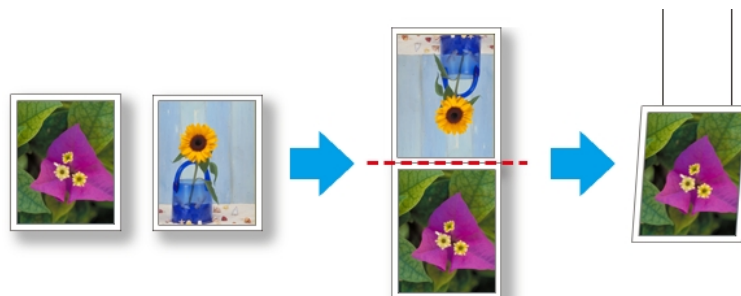

### Note

- The media type, image size, detailed media settings, and the printer settings can cause the actual print output to differ from the Free Layout settings.

## Operating Environment

You can use the Free Layout in the following environments.

- Compatible Operating System  
Windows 2000, Windows XP, Windows Server 2003, Windows Server 2003 R2, Windows Vista, Windows Server 2008, Windows 7



### Note

- This function is not available on 64-bit version of Windows.
- For the Windows OS, use the latest version of Service Pack.

- Software that requires installation  
imagePROGRAF Printer Driver

## Starting Free Layout

Follow the procedure below to start the Free Layout.

1. Start the application software which you use.
2. From the application software's **File** menu, select the printer setup menu to open the **Print** dialog box.



### Note

- Normally, select **Print** from the **File** menu.

3. From the list, select the printer and select the **Layout** sheet.

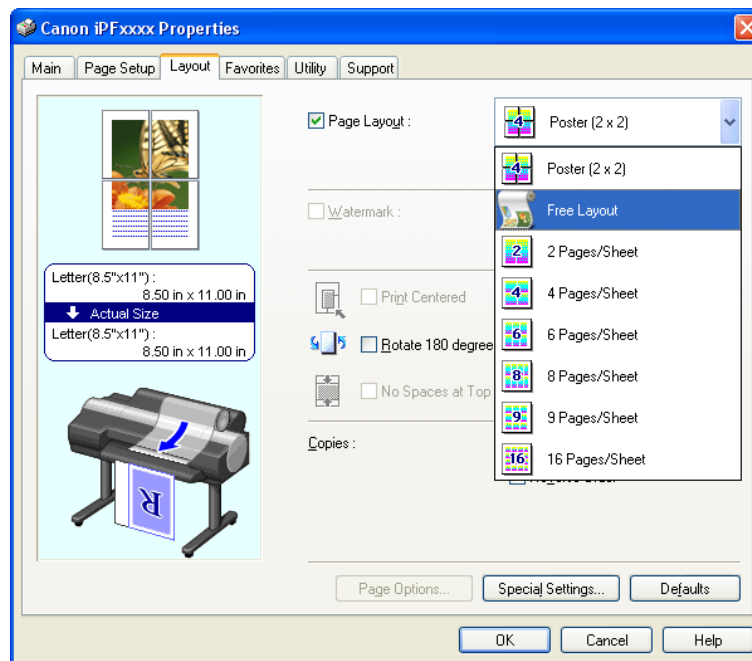

**Note**

- Your printer is depicted in the lower-left area of this screen.

4. In the **Layout** sheet, click on the **Page Layout** check box and select Free Layout from the list. Click the **OK** button to save the settings.

**Note**

- When you select Free Layout, all other setting items will be disabled.

5. On the **Print** dialog box in the application software, click the **Print** button. Free Layout main window is displayed.

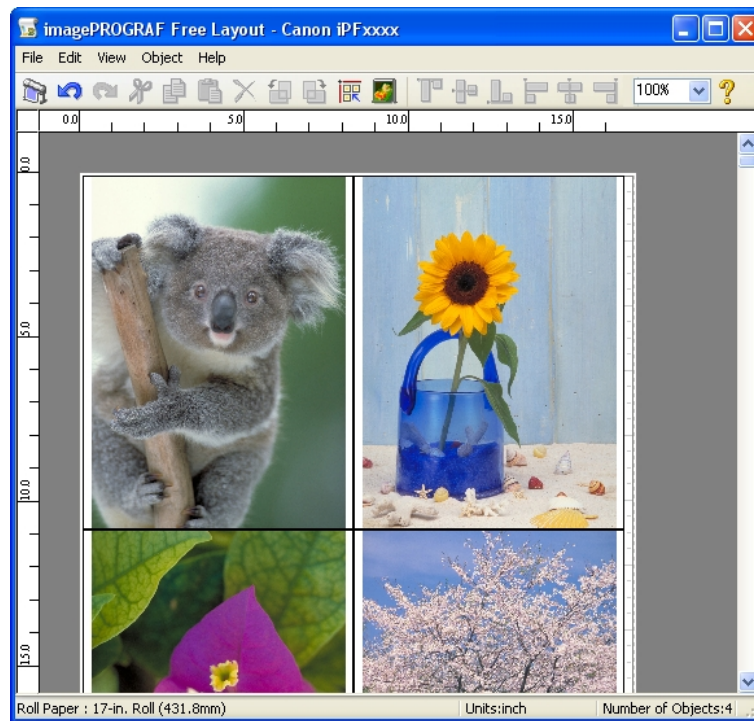

## Free Layout Main Window

The Free Layout main window consists of the menu and tool bars, layout area and status bar.

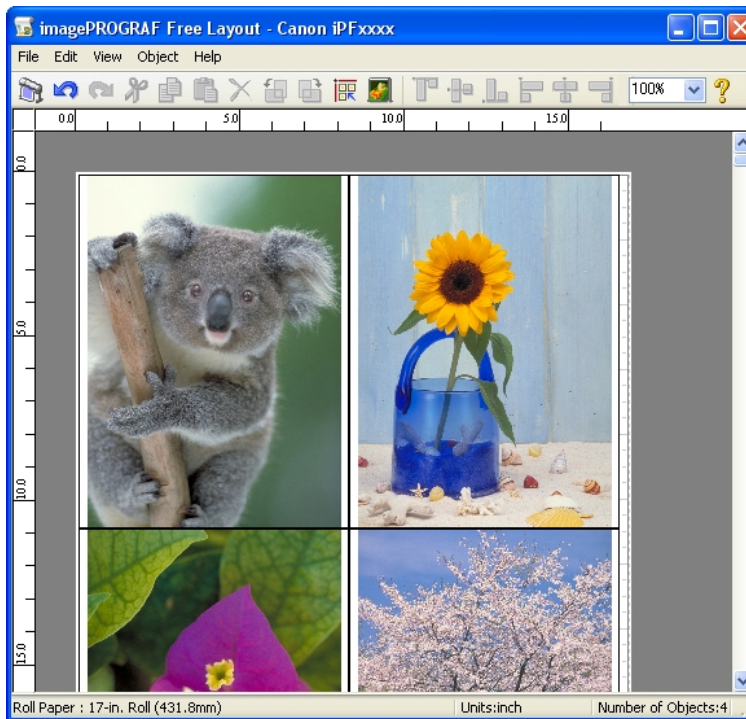

### Note

- You can use the **View** menu to show or hide the tool and status bar.

### • Menu Bar

This allows you to select menus required for operations.

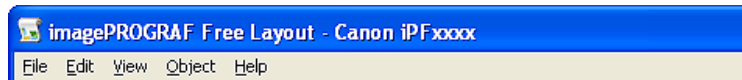

### • Tool Bar

This allows you to select tool buttons required for major operations.

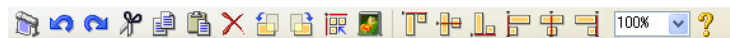

- **Layout Area**

This allows you to lay out objects and edit the object size and orientation.



- **Status Bar**

This shows the paper size, unit of length, and number of objects.

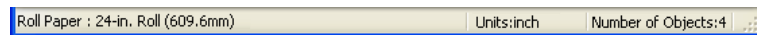

## Detailed Settings

The printer driver opens when you select **Detailed Settings** from the **File** menu. The printer driver is used to configure basic settings to match the type of media loaded in the printer.

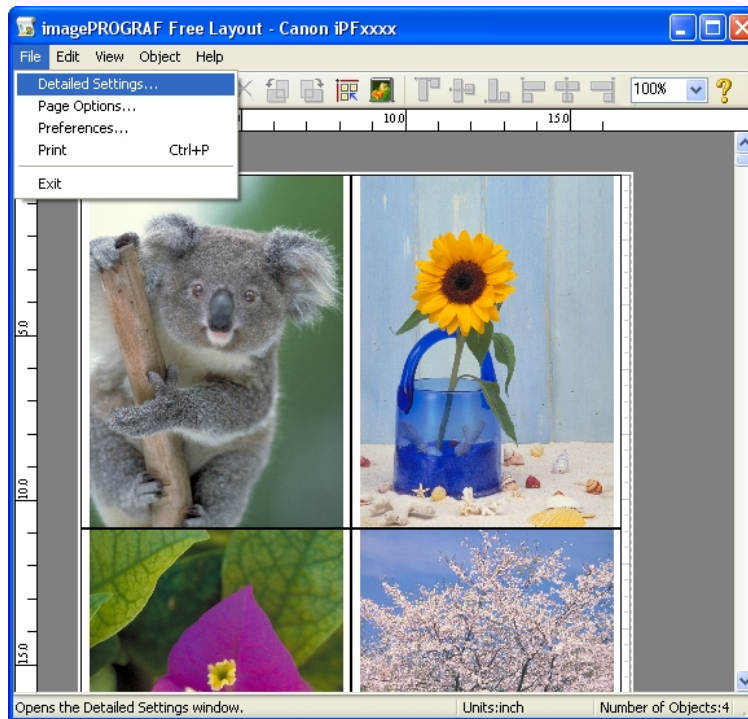

Refer to Printer Driver →P.207 for details on the printer driver.



### Note

- When you select the **Detailed Settings**, the only three sheets displayed are the **Main** sheet, the **Page Setup** sheet, and the **Layout** sheet. Some of the printer driver settings may be disabled.

## Preferences Dialog Box

This dialog box appears when you select **Preferences** from the **File** menu. This allows you to configure the preferences of Free Layout.

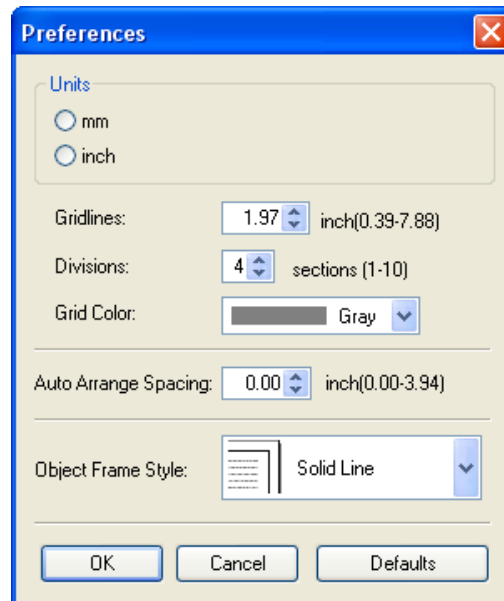

### • Units

Set the unit for paper length, margins, and so on.

### • Gridlines

You can input a grid line width value in numerical characters so that they serve as a guide to laying out objects.



#### Note

- You can input between 10.0 and 200.0(mm) (between 0.39 and 7.88(inch)).
- You can change the numbers by clicking either ▲ button or ▼ button.

### • Divisions

You can change the number of divisions of grid lines so that they serve as a guide to laying out objects.



#### Note

- You can input between 1 and 10.
- You can change the numbers by clicking either ▲ button or ▼ button.

### • Grid Color

Select the grid line color.

### • Auto Arrange Spacing

Change the object-to-object spacing to be applied in the operation of laying out objects automatically.



#### Note

- You can input between 0.0 and 100.0(mm) (between 0.00 and 3.94(inch)).
- You can change the numbers by clicking either ▲ button or ▼ button.



### • Object Frame Style

You can select the object frame style for printing.

The following settings are available for the object frame style.

Setting	Details
<b>None</b>	You can print with no frame style.
<b>Solid Line</b>	You can print the solid line as the frame style.
<b>Dotted Line</b>	You can print the dotted line as the frame style.
<b>Dashed Line</b>	You can print the dashed line as the frame style.
<b>Crop Marks</b>	You can print with the crop marks.

## Page Options Dialog Box

3

This dialog box appears when you select **Page Options** from the **File** menu. This allows you to configure the roll paper length, object layout order, and margins of Free Layout.

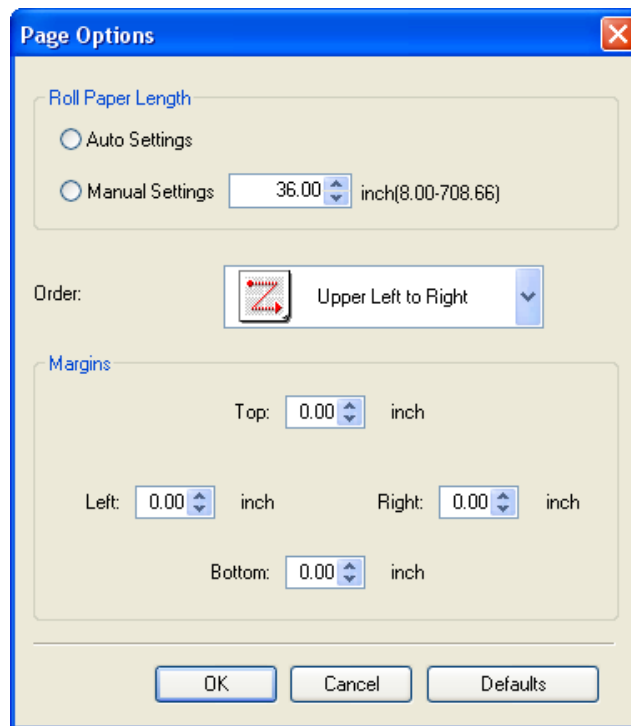

### • Roll Paper Length

Set the length of one page to print on roll paper.

The following settings are available for roll paper length.

Setting	Details
<b>Auto Settings</b>	The one-page length to be printed on roll paper is automatically set so that the laid-out objects are printed on one page.
<b>Manual Settings</b>	You can input the length of one page to print on roll paper in numerical characters.



**Note**

- Available only if rolls are selected in **Paper Source**.
- You can input between 203.2 and 18000.0(mm) (between 8.00 and 708.66(inch)).
- You can change the numbers by clicking either ▲ button or ▼ button.

**• Order**

Set the object layout order.

The following settings are available for order.

Setting	Details
<b>Upper Left to Right</b>	The objects are laid out from upper left to right.
<b>Upper Left to Bottom</b>	The objects are laid out from upper left to bottom.
<b>Upper Right to Left</b>	The objects are laid out from upper right to left.
<b>Lower Left to Top</b>	The objects are laid out from lower left to top.

**Note**

- When you have selected **Roll Paper Length > Auto Settings** and **Paper Orientation > Vertical**, you can choose **Upper Left to Right** or **Upper Right to Left**.
- When you have selected **Roll Paper Length > Auto Settings** and **Paper Orientation > Horizontal**, you can choose **Upper Left to Bottom** or **Lower Left to Top**.

**• Margins**

You can input the paper margins in numerical characters.

**Note**

- You can input between 0.0 and 50.0(mm) (between 0.00 and 1.97(inch)).
- You can change the numbers by clicking either ▲ button or ▼ button.

**Zoom Dialog Box**

This dialog box appears when you select **Zoom** from the **View** menu. You can enlarge or reduce the screen display.

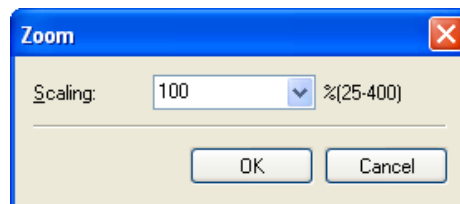
**• Scaling**

Set the magnification for enlargement or reduction of the screen display.

**Note**

- You can input between 25 and 400.
- You can change the numbers by clicking ▼ button.

## Format Dialog Box

This dialog box appears when you select **Format** from the **Object** menu after you select an object.

### Size Sheet

You can rotate, enlarge, or reduce an object.

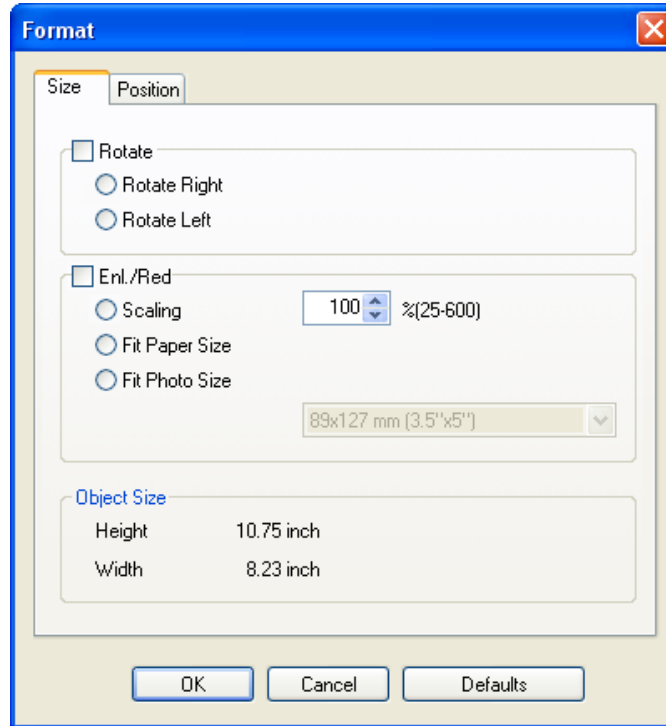

#### Note

- When the objects are not selected, you can not select **Format**.

#### • Rotate

When you place a checkmark here, you can select **Rotate Right** or **Rotate Left**.

Setting	Details
<b>Rotate Right</b>	Rotates the object 90 degrees clockwise.
<b>Rotate Left</b>	Rotates the object 90 degrees counterclockwise.



#### Note

- When several objects are selected, you cannot select **Rotate**.

#### • Enl./Red.

When you place a checkmark here, you can select **Scaling**, **Fit Paper Size**, or **Fit Photo Size**.

Setting	Details
<b>Scaling</b>	Allows you to input the value of the enlargement or reduction ratio of an object.

Setting	Details
<b>Fit Paper Size</b>	Prints by enlarging or reducing each object to match the paper size. If you are using roll paper, objects are enlarged or reduced so that the width of each object matches the width of the roll paper.
<b>Fit Photo Size</b>	Prints all of the objects at the specified photo size.

**Note**

- You can input between 25 and 600.
- You can change the numbers by clicking either ▲ button or ▼ button.

## Position Sheet

You can rotate, enlarge, or reduce an object.

**Note**

- When the objects are not selected, you can not select **Format**.

### • Object Position

You can move the object position by changing the values.

Setting	Details
<b>Vertical Pos</b>	You can input the number of the vertical position in numerical characters.
<b>Horizontal Pos</b>	You can input the number of the horizontal position in numerical characters.
<b>Page Pos</b>	You can input the number of the page position in numerical characters.

### • Object Size

You can confirm the object size.



**Note**

- When several objects are selected, you cannot display **Object Size**.

## Laying out a Multiple-File Document on One Page

You can lay out and print a multiple-file document on one page.

1. From the application software's **File** menu, select the printer setup menu to open the **Print** dialog box.



**Note**

- Normally, select **Print** from the **File** menu.

2. Click **Properties** to open the **Properties** dialog box.

3

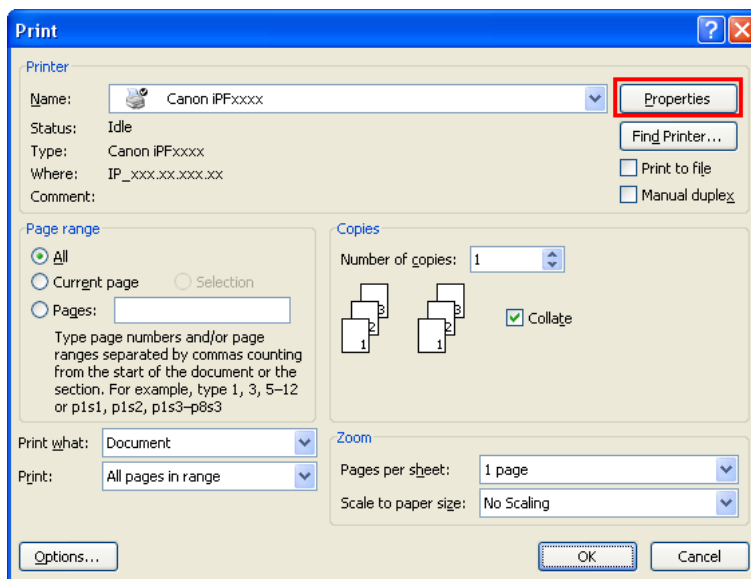

### 3. In the **Page Setup** sheet, select **Paper Source**.

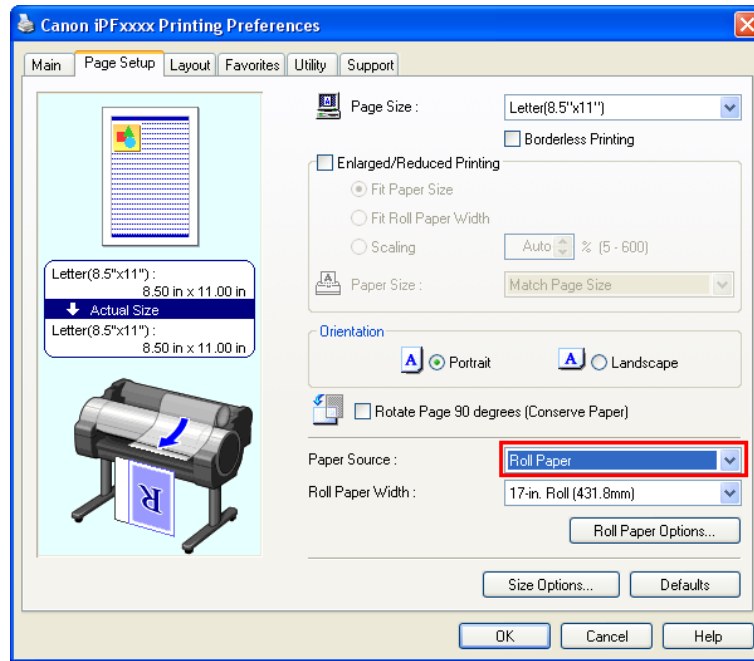

#### Note

- Your printer is depicted in the lower-left area of this screen.

### 4. In the **Layout** sheet, click on the **Page Layout** check box and select Free Layout from the list.

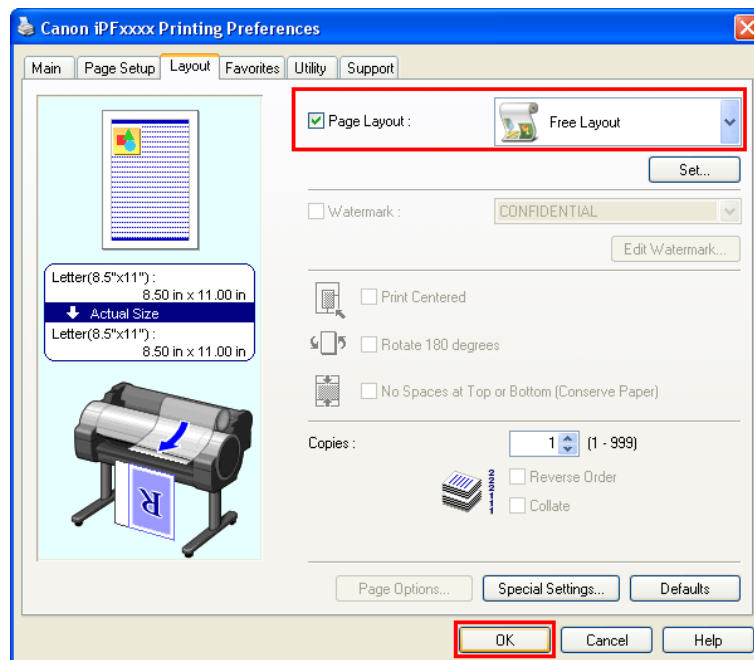



**Note**

- Your printer is depicted in the lower-left area of this screen.
- When you select Free Layout, all other setting items will be disabled.

**5.** Click the **OK** button to save the settings.

**6.** In the **Print** dialog box, select the pages to print and the number of copies, and click the **OK** button.

3

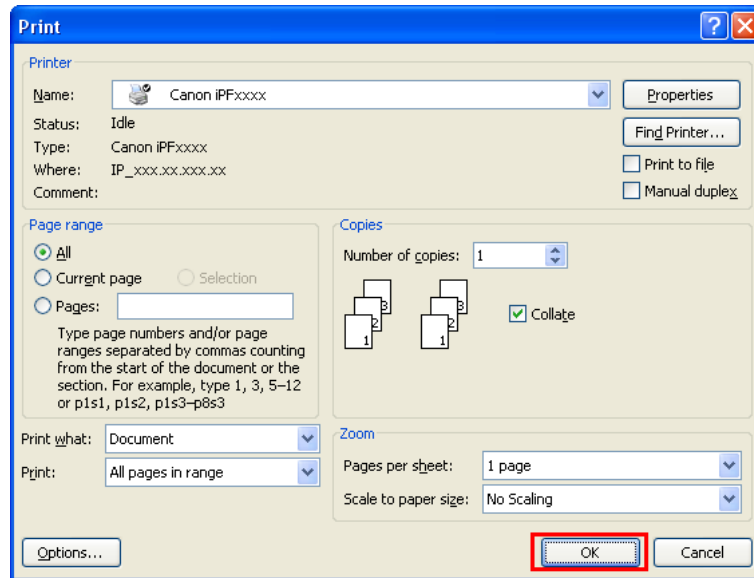

Free Layout starts, laying out the document created with application software in the layout area as an object.

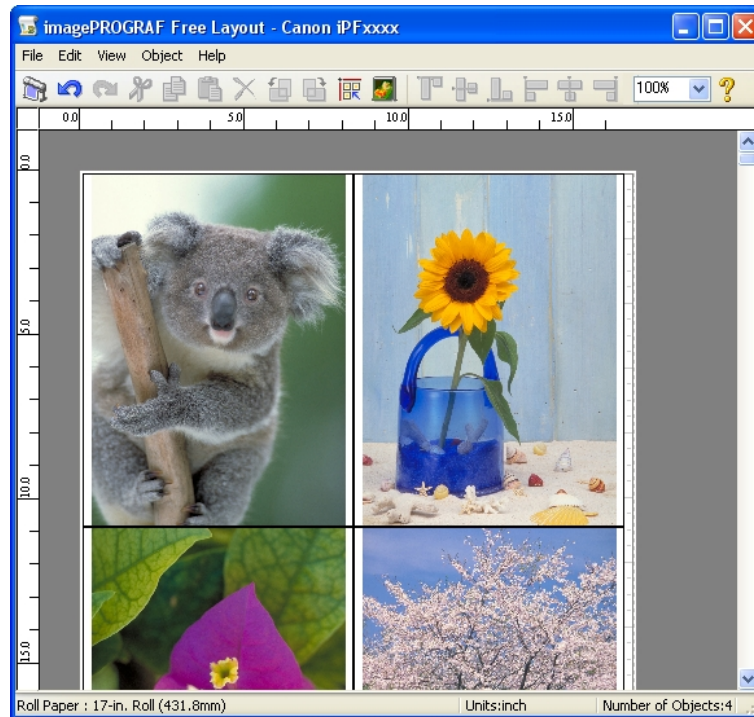

272

7. Leaving Free Layout running, open other files with the application software and repeat the above steps.

## Laying out a Document Created with Multiple Application Programs on One Page

You can lay out and print a document created with multiple application programs on one page.

1. From the application software's **File** menu, select the printer setup menu to open the **Print** dialog box.



### Note

- Normally, select **Print** from the **File** menu.

2. Click **Properties** to open the **Properties** dialog box.

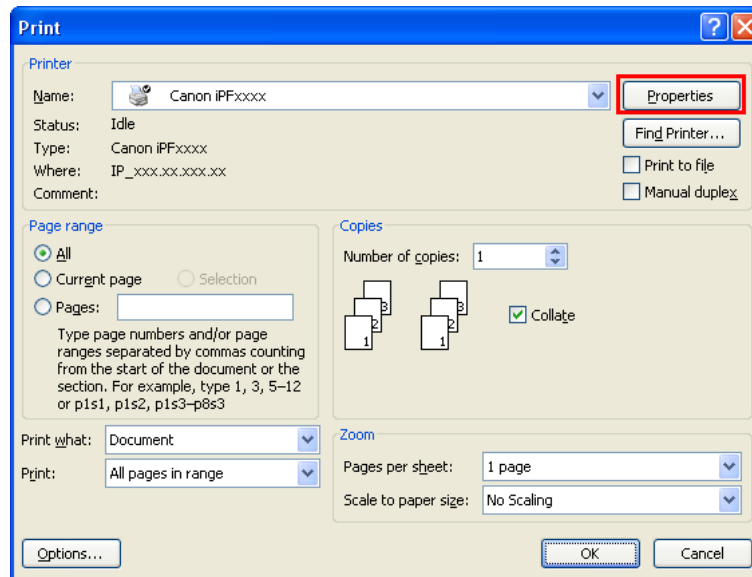

**3.** In the **Page Setup** sheet, select **Paper Source**.

3

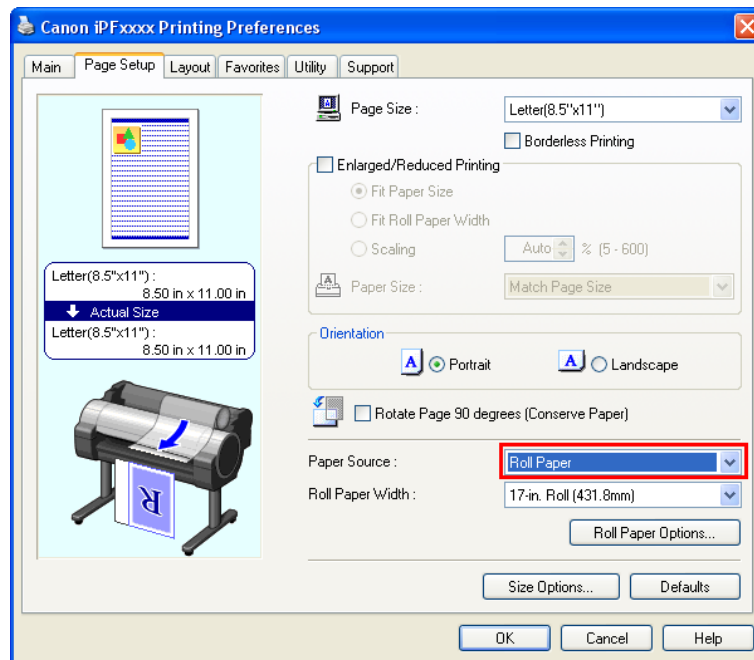

**Note**

- Your printer is depicted in the lower-left area of this screen.

**4.** In the **Layout** sheet, click on the **Page Layout** check box and select **Free Layout** from the list.

274

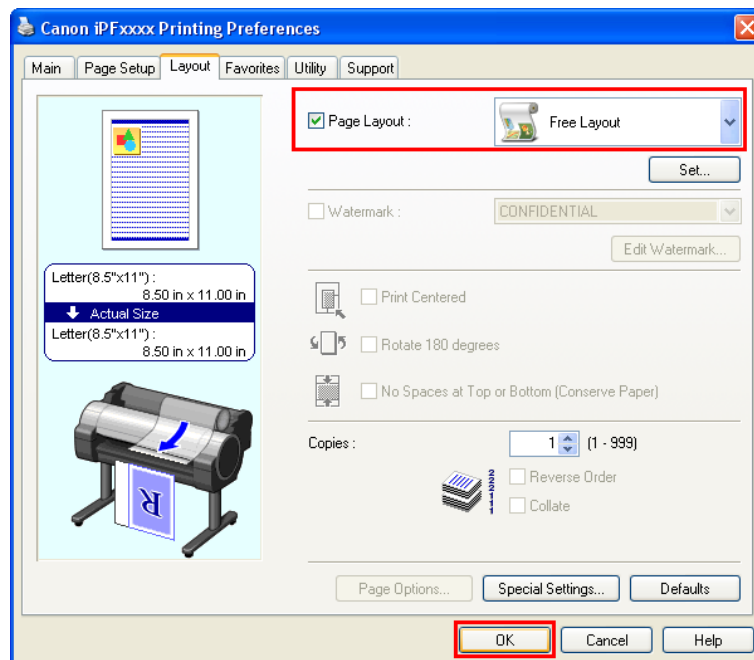



**Note**

- Your printer is depicted in the lower-left area of this screen.
- When you select Free Layout, all other setting items will be disabled.

5. Click the **OK** button to save the settings.

6. In the **Print** dialog box, select the pages to print and the number of copies, and click the **OK** button.

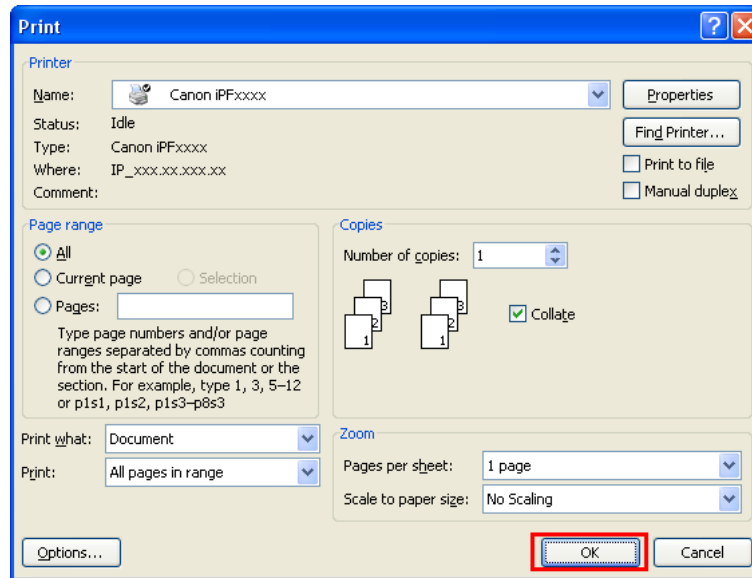

Free Layout starts, laying out the document created with application software in the layout area as an object.

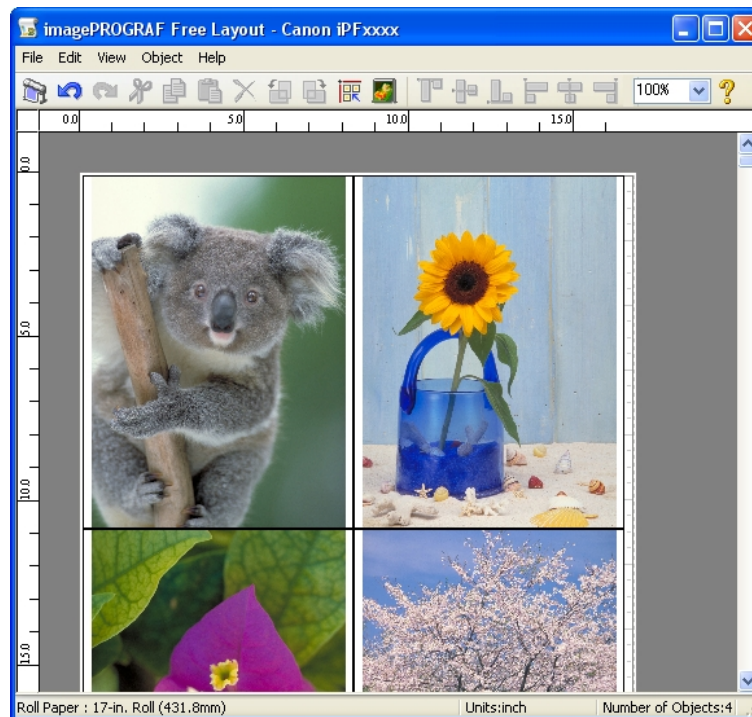

7. Leaving Free Layout running, open other files with other application software and repeat the above steps.

## Selecting an Object

When an object is selected, a select box (blue border) appears around the object.



### Note

- To select an object, click that object.
- To select multiple successive objects, click them while holding down the Shift key.
- To select multiple arbitrary objects, click them while holding down the Ctrl key.
- To select all objects, select **Select All** from the **Edit** menu.
- When you specify the area with dragging the mouse, the object in the area is selected.

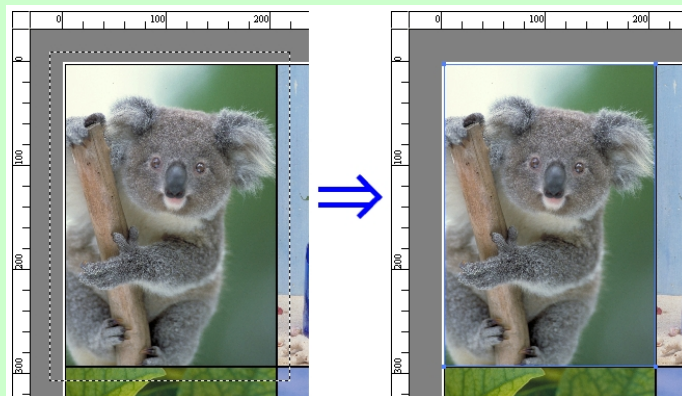

## Changing the Object Size

You can change the object size by means of mouse operation or by specifying a scaling value.



### Note

- The vertical-to-horizontal ratio remains unchanged when the object is enlarged or reduced.

### Resizing by means of mouse operation

1. Select an object.
2. Place the pointer at a corner of the selection box around the object to show the arrow handle, and drag this handle to change the object size.

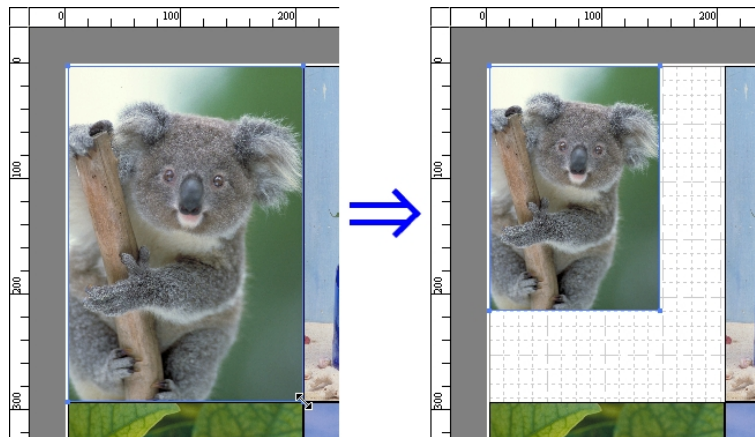

3

### Resizing by specifying a scaling value

1. Select an object.  
Click on the **Enl./Red.** checkbox in the Format Dialog Box **→P.268** and select **Scaling**.
2. You either enter numbers directly.



### Note

- You can input between 25 and 600.
- You can change the numbers by clicking either ▲ button or ▼ button.

3. Click the **OK** button.

277

## Moving an Object

You can move the object position.

1. Select an object.

- Place the pointer inside the selection box of the object to show the crosshair handle, and drag it to move the object. Alternatively, you can move the **Object Position** by changing the values in **Vertical Pos**, **Horizontal Pos** and **Page Pos** in the Format Dialog Box [→P.268](#).

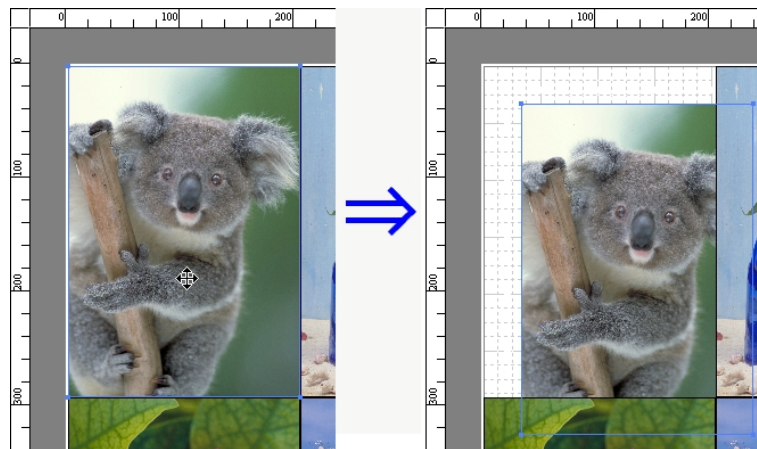

## Rotating an Object

You can rotate the object.

- Select an object.
- Select **Rotate Left 90 Degrees** or **Rotate Right 90 Degrees** from the toolbar. Alternatively, you may click on the **Rotate** check box in the Format Dialog Box [→P.268](#) then select **Rotate Right** or **Rotate Left**, and click the **OK** button.

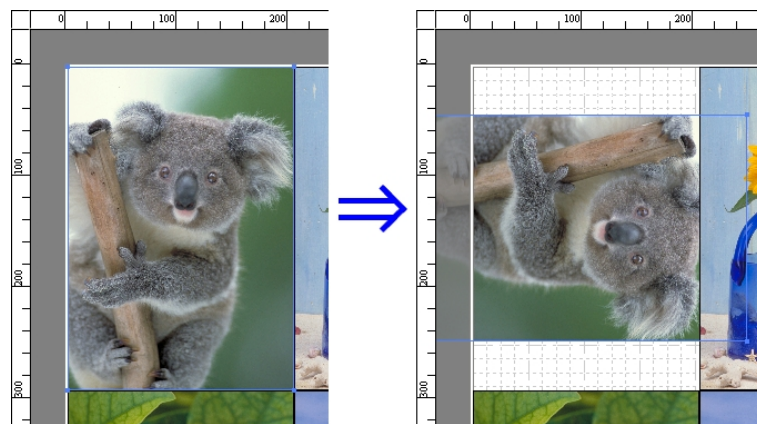

## Laying out Objects Automatically

Click **Auto Arrange Object** in the tool bar. This automatically lays out objects. Alternatively, you may select **Auto Arrange Object** from the **Object** menu.

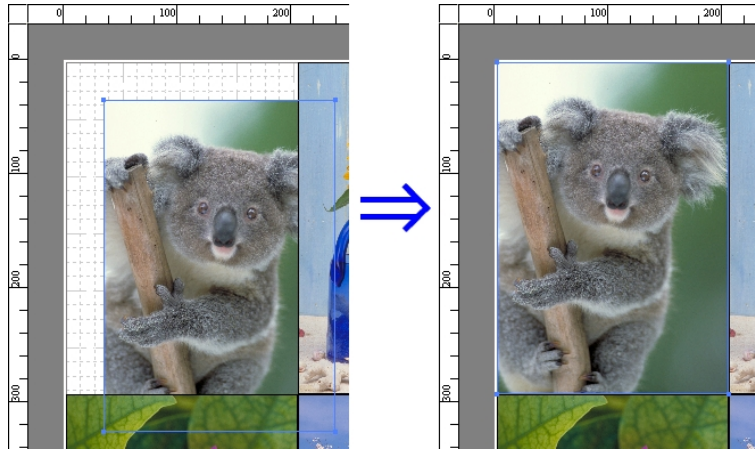

### Note

- The object layout order varies depending on the **Order** setting in the Page Options Dialog Box → P.266 dialog box.

3

## Aligning Objects

You can align objects systematically.

- Select multiple objects.
- Click the align button from the toolbar.  
Alternatively, you may select the align menu from the **Object** menu.

### • Align Top

Lays out the objects, justifying them to the top.

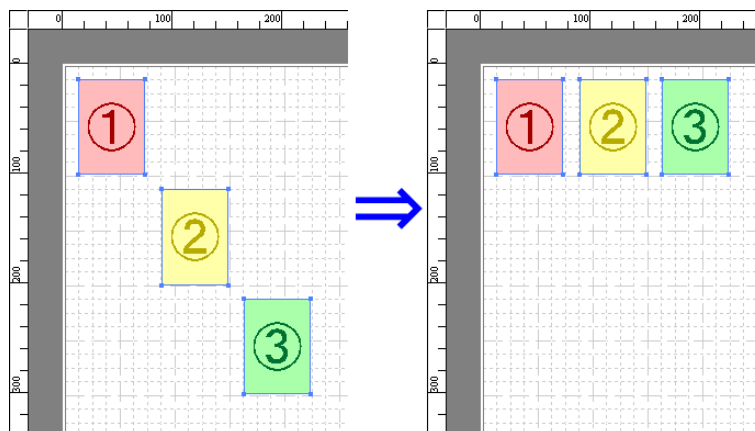

279

• **Center Vertically**

Lays out the objects, justifying them to the vertical center.

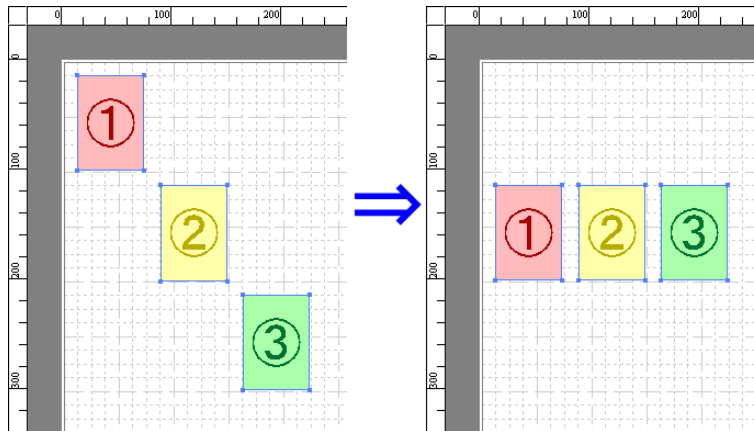

• **Align Bottom**

Lays out the objects, justifying them to the bottom.

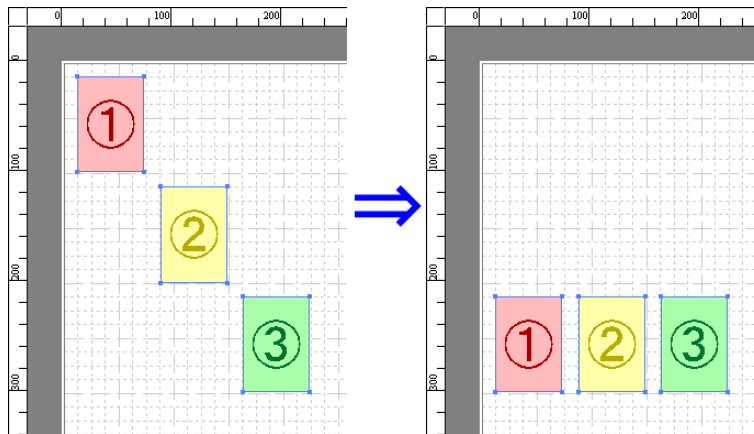

• **Align Left**

Lays out the objects, justifying them to the left.

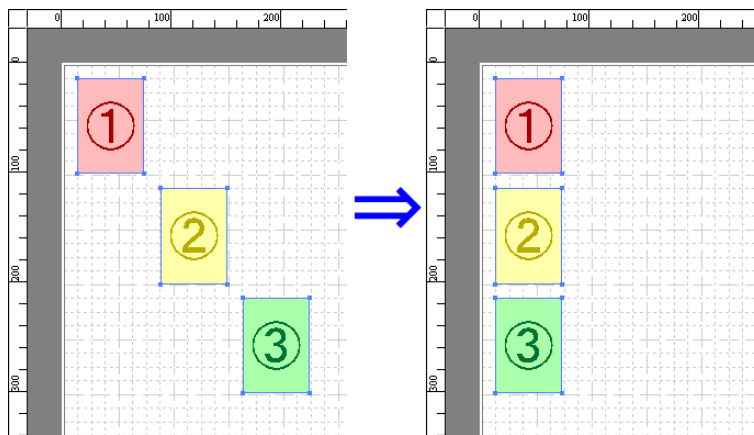



### • Center Horizontally

Lays out the objects, justifying them to the horizontal center.

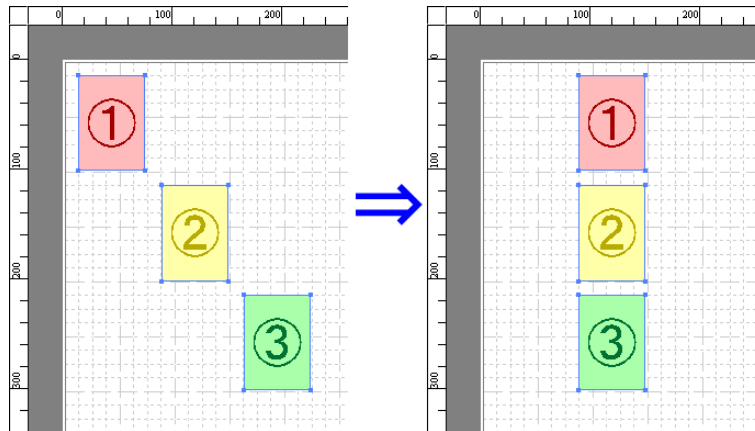

### • Align Right

Lays out the objects, justifying them to the right.

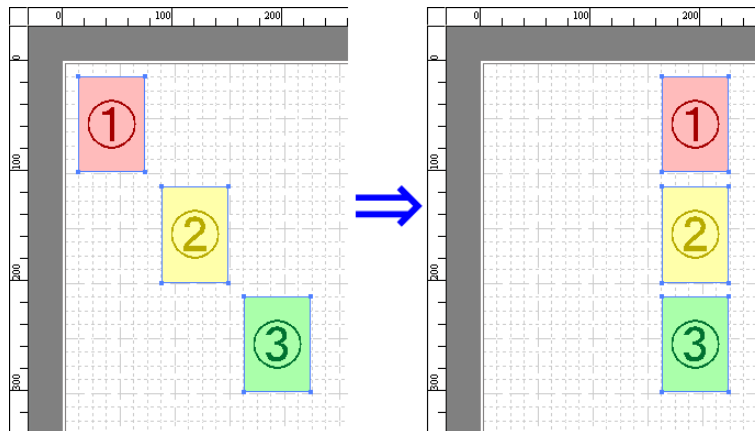

3

## Changing the Object Overlapping Order

You can change the object overlapping order.

1. Select an object.
2. Select the Overlapping Order menu from the **Object** menu.



#### Note

- The order of overlapping affects the order of objects automatically laid out.
- You can also select by clicking the right button of the mouse on an object.

281

• **Bring to Front**

Moves the object to the frontmost position.

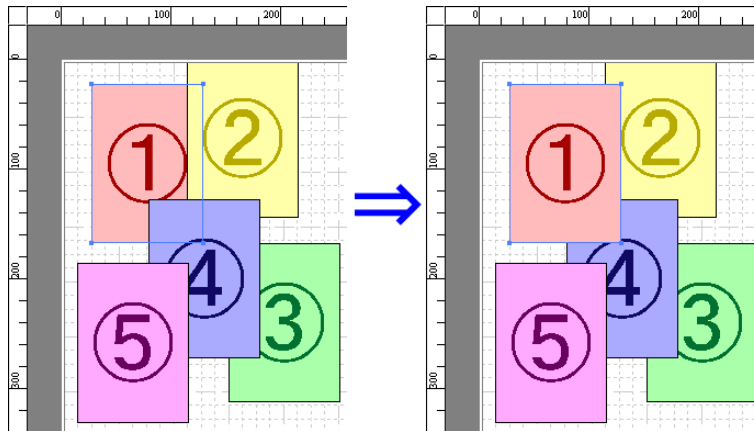

• **Send to Back**

Moves the object to the backmost position.

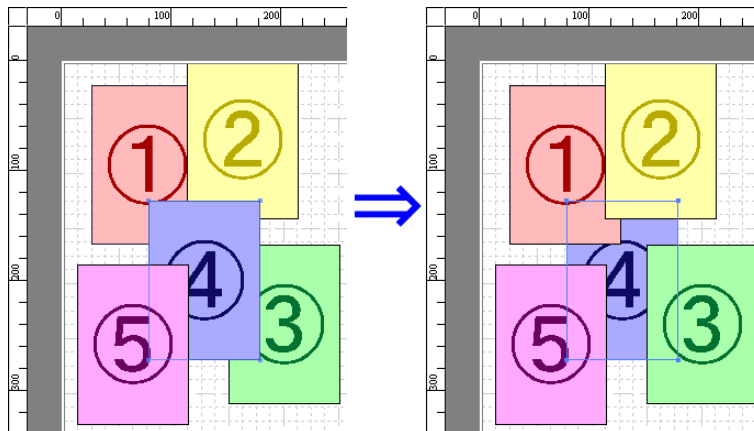

• **Bring Forward**

Moves the object one position to the front.

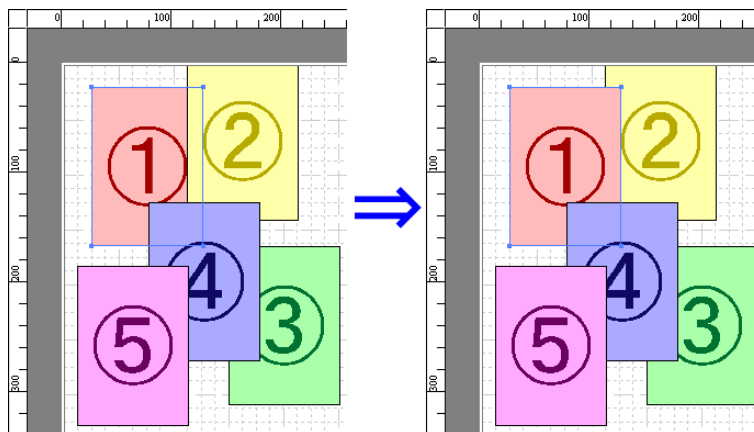



- **Send Backward**

Moves the object one position to the back.

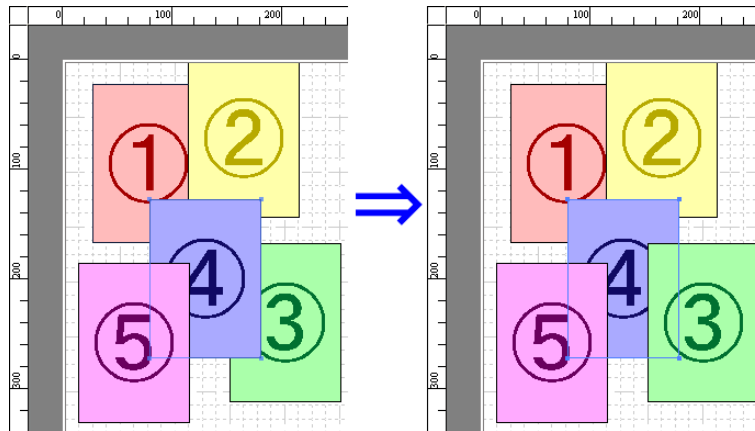

3

## Pasting a Copied or Cut Object

1. Click **Copy** or **Cut** from the toolbar.  
Alternatively, you may select **Copy** or **Cut** from the **Edit** menu.
2. Click **Paste** from the toolbar.  
Alternatively, you may select **Paste** from the **Edit** menu.



### Note

- The copied or cut object is laid out at the end of the page.
- You can also select by clicking the right button of the mouse on an object.
- In order to paste an object on any position that you like, you can paste the object with **Pointed Paste** by clicking the right button of the mouse on any position that you want.

283

## Folded Duplex Window

This window is displayed if you select **Folded Duplex** from the **Edit** menu after selecting an object. Using the **Folded Duplex** function allows you to print with fold lines added.

The **Folded Duplex** window consists of the menu and tool bars, layout area and status bar.

3

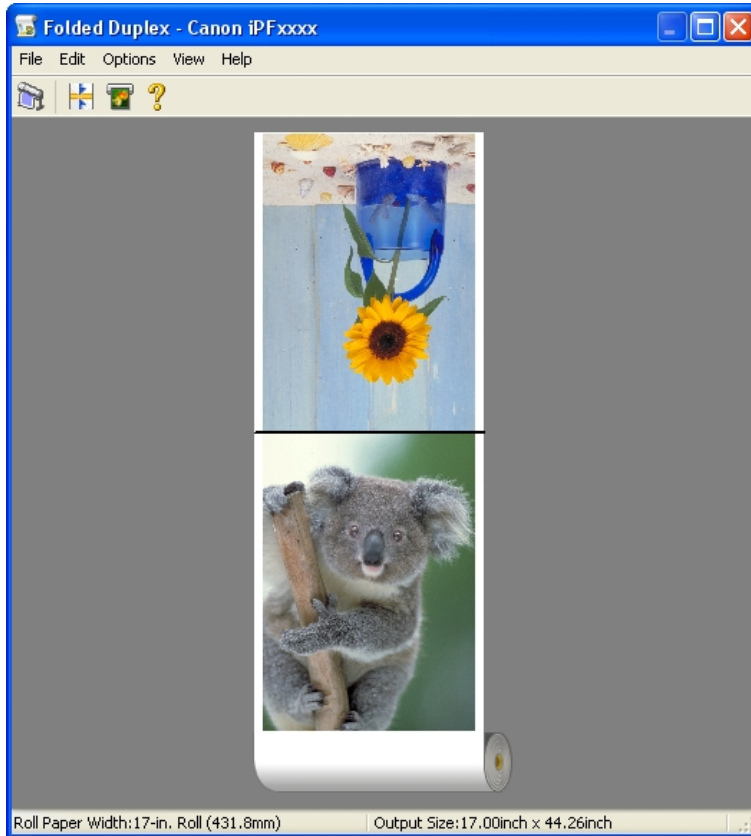

**Note**

- The toolbar and status bar can be toggled between hidden and displayed from the **View** menu.

- **Menu Bar**

This allows you to select menus required for operations.



- **Tool Bar**

This allows you to select tool buttons required for major operations.



- **Layout Area**

This allows you to check the arrangement and orientation of objects.

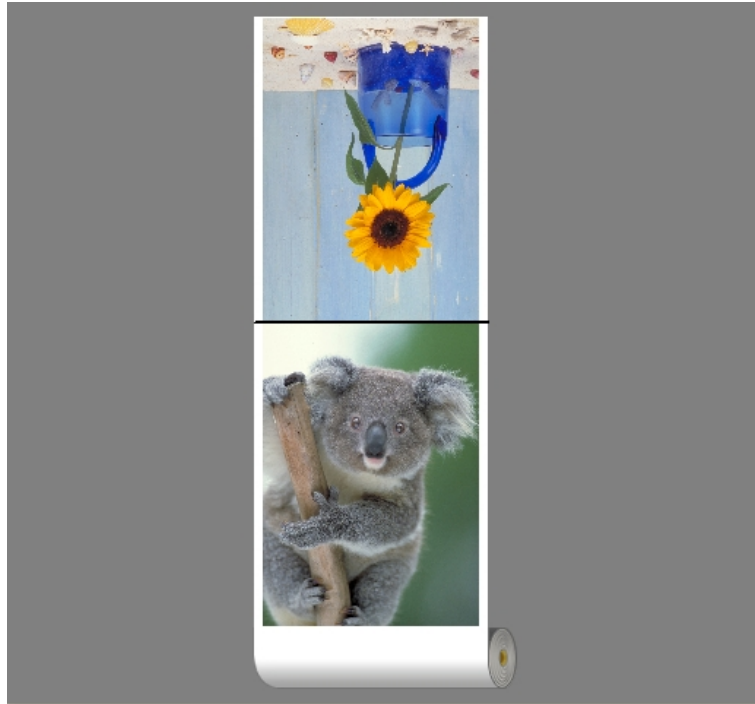

- **Status Bar**

This shows the paper source, roll paper width, and output size.

Roll Paper Width:17-in. Roll (431.8mm)      Output Size:17.00inch x 44.26inch

3

## Finished Size Settings Dialog Box

This dialog box is displayed when you select **Finished Size Settings** from the **Edit** menu. This allows you to configure finished size settings.

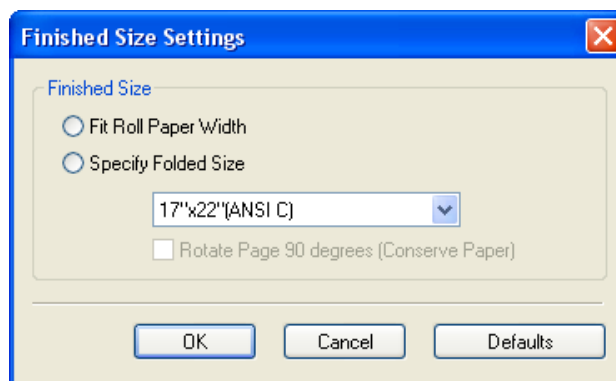

- **Finished Size**

Selects the method for setting the finished size.

The following settings are available for the finished size.

285

Setting	Details
<b>Fit Roll Paper Width</b>	Prints by automatically enlarging or reducing the entire document so that the width of the document matches the roll paper width.
<b>Specify Folded Size</b>	Prints by automatically enlarging or reducing the entire document to match the size of the paper. Select the actual size of the paper you want to print on in <b>Fit Paper Size</b> .
<b>Rotate Page 90 degrees (Conserve Paper)</b>	Prints by rotating pages by 90 degrees. Pages are automatically rotated if they will fit within the roll paper width when rotated, and are not rotated if they will not fit within the roll paper width.

## Binding Settings Dialog Box

This is displayed when you select **Binding Settings** from the **Edit** menu. This allows you to configure the binding edge settings.

3

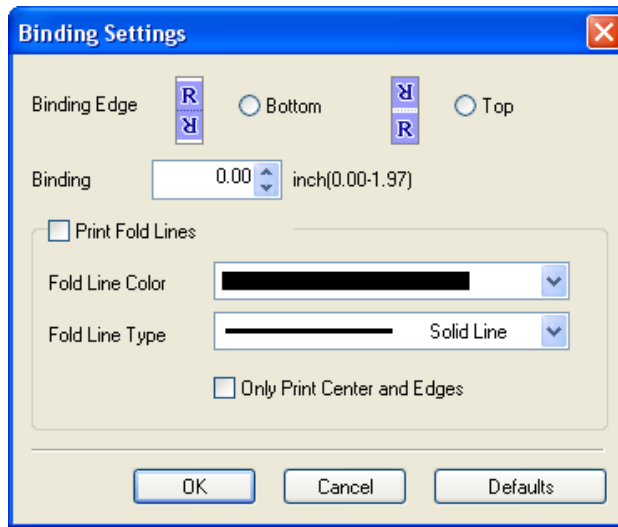

### • Binding Edge

Configures the binding edge when folding paper.  
The following settings are available for the binding edge.

Setting	Details
<b>Bottom</b>	Prints by placing the binding margin (gutter) at the bottom of the document.
<b>Top</b>	Prints by placing the binding margin (gutter) at the top of the document.

### • Binding

Configures the binding margin (gutter).  
Prints by creating a binding margin (gutter) of the specified size. Enter the margin size as a number.



**Note**  
• The values that can be entered are 0 to 50 (mm).

### • Print Fold Lines

Configures the color and type of fold lines.

**Note**

- To not print fold lines, clear the **Print Fold Lines** checkbox.

- **Fold Line Color**

You can select the fold lines.

- **Fold Line Type**

You can select the fold lines.

The following settings are available for the fold line type.

Setting	Details
<b>Solid Line</b>	You can print the solid line as the frame style.
<b>Dotted Line</b>	You can print the dotted line as the frame style.
<b>Dashed Line</b>	You can print the dashed line as the frame style.

- **Only Print Center and Edges**

To print fold lines at the center and both edges, select the **Only Print Center and Edges** checkbox.

3

## Prints using Folded Duplex

This prints 2 pages consecutively. Folding back the paper at the fold lines of the center substitutes for duplex printing.

1. Select two objects from the layout area of Free Layout.
  2. Select **Folded Duplex** from the **Edit** menu of Free Layout.  
Open the **Folded Duplex** window and arrange the selected objects in the layout area.
  3. Open the **Finished Size Settings** dialog box from the **Edit** menu.
  4. Select **Fit Roll Paper Width** or **Specify Folded Size** in **Finished Size**.
- 

**Note**

  - **Rotate Page 90 degrees (Conserve Paper)** is also available when **Specify Folded Size** is selected.
5. Click **OK** to save the settings.
  6. Open the **Binding Settings** dialog box from the **Edit** menu.
  7. Select **Bottom** or **Top** in **Binding Edge**.
  8. Specify the **Binding** width in **Binding**.

287

**9.** Configure the **Fold Line Color** and **Fold Line Type** from **Print Fold Lines**.



**Note**

- When the **Only Print Center and Edges** checkbox is selected, fold lines are only printed at the three locations of the center and both edges.

**10.** Click **OK** to save the settings.

**11.** Confirm the print setting and begin printing.

## Color imageRUNNER Enlargement Copy

The Features of Color imageRUNNER Enlargement Copy .....	289
Operating Environment .....	289
Starting Color imageRUNNER Enlargement Copy .....	290
Color imageRUNNER Enlargement Copy Dialog Box .....	291
Hot Folder .....	292
Creating a New Hot Folder .....	293
Specifying an Existing Shared Folder as a Hot Folder .....	297
Setting the Print Parameters .....	300
Printing Enlargements of Scanned Originals from a Color imageRUNNER .....	301

### The Features of Color imageRUNNER Enlargement Copy

3

The main features of Color imageRUNNER Enlargement Copy are as follows.

- Allows the document scanned with the Color imageRUNNER to be automatically enlarged and printed.
- You can perform basic printer settings such as printer selection, media type and output profile selection, and matching methods, in addition to borderless printing and enlargement/reduction process without growing through the printer driver.



#### Note

- The media type, image size, detailed media settings, and the printer settings can cause the actual print output to differ from the Color imageRUNNER Enlargement Copy settings.

### Operating Environment

You can use the Color imageRUNNER Enlargement Copy in the following environments.

- Compatible Operating System  
Windows 2000, Windows XP, Windows Server 2003, Windows Server 2003 R2, Windows Vista, Windows Server 2008, Windows 7



#### Note

- This function is not available on 64-bit version of Windows.
  - For the Windows OS, use the latest version of Service Pack.
- Software that requires installation  
imagePROGRAF Printer Driver

289

## Starting Color imageRUNNER Enlargement Copy

Follow the procedure below to start the Color imageRUNNER Enlargement Copy.

### To start by selecting **Printers and Faxes** from the **start** button

1. Open the folder of the OS you are using for configuring printers.  
For example, on Windows XP click the **start** button on the desktop, and then select **Printers and Faxes**.
2. Right-click the Printers icon and select **Printing Preferences** to open the **Printing Preferences** dialog box.  
In the **Utility** sheet, click the **Color imageRUNNER Enlargement Copy** button.

3

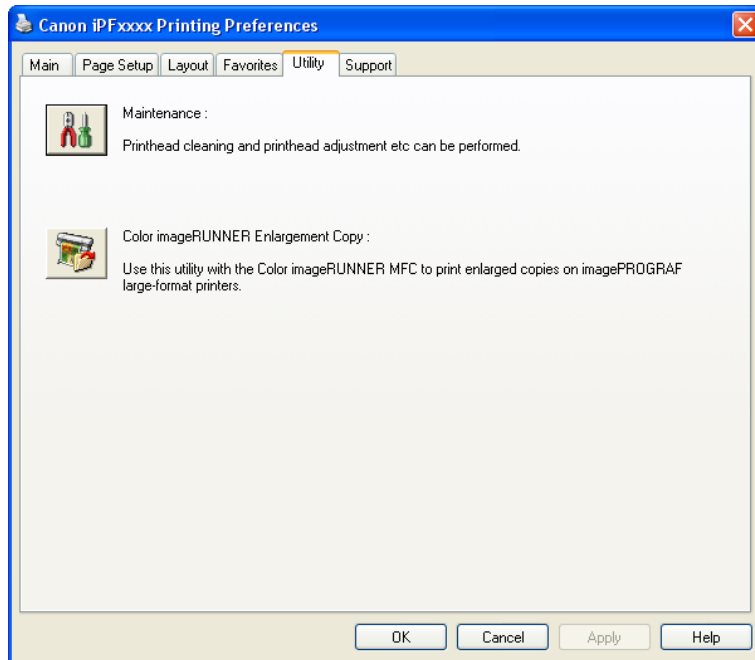

3. The **Color imageRUNNER Enlargement Copy** dialog box displays.

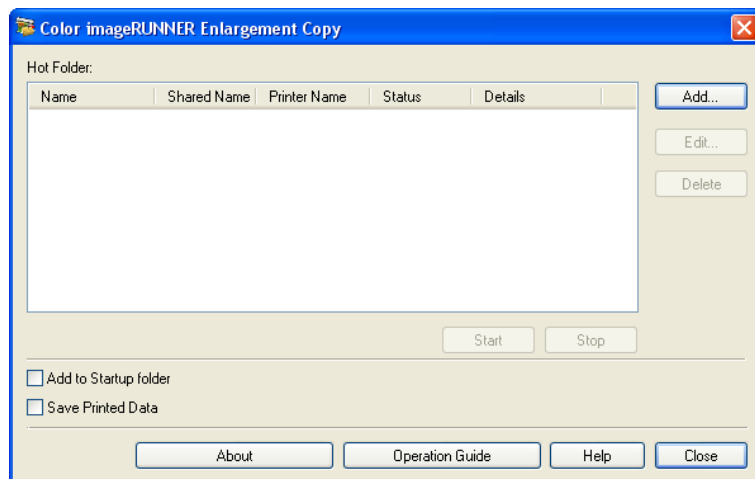

290



**Note**

- If you click on the **Add to Startup folder** check box in the **Color imageRUNNER Enlargement Copy** dialog box, the icon of Color imageRUNNER Enlargement Copy utility will appear on the task bar when starting Windows thereafter.

To start by selecting **Color imageRUNNER Enlargement Copy** from the **start** button

1. From the Windows **start** button, select **Color imageRUNNER Enlargement Copy**.

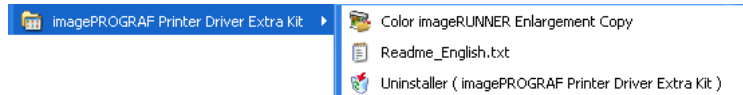

2. The **Color imageRUNNER Enlargement Copy** dialog box displays.

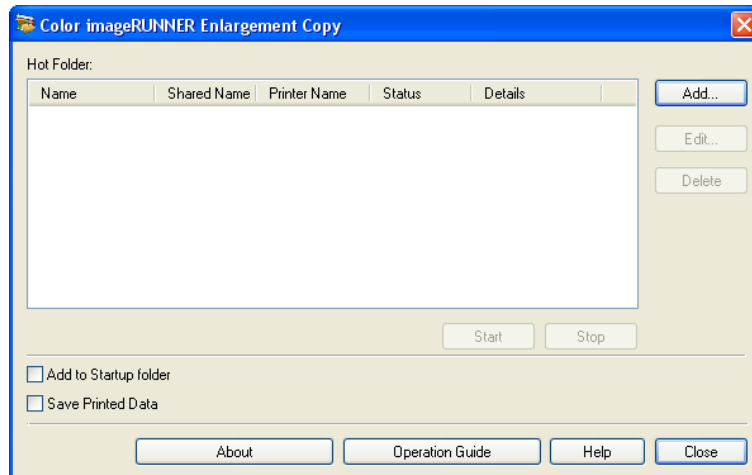

3

## Color imageRUNNER Enlargement Copy Dialog Box

The explanation below is on the **Color imageRUNNER Enlargement Copy** dialog box.

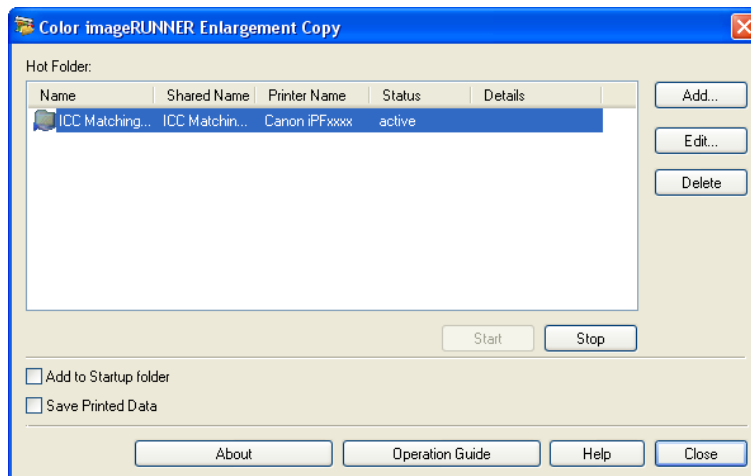

291



Note

- For the step to open the **Color imageRUNNER Enlargement Copy** dialog box, see "Starting Color imageRUNNER Enlargement Copy." →P.290

• **Hot Folder**

The hot folder list appears.

• **Add Button**

Click the button to open the **Easy Setup Wizard** dialog box so that you can add a hot folder.

• **Edit Button**

From the **Hot Folder** list, select a hot folder and click the button to open the **Add/Edit Hot Folder** dialog box that allows you to edit the hot folder.

• **Delete Button**

From the **Hot Folder** list, select a hot folder and click the button to delete the hot folder.

• **Start Button**

Clicking the button changes the status of the selected **inactive** Hot Folder to **active**.

• **Stop Button**

Clicking the button changes the status of the selected **active** Hot Folder to **inactive**.

• **Add to Startup folder**

Register the application in the Windows startup menu.

• **Save Printed Data**

Automatically saves printed data.

• **About Button**

Click the button to display the name and the version number of the utility.

• **Operation Guide Button**

Click the button to display the **Color imageRUNNER Enlargement Copy Setup Manual**.

## Hot Folder

Hot folder refers to a folder used for Color imageRUNNER Enlargement Copy.

- When transferred to the PC's hot folder, the document data scanned with the Color imageRUNNER is printed in enlarged size from the printer according to the print conditions set in the hot folder.
- You can create a new hot folder, edit or delete an existing one, and set print conditions at will.



Note

- You can create up to 20 hot folders.

## Creating a New Hot Folder

1. Open the **Color imageRUNNER Enlargement Copy** dialog box, and then click the **Add** button.

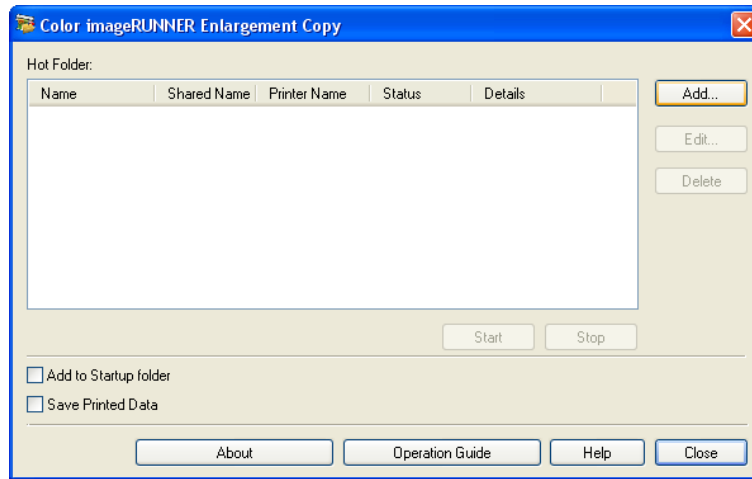

### Note

- For the step to open the **Color imageRUNNER Enlargement Copy** dialog box, see "Starting Color imageRUNNER Enlargement Copy." →P.290

2. The **Easy Setup Wizard** dialog box displays. Click the **Next** button.



3. Select the type of printer to use.  
Click the **Next** button.

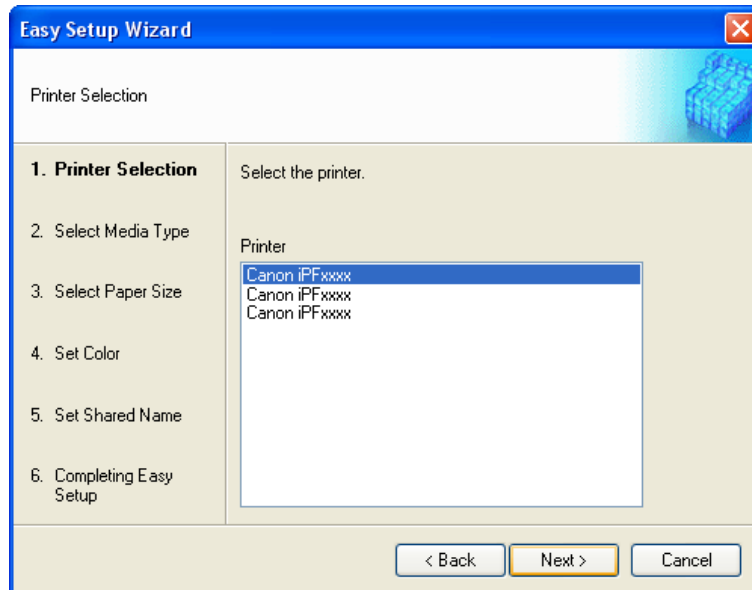

4. Select the media type to print.



**Note**

- If the **Borderless Printing** checkbox is checked, only media types that can be used for borderless printing are displayed in the list.

Click the **Next** button.

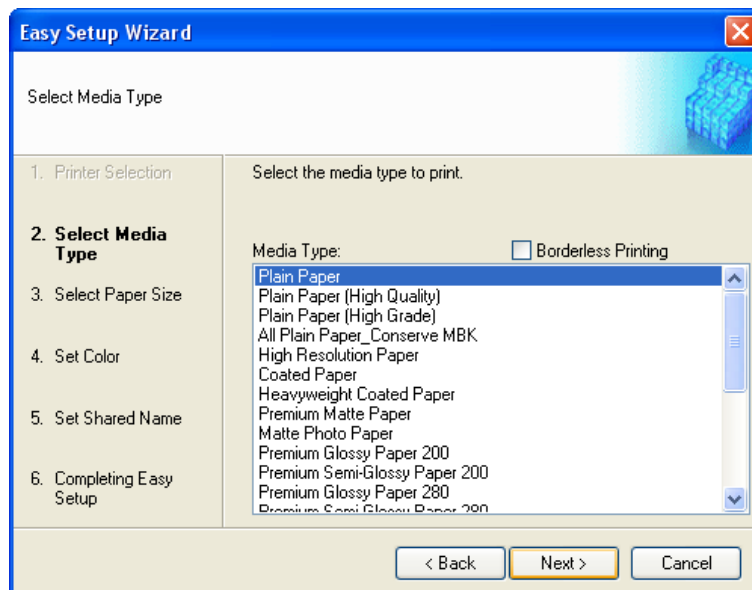

5. Select roll paper or cut sheet to print. Also, select the media size to print.  
Click the **Next** button.

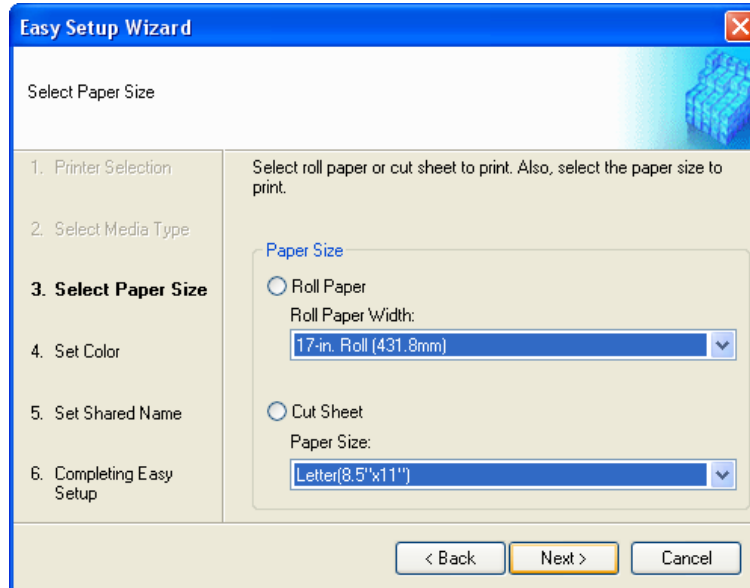

6. Select the color matching method.  
Click the **Next** button.

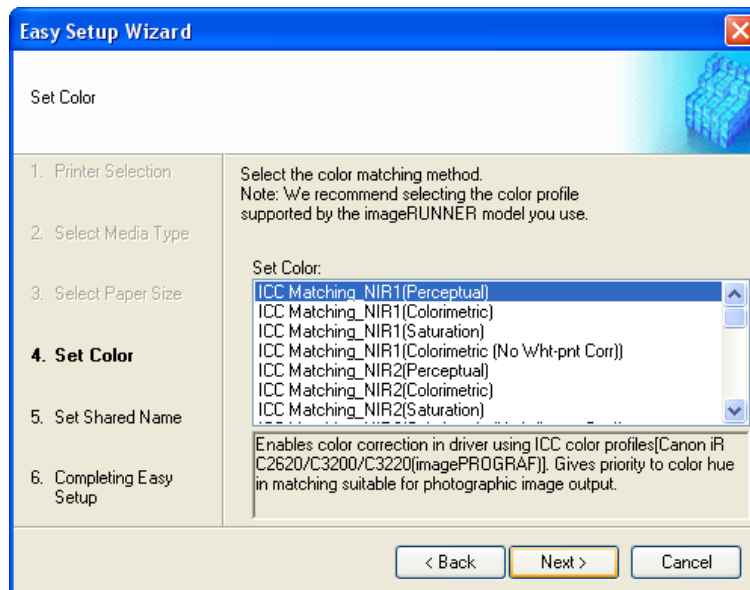

7. To receive a document scanned with the Color imageRUNNER, you need to share a folder. Enter the folder shared name in **Shared Name**.  
Click the **Next** button.



**Note**

- This shared name is used as the name of the hot folder.
- You cannot use the **Back** button, after clicking the **Next** button here.

3

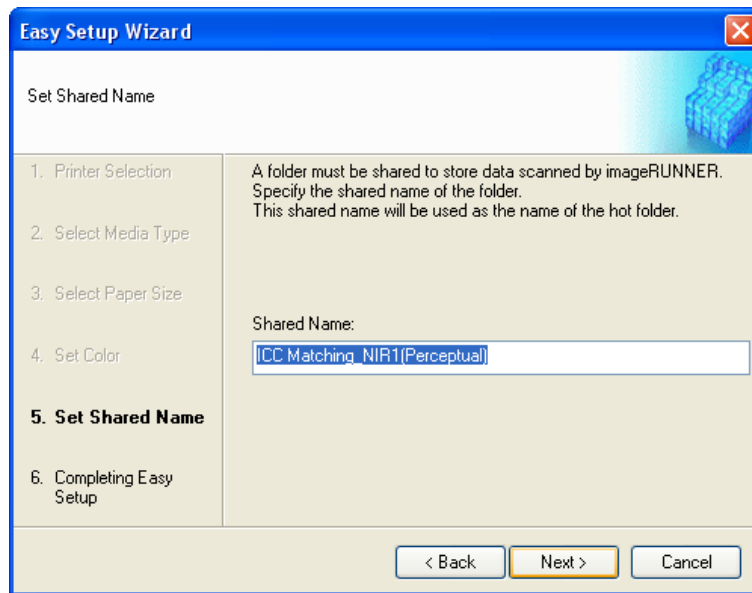

8. Click **Finish** button to close the **Easy Setup Wizard** dialog box.

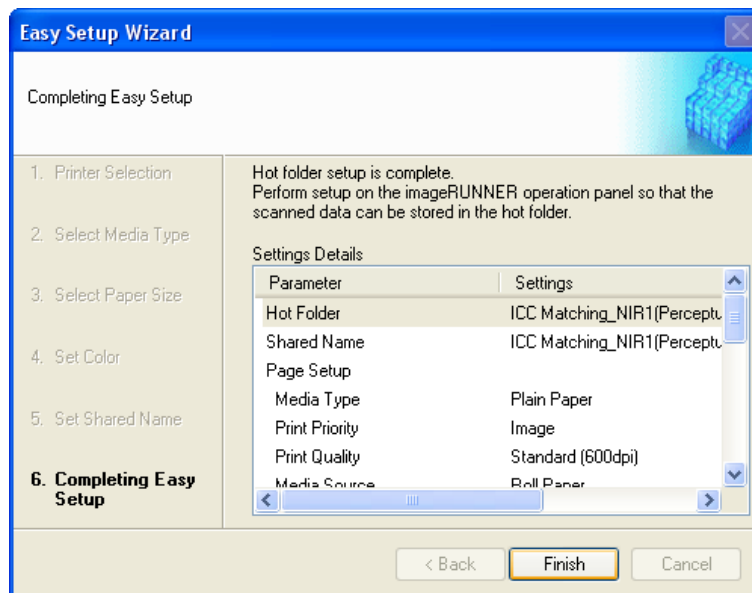

The hot folder you have created appears in the **Hot Folder** list in the **Color imageRUNNER Enlargement Copy** dialog box.

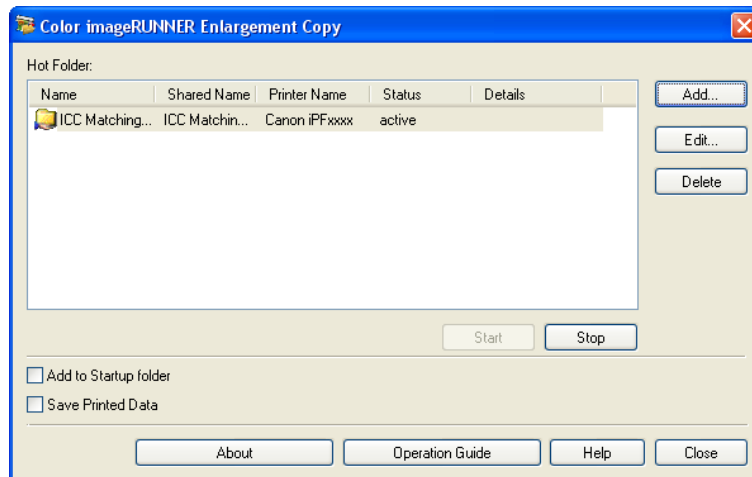

3

## Specifying an Existing Shared Folder as a Hot Folder

1. Share the folder you want to specify as a hot folder.
2. Open the **Color imageRUNNER Enlargement Copy** dialog box, and then click the **Add** button.

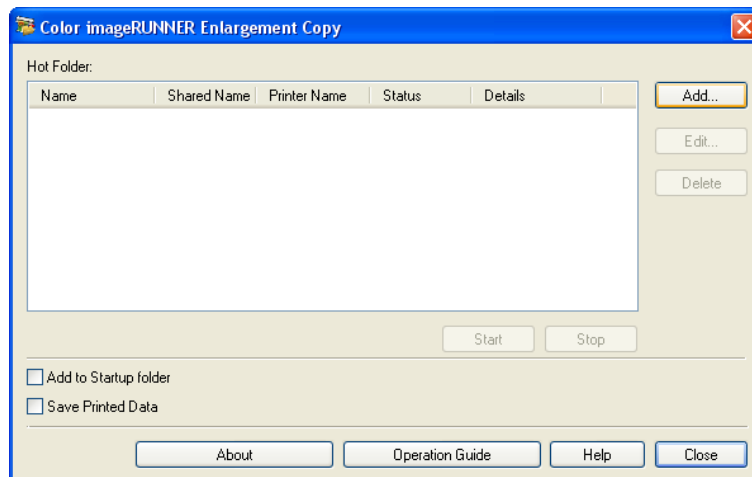

### Note

- For the step to open the **Color imageRUNNER Enlargement Copy** dialog box, see "Starting Color imageRUNNER Enlargement Copy." →P.290

297

3. The **Easy Setup Wizard** dialog box displays.  
Click the **Manual Settings** button.

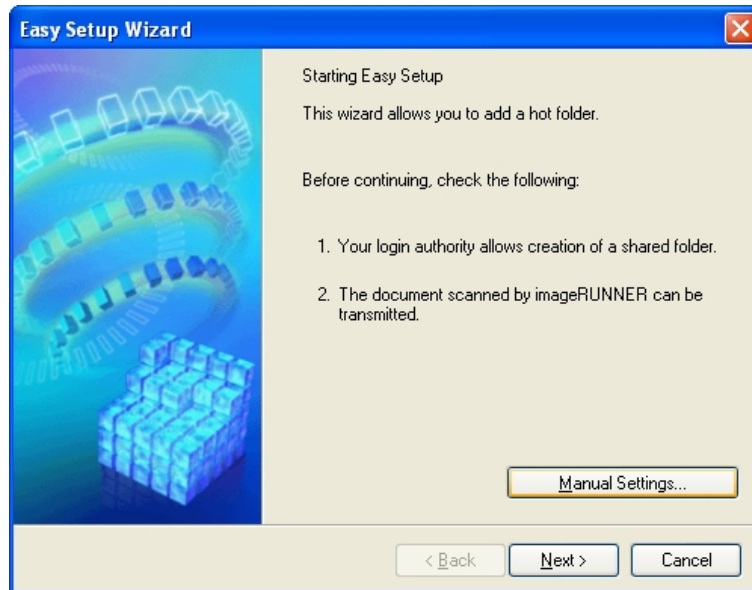

4. The **Add/Edit Hot Folder** dialog box displays.  
Enter the hot folder name in **Name**.  
Click the **Browse** button, with selecting **Specify a folder**, to set the existing shared folder.

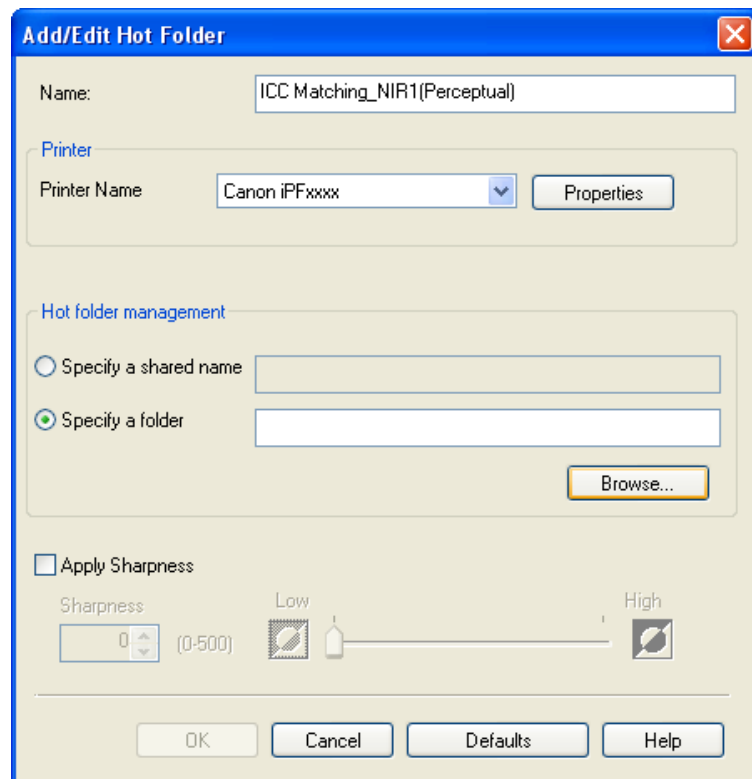



5. The location of the folders will appear.  
Select the folder to specify a hot folder, and click the **OK** button.

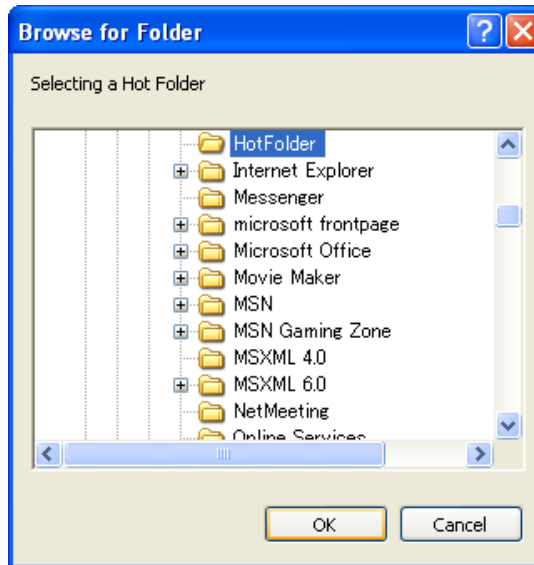

6. As necessary, set the print conditions in the hot folder. (See "Setting the Print Parameters.") →P.300  
Click the **OK** button to close the **Add/Edit Hot Folder** dialog box.

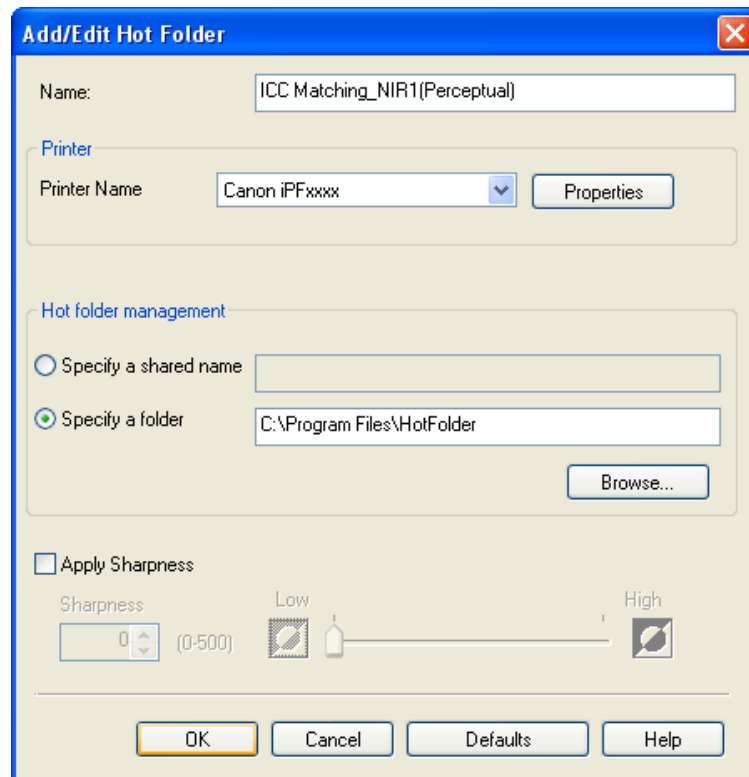

The hot folder you have created appears in the **Hot Folder** list in the **Color imageRUNNER Enlargement Copy** dialog box.

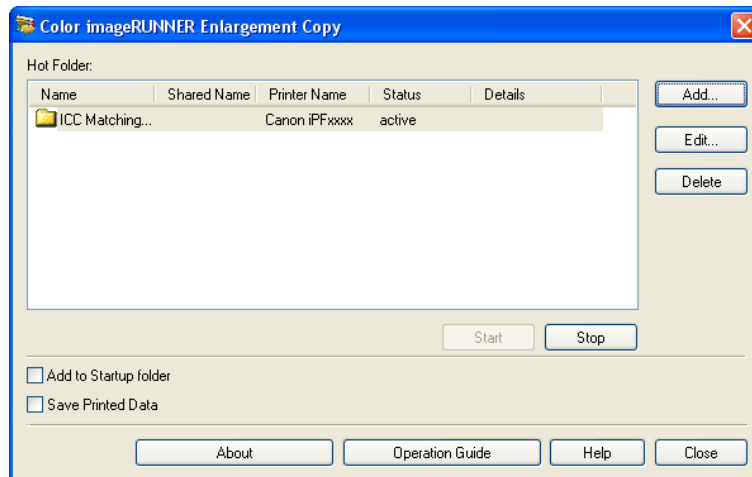

## Setting the Print Parameters

The printer driver opens when you click the **Properties** button in the **Add/Edit Hot Folder** dialog box. The printer driver is used to configure basic settings to match the type of media loaded in the printer.

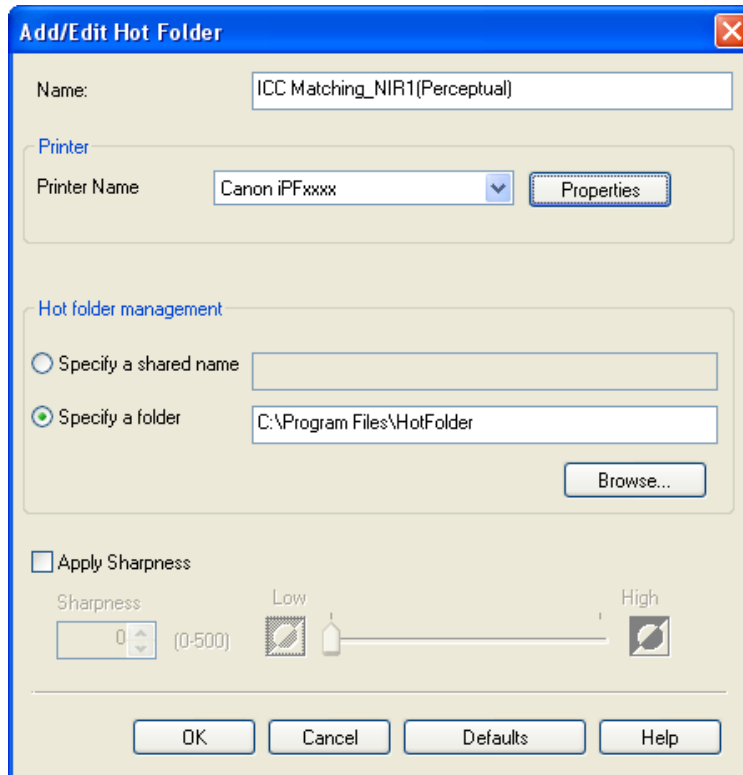

Refer to Printer Driver →P.207 for details on the printer driver.

**Note**

- The only three sheets displayed are the **Main** sheet, the **Page Setup** sheet, and the **Layout** sheet. Some of the printer driver settings may be disabled.

**• Apply Sharpness**

Place a checkmark here to set the sharpness.

Drag the slider bar to the left or right to adjust. You can also adjust by directly entering a number in the numeric input field.

**Note**

- You can input between 0 and 500.
- You can change the numbers by clicking either ▲ button or ▼ button.
- You cannot be applied to PDF files.

**Printing Enlargements of Scanned Originals from a Color imageRUNNER**

Scanned originals from a Color imageRUNNER can be enlarged and printed automatically.

Originals you create by scanning with a Color imageRUNNER are transferred to a "hot folder" and printed automatically after enlargement according to printing conditions you specify for that folder.

This processing sequence is called the Color imageRUNNER Enlargement Copy function.

To use Color imageRUNNER Enlargement Copy, first complete these settings in the following order.

1. Register a hot folder on your computer.  
Register a hot folder on your computer for storing scanned originals from the Color imageRUNNER and complete the settings for enlargement copy. For details, see "Creating a New Hot Folder." →P.293
2. Complete the scanning settings on the Color imageRUNNER.  
Configure the Color imageRUNNER to send scanned originals to the hot folder.

After these settings are complete, you can print enlarged copies of scanned originals from the Color imageRUNNER.

**Completing the scanning settings on the Color imageRUNNER.**

Configure the Color imageRUNNER to send scanned originals to the hot folder. It is easy to send scanned originals to the hot folder if you assign the scanning settings and destination to a **Favorites** button on the Color imageRUNNER.

For instructions on assigning scanning settings and destinations to a **Favorites** button, refer to the setting manual, displayed by clicking **Color imageRUNNER Enlargement Copy Setup Manual** button of Color imageRUNNER Enlargement Copy utility, or refer to the Color imageRUNNER manual.

**Scanning the original and print an enlargement**

Follow the steps below to scan an original on the Color imageRUNNER for enlarged printing on the printer. For detailed instructions, refer to the Color imageRUNNER manual.

1. Load the original on the platen glass or document feeder of the Color imageRUNNER.
2. Press **Send** to display the screen for transmission.
3. Press **Favorites**, and then press the **Favorites** button assigned to the hot folder.

- 4.** Press **Start** on the control panel. If you scan originals on the platen glass, after scanning all originals, press **Done** on the touch-panel display.  
Scanned originals are sent to the hot folder and automatically enlarged and printed following the conditions you specified for the folder.

## Print Plug-In for Office

Print Plug-In for Office features .....	303
Operating Environment .....	303
Steps to install .....	304
Steps to uninstall .....	308
When Print Plug-In for Office is not displayed .....	309
To start from Microsoft Word .....	314
Print Matching Roll Width (Word) .....	316
Borderless Printing (Word) .....	319
Multi-Page Printing (Word) .....	322
Register the settings (Word) .....	324
Print Using Registered Settings (Word) .....	325
Portrait Orientation / Landscape Orientation (Word) .....	328
To start from Microsoft PowerPoint .....	330
Print Matching Roll Width (PowerPoint) .....	332
Borderless Printing (PowerPoint) .....	335
Multi-Page Printing (PowerPoint) .....	338
Register the settings (PowerPoint) .....	340
Print Using Registered Settings (PowerPoint) .....	341
Portrait Orientation / Landscape Orientation (PowerPoint) .....	344
To start from Microsoft Excel .....	346
Print Entire Sheet (Excel) .....	348
Print Selected Area (Excel) .....	351
Configuring Binding (Excel) .....	355
Configuring Special Settings .....	356

## Print Plug-In for Office features

**Print Plug-In for Office** is a Plug-In that enables easy printing from **Microsoft Office**.

- It is displayed on the toolbar/ribbon, so it is easily accessible.
- It can be set by just selecting from the Wizard.
- **Large-Format Printing** custom size can also be set in the Wizard from **Microsoft Word** or **Microsoft PowerPoint**.
- Custom size can be set automatically from **Microsoft Excel**.
- The layout can be checked before printing by starting the preview screen.



### Important

- The **Print Plug-In for Office** toolbar/ribbon might not be displayed in **Microsoft Office** after installing **imagePROGRAF Print Plug-In for Office**.

Refer to the following topic for details on how to display the **imagePROGRAF Print Plug-In for Office** toolbar/ribbon.

- When Print Plug-In for Office is not displayed → **P.309**

## Operating Environment

**Print Plug-In for Office** 's operating environment is as below.

- Compatible Operating System

Windows XP, Windows Server 2003, Windows Server 2003 R2, Windows Vista, Windows Server 2008, Windows 7



**Note**

- For the Windows OS, use the latest version of Service Pack.

- Software that requires installation  
Microsoft Office XP/2003/2007/2010  
imagePROGRAF Printer Driver Ver. 3.95 or later
- Hardware  
CPU 2.0 GHz Pentium 4 or better  
RAM 512 MB or more



**Important**

- If you opened the Office document from **Internet Explorer**, the software will not run correctly.
- If you are editing an embedded object or link object, the software will not run correctly.
- If you added the **imagePROGRAF Print Plug-In** ribbon to the **Microsoft Office 2007/2010** Quick Access toolbar, the software will not run correctly.

## Steps to install

Below are the steps to install **Print Plug-In for Office**.



**Note**

- You must log into Windows as an Administrator before the installation.

1. Insert "User Software CD-ROM" into the CD-ROM drive and start the installer.



**Note**

- If the installer screen does not display, open the CD-ROM icon from **My Computer**, click **set-up.exe**, and open the icon.

2. Click the **Install Individual Software** button.

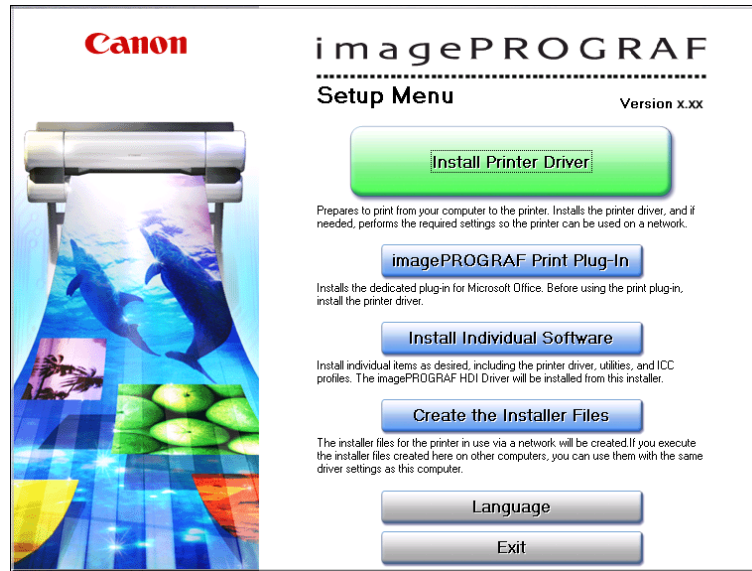

3

3. Click **Install** in **imagePROGRAF Print Plug-In for Office**.

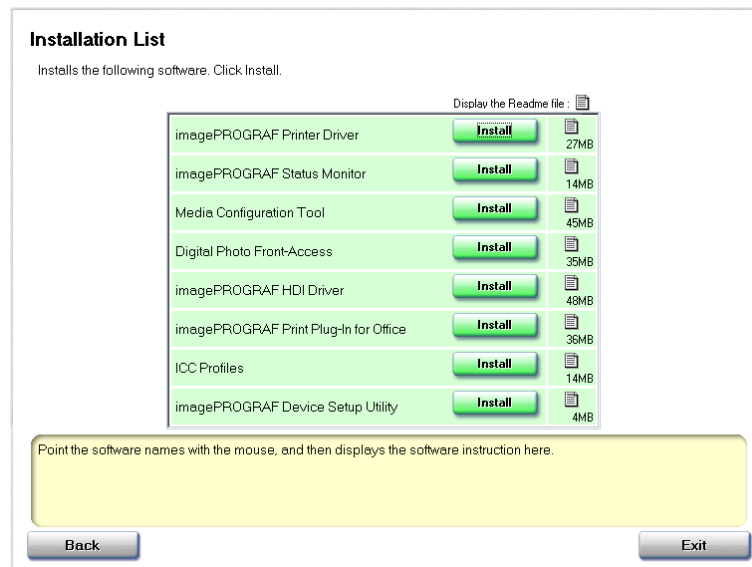

305

4. Click the **Next** button.

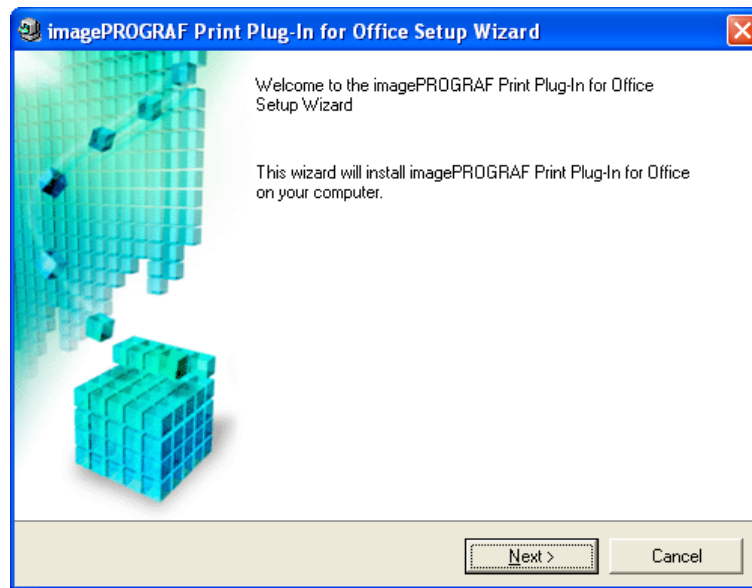

5. Read the **License Agreement**, and click the **Yes** button.

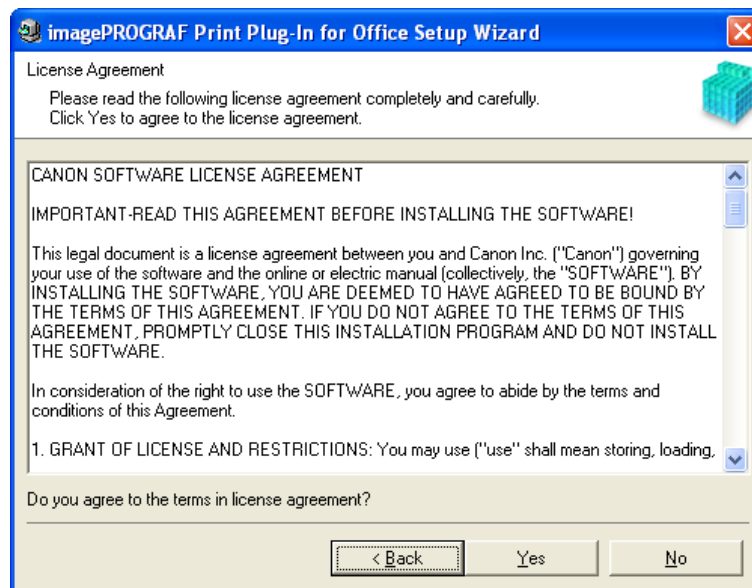



## 6. Click the **Start** button.

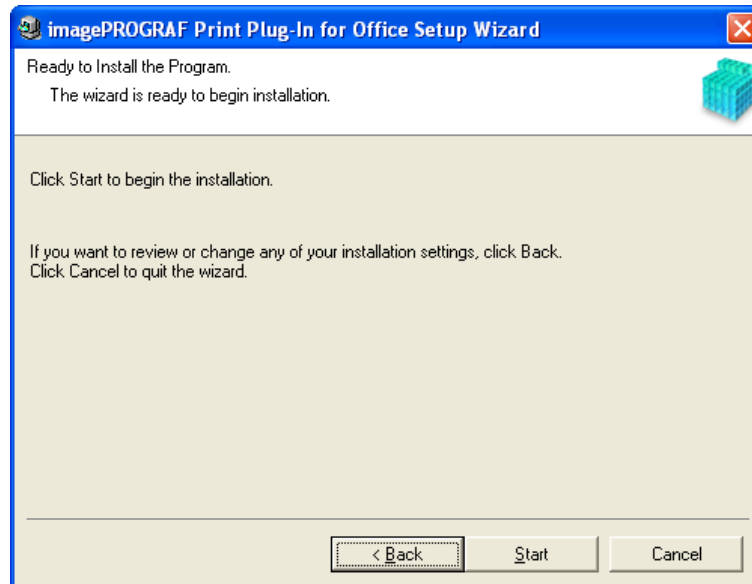

## 7. Click the **Yes** button.

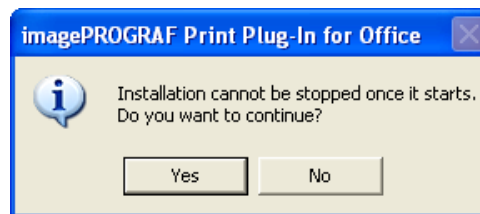

## 8. Click the **Exit** button.

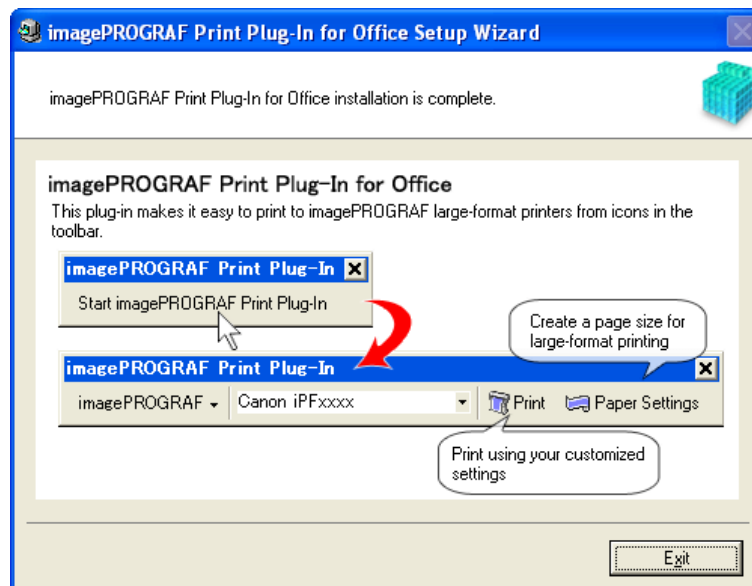

The installation for **Print Plug-In for Office** is complete.



### Important

- When you install this software, the virtual printer **Canon imagePROGRAF PrintPlugIn** may be installed. If you want to use this software, do not uninstall the virtual printer **Canon imagePROGRAF PrintPlugIn**.
- The **Print Plug-In for Office** toolbar/ribbon might not be displayed in **Microsoft Office** after installing **imagePROGRAF Print Plug-In for Office**. Refer to the following topic for details on how to display the **imagePROGRAF Print Plug-In for Office** toolbar/ribbon.
  - When Print Plug-In for Office is not displayed →P.309

## Steps to uninstall

Below are the steps to uninstall **Print Plug-In for Office**.

1. If **Microsoft Office** is open, close it.
2. Select **Control Panel** from the **start** menu.
3. Open **Add or Remove Programs**.
4. Select **imagePROGRAF Print Plug-In**, and click the **Remove** button.

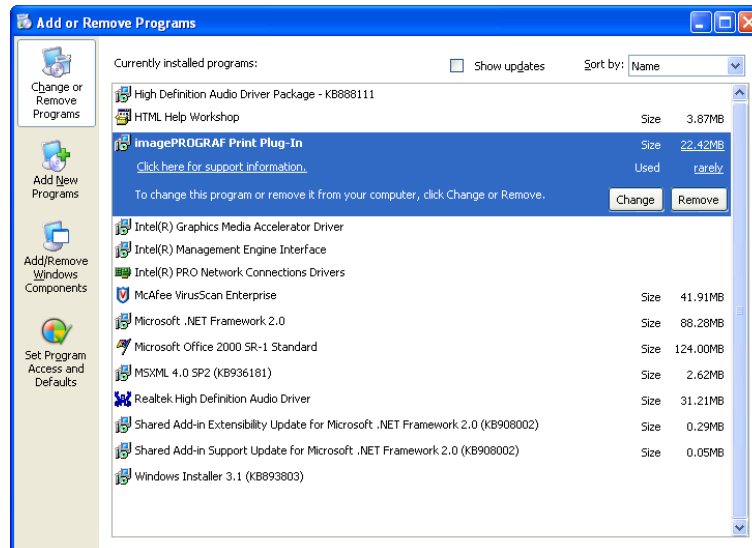

### Note

- You cannot uninstall **Print Plug-In for Office** if an Office application is running. When a message appears, select **Cancel** and close all Office applications that are running.

## When Print Plug-In for Office is not displayed

Buttons such as **Start imagePROGRAF Print Plug-In** sometimes do not appear in the **Word**, **PowerPoint** and **Excel** Office applications, and the **Print Plug-In for Office** functions are not available.

In this event, re-install **Print Plug-In for Office**.

If you are using **Microsoft Office 2003** or later, you can also enable add-ins to display **Print Plug-In for Office**.

See below for the procedure for re-installing the plug-in or enabling add-ins.

### Re-installing Print Plug-In for Office

If a problem occurs, such as the system or an application terminating abnormally, the **Microsoft Office** application disables add-ins as a safety precaution.

In this event, you will need to re-install **Print Plug-In for Office** to display the **imagePROGRAF Print Plug-In** toolbar/ribbon.



#### Note

- You cannot re-install **Print Plug-In for Office** once an Office application is running. When the message appears, select **Cancel** and close the active Office application.

Re-install **Print Plug-In for Office** as follows:

**1.** Close **Microsoft Office** if it is open.

**2.** Install **Print Plug-In for Office**.

For information about installing, see "Steps to install." →P.304

### Enabling Print Plug-In for Office for items disabled in Office applications

If a problem occurs, such as the system or an application terminating abnormally, the **Microsoft Office** application disables add-ins as a safety precaution.

In this event, you will need to restore the disabled add-ins in order to display the **imagePROGRAF Print Plug-In** toolbar/ribbon.

Use the procedure below to restore the add-ins disabled by **Microsoft Office**.

- For **Microsoft Office 2010**

**1.** Select **Options** from the **File** menu.

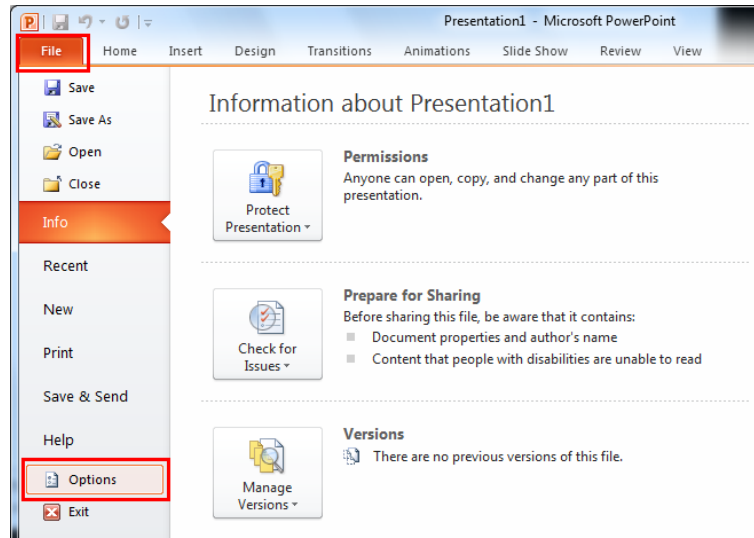

**2.** From the list on the left side of the <application name> options dialog box, select **Add-ins**.

**3.** Select **Disabled Items** in the **Manage** combo box and click the **Go** button.

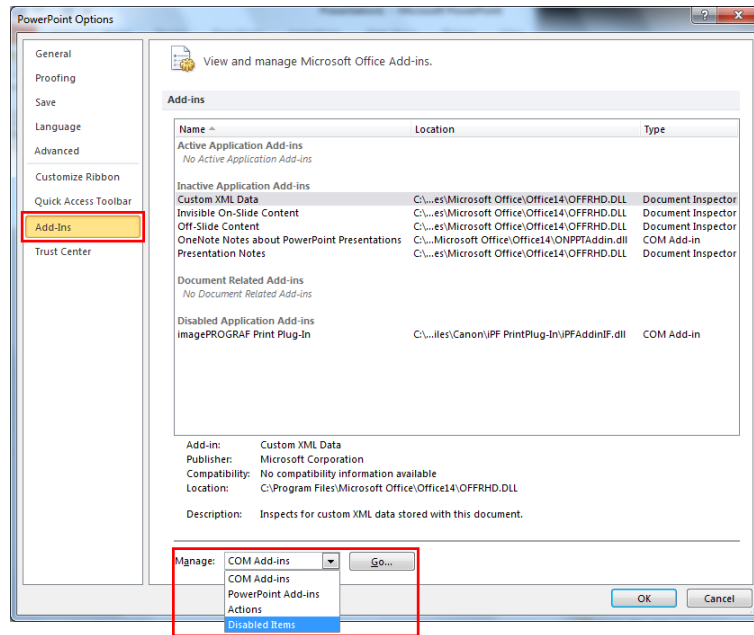

3

310

4. If **Addin imageprograf print plug-in (ipfaddinif.dll)** is displayed in the **Disabled Items** dialog box, select it and click the **Enable** button.

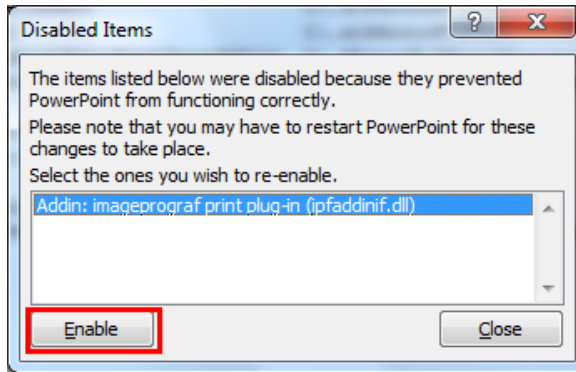

5. Close all the dialog boxes and restart the Office application.

- For **Microsoft Office 2007**

1. Click the **Office** button and then click the **<application name> options** button.

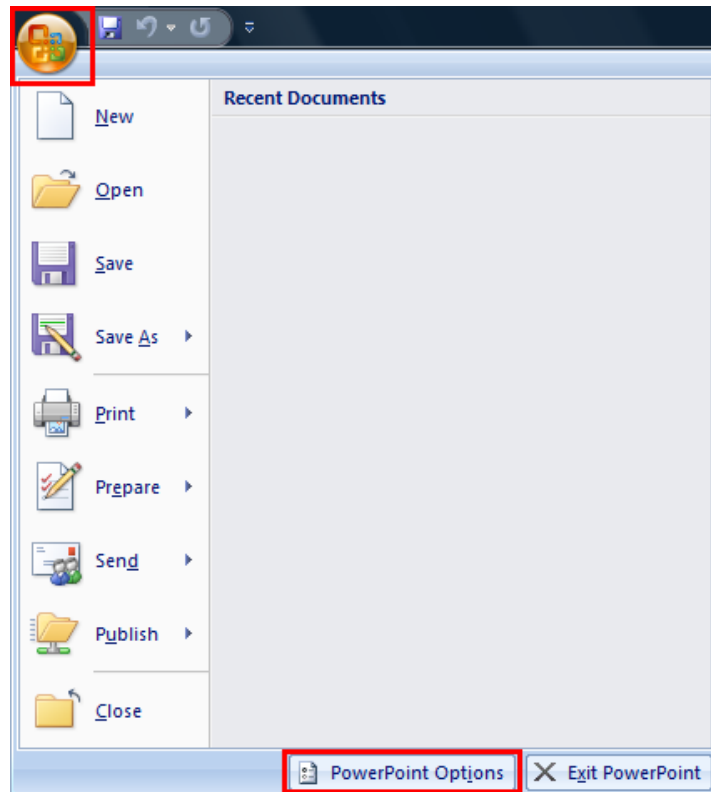

2. From the list on the left side of the **<application name> options** dialog box, select **Add-ins**.

**3.** Select **Disabled Items** in the **Manage** combo box and click the **Go** button.

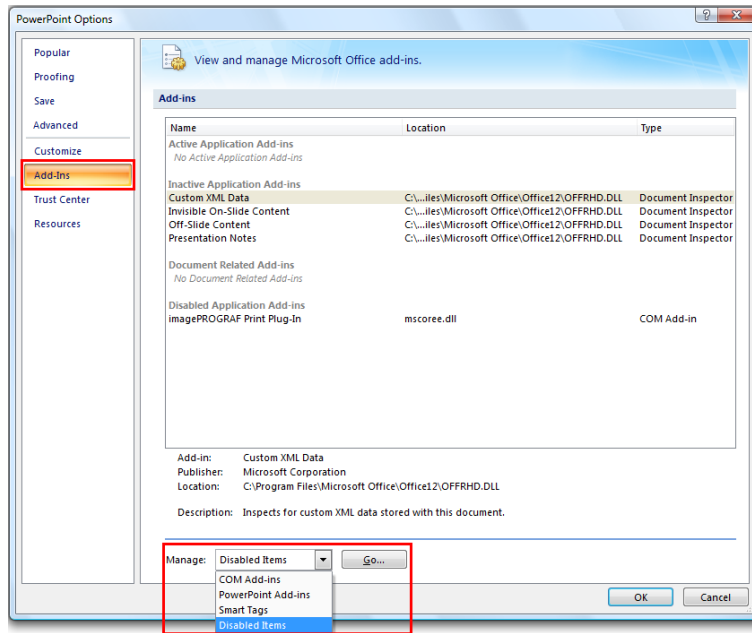

**4.** If Addin **imageprograf print plug-in (ipfaddinif.dll)** is displayed in the **Disabled Items** dialog box, select it and click the **Enable** button.

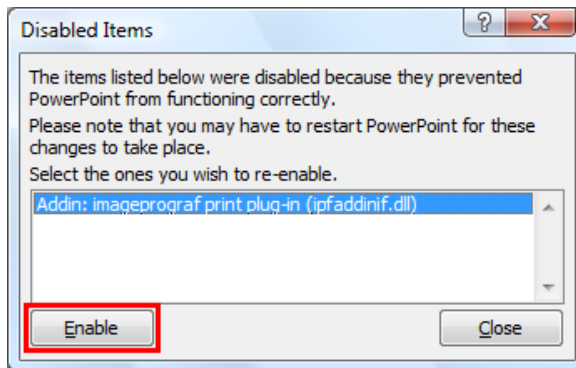

**5.** Close all the dialog boxes and restart the Office application.

- For **Microsoft Office 2003**

1. Click **About <application name>** in the **Help** menu of application.

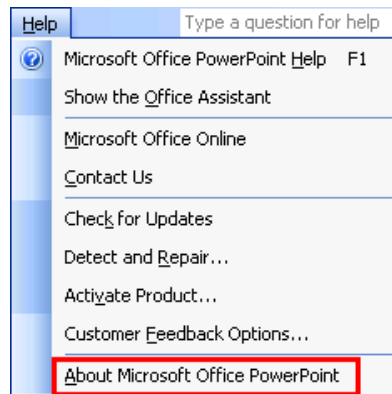

2. Click the **Disabled Items** button in the **About <application name>** dialog box.

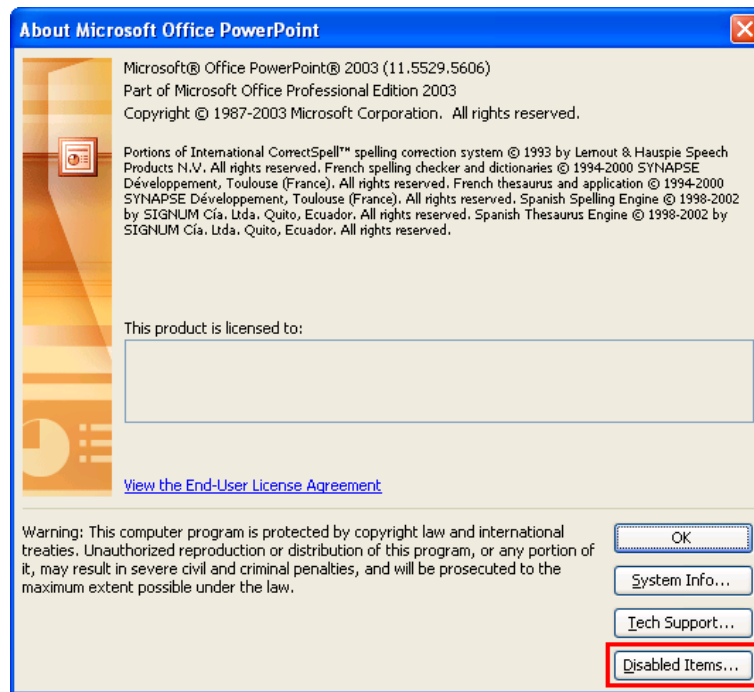

3. If **Addin imageprograf print plug-in (ipfaddinif.dll)** is displayed in the **Disabled Items** dialog box, select it and click the **Enable** button.

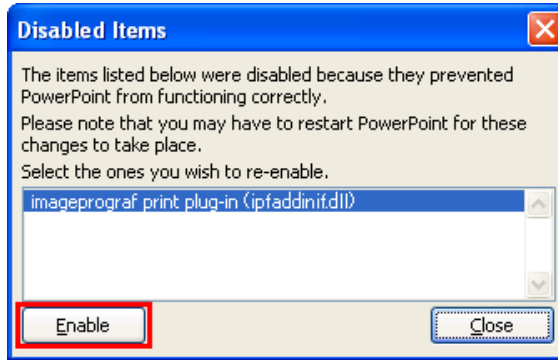

4. Close all the dialog boxes and restart the Office application.

## To start from Microsoft Word

Below are the steps to start **Print Plug-In for Office** from **Microsoft Word**.

1. Start **Microsoft Word**.
2. If **Start imagePROGRAF Print Plug-In** is displayed on the toolbar/ribbon, click it.

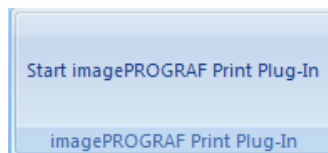

### Important

- If the **imagePROGRAF Print Plug-In** toolbar/ribbon is not displayed, refer to the following.
- When Print Plug-In for Office is not displayed →P.309

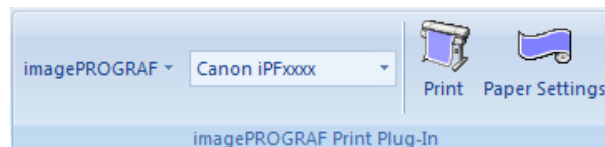

3. Check that the **imagePROGRAF Print Plug-In** toolbar/ribbon is displayed.



4. Click the buttons on the toolbar/ribbon according to the items you want to set.

Icon	Contents
 Menu	Displays the <b>About</b> , <b>Help</b> , and <b>Special Settings</b> dialog boxes. You can change the settings using the <b>Special Settings</b> dialog box. Refer to <b>Configuring Special Settings</b> →P.356 for details.

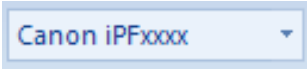

Icon	Contents
 Printer list	Select Printer. If you select <b>Show All Printers</b> , the <b>imagePROGRAF</b> printers will be displayed again. Select this when you want to display all printer drivers or update the display.
 Print Button	The print Wizard is displayed. The settings <b>Print Matching Roll Width</b> , <b>Borderless Printing</b> , <b>Multi-Page Printing</b> , and <b>Print Using Registered Settings</b> can be set.
 Paper Settings Button	Large-Format Wizard is displayed. Settings for Portrait or Landscape Orientation can be set.

3

### Printing Wizard dialog box

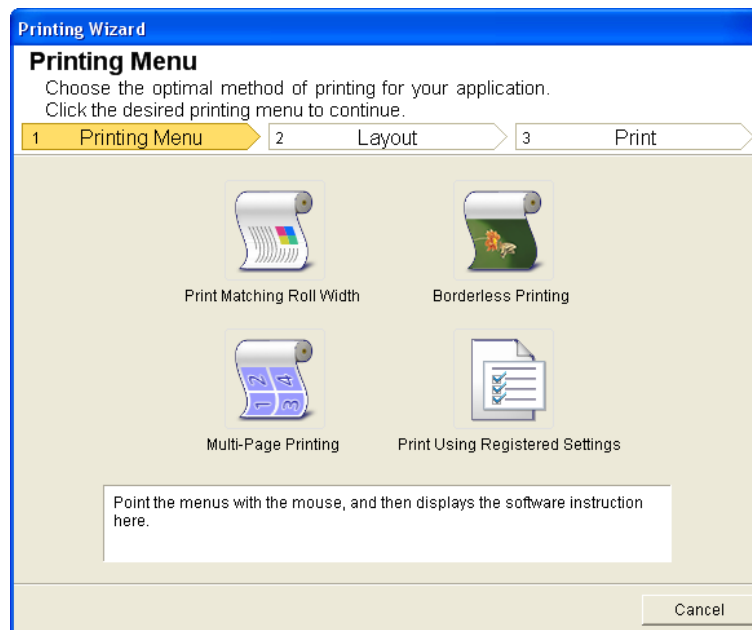



#### Important

- If you want to change the display to another file or application while the **Printing Wizard** is open, close the **Printing Wizard** dialog box. Otherwise, you may not be able to change displays or operate the toolbar.

315

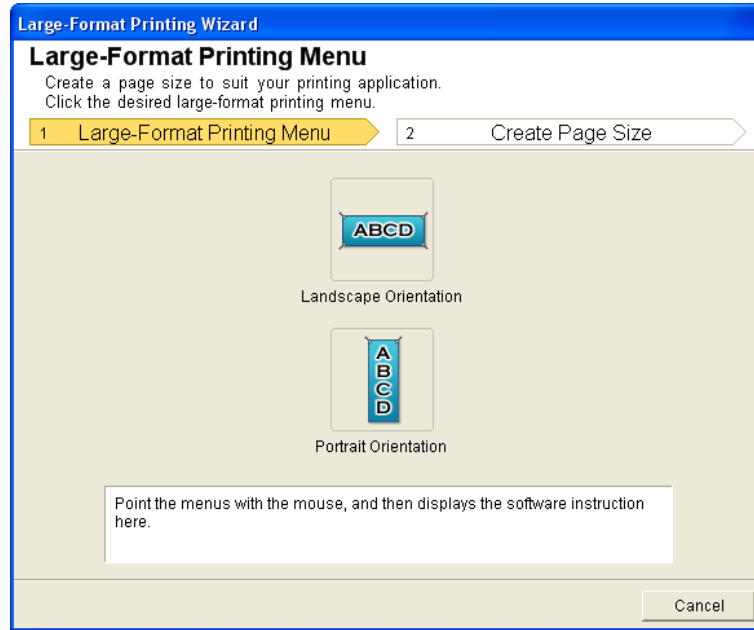
### Large-Format Printing Wizard dialog box



 **Important**

- If you want to change the display to another file or application while the **Large-Format Printing Wizard** is open, close the **Large-Format Printing Wizard** dialog box. Otherwise, you may not be able to change displays or operate the toolbar/ribbon.
- The layout may collapse if you create a form using existing data. If that is the case, modify the data again.

## Print Matching Roll Width (Word)

Prints to the edge of the roll width. You can print large exhibits and posters, and also print Portrait and Landscape orientations made in **Large-Format Printing Wizard**.

1. Start **Microsoft Word**.
2. If **Start imagePROGRAF Print Plug-In** is displayed, click it.

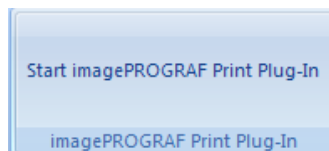

- Click **Print** from the **imagePROGRAF Print Plug-In** toolbar/ribbon.  
The **Printing Wizard** dialog box is displayed.

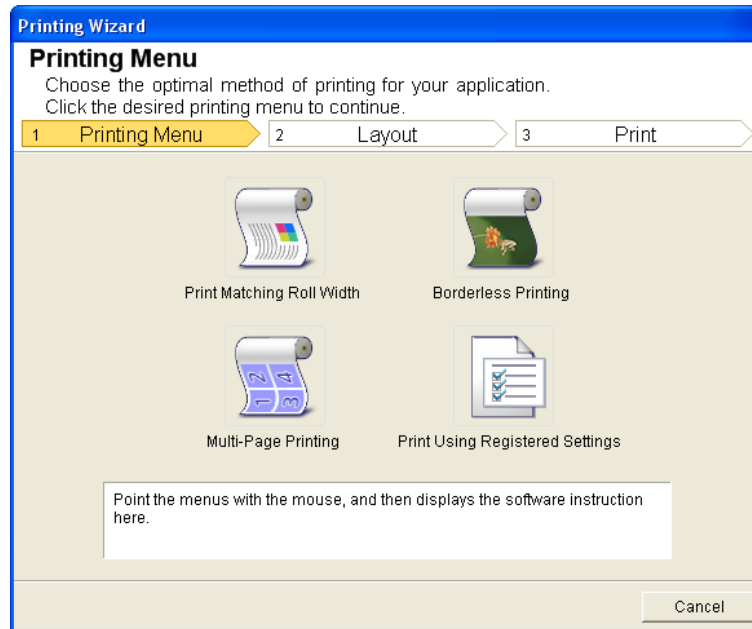

#### Important

- If you want to change the display to another file or application while the **Printing Wizard** is open, close the **Printing Wizard** dialog box. Otherwise, you may not be able to change displays or operate the toolbar/ribbon.

- Click **Print Matching Roll Width**.

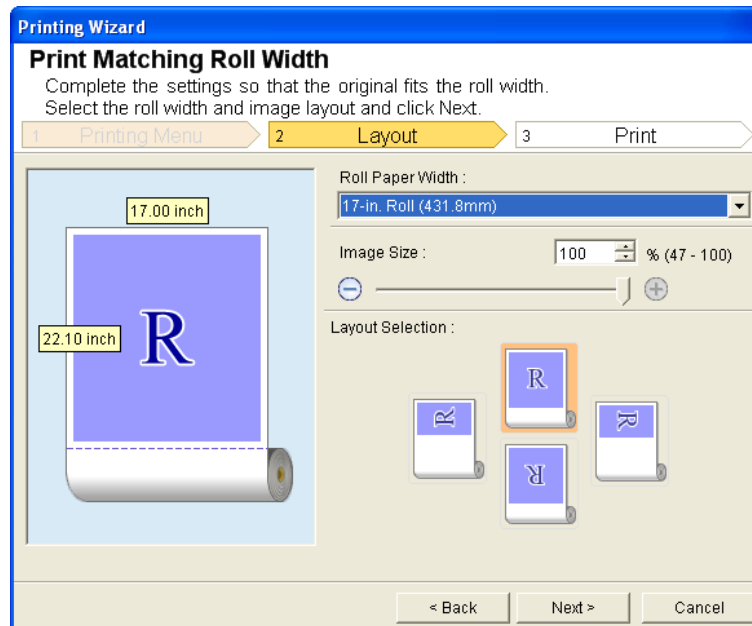

5. Select **Roll Paper Width** that is set in the printer.

6. Select image size.

7. Select layout.

8. Select **Next**.

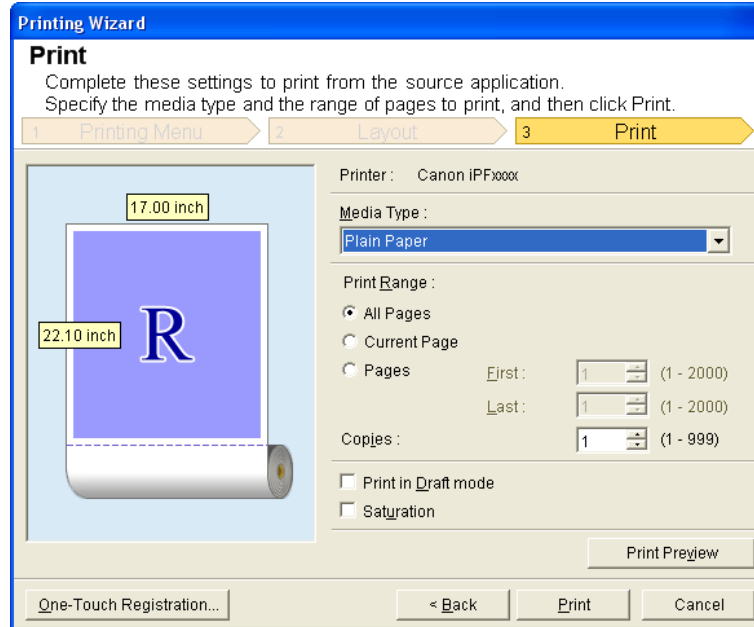

9. Select **Media Type**.

10. Select **Print Range** from **All Pages**, **Current Page**, and **Pages**.  
If **Pages** is selected, enter the number of pages.

11. Enter **Copies**.



**Note**

- When **Print in Draft mode** is selected, printing is fast but the print quality is poor.
- The settings are registered when the **One-Touch Registration** is pressed. This is convenient if you to need print multiple times using the same setting.
- Press the **Print Preview** button to display the preview screen. You can check and make changes to the layout in the preview screen.
- When you print to the edge of the roll width, the maximum length will be the lesser of 5.587 times the roll paper width, or 18.0m.

12. Press **Print** to start printing.

## Borderless Printing (Word)

Prints up to the border of the media. Photos and posters can be printed without worrying about margins.

1. Start **Microsoft Word**.
2. If **Start imagePROGRAF Print Plug-In** is displayed, click it.

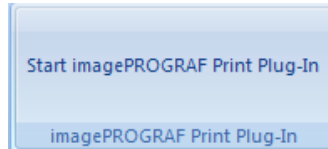

3. Click **Print** from the **imagePROGRAF Print Plug-In** toolbar/ribbon. The **Printing Wizard** dialog box is displayed.

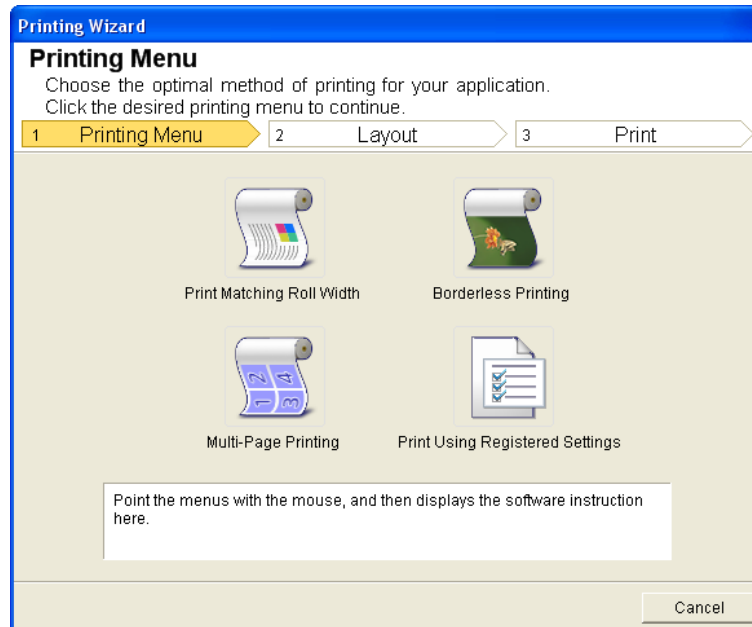

### Important

- If you want to change the display to another file or application while the **Printing Wizard** is open, close the **Printing Wizard** dialog box. Otherwise, you may not be able to change displays or operate the toolbar/ribbon.

**4.** Click **Borderless Printing**.

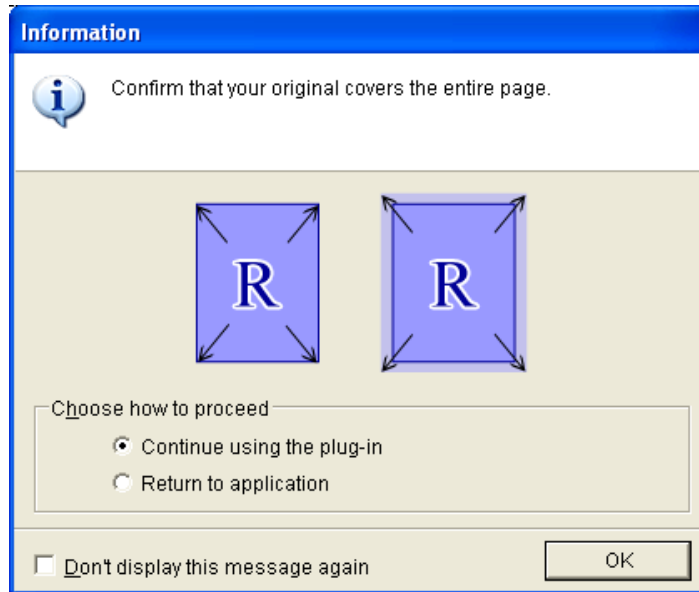

**5.** A confirmation dialog box is displayed. If the data fills up the page, confirm that **Continue using the plug-in** is selected in **Choose how to proceed** and press **OK**.



**Note**

- To adjust the data, select **Return to application** and press **OK**. Exit **Print Plug-In for Office** and return to the application.

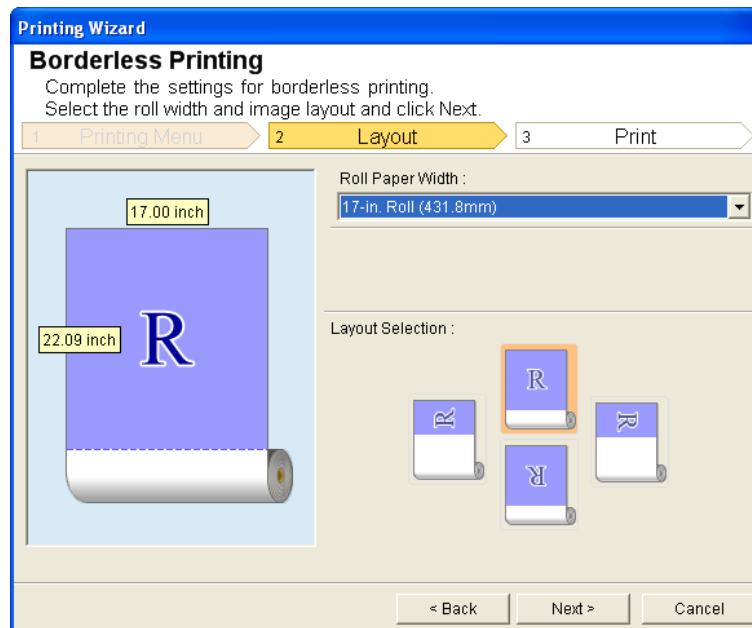

**6.** Select **Roll Paper Width** that is set in the printer.

7. Select **Layout**.

8. Select **Next**.

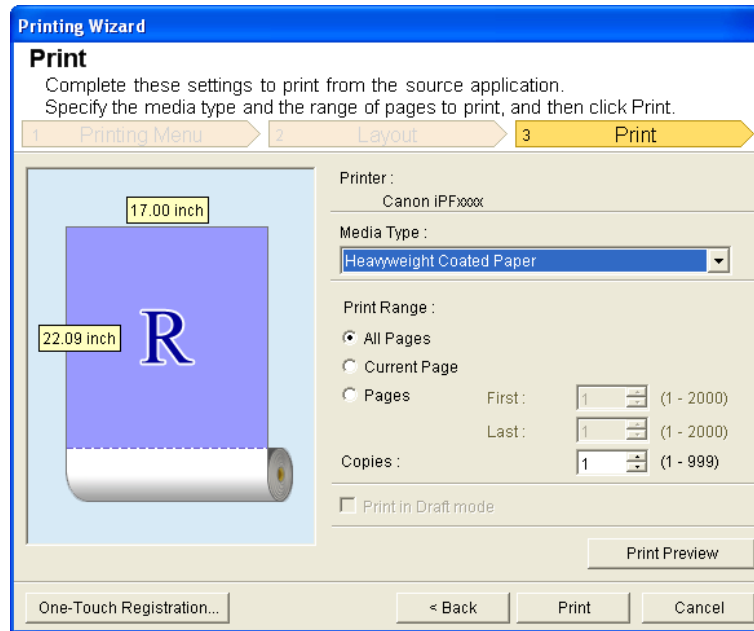

9. Select **Media Type**.

10. Select **Print Range** from **All Pages**, **Current Page**, and **Pages**.  
For **Pages**, insert the page number.

11. Enter **Copies**.



**Note**

- When **Print in Draft mode** is selected, printing is fast but the print quality is poor.
- Press the **One-Touch Registration** button to register the settings. This is useful for multiple printing using the same settings.
- Press the **Print Preview** button to display the preview screen. You can confirm and make changes to the layout in the preview screen.
- The maximum length for Borderless Printing is the lesser of 5.587 times the roll paper width, or 18.0m.

12. Press **Print** to start printing.

## Multi-Page Printing (Word)

Prints multiple pages as one page. You can print handouts into a single page, or print matter with many pages.

1. Start **Microsoft Word**.
2. If **Start imagePROGRAF Print Plug-In** is displayed, click it.

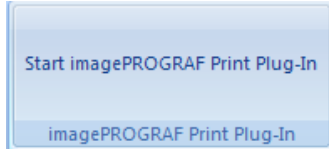

3. Click **Print** from the **imagePROGRAF Print Plug-In** toolbar/ribbon. The **Printing Wizard** dialog box is displayed.

3

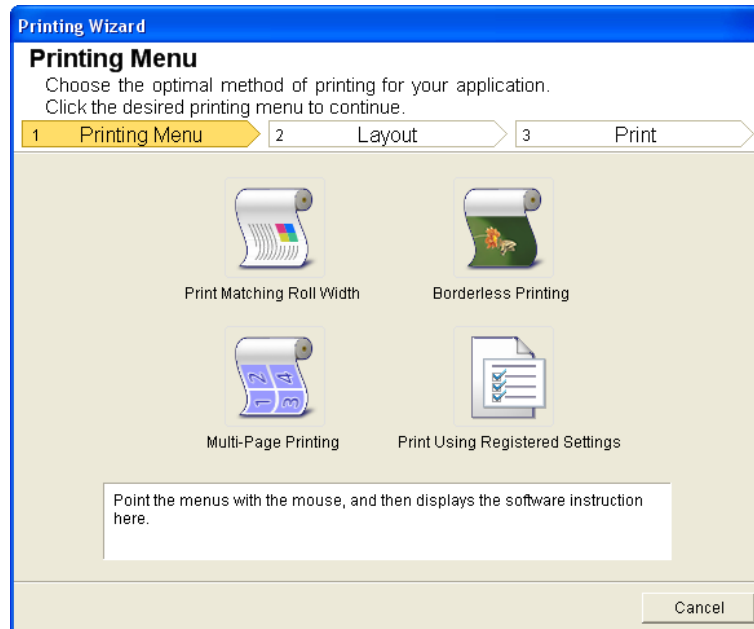

 **Important**

- If you want to change the display to another file or application while the **Printing Wizard** is open, close the **Printing Wizard** dialog box. Otherwise, you may not be able to change displays or operate the toolbar/ribbon.



#### 4. Click **Multi-Page Printing**.

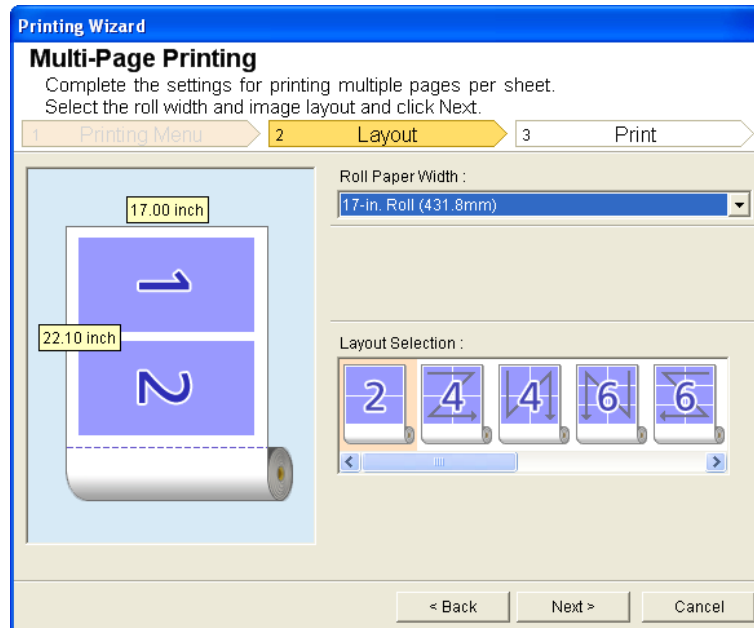

#### 5. Select the **Roll Paper Width** that is set in the printer.

#### 6. Select layout from **Layout Selection**.

#### 7. Select **Next**.

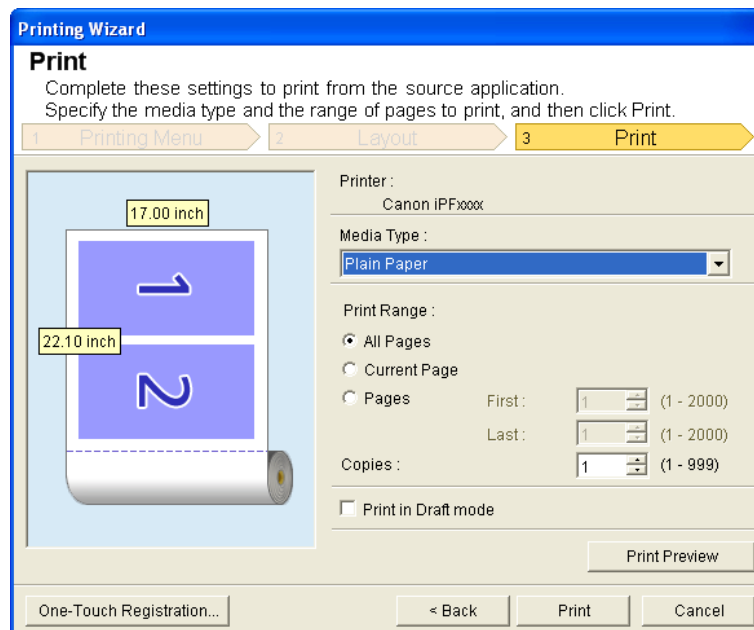

**8.** Select **Media Type**.

**9.** Select **Print Range** from **All Pages**, **Current Page**, and **Pages**.  
If **Pages** is selected, enter the number of pages.

**10.** Enter **Copies**.



**Note**

- When **Print in Draft mode** is selected, printing is fast but the print quality is poor.
- The settings are registered when the **One-Touch Registration** is pressed. This is convenient if you to need print multiple times using the same setting.
- Press the **Print Preview** button to display the preview screen. You can check and make changes to the layout in the preview screen.
- The maximum length for Multi-Page Printing is the lesser of 5.587 times the roll paper width, or 18.0m.

**11.** Press **Print** to start printing.

## Register the settings (Word)

If you are going to print multiple times using the same setting, you can select **One-Touch Registration**. Registered settings can be recalled from **Print Using Registered Settings**.

**1.** Set up to the **Print** screen from **Print Matching Roll Width**, **Borderless Printing** or **Multi-Page Printing** of **Printing Menu**.



**Note**

- Up to 20 items can be registered.
- The available settings are as follows.
  - Print Matching Roll Width (Word) →P.316
  - Borderless Printing (Word) →P.319
  - Multi-Page Printing (Word) →P.322

- Click the **One-Touch Registration** button.

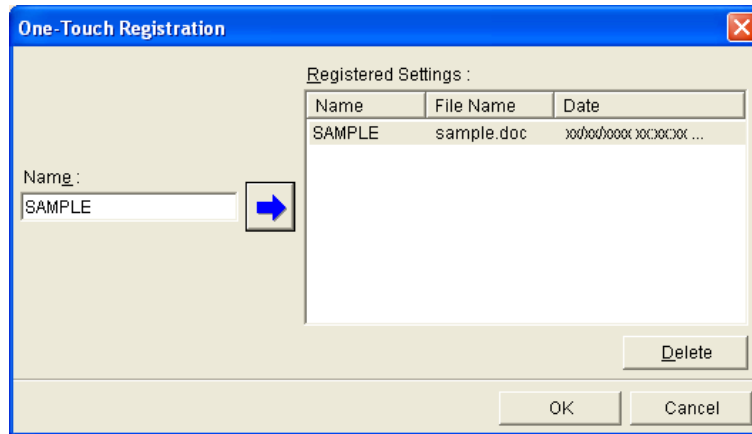

- Enter name in **Name**.  
Up to 31 characters can be entered.
- Click . The name you entered is displayed in **Registered Settings**.
- Click **OK**, and return to the **Print** screen.
- Click **Print** to print, and click **Cancel** to cancel the print.



#### Note

- Clicking **Cancel** in the **Print** screen will not delete the registered settings.

3

## Print Using Registered Settings (Word)

Prints using the registered settings.

- Start **Microsoft Word**.
- If **Start imagePROGRAF Print Plug-In** is displayed, click it.

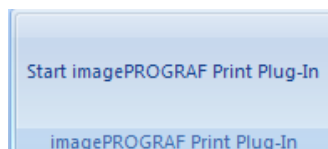

325

3. Click **Print** from the **imagePROGRAF Print Plug-In** toolbar/ribbon. The **Printing Wizard** dialog box is displayed.

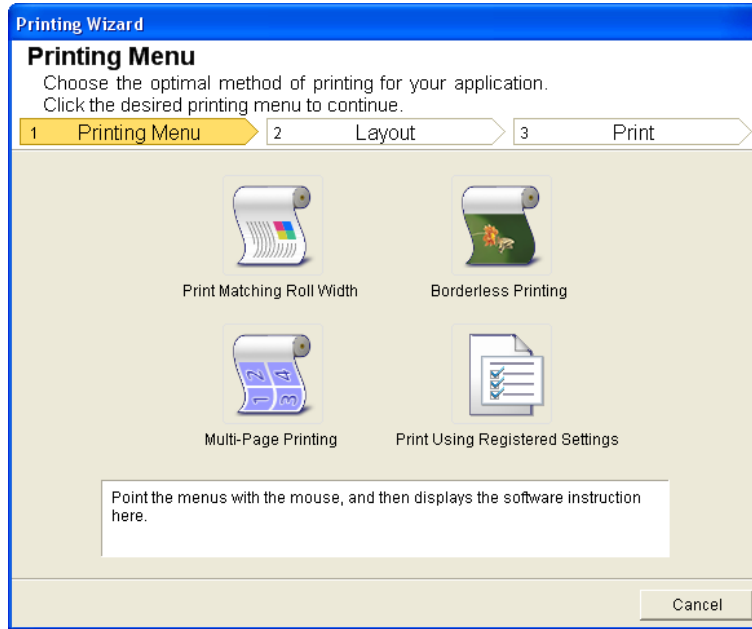

**Important**

- If you want to change the display to another file or application while the **Printing Wizard** is open, close the **Printing Wizard** dialog box. Otherwise, you may not be able to change displays or operate the toolbar/ribbon.

4. Click **Print Using Registered Settings**.

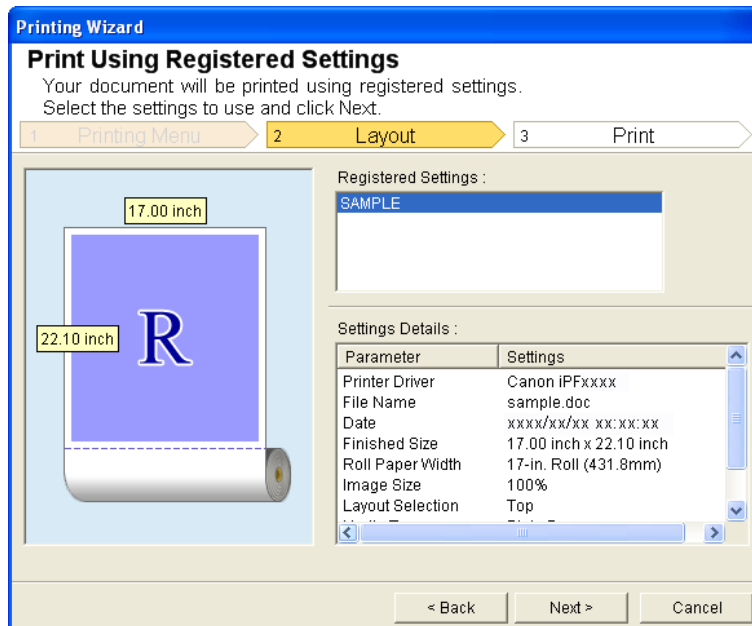

5. Click the **Next** button.

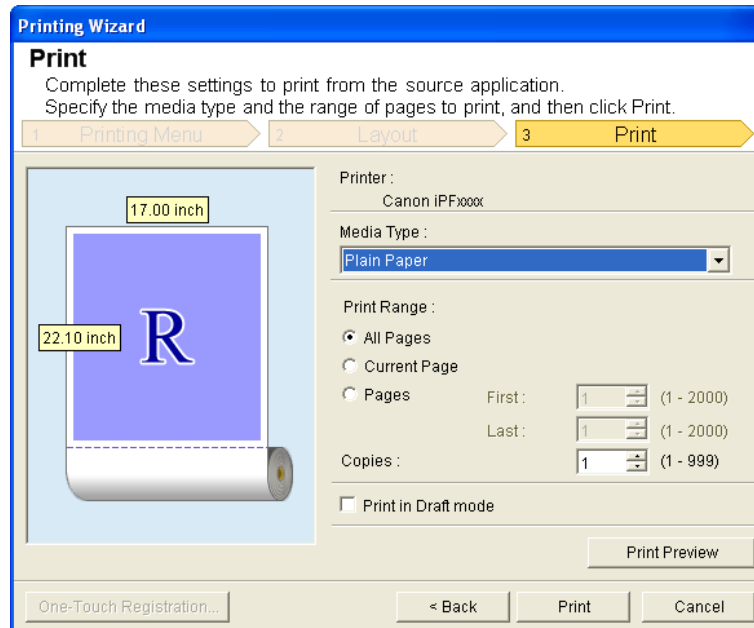

6. Select **Media Type**.
7. Select **Print Range** from **All Pages**, **Current Page**, or **Pages**.  
If **Pages** is selected, enter the number of pages.
8. Enter **Copies**.



**Note**

- When **Print in Draft mode** is selected, printing is fast but the print quality is poor.
- Press the **Print Preview** button to display the preview screen. You can check and make changes to the layout in the preview screen.
- The maximum print length when printing with the registered settings is the lesser of 5.587 times the roll paper width, or 18.0m.

9. Press **Print** to start printing.

## Portrait Orientation / Landscape Orientation (Word)

Print to the edge of the roll width. You can print large exhibits and posters, or print the Landscape or Portrait Orientation Page Sizes made in the **Large-Format Printing Wizard**.

### Create Page Size in Portrait or Landscape Orientation.

Use the **Large-Format Printing Wizard** to create portrait page sizes for Potrait Orientation, and landscape page sizes for Landscape Orientation.

1. Start **Microsoft Word**.
2. If **Start imagePROGRAF Print Plug-In** is displayed, click it.



3. Click **Paper Settings** from the **imagePROGRAF Print Plug-In** toolbar/ribbon. The **Large-Format Printing Wizard** dialog box is displayed.

**Note**

- If you want to change the display to another file or application while the **Large-Format Printing Wizard** is open, close the **Large-Format Printing Wizard** dialog box. Otherwise, you may not be able to change displays or operate the toolbar/ribbon.

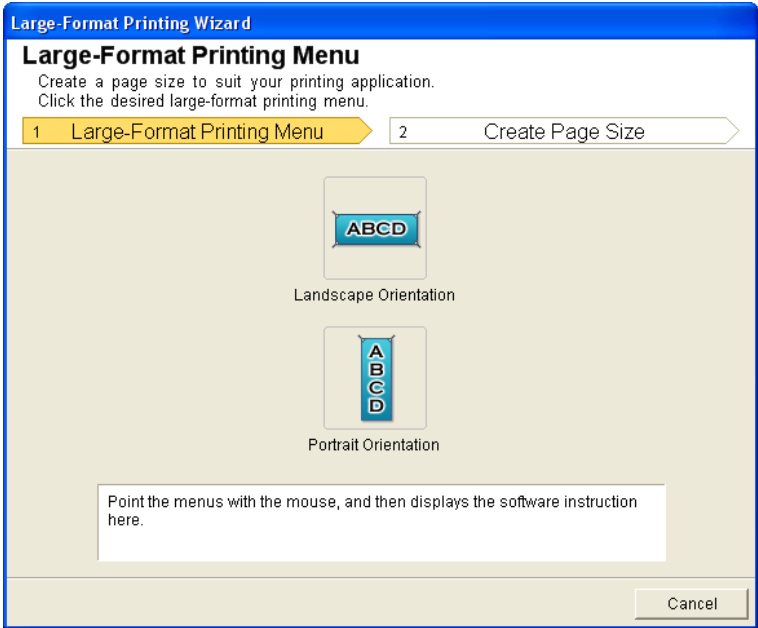

4. Click **Portrait Orientation** or **Landscape Orientation**.

**Note**

- The steps taken to create a Portrait Page Size will be used as an example to explain the procedure.

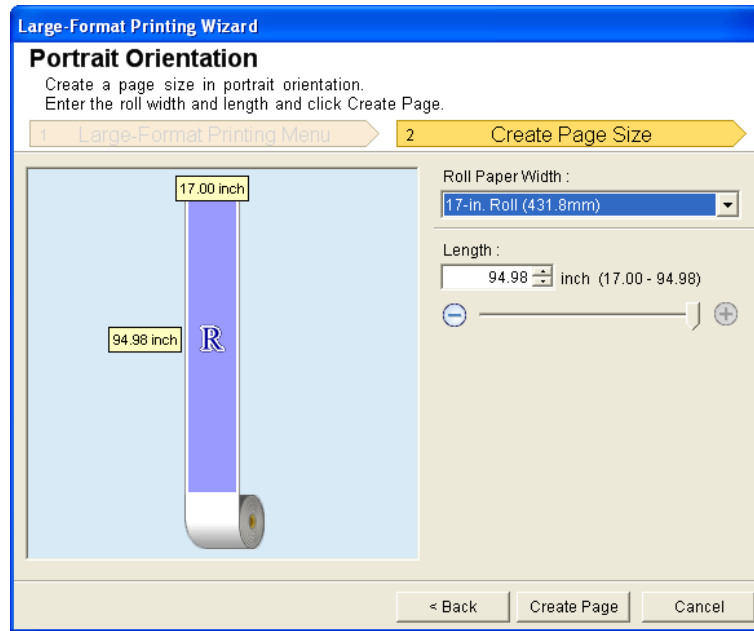

3

5. Adjust **Length** from the list-box or slide-bar.

6. Click the **Create Page** button.

7. Click **OK** if the message is displayed.

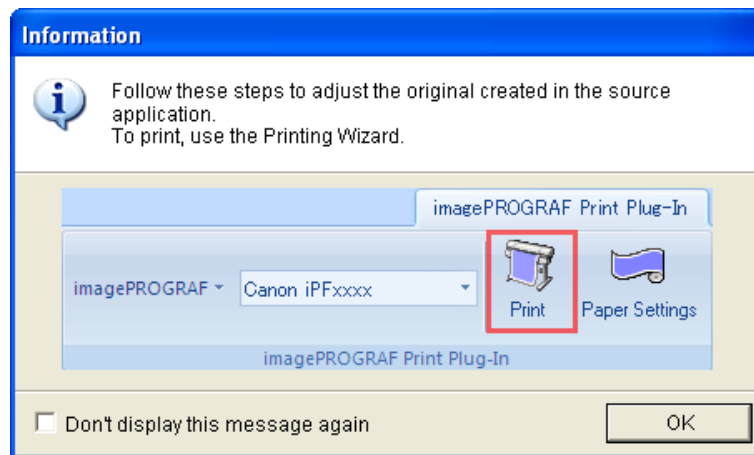

8. Edit and create the document.



**Note**

- Printing is done in **Print Matching Roll Width** of the **Printing Wizard**. For details on **Print Matching Roll Width**, refer to see "Print Matching Roll Width (Word)." →P.316 .

329



**Important**

- The layout may collapse if you create a form using existing data. If that is the case, modify the data again.

## To start from Microsoft PowerPoint

Below are the steps to start **Print Plug-In for Office** from **Microsoft PowerPoint**.

1. Start **Microsoft PowerPoint**.
2. If **Start imagePROGRAF Print Plug-In** is displayed on the toolbar/ribbon, click it.

3

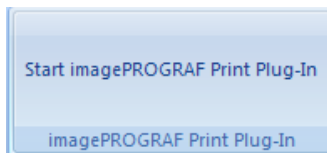



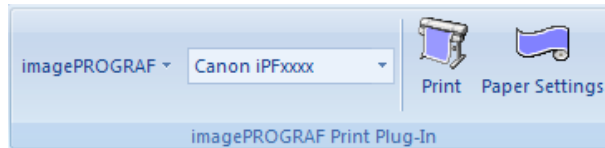

**Important**

- If the **imagePROGRAF Print Plug-In** toolbar/ribbon is not displayed, refer to the following.
- When **Print Plug-In for Office** is not displayed →P.309

3. Check that the **imagePROGRAF Print Plug-In** toolbar/ribbon is displayed.

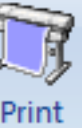

4. Click the buttons on the toolbar/ribbon according to the items you want to set.

Icon	Contents
 Menu	Displays the <b>About</b> , <b>Help</b> , and <b>Special Settings</b> dialog boxes. (See "Configuring Special Settings.") →P.356
 Printer list	Select Printer. If you select <b>Show All Printers</b> , the <b>imagePROGRAF</b> printers will be displayed again. Select this when you want to display all printer drivers or update the display.
 Print Button	The print Wizard is displayed. The settings <b>Print Matching Roll Width</b> , <b>Borderless Printing</b> , <b>Multi-Page Printing</b> , and <b>Print Using Registered Settings</b> can be set.
 Paper Settings	Large-Format Wizard is displayed. Settings for Portrait or Landscape Orientation can be set.

330



Icon	Contents
<b>Paper Settings</b> Button	Large-Format Wizard is displayed. Settings for Portrait or Landscape Orientation can be set.

### Printing Wizard dialog box

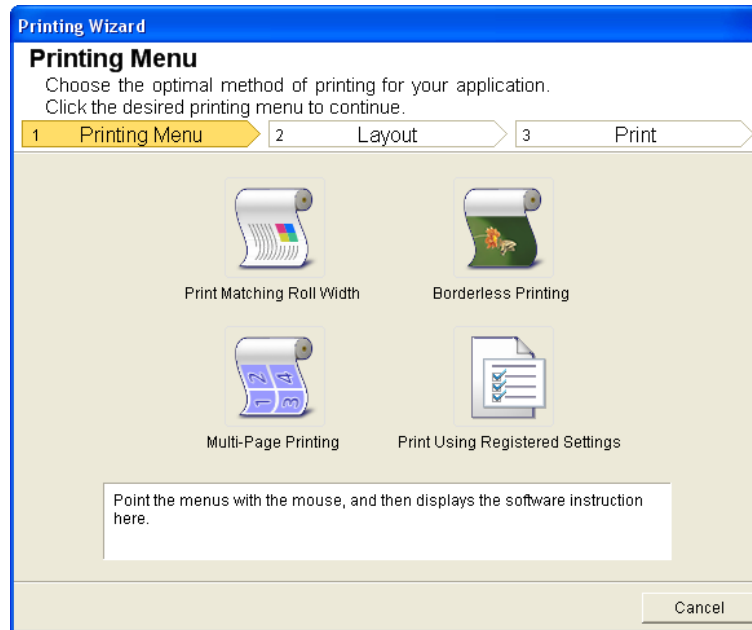

#### Important

- If you want to change the display to another file or application while the **Printing Wizard** is open, close the **Printing Wizard** dialog box. Otherwise, you may not be able to change displays or operate the toolbar/ribbon.



#### Note

- If you open a password protected document as read-only, the **Printing Wizard** cannot be run.

3

**Large-Format Printing Wizard dialog box**

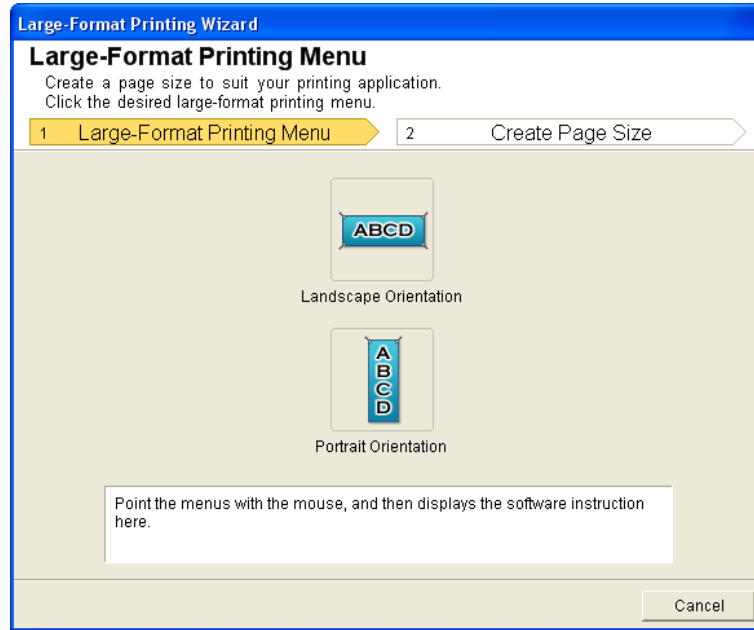

**Important**

- If you want to change the display to another file or application while the **Large-Format Printing Wizard** is open, close the **Large-Format Printing Wizard** dialog box. Otherwise, you may not be able to change displays or operate the toolbar/ribbon.
- The layout may collapse if you create a form using existing data. If that is the case, modify the data again.

**Note**

- If you open a password protected document as read-only, the **Large-Format Printing Wizard** cannot be run. Remove the password protection.

**Print Matching Roll Width (PowerPoint)**

Prints to the edge of the roll width. You can print large exhibits and posters, and also print Portrait and Landscape orientations made in **Large-Format Printing Wizard**.

1. Start **Microsoft PowerPoint**.
2. If **Start imagePROGRAF Print Plug-In** is displayed, click it.

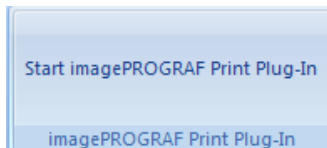

332

3. Click **Print** from the **imagePROGRAF Print Plug-In** toolbar/ribbon. The **Printing Wizard** dialog box is displayed.

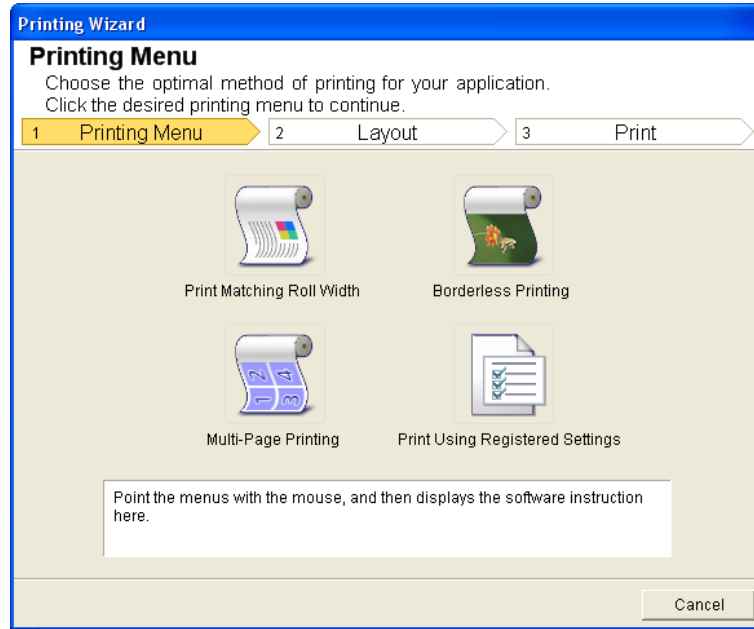

**Important**

- If you want to change the display to another file or application while the **Printing Wizard** is open, close the **Printing Wizard** dialog box. Otherwise, you may not be able to change displays or operate the toolbar/ribbon.

4. Click **Print Matching Roll Width**.

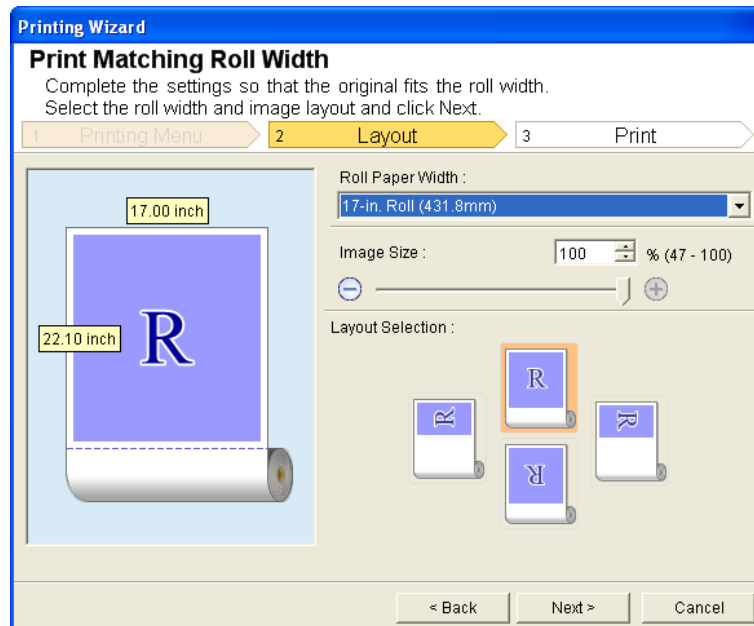

5. Select **Roll Paper Width** that is set in the printer.

6. Select image size.

7. Select layout.

8. Select **Next**.

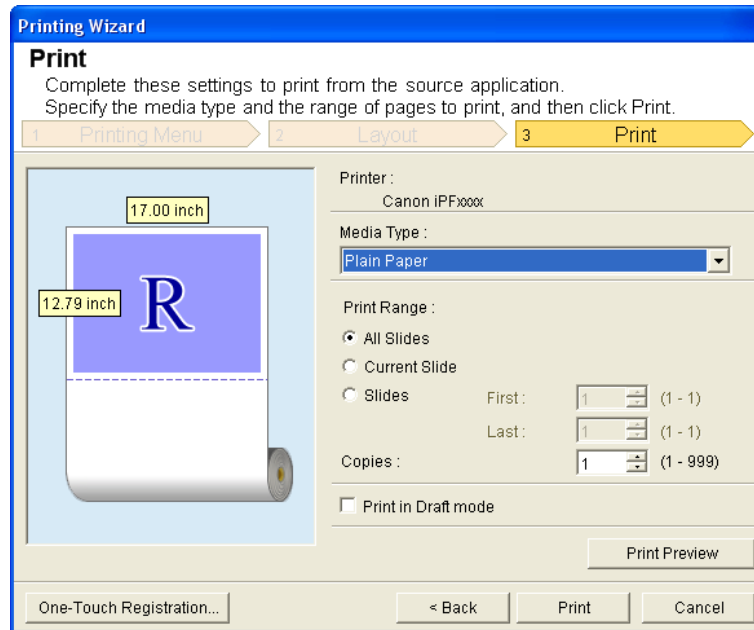

9. Select **Media Type**.

10. Select **Print Range** from **All Slides**, **Current Slide**, and **Slides**.  
If **Slides** is selected, enter the slide number.

11. Enter **Copies**.



**Note**

- When **Print in Draft mode** is selected, printing is fast but the print quality is poor.
- The settings are registered when the **One-Touch Registration** is pressed. This is convenient if you to need print multiple times using the same setting.
- Press the **Print Preview** button to display the preview screen. You can check and make changes to the layout in the preview screen.
- When you print to the edge of the roll width, the maximum length will be the lesser of 14.22 times the roll paper width, or 18.0m.

12. Press **Print** to start printing.

## Borderless Printing (PowerPoint)

Prints up to the border of the media. Photos and posters can be printed without worrying about margins.

1. Start **Microsoft PowerPoint**.
2. If **Start imagePROGRAF Print Plug-In** is displayed, click it.

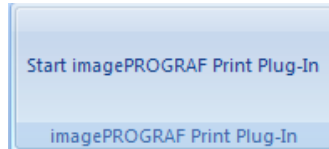

3. Click **Print** from the **imagePROGRAF Print Plug-In** toolbar/ribbon. The **Printing Wizard** dialog box is displayed.

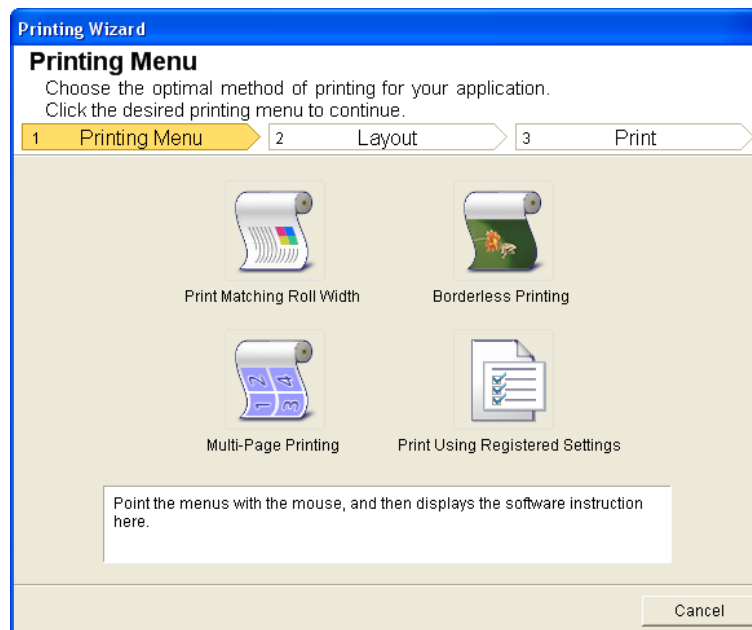

### Important

- If you want to change the display to another file or application while the **Printing Wizard** is open, close the **Printing Wizard** dialog box. Otherwise, you may not be able to change displays or operate the toolbar/ribbon.

**4.** Click **Borderless Printing**.

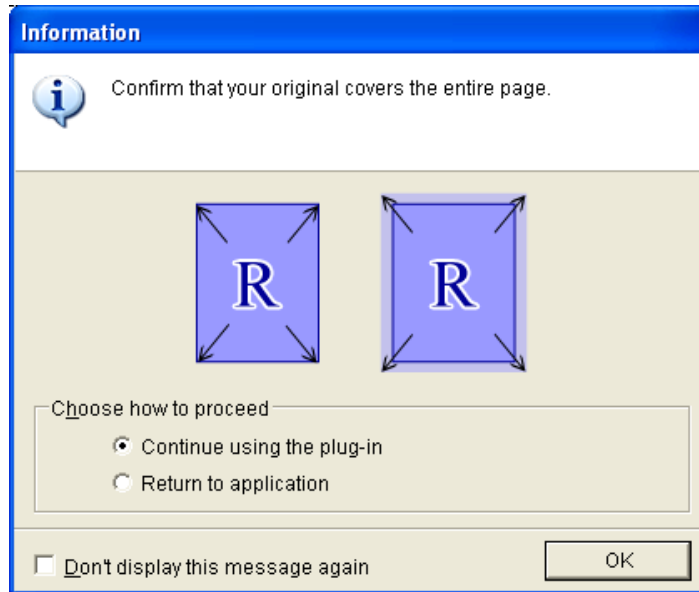

**5.** A confirmation dialog box is displayed. If the data fills up the page, confirm that **Continue using the plug-in** is selected in **Choose how to proceed** and press **OK**.



**Note**

- To adjust the data, select **Return to application** and press **OK**. Exit **Print Plug-In for Office** and return to the application.

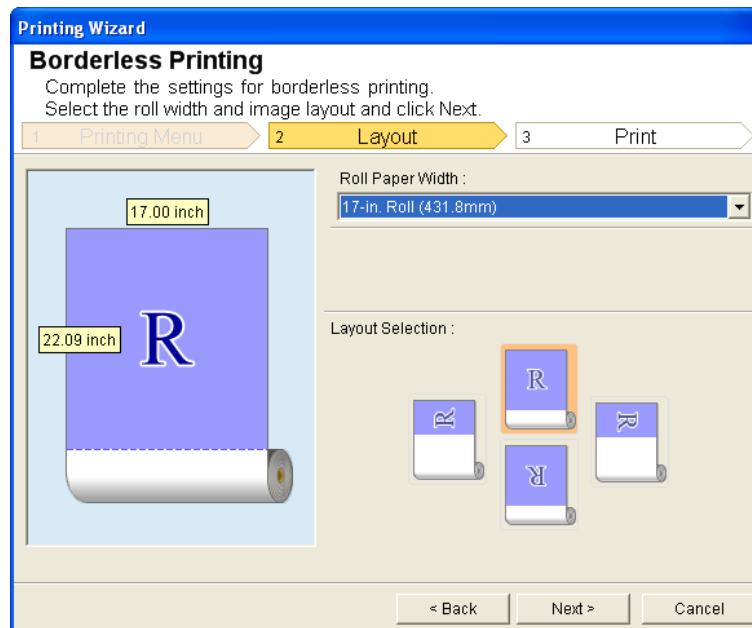

**6.** Select **Roll Paper Width** that is set in the printer.

7. Select **Layout**.

8. Select **Next**.

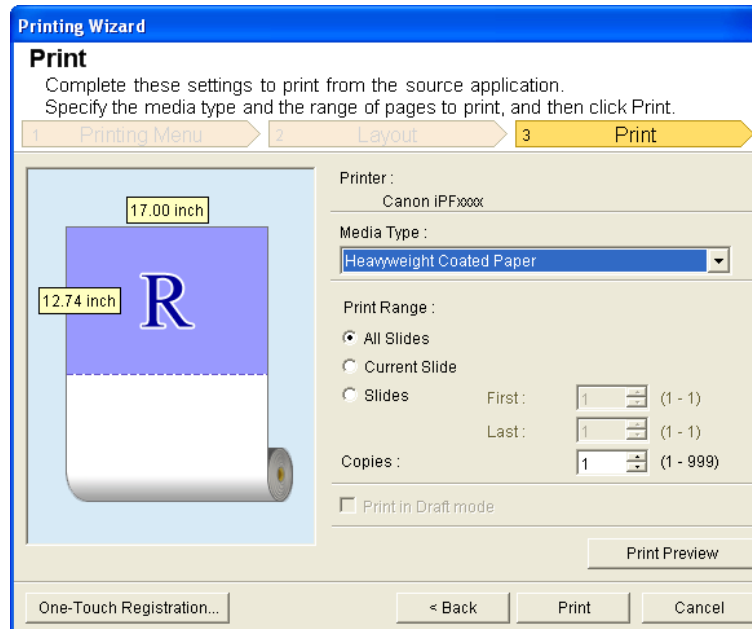

9. Select **Media Type**.

10. Select **Print Range** from **All Slides**, **Current Slide**, and **Slides**.  
If **Slides** is selected, enter the slide number.

11. Enter **Copies**.



**Note**

- When **Print in Draft mode** is selected, printing is fast but the print quality is poor.
- Press the **One-Touch Registration** button to register the settings. This is useful for multiple printing using the same settings.
- Press the **Print Preview** button to display the preview screen. You can confirm and make changes to the layout in the preview screen.
- The maximum length for Borderless Printing is the lesser of 14.22 times the roll paper width, or 18.0m.

12. Press **Print** to start printing.

## Multi-Page Printing (PowerPoint)

Prints multiple pages as one page. You can print handouts into a single page, or print matter with many pages.

1. Start **Microsoft PowerPoint**.
2. If **Start imagePROGRAF Print Plug-In** is displayed, click it.

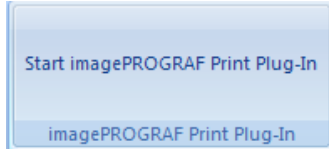

3. Click **Print** from the **imagePROGRAF Print Plug-In** toolbar/ribbon. The **Printing Wizard** dialog box is displayed.

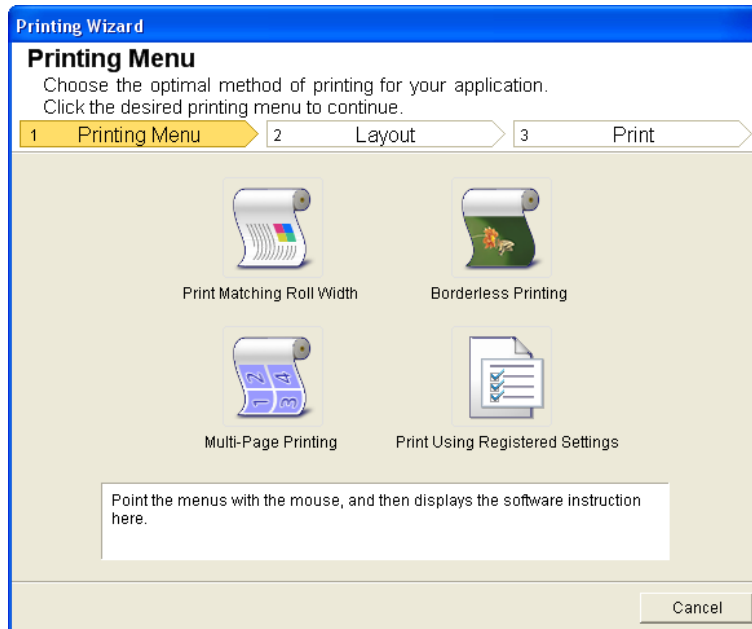

**Important**

- If you want to change the display to another file or application while the **Printing Wizard** is open, close the **Printing Wizard** dialog box. Otherwise, you may not be able to change displays or operate the toolbar/ribbon.



## 4. Click **Multi-Page Printing**.

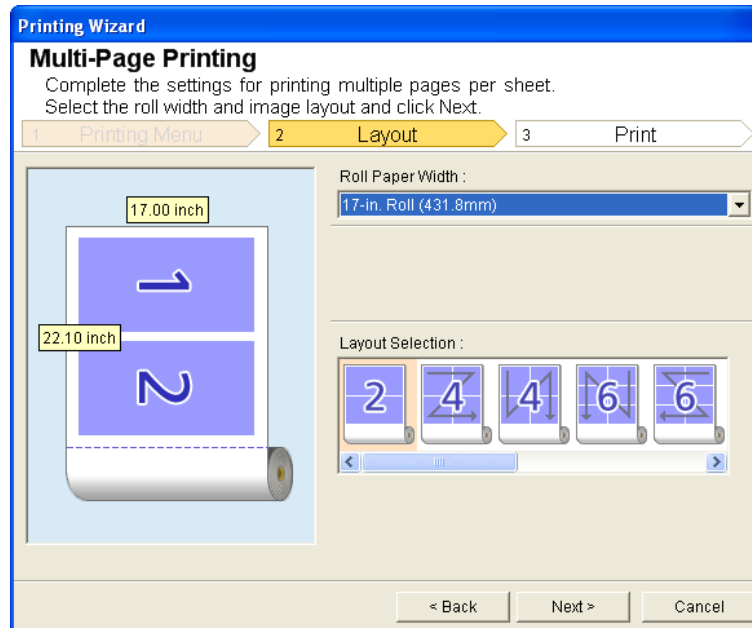

## 5. Select the **Roll Paper Width** that is set in the printer.

## 6. Select layout from **Layout Selection**.

## 7. Select **Next**.

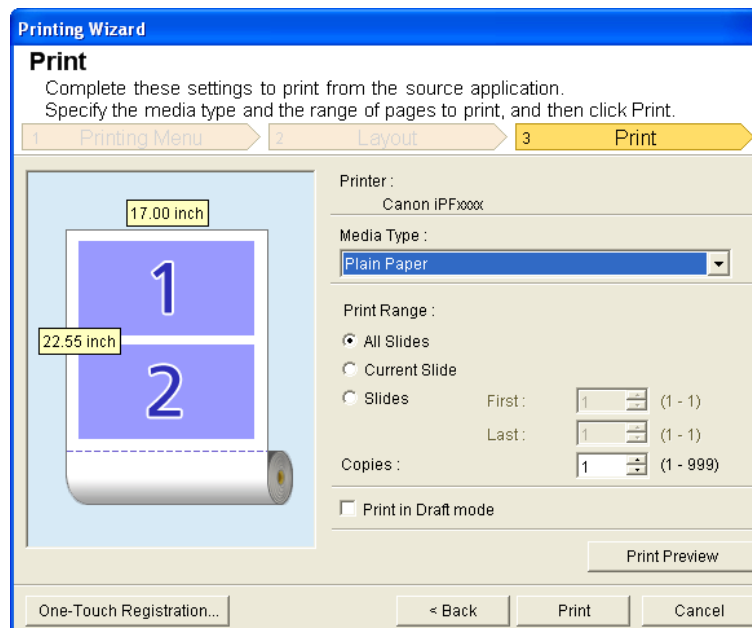

**8.** Select **Media Type**.

**9.** Select **Print Range** from **All Slides**, **Current Slide**, and **Slides**.  
If **Slides** is selected, enter the slide number.

**10.** Enter **Copies**.



**Note**

- When **Print in Draft mode** is selected, printing is fast but the print quality is poor.
- The settings are registered when the **One-Touch Registration** is pressed. This is convenient if you to need print multiple times using the same setting.
- Press the **Print Preview** button to display the preview screen. You can check and make changes to the layout in the preview screen.
- The maximum length for Multi-Page Printing is the lesser of 14.22 times the roll paper width, or 18.0m.

**11.** Press **Print** to start printing.

## Register the settings (PowerPoint)

If you are going to print multiple times using the same setting, you can select **One-Touch Registration**. Registered settings can be recalled from **Print Using Registered Settings**.

**1.** Set up to the **Print** screen from **Print Matching Roll Width**, **Borderless Printing** or **Multi-Page Printing** of **Printing Menu**.



**Note**

- Up to 20 items can be registered.
- The available settings are as follows.
  - Print Matching Roll Width (PowerPoint) →P.332
  - Borderless Printing (PowerPoint) →P.335
  - Multi-Page Printing (PowerPoint) →P.338

- Click the **One-Touch Registration** button.

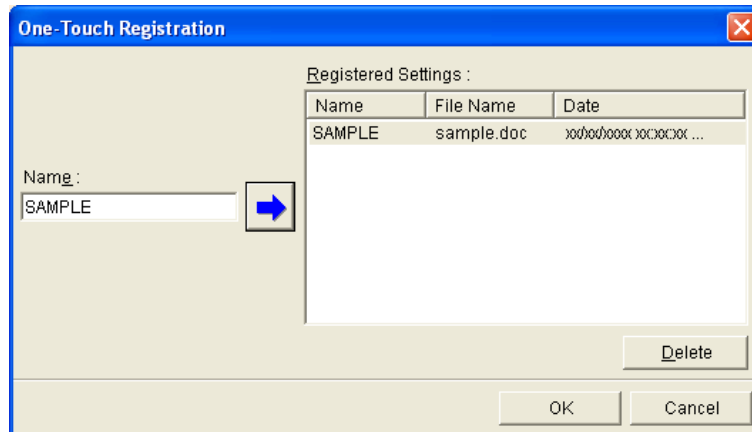

- Enter name in **Name**.  
Up to 31 characters can be entered.
- Click . The name you entered is displayed in **Registered Settings**.
- Click **OK**, and return to the **Print** screen.
- Click **Print** to print, and click **Cancel** to cancel the print.

**Note**

- Clicking **Cancel** in the **Print** screen will not delete the registered settings.

3

## Print Using Registered Settings (PowerPoint)

Prints using the registered settings.

- Start **Microsoft PowerPoint**.
- If **Start imagePROGRAF Print Plug-In** is displayed, click it.

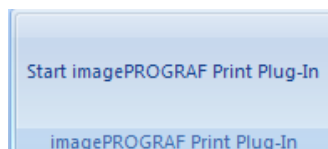

341

3. Click **Print** from the **imagePROGRAF Print Plug-In** toolbar/ribbon. The **Printing Wizard** dialog box is displayed.

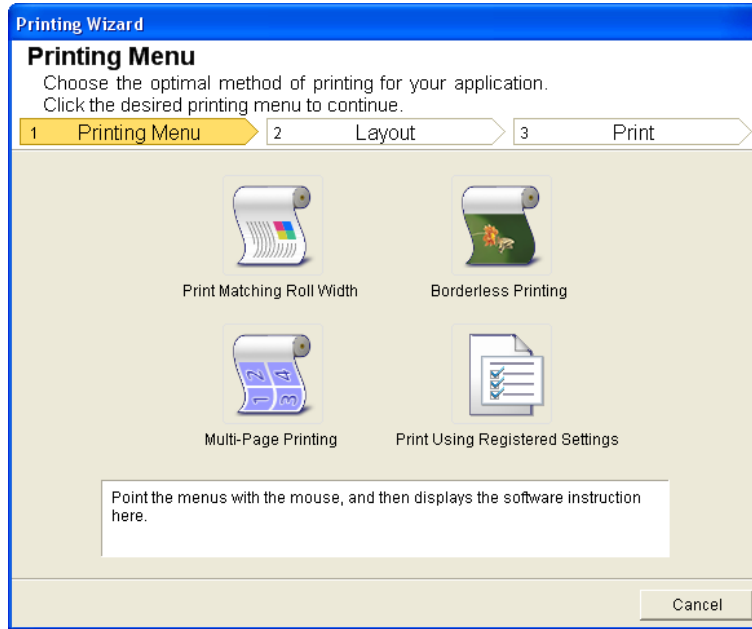

3



**Important**

- If you want to change the display to another file or application while the **Printing Wizard** is open, close the **Printing Wizard** dialog box. Otherwise, you may not be able to change displays or operate the toolbar/ribbon.

4. Click **Print Using Registered Settings**.

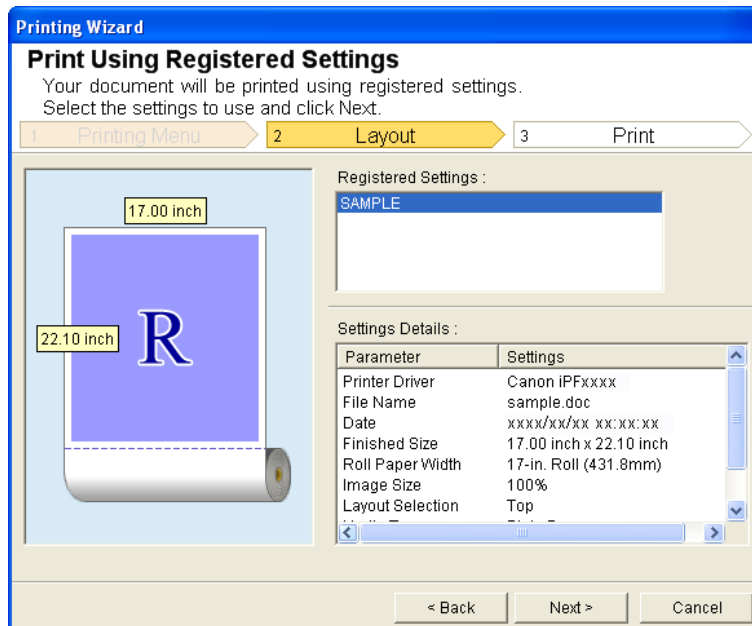

342

5. Click the **Next** button.

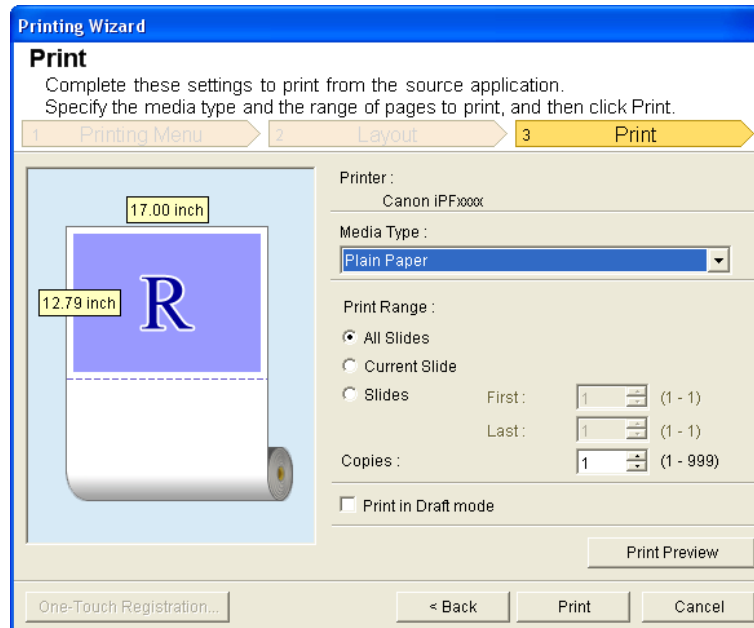

6. Select **Media Type**.

7. Select **Print Range** from **All Slides**, **Current Slide**, and **Slides**.  
If **Slides** is selected, enter the slide number.

8. Enter **Copies**.



**Note**

- When **Print in Draft mode** is selected, printing is fast but the print quality is poor.
- Press the **Print Preview** button to display the preview screen. You can check and make changes to the layout in the preview screen.
- The maximum print length when printing with the registered settings is the lesser of 14.22 times the roll paper width, or 18.0m.

9. Press **Print** to start printing.

## Portrait Orientation / Landscape Orientation (PowerPoint)

Print to the edge of the roll width. You can print large exhibits and posters, or print the Landscape or Portrait Orientation Page Sizes made in the **Large-Format Printing Wizard**.

### Create Page Size in Portrait or Landscape Orientation.

Use the **Large-Format Printing Wizard** to create portrait page sizes for Potrait Orientation, and landscape page sizes for Landscape Orientation.

1. Start **Microsoft PowerPoint**.
2. If **Start imagePROGRAF Print Plug-In** is displayed, click it.

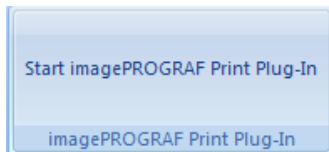

3. Click **Paper Settings** from the **imagePROGRAF Print Plug-In** toolbar/ribbon. The **Large-Format Printing Wizard** dialog box is displayed.

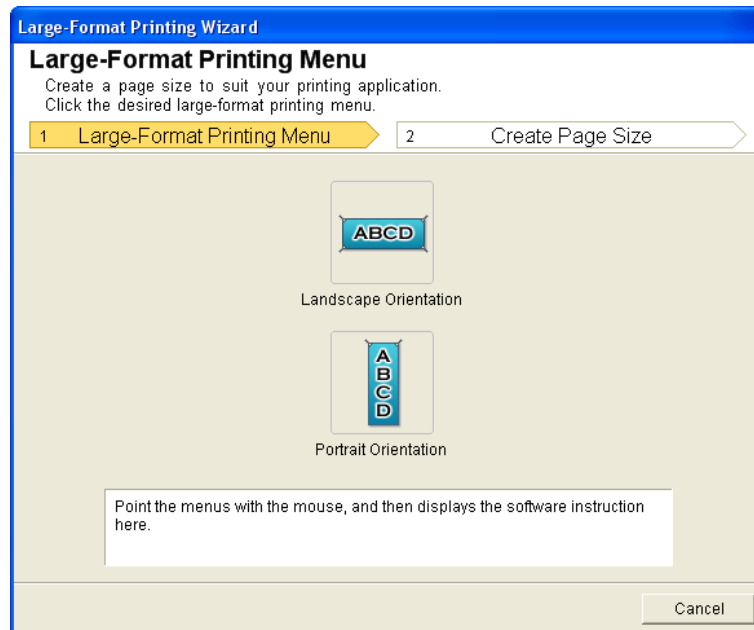

**Important**

- If you want to change the display to another file or application while the **Large-Format Printing Wizard** is open, close the **Large-Format Printing Wizard** dialog box. Otherwise, you may not be able to change displays or operate the toolbar/ribbon.

4. Click **Portrait Orientation** or **Landscape Orientation**.

**Note**

- The steps taken to create a Portrait Page Size will be used as an example to explain the procedure.

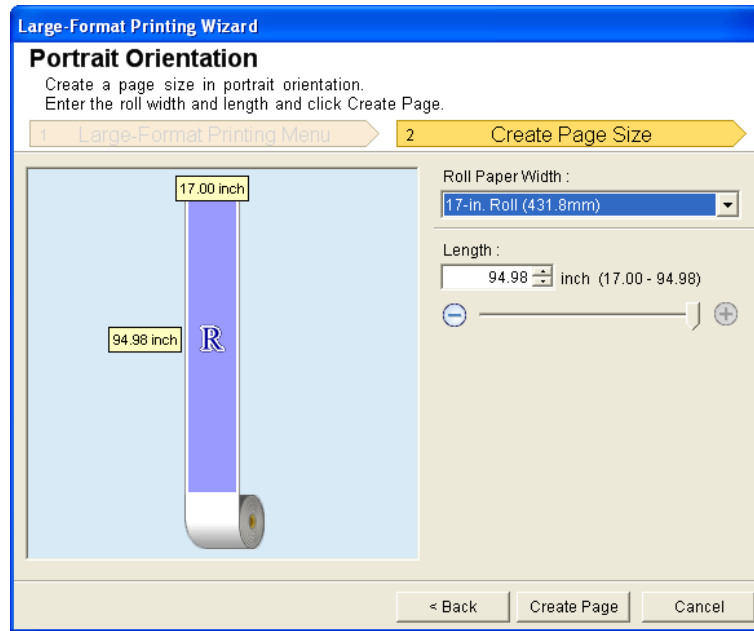

3

5. Adjust **Length** from the list-box or slide-bar.

6. Click the **Create Page** button.

7. Click **OK** if the message is displayed.

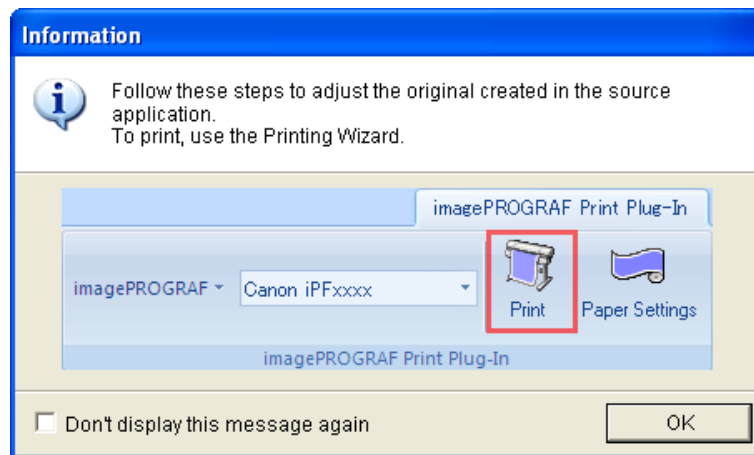

8. Edit and create the document.



#### Important

- The layout may collapse if you create a form using existing data. If that is the case, modify the data again.

345



**Note**

- Printing is done in **Print Matching Roll Width** of the **Printing Wizard**. For details on **Print Matching Roll Width**, refer to see "Print Matching Roll Width (PowerPoint)." →P.332 .

**To start from Microsoft Excel**

Below are the steps to start **Print Plug-In for Office** from **Microsoft Excel**.

1. Start **Microsoft Excel**.
2. If **Start imagePROGRAF Print Plug-In** is displayed on the toolbar/ribbon, click it.

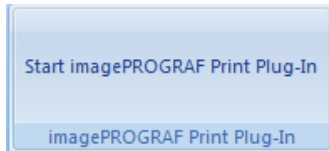



**Important**

- If the **imagePROGRAF Print Plug-In** toolbar/ribbon is not displayed, refer to the following.
  - When Print Plug-In for Office is not displayed →P.309

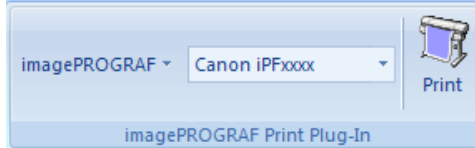
3. Check that the **imagePROGRAF Print Plug-In** toolbar/ribbon is displayed.

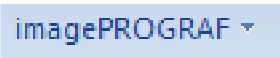
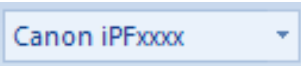

4. Click the buttons on the toolbar/ribbon according to the items you want to set.

Icon	Contents
 Menu	Displays the <b>About</b> , <b>Help</b> , and <b>Special Settings</b> dialog boxes. (See "Configuring Special Settings.") →P.356
 Printer list	Select Printer. If you select <b>Show All Printers</b> , the <b>imagePROGRAF</b> printers will be displayed again. Select this when you want to display all printer drivers or update the display.
 Print Button	The print Wizard is displayed. The settings <b>Print Entire Sheet</b> and <b>Print Selected Area</b> can be set.



### Printing Wizard dialog box

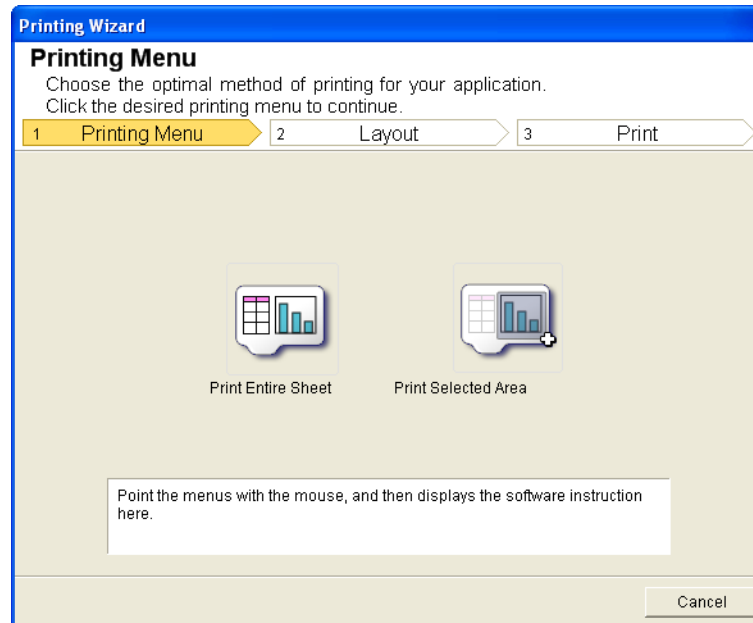

#### Important

- If you want to change the display to another file or application while the **Printing Wizard** is open, close the **Printing Wizard** dialog box. Otherwise, you may not be able to change displays or operate the toolbar/ribbon.
- The **Printing Wizard** will not start if you click the **Print** button on the toolbar/ribbon while editing a cell.
- When more than one worksheet is selected, the **Printing Wizard** cannot be run. Select only one worksheet and click **Print** again.
- When an object is selected, the **Printing Wizard** is not started if you click the **Print** button on the toolbar/ribbon.
- If the paper size in Excel is blank, the **Printing Wizard** cannot be run. From the **File** menu in Excel, select **Page Setup** and check **Paper size**.



#### Note

- If you click the **Print** button with a graph selected, a message dialog box will appear asking if you want to continue printing. If you click **No**, you will return to the application.
- If you click the **Print** button with a page break set, a message dialog box will appear asking if you want to continue printing. If you click **No**, you will return to the application. If you do not use the set page break, check the page break preview and change the setting.
- If you click the **Print** button with a page range set, a message dialog box will appear asking if you want to continue printing. If you click **No**, you will return to the application. If you do not use the set page range, check the page break preview and change the setting.
- If you click the **Print** button with a worksheet or cell protected, a message dialog box will appear asking if you want to continue printing. If you click **No**, you will return to the application. If you want to change the setting, remove the protection from the worksheet or cell.

## Print Entire Sheet (Excel)

For resizing the entire sheet to fit the roll width. Choose this option to enlarge the currently displayed sheet before printing.

1. Start **Microsoft Excel**.
2. If **Start imagePROGRAF Print Plug-In** is displayed, click it.

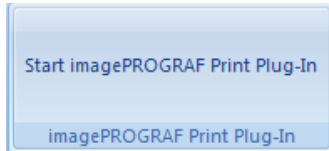

3. Click **Print** from the **imagePROGRAF Print Plug-In** toolbar/ribbon.

3



### Important

- When more than one worksheet is selected, the **Printing Wizard** cannot be run. Select only one worksheet and click **Print** again.

If a print area is set, a confirmation message dialog box will appear.  
To print the entire sheet, cancel the setting of the print area.

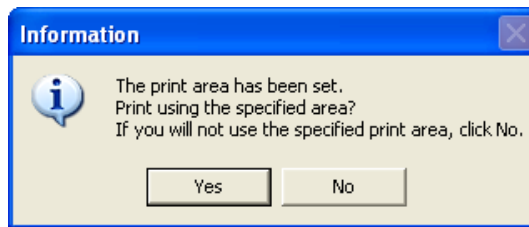

The **Printing Wizard** dialog box is displayed.

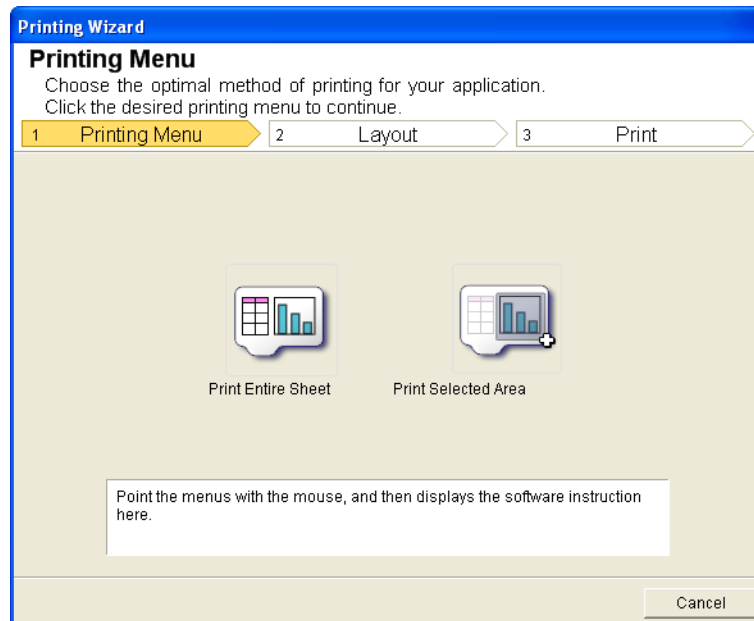

348

#### 4. Click **Print Entire Sheet**.

A message will appear informing you that analysis is in progress.

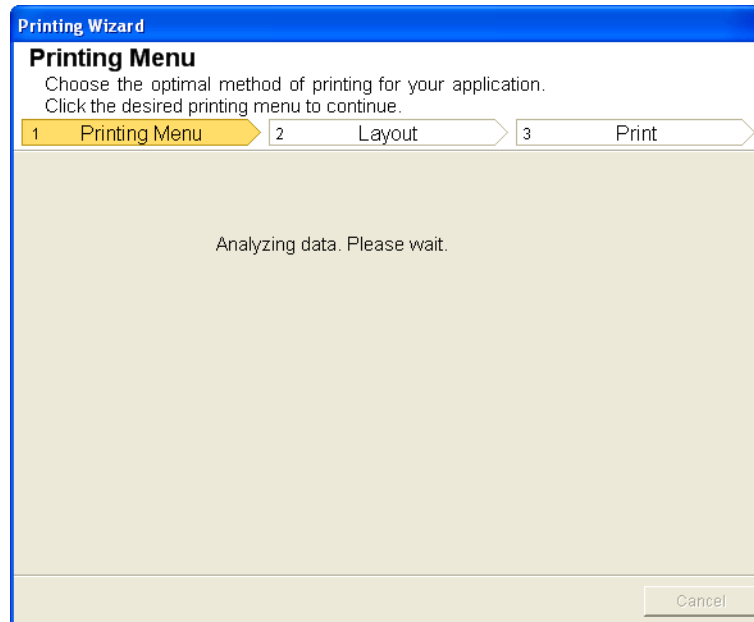

The Layout menu will appear automatically.

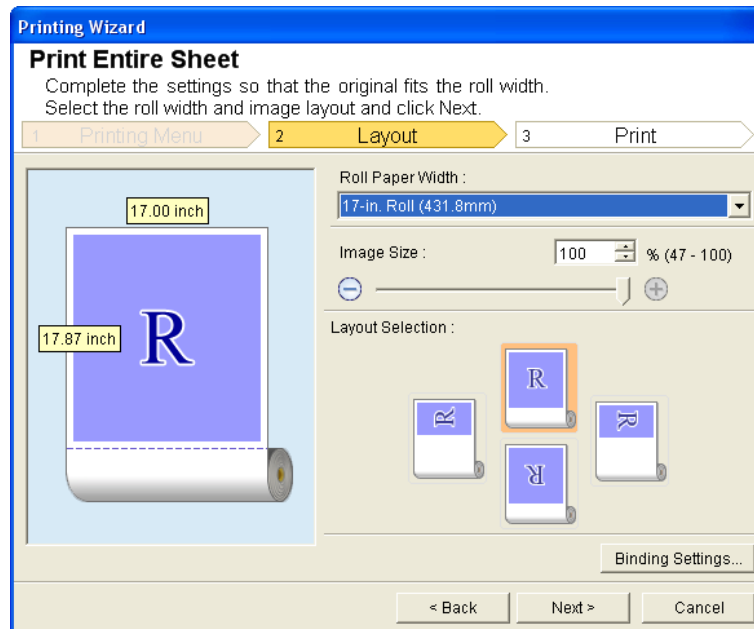

#### Note

- If data analysis requires time, a message dialog will appear. If you select **No**, you will return to the application.

#### 5. Select **Roll Paper Width** that is set in the printer.

6. Select image size.
7. Select layout.
8. To configure **Binding**, click the **Binding Settings** button.  
Refer to **Configuring Binding (Excel)** →P.355 for details on the procedure for configuring **Binding**.
9. Select **Next**.

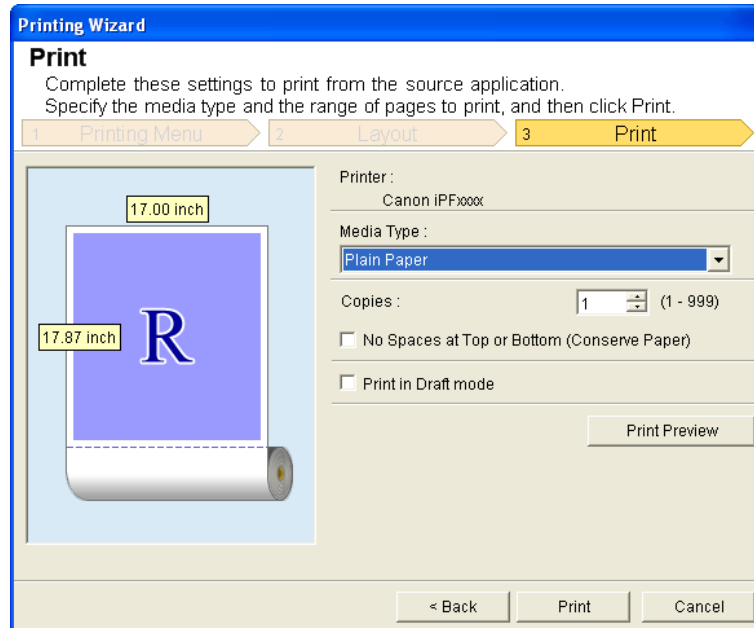

10. Select **Media Type**.

11. Enter **Copies**.

**Note**

- When **Print in Draft mode** is selected, printing is fast but the print quality is poor.
- Press the **Print Preview** button to display the preview screen. You can check and make changes to the layout in the preview screen.
- When you print to the edge of the roll width, the maximum print length is 18.0m.

12. If the upper and lower margins are too wide, check **No Spaces at Top or Bottom (Conserve Paper)**.  
The upper and lower margins can be checked in **Print Preview**.

## 13. Press **Print** to start printing.



### Important

- If divided into plural pages, try reducing the data size or the range you select.
- You cannot run **Print** or **Print Preview** if you select it for a worksheet with no data displayed.

## Print Selected Area (Excel)

For resizing the selected range of cells to fit the roll width. Choose this option to enlarge a particular part of the sheet before printing.

1. Start **Microsoft Excel**.
2. If **Start imagePROGRAF Print Plug-In** is displayed, click it.

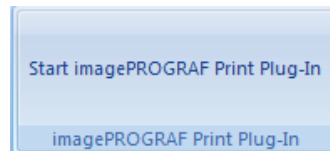

3. Click **Print** from the **imagePROGRAF Print Plug-In** toolbar/ribbon.



### Important

- When more than one worksheet is selected, the **Printing Wizard** cannot be run. Select only one worksheet and click **Print** again.

If a print area is set, a confirmation message dialog box will appear.  
To print the selected area, cancel the setting of the print area.

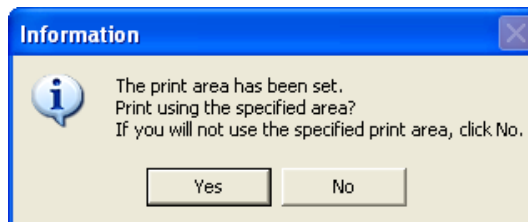

The **Printing Wizard** dialog box is displayed.

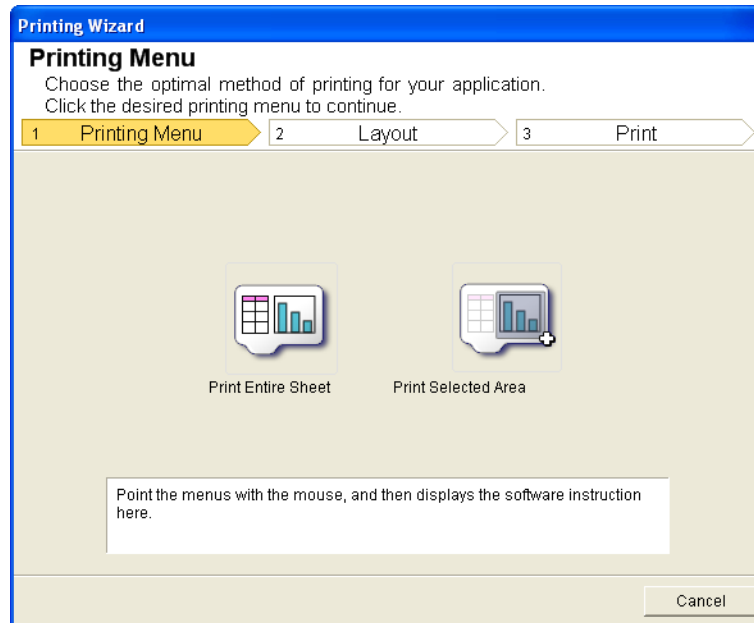

**4.** Click **Print Selected Area**.



**Important**

- If only one cell is selected, **Print Selected Area** cannot be selected.

A message will appear informing you that analysis is in progress.

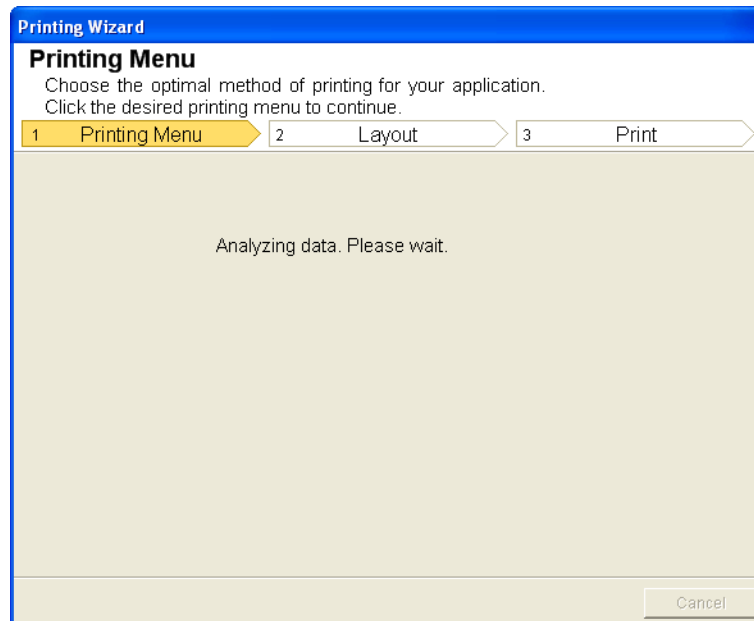

The Layout menu will appear automatically.

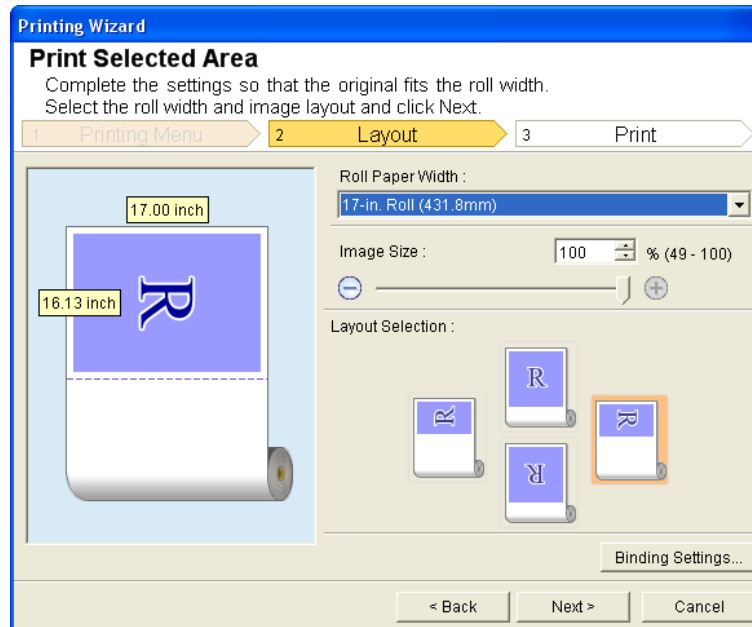

#### Important

- If the range selected in **Excel 2007/2010** is too large, it will not be possible to analyze the data. Select a smaller range and then run the analysis.



#### Note

- If data analysis requires time, a message dialog will appear. If you select **No**, you will return to the application.

5. Select **Roll Paper Width** that is set in the printer.
6. Select image size.
7. Select layout.
8. To configure **Binding**, click the **Binding Settings** button.  
Refer to **Configuring Binding (Excel)** → **P.355** for details on the procedure for configuring **Binding**.

## 9. Select **Next**.

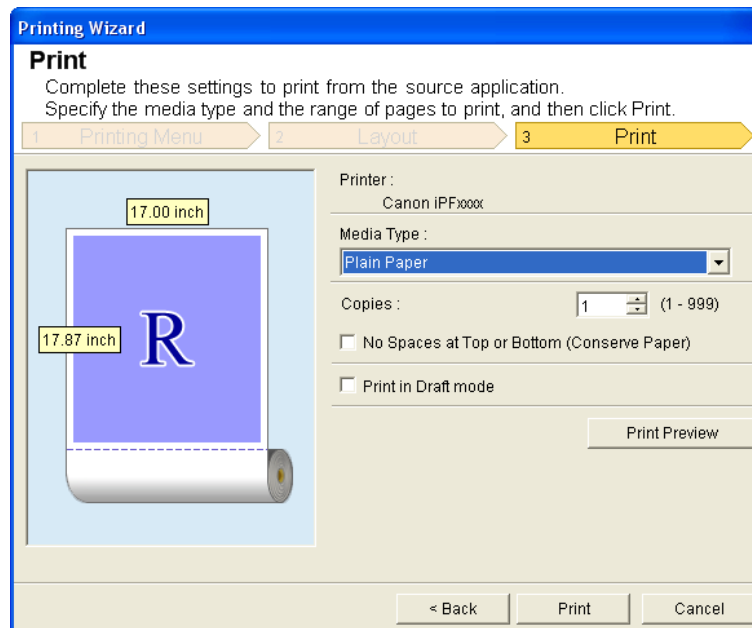

3

## 10. Select **Media Type**.

## 11. Enter **Copies**.



### Note

- When **Print in Draft mode** is selected, printing is fast but the print quality is poor.
- Press the **Print Preview** button to display the preview screen. You can check and make changes to the layout in the preview screen.
- When you print to the edge of the roll width, the maximum print length is 18.0m.

## 12. If the upper and lower margins are too wide, check **No Spaces at Top or Bottom (Conserve Paper)**. The upper and lower margins can be checked in **Print Preview**.

## 13. Press **Print** to start printing.



### Important

- If divided into plural pages, try reducing the data size or the range you select.
- You cannot run **Print** or **Print Preview** if you select it for a worksheet with no data displayed.

354



## Configuring Binding (Excel)

You can configure **Binding** margins for binding printouts.

1. Configure the settings up to **Layout Selection** in the **Layout** screen in **Print Entire Sheet** or **Print Selected Area**. Refer to **Print Entire Sheet (Excel)** →P.348 and **Print Selected Area (Excel)** →P.351 for the configuration methods.
2. Click the **Binding Settings** button.



### Important

- You cannot click the **Binding Settings** button in the following situations.
  - When the **Image Size** is set to **100%**
  - When a graph is selected
  - When page breaks have been set
  - When a sheet or cell is protected

Open the **Binding Settings** dialog box.

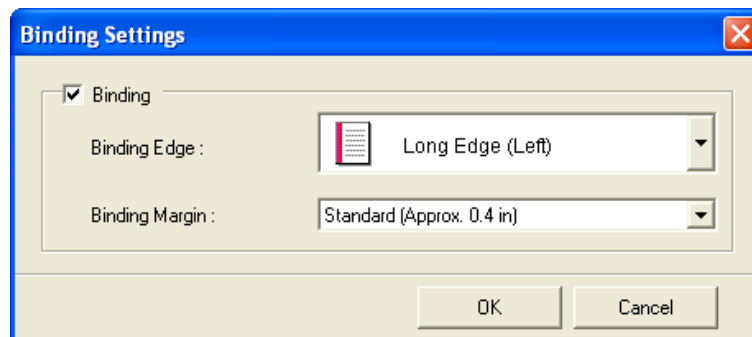

3. If the **Binding** checkbox is not checked, select it to turn binding on.
4. Select **Binding Edge**.
5. Select **Binding Margin**.

- Click the **OK** button.  
Return to the **Layout** screen.

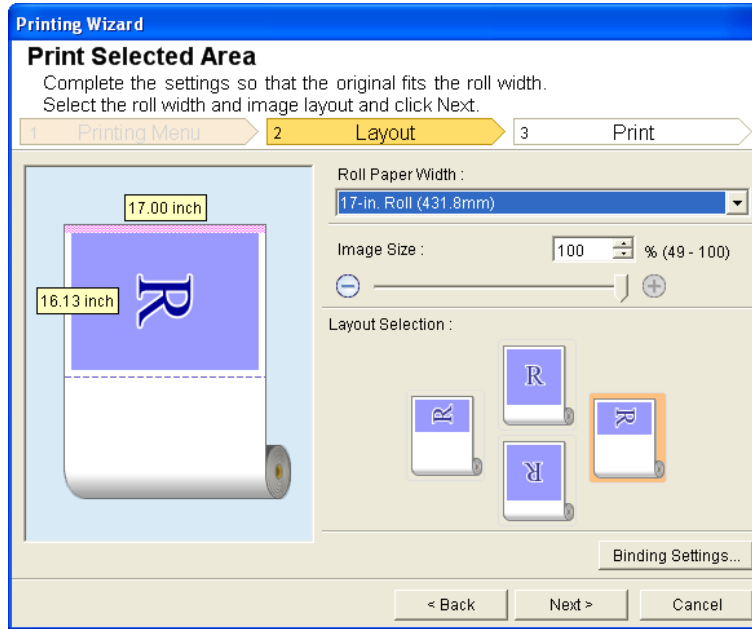

Check that the **Binding** settings are applied in the preview screen.

- Configure the settings in the **Printing Wizard** dialog box.

## Configuring Special Settings

You can configure **Special Settings** from the **imagePROGRAF Print Plug-In** toolbar.

- Click **imagePROGRAF** in the toolbar, and select **Special Settings**.

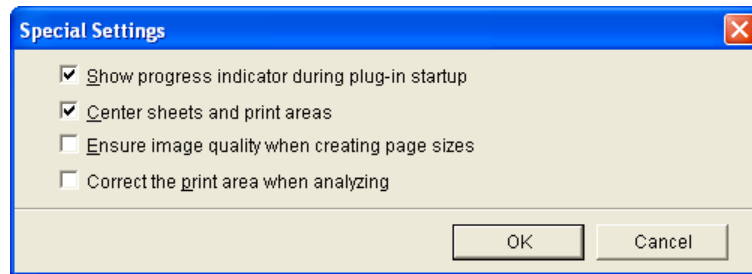

- Turn the checkbox for the item you want to change on or off.

Item	Details
<b>Show progress indicator during plug-in startup</b>	When this setting is off, hides the progress indicator that appears while the plug-in is starting up.

Item	Details
<b>Center sheets and print areas</b>	When this setting is off, printing is performed without changing the position. When this setting is on, printing is performed with the top, bottom, left, and right margins layed out equally. When this setting is off, printing is performed without changing the position. This function is only valid in <b>Microsoft Excel</b> .
<b>Ensure image quality when creating page sizes</b>	When this setting is on, documents are created at the maximum size. This reduces the enlargement ratio during actual printing, which minimizes degradation of the quality of photos, etc. This function is only valid in [ <b>Microsoft PowerPoint</b> .
<b>Correct the print area when analyzing</b>	For data that cannot be processed with usual data analysis, the print area is corrected and then the data is processed. When data analysis fails, you may be able to print by turning on this checkbox. This function is only valid in <b>Microsoft Excel</b> .

3. Click **OK** to close the **Special Settings** dialog box.

## HDI Driver

The Features of HDI Driver .....	358
Operating Environment .....	358
Installation Procedure .....	359
Installing with the Canon Installer .....	359
Installing with the Add-A-Plotter Wizard .....	367
Opening the Plotter Configuration Dialog Box .....	371
Opening from the AutoCAD File Menu .....	372
Opening from the Start Menu .....	373
Plotter Configuration Editor Dialog Box .....	375
Media Source and Media Size Settings .....	376
Graphics Settings .....	377
Opening the Custom Properties Dialog Box .....	380
Custom Properties dialog box .....	382
Paper Detailed Settings .....	384
Color Compatibility Dialog Box .....	386
Printing .....	386

## The Features of HDI Driver

The main features of HDI Driver are as follows.

- A special HDI (Heidi Device Interface) compatible printer driver for the Autodesk, Inc. software applications for AutoCAD and AutoCAD LT architecture (hereafter referred to together as "AutoCAD").
- You can set up the print job with the most appropriate settings for the media and print clear, sharp printouts of plans and diagrams created with AutoCAD.

## Operating Environment

The HDI driver operating environment is as follows.

- Compatible Operating System  
Windows 2000, Windows XP, Windows Vista
- Compatible AutoCAD Version  
AutoCAD 2000, AutoCAD LT2000, AutoCAD 2000i, AutoCAD LT2000i, AutoCAD 2002, AutoCAD LT2002, AutoCAD 2004, AutoCAD LT2004, AutoCAD 2005, AutoCAD LT2005, AutoCAD 2006, AutoCAD LT2006, AutoCAD 2007, AutoCAD LT2007, DWG TrueView 2007, AutoCAD 2008, AutoCAD LT2008, DWG TrueView 2008, AutoCAD 2009, AutoCAD LT2009, DWG TrueView 2009, AutoCAD 2010, AutoCAD LT2010, DWG TrueView 2010, AutoCAD 2008(x64), DWG TrueView 2008(x64), AutoCAD 2009(x64), AutoCAD LT2009(x64), DWG TrueView 2009(x64), AutoCAD 2010(x64), AutoCAD LT2010(x64), DWG TrueView 2010(x64)



### Note

- The supported OS version differs for each version of AutoCAD. Check with Autodesk for details.
- For the Windows OS, use the latest version of Service Pack.

## Installation Procedure

There are two ways to install the HDI driver.

- Installing with the Canon Installer →P.359
- Installing with the Add-A-Plotter Wizard →P.367

## Installing with the Canon Installer

The Canon installer opens and displays as soon as you start the User Software CD-ROM provided with the printer. Follow the procedure below to perform the installation from this screen.

1. Mount the User Software CD-ROM in the CD-ROM drive and start the Canon installer.



### Note

- If the Canon installer screen does not appear, double-click the **CD-ROM** icon from the **My Computer** to open the installer screen.

2. Select **Install Individual Software** in the Canon installer **Setup Menu**.



The **Installation List** appears. Click the **Install** button of the **imagePROGRAF HDI Driver**.

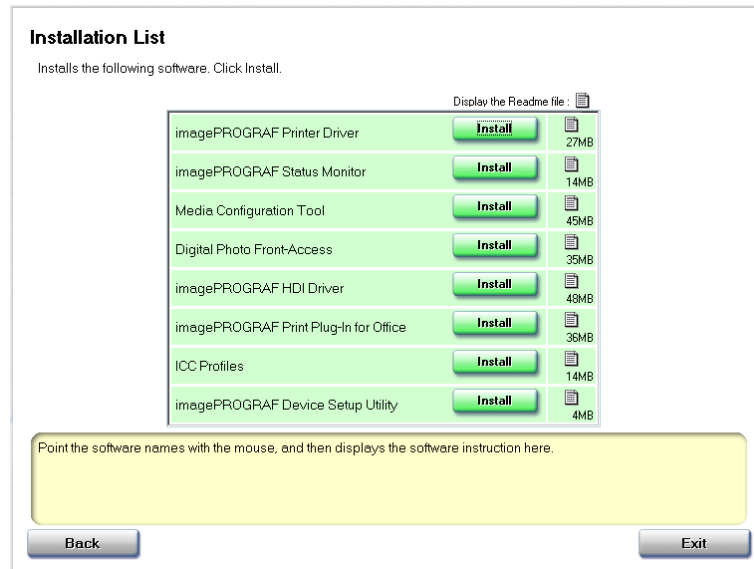

The driver setup screen appears. Click the **Next** button.

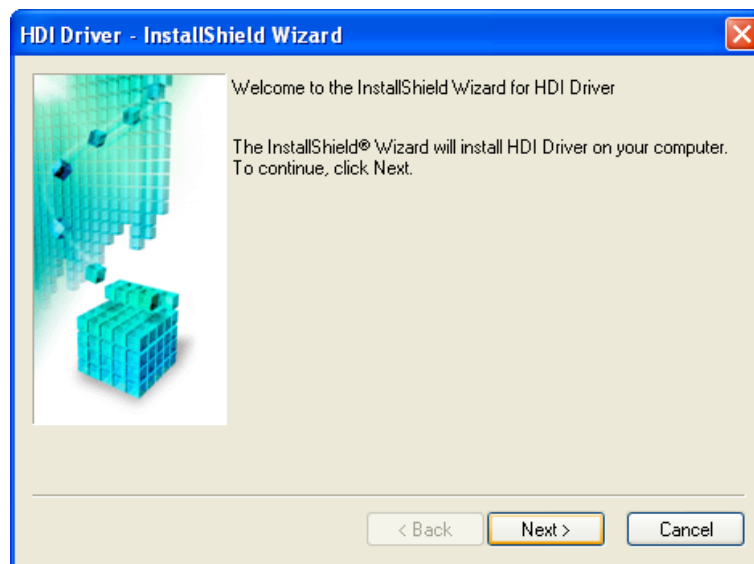

3

360

3. After you have read the Licensing Agreement, select **I accept the terms of the license agreement** and click the **Next** button.

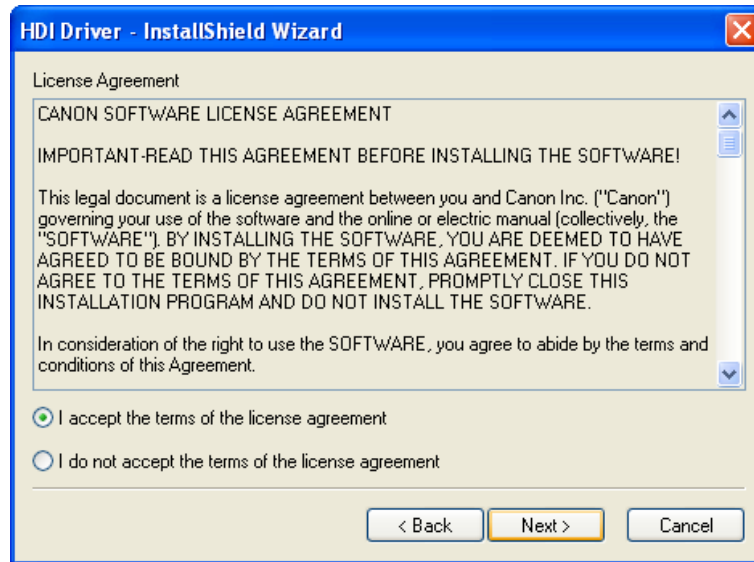

4. Confirm that the installed AutoCAD is compatible with your computer environment. Click the **OK** button.

**Note**

- Confirm that the installed AutoCAD is compatible with your computer environment.

5. The **Ready to Install the Program** screen opens. Click the **Install** button.

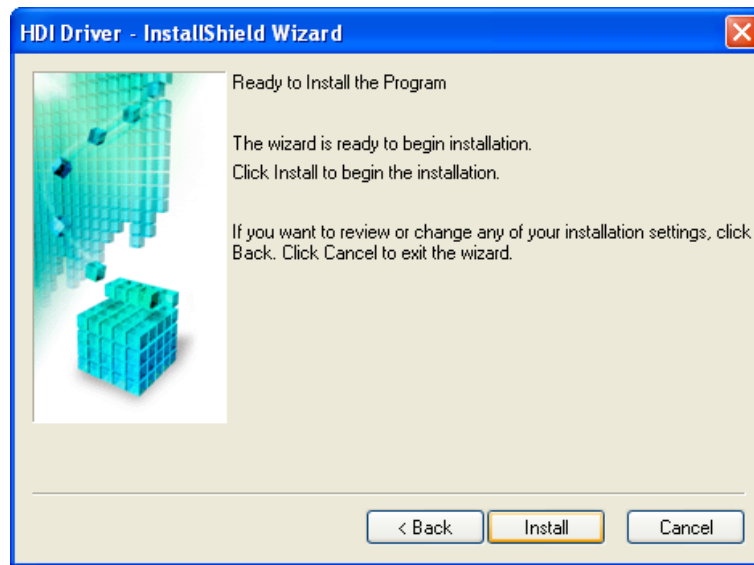

6. The HDI driver files are copied to the **Drv** folder where the AutoCAD program files are stored. Click the **Finish** button. This completes the setup of the HDI driver.

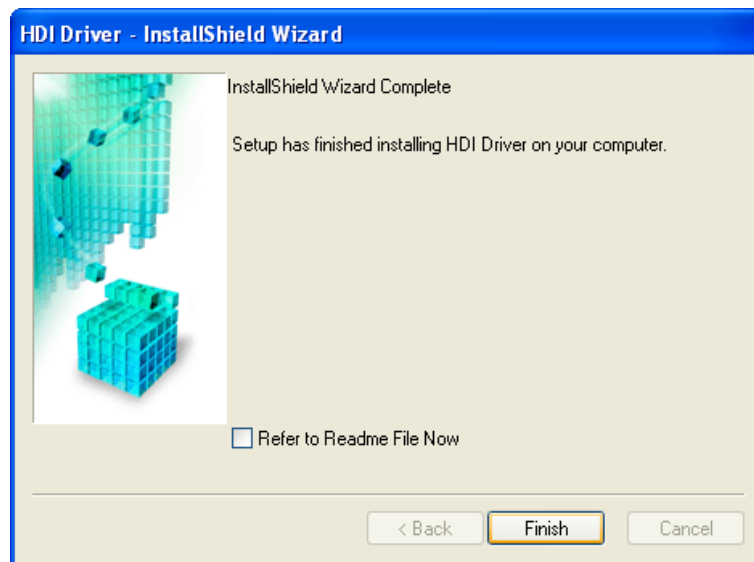

3

362



7. After AutoCAD starts, select **Plotter Manager** from the **File** menu. The **Plotters** window opens. Click the **Add-A-Plotter Wizard** icon.

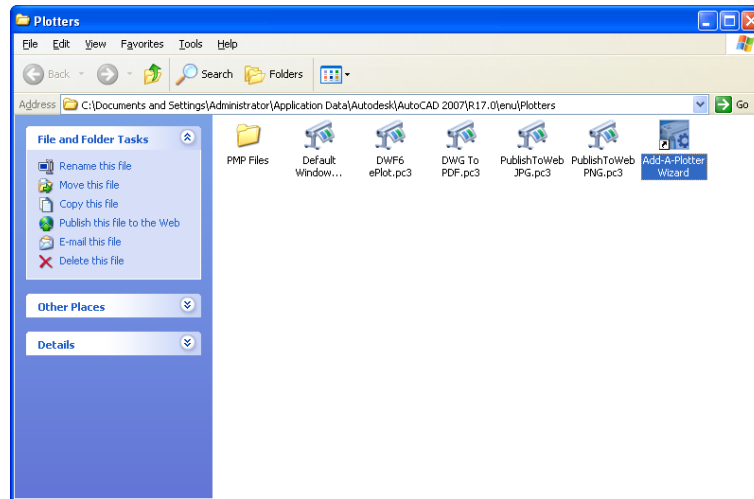

3

8. The **Add Plotter - Introduction Page** screen opens. Check the displayed screen and then click the **Next** button.

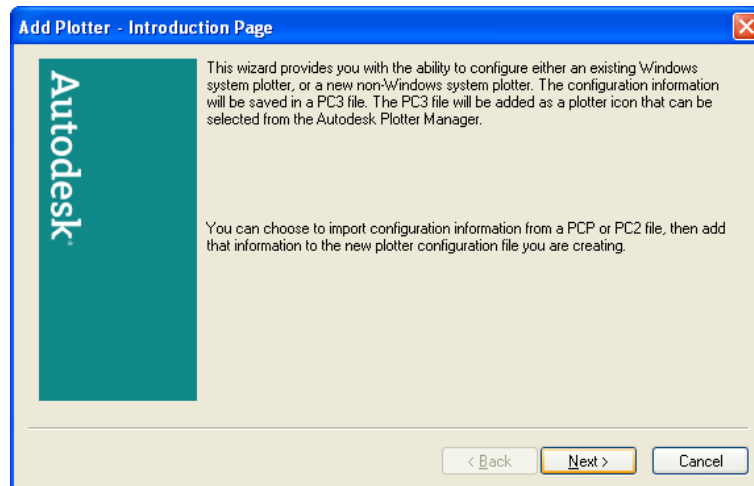

**Note**

- To open the **Add-A-Plotter Wizard** you can also click **Start > Control Panel > Autodesk Plotter Manager >** and then double-click the **Plotter Wizard** icon in the **Plotters** window.

363

**9.** Add Plotter - Begin screen opens. Select **My Computer** then click the **Next** button.

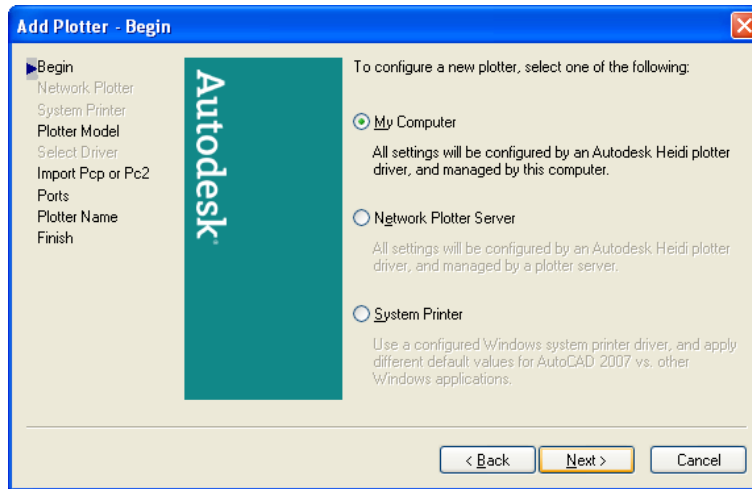

3

**10.** The **Add Plotter - Plotter Model** screen opens. Make sure that **Canon Inc.** is selected in the list of **Manufacturers**, and for the **Models** select the name of the printer that you want to install then click the **Next** button.

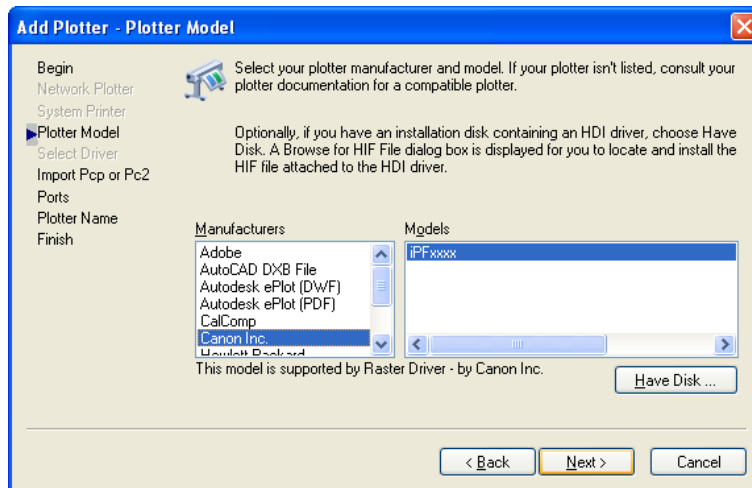

364

- 11.** The **Add Plotter - Import Pcp or Pc2** screen opens. Click the **Next** button.

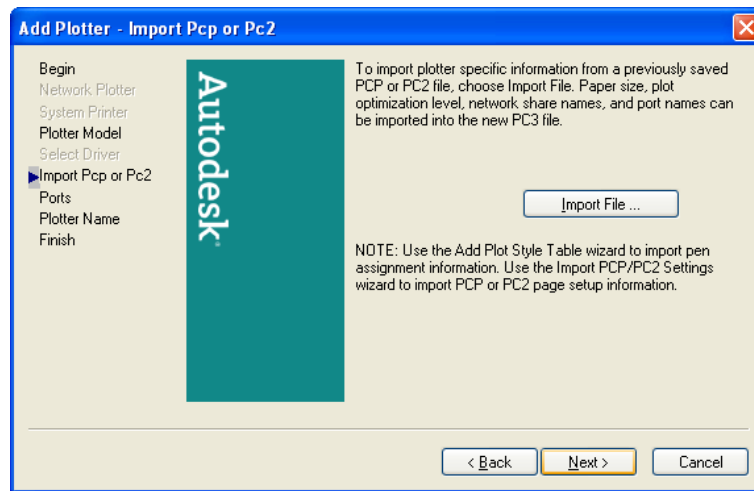

**Note**

- If you want the installer to read plotter information from previously stored PCP or PC2 files, click the **Import File** button.

- 12.** The **Add Plotter - Ports** screen opens. Make sure that **Plot to a port** is selected, select the port that you want to use for the plotter, then click the **Next** button.

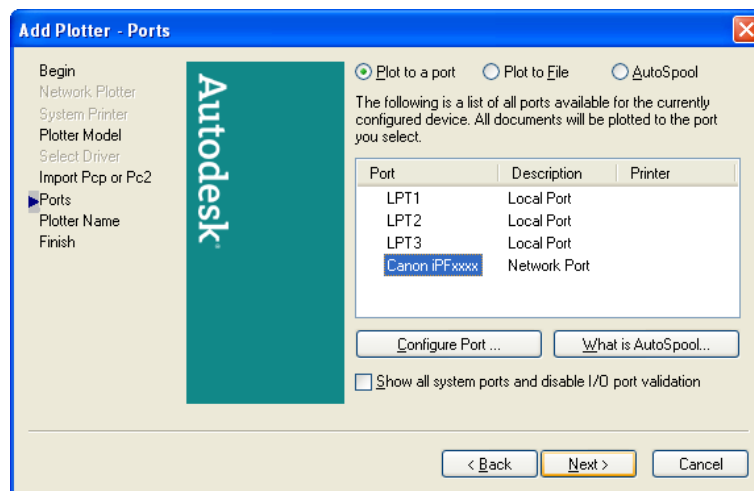

**Note**

- In the **Add Plotter - Ports** screen, it is recommended to select **Network Port**. If you select **Local Port**, the AutoCAD warning message may appear when printing.

## 13. The **Add Plotter - Plotter Name** screen opens. Click the **Next** button.

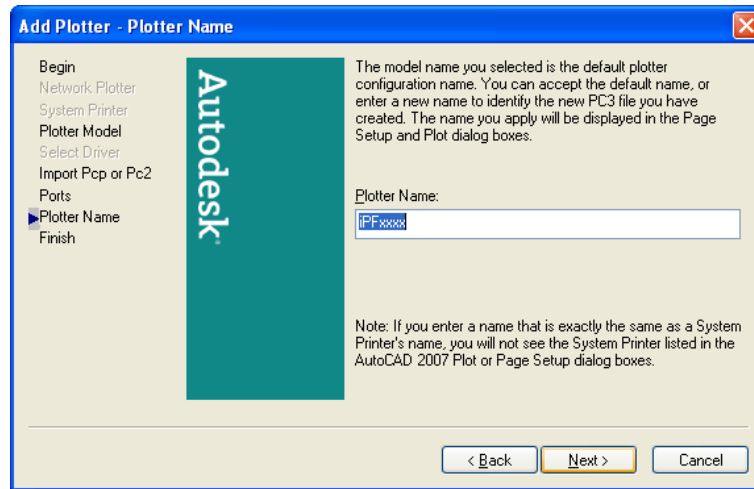

### Note

- You can change the **Plotter Name** setting here, but you will normally leave it as it is and go to Step 14.

## 14. The **Add Plotter - Finish** screen opens. Click the **Finish** button. This completes the installation of the HDI driver.

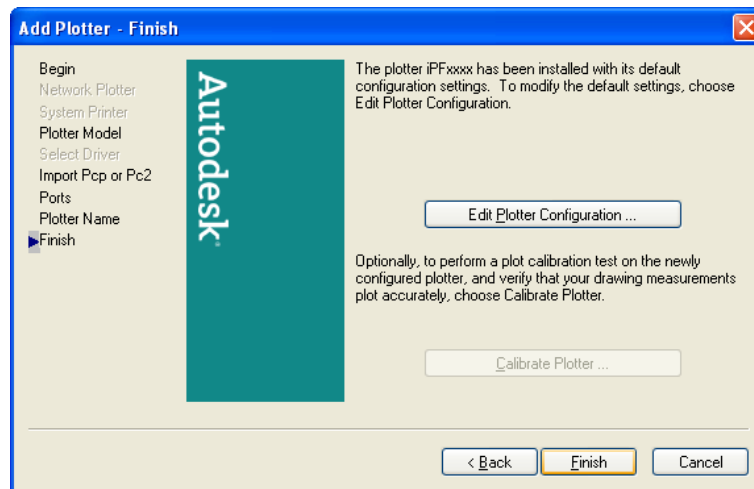

## 15. Clicking the **Finish** button closes the **Installation List** and **Setup Menu** and ejects the User Software CD-ROM from the CD-ROM drive.

## Installing with the Add-A-Plotter Wizard

Follow the procedure below to use the **Add-A-Plotter Wizard** to install the HDI driver without the Canon installer.

1. After AutoCAD starts, select **Plotter Manager** from the **File** menu.  
The **Plotters** window opens. Click the **Add-A-Plotter Wizard** icon.

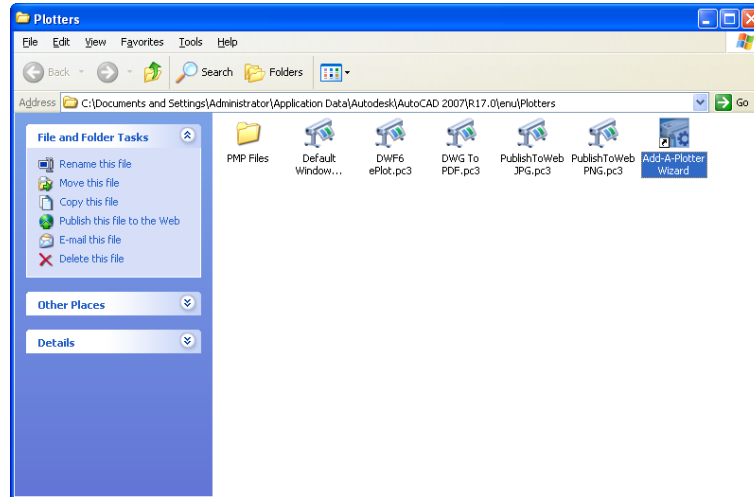

2. The **Add Plotter - Introduction Page** screen opens. Check the displayed screen and then click the **Next** button.

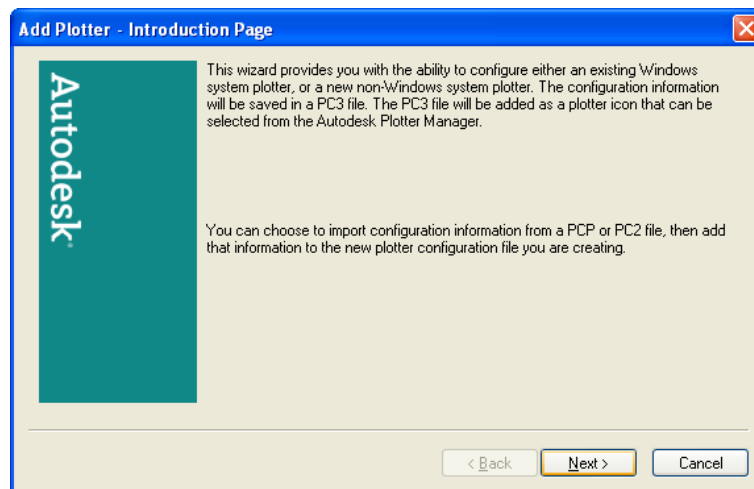

### Note

- To open the **Add-A-Plotter Wizard** you can also click **Start > Control Panel > Autodesk Plotter Manager >** and then click the **Add-A-Plotter Wizard** icon in the **Plotters** window.

**3.** The **Add Plotter - Begin** screen opens. Select **My Computer** then click the **Next** button.

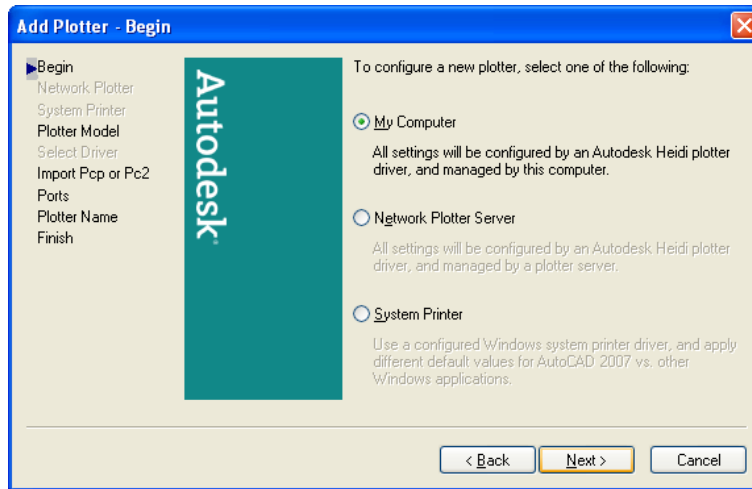

**4.** The **Add Plotter - Plotter Model** screen opens. Mount the User Software CD-ROM in the CD-ROM drive.

**5.** On the **Add Plotter - Plotter Model** screen, click the **Have Disk** button.

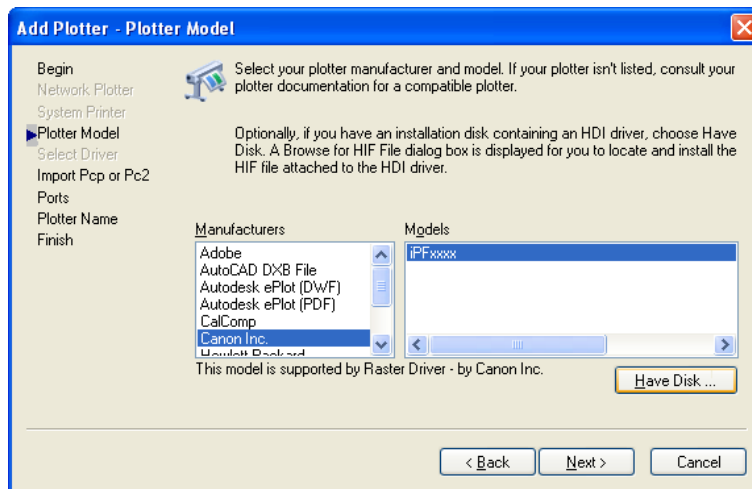

3

368

6. The **Open** dialog box opens. From the **Look in** box, select the CD-ROM drive, and then browse to the folder that holds the hif file.  
Select the hif file then click the **Open** button.

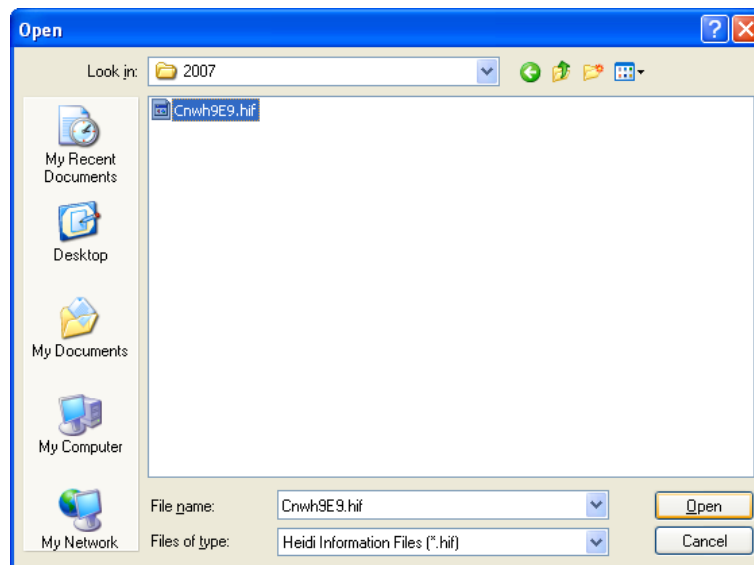
**Note**

- The hif format file is contained in the following folder.  
 \HDI Driver\English\2007 (AutoCAD Version 2007)

7. The display returns to the **Add Plotter - Plotter model** screen.  
Select **Canon Inc.** from the list of **Manufacturers**, select the name of the printer for **Models**, and then click the **Next** button.

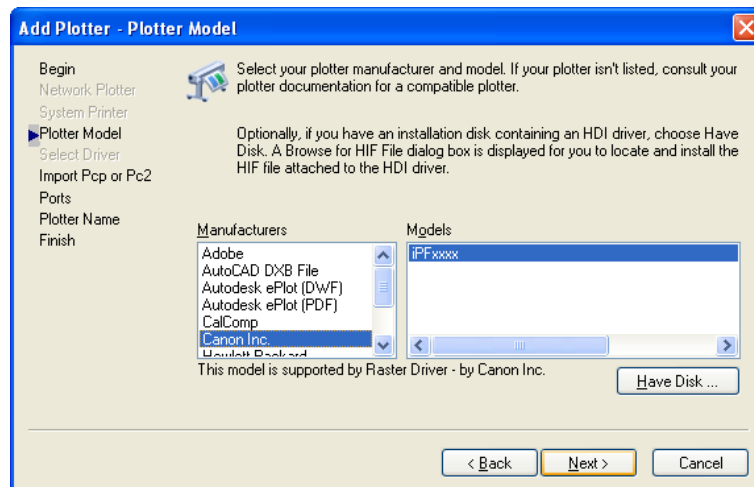

8. The **Add Plotter - Import Pcp or Pc2** screen opens. Click the **Next** button.

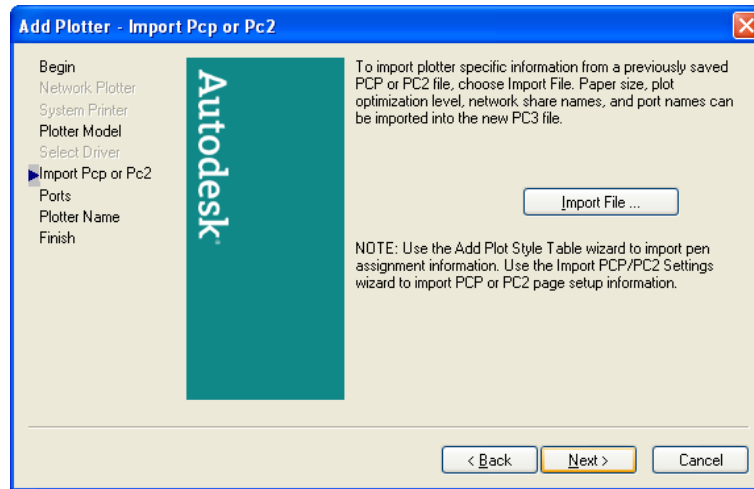

**Note**

- If you want the installer to read plotter information from previously stored PCP or PC2 files, click the **Import File** button.

9. The **Add Plotter - Ports** screen opens. Make sure that **Plot to a port** is selected, select the port that you want to use for the plotter, then click the **Next** button.

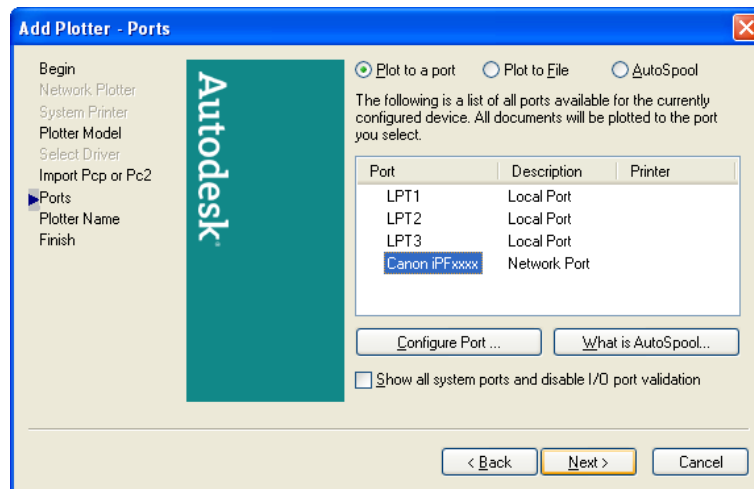

**Note**

- In the **Add Plotter - Ports** screen, it is recommended to select **Network Port**. If you select **Local Port**, the AutoCAD warning message may appear when printing.



- 10.** The **Add Plotter - Plotter Name** screen opens. Click the **Next** button.

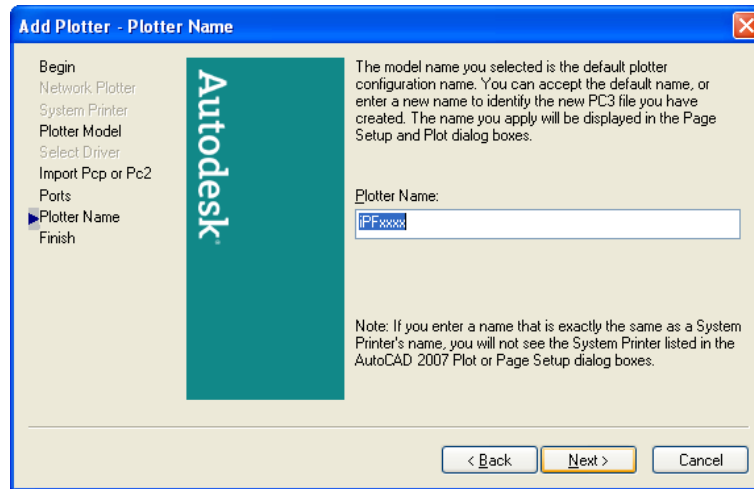

**Note**

- You can change the **Plotter Name** setting here, but you will normally leave it as it is and go to Step 11.

- 11.** The **Add Plotter - Finish** screen opens. Click the **Finish** button.  
This completes the installation of the HDI driver.

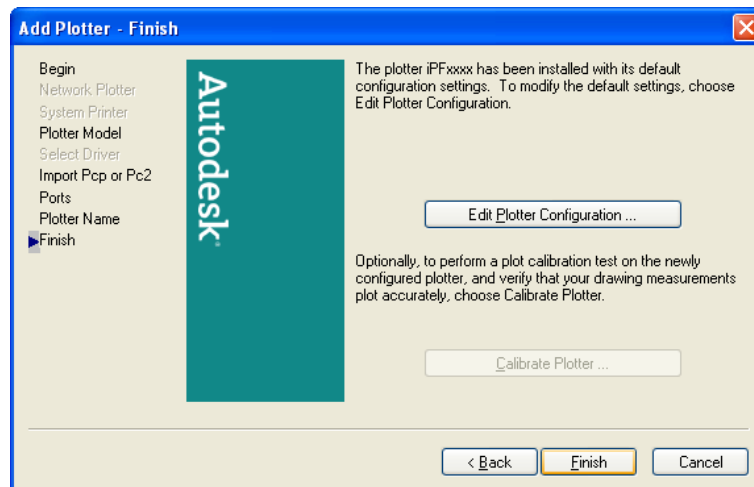

- 12.** Remove the User Software CD-ROM from the CD-ROM drive.

## Opening the Plotter Configuration Dialog Box

You can open the **Plotter Configuration Editor** dialog box by two ways.

- Opening from the AutoCAD File Menu →P.372
- Opening from the Start Menu →P.373

## Opening from the AutoCAD File Menu

Follow the procedure below to open the **Plotter Configuration Editor** dialog box from the AutoCAD **File** menu.

1. Select **Plot** from the AutoCAD **File** menu. The **Plot** dialog box opens.  
Check the **Name** setting under **Printer/plotter** and confirm that **iPFxxxx.pc3** (the name of the printer you use) is displayed.  
Click the **Properties** button.

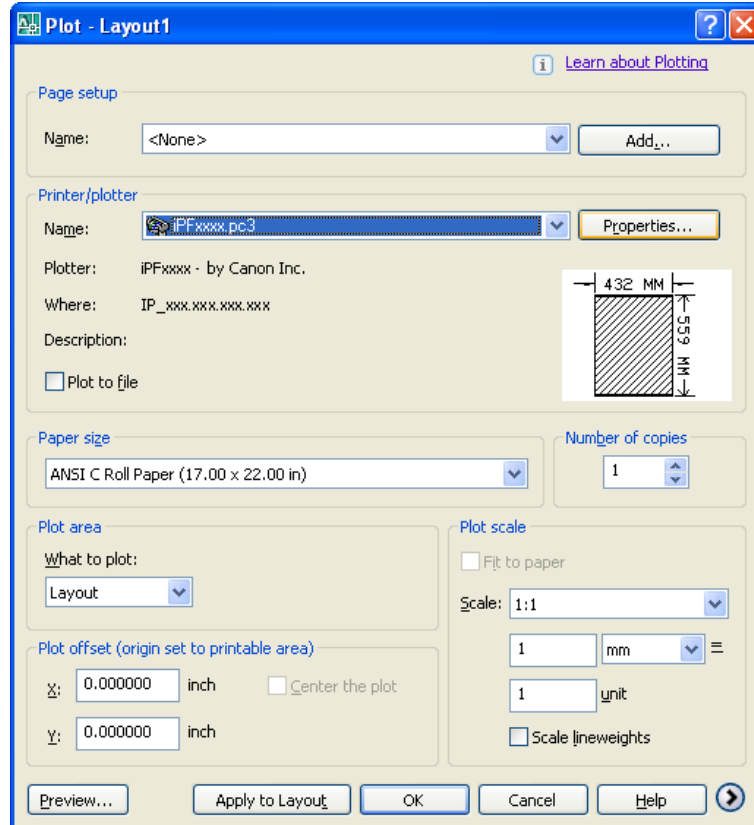

### Note

- If any other printer name is selected, select the name of the printer that you want to use from the **Name** list.
- The names of the printers installed when the HDI driver was installed are in the **Name** list.

2. The **Plotter Configuration Editor** dialog box opens.

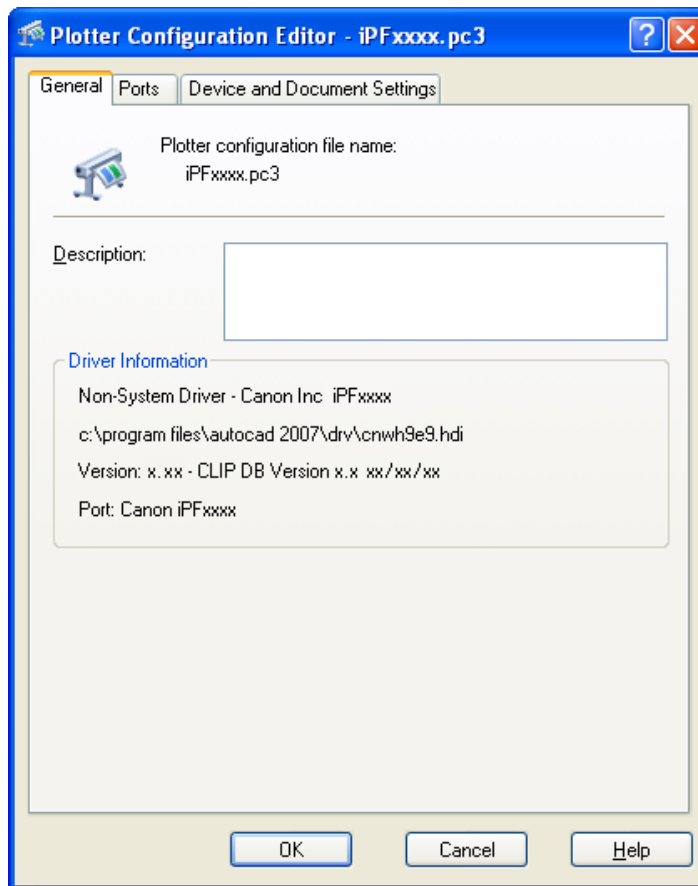

## Opening from the Start Menu

Follow the procedure below to open the **Plotter Configuration Editor** dialog box from the **Start** menu.

1. Click the **Start** button then select **Control Panel**.  
The **Control Panel** window opens.

2. Double-click the **Autodesk Plotter Manager** icon.  
The **Plotters** window opens.  
Double-click the **iPFxxxx.pc3** icon (the icon name is the name of the printer you use) to open.

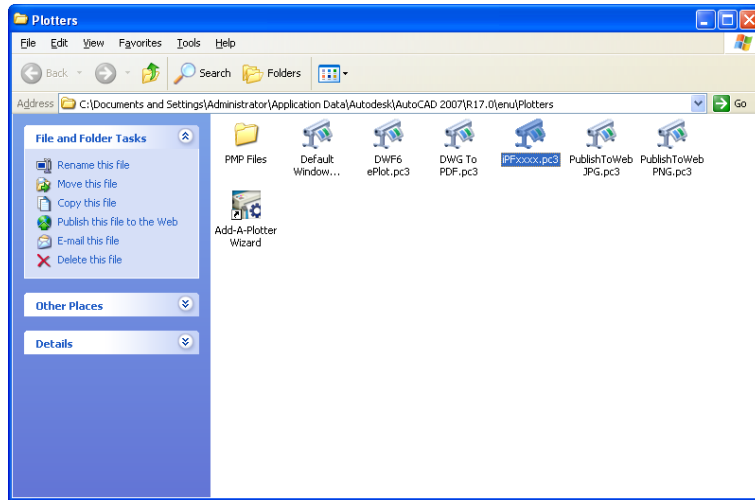

3. The **Plotter Configuration Editor** dialog box opens.

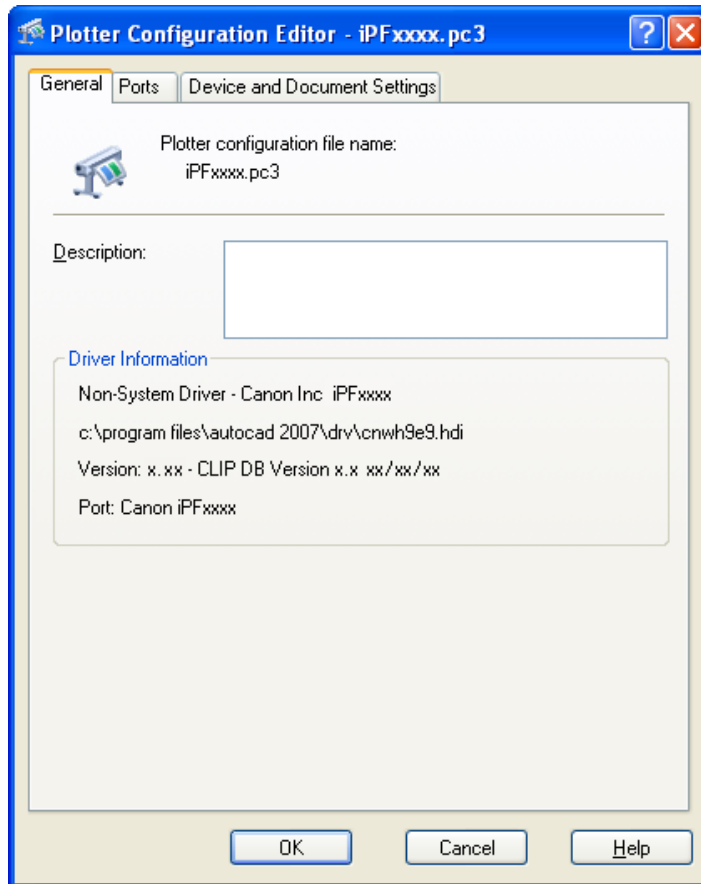

3

374

## Plotter Configuration Editor Dialog Box

The **Plotter Configuration Editor** dialog box has three sheets.

The **Plotter Configuration Editor** dialog box display can be manipulated by selecting the items on these sheets or in the Explorer tree.



### Note

- For more details about the **General** sheet and the **Ports** sheet, please refer to the AutoCAD manual.

## Device and Document Settings Sheet

Use this sheet to perform the main printing settings. The settings for each item are shown in a tree structure on this sheet. When you select an item the screen display changes so you make changes for the resolution and other graphic settings, the media type, the color matching and **Custom Properties** settings, the drying time and the roll paper margin for safety and other detailed media settings.

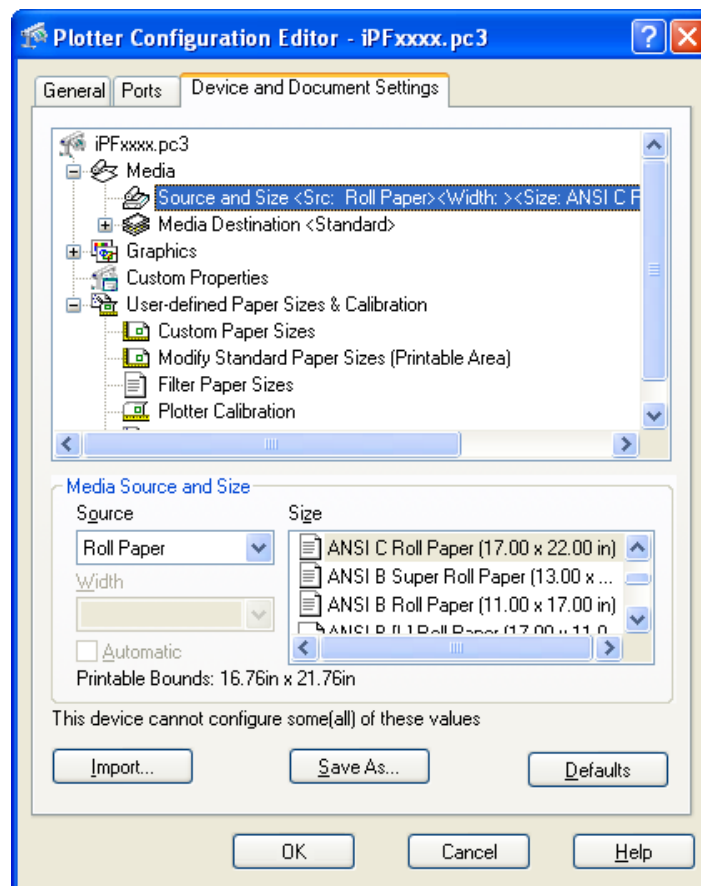

The available settings are as follows.

- Media Source and Media Size Settings →P.376
- Graphics Settings →P.377
- Custom Properties dialog box →P.382

## Media Source and Media Size Settings

Follow this procedure to select the media source and the media size.

1. Press the **Source and Size** below **Media**.  
The **Device and Document Settings** sheet opens and switches to the display that presents the media source and size settings.

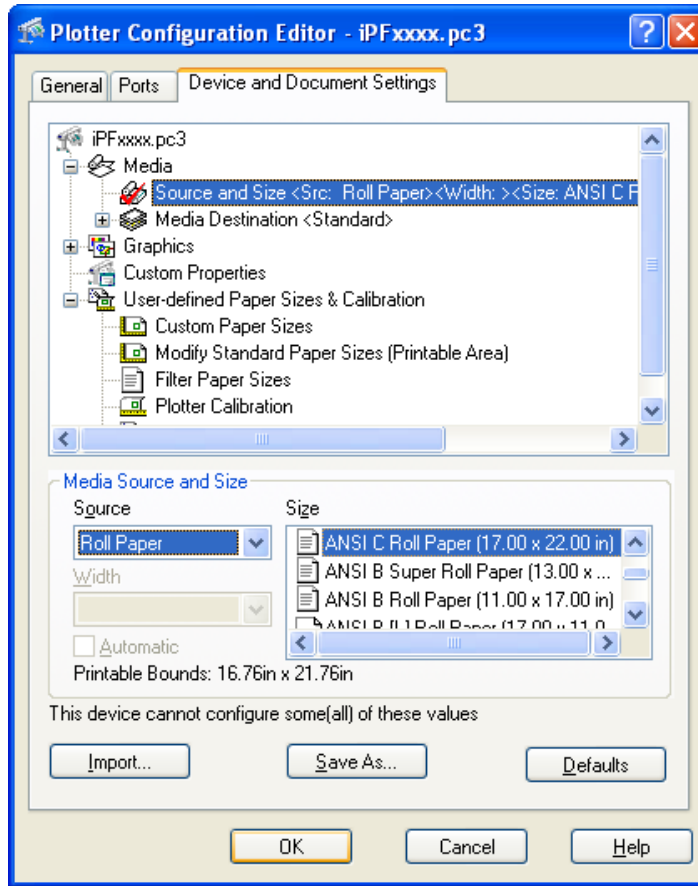

2. From the **Source** list, select the media source.

3. From the **Size** list, select the media size.



### Note

- When you change the **Source** setting, the **Size** setting returns automatically to its default settings. Every time you adjust the **Source** setting, you should also re-adjust the **Size** setting.

4. Click the **OK** button.

## Graphics Settings

You can perform the graphics settings.

### Vector Graphics settings

Use these settings to adjust the print mode and resolution.

1. Click the **Vector Graphics** below **Graphics**.  
The **Device and Document Settings** sheet opens and switches to the Vector Graphics settings.

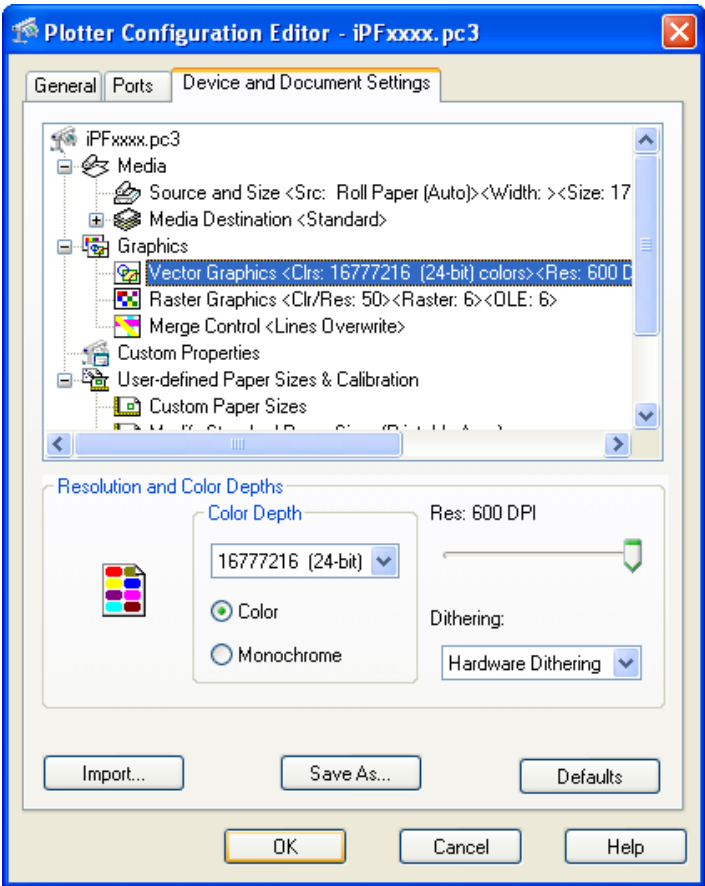

3

2. Select **Color** or **Monochrome**.

3. Select a setting for **Color Depth** from the list.  
**Color Depth** presents the following items for selection.

377

Setting	Details
<b>Color</b>	16777216(24-bit) colors
<b>Monochrome</b>	16777216-Level grayscale

4. Move the **Res** slider to adjust the settings.  
**Res** presents the following items for selection.

Setting	Details
<b>300 DPI</b>	Due to this low resolution, the image will print faster but its texture will appear rough.
<b>600 DPI</b>	This high resolution will achieve the best results.

5. Select **Dithering**.

Setting	Details
<b>Hardware Dithering</b>	Perform dithering on the printer.

6. Click the **OK** button.

### Raster Graphics settings

Use these settings to adjust the balance between the print quality, memory consumption, and the print speed of raster graphics.

1. Click the **Raster Graphics** below **Graphics**.  
 The **Device and Document Settings** sheet opens and switches to the Raster Graphic settings.

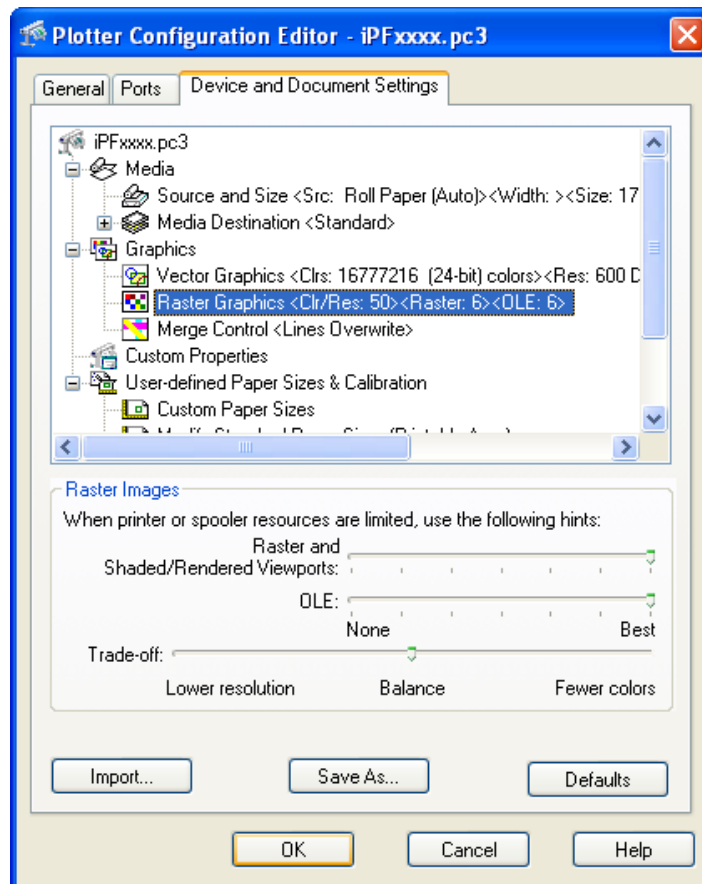



2. Move the slider for each item to the left or right to adjust the settings.

Setting	Details
<b>Raster and Shaded/Rendered Viewports</b>	Use these settings to adjust the balance between print quality, memory consumption, and the print speed. If set to <b>None</b> , you cannot print raster images. Printing time will take longer the higher you set the <b>Best</b> setting.
<b>OLE</b>	Use these settings to adjust the balance between print quality, memory consumption and the print speed when printing a OLE object. If set to <b>None</b> , you cannot print OLE objects. Printing time will take longer the higher you set the <b>Best</b> setting.
<b>Trade-off</b>	Use these settings to lower the print quality by a certain degree if the print job cannot be completed at the best quality.

3. Click the **OK** button.

### Merge Control Settings

Use these settings to merge intersecting lines.

1. Click the **Merge Control** below **Graphics**.  
The **Device and Document Settings** sheet opens and switches to the Merge Control settings.

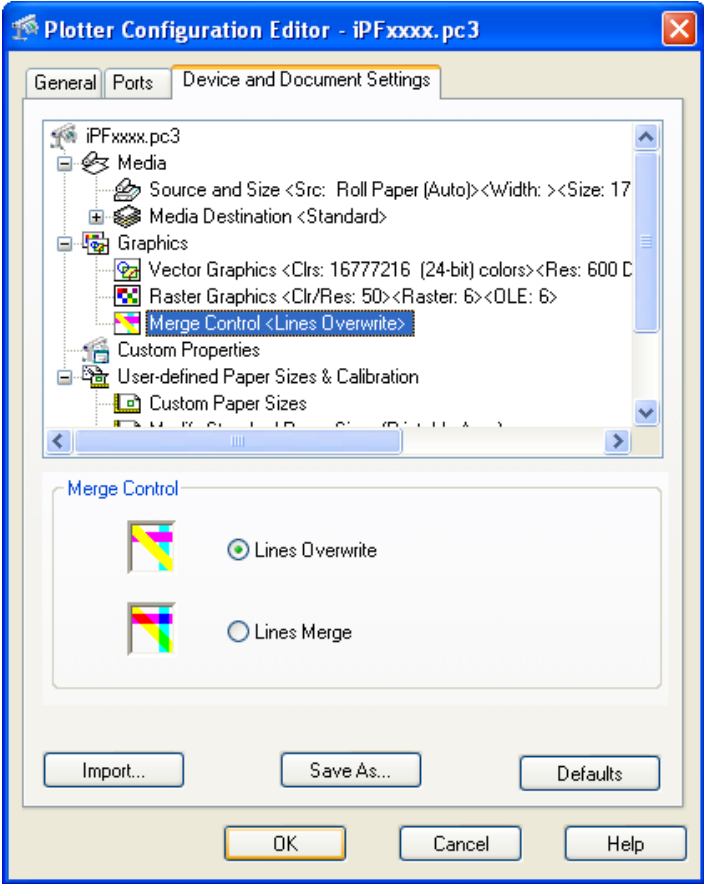

Setting	Details
<b>Lines Overwrite</b>	Where the lines intersect, the line that is printed last is visible, but the lines below it are not visible.

Setting	Details
<b>Lines Merge</b>	Where the lines intersect, the line colors merge.

- Click the **OK** button.

## Opening the Custom Properties Dialog Box

Follow the procedure below to open the **Custom Properties** dialog box.

- In the **Plotter Configuration Editor** dialog box, select and open the **Device and Document Settings** sheet.



### Note

- For more details about how to open the **Plotter Configuration Editor** dialog box, see "Opening the Plotter Configuration Dialog Box." →P.371 .

- Click **Custom Properties**.

- The **Device and Document Settings** sheet opens and switches to the display that presents the custom properties settings.  
Click the **Custom Properties** button.

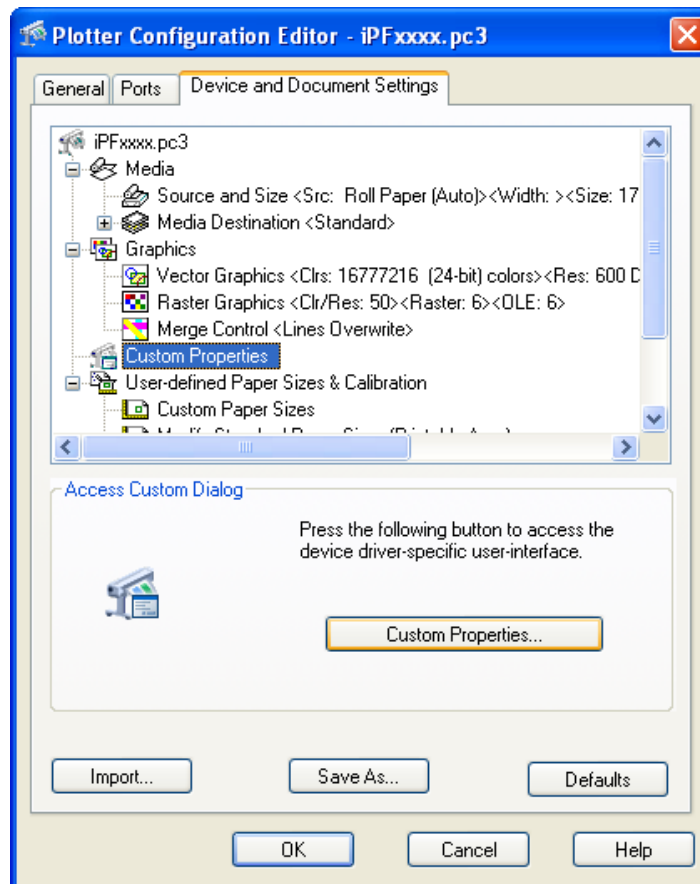

4. The Custom Properties dialog box opens.

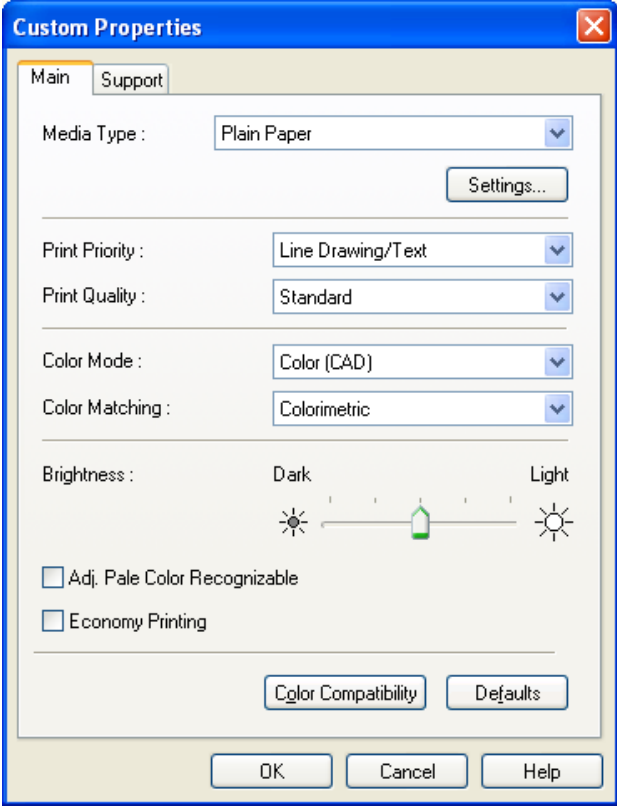

## Custom Properties dialog box

You can perform the settings for the media type, color matching, brightness, and other settings.

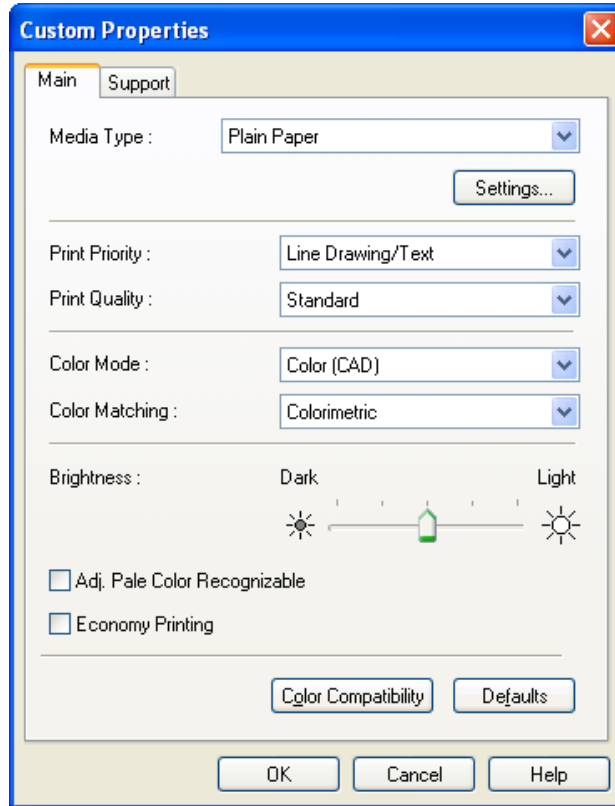

### • Media Type

This allows you to select the media type.



#### Note

- Always select media type that is actually set in the printer. When the media you chose is different from the media set in the printer, you may not receive the desired print results.

### • Print Priority

Select a print quality to suit the print job.

Setting	Details
<b>Image</b>	This mode achieves the best results for printing photographic images and illustrations.
<b>Line Drawing</b>	This mode is best for printing CAD drawings with fine lines or wall newsheet or other documents that contain large amounts of text. However, you may not achieve the quality you expect with printing photographs or other images with many filled areas. For these types of jobs, select <b>Image</b> .



#### Note

- The number of settings available for selection depends on the media type.

### • Print Quality

Select a print quality to suit the print job.

Setting	Details
<b>Highest</b>	Gives priority to the highest possible image quality.
<b>High</b>	Prints images of high quality.
<b>Standard</b>	Balances quality with the need for faster printing.
<b>Draft</b>	Gives priority to high speed printing.



#### Note

- The availability of settings is determined by the media type and print priority selections.

### • Color Mode

You can select a color mode to suit the print job.

Setting	Details
<b>Color</b>	Enables color printing.
<b>Monochrome</b>	Disables color printing and converts image from continuous color to grayscaled monochrome.
<b>Color (CAD)</b>	Prints lines in the best color possible so they are easy to see.
<b>Monochrome (BK ink)</b>	Select to print all lines with black ink.



#### Note

- The availability of settings depends on the print priority and media type selections.

### • Color Matching

You can select a color matching to suit the print job.

Setting	Details
<b>Perceptual</b>	This item does color matching with priority on color tones to reproduce the best results in printing photographic images.
<b>Colorimetric</b>	This item places priority on reducing the differences between the color tones you seen on the computer screen and those you see in the printout, so the printout more closely resemble the colors of the original.
<b>Saturation</b>	This item does color matching with priority on saturation.
<b>None</b>	Color matching is not performed.



#### Note

- **Color Matching** is available for selection only when **Color** is selected for **Color Mode**.

### • Brightness

Adjust Brightness to achieve the best level of brightness in printed line drawings.

Drag slide bar left and right to adjust the level of brightness.

- **Adj. Pale Color Recognizable**

When you place a checkmark here, yellow or cyan lines or other portions of images that are difficult to see when printed in white space can become easier to see.

- **Economy Printing**

You can reduce the amount of ink consumed for printing by placing a checkmark here.

- **Color Compatibility** button

Click the button to open the **Color Compatibility** dialog box, and you can set color for when **Color (CAD)** is selected in **Color Mode**.

For more information on setting color compatibility, see "Color Compatibility Dialog Box." →P.386

## Paper Detailed Settings

3

To open the **Paper Detailed Settings** dialog box, click **Settings** button of the **Media Type** in the **Custom Properties** dialog box. You can perform the settings for ink drying time of each media and other features.

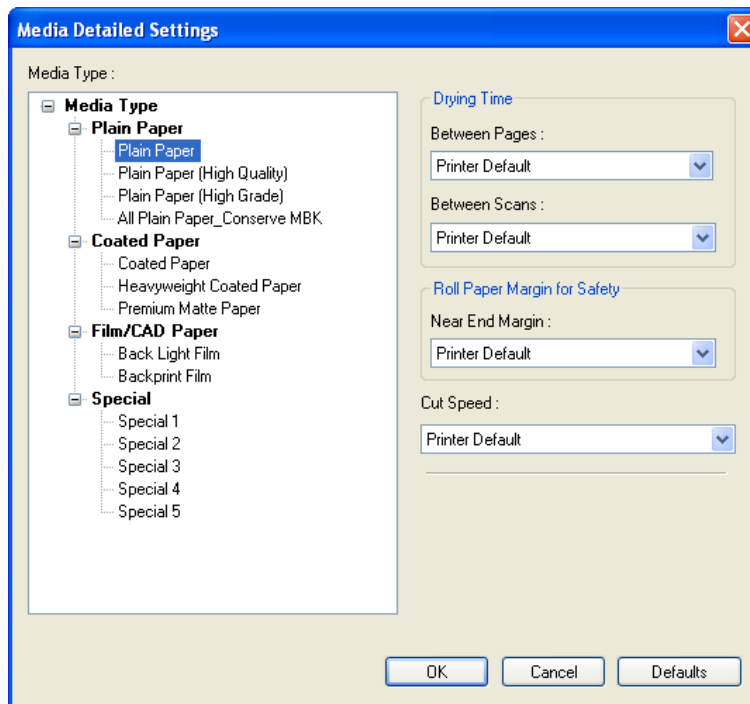

**Note**

- The settings in the **Paper Detailed Settings** dialog box are temporary; after the print job finishes the settings of the printer operation panel are restored.

- **Drying Time**

**Between Pages**

This sets the wait time for the ink to dry between each completely printed sheet and the output of the sheet.

Setting	Details
<b>Printer Default</b>	The settings of the printer operating panel are applied.
<b>None</b>	The paper is ejected immediately after printing.

Setting	Details
<b>30sec. / 1min. / 3min. / 5min. / 10min. / 30min. / 60min.</b>	The sheet is ejected when the specified time after printing has elapsed.

### Between Scans

This sets the wait time between line scans during printing.

Setting	Details
<b>Printer Default</b>	The settings of the printer operating panel are applied.
<b>None</b>	The printing continues to the next line immediately after the last line.
<b>1sec. / 3sec. / 5sec. / 7sec. / 9sec.</b>	The printing continues to the next line after the set time.  *For the media type that has problems, such as ink smears on the page or colors that seem uneven during borderless printing etc., increase the value for this setting.

### • Roll Paper Margin for Safety

#### Near End Margin

This sets the length of the near end margin of the roll paper.

Setting	Details
<b>Printer Default</b>	The settings of the printer operating panel are applied.
<b>3mm</b>	Print at a standard size.  *Select for Media Type that has no problem when printing with a standard size margin.
<b>20mm</b>	This setting sets the margin about 17 mm (in the feed direction) longer than the standard margin for the media size.  *This is for Media Type that has a strong tendency to curl, causing the printhead to scratch the surface.



#### Important

- If you make the margin (white space) too small, this could disturb the print image or cause the printhead to scour the surface of some types of media. If the printhead scours the surface of the media, adjust the height of the printhead.

### • Cut Speed

This selects the auto cut speed.

Setting	Details
<b>Printer Default</b>	The settings of the printer operating panel are applied.
<b>Fast</b>	Select this setting if cutting with the <b>Standard</b> setting is not clean.
<b>Standard</b>	Select this setting when you are not experiencing problems.
<b>Slow</b>	Select this setting if cutting with the <b>Standard</b> setting is not clean.

## Color Compatibility Dialog Box

**Color Compatibility** dialog box appears when you click the **Color Compatibility** button on the **Main** sheet in the **Custom Properties** dialog box. You can set color for when **Color (CAD)** is selected in **Color Mode**.

You can print with color approximating the specified model by selecting **Color Compatibility** for printing.

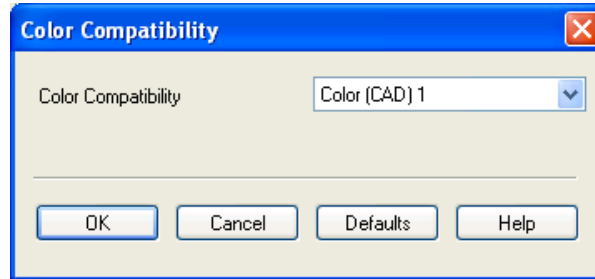

### Note

- **Color (CAD)** is displayed by selecting the **Main** sheet, and then **Line Drawing/Text** in **Print Priority**.



### Important

- The color and quality of the specified model cannot be perfectly matched.

### • Color Compatibility

Color settings and compatible models are listed below.

Color settings	Compatible models
<b>Color (CAD) 1</b>	Print with standard color.
<b>Color (CAD) 2</b>	Print with a light-shade color.
<b>Color (CAD) 3</b>	Print with approximate colors emulating Canon iPF500/iPF600/iPF700/iPF510/iPF610/iPF710/iPF605/iPF720/iPF810/iPF820.
<b>Color (CAD) 4</b>	Print with approximate colors emulating HP Designjet 500/800.
<b>Color (CAD) 5</b>	Print with approximate colors emulating HP Designjet 1000.

## Printing

This section describes how to execute a print job with the HDI driver.



### Note

- The description below uses printing with the AutoCAD 2007 as an example.

1. Start AutoCAD and open the image file.



2. Select **Plot** from the **File** menu. The **Plot** dialog box opens. Check the **Name** setting under **Printer/plotter** and confirm that **iPFxxxx.pc3** (the name of the printer you use) is displayed. Click the **Properties** button.

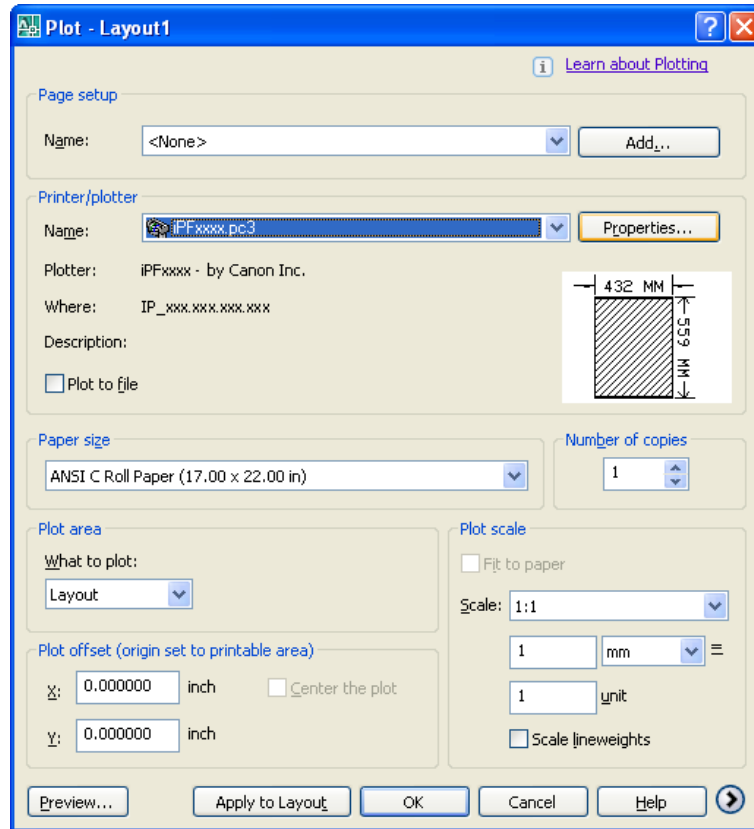

#### Note

- If any other printer name is selected, select the name of the printer that you want to use from the **Name** list.
- The names of the printers installed when the HDI driver was installed are in the **Name** list.

3. The **Plotter Configuration Editor** dialog box opens. Perform the settings that you need for the print job. Click the **OK** button to close the **Plotter Configuration Editor** dialog box.

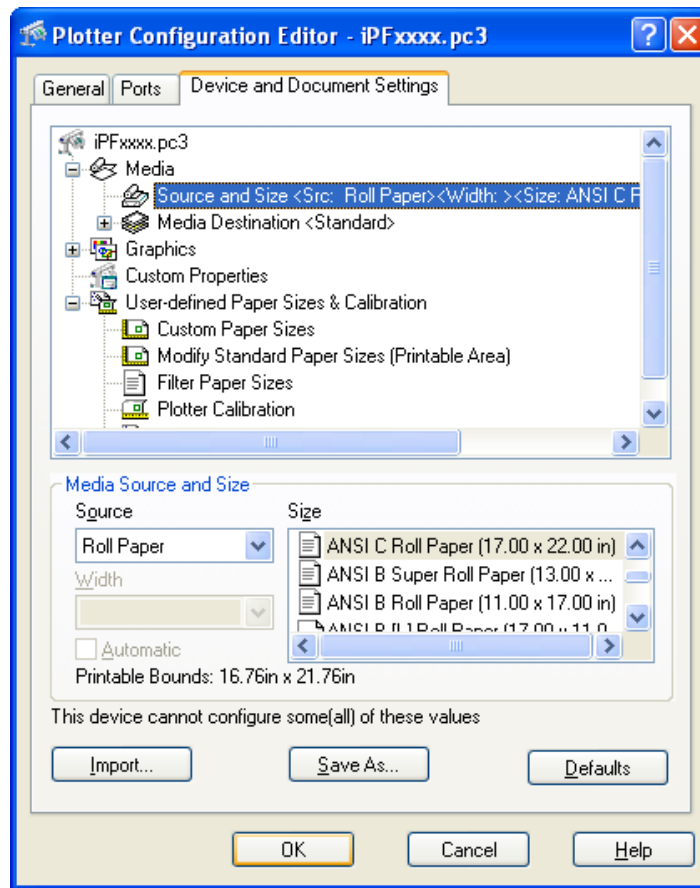
**Note**

- For more details about how to perform the settings in the **Plotter Configuration Editor** dialog box, see "Plotter Configuration Editor Dialog Box." →P.375

4. The **Plot** dialog box opens.  
Perform the settings that you need on the **Plot** dialog box, then click the **OK** button.

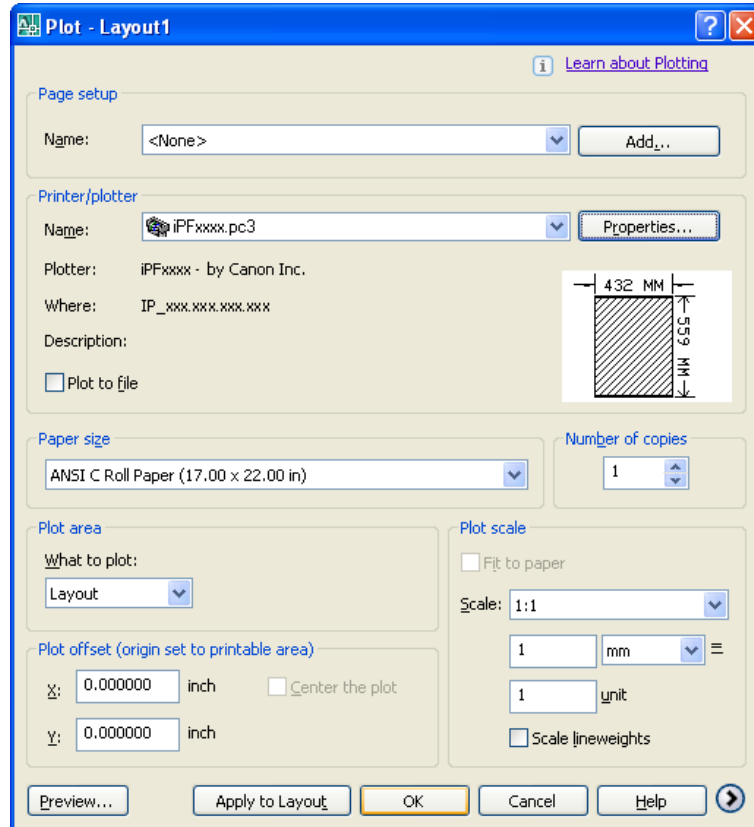
**Note**

- The content of the settings done in the **Plotter Configuration Editor** dialog box are reflected in the **Paper size** settings on the **Plot** dialog box.
- For more details about the **Plot** dialog box, please refer to the AutoCAD manual.

5. The print job begins.

**Note**

- If the output exceeds the number of pixels prescribed for the media, in order to prevent AutoCAD from hanging up during the print job a warning dialog box opens and asks if you want to lower the resolution or reduce the number of colors. If this occurs, click the **OK** button to cancel the print job and then lower the resolution or reduce the number of colors.
- Some media may not allow printing with certain resolution settings. If you have selected a resolution setting that cannot be used for printing, then a dialog box will open and prompt you to change the resolution. If this occurs, click the **OK** button to cancel the print job and then lower the resolution.
- A message from AutoCAD is displayed when printing starts. Press the **OK** button to execute the print job. This message display can be disabled with the **Options** setting in the AutoCAD **Tools** menu. For more details, please refer to the AutoCAD manual.

## Status Monitor

The Features of imagePROGRAF Status Monitor ..... 390  
 Job Management Using imagePROGRAF Status Monitor ..... 391

### The Features of imagePROGRAF Status Monitor

imagePROGRAF Status Monitor is a utility for checking the printer status and managing print jobs. Two screens are available in imagePROGRAF Status Monitor : **Printer List** shows a list of printers, and **Status Monitor** shows details for each printer.

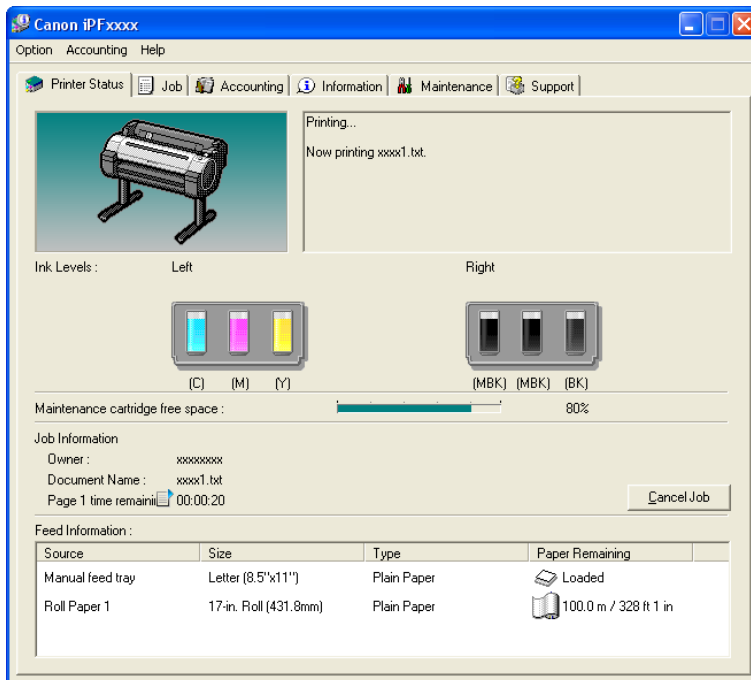
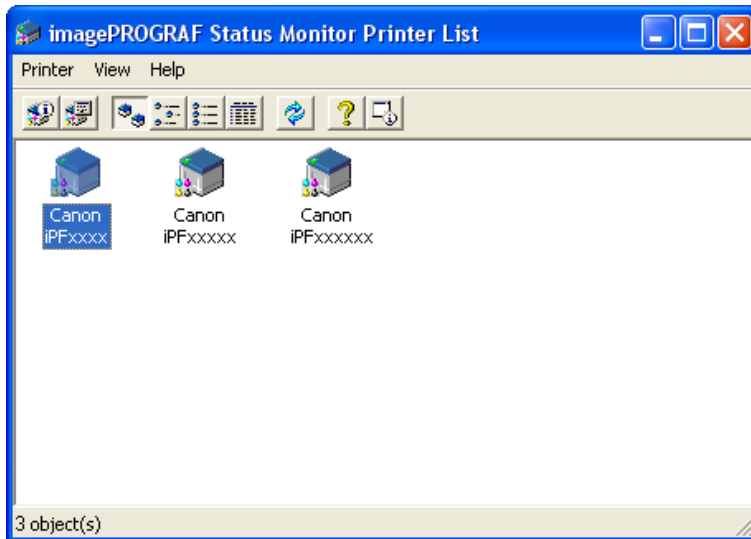

- You can view a list of the printers for which printer drivers have been installed on your computer, printers connected to your computer, and printers found on the network.

- If a printer error occurs, you can investigate the corrective action immediately.
- Printer status can be checked in real time on a computer monitor.
- Displays the ink level of every color in the printer. An icon and warning message will notify you when ink levels are low.
- The type of paper loaded in each media source is identified. You can also check to see if paper has run out.
- This way, the utility enables you to check printer information and take care of printer maintenance for optimal printing results.
- You can also set up automatic email notification of any printer problems or errors to email addresses you designate in advance.
- You can use the Accounting Manager to collect the print job logs for the printers and check information such as the printing costs.  
For details of the Accounting Manager, see Accounting Manager →P.393 .

**Note**

- For details, refer to the imagePROGRAF Status Monitor help.

## Job Management Using imagePROGRAF Status Monitor

You can use the **Job** sheet in imagePROGRAF Status Monitor for operations such as pausing and canceling print jobs.

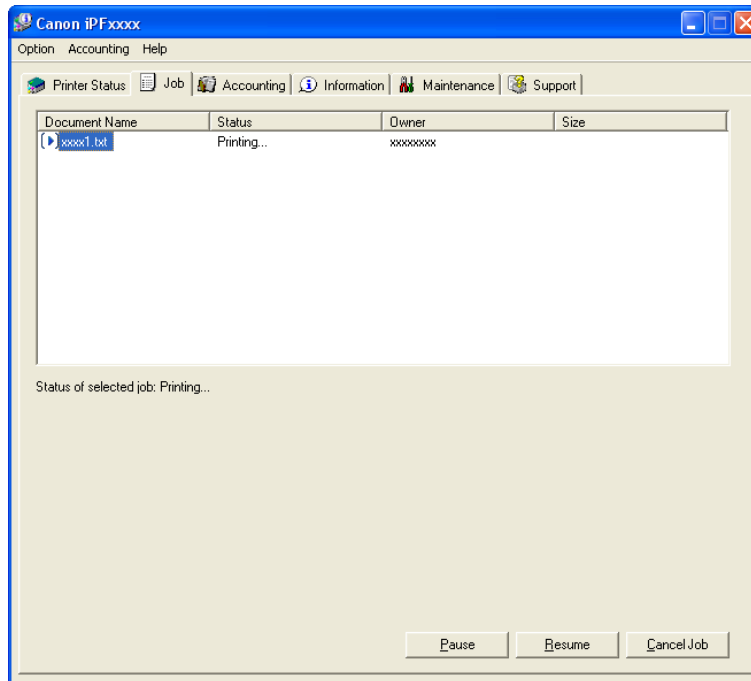

### • Pausing/Resuming Print Jobs

Selecting a print job and clicking the **Pause** button pauses printing of the selected job.

To resume printing of a paused print job, select the print job and click the **Resume** button.

**Note**

- Once all the print data for a print job has been sent to the printer, the job can no longer be paused/resumed.

- **Canceling Print Jobs**

Selecting a print job and clicking the **Cancel Job** button cancels printing of the selected job.



**Note**

- You cannot cancel other users' print jobs.

## Accounting

Accounting Manager .....	393
Launching the Accounting Manager .....	394
Accounting Manager Main Window .....	394
Job List Area .....	397
Accounting Manager Basic Procedures .....	397
Configuring Unit Costs in Accounting Manager .....	398
Setting the Unit Cost for Ink .....	399
Setting the Unit Cost for Paper .....	400
Setting the Unit Cost for Items Other Than Ink and Paper .....	401
Configuring Units and Display Settings in Accounting Manager .....	402
Automatically Acquiring Print Job Logs at Regular Intervals .....	403
Canceling Regular Print Job Log Acquisition .....	403
Switching Between Displaying Jobs on Printer and Regularly Acquired Jobs .....	404
Exporting Print Job Data as a CSV File .....	404
Showing Job Properties .....	405
Showing, Saving and Loading Selected Unit Cost Data .....	405
Showing the Total Amount of Ink and Paper Consumed .....	405

## Accounting Manager

The Accounting Manager stores the printer's print job logs so that you can use the information for checking printing costs, etc.

The benefits of using the Accounting Manager are outlined below.

- **Print Job Log Collection**  
This allows you to check which documents were printed from each printer, who printed them and when.
- **Calculation of the Total Pages Used and the Total Cost**  
This allows you to use the collected print job logs to calculate totals for items such as the number of pages printed, the amount of paper used and the printing costs incurred.
- **Regular Data Acquisition for Print Jobs**  
Job logs can be automatically collected periodically.
- **Exporting Print Job Data**  
This allows you to export collected print job data as a CSV file.



### Important

- The Accounting Manager in Status Monitor displays approximate estimates of the amount of paper consumed and the ink consumed per job. Canon cannot guarantee the accuracy of these estimates. These estimates will also vary depending on the conditions of printer use.
- Print job log collection is not performed when **Set./Adj. Menu -> Printer Info -> Show Job Log** of the control panel is **Off**. However,
  - even if **Show Job Log** is set to **Off**, regularly acquired jobs that already have been retrieved at that time are displayed.
  - When **Show Job Log** has been set to **On** again, all jobs within the printer at that time are displayed.

## Launching the Accounting Manager

The procedure for launching the Accounting Manager is shown below.

1. Open the imagePROGRAF Status Monitor window.
2. Select **Accounting** in the **Accounting** menu.  
Or, open the **Accounting** sheet and click the **Accounting** button.

3

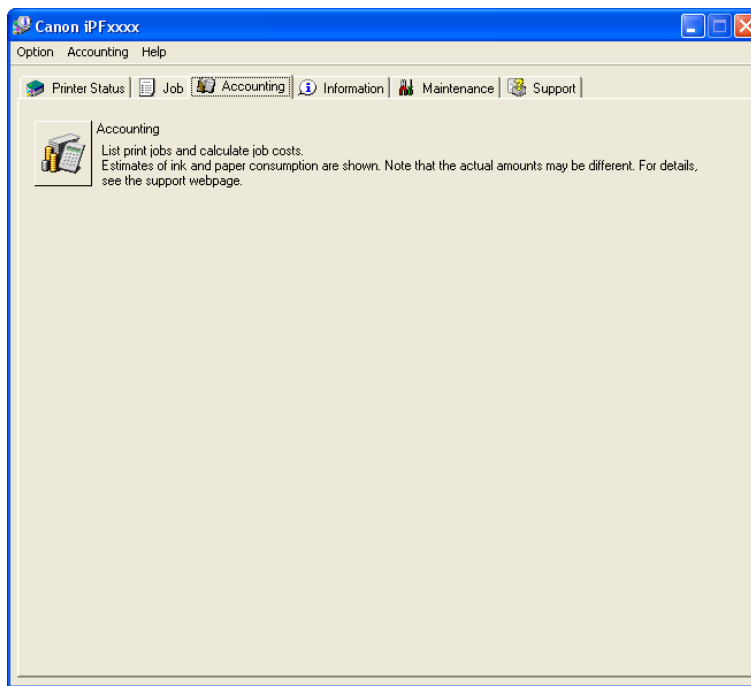

## Accounting Manager Main Window

The Accounting Manager main window consists of a title bar, menu bar, toolbars, listed job selection area, job list area, totals area and status bar.

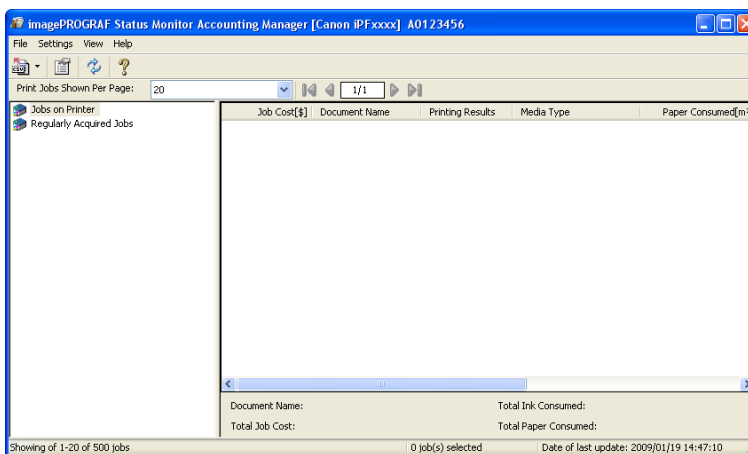

394



- **Title Bar**

This displays the printer model, its serial number and the port number it is using.

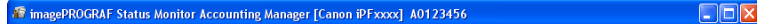

- **Menu Bar**

Allows you to select the menu options required for operation.



- **Toolbars**

Provide tool buttons and pull-down menus for the main operations.



**Note**

- You can opt to either show or hide the toolbars in the **View** menu.

- **Listed Job Selection Area**

You can use this area to select which job log is displayed.

If you are using regular data acquisition, this area allows you to view the collective job logs for each specified period.

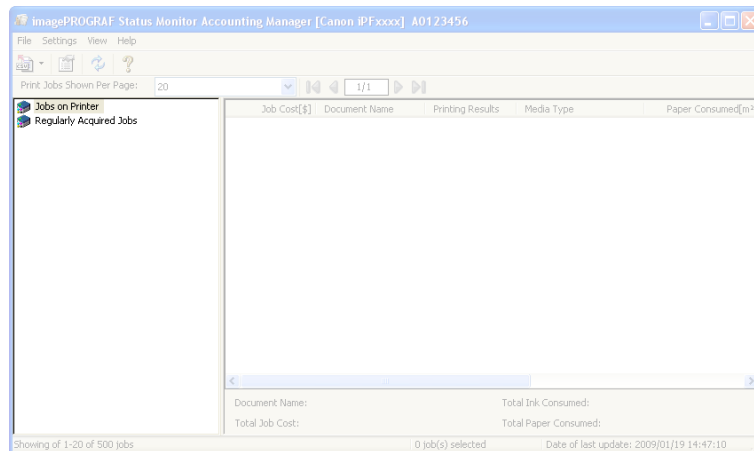

For more information on how to select the job logs displayed, see [Switching Between Displaying Jobs on Printer and Regularly Acquired Jobs](#) → **P.404** .

- **Job List Area**

This area lists the details of acquired jobs.

Display a list of jobs within the printer or of jobs collected periodically. For details, refer to Job List Area →P.397 .

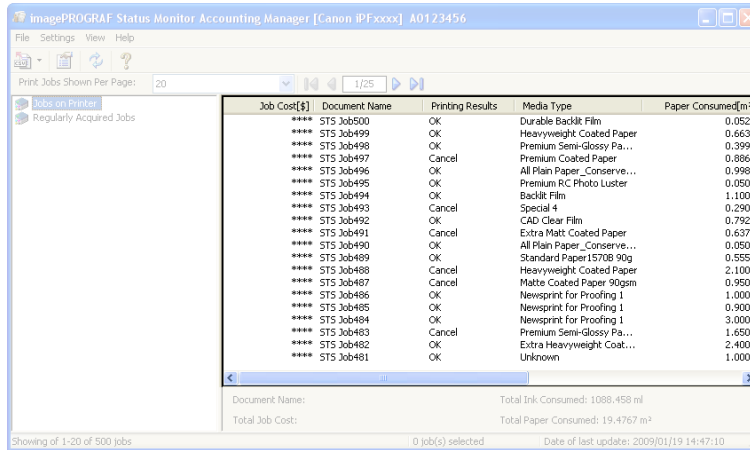

• Totals Area

Displays the total costs for the selected job and the amounts of paper and ink consumed.

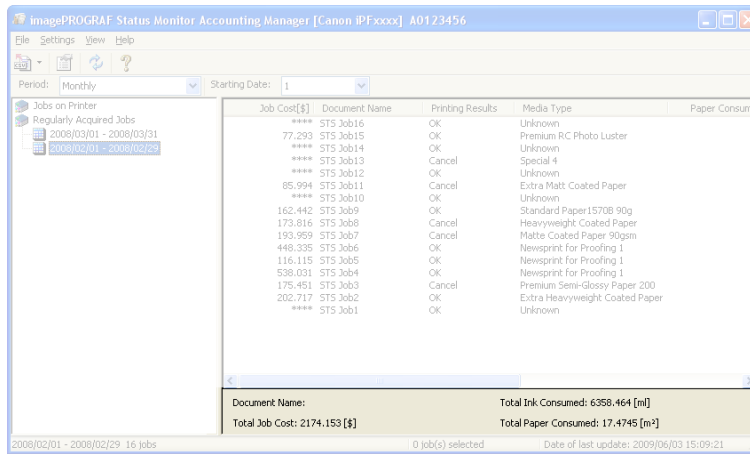

Note

- If you are viewing regularly acquired print jobs, selecting a period on the left side of the window displays the total costs for that period and the amounts of paper and ink consumed.

- **Status Bar**

Displays messages and other information.

Job Cost[\$]	Document Name	Printing Results	Media Type	Paper Consumed[m <sup>2</sup> ]
****	STS Job500	OK	Durable Backlit Film	0.0525
****	STS Job499	OK	Heavyweight Coated Paper	0.6636
****	STS Job498	OK	Premium Semi-Glossy Pa...	0.3997
****	STS Job497	Cancel	Premium Coated Paper	0.8684
****	STS Job496	OK	All Plain Paper_Conserve...	0.9987
****	STS Job495	OK	Premium RC Photo Luster	0.0500
****	STS Job494	OK	Backlit Film	1.1000
****	STS Job493	Cancel	Special 4	0.2900
****	STS Job492	OK	CAD Clear Film	0.7925
****	STS Job491	Cancel	Extra Matt Coated Paper	0.6378
****	STS Job490	OK	All Plain Paper_Conserve...	0.0500
****	STS Job489	OK	Standard Paper 15708 90g	0.5555
****	STS Job488	Cancel	Heavyweight Coated Paper	2.1000
****	STS Job487	Cancel	Matte Coated Paper 90gsm	0.9500
****	STS Job486	OK	Newsprint for Proofing 1	1.0000
****	STS Job485	OK	Newsprint for Proofing 1	0.9000
****	STS Job484	OK	Newsprint for Proofing 1	3.0000
****	STS Job483	Cancel	Premium Semi-Glossy Pa...	1.6500
****	STS Job482	OK	Extra Heavyweight Coat...	2.4000
****	STS Job481	OK	Unknown	1.0000

Document Name: Total Ink Consumed: 1088.458 ml  
Total Job Cost: Total Paper Consumed: 19.4767 m<sup>2</sup>

Showing of 1-20 of 500 jobs 0 job(s) selected Date of last update: 2009/01/19 14:47:10

3

## Job List Area

The content and items of the jobs displayed in the job list area are as follows.

- **Job Cost**

This is the cost incurred in printing.



Note

- If the Unit Cost of Ink or Paper have not been set, \*\*\*\* is displayed in the Job Cost field.

- **Document Name**

This is the name of the printed document.

- **Printing Results**

Displays **OK** when printing is executed, and **Cancel** when it is not executed

- **Media Type**

This is the type of paper used in printing.

- **Paper Consumed**

This is the area of paper used in printing.

## Accounting Manager Basic Procedures

397

The first time you use the Accounting Manager, use the following procedures to configure the settings.

1. Configure unit costs, including the costs of ink and paper.  
For details of the unit cost settings, see [Configuring Unit Costs in Accounting Manager](#) →P.398 .
2. Set options such as the units displayed.  
For details of the unit settings, see [Configuring Units and Display Settings in Accounting Manager](#) →P.402 .

3. If you are using Regular Data Acquisition, configure the Regular Data Acquisition settings. For details of the Regular Data Acquisition settings, see [Automatically Acquiring Print Job Logs at Regular Intervals](#) →P.403 .
4. Specify the jobs to be listed. For details of how to select the job logs displayed, see [Switching Between Displaying Jobs on Printer and Regularly Acquired Jobs](#) →P.404 .

This displays the required print job logs and lists the details.

## Configuring Unit Costs in Accounting Manager

Select **Unit Costs** in the **Settings** menu to open the **Unit Costs** dialog box. Configure the unit cost settings in this dialog box.



### Note

- When you select a job and then open the **Unit Costs** dialog box, items with unit costs that have not yet been configured for that job are shown highlighted.
- Setting the Unit Cost for Ink →P.399
- Setting the Unit Cost for Paper →P.400
- Setting the Unit Cost for Items Other Than Ink and Paper →P.401

## Setting the Unit Cost for Ink

Open the **Ink** sheet. Set the unit cost for ink in this sheet.

Ink Color	Tank Capacity[ml]	Price[\$]
C (Cyan)	130	Not Specified
M (Magenta)	130	Not Specified
Y (Yellow)	130	Not Specified
MBK (Matte Black)	130	Not Specified
MBK (Matte Black)	130	Not Specified
BK (Black)	130	Not Specified

3

To set the same unit cost for all the inks

1. Select the **Use same price for all ink** checkbox.
2. Enter the **Tank Capacity** and corresponding **Price**.
3. Click the **OK** button.



### Important

- Your settings are not applied until you click the **OK** button.

399

To set different unit costs for each ink color

1. Select the ink color to be costed.

2. Enter the **Tank Capacity** and corresponding **Price**.
3. Click the **Overwrite** button.
4. Repeat steps 1 to 3 for all the inks.
5. Click the **OK** button.

**Important**

- Your settings are not applied until you click the **OK** button.

## 3

## Setting the Unit Cost for Paper

Open the **Paper** sheet. Set the unit cost for paper in this sheet.

**Unit Costs**

Ink **Paper** Other

Price List:

Media Type	Width[m]	Length[m]	Price[\$]

Delete

**Paper Unit Cost Settings**

Media Type: Plain Paper

Width:  m

Length:  m

Price:  \$

Add Overwrite

OK Cancel Help

1. Select a media type from the **Media Type** list.

2. Enter the **Width** and **Length** of the paper, and the **Price** per area for the configured width x height.
3. Click the **Add** button. To change the unit cost for a media type you have already set, click the **Overwrite** button.
4. Click the **OK** button.

**Important**

- Your settings are not applied until you click the **OK** button.

## Setting the Unit Cost for Items Other Than Ink and Paper

Open the **Other** sheet. Use this sheet to set any price for items other than inks and paper.

The screenshot shows the 'Unit Costs' dialog box with the 'Other' tab selected. The 'Price List' table is empty. The 'Unit Costs' section at the bottom has the following fields:

- Name:
- Unit Cost:  \$
- Allocated:  ▼

Buttons: Add, Overwrite, OK, Cancel, Help, Delete.

1. Enter any name in the **Name** field.
2. Enter a value in **Unit Cost**.

3. Use **Allocated** to specify whether the costs are allocated as being incurred by the print job.
4. Click the **Add** button. To change the unit cost for a media type you have already set, click the **Overwrite** button.
5. Click the **OK** button.

**Important**

- Your settings are not applied until you click the **OK** button.

**Note**

- You can set unit costs for up to 5 items.

3

## Configuring Units and Display Settings in Accounting Manager

Select **Units and Display** in the **Settings** menu to open the **Units and Display** dialog box. Use this dialog box to configure the display settings.

The screenshot shows the 'Units and Display' dialog box with the following settings:

- Date Display Format: YYYY/MM/DD
- Currency Unit: \$ (Three characters or less)
- 1000 Separator: None
- Decimal Symbol: . (Period)
- Ink level: ml
- Paper Width: m
- Paper Length: m
- Area Display Format: m<sup>2</sup>

Buttons: OK, Cancel, Help

- **Date Display Format**

Use this option to select the display format for dates. "YYYY" indicates the year, "MM" the month and "DD" the day.

- **Currency Unit**

Enter the currency unit. Enter a text string up to 3 characters long.

- **1000 Separator**

Use this option to select the symbol used as a separator in numbers. The symbol is inserted every 3 digits.

- **Decimal Symbol**

Use this option to select the symbol used as a decimal point.

402



- **Ink Consumed**

Use this option to select the unit used for ink consumption.

- **Paper Width**

Use this to select the unit used for paper width.

- **Paper Length**

Use this to select the unit used for paper length.

- **Area Display Format**

Use this to select the unit used for paper area.

## Automatically Acquiring Print Job Logs at Regular Intervals

This feature collects print job logs from the printer at regular intervals and saves the logs on your computer.

1. Select **Regular Data Acquisition** in the **Settings** menu.
2. Select **Acquire print job logs regularly**.
3. Click the **OK** button to close the dialog box.



### Important

- Print job log collection is not performed when **Set./Adj. Menu -> Printer Info -> Show Job Log** of the control panel is **Off**. However, even if **Show Job Log** is set to **Off**, regularly acquired jobs that already have been retrieved at that time are displayed.



### Note

- Immediately after you configure Regular Data Acquisition, no print jobs are displayed. Wait a few moments and then select **Refresh** in the **View** menu to display the print jobs.
- A maximum of 10,000 records are saved in a print job log. If this number is exceeded, jobs are deleted from the log starting from the oldest record. To save old data, it is recommended that you export the data as a CSV file.  
For details of how to export print job logs as CSV files, see [Exporting Print Job Data as a CSV File](#) →P.404 .

## Canceling Regular Print Job Log Acquisition

You can use this procedure to cancel the regular acquisition of print job logs from printers.

1. Select **Regular Data Acquisition** in the **Settings** menu.
2. Uncheck the **Acquire print job logs regularly** option.
3. Click the **OK** button to close the dialog box.

## Switching Between Displaying Jobs on Printer and Regularly Acquired Jobs

The print job logs displayed by the Status Monitor Accounting Manager contain two types of job: Jobs on Printer and Regularly Acquired Jobs.

You can select whether to display Jobs on Printer or Regularly Acquired Jobs in the Listed Job Selection Area on the left side of the window.

### • Jobs on Printer

This shows a list of the print jobs currently held on printers.

You can change the number of jobs displayed per page using the **Print Jobs Shown Per Page** setting in the **View** menu or the toolbar.

You can skip to a particular page using the **Go to** option in the **View** menu or the toolbar.



#### Note

- For printers with built-in hard disks, you can view up to 500 print jobs per printer.
- For printers without built-in hard disks, you can view up to 32 print jobs per printer. However, only 10 jobs can be displayed if the printer is switched off.

### • Regularly Acquired Jobs

This shows a list of regularly acquired print jobs.

To view all the jobs in a set period, specify the period using **Period** and then **Starting Date** (or **Starting Day of Week** or **Starting Month**) in the **View** menu or the toolbar.

For example, to view monthly job logs starting on the 1st of each month, set **Period** to **Monthly** and set **Starting Date** to **1**.



#### Note

- Up to 10,000 regularly acquired jobs are displayed for each printer.

## Exporting Print Job Data as a CSV File

You can export the collected print job data in the form of a CSV file by selecting **Export Job Cost Data** in the **File** menu.



#### Note

- You can also select **Export Job Cost Data** using the icon in the toolbar.

### • Selected Jobs

Exports the data for the selected print jobs in the job list as a CSV file.



#### Note

- You can select multiple jobs by holding down the Shift key or Ctrl key as you click the job names.

### • Listed Jobs

Exports the data for the print jobs currently displayed in the list as a CSV file.

## Showing Job Properties

If you select a job in the job list and then select **Show Job Properties** in the **File** menu, the **Job Properties** dialog box appears, allowing you to check information such as detailed cost data.

You can copy text-based information in this dialog box to the clipboard by clicking the **Copy** button.



### Note

- You can also open this dialog box by right-clicking the selected job and selecting **Show Job Properties**. Or you can also use the toolbar icon to open the dialog box.
- If you select multiple jobs and open the **Job Properties** dialog box, the total costs for the selected jobs are displayed.

## Showing, Saving and Loading Selected Unit Cost Data

### • Show Unit Cost Data

Select **Show Unit Cost Data** in the **File** menu to open the **Unit Cost Data** dialog box. This lists the unit costs for items such as the selected ink and paper.

You can copy text-based information in this dialog box to the clipboard by clicking the **Copy** button.

### • Save Unit Cost Data

Select a destination folder using **Save Unit Cost Data** in the **File** menu. The unit cost data for items such as the selected ink and paper is saved as a file.

### • Load Unit Cost Data

Selecting **Load Unit Cost Data** in the **File** menu loads saved unit cost data.

## Showing the Total Amount of Ink and Paper Consumed

Select **Show Ink and Paper Consumed** in the **File** menu to open the **Show Ink and Paper Consumed** dialog box.

This lists the total amounts of ink and paper consumed by the printer so far.

You can copy text-based information in this dialog box to the clipboard by clicking the **Copy** button.



### Note

- Up to 7 types of media are listed in order of the amount consumed. The total consumption for other media types is shown as **Other**.

## Digital Photo Front-Access

Digital Photo Front-Access ..... 406

### Digital Photo Front-Access

Digital Photo Front-Access is an application that links photos from Canon digital cameras and other image files on your computer with various other applications.

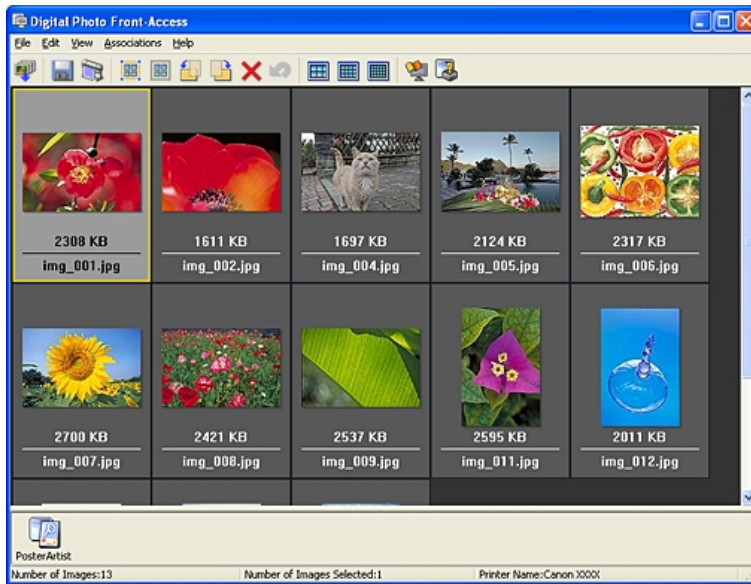

- Simply select an image and click the icon of the application you want to start to launch the application.
- You can also print from Digital Photo Front-Access. In short, Digital Photo Front-Access can help you manage images in many ways from editing to printing as an effective way to work with other applications.
- Digital Photo Front-Access also enables image retouching. For automatic retouching, select an image for retouching and click Image Adjustment.
- Because this application automates the workflow from retouching to display for all of your images, it can save time and work in retouching.



#### Note

- For details, refer to the Digital Photo Front-Access help.

## Device Setup Utility

imagePROGRAF Device Setup Utility .....	407
Installing imagePROGRAF Device Setup Utility .....	407
Configuring the IP Address Using imagePROGRAF Device Setup Utility .....	408

## imagePROGRAF Device Setup Utility

imagePROGRAF Device Setup Utility is a utility to establish communication between the printer and your computer by completing relevant settings. After the printer is installed, for example, you can use imagePROGRAF Device Setup Utility to complete the network settings initially.

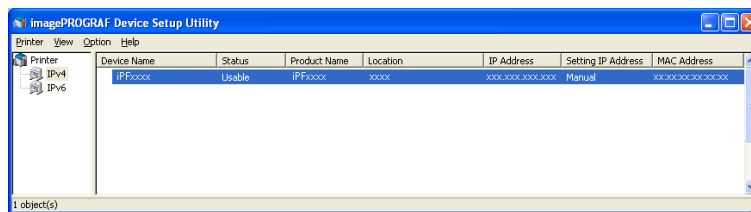

- Starting imagePROGRAF Device Setup Utility will show a list of printers found on the network. In this list, select the printer (specifically, the printer's MAC address) that you want to set up, and then configure the basic settings from your computer, such as the printer's IP address and the network frame type.
- You can see which printers are online in the network by checking the printer list. Communication between your computer and these printers is possible.



### Note

- We recommend that your network or printer administrator complete the setup work using imagePROGRAF Device Setup Utility.
- For details, refer to the imagePROGRAF Device Setup Utility help.

## Installing imagePROGRAF Device Setup Utility

Install imagePROGRAF Device Setup Utility from the User Software CD-ROM provided with the printer as follows:



### Important

- In Windows 2000/Windows XP/Windows Server 2003/Windows Vista/Windows Server 2008, you must log on with administrative rights equivalent to the **Administrator** account.

1. Insert the User Software CD-ROM in the CD-ROM drive.
2. On the **Setup Menu** window, click **Install Individual Software**.
3. Click **Install** in imagePROGRAF Device Setup Utility.
4. Follow the instructions on the screen to proceed with the installation.

## Configuring the IP Address Using imagePROGRAF Device Setup Utility

On a computer running Windows, you can use imagePROGRAF Device Setup Utility provided with the printer to configure the printer's IP address. This topic describes how to configure the IP address using imagePROGRAF Device Setup Utility.



### Important

- To configure network settings, you must be logged in with administrative rights such as **Administrator** account. We recommend that your network administrator configure the network settings.



### Note

- For instructions on installing imagePROGRAF Device Setup Utility, see "Installing imagePROGRAF Device Setup Utility." [→P.407](#)

## When specifying an IPv4 IP address

1. Start imagePROGRAF Device Setup Utility from the **start** menu.

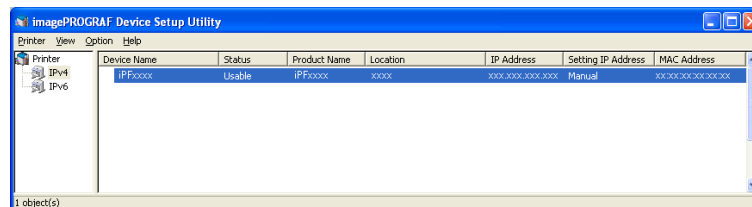

2. In the **Device Name** list displayed, select the printer to configure.
3. Choose **Protocol Settings** from the **Printer** menu.

## 4. Select the IPv4 tab.

**Protocol Settings**

Set the protocol information for the network interface board, then click Set.

Device Name:

Location:

IPv4 | IPv6 | NetWare | AppleTalk

Frame Type:

Setting IP Address:

RARP  BOOTP  DHCP

IP Address:

Subnet Mask:

Gateway Address:

## 5. In the **Setting IP Address** list, choose **Manual**.

## 6. Enter the IP address assigned to the printer and click the **Set** button.

## 7. Click **OK** after the **Confirmation** message is displayed.

## 8. Exit imagePROGRAF Device Setup Utility.



### Note

- To configure the IP address automatically, choose **Auto** in the **Setting IP Address** list and select **DHCP**, **BOOTP**, or **RARP**.
- You can also specify the subnet mask and default gateway.

## When specifying an IPv6 IP address

1. Start imagePROGRAF Device Setup Utility from the **start** menu.

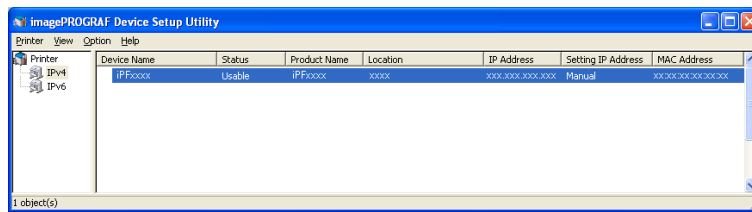

2. In the **Device Name** list displayed, select the printer to configure.

3. Choose **Protocol Settings** from the **Printer** menu.

4. Select the **IPv6** tab.

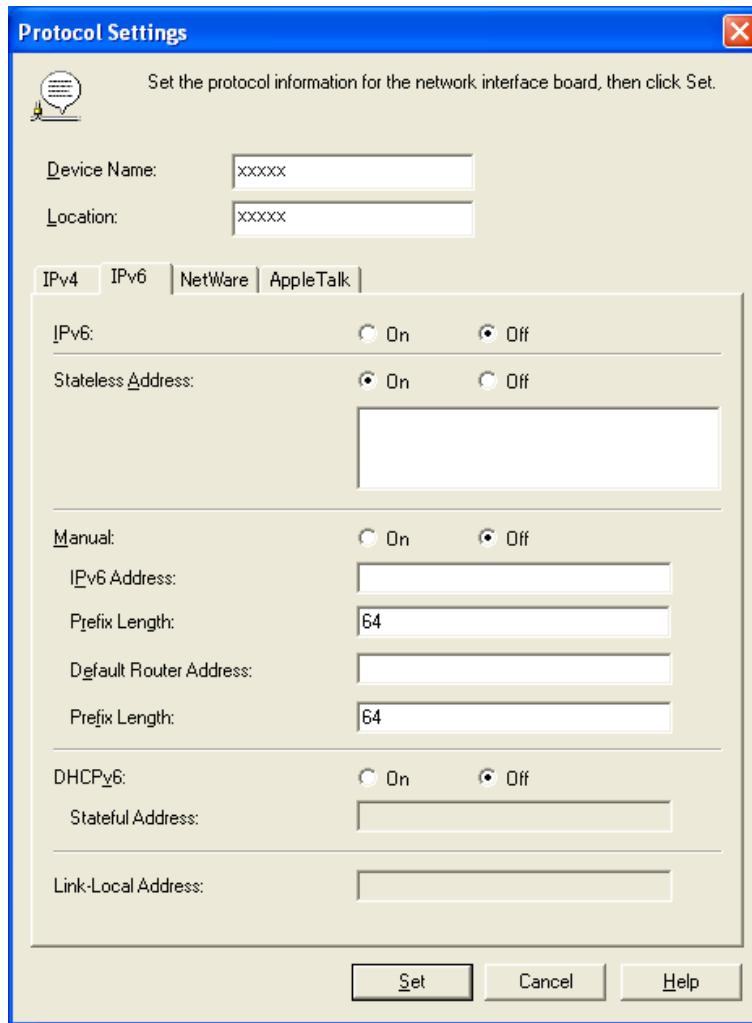



5. In **IPv6**, select **On**.
6. When there is an IPv6-compatible router in the network environment, select **On** in **Stateless Address**. Additionally, when there is an DHCPv6-compatible server in the network environment, select **On** in **DHCPv6**.

**Note**

- When there is no IPv6-compatible router or DHCPv6-compatible server, select **On** in **Manual** and enter the **IPv6 Address** and **Prefix Length**.

7. Click **Set**.
8. Click **OK** after the **Confirmation** message is displayed.
9. Exit imagePROGRAF Device Setup Utility.

## Media Configuration Tool

The Features of Media Configuration Tool .....	412
Operating Environment .....	412
Installation Procedures .....	413
Starting the Media Configuration Tool .....	416
Media Configuration Tool Main Window .....	417
Editing Media Type Information .....	418
Adding Media Types .....	418
Changing Media Names .....	421
Deleting Media Types You Have Added .....	423
Switching Media Types Display Show/Hide .....	425
Changing the Display Order of Media Types .....	426
Updating Media Types .....	428

### 3

## The Features of Media Configuration Tool

The Media Configuration Tool offers the following features.

- Enables information about additional media (types of paper) supported by the printer to be registered on the printer control panel and in the printer driver, through the use of relevant media information files (.amf and .med files).
- You can rearrange lists of the types of paper on the printer control panel and in printer driver dialog boxes and rename them, in addition to other functions.



### Important

- The Media Configuration Tool is normally installed when you install the printer driver from the User Software CD-ROM by selecting **Install Printer Driver** and media information is registered at this time. The tool can be used later to add or edit media information as desired.

## Drivers Applicable with Media Configuration Tool

- imagePROGRAF Printer Driver
- imagePROGRAF HDI Driver

## Operating Environment

You can use Media Configuration Tool in the following environments.

- Compatible Operating System
  - 32 bit edition Windows OS  
Windows 2000, Windows XP, Windows Server 2003, Windows Server 2003 R2, Windows Vista, Windows Server 2008, Windows 7
  - 64 bit edition Windows OS  
Windows XP, Windows Server 2003, Windows Server 2003 R2, Windows Vista, Windows Server 2008, Windows Server 2008 R2, Windows 7



### Note

- For the Windows OS, use the latest version of Service Pack.

- Software that requires installation  
imagePROGRAF Printer Driver

## Installation Procedures

The Media Configuration Tool installation screen appears when you start the installation of a new version of the Media Configuration Tool. The installation procedure started from this screen is described below.



### Important

- The Media Configuration Tool is normally installed when you install the printer driver from the User Software CD-ROM by selecting **Install Printer Driver** and media information is registered at this time.
- You must be logged in as Administrator when installing software in Windows.

1. Start the Media Configuration Tool installer.  
Click the **Next** button.

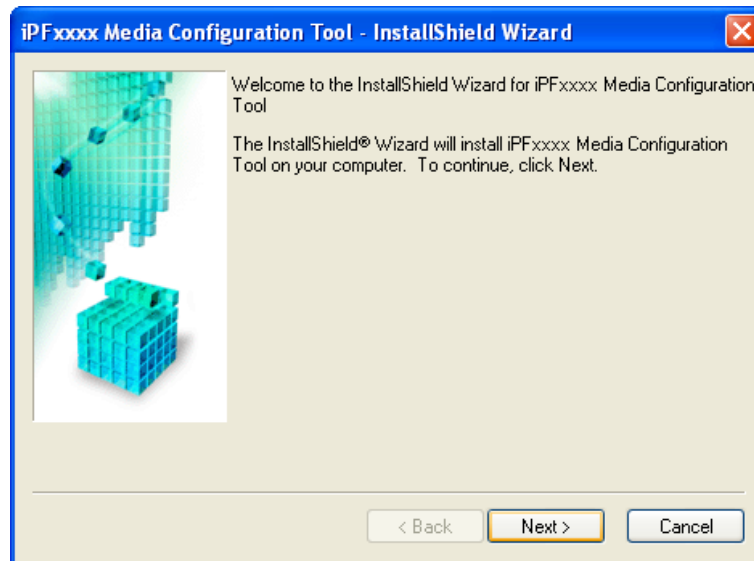

- The next screen presents selections for the country or area where the printer is used. Select a country or territory then click the **Next** button.

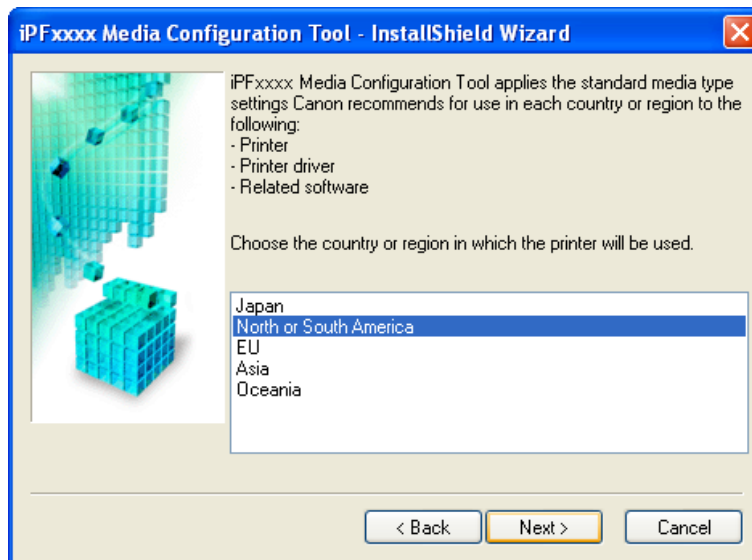

- The **License Agreement** is displayed. Select **I accept the terms of the license agreement** and click the **Next** button.

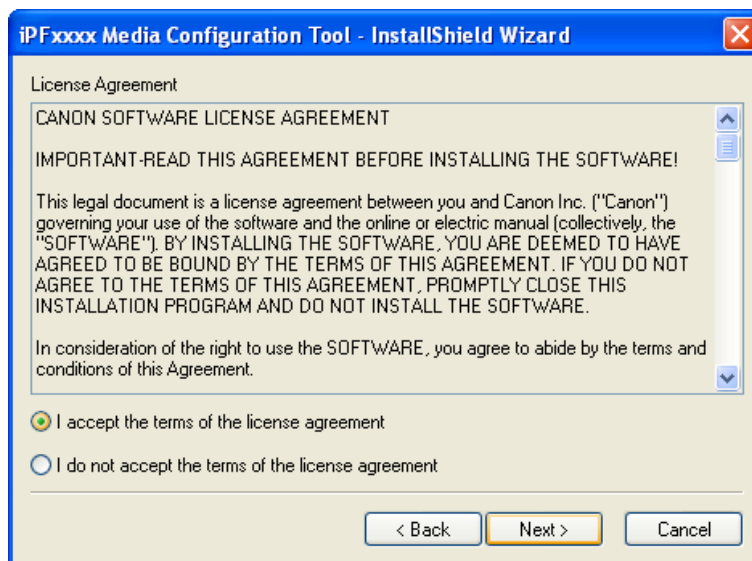

3

414

4. The **Choose Destination Location** screen appears.  
Select the destination folder then click the **Next** button.

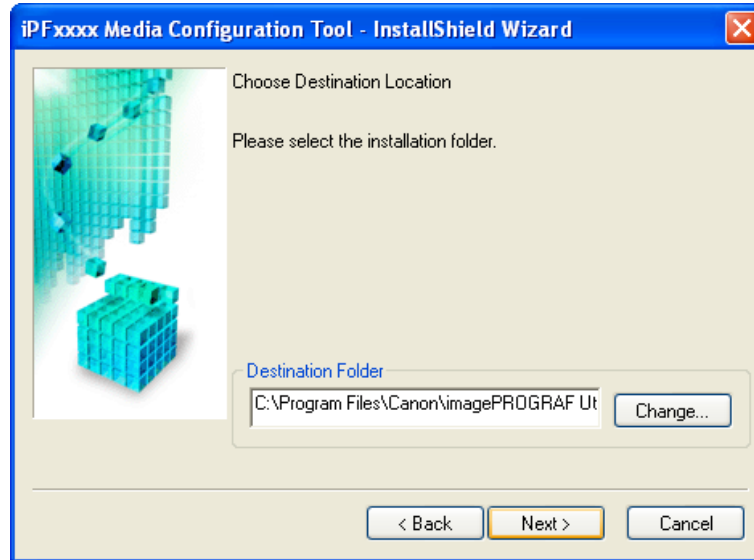

5. The **Ready to Install the Program** screen appears.  
Click the **Install** button.

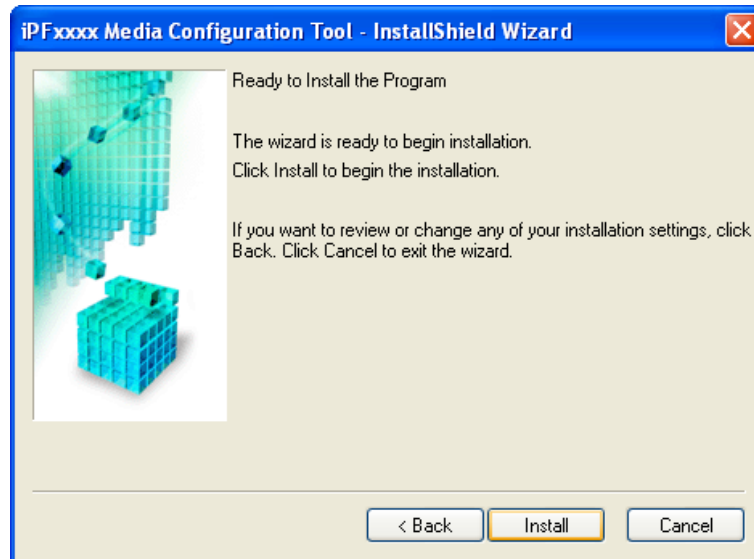

- 6. All the required files are copied to your computer and **InstallShield Wizard Complete** screen appears. Click the **Finish** button.

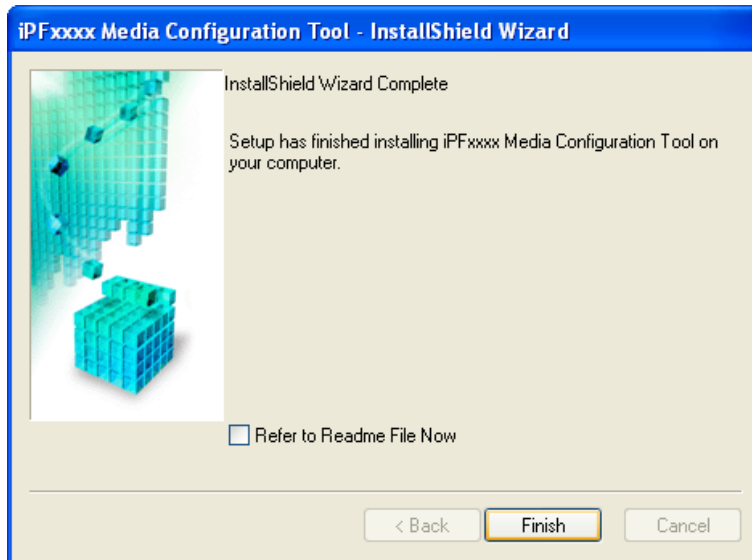

This completes the installation of Media Configuration Tool.

## Starting the Media Configuration Tool

Follow the procedure below to start Media Configuration Tool.

From the **start** menu go to **All Programs > iPFxxxx Media Configuration Tool > iPFxxxx Media Configuration Tool**. Media Configuration Tool main window is displayed.

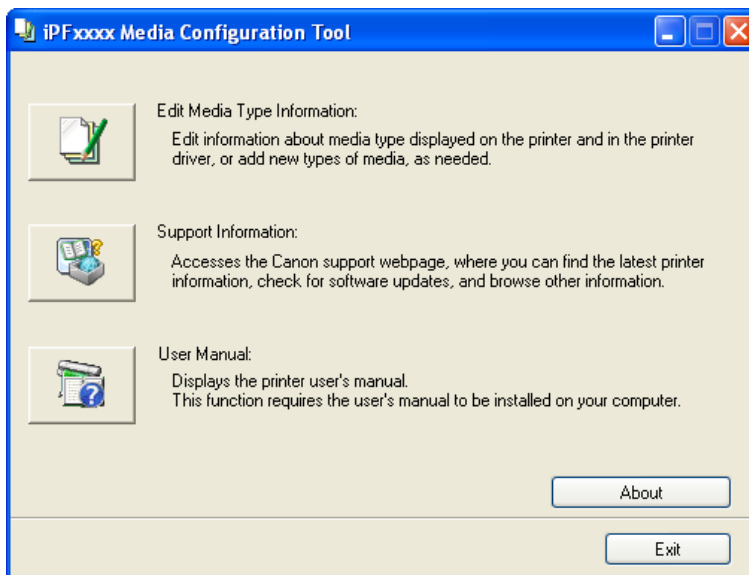

## Media Configuration Tool Main Window

The explanation below is on the Media Configuration Tool main window.

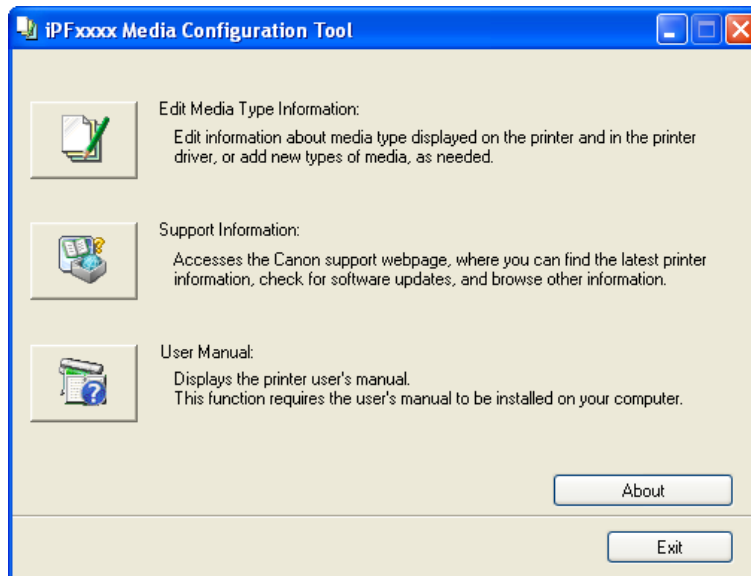

### Note

- For the step to open the Media Configuration Tool main window, see "Starting the Media Configuration Tool." →P.416

### • Edit Media Type Information Button

Click the button to open the **Edit Media Types** dialog box and you can edit the media types.

For more information about **Edit Media Type Information**, see "Editing Media Type Information." →P.418

### • Support Information Button

Click this button to access the Canon support webpage, where you can find the latest printer information, check for software updates, and browse other information.

### • User Manual Button

Click this button to display the printer user manual. This function requires that the user manual be installed on your computer.

## Editing Media Type Information

Click the **Edit Media Type Information** button in the Media Configuration Tool main window to display the **Edit Media Types** dialog box.

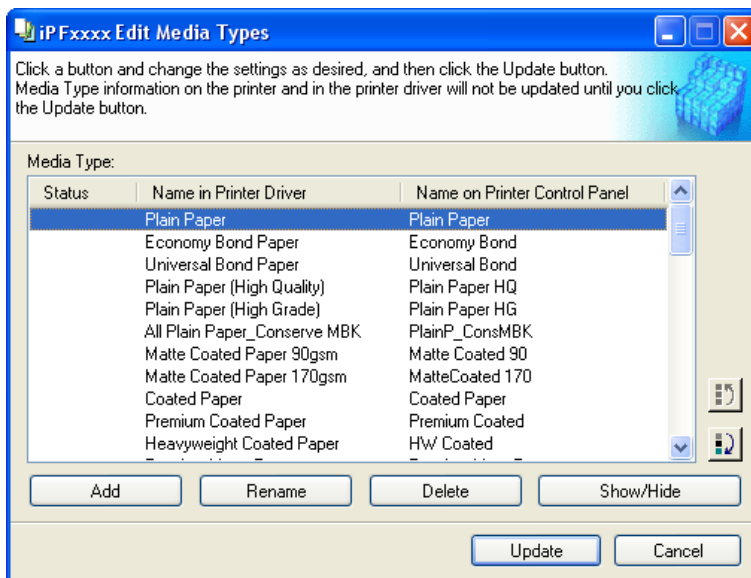

This dialog box presents functions for the following tasks.

- Adding Media Types →P.418
- Changing Media Names →P.421
- Deleting Media Types You Have Added →P.423
- Switching Media Types Display Show/Hide →P.425
- Changing the Display Order of Media Types →P.426



### Note

- It may not be possible to deleting, showing/hiding, and changing the display order under some conditions.

## Adding Media Types

Media information files (.amf files) released by Canon are registered in the printer control panel and printer driver.



### Important

- Do not perform printing on the target printer while adding the media types.
- Reinstalling Media Configuration Tool after registering a media information file may delete the registered media information file. In this case, first download and install latest Media Configuration Tool, then download and register the required media information file.



1. Open the **Edit Media Types** dialog box, and then click the **Add** button.

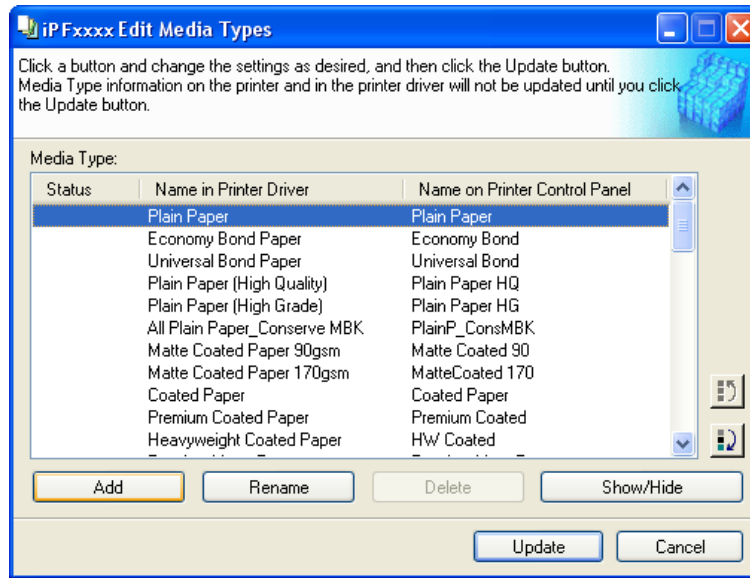

2. The **Add Media Type** dialog box displays. Click the **Browse** button.

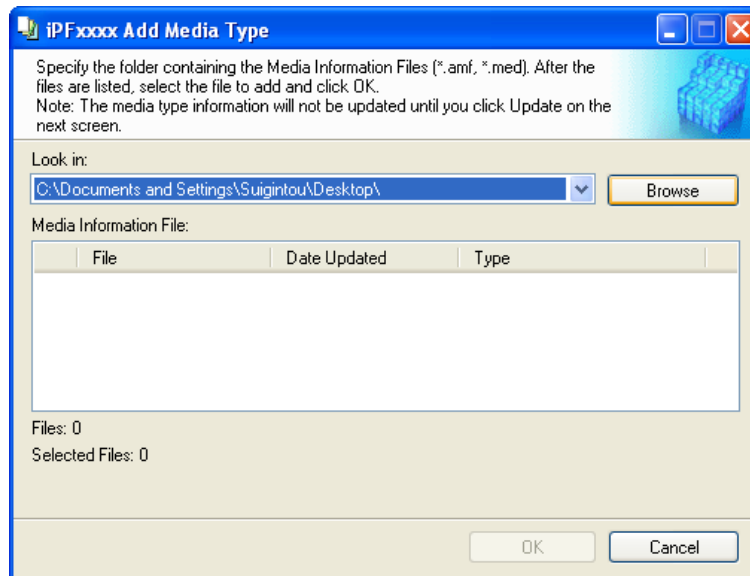

3. The **Browse for Folder** dialog box opens.  
Select the folder that contains the media information files (.amf files), and then click the **OK** button.

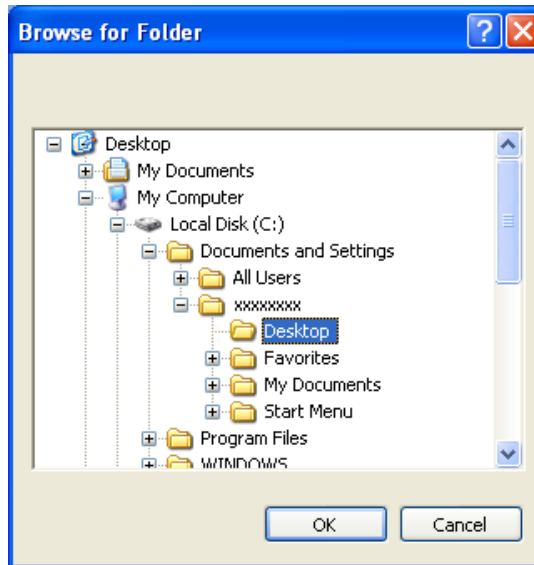

4. The names of media information files in the folder you selected in the **Browse for Folder** dialog box are displayed under **Media Information File** in the **Add Media Type** dialog box. Select the check boxes of paper to add and click the **OK** button.

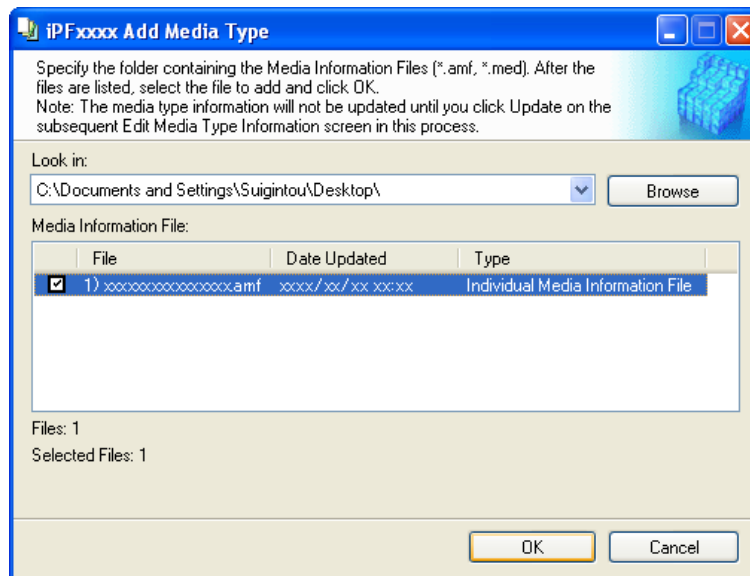

#### Important

- If **Master Media Information File** is displayed as the **Type** of the **Media Information File**, the media type display order and media type display/non-display settings are initialized. Reconfigure these after added the master media information file.

5. Click **OK** when the confirmation message is displayed.

6. In the **Edit Media Types** dialog box, click the **Update** button.

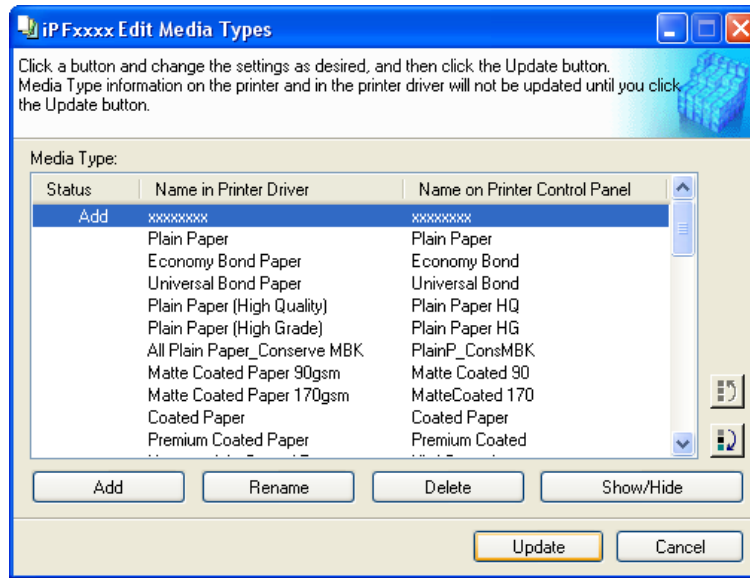

The **Update Media Types** wizard is started at this point. For details on the procedure to update paper information using the **Update Media Types** wizard, see "Updating Media Types." →P.428



#### Important

- Be sure to click the Update button. If you do not, your changes will not be applied to the printer and printer driver.

## Changing Media Names

1. Open the **Edit Media Types** dialog box.

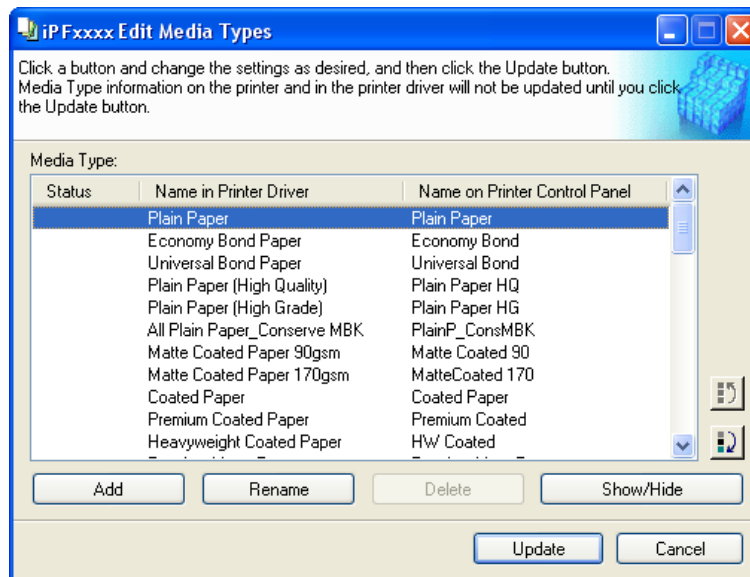

- In the **Media Type** list, select the name to change.  
Click the **Rename** button.

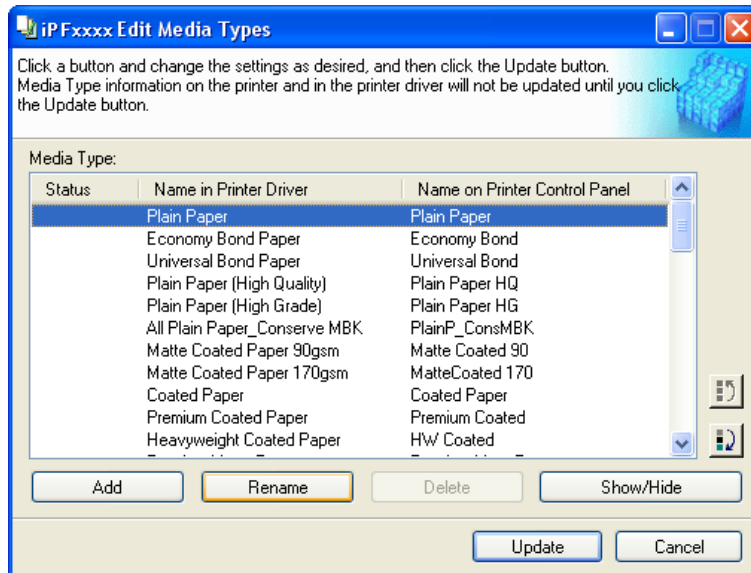

- The **Rename Media** dialog box is displayed.  
Edit the names in **Name in Printer Driver** and **Name on Control Panel** and click the **OK** button.

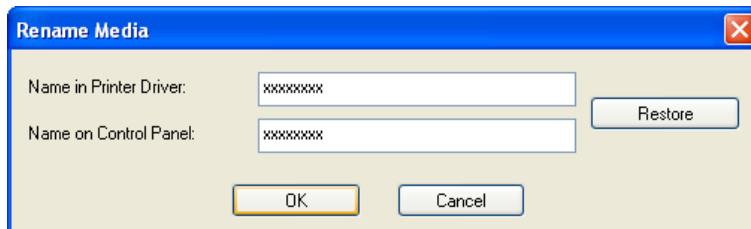

 **Note**

- To restore the original names, click the **Restore** button.

4. In the **Edit Media Types** dialog box, click the **Update** button.

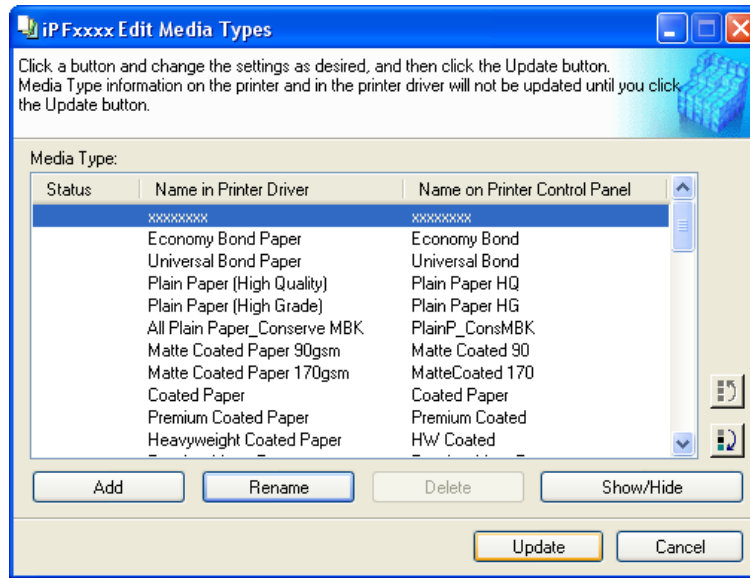

The **Update Media Types** wizard is started at this point. For details on the procedure to update paper information using the **Update Media Types** wizard, see "Updating Media Types." →P.428



#### Important

- Be sure to click the Update button. If you do not, your changes will not be applied to the printer and printer driver.

## Deleting Media Types You Have Added

1. Open the **Edit Media Types** dialog box.

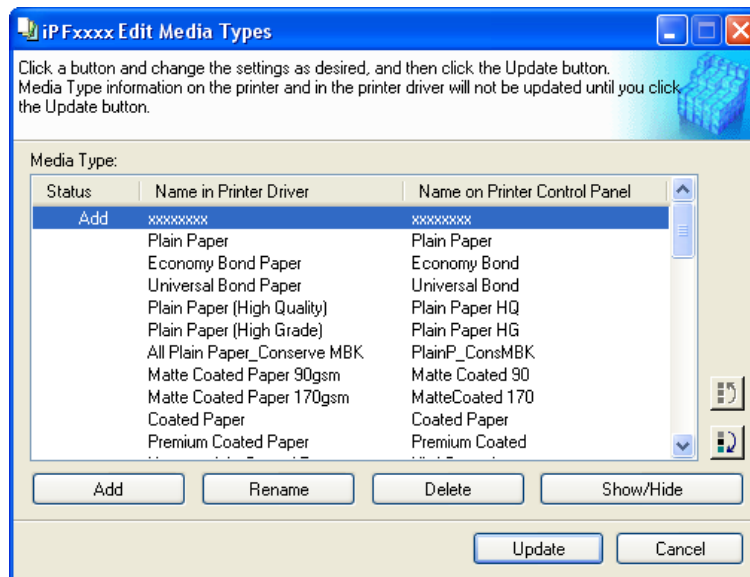

2. In the **Media Type** list, select the name of the media to delete.  
Click the **Delete** button.

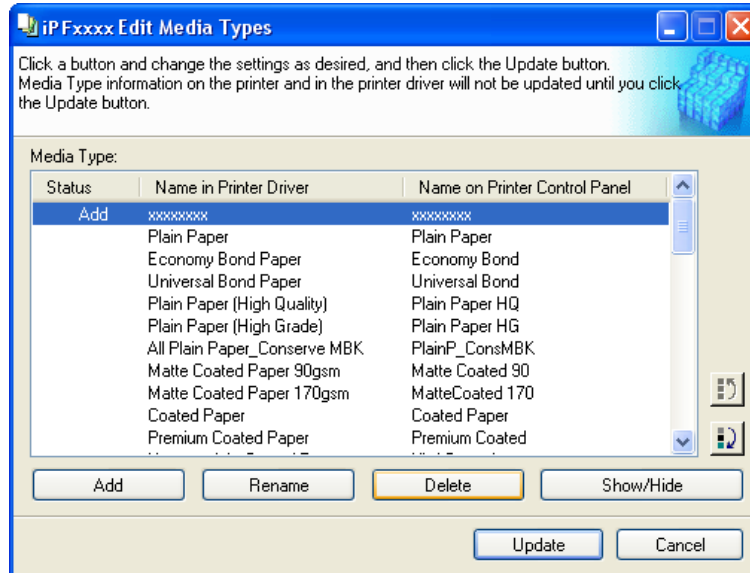
**Note**

- Only paper for which **Status** in the **Media Type** is **Add** can be deleted.

3. In the **Edit Media Types** dialog box, click the **Update** button.

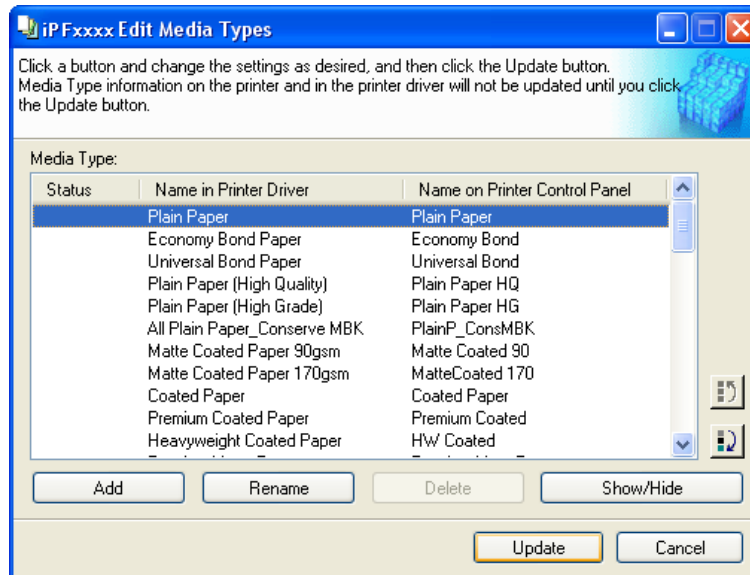

The **Update Media Types** wizard is started at this point. For details on the procedure to update paper information using the **Update Media Types** wizard, see "Updating Media Types." →P.428

**Important**

- Be sure to click the Update button. If you do not, your changes will not be applied to the printer and printer driver.

## Switching Media Types Display Show/Hide

1. Open the **Edit Media Types** dialog box.

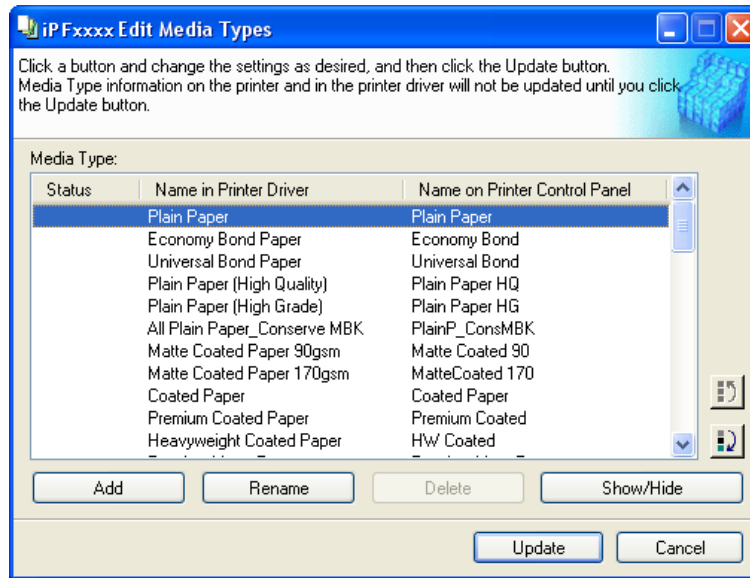

2. In the **Media Type** list, select the name of the media to switch off or on for display. Click the **Show/Hide** button. The selected paper is alternately shown or hidden.

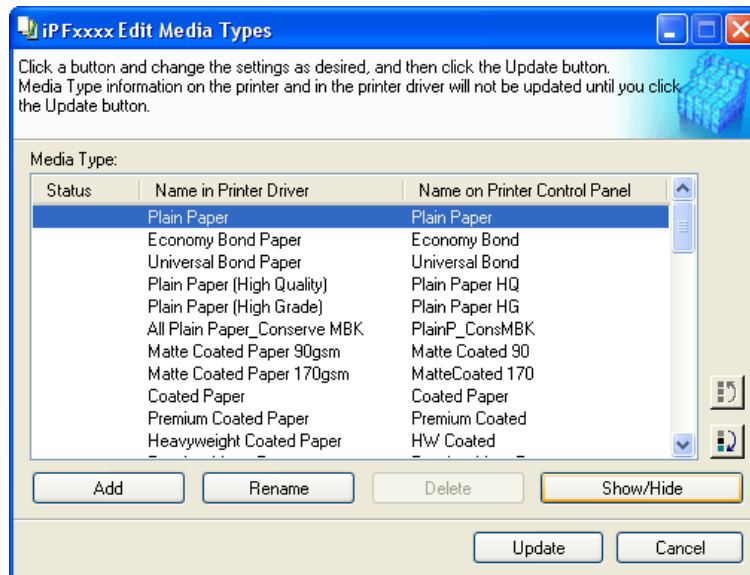

### Note

- The names of media switched for non-display appear grayed out in the **Media Type** list.
- Each time you click the **Show/Hide** button, the display mode cycles from showing both the printer driver and printer panel, to hiding both the printer driver and printer panel, and then to showing only the printer panel.

**3.** In the **Edit Media Types** dialog box, click the **Update** button.

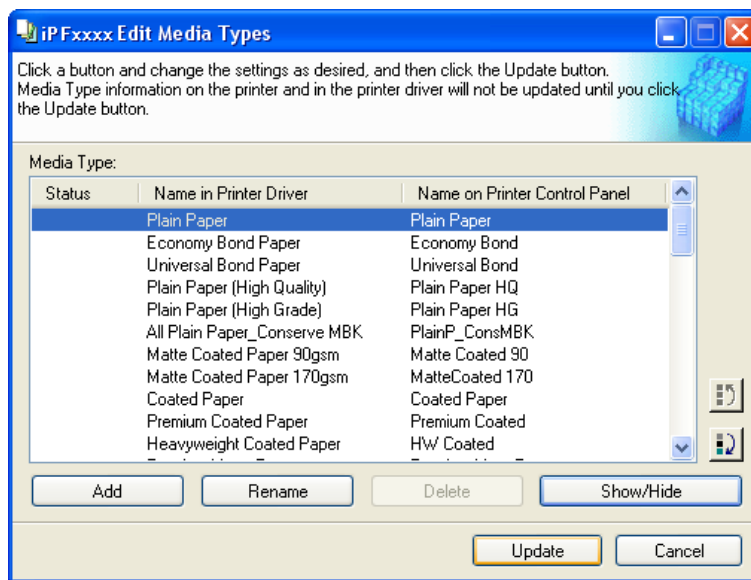

The **Update Media Types** wizard is started at this point. For details on the procedure to update paper information using the **Update Media Types** wizard, see "Updating Media Types." →P.428



**Important**



- Be sure to click the Update button. If you do not, your changes will not be applied to the printer and printer driver.

## Changing the Display Order of Media Types

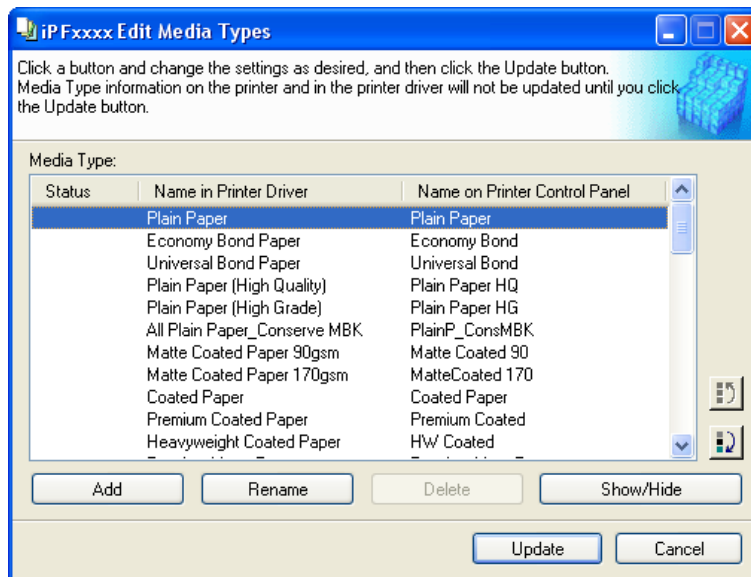
**1.** Open the **Edit Media Types** dialog box.





2. Select the paper in the **Media Type** list for which to change the display order, and then click the buttons to move the item (  or  ).  
The selected item moves one line up or down for every button click.

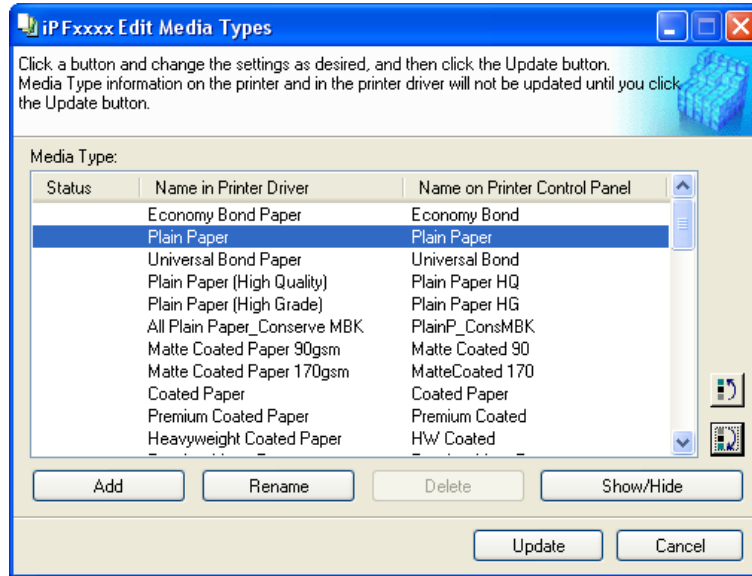

3. In the **Edit Media Types** dialog box, click the **Update** button.

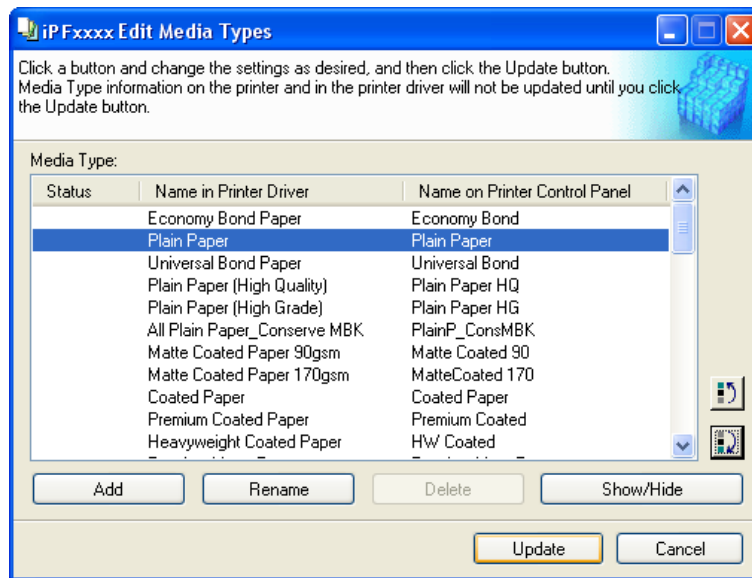

The **Update Media Types** wizard is started at this point. For details on the procedure to update paper information using the **Update Media Types** wizard, see "Updating Media Types." →P.428



**Important**

- Be sure to click the Update button. If you do not, your changes will not be applied to the printer and printer driver.

## Updating Media Types

Clicking the **Update** button on the **Edit Media Types** dialog box opens the **Update Media Types** wizard. You can use this wizard to apply new information about print media in the printer and in the printer driver.

The procedures for updating the media information with the **Update Media Types** wizard are as follows.



### Important

- The use of this procedure is based on the assumption that Media Configuration Tool is updated or you have a media information file for print media that is to be updated.

- Confirm the printer, where media type information is to be updated, to be displayed in **Printer** in the **Update Media Types - Select Printer** dialog box, and then click the **Next** button.

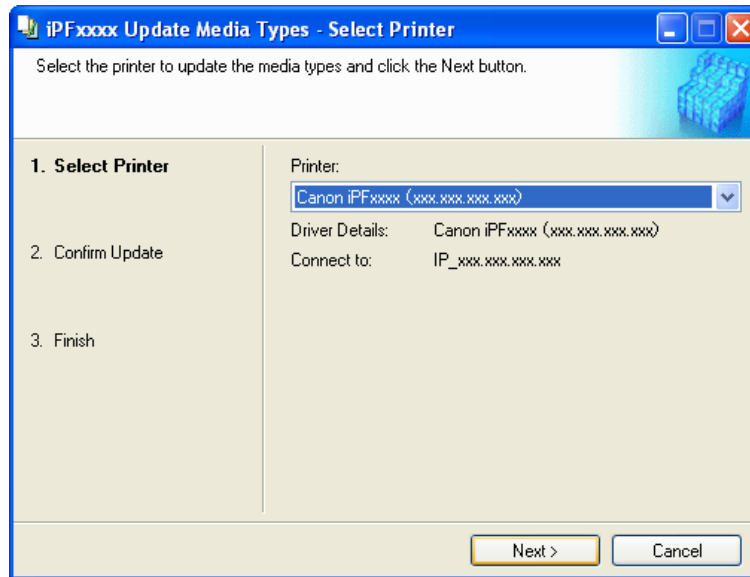

### Note

- If the printer driver is not installed, the following dialog box is displayed. Select how the printer to update is connected.

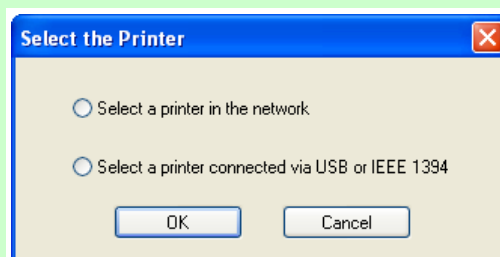

- Communication with the printer starts and the following dialog box is displayed.

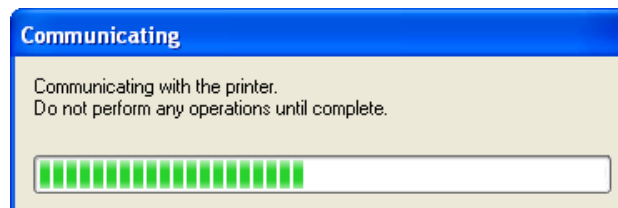

**Important**

- Do not attempt to print or turn the printer off while the program is communicating with the printer.
- When the program cannot communicate with the printer, the following warning message is displayed.

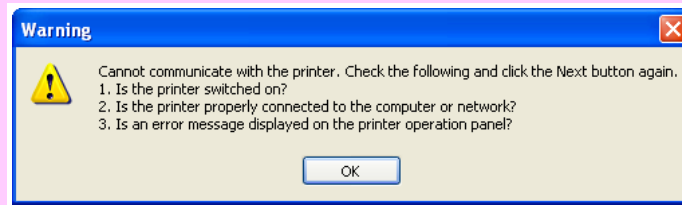

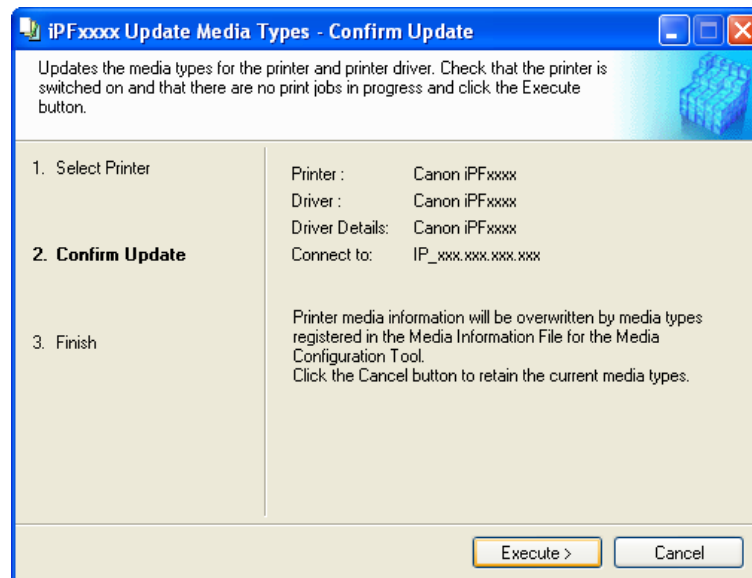

3. When the program has finished communicating with the printer, the screen moves to display **Update Media Types - Confirm Update**. Confirm the information received from the printer. To update click the **Execute** button.

**Important**

- When setting a data to the printer that differs from the data to be updated, the selected media information file is updated. When you would like to remain the data that is set to the printer, click the **Cancel** button.

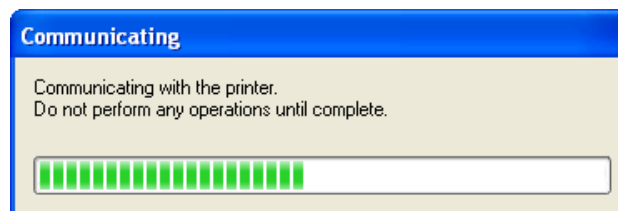
4. Communication with the printer starts and the following dialog box is displayed.



 **Important**

- Do not attempt to print or turn the printer off while the program is communicating with the printer.
- When the program cannot communicate with the printer, the following warning message is displayed.

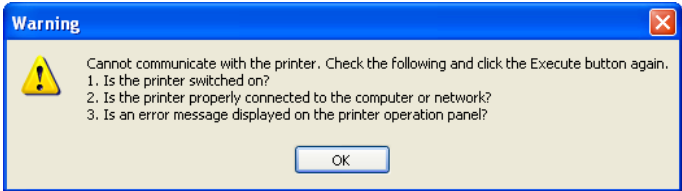

The warning dialog box has a blue title bar with the text "Warning" and a close button. It contains a yellow warning triangle icon and the following text: "Cannot communicate with the printer. Check the following and click the Execute button again." Below this are three numbered items: "1. Is the printer switched on?", "2. Is the printer properly connected to the computer or network?", and "3. Is an error message displayed on the printer operation panel?". At the bottom center is an "OK" button.

**5.** After the media information file is updated successfully, the screen switches to the **Update Media Types - Finish** dialog box. Click **Finish** to close the **Update Media Types** wizard.

3

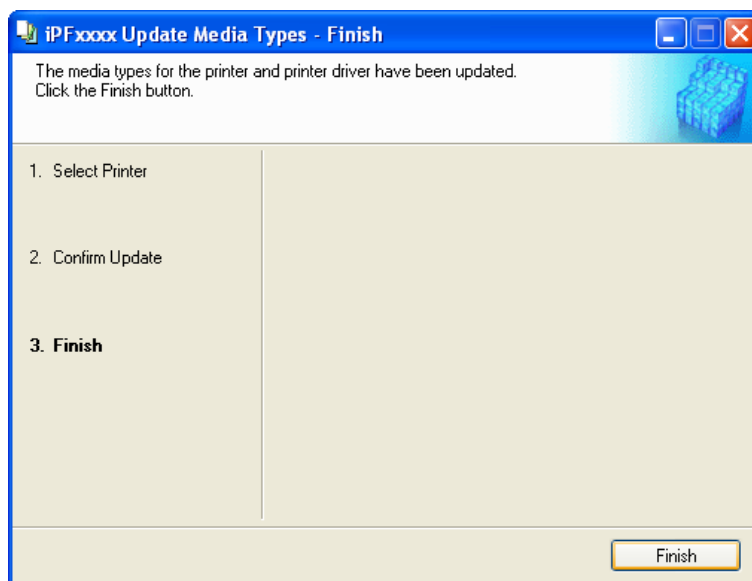

430

## Mac OS X Software

Printer Driver	432
Preview	457
Free Layout	486
Color imageRUNNER Enlargement Copy	518
Printmonitor	541
Media Configuration Tool	543

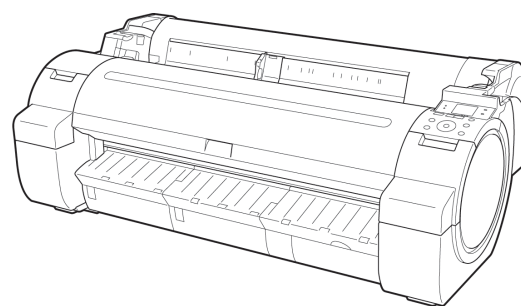

## Printer Driver

Printer Driver Settings .....	432
Specifying Paper in the Printer Driver .....	434
Confirming Print Settings .....	436
Checking the Layout in a Preview Before Printing .....	437
Using Favorites .....	439
Accessing the Printer Driver Dialog Box from Applications .....	439
Main Pane .....	440
Paper Information on Printer Dialog Box .....	443
Paper Detailed Settings Dialog Box .....	444
View settings Dialog Box for the Printing Application .....	445
Matching pane .....	446
Color Settings Pane: Color .....	448
Object Adjustment dialog box: Color .....	449
Color Settings Pane: Monochrome .....	450
Object Adjustment dialog box: Monochrome .....	451
Page Setup Pane .....	452
Utility Pane .....	454
Additional Settings Pane .....	455
Support Pane .....	455

## Printer Driver Settings

For instructions on accessing the Mac OS X printer driver, refer to the following topics.

- Accessing the Printer Driver Dialog Box from Applications →P.439

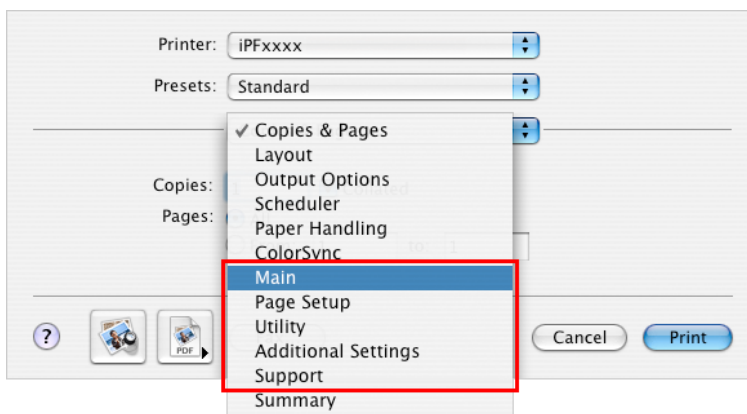

For information on the Mac OS X printer driver settings, refer to the following topics.

- Main Pane →P.440  
 You can specify the media type, color processing, print quality, print preview, and other settings. Choose **Easy Settings** to specify basic print settings based on the printing application or **Advanced Settings** to complete more detailed settings as desired.
  - Paper Detailed Settings Dialog Box →P.444
  - View settings Dialog Box for the Printing Application →P.445
  - Color Settings Pane: Color →P.448

- **Color Settings Pane: Monochrome** →P.450
- **Page Setup Pane** →P.452  
You can specify the page size of the original, borderless printing, enlargement or reduction, the orientation, the paper size and source, and automatic cutting.
- **Utility Pane** →P.454  
You can specify settings related to maintenance for the Printhead and feed amount, as well as settings for **Color imageRUNNER Enlargement Copy**.
- **Additional Settings Pane** →P.455  
You can specify settings for how print jobs are sent to the printer.
- **Support Pane** →P.455  
You can view support information and the user's manual.

With the **imagePROGRAF Free Layout** feature, you can arrange originals from various source applications on a single page before printing. For details, see **Free Layout** →P.486 .

With the **imagePROGRAF Preview** feature, you can check the layout before printing and adjust layout or size settings while viewing a preview screen. For details, see **Preview** →P.457 .

With the **Color imageRUNNER Enlargement Copy** feature, you can automatically enlarge and print scanned originals from a **Color imageRUNNER**. For details, see **Color imageRUNNER Enlargement Copy** →P.518 .

## Specifying Paper in the Printer Driver

If you have replaced the paper, you must complete the following settings in the printer driver.

1. This sets the **B Format for** and **C Paper Size**.



### Note

- The configuration method varies depending on the OS and application software you are using. If **Page Setup** is displayed in the application menu, the settings are configured by opening the **Page Attributes** dialog box from **Page Setup**.

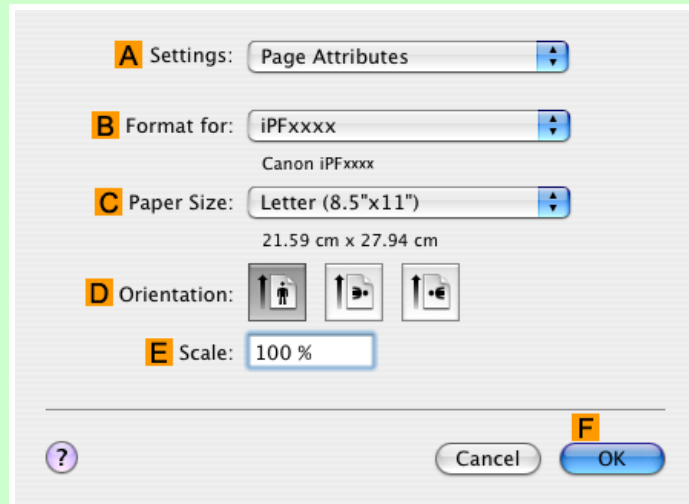

If it is not displayed, the settings are configured in the upper part of the printer driver displayed when you select **Print** from the application software menu.

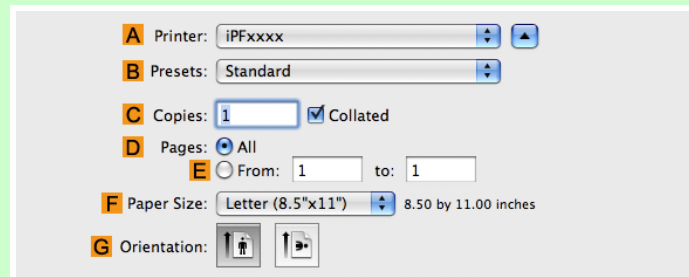

2. Select the printer in the **A Printer** list.

3. Choose the original size in the **F Paper Size** list.

4. If you configured the settings using the **Page Attributes** dialog box, click **F OK** to close the dialog box, and then select **Print** from the application software menu.



5. Access the **Main** pane.

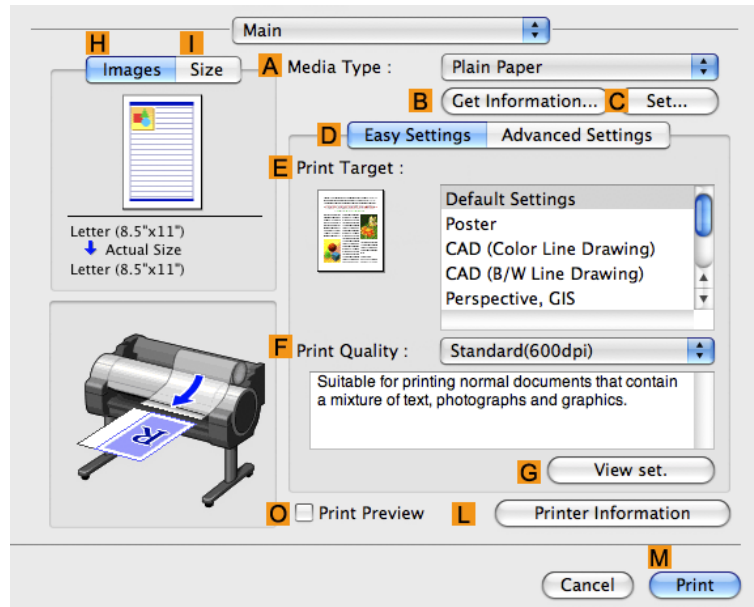

6. In the **A Media Type** list, select the type of paper that is loaded.

7. Access the **Page Setup** pane.

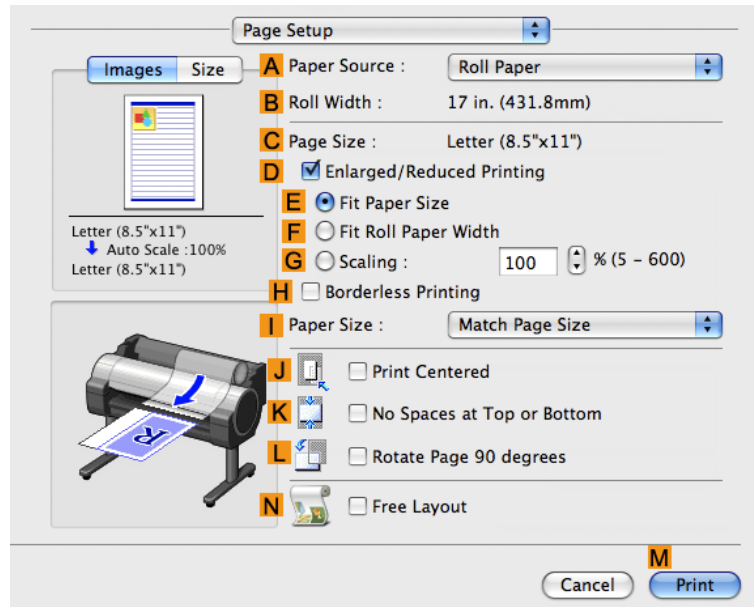

8. In the **A Paper Source** list, select how paper is supplied.

9. If you have selected **Manual** in **A Paper Source**, make sure the size as selected in **Page Setup** is displayed in **C Page Size**. If you have selected **Roll Paper** in **A Paper Source**, make sure the width of the loaded roll is displayed in **B Roll Width**.



**Note**

- If the width of the roll loaded in the printer is not shown in **B Roll Width**, click **L Printer Information** on the **Main** pane to update the printer information.

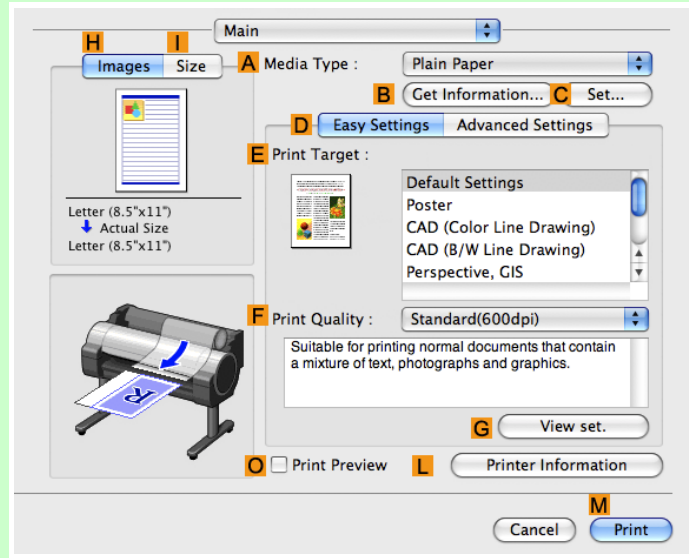

**Note**

- A variety of settings are available in the printer driver to suit different printing applications. For details on available printing conditions, see "Printer Driver Settings →P.432 "

## Confirming Print Settings

There are two ways to confirm what printing conditions have been specified, as follows.

- Checking a preview of the settings
- Checking a print preview

## Checking a preview of the settings

A preview of the settings is displayed on the left side of the **Main**, **Page Setup**, **Utility**, and **Additional Settings** panes. By checking images and numerical values in the preview, you can confirm current settings for the page size, orientation, paper source, and so on.

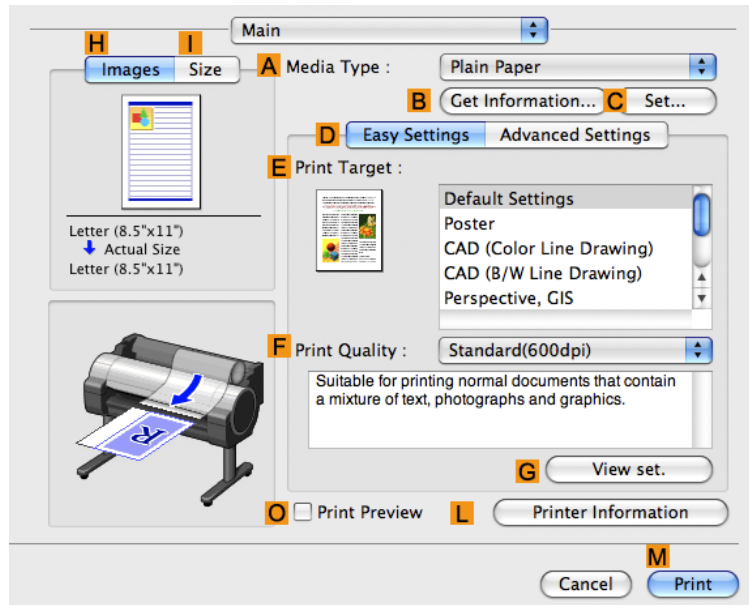

Display Area	Information Displayed
Pane displayed when the <b>H Images</b> tab is clicked	On top, illustrations indicate the page size of the original, the paper size, orientation, layout, borderless printing selection, color mode, and other settings information. Under this, the page size, paper size, and method and percentage of enlargement or reduction is displayed.
Pane displayed when the <b>I Size</b> tab is clicked	Paper size details are indicated numerically.
Pane with printer and paper illustrations	Illustrations indicate the paper source, orientation, borderless printing selection, and other settings information.



### Note

- To confirm the **Print Target** specified in **Easy Settings**, click **G View set.** on the **Main** pane to display the **View settings** dialog box.

## Checking a print preview

You can check an image of the original just as it will be printed.

Confirming the image of print jobs beforehand helps prevent printing errors.

For details on print previews, see "Checking the Layout in a Preview Before Printing →P.188 "

## Checking the Layout in a Preview Before Printing

This topic describes how to check the layout before printing using the **Canon imagePROGRAF Preview** function.

1. Choose **Print** in the application menu.

**2.** Access the **Main** pane.

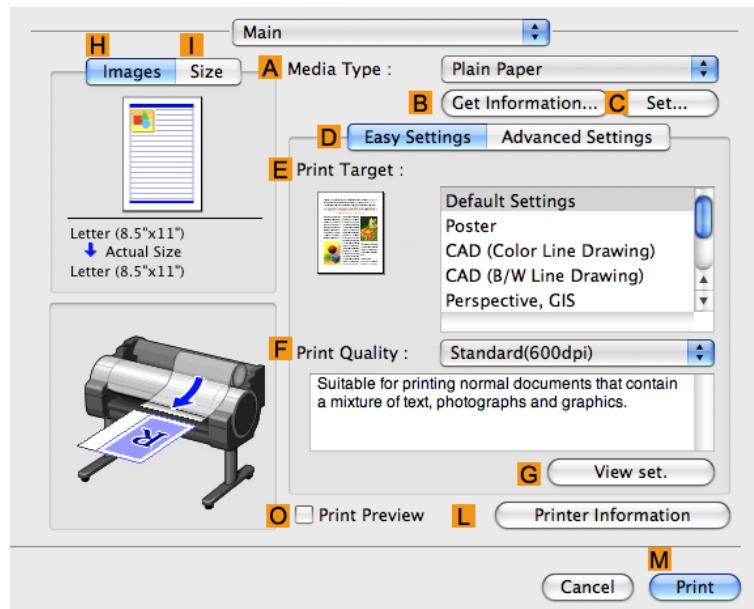

**3.** Select the **O Print Preview** check box.

**4.** Click **M Print**.

**5.** The **Canon imagePROGRAF Preview** window is displayed.

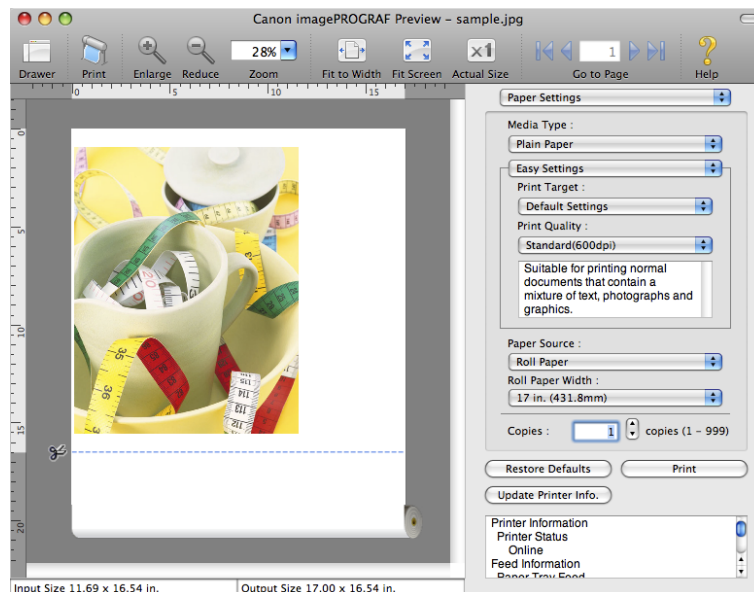

**6.** Check the layout and adjust settings in the **Canon imagePROGRAF Preview** window as desired.

4

438

## 7. Print from the **Canon imagePROGRAF Preview** menu.



### Note

- For details on **imagePROGRAF Preview** functions, refer to **Preview** →P.457 .

## Using Favorites

You can use the **Presets** function in Mac OS X for favorite-based printing.



### Note

- In the printing dialog box, click **Save As** in the **Presets** list to save the current print settings. This is a standard feature of the operating system. For details, refer to the Mac OS documentation.

## Accessing the Printer Driver Dialog Box from Applications

4

### 1. In the application software, select **Print** from the **File** menu to display the dialog box for printing conditions.



### Note

- This dialog box includes basic printing options and enables you to choose the printer, specify the range of pages, number of copies, and so on.

### 2. Select the printer in the **Printer** list.

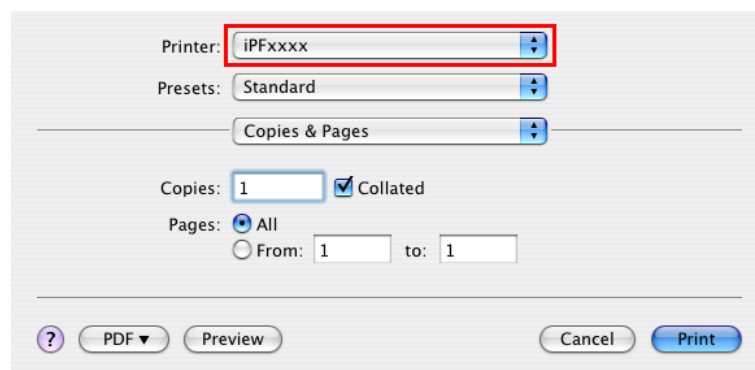

- Click **Print** to start printing.  
As shown in the following illustration, you can switch to other panes in this dialog box to complete settings for various methods of printing, including enlarged and reduced printing, borderless printing, and so on.

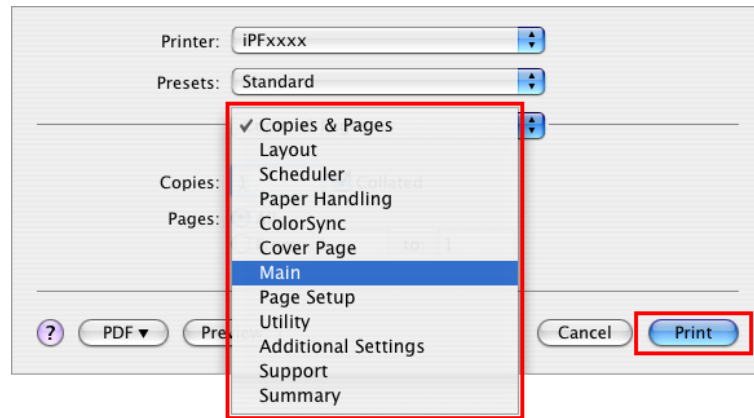

4

**Main Pane**

The following settings are available on the **Main** pane. For details on settings items, refer to the printer driver help.



Note

- On the **Main** pane, choose **Easy Settings** to specify basic print settings based on the print target, or switch to **Advanced Settings** to complete more detailed settings as desired.

**Common Items**

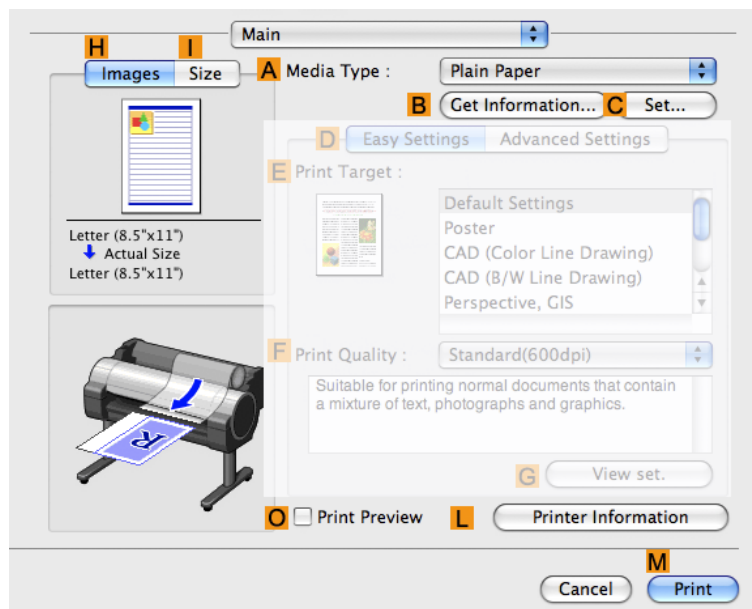

• **A Media Type**

Select the paper type.

For information on the types of paper the printer supports, refer to the Paper Reference Guide.(See "Types of Paper →P.568 ")

- **B Get Information**

Displays **Paper Information on Printer**. You can update the printer driver settings for the feed source, media type, and roll width by selecting the feed source.

- Paper Information on Printer Dialog Box →P.443

- **C Set**

Displays **Paper Detailed Settings**. You can configure the printing settings to match the type of media, such as the ink drying time.

- Paper Detailed Settings Dialog Box →P.444

- **O Print Preview**

If you turn this on, **imagePROGRAF Preview** starts before printing.

This allows you to check on-screen previews of documents before printing.



**Important**

- When **Free Layout** is selected on the **Page Setup** panel, **Free Layout** is disabled.

- Checking the Layout in a Preview Before Printing →P.188

- **L Printer Information**

Displays **Printer Information**. You can display printer information such as the remaining ink levels.

## Configuration using **Easy Settings**

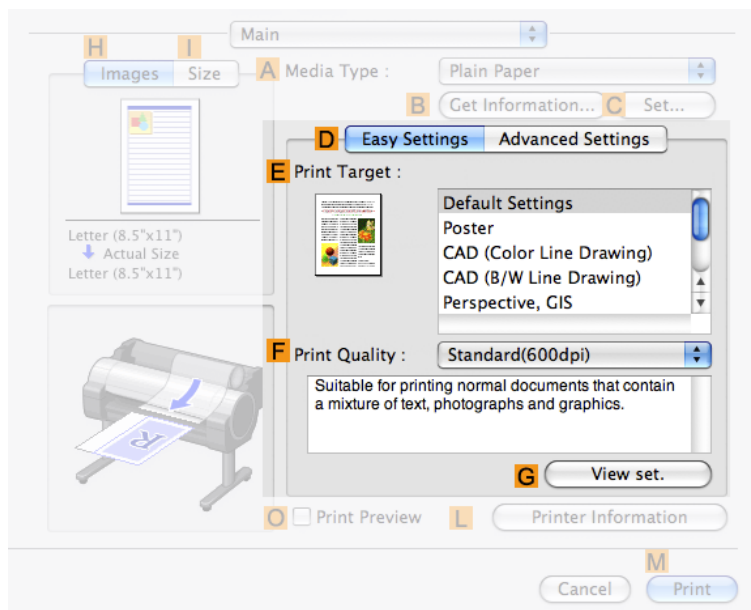

- **E Print Target**

Choose presets that match the type of document to be printed.

- Printing Photos and Images →P.22
- Printing Line Drawings and Text →P.39
- Printing Office Documents →P.29

- **F Print Quality**

Choose the level of print quality.

- **G View set.**

Click to display the **View settings** dialog box, which enables you to confirm the settings for the selected item from the **E Print Target** list or change the order of items listed in **E Print Target**.

- View settings Dialog Box for the Printing Application →P.445

## Configuration using **Advanced Settings**

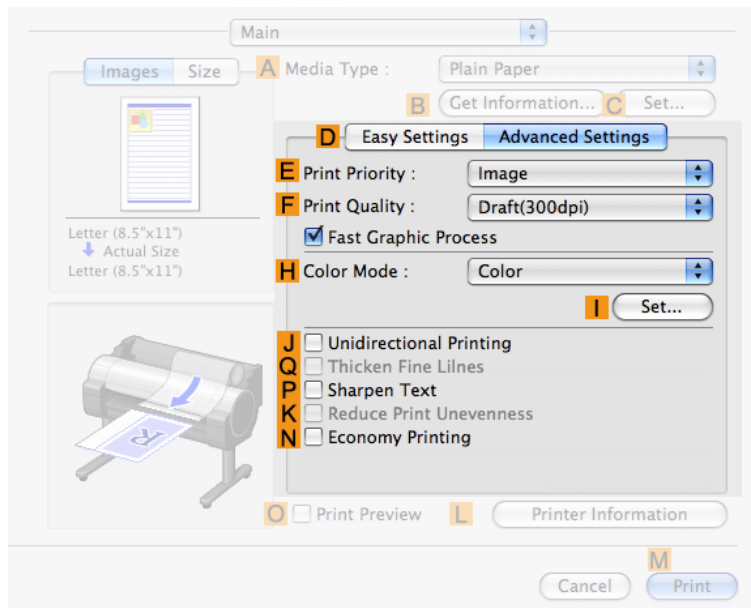

- **E Print Priority**

Choose the graphic elements that you want to emphasize for printing.

- Giving Priority to Particular Graphic Elements and Colors for Printing →P.60

- **F Print Quality**

Choose the level of print quality.

- Giving Priority to Particular Graphic Elements and Colors for Printing →P.60

- **H Color Mode**

Choose the color mode.

- Giving Priority to Particular Graphic Elements and Colors for Printing →P.60

- **I Set**

Click to display the **Color Settings** dialog box for more advanced color settings.

- Adjusting the Color in the Printer Driver →P.51

- **J Unidirectional Printing**

Select this checkbox to prevent problems such as misaligned lines and improve the print quality. However, the printing speed becomes slower.

- **Q Thicken Fine Lines**

Activate this option to print fine lines more distinctly.



- **P Sharpen Text**

Activate this option to print text more sharply.

- **K Reduce Print Unevenness**

Select this checkbox for two-pass printing to reduce color shading.

This option is displayed if you have selected Plain Paper in **Media Type** and **Office Document** in **Print Priority**.

- **N Economy Printing**

Select this checkbox to reduce the amount of ink consumed during printing. However, the print quality is worse than for normal printing.

Select this mode if you want to conserve ink when checking drawings, for example. Depending on the **Media Type** and **Print Quality** settings, this mode may not be available.

## Paper Information on Printer Dialog Box

On the **Paper Information on Printer** dialog box, you can obtain information on the paper in the printer and configure printer driver media type setting.

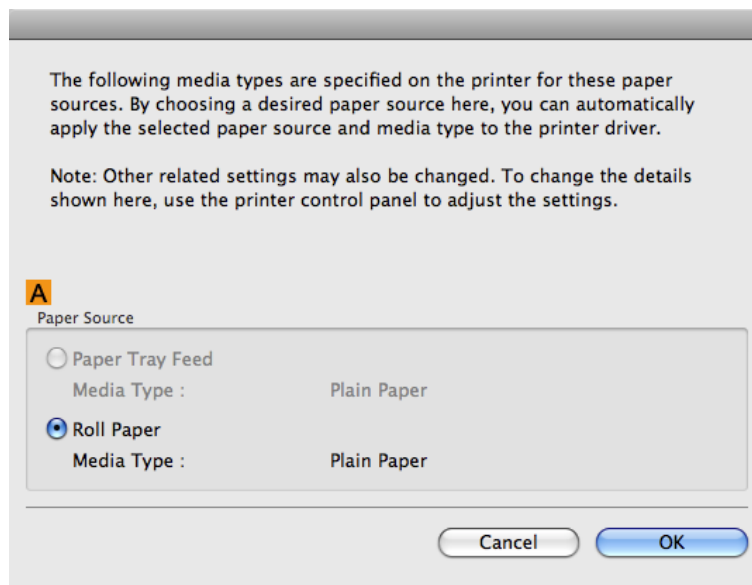

### Note

- To display the **Paper Information on Printer** dialog box, on the **Main** pane, click **Get Information by Media Type**. (See "Main Pane →P.440 ")

- **A Paper Source**

Shows the **Paper Source** supported by the printer, as well as the type of paper loaded. To update the media type setting in the printer driver, select the desired **Paper Source** option and click **OK**.

## Paper Detailed Settings Dialog Box

The **Paper Detailed Settings** dialog box offers the following settings. For details on settings items, refer to the printer driver help.

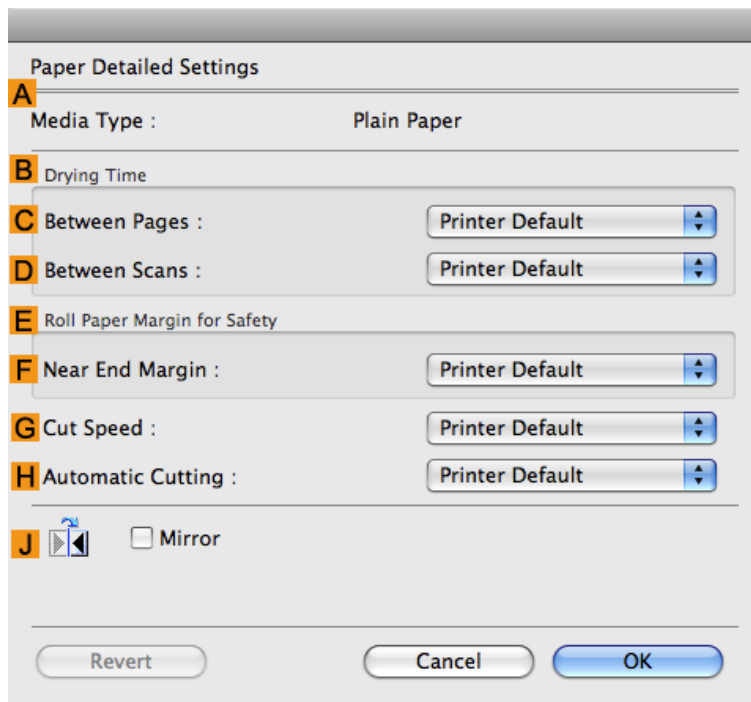

### Note

- To display the **Paper Detailed Settings** dialog box, on the **Main** pane, click **Set by Media Type**. (See "Main Pane →P.440 ")

#### • **A Media Type**

Select the paper type.

For information on the types of paper the printer supports, refer to the Paper Reference Guide. (See "Types of Paper →P.568 ")

#### • **B Drying Time**

Specify the time that the printer waits for ink to dry, as needed. The **Drying Time** setting is only valid for rolls.

- (See "Specifying the Ink Drying Time for Rolls →P.592 ")

#### • **C Between Pages**

Specify the time the printer waits after printing a page until ejecting the paper, as needed.

#### • **D Between Scans**

Specify the time the printer waits after printing a line on the page until printing the next line, as needed.

#### • **E Roll Paper Margin for Safety**

You can specify the length of a margin on the leading edge of paper to ensure that paper susceptible to curling is held firmly against the Platen.

#### • **F Near End Margin**

Specify the length of the **Near End Margin** (the leading edge margin) of the roll, as needed.

- **G Cut Speed**

Select the speed of automatic cutting, as needed. You can adjust this setting if paper is not cut well when automatic cutting is used.

- **H Automatic Cutting**

You can activate or deactivate automatic cutting and printing of cut lines, as desired. In this list, specify **Printer Default**, **None**, or **Print Cut Guideline**.

- **J Mirror**

Specify whether to print a mirror image, as needed. Select this option to print a version of the document or image with the left and right sides inverted.

## View settings Dialog Box for the Printing Application

In the **View settings** dialog box, you can check details of the selected printing application.

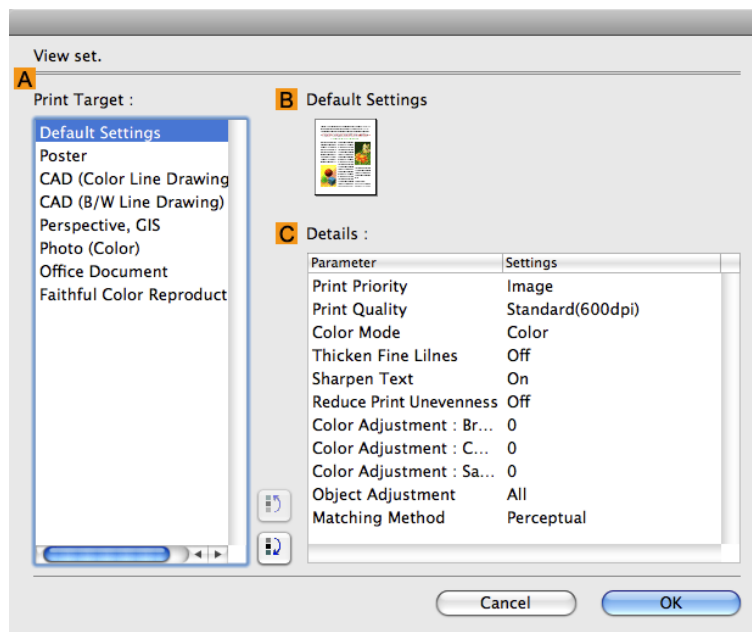

### Note

- To display the **View settings** dialog box, on the **Main** pane, click **View settings** by **Print Target**.(See "Main Pane →P.440 ")

- **A Print Target**

Shows all **Print Target** options (settings items for the printing application).

- **B Name**

Identifies the item selected in **Print Target** by its name and an icon.

- **C Details**

Here, you can confirm detailed settings values for each item selected in the **Print Target** list.

## Matching pane

On the **Matching** pane, you can specify color matching to compensate for differences in the appearance of colors on various devices.

 **Important**

- If **No color correction** is selected under **Color Mode**, the **Matching** pane is not displayed.

 **Note**

- To display the **Matching** pane, on the **Main** pane click **Color Settings** in **Color Mode** in **Advanced Settings**, and then click the **Matching** tab. (Refer to "Main Pane →P.440 ")

## Driver Matching Mode

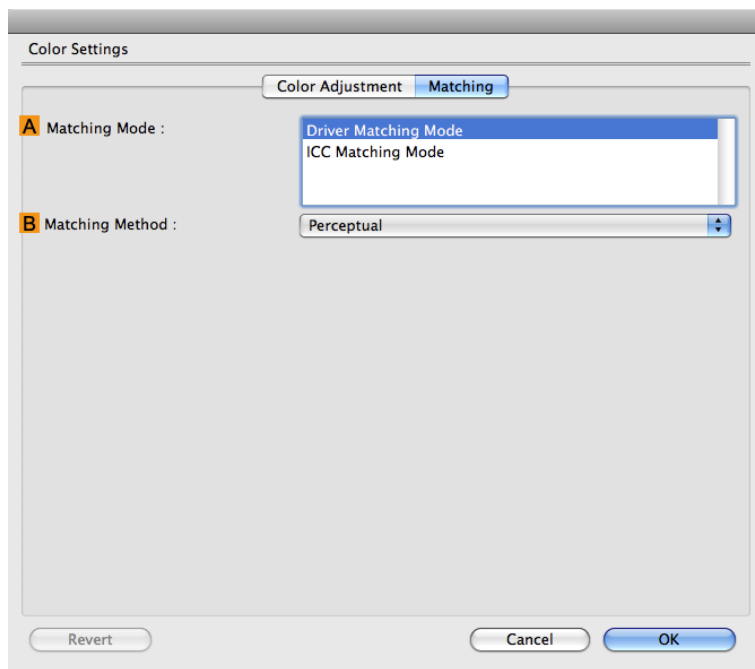

4

- **A Matching Mode**

Select the color matching mode to use, as desired.

- **B Matching Method**

Select the color matching method that suits the document to be printed. Various **B Matching Method** options are available depending on your selection in **A Matching Mode**.

## ICC Matching Mode

The following options are available when you select **ICC Matching Mode**, in the **A Matching Mode** list.

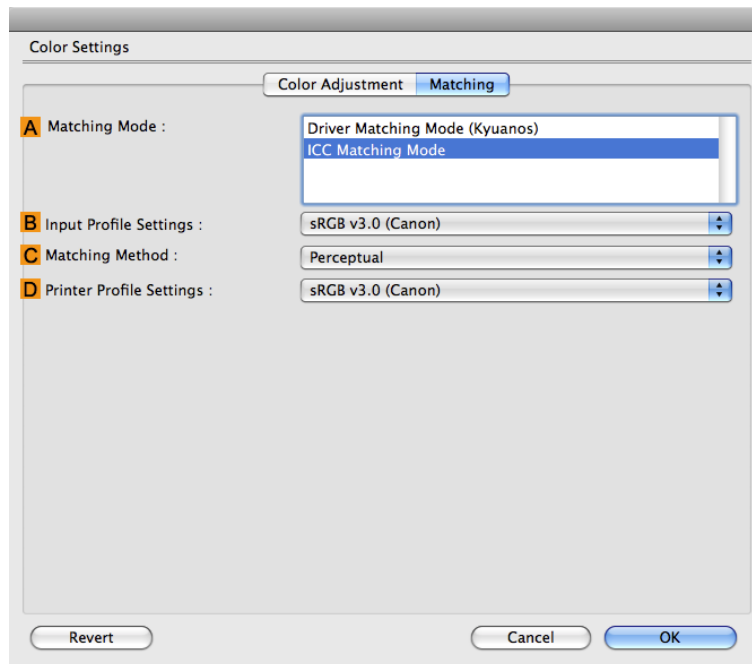

### Note

- To display the **Matching** pane, on the **Main** pane, click **Color Settings** by **Color Mode** in **Advanced Settings**, and then click the **Matching** tab. (See "Main Pane →P.440 ")

### • **A Matching Mode**

Select the color matching mode to use, as desired.

### • **B Input Profile Settings**

You can choose **Input Profile**.

Various options are available depending on your selected **A Matching Mode**.

### • **C Matching Method**

You can choose **C Matching Method**.

Various options are available depending on your selected **A Matching Mode**.

### • **D Printer Profile Settings**

Specify the printer profile as desired.



### Note

- For details on settings items, see "Adjusting the Color in the Printer Driver →P.51 "

## Color Settings Pane: Color

In general, make any needed adjustments to the color of documents in the application used to create them. However, if the color tone as printed is not as you expected, you can also adjust the color in the printer driver. If the color tone as printed is not as you expected, you can adjust it on the **Color Adjustment** pane.

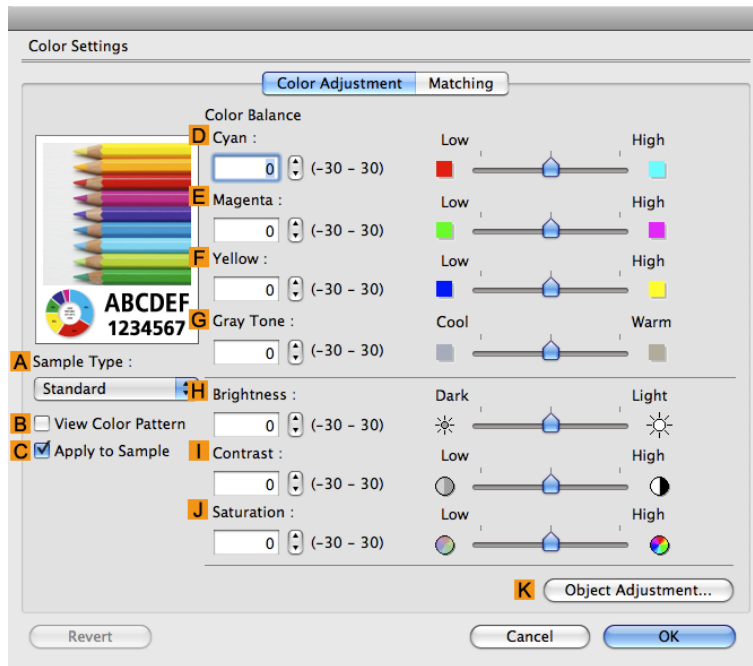

**Note**

- To display the **Color Adjustment** pane, on the **Main** pane click **Color Settings** by **Color Mode** in **Advanced Settings**. (See "Main Pane →P.440 ")
- For details on settings items, see "Adjusting the Color in the Printer Driver →P.51 "

- **A Sample Type**

Choose a sample image from **Standard**, **Portrait**, **Landscape**, or **Graphics**.

- **B View Color Pattern**

Select this checkbox to display the color pattern.

- **C Apply to Sample**

Select this checkbox to apply the changed settings to the sample image.

- **D Cyan / E Magenta / F Yellow**

Correct color tones by adjusting the levels of each color.

- **G Gray Tone**

Adjust the color tone of grays as desired. Choose **Cool** (tinged with blue) or **Warm** (tinged with red).

- **H Brightness**

Adjust the overall image brightness as desired. You can adjust the brightness if the printed document is lighter or darker than the original image (that is, the original photo that was scanned or the original graphic as it appears on the computer screen).

- **I Contrast**

Adjust the contrast of the darkest and lightest portions relative to each other, as desired. Increasing the **Contrast** makes images sharper, and reducing the **Contrast** softens images.

- **J Saturation**

Adjust the color intensity as desired. Increasing the **Saturation** setting makes colors more vivid, and reducing the **Saturation** makes colors more subdued.

- **K Object Adjustment**

Select this option to display the **Object Adjustment** dialog box, in which you can specify objects subject to color adjustment.

- Object Adjustment dialog box: Color →P.449

## Object Adjustment dialog box: Color

In the **Object Adjustment** dialog box, you can specify what type of print jobs to apply color adjustment to. If an original comprises images, graphics, and text, you can specify which portion to apply color adjustment to.

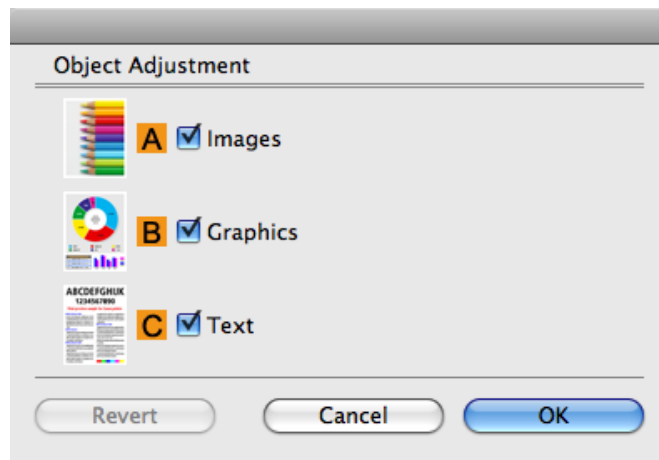

### Note

- To display the **Object Adjustment** dialog box, click **Object Adjustment** on the **Color Adjustment** panel.

- **A Images**

Select this option to apply color adjustment to image areas, such as photos.

- **B Graphics**

Select this option to apply color adjustment to graphics, such as lines and circles.

- **C Text**

Select this option to apply color adjustment to text.

## Color Settings Pane: Monochrome

On the **Color Adjustment** pane for monochrome printing, you can adjust the brightness and contrast.

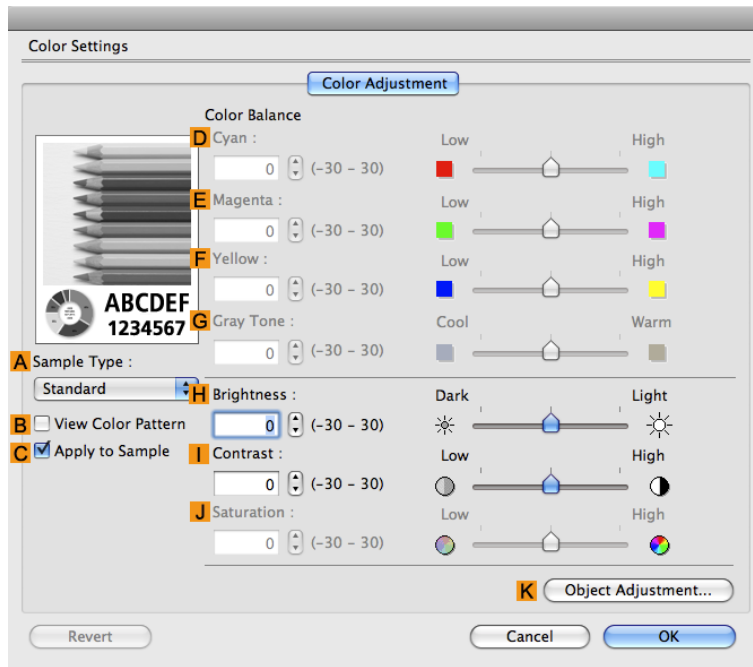

**Note**

- To display the **Color Adjustment** pane, on the **Main** pane, click **Color Settings** in **Advanced Settings**. (See "Main Pane →P.440 ")
- For details on settings items, see "Adjusting the Color in the Printer Driver →P.51 "

- **A Sample Type**  
Choose a sample image from **Standard**, **Portrait**, **Landscape**, or **Graphics**.
- **B View Color Pattern**  
Select this checkbox to display the color pattern.
- **C Apply to Sample**  
Select this checkbox to apply the changed settings to the sample image.
- **D Cyan / E Magenta / F Yellow**  
Not available.
- **G Gray Tone**  
Not available.
- **H Brightness**  
Adjust the overall image brightness as desired. You can adjust the brightness if the printed document is lighter or darker than the original image (that is, the original photo that was scanned or the original graphic as it appears on the computer screen).

4

450



- **I Contrast**

Adjust the contrast of the darkest and lightest portions relative to each other, as desired. Increasing the **I Contrast** makes images sharper, and reducing the **I Contrast** softens images.

- **J Saturation**

Not available.

- **K Object Adjustment**

Select this option to display the **Object Adjustment** dialog box, in which you can specify objects subject to color adjustment.

- Object Adjustment dialog box: Monochrome →P.451

## Object Adjustment dialog box: Monochrome

In the **Object Adjustment** dialog box, you can specify what type of print jobs to apply color adjustment to. If an original comprises images, graphics, and text, you can specify which portion to apply color adjustment to.

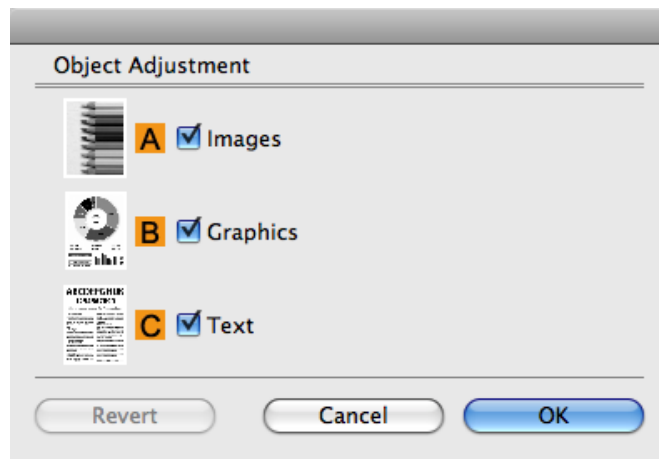

### Note

- To display the **Object Adjustment** dialog box, click **Object Adjustment** on the **Color Adjustment** panel.

- **A Images**

Select this option to apply color adjustment to image areas, such as photos.

- **B Graphics**

Select this option to apply color adjustment to graphics, such as lines and circles.

- **C Text**

Select this option to apply color adjustment to text.

## Page Setup Pane

The following settings are available on the **Page Setup** pane. For details on settings items, refer to the printer driver help.

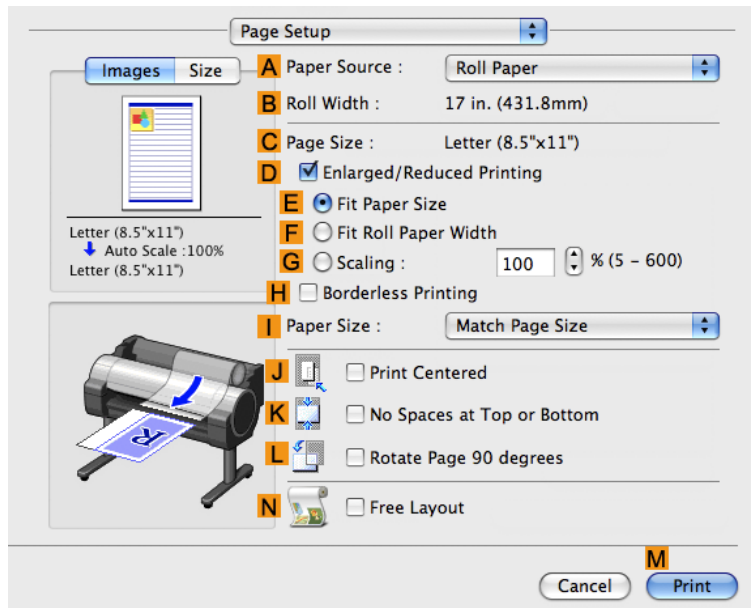

### • **A Paper Source**

Choose how paper is supplied.

Options displayed in the list vary depending on the selection in **A Media Type** in the **Main** pane.

### • **B Roll Width**

Displays the paper width of the roll loaded in the printer. **Unknown** is displayed if the printer cannot detect the roll paper width.

### • **C Page Size**

Displays the size of the original, as specified in the page settings of the application.

For details on page sizes available in the application. see "Paper Sizes →P.569 "

### • **D Enlarged/Reduced Printing**

Select this checkbox to choose the following options.

- Resizing Originals to Match the Paper Size →P.69
- Resizing Originals to Fit the Roll Width →P.75
- Resizing Originals by Entering a Scaling Value →P.81

### • **E Fit Paper Size**

Resizes the document image to match the paper size.

### • **F Fit Roll Paper Width**

Resizes the document image to match the roll width.

### • **G Scaling**

Resizes the document image based on a specified scaling value. Enter a value in a range of **5–600**.

### • **H Borderless Printing**

Borderless printing is available if roll paper is selected in the **A Paper Source** list.

Activate this setting for borderless printing to match the size and width of the paper.

- Borderless Printing on Paper of Equivalent Size →P.104
- Borderless Printing by Resizing Originals to Fit the Roll Width →P.111
- Borderless Printing at Actual Size →P.95

### • **I Paper Size**

Choose the size of the paper you will print on.

Click **Display all selections for Paper Size** to list available sizes.

For details on available paper sizes, see "Paper Sizes →P.569 "

### • **J Print Centered**

Select this checkbox to print document images in the center of the paper.

- Printing Originals Centered on Rolls →P.161
- Printing Originals Centered on Sheets →P.167

### • **K No Spaces at Top or Bottom**

Select this checkbox to print the next image skipping blank areas above and below printable data in documents, which enables you to conserve the paper.

- Conserving Roll Paper by Printing Originals Without Top and Bottom Margins →P.180

### • **L Rotate Page 90 degrees**

Select this checkbox to rotate the document image by 90 degrees before printing.

- Conserving Roll Paper by Rotating Originals 90 Degrees →P.174

### • **N Free Layout**

Select this checkbox to start **imagePROGRAF Free Layout** before printing.

This allows you to print multiple documents next to each other.



#### Important

- When **Print Preview** is selected on the **Main** panel, **Print Preview** is disabled.

- Printing Multiple Originals Next to Each Other →P.139

## Utility Pane

The following settings are available on the **Utility** pane.

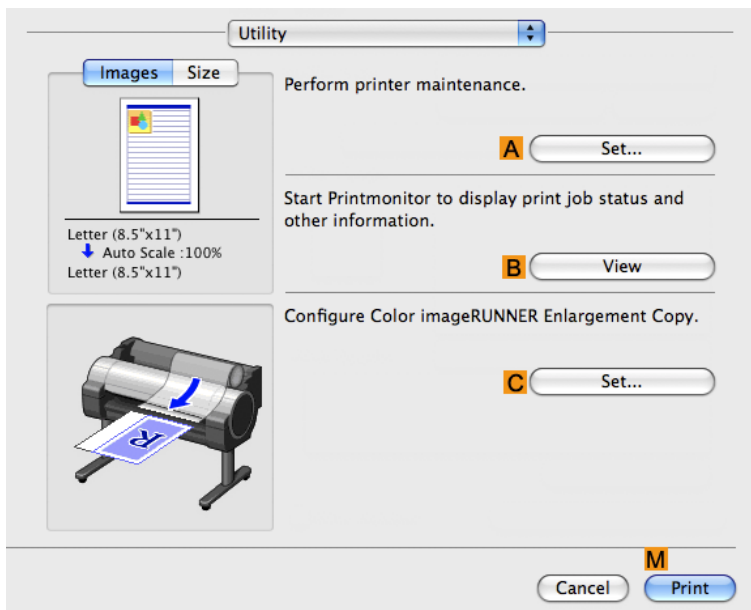

- **A Set**

Click to display the **Printer Information** dialog box, which offers the following maintenance for the printer.

- Nozzle (ink ejecting outlet) cleaning
- Head alignment adjustment
- Feed amount adjustment

- **B View**

Click to start **imagePROGRAF Printmonitor**, which enables you to view the status of print jobs.

- **C Set**

Click to complete the settings for Color imageRUNNER Enlargement Copy (iR enlargement copy).

For details, see Color imageRUNNER Enlargement Copy [→P.518](#) .

## Additional Settings Pane

The following settings are available on the **Additional Settings** pane.

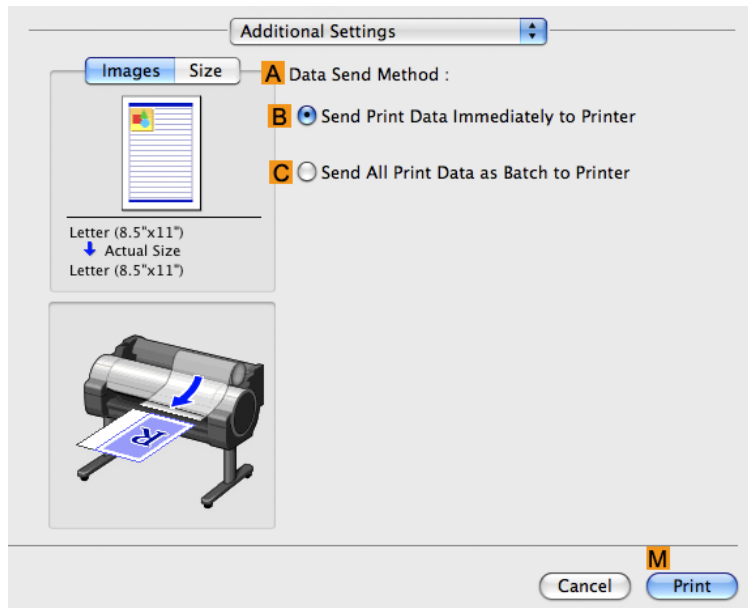

- **A Data Send Method**

Choose how print data is sent to the printer.

- **B Send Print Data Immediately to Printer**
- **C Send All Print Data as Batch to Printer**

## Support Pane

On the **Support** pane, you can view support information and the user's manual.

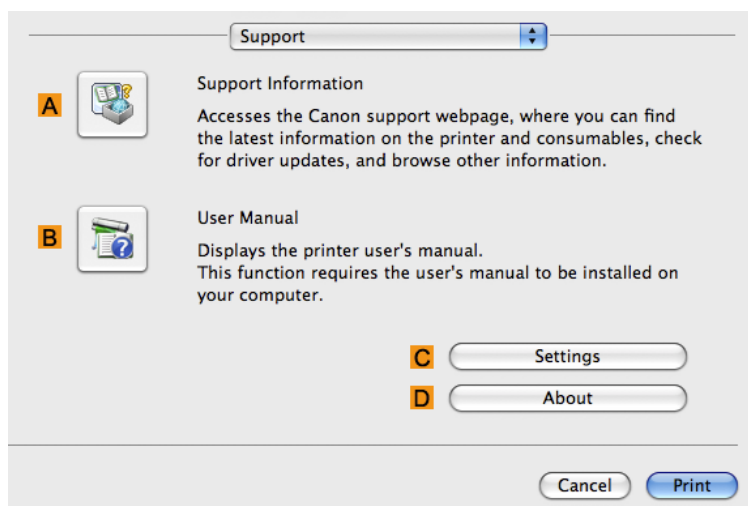

- **A Support Information**

Click to access the Canon support webpage, where you can find the latest information on the printer and consumables, check for printer driver updates, and browse other information.

- **B User Manual**

Click to view the printer user's manual. This function requires the user's manual to be installed on your computer.

- **C Settings**

The settings can be saved as a file. Click to display the **Export** dialog box, which enables you to specify where to save the file.

- **D About**

You can display version information for the printer driver.

## Preview

The Features of Preview .....	457
Operating Environment .....	457
Starting Preview .....	458
Preview Main Window .....	459
Paper Settings Panel .....	462
Easy Settings .....	464
Advanced Settings .....	466
Output Settings Panel .....	467
Color Settings Panel .....	469
Color Adjustment .....	470
Matching .....	473
Driver Matching Mode .....	475
ICC Matching Mode .....	476
ColorSync .....	477
Preferences Dialog Box .....	477
Zoom Dialog Box .....	478
Go to Page Dialog Box .....	478
Print with No Borders .....	479
Print on the Center .....	479
Not Print Spaces at the Top/Bottom .....	480
Print Page Rotated 90 Degrees .....	481
Display with Fitting to the Width of the Paper .....	482
Display with All .....	483
Display with Actual Size .....	484
Moving a Page .....	484

## The Features of Preview

The main features of Preview are as follows.

- While viewing this screen, you can adjust layout settings of a document created with application software.
- You can not only adjust layout settings but also your changes will be instantly applied on the preview screen, and you can print the preview screen as it is seen.



### Note

- The media type, image size, detailed media settings, and the printer settings can cause the actual print output to differ from the Preview settings.

## Operating Environment

You can use the Preview in the following environments.

- Compatible Operating System  
Mac OS X (10.3.9 to 10.6)
- Software that requires installation  
imagePROGRAF Printer Driver

## Starting Preview

Follow the procedure below to start the Preview.

1. Start the application software which you use.
2. From the application software's **File** menu, select the printer setup menu to open the **Print** dialog box.

 **Note**  
• Normally, select **Print** from the **File** menu.

3. Click **Print Preview** in the **Main** panel to attach a checkmark.

4. Click the **Print** button in the **Print** dialog box.

4

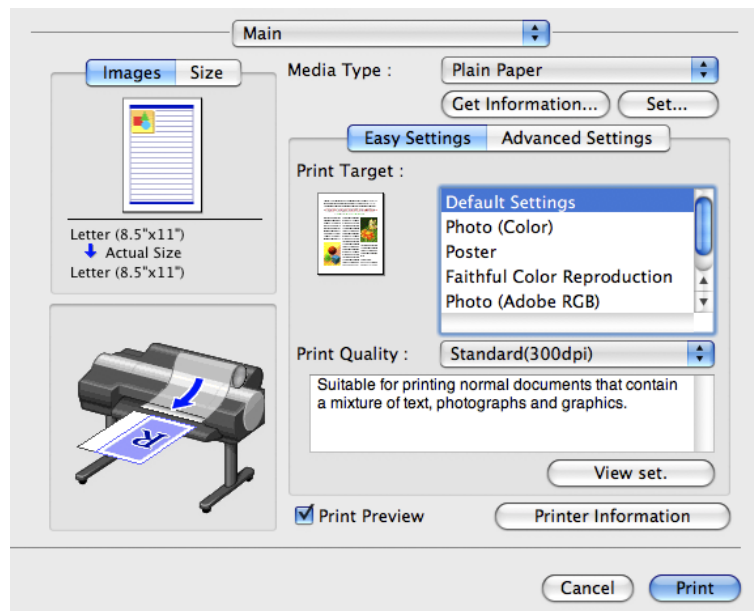

 **Note**  
• Your printer is depicted in the lower-left area of this screen.



## 5. Preview main window is displayed.

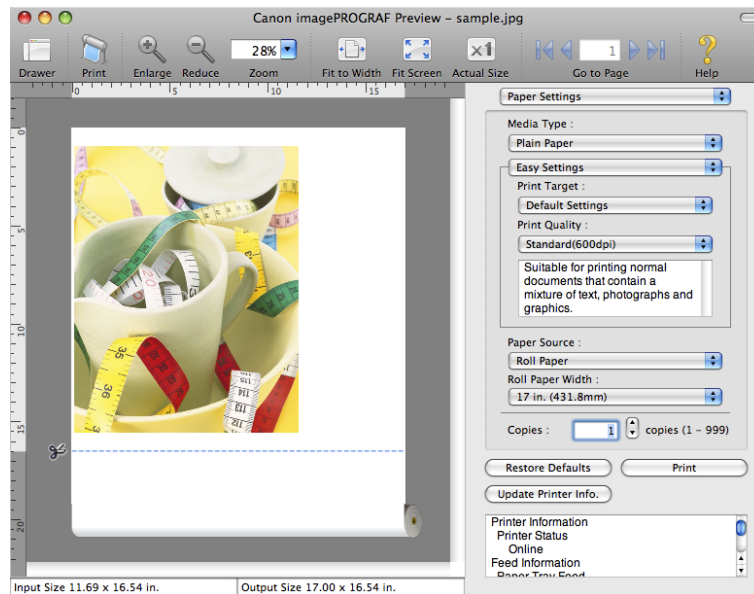

4

### Preview Main Window

The Preview main window consists of the menu and tool bars, and preview, dialog, drawer and status area.

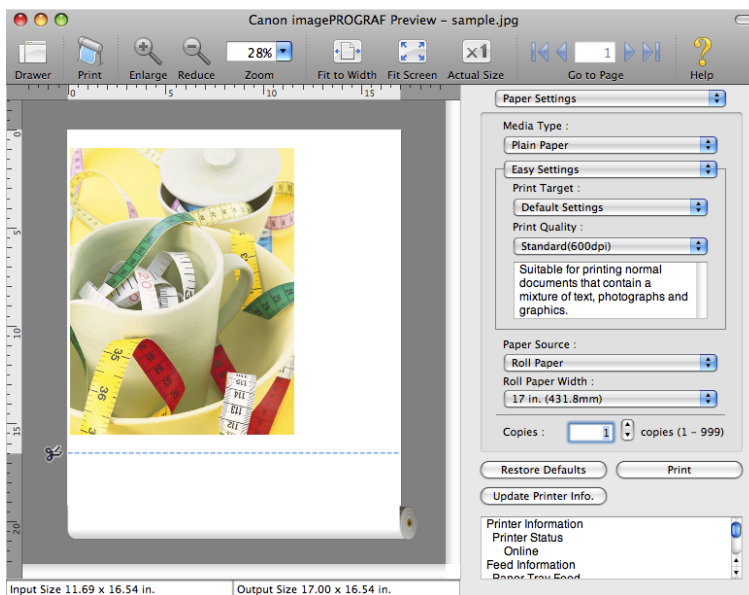

459



#### Note

- You can use the **View** menu to show or hide the tool bar.

#### • Menu Bar

This allows you to select menus required for operations.



- Tool Bar

This allows you to select tool buttons required for major operations.



- Preview Area

You can check the settings you made in this area.

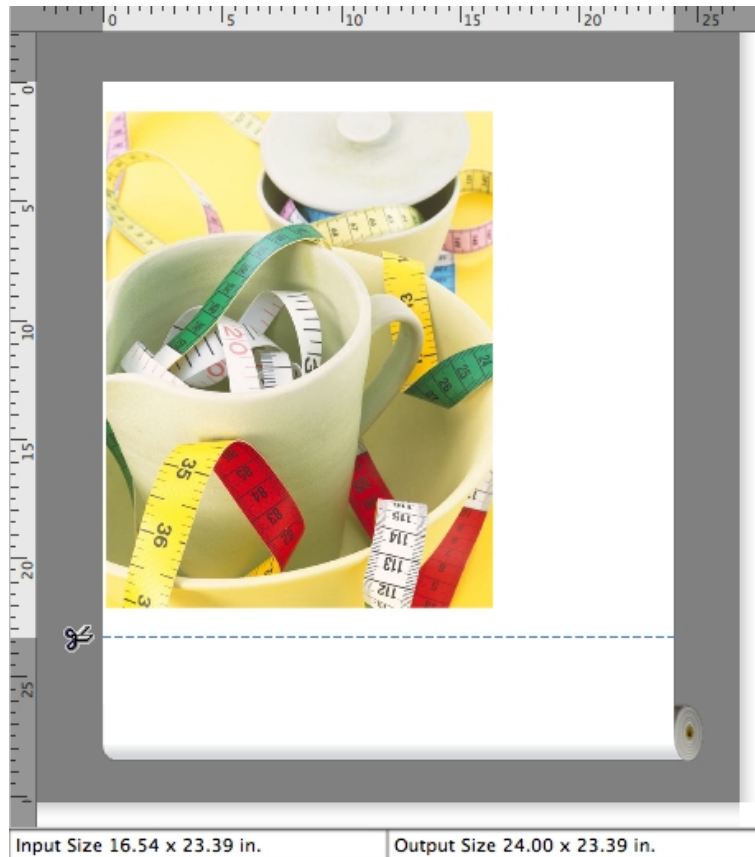

- **Dialog Area**

This allows you to set the print conditions and perform a print job.

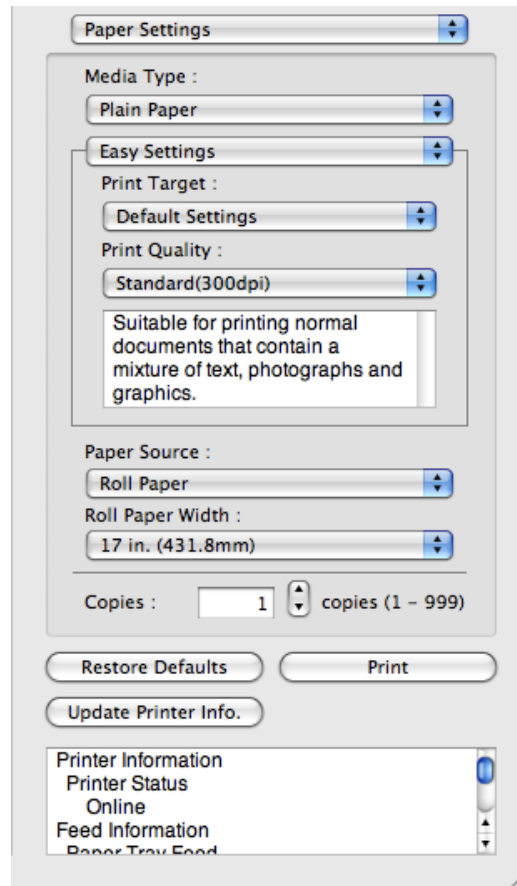

4

- **Drawer Area**

This allows you to display the thumbnails of a document.

This area appears when you click  **Drawer** from the tool bar.

Alternatively, you may select **Drawer** from the **View** menu.

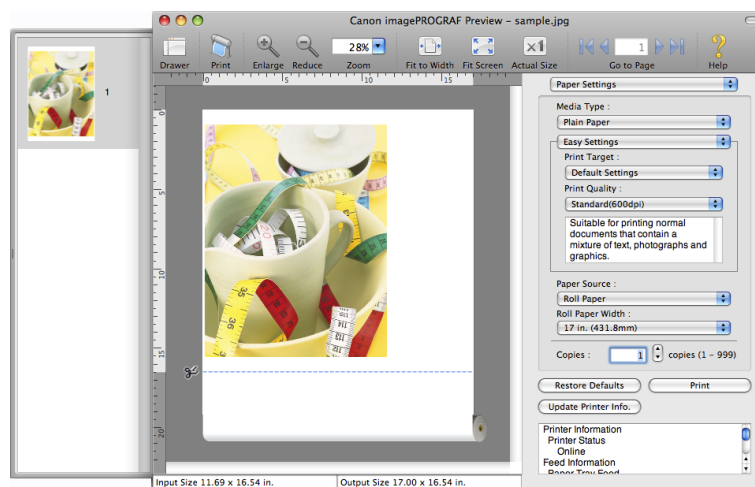

461

- **Status Area**

This shows **Input Size** and **Output Size**.



## Paper Settings Panel

This panel appears when you select **Paper Settings** in the dialog area.

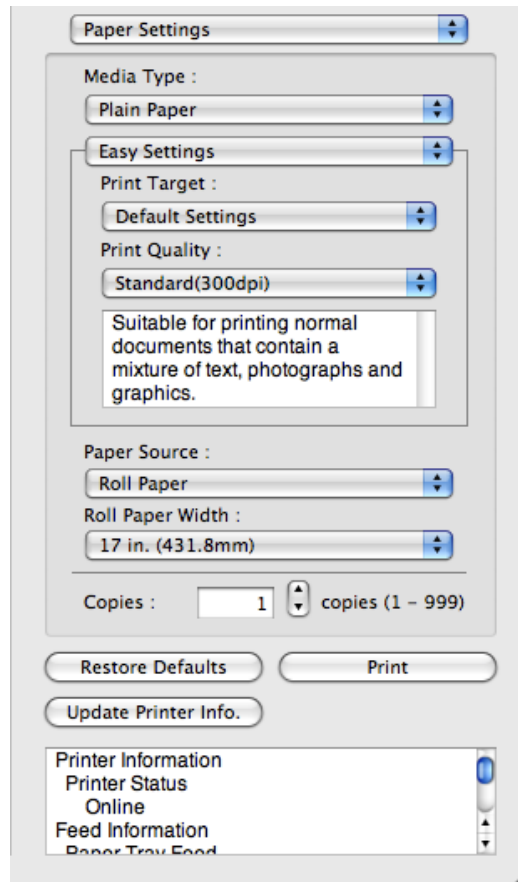

- **Media Type**

This allows you to select the media type.



**Note**

- Always select media type that is actually set in the printer. When the media you chose is different from the media set in the printer, you may not receive the desired print results.

- **Easy Settings / Advanced Settings**

Two modes are available to provide the optimum print settings for jobs.

The settings available on each mode are as follows.

- Easy Settings →P.464
- Advanced Settings →P.466

### • Paper Source

You can select the paper source.

The following settings are available for paper source.

Setting	Details
<b>Manual</b>	Select for manual paper feed printing.
<b>Roll Paper</b>	Select to print on roll paper.

### • Roll Paper Width

This selects the width of the roll media set to the printer.



#### Note

- Available only if rolls are selected in **Paper Source**.

### • Copies

You can input the number of print copies in numerical characters.



#### Note

- The maximum value is 999.
- You can change the numbers by clicking either ▲ button or ▼ button.

### • Restore Defaults Button

Click the button to reset to the setting when starting Preview.

### • Print Button

Click the button to begin printing.

### • Update Printer Info. Button

Click the button to acquire printer information.

## Easy Settings

You can easily select the best settings for the print job by just selecting an item from the print target list that matches the content of the document.

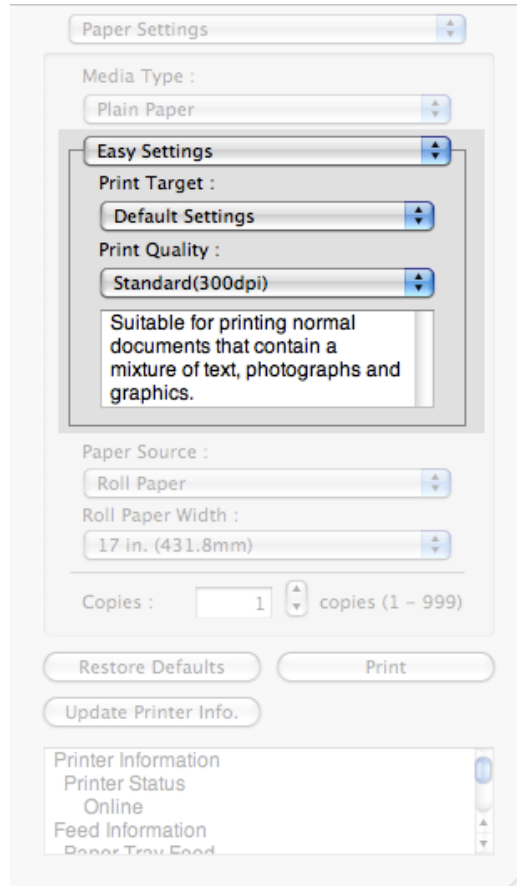

4

- **Print Target**

You can easily select the best settings for the print job simply.

If you select each **Print Target** item the corresponding comment for that item is displayed below the list.

Setting	Details
<b>Default Settings</b>	Suitable for printing normal documents that contain a mixture of text, photographs, and graphics.
<b>Office Document</b>	Suitable for printing handouts as well as general office documents for which print clarity is key.
<b>Poster</b>	The best setting for posters. Prints using vivid and high impact colors.
<b>CAD (Color Line Drawing)</b>	Prints the fine lines of CAD drawings and other such documents sharp and clear.
<b>CAD (B/W Line Drawing)</b>	Suitable for printing CAD drawings with sharp, dark lines.
<b>Perspective, GIS</b>	Suitable for attractive printing of 3D-CAD drawings, perspective drawings, and GIS drawings including maps.
<b>Photo (Color)</b>	Suitable for printing photographic images captured with a digital camera.
<b>Faithful Color Reproduction</b>	Prints by faithfully reproducing the colors of the original image.
<b>Custom Settings</b>	Suitable for printing documents for which Advanced Settings have been specified.

464

**Note**

- The number of settings available for selection depends on the media type.

### • Print Quality

Selecting print quality strikes a balance between the quality of the printed image and printing speed.

The level of the print quality and resolution settings are displayed in the following combinations.

Setting	Details
Print Quality	<b>Highest / High / Standard / Draft</b>
Resolution	<b>1200dpi / 600dpi / 300dpi</b>

**Note**

- The availability of settings is determined by the media type and print priority selections.
- Printing time is longer and more ink is consumed with **High** than with **Draft**, however, print quality is higher.
- Printing time is shorter and less ink is consumed with **Draft** than with **High**, however, print quality is lower.

## Advanced Settings

Presents detailed settings for the print quality, the color mode, and other items so you can select the values for these settings yourself.

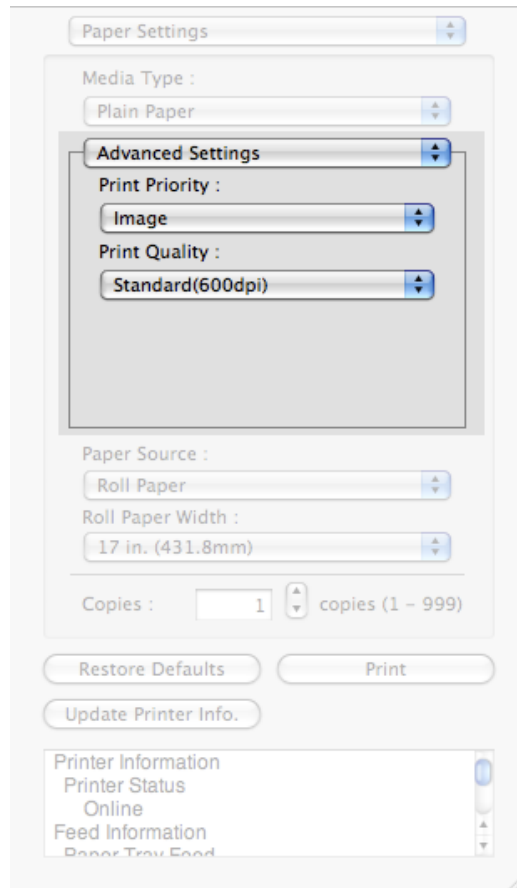

### • Print Priority

Select a print quality mode that is appropriate for the print job.

Setting	Details
<b>Image</b>	This mode achieves the best results for printing photographic images and illustrations.
<b>Line Drawing</b>	This mode is best for printing CAD drawings with fine lines or wall newsheet or other documents that contain large amounts of text. However, you may not achieve the quality you expect with printing photographs or other images with many filled areas. For these types of jobs, select <b>Image</b> .
<b>Office Document</b>	Prints common office documents, such as proposals, memos for distribution, etc., so they are easy to read.



#### Note

- The number of settings available for selection depends on the media type.

### • Print Quality

Selecting print quality strikes a balance between the quality of the printed image and printing speed.



The level of the print quality and resolution settings are displayed in the following combinations.

Setting	Details
Print Quality	<b>Highest / High / Standard / Draft</b>
Resolution	<b>1200dpi / 600dpi / 300dpi</b>



#### Note

- The availability of settings is determined by the media type and print priority selections.
- Printing time is longer and more ink is consumed with **High** than with **Draft**, however, print quality is higher.
- Printing time is shorter and less ink is consumed with **Draft** than with **High**, however, print quality is lower.

## Output Settings Panel

This panel appears when you select **Output Settings** in the dialog area.

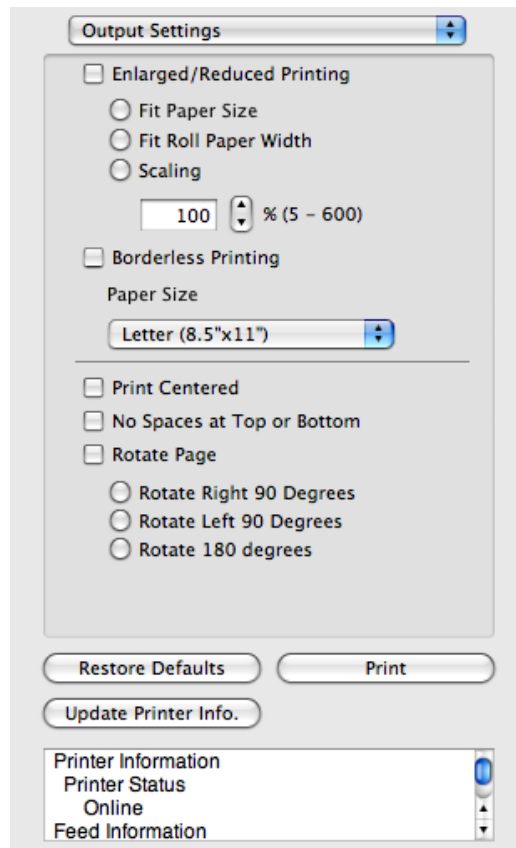

### • Enlarged/Reduced Printing

Select the method for enlarged/reduced printing.

The following settings are available for enlarged/reduced printing.

Setting	Details
<b>Fit Paper Size</b>	Enlarges/reduces the whole page automatically to fit the media size selected for output. Select the media size to print from <b>Paper Size</b> .

Setting	Details
<b>Fit Roll Paper Width</b>	<p>Enlarges/reduces the whole page automatically to fit the width of the roll paper with the page width.</p> <p>*Make sure that the width of the roll paper in the printer is set correctly for <b>Roll Paper Width</b> in the <b>Paper Settings</b> panel.</p> <p>*Displayed only if rolls are selected in <b>Paper Source</b>.</p>
<b>Scaling</b>	<p>Enlarges/reduces the whole page by the scaling rate as specified. Input the scaling value in numerical characters. You can specify a range between 5 and 600%.</p> <p>*You can change the numbers by clicking either ▲ button or ▼ button.</p> <p>*Although Scaling can be set to make the image larger than the media size, the part that does not fit in the media cannot be printed.</p> <p>*This is not displayed when a checkmark is placed in <b>Borderless Printing</b>.</p>

#### • **Borderless Printing**

You can print the media without margins on all sides when the roll paper with the specific width and the specific media type is used.

For more information about **Borderless Printing**, see "Print with No Borders." →P.479



#### Note

- Available only if rolls are selected in **Paper Source**.
- This is not displayed when a checkmark is placed in **Print Centered**.

#### • **Paper Size**

You can select the size of the print media.



#### Note

- This is not displayed when **Fit Roll Paper Width** is set in **Enlarged/Reduced Printing**.

#### • **Print Centered**

You can print on the center of the media loaded in the printer.

For more information about **Print Centered**, see "Print on the Center." →P.479



#### Note

- This is not displayed when a checkmark is placed in **Borderless Printing**.

#### • **No Spaces at Top or Bottom**

You can save paper on not to feed roll paper for the empty spaces when the print data contains spaces at the top or bottom.

For more information about **No Spaces at Top or Bottom**, see "Not Print Spaces at the Top/Bottom." →P.480



#### Note

- Available only if rolls are selected in **Paper Source**.

#### • **Rotate Page**

Select the method for rotating page.

The following settings are available for rotating page.

Setting	Details
<b>Rotate Right 90 Degrees</b>	Rotates the portrait page right 90 degrees and print in landscape orientation. When the rotated page can fit in the width of roll paper, the page is rotated automatically, and when it can not fit in the width of roll paper, the page is not rotated.
<b>Rotate Left 90 Degrees</b>	Rotates the portrait page left 90 degrees and print in landscape orientation. When the rotated page can fit in the width of roll paper, the page is rotated automatically, and when it can not fit in the width of roll paper, the page is not rotated.
<b>Rotate 180 degrees</b>	Allows you to rotate the image 180 degrees from the vertical to the right.

- **Restore Defaults Button**

Click the button to reset to the setting when starting Preview.

- **Print Button**

Click the button to begin printing.

- **Update Printer Info. Button**

Click the button to acquire printer information.

4

## Color Settings Panel

This panel appears when you select **Color Settings** in the dialog area.

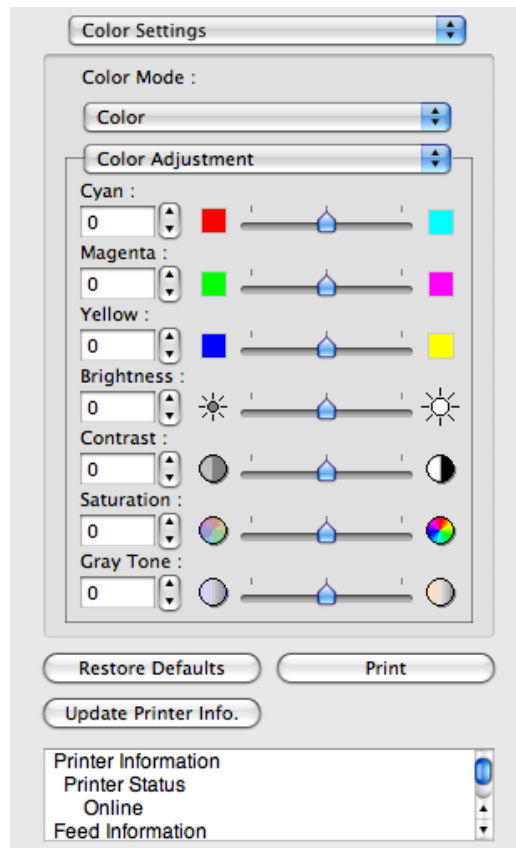

469

- **Color Mode**

You can select a color mode to suit the print job.

Setting	Details
<b>Color</b>	Enables color printing.
<b>Monochrome</b>	Disables color printing and converts image from continuous color to grayscale monochrome.
<b>Color (CAD)</b>	Prints lines in the best color possible so they are easy to see.
<b>Monochrome Bitmap</b>	Prints all colors other than white in black.
<b>Monochrome (BK ink)</b>	Select to print all lines with black ink.
<b>No color correction</b>	Prints without performing color matching in the printer driver. Select this when color matching is performed by the application such as Adobe Photoshop or when you want to print color charts using the profile creation tool.

**Note**

- The availability of settings depends on the print priority and media type selections.

#### 4 • Color Adjustment / Matching

You can set the color adjustment and matching.

- Color Adjustment →P.470
- Matching →P.473

#### • Restore Defaults Button

Click the button to reset to the setting when starting Preview.

#### • Print Button

Click the button to begin printing.

#### • Update Printer Info. Button

Click the button to acquire printer information.

## Color Adjustment

You can set the color adjustment.

### Adjusting Color

Normally colors should be adjusted in the software application, but if you see colors in the printout that do not match colors on the screen, you can perform color adjustments.

1. Select **Color** on **Color Mode** in the **Color Settings** panel.

## 2. Select Color Adjustment.

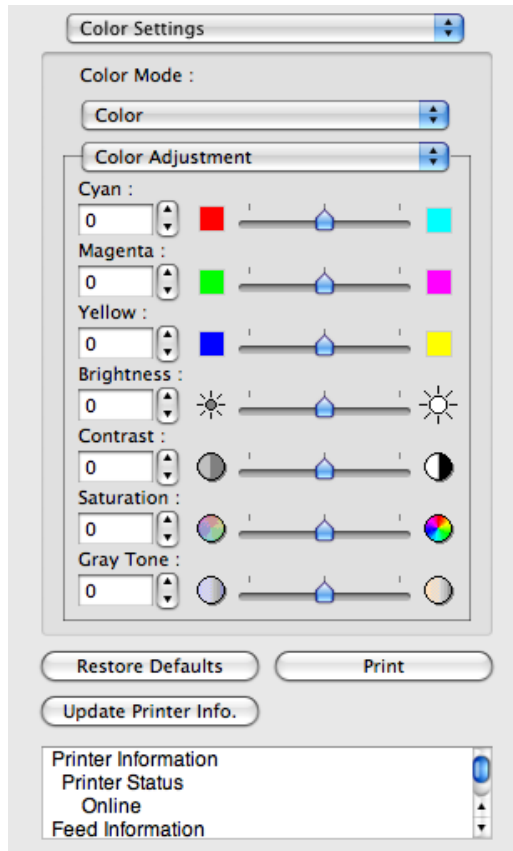

## 3. Drag each slider to the left or right to adjust.

Setting	Details
<b>Cyan</b>	Adjusts the strength of colors to compensate the hues.
<b>Magenta</b>	Adjusts the strength of colors to compensate the hues.
<b>Yellow</b>	Adjusts the strength of colors to compensate the hues.
<b>Brightness</b>	Adjusts the brightness of the entire image. When the results of the printout are brighter than the original images such as the original photo before scanning and graphics created on the display, or when you want to print in different degrees of brightness, use this feature.
<b>Contrast</b>	Adjusts the relative brightness between the brightest and darkest portions of the image. *For soft gradation, decrease the contrast. For hard gradation, increase the contrast.
<b>Saturation</b>	Adjusts the hues for vivid color or dark color.
<b>Gray Tone</b>	Adjusts gray from cool black (bluish tones) to warm black (reddish tones).



### Note

- You can also click the up or down arrow, or enter the number directly to increase or decrease the value.

## Adjusting Monochrome

Use the monochrome setting to print monochrome images of color photographs captured with a scanner or digital camera or other color images.

1. Select **Monochrome** on **Color Mode** in the **Color Settings** panel.
2. Select **Color Adjustment**.

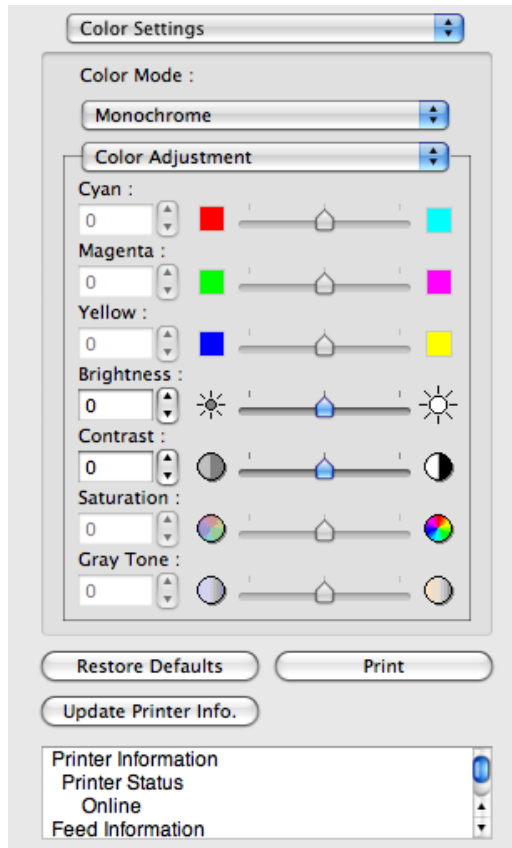

3. Drag each slider to the left or right to adjust.

Setting	Details
<b>Brightness</b>	Adjusts the brightness of the entire image. When the results of the printout are brighter than the original images such as the original photo before scanning and graphics created on the display, or when you want to print in different degrees of brightness, use this feature.
<b>Contrast</b>	Adjusts the relative brightness between the brightest and darkest portions of the image.  *For soft gradation, decrease the contrast. For hard gradation, increase the contrast.



**Note**

- You can also click the up or down arrow, or enter the number directly to increase or decrease the value.

## Matching

You can set the matching.



### Important

- If **No color correction** is selected under **Color Mode**, the **Matching** is not displayed.

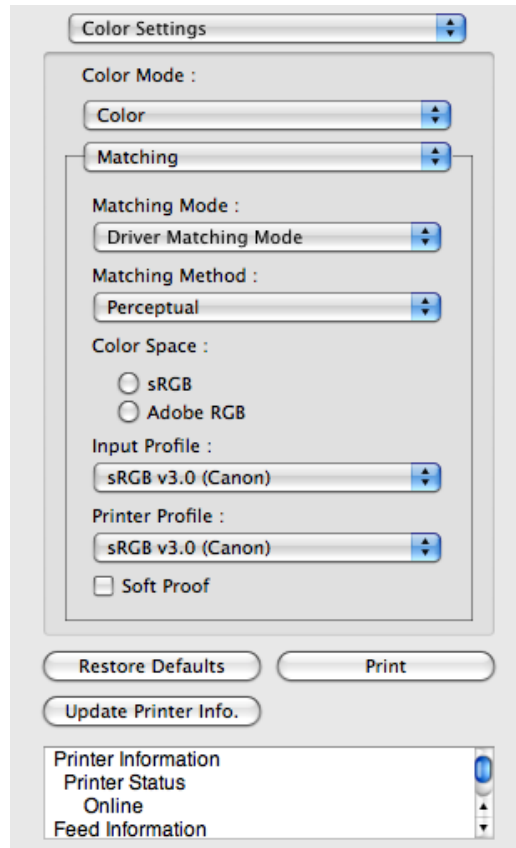

### • Matching Mode

You can select a matching mode to suit the print job.

Setting	Details
Driver Matching Mode →P.475	Enables printing of optimal color tones using a driver specific color profile. You should normally select this mode.
ICC Matching Mode →P.476	Enables color matching using ICC profiles. Select this if you want to print by specifying the input profile, printer profile, and matching method in detail. This allows you to use ICC profiles for digital cameras and scanners, ICC profiles created using the profile creation tool, etc.
ColorSync →P.477	Enables color matching by using the ColorSync function of Mac OS. Select this if you want to perform soft proofing using ColorSync before printing.



### Note

- You need to set each correction on the printer driver.
- Using Mac OS X 10.5 or later, **ColorSync** needs to be selected in the **Color Matching** panel of the driver in order to select **ColorSync**.

• **Matching Method**

You can select a matching method to suit the print job.

• **Input Profile**

Select the input profile.



Note

- You can select only after **ICC Matching Mode** has been selected in **Matching Mode**.

• **Printer Profile**

Select the printer profile.



Note

- (Using Mac OS X 10.3.9 - 10.4) You can select only after **ICC Matching Mode** or **ColorSync** has been selected in **Matching Mode**.
- (Using Mac OS X 10.5 or later) You can select only after **ICC Matching Mode** has been selected in **Matching Mode**.

• **Soft Proof**

When you place a checkmark here, **ColorSync** applies to the preview area.



Note

- You can select only after **ColorSync** has been selected in **Matching Mode**.



## Driver Matching Mode

1. Under **Matching Mode**, select **Driver Matching Mode**.

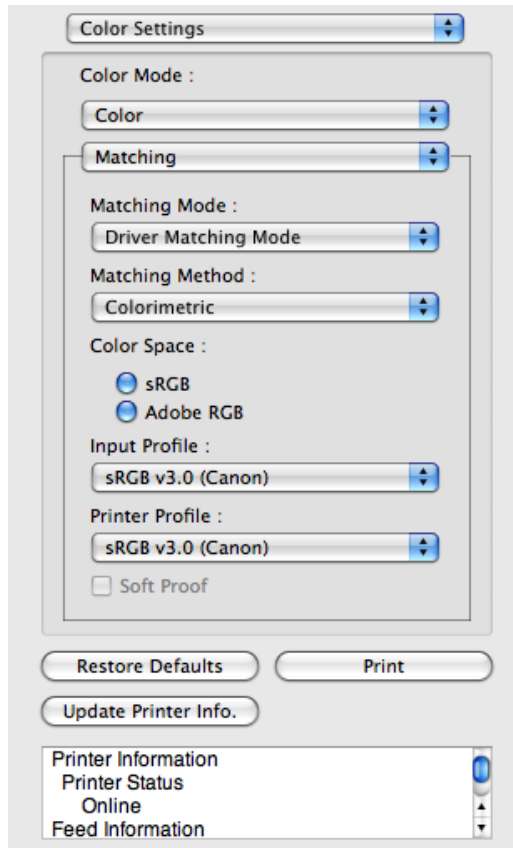

2. Click **Matching Method** list, and then select a setting.

Setting	Details
<b>Auto</b>	Automatically selects the best color matching method for each Image, Graphics, Text.
<b>Perceptual</b>	Color-matching optimized for printing typical photos attractively. Smooth gradation is a feature. This is also an easy-to-use mode when performing color adjustment using application software.
<b>Saturation</b>	Color-matching optimized for printing posters, etc., vividly.
<b>Colorimetric</b>	Color-matching optimized for printing image data with accurate colors in input color space. This is the easiest-to-use mode when you want to adjust the color and print. However, gradation may be lost for colors of wider range than the color reproduction range of the printer. Generally, this is also called relative colorimetric.

## ICC Matching Mode

1. Under **Matching Mode**, select **ICC Matching Mode**.

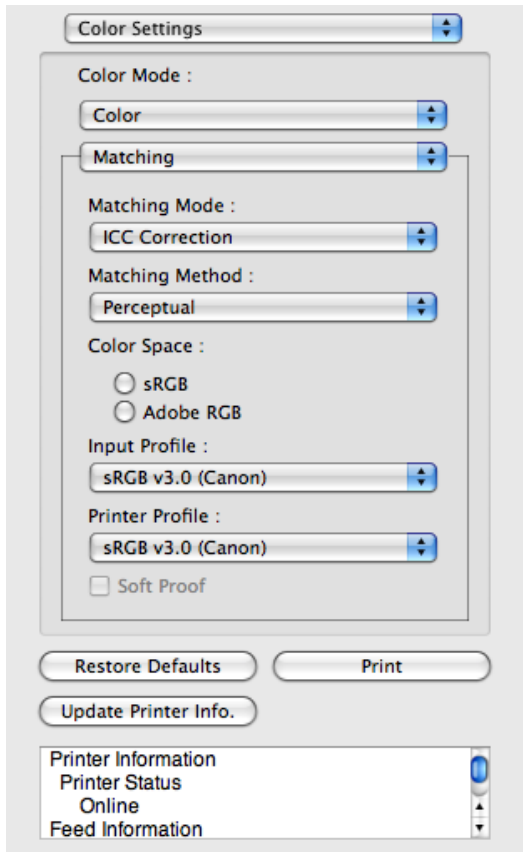

2. Click the **Matching Method** list, and then select a setting.

Setting	Details
<b>Perceptual</b>	Color-matching optimized for printing typical photos attractively. Smooth gradation is a feature. This is also an easy-to-use mode when performing color adjustment using application software.
<b>Saturation</b>	Color-matching optimized for printing posters, etc., vividly.
<b>Colorimetric</b>	Color-matching optimized for printing image data with accurate colors in input color space. This is the easiest-to-use mode when you want to adjust the color and print. However, gradation may be lost for colors of wider range than the color reproduction range of the printer. Generally, this is also called relative colorimetric.
<b>Colorimetric (No White-Point Correction)</b>	The processing method of color-matching is identical to <b>Colorimetric</b> . Use this when you want to further reproduce the target paper material color of the image data. Generally, this also is called absolute colorimetric.

3. Click the **Input Profile** list and select an input profile.

4. Click the **Printer Profile** list and select a printer profile.

## ColorSync

1. Check that **ColorSync** is selected in **Matching Mode**.

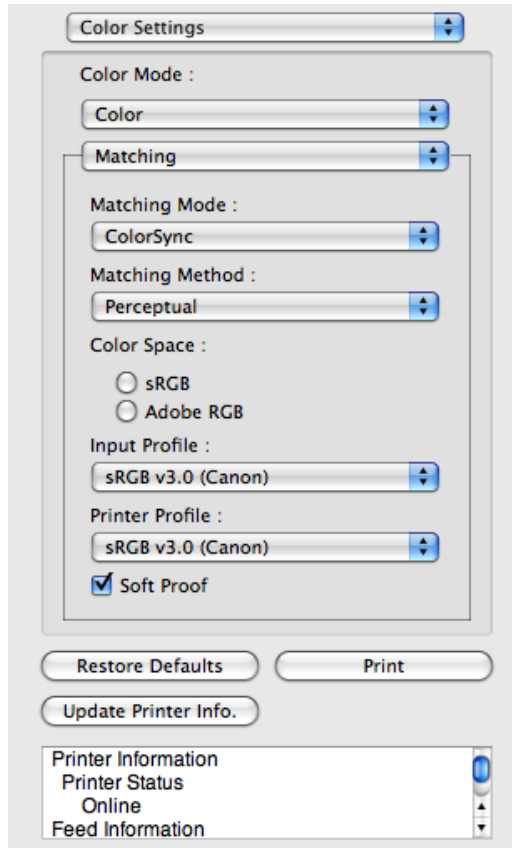

2. To apply **ColorSync** to previews, check the **Soft Proof** check box.

## Preferences Dialog Box

This dialog box appears when you select **Preferences** from the **imagePROGRAF Advanced Preview** menu. You can set the preferences for Preview.

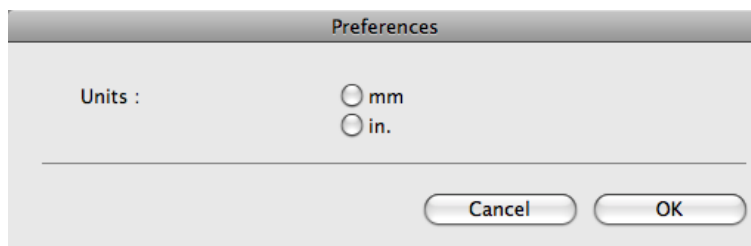

• **Units**

Set the unit for paper length, margins, and so on.

## Zoom Dialog Box

This dialog box appears when you select **Zoom** from the **View** menu. You can enlarge or reduce the screen display.

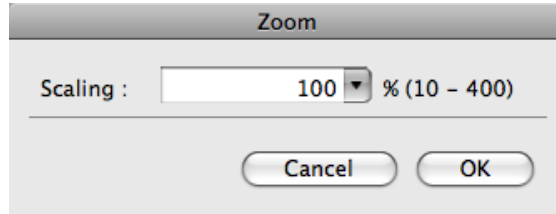

• **Scaling**

Set the magnification for enlargement or reduction of the screen display.



**Note**

- You can input between 10 and 400.
- You can change the numbers by clicking ▼ button.

## Go to Page Dialog Box

This dialog box appears when you select **Go to Page** from the **View** menu.

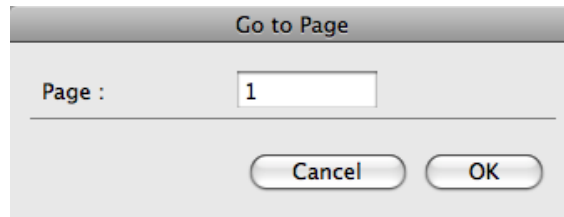

**Note**

- You can not select **Go to Page** if the document is only one page.

• **Page**

Input the page number in numerical characters to display in the preview area.



**Note**

- You can change the numbers in the range of the page of the documents.

## Print with No Borders

You can use the borderless printing function to print without margins surrounding the image.



### Note

- With some media borderless printing can be performed only between two edges.
- To use the borderless printing function, the specified media must be set to the printer.

1. On the Paper Settings Panel [→P.462](#) , select **Roll Paper** in **Paper Source**.
2. On the **Output Settings** panel, click the **Enlarged/Reduced Printing** check box on.
3. Select **Fit Roll Paper Width**.
4. Click the **Borderless Printing** check box on.

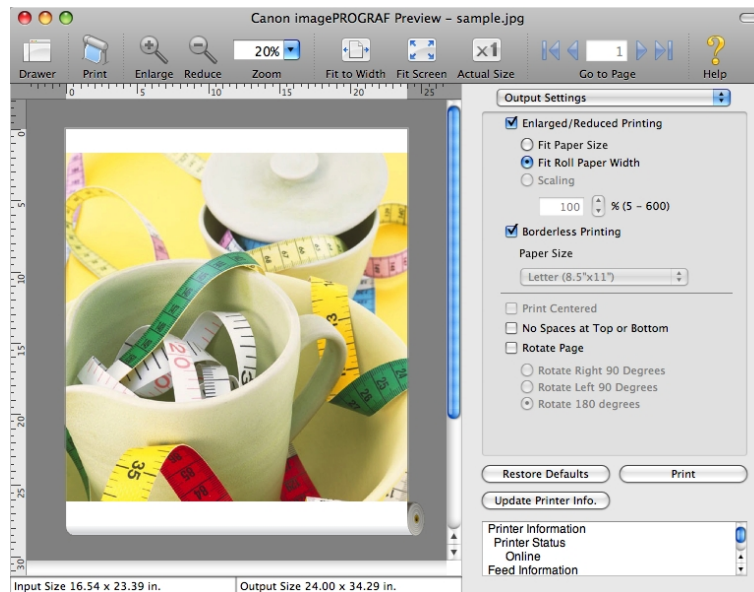

5. Click the **Print** button.  
Borderless printing begins.

## Print on the Center

You can print on the center of the media loaded in the printer.



### Note

- This is not displayed when a checkmark is placed in **Borderless Printing**.

1. On the **Output Settings** panel, click the **Print Centered** check box on.

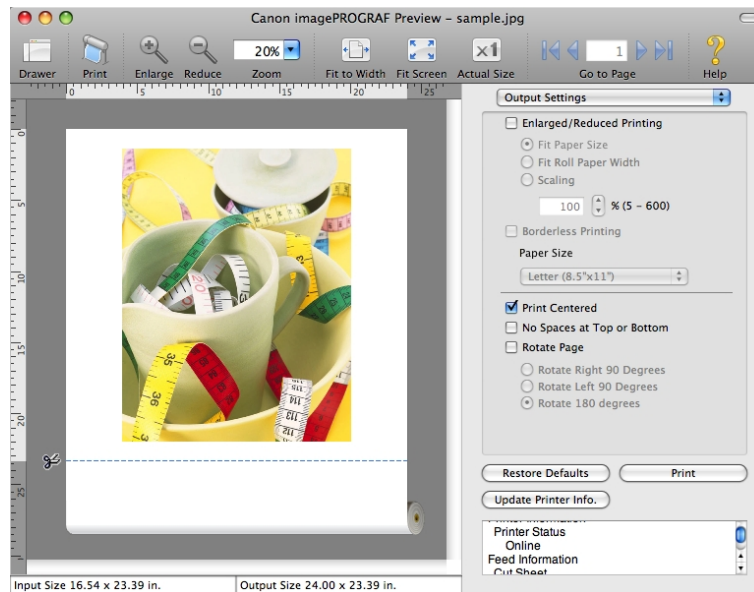

2. Click the **Print** button.  
Printing on the center begins.

## Not Print Spaces at the Top/Bottom

You can save paper on not to feed roll paper for the empty spaces when the print data contains spaces at the top or bottom.



### Note

- This is not displayed when a checkmark is placed in **Borderless Printing**.

1. On the Paper Settings Panel **→P.462**, select **Roll Paper** in **Paper Source**.

- On the **Output Settings** panel, click the **No Spaces at Top or Bottom** check box on.

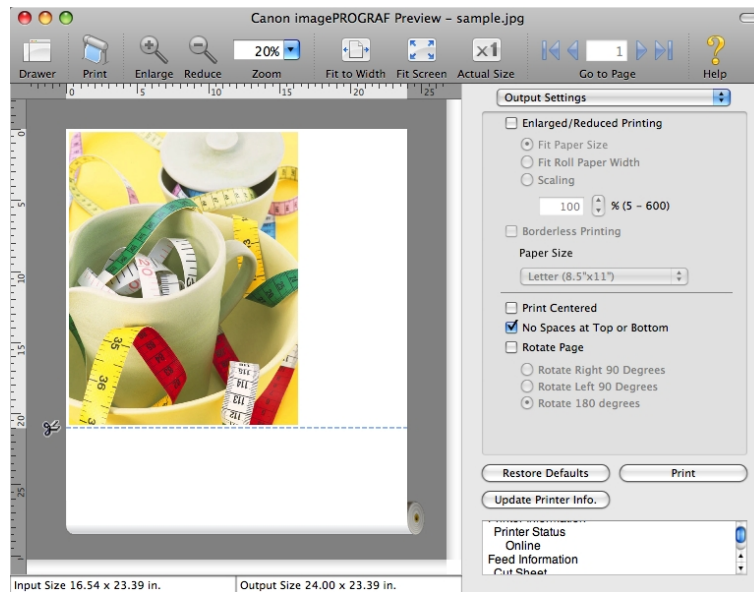

- Click the **Print** button.

Printing on the settings with no spaces at top or bottom begins.

4

## Print Page Rotated 90 Degrees

You can save paper by printing in landscape orientation on roll paper.

- On the Paper Settings Panel [→P.462](#), select **Roll Paper** in **Paper Source**.
- On the **Output Settings** panel, click the **Rotate Page** check box on.

481

### 3. Select **Rotate Right 90 Degrees** or **Rotate Left 90 Degrees**.

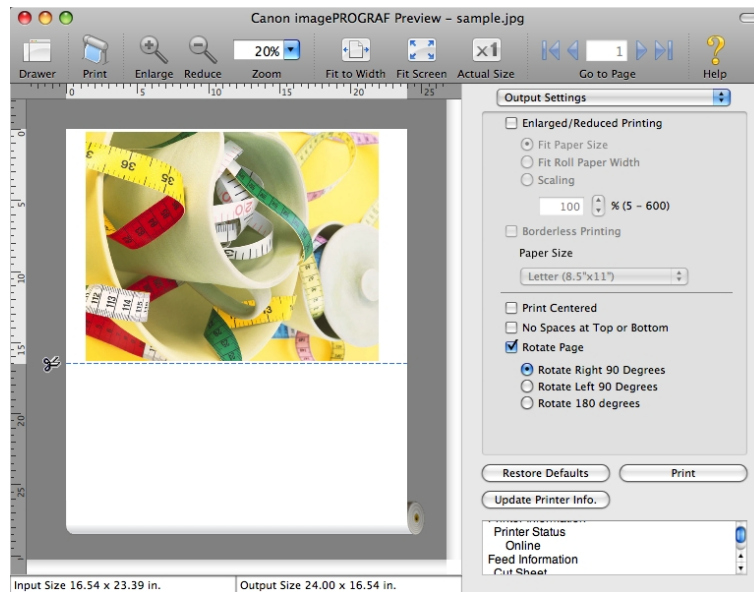

### 4. Click the **Print** button.

Printing on rotating 90 degrees begins.

## Display with Fitting to the Width of the Paper

In the preview area, you can display to the width of the paper.

1. Select  **Fit to Width** from the tool bar.



## 2. Fitting to the width of the paper, it is displayed.

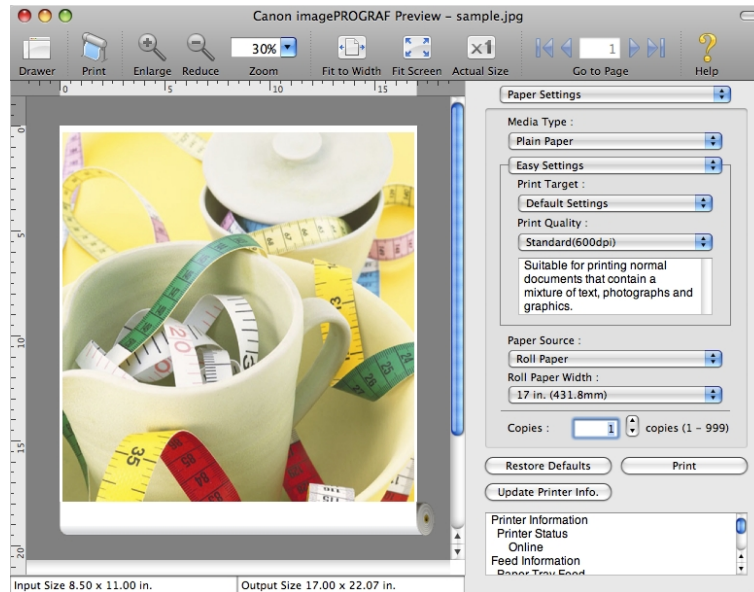

4

## Display with All

In the preview area, you can display all.

1. Select  **Fit Screen** from the tool bar.

2. All is displayed.

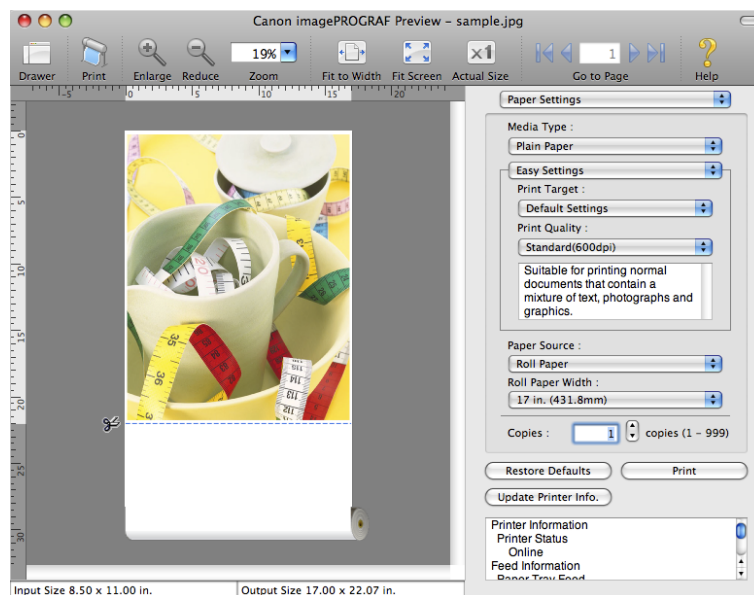

483

## Display with Actual Size

In the preview area, you can display the actual size.

1. Select  **Actual Size** from the tool bar.
2. Actual size is displayed.

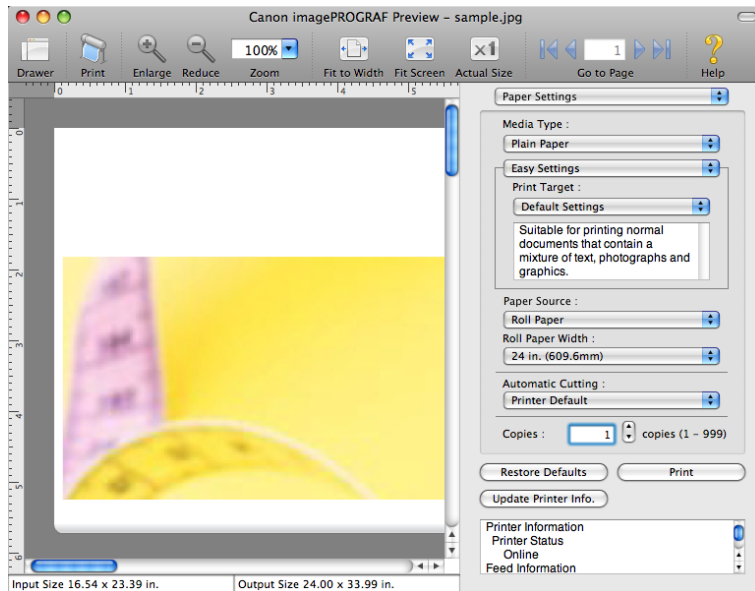





4

## Moving a Page

You can move a page to display in the preview area.

1. Select each button in **Go to Page** on the tool bar.

Setting	Details
	Go to the first page.
	Go to the previous page.
	Go to the next page.
	Go to the last page.

484

## 2. The target page appears.

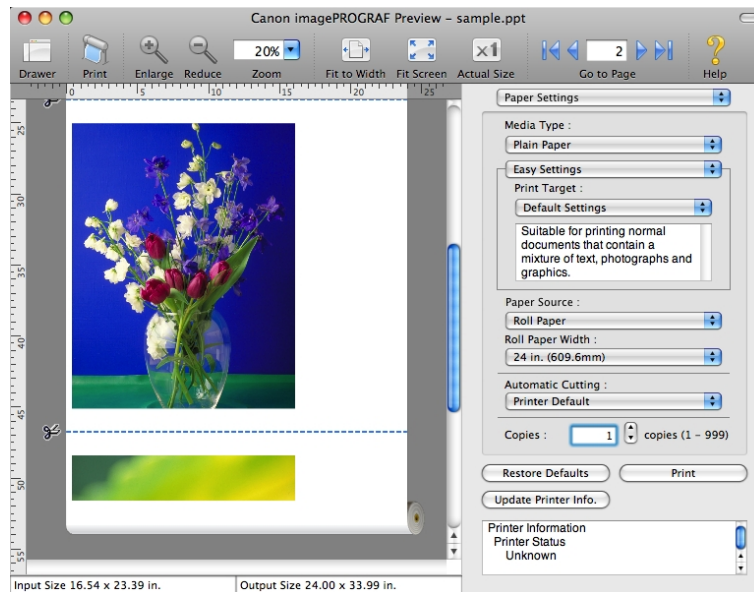

### Note

- You can also move a page by clicking the page on the thumbnails.

## Free Layout

The Features of Free Layout .....	486
Operating Environment .....	486
Starting Free Layout .....	487
Free Layout Main Window .....	488
Paper Settings Panel .....	491
Easy Settings .....	493
Advanced Settings .....	495
Color Settings Panel .....	496
Color Adjustment .....	497
Matching .....	500
Driver Matching Mode .....	502
ICC Matching Mode .....	503
ColorSync .....	504
Preferences Dialog Box .....	505
Page Setup Dialog Box .....	506
Zoom Dialog Box .....	507
Format Dialog Box .....	508
Laying out a Multiple-File Document on One Page .....	509
Laying out a Document Created with Multiple Application Programs on One Page .....	509
Selecting an Object .....	510
Changing the Object Size .....	510
Moving an Object .....	511
Rotating an Object .....	512
Laying out Objects Automatically .....	513
Aligning Objects .....	513
Changing the Object Overlapping Order .....	515
Pasting a Copied or Cut Object .....	517

## The Features of Free Layout

The main features of Free Layout are as follows.

- Allows you to lay out at will and print a document created with application software.
- You can not only lay out multiple pages on one page but also lay out and print a multiple-file document on one page, or lay out and print a document created with multiple application programs on one page.



### Note

- The media type, image size, detailed media settings, and the printer settings can cause the actual print output to differ from the Free Layout settings.

## Operating Environment

You can use the Free Layout in the following environments.

- Compatible Operating System  
Mac OS X (10.3.9 to 10.6)
- Software that requires installation

## Starting Free Layout

Follow the procedure below to start the Free Layout.

1. Start the application software which you use.
2. From the application software's **File** menu, select the printer setup menu to open the **Print** dialog box.



### Note

- Normally, select **Print** from the **File** menu.

3. Click on **Free Layout** in the **Page Setup** panel to attach a checkmark.
4. Click the **Print** button in the **Print** dialog box.

4

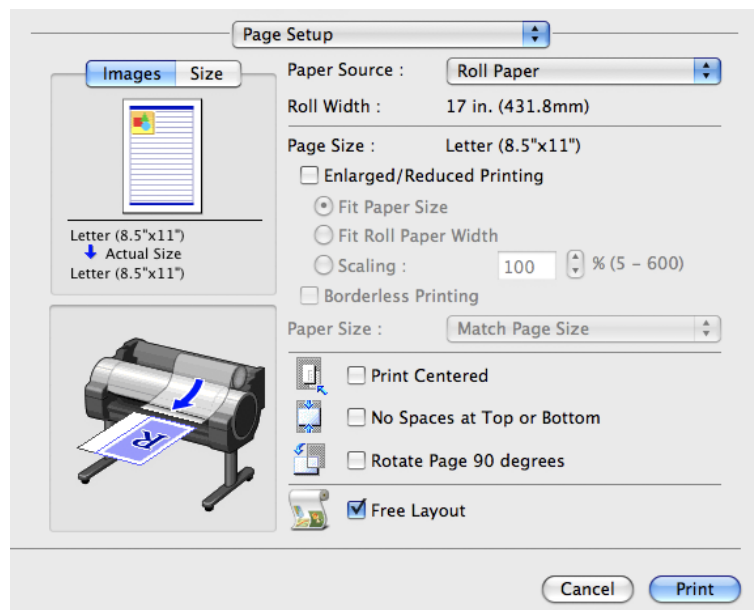

### Note

- Your printer is depicted in the lower-left area of this screen.

487

## 5. Free Layout main window is displayed.

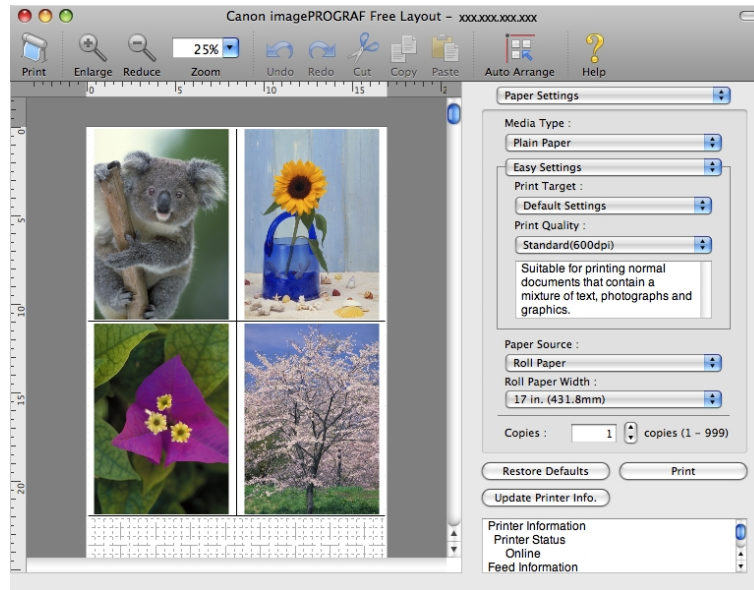

### Free Layout Main Window

The Free Layout main window consists of the menu and tool bars, layout area and dialog areas.

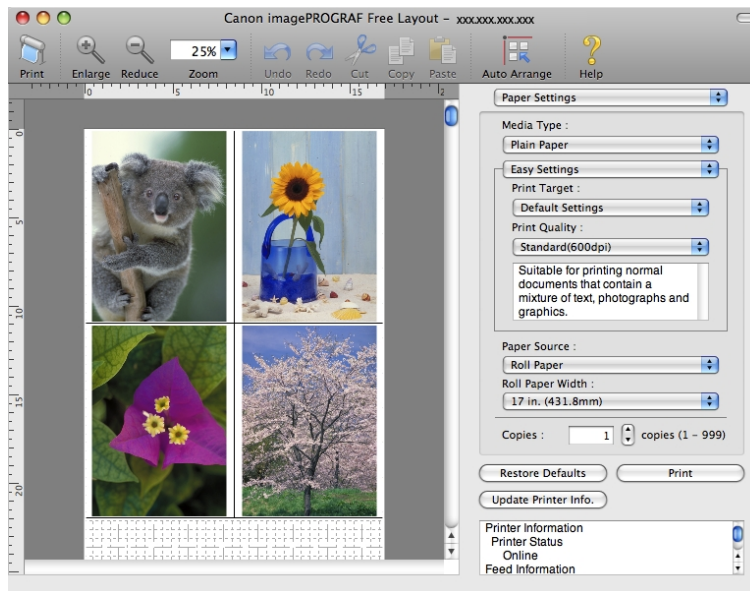

#### Note

- You can use the **View** menu to show or hide the tool.

#### • Menu Bar

This allows you to select menus required for operations.

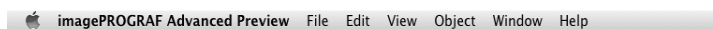

- **Tool Bar**

This allows you to select tool buttons required for major operations.



- **Layout Area**

This allows you to lay out objects and edit the object size and orientation.

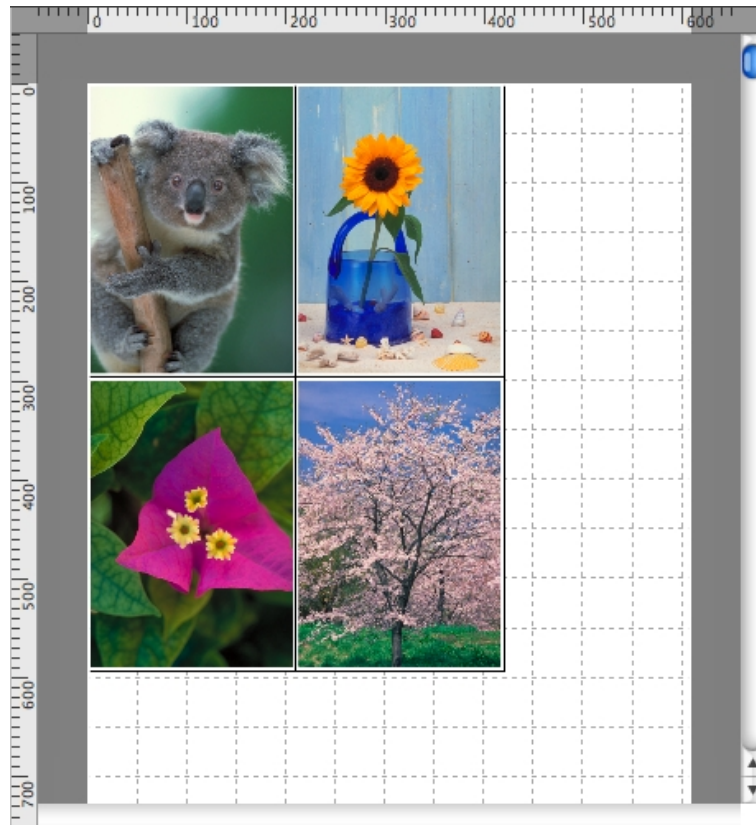

- Dialog Area

This allows you to set the print conditions and perform a print job.

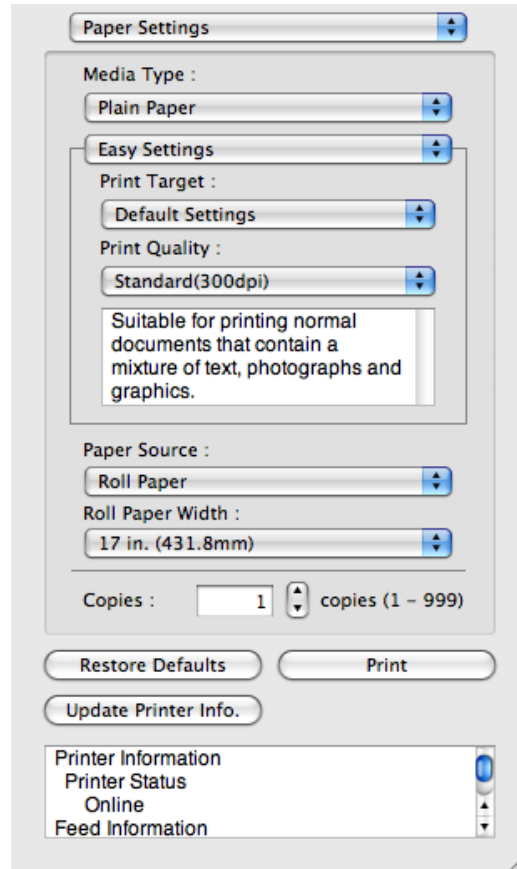



## Paper Settings Panel

This panel appears when you select **Paper Settings** in the dialog area.

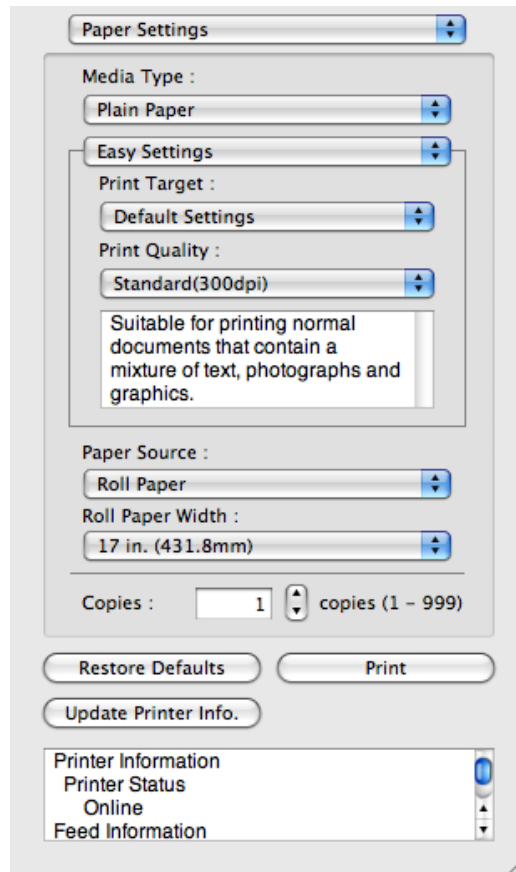

### • Media Type

This allows you to select the media type.



#### Note

- Always select media type that is actually set in the printer. When the media you chose is different from the media set in the printer, you may not receive the desired print results.

### • Easy Settings / Advanced Settings

Two modes are available to provide the optimum print settings for jobs.

The settings available on each mode are as follows.

- Easy Settings →P.493
- Advanced Settings →P.495

### • Paper Source

You can select the paper source.

The following settings are available for paper source.

Setting	Details
<b>Manual</b>	Select for manual paper feed printing.
<b>Roll Paper</b>	Select to print on roll paper.

- **Roll Paper Width**

This selects the width of the roll media set to the printer.



**Note**

- Available only if rolls are selected in **Paper Source**.

- **Copies**

You can input the number of print copies in numerical characters.



**Note**

- The maximum value is 999.
- You can change the numbers by clicking either ▲ button or ▼ button.

- **Restore Defaults Button**

Click the button to reset to the setting when starting Free Layout.

- **Print Button**

Click the button to begin printing.

- **Update Printer Info. Button**

Click the button to acquire printer information.

## Easy Settings

You can easily select the best settings for the print job by just selecting an item from the print target list that matches the content of the document.

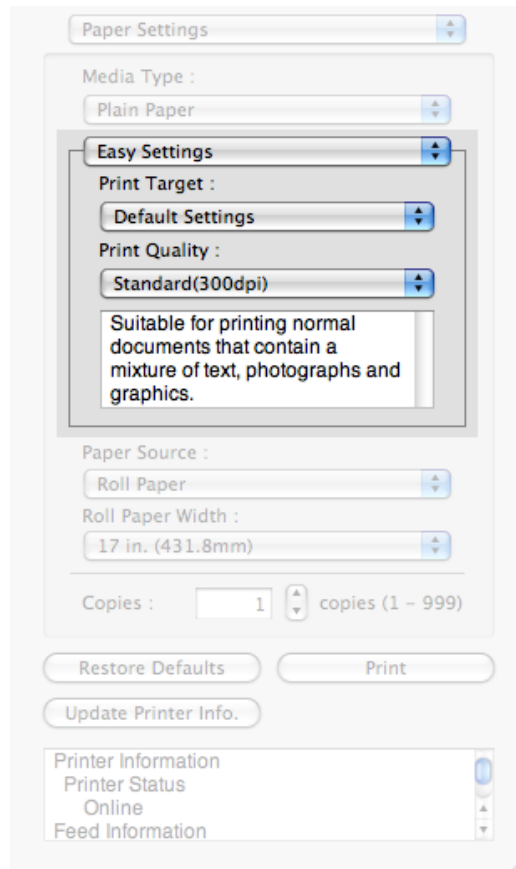

4

### • Print Target

You can easily select the best settings for the print job simply.

If you select each **Print Target** item the corresponding comment for that item is displayed below the list.

Setting	Details
<b>Default Settings</b>	Suitable for printing normal documents that contain a mixture of text, photographs, and graphics.
<b>Office Document</b>	Suitable for printing handouts as well as general office documents for which print clarity is key.
<b>Poster</b>	The best setting for posters. Prints using vivid and high impact colors.
<b>CAD (Color Line Drawing)</b>	Prints the fine lines of CAD drawings and other such documents sharp and clear.
<b>CAD (B/W Line Drawing)</b>	Suitable for printing CAD drawings with sharp, dark lines.
<b>Perspective, GIS</b>	Suitable for attractive printing of 3D-CAD drawings, perspective drawings, and GIS drawings including maps.
<b>Photo (Color)</b>	Suitable for printing photographic images captured with a digital camera.
<b>Faithful Color Reproduction</b>	Prints by faithfully reproducing the colors of the original image.
<b>Custom Settings</b>	Suitable for printing documents for which Advanced Settings have been specified.

493

**Note**

- The number of settings available for selection depends on the media type.

### • Print Quality

Selecting print quality strikes a balance between the quality of the printed image and printing speed.

The level of the print quality and resolution settings are displayed in the following combinations.

Setting	Details
Print Quality	<b>Highest / High / Standard / Draft</b>
Resolution	<b>1200dpi / 600dpi / 300dpi</b>

**Note**

- The availability of settings is determined by the media type and print priority selections.
- Printing time is longer and more ink is consumed with **High** than with **Draft**, however, print quality is higher.
- Printing time is shorter and less ink is consumed with **Draft** than with **High**, however, print quality is lower.

## Advanced Settings

Presents detailed settings for the print priority, the print quality, and other items so you can select the values for these settings yourself.

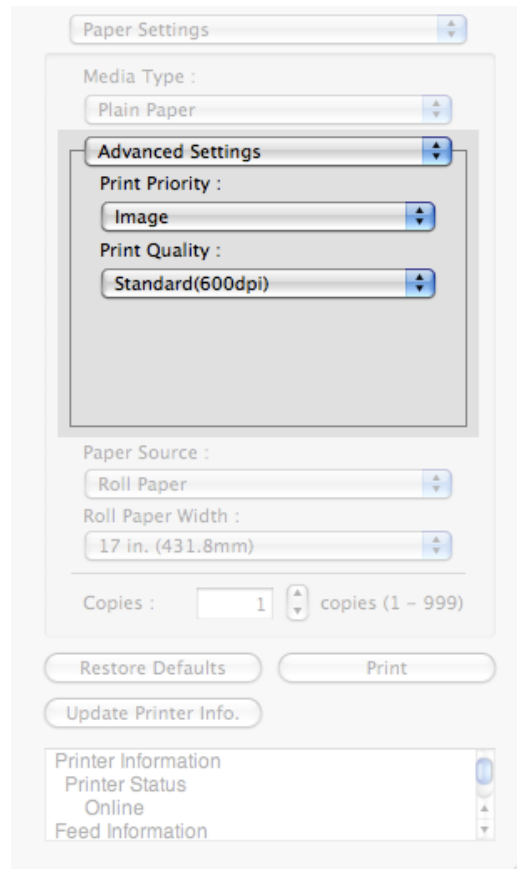

### • Print Priority

Select a print quality mode that is appropriate for the print job.

Setting	Details
<b>Image</b>	This mode achieves the best results for printing photographic images and illustrations.
<b>Line Drawing</b>	This mode is best for printing CAD drawings with fine lines or wall newsheet or other documents that contain large amounts of text. However, you may not achieve the quality you expect with printing photographs or other images with many filled areas. For these types of jobs, select <b>Image</b> .
<b>Office Document</b>	Prints common office documents, such as proposals, memos for distribution, etc., so they are easy to read.



#### Note

- The number of settings available for selection depends on the media type.

### • Print Quality

Selecting print quality strikes a balance between the quality of the printed image and printing speed.

The level of the print quality and resolution settings are displayed in the following combinations.

Setting	Details
Print Quality	<b>Highest / High / Standard / Draft</b>
Resolution	<b>1200dpi / 600dpi / 300dpi</b>



**Note**

- The availability of settings is determined by the media type and print priority selections.
- Printing time is longer and more ink is consumed with **High** than with **Draft**, however, print quality is higher.
- Printing time is shorter and less ink is consumed with **Draft** than with **High**, however, print quality is lower.

## Color Settings Panel

This panel appears when you select **Color Settings** in the dialog area.

4

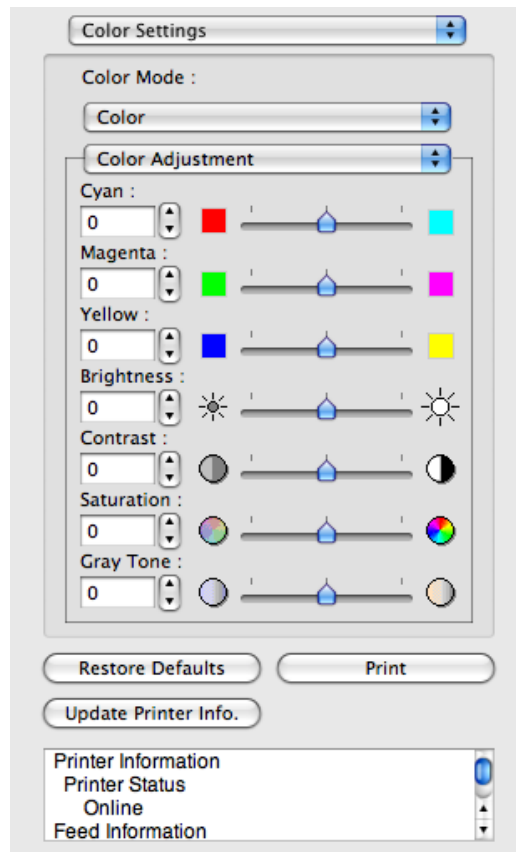

496

**• Color Mode**

You can select a color mode to suit the print job.

Setting	Details
<b>Color</b>	Enables color printing.
<b>Monochrome</b>	Disables color printing and converts image from continuous color to grayscale monochrome.
<b>Color (CAD)</b>	Prints lines in the best color possible so they are easy to see.

Setting	Details
<b>Monochrome Bitmap</b>	Prints all colors other than white in black.
<b>Monochrome (BK ink)</b>	Select to print all lines with black ink.
<b>No color correction</b>	Prints without performing color matching in the printer driver. Select this when color matching is performed by the application such as Adobe Photoshop or when you want to print color charts using the profile creation tool.

**Note**

- The availability of settings depends on the print priority and media type selections.

### • Color Adjustment / Matching

You can set the color adjustment and matching.

- Color Adjustment →P.497
- Matching →P.500

**Note**

- **Matching** is not displayed if **No color correction** has been selected in **Color Mode**.

### • Restore Defaults Button

Click the button to reset to the setting when starting Free Layout.

### • Print Button

Click the button to begin printing.

### • Update Printer Info. Button

Click the button to acquire printer information.

## Color Adjustment

You can set the color adjustment.

### Adjusting Color

Normally colors should be adjusted in the software application, but if you see colors in the printout that do not match colors on the screen, you can perform color adjustments.

1. Select **Color** on **Color Mode** in the **Color Settings** panel.

## 2. Select Color Adjustment.

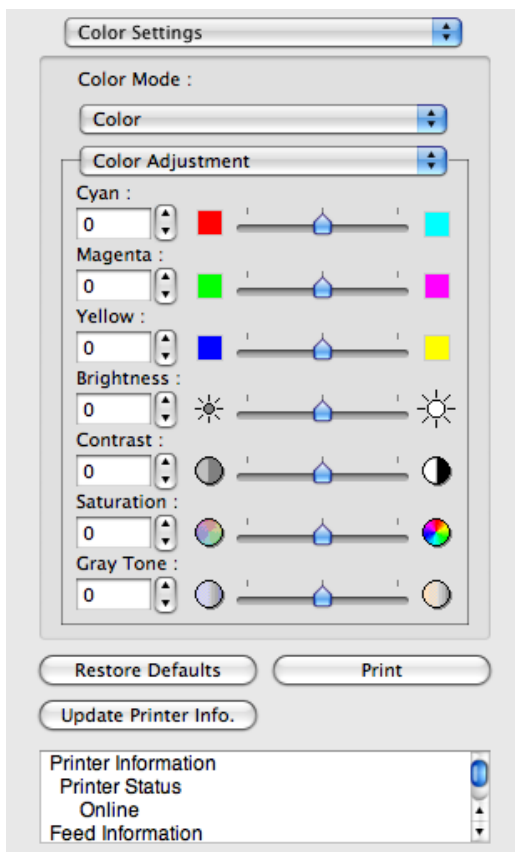

## 3. Drag each slider to the left or right to adjust.

Setting	Details
<b>Cyan</b>	Adjusts the strength of colors to compensate the hues.
<b>Magenta</b>	Adjusts the strength of colors to compensate the hues.
<b>Yellow</b>	Adjusts the strength of colors to compensate the hues.
<b>Brightness</b>	Adjusts the brightness of the entire image. When the results of the printout are brighter than the original images such as the original photo before scanning and graphics created on the display, or when you want to print in different degrees of brightness, use this feature.
<b>Contrast</b>	Adjusts the relative brightness between the brightest and darkest portions of the image.  *For soft gradation, decrease the contrast. For hard gradation, increase the contrast.
<b>Saturation</b>	Adjusts the hues for vivid color or dark color.
<b>Gray Tone</b>	Adjusts gray from cool black (bluish tones) to warm black (reddish tones).



**Note**

- You can also click the up or down arrow, or enter the number directly to increase or decrease the value.



## Adjusting Monochrome

Use the monochrome setting to print monochrome images of color photographs captured with a scanner or digital camera or other color images.

1. Select **Monochrome** on **Color Mode** in the **Color Settings** panel.
2. Select **Color Adjustment**.

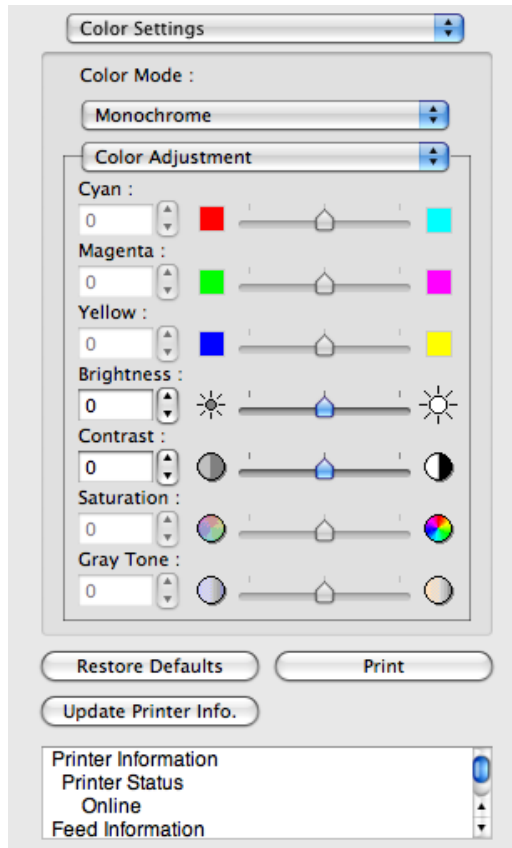

3. Drag each slider to the left or right to adjust.

Setting	Details
<b>Brightness</b>	Adjusts the brightness of the entire image. When the results of the printout are brighter than the original images such as the original photo before scanning and graphics created on the display, or when you want to print in different degrees of brightness, use this feature.
<b>Contrast</b>	Adjusts the relative brightness between the brightest and darkest portions of the image.  *For soft gradation, decrease the contrast. For hard gradation, increase the contrast.



### Note

- You can also click the up or down arrow, or enter the number directly to increase or decrease the value.

## Matching

You can set the matching.



**Important**

- If **No color correction** is selected under **Color Mode**, the **Matching** is not displayed.

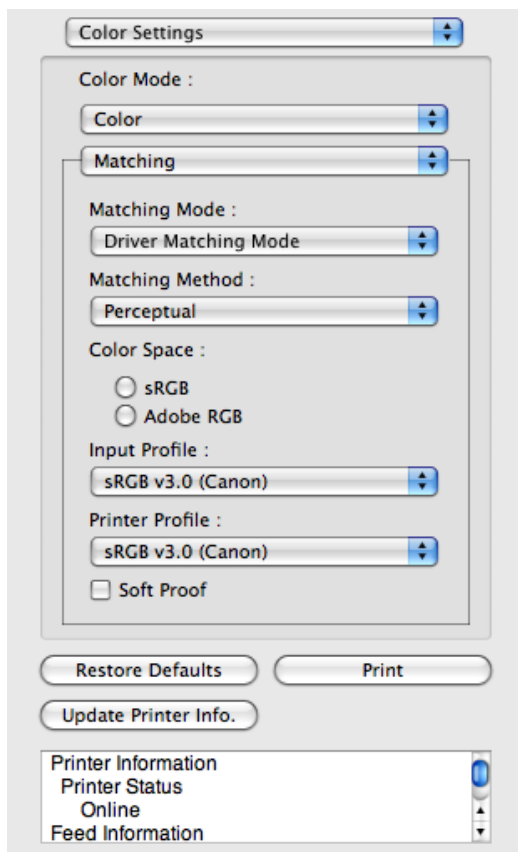

**• Matching Mode**

You can select a matching mode to suit the print job.

Setting	Details
Driver Matching Mode →P.502	Enables printing of optimal color tones using a driver specific color profile. You should normally select this mode.
ICC Matching Mode →P.503	Enables color matching using ICC profiles. Select this if you want to print by specifying the input profile, printer profile, and matching method in detail. This allows you to use ICC profiles for digital cameras and scanners, ICC profiles created using the profile creation tool, etc.
ColorSync →P.504	Enables color matching by using the ColorSync function of Mac OS. Select this if you want to perform soft proofing using ColorSync before printing.



**Note**

- You need to set each correction on the printer driver.
- Using Mac OS X 10.5 or later, **ColorSync** needs to be selected in the **Color Matching** panel of the driver in order to select **ColorSync**.

### • Matching Method

You can select a matching method to suit the print job.

### • Input Profile

Select the input profile.



#### Note

- You can select only after **ICC Matching Mode** has been selected in **Matching Mode**.

### • Printer Profile

Select the printer profile.



#### Note

- (Using Mac OS X 10.3.9 - 10.4) You can select only after **ICC Matching Mode** or **ColorSync** has been selected in **Matching Mode**.
- (Using Mac OS X 10.5 or later) You can select only after **ICC Matching Mode** has been selected in **Matching Mode**.

### • Soft Proof

When you place a checkmark here, **ColorSync** applies to the layout area.



#### Note

- You can select only after **ColorSync** has been selected in **Matching Mode**.

## Driver Matching Mode

**1.** Under **Matching Mode**, select **Driver Matching Mode**.

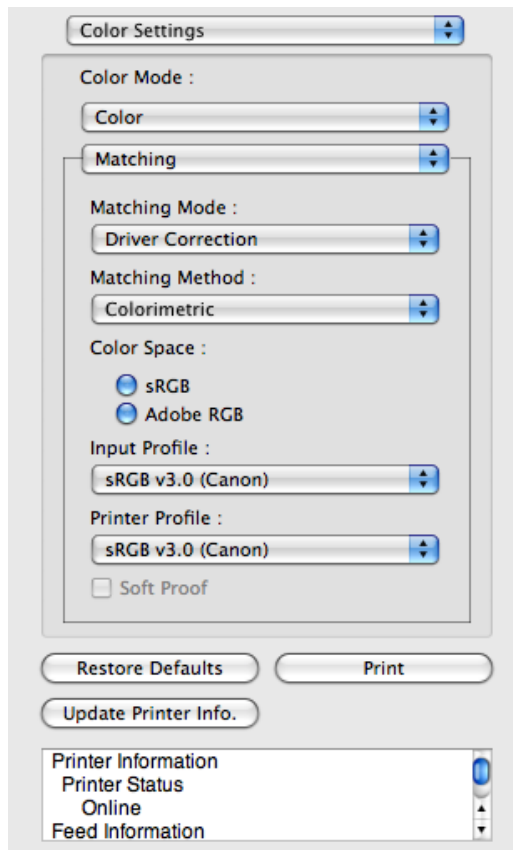

**2.** Click **Matching Method** list, and then select a setting.

Setting	Details
<b>Auto</b>	Automatically selects the best color matching method for each Image, Graphics, Text.
<b>Perceptual</b>	Color-matching optimized for printing typical photos attractively. Smooth gradation is a feature. This is also an easy-to-use mode when performing color adjustment using application software.
<b>Saturation</b>	Color-matching optimized for printing posters, etc., vividly.
<b>Colorimetric</b>	Color-matching optimized for printing image data with accurate colors in input color space. This is the easiest-to-use mode when you want to adjust the color and print. However, gradation may be lost for colors of wider range than the color reproduction range of the printer. Generally, this is also called relative colorimetric.

4

502

## ICC Matching Mode

1. Under **Matching Mode**, select **ICC Matching Mode**.

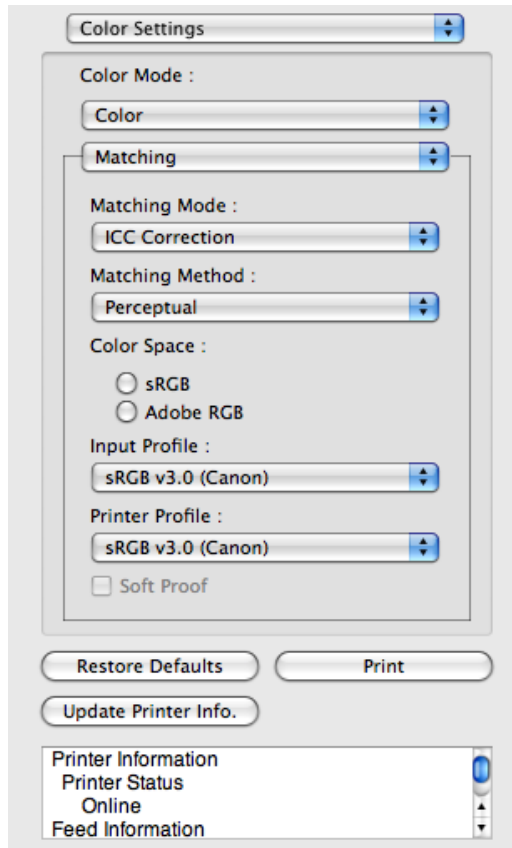

2. Click the **Matching Method** list, and then select a setting.

Setting	Details
<b>Perceptual</b>	Color-matching optimized for printing typical photos attractively. Smooth gradation is a feature. This is also an easy-to-use mode when performing color adjustment using application software.
<b>Saturation</b>	Color-matching optimized for printing posters, etc., vividly.
<b>Colorimetric</b>	Color-matching optimized for printing image data with accurate colors in input color space. This is the easiest-to-use mode when you want to adjust the color and print. However, gradation may be lost for colors of wider range than the color reproduction range of the printer. Generally, this is also called relative colorimetric.
<b>Colorimetric (No White-Point Correction)</b>	The processing method of color-matching is identical to <b>Colorimetric</b> . Use this when you want to further reproduce the target paper material color of the image data. Generally, this also is called absolute colorimetric.

3. Click the **Input Profile** list and select an input profile.

4. Click the **Printer Profile** list and select a printer profile.

## ColorSync

1. Check that **ColorSync** is selected in **Matching Mode**.

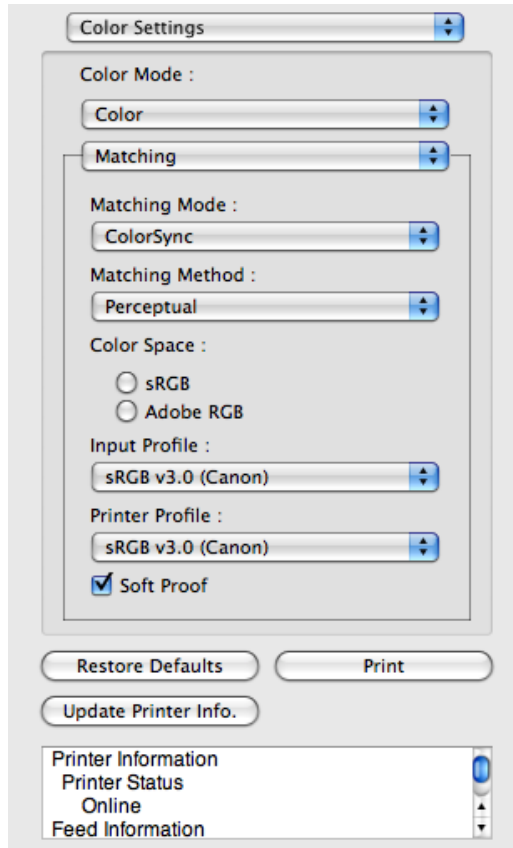

2. Place a checkmark on **Soft Proof** to simulate the output product in Layout Area.

4

504

## Preferences Dialog Box

This dialog box appears when you select **Preferences** from the imagePROGRAF Advanced Preview menu. You can set the preferences for Free Layout.

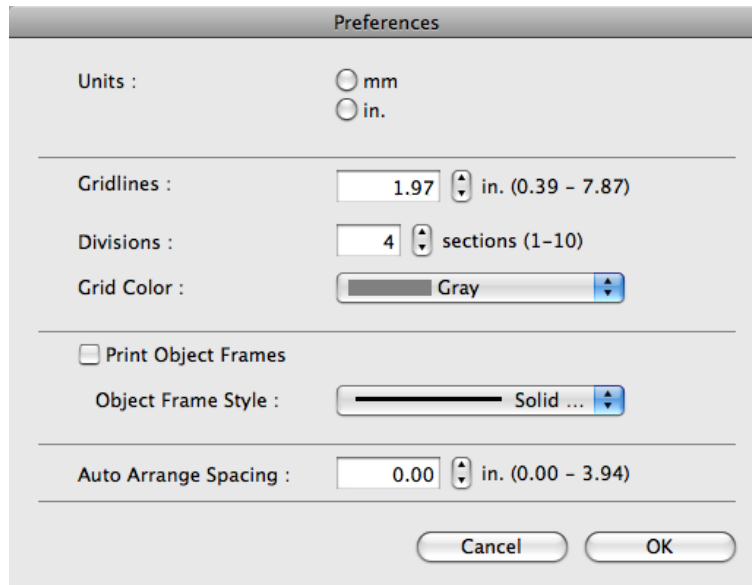

### • Units

Set the unit for paper length, margins, and so on.

### • Gridlines

You can input a grid line width value in numerical characters so that they serve as a guide to laying out objects.



#### Note

- You can input between 10.0 and 200.0(mm) (between 0.39 and 7.87(inch)).
- You can change the numbers by clicking either ▲ button or ▼ button.

### • Divisions

You can change the number of divisions of grid lines so that they serve as a guide to laying out objects.



#### Note

- You can input between 1 and 10.
- You can change the numbers by clicking either ▲ button or ▼ button.

### • Grid Color

Select the grid line color.

### • Print Object Frames

You can print the object border.



#### Note

- If you do not want to print the object border, deselect the **Print Object Frames** check box.

### • Object Frame Style

You can select the object frame style for printing.

The following settings are available for the object frame style.

Setting	Details
<b>Solid Line</b>	You can print the solid line as the frame style.
<b>Dotted Line</b>	You can print the dotted line as the frame style.
<b>Dashed Line</b>	You can print the dashed line as the frame style.

**• Auto Arrange Spacing**

Change the object-to-object spacing to be applied in the operation of laying out objects automatically.



**Note**

- You can input between 0.0 and 100.0(mm) (between 0.00 and 3.94(inch)).
- You can change the numbers by clicking either ▲ button or ▼ button.

**Page Setup Dialog Box**

4

This dialog box appears when you select **Page Setup** from the **File** menu. This dialog box provides selections for setting the media size, orientation and other important features.

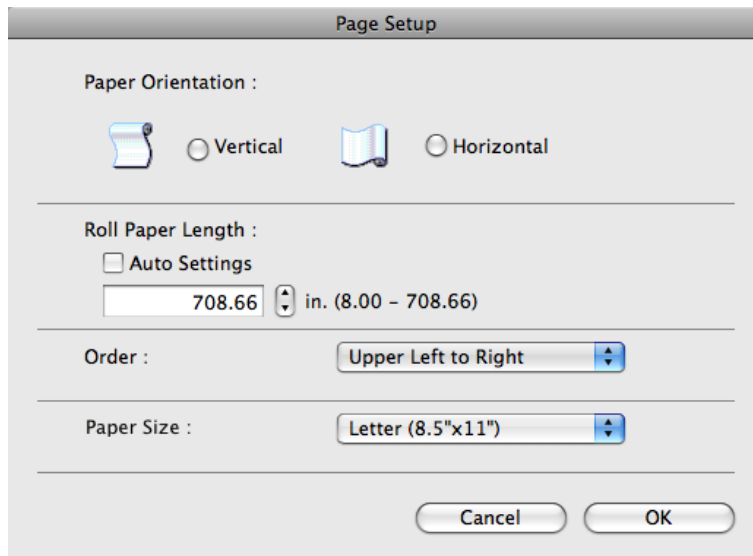

**• Paper Orientation**

This selects the paper orientation.

The following settings are available for orientation.

Setting	Details
<b>Vertical</b>	Prints the image and text created with the application software in the orientation as it is.
<b>Horizontal</b>	Prints the image and text by rotating sideways 90 degrees from the orientation as specified in the application.

**• Roll Paper Length**

Set the length of one page to print on roll paper.

When you place a checkmark on **Auto Settings**, the one-page length to be printed on roll paper is automatically set so that the laid-out objects are printed on one page.



**Note**

- Available only if rolls are selected in **Paper Source**.
- You can input between 203.2 and 18000.0(mm) (between 8.00 and 708.66(inch)).
- You can change the numbers by clicking either ▲ button or ▼ button.

**• Order**

Set the object layout order.

The following settings are available for order.

Setting	Details
<b>Upper Left to Right</b>	The objects are laid out from upper left to right.
<b>Upper Left to Bottom</b>	The objects are laid out from upper left to bottom.

**Note**

- When you have selected **Roll Paper Length > Auto Settings** and **Paper Orientation > Vertical**, you can choose only **Upper Left to Right**.
- When you have selected **Roll Paper Length > Auto Settings** and **Paper Orientation > Horizontal**, you can choose only **Upper Left to Bottom**.

4

**• Paper Size**

You can select the size of the print media.

**Note**

- You cannot display this if **Roll Paper** is selected in **Paper Source**.

**Zoom Dialog Box**

This dialog box appears when you select **Zoom** from the **View** menu. You can enlarge or reduce the screen display.

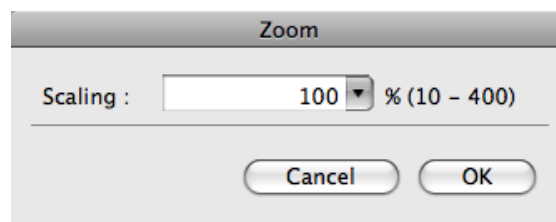
**• Scaling**

Set the magnification for enlargement or reduction of the screen display.

**Note**

- You can input between 10 and 400.
- You can change the numbers by clicking ▼ button.

507

## Format Dialog Box

This dialog box appears when you select **Format** from the **Object** menu after you select an object. You can rotate, enlarge, or reduce an object.

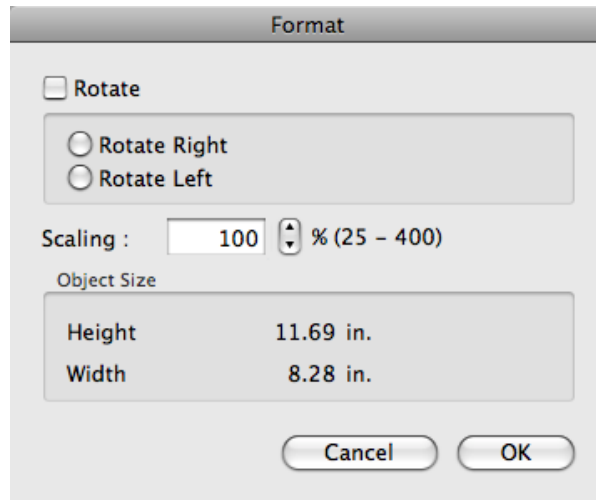

**Note**

- When the objects are not selected, you can not select **Format**.

**• Rotate**

When you place a checkmark here, you can select **Rotate Right** or **Rotate Left**.

Setting	Details
<b>Rotate Right</b>	Rotates the object 90 degrees clockwise.
<b>Rotate Left</b>	Rotates the object 90 degrees counterclockwise.



**Note**

- When several objects are selected, you cannot select **Rotate**.

**• Scaling**

You can input the value for enlargement or reduction of the object in numerical characters.



**Note**

- You can input between 25 and 400.
- You can change the numbers by clicking either ▲ button or ▼ button.

**• Object Size**

You can confirm the object size.



**Note**

- When several objects are selected, you cannot display **Object Size**.

## Laying out a Multiple-File Document on One Page

You can lay out and print a multiple-file document on one page.

1. From the application software's **File** menu, select the printer setup menu to open the **Print** dialog box.



### Note

- Normally, select **Print** from the **File** menu.

2. Click on **Free Layout** in the **Page Setup** panel to attach a checkmark.
3. In the **Print** dialog box, select the pages to print and the number of copies, and click the **Print** button.  
Free Layout starts, laying out the document created with application software in the layout area as an object.
4. Leaving Free Layout running, open other files with the application software and repeat the above steps.

4

## Laying out a Document Created with Multiple Application Programs on One Page

You can lay out and print a document created with multiple application programs on one page.

1. From the application software's **File** menu, select the printer setup menu to open the **Print** dialog box.



### Note

- Normally, select **Print** from the **File** menu.

2. Click on **Free Layout** in the **Page Setup** panel to attach a checkmark.
3. In the **Print** dialog box, select the pages to print and the number of copies, and click the **Print** button.  
Free Layout starts, laying out the document created with application software in the layout area as an object.
4. Leaving Free Layout running, open the files with other application software and repeat the above steps.

509

## Selecting an Object

When an object is selected, a select box (blue border) appears around the object.

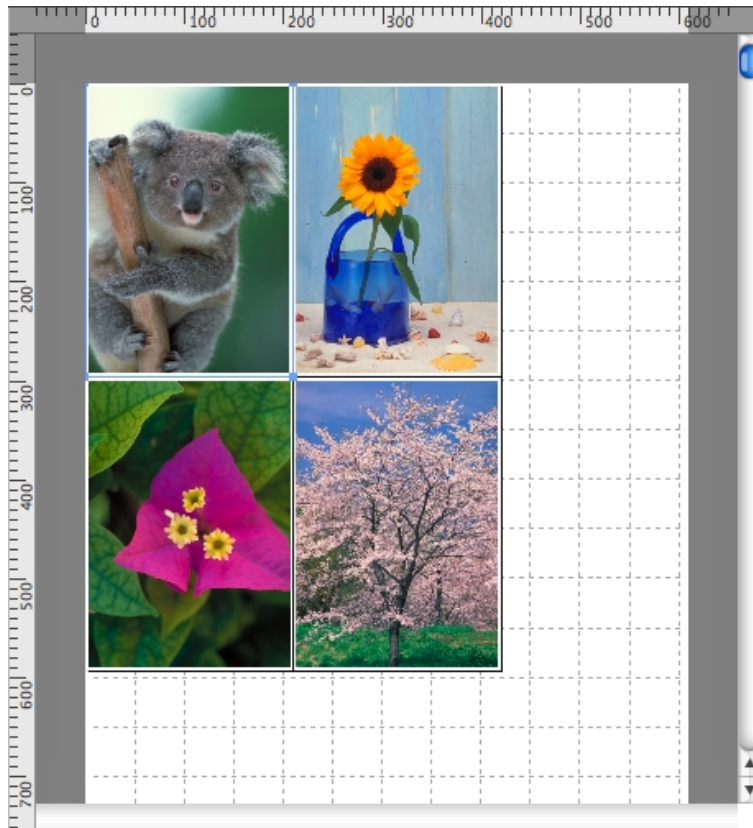

### Note

- To select an object, click that object.
- To select multiple successive objects, click them while holding down the shift key.
- To select multiple arbitrary objects, click them while holding down the command key.
- To select all objects, select **Select All** from the **Edit** menu.

## Changing the Object Size

You can change the object size by means of mouse operation or by specifying a scaling value.



### Note

- The vertical-to-horizontal ratio remains unchanged when the object is enlarged or reduced.

### Resizing by means of mouse operation

1. Select an object.

- Place the pointer at a corner of the selection box around the object to show the arrow handle, and drag this handle to change the object size.

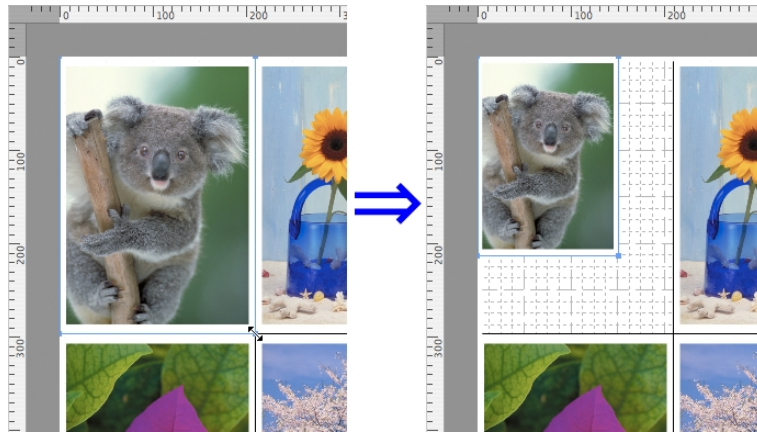

### Resizing by specifying a scaling value

4

- Select an object.
- Open the Format Dialog Box [→P.508](#).
- Use **Scaling** to set the magnification for enlargement or reduction. You either enter numbers directly.



#### Note

- You can input between 25 and 400.
- You can change the numbers by clicking either ▲ button or ▼ button.

- Click the **OK** button.

### Moving an Object

You can move the object position.

- Select an object.

511

2. Place the pointer inside the selection box of the object to show the crosshair handle, and drag it to move the object.

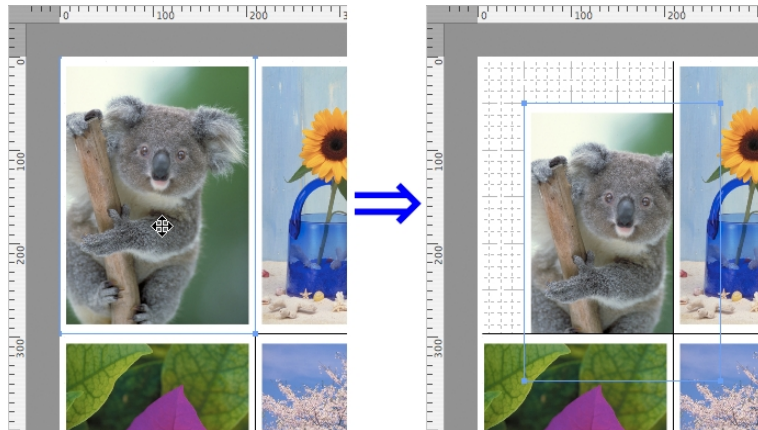

## 4

### Rotating an Object

You can rotate the object.

1. Select an object.
2. Select **Rotate Left** or **Rotate Right** from the toolbar.  
Alternatively, you may click on the **Rotate** check box in the Format Dialog Box [→P.508](#) then select **Rotate Right** or **Rotate Left**, and click the **OK** button.

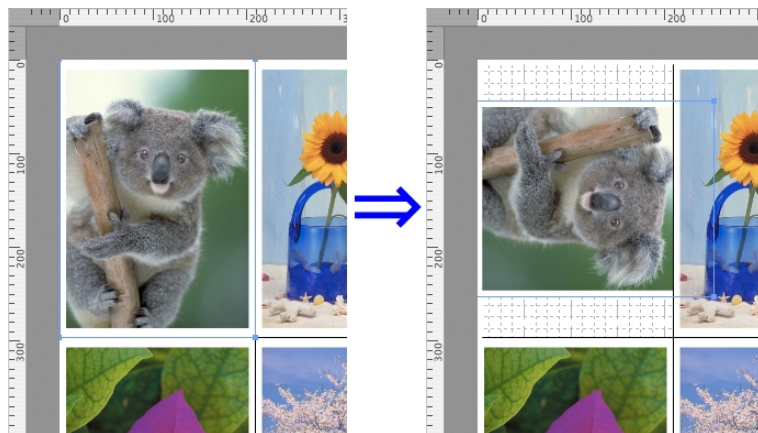

#### Note

- When several objects are selected, you cannot select **Rotate**.

## Laying out Objects Automatically

Click **Auto Arrange** in the tool bar. This automatically lays out objects. Alternatively, you may select **Auto Arrange Object** from the **Object** menu.

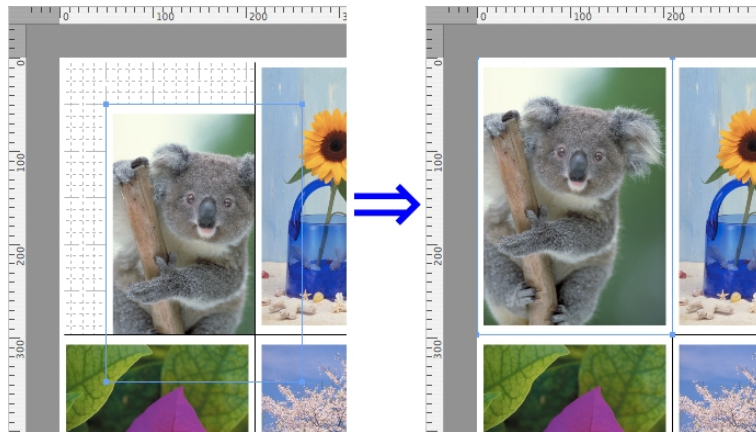

### Note

- The object layout order varies depending on the **Order** setting on the Page Setup Dialog Box →P.506 .

4

## Aligning Objects

You can align objects systematically.

1. Select multiple objects.
2. Select the align menu from the **Object** menu.

### • Align Top

Lays out the objects, justifying them to the top.

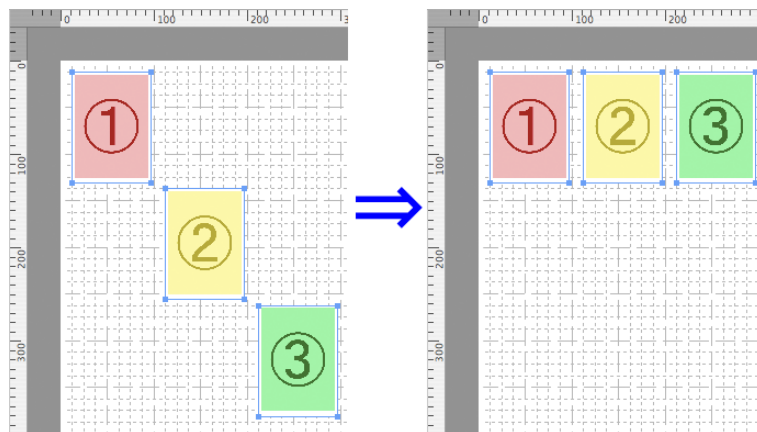

513

• **Center Vertically**

Lays out the objects, justifying them to the vertical center.

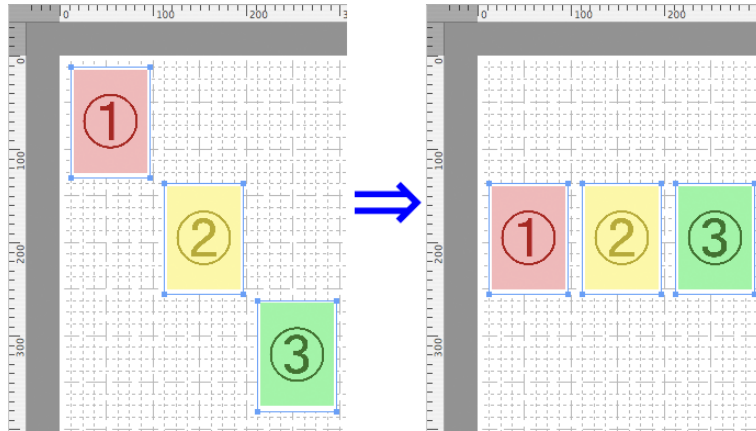

• **Align Bottom**

Lays out the objects, justifying them to the bottom.

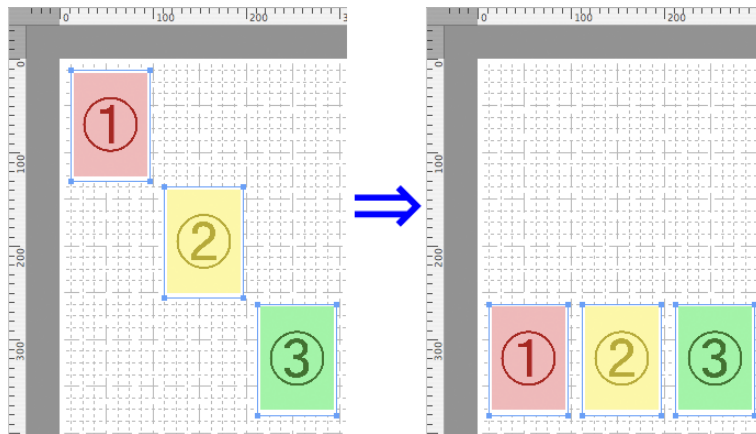

• **Align Left**

Lays out the objects, justifying them to the left.

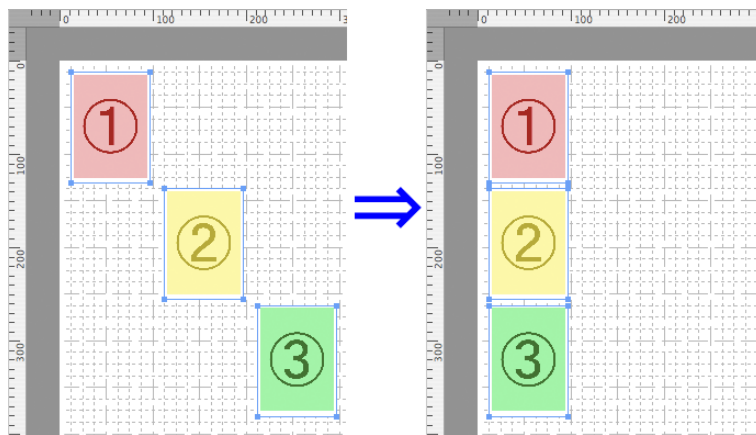



- **Center Horizontally**

Lays out the objects, justifying them to the horizontal center.

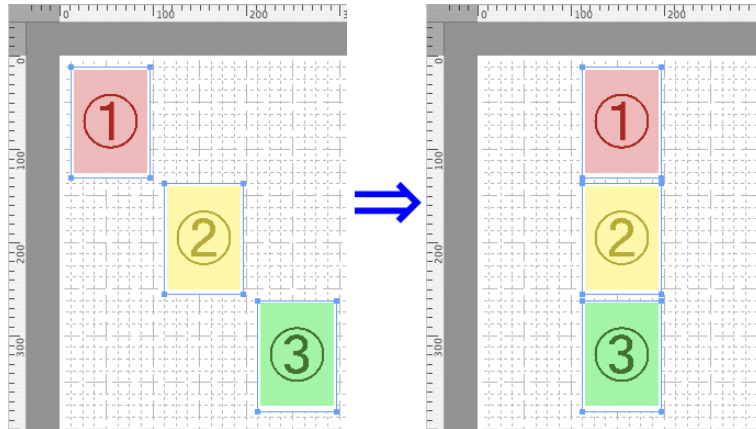

- **Align Right**

Lays out the objects, justifying them to the right.

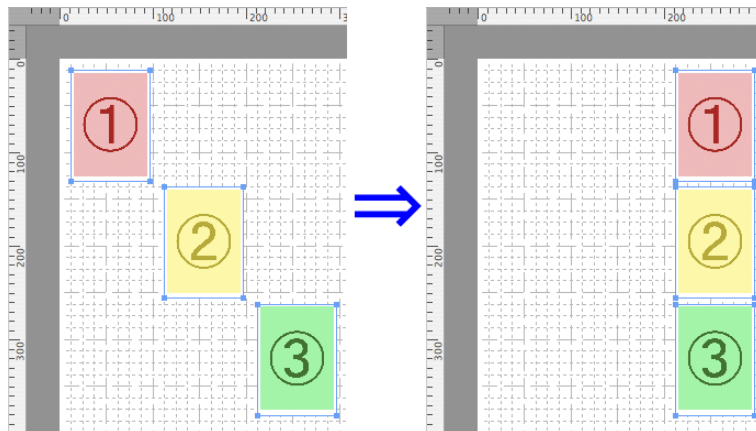

4

## Changing the Object Overlapping Order

You can change the object overlapping order.

1. Select an object.

## 2. Select the overlapping order menu from the **Object** menu.

- **Bring to Front**

Moves the object to the frontmost position.

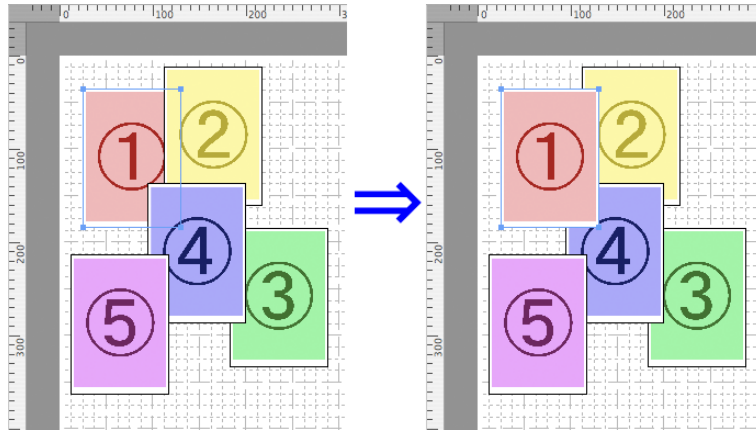

- **Send to Back**

Moves the object to the backmost position.

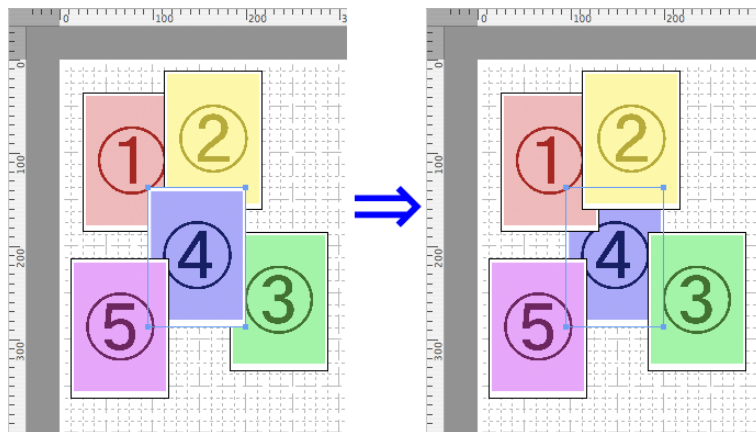

- **Bring Forward**

Moves the object one position to the front.

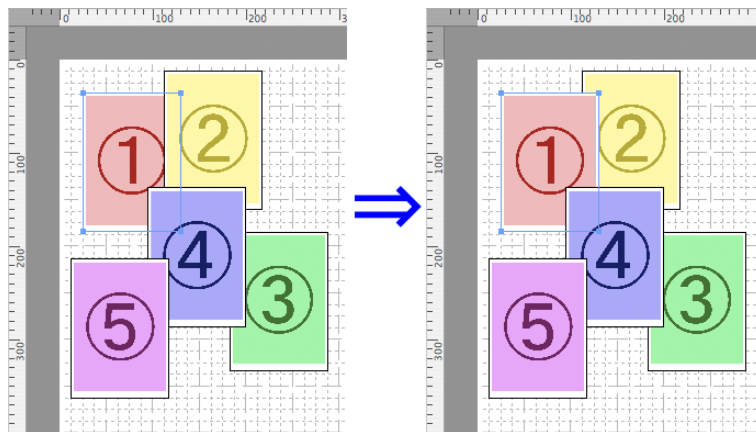

- **Send Backward**

Moves the object one position to the back.

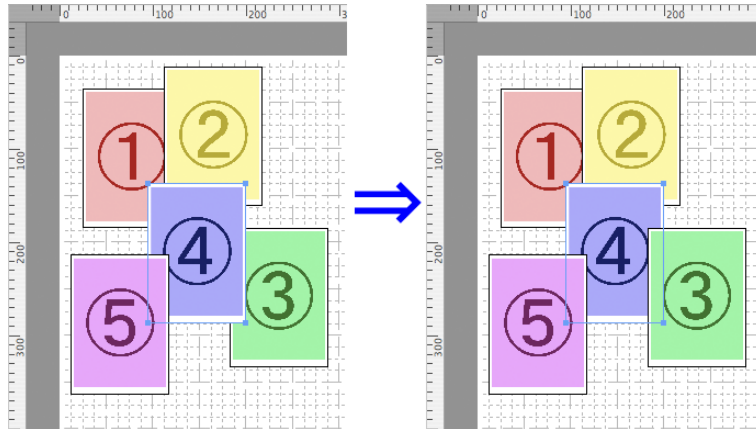

## Pasting a Copied or Cut Object

4

1. Click **Copy** or **Cut** from the toolbar.  
Alternatively, you may select **Copy** or **Cut** from the **Edit** menu.
2. Click **Paste** from the toolbar.  
Alternatively, you may select **Paste** from the **Edit** menu.

**Note**

- The copied or cut object is laid out at the end of the page.

## Color imageRUNNER Enlargement Copy

The Features of Color imageRUNNER Enlargement Copy .....	518
Operating Environment .....	518
Starting Color imageRUNNER Enlargement Copy .....	519
Color imageRUNNER Enlargement Copy Dialog Box .....	520
Hot Folder .....	521
Creating a New Hot Folder .....	522
Editing a Hot Folder (Setting Print Conditions) .....	525
Deleting a Hot Folder .....	528
Setting the Print Parameters .....	528
Paper Settings Panel .....	529
Easy Settings .....	531
Advanced Settings .....	532
Output Settings Panel .....	534
Color Settings Panel .....	536
Driver Matching Mode .....	537
ICC Matching Mode .....	538
ColorSync .....	539
Printing Enlargements of Scanned Originals from a Color imageRUNNER .....	539

## The Features of Color imageRUNNER Enlargement Copy

The main features of Color imageRUNNER Enlargement Copy are as follows.

- Allows the document scanned with the Color imageRUNNER to be automatically enlarged and printed.
- You can perform basic printer settings such as printer selection, media type and output profile selection, and matching methods, in addition to borderless printing and enlargement/reduction process without growing through the printer driver.



### Note

- The media type, image size, detailed media settings, and the printer settings can cause the actual print output to differ from the Color imageRUNNER Enlargement Copy settings.

## Operating Environment

You can use the Color imageRUNNER Enlargement Copy in the following environments.

- Compatible Operating System  
Mac OS X (10.3.9 to 10.6)
- Software that requires installation  
imagePROGRAF Printer Driver

## Starting Color imageRUNNER Enlargement Copy

Follow the procedure below to start the Color imageRUNNER Enlargement Copy.

1. Open the **Utility** panel of the **Print** dialog box.

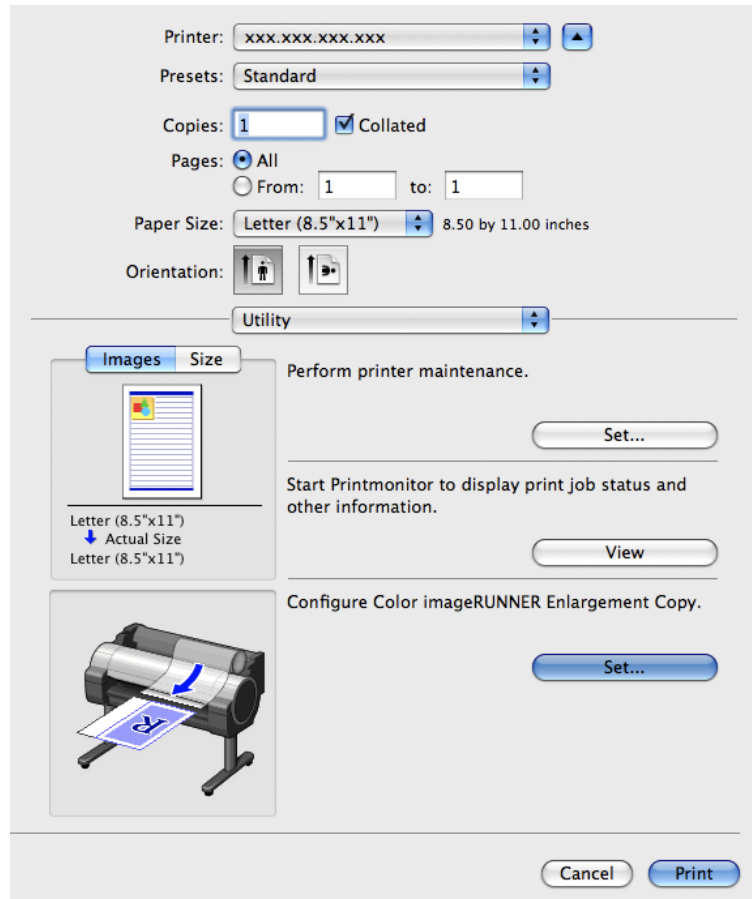

### Note

- Your printer is depicted in the lower-left area of this screen.

2. Click the **Set** button in **Configure Color imageRUNNER Enlargement Copy**. to open the **Color imageRUNNER Enlargement Copy** dialog box.

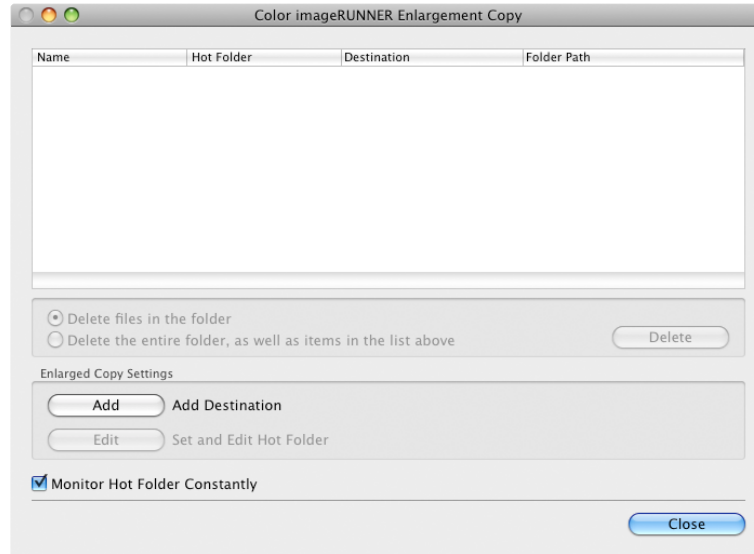

**Note**

- You can also start the utility directly by clicking on the **Color imageRUNNER Enlargement Copy.app** icon in **Applications > Canon Utilities > iR Enlargement Copy**.

## Color imageRUNNER Enlargement Copy Dialog Box

The explanation below is on the **Color imageRUNNER Enlargement Copy** dialog box.

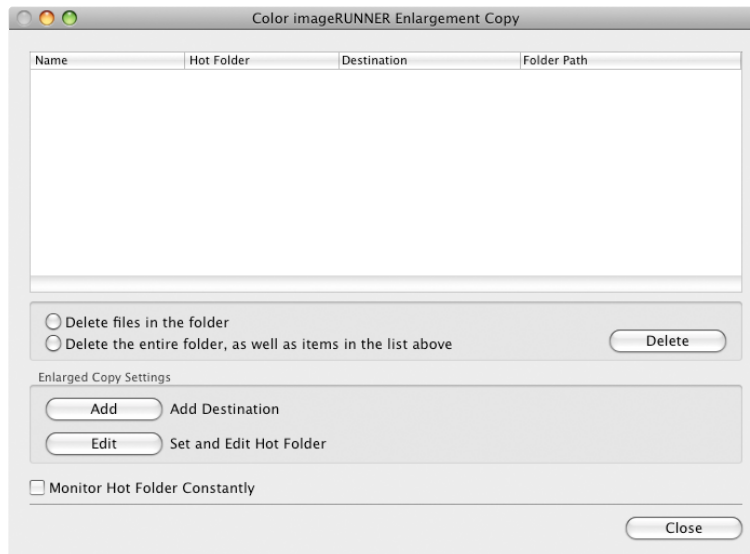

**Note**

- For the step to open the **Color imageRUNNER Enlargement Copy** dialog box, see "Starting Color imageRUNNER Enlargement Copy." → **P.519**

- **Delete files in the folder**

From the Hot Folder list, select a hot folder and click the **Delete** button to delete only files in the hot folder.

- **Delete the entire folder, as well as items in the list above**

From the Hot Folder list, select a hot folder and click the **Delete** button to delete the hot folder.

- **Delete Button**

Select **Delete files in the folder** or **Delete the entire folder, as well as items in the list above** and click this button to delete the hot folder or only files in the hot folder.

- **Add Button**

Click the button to open the **Destination Selection** dialog box so that you can add a hot folder.

- **Edit Button**

From the Hot Folder list, select a hot folder and click this button to open the **Add/Edit Hot Folder** dialog box that allows you to edit the hot folder.

- **Monitor Hot Folder Constantly**

If you click on the check box, the icon of Color imageRUNNER Enlargement Copy utility will appear on the Dock when starting OS X thereafter.

## Hot Folder

Hot folder refers to a folder used for Color imageRUNNER Enlargement Copy.

- When transferred to the PC's hot folder, the document data scanned with the Color imageRUNNER is printed in enlarged size from the printer according to the print conditions set in the hot folder.
- You can create a new hot folder, edit or delete an existing one, and set print conditions at will.



### Note

- You can create up to 10 hot folders.

## Creating a New Hot Folder

1. Open the **Color imageRUNNER Enlargement Copy** dialog box.

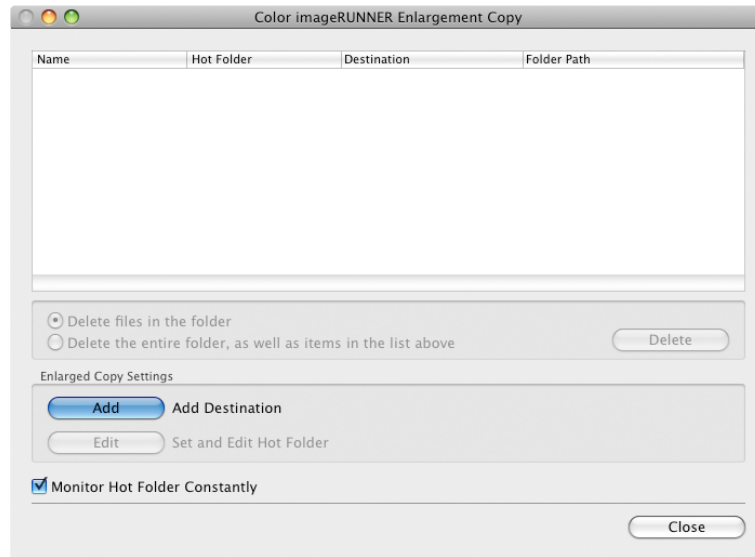

4



**Note**

- For the step to open the **Color imageRUNNER Enlargement Copy** dialog box, see "Starting Color imageRUNNER Enlargement Copy." →P.519

2. Click the **Add** button in **Enlarged Copy Settings** to open the **Destination Selection** dialog box.

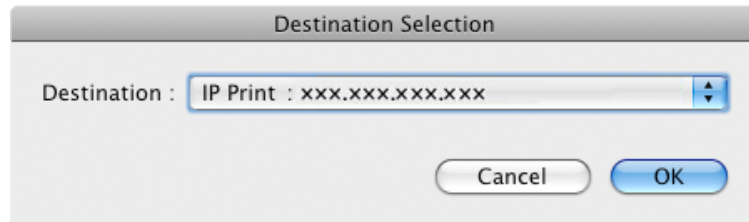

3. From the printer list in **Destination**, select the printer of destination.



4. Click the **OK** button to open the **Add/Edit Hot Folder** dialog box.

The screenshot shows the 'Add/Edit Hot Folder' dialog box. The 'Name' field is set to 'Hot Folder' and the 'Hot Folder' field is set to 'Shared Folder'. The 'Paper Settings' tab is active, showing 'Media Type' as 'Plain Paper', 'Print Target' as 'Default Settings', and 'Print Quality' as 'Standard(600dpi)'. The 'Easy Settings' section is expanded, showing a description: 'Suitable for printing normal documents that contain a mixture of text, photographs and graphics.' Other settings include 'Paper Source' as 'Roll Paper', 'Roll Paper Width' as '17 in. (431.8mm)', and 'Automatic Cutting' as 'Printer Default'. The 'Copies' field is set to '1' and the 'OK' button is highlighted.

5. In **Name**, enter the name to display in the Hot Folder list.

6. In **Hot Folder**, enter the Hot Folder name.

7. Click the **OK** button. The created Hot Folder is listed in the **Color imageRUNNER Enlargement Copy** dialog box.

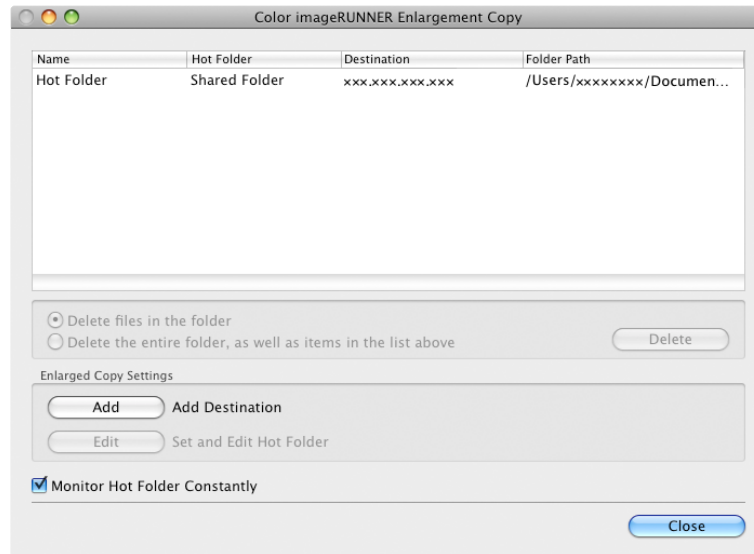

8. Click the **Close** button to close the **Color imageRUNNER Enlargement Copy** dialog box.

9. From the **Apple** Menu, open the **Sharing** dialog box for **System Preferences**.

10. Select the check box labeled **File Sharing**, and click the **Options** button.

11. Select the check box labeled **Share files and folders using FTP** and **Share files and folders using SMB** to make shared settings.



**Note**

- You can create up to 10 hot folders.

## Editing a Hot Folder (Setting Print Conditions)

1. Open the **Color imageRUNNER Enlargement Copy** dialog box.

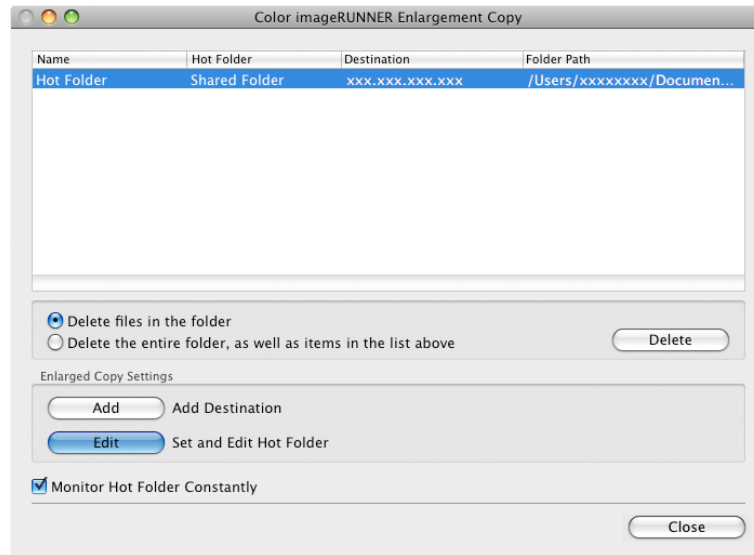

2. Select the Hot Folder from the Hot Folder list.
3. From **Enlarged Copy Settings**, click **Edit** button to open the **Add/Edit Hot Folder** dialog box.

**4.** Make the necessary settings in the Paper Settings Panel →P.529 .

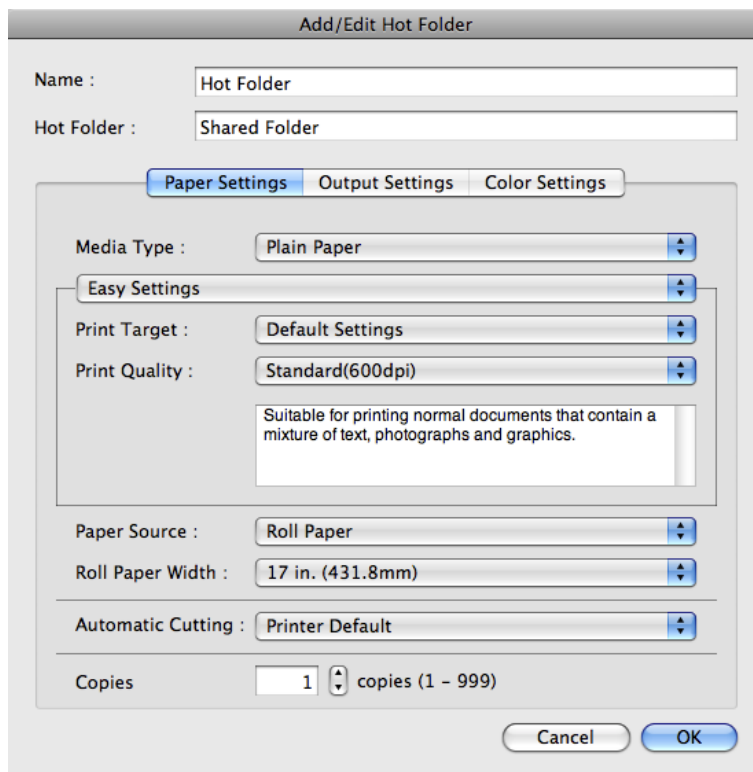

**5.** Make the necessary settings in the Output Settings Panel →P.534 .

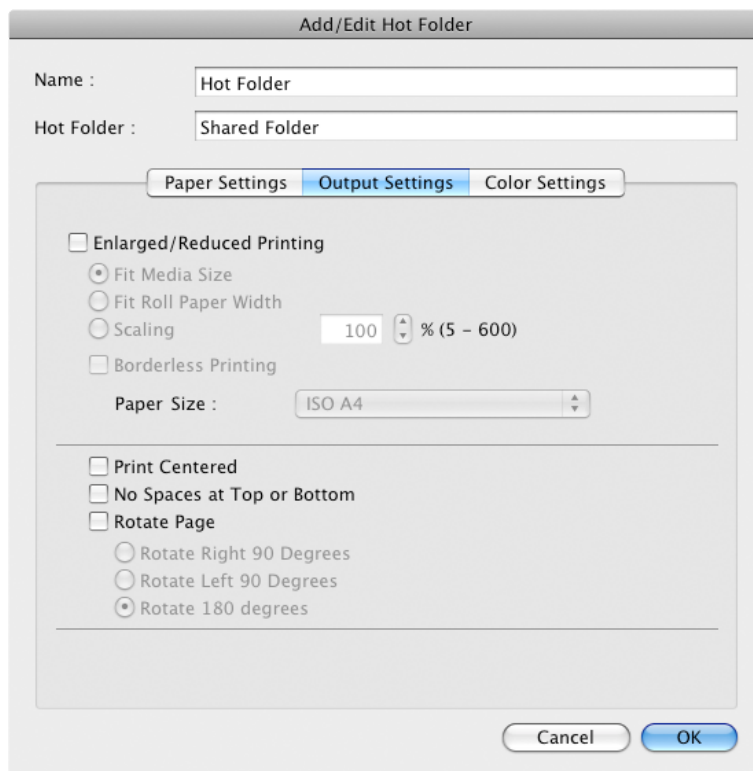

4

526

6. Make the necessary settings in the Color Settings Panel **→P.536** .

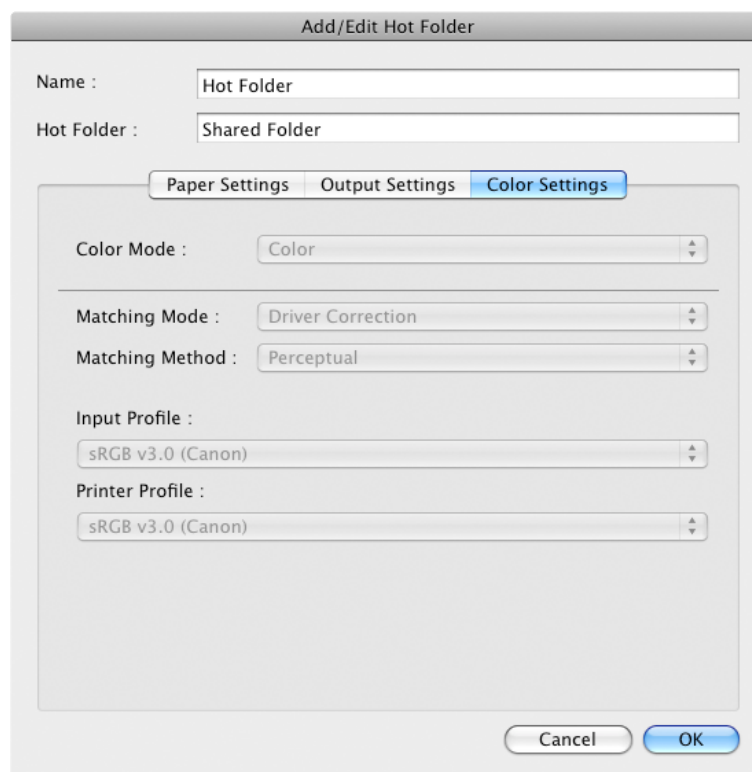

7. Click the **OK** button to close the **Add/Edit Hot Folder** dialog box.
8. From the **Apple** Menu, open the **Sharing** dialog box for **System Preferences**.
9. Select the check box labeled **File Sharing**, and click the **Options** button.
10. Select the check box labeled **Share files and folders using FTP** and **Share files and folders using SMB** to make shared settings.



**Note**

- If you've made shared settings when you created a new Hot Folder, you do not need to execute steps 8 to 10.

## Deleting a Hot Folder

1. Open the **Color imageRUNNER Enlargement Copy** dialog box.

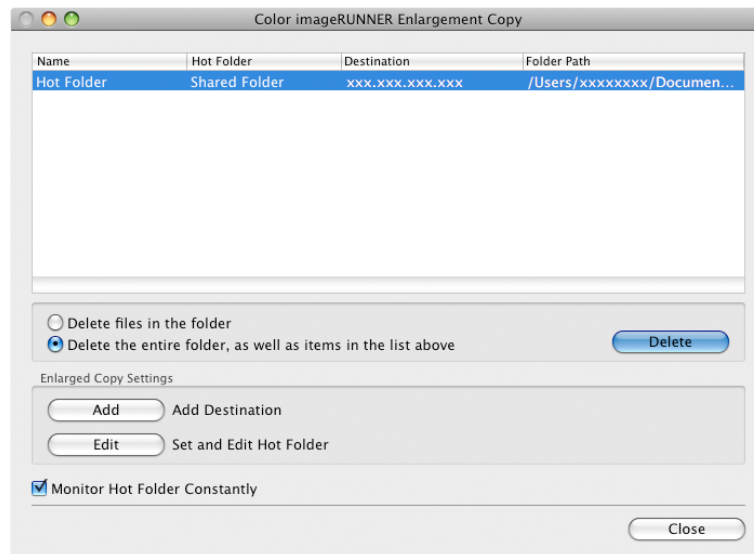

2. Select the Hot Folder you want to delete from the Hot Folder list.
3. Select **Delete the entire folder, as well as items in the list above**, and then click the **Delete** button.

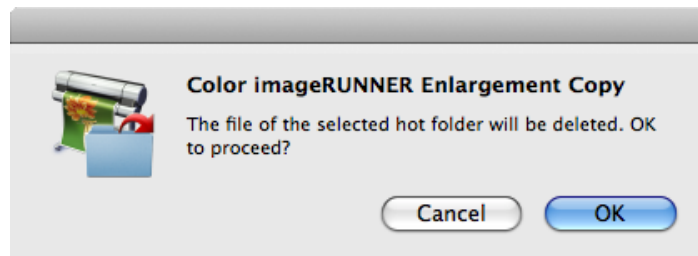

4. Read the message and then click the **OK** button.



### Note

- Select **Delete files in the folder** to delete only files in the hot folder.

## Setting the Print Parameters

You can set the print conditions in the setting panels within the **Add/Edit Hot Folder** dialog box. The settings available on each panel are as follows.

- Paper Settings Panel →P.529
- Output Settings Panel →P.534
- Color Settings Panel →P.536

## Paper Settings Panel

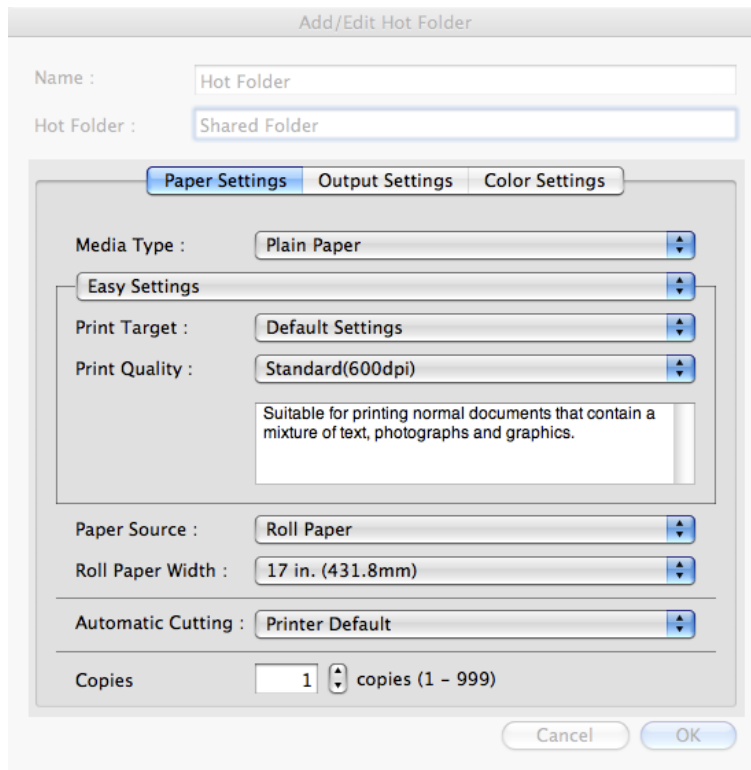

### • Easy Settings / Advanced Settings

Two modes are available to provide the optimum print settings for jobs. The settings available on each mode are as follows.

- Easy Settings →P.531
- Advanced Settings →P.532

### • Media Type

This allows you to select the media type.



#### Note

- Always select media type that is actually set in the printer. When the media you chose is different from the media set in the printer, you may not receive the desired print results.

### • Paper Source

You can select the paper source.

The following settings are available for paper source.

Setting	Details
<b>Manual</b>	Select for manual paper feed printing.
<b>Roll Paper</b>	Select to print on roll paper.

### • Roll Paper Width

This selects the width of the roll media set to the printer.



**Note**

- Available only if rolls are selected in **Paper Source**.

• **Automatic Cutting**

You can set the printer to cut roll paper automatically or print a guideline for cutting.

The following settings are available for automatic cutting.

Setting	Details
<b>Printer Default</b>	The value set on the printer operation panel takes priority.
<b>None</b>	Each page is not cut after it is printed and printing continues without interruption.
<b>Print Cut Guideline</b>	A print cut guideline is printed after each page and printing continues without interruption.



**Note**

- Available only if rolls are selected in **Paper Source**.

• **Copies**

You can input the number of print copies in numerical characters.



**Note**

- The maximum value is 999.
- You can change the numbers by clicking either ▲ button or ▼ button.



## Easy Settings

You can easily select the best settings for the print job by just selecting an item from the print target list that matches the content of the document.

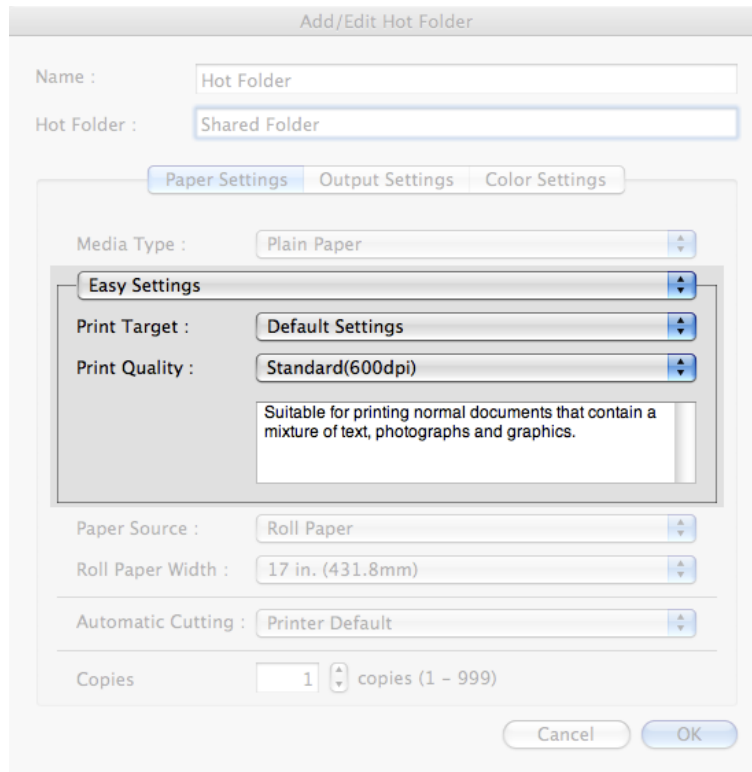

4

### • Print Target

You can easily select the best settings for the print job simply.

If you select each **Print Target** item the corresponding comment for that item is displayed below the list.

Setting	Details
<b>Default Settings</b>	Suitable for printing normal documents that contain a mixture of text, photographs, and graphics.
<b>Office Document</b>	Suitable for printing handouts as well as general office documents for which print clarity is key.
<b>Poster</b>	The best setting for posters. Prints using vivid and high impact colors.
<b>CAD (Color Line Drawing)</b>	Prints the fine lines of CAD drawings and other such documents sharp and clear.
<b>CAD (B/W Line Drawing)</b>	Suitable for printing CAD drawings with sharp, dark lines.
<b>Perspective, GIS</b>	Suitable for attractive printing of 3D-CAD drawings, perspective drawings, and GIS drawings including maps.
<b>Photo (Color)</b>	Suitable for printing photographic images captured with a digital camera.
<b>Faithful Color Reproduction</b>	Prints by faithfully reproducing the colors of the original image.
<b>Custom Settings</b>	Suitable for printing documents for which Advanced Settings have been specified.

531



#### Note

- The number of settings available for selection depends on the media type.

**• Print Quality**

Selecting print quality strikes a balance between the quality of the printed image and printing speed.

The level of the print quality and resolution settings are displayed in the following combinations.

Setting	Details
Print Quality	<b>Highest / High / Standard / Draft</b>
Resolution	<b>1200dpi / 600dpi / 300dpi</b>



**Note**

- The availability of settings is determined by the media type and print priority selections.
- Printing time is longer and more ink is consumed with **High** than with **Draft**, however, print quality is higher.
- Printing time is shorter and less ink is consumed with **Draft** than with **High**, however, print quality is lower.

**4**

**Advanced Settings**

Presents detailed settings for the print priority, the print quality, and other items so you can select the values for these settings yourself.

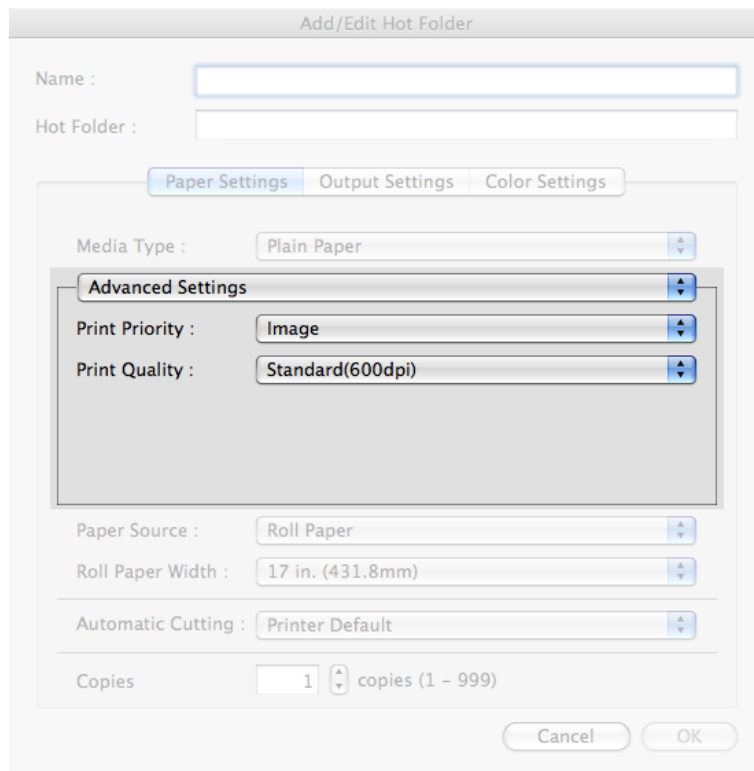

**• Print Priority**

Select a print quality mode that is appropriate for the print job.

Setting	Details
<b>Image</b>	This mode achieves the best results for printing photographic images and illustrations.

Setting	Details
<b>Line Drawing</b>	This mode is best for printing CAD drawings with fine lines or wall newssheet or other documents that contain large amounts of text. However, you may not achieve the quality you expect with printing photographs or other images with many filled areas. For these types of jobs, select <b>Image</b> .
<b>Office Document</b>	Prints common office documents, such as proposals, memos for distribution, etc., so they are easy to read.

**Note**

- The number of settings available for selection depends on the media type.

### • Print Quality

Selecting print quality strikes a balance between the quality of the printed image and printing speed.

The level of the print quality and resolution settings are displayed in the following combinations.

Setting	Details
Print Quality	<b>Highest / High / Standard / Draft</b>
Resolution	<b>1200dpi / 600dpi / 300dpi</b>

**Note**

- The availability of settings is determined by the media type and print priority selections.
- Printing time is longer and more ink is consumed with **High** than with **Draft**, however, print quality is higher.
- Printing time is shorter and less ink is consumed with **Draft** than with **High**, however, print quality is lower.

## Output Settings Panel

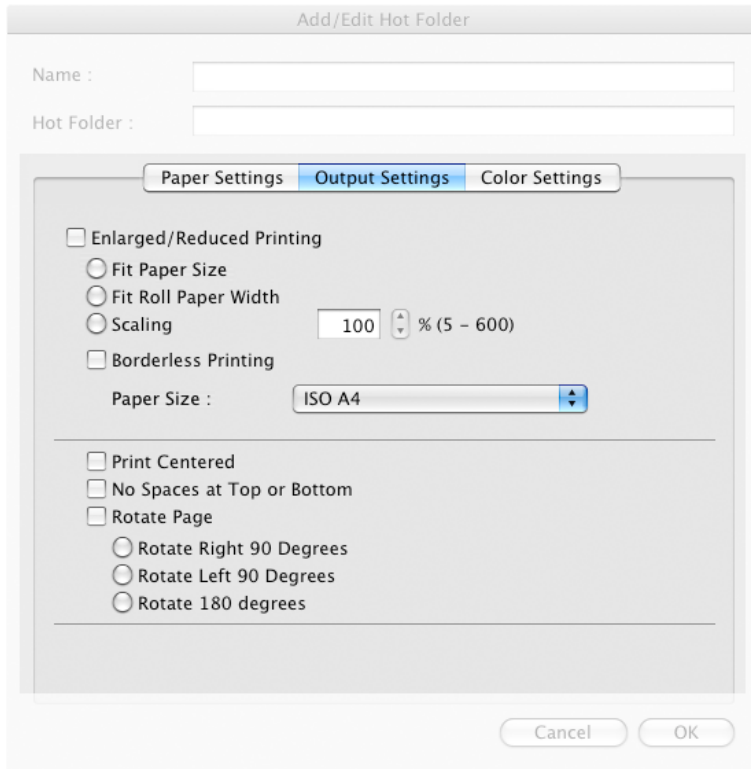

### • Enlarged/Reduced Printing

Select the method for enlarged/reduced printing.

The following settings are available for enlarged/reduced printing.

Setting	Details
<b>Fit Paper Size</b>	Enlarges/reduces the whole page automatically to fit the media size selected for output. Select the media size to print from <b>Paper Size</b> .
<b>Fit Roll Paper Width</b>	Enlarges/reduces the whole page automatically to fit the width of the roll paper with the page width. *Make sure that the width of the roll paper in the printer is set correctly for <b>Roll Paper Width</b> in the <b>Paper Settings</b> panel. *Displayed only if rolls are selected in <b>Paper Source</b> .
<b>Scaling</b>	Enlarges/reduces the whole page by the scaling rate as specified. Input the scaling value in numerical characters. You can specify a range between 5 and 600%. *You can change the numbers by clicking either ▲ button or ▼ button. *Although Scaling can be set to make the image larger than the media size, the part that does not fit in the media cannot be printed. *This is not displayed when a checkmark is placed in <b>Borderless Printing</b> .

### • Borderless Printing

You can print the media without margins on all sides when the roll paper with the specific width and the specific media type is used.

**Note**

- Available only if rolls are selected in **Paper Source**.

### • Paper Size

You can select the size of the print media.

**Note**

- This is not displayed when **Fit Roll Paper Width** is set in **Enlarged/Reduced Printing**.

### • Print Centered

Select this feature to print the image in the center of a cut sheet or to print left and right margins evenly from the edges of roll paper.

**Note**

- This feature is useful when you print the document enlarged or reduced with **Scaling** as well. When an image is scaled, it is always enlarged or reduced in reference to a starting point in the upper left corner of the page. If the image is reduced, the bottom and right margins are enlarged and the top and left margins remain unchanged. At that point, you can set all margins evenly with this feature.

### • No Spaces at Top or Bottom

You can set the printer to print without any empty area when the print data contains empty area at the top or bottom. Since the printer does not feed paper over the empty area, you can save paper.

**Note**

- Available only if rolls are selected in **Paper Source**.

### • Rotate Page

Select the method for rotating page.

The following settings are available for rotating page.

Setting	Details
<b>Rotate Right 90 Degrees</b>	Rotates the portrait page right 90 degrees and print in landscape orientation. When the rotated page can fit in the width of roll paper, the page is rotated automatically, and when it can not fit in the width of roll paper, the page is not rotated.  *When <b>Fit Roll Paper Width</b> is selected under <b>Enlarged/Reduced Printing</b> , then the image is enlarged or reduced after rotating to fit the width of the roll paper.
<b>Rotate Left 90 Degrees</b>	Rotates the portrait page left 90 degrees and print in landscape orientation. When the rotated page can fit in the width of roll paper, the page is rotated automatically, and when it can not fit in the width of roll paper, the page is not rotated.  *When <b>Fit Roll Paper Width</b> is selected under <b>Enlarged/Reduced Printing</b> , then the image is enlarged or reduced after rotating to fit the width of the roll paper.
<b>Rotate 180 degrees</b>	Allows you to rotate the image 180 degrees from the vertical to the right.

**Note**

- Available only if rolls are selected in **Paper Source**.

## Color Settings Panel

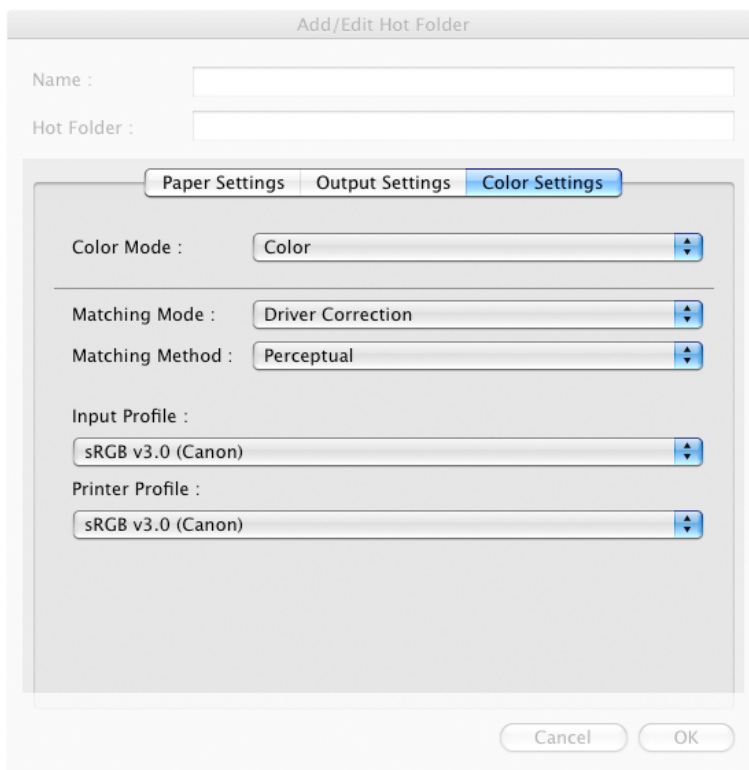

### • Color Mode

You can select a color mode to suit the print job.

Setting	Details
<b>Color</b>	Enables color printing.
<b>Monochrome</b>	Disables color printing and converts image from continuous color to grayscaled monochrome.
<b>Color (CAD)</b>	Prints lines in the best color possible so they are easy to see.
<b>Monochrome Bitmap</b>	Prints all colors other than white in black.
<b>Monochrome (BK ink)</b>	Select to print all lines with black ink.



#### Note

- The availability of settings depends on the print priority and media type selections.

### • Matching Mode

Under **Matching Mode**, select the matching mode.

Setting	Details
Driver Matching Mode <b>→P.537</b>	Enables printing of optimal color tones using a driver specific color profile. You should normally select this mode.

Setting	Details
ICC Matching Mode →P.538	Enables color matching using ICC profiles. Select this if you want to print by specifying the input profile, printer profile, and matching method in detail. This allows you to use ICC profiles for digital cameras and scanners, ICC profiles created using the profile creation tool, etc.
ColorSync →P.539	Enables color matching by using the ColorSync function of Mac OS. Select this if you want to perform soft proofing using ColorSync before printing.
No Correction	No color matching is performed. Select this option when you want to perform color matching in the software application.

## Driver Matching Mode

- Under **Matching Mode**, select **Driver Matching Mode**.

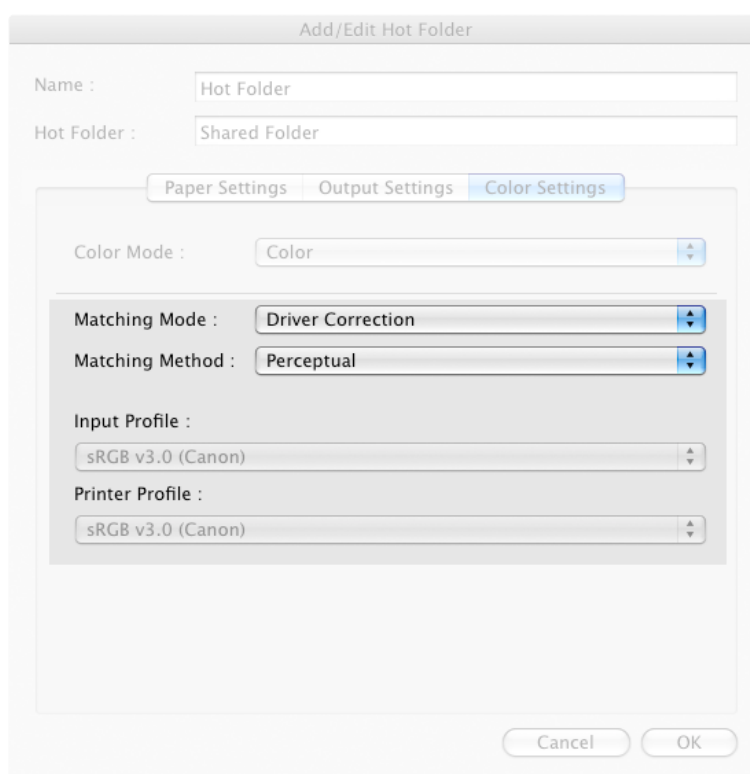

- Click **Matching Method** list, and then select a setting.

Setting	Details
<b>Auto</b>	Automatically selects the best color matching method for each Image, Graphics, Text.
<b>Perceptual</b>	Color-matching optimized for printing typical photos attractively. Smooth gradation is a feature. This is also an easy-to-use mode when performing color adjustment using application software.
<b>Saturation</b>	Color-matching optimized for printing posters, etc., vividly.

Setting	Details
<b>Colorimetric</b>	Color-matching optimized for printing image data with accurate colors in input color space. This is the easiest-to-use mode when you want to adjust the color and print. However, gradation may be lost for colors of wider range than the color reproduction range of the printer. Generally, this is also called relative colorimetric.

## ICC Matching Mode

- Under **Matching Mode**, select **ICC Matching Mode**.

4

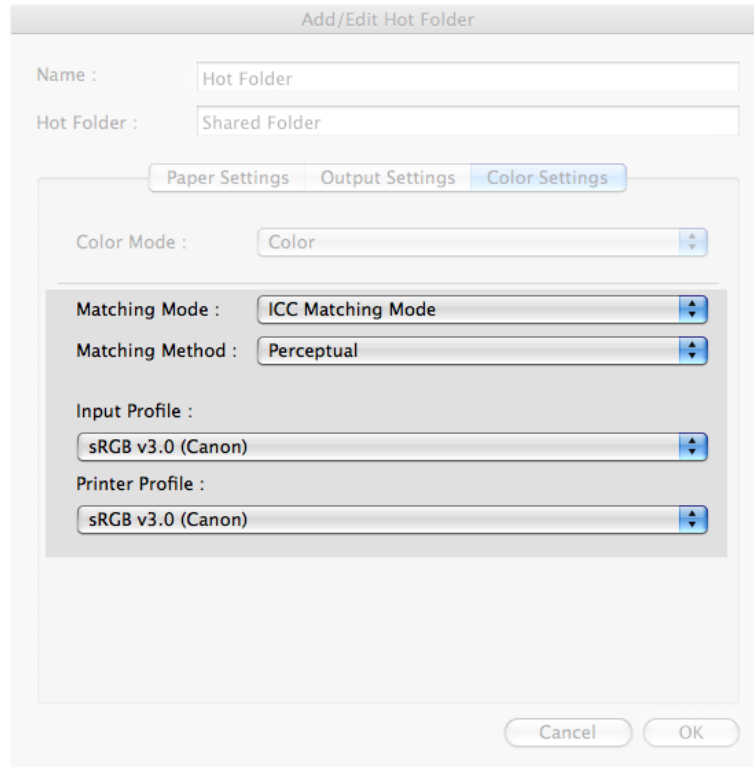

- Click **Matching Method** list, and then select a setting.

Setting	Details
<b>Perceptual</b>	Color-matching optimized for printing typical photos attractively. Smooth gradation is a feature. This is also an easy-to-use mode when performing color adjustment using application software.
<b>Saturation</b>	Color-matching optimized for printing posters, etc., vividly.
<b>Colorimetric</b>	Color-matching optimized for printing image data with accurate colors in input color space. This is the easiest-to-use mode when you want to adjust the color and print. However, gradation may be lost for colors of wider range than the color reproduction range of the printer. Generally, this is also called relative colorimetric.
<b>Colorimetric (No White-Point Correction)</b>	The processing method of color-matching is identical to <b>Colorimetric</b> . Use this when you want to further reproduce the target paper material color of the image data. Generally, this also is called absolute colorimetric.

538



3. Click the **Input Profile** list, and then select an input profile.

**Note**

- To match the color on the printing, select the input profile for Color imageRUNNER Enlargement Copy of the Color imageRUNNER type in use.

4. Click the **Printer Profile** list, and then select a printer profile.

## ColorSync

1. Under **Matching Mode**, select **ColorSync**.

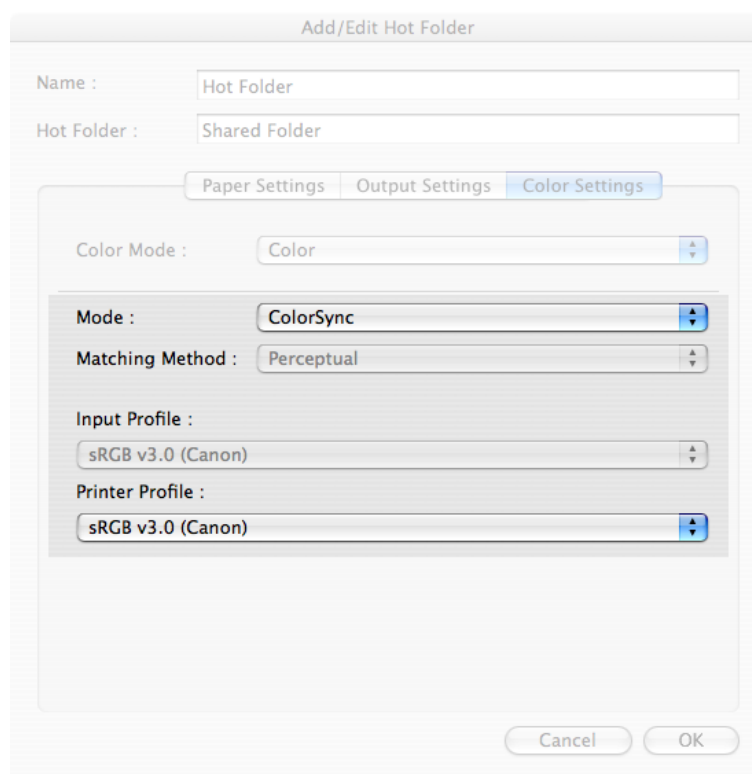

2. Click the **Printer Profile** list, and then select a printer profile.

**Note**

- Available when using Mac OS X 10.3.9-10.4.

## Printing Enlargements of Scanned Originals from a Color imageRUNNER

Scanned originals from a Color imageRUNNER can be enlarged and printed automatically. Originals you create by scanning with a Color imageRUNNER are transferred to a "hot folder" and printed automatically after enlargement according to printing conditions you specify for that folder.

This processing sequence is called the Color imageRUNNER Enlargement Copy function. To use Color imageRUNNER Enlargement Copy, first complete these settings in the following order.

1. Register a hot folder on your computer.  
Register a hot folder on your computer for storing scanned originals from the Color imageRUNNER and complete the settings for enlargement copy. For details, see "Creating a New Hot Folder." →P.522
2. Complete the scanning settings on the Color imageRUNNER.  
Configure the Color imageRUNNER to send scanned originals to the hot folder.

After these settings are complete, you can print enlarged copies of scanned originals from the Color imageRUNNER.

### Completing the scanning settings on the Color imageRUNNER.

Configure the Color imageRUNNER to send scanned originals to the hot folder. It is easy to send scanned originals to the hot folder if you assign the scanning settings and destination to a **Favorites** button on the Color imageRUNNER. For instructions on assigning scanning and sending settings to the **Favorites** button, refer to the Color imageRUNNER manual.

## 4

### Scanning the original and print an enlargement

Follow the steps below to scan an original on the Color imageRUNNER for enlarged printing on the printer. For detailed instructions, refer to the Color imageRUNNER manual.

1. Load the original on the platen glass or document feeder of the Color imageRUNNER.
2. Press **Send** to display the screen for transmission.
3. Press **Favorites**, and then press the **Favorites** button assigned to the hot folder.
4. Press **Start** on the control panel. If you scan originals on the platen glass, after scanning all originals, press **Done** on the touch-panel display.  
Scanned originals are sent to the hot folder and automatically enlarged and printed following the conditions you specified for the folder.

## Printmonitor

The Features of imagePROGRAF Printmonitor .....	541
Job Management Using imagePROGRAF Printmonitor .....	542

## The Features of imagePROGRAF Printmonitor

**imagePROGRAF Printmonitor** is a utility for checking the printer status and managing print jobs.

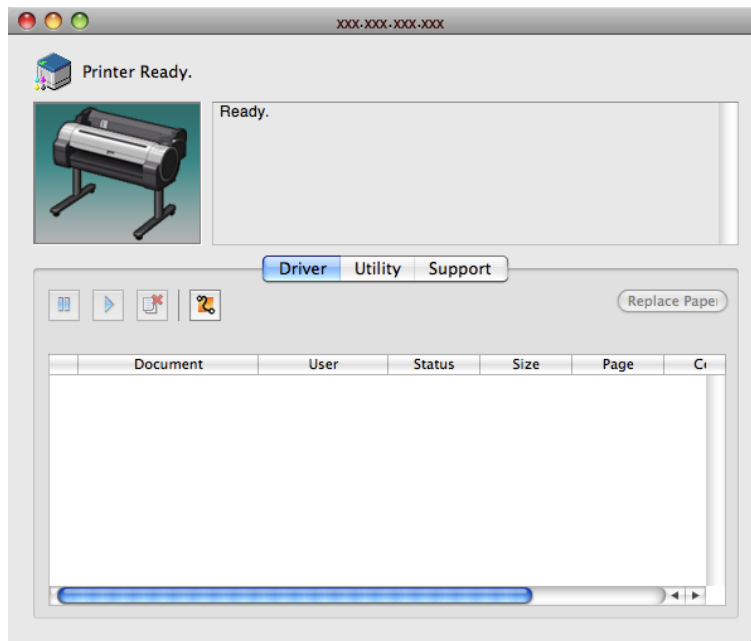

- Printer status can be checked in real time on a computer monitor.
- You can check the status of print jobs, cancel jobs, and manage them as needed.
- If a printer error occurs, you can investigate the corrective action immediately.
- You can also set up automatic email notification of any printer problems or errors to email addresses you designate in advance.



### Note

- If the status of the desired printer is not shown in imagePROGRAF Printmonitor, select the printer again as follows.
  1. Make sure the printer is on and connected to the network or to a local port.
  2. In the **Printer** menu, select the name of the desired printer. After the printer is detected, the printer status is shown.
  3. If information about the printer is not shown in step 2, choose **Search Printer** in the **Printer** menu. Printer names listed in the **Printer** menu are updated with the printers that are now detected.
  4. In the **Printer** menu, select the name of the desired printer. After the printer is detected, the printer status is shown.

## Job Management Using imagePROGRAF Printmonitor

You can use the **Driver** Panel in imagePROGRAF Printmonitor for operations such as pausing and canceling print jobs.

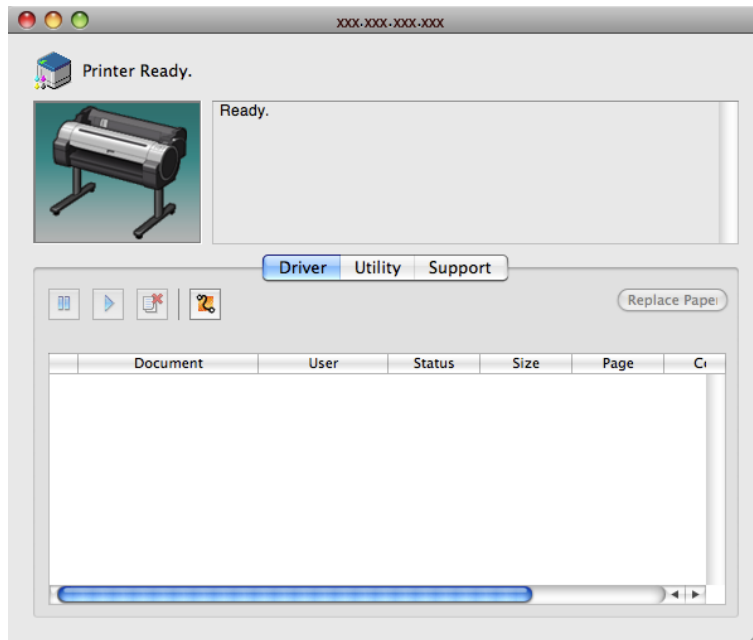

### • Pausing/Resuming Print Jobs

Selecting a print job and clicking the  button pauses printing of the selected job.

To resume printing of a paused print job, select the print job and click the  button.

 **Note**

- Once all the print data for a print job has been sent to the printer, the job can no longer be paused/resumed.

### • Canceling Print Jobs

Selecting a print job and clicking the  button cancels printing of the selected job.

 **Note**

- You cannot cancel other users' print jobs.

## Media Configuration Tool

The Features of Media Configuration Tool .....	543
Operating Environment .....	543
Procedures for Installing .....	544
Procedures for Uninstalling .....	547
Starting the Media Configuration Tool .....	551
Media Configuration Tool main window .....	552
Editing Media Type Information .....	553
Adding Media Types .....	553
Changing Media Names .....	556
Deleting Media Types You Have Added .....	558
Switching Media Types Display Show/Hide .....	560
Changing the Display Order of Media Types .....	562
Updating Media Types .....	564

### The Features of Media Configuration Tool

The Media Configuration Tool offers the following features.

- Enables information about additional media (types of paper) supported by the printer to be registered on the printer control panel and in the printer driver, through the use of relevant media information files (.amf and .med files).
- You can rearrange lists of the types of paper on the printer control panel and in printer driver dialog boxes and rename them, in addition to other functions.



#### Important

- The Media Configuration Tool is normally installed when you install the printer driver from the User Software CD-ROM, and media information is configured. The tool can be used later to add or edit media information as desired.

### Drivers Applicable with Media Configuration Tool

- imagePROGRAF Printer Driver

### Operating Environment

You can use Media Configuration Tool in the following environments.

- Compatible Operating System  
Mac OS X (10.3.9 or later)
- Software that requires installation  
imagePROGRAF Printer Driver

## Procedures for Installing

Start the installer in the new version of Media Configuration Tool, and follow procedures below to install the Media Configuration Tool.



### Important

- The Media Configuration Tool is normally installed when you install the printer driver from the User Software CD-ROM, and media information is registered at this time.

1. Double click the **MCT Installer iPFxxxx for X** icon to start the Media Configuration Tool installer.



iPFxxxx MCT Installer X



### Note

- The **iPFxxxx** in the icon will be the printer name in use.

2. Input the administrator name and password, and click the **OK** button.



3. The next screen presents selections for the country or area where the printer is used. Select a country or territory then click the **OK** button.

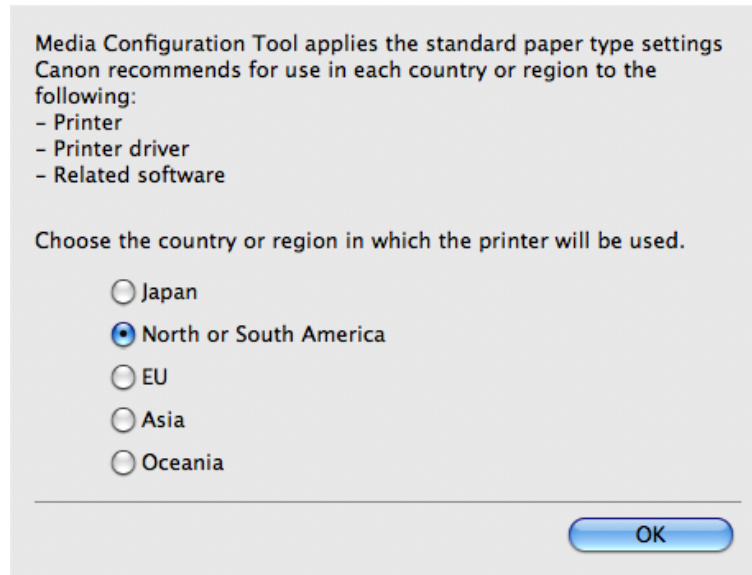

4

4. The **License** is displayed. After you have read Canon Software License Agreement, click the **Continue** button.

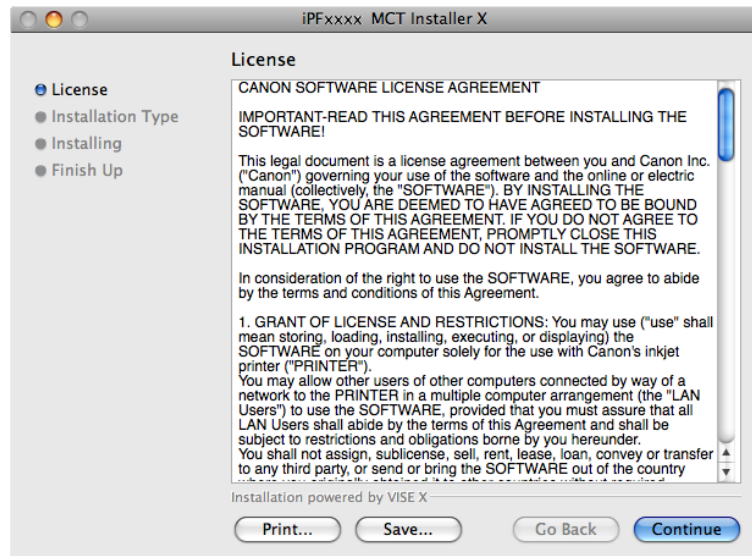

545

5. Click the **Agree** button.



6. Select **Easy Install** then click the **Install** button.

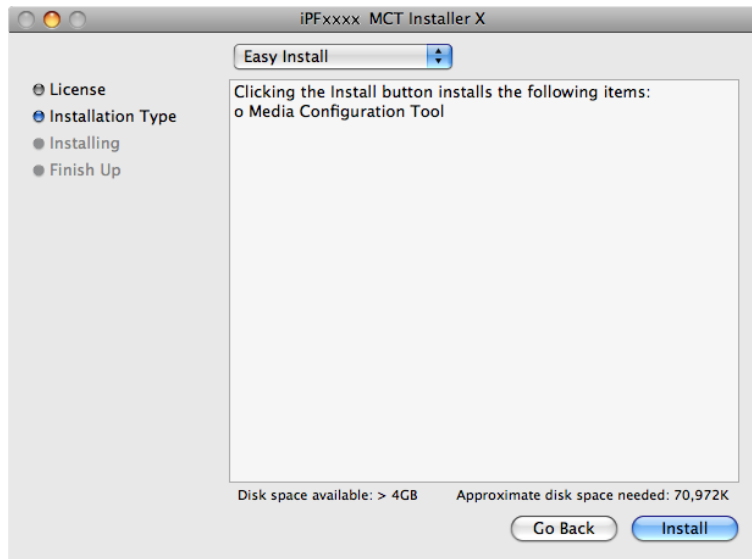

7. Click the **Continue** button to quit another application.

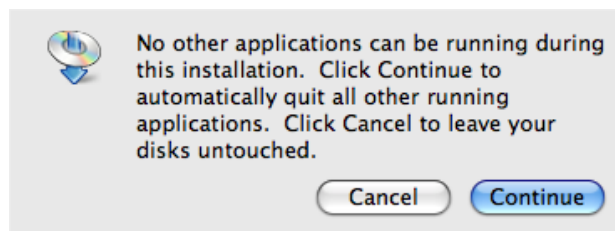

4

546



8. When the following message is displayed, click the **Quit** button.

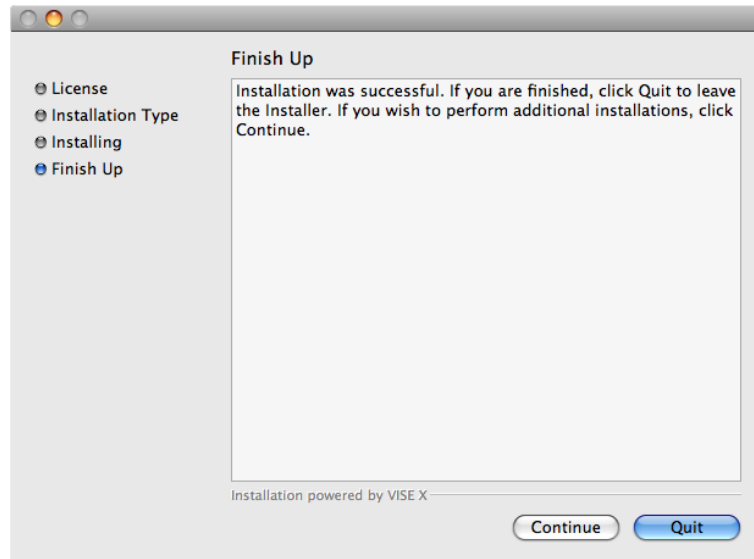

The installation of Media Configuration Tool is complete.



**Note**

- When the installation is completed properly, the **Media Configuration Tool** folder is saved in the following folder.  
**Applications > Canon Utilities > iPFxxxx Media Configuration Tool**
- The **iPFxxxx** in the folder above will be the printer name in use.

4

## Procedures for Uninstalling

1. Double click the **MCT Installer iPFxxxx for X** icon to start the Media Configuration Tool installer.



iPFxxxx MCT Installer X



**Note**

- The **iPFxxxx** in the icon will be the printer name in use.

547

2. Input the administrator name and password, and click the **OK** button.



3. The next screen presents selections for the country or area where the printer is used. Select a country or territory then click the **OK** button.

4

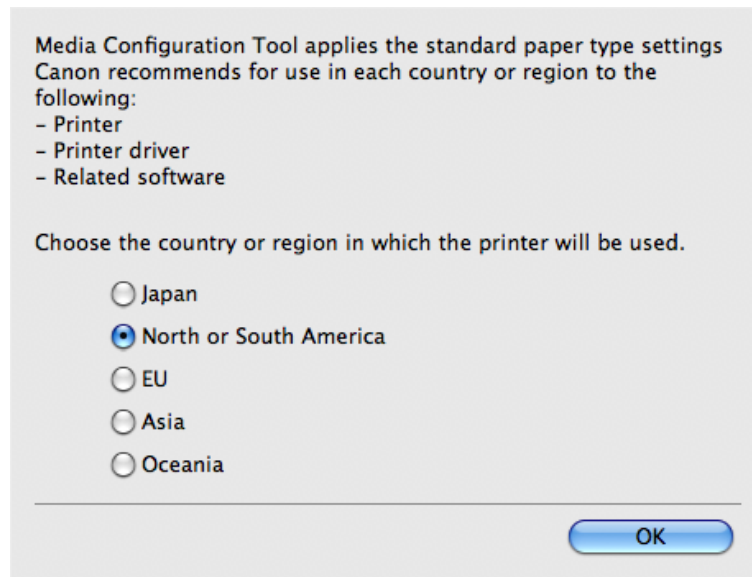

- 4.** The **License** is displayed.  
After you have read Canon Software License Agreement, click the **Continue** button.

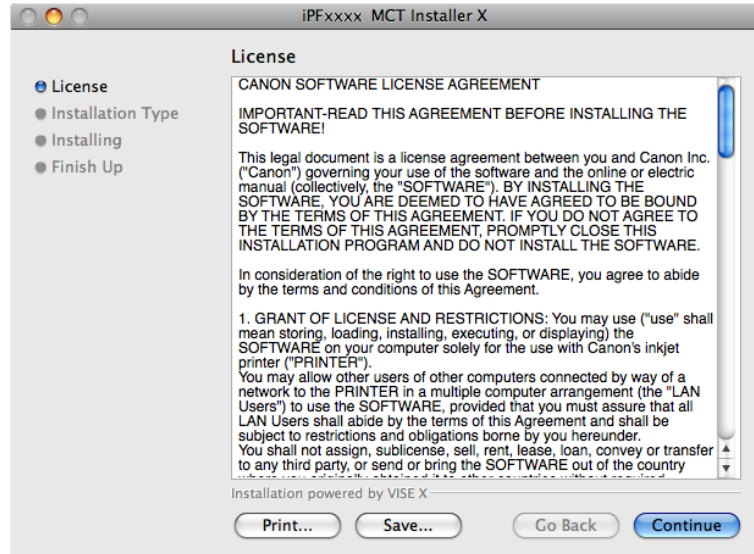

4

- 5.** Click the **Agree** button.

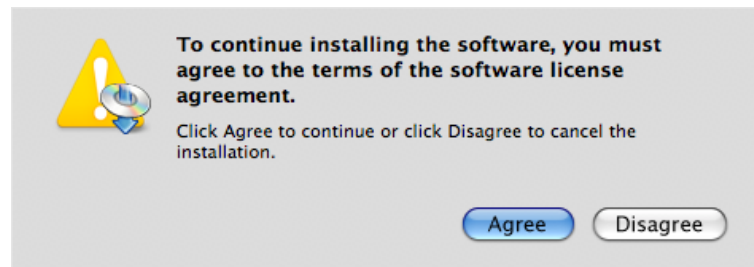

- 6.** Select **Uninstall**.

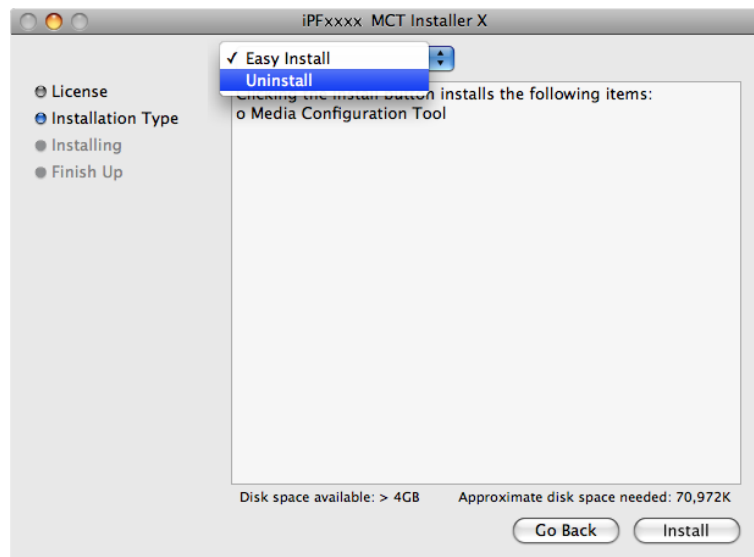

549

**7.** Click the **Uninstall** button.

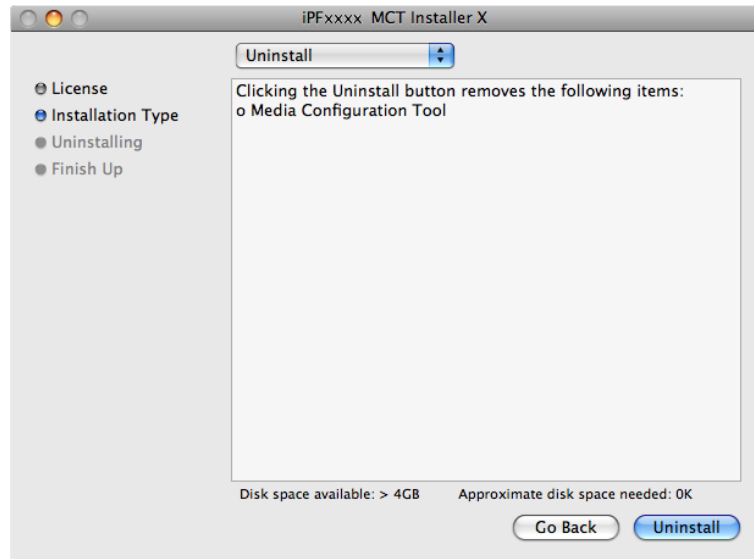

**8.** Press the **Continue** button when another application is running.

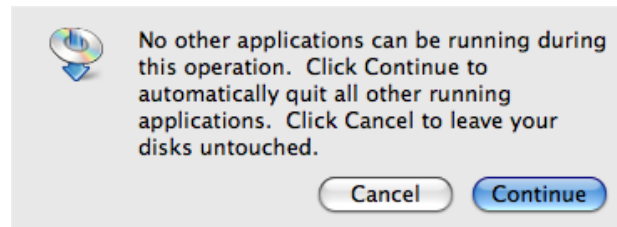

**9.** When the following message is displayed, click the **Quit** button.

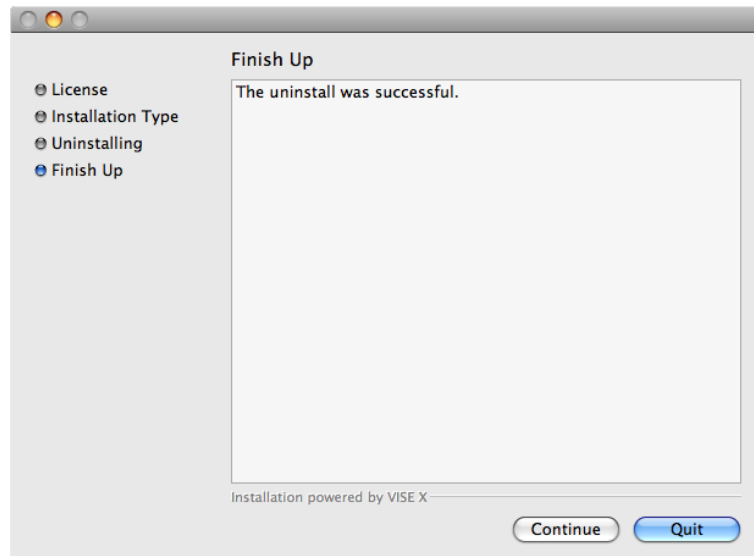

Media Configuration Tool has been uninstalled.

## Starting the Media Configuration Tool

Follow the procedure below to start the Media Configuration Tool.

From the **Applications** menu > **Canon Utilities** > **iPFxxxx Media Configuration Tool** > **MCTxxxx.app**.  
Media Configuration Tool main window is displayed.

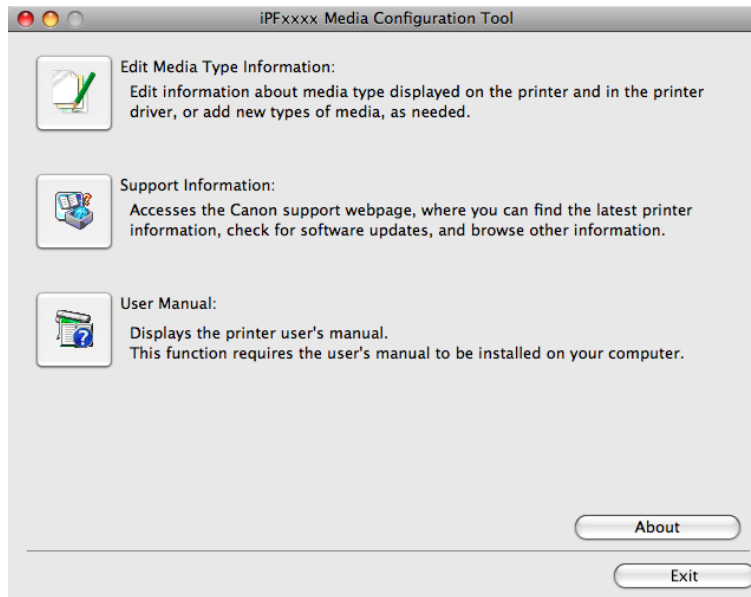

### Note

- If a compatible printer driver is not installed, the Media Configuration Tool will not start. If you attempt to start the Media Configuration Tool when a printer driver is not installed, the warning message below is displayed.

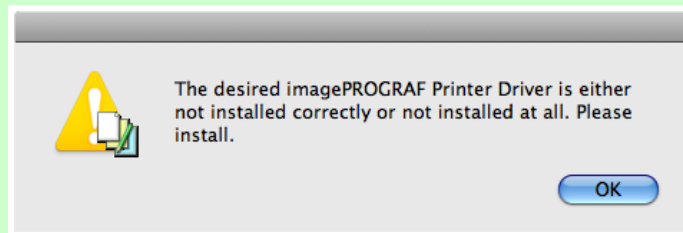

## Media Configuration Tool main window

The explanation below is on the Media Configuration Tool main window.

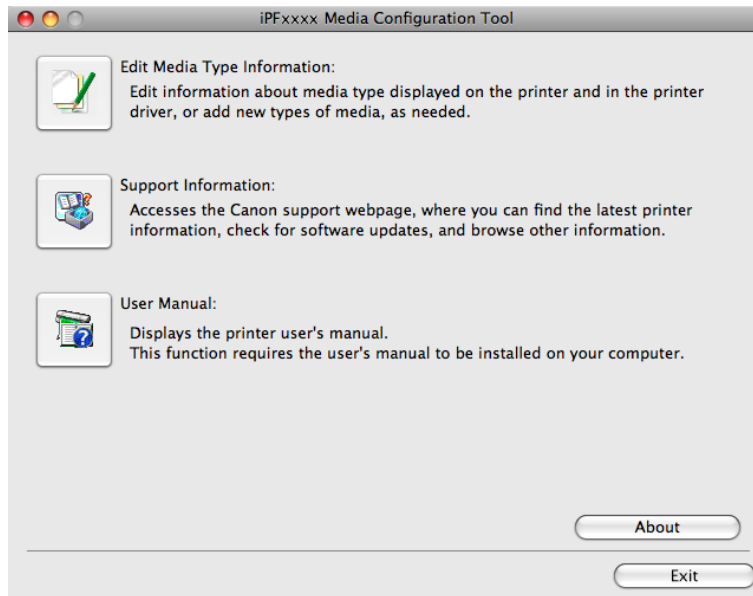

### Note

- For the step to open the Media Configuration Tool main window, see "Starting the Media Configuration Tool." →P.551

### • Edit Media Type Information Button

Click the button to open the **Edit Media Types** dialog box and you can edit the media types.

For more information about **Edit Media Type Information**, see "Editing Media Type Information." →P.553

### • Support Information Button

Click this button to access the Canon support webpage, where you can find the latest printer information, check for software updates, and browse other information.

### • User Manual Button

Click this button to display the printer user manual. This function requires that the user manual be installed on your computer.

## Editing Media Type Information

Click the **Edit Media Type Information** button in the Media Configuration Tool main window to display the **Edit Media Types** dialog box.

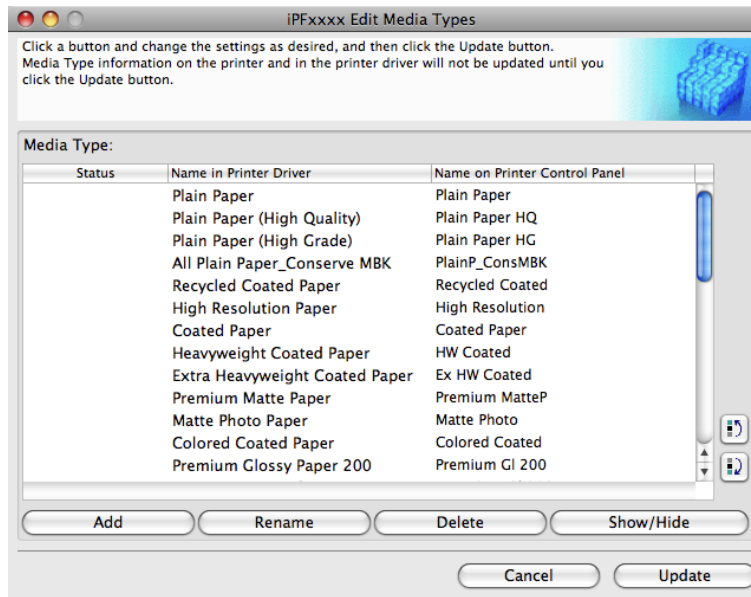

This dialog box presents functions for the following tasks.

- Adding Media Types →P.553
- Changing Media Names →P.556
- Deleting Media Types You Have Added →P.558
- Switching Media Types Display Show/Hide →P.560
- Changing the Display Order of Media Types →P.562



### Note

- It may not be possible to deleting, showing/hiding, and changing the display order under some conditions.

## Adding Media Types

Media information files (.amf files) released by Canon are registered in the printer control panel and printer driver.



### Important

- Do not perform printing on the target printer while adding the media types.
- Reinstalling Media Configuration Tool after registering a media information file may delete the registered media information file. In this case, first download and install latest Media Configuration Tool, then download and register the required media information file.

1. Open the **Edit Media Types** dialog box, and then click the **Add** button.

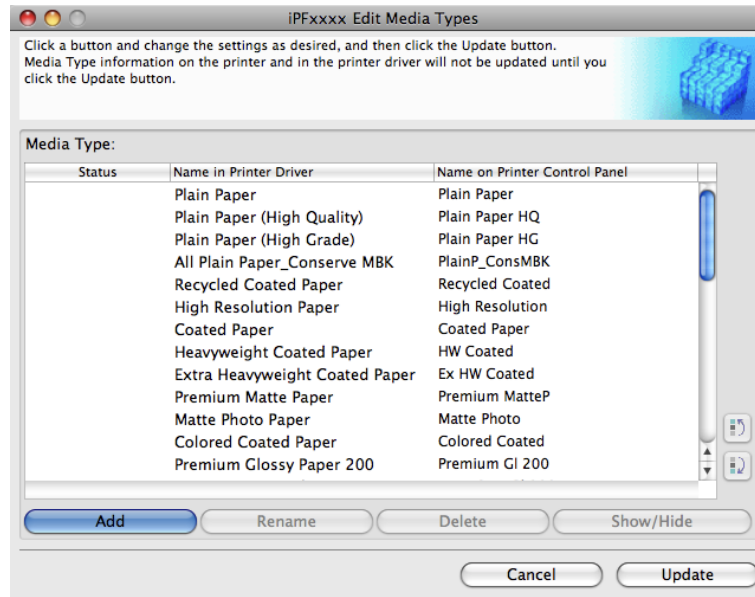

2. The **Add Media Type** dialog box displays. Click the **Browse** button.

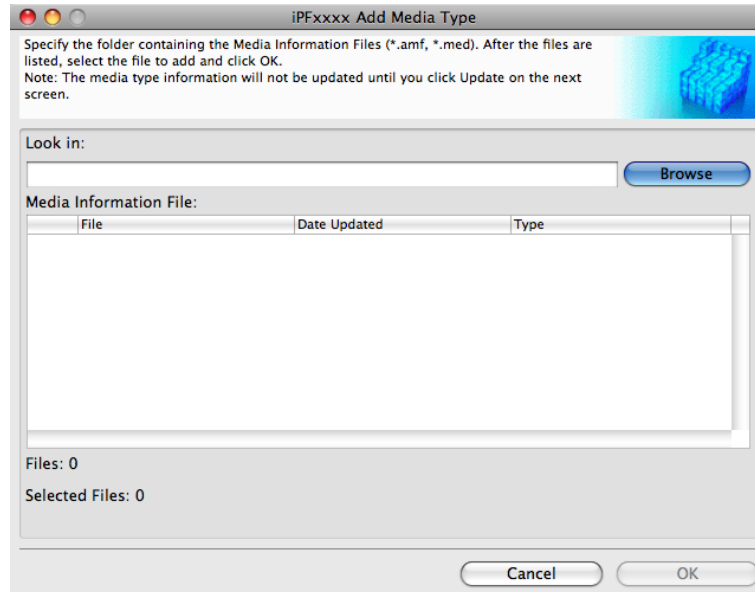

4



3. Select the folder that contains the media information files (.amf files), and then click the **Open** button.

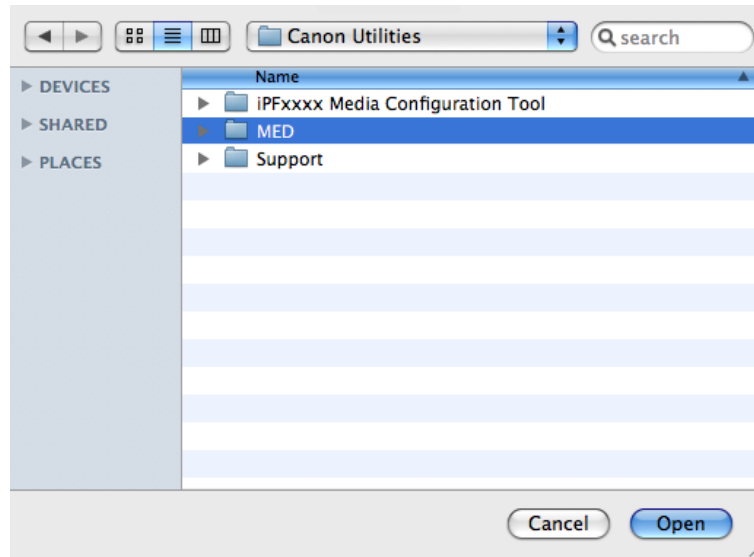

4

4. The names of media information files in the folder you selected in the **Open** dialog box are displayed under **Media Information File** in the **Add Media Type** dialog box. Select the check boxes of paper to add and click the **OK** button.

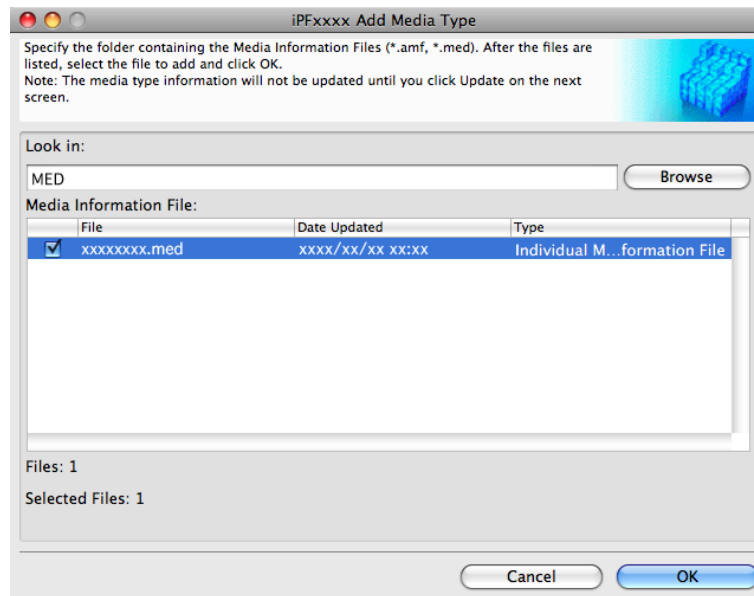

#### Important

- If **Master Media Information File** is displayed as the **Type** of the **Media Information File**, the media type display order and media type display/non-display settings are initialized. Reconfigure these after added the master media information file.

5. Click **OK** when the confirmation message is displayed.

555

6. In the **Edit Media Types** dialog box, click the **Update** button.

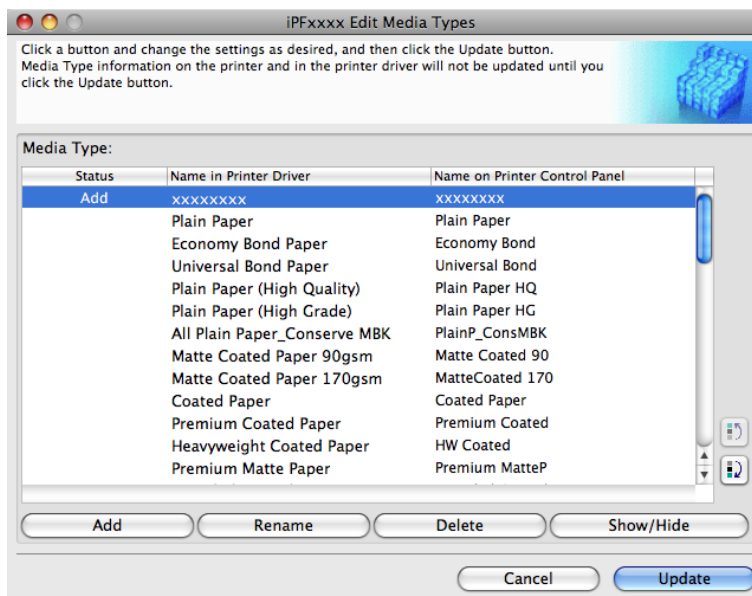

The **Update Media Types** wizard is started at this point. For details on the procedure to update paper information using the **Update Media Types** wizard, see "Updating Media Types." →P.564



**Important**

- Be sure to click the Update button. If you do not, your changes will not be applied to the printer and printer driver.

## Changing Media Names

1. Open the **Edit Media Types** dialog box.

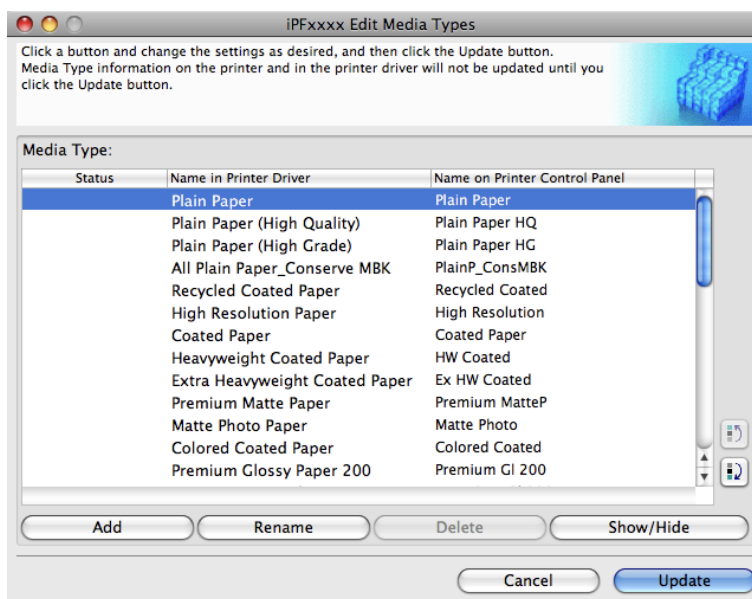

- In the **Media Type** list, select the name to change.  
Click the **Rename** button.

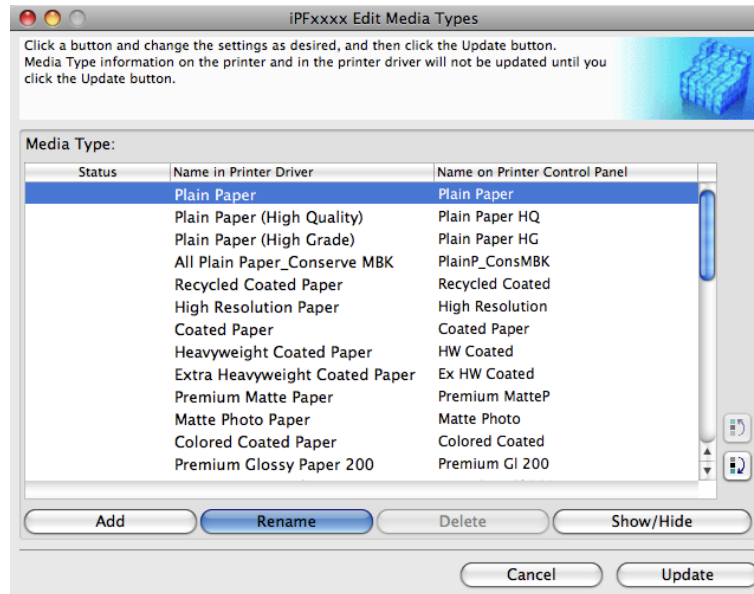

- The **Rename Media** dialog box is displayed.  
Edit the names in **Name in Printer Driver** and **Name on Control Panel** and click the **OK** button.

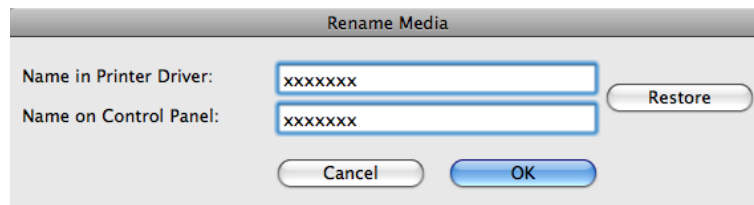
**Note**

- To restore the original names, click the **Restore** button.

4. In the **Edit Media Types** dialog box, click the **Update** button.

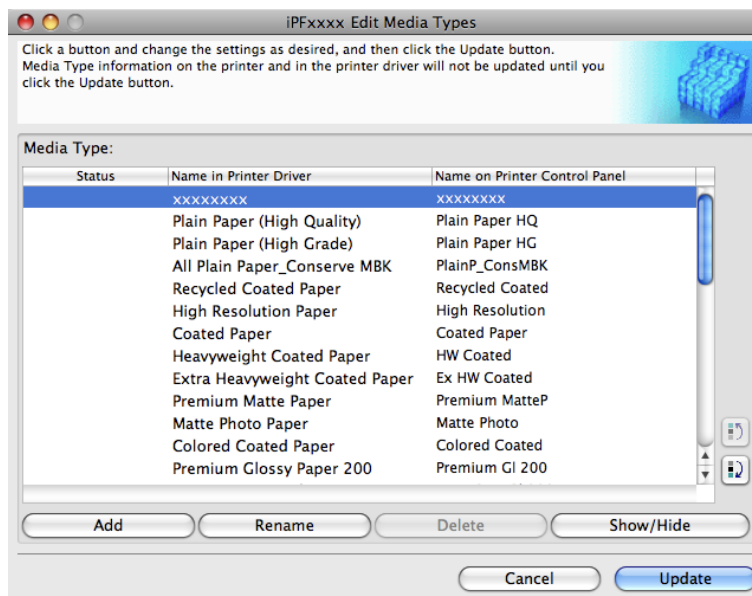

The **Update Media Types** wizard is started at this point. For details on the procedure to update paper information using the **Update Media Types** wizard, see "Updating Media Types." →P.564



**Important**

- Be sure to click the Update button. If you do not, your changes will not be applied to the printer and printer driver.

## Deleting Media Types You Have Added

1. Open the **Edit Media Types** dialog box.

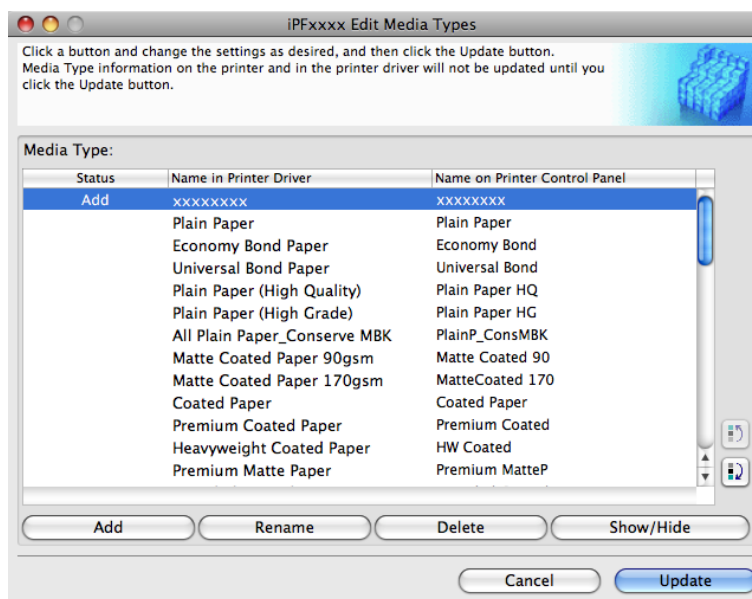

2. In the **Media Type** list, select the name of the media to delete.  
Click the **Delete** button.

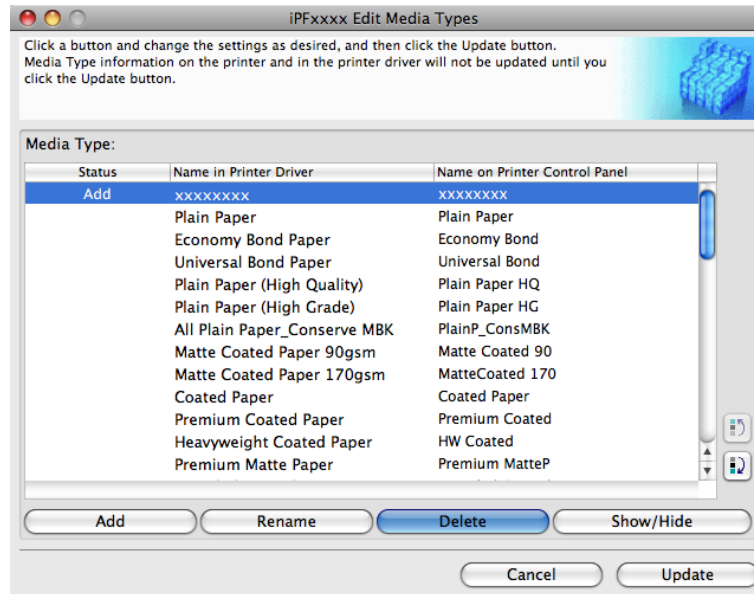
**Note**

- Only paper for which **Status** in the **Media Type** is **Add** can be deleted.

3. In the **Edit Media Types** dialog box, click the **Update** button.

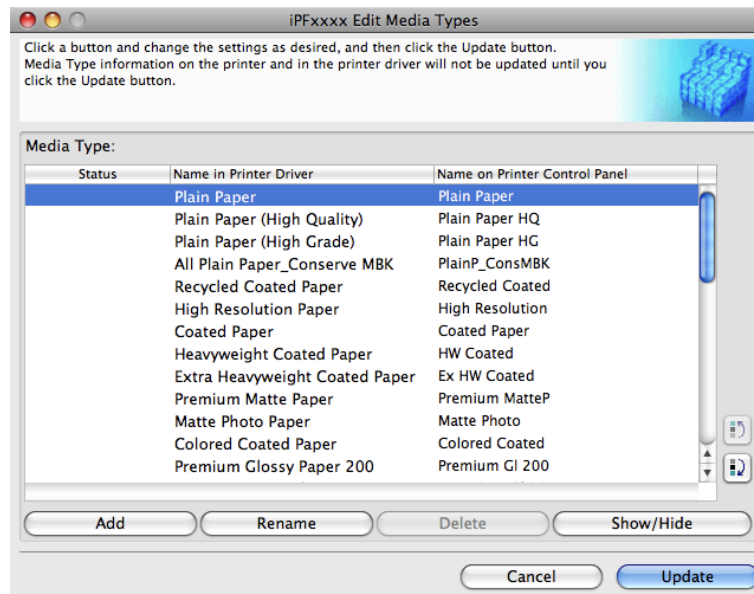

The **Update Media Types** wizard is started at this point. For details on the procedure to update paper information using the **Update Media Types** wizard, see "Updating Media Types." →P.564



**Important**

- Be sure to click the Update button. If you do not, your changes will not be applied to the printer and printer driver.

## Switching Media Types Display Show/Hide

1. Open the **Edit Media Types** dialog box.

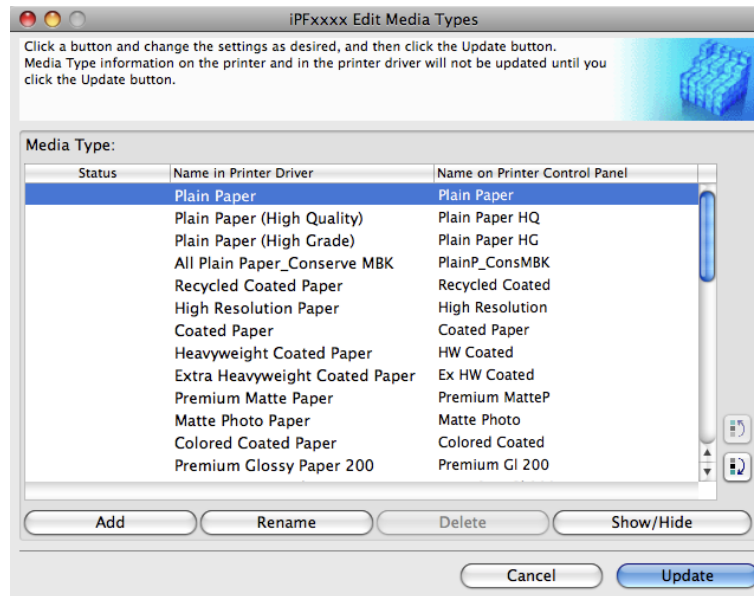

4

2. In the **Media Type** list, select the name of the media to switch off or on for display. Click the **Show/Hide** button. The selected paper is alternately shown or hidden.

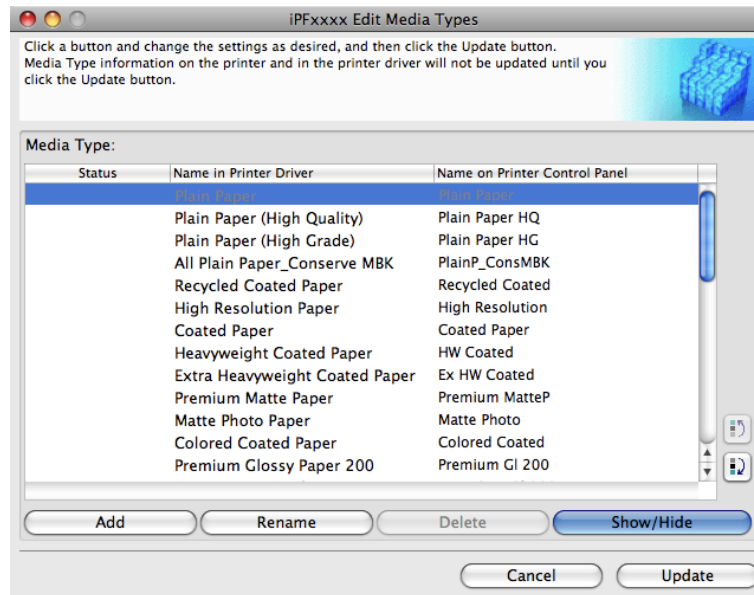
**Note**

- The names of media switched for non-display appear grayed out in the **Media Type** list.
- Each time you click the **Show/Hide** button, the display mode cycles from showing both the printer driver and printer panel, to hiding both the printer driver and printer panel, and then to showing only the printer panel.

3. In the **Edit Media Types** dialog box, click the **Update** button.

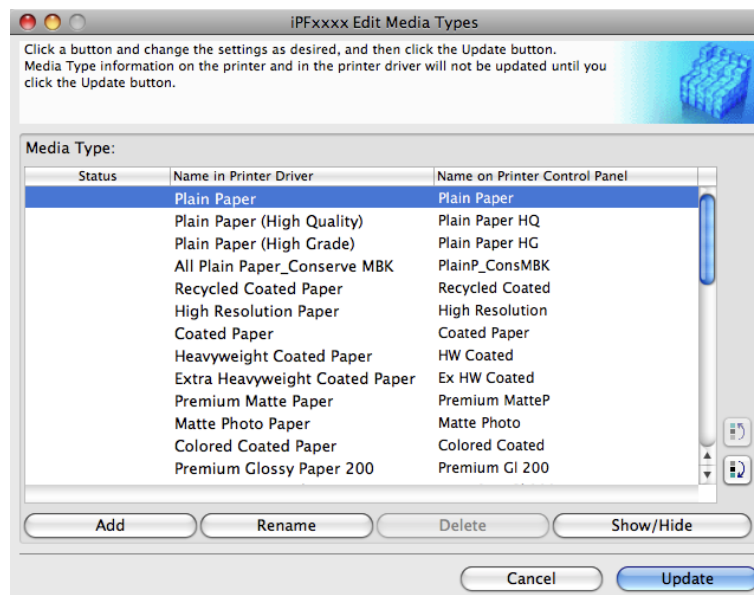

The **Update Media Types** wizard is started at this point. For details on the procedure to update paper information using the **Update Media Types** wizard, see "Updating Media Types." →P.564



**Important**

- Be sure to click the Update button. If you do not, your changes will not be applied to the printer and printer driver.

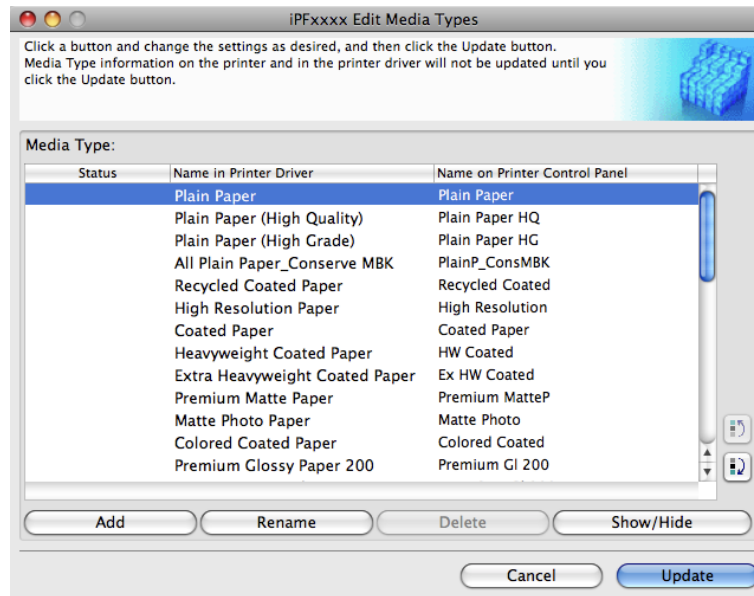

## Changing the Display Order of Media Types

1. Open the **Edit Media Types** dialog box.



4



2. Select the paper in the **Media Type** list for which to change the display order, and then click the buttons to move the item (  or  ).  
The selected item moves one line up or down for every button click.

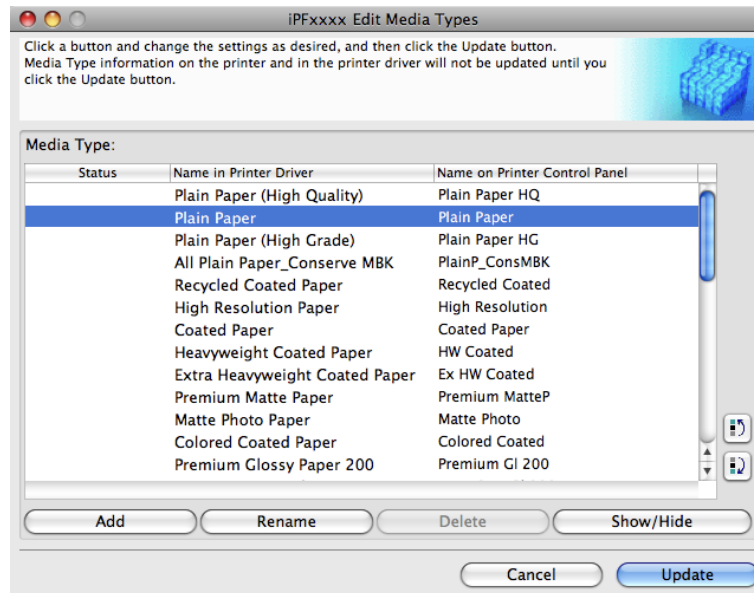

3. In the **Edit Media Types** dialog box, click the **Update** button.

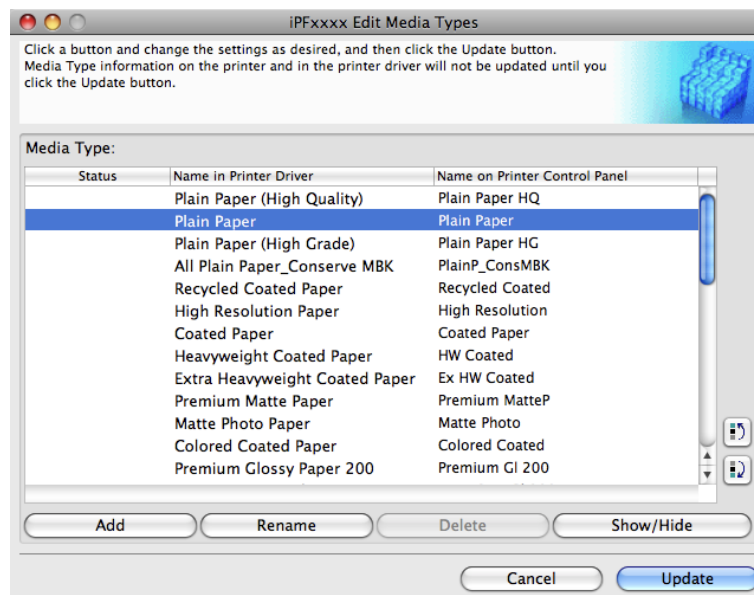

The **Update Media Types** wizard is started at this point. For details on the procedure to update paper information using the **Update Media Types** wizard, see "Updating Media Types." →P.564



#### Important

- Be sure to click the Update button. If you do not, your changes will not be applied to the printer and printer driver.

## Updating Media Types

Clicking the **Update** button on the **Edit Media Types** dialog box opens the **Update Media Types** wizard. You can use this wizard to apply new information about print media in the printer and in the printer driver. The procedures for updating the media information with the **Update Media Types** wizard are as follows.

 **Important**

- The use of this procedure is based on the assumption that Media Configuration Tool is updated or you have a media information file for print media that is to be updated.

1. Confirm the printer, where media type information is to be updated, to be displayed in **Printer** in the **Update Media Types - Select Printer** dialog box, and then click the **Next** button.

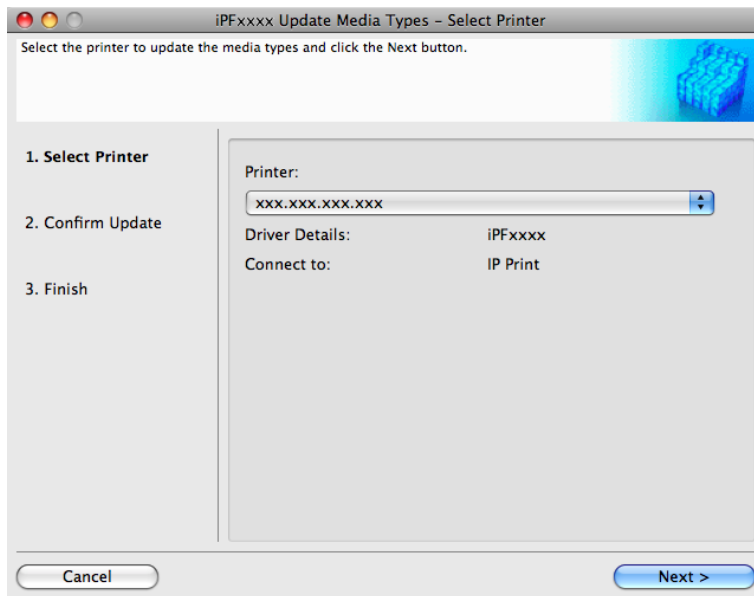

2. Communication with the printer starts and the following dialog box is displayed.

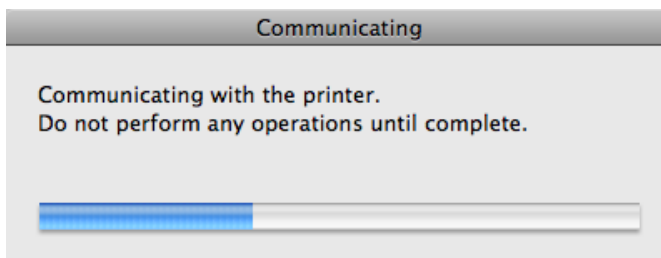

 **Important**

- Do not attempt to print or turn the printer off while the program is communicating with the printer.

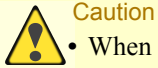
**Caution**

- When the program cannot communicate with the printer, the following warning message is displayed.

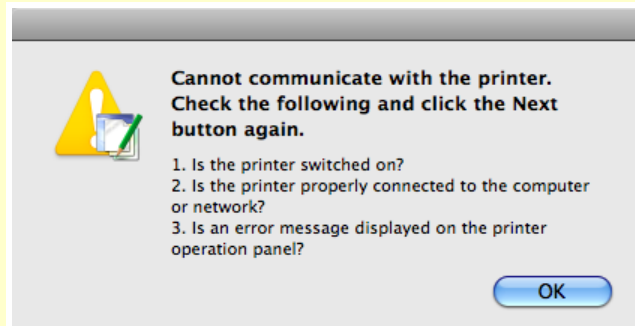

3. When the program has finished communicating with the printer, the screen moves to display **Update Media Types - Confirm Update**. Confirm the information received from the printer. To update click the **Execute** button.

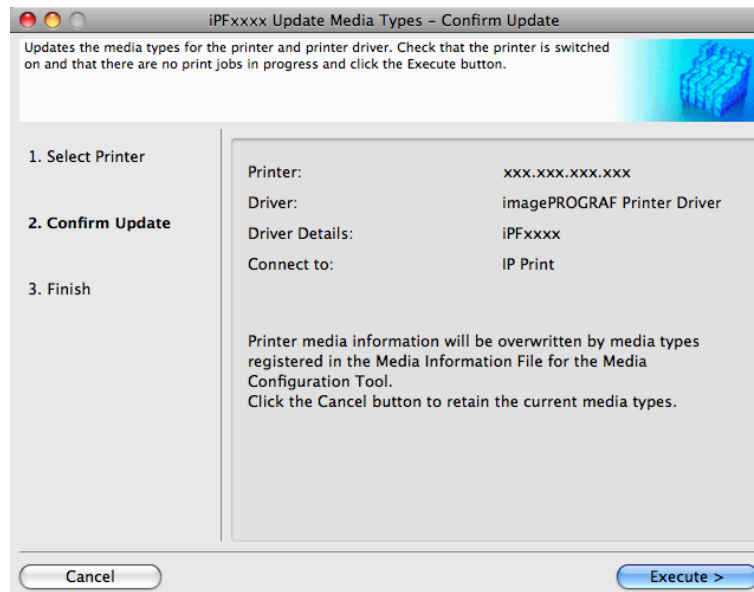
**Important**

- When setting a data to the printer that differs from the data to be updated, the selected media information file is updated. When you would like to remain the data that is set to the printer, click the **Cancel** button.

4. Communication with the printer starts and the following dialog box is displayed.

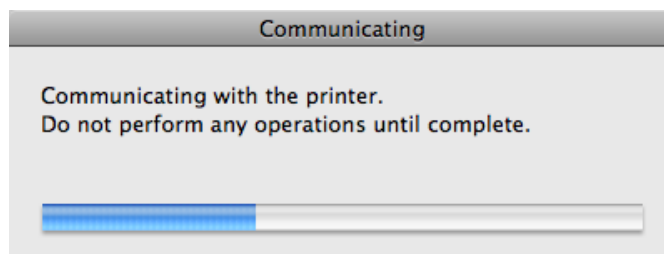



**Important**

- Do not attempt to print or turn the printer off while the program is communicating with the printer.



**Caution**

- When the program cannot communicate with the printer, the following warning message is displayed.



4

5. After the media information file is updated successfully, the screen switches to the **Update Media Types - Finish** dialog box. Click **Finish** to close the **Update Media Types** wizard.

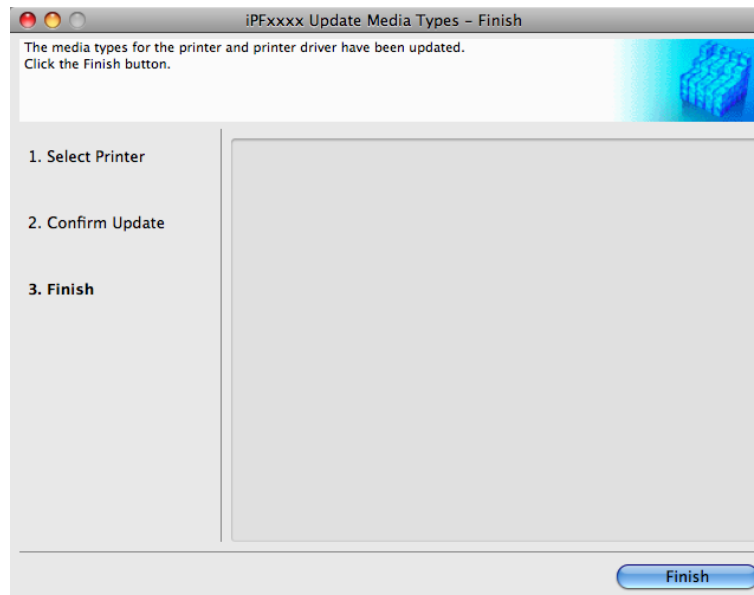

566

## Handling Paper

Paper	568
Handling rolls	575
Handling sheets	602
Output Stacker	611

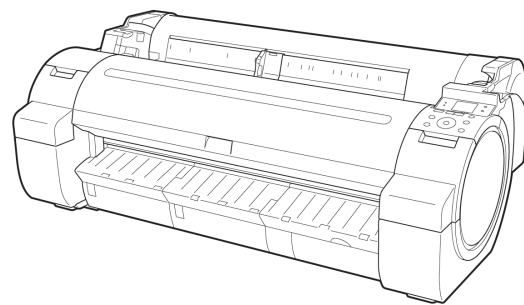

## Paper

Types of Paper .....	568
Paper Sizes .....	569
Displaying the Paper Reference Guide .....	571
Updating paper information .....	573
Adding Custom Paper .....	574

### Types of Paper

The following types of paper are supported by the printer. For details on the paper supported by the printer, refer to the Paper Reference Guide. (See Paper Reference Guide.)

- Plain Paper
- Coated Paper
- Photo Paper
- Glossy Paper
- Proofing Paper
- CAD-dedicated Paper Etc.

The following content is described in the Paper Reference Guide.

- Types of paper
- Paper handling
- Paper product specifications
- Use precautions
- Setting of printer driver, control panel etc.

#### Paper Reference Guide display method

You can display the Paper Reference Guide from [imagePROGRAF Support Information]. (See "Displaying the Paper Reference Guide.") →P.571

#### Method of Updating Supported Paper

Paper supported by the printer may be newly released on the imagePROGRAF website.

To use newly released paper, register the latest paper information on the printer with the Media Configuration Tool. (See "Updating paper information.") →P.573



#### Important

- To install the Paper Reference Guide and register paper types applicable to your region on your printer even when not using the printer driver, install the Media Configuration Tool. For information about the Media Configuration Tool, see Media Configuration Tool →P.412 or Media Configuration Tool →P.543 .



#### Note

- To use paper not described in the Paper Reference Guide, configure the custom paper setting. (See "Adding Custom Paper.") →P.574

## Paper Sizes

### Rolls

Rolls that meet the following conditions are supported.

- Outer diameter: Up to 150 mm (6 in)
- Inner diameter of paper core: 2 or 3 inches
- Printing side out

Roll Width	Roll Paper Width Setting in Printer Driver	Borderless Printing (*1 →P.569 )
914.4 mm (36.00 in)	<b>36-in. Roll (914.4mm)</b>	Yes
841.0 mm (33.11 in)	<b>ISO A0/A1 Roll (841.0mm)</b>	Yes
762.0 mm (30.00 in)	<b>30-in. Roll (762.0mm)</b>	No
728.0 mm (28.66 in)	<b>JIS B1/B2 Roll (728.0mm)</b>	Yes
609.6 mm (24.00 in)	<b>24-in. Roll (609.6mm)</b>	Yes
594.0 mm (23.39 in)	<b>ISO A1/A2 Roll (594.0mm)</b>	Yes
515.0 mm (20.28 in)	<b>JIS B2/B3 Roll (515.0mm)</b>	Yes
431.8 mm (17.00 in)	<b>17-in. Roll (431.8mm)</b>	Yes
420.0 mm (16.54 in)	<b>ISO A2/A3 Roll (420.0mm)</b>	Yes
406.4 mm (16.00 in)	<b>16-in. Roll (406.4mm)</b>	No
355.6 mm (14.00 in)	<b>14-in. Roll (355.6mm)</b>	Yes
300.0 mm (11.81 in)	<b>300mm Roll (300.0mm)</b>	Yes
297.0 mm (11.69 in)	<b>ISO A3/A4 Roll (297.0mm)</b>	Yes
257.0 mm (10.12 in)	<b>JIS B4 Roll (257.0mm)</b>	Yes
254.0 mm (10.00 in)	<b>10-in. Roll (254.0mm)</b>	Yes

\*1: For information on types of paper compatible with borderless printing, refer to the Paper Reference Guide. (See "Types of Paper." →P.568)

### Sheets

Sheets of the following sizes are supported.

Paper Sizes	Dimensions
<b>ISO A0</b>	841.0 × 1189.0 mm (33.11 × 46.81 in)
<b>ISO A1</b>	594.0 × 841.0 mm (23.39 × 33.11 in)
<b>ISO A2+</b>	431.8 × 609.6 mm (17.00 × 24.00 in)
<b>ISO A2</b>	420.0 × 594.0 mm (16.54 × 23.39 in)
<b>ISO A3+</b>	329.0 × 483.0 mm (12.95 × 19.02 in)
<b>ISO A3</b>	297.0 × 420.0 mm (11.69 × 16.54 in)
<b>ISO A4</b>	210.0 × 297.0 mm (8.27 × 11.69 in)
<b>ISO B1</b>	707.0 × 1000.0 mm (27.83 × 39.37 in)
<b>ISO B2</b>	500.0 × 707.0 mm (19.69 × 27.83 in)
<b>ISO B3</b>	353.0 × 500.0 mm (13.90 × 19.69 in)

Paper Sizes	Dimensions
<b>ISO B4</b>	250.0 × 353.0 mm (9.84 × 13.90 in)
<b>JIS B1</b>	728.0 × 1030.0 mm (28.66 × 40.55 in)
<b>JIS B2</b>	515.0 × 728.0 mm (20.28 × 28.66 in)
<b>JIS B3</b>	364.0 × 515.0 mm (14.33 × 20.28 in)
<b>JIS B4</b>	257.0 × 364.0 mm (10.12 × 14.33 in)
<b>34"x44"(ANSI E)</b>	863.6 × 1117.6 mm (34.00 × 44.00 in)
<b>28"x40"(ANSI F)</b>	711.2 × 1016.0 mm (28.00 × 40.00 in)
<b>22"x34"(ANSI D)</b>	558.8 × 863.6 mm (22.00 × 34.00 in)
<b>17"x22"(ANSI C)</b>	431.8 × 558.8 mm (17.00 × 22.00 in)
<b>11"x17"(Ledger)</b>	279.4 × 431.8 mm (11.00 × 17.00 in)
<b>13"x19"(Super B)</b>	330.2 × 482.6 mm (13.00 × 19.00 in)
<b>Letter(8.5"x11")</b>	215.9 × 279.4 mm (8.50 × 11.00 in)
<b>Legal(8.5"x14")</b>	215.9 × 355.6 mm (8.50 × 14.00 in)
<b>36"x48"(ARCH E)</b>	914.4 × 1219.2 mm (36.00 × 48.00 in)
<b>30"x42"(ARCH E1)</b>	762.0 × 1066.8 mm (30.00 × 42.00 in)
<b>26"x38"(ARCH E2)</b>	660.4 × 965.2 mm (26.00 × 38.00 in)
<b>27"x39"(ARCH E3)</b>	685.8 × 990.6 mm (27.00 × 39.00 in)
<b>24"x36"(ARCH D)</b>	609.6 × 914.4 mm (24.00 × 36.00 in)
<b>18"x24"(ARCH C)</b>	457.2 × 609.6 mm (18.00 × 24.00 in)
<b>12"x18"(ARCH B)</b>	304.8 × 457.2 mm (12.00 × 18.00 in)
<b>9"x12"(ARCH A)</b>	228.6 × 304.8 mm (9.00 × 12.00 in)
<b>DIN C0</b>	917.0 × 1296.0 mm (36.10 × 51.02 in)
<b>DIN C1</b>	648.0 × 917.0 mm (25.51 × 36.10 in)
<b>DIN C2</b>	458.0 × 648.0 mm (18.03 × 25.51 in)
<b>DIN C3</b>	324.0 × 458.0 mm (12.76 × 18.03 in)
<b>DIN C4</b>	229.0 × 324.0 mm (9.02 × 12.76 in)
<b>20"x24"</b>	508.0 × 609.6 mm (20.00 × 24.00 in)
<b>18"x22"</b>	457.2 × 558.8 mm (18.00 × 22.00 in)
<b>14"x17"</b>	355.6 × 431.8 mm (14.00 × 17.00 in)
<b>12"x16"</b>	304.8 × 406.4 mm (12.00 × 16.00 in)
<b>10"x12"</b>	254.0 × 304.8 mm (10.00 × 12.00 in)
<b>10"x15"</b>	254.0 × 381.0 mm (10.00 × 15.00 in)
<b>US Photo 16"x20"</b>	406.4 × 508.0 mm (16.00 × 20.00 in)
<b>Poster 20"x30"</b>	508.0 × 762.0 mm (20.00 × 30.00 in)
<b>Poster 30"x40"</b>	762.0 × 1016.0 mm (30.00 × 40.00 in)
<b>13"x22"</b>	329.0 × 558.0 mm (12.95 × 21.97 in)
<b>Poster 300x900mm</b>	300.0 × 900.0 mm (11.81 × 35.43 in)
<b>Custom Paper Size</b>	203.2 x 203.2 mm (8.00 x 8.00 in) to 917.0 x 1600.0 mm (36.10 x 62.99 in)



**Note**

- For details on non-standard paper sizes, see "Printing on Non-Standard Paper Sizes." →P.130
- Borderless printing is not supported on sheets.

## Displaying the Paper Reference Guide

The Paper Reference Guide can be accessed from **imagePROGRAF Support Information**. Follow these instructions, as appropriate for your operating system.

- Windows

1. Double-click the **iPFxxxx Support** desktop icon. (iPFxxxx indicates the printer model.)



The **imagePROGRAF Support Information** window is displayed.

2. Click the **Paper Reference Guide** button.

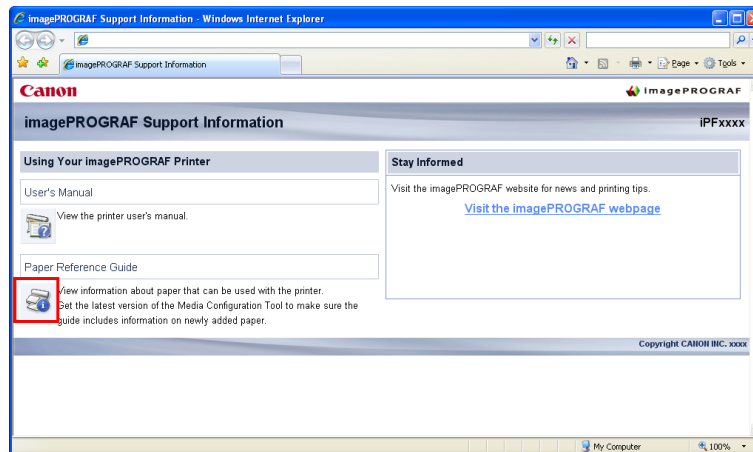

The Paper Reference Guide is displayed.

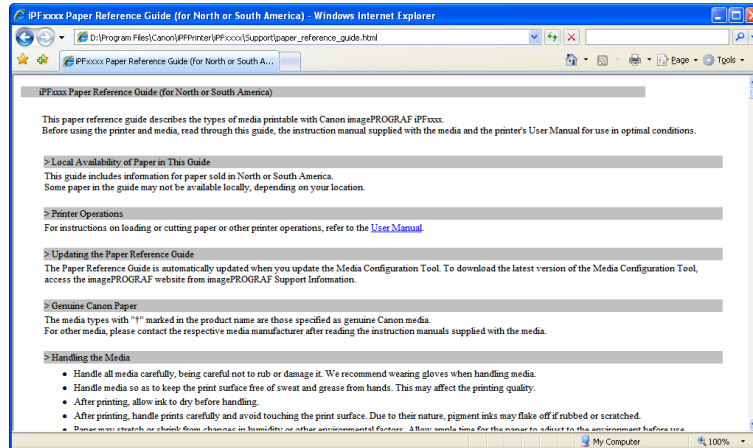

• Mac OS X

1. Click the **iPF Support** icon in the **Dock**.



The **imagePROGRAF Support Information** window is displayed.

2. Click the **Paper Reference Guide** button.

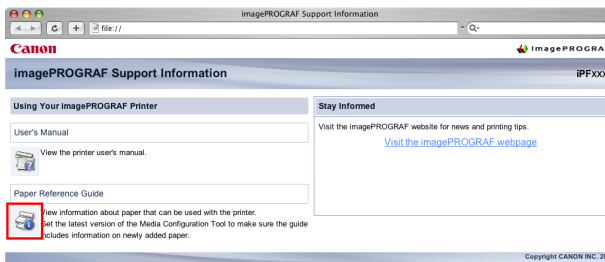

The Paper Reference Guide is displayed.

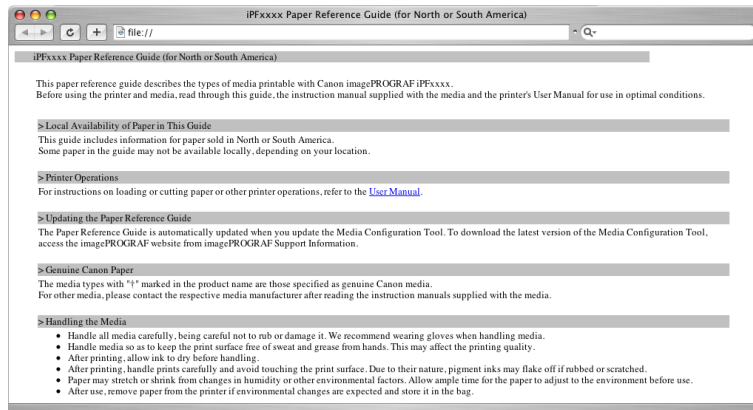

## Updating paper information

As for paper information of the Paper Reference Guide, printer Control Panel, and printer driver, you can update it to the latest information by downloading and installing the latest version of **Media Information File** (Media Information File) from the imagePROGRAF website.

Download the latest **Media Information File** (Media Information File) after accessing the imagePROGRAF-dedicated site from **imagePROGRAF Support Information**. If you cannot download it, contact your Canon dealer.

For details on **Media Information File** (Media Information File), refer as follows.

- Media Configuration Tool →P.412 (Windows)
- Media Configuration Tool →P.543 (Macintosh)



### Important

- When your version of Media Configuration Tool is older than the version released on the imagePROGRAF website, download and install the latest version of Media Configuration Tool before installing **Media Information File**. If you do not install the latest version of Media Configuration Tool before installing **Media Information File**, the latest paper information cannot be updated.

### • Windows

1. Double-click the **iPFxxxx Support** desktop icon. (iPFxxxx indicates the printer model.)



The **imagePROGRAF Support Information** window is displayed.

2. Click **Visit the imagePROGRAF webpage**.

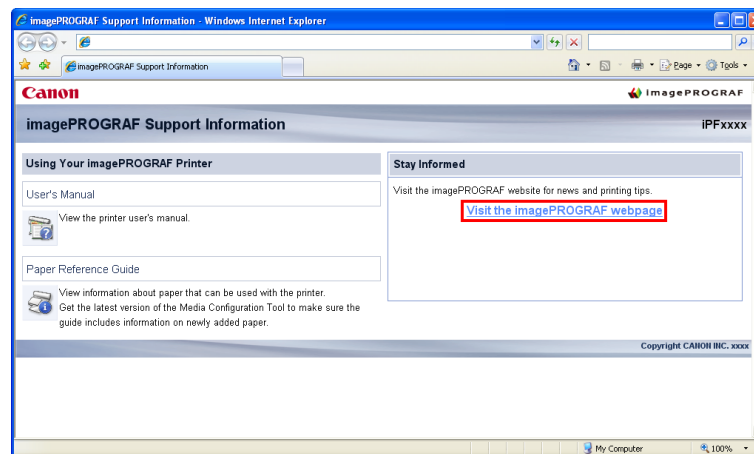

The default browser on your computer is started and the imagePROGRAF webpage is displayed.

- Mac OS X

1. Click the **iPF Support** icon in the **Dock**.



The **imagePROGRAF Support Information** window is displayed.

2. Click **Visit the imagePROGRAF webpage**.

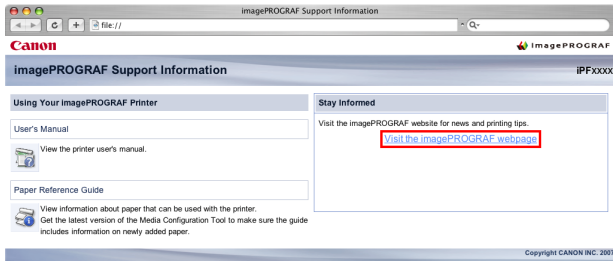

The default browser on your computer is started and the imagePROGRAF webpage is displayed.

## Adding Custom Paper

Using Media Configuration Tool, you can add custom paper (paper not listed in the Paper Reference Guide) to the printer driver and control panel of the printer.

For details on Media Configuration Tool, refer as follows.

- Media Configuration Tool →P.412 (Windows)
- Media Configuration Tool →P.543 (Macintosh)



### Important

- If a malfunction occurs in the printer resulting from the use of custom paper (paper not listed in the Paper Reference Guide), it is not guaranteed even within the warranty period.

## Handling rolls

Attaching the Roll Holder to Rolls .....	575
Loading Rolls in the Printer .....	579
Changing the Type of Paper .....	583
Specifying the Paper Length .....	585
Removing the Roll from the Printer .....	585
Removing the Roll Holder from Rolls .....	589
Feeding Roll Paper Manually .....	590
Keeping Track of the Amount of Roll Paper Left .....	591
Specifying the Ink Drying Time for Rolls .....	592
Specifying the Cutting Method for Rolls .....	594
Cutting the Leading Edge of Roll Paper Automatically .....	599
Reducing Dust from Cutting Rolls .....	601

### Attaching the Roll Holder to Rolls

When printing on rolls, attach the Roll Holder to the roll.

Rolls have a two- or three-inch paper core. Use the correct attachment for the paper core. The printer comes equipped with the 2-Inch Paper Core Attachment installed.

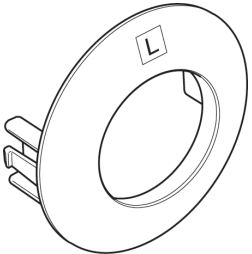
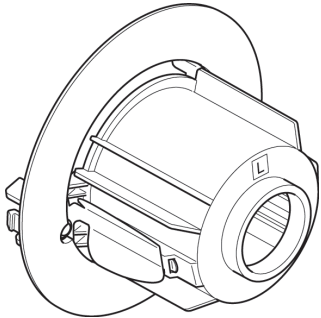
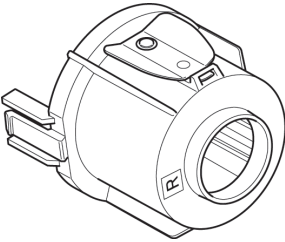
Using Rolls with a 2-Inch Paper Core		Using Rolls with a 3-Inch Paper Core	
Holder Stopper (Left Side)	Roll Holder (Right Side)	Holder Stopper (Left Side)	Roll Holder (Right Side)
2-Inch Paper Core Attachment 	No Attachment Needed	3-Inch Paper Core Attachment L 	3-Inch Paper Core Attachment R 



**Caution**

- Set the roll on a table or other flat surface so that it does not roll or fall. Rolls are heavy, and dropping a roll may cause injury.



**Important**

- When handling the roll, be careful not to soil the printing surface. This may affect the printing quality. We recommend wearing clean cloth gloves when handling rolls to protect the printing surface.
- Use scissors or a cutting tool to cut the edge of the roll paper if it is uneven, dirty, or has tape residue. Otherwise, it may cause feeding problems and affect the printing quality. Be careful not to cut through any barcodes printed on the roll.
- Align the edges of the paper on both ends of the roll. Misalignment may cause feeding problems.

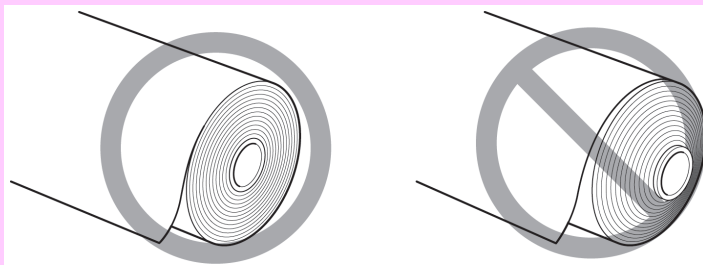

**Note**

- For details on supported sizes and types of rolls, see **Paper Sizes** or the Paper Reference Guide. (See "Paper Sizes.") →P.569 (See "Types of Paper.") →P.568
- To view instructions as you attach the Roll Holder, press the **Navigate** button. (See "How to View Instructions With Navigate.") →P.655

1. Lift the Holder Stopper lever (a) from the shaft side to unlock it. Holding the Holder Stopper at the position indicated (b), remove it from the Roll Holder.

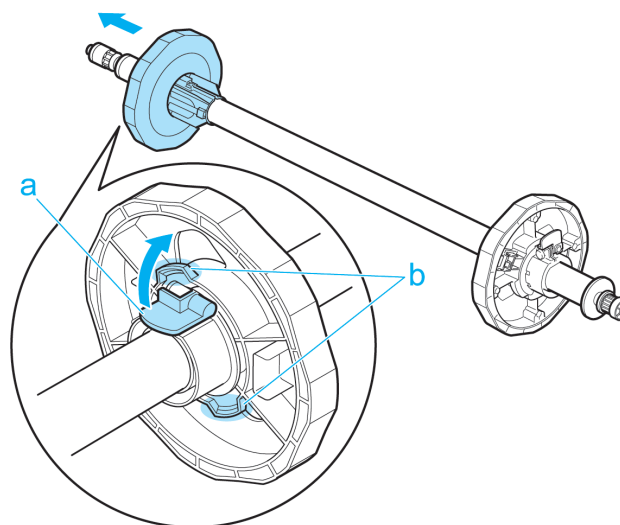

**2.** Insert the respective attachments for the roll paper core on the Roll Holder and Holder Stopper.

- Using rolls with a 2-inch paper core

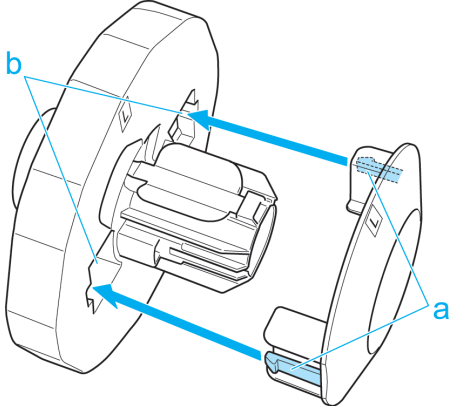
Holder Stopper (Left Side)	Roll Holder (Right Side)
<p>Align the tips (a) of the 2-Inch Paper Core Attachment with the holes (b) of the Holder Stopper and insert it firmly.</p> 	<p>No attachment is needed.</p>

- Using rolls with a 3-inch paper core

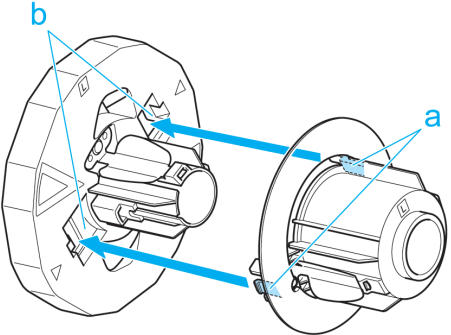
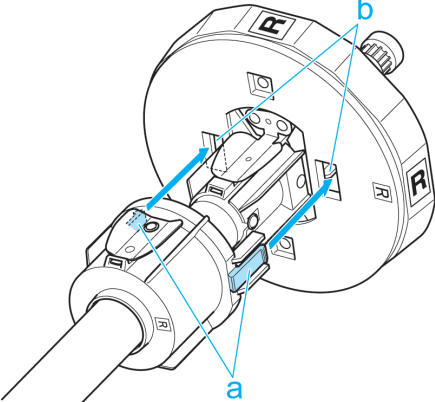
Holder Stopper (Left Side)	Roll Holder (Right Side)
<p>Align the tips (a) of the 3-Inch Paper Core Attachment L with the holes (b) of the Holder Stopper and insert it firmly.</p> 	<p>Align the tips (a) of 3-Inch Paper Core Attachment R with the holes (b) of the Roll Holder and insert it firmly.</p> 

3. With the edge of the roll paper facing forward as shown, insert the Roll Holder from the right of the roll. Insert it firmly until the roll touches the flange (a) of the Roll Holder, leaving no gap.

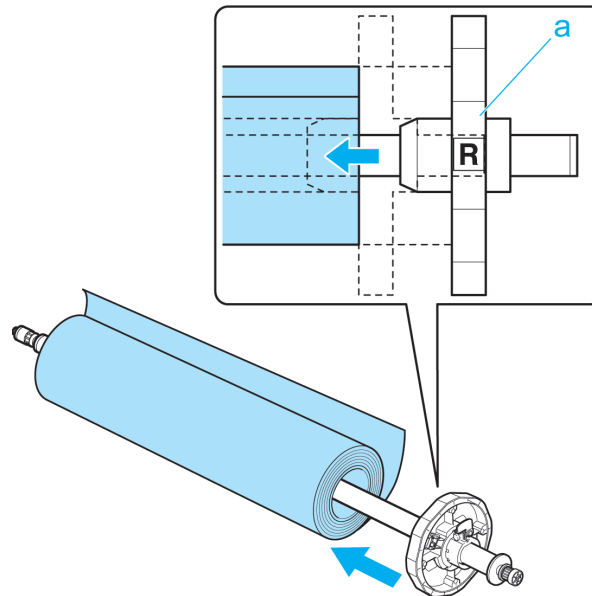

4. Insert the Holder Stopper from the left in the Roll Holder as shown. Holding it at the position shown (b), push it firmly in until the flange (a) of the Holder Stopper touches the roll. Lock the Holder Stopper lever (c) by pushing it down toward the shaft side.

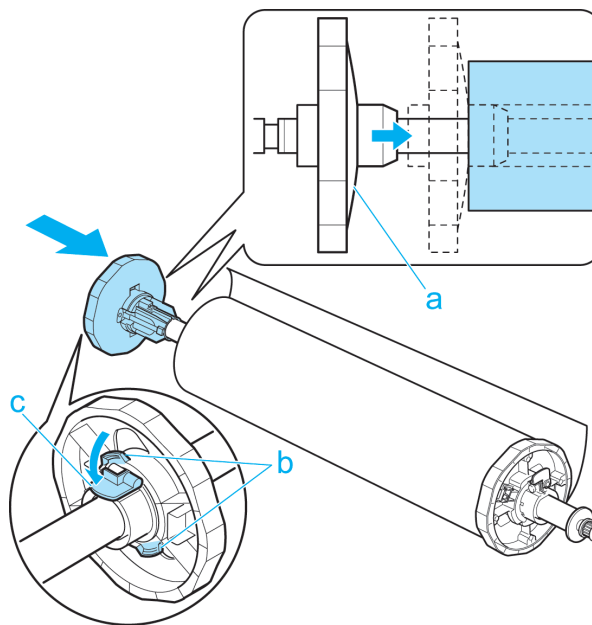

5

578



## Loading Rolls in the Printer

Follow these steps to load rolls in the printer.



### Note

- Before loading rolls, make sure the printer is clean inside the Top Cover and around the Ejection Guide. If these areas are dirty, we recommend cleaning them in advance. (See "Cleaning Inside the Top Cover.")

→P.756

1. Press the **Load** button.



2. Press ▲ or ▼ to select **Load Roll Paper**, and then press the **OK** button.



### Note

- If any paper has been advanced that will not be used, a message is shown requesting you to remove it. Press ▲ or ▼ to select "Yes", and then press the **OK** button. Remove the paper and go to the next step.

3. Positioning your hands as shown, open the Roll Cover.

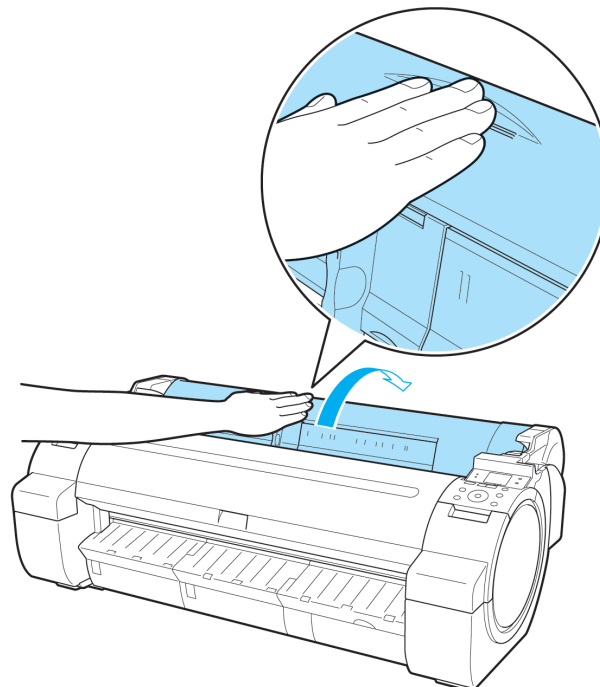

4. Holding the Roll Holder flange (a), rest the Roll Holder shaft on the Roll Ledge (b).  
At this time, position the holder so that the **R** label (c) on the [W label (c) on the Roll Holder flange is aligned with the **R** label (d) on the printer .

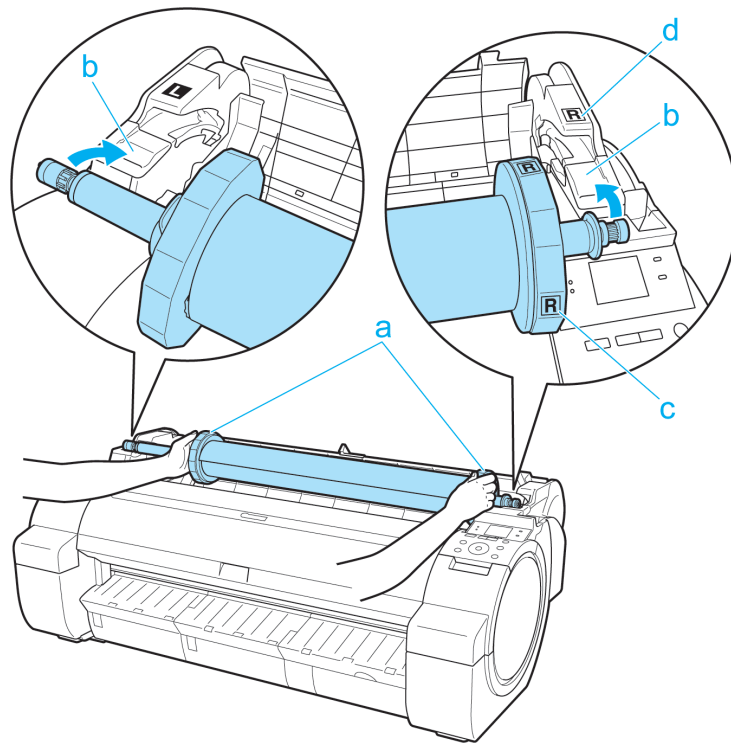

5

- 5.** Holding the Roll Holder flange (a), guide the holder along the Roll Loading Slots (b) on both ends, keeping the holder level as you load it in the Roll Holder Slot.

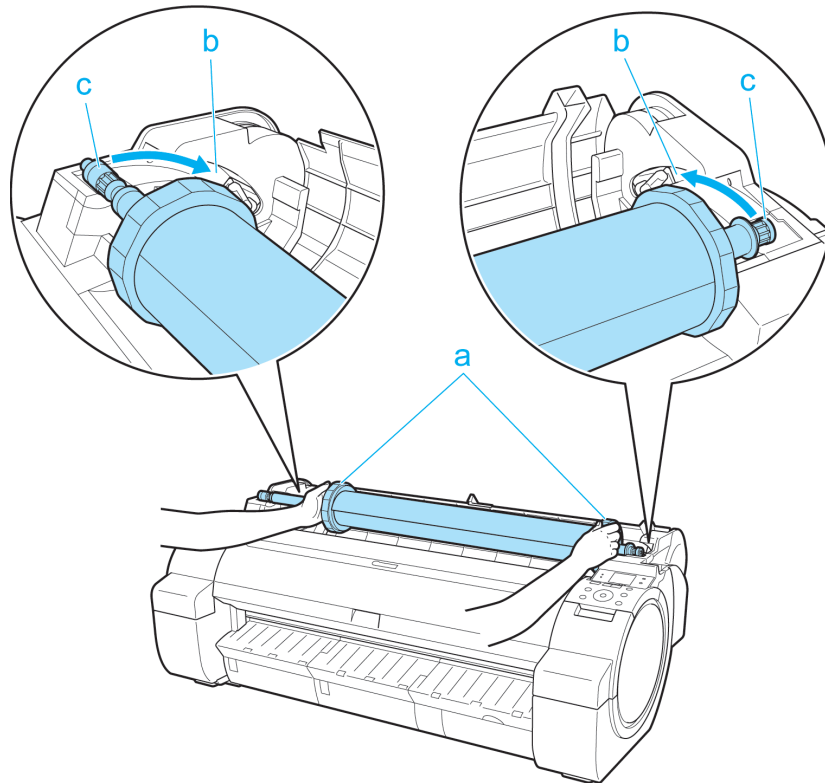

**Caution**

- Do not force the Roll Holder into the printer with the right and left ends reversed. This may damage the printer and Roll Holder.
- Do not release the flanges until the holder is loaded in the Roll Holder Slot.
- Be careful not to pinch your fingers between the Roll Loading Slots (b) and the Roll Holder shaft (c) when loading rolls.

- 6.** Advance the roll to insert the leading edge in the Paper Feed Slot (a) until you hear a tone.

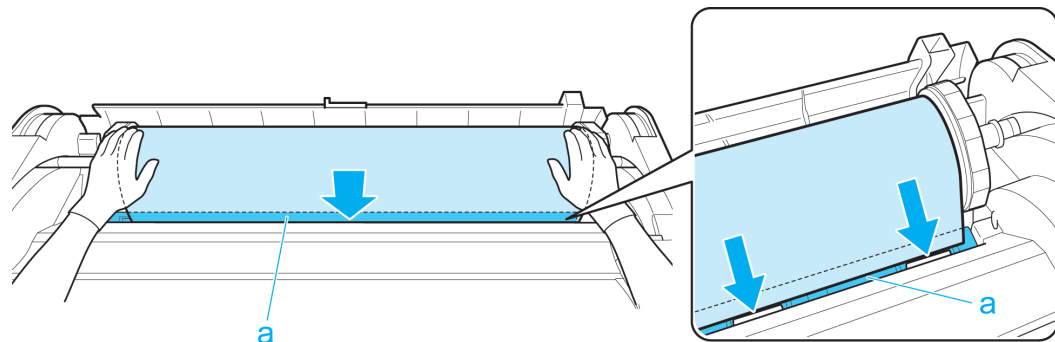



**Important**

- Be careful not to soil the printing surface of roll paper as you insert it in the slot. This may affect the printing quality. We recommend wearing clean cloth gloves when handling rolls to protect the printing surface.
- If the paper is wrinkled or warped, straighten it out before loading it.
- Load paper straight so it is not fed askew.

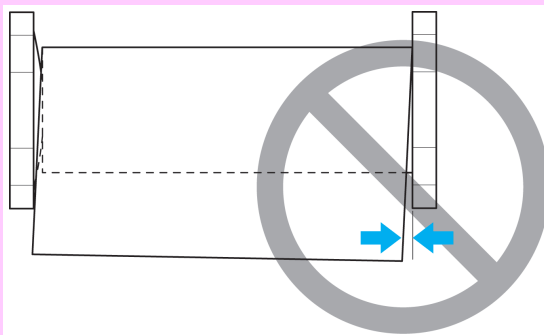

- 5** **7.** Once paper feeding starts, you will need to do the following, based on the **ManageRemainRoll** setting and the barcode printed on rolls. (See "Keeping Track of the Amount of Roll Paper Left.") →P.591

ManageRemainRoll	Barcodes	Printer Operation After the Paper is Fed
<b>Off</b>	Printed	A menu for selection of the type of paper is automatically shown on the Display Screen. Press ▲ or ▼ to select the type of paper, and then press the <b>OK</b> button.
	Not printed	
<b>On</b>	Printed	The type and amount of paper left is automatically detected based on the barcode printed on the roll. There is no need to specify the type and length of the paper.
	Not printed	A menu for selection of the paper type and length is automatically shown on the Display Screen. Press ▲ or ▼ to select the type and length of paper loaded, and then press the <b>OK</b> button.



**Note**

- For details on types of paper to select, see the Paper Reference Guide. (See "Types of Paper.") →P.568

- 8.** Holding it at the positions indicated, close the Roll Cover.

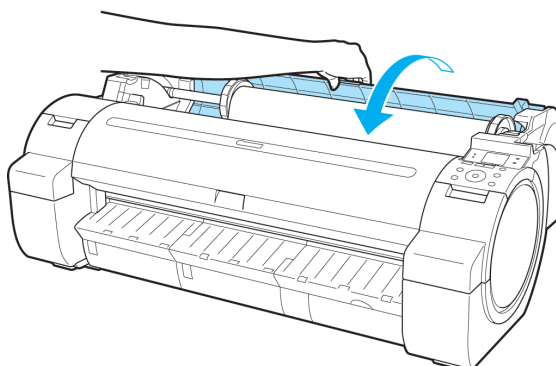

**Note**

- Cut the edge of the roll after the paper is advanced if it is soiled or if there are cuts from scissors or the blade after removing creased edges. (See "Specifying the Cutting Method for Rolls.")

→P.594

## Changing the Type of Paper

Follow these steps to change the type of paper specified on the printer after you have loaded paper.

If you will continue using this type of paper later, selecting **Keep Paper Type > On** will save the time and effort of configuring the media type setting when you load the paper again. The current media type settings before you select **On** will be automatically selected at that time. (See "Using the Same Type of Paper Regularly.") →P.584

**Important**

- For best printing results, the printer fine-tunes the print head height and the feed amount for each type of paper. Be sure to select the type of paper to use correctly before printing.
- Because the printer fine-tunes the feed amount for each type of paper, the margins and the size of printed images may vary depending on the type of paper used. If margins and the size of images are not as you expected, adjust the paper feed amount.

(See "Adjusting the Feed Amount.") →P.628

5

## Changing the Type of Paper

**Note**

- When you load a roll, a menu for selection of the type of paper is shown on the Display Screen. Select the type of paper, and then press the **OK** button.

If no barcode has been printed on the roll and you have set **ManageRemainRoll** to **On**, specify the roll length after the type of paper. (See "Specifying the Paper Length.") →P.585

1. On the **Tab Selection** screen of the Control Panel, press ◀ or ▶ to select the Paper tab (  ).

**Note**

- If the **Tab Selection** screen is not displayed, press the **Menu** button.

2. Press the **OK** button.  
The **Paper Menu** is displayed.
3. Press ▲ or ▼ to select **Chg. Paper Type**, and then press the **OK** button.
4. Press ▲ or ▼ to select the type of paper loaded ( **Roll Paper** or **Cut Sheet** ), and then press the **OK** button.

583

5. Press ▲ or ▼ to select the type of paper loaded in the printer, and then press the **OK** button.



**Important**

- Be sure to select the correct paper type. If this setting does not match the loaded paper, it may cause feed errors and affect printing quality.



**Note**

- For details on types of paper, see the Paper Reference Guide. (See "Types of Paper.") →P.568 By default, Plain Paper is selected.
- If you move the Release Lever, the setting automatically reverts to the previously selected paper.

### Using the Same Type of Paper Regularly

Configure this setting so that current media type settings will be automatically selected when you load the same type of paper later.

1. On the **Tab Selection screen** of the Control Panel, press ◀ or ▶ to select the Paper tab (  ).

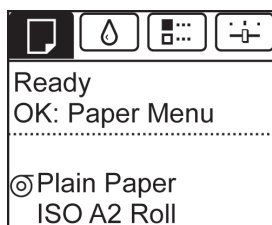

**Note**

- If the **Tab Selection screen** is not displayed, press the **Menu** button.

2. Press the **OK** button.  
The **Paper Menu** is displayed.

3. Press ▲ or ▼ to select **Keep Paper Type**, and then press the **OK** button.

4. Press ▲ or ▼ to select **On**, and then press the **OK** button.



**Note**

- The specified media type setting is updated in the following situations.
  - When using sheets, if you send a print job before loading a sheet, the media type setting is updated to match the type of paper specified by the print job.
  - When you have selected **ManageRemainRoll > On** on the Control Panel and a barcode is printed on the roll, the media type setting is updated to match the type of paper specified by the barcode.
- To change the media type setting, see "Changing the Type of Paper." →P.583

## Specifying the Paper Length

When changing the length of paper after the paper has been advanced, specify the length as follows.



### Note

- Specify the paper length when you have set **ManageRemainRoll** to **On**. (See "Keeping Track of the Amount of Roll Paper Left." →P.591)

- On the **Tab Selection screen** of the Control Panel, press ◀ or ▶ to select the Paper tab (  ).

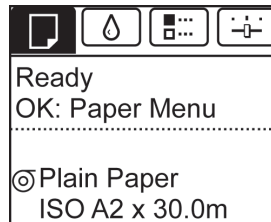

### Note

- If the **Tab Selection screen** is not displayed, press the **Menu** button.

- Press the **OK** button.  
The **Paper Menu** is displayed.
- Press ▲ or ▼ to select **Chg. Paper Size**, and then press the **OK** button.
- Press ▲ or ▼ to select **Roll Length**, and then press the **OK** button.
- Press ▲ or ▼ to select the length of paper loaded in the printer, and then press the **OK** button.  
Specify the roll length as follows.
  - Press the ◀ or ▶ button to move to the next field for input.
  - Press the ▲ or ▼ button to enter the value.
  - Repeat steps 1 and 2 to finish entering the value, and then press the **OK** button.

## Removing the Roll from the Printer

Remove rolls from the printer as follows.



### Note

- If you need to cut the roll, see "Specifying the Cutting Method for Rolls." →P.594

1. On the **Tab Selection screen** of the Control Panel, press ◀ or ▶ to select the Paper tab (  ).

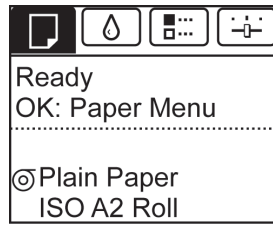

**Note**

- If the **Tab Selection screen** is not displayed, press the **Menu** button.

2. Press the **OK** button.  
The **Paper Menu** is displayed.
3. Press ▲ or ▼ to select **Eject Paper**, and then press the **OK** button.
4. Press ▲ or ▼ to select "Yes", and then press the **OK** button.  
The roll is now rewound and ejected.



**Caution**

- If you have selected **ManageRemainRoll > On** in the Control Panel menu, a barcode is printed on the leading edge of the roll.  
Do not remove the roll before the barcode is printed. You will be unable to keep track of the amount of roll paper left. (See "Keeping Track of the Amount of Roll Paper Left.") →P.591

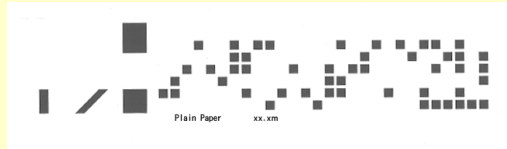

5



5. Positioning your hands as shown, open the Roll Cover.

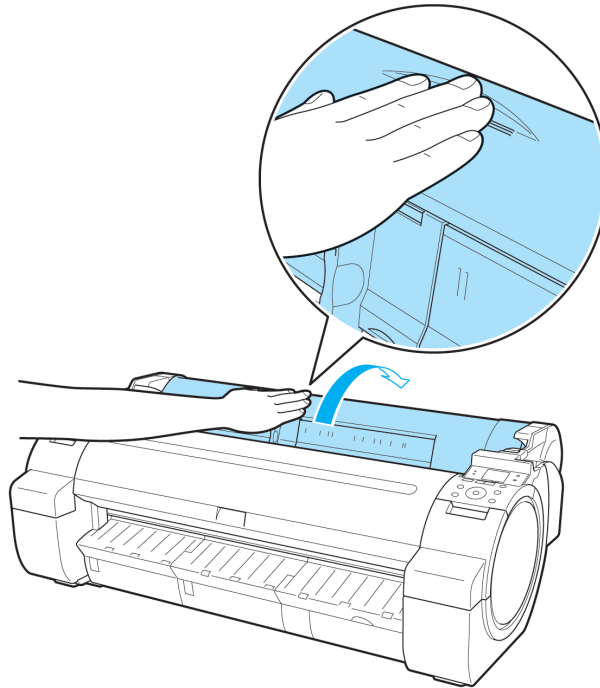

5

6. Using both hands, rotate the Roll Holder toward the back to rewind the roll.

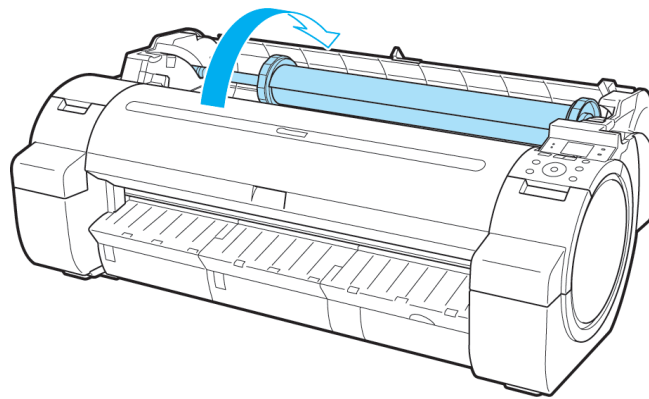

587

7. Holding the Roll Holder flange (a), remove the holder from the Roll Holder Slot.

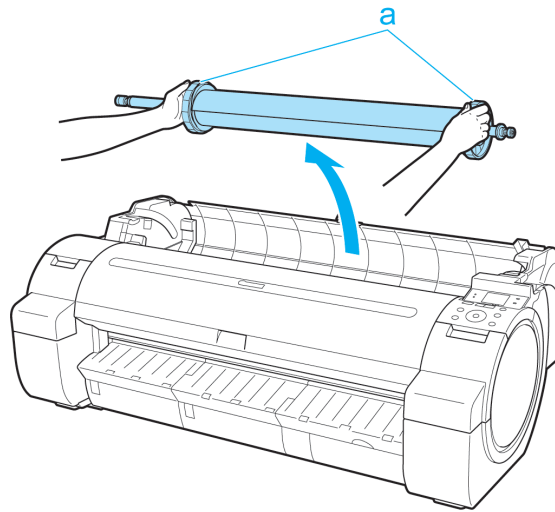

Note

- For instructions on removing the Roll Holder from rolls, see "Removing the Roll Holder from Rolls." →P.589

8. Holding it at the positions indicated, close the Roll Cover.

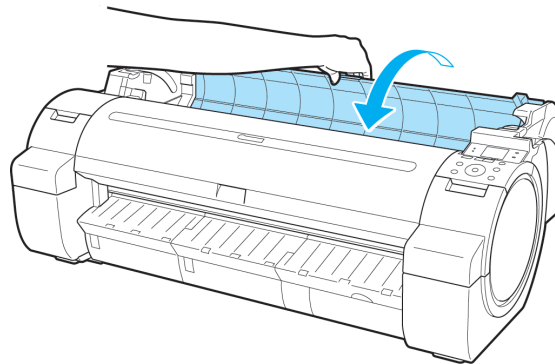

Note

- To load new paper in the printer at this point, see "Loading Rolls in the Printer." →P.579

## Removing the Roll Holder from Rolls

1. Lift the Holder Stopper lever (a) from the shaft side to unlock it. Holding the Holder Stopper at the position indicated (b), remove it from the Roll Holder.

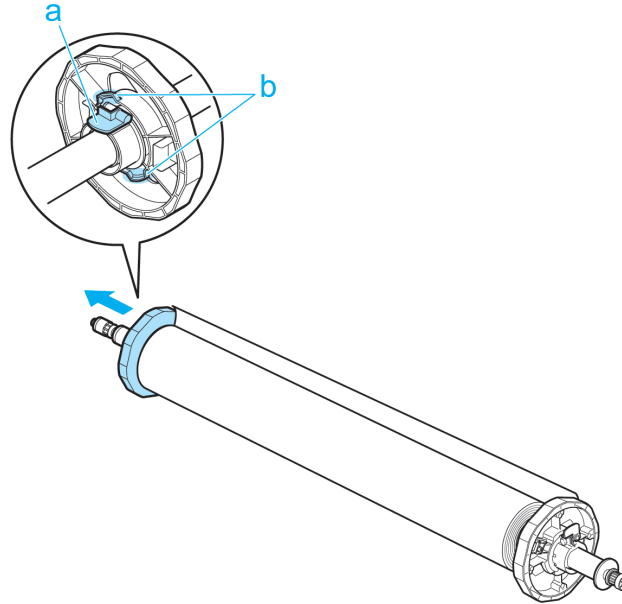

2. Remove the Roll Holder from the roll.

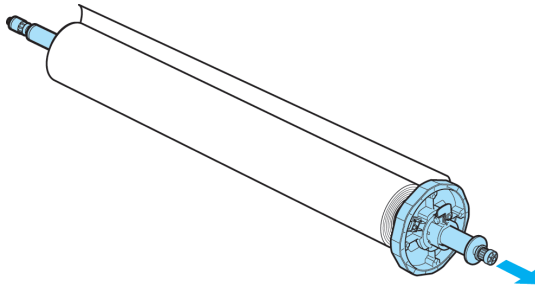

3. When removing attachments, push the tips (a) in as you remove the attachment.

- 3-Inch Paper Core Attachment R ( Roll Holder side)

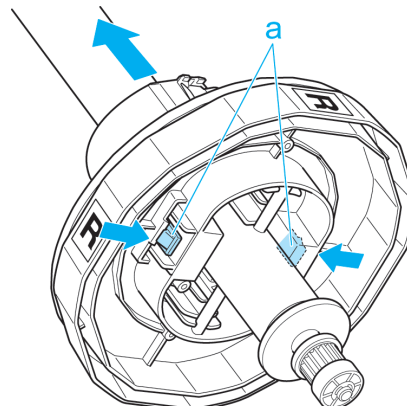

- 3-Inch Paper Core Attachment L ( Holder Stopper side)

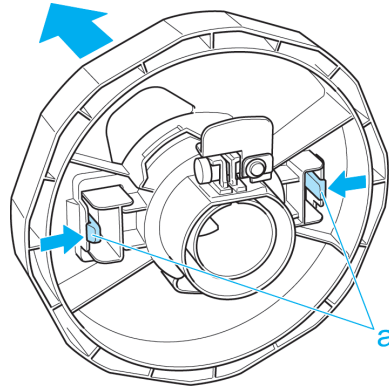

- 2-Inch Paper Core Attachment

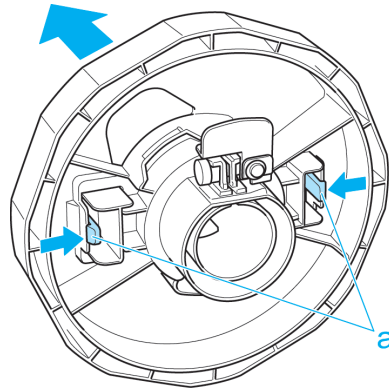

**Important**

- Store the roll in the original bag or box, away from high temperature, humidity, and direct sunlight. If paper is not stored properly, the printing surface may become scratched, which may affect the printing quality when you use it again.

## Feeding Roll Paper Manually

After a roll has been advanced, you can press the **Feed** button to feed or retract the roll with the ▲ and ▼ buttons.

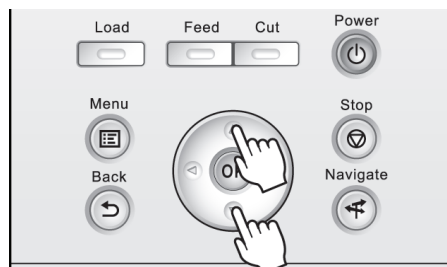

1. Press the **Feed** button.

2. Press the ▲ or ▼ button to advance or retract the roll.  
Press ▲ to retract the roll manually.  
Press ▼ to advance the roll manually.

**Note**

- If you hold down ▲ or ▼ for less than a second, the roll will move about 1 mm (0.04 in).  
If you hold down ▲ or ▼ for more than a second, the roll will move until you release the button. Release the button when the Display Screen indicates "End of paper feed. Cannot feed paper more."

## Keeping Track of the Amount of Roll Paper Left

Setting **ManageRemainRoll** to **On** in the **Paper Menu** of the Control Panel will print a barcode with text on the roll when the roll is removed that identifies the type of paper and amount left. When **ManageRemainRoll** is **On** and you load rolls with printed barcodes, the type of paper and amount left are automatically detected after rolls are loaded. The barcode will be cut off after it has been read.

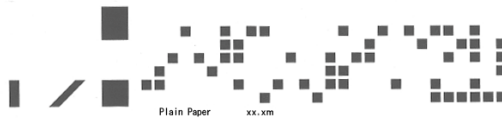
**Important**

- If the barcode on the roll is not detected, enter the type and length of paper on the Control Panel.

Follow these steps to set **ManageRemainRoll** to **On** as follows.

1. On the **Tab Selection** screen of the Control Panel, press ◀ or ▶ to select the Paper tab (  ).

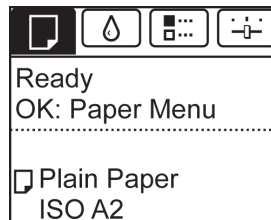
**Note**

- If the **Tab Selection** screen is not displayed, press the **Menu** button.

2. Press the **OK** button.  
The **Paper Menu** is displayed.
3. Press ▲ or ▼ to select **ManageRemainRoll**, and then press the **OK** button.
4. Press ▲ or ▼ to select **On**, and then press the **OK** button.

## Specifying the Ink Drying Time for Rolls

When you are using paper that takes longer for ink to adhere, ink may be transferred onto the paper surface during ejection, soiling it. In that case, you may be able to improve the condition by setting the time to wait for the ink to dry after printing.



**Note**

- If the Cutter touches the print surface on which the ink is not dry, the paper surface may become scratched or soiled, or the paper surface may rub against the output stacker when the paper falls and the surface may become soiled.

To wait for the ink to dry without allowing printed documents to fall after printing, set **Cutting Mode** on the menu of the printer to **Eject**. (See "Specifying the Cutting Method for Rolls.") →P.594

## Windows

1. Display the printer driver dialog box.  
(See "Accessing the Printer Driver Dialog Box from the Operating System Menu(Windows).") →P.218

2. Select the **Main** sheet and click **C Advanced Settings** in **A Media Type**.

5

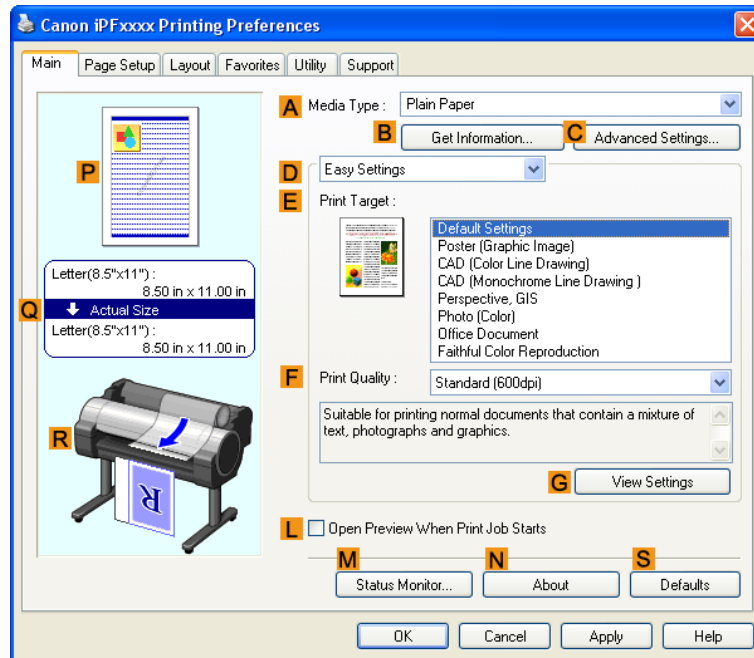

592

3. In the **Paper Detailed Settings** dialog box displayed next, select the desired settings values in **B Between Pages** and **C Between Scans** in **A Drying Time**, and then click **OK**.  
(See "Paper Detailed Settings Dialog Box(Windows).") →P.225

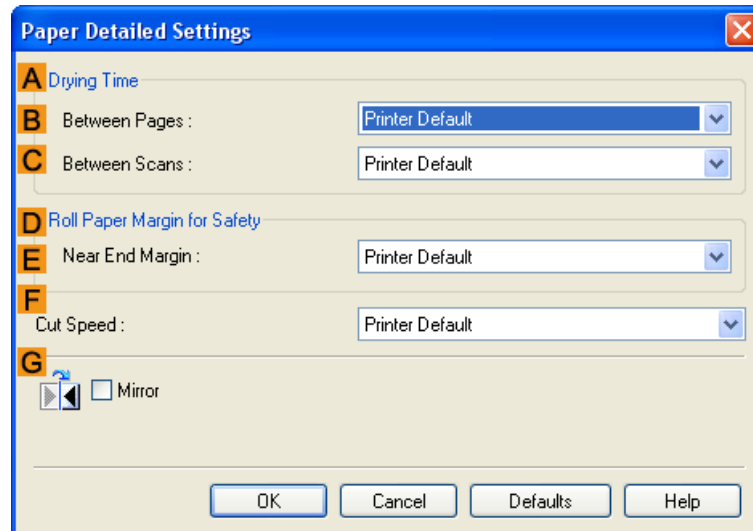

5

## Mac OS X

1. Choose **Print** in the application menu.
2. Select the **Main** pane and click **C Settings** in **A Media Type**.

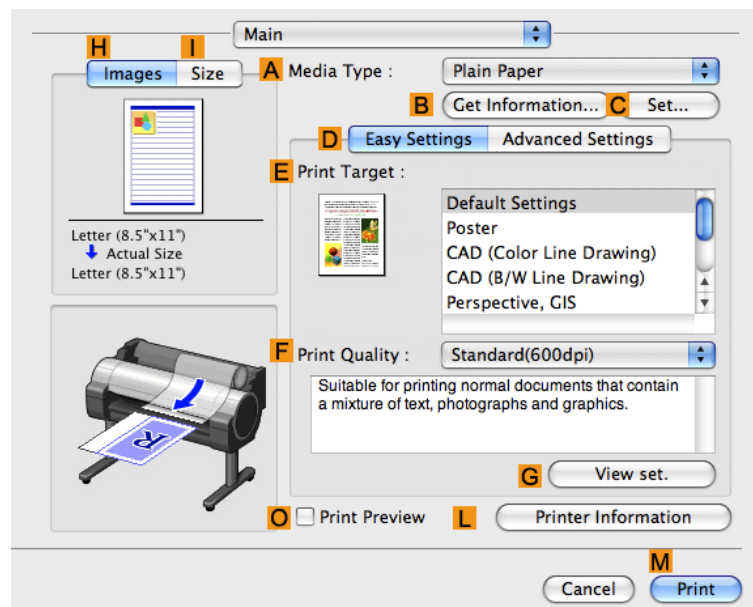

593

3. In the **Paper Detailed Settings** dialog box displayed next, select the desired settings values in **C Between Pages** and **D Between Scans** in **B Drying Time**, and then click **OK**.  
 (See "Paper Detailed Settings Dialog Box(Mac OS X).") →P.444

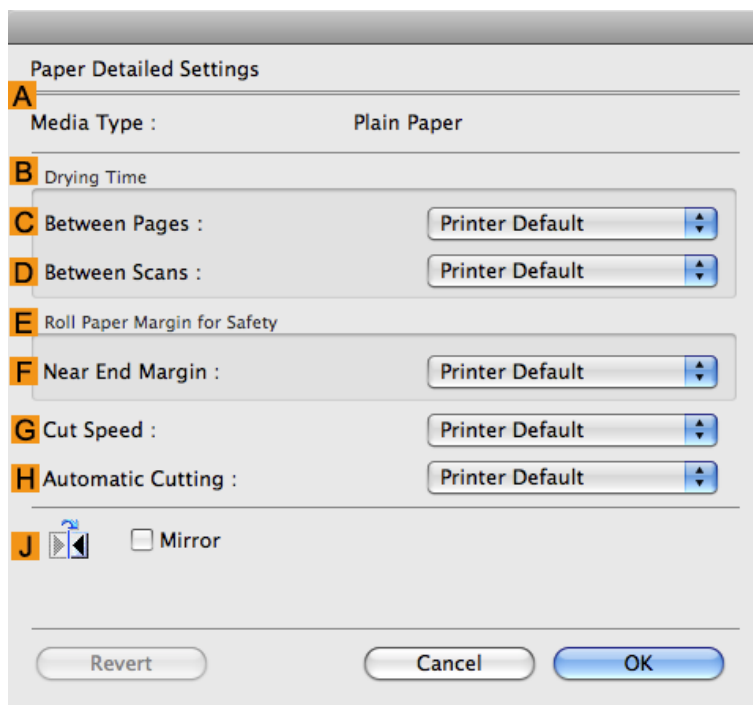

## Specifying the Cutting Method for Rolls

How rolls are cut after ejection varies depending on printer settings.

Cutting Method		Printer Setting		Driver Setting	
Automatic	The roll is automatically cut by the Cutter Unit following printer driver settings.	<b>Media Menu &gt; Paper Details &gt; (Various Types of Paper) &gt; Cutting Mode</b>	<b>Automatic</b>	<b>Auto Cut</b>	<b>Yes</b>
Eject →P.595	Choose this setting if you prefer not to have documents dropped immediately after printing, as when waiting for ink to dry. To cut the roll with the Cutter Unit, press the <b>Cut</b> button.		<b>Eject</b>		<b>Yes</b>
Man-ual →P.596	Choose this setting when using media that cannot be cut using the Cutter Unit. Cut each page from the roll using scissors. For continuous printing (if you will cut each page later), select <b>Auto Cut &gt; Yes</b> or select <b>Print Cut Guideline</b> . (See "Cutting Roll Paper After Printing.") →P.200		<b>Manual</b>	<b>No Yes Print Cut Guideline</b>	
Paper Cut-ting →P.598	Choose this option if you want to cut pages by pressing Cutter Unit buttons for manual cutting after printing when <b>Auto Cut &gt; No</b> is selected or <b>Print Cut Guideline</b> is selected in the printer driver.		<b>Yes</b>		<b>No Print Cut Guideline</b>



Cutting Method		Printer Setting		Driver Setting	
Paper Cutting →P.598	Otherwise choose this option if you want to cut the roll edge after loading a roll.	<b>Cut</b> button pressed	<b>Yes</b>	<b>Auto Cut</b>	<b>No Print Cut Guideline</b>



**Note**

- Automatic and Eject are valid only when you have selected **Auto Cut > Yes** in the printer driver.
- With Eject, printing does not resume after a series of jobs have been printed continuously until the roll is cut.
- **Eject** is the preset selection in **Cutting Mode** for some types of paper. For this paper, we recommend keeping the preset cutting mode.

Cut rolls manually in the following cases:

Eject (waiting for ink to dry after printing)

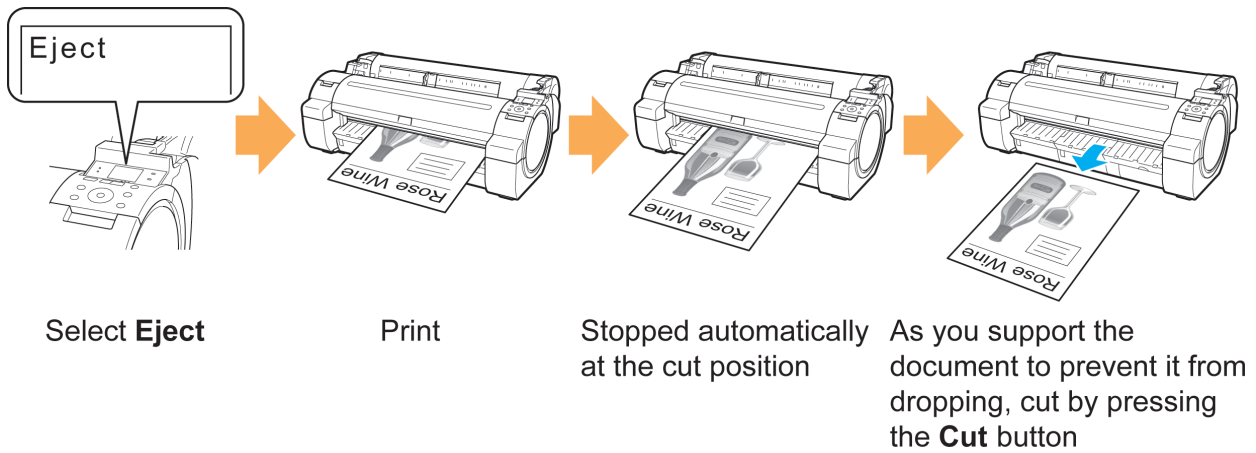

**Important**

- When cutting wide printed documents after ejection, have two people support the documents. If the paper drops, printed documents may be damaged.
- Do not lift the paper when holding printed documents before cutting. If the paper rises, it may affect the printing quality or cause rough cut edges.

1. On the **Tab Selection screen** of the Control Panel, press ◀ or ▶ to select the Paper tab (  ).

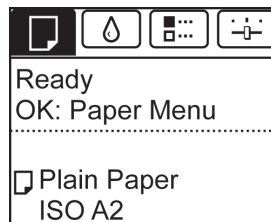

**Note**

- If the **Tab Selection screen** is not displayed, press the **Menu** button.

2. Press the **OK** button. The **Paper Menu** is displayed.

3. Press ▲ or ▼ to select **Paper Details**, and then press the **OK** button.
4. Press ▲ or ▼ to select the type of paper, and then press the **OK** button.
5. Press ▲ or ▼ to select **Cutting Mode**, and then press the **OK** button.
6. Press ▲ or ▼ to select **Eject**, and then press the **OK** button.
7. Starts printing.  
When printing is finished, the printer will stop without cutting.
8. Holding the printed document to prevent it from dropping, press the **Cut** button to cut the roll.



5

Manual (when using media that cannot be cut with the Cutter Unit)

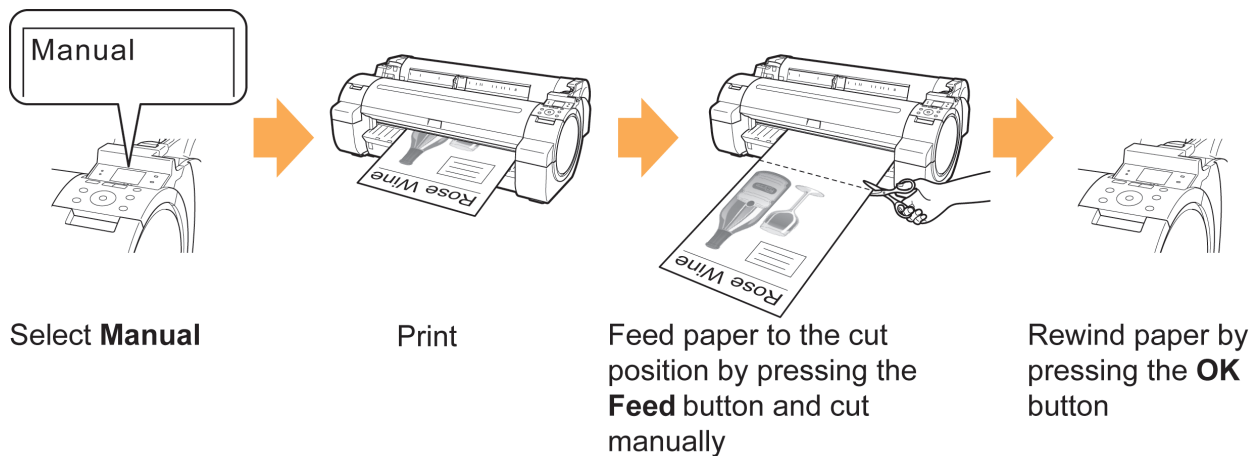

596

1. On the **Tab Selection screen** of the Control Panel, press ◀ or ▶ to select the Paper tab (  ).

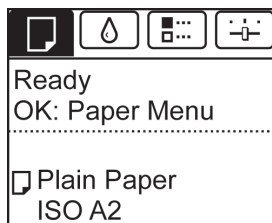

**Note**

- If the **Tab Selection** screen is not displayed, press the **Menu** button.

2. Press the **OK** button. The **Paper Menu** is displayed.
3. Press **▲** or **▼** to select **Paper Details**, and then press the **OK** button.
4. Press **▲** or **▼** to select the type of paper, and then press the **OK** button.
5. Press **▲** or **▼** to select **Cutting Mode**, and then press the **OK** button.
6. Press **▲** or **▼** to select **Manual**, and then press the **OK** button.
7. Starts printing.  
The printer stops advancing the paper after printing.
8. Press the **Feed** button.



Roll paper is fed to the specified cut position and then automatically stopped.

9. Cut the roll paper manually with scissors or the like.

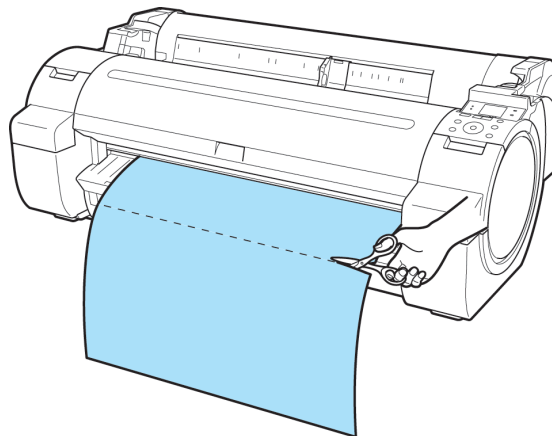

# 10.

Press the **OK** button.

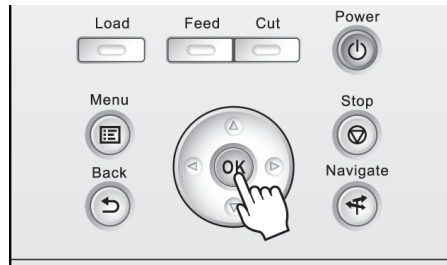

After the roll is rewound, it stops automatically.

## Paper cutting (to have the roll cut at your specified position)

5

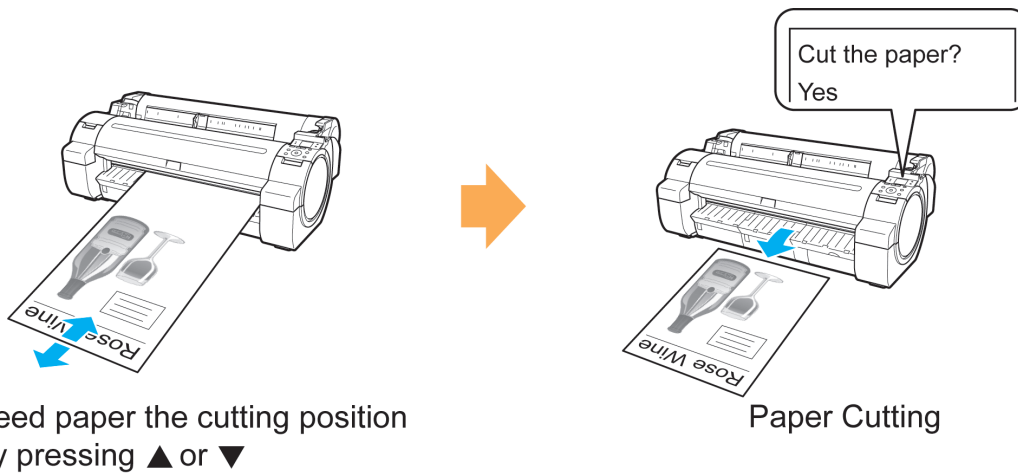

1. Press the **Feed** button.

2. Press the ▼ button to advance the roll to the position for cutting.



598

### 3. Press the **Cut** button.



### 4. Press ▲ or ▼ to select **Yes**, and then press the **OK** button. After the roll paper is cut, it is rewound automatically.



#### Caution

- If paper would be short when cut at a particular position, the roll may automatically be advanced in some cases before cutting.

## Cutting the Leading Edge of Roll Paper Automatically

5

If the leading edge of a roll is crooked or warped, it may cause an error message or printing problems. In this case, set **Trim Edge First** to **Automatic** or **On** in the **Paper Menu** on the Control Panel to have the printer cut the leading edge to make the edge straight after you load a roll.

**Trim Edge First** offers the following options.

#### • Automatic

If the left and right side of the leading edge of the roll ((a) and (b)) are uneven by 3 mm (0.12 in) or more when you load the roll, the edge is cut an amount relative to the slant to ensure a straight edge, and scraps are removed. The edge is not cut if the unevenness is less than 3 mm. However, paper may sometimes be cut, depending on the state of the leading edge.

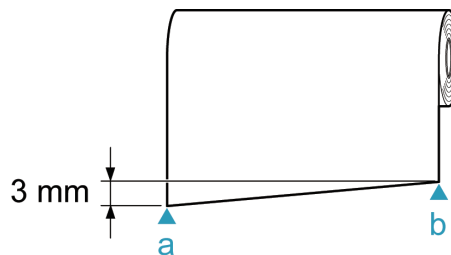

#### • Off

The edge is not cut and scraps are not removed. This setting is **Off** for most types of paper, by default. For more information, see the Paper Reference Guide. (See "Types of Paper.") →P.568

599

• **On**

The leading edge is cut off when you load a roll, and scraps are removed. The amount of paper cut from the leading edge varies depending on the type of paper. For more information, see the Paper Reference Guide. (See "Types of Paper.") →P.568

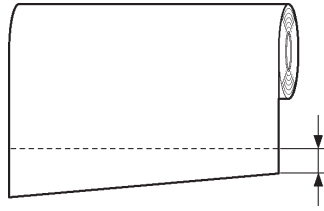

**Important**

- If the width of the paper differs, setting **Skew Check Lv.** to **Loose** relaxes the accuracy of the paper skew detection feature, and setting it to **Off** ignores the skew detection feature. However, when **Off** is selected and the paper is loaded skewed, a paper jam may result or the Platen may become soiled.



**Note**

- In the condition at the time of factory shipment, the setting differs depending on the paper. For details, refer to the Paper Reference Guide. (See "Types of Paper.") →P.568

5

Follow these steps to change the **Trim Edge First** setting.

1. On the **Tab Selection screen** of the Control Panel, press ◀ or ▶ to select the Paper tab (  ).

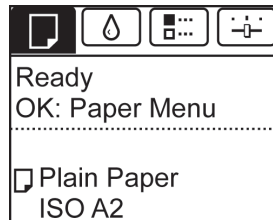

**Note**

- If the **Tab Selection screen** is not displayed, press the **Menu** button.

2. Press the **OK** button.  
The **Paper Menu** is displayed.
3. Press ▲ or ▼ to select **Paper Details**, and then press the **OK** button.
4. Press ▲ or ▼ to select the type of paper, and then press the **OK** button.
5. Press ▲ or ▼ to select **Trim Edge First**, and then press the **OK** button.
6. Press ▲ or ▼ to select the desired setting option, and then press the **OK** button.  
This setting takes effect the next time you load a roll.

## Reducing Dust from Cutting Rolls

For media such as Backlit Film that are more likely to generate debris when cut, select **CutDustReduct. > On** in the **Paper Menu** of the Control Panel. This option reduces debris from cutting by printing black lines at the leading and trailing edges of documents. It may help prevent Printhead damage. You can specify for **CutDustReduct.** to be activated for particular types of paper.

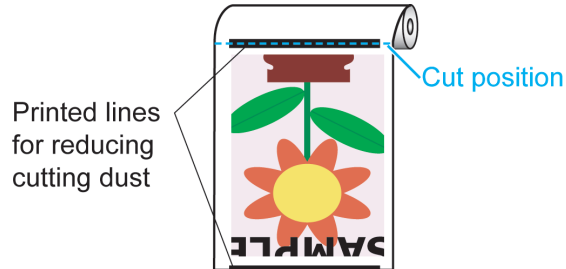

### Important

- Do not set **CutDustReduct.** to **On** for paper that wrinkles easily, such as Plain Paper or lightweight paper. This may impair cutting and cause paper jams.
- Borderless printing is not available when **CutDustReduct.** is set to **On**. To use borderless printing, select **CutDustReduct. > Off**.

5

Set **CutDustReduct.** to **On** as follows.

1. On the **Tab Selection screen** of the Control Panel, press ◀ or ▶ to select the Paper tab (  ).

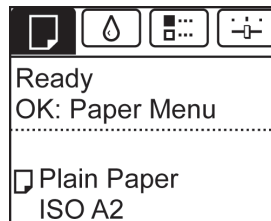

### Note

- If the **Tab Selection screen** is not displayed, press the **Menu** button.

2. Press the **OK** button.  
The **Paper Menu** is displayed.
3. Press ▲ or ▼ to select **Paper Details**, and then press the **OK** button.
4. Press ▲ or ▼ to select the type of paper loaded in the printer, and then press the **OK** button.
5. Press ▲ or ▼ to select **CutDustReduct.**, and then press the **OK** button.
6. Press ▲ or ▼ to select **On**, and then press the **OK** button.

601

## Handling sheets

Loading Sheets in the Printer ..... 602  
 Printing From a Desired Starting Point ..... 606  
 Removing Sheets ..... 609

### Loading Sheets in the Printer

Follow these steps to load sheets in the printer.



#### Important

- One sheet of paper can be loaded in the Paper Feed Slot at a time. Do not load more than one sheet at a time. This may cause paper jams.
- Before feeding paper or printing, make sure the sheet is flat against the Roll Cover. The sheet may jam if it curls before feeding or printing and the trailing edge drops toward the front.



#### Note

- Store unused paper in the original package, away from high temperature, humidity, and direct sunlight.
- Paper that is wrinkled or warped may jam. If necessary, straighten the paper and reload it.
- Load the paper straight. Loading paper askew will cause an error.

### 1. Select sheets as the paper source.

- If a print job was received

Sheets are automatically selected, and the media type and size specified by the print job are shown on the Display Screen. Go to the next step.

- If no print job was received

#### 1. Press the **Load** button.



#### 2. Press ▲ or ▼ to select **Load Cut Sheet**, and then press the **OK** button.



#### Note

- If any paper has been advanced that will not be used, a message is shown requesting you to remove it. Press ▲ or ▼ to select "Yes", and then press the **OK** button. Remove the paper and go to the next step.



2. Slide the Width Guide (a) to align it with the mark for the size of paper you will load.

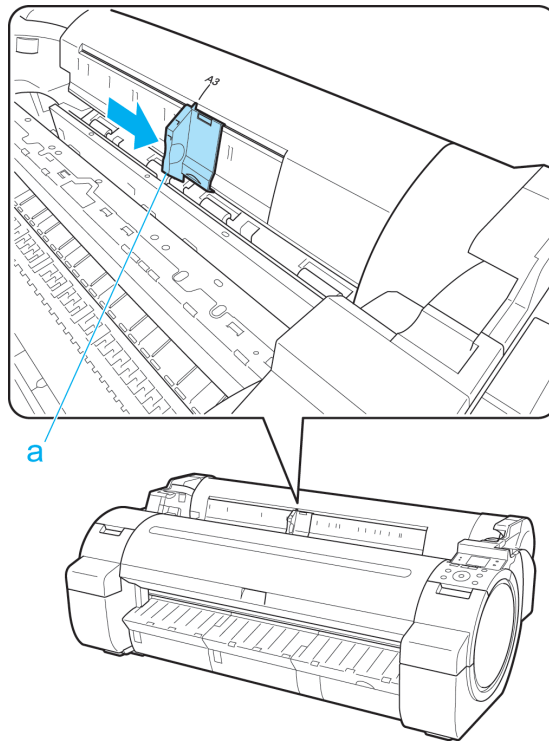

3. Load a single sheet printing-side up in the Paper Feed Slot, with the right edge aligned with the Paper Alignment Guide (a) to the right of the Roll Cover.  
Insert the paper until the leading edge makes contact and you hear a tone.

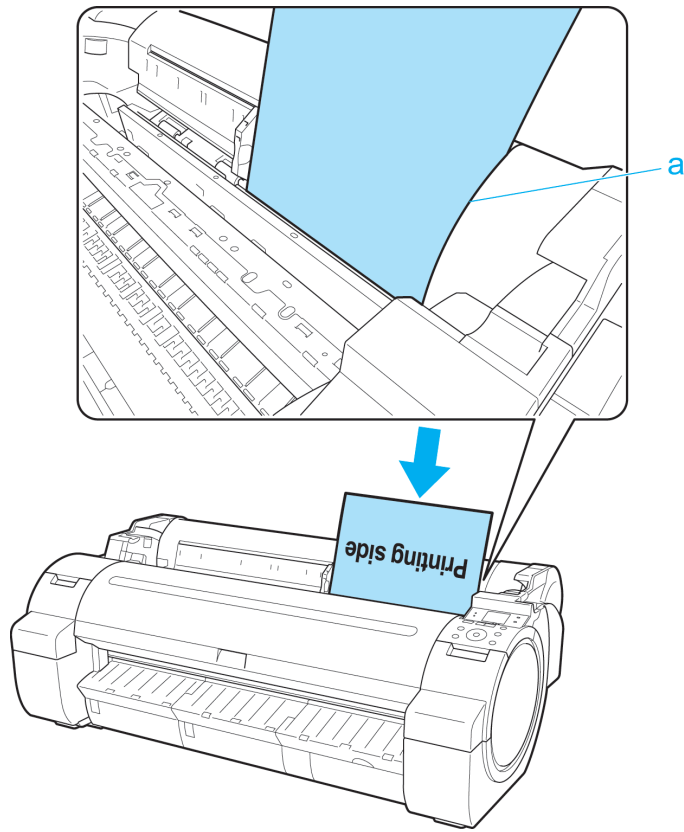

- 4.** Move the Width Guide (a) carefully to match the size of paper loaded.  
Set the Width Guide against the edge of the paper to prevent the paper from becoming crooked or wrinkled.

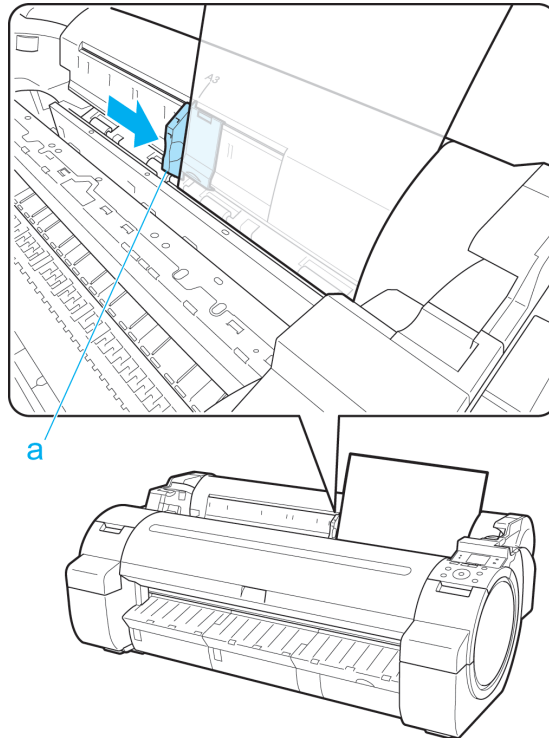

- 5.** Press the **OK** button.

- If a print job was received

The printer now starts printing the print job.

- If no print job was received

A menu for selection of the type of paper is automatically shown on the Display Screen.

Press ▲ or ▼ to select the type of paper, and then press the **OK** button.

The printer now starts feeding the paper.



**Note**

- For details on types of paper to select, see the Paper Reference Guide. (See "Types of Paper.")

→P.568

## Printing From a Desired Starting Point

When printing inside boundaries or in other situations when you want to specify a particular position to start printing from, set **Width Detection** to **Off** in the printer menu for the type of paper used.

### Set Width Detection to Off

1. On the **Tab Selection** screen of the Control Panel, press ◀ or ▶ to select the Paper tab (  ).

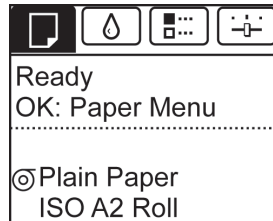

**Note**  
• If the **Tab Selection** screen is not displayed, press the **Menu** button.

2. Press the **OK** button.  
The **Paper Menu** is displayed.
3. Press ▲ or ▼ to select **Paper Details**, and then press the **OK** button.
4. Press ▲ or ▼ to select the type of paper, and then press the **OK** button.
5. Press ▲ or ▼ to select **Width Detection**, and then press the **OK** button.
6. Press ▲ or ▼ to select **Off**, and then press the **OK** button.

### Load paper in the desired position to start printing from

Follow these instructions to load paper at the desired starting position for printing when **Width Detection** is **Off**.

1. If you did not send a print job in advance, a menu for selection of the type of paper is displayed.  
Press ▲ or ▼ to select the type of paper, and then press the **OK** button.



**Note**  
• If a print job was received before paper was advanced, the media type and size specified by the job are shown on the Display Screen.  
Thus, this screen is not displayed. Go to step 2.

2. "**Width Detection OFF. OK to continue?**" is now shown on the Display Screen. Press ▲ or ▼ to select "**Leave OFF**", and then press the **OK** button.

3. After a menu for selection of the paper size is displayed, press ▲ or ▼ to select the paper size, and then press the **OK** button.
4. Open the Top Cover and check the position where paper is loaded.

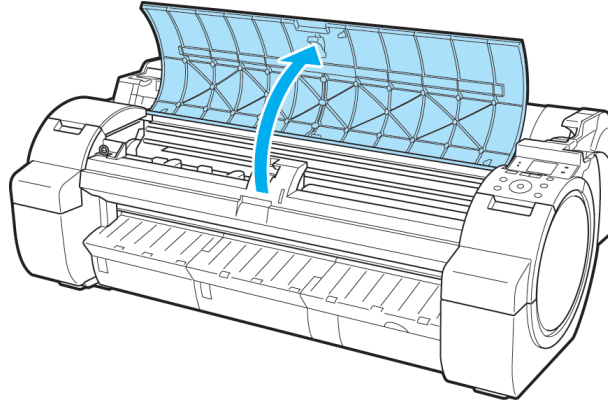

To start printing from the current position, close the Top Cover.  
To reposition the paper, push the Release Lever back.

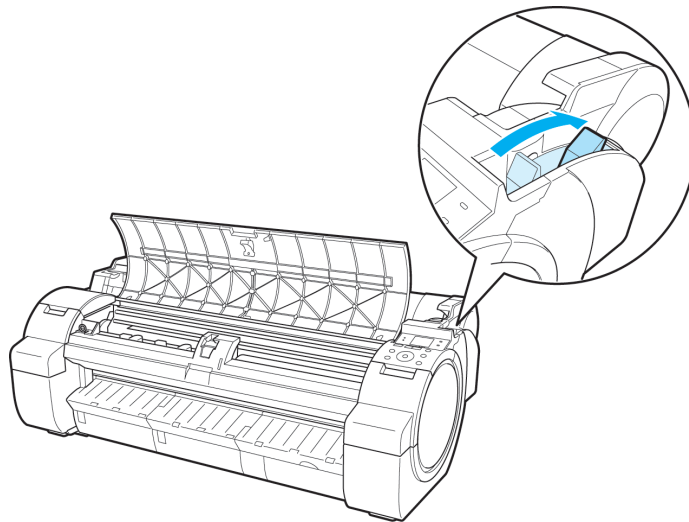

5

5. Keeping the right edge of the paper aligned with the extended line of the Paper Alignment Line (a) to the right of the ejection guide and the leading edge aligned with the groove (b) at the far end of the Platen, load the paper at the position from which to start printing.

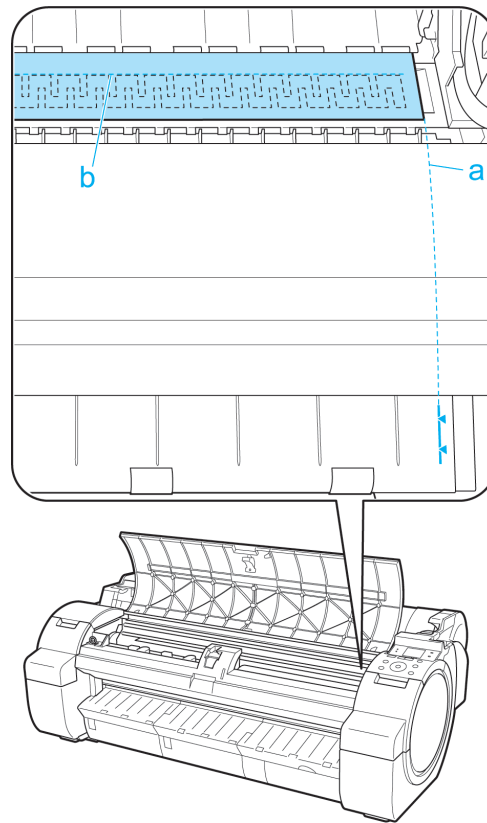

6. Pull the Release Lever forward and close the Top Cover.

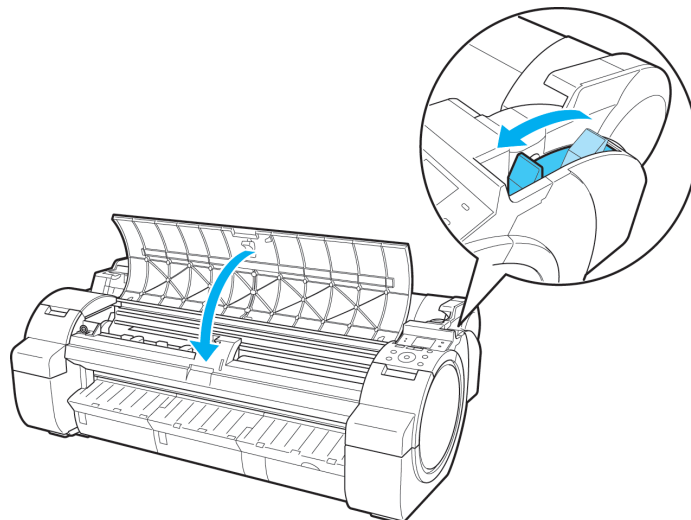

5

608

## Removing Sheets

Remove sheets from the printer as follows.

1. On the **Tab Selection screen** of the Control Panel, press ◀ or ▶ to select the Paper tab (  ).

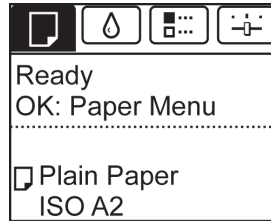

### Note

- If the **Tab Selection screen** is not displayed, press the **Menu** button.

2. Press the **OK** button.  
The **Paper Menu** is displayed.
3. Press ▲ or ▼ to select **Eject Paper**, and then press the **OK** button.
4. Press ▲ or ▼ to select "Yes", and then press the **OK** button.  
The paper is ejected from the front of the printer.
5. Holding the paper, push the Release Lever back and remove the sheet.

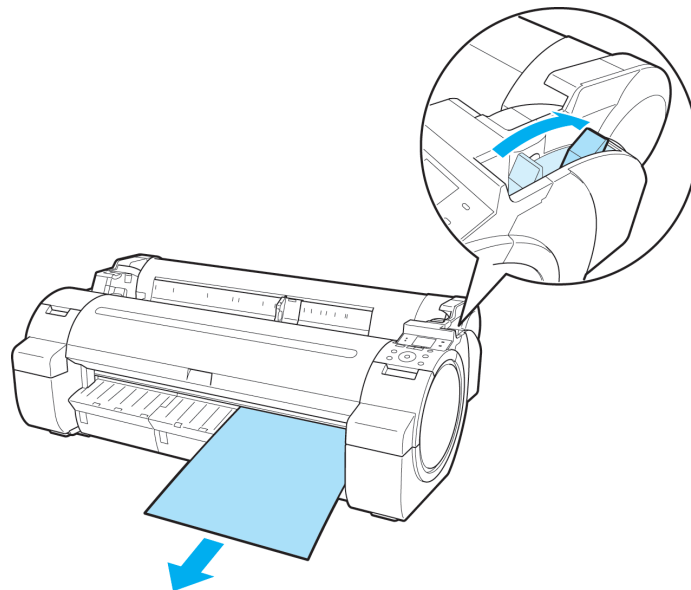

**6.** Pull the Release Lever forward.

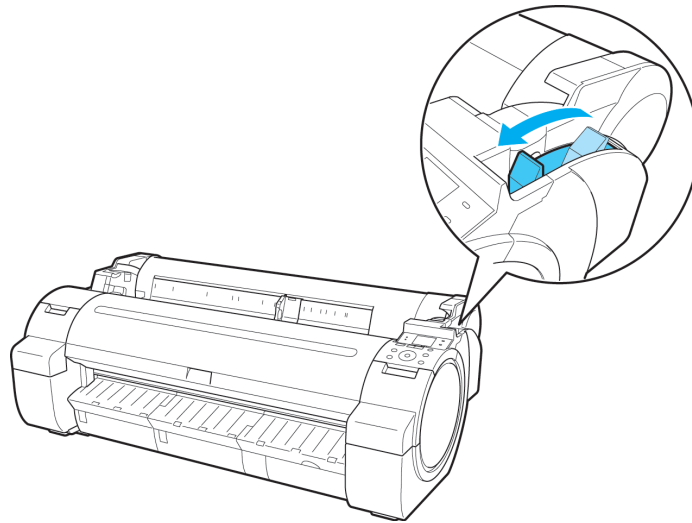

5



## Output Stacker

Using the Output Stacker ..... 611

### Using the Output Stacker

This section describes how to use the Output Stacker.



#### Note

- The Stand that can be used with this printer is Printer Stand ST-34 and Printer Stand ST-33. Either one or the other of these Stand is included with the printer depending on the region and time when you purchased the printer.
- The Stand is described in the illustration of Printer Stand ST-34. Note that the illustrations may look different from the appearance of your printer in some cases.

#### • When storing printed documents on the Output Stacker

Use position (1). For details on how to use the Extended position which is a useful function for retrieving printed matter, refer to the note regarding the Extended position. (See "Note regarding the extended position.") →P.612

#### • When the Output Stacker is not used, when loading paper, or when moving the printer

Use position (2).

When moving the printer, always lift the Support Rod to Extended position A before putting it in position (2), otherwise the Basket Cloth may touch the floor and be soiled or damaged. (See "Switching to Extended position A.")

→P.612

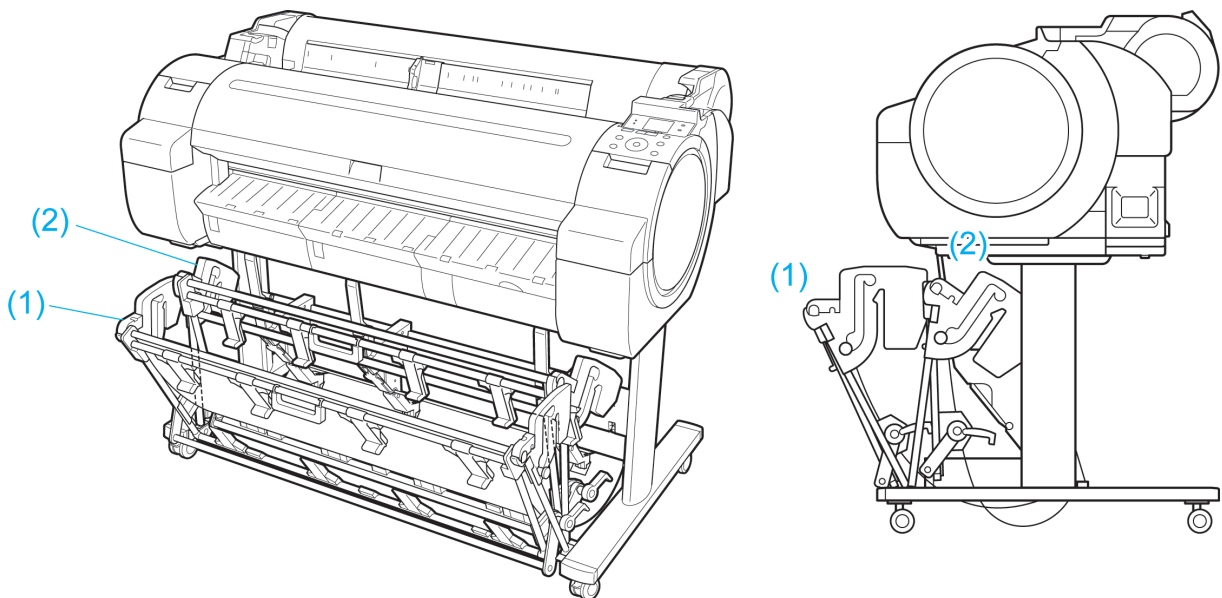

#### Important

- When storing printed documents on the Output Stacker, always use it in position (1). If you do not, printed documents may not be dropped into the Output Stacker, and the printed surface may become soiled.
- The Output Stacker can hold one sheet. When printing multiple pages, remove each sheet after it is printed.

### Note regarding the Extended position

The Output Stacker has a regular position and a position for easy removal of printed documents. Use the best position for the paper size and orientation that you are using.

For information on the types and sizes of paper that the Extended position supports, refer to the following.

- Printer Stand ST-34 : Output stacker operation guide (Included with the Printer Stand ST-34)
- Printer Stand ST-33 : Paper Reference Guide (See "Types of Paper." →P.568)

#### Regular position

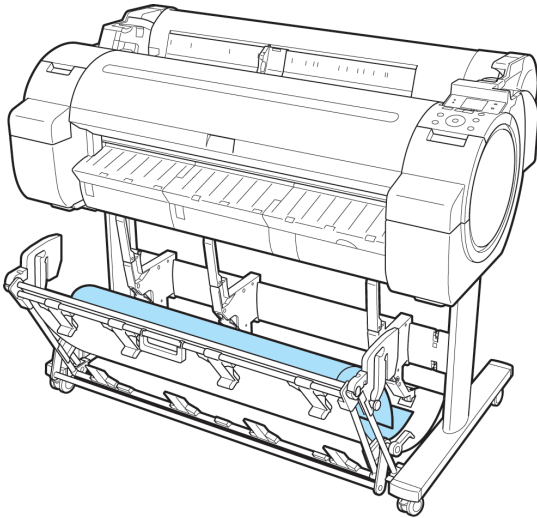

#### Extended position A

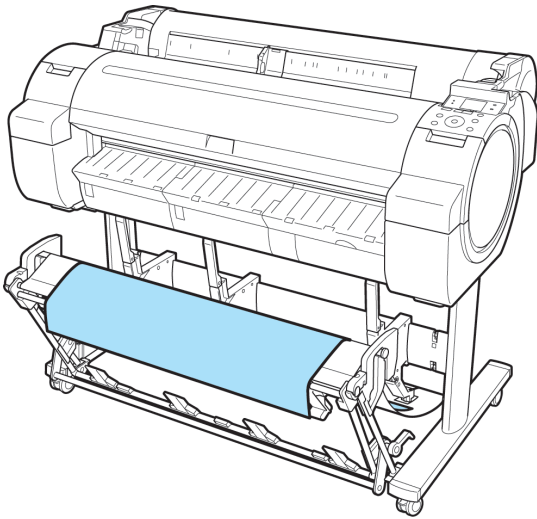

#### Extended position B (ST-34 only)

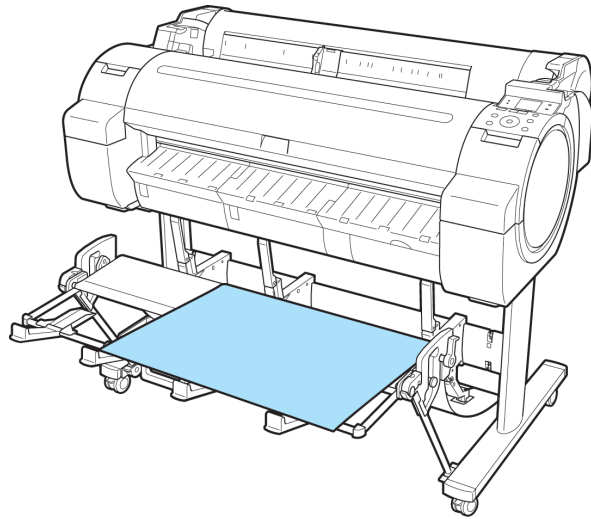

- Switching to Extended position A

Switch the stacker to Extended position A as follows.

1. Lift the Support Rod to the position shown (a) and switch the stacker to Extended position A.

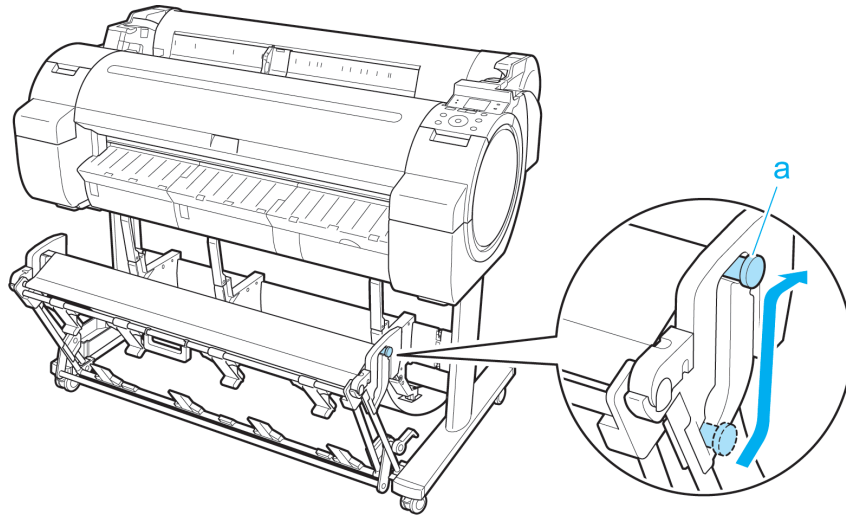

2. When using 24-inch or A1 (portrait) rolls, pull out the Adjustable Stopper (a). This completes the procedure for switching to Extended position A.

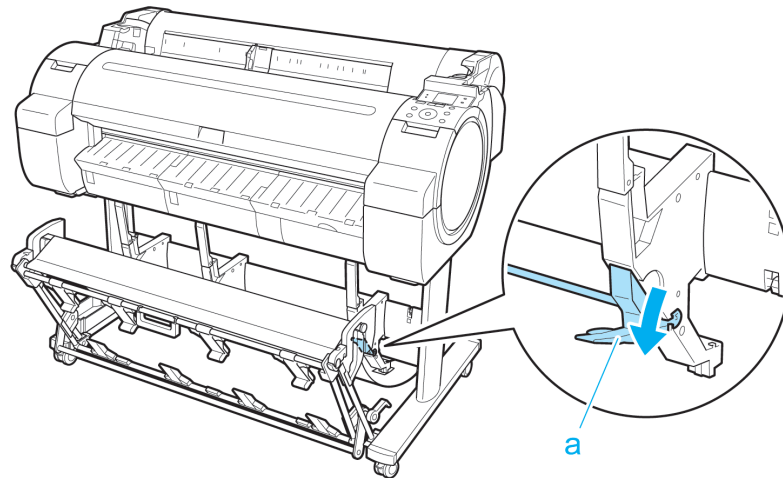

Once the printing has finished, use the following procedure to return to the regular position.

1. Lower the Support Rod to the position shown (a) to return to the regular position. If the Adjustable Stopper (b) is extended, retract it.

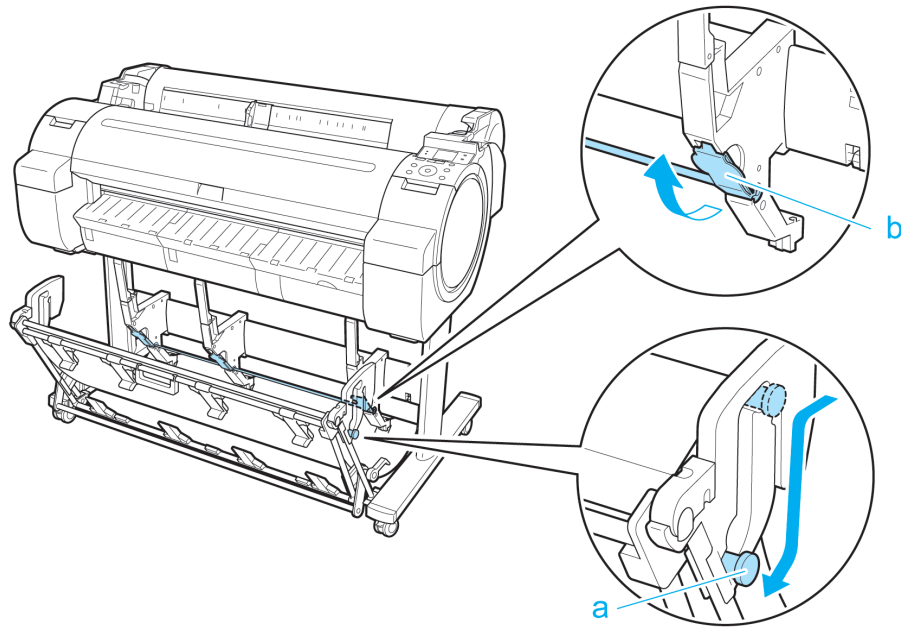

2. Return to the regular position.

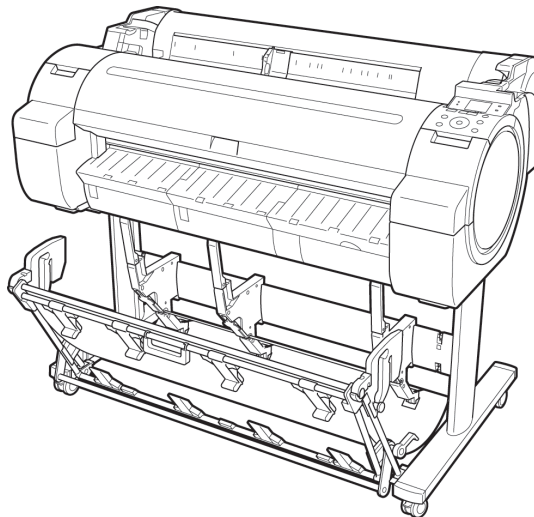

- Switching to Extended position B (ST-34 only)  
Switch the stacker to Extended position B as follows.

1. Grasp the Output stacker handle (a) and pull out the Output Stacker so that it tilts towards you.

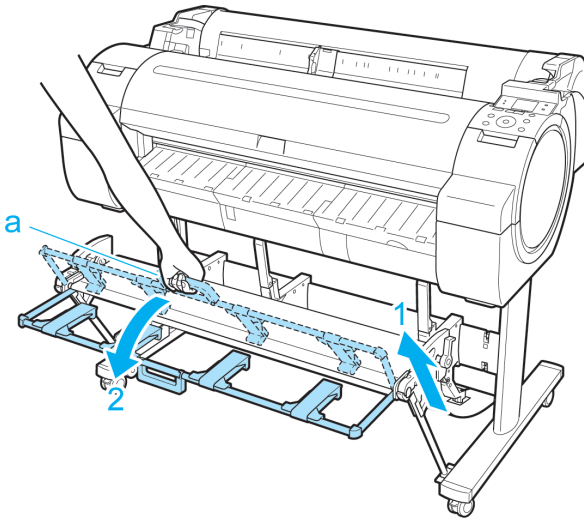

2. Open the Output Stacker Ejection Guides (a). This completes the procedure of switching to Extended position B.

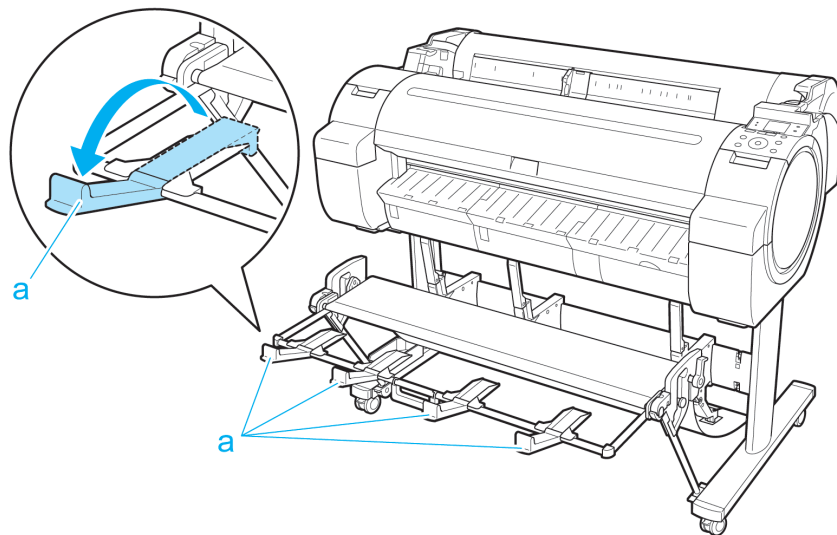

Once the printing has finished, use the following procedure to return to the regular position.

1. Push the Output Stacker Ejection Guides (a) closed until it clicks into place.

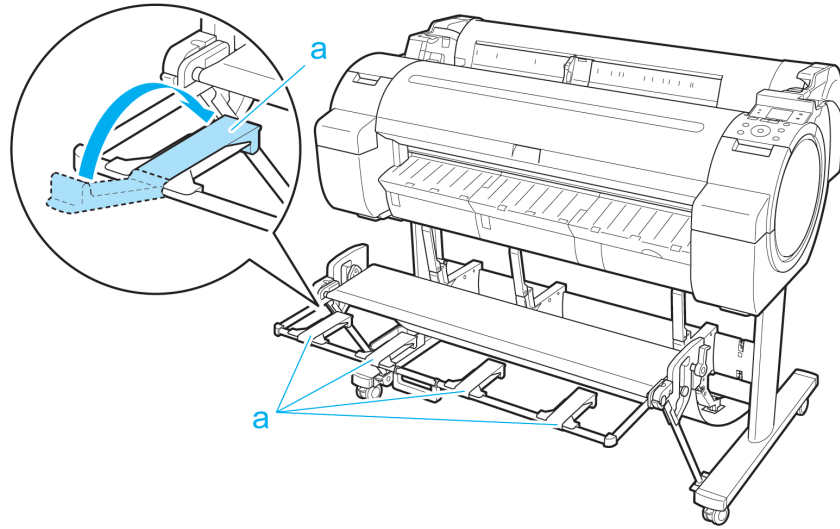

2. Hold onto the Output stacker handle (a) and pull the Output stacker release lever (b) towards you.

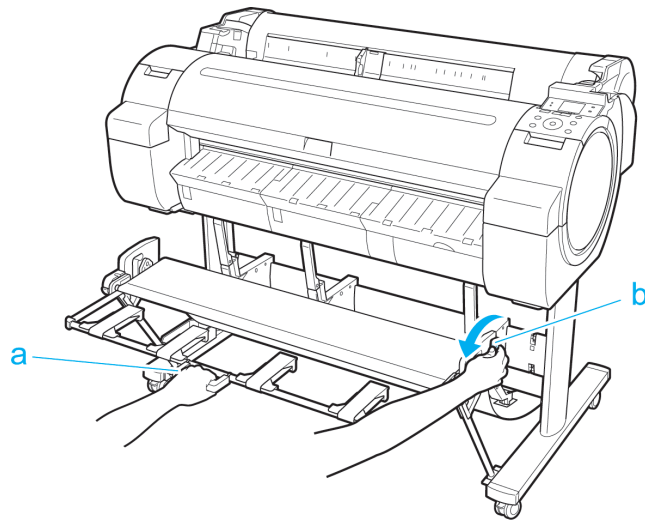



3. While continuing to hold the Output stacker handle (a), slowly lower the Output Stacker.

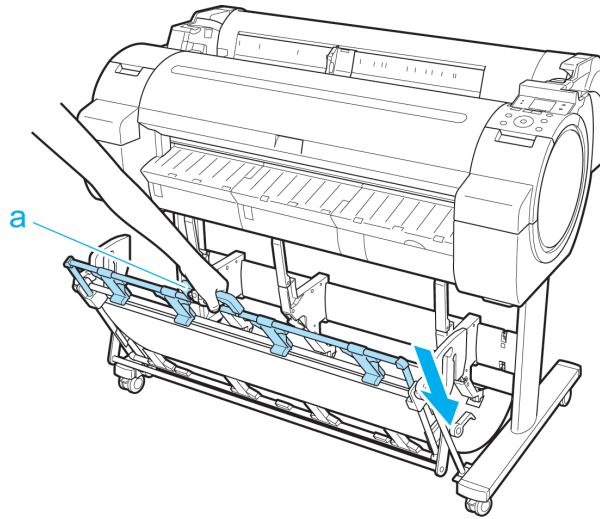

4. Return to the regular position.

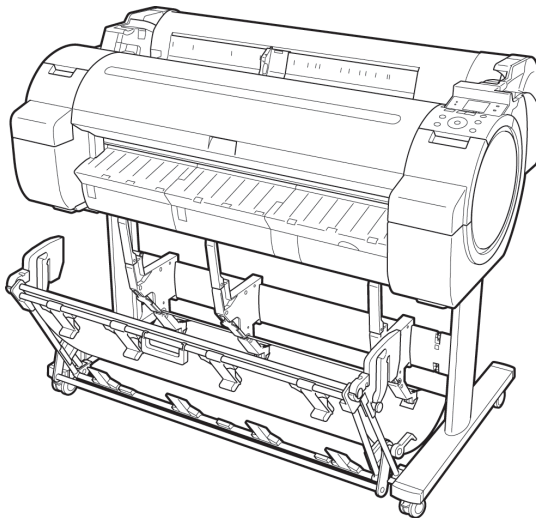

5

## Adjustments for Better Print Quality

Adjusting the Printhead

619

Adjusting the feed amount

628

6

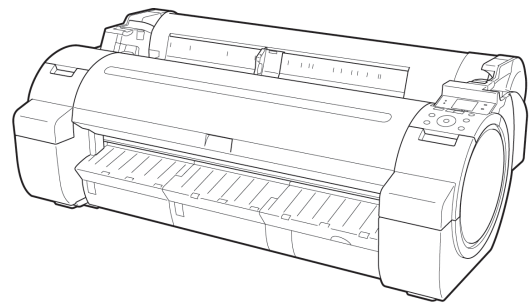

618



## Adjusting the Printhead

Adjusting the Printhead .....	619
Automatic Adjustment to Straighten Lines and Colors (Head Posi. Adj.) .....	619
Manual Adjustment to Straighten Lines and Colors (Head Posi. Adj.) .....	621
Adjusting Line Misalignment (Head Inc. Adj.) .....	623
Troubleshooting Paper Abrasion and Blurry Images (Head Height) .....	626

## Adjusting the Printhead

If printed documents are affected by the following problems, try adjusting the printhead.

- Printing is faint or affected by banding in different colors  
Execute **Nozzle Check** to check for printhead nozzle clogging.  
For instructions, see "Checking for Nozzle Clogging." →P.739
- Printed vertical lines are warped or colors are out of alignment  
Execute **Head Posi. Adj.** to adjust the printhead position.  
Normally, execute **Auto(Standard)** or **Auto(Advanced)**. However, when using special paper or if printing is not improved after executing **Auto(Advanced)**, try **Manual**.  
(See "Automatic Adjustment to Straighten Lines and Colors (Head Posi. Adj.)." →P.619)  
(See "Manual Adjustment to Straighten Lines and Colors (Head Posi. Adj.)." →P.621)
- Printed lines are misaligned  
Execute **Head Inc. Adj.** to adjust the angle of inclination of the printhead.  
Even slight misalignment can be corrected.  
(See "Adjusting Line Misalignment (Head Inc. Adj.)." →P.623)
- Paper rubs against the printhead, or image edges are blurred  
Executing **Head Height** to adjust the printhead height may improve printing results.  
(See "Troubleshooting Paper Abrasion and Blurry Images (Head Height).") →P.626

6

## Automatic Adjustment to Straighten Lines and Colors (Head Posi. Adj.)

If printed vertical lines are warped or colors are out of alignment, execute **Head Posi. Adj.** to adjust the Printhead alignment.

There are two modes for automatic Printhead adjustment: **Auto(Standard)** and **Auto(Advanced)**.

**Auto(Standard)** will fix most slight image distortion or color misalignment, but if not, try **Auto(Advanced)**.

Use **Auto(Standard)** or **Auto(Advanced)** to have the printer print and read a test pattern for automatic adjustment of the Printhead.



619

**Important**

- Always make sure the loaded paper matches the type of paper specified on the printer. Adjustment cannot be completed correctly unless the loaded paper matches the settings.
- This function is not available with CAD Tracing Paper, CAD Translucent Matte Film, or CAD Clear Film. If adjustment is not possible as expected using highly transparent film or similar media, try another type of paper, or try **Manual** adjustment.  
(See "Manual Adjustment to Straighten Lines and Colors (Head Posi. Adj.)." →P.621)

**Note**

- When printing on special paper, or if printing is not improved after **Auto(Advanced)**, try **Manual**.  
(See "Manual Adjustment to Straighten Lines and Colors (Head Posi. Adj.)." →P.621)
- Use **Auto(Standard)** if you have switched to another type of paper or if you want the boundaries between colors to appear as clear as possible.
- Use **Auto(Advanced)** to fine-tune the space between nozzles or colors if you have switched the printhead or if clearer printing is required. We recommend **Auto(Advanced)** for printing at the highest level of quality.
- We recommend using the type of paper you use most often for adjustment.

**Paper to Prepare**

Rolls	An unused roll at least 10 inches wide
Sheets	<b>Auto(Standard)</b> : One sheet of unused paper of at least A4/Letter size <b>Auto(Advanced)</b> : Five sheets of unused paper of at least A4/Letter size (or one sheet when using A2 or larger)

Perform adjustment as follows.

1. Load the paper.
  - Attaching the Roll Holder to Rolls →P.575
  - Loading Rolls in the Printer →P.579
  - Loading Sheets in the Printer →P.602
2. On the **Tab Selection screen** of the Control Panel, press ◀ or ▶ to select the Settings/Adj. tab (  ).

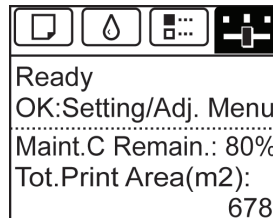
**Note**

- If the **Tab Selection screen** is not displayed, press the **Menu** button.

3. Press the **OK** button.  
The **Set./Adj. Menu** is displayed.
4. Press ▲ or ▼ to select **Adjust Printer**, and then press the **OK** button.

5. Press ▲ or ▼ to select **Head Posi. Adj.**, and then press the **OK** button.
6. Press ▲ or ▼ to select **Auto(Standard)** or **Auto(Advanced)**, and then press the **OK** button.  
A test pattern is printed for adjustment.  
Adjustment is now finished if you have printed on a roll or a sheet of A2 size or larger.
7. If you are printing on sheets smaller than A2 size for **Auto(Advanced)**, a confirmation message is displayed requesting you to continue printing. Press the **OK** button and follow the instructions displayed.

## Manual Adjustment to Straighten Lines and Colors (Head Posi. Adj.)

If printed vertical lines are warped or colors are out of alignment, execute **Head Posi. Adj.** to adjust the Printhead alignment.

Normally, execute **Auto(Standard)** or **Auto(Advanced)**.

(See "Automatic Adjustment to Straighten Lines and Colors (Head Posi. Adj.)." →P.619)

However, when printing on special paper, or if printing is not improved after **Auto(Advanced)**, try **Manual**.

**Manual** adjustment requires you to examine the printed test pattern and enter an adjustment value.



### Note

- **Manual** may be unavailable in some cases, even if it is displayed in the menu.  
If so, execute **Auto(Advanced)** once.
- Always make sure the loaded paper matches the type of paper specified on the printer. Adjustment cannot be completed correctly unless the loaded paper matches the settings.
- We recommend using the type of paper you use most often for adjustment.

### Paper to Prepare

Rolls	An unused roll at least 10 inches wide
Sheets	One sheet of unused paper of at least A4/Letter size

Perform adjustment as follows.

1. Load the paper.
  - Attaching the Roll Holder to Rolls →P.575
  - Loading Rolls in the Printer →P.579
  - Loading Sheets in the Printer →P.602

2. On the **Tab Selection screen** of the Control Panel, press ◀ or ▶ to select the Settings/Adj. tab (  ).

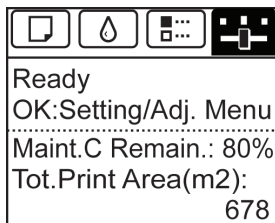

**Note**

- If the **Tab Selection screen** is not displayed, press the **Menu** button.

3. Press the **OK** button.  
The **Set./Adj. Menu** is displayed.

4. Press ▲ or ▼ to select **Adjust Printer**, and then press the **OK** button.

5. Press ▲ or ▼ to select **Head Posi. Adj.**, and then press the **OK** button.

6. Press ▲ or ▼ to select **Manual**, and then press the **OK** button.  
A test pattern is printed for adjustment.

7. Press ▲ or ▼ to select **D**, and then press the **OK** button.

8. Press ▲ or ▼ to select **D-1**, and then press the **OK** button.

9. Examine adjustment test pattern **D-1** and determine the number with straight lines.

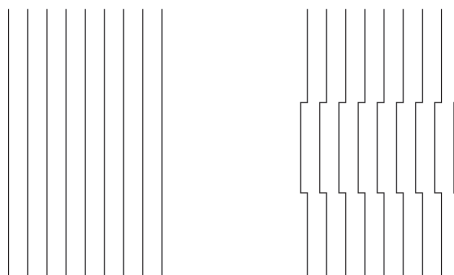
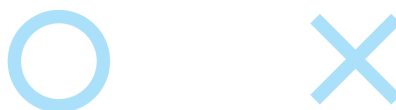

**Note**

- If two patterns seem equally good and you cannot decide which one is better, choose an intermediate value.  
For example, choose 11 if you cannot decide whether pattern 10 or 12 is better.

**10.** Press **▲** or **▼** to select the pattern number you have decided, and then press the **OK** button.

**11.** Repeat steps 8–10 to specify the adjustment value for **D-2** to **D-5** and **D-7** to **D-11**.

**12.** Press the **Back** button.

**13.** Press **▲** or **▼** to select **Register Setting**, and then press the **OK** button.

**14.** Press **▲** or **▼** to select **Yes**, and then press the **OK** button.  
The adjustment value is now registered, and adjustment is complete.

## Adjusting Line Misalignment (Head Inc. Adj.)

6

If printed lines are misaligned, execute **Head Inc. Adj.** to adjust the angle of inclination of the Printhead. Executing **Head Inc. Adj.** requires you to examine a printed test pattern and enter an adjustment value.

### Paper to Prepare

Rolls	An unused roll at least 10 inches wide
Sheets	One sheet of unused paper of at least A4/Letter size

Perform adjustment as follows.

**1.** Load the paper.

- Attaching the Roll Holder to Rolls →P.575
- Loading Rolls in the Printer →P.579
- Loading Sheets in the Printer →P.602

**Note**

- When loading paper, specify the type of paper correctly. Using paper that you have not specified on the printer may cause feeding problems and affect the printing quality.
- We recommend loading a type of paper that you use often.

623

2. On the **Tab Selection screen** of the Control Panel, press ◀ or ▶ to select the Settings/Adj. tab (  ).

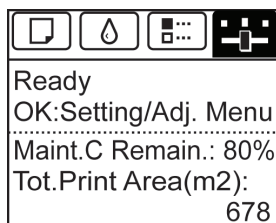
**Note**

- If the **Tab Selection screen** is not displayed, press the **Menu** button.

3. Press the **OK** button.  
The **Set./Adj. Menu** is displayed.
4. Press ▲ or ▼ to select **Adjust Printer**, and then press the **OK** button.
5. Press ▲ or ▼ to select **Head Inc. Adj.**, and then press the **OK** button.  
After the Carriage is moved, a message is displayed requesting you to open the Top Cover.
6. Open the Top Cover.

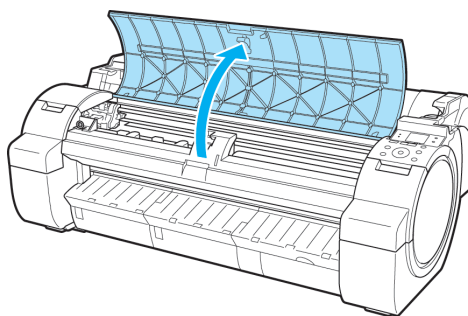

7. Align the Angle Adjustment Lever with the red square and close the Top Cover.

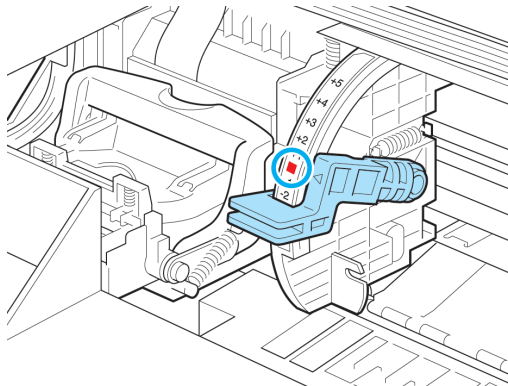

A test pattern is printed for adjustment.



**Important**

- Do not touch the Linear Scale (a) or Carriage Shaft (b). Touching these parts may damage them.

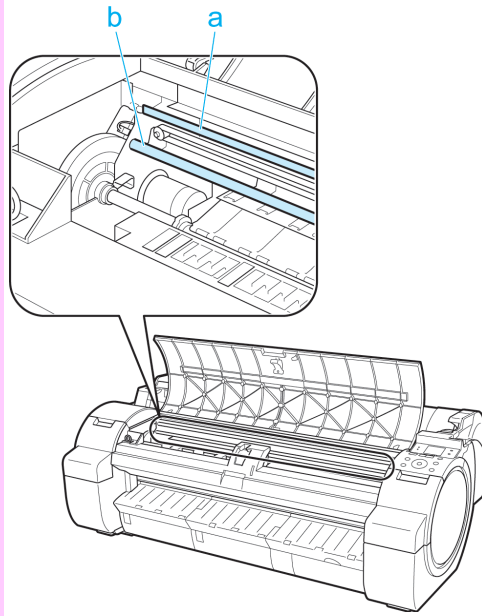

- If you accidentally move the Carriage, you will hear a warning tone. In this case, close the Top Cover.

6

- 8.** Examine the test pattern for adjustment. Determine the straightest set of lines.

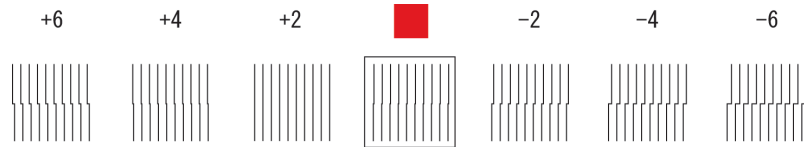

- 9.** Open the Top Cover and move the Angle Adjustment Lever to match the number (or the square) of the straightest set of lines.

If no single set of lines is perfectly straight, move the Angle Adjustment Lever to a position between the numbers (or between the number and the square) of the two sets of lines that are least misaligned.

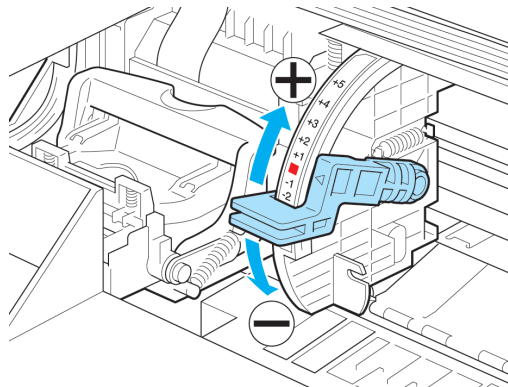

625

- 10.** Close the Top Cover.  
The Printhead is now straight, and adjustment is complete.

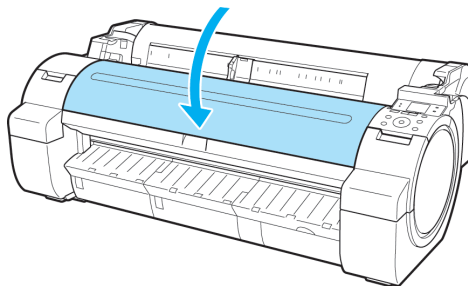

### Troubleshooting Paper Abrasion and Blurry Images (Head Height)

If the Printhead rubs against paper during printing, adjusting the Printhead height may improve results. If image edges are blurred, it may help to lower the Printhead.



**Note**

- Raise or lower the printhead, depending on the nature of the problem.  
(See "Paper rubs against the Printhead.") →P.787  
(See "The edges of the paper are dirty.") →P.788  
(See "Image edges are blurred or white banding occurs.") →P.791

- 1.** On the **Tab Selection screen** of the Control Panel, press ◀ or ▶ to select the Paper tab (  ).

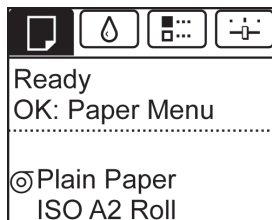

**Note**

- If the **Tab Selection screen** is not displayed, press the **Menu** button.

- 2.** Press the **OK** button.  
The **Paper Menu** is displayed.
- 3.** Press ▲ or ▼ to select **Paper Details**, and then press the **OK** button.
- 4.** Press ▲ or ▼ to select the type of paper, and then press the **OK** button.
- 5.** Press ▲ or ▼ to select **Head Height**, and then press the **OK** button.



6. Press ▲ or ▼ to select the desired setting value, and then press the **OK** button.



Note

- Depending on the type of paper, some setting values may not be available.

## Adjusting the feed amount

Adjusting the Feed Amount .....	628
Selecting a Feed Amount Adjustment Method (Feed Priority) .....	628
Automatic Banding Adjustment (Adj. Quality) .....	630
Manual Banding Adjustment (Adj. Quality) .....	631
Fine-Tuning the Paper Feed Amount (Adj. Fine Feed) .....	633
Adjusting Line Length (Adjust Length) .....	634
Adjusting the Vacuum Strength (VacuumStrength) .....	636

## Adjusting the Feed Amount

If printed documents are affected by the following problems, try adjusting the feed amount.

- Banding in different colors
- Line length is not accurate in the direction paper is fed

To adjust the feed amount, do the following, in this order.

1. Depending on the issue, adjust **Adj. Priority** to suit the particular type of paper.  
(See "Selecting a Feed Amount Adjustment Method (Feed Priority).") →P.628
2. Execute **Adj. Quality** or **Adjust Length**, depending on the selection in **Adj. Priority**.  
(See "Automatic Banding Adjustment (Adj. Quality).") →P.630  
(See "Manual Banding Adjustment (Adj. Quality).") →P.631  
(See "Adjusting Line Length (Adjust Length).") →P.634
3. After executing **Adj. Quality**, execute **Adj. Fine Feed** for further adjustment as needed.  
(See "Fine-Tuning the Paper Feed Amount (Adj. Fine Feed).") →P.633

## Selecting a Feed Amount Adjustment Method (Feed Priority)

Methods of adjusting the amount paper is fed are set in **Adj. Priority**.

Adjust **Adj. Priority** to suit your particular printing application.

- **Print Quality** : Adjusts the feed amount to reduce banding across the sheet in printed documents.  
**Adj. Quality** settings are applied. When **Adj. Fine Feed** is executed, the **Adj. Fine Feed** settings are applied in addition to the **Adj. Quality** settings.
- **Print Length** : Adjusts the feed amount for better accuracy of lines in printed documents.  
The settings of **A:High** or **B:Standard/Draft** in **Adjust Length** are applied.
- **Automatic** : **Print Quality** or **Print Length** is selected, depending on **Print Priority** as selected in the printer driver at the time of printing.  
**Image** or **Office Document** : **Print Quality** is selected.  
**Line Drawing/Text** : **Print Length** is selected.

**Note**

- Either **A:High** or **B:Standard/Draft** in the **Adjust Length** menu is applied, depending on printer driver settings at the time of printing.
- If you have selected **Easy Settings** in the printer driver, follow these steps to confirm the **Print Priority** setting.
  - Windows: Click **View Settings** on the **Main** tab to display the **View Settings** dialog box.
  - Mac OS X: Click **View set.** on the **Main** pane to display the **View settings** dialog box.

Follow these steps to configure the settings.

**1.** Load the paper.

- Attaching the Roll Holder to Rolls →P.575
- Loading Rolls in the Printer →P.579
- Loading Sheets in the Printer →P.602

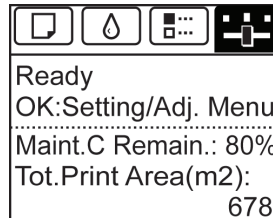
**2.** On the **Tab Selection screen** of the Control Panel, press ◀ or ▶ to select the Settings/Adj. tab (  ).**Note**

- If the **Tab Selection screen** is not displayed, press the **Menu** button.

**3.** Press the **OK** button.

The **Set./Adj. Menu** is displayed.

**4.** Press ▲ or ▼ to select **Adjust Printer**, and then press the **OK** button.**5.** Press ▲ or ▼ to select **Feed Priority**, and then press the **OK** button.**6.** Press ▲ or ▼ to select **Adj. Priority**, and then press the **OK** button.**7.** Press ▲ or ▼ to select **Automatic**, **Print Quality**, or **Print Length**, and then press the **OK** button.

## Automatic Banding Adjustment (Adj. Quality)

If printed images are affected by banding in different colors across the sheet, execute **Adj. Quality** for automatic adjustment of the paper feed amount.

There are two modes of automatic adjustment to correct banding: **Auto(GenuinePpr)** and **Auto(OtherPaper)**. In either mode, the printer prints and reads a test pattern for automatic adjustment of the feed amount.

- **Auto(GenuinePpr)**

Use this mode with paper identified in the Paper Reference Guide.

(See "Types of Paper.") →P.568

- **Auto(OtherPaper)**

Use this mode with paper not in the Paper Reference Guide, or if **Auto(GenuinePpr)** does not eliminate banding.

(See "Types of Paper.") →P.568



### Note

- Always check the **Adj. Priority** values before using **Auto(GenuinePpr)** or **Auto(OtherPaper)**.  
(See "Selecting a Feed Amount Adjustment Method (Feed Priority).") →P.628
- Adjustment is not possible with **Auto(GenuinePpr)** and **Auto(OtherPaper)** when using highly transparent media.  
In this case, use **Manual** adjustment.  
(See "Manual Banding Adjustment (Adj. Quality).") →P.631
- If additional fine-tuning is necessary after **Auto(GenuinePpr)** and **Auto(OtherPaper)**, execute **Adj. Fine Feed**.  
(See "Fine-Tuning the Paper Feed Amount (Adj. Fine Feed).") →P.633
- Use **Adjust Length** to ensure that lines in CAD drawings are printed at exactly the right length.  
(See "Adjusting Line Length (Adjust Length).") →P.634
- This may take some time, depending on the type of paper.
- Use paper of the same type and size for adjustment as you will use for printing.

### Paper to Prepare

Rolls	An unused roll at least 10 inches wide
Sheets	<b>Auto(GenuinePpr)</b> : One sheet of unused paper of at least A4/Letter size <b>Auto(OtherPaper)</b> : Two sheets of unused paper of at least A4/Letter size (or one sheet when using A2 or larger)

Perform adjustment as follows.

### 1. Load the paper.

- Attaching the Roll Holder to Rolls →P.575
- Loading Rolls in the Printer →P.579
- Loading Sheets in the Printer →P.602



### Note

- Always make sure the loaded paper matches the type of paper specified. Adjustment cannot be completed correctly unless the loaded paper matches the settings.

2. On the **Tab Selection screen** of the Control Panel, press ◀ or ▶ to select the Settings/Adj. tab (  ).

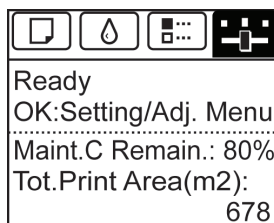

#### Note

- If the **Tab Selection screen** is not displayed, press the **Menu** button.

3. Press the **OK** button.  
The **Set./Adj. Menu** is displayed.
4. Press ▲ or ▼ to select **Adjust Printer**, and then press the **OK** button.
5. Press ▲ or ▼ to select **Feed Priority**, and then press the **OK** button.
6. Press ▲ or ▼ to select **Adj. Quality**, and then press the **OK** button.
7. Press ▲ or ▼ to select **Auto(GenuinePpr)** or **Auto(OtherPaper)**, and then press the **OK** button.  
A test pattern is printed for adjustment.  
Adjustment is now finished if you have printed on a roll or a sheet of A2 size or larger.
8. If you are printing on sheets smaller than A2 size for **Auto(OtherPaper)**, a confirmation message is shown on the Display Screen requesting you to continue printing.  
Press the **OK** button and follow the instructions on the Display Screen.

## Manual Banding Adjustment (Adj. Quality)

If printed images are affected by banding in different colors, execute **Adj. Quality** for adjustment of the paper feed amount. Use **Manual** adjustment with highly transparent media or other paper for which **Auto(GenuinePpr)** or **Auto(OtherPaper)** cannot be used.

(See "Automatic Banding Adjustment (Adj. Quality).") →P.630

**Manual** adjustment requires you to enter an adjustment value after a test pattern is printed.

**Note**

- Always check the **Adj. Priority** values before using **Manual** adjustment. (See "Selecting a Feed Amount Adjustment Method (Feed Priority).") →P.628
- If additional fine-tuning is necessary after **Manual** adjustment, use **Adj. Fine Feed** (See "Fine-Tuning the Paper Feed Amount (Adj. Fine Feed).") →P.633
- Use **Adjust Length** to ensure that lines in CAD drawings are printed at exactly the right length. (See "Adjusting Line Length (Adjust Length).") →P.634
- Use paper of the same type and size for adjustment as you will use for printing.

**Paper to Prepare**

Rolls	An unused roll at least 10 inches wide
Sheets	Two sheets of unused paper of at least A4/Letter size

Perform adjustment as follows.

**1.** Load the paper.

- Attaching the Roll Holder to Rolls →P.575
- Loading Rolls in the Printer →P.579
- Loading Sheets in the Printer →P.602

**Note**

- Always make sure the loaded paper matches the type of paper specified. Adjustment cannot be completed correctly unless the loaded paper matches the settings.

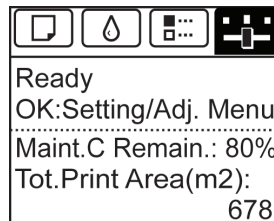
**2.** On the **Tab Selection screen** of the Control Panel, press ◀ or ▶ to select the Settings/Adj. tab (.**Note**

- If the **Tab Selection screen** is not displayed, press the **Menu** button.

**3.** Press the **OK** button.  
The **Set./Adj. Menu** is displayed.**4.** Press ▲ or ▼ to select **Adjust Printer**, and then press the **OK** button.**5.** Press ▲ or ▼ to select **Feed Priority**, and then press the **OK** button.**6.** Press ▲ or ▼ to select **Adj. Quality**, and then press the **OK** button.

7. Press ▲ or ▼ to select **Manual**, and then press the **OK** button.  
Test pattern A is printed for manual adjustment.

**Note**

- When printing on sheets, follow the instructions on the Display Screen and remove the sheet.

8. Examine test pattern A for adjustment. Determine the pattern in which banding is least noticeable.

**Note**

- If banding seems least noticeable in two patterns but you cannot decide which one is better, choose an intermediate value.  
For example, choose 11 if you cannot decide whether pattern 10 or 12 is better.

9. Press ▲ or ▼ to select the pattern number you have decided, and then press the **OK** button.  
Test pattern B is printed for adjustment.

**Note**

- If you printed test pattern A on a sheet, follow the instructions on the Display Screen and use another sheet of the same type of paper.  
Additionally, after test pattern B is printed, follow the instructions on the Display Screen and remove the sheet.

10. Examine test pattern B for adjustment. Determine the pattern in which banding is least noticeable.

11. Press ▲ or ▼ to select the pattern number you have decided, and then press the **OK** button.  
The adjustment value is now registered, and adjustment is complete.

## Fine-Tuning the Paper Feed Amount (Adj. Fine Feed)

If the contrast is uneven or banding in different colors appears at 50 mm (2.0 in) intervals in printed documents, try executing **Adj. Fine Feed** during printing to fine-tune the feed amount.

**Note**

- Always execute **Adj. Quality** before **Adj. Fine Feed**.  
Once you execute **Adj. Quality**, the **Adj. Fine Feed** value will revert to 0.  
(See "Automatic Banding Adjustment (Adj. Quality).") →P.630  
(See "Manual Banding Adjustment (Adj. Quality).") →P.631

Perform adjustment as follows.

1. On the **Tab Selection screen** of the Control Panel, press ◀ or ▶ to select the Settings/Adj. tab (  ).

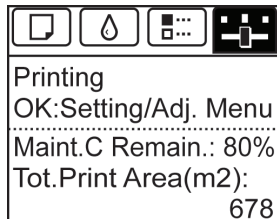

#### Note

- If the **Tab Selection screen** is not displayed, press the **Menu** button.

2. Press the **OK** button.  
The **Set./Adj. Menu** is displayed.
3. Press ▲ or ▼ to select **Adj. Fine Feed**, and then press the **OK** button.
4. Press ▲ or ▼ to select a setting value in the range -5 to +5, and then press the **OK** button.  
The setting is now applied.

## Adjusting Line Length (Adjust Length)

To ensure that lines in CAD drawings are printed at exactly the right length, use **Adjust Length** to adjust the amount that paper is advanced.

There are two options in **Adjust Length** : **AdjustmentPrint** and **Change Settings**.

- **AdjustmentPrint**  
After a test pattern is printed, you will measure the discrepancy based on the results of printing.
- **Change Settings**  
No test pattern is printed. Instead, you will measure a document already printed to determine the discrepancy.

Additionally, two modes are available in both **AdjustmentPrint** and **Change Settings** : **A:High** or **B:Standard/Draft**. Choose the mode that suits your particular printing application.

- **A:High**  
This setting is applied when **Highest** or **High** is selected in **Print Quality** in the printer driver.
- **B:Standard/Draft**  
This setting is applied when **Standard** or **Draft** is selected in **Print Quality** in the printer driver.



#### Note

- Always check the **Adj. Priority** values before using **Adjust Length**. (See "Selecting a Feed Amount Adjustment Method (Feed Priority).") [→P.628](#)
- Use paper of the same type and size for adjustment as you will use for printing.



## Paper to Prepare

Rolls	<ul style="list-style-type: none"> <li>• An unused roll at least 10 inches wide</li> <li>• High-precision ruler</li> </ul>
Sheets	<ul style="list-style-type: none"> <li>• One sheet of unused paper of at least A4/Letter size</li> <li>• High-precision ruler</li> </ul>

Perform adjustment as follows.

## 1. Load the paper.

- Attaching the Roll Holder to Rolls →P.575
- Loading Rolls in the Printer →P.579
- Loading Sheets in the Printer →P.602



### Note

- Always make sure the loaded paper matches the type of paper specified. Adjustment cannot be completed correctly unless the loaded paper matches the settings.

## 2. On the **Tab Selection screen** of the Control Panel, press ◀ or ▶ to select the Settings/Adj. tab ( ).

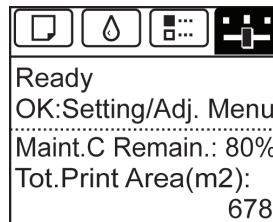

### Note

- If the **Tab Selection screen** is not displayed, press the **Menu** button.

## 3. Press the **OK** button. The **Set./Adj. Menu** is displayed.

## 4. Press ▲ or ▼ to select **Adjust Printer**, and then press the **OK** button.

## 5. Press ▲ or ▼ to select **Feed Priority**, and then press the **OK** button.

## 6. Press ▲ or ▼ to select **Adjust Length**, and then press the **OK** button.

7. Press ▲ or ▼ to select **AdjustmentPrint** or **Change Settings**, and then press the **OK** button. When you select **AdjustmentPrint**, a test pattern is printed for you to measure the scale and calculate the discrepancy. The scale bar shows **Millimeter** in 50 mm units and **Inch** in 1 inch units.

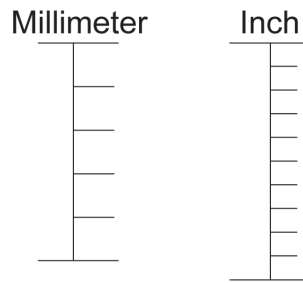
**Note**

- A test pattern is printed in black when you choose **A:High** or in magenta if you choose **B:Standard/Draft**.
- To cancel printing the test pattern for adjustment, hold down the **Stop** button. When "**Stop printing?**" is displayed, press ▲ or ▼ to select "**Yes**", and then press the **OK** button.

8. Press ▲ or ▼ to enter the amount of discrepancy, and then press the **OK** button. If the scale is shorter than the actual size, use a positive setting value. If it is longer, use a negative value. The feed amount can be adjusted in 0.02% increments.

## Adjusting the Vacuum Strength (VacuumStrngth)

When printing on heavyweight paper or paper that curls or wrinkles easily, if the Printhead rubs against paper, adjusting the level of suction against paper on the Platen may improve results.

1. On the **Tab Selection** screen of the Control Panel, press ◀ or ▶ to select the Paper tab (  ).

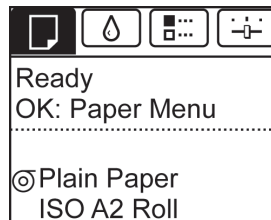
**Note**

- If the **Tab Selection** screen is not displayed, press the **Menu** button.

2. Press the **OK** button. The **Paper Menu** is displayed.
3. Press ▲ or ▼ to select **Paper Details**, and then press the **OK** button.
4. Press ▲ or ▼ to select the type of paper, and then press the **OK** button.

**5.** Press ▲ or ▼ to select **VacuumStrngth**, and then press the **OK** button.

**6.** Press ▲ or ▼ to select the desired setting value, and then press the **OK** button.

## Printer Parts

Printer parts

639

Optional accessories

647

7

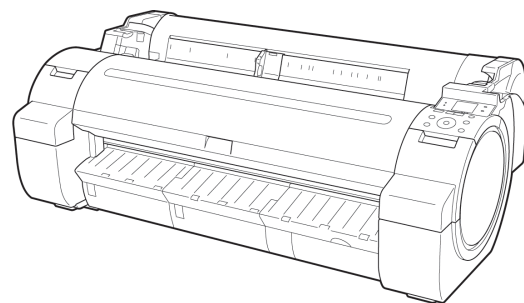

638

## Printer parts

Front .....	639
Side .....	641
Top Cover (Inside) .....	642
Roll Cover (Inside) .....	643
Carriage .....	644
Ink Tank Cover (Inside) .....	644
Stand .....	645

## Front

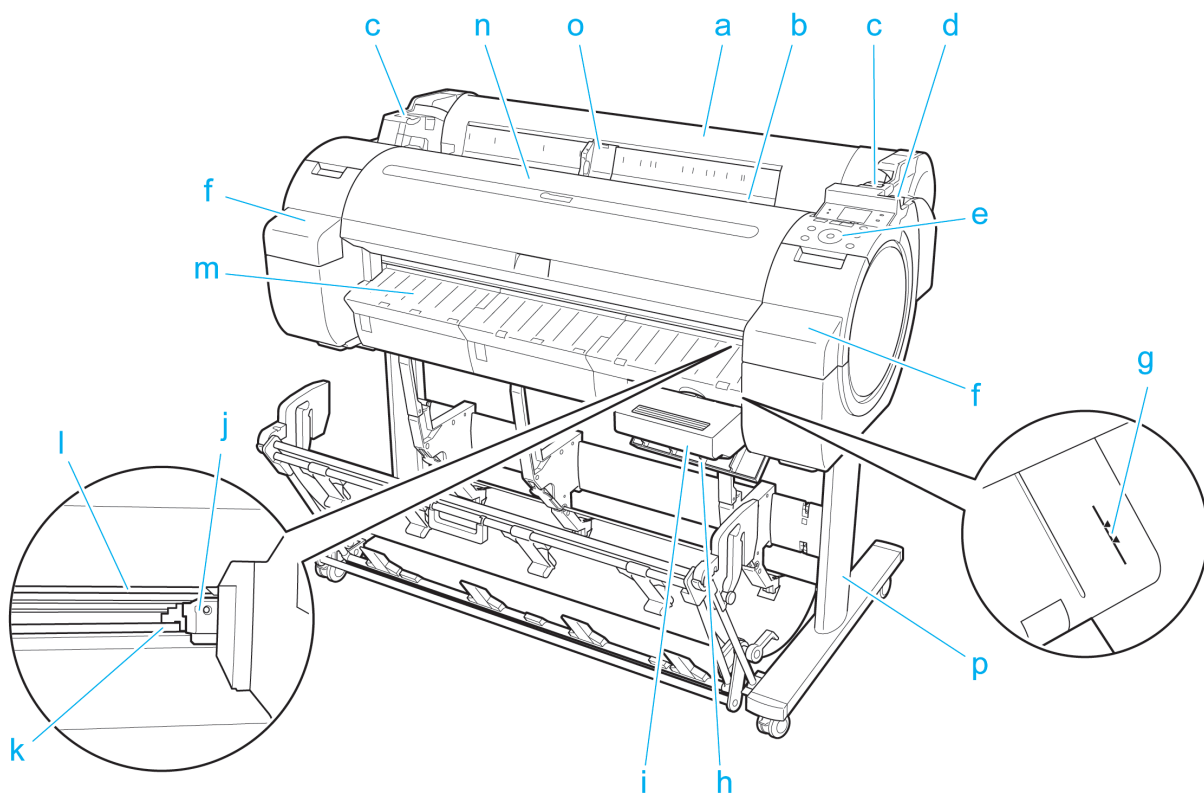

### a. Roll Cover

Open this cover to load rolls. (See "Roll Cover (Inside).") →P.643

### b. Paper Feed Slot

When loading paper, insert it here.

### c. Roll Ledge

When loading rolls, rest the Roll Holder here before loading it in the Roll Holder Slot.

### d. Release Lever

When releasing the Paper Retainer, push this lever back.

### e. Control Panel

Use this panel to operate the printer and check the printer status. (See "Control Panel.") →P.649

**f. Ink Tank Cover**

Open this cover to replace an Ink Tank. (See "Ink Tank Cover (Inside).") →P.644

**g. Paper Alignment Line**

An orange line for alignment of paper.

**h. Maintenance Cartridge Cover**

Open this cover to replace the Maintenance Cartridge.

**i. Maintenance Cartridge**

Absorbs ink used for maintenance purposes such as head cleaning. (Replace the cartridge when it is full.)

**j. Cutter Unit**

A round-bladed cutter for automatic roll cutting.

**k. Cutter Rail**

The Cutter Unit passes over this rail to cut paper.

**l. Output Tray**

All printed documents are ejected from this slot.

**m. Ejection Guide**

Guides printed documents as they are ejected.

**n. Top Cover**

Open this cover to install the Printhead and remove any jammed paper from inside the printer, as needed. (See "Top Cover (Inside).") →P.642

**o. Width Guide**

When loading the sheets, move the guide to match the paper size.

**p. Stand**

A stand that holds the printer. Equipped with casters to facilitate moving it. (See "Stand.") →P.645

## Side

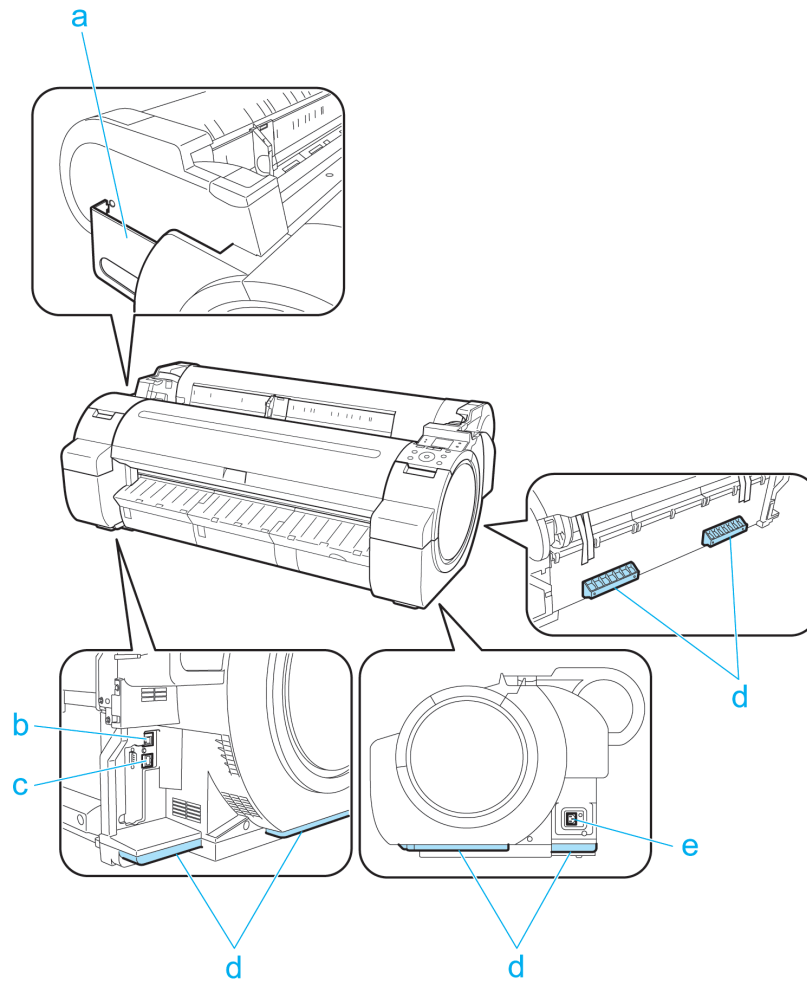
**a. Manual Pocket**

Store printer manuals in this pocket.

**b. Ethernet Port**

Connect an Ethernet cable to this port. The lamp is lit if the Ethernet cable is connected correctly and communication is possible between the computer and printer.

**c. USB Port**

Connect a USB cable to this port. The printer is compatible with Hi-Speed USB connections.

**d. Carrying Handles**

When carrying the printer, have three people hold it by these handles on the back at both ends.

**e. Power Supply Connector**

Connect the power cord to this connector.

## Top Cover (Inside)

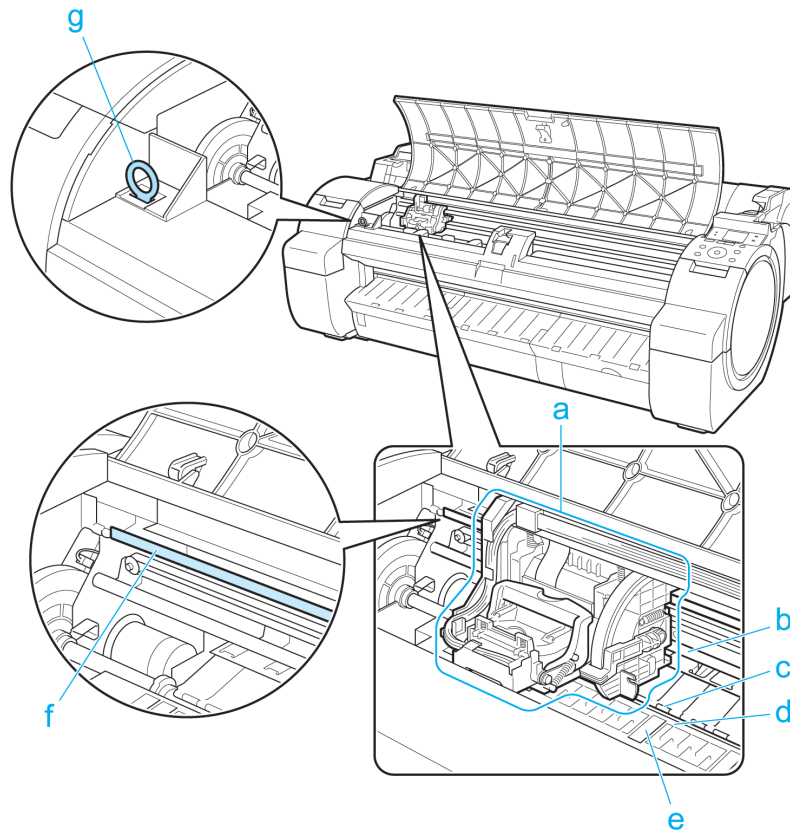

### a. Carriage

Moves the Printhead. The carriage serves a key role in printing. (See "Carriage.") →P.644

### b. Carriage Shaft

The Carriage slides along this shaft.

### c. Paper Retainer

Important in supplying the paper. This retainer holds paper as it is fed.

### d. Platen

The Printhead moves across the platen to print. Vacuum holes on the platen hold paper in place.

### e. Borderless Printing Ink Grooves

For catching ink outside the edges of paper during borderless printing.

### f. Linear Scale

The linear scale serves a key role in detecting the Carriage position. Be careful not to touch this part when cleaning inside the Top Cover or clearing paper jams.

### g. Cleaning Brush

When cleaning inside the printer under the Top Cover, use this brush to sweep away paper dust on the Platen.



## Roll Cover (Inside)

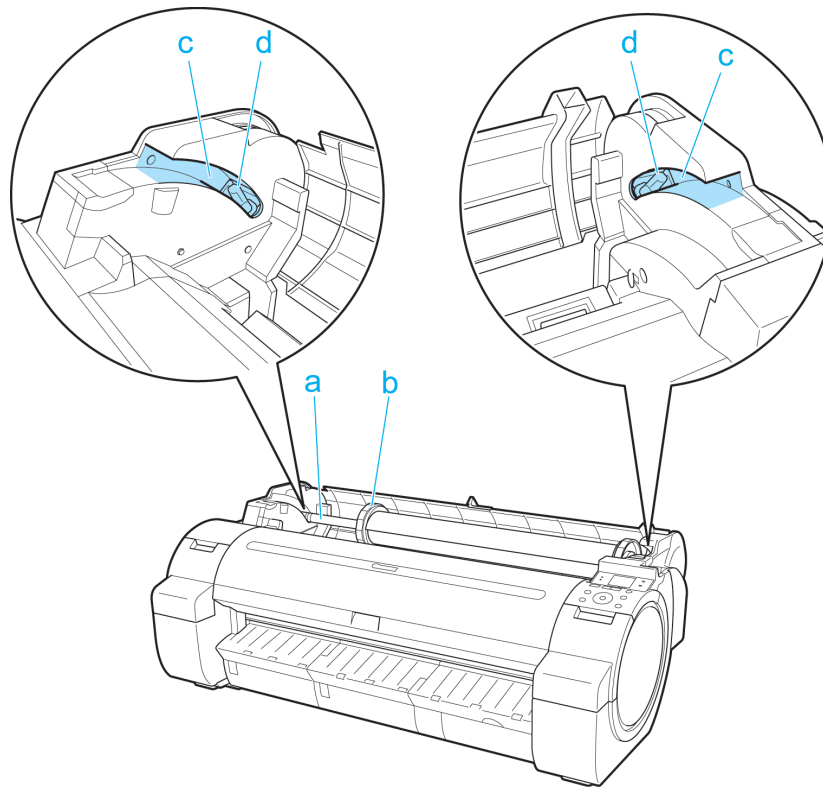

**a. Roll Holder**

Load the roll on this holder.

**b. Holder Stopper**

Secure rolls on the Roll Holder with this part.

**c. Roll Loading Slots**

Slide the Roll Holder along these slots.

**d. Roll Holder Slot**

Load the Roll Holder into this holder slot.

## Carriage

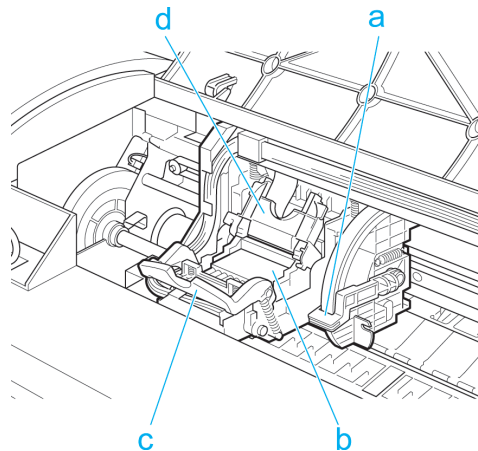

**a. Angle Adjustment Lever**

Use this lever to fine-tune the printer to correct misalignment of printed lines.

**b. Printhead**

The printhead is equipped with ink nozzles. The carriage serves a key role in printing.

**c. Printhead Fixer Lever**

Locks the Printhead Fixer Cover.

**d. Printhead Fixer Cover**

Holds the Printhead in place.

7

## Ink Tank Cover (Inside)

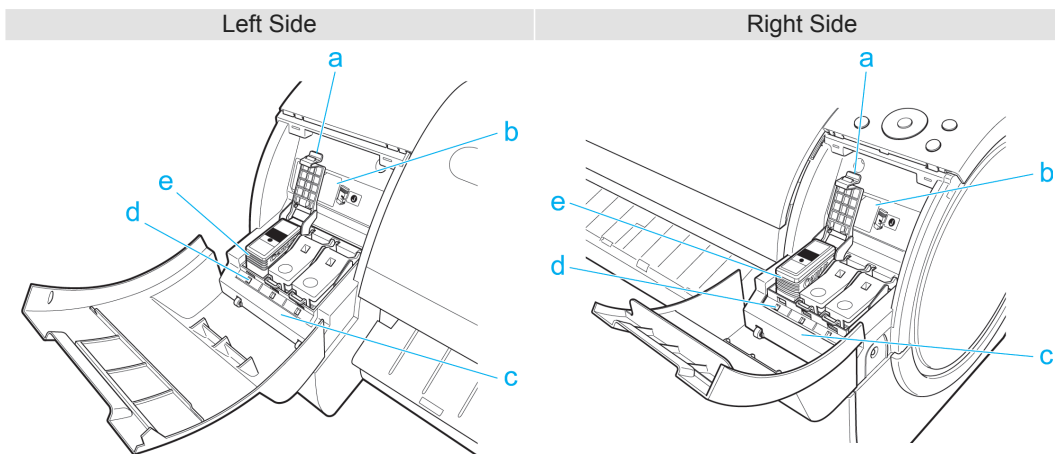

**a. Ink Tank Lock Lever**

A lever that locks the Ink Tank in place and protects it. Lift and press down the lever when replacing an Ink Tank.

644

**b. Ink Set Label**

An Ink Tank that can be used in the printer is labeled with a white letter **J** in a black circle on the side. When purchasing an Ink Tank, make sure a **J** is printed on the label. (See "Ink Tanks.") →P.731

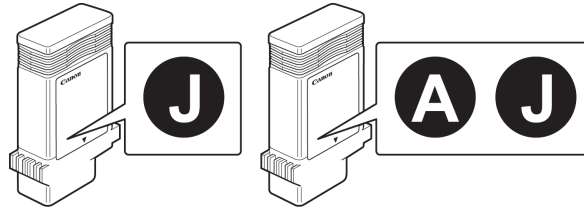
**c. Ink Color Label**

Load an Ink Tank that matches the color and name on this label.

**d. Ink Lamp (Red)**

Indicates the state of the Ink Tank as follows when the Ink Tank Cover is opened.

- On

The Ink Tank is installed correctly.

- Off

No Ink Tank is installed, or the ink level detection function has been released.

- Flashing Slowly

Not much ink is left.

- Flashing Rapidly

There is no ink left.

**e. Ink Tank**

Cartridges of ink in various colors.

**Stand**

- Printer Stand ST-34

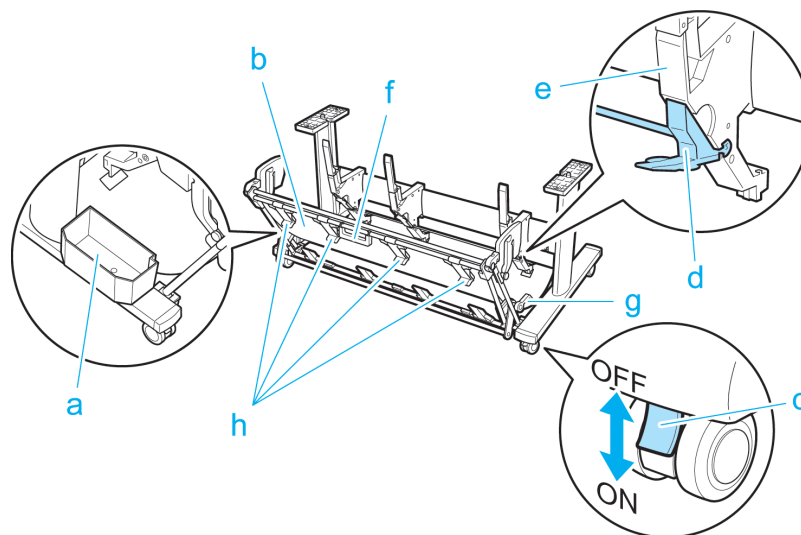

**a. Accessory Pocket**

Stores printer accessories.

**b. Output Stacker**

Printed documents are ejected into the output tray.

**c. Locking Caster**

Lock to immobilize the caster.

Before moving the printer, always unlock all four casters. Moving the printer while casters are locked may scratch the casters or the floor.

**d. Adjustable Stopper**

Pull out depending on the paper size when using the output stacker in the Extended position A.

For details on the extended position, see "Using the Output Stacker." →P.611

**e. Paper Guide**

Guides printed documents into the output stacker.

**f. Output stacker handle**

This handle is grasped and supports the sliding output stacker when putting the output stacker into Extended position B and returning it to the regular position.

For details on the extended position, see "Using the Output Stacker." →P.611

**g. Output stacker release lever**

Pull this lever towards you to release Extended position B.

For details on the extended position, see "Using the Output Stacker." →P.611

**h. Output Stacker Ejection Guides**

This guide supports the paper that is output when using the output stacker in Extended position B.

**Note**

- The Stand that can be used with this printer is Printer Stand ST-34 and Printer Stand ST-33. Either one or the other of these Stand is included with the printer depending on the region and time when you purchased the printer.
- The output stacker of the Printer Stand ST-33 has a regular position and an Extended position A. For details on the extended position, see "Using the Output Stacker." →P.611
- The Stand is described in the illustration of Printer Stand ST-34. Note that the illustrations may look different from the appearance of your printer in some cases.

## Optional accessories

Roll Holder Set ..... 647

### Roll Holder Set

Load a roll on the roll holder and then load the holder in the printer. The Roll Holder in the Roll Holder Set RH2-33 is for use with both 2-inch and 3-inch paper cores. Use the correct attachment for the particular paper core. (See "Attaching the Roll Holder to Rolls.") →P.575

- Roll Holder Set RH2-33
  - Roll Holder (for 2- and 3-inch paper cores)

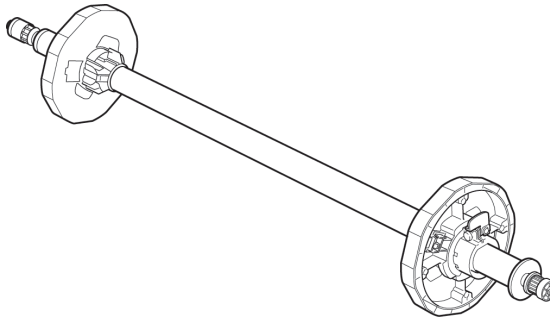

- Attachments

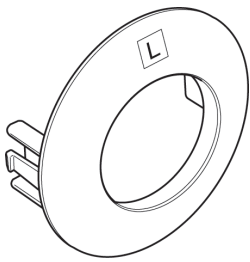
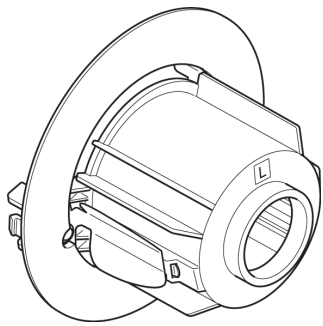
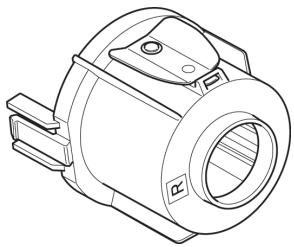
Using the 2-Inch Paper Core Attachment	Using the 3-Inch Paper Core Attachment	
2-Inch Paper Core Attachment 	3-Inch Paper Core Attachment L 	3-Inch Paper Core Attachment R 

## Control Panel

Operations and Display Screen 649

Printer Menu 659

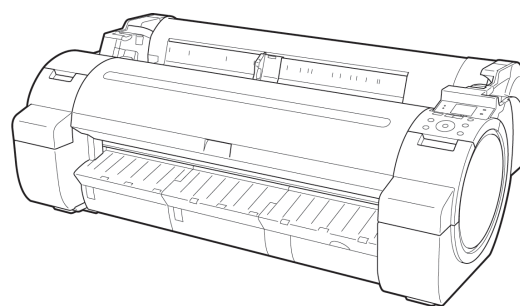

## Operations and Display Screen

Control Panel .....	649
Control Panel Display .....	651
How to View Instructions With Navigate .....	655
Checking Instructions During Printer Operations .....	656

## Control Panel

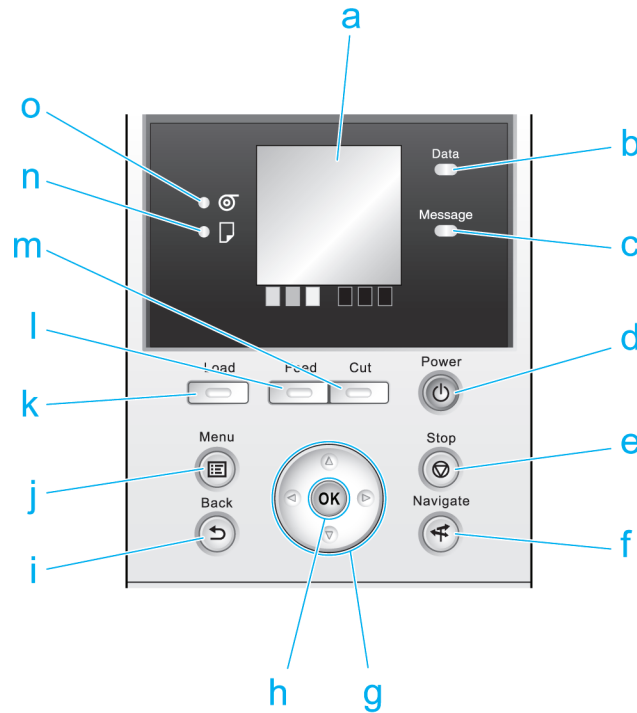

### a. Display Screen

Shows printer menus, as well as the printer status and messages.

### b. Data Lamp (green)

- **Flashing**

During printing, the Data lamp flashes when the printer is receiving or processing print jobs. Otherwise, this lamp flashes when the print job is paused or the printer is updating the firmware.

- **Off**

There are no active print jobs when the Data lamp is off.

### c. Message Lamp (orange)

- **On**

A warning message is displayed.

- **Flashing**

An error message is displayed.

- **Off**

The printer is off or is operating normally.

**d. Power button (green)**

Turns the printer on and off. (See "Turning the Printer On and Off.") →P.3

The **Power** button is lit when the printer is on or in Sleep mode.

**e. Stop button**

Cancels print jobs in progress and ends the ink drying period.

**f. Navigate button**

Enables you to check instructions for loading and removing paper or replacing ink tanks or printheads, as well as other operations. (See "How to View Instructions With Navigate.") →P.655

**g. Arrow buttons**

## • ◀ button

Press this button on the **Tab Selection screen** to move to another tab.

In menu items requiring numerical input, press this button to move to another digit.

## • ▲ button

Press this button when viewing menus to display the next menu item or setting value.

## • ▶ button

Press this button on the **Tab Selection screen** to move to another tab.

In menu items requiring numerical input, press this button to move to another digit.

## • ▼ button

Press this button when viewing menus to display the next menu item or setting value.

**h. OK button**

Press this button on the **Tab Selection screen** to display the menu of the tab shown.

Pressing this button in menu items of each tab for which  is displayed at left will move to the lower level of the menu item, enabling you to execute menu commands or set menu values.

Also press this button if the Display Screen indicates to press the **OK** button.

**i. Back button**

Displays the screen before the current screen.

**j. Menu button**

Displays the **Tab Selection screen**. (See "Menu Settings.") →P.673

**k. Load button**

Press this button when loading or replacing paper.

(See "Loading Rolls in the Printer.") →P.579

(See "Loading Sheets in the Printer.") →P.602

**l. Feed button**

Pressing this button when rolls are loaded enables you to reposition the paper. (See "Feeding Roll Paper Manually.")

→P.590

**m. Cut button**

Pressing this button when rolls are loaded cuts the paper, if you have specified **Automatic** or **Eject** in **Cutting Mode** in the Control Panel menu. (See "Specifying the Cutting Method for Rolls.") →P.594

**n. Cut Sheet lamp (green)**

Lit when sheets are selected as the paper source.

**o. Roll Media lamp (green)**

Lit when rolls are selected as the paper source.



**Note**

- To recover from Sleep mode, any button can be pressed except the **Power** button.



## Control Panel Display

After the printer starts up, the **Tab Selection screen** is displayed.

Each of the four tabs presents status, menus, and error information related to the particular tab.

### Types of tabs

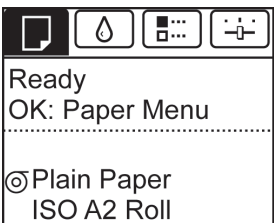
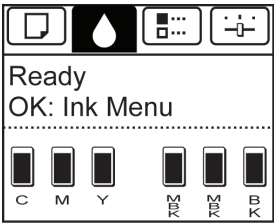
The **Tab Selection screen** presents four tabs. Each tab is represented by an icon in the top row. Press the ◀ or ▶ button to access other tabs.

<p>Paper tab</p> 	<p>A tab indicating status and showing menus related to paper. Pressing the <b>OK</b> button when this tab is highlighted will display the <b>Paper Menu</b>.</p> <ul style="list-style-type: none"> <li>• <b>Top line displayed</b> The paper icon is highlighted.</li> <li>• <b>Middle line displayed</b> Indicates the printer status and shows menu names.</li> <li>• <b>Bottom line displayed</b> The first and second lines display the paper type and size.</li> </ul>
<p>Ink tab</p> 	<p>A tab indicating status and showing menus related to ink. Pressing the <b>OK</b> button when this tab is highlighted will display the <b>Ink Menu</b>.</p> <ul style="list-style-type: none"> <li>• <b>Top line displayed</b> The ink icon is highlighted.</li> <li>• <b>Middle line displayed</b> Indicates the printer status and shows menu names.</li> <li>• <b>Bottom line displayed</b> Here, the remaining ink level is indicated. (See "Checking Ink Tank Levels.") →P.736</li> </ul>
<p>Job tab</p> 	<p>A tab indicating status and showing menus related to print jobs. Pressing the <b>OK</b> button when this tab is highlighted will display the <b>Job Menu</b> menu.</p> <ul style="list-style-type: none"> <li>• <b>Top line displayed</b> The job icon is highlighted.</li> <li>• <b>Middle line displayed</b> Indicates the printer status and shows menu names.</li> </ul>

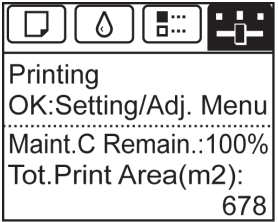
<p>Settings/Adj. tab</p> 	<p>A tab indicating status and showing menus related to settings and adjustment. Pressing the <b>OK</b> button when this tab is highlighted will display the <b>Set./Adj. Menu</b>.</p> <ul style="list-style-type: none"> <li>• <b>Top line displayed</b> The settings/adjustment icon is highlighted.</li> <li>• <b>Middle line displayed</b> Indicates the printer status and shows menu names.</li> <li>• <b>Bottom line displayed</b> The remaining Maintenance Cartridge capacity is shown on the first line and <b>Tot.Print Area</b> on the second. The display unit for <b>Tot.Print Area</b> can be specified in the <b>Length Unit</b> menu. (See "Menu Settings.") <b>→P.673</b></li> </ul>
------------------------------------------------------------------------------------------------------------	---------------------------------------------------------------------------------------------------------------------------------------------------------------------------------------------------------------------------------------------------------------------------------------------------------------------------------------------------------------------------------------------------------------------------------------------------------------------------------------------------------------------------------------------------------------------------------------------------------------------------------------------------------------------------------------------------------------------

## Printer status and modes

Printer status is classified according to the following five modes.

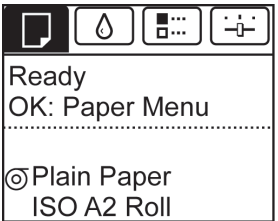
<p><b>Standby</b></p> 	<p>The printer is ready to receive jobs sent from the computer. Jobs sent from the computer are printed immediately.</p>
---------------------------------------------------------------------------------------------------------	--------------------------------------------------------------------------------------------------------------------------

<p><b>Printing Paused</b></p> 	<p>Printing is paused on the printer. Any jobs sent from the computer are held without being printed.</p>
-------------------------------------------------------------------------------------------------------------------	-----------------------------------------------------------------------------------------------------------

<p><b>Printing</b></p> 	<p>Printing is in progress on the printer. Jobs sent from the computer are printed after the current job. The time left until printing is finished is indicated in the upper-right corner of the screen. (Values exceeding 10 hours are not shown.)</p>
------------------------------------------------------------------------------------------------------------	---------------------------------------------------------------------------------------------------------------------------------------------------------------------------------------------------------------------------------------------------------

8

652

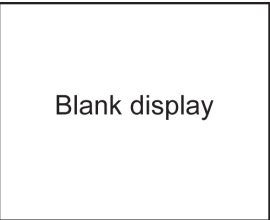
<p><b>Sleep</b></p> 	<p>The printer is in power-saving mode. The printer automatically enters Sleep mode to conserve power when idle for a specific period (by default, five minutes), that is, if no print jobs are received or buttons are pressed while all covers are closed.</p> <p>You can specify the period before the printer enters <b>Sleep</b> mode in the <b>Sleep Timer</b> menu. (See "Menu Settings.") →P.673</p> <p>After entering <b>Sleep</b> mode from <b>Standby</b> mode, the printer automatically recovers if print jobs are received, and the jobs are printed.</p>
-------------------------------------------------------------------------------------------------------	-------------------------------------------------------------------------------------------------------------------------------------------------------------------------------------------------------------------------------------------------------------------------------------------------------------------------------------------------------------------------------------------------------------------------------------------------------------------------------------------------------------------------------------------------------------------------

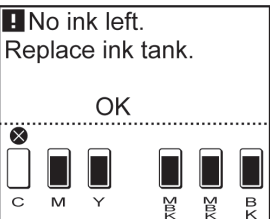
<p><b>Error</b></p> 	<p>The printer requires your attention. Any jobs sent from the computer cannot be processed. The tab related to the error is displayed.</p> <p>For information about the display in the case of multiple errors, see "Error message mode transition." →P.655</p>
-------------------------------------------------------------------------------------------------------	------------------------------------------------------------------------------------------------------------------------------------------------------------------------------------------------------------------------------------------------------------------

## Mode transition

- Mode display

The printer mode is indicated as follows.

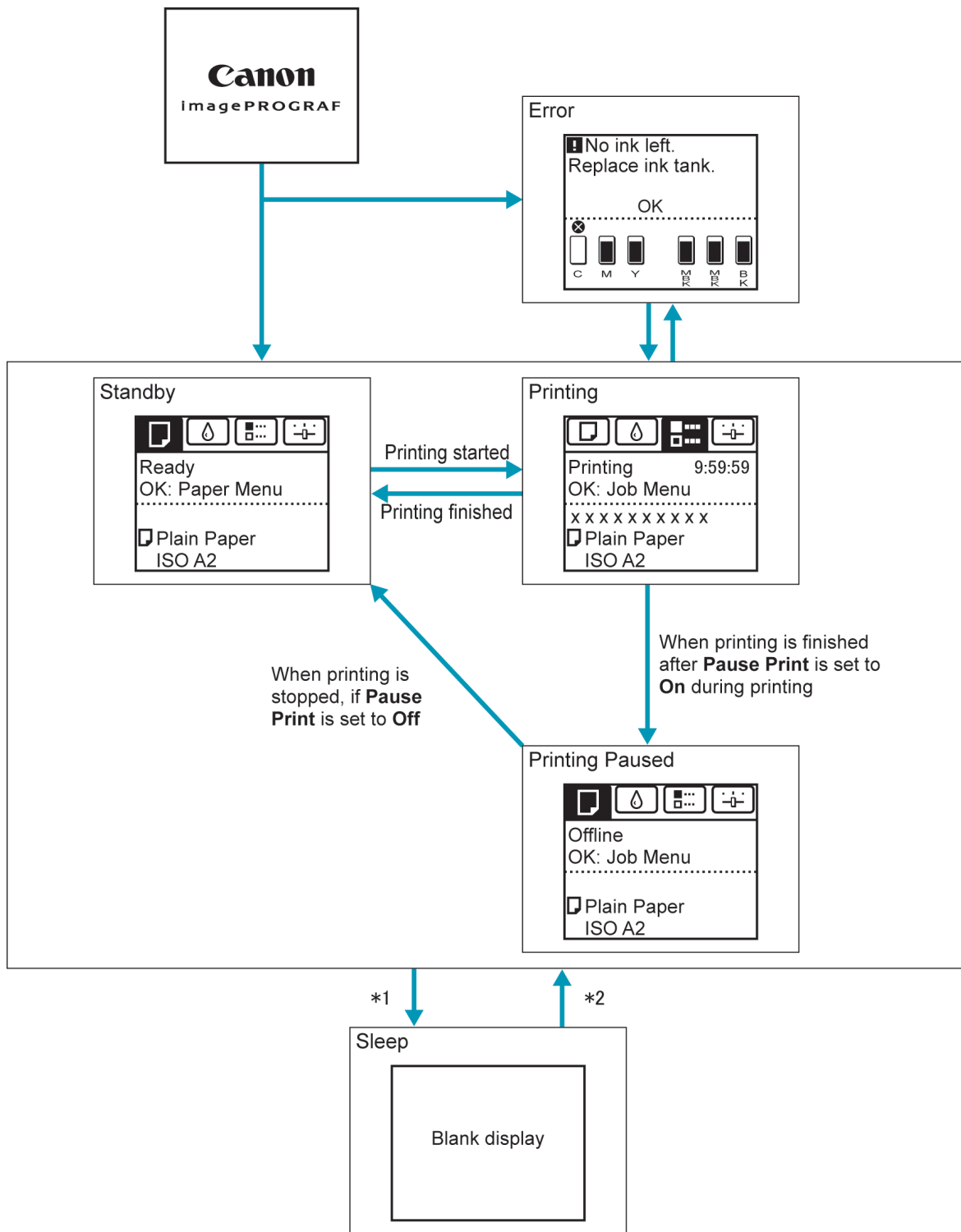

- \*1: The printer automatically enters **Sleep** mode when idle for a specific period (by default, five minutes), that is, if no print jobs are received or buttons are pressed while all covers are closed. However, it does not enter **Sleep** mode while error messages are displayed.
- \*2: In **Sleep** mode, any button can be pressed except the **Power** button to recover from **Sleep** mode. **Sleep** mode is also terminated if a print job is received or a command is issued from RemoteUI.

- Error display

Mode transition during error display is as follows.

If multiple errors occur, tabs related to errors other than the error currently shown flash. Press the ◀ or ▶ button to access other tabs and check those errors. If multiple errors occur that are related to the Job tab and Settings/Adj. tab, each error message is displayed for 4 seconds on each tab before another message is shown.

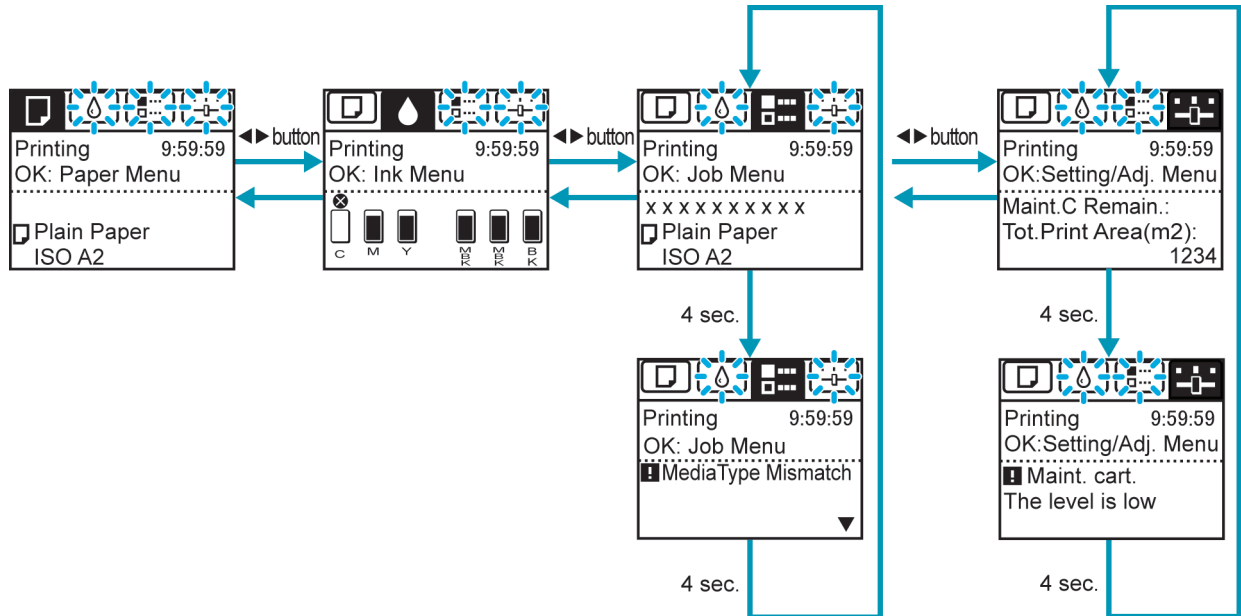

## How to View Instructions With Navigate

You can refer to instructions for loading paper, replacing ink tanks, and performing other operations on the printer control panel.

1. Press the **Navigate** button.
2. Press ▲ or ▼ to select the desired navigation menu.
3. Press ▲ or ▼ to select **View Op. Guide**, and then press the **OK** button. Instructions are now displayed.

Example: Loading sheets

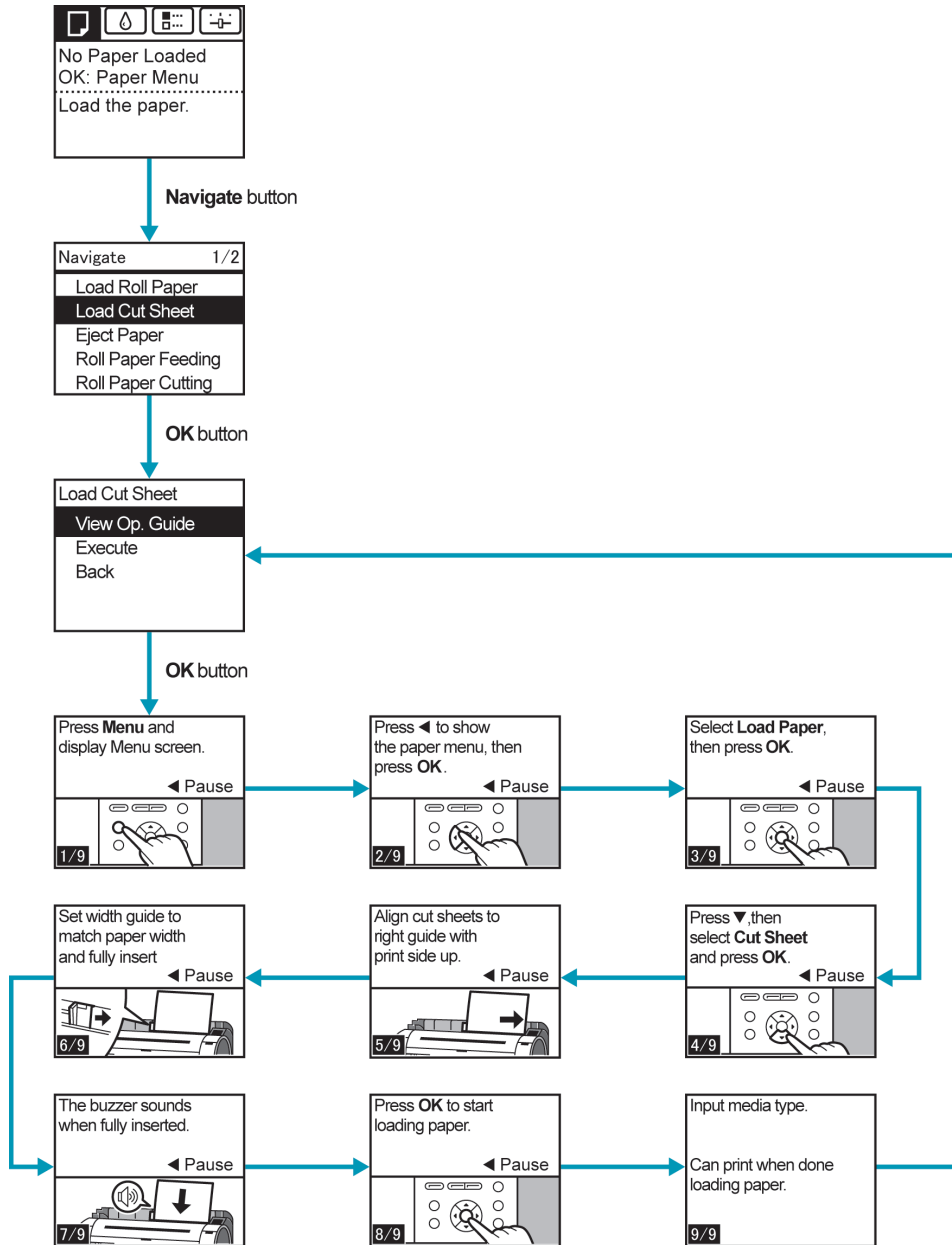

## Checking Instructions During Printer Operations

You can refer to instructions on the printer control panel when loading paper, replacing ink tanks, or performing other operations.

### How to view instructions

Once you complete an action described in the instructions, the printer detects the action and switches to the next instruction screen.

In the case of actions the printer cannot detect, instruction screens are switched every four seconds, and the sequence of operations is shown repeatedly.

When all actions in the sequence are finished, the instruction screen for the next step is displayed.

Example: Ink tank replacement

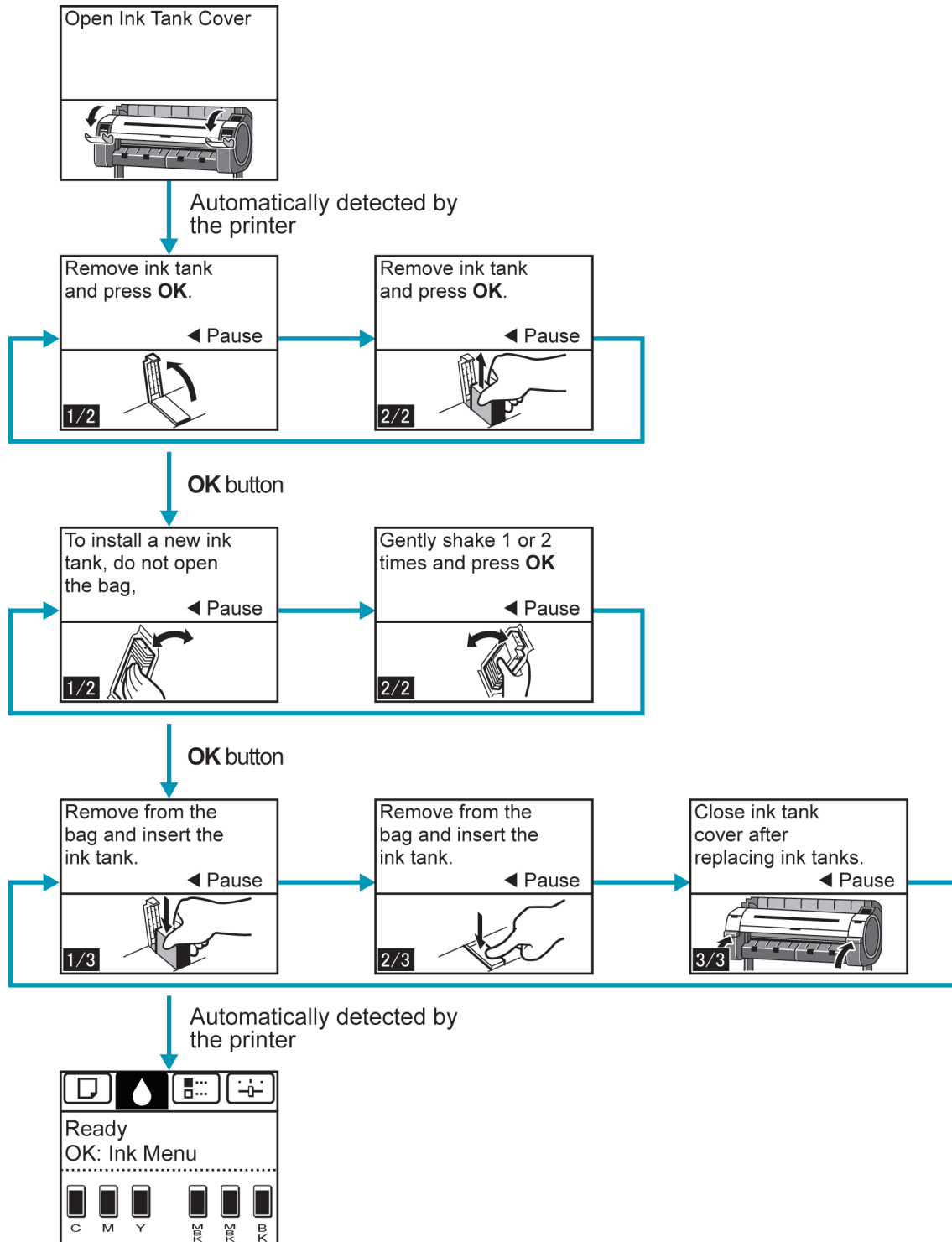



Note

- During a continuous display of instructions, you can press the ◀ button to pause the instructions on the current screen.  
Press the ◀ or ▶ button to display the previous or next screens. If you do not press the ◀ or ▶ button within 30 seconds, continuous display is resumed.  
Press the **OK** button to display the instruction screen for the next step.



## Printer Menu

Printer Menu Operations .....	659
Menu Operations .....	660
Menu Structure .....	663
Menu Settings .....	673
Menu Settings (During Printing) .....	684
Status Print .....	686
Printing Interface Setting Reports .....	688

## Printer Menu Operations

The printer menu is classified into menu items available when no print job is in progress and menu items only available during printing.

- Menu operations when no print job is in progress →P.659
- Menu operations during printing →P.659

### Menu operations when no print job is in progress

To view available menus organized on tabs, select a tab on the **Tab Selection screen** and press the **OK** button.



#### Note

- If the **Tab Selection screen** is not displayed, pressing **OK** will not display menus. Menus can be selected after you resolve the problem.

The following operations are available from the menu.

- **Paper Menu**  
Paper menu settings
- **Ink Menu**  
Ink menu operations
- **Job Menu**  
Menu operations to manage print jobs
- **Set./Adj. Menu**  
Menu operations for printer adjustment and maintenance  
Settings related to HP-GL2 jobs

For a description of specific menu items available, see "Menu Settings." →P.673

For instructions on selecting menu items, see "Menu Operations." →P.660



#### Note

- By default, menu settings apply to all print jobs. However, for settings that are also available in the printer driver, the values specified in the printer driver take priority.

### Menu operations during printing

To display menus during printing, select a tab on the **Tab Selection screen** on the Control Panel, and then press the **OK** button. Other menus are available after printing is finished.



Note

- If the **Tab Selection screen** is not displayed, pressing **OK** will not display menus. Menus can be selected after you resolve the problem.

The following operations are available from the menu during printing.

- **Ink Menu**  
Ink menu operations
- **Job Menu**  
Menu operations to manage print jobs
- **Set./Adj. Menu**  
Fine-tuning paper feeding  
Display of printer-related information

For a description of specific menu items available during printing, see "Menu Settings (During Printing)." →P.684  
 For instructions on selecting menu items during printing, see "Menu Operations." →P.660

## Menu Operations

To view available menus organized on tabs, select a tab on the **Tab Selection screen** and press the **OK** button. For details, see "Menu Settings." →P.673

- Menus (when the Ink tab is selected and the **OK** button is pressed)

Ink Menu
Rep. Ink Tank
Head Cleaning A



Note

- If the **Tab Selection screen** is not displayed, pressing **OK** will not display menus. Menus can be selected after you resolve the problem.

Simply press buttons on the Control Panel to access menus on various tabs from the **Tab Selection screen** and set or execute **Menu** items.

The following section describes menu operations and how they are presented in this **User Manual**.

- Accessing menus →P.660
- Specifying menu items →P.662
- Specifying numerical values →P.662
- Executing menu commands →P.663

## Accessing menus

Printer menus are grouped by function.

Menus are displayed with the upper line selected. You can use the buttons on the Control Panel to access each menu.

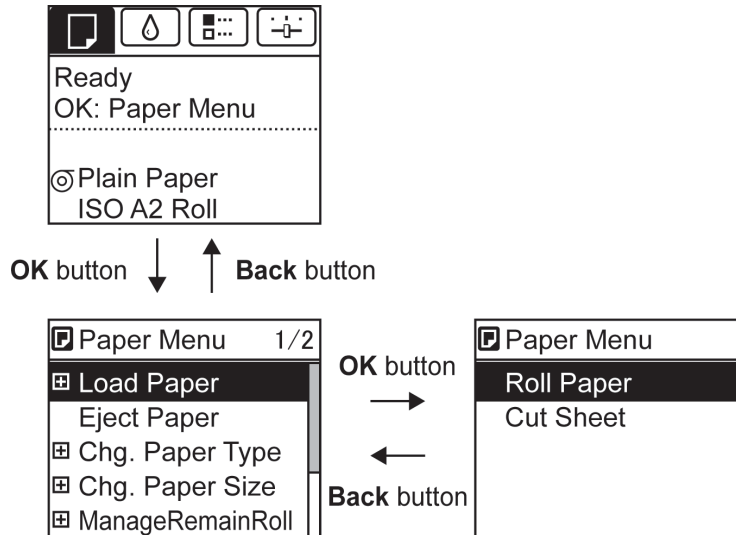

- Press **Back** to access a higher menu in the menu list, and press **OK** to access a lower one. If not all menu items are displayed, hold down ▲ or ▼ to scroll through higher and lower menu items. Items you select are highlighted.

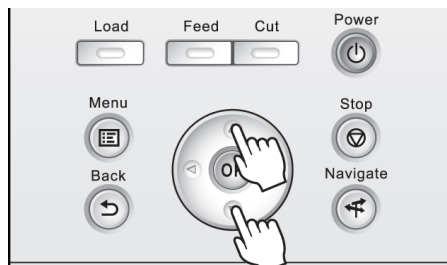

The scroll bar at right indicates the current position in the overall menu.

- Lower menus are available if + is displayed at right next to the second and subsequent rows. To access the lower menus, select the menu and press the **OK** button.

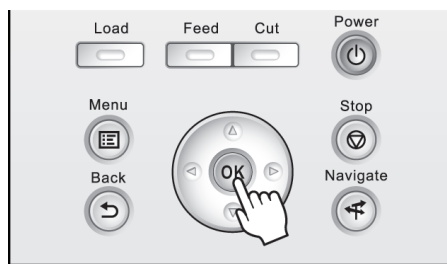

## Specifying menu items

Menu items can be set as follows.

1. Press ▲ or ▼ to select the desired setting, and then press the **OK** button.

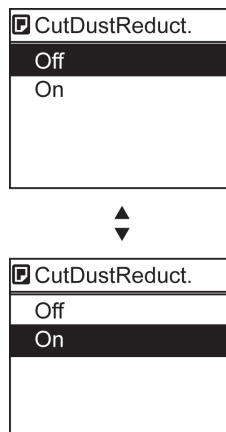

After two seconds, the display reverts to the upper level menu.



### Note

- If a confirmation message is displayed regarding the setting you entered, press the **OK** button. The setting is applied, and the printer is now in **Standby**.

## 8

## Specifying numerical values

Follow these steps to enter numbers. In this example, network settings items are entered.

1. Press the ◀ or ▶ button to move to the next field for input.

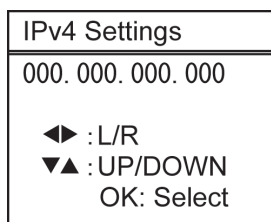

2. Press the ▲ or ▼ button to enter the value.



### Note

- Hold down ▲ or ▼ to increase or decrease the value continuously.

3. Repeat steps 1 and 2 to complete the settings, and then press the **OK** button.



### Note

- If a confirmation message is displayed regarding the setting you entered, press the **OK** button. The setting is applied, and the printer is now in **Standby**.

## Executing menu commands

Menu commands can be executed as follows.

1. Press ▲ or ▼ to select the action to execute, and then press the **OK** button.  
The menu command is now executed.

## Menu Structure

The menu structure is organized by tabs, as follows. Values at right indicated by an asterisk are the defaults.

- Paper Menu →P.663
- Ink Menu →P.665
- Job Menu →P.665
- Set./Adj. Menu →P.666

For instructions on menu operations, see "Menu Operations." →P.660

For details on menu items, see "Menu Settings." →P.673

## Paper Menu

First Level	Second Level	Third Level	Fourth Level	Fifth Level
<b>Load Paper</b>	<b>Roll Paper</b>			
	<b>Cut Sheet</b>			
<b>Eject Paper</b>				
<b>Chg. Paper Type</b> (*1 →P.665 )	<b>Roll Paper</b>	(The paper type is displayed here.) (*1 →P.665 )		
	<b>Cut Sheet</b>	(The paper type is displayed here.) (*1 →P.665 )		
<b>Chg. Paper Size</b>	<b>Sheet Size</b>	(The size of paper is displayed here.) (*2 →P.665 )		
		<b>CustomPaperSize</b>	(Set the length and width)	
	<b>Roll Length</b> (*3 →P.665 )	(Set the length)		
	<b>Roll Width</b> (*4 →P.665 )	(Set the width)		
<b>ManageRemainRoll</b>	<b>Off *</b>			
	<b>On</b>			
<b>Paper Details</b>  (The paper type is displayed here.) (*1 →P.665 )	<b>Head Height</b>	<b>Automatic *</b>		
		<b>Highest</b>		
		<b>High</b>		
		<b>Standard</b>		
		<b>Low</b>		
		<b>Lowest</b>		
	<b>Skew Check Lv.</b>	<b>Super Low</b>		
		<b>High Accuracy</b>		
		<b>Standard *</b>		
		<b>Loose</b>		

First Level	Second Level	Third Level	Fourth Level	Fifth Level	
<b>Paper Details</b>	(The paper type is displayed here.) (*1 →P.665 )	<b>Skew Check Lv.</b>	<b>Off</b>		
		<b>Cutting Mode</b> (*6 →P.665 )	<b>Automatic</b>		
			<b>Eject</b>		
			<b>Manual</b>		
		<b>Cut Speed</b>	<b>Fast</b>		
			<b>Standard</b>		
			<b>Slow</b>		
		<b>Trim Edge First</b>	<b>Automatic</b>		
			<b>Off</b>		
			<b>On</b>		
		<b>CutDustReduct.</b>	<b>Off</b>		
			<b>On</b>		
		<b>VacuumStrngth</b>	<b>Automatic *</b>		
			<b>Strongest</b>		
			<b>Strong</b>		
			<b>Standard</b>		
			<b>Weak</b>		
			<b>Weakest</b>		
		<b>Scan Wait Time</b>	<b>Dry time</b>	<b>Off *</b>	
				<b>1 sec.</b>	
				<b>3 sec.</b>	
				<b>5 sec.</b>	
				<b>7 sec.</b>	
				<b>9 sec.</b>	
			<b>Area</b> (*5 →P.665 )	<b>Entire area *</b>	
				<b>Leading edge</b>	
		<b>Roll DryingTime</b>	<b>Off</b>		
			<b>30 sec.</b>		
			<b>1 min.</b>		
			<b>3 min.</b>		
			<b>5 min.</b>		
<b>10 min.</b>					
<b>30 min.</b>					
<b>60 min.</b>					
<b>NearEnd RollMrgn</b>	<b>3mm</b>				
	<b>20mm</b>				
<b>NearEnd Sht Mrgn</b>	<b>3mm</b>				
	<b>20mm</b>				

First Level	Second Level	Third Level	Fourth Level	Fifth Level
<b>Paper Details</b>	(The paper type is displayed here.) (*1 →P.665 )	<b>Bordless Margin</b>	<b>Automatic</b>	
			<b>Fixed</b>	
		<b>Width Detection</b>	<b>Off</b>	
			<b>On *</b>	
		<b>Return Defaults</b>		
<b>Paper Details</b>				
<b>Keep Paper Type</b>	<b>Off *</b>			
	<b>On</b>			

- \*1: For information on the types of paper the printer supports, refer to the Paper Reference Guide. (See Paper Reference Guide.) Types of paper in the printer driver and related software (as well as on the Control Panel) are updated when you install the printer driver from the User Software CD-ROM or if you update paper information with the Media Configuration Tool. (See "Updating paper information.") →P.573
- \*2: For information on the sizes of paper the printer supports, see "Paper Sizes." →P.569
- \*3: Available only if **ManageRemainRoll** is **On**.
- \*4: Available only if **Width Detection** is **Off**.
- \*5: **Leading edge** is not available as a setting option in the **Paper Detailed Settings** dialog box of the printer driver.
- \*6: see "Specifying the Cutting Method for Rolls." →P.594

## Ink Menu

First Level
<b>Rep. Ink Tank</b>
<b>Head Cleaning A</b>

## Job Menu

First Level	Second Level	Third Level	Fourth Level	Fifth Level	
<b>Job Log</b>	(Choose from information about the latest three print jobs.)	<b>Document Name</b>			
		<b>User Name</b>			
		<b>Page Count</b>			
		<b>Job Status</b>	<b>OK</b>		
			<b>CANCELED</b>		
		<b>Print Start Time</b>	yyyy/mm/dd hh:mm:ss		
		<b>Print End Time</b>	yyyy/mm/dd hh:mm:ss		
		<b>Print Time</b>	xxxsec.		
		<b>Print Size</b>	xxxxxxxxsq.mm		
		<b>Media Type</b>			
		<b>Interface</b>	<b>USB</b>		
			<b>Network</b>		
		<b>Ink Consumed</b>	(The ink color is displayed here.)	<b>xxx.xxx ml</b>	

First Level	Second Level	Third Level	Fourth Level	Fifth Level
<b>Print Job Log</b>				
<b>Pause Print</b>	<b>Off *</b>			
	<b>On</b>			

## Set./Adj. Menu

First Level	Second Level	Third Level	Fourth Level	Fifth Level	Sixth Level	Seventh Level	Eighth Level
<b>Test Print</b>	<b>Nozzle Check</b>						
	<b>Status Print</b>						
	<b>Interface Print</b>						
	<b>GL2 Set Print</b>						
	<b>Paper Details</b>						
	<b>Print Job Log</b>						
	<b>Menu Map</b>						
	<b>Color Palette</b>						
<b>Adjust Printer</b>	<b>Head Posi. Adj.</b>	<b>Auto(Standard)</b>					
		<b>Auto(Advanced)</b>					
		<b>Manual (*1 →P.673 )</b>					
	<b>Head Inc. Adj.</b>						
	<b>Feed Priority</b>	<b>Adj. Priority</b>	<b>Automatic *</b>				
			<b>Print Quality</b>				
			<b>Print Length</b>				
		<b>Adj. Quality (*2 →P.673 )</b>	<b>Auto(GenuinePpr)</b>				
			<b>Auto(OtherPaper)</b>				
			<b>Manual</b>				
	<b>Adjust Length (*3 →P.673 )</b>	<b>AdjustmentPrint</b>	<b>A:High</b>				
			<b>B:Standard/Draft</b>				
		<b>Change Settings</b>	<b>A:High</b>				
			<b>B:Standard/Draft</b>				
<b>Maintenance</b>	<b>Head Cleaning</b>	<b>Head Cleaning A</b>					
		<b>Head Cleaning B</b>					
	<b>Nozzle Check</b>						
	<b>Replace P.head</b>						
	<b>Repl. maint cart</b>						
	<b>Head Info</b>	<b>ProductName:</b>					
		<b>s/n:</b>					
<b>Days elapsed:</b>							



First Level	Second Level	Third Level	Fourth Level	Fifth Level	Sixth Level	Seventh Level	Eighth Level
Maintenance	Head Info	Count [Mdot]:					
GL2 Replot							
GL2 BufferClear							
GL2 Settings	Quality Manager	Color Mode	Monochrome				
			Color (CAD) 1 *				
			Color (CAD) 2				
			Color (CAD) 3				
			Color (CAD) 4				
			Color (CAD) 5				
		Print Quality	Fast				
			Standard *				
			High				
		Input Resolution	600dpi *				
			300dpi				
		Print (Economy)	Off *				
	On						
	Paper Manager	Paper Source	Automatic *				
			Roll Paper				
			Cut Sheet				
		Margin	3mm(Standard) *				
			5mm				
		Conserve Paper	Off *				
			On				
		Auto Rotate	Off *				
			On				
		Line & Pen Manager	Enable merge	Off *			
On							
Pen Setup	Select Palette		Software *				
			Palette A				
			Palette B				
	Factory						
Define Palette	Palette A		(Select the pen number)	Width	(Indicates the value of Width)		
				Color	0-255		
		Line Attributes		No Setting			

First Level	Second Level	Third Level	Fourth Level	Fifth Level	Sixth Level	Seventh Level	Eighth Level		
<b>GL2 Settings</b>	<b>Line &amp; Pen Manager</b>	<b>Pen Setup</b>	<b>Define Palette</b>	<b>Palette A</b>	(Select the pen number)	<b>Line Attributes</b>	<b>Circle Setting</b>		
				<b>Palette B</b>	(Select the pen number)		(Indicates <b>Width, Color, and Line Attributes</b> )	(Specify the values of <b>Width, Color, and Line Attributes</b> )	
				<b>Factory</b>	(Select the pen number)	(Indicates <b>Width, Color, and Line Attributes</b> )			
			<b>Reset Palette</b>	<b>All Palette</b>					
				<b>Palette A</b>					
				<b>Palette B</b>					
			<b>Smoothing</b>	<b>Software *</b>					
				<b>Smooth</b>					
			<b>Thicken-FineLines</b>	<b>Off *</b>					
		<b>On</b>							
		<b>Adjust-FaintLines</b>	<b>Off</b>						
			<b>On *</b>						
		<b>ProcessingOption</b>	<b>Warning</b>	<b>Off *</b>					
	<b>On</b>								
	<b>PageSize-Process1</b>		<b>Off *</b>						
			<b>On</b>						
	<b>PageSize-Process2</b>		<b>Off *</b>						
			<b>On</b>						
	<b>GL2 Set Print</b>								
	<b>Interface Setup</b>	<b>EOP Timer (*8 →P.673)</b>	<b>10 sec.</b>						
<b>30 sec.</b>									
<b>1 min.</b>									
<b>2 min.</b>									
<b>5 min.</b>									
<b>10 min. *</b>									
<b>30 min.</b>									
<b>60 min.</b>									
<b>TCP/IP (*8 →P.673)</b>		<b>IPv4</b>	<b>IPv4 Mode</b>	<b>Automatic</b>					
				<b>Manual *</b>					
		<b>Protocol (*4 →P.673)</b>	<b>DHCP</b>	<b>On</b>					
				<b>Off *</b>					
			<b>BOOTP</b>	<b>On</b>					
<b>Off *</b>									

First Level	Second Level	Third Level	Fourth Level	Fifth Level	Sixth Level	Seventh Level	Eighth Level		
<b>Interface Setup</b>	<b>TCP/IP</b> (*8 →P.673 )	<b>IPv4</b>	<b>Protocol</b> (*4 →P.673 )	<b>RARP</b>				<b>On</b>	
								<b>Off *</b>	
			<b>IPv4 Settings</b> (*9 →P.673 )	<b>IP Address</b>		xxx.xxx.xxx.xxx			
				<b>Subnet Mask</b>		xxx.xxx.xxx.xxx			
				<b>Default G/W</b>		xxx.xxx.xxx.xxx			
			<b>DNS Settings</b> (*9 →P.673 )	<b>DNS Dync update</b>		<b>On</b>			
						<b>Off *</b>			
				<b>Pri. DNS SrvAddr</b>					
				<b>Sec. DNS SrvAddr</b>					
			<b>DNS Host Name</b>						
		<b>DNS Domain Name</b>							
		<b>IPv6</b>	<b>IPv6 Support</b>	<b>On</b>					
				<b>Off *</b>					
	<b>IPv6 Stles-sAddr</b> (*10 →P.673 )		<b>On *</b>						
			<b>Off</b>						
	<b>DHCPv6</b> (*10 →P.673 )		<b>On</b>						
			<b>Off *</b>						
	<b>DNS Settings</b> (*9 →P.673 ) (*10 →P.673 )		<b>DNS Dync update</b>	<b>Statefull Addr</b>	<b>On</b>				
					<b>Off *</b>				
				<b>Stateless Addr</b>	<b>On</b>				
					<b>Off *</b>				
			<b>Pri. DNS SrvAddr</b>						
			<b>Sec. DNS SrvAddr</b>						
<b>DNS Host Name</b>									
<b>DNS Domain Name</b>									
<b>NetWare</b> (*8 →P.673 )	<b>NetWare</b>	<b>On</b>							
		<b>Off *</b>							
	<b>Frame Type</b> (*5 →P.673 )	<b>Auto Detect</b>							
		<b>Ethernet 2</b>							
		<b>Ethernet 802.2 *</b>							
		<b>Ethernet 802.3</b>							
		<b>Ethernet SNAP</b>							

First Level	Second Level	Third Level	Fourth Level	Fifth Level	Sixth Level	Seventh Level	Eighth Level
<b>Interface Setup</b>	<b>NetWare</b> (*8 →P.673 )	<b>Print Service</b> (*5 →P.673 )	<b>BinderyPServer</b>				
			<b>RPrinter</b>				
			<b>NDSPServer *</b>				
			<b>NPrinter</b>				
	<b>AppleTalk</b> (*8 →P.673 )	<b>On</b>					
		<b>Off *</b>					
	<b>Ethernet Driver</b> (*8 →P.673 )	<b>Auto Detect</b>	<b>On *</b>				
			<b>Off</b>				
		<b>Comm.Mo de</b> (*6 →P.673 )	<b>Half Duplex *</b>				
			<b>Full Duplex</b>				
		<b>Ethernet Type</b> (*6 →P.673 )	<b>10 Base-T *</b>				
			<b>100 Base-TX</b>				
			<b>1000 Base-T</b>				
		<b>Spanning Tree</b>	<b>Not Use *</b>				
	<b>Use</b>						
	<b>MAC Ad- dress</b>		xxxxxxxxxxxx				
	<b>Interface Print</b> (*8 →P.673 )						
<b>Return Defaults</b> (*8 →P.673 )							
<b>System Setup</b>	<b>Sleep Tim- er</b> (*11 →P.673 )	<b>5 min. *</b>					
		<b>10 min.</b>					
		<b>15 min.</b>					
		<b>20 min.</b>					
		<b>30 min.</b>					
		<b>40 min.</b>					
		<b>50 min.</b>					
		<b>60 min.</b>					
		<b>240 min.</b>					
	<b>Buzzer</b>	<b>Off</b>					
		<b>On *</b>					
<b>Contrast Adj.</b>	-4,-3,-2,-1,0*,+1,+2,+3,+4						

First Level	Second Level	Third Level	Fourth Level	Fifth Level	Sixth Level	Seventh Level	Eighth Level
System Setup	Date & Time (*8 →P.673 )	Date yyyy/mm/dd (*7 →P.673 )					
			Time hh:mm				
	Date Format (*8 →P.673 )	yyyy/mm/dd *					
		dd/mm/yyyy					
		mm/dd/yyyy					
	Language	English					
		日本語					
		Français					
		Italiano					
		Deutsch					
		Español					
		Русский					
		中文(簡体字)					
	Time Zone (*8 →P.673 )	한국어					
		0:London (GMT)					
		+1:Paris,Rome					
		+2:Athens,Cairo					
		+3:Moscow					
		+4:Eerevan,Baku					
		+5:Islamabad					
		+6:Dacca					
		+7:Bangkok					
		+8:Hong Kong					
		+9:Tokyo,Seoul					
		+10:Canberra					
		+11NewCaledonia					
		+12:Wellington					
-12:Eniwetok							
-11:Midway is.							
-10Hawaii(AHST)							
-9:Alaska(AKST)							
-8:Oregon (PST)							

First Level	Second Level	Third Level	Fourth Level	Fifth Level	Sixth Level	Seventh Level	Eighth Level
<b>System Setup</b>	<b>Time Zone</b> (*8 →P.673 )	<b>-7:Arizona(MST)</b>					
		<b>-6:Texas (CST)</b>					
		<b>-5:NewYork(EST)</b>					
		<b>-4:Santiago</b>					
		<b>-3:Buenos Aires</b>					
		<b>-2:</b>					
		<b>-1:Cape Verde</b>					
	<b>Length Unit</b>	<b>meter *</b>					
		<b>feet/inch</b>					
	<b>Detect Mismatch</b>	<b>Pause</b>					
		<b>Warning</b>					
		<b>None *</b>					
	<b>Paper Size Basis</b>	<b>Roll Selection 1</b>	<b>ISO A3 (297mm) *</b>				
			<b>300mm Roll</b>				
		<b>Roll Selection 2</b>	<b>10in. (254mm) *</b>				
			<b>JIS B4 (257mm)</b>				
	<b>Keep Paper Size</b>	<b>Off *</b>					
		<b>On</b>					
	<b>TrimEdge Reload</b>	<b>Automatic</b>					
		<b>Off *</b>					
		<b>On</b>					
	<b>Rep.P.head Print</b>	<b>Off</b>					
		<b>On *</b>					
<b>Nozzle Check</b>	<b>Frequency</b>	<b>Standard *</b>					
		<b>1 page</b>					
	<b>Warning</b>	<b>Off *</b>					
		<b>On</b>					
<b>Use RemoteUI</b> (*8 →P.673 )	<b>On *</b>						
	<b>Off</b>						
<b>Reset PaprSetngs (*8 →P.673 )</b>							
<b>Show Job Log</b> (*8 →P.673 )	<b>Off</b>						
	<b>On *</b>						
<b>Prep.MovePrinter</b>							

First Level	Second Level	Third Level	Fourth Level	Fifth Level	Sixth Level	Seventh Level	Eighth Level
<b>Admin. Menu</b> (*8 →P.673 )	<b>Change Password</b> (*9 →P.673 )	(The screen for setting the password is displayed)					
		<b>Init.Admin.Pswd</b> (*9 →P.673 )					
<b>Printer Info</b>	<b>Paper Info</b>						
	<b>Ink Info</b>						
	<b>Head Info</b>	<b>ProductName:</b>					
		s/n:					
		<b>Days elapsed:</b>					
		<b>Count [Mdot]:</b>					
	<b>Printhead L</b>	<b>ProductName:</b>					
		s/n:					
		<b>Days elapsed:</b>					
		<b>Count [Mdot]:</b>					
	<b>Printhead R</b>	<b>ProductName:</b>					
		s/n:					
		<b>Days elapsed:</b>					
<b>Count [Mdot]:</b>							
<b>System Info</b>							
<b>Error Log</b>							
<b>Other Counter</b>							

- \*1: Available after you have used **Auto(Advanced)** in **Head Posi. Adj.** once.
- \*2: Available if **Adj. Priority** is **Automatic** or **Print Quality**.
- \*3: Available if **Adj. Priority** is **Automatic** or **Print Length**.
- \*4: Not displayed if **IPv4 Mode** is **Manual**.
- \*5: Not displayed if **NetWare** is **Off**.
- \*6: Not displayed if **Auto Detect** is **On**.
- \*7: Follows the setting in **Date Format**.
- \*8: Viewing and configuration is possible for administrators, and only viewing for other users.
- \*9: Viewing and configuration is possible for administrators only.
- \*10: Not displayed if **IPv6 Support** is **Off**.
- \*11: Default setting for the time to enter the power save mode/Sleep mode is recommended.

## Menu Settings

Menu items are as follows.

For instructions on selecting menu items, see "Menu Operations." →P.660

For details on menu levels and values, see "Menu Structure." →P.663

## Paper Menu

Setting Item		Description, Instructions
<b>Load Paper</b>		Select sheets or rolls and load the paper.
<b>Eject Paper</b>		Choose this item before removing loaded paper.
<b>Chg. Paper Type</b> (*1 →P.675 )		Change the type of paper loaded. (See "Changing the Type of Paper.") →P.583
<b>Chg. Paper Size</b>		Change the size of paper loaded. (See "Specifying the Paper Length.") →P.585 (See "Paper Sizes.") →P.569
<b>ManageRemainRoll</b>		Choose <b>On</b> to print a barcode at the end of a roll before you remove it. The printed barcode can be used in managing the amount of roll paper left. Choose <b>Off</b> if you prefer not to print the barcode. (See "Keeping Track of the Amount of Roll Paper Left.") →P.591
<b>Paper Details</b> (The type of paper is displayed here.) (*1 →P.675 )	<b>Head Height</b>	Adjust the Printhead height. (See "Troubleshooting Paper Abrasion and Blurry Images (Head Height).") →P.626
	<b>Skew Check Lv.</b>	If you print on Japanese paper (washi) or other handmade paper that has an irregular width, choose <b>Loose</b> for a higher skew detection threshold, or choose <b>Off</b> to disable skew detection. However, if paper is loaded askew when detection is <b>Off</b> , note that paper jams or Platen soiling may occur.
	<b>Cutting Mode</b>	Specify whether or not to cut with the standard round-bladed cutter. Choose <b>Automatic</b> to have the roll cut automatically after printing. If you choose <b>Manual</b> , the paper will not be cut after printing. Instead, a line will be printed at the cut position. Choose <b>Eject</b> if you prefer not to have documents dropped immediately after printing, as when waiting for ink to dry.
	<b>Cut Speed</b>	Choose the cutting speed. If you use adhesive paper, choosing <b>Slow</b> helps prevent adhesive from sticking to the cutter and keeps the cutter sharp.
	<b>Trim Edge First</b>	If a roll is loaded, the end of the paper will be cut.
	<b>CutDustRe-duct.</b>	If you choose <b>On</b> , a line will be printed at the cut position when paper cutting is selected. This option reduces the amount of debris given off after cutting. It also helps prevent adhesive from sticking to the cutter and keeps the cutter sharp if you use adhesive paper. (See "Reducing Dust from Cutting Rolls.") →P.601
	<b>VacuumStrngth</b>	Specify the level of suction that holds paper against the Platen. (See "Adjusting the Vacuum Strength (VacuumStrngth).") →P.636



Setting Item		Description, Instructions
<b>Paper Details</b>	(The type of paper is displayed here.) (*1 →P.675 )	<b>Scan Wait Time</b> Specify the time to wait for the ink to dry between each scan (after the printhead finishes moving in one direction), in consideration of how quickly the ink dries. Also specify the applicable area for the ink drying time. Select <b>Entire area</b> to apply the ink drying time after each scan until the document is fully printed. Select <b>Leading edge</b> to apply the ink drying time after each scan only in the area 110–140 mm from the leading edge. (The applicable length varies depending on the <b>Print Quality</b> setting.) Note that printing will take longer if you specify the <b>Scan Wait Time</b> setting. In particular, when <b>Leading edge</b> is selected, colors may be uneven in the boundary between the areas with and without a drying time.
		<b>Roll Drying-Time</b> Specify the time to wait for the ink to dry for each sheet.
		<b>NearEnd RollMrgn</b> Specify the minimum margin at the leading edge of roll paper to ensure better printing quality at the leading edge. Note that if you choose <b>3mm</b> , it may lower the printing quality at the leading edge and affect feeding accuracy. The printed surface may be scratched, and ink may adhere to the leading edge. It may also cause the Platen to become soiled.
		<b>NearEnd Sht Mrgn</b> Specify a margin at the leading edge of sheets to ensure better printing quality at the leading edge. Note that if you choose <b>3mm</b> , it may lower the printing quality at the leading edge and affect feeding accuracy. The printed surface may be scratched, and ink may adhere to the leading edge.
		<b>Bordless Margin</b> Adjust the margin during borderless printing. Choose <b>Automatic</b> to have the printer automatically detect the paper width and configure the margin settings for borderless printing. If margins are mistakenly created when <b>Automatic</b> is selected, choose <b>Fixed</b> . In this case, the paper width is not detected automatically, and the document is printed without borders, using the margin settings required by the printer.
		<b>Width Detection</b> Specify this option to print inside boundaries or in other cases when specifying a particular starting position for printing. (See "Printing From a Desired Starting Point.") →P.606 Paper width and skew are not detected if you select <b>Off</b> . If paper is loaded askew, note that paper jams or Platen soiling may occur.
		<b>Return Defaults</b> Choose <b>OK</b> to restore <b>Paper Details</b> to the default values.
<b>Paper Details</b>		Print the paper settings as specified in <b>Paper Details</b> .
<b>Keep Paper Type</b>		Select <b>On</b> when printing on a particular type of paper regularly. (See "Changing the Type of Paper.") →P.583

\*1: For information on the types of paper the printer supports, refer to the Paper Reference Guide. (See "Types of Paper.") →P.568 The types of paper indicated in the printer driver and related software (as well as on the Control Panel) are updated when you install the printer driver from the User Software CD-ROM or if you update paper information by using the Media Configuration Tool. (See Media Configuration Tool →P.412 or Media Configuration Tool →P.543 .)

## Ink Menu

Setting Item	Description, Instructions
<b>Rep. Ink Tank</b>	Replace the Ink Tank at this point. Follow the instructions displayed to complete the required procedure. (See "Replacing Ink Tanks.") →P.731
<b>Head Cleaning A</b>	Printhead cleaning options. (See "Cleaning the Printhead.") →P.740 Execute <b>Head Cleaning A</b> if printing is faint, oddly colored, or contains foreign substances.

## Job Menu

Setting Item	Description, Instructions
<b>Job Log</b> (Choose from information about the last three print jobs.)	<b>Document Name</b> Indicates the document name in the last print job.
	<b>User Name</b> Indicates the name of the user who sent the print job.
	<b>Page Count</b> Indicates the number of pages in the job.
	<b>Job Status</b> Indicates the printing results.
	<b>Print Start Time</b> Indicates when the print job was started.
	<b>Print End Time</b> Indicates when the print job was finished.
	<b>Print Time</b> Indicates the time required to print the job.
	<b>Print Size</b> Indicates the paper size in the print job.
	<b>Media Type</b> Indicates the type of paper in the print job.
	<b>Interface</b> Indicates the interface used for the print job.
	<b>Ink Consumed</b> Indicates a rough estimate of how much ink was consumed per page.(*1 →P.676 )
<b>Print Job Log</b>	Print a record of print jobs, including the paper type and size, amount of ink consumed, and so on. Ink consumption indicates a rough estimate of how much ink was consumed per page.(*1 →P.676 )
<b>Pause Print</b>	Choose <b>On</b> to stop printing.



\*1: Indicates a rough estimate of how much ink was consumed per page. Actual ink consumption may be different. The average margin of error for estimates calculated according to Canon measurement conditions for ink costs is ±15%. Canon does not guarantee the accuracy of these estimates. Estimates may vary depending on conditions of use. Calculation of these estimates does not include ink consumed when cleaning printheads by forceful ejection of ink.

## Set./Adj. Menu

Setting Item	Description, Instructions
<b>Test Print</b>	<b>Nozzle Check</b> Print a test pattern to check the nozzles.
	<b>Status Print</b> Print information about the printer.
	<b>Interface Print</b> Print interface settings information.
	<b>GL2 Set Print</b> Print GL2 settings information.

Setting Item		Description, Instructions		
<b>Test Print</b>	<b>Paper Details</b>	Print the paper settings as specified in <b>Paper Details</b> .		
	<b>Print Job Log</b>	Print a record of print jobs, including the paper type and size, amount of ink consumed, and so on. Ink consumption indicates a rough estimate of how much ink was consumed per page. (*1 →P.684 )		
	<b>Menu Map</b>	Print the menu structure.		
	<b>Color Palette</b>	Print the GL2 color palette.		
<b>Adjust Printer</b>	<b>Head Posi. Adj.</b>	<b>Auto(Standard)</b>	The printer prints and reads a test pattern for the automatic adjustment of Printhead alignment relative to the printing direction. (See "Automatic Adjustment to Straighten Lines and Colors (Head Posi. Adj.).") →P.619	
		<b>Auto(Advanced)</b>	The printer prints and reads a test pattern for the automatic adjustment of Printhead alignment relative to the printing direction and spacing between nozzles and colors. (See "Automatic Adjustment to Straighten Lines and Colors (Head Posi. Adj.).") →P.619	
		<b>Manual</b>	Print a test pattern for adjustment of Printhead alignment relative to the printing direction. Enter the adjustment value manually based on the resulting pattern. (See "Manual Adjustment to Straighten Lines and Colors (Head Posi. Adj.).") →P.621	
	<b>Head Inc. Adj.</b>		Print a test pattern for adjustment of the Printhead orientation. (See "Adjusting Line Misalignment (Head Inc. Adj.).") →P.623	
	<b>Feed Priority</b>	<b>Adj. Priority</b>	<b>Automatic</b>	Specify exact paper feeding, if desired. Normally, select <b>Automatic</b> . Choose <b>Print Quality</b> for attractive printing. Choosing <b>Print Quality</b> also makes banding less noticeable. Choose <b>Print Length</b> if you prefer to feed the paper an exact amount. However, note that slight banding may occur in the direction of carriage scanning when <b>Print Length</b> is selected.
			<b>Print Quality</b>	
			<b>Print Length</b>	
<b>Adj. Quality</b>		<b>Auto(GenuinePpr)</b>	Specify this mode with paper identified in the Paper Reference Guide. The printer prints and reads a test pattern for automatic adjustment of the feed amount. (See "Automatic Banding Adjustment (Adj. Quality).") →P.630	
		<b>Auto(OtherPaper)</b>	Specify this mode with paper not in the Paper Reference Guide. The printer prints and reads a test pattern for automatic adjustment of the feed amount. Note that this function takes more time and consumes more ink than <b>Auto(GenuinePpr)</b> . (See "Automatic Banding Adjustment (Adj. Quality).") →P.630	
	<b>Manual</b>	Use this mode with highly transparent media or other paper for which <b>Auto(GenuinePpr)</b> or <b>Auto(OtherPaper)</b> cannot be used. Print a test pattern for adjustment of the feed amount based on the type of paper. (See "Manual Banding Adjustment (Adj. Quality).") →P.631		

Setting Item				Description, Instructions
Adjust Printer	Feed Priority	Adjust Length	A:High	Print a test pattern for particular types of paper to compensate for paper stretching or shrinkage, after which you enter the amount of adjustment. (See "Adjusting Line Length (Adjust Length).") →P.634
			B:Standard/Draft	
		Change Settings	A:High	Displayed when you have selected <b>Feed Priority</b> > <b>Adj. Priority</b> > <b>Print Length</b> . Adjustment relative to the amount of stretching or shrinkage of the current paper. Enter either the adjustment results from <b>Adjustment-Print</b> or the discrepancy that you measured (as a percentage). For paper that tends to stretch, increase the feed amount by choosing a higher adjustment value. For paper that tends to shrink, decrease the feed amount by choosing a lower adjustment value.
			B:Standard/Draft	
Maintenance	Head Cleaning			Clean the Printhead. (See "Cleaning the Printhead.") →P.740 Choose <b>Head Cleaning A</b> if printing is faint, oddly colored, or contains foreign substances. Choose <b>Head Cleaning B</b> if no ink is printed at all, or if printing is not improved by <b>Head Cleaning A</b> .
	Nozzle Check			Print a test pattern to check the nozzles.
	Replace P.head			When replacing the Printhead, choose <b>Yes</b> and follow the instructions on the screen. (See "Replacing the Printhead.") →P.741 Not displayed during a warning message that the remaining Maintenance Cartridge capacity is low.
	Repl. maint cart			When replacing the Maintenance Cartridge, choose <b>Yes</b> and follow the instructions on the screen. (See "Replacing the Maintenance Cartridge.") →P.749
	Head Info			Indicates information about the printhead.
GL2 Replot				Print the previous GL2 print job again.
GL2 BufferClear				Clear the print data in the replot buffer.
GL2 Settings	Quality Manager	Color Mode	Monochrome	Print in monochrome.
			Color (CAD) 1	Print in standard colors.
			Color (CAD) 2	Print in brighter colors.
			Color (CAD) 3	Print emulating the following printers, in colors resembling colors produced by these printers: Canon BJ-W3000/W3050.(*2 →P.684 )
			Color (CAD) 4	Print emulating the HP Designjet 500/800, in colors resembling colors produced by these printers. (*2 →P.684 )
			Color (CAD) 5	Print emulating the HP Designjet 1000, in colors resembling colors produced by this printer. (*2 →P.684 )
		Print Quality	Choose the print quality.	
Input Resolution			Choose the printer input resolution, <b>600dpi</b> or <b>300dpi</b> .	

Setting Item		Description, Instructions
<b>GL2 Settings</b>	<b>Quality Manager</b>	<b>Print (Economy)</b> Although printing quality is diminished, less ink is consumed than in regular printing. Select <b>On</b> to conserve ink.
	<b>Paper Manager</b>	<b>Paper Source</b> Choose the source of paper for HP-GL/2 printing.
		<b>Margin</b> Specify the margin around paper. The margin for the trailing edge of sheets is 23 mm (0.9 in). However, if you have specified the leading margin in <b>Paper Details</b> , the value in <b>Paper Details</b> has priority.
		<b>Conserve Paper</b> Conserves paper when printing.
	<b>Auto Rotate</b> If the long side of an original is shorter than the roll width, the original is automatically rotated 90 degrees to conserve paper. Similarly, if the long side of an original in landscape orientation is longer than the roll width and the short side is shorter than the roll width, the original is repositioned to fit on the paper. HP RTL print jobs are not rotated. Because HP RTL images are not rotated even if the paper is rotated 90 degrees, images may be cut off or the blank paper may be ejected. In this case, set <b>Auto Rotate</b> to <b>Off</b> .	
<b>Line &amp; Pen Manager</b>	<b>Enable merge</b> Specify whether to merge or print over colors where lines overlap. Choose <b>Off</b> to print the second line over the first. Choose <b>On</b> to merge all overlapping colors.	
	<b>Pen Setup</b>	<b>Select Palette</b> As pen values, choose <b>Software</b> , <b>Palette A</b> , <b>Palette B</b> , or <b>Factory</b> . Choose <b>Software</b> to print according to software settings. Choose <b>Palette A</b> or <b>Palette B</b> to print using the value specified in <b>Define Palette</b> .
		<b>Define Palette</b> Specify the <b>Width</b> , <b>Color</b> , and <b>Line Attributes</b> in the palette <b>Pen no.</b> . Choose <b>Factory</b> to confirm the values when <b>Factory</b> is selected in <b>Select Palette</b> . In <b>Line Attributes</b> , choose <b>No Setting</b> or <b>Circle Setting</b> as the processing for the ends and junctions of lines. <ul style="list-style-type: none"><li>• If you choose <b>No Setting</b> </li><li>• If you choose <b>Circle Setting</b> </li></ul>
	<b>Reset Palette</b> Restore <b>Define Palette</b> to the default palette settings.	
<b>Smoothing</b> Choose whether to print arcs as smooth curved lines or as multiple connected line segments.		

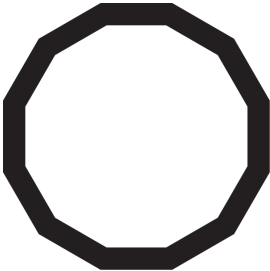
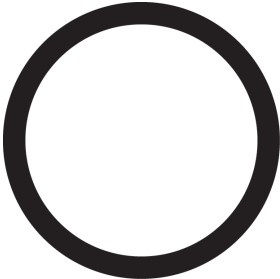
Setting Item			Description, Instructions		
GL2 Settings	Line & Pen Manager	Smoothing	<ul style="list-style-type: none"> <li>If you choose <b>Software</b> Operation is determined by the application. If nothing is specified by the application, the result is as shown in the figure.</li> </ul>  <p>Note: By default, this is a 72-sided figure</p> <ul style="list-style-type: none"> <li>If you choose <b>Smooth</b></li> </ul> 		
		ThickenFineLines	Select <b>On</b> to print fine lines more distinctly.		
		AdjustFaintLines	If fine lines are printed in colors that do not match the colors of other shapes, selecting <b>Off</b> may help produce the expected results. However, lines in some colors may appear broken.		
		Warning	Select <b>On</b> to have any GL2-related warnings displayed.		
	ProcessingOption	PageSizeProcess1	Normally, the area available for printing excludes a margin required by the printer, and images are positioned accordingly. Selecting <b>On</b> in this setting eliminates any misalignment of the printing position if the image itself includes a border.		
		PageSizeProcess2	Selecting <b>On</b> will determine the paper size based on the image rendering area.		
		GL2 Set Print	Print GL2 settings information.		
	Interface Setup	EOP Timer		Specify the timeout period before cancellation of print jobs that cannot be received by the printer.	
		TCP/IP	IPv4	IPv4 Mode	Choose whether the printer IP address is configured automatically or a static IP address is entered manually.
				Protocol	DHCP
BOOTP					
RARP					

Setting Item			Description, Instructions					
Inter- face Setup	TCP/I P	IPv4	IPv4 Set- tings	IP Address	Specify the printer network information when using a static IP address. Enter the IP address assigned to the printer, as well as the network subnet mask and default gateway.			
				Subnet Mask				
				Default G/W				
		DNS Set- tings			DNS Dync update	Specify whether DNS server registration is updated automatically.		
					Pri. DNS SrvAddr	Specify the DNS server address.		
					Sec. DNS SrvAddr			
					DNS Host Name	Specify the DNS host name.		
					DNS Domain Name	Specify the DNS domain name.		
		IPv6		IPv6	IPv6 Support	Specify whether to connect via IPv6.		
					IPv6 StatelessAddrs	Specify whether a IPv6 stateless address is used.		
					DHCPv6	Specify whether DHCPv6 settings are used.		
				DNS Set- tings		DNS Dync update	State- full Addr	Specify whether DNS server registration is updated automatically.
							State- less Addr	
						Pri. DNS SrvAddr	Specify the DNS server address.	
	Sec. DNS SrvAddr							
	DNS Host Name					Specify the DNS host name.		
	DNS Domain Name					Specify the DNS domain name.		
	Net- Ware	NetWare			Specify the NetWare protocol. To apply your changes, choose <b>Register Setting</b> .			
			Frame Type	Specify the frame type to use.				
			Print Service	Choose the print service.				
AppleTalk				Specify whether to use the AppleTalk protocol. To apply your changes, choose <b>Register Setting</b> .				
Ether- net Driver	Auto Detect			Specify the communication method. To apply your changes, choose <b>Register Setting</b> . Choose <b>On</b> for automatic configuration of the LAN communication protocol. Choose <b>Off</b> to use settings values of <b>Comm.Mode</b> and <b>Ethernet Type</b> .				
	Comm.Mode			Choose the LAN communication method.				
	Ethernet Type			Choose the LAN transfer rate.				
	Spanning Tree			Choose whether spanning-tree packets are supported over the LAN.				

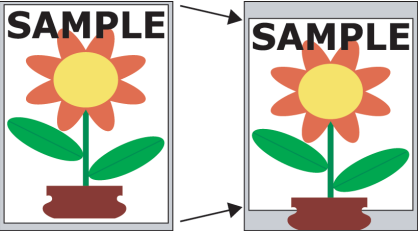
Setting Item		Description, Instructions	
<b>Inter- face Setup</b>	<b>Ether- net Driver</b>	<b>MAC Address</b> Indicates the MAC address.	
	<b>Interface Print</b> Print interface settings information.		
	<b>Return Defaults</b> Choose <b>OK</b> to restore <b>Interface Setup</b> settings to the default values.		
<b>System Setup</b>	<b>Sleep Timer</b> Specify the period before the printer enters sleep mode.		
	<b>Buzzer</b> Choose <b>On</b> for the buzzer to sound in case of errors.		
	<b>Contrast Adj.</b> Adjust the Display Screen contrast level.		
	<b>Date &amp; Time</b>	<b>Date</b>	Set the current date.
		<b>Time</b>	Set the current time. Available only if the <b>Date</b> setting is specified.
	<b>Date Format</b> Specify the date format.		
	<b>Language</b> Specify the language used on the Display Screen.		
	<b>Time Zone</b> Specify the time zone. Time zone options indicate a main city in this time zone and the difference from Greenwich Mean Time.		
	<b>Length Unit</b> Choose the display unit for length. Change the unit displayed for the remaining amount of roll paper, <b>Tot.Print Area</b> , and so on.		
	<b>Detect Mismatch</b> Specify printing behavior if the type and size of paper specified in the printer menu does not match the type and size in the printer driver. Choose <b>Pause</b> to have printing paused under these circumstances. Choose <b>Warning</b> to continue printing after notification. Choose <b>None</b> to continue printing without notification.		
<b>Paper Size Basis</b>	<b>Roll Selection 1</b>	If roll size detection is activated, choose whether <b>ISO A3 (297mm)</b> or <b>300mm Roll</b> is applied when a roll of an intermediate width is detected.	
	<b>Roll Selection 2</b>	If roll size detection is activated, choose whether <b>10in. (254mm)</b> or <b>JIS B4 (257mm)</b> is applied when a roll of an intermediate width is detected.	
<b>Keep Paper Size</b> Choose <b>On</b> to use the paper size setting as the basis for printing instead of other settings. The margin setting of the printer menu will be used instead of the margin setting of the printer driver if the latter is smaller, which may prevent text or images in the margin from being printed.			
			

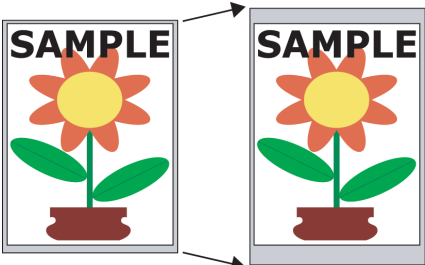

Setting Item		Description, Instructions
System Setup	<b>Keep Paper Size</b>	<p>Choose <b>Off</b> to give priority to margin settings. The larger value is used if the margin specified in the printer driver does not match the margin in the printer menu</p> 
	<b>TrimEdge Reload</b>	<p>Specify whether to trim the leading edge of the currently retracted roll when the roll is advanced. Cut the edge if you are concerned about any marks left on the roll when the roll is left in the retracted position. Specify <b>On</b> to have rolls cut when printing begins after Sleep mode or when the power is restored. Selecting <b>Automatic</b> will trim the edge when the roll has been in the retracted position for two days or more.</p>
	<b>Rep.P.head Print</b>	<p>Choose <b>On</b> to have the printer automatically execute the <b>Advanced Adj.</b> operations after you replace the Printhead. (See "Automatic Adjustment to Straighten Lines and Colors (Head Posi. Adj.).") →P.619</p>
	<b>Nozzle Check</b>	<p>In <b>Frequency</b>, specify the timing for automatic checks of nozzle clogging. Choose <b>Standard</b> to have the printer adjust the timing for checks based on the frequency of nozzle use. Choose <b>1 page</b> to check once per page.</p> <p>Select <b>Warning &gt; On</b> to display warnings if the nozzles clog during printing.</p>
	<b>Use RemoteUI</b>	<p>Choosing <b>Off</b> prohibits access from RemoteUI. Settings can only be configured from the control panel.</p>
	<b>Reset PaprSetngs</b>	<p>Restores settings that you have changed with Media Configuration Tool to the default values.</p>
	<b>Show Job Log</b>	<p>Selecting <b>Off</b> prevents display of the log in <b>Job Menu &gt; Job Log</b>. Additionally, the log is not printed if you choose <b>Job Menu &gt; Print Job Log</b>. Note that because job logs are not collected, the Status Monitor accounting functions will not work correctly.</p>
<b>Prep.MovePrinter</b>		<p>Select this option when transferring the printer to another location. Follow the instructions displayed to complete the required procedure. (See "Preparing to Transfer the Printer.") →P.762</p> <p>Not displayed during a warning message that the remaining Maintenance Cartridge capacity is low.</p>
Admin. Menu	<b>Change Password</b>	<p>By setting a password, you can restrict menu display and configuration as follows. You can input between 0 and 9999999.</p>

Setting Item		Description, Instructions
<b>Admin. Menu</b>	<b>Change Password</b>	<ul style="list-style-type: none"> <li>Viewing and configuration by administrators only               <ul style="list-style-type: none"> <li>IPv4 Settings</li> <li>Change Password</li> <li>Init.Admin.Pswd</li> </ul> </li> <li>Viewing and configuration by administrators, and only viewing by other users               <ul style="list-style-type: none"> <li>Interface Setup settings (except IPv4 Settings)</li> <li>Date &amp; Time</li> <li>Date Format</li> <li>Time Zone</li> <li>Use RemoteUI</li> <li>Reset PaprSetngs</li> </ul> </li> </ul>
	<b>Init.Admin.Pswd</b>	Choose <b>OK</b> to restore the <b>Admin. Menu</b> password to the default values.
<b>Printer Info</b>	<b>Paper Info</b>	Indicates the current paper size, type, and related printer settings.
	<b>Ink Info</b>	Indicates ink levels and maintenance cartridge capacity.
	<b>Head Info</b>	Indicates the model name, serial number, number of days used, and dot count of the current printhead.
	<b>System Info</b>	Indicates the firmware version, serial number, and interface information.
	<b>Error Log</b>	Indicates the most recent error messages (up to five).
	<b>Other Counter</b>	Indicates the total printing volume of the printer.

\*1: Indicates a rough estimate of how much ink was consumed per page. Actual ink consumption may be different. The average margin of error for estimates calculated according to Canon measurement conditions for ink costs is  $\pm 15\%$ . Canon does not guarantee the accuracy of these estimates. Estimates may vary depending on conditions of use. Calculation of these estimates does not include ink consumed when cleaning printheads by forceful ejection of ink.

\*2: It is not possible to match the colors and image quality produced by the specified printer exactly.

## Menu Settings (During Printing)

Menu items are described in the following tables.

For instructions on selecting menu items, see "Menu Operations." →P.660

For details on menu levels and values, see "Menu Structure." →P.663

### Ink Menu

Setting Item	Description, Instructions
<b>Rep. Ink Tank</b>	Replace the Ink Tank at this point. Follow the instructions displayed to complete the required procedure. (See "Replacing Ink Tanks.") →P.731
<b>Head Cleaning A</b>	Clean the Printhead. (See "Cleaning the Printhead.") →P.740 Execute <b>Head Cleaning A</b> if printing is faint, oddly colored, or contains foreign substances.

## Job Menu

Setting Item		Description, Instructions	
<b>Job Log</b>	(Choose from information about the last three print jobs.)	<b>Document Name</b>	Indicates the document name of the selected print job.
		<b>User Name</b>	Indicates the name of the user who sent the print job.
		<b>Page Count</b>	Indicates the number of pages in the job.
		<b>Job Status</b>	Indicates the printing results.
		<b>Print Start Time</b>	Indicates when the print job was started.
		<b>Print End Time</b>	Indicates when the print job was finished.
		<b>Print Time</b>	Indicates the time required to print the job.
		<b>Print Size</b>	Indicates the paper size in the print job.
		<b>Media Type</b>	Indicates the type of paper in the print job.
		<b>Interface</b>	Indicates the interface used for the print job.
<b>Ink Consumed</b>	Indicates a rough estimate of how much ink was consumed per job. (*1 →P.685 )		
<b>Print Job Log</b>		Print a record of print jobs, including the paper type and size, amount of ink consumed, and so on. Ink consumption indicates a rough estimate of the amount of ink consumed per print job. (*1 →P.685 )	
<b>Pause Print</b>		If you set this option to <b>On</b> , printing is stopped at that point and the printer enters a state in which printing is paused.	

\*1: A rough estimate of how much ink was consumed per job is displayed. Actual ink consumption may be different. The average margin of error for estimates calculated according to Canon measurement conditions for ink costs is  $\pm 15\%$ . Canon does not guarantee the accuracy of these estimates. Estimates may vary depending on conditions of use. Calculation of these estimates does not include ink consumed when cleaning printheads by forceful ejection of ink.

## Set./Adj. Menu

Setting Item		Description, Instructions	
<b>Adj. Fine Feed</b>		Displayed when you have selected <b>Feed Priority &gt; Adj. Priority &gt; Automatic</b> or <b>Print Quality</b> . Fine-tune the feed amount manually.	
<b>Printer Info</b>	<b>Paper Info</b>	Indicates the current paper size, type, and related printer settings.	
	<b>Ink Info</b>	Indicates ink levels and maintenance cartridge capacity.	
	<b>Head Info</b>	Indicates the model name, serial number, number of days used, and dot count of the current printhead.	
	<b>System Info</b>	Indicates the firmware version, serial number, and interface information.	
	<b>Error Log</b>	Indicates the most recent error messages (up to five).	
<b>Other Counter</b>		Indicates the total printing volume of the printer.	

## Status Print

You can print a **Status Print** report indicating the current status of the printer.

With **Status Print**, information is printed regarding the printer firmware version, various settings, and the status of consumables.

### Printing **Status Print** reports

1. Load paper.  
If using sheets, load paper of A4/Letter size. You will need at least three sheets.
2. On the **Tab Selection screen** of the Control Panel, press ◀ or ▶ to select Settings/Adj. tab (  ).

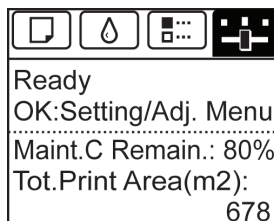

#### Note

- If the **Tab Selection screen** is not displayed, press the **Menu** button.

3. Press the **OK** button.  
The **Set./Adj. Menu** is displayed.
4. Press ▲ or ▼ to select **Test Print**, and then press the **OK** button.
5. Press ▲ or ▼ to select **Status Print**, and then press the **OK** button.

### Checking the information in **Status Print** reports

The following information is included in **Status Print** reports.

Canon imagePROGRAF iPFxxxx Status Print	Printer model
Firm	Firmware Version
Boot	Boot ROM Version
MIT(DBF)	MIT Database Format Version
MIT(DB)	MIT Database Version
S/N	Printer serial number
Date	Indicates when the status print report was printed.
Paper Menu	Information on the loaded paper.

	Roll Media Type	Information on the loaded paper.
	Cut Sheet Type	
	ManageRemainRoll	
	Keep Paper Type	

Set./Adj. Menu		Settings and adjustment information.	
	System Setup		
		Sleep Timer	Printer system settings, as well as settings regarding warnings and errors.
		Buzzer	
		Contrast Adj.	
		Date Format	
		Language	
		Time Zone	
		Length Unit	
		Detect Mismatch	
		Paper Size Basis	
		Roll Selection 1	
		Roll Selection 2	
		Keep Paper Size	Current paper-related settings.
		TrimEdge Reload	
	Rep.P.head Print	Settings after a test pattern was printed following head replacement.	
	Nozzle Check	Timing	Nozzle-check settings.
		Warning	
	Use RemoteUI	Settings used by RemoteUI.	
Printer Info		Various printer information.	
	Ink Info		Ink-related information.
		MC	Maintenance Cartridge capacity (%)
		C,M,Y,MBK,MBK2,BK	Ink levels. The remaining ink is displayed in a five-level scale.
	System Info		System-related information.
		RAM	Total RAM (system RAM and print buffer)
	Error Log		The past five error codes.

HEAD LOT NUMBER		Printhead lot number.
	LOT	
PARTS STATUS		Utilization status of replacement parts that require servicing.
	COUNTER	

	CR1-5, SP1, PG1, HMa1, MT1, PL1, Mi1,CT1,WF1-2	Utilization status of replacement parts that require servicing.
COUNTER		Utilization status of the cutter, media, and other items (indicating how much they have been used).
	CUTTER	
	MEDIA	
	LIFE TTL	
	LIFE ROLL	
	LIFE CUT-SHEET	
	MEDIA 1-7,OTHER	
	NAME	
	TTL	
	ROLL	
	CUTSHEET	
	AFTER INSTALLATION	
DUTY		Counters for maintenance purposes. Needed when service is requested.
	UNIT:m2	
	UNIT:sq.f	
	UNIT:A4 Sheet	
	UNIT:Letter Sheet	

## Printing Interface Setting Reports

You can print an **Interface Print** report indicating the current interface settings values of the printer. **Interface Print** reports indicate settings values for TCP/IP, NetWare, and other settings.

### Printing **Interface Print** reports

1. Load the paper.  
If using sheets, load paper A4/Letter-sized, you will need at least three sheets.
2. On the **Tab Selection** screen of the Control Panel, press ◀ or ▶ to select the Settings/Adj. tab (  ).

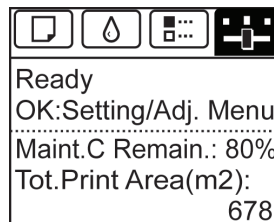

**Note**

- If the **Tab Selection screen** is not displayed, press the **Menu** button.

3. Press the **OK** button.  
The **Set./Adj. Menu** is displayed.
4. Press **▲** or **▼** to select **Test Print**, and then press the **OK** button.
5. Press **▲** or **▼** to select **Interface Print**, and then press the **OK** button.

**Confirming Interface Print information**

The following information is included in the **Interface Print** report.

Canon imagePROGRAF iPFxxxx Interface Print		Printer model
Firm	Firmware Version	
Boot	Boot ROM Version	
MIT(DBF)	MIT Database Format Version	
MIT(DB)	MIT Database Version	
S/N	Printer serial number	
Date	The date when the interface setup print report was printed.	
EOP Timer	Specify the timeout period before cancellation of print jobs that cannot be received by the printer.	
TCP/IPv4	Frame Type	<b>IPv4</b> settings values.
	Use DHCP	
	Use BOOTP	
	Use RARP	
	Enable DNS Dynamic Update	
	Use Zeroconf Function	
	IP Address	
	Subnet Mask	
	Gateway Address	
	LPD Printing	
	IPP Printing	
	IPP Printer URI	
	RAW Printing	
Raw Mode Bi-direction		

TCP/IPv4	FTP Printing	IPv4 settings values.
	Use Discovery	
	Scope	
	Primary DNS Server Address	
	Secondary DNS Server Address	
	DNS Host Name	
	DNS Domain Name	
	MulticastDNS ServiceName	
	SNMPv1	
	SNMPv3	

TCP/IPv6	Use IPv6	IPv6 settings values.	
	Use DHCPv6		Stateful Address
			Prefix Length
			Primary DNS Server Address
			Secondary DNS Server Address
	Use a stateless address		Stateless Address 1
			Prefix Length 1
			Stateless Address 2
			Prefix Length 2
			Stateless Address 3
			Prefix Length 3
			Stateless Address 4
			Prefix Length 4
			Stateless Address 5
			Prefix Length 5
			Stateless Address 6
			Prefix Length 6
	Use a link-local Address		Link-Local Address
			Prefix Length
	Use a manual address		IP Address
			Prefix Length
			Default Router Address
			Prefix Length
	Primary DNS Server Address		
	Secondary DNS Server Address		
Use the same host name and domain name as IPv4	DNS Host Name		
	DNS Domain Name		



TCP/IPv6	Perform dynamic updating of stateful addresses	<b>IPv6</b> settings values.	
	Dynamically update the stateless address		
	Dynamically update the manual address		
NetWare	Frame Type	<b>NetWare</b> settings values.	
	IPX External Network Number		
	Node Number		
	Print Application		
	Bindery PServer		File Server Name
			Print Server Name
			Print Server Password
			Polling Interval
	RPrinter		Print Server Name
			Printer Number
	NDS PServer		Tree Name
			Context Name
			Print Server Name
			Print Server Password
	NPrinter		Print Server Name
			Printer Number
AppleTalk	Phase Type	<b>AppleTalk</b> settings values.	
	Name		
	Network Number		
	Zone		
Network Interface	Physical Interface	Network interface settings values.	
	Transmission Rate		
	MAC Address		
	Auto Detect		
	Communication		
	Ethernet Type		
	Spanning Tree		
	Use the Jumbo Frame Function		

## Network Setting

Network Environment	693
Using RemoteUI	696
Initial Settings	699
NetWare Settings	708
Mac OS X Settings	719
Other Settings	726

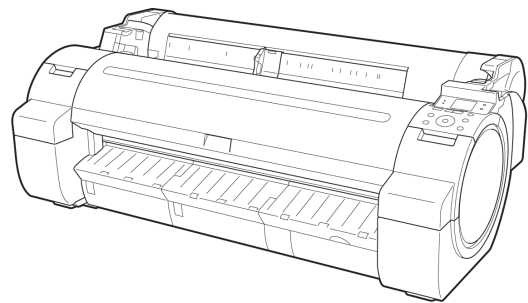

## Network Environment

Network Environment ..... 693

## Network Environment

### System requirements

The system requirements, which vary depending on your network, are as follows.

#### • Printing over a TCP/IP network (when using IPv4)

- Compatible operating systems
  - Windows 2000 (Professional or Server)
  - Windows XP (Home Edition or Professional)
  - Windows Server 2003 (Standard Edition)
  - Windows Vista (Home Basic/Business/Ultimate)
  - Windows Server 2008 (Standard Edition or Enterprise Edition)
  - Windows 7
  - Windows XP Professional x64 Edition
  - Windows Server 2003 x64 Edition
  - Windows Vista x64
  - Windows Server 2008 x64
  - Windows 7 x64
  - Mac OS X 10.2.8 or later
  - Unix (Solaris 9)
  - Unix (Red Hat 9)
- Compatible computer
  - A computer that runs one of the above operating systems

#### • Printing over a TCP/IP network (when using IPv6)

- Compatible operating systems
  - Windows Vista (Home Basic/Business/Ultimate)
  - Windows Server 2008 (Standard Edition or Enterprise Edition)
  - Windows 7
  - Windows Vista x64
  - Windows Server 2008 x64
  - Windows 7 x64
  - Mac OS X 10.3.9 or later



#### Note

- When using IPv6, you must specify IPv6 on the Control Panel or in RemoteUI. For instructions, see "Configuring TCP/IPv6 Network Settings." →P.702 or see "Configuring the Printer's TCP/IP Network Settings With RemoteUI." →P.704
- The imagePROGRAF printer driver is supported in Mac OS X 10.3.9 or later.
- The imagePROGRAF printer driver is not compatible with Unix.

#### • Printing over an AppleTalk network

- Compatible operating systems

- Mac OS X 10.2.8–10.4
- Compatible computer
  - A computer that runs one of the above operating systems



**Note**

- The printer cannot be used over a LocalTalk network.
- Compatible with EtherTalk Phase 2.
- The imagePROGRAF printer driver is not compatible with AppleTalk.

• **Printing over a NetWare network**

- Compatible servers
  - Novell NetWare 4.2/5.1/6.0
- Compatible clients
  - Windows 2000 (Professional or Server)
  - Windows XP (Professional)
- Compatible computer
  - A computer that runs one of the above operating systems



**Note**

- In NetWare 6.0, iPrint is not supported.

## Network Environment

After confirming what type of network environment you will connect the printer to, set up the printer and computers as needed.

• **Example of a Windows network**

In Windows networks, print over TCP/IP.

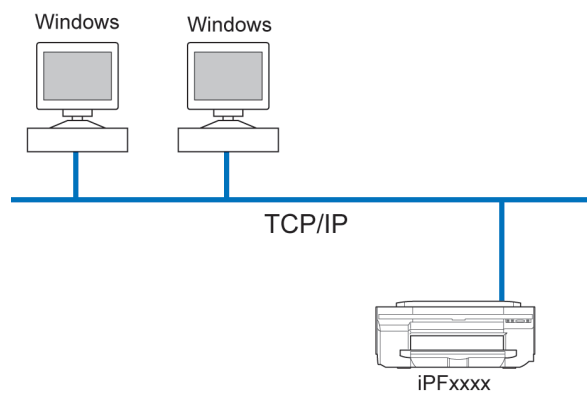

**Note**

- NetBIOS is not supported.

- Example of a Macintosh network

In Macintosh networks, print over AppleTalk (EtherTalk) or TCP/IP, using Bonjour (Zeroconf) functions.

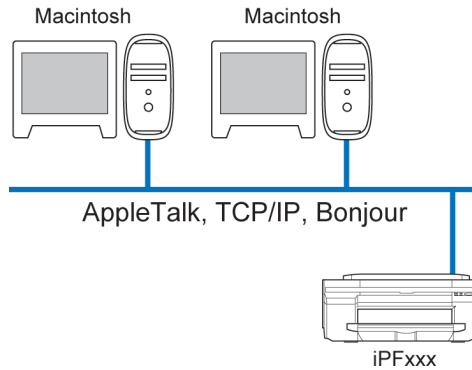

**Note**

- The imagePROGRAF printer driver is not compatible with AppleTalk.

- Example of a NetWare network

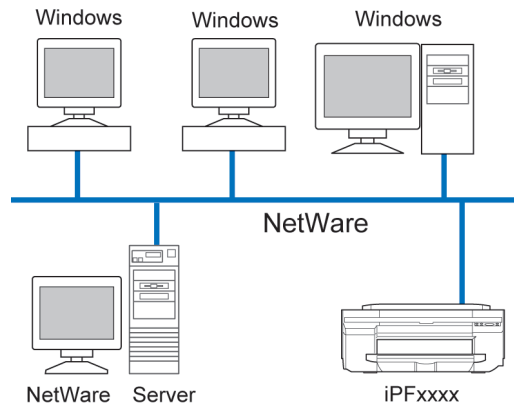

**Note**

- Even if there is a NetWare server in your network environment, you can use it in conjunction with TCP/IP or AppleTalk. In this case, complete the settings for each protocol you will use.

## Using RemoteUI

Using RemoteUI ..... 696

### Using RemoteUI

RemoteUI is software with which you can access the printer via the network from your Web browser to confirm the printer status, operate jobs, and configure the settings. Since the software (Web server) for using RemoteUI is built in the printer, preparing software other than a Web browser is unnecessary. You can use RemoteUI if an imagePROGRAF printer on a network is connected to your computer. If you start your Web browser and specify the IP address of the printer, the RemoteUI screen is displayed, and you can use RemoteUI.



#### Important

- To use RemoteUI, an IP address must be set on the printer in advance. For the method of setting an IP address, see "Configuring the IP Address on the Printer." →P.699

### What You Can Do With RemoteUI

With RemoteUI, you can access the printer via a network, configure network settings, and display the current status of the printer, various types of information, the processing status of jobs, etc.

### Starting RemoteUI

Start RemoteUI by the following operations.

1. Start your Web browser.
2. Enter the following URL in **Address** or **Location**.  
http://printer IP address or name/  
Example: http://xxx.xxx.xxx.xxx/

### 3. The RemoteUI screen is displayed.

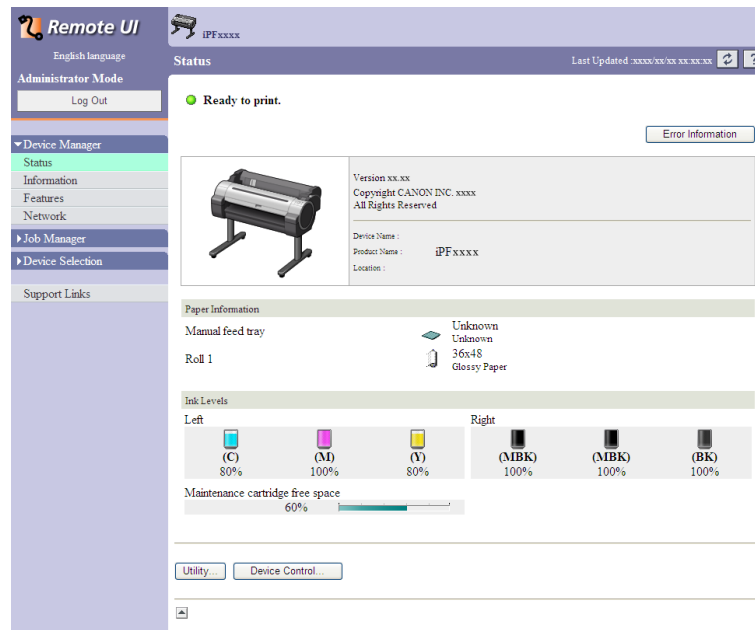

#### Note

- The screen slightly differs depending on the model of printer.

## Configuring the Network With RemoteUI

For details on configuring printer settings for networks, refer to the following topics.

- Configuring the Printer's TCP/IP Network Settings With RemoteUI →P.704
- Configuring the Printer's AppleTalk Network Settings →P.725
- Configuring the Printer's NetWare Network Settings With RemoteUI →P.716
- Specifying Printer-Related Information →P.726



#### Important

- For the Web browser, use Netscape Navigator 6.0 or later, Internet Explorer 5.01 or later, or Firefox 1.5 or later. For Mac OS X, Safari 1.32 or later or 2.03 or later also is supported.
- This cannot be used connected via a proxy server. In environments where a proxy server is used, add the printer's IP address to **Exceptions** (addresses accessed without a proxy server) in the web browser proxy server settings. (Settings may vary depending on the network environment.)
- Enable JavaScript and cookies in the web browser.
- If you access RemoteUI with the printer name instead of its IP address, make sure the DNS settings are correctly configured.
- Depending on the network environment, you may not be able to start RemoteUI.
- Confirm whether **System Setup > Use RemoteUI** is set to **On** on the Control Panel of the printer.



Note

- RemoteUI also offers many other features. You can display the ink levels, check error messages and other status information, and cancel print jobs.
- By factory default, the English screen is displayed. To change the display language, select the desired language under **Language** before logging on in administrator mode.
- If you login in Administrator Mode, you can configure to use the Jumbo Frame function in the **Network** page. However, this function might not be able to be used depending on the network environment.



## Initial Settings

Configuring the IP Address on the Printer .....	699
Configuring the IP Address Using the Printer Control Panel .....	700
Configuring the IP Address Using ARP and PING Commands .....	701
Configuring TCP/IPv6 Network Settings .....	702
Configuring the Printer Driver Destination (Windows) .....	703
Configuring the Printer Driver Destination (Mac OS X) .....	704
Configuring the Printer's TCP/IP Network Settings With RemoteUI .....	704

## Configuring the IP Address on the Printer

You must configure the printer's IP address before using the printer in a TCP/IP network.

The printer's IP address is configured automatically when you install the printer driver following the instructions in the Set-up Guide.

Configure the IP address by using imagePROGRAF Device Setup Utility, the printer Control Panel, or ARP or PING commands, if the IP address is changed, or if you change the printer connection mode to a network connection. For details on configuring the IP address, refer to the following topics.

- Configuring the IP Address Using imagePROGRAF Device Setup Utility →P.408 (Windows)
- Configuring the IP Address Using the Printer Control Panel →P.700
- Configuring the IP Address Using ARP and PING Commands →P.701



### Important

- If you use a DHCP server for automatic assignment of the printer's IP address, printing may no longer be possible after the printer is turned off and on. This is because an IP address different from before has been assigned. Thus, when using DHCP server functions, consult your network administrator and configure the settings in one of the following ways.
  - Configure the setting for dynamic DNS updating  
In the printer menu, either set **DNS Dync update** to **On**, or activate the setting **Enable DNS Dynamic Update** in RemoteUI.  
(See "Menu Settings.") →P.673  
(See "Configuring the Printer's TCP/IP Network Settings With RemoteUI.") →P.704
  - Configure the setting for assignment of the same IP address each time the printer starts up



### Note

- We recommend configuring the printer's IP address even if you will use the printer in networks other than TCP/IP networks. Configuring the printer's IP address enables you to use RemoteUI to configure the network settings and manage the printer with a web browser.  
For details on RemoteUI, see "Using RemoteUI." →P.696

## Configuring the IP Address Using the Printer Control Panel

This topic describes how to configure the printer's IP address on the Control Panel.

1. On the **Tab Selection** screen of the Control Panel, press ◀ or ▶ to select the Settings/Adj. tab (  ).

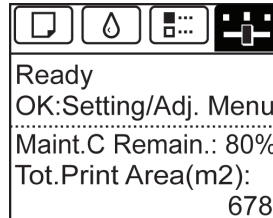

### Note

- If the **Tab Selection** screen is not displayed, press the **Menu** button.

2. Press the **OK** button.  
The **Set./Adj. Menu** is displayed.
3. Press ▲ or ▼ to select **Interface Setup**, and then press the **OK** button.
4. Press ▲ or ▼ to select **TCP/IP**, and then press the **OK** button.
5. Press ▲ or ▼ to select **IPv4**, and then press the **OK** button.
6. Press ▲ or ▼ to select **IPv4 Settings**, and then press the **OK** button.
7. Press ▲ or ▼ to select **IP Address**, and then press the **OK** button.
8. After you press ◀ or ▶ to select the input field, numerical input is possible.
9. Press the ▲ or ▼ button to enter the value.



### Note

- Pressing the ▲ button increases the number by 1. The maximum value is 9, after which 0 is displayed.
- Pressing the ▼ button decreases the number by 1. The minimum value is 0, after which 9 is displayed.
- Hold down ▲ or ▼ to increase or decrease the value continuously.
- Make sure the IP address you enter for the printer is not the same as any computer IP address in your network.

**10.** Repeat steps 8 and 9 to complete the settings, and then press the **OK** button.

**11.** Press the **Menu** button.

If you have changed the settings, a confirmation message is displayed. Press **▲** or **▼** to select **Yes**, and then press the **OK** button.

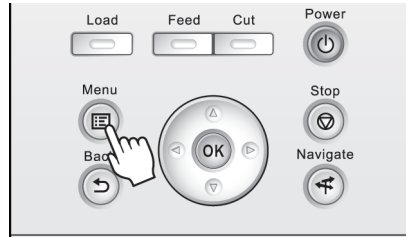

#### Important

- Be sure to complete step 11. This will activate the values you have entered.
- If an error message is displayed, check the settings and correct any invalid values.



#### Note

- You can also specify the subnet mask and default gateway on the Control Panel.

## Configuring the IP Address Using ARP and PING Commands

This topic describes how to configure the IP address using ARP and PING commands.

To use the ARP and PING commands, you will need to know the printer's MAC address. You can confirm the MAC address on the Control Panel.

**1.** Check the printer's MAC address.

You can confirm the MAC address on the Control Panel as follows:

1. On the **Tab Selection screen** of the Control Panel, press **◀** or **▶** to select the Settings/Adj. tab (  ).

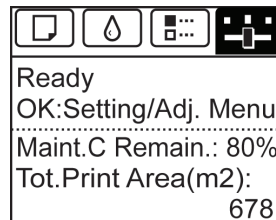

2. Press the **OK** button.  
The **Set./Adj. Menu** is displayed.
3. Press **▲** or **▼** to select **Interface Setup**, and then press the **OK** button.
4. Press **▲** or **▼** to select **Ethernet Driver**, and then press the **OK** button.
5. Press **▲** or **▼** to select **MAC Address**, and then press the **OK** button.



**Note**

- If the **Tab Selection screen** is not displayed, press the **Menu** button.
- You can investigate the MAC address by printing an interface setting report. (See "Printing Interface Setting Reports.") →P.688

2. In Windows, open a command prompt, or in Mac OS X, start Terminal.
3. Execute the following command to add entries to the ARP table for managing IP addresses and corresponding MAC addresses.  
arp -s [IP address] [the printer's MAC address you have verified]  
Example: arp -s xxx.xxx.xxx.xxx 00-1E-8F-xx-xx-xx



**Note**

- In Mac OS X when using Terminal, enter the arp command in the format arp -s xxx.xxx.xxx.xxx 00:1E:8F:xx:xx:xx. For details, refer to the help file for the command line.

4. Execute the following command to send the IP address to the printer and configure it.  
ping [IP address as specified in the ARP command] -l 479  
Example: ping xxx.xxx.xxx.xxx -l 479



**Note**

- In -l, the l is the letter l.
- In Mac OS X when using Terminal, enter the ping command in the format ping -s 479 xxx.xxx.xxx.xxx. For details, refer to the help file for the command line.



**Note**

- The subnet mask and default gateway are set to 0.0.0.0. Use RemoteUI to change the subnet mask and default gateway to match your network settings. For details on RemoteUI, see "Using RemoteUI." →P.696

## Configuring TCP/IPv6 Network Settings

When printing in a TCP/IPv6 network, you must configure the TCP/IPv6 settings on the Control Panel. Follow the steps below to configure the TCP/IPv6 network settings.

1. On the **Tab Selection screen** of the Control Panel, press ◀ or ▶ to select the Settings/Adj. tab (  ).

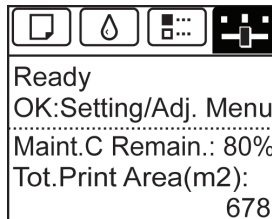

**Note**

- If the **Tab Selection screen** is not displayed, press the **Menu** button.

2. Press the **OK** button.  
The **Set./Adj. Menu** is displayed.
3. Press **▲** or **▼** to select **Interface Setup**, and then press the **OK** button.
4. Press **▲** or **▼** to select **TCP/IP**, and then press the **OK** button.
5. Press **▲** or **▼** to select **IPv6**, and then press the **OK** button.
6. Press **▲** or **▼** to select **IPv6 Support**, and then press the **OK** button.
7. Press **▲** or **▼** to select **On**, and then press the **OK** button.

**Important**

- Once you set **IPv6 Support** to **On**, the **IPv6 StlessAddrs** setting takes effect.

**Note**

- You can also configure **IPv6 StlessAddrs** and **DHCPv6** from the printer Control Panel.

## Configuring the Printer Driver Destination (Windows)

9

This topic describes how to specify the printer driver destination if the printer's IP address is changed, or if you will use the printer over a network connection instead of via USB connection.

The procedure described below is the configuration based on the LPR or Raw protocol using the standard TCP/IP port in Windows ( **Standard TCP/IP Port** ).

**Important**

- If you will use the printer in a TCP/IP network, make sure the printer's IP address is configured correctly.
  - [Configuring the IP Address on the Printer](#) →P.699

1. Open the **Printers and Faxes** (or **Printers, Devices and Printers**) window.
2. Right-click the icon of this printer and choose **Properties** (For Windows 7 and Windows Vista, **Printer Properties**) to open the printer properties window.
3. Click the **Port** tab to display the **Port** sheet.
4. Click **Add Port** to display the **Printer Ports** dialog box.

703

5. In the **Available Port** list, select **Standard TCP/IP Port**.
6. Click **New Port**.  
After the wizard starts, a window is displayed for the **Welcome to the Add Standard TCP/IP Printer Port Wizard**.
7. Click **Next**.
8. In **Printer Name or IP Address**, enter the printer's IP address. If the DNS is configured, you can also enter the DNS Domain Name.
9. Follow the instructions on the screen to add a printer port.
10. Click **Close** to close the **Printer Ports** dialog box.
11. Make sure the printer port you added is displayed under **Ports**, and that the port is selected.
12. Click **Close** to close the printer properties window.

## 9

## Configuring the Printer Driver Destination (Mac OS X)

Specify the printer driver destination as follows if the printer's IP address is changed, or if you will use the printer over a network connection instead of via USB connection.

- If you switch to printing in a TCP/IP network, or if the printer's IP address is changed, see "Configuring the Destination in TCP/IP Networks." →P.719
- If you switch to printing in a Bonjour network, see "Configuring the Destination for Bonjour Network." →P.721

## Configuring the Printer's TCP/IP Network Settings With RemoteUI

Follow the steps below to configure the TCP/IP network settings.

### When using an IPv4 IP address

1. Start the web browser and enter the following URL in the **Location** (or **Address**) box to display the RemoteUI page.  
http://**printer IP address or name**/  
Example: http://xxx.xxx.xxx.xxx/
2. Select **Administrator Mode** and click **Logon**.

3. If a password has been set on the printer, enter the password.
4. Click **Network** in the **Device Manager** menu at left to display the **Network** page.
5. Click **Edit** in the upper-right corner of the **TCP/IPv4** group to display the **Edit TCP/IP Protocol Settings** page.
6. Refer to the TCP/IP Settings Items table to complete the settings.

TCP/IP Settings Items

Item	Details	Default Setting
<b>Use DHCP</b>	Activate this setting to use DHCP for configuring the IP address.	Off
<b>Use BOOTP</b>	Activate this setting to use BOOTP for configuring the IP address.	Off
<b>Use RARP</b>	Activate this setting to use RARP for configuring the IP address.	Off
<b>Enable DNS Dynamic Update</b>	Activate this setting to perform DNS server registration automatically.	Off
<b>Use Zeroconf Function</b>	Activate this setting to use Bonjour.	On
<b>IP Address</b>	Specify the printer's IP address.	0.0.0.0
<b>Subnet Mask</b>	Specify the printer's subnet mask.	0.0.0.0
<b>Gateway Address</b>	Specify the printer's default gateway.	0.0.0.0
<b>LPD Printing</b>	Activate this setting to use LDP Printing.	On
<b>IPP Printing</b>	Activate this setting to use IPP Printing.	On
<b>IPP Printer URI</b>	Specify the URI of the printer used for IPP printing using up to 252 characters.	printer
<b>RAW Printing</b>	Activate this setting to use Raw Printing.	On
<b>RAW Mode Bi-direction</b>	Activate this setting to use Raw mode bidirectional communication.	Off
<b>FTP Printing</b>	Activate this setting to use FTP Printing.	On
<b>Use Discovery</b>	Activate this setting to use SLP Discovery function.	On
<b>Scope</b>	Enter the SLP search range.	default
<b>SMTP Server Address</b>	Specify the SMTP server's IP address. You can also specify the SMTP server domain name, if desired.	0.0.0.0
<b>Primary DNS Server Address</b>	Specify the IP address of the primary DNS server.	0.0.0.0
<b>Secondary DNS Server Address</b>	Specify the IP address of the secondary DNS server.	0.0.0.0
<b>DNS Host Name</b>	Specify the printer host name, up to 63 characters (1–63 characters). Use single-byte letters, numbers, and - (hyphens). Do not use numbers or - for the first character or - for the last character.	NB-18GBipxxxxxx
<b>DNS Domain Name</b>	Specify the printer domain name, up to 63 characters. Use single-byte letters, numbers, - (hyphens), and . (periods). Do not use numbers, -, or . for the first character, or - or . for the last character.	blank

Item	Details	Default Setting
<b>Multicast DNS Service Name</b>	Specify the printer's Multicast DNS service name. (1–63 characters) This name will be displayed when Bonjour functions are used.	Canon iPFxxxx (xxxxxxx)

7. Click **OK** to display the **Network** page.



**Note**

- If you specify to configure the IP address using DHCP, BOOTP, or RARP, there must be a server that supports such protocol running in the network.
- If you specify to configure the IP address using DHCP, BOOTP, or RARP, the IP address obtained by this method is used first. If you cannot obtain the IP address, the address specified in **IP Address** is used.
- It takes up to two minutes to determine whether DHCP, BOOTP, or RARP are available. We recommend clearing check boxes of options you will not use.
- If you are using a DNS server, select **Enable DNS Dynamic Update** and enter the IP Address for DNS servers and DNS domain name in **Primary DNS Server Address**, **Secondary DNS Server Address** and **DNS Domain Name**, respectively.

When using an IPv6 IP address

1. Start the web browser and enter the following URL in the **Location** (or **Address**) box to display the RemoteUI page.  
http://**printer IP address or name**/  
Example: http://xxx.xxx.xxx.xxx/
2. Select **Administrator Mode** and click **Logon**.
3. If a password has been set on the printer, enter the password.
4. Click **Network** in the **Device Manager** menu at left to display the **Network** page.
5. Click **Edit** in the upper-right corner of the **TCP/IPv6** group to display the **Edit TCP/IPv6 Protocol Settings** page.
6. Refer to the TCP/IPv6 Settings Items table to complete the settings.

TCP/IPv6 Settings Items

Item	Details	Default Setting
<b>Use IPv6</b>	Activate to enable IPv6.	Off
<b>Use DHCPv6</b>	Activate when using a DHCPv6 server to acquire the IP address.	Off
<b>Use a stateless address</b>	Activate when using an IPv6-compatible router to acquire the IP address.	On
<b>Use a manual address</b>	Activate when configuring the IP address manually.	Off
<b>IP Address</b>	Enter the printer's IP address.	::



Item	Details	Default Setting
<b>Prefix Length</b>	Enter the IP address prefix length.	0
<b>Default Router Address</b>	Enter the default router address.	::
<b>Prefix Length</b>	Enter the prefix length of the default router address.	0
<b>Primary DNS Server Address</b>	Specify the IP address of the primary DNS server.	::
<b>Secondary DNS Server Address</b>	Specify the IP address of the secondary DNS server.	::
<b>Use the same host name and domain name as IPv4</b>	Activate when using the same DNS host and domain names as for IPv4.	Off
<b>DNS Host Name</b>	Specify the printer host name, up to 63 characters (1–63 characters). Use single-byte letters, numbers, and - (hyphens). Do not use numbers or - for the first character or - for the last character.	NB-18GBip6xxxxxx
<b>DNS Domain Name</b>	Specify the printer domain name, up to 63 characters. Use single-byte letters, numbers, - (hyphens), and . (periods). Do not use numbers, -, or . for the first character, or - or . for the last character.	blank
<b>Perform dynamic updating of stateful addresses</b>	Activate this setting to automatically register the stateful address with the DNS server.	Off
<b>Dynamically update the stateless address</b>	Activate this setting to automatically register the stateless address with the DNS server.	Off
<b>Dynamically update the manual address</b>	Activate this setting to automatically register the manual address with the DNS server.	Off

7. Click **OK** to display the **Network** page.



**Note**

- If you are using a DNS server, select **Enable DNS Dynamic Update** and enter the IP Address for DNS servers and DNS domain name in **Primary DNS Server Address**, **Secondary DNS Server Address** and **DNS Domain Name**, respectively.

## NetWare Settings

Configuring NetWare Network Settings .....	708
Specifying the Printer's Frame Type .....	709
Specifying NetWare Print Services .....	713
Configuring the Printer's NetWare Network Settings With RemoteUI .....	716

### Configuring NetWare Network Settings

Follow these steps to configure the network environment when using the printer in a NetWare network.



**Important**

- To configure network settings, you must be logged in with administrative rights such as **Administrator**. We recommend that your network administrator configure the network settings.

1. Configure the Ethernet frame type to be used in communication by the printer with the computer.  
For details on configuring settings, see "Specifying the Printer's Frame Type." →P.709
2. Configure the NetWare print service such as the print server and queue.  
For details on configuring settings, see "Specifying NetWare Print Services." →P.713
3. Configure the NetWare protocol details other than the frame type.  
For details on configuring settings, see "Configuring the Printer's NetWare Network Settings With RemoteUI." →P.716  
After completing the settings of this procedure, configure the settings on each computer for printing in a NetWare network.
4. Connect to the NetWare network.  
Install the NetWare client software on all computers that are to perform printing, and log in to the NetWare server or tree. For details on connecting, refer to the documentation for NetWare or your operating system.
5. Install the printer driver.  
According to the instructions of your network administrator, install the printer driver on all computers that are to perform printing. When installing, select **Network Printer** as the printer connection destination, and select the queue created when configuring the NetWare print service.
6. Configure the printer port by the following procedure. If you configured the printer connection destination while installing the printer driver, this procedure is unnecessary.
  1. Open the **Printers and Faxes** (or **Printers, Devices and Printers**) window.
  2. Right-click the icon of this printer and choose **Properties** (For Windows 7 and Windows Vista, **Printer Properties**) to open the printer properties window.
  3. Click the **Port** (or **Advanced**) tab to display the **Port** (or **Advanced**) sheet.
  4. Configure the print destination port to the print queue created when configuring the NetWare print service.

## Specifying the Printer's Frame Type

To enable communication between the printer and computers on your network, specify the Ethernet frame type in your NetWare environment.

Follow the steps below to specify the frame type by using imagePROGRAF Device Setup Utility or the printer Control Panel.



### Important

- Before specifying the frame type, make sure the printer is on and connected to the network.



### Note

- You can specify the frame type by using RemoteUI if the printer's IP address is configured.
- For instructions on installing imagePROGRAF Device Setup Utility, see "Installing imagePROGRAF Device Setup Utility." →P.407 .

## Specifying the frame type using imagePROGRAF Device Setup Utility

1. Start imagePROGRAF Device Setup Utility.

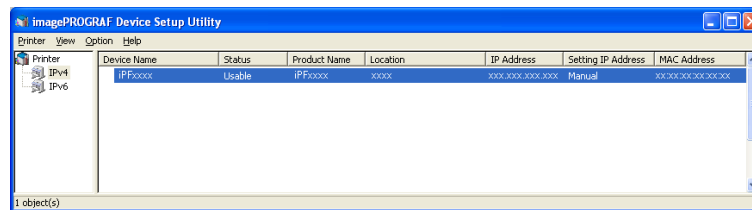

2. In the list of printers, select the printer to configure.
3. Choose **Protocol Settings** from the **Printer** menu.

4. Click the **NetWare** tab and select the frame type in the **NetWare Frame Type** list.

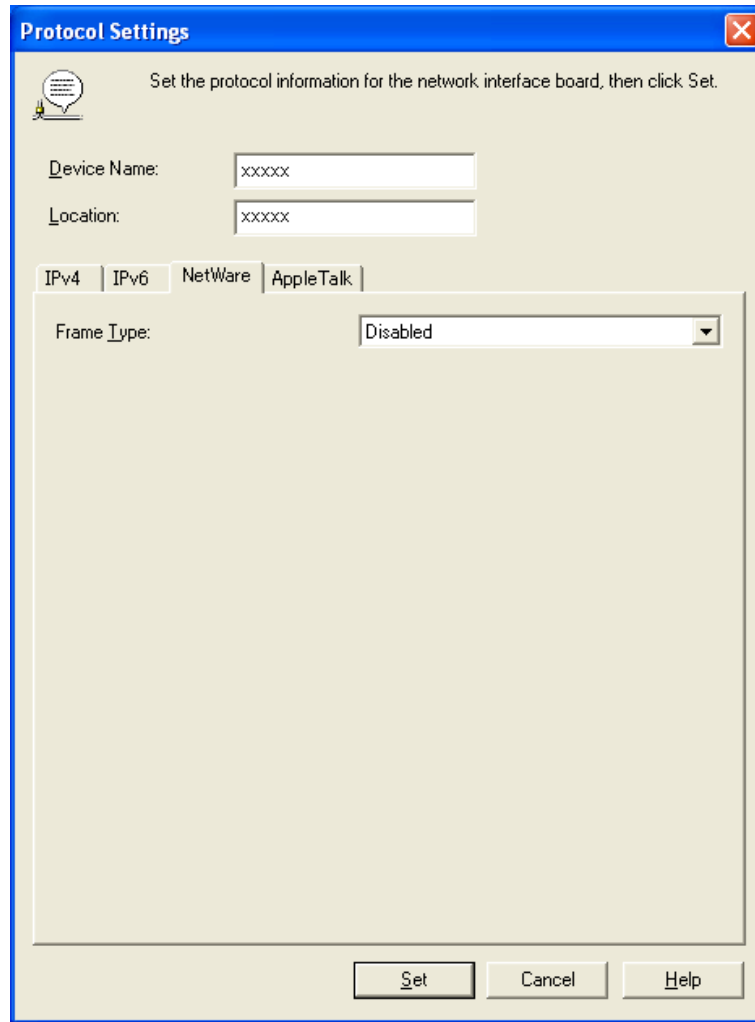

5. Select the **IPv4** tab. In **IP Address**, enter the IP address assigned to the printer, and then enter the subnet mask in **Subnet Mask** and the default gateway in **Gateway Address**.



#### Important

- You must specify the IP address here to be able to configure NetWare protocol settings using RemoteUI.

6. Click **Set**.
7. Click **OK** after the **Confirmation** message is displayed.
8. Exit imagePROGRAF Device Setup Utility.

## Specifying the frame type using the printer Control Panel

1. On the **Tab Selection screen** of the Control Panel, press ◀ or ▶ to select the Settings/Adj. tab (  ).

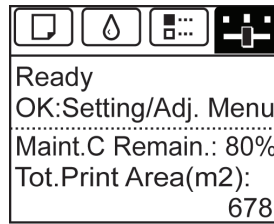
**Note**

- If the **Tab Selection screen** is not displayed, press the **Menu** button.

2. Press the **OK** button.  
The **Set./Adj. Menu** is displayed.
3. Press ▲ or ▼ to select **Interface Setup**, and then press the **OK** button.
4. Press ▲ or ▼ to select **NetWare**, and then press the **OK** button.
5. Press ▲ or ▼ to select **NetWare**, and then press the **OK** button.
6. Press ▲ or ▼ to select **On**, and then press the **OK** button.  
The display reverts to the **NetWare** menu.
7. Press ▲ or ▼ to select **Frame Type**, and then press the **OK** button.
8. Press ▲ or ▼ to select the frame type to use, and then press the **OK** button.  
The display reverts to the **NetWare** menu.
9. Press ▲ or ▼ to select **Print Service**, and then press the **OK** button.
10. Press ▲ or ▼ to select the desired print service, and then press the **OK** button.  
The display reverts to the **NetWare** menu.

- 11.** Press the **Menu** button.  
If any of the settings is changed, a confirmation message is displayed. In this case, press the **OK** button.

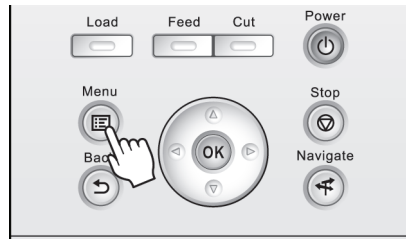

#### Important

- Be sure to complete step 11. This will activate the values you have entered.



#### Note

- If an error message is displayed, check the settings and correct any invalid values.
- To cancel this process, press the **Stop** button.

## Specifying NetWare Print Services

Before printing in a NetWare network, you must configure print services such as print servers, print queues, and so on. You can configure the print service settings from a computer using any of the following Novell software provided with NetWare.

- NWADMIN
- PCONSOLE



#### Important

- If you use NWADMIN to configure the print service settings, Novell Client (the Novell NetWare client software) must be installed as the client software application.
- NetWare networking is unsupported in Windows Vista, Windows Server 2008 and Windows 7.

This topic gives instructions for configuring NetWare print services. The order of this procedure may vary depending on the environment.

## Choosing the type of print services

Before completing print service settings, choose the type of print service. Refer to the following descriptions as needed.



#### Note

- In NetWare 5.1 or 6.0, NDPS may also be used as the print service. If you use NDPS, use the Novell printer gateway included with NetWare. For details on configuring NDPS, refer to the NetWare documentation.

- NDS (Novell Directory Service) and bindery  
NDS and bindery are both supported. Use the mode that is compatible with your network environment.
- Queue server mode and remote printer mode  
Queue server mode and remote printer mode are both supported.
  - Queue server mode

When using queue server mode, all print server functions are supported, so there is no need for other print server software or hardware. In NDS queue server mode (NDS PServer), the NDS print server is used for printing. In bindery queue server mode (Bindery PServer), the bindery print server is used for printing. Note that if you use queue server mode, a NetWare user license is required for each network interface.

- Remote printer mode

In remote printer mode, the printer is controlled by the NetWare print server. Thus, a NetWare print server is required. In NDS remote printer mode (NPrinter), the NDS print server is used for printing, and in bindery remote printer mode (RPrinter), the bindery print server is used for printing.

## Using NWADMIN or PCONSOLE to set up the print server

Use NWADMIN to set up the print server if NDS queue server mode or remote printer mode is used.

1. Log into NetWare as Administrator or with equivalent rights, and then start NWADMIN.
2. Run Quick Setup.
  1. Choose **Print Services Quick Setup** in the **Tools** menu.
  2. Enter a desired name in **Print Server Name**. To use an existing print server, click the button at right and choose the name from the list.
  3. Enter a desired printer name in **Name**.
  4. To use the printer in queue server mode, choose **Other/Unknown** in **Type**. To use the printer in remote printer mode, choose **Parallel** in **Type**, click **Communications**, and set **Ports** to **LPT1** and **Connection Type** to **Manual Load**.
  5. Enter a desired queue name in **Name**.
  6. In **Volume**, enter the volume object (that is, the object representing the physical volume on the network) where the print queue will be created. Click the button at right to choose from a list.
  7. Complete other settings as needed and click **OK**.



### Note

- The print server name will be required when configuring the printer's protocol settings. Write down the print server name for future reference.
- When running Quick Setup, the printer is assigned printer number 0. When using the printer in queue server mode, do not change the printer number from 0.

3. Set a password.

1. Right-click the print server created in step 2 and choose **Details**.
2. Click **Change Password** to open the password input dialog box. Enter the password.
3. Click **OK** to close the password input dialog box.
4. Click **OK** or **Cancel** to close the details dialog box.



4. To use the printer in remote printer mode, start the print server.  
To use the NetWare file server as the print server, enter **LOAD PSERVER.NLM** at the file server and press the Enter key.



**Note**

- This procedure is not required when using queue server mode.

Use PCONSOLE to set up the print server if bindery queue server mode or remote printer mode is used.

1. Log into NetWare as Admin and start PCONSOLE.
2. Switch to bindery mode.
3. If the print server has not been created, create it.
  1. In **Available Options**, select **Quick Setup**, and press the Enter key.
  2. Enter the name of the new print server, the new printer, and the queue.



**Note**

- The print server name will be required when configuring the printer's protocol settings. Write down the print server name for future reference.

4. Specify the printer type.
  1. To use the printer in queue server mode, choose **Other/Unknown** in **Type**. To use remote printer mode, set **Printer Type** to **Parallel** and **Position** to **Manual Load**.
  2. Press the Esc key.
  3. After the confirmation message is displayed, choose **Yes** and press the Enter key.
5. Set a password.
  1. In **Available Options**, select **Print Servers** and press the Enter key.
  2. Select the print server created in step 2 and press the Enter key.
  3. Select **Password**, and press the Enter key to display the password input dialog box.
  4. Enter the password and press the Enter key.
6. Press the Esc key several times to display the dialog box for confirming that PCONSOLE is finished.
7. Click **Yes** to exit PCONSOLE.

## Configuring the Printer's NetWare Network Settings With RemoteUI

Follow the steps below to configure NetWare protocol settings other than the frame type by using RemoteUI.



**Note**

- For details on RemoteUI, see "Using RemoteUI." →P.696

1. Start the web browser and enter the following URL in the **Location** (or **Address**) box to display the RemoteUI page.  
 http://printer IP address or name/  
 Example: http://xxx.xxx.xxx.xxx/
2. Select **Administrator Mode** and click **Logon**.
3. If a password has been set on the printer, enter the password.
4. Click **Network** in the **Device Manager** menu at left to display the **Network** page.
5. Click **Edit** in the upper-right corner of the **NetWare** group to display the **Edit NetWare Protocol Settings** page.
6. Refer to the NetWare Settings Items table to complete the settings.

NetWare Settings Items

Item	Details	Default Setting
<b>Frame Type</b>	Specify the type of frame to use in NetWare.	Disabled
<b>NCP Burst Mode</b>	Activate this setting to use NCP Burst Mode. This mode supports fast data transfer when printing in queue server mode. Normally, leave the setting On.	On
<b>Print Application</b>	Choose the print service. The print service selected here is enabled. Multiple print services cannot be enabled simultaneously. <ul style="list-style-type: none"> <li>• <b>Bindery PServer</b></li> <li>• <b>RPrinter</b></li> <li>• <b>NDS PServer</b></li> <li>• <b>NPrinter</b></li> </ul>	NDS PServer
<b>Packet Signature</b>	Select <b>If Requested by Server</b> to use packet signature.	<b>If Requested by Server</b>
<b>Bindery PServer</b>	<b>File Server Name</b> Specify the name of a file server that has a NetWare print server. (0–47 characters)	—
	<b>Print Server Name</b> Specify the name of a NetWare print server. (0–47 characters)	—
	<b>Print Server Password</b> Set a password for the print server. (0–20 characters)	—
	<b>Polling Interval</b> Specify the interval to confirm jobs.	5

Item		Details	Default Setting
<b>Bindery PServer</b>	<b>Polling Interval</b>	(1–15 seconds)	5
<b>RPrinter</b>	<b>Print Server Name</b>	Specify the name of a NetWare print server. (0–47 characters)	—
	<b>Printer Number</b>	Specify the number of the printer connected to the NetWare print server. (0–15)	0
<b>NDS PServer</b>	<b>Tree Name</b>	Specify the name of an NDS tree that has a NetWare print server. (0–32 characters)	—
	<b>Context Name</b>	Specify the name of a context that has a NetWare print server. (0–255 characters)	—
	<b>Print Server Name</b>	Specify the name of a NetWare print server. (0–64 characters)	—
	<b>Print Server Password</b>	Set a password for the print server. (0–20 characters)	—
	<b>Polling Interval</b>	Specify the interval to confirm jobs. (1–255 seconds)	5
<b>NPrinter</b>	<b>Print Server Name</b>	Specify the name of a NetWare print server. (0–47 characters)	—
	<b>Printer Number</b>	Specify the number of the printer connected to the NetWare print server. (0–254)	0

## 7. Complete the following settings based on the selected service.

- If you have selected Bindery PServer: Queue Server Mode (Using a Bindery Print Server)
  1. In **File Server Name**, enter the file server name.
  2. In **Print Server Name**, enter the name of the print server created in "Specifying NetWare Print Services →P.713 ."
  3. In **Print Server Password**, enter the password of the print server created in "Specifying NetWare Print Services →P.713 ."
  4. In **Polling Interval**, specify the interval at which the printer checks the NetWare print queue.
- If you have selected RPrinter: Remote Printer Mode (Using a Bindery Print Server)
  1. In **Print Server Name**, enter the advertising name of the print server created in "Specifying NetWare Print Services →P.713 ."
  2. In **Printer Number**, enter the same printer number specified in "Specifying NetWare Print Services →P.713 ."
- If you have selected NDS PServer: Queue Server Mode (Using an NDS Print Server)
  1. In **Tree Name** and **Context Name**, enter the tree and context name of the print server.
  2. In **Print Server Name**, enter the name of the print server created in "Specifying NetWare Print Services →P.713 ."

- 3.** In **Print Server Password**, enter the password of the print server created in "Specifying NetWare Print Services →P.713 ."
  - 4.** In **Polling Interval**, specify the interval at which the printer checks the NetWare print queue.
  - If you have selected NPrinter: Remote Printer Mode (Using a NDS Print Server)
    - 1.** In **Print Server Name**, enter the advertising name of the print server created in "Specifying NetWare Print Services →P.713 ." Usually, the advertising name is the same as the name of the print server.
    - 2.** In **Printer Number**, enter the same printer number specified in "Specifying NetWare Print Services →P.713 ."
- 8.** Click **OK** to display the **Network** page.

## Mac OS X Settings

Configuring the Destination in TCP/IP Networks .....	719
Configuring the Destination for Bonjour Network .....	721
Configuring the Destination for AppleTalk Networks .....	723
Configuring the Printer's AppleTalk Network Settings .....	725

### Configuring the Destination in TCP/IP Networks

Follow these steps to configure the destination when using the printer in a TCP/IP network.



#### Important

- If you use the printer in a TCP/IP network, make sure the printer's IP address is configured correctly. (See "Configuring the IP Address Using the Printer Control Panel.") →P.700

### Configuring the Destination (Mac OS X)

1. Navigate to **Applications > Canon Utilities > imagePROGRAF PrinterSetup** and double-click **imagePROGRAF PrinterSetup.app**.
2. Click **Next**.

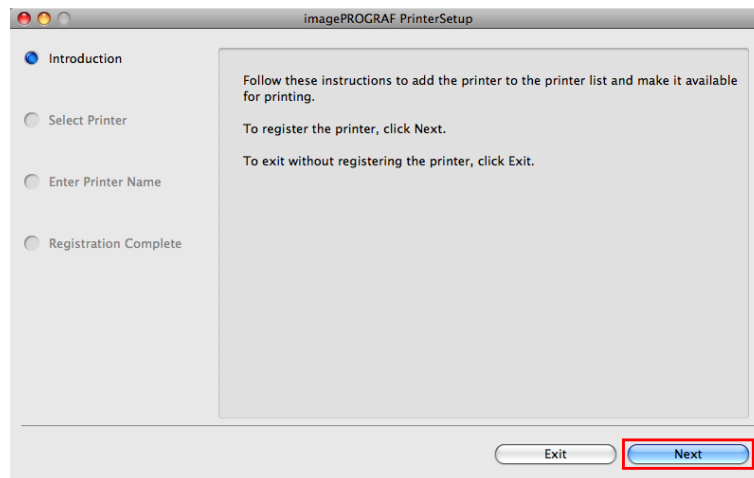

### 3. Click **Registering IP Address**.

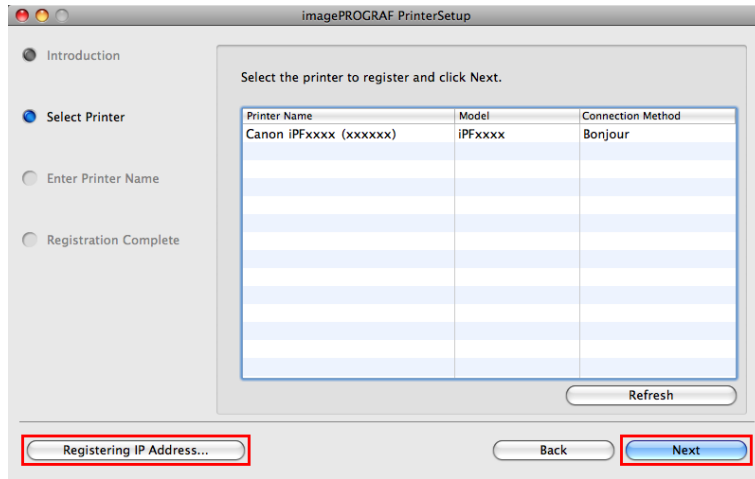

### 4. Select the model and type and then enter the IP address before clicking the **Next** button.

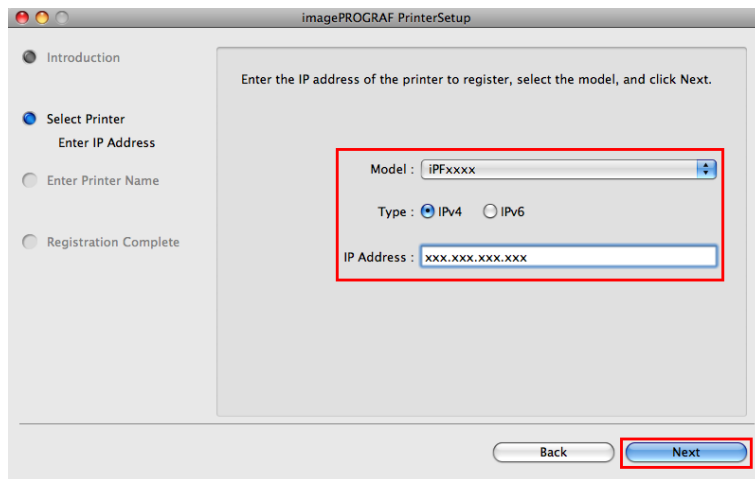

### 5. Complete **Printer Name** and **Location** as desired and click **Register**.

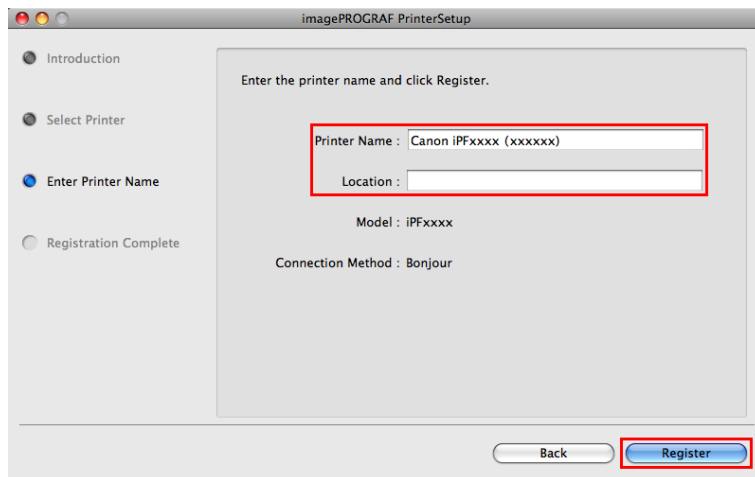

9

720

## 6. Click **Finish**.

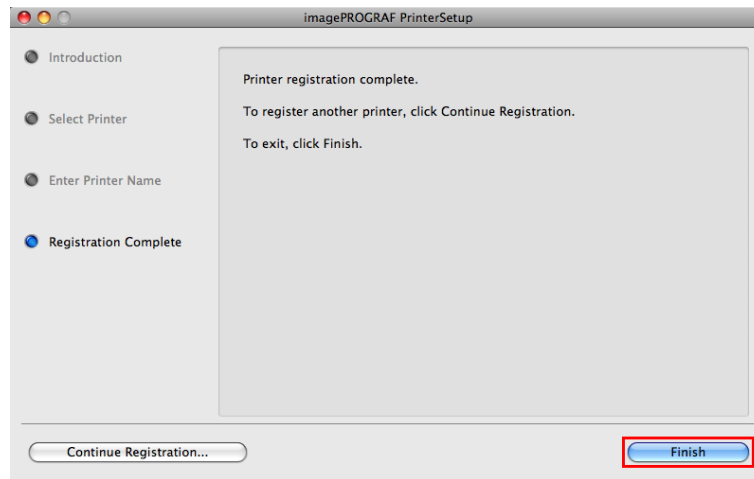

## Configuring the Destination for Bonjour Network

Follow the steps below to configure the destination if you are using the printer in a network that uses the Bonjour function.



### Important

- Bonjour and **IP Print (Auto)** do not support printing to a printer on other network groups that require a router for connection. Make sure the computer and printer are on the same network. For information about network settings, ask your network administrator.
- By default, Bonjour is activated on the printer. You can activate or deactivate the Bonjour function or change the printer name by using RemoteUI. For instructions on changing it, see "Using RemoteUI." →P.696

1. Navigate to **Applications > Canon Utilities > imagePROGRAF PrinterSetup** and double-click **imagePROGRAF PrinterSetup.app**.

2. Click **Next**.

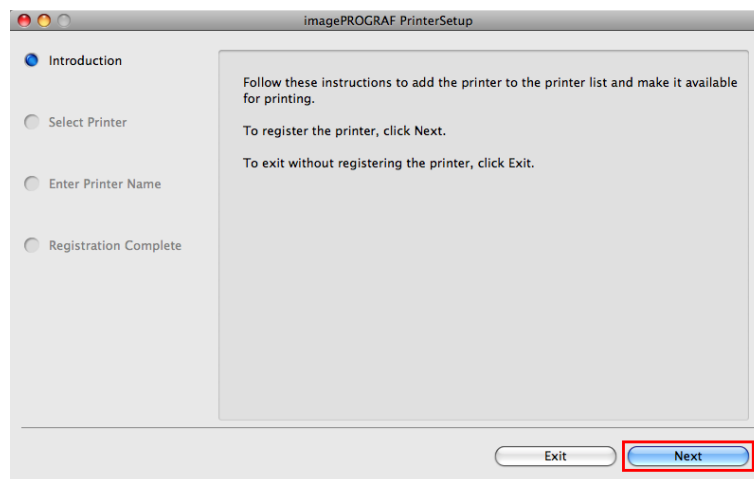

**3.** Select the printer to register and click **Next**.

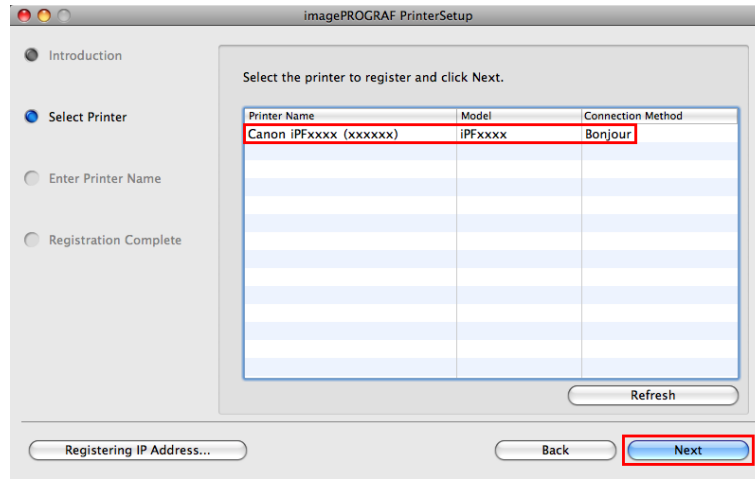

**4.** Complete **Printer Name** and **Location** as desired and click **Register**.

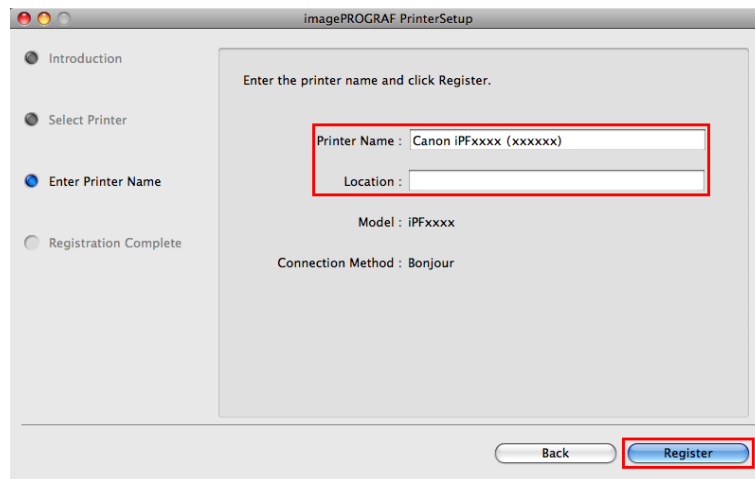

**5.** Click **Finish**.

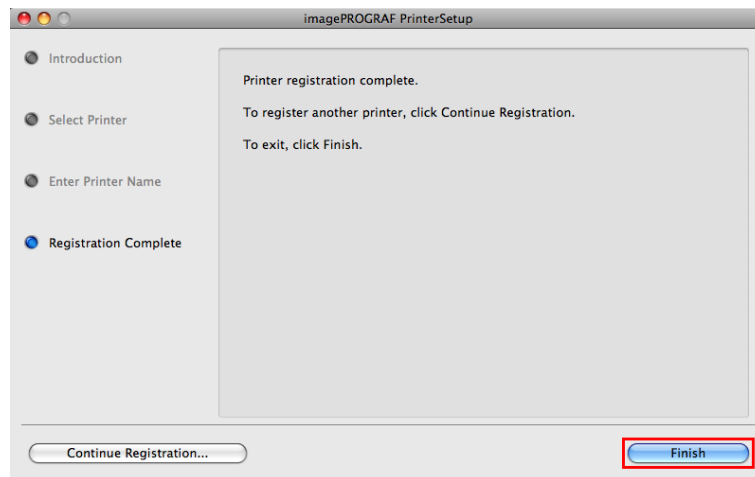

9

722



## Configuring the Destination for AppleTalk Networks

To print over an AppleTalk network, activate the AppleTalk protocol and configure the destination as follows.

### Activating AppleTalk on the printer



#### Important

- By factory default, the AppleTalk protocol is disabled on the printer.

1. On the **Tab Selection screen** of the Control Panel, press ◀ or ▶ to select the Settings/Adj. tab (  ).

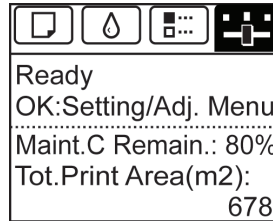

#### Note

- If the **Tab Selection screen** is not displayed, press the **Menu** button.

2. Press the **OK** button.  
The **Set./Adj. Menu** is displayed.
3. Press ▲ or ▼ to select **Interface Setup**, and then press the **OK** button.
4. Press ▲ or ▼ to select **AppleTalk**, and then press the **OK** button.
5. Press ▲ or ▼ to select **On**, and then press the **OK** button.
6. Press the **Menu** button.  
If any of the settings is changed, a confirmation message is displayed. In this case, press the **OK** button.

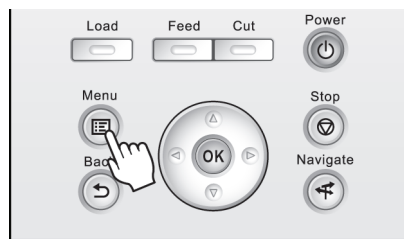

#### Important

- Be sure to complete step 6. This will activate the values you have entered.



**Note**

- By using RemoteUI, you can also specify the object name used for AppleTalk, as well as the printer zone name.  
For details on RemoteUI, see "Using RemoteUI." →P.696

**Configuring the Destination (Mac OS X)**



**Important**

- AppleTalk is supported in Mac OS X 10.2.8–10.4.



**Note**

- The following procedures are based on Mac OS X 10.4. The method of configuring the destination varies depending on the version of Mac OS X.
- The imagePROGRAF printer driver is not compatible with AppleTalk.

1. In **System Preferences**, click **Network** to display the **Network** window.
2. In **Show**, choose **Built-in Ethernet**. Next, click **AppleTalk**, select **Make AppleTalk Active**, and click **Apply now**.

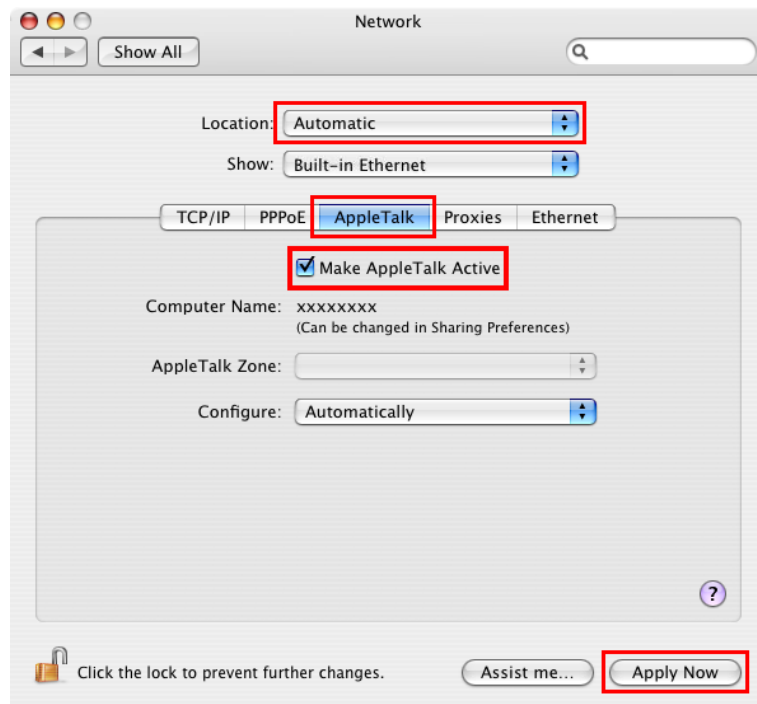

3. Close the **Network** window and save the settings.

## Configuring the Printer's AppleTalk Network Settings

Follow the steps below to configure the AppleTalk network settings.

1. Start the web browser and enter the following URL in the **Location** (or **Address**) box to display the RemoteUI page.  
http://printer IP address or name/  
Example: http://xxx.xxx.xxx.xxx/
2. Select **Administrator Mode** and click **Logon**.
3. If a password has been set on the printer, enter the password.
4. Click **Network** in the **Device Manager** menu at left to display the **Network** page.
5. Click **Edit** in the upper-right corner of the **AppleTalk** group to display the **Edit AppleTalk Protocol Settings** page.
6. Refer to the AppleTalk Settings Items table to complete the settings.

AppleTalk Settings Items

Item	Details	Default Setting
<b>Phase Type</b>	Specify whether to use AppleTalk. If you will use AppleTalk, choose <b>Phase 2</b> . If you will not use AppleTalk, choose <b>Disabled</b> .	Disabled
<b>Name (*1)</b>	Specify the object name used by AppleTalk (in up to 31 single-byte or 15 double-byte characters). However, do not use the following single-byte characters: @, *, :, and =.	Canon NB-18GB (xxxxxx)
<b>Zone (*2)</b>	Specify the printer zone name, up to 31 single-byte characters. However, do not use the following single-byte characters: Also avoid using * (which represents the default zone) in the middle of a string.	*

\*1: The object name you have specified in **Name** is displayed in **Printer Setup Utility** (or **Print Center**) in Mac OS X 10.2.8–10.4. If you use multiple printers in the same zone, assign a unique name to each printer. By default, the network interface name is **Canon NB-18GB (xxxxxx)**. (Here, xxxxxx is the last six digits of the printer's MAC address.)

\*2: If zones have been created on the network, enter the name of the printer's zone. If there are no zones, leave the asterisk \* entry (for the default zone) as it is. If you enter a network zone name that does not match created zones, the printer will not be detected by Macintosh computers. Consult your network administrator for information on zone names.

7. Click **OK** to display the **Network** page.

## Other Settings

Specifying Printer-Related Information ..... 726  
 Configuring the Communication Mode Manually ..... 727  
 Email Notification When Printing is Finished or Errors Occur ..... 728  
 Initializing the Network Settings ..... 729

### Specifying Printer-Related Information

Follow the steps below to specify device information and security settings.

1. Start the web browser and enter the following URL in the **Location** (or **Address**) box to display the RemoteUI page.  
 http://printer IP address or name/  
 Example: http://xxx.xxx.xxx.xxx/
2. Select **Administrator Mode** and click **Logon**.
3. If a password has been set on the printer, enter the password.
4. Click **Information** in the **Device Manager** menu at left to display the **Information** page.
5. To display the relevant settings page, click **Edit** in the upper-right corner of **Device Information** or **Security**, depending on what information you want to specify.  
 To change the administrator password, click the **Change Password** button in the **Security** group.
6. Refer to the table of settings for device information and security as you complete these settings.  
 Security setting items are displayed when you click the **Change Password** button in the **Security** group.

Device Information Settings

Item	Details	Default Setting
<b>Device Name</b>	Enter a device name. (0–32 characters)	blank
<b>Location</b>	Enter the location where the device is installed. (0–32 characters)	blank
<b>Administrator</b>	Enter the administrator's name. (0–32 characters)	blank
<b>Phone</b>	Enter the administrator's contact information. (0–32 characters)	blank
<b>Comments(E-mail)</b>	Enter any comments regarding the administrator. (0–32 characters)	blank

## Security Settings

Item	Details	Default Setting
<b>New Password</b>	Enter the new password. (0-9999999)	blank
<b>Confirm</b>	Enter the new password again to confirm it. (0-9999999)	blank

\*1: On the **Security** settings screen, besides entering a password, you can specify other security-related information, such as IP address-based SNMP or TCP usage restrictions, MAC address-based access restrictions, or IPP and FTP authentication settings.

7. Click **OK** to activate the settings.

## Configuring the Communication Mode Manually

This topic gives instructions for configuring the communication mode manually.

1. On the **Tab Selection screen** of the Control Panel, press ◀ or ▶ to select the Settings/Adj. tab (  ).

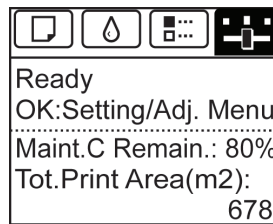

### Note

- If the **Tab Selection screen** is not displayed, press the **Menu** button.

2. Press the **OK** button.  
The **Set./Adj. Menu** is displayed.
3. Press ▲ or ▼ to select **Interface Setup**, and then press the **OK** button.
4. Press ▲ or ▼ to select **Ethernet Driver**, and then press the **OK** button.
5. Press ▲ or ▼ to select **Auto Detect**, and then press the **OK** button.
6. Press ▲ or ▼ to select **Off**, and then press the **OK** button.  
The display reverts to the **Ethernet Driver** menu.
7. Press ▲ or ▼ to select **Comm.Mode**, and then press the **OK** button.

8. Press ▲ or ▼ to select the communication mode, and then press the **OK** button.  
The display reverts to the **Ethernet Driver** menu.
9. Press ▲ or ▼ to select **Ethernet Type**, and then press the **OK** button.
10. Press ▲ or ▼ to select the Ethernet type, and then press the **OK** button.  
The display reverts to the **Ethernet Driver** menu.
11. Press ▲ or ▼ to select **Spanning Tree**, and then press the **OK** button.
12. Press ▲ or ▼ to enable or disable spanning tree support, and then press the **OK** button.  
The display reverts to the **Ethernet Driver** menu.
13. Press the **Menu** button.  
After the confirmation message is displayed, press the **OK** button.  
The new settings will take effect after the printer restarts.

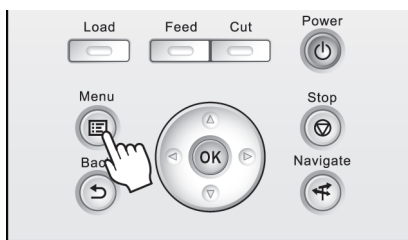

### Email Notification When Printing is Finished or Errors Occur

The printer can notify you of the printer status by email. Even when you are away from the printer, you can know when printing is finished or if errors occur. Receive notification via email on your mobile phone or at your computer.

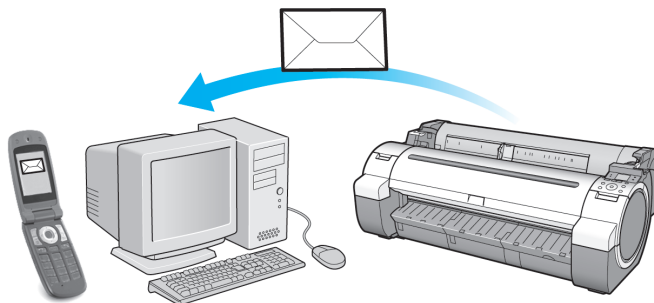

Use the imagePROGRAF Status Monitor (Windows) function to set up email recipients and message timing. Besides being informed of finished print jobs or errors, you can also complete settings for email notification when service is needed or it's time to replace consumables. For detailed instructions, see "Specifying Printer-Related Information." →P.726

**Note**

- For details on email notification using imagePROGRAF Status Monitor (in Windows), refer to the imagePROGRAF Status Monitor help.
- Mail server authentication is only supported with imagePROGRAF Status Monitor.

## Initializing the Network Settings

Use RemoteUI to restore the network settings to the default values as follows.

**Important**

- Initializing the network settings will also restore the default value of the printer's IP address. As a result, the RemoteUI page cannot be displayed in the web browser after this procedure.
- For instructions on reconfiguring the IP address, see "Configuring the IP Address on the Printer." →P.699
- For details on RemoteUI, see "Using RemoteUI." →P.696

1. Start the web browser and enter the following URL in the **Location** (or **Address**) box to display the RemoteUI page.  
http://printer IP address or name/  
Example: http://xxx.xxx.xxx.xxx/
2. Select **Administrator Mode** and click **Logon**.
3. If a password has been set on the printer, enter the password.
4. Click **Network** in the **Device Manager** menu at left to display the **Network** page.
5. Click **Reset to Default settings** in the lower-right corner of the **Network Interface** group.
6. After confirming the message, click **OK** to restore the network settings to the default values.

**Note**

- You can also use imagePROGRAF Device Setup Utility or the Control Panel to restore the default network settings.

## Maintenance and Consumables

Ink Tanks	731
Printheads	739
Maintenance Cartridge	749
Cleaning the Printer	756
Other Maintenance	762
Consumables	767

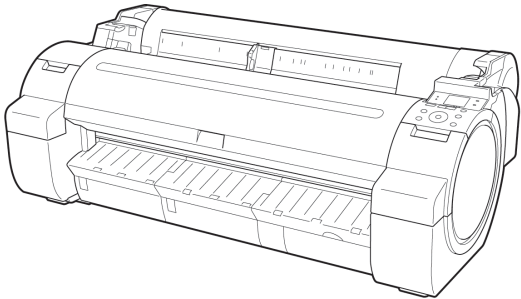



## Ink Tanks

Ink Tanks .....	731
Replacing Ink Tanks .....	731
Checking Ink Tank Levels .....	736
When to Replace Ink Tanks .....	737

## Ink Tanks

When purchasing ink tanks, make sure a **J** is printed on the label, along with the following Ink Tank serial numbers.

- 130 ml (4.4 fl oz) per color

- BK Ink Tank PFI-102BK
- MBK Ink Tank PFI-102MBK
- C Ink Tank PFI-102C
- M Ink Tank PFI-104M
- Y Ink Tank PFI-102Y

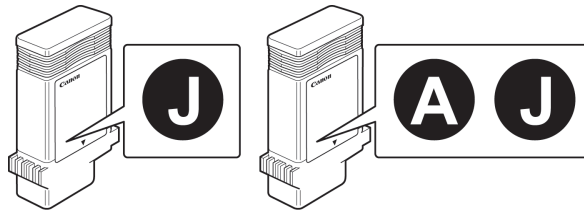

### Note

- For instructions on ink tank replacement, see "Replacing Ink Tanks." →P.731
- You can also use ink tanks other than M Ink Tank PFI-104M that are simply labeled **A**.

10

## Replacing Ink Tanks

### Compatible ink tanks

Ink tanks that can be used in the printer are labeled with a white letter **J** in a black circle on the side. Request ink tanks with the same label when you purchase new ones. For details, see "Ink Tanks." →P.731

### Precautions when handling ink tanks

Take the following precautions when handling ink tanks.



### Caution

- For safety, keep ink tanks out of the reach of children.
- If ink is accidentally ingested, contact a physician immediately.
- There may be ink around the ink supply section of ink tanks you removed. Handle ink tanks carefully during replacement. The ink may stain clothing.

731



**Important**

- Do not install used ink tanks in another model of printer. This will prevent correct ink level detection, which may damage the printer or cause other problems.
- We recommend using up an Ink Tank in the course of printing within six months after breaking the seal. Printing quality may be affected if you use older ink tanks.
- Do not leave the printer without ink tanks installed for extended periods (a month or more). Residual ink may become clogged inside the printer and affect printing quality.

**Make sure the printer is ready for Ink Tank replacement**

You can replace ink tanks if the Display Screen advises you to check the amount of ink left or replace ink tanks.

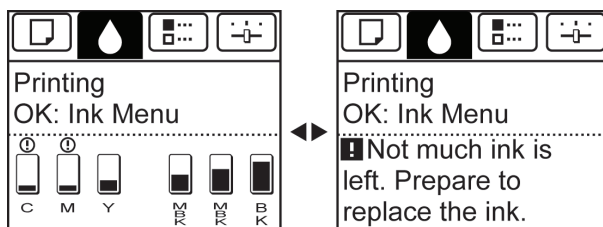

If a message requests you to replace an Ink Tank, press the **OK** button. In this case, you can skip the step **Access the menu for ink tank replacement**. Follow the instructions in **Remove the ink tanks**.

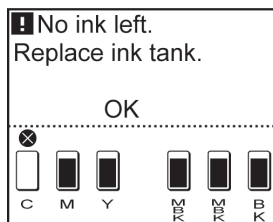

**Important**

- Do not remove an Ink Tank during initialization immediately after turning on the printer, or during printhead cleaning.



**Note**

- Ink Tank replacement is possible even during printing, when print jobs are being canceled, or when paper is being advanced.

**Access the menu for Ink Tank replacement**

1. On the **Tab Selection screen** of the Control Panel, press ◀ or ▶ to select the Ink tab (  ).

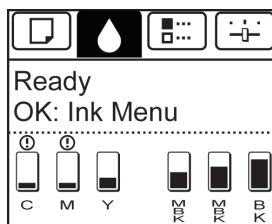

**Note**

- If the **Tab Selection** screen is not displayed, press the **Menu** button.

2. Press the **OK** button.  
The **Ink Menu** is displayed.
3. Press **▲** or **▼** to select **Rep. Ink Tank**, and then press the **OK** button.  
A message on the Display Screen requests you to open the Ink Tank Cover. Remove the Ink Tank at this point.

## Remove the Ink Tank

1. Open the Ink Tank Cover and check the ink lamps.  
Ink lamps flash when there is little ink left.

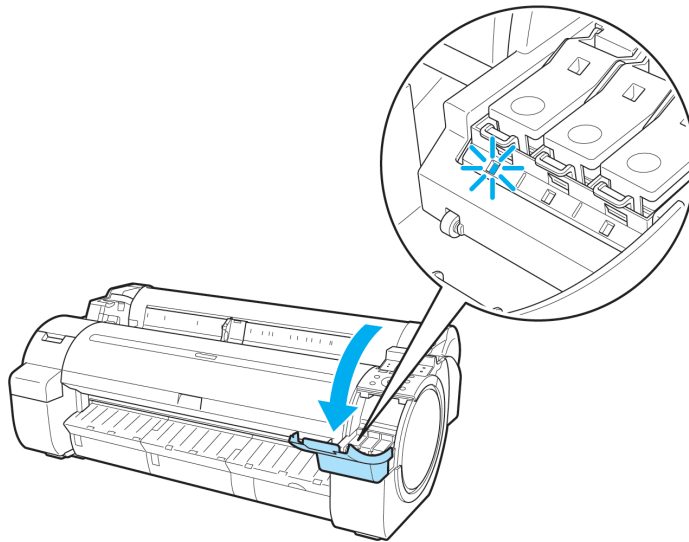

2. Press the tip of the Ink Tank Lock Lever of the color for replacement horizontally and pull the Ink Tank Lock Lever up to open it.

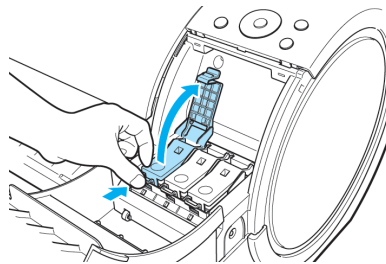

3. Hold the Ink Tank by the grips and remove it. Press the **OK** button.

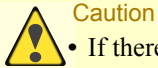
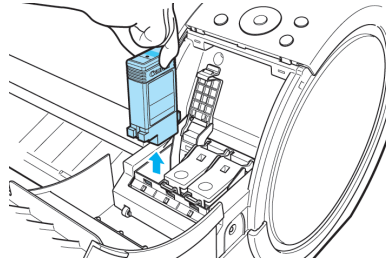

**Caution**

- If there is still ink in the Ink Tank you removed, store it with the ink holes (a) facing up. Otherwise, ink may leak and cause stains. Put the Ink Tank in a plastic bag and seal it.

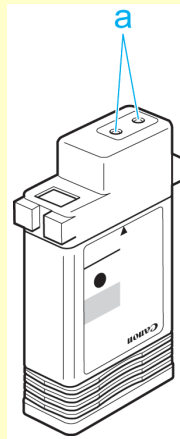

**Note**

- Dispose of used ink tanks according to local regulations.

### Install the ink tanks

1. Before opening the pouch, gently agitate the Ink Tank once or twice. Agitate the ink in the Ink Tank by slowly rotating the Ink Tank upside-down and right side up repeatedly.

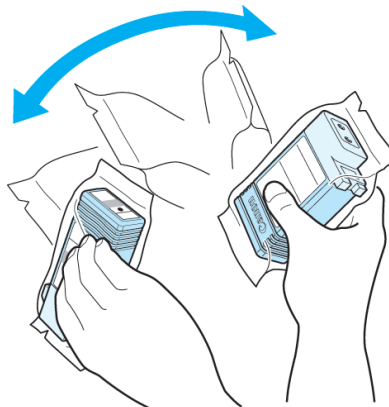

**Caution**

- Do not remove and agitate ink tanks that have already been installed in the printer. Ink may leak out.

**Important**

- If you do not agitate the Ink Tank, the ink may settle, which may affect printing quality.

2. Open the pouch and remove the Ink Tank.

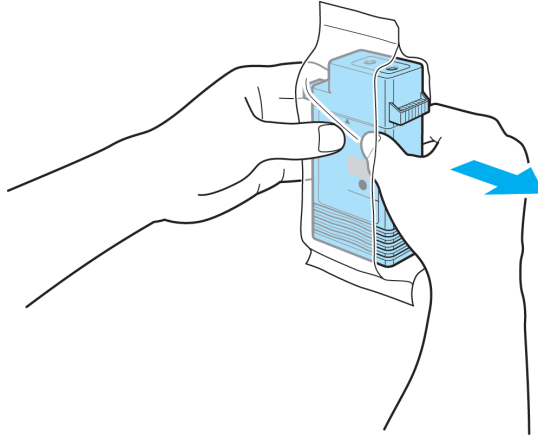
**Caution**

- Never touch the ink holes or electrical contacts. This may cause stains, damage the Ink Tank, and affect printing quality.

3. Press the **OK** button and insert the Ink Tank into the holder facing as shown, with the ink holes down.

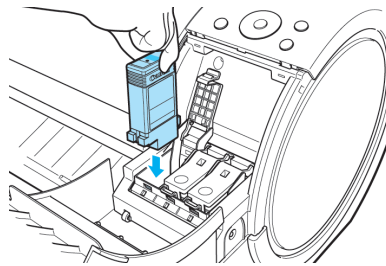
**Important**

- Ink tanks cannot be loaded in the holder if the color or orientation is incorrect. If the Ink Tank does not fit in the holder, do not force it into the holder. Make sure the color of the Ink Tank Lock Lever matches the color of the Ink Tank and check the orientation of the Ink Tank before reloading it.

4. Push the Ink Tank Lock Lever closed until it clicks into place.

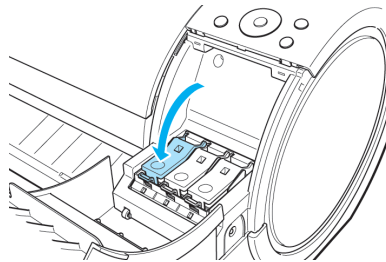

**5.** Make sure the Ink Lamp is lit in red.

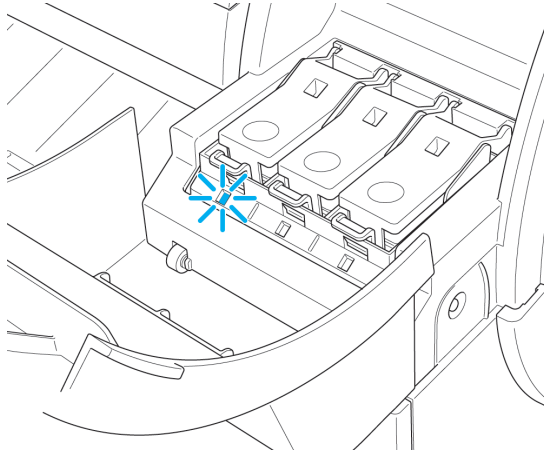

 **Note**  
• If the Ink Lamp is not lit, reload the tank.

**6.** Close the Ink Tank Cover.

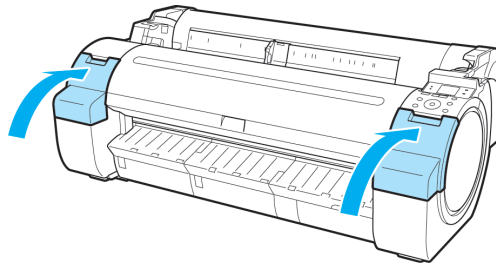

**Checking Ink Tank Levels**

On the Display Screen, you can check how much ink is left in the ink tanks.

To check remaining Ink Tank levels, access the **Tab Selection screen** on the Control Panel and press ◀ or ▶ to select the Ink tab (  ).

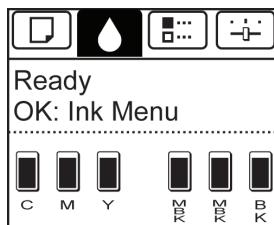

**Note**

- If the **Tab Selection screen** is not displayed, press the **Menu** button.
- If an error has occurred and the **Tab Selection screen** cannot be displayed, display **Ink Info** as follows.
  1. Press the **OK** button to display **Printer Info**.
  2. Press the **▲** or **▼** button to select **Ink Info**.
  3. Press the **OK** button.

The remaining ink levels shown on the Display Screen correspond to the inks identified by the Color Label on the bottom of the Display Screen.

These symbols may be displayed above the ink level: **!** if ink is low, **×** if no ink is left, and **?** if you have deactivated ink level detection.

The remaining ink level is indicated as shown below.

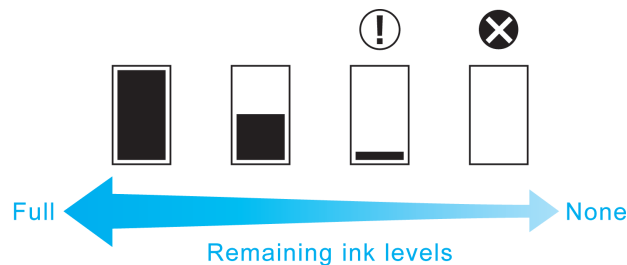

If the Display Screen indicates to replace the Ink Tank, replace the Ink Tank. If a message is displayed indicating to check the remaining ink levels, or after tasks that consume a lot of ink such as large-format printing or head cleaning, check the remaining levels and replace Ink Tank as needed. (See "Replacing Ink Tanks.") →P.731

## When to Replace Ink Tanks

Replace or prepare to replace ink tanks in the following situations.

10

### If a message for checking the ink is shown on the Display Screen

When there is little ink left, the **Message Lamp** is lit and "**Not much ink is left.**" is shown on the Display Screen. You can continue to print, but prepare to replace the Ink Tank. (See "Checking Ink Tank Levels.") →P.736

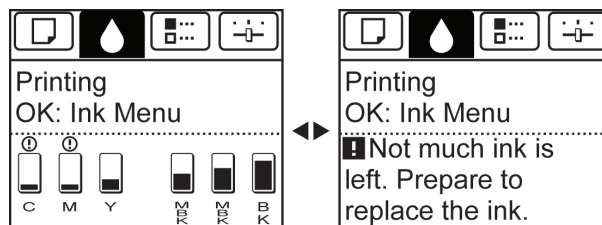

737

### Before print jobs and maintenance that consume a lot of ink

If little ink is left, there may not be enough for large-format printing, head cleaning, and maintenance, which require a lot of ink. In this case, replace or prepare to replace the Ink Tank before maintenance.

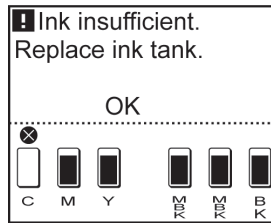

### If a message for ink replacement is shown on the Display Screen

When ink runs out, the **Message Lamp** flashes, a message regarding Ink Tank replacement is shown on the Display Screen, and printing is disabled. Replace the Ink Tank at this point.

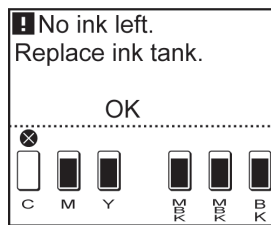



## Printheads

Printhead .....	739
Checking for Nozzle Clogging .....	739
Cleaning the Printhead .....	740
Replacing the Printhead .....	741

## Printhead

A replacement Printhead.

- Printhead PF-04

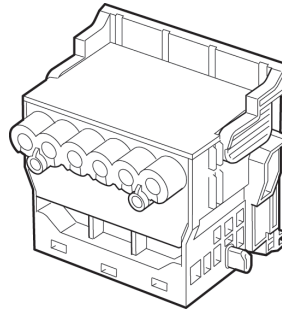

### Note

- For instructions on replacing the Printhead, see "Replacing the Printhead." →P.741

## Checking for Nozzle Clogging

If printing is faint or affected by banding in different colors, make sure the Printhead nozzles are clear by printing a test pattern to check the nozzles.



### Note

- Nozzles are periodically checked to ensure they are clear. Configure the settings on the Control Panel menu in **Nozzle Check**. (See "Menu Settings.") →P.673

**1.** Load unused paper.

- Attaching the Roll Holder to Rolls →P.575
- Loading Rolls in the Printer →P.579
- Loading Sheets in the Printer →P.602

**2.** On the **Tab Selection screen** of the Control Panel, press ◀ or ▶ to select the Settings/Adj. tab (  ).

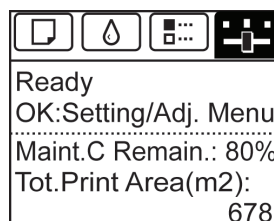

**Note**

- If the **Tab Selection screen** is not displayed, press the **Menu** button.

3. Press the **OK** button.  
The **Set./Adj. Menu** is displayed.
4. Press **▲** or **▼** to select **Test Print**, and then press the **OK** button.
5. Press **▲** or **▼** to select **Nozzle Check**, and then press the **OK** button.  
The printer now prints a test pattern for checking the nozzles.
6. Check the printing results.  
If the horizontal lines are not faint or incomplete, the nozzles are clear.

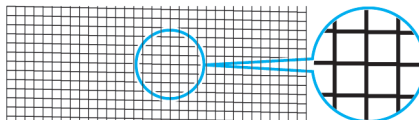

If some sections of the horizontal lines are faint or incomplete, the nozzles for those colors are clogged.

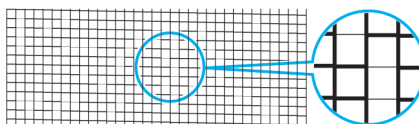

If horizontal lines are faint or incomplete, follow the steps below and check again for nozzle clogging.

1. Clean the Printhead. (See "Cleaning the Printhead.") →P.740
2. Print a test pattern to check the nozzles.

**Note**

- If you repeat these steps several times but the horizontal lines are still faint or incomplete, contact your Canon dealer.

## Cleaning the Printhead

If printing is faint, cleaning the Printhead may improve results.

Choose one of two Printhead cleaning modes ( **Head Cleaning A** or **Head Cleaning B**), depending on the problem to resolve.

- **Head Cleaning A**  
Use this mode if printing is faint or contains foreign substances. This method of cleaning consumes the least amount of ink.  
It takes about three and a half minutes to complete.
- **Head Cleaning B**  
Use this mode if no ink is ejected at all, or if **Head Cleaning A** does not solve the problem.  
It takes about four minutes to complete.

**Caution**

- Do not remove the Maintenance Cartridge or ink tanks during either **Head Cleaning A** or **Head Cleaning B**.

**Note**

- If printing does not improve after **Head Cleaning B**, try repeating **Head Cleaning B** once or twice. If this still does not improve printing, the Printhead may have reached the end of its useful life. Contact your Canon dealer for assistance.
- Nozzles are periodically checked to ensure they are clear. Configure the settings on the Control Panel menu in **Nozzle Check**. (See "Menu Settings.") →P.673

Perform cleaning as follows.

1. On the **Tab Selection screen** of the Control Panel, press ◀ or ▶ to select the Settings/Adj. tab (  ).

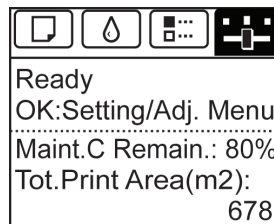
**Note**

- If the **Tab Selection screen** is not displayed, press the **Menu** button.

2. Press the **OK** button.  
The **Set./Adj. Menu** is displayed.
3. Press ▲ or ▼ to select **Maintenance**, and then press the **OK** button.
4. Press ▲ or ▼ to select **Head Cleaning**, and then press the **OK** button.
5. Press ▲ or ▼ to select **Head Cleaning A** or **Head Cleaning B**, and then press the **OK** button.  
Head cleaning is now executed.
6. Print a test pattern to check the nozzles, and determine whether cleaning has cleared the nozzles. (See "Checking for Nozzle Clogging.") →P.739

## Replacing the Printhead

### When to replace the Printhead

Replace the Printhead in the following situations.

- If the printing quality does not improve even after one or two cycles of **Head Cleaning B** from the printer menu

- If the Display Screen indicates **"Open top cover and replace the printhead."**
- If your Canon dealer has advised you to replace the Printhead

### Compatible printheads

For information on compatible printheads, see "Printhead." →P.739

### Precautions when handling the Printhead

Take the following precautions when handling the Printhead.

**Caution**

- For safety, keep the Printhead out of the reach of children.
- If ink is accidentally ingested, contact a physician immediately.
- Do not touch the Printhead immediately after printing. The Printhead becomes extremely hot, and there is a risk of burns.

**Important**

- There may be ink around the nozzles of the Printhead you remove. Handle the Printhead carefully during replacement. The ink may stain clothing.
- Do not open the Printhead pouch until immediately before installation. After removing the Printhead from the pouch, install it right away. If the Printhead is left after the pouch is opened, the nozzles may dry out, which may affect printing quality.

### Access the menu for Printhead replacement

**Caution**

- When replacing the Printhead immediately after printing, wait a few minutes before replacing it. The metal parts of the Printhead become hot during printing, and there is a risk of burns from touching these parts.

**Note**

- Prepare a new Ink Tank when ink levels are low.
- Your hands may become dirty during Printhead replacement. Use the gloves provided with the new Printhead for replacement.

1. If the roll is not ejected because of the cutting method selected, cut it manually and remove it. (See "Cutting Roll Paper After Printing.") →P.200
2. Clean inside the Top Cover. (See "Cleaning Inside the Top Cover.") →P.756
3. On the **Tab Selection screen** of the Control Panel, press ◀ or ▶ to select the Settings/Adj. tab (  ).

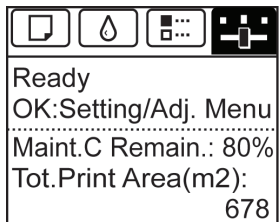

10

742

**Note**

- If the **Tab Selection screen** is not displayed, press the **Menu** button.

4. Press the **OK** button.  
The **Set./Adj. Menu** is displayed.
5. Press **▲** or **▼** to select **Maintenance**, and then press the **OK** button.
6. Press **▲** or **▼** to select **Replace P.head**, and then press the **OK** button.  
Ink is now filled.  
After about two minutes, a message is shown on the Display Screen instructing you to open the Top Cover.

**Replace the Printhead**

1. Open the Top Cover.

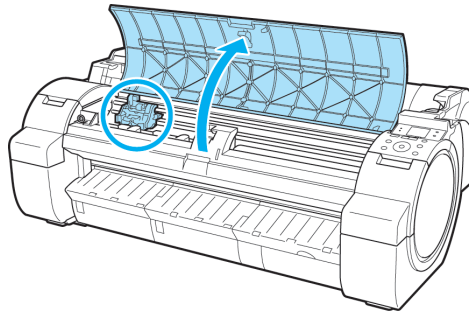

Instructions are now shown on the Display Screen regarding Printhead replacement.

**Important**

- During Printhead replacement, do not move the Carriage from the position indicated. If you accidentally move the Carriage, you will hear a warning tone, and Printhead replacement is no longer possible.  
If you move the Carriage by mistake, close the Top Cover. The Carriage will be moved to the position as indicated.

2. If the Printhead Fixer Cover or Printhead Fixer Lever is dirty, use a damp cloth that you have wrung out completely to wipe it clean.

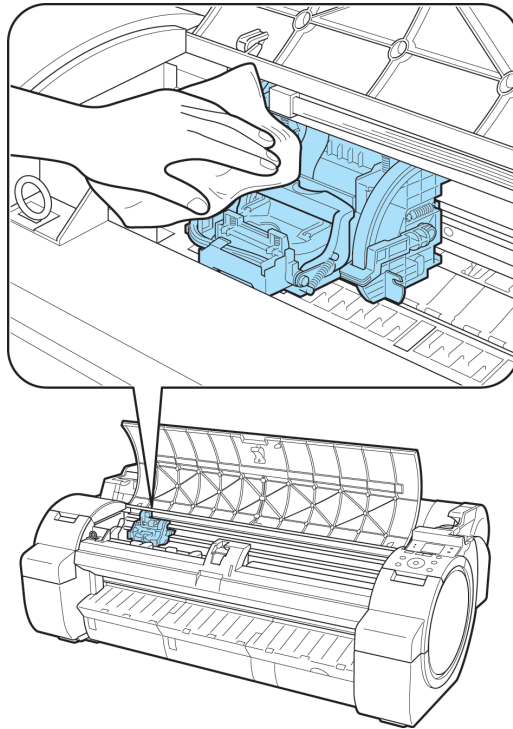

**Important**

- Do not touch the Linear Scale (a) or Carriage Shaft (b). Touching these parts may damage them.

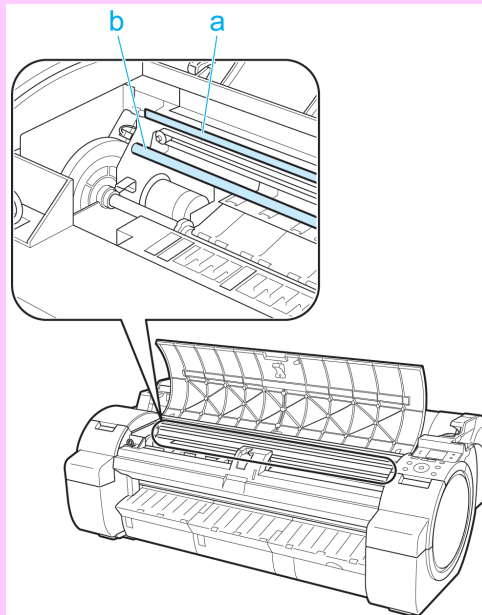

- Never touch the metal contacts of the Carriage. This may damage the printer.

3. Pull the Printhead Fixer Lever forward all the way to open it completely.

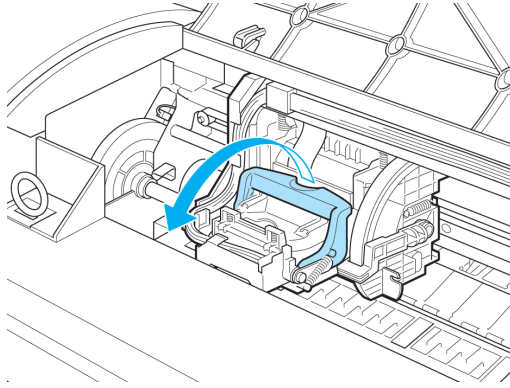

4. Pull up the Printhead Fixer Cover to open it completely.

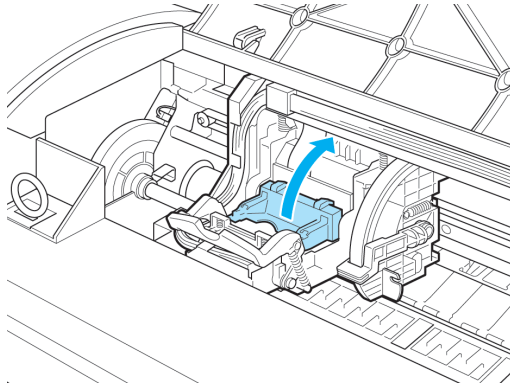

5. Remove the Printhead and press the **OK** button.

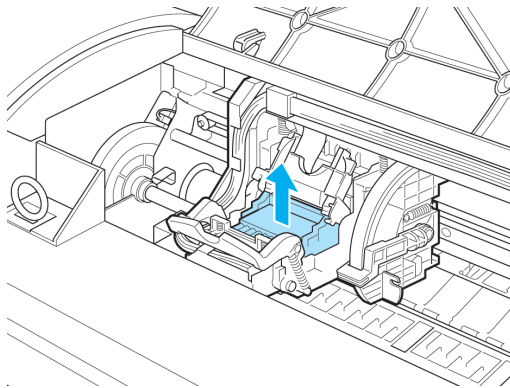
**Note**

- Dispose of the used Printhead in accordance with local regulations.

6. Holding the new Printhead by the grips (a), remove it from the pouch.

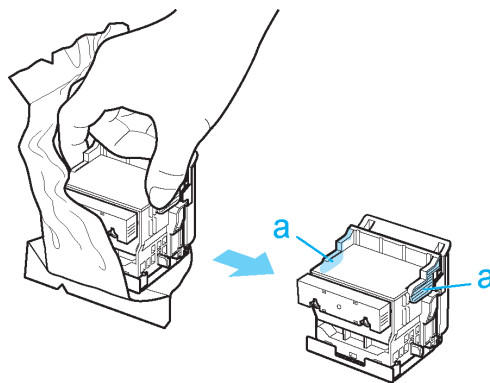

**Important**

- When handling the Printhead, always hold it by the grips (a). Never touch the nozzles (b) or metal contacts (c). This may damage the Printhead and affect printing quality.
- Never touch the ink supply section (d). This may cause printing problems.

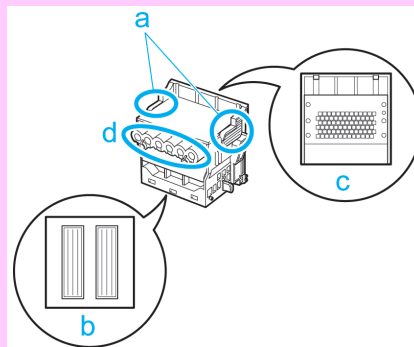

- If you need to put a Printhead somewhere temporarily before installation, do not keep the nozzles and metal contacts facing down. If the nozzles or metal contacts are damaged, it may affect the printing quality.

7. While firmly holding the Printhead you have removed, use your other hand to remove the orange Protective Part (a). Squeeze the grips (c) of Protective Part (b) and pull it down to remove it.

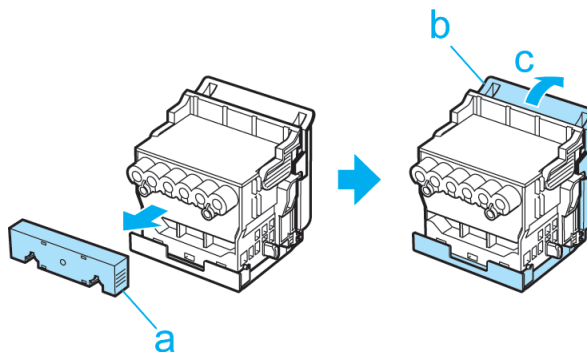



**Important**

- The inside surface of the Protective Part (a) and Protective Part (b) is coated with ink to protect the nozzles. Be careful not to touch these surfaces when removing the caps.
- The Printhead contains ink to protect the nozzles. We recommend removing Protective Part (b) as you hold it over the Printhead package or safely out of the way to avoid spilling ink and staining your clothes or the surrounding area. If ink accidentally spills, wipe off the ink with a dry cloth.
- Do not reattach the Protective Part or protective material. Dispose of these materials in accordance with local regulations.

- 8.** With the nozzles facing down and the metal contacts toward the back, insert the Printhead into the Carriage. Carefully push the printhead firmly into the Carriage, ensuring that the nozzles and metal contacts do not touch the carriage.

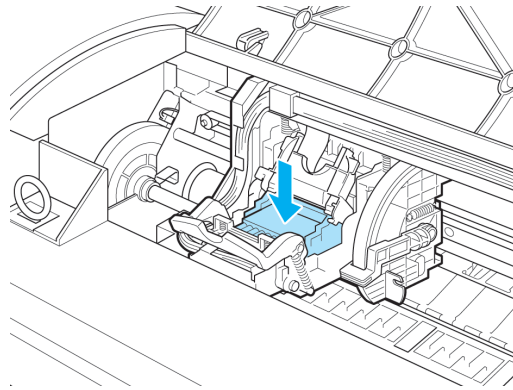

- 9.** Pull the Printhead Fixer Cover down toward the front to lock the Printhead in place.

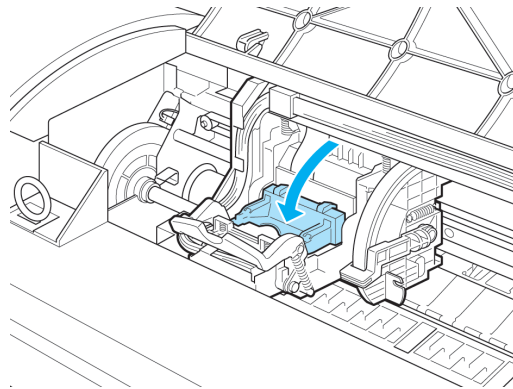

**10.** Push the Printhead Fixer Lever toward the back of the printer until it clicks.

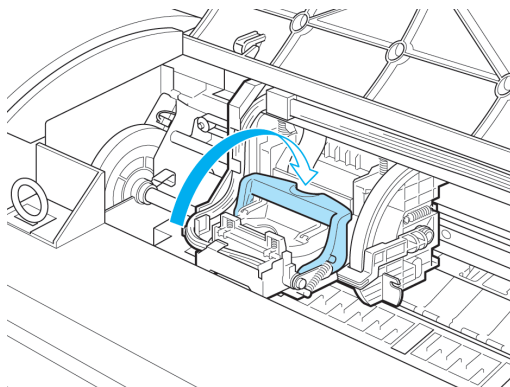

**11.** Close the Top Cover.

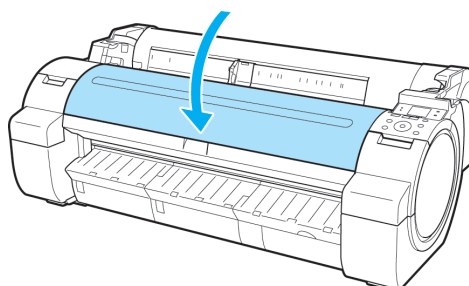

Ink now fills the system. It takes about seven minutes to complete.



**Important**

- Never remove an Ink Tank while the system is filling with ink.
- After Printhead has been replaced and filled with ink, **Head Posi. Adj. ( Auto(Advanced))** is performed if you have selected **Rep.P.head Print > On** in the Control Panel menu. (See "Menu Settings.") →P.673  
In this case, follow the instructions on the Display Screen for Printhead adjustment.  
If **Rep.P.head Print** is **Off**, perform **Head Posi. Adj. ( Auto(Advanced))** yourself. (See "Automatic Adjustment to Straighten Lines and Colors (Head Posi. Adj.).") →P.619

## Maintenance Cartridge

Maintenance Cartridge .....	749
Replacing the Maintenance Cartridge .....	749
Checking the Remaining Maintenance Cartridge Capacity .....	754
When to Replace the Maintenance Cartridge .....	755

## Maintenance Cartridge

A replacement Maintenance Cartridge.

- Maintenance Cartridge MC-10

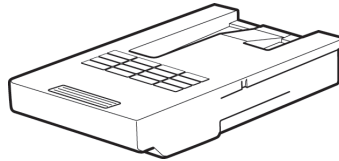

### Note

- For instructions on replacing the Maintenance Cartridge, see "Replacing the Maintenance Cartridge."

→P.749

## Replacing the Maintenance Cartridge

### Compatible maintenance cartridges

For information on compatible maintenance cartridges, see "Maintenance Cartridge." →P.749

### Precautions when handling the Maintenance Cartridge

Take the following precautions when handling the Maintenance Cartridge.



### Caution

- For safety, keep the Maintenance Cartridge out of the reach of children.
- If ink is accidentally ingested, contact a physician immediately.
- To prevent ink from leaking from a used Maintenance Cartridge, avoid dropping the cartridge or storing it at an angle. Otherwise, ink may leak and cause stains.
- Ink adheres to the top of the Maintenance Cartridge after it has been used. Handle the Maintenance Cartridge carefully during replacement. The ink may stain clothing.



### Important

- Do not remove the Maintenance Cartridge except to replace it.
- Do not install a used Maintenance Cartridge in another printer.

## Make sure the printer is ready for Maintenance Cartridge replacement

You can replace Maintenance Cartridge if the Display Screen advises you to check the remaining capacity or replace the Maintenance Cartridge.

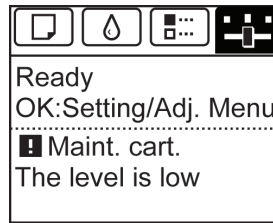

If a message is displayed requesting Maintenance Cartridge replacement, you can skip the step **Access the menu for Maintenance Cartridge replacement**. Follow the instructions in **Replace the Maintenance Cartridge**.

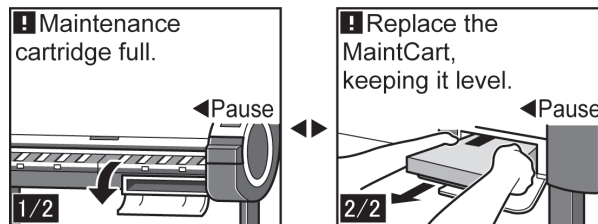

### Caution

- Do not replace the Maintenance Cartridge during initialization immediately after turning on the printer, during Printhead cleaning, or when ink is being absorbed. Ink may leak out.

## Access the menu for Maintenance Cartridge replacement

1. On the **Tab Selection screen** of the Control Panel, press ◀ or ▶ to select the Settings/Adj. tab (  ).

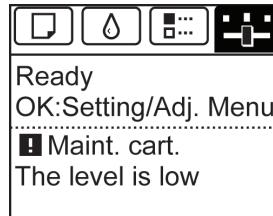

### Note

- If the **Tab Selection screen** is not displayed, press the **Menu** button.

2. Press the **OK** button.  
The **Set./Adj. Menu** is displayed.
3. Press ▲ or ▼ to select **Maintenance**, and then press the **OK** button.
4. Press ▲ or ▼ to select **Repl. maint cart**, and then press the **OK** button.  
A message on the Display Screen advises you to open the Maintenance Cartridge Cover.

## Replace the Maintenance Cartridge

1. Open the box, remove the plastic bag and packaging material, and take out the Maintenance Cartridge.

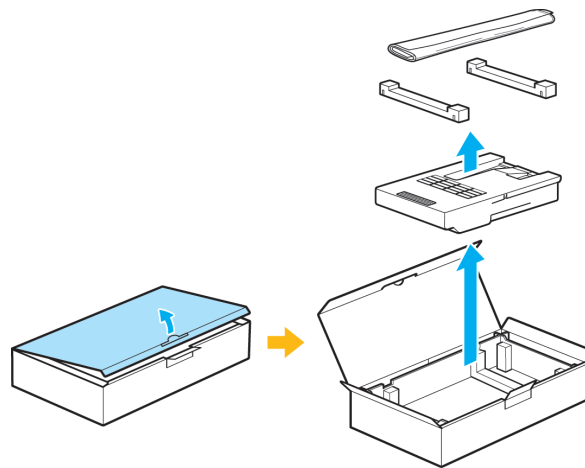

### Important

- Never touch the metal contacts (a). This may damage the Maintenance Cartridge.

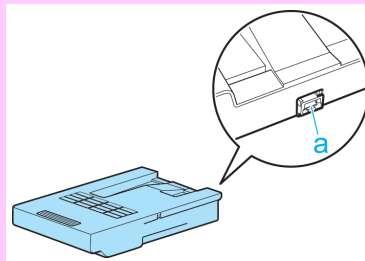

2. At this point, open the Maintenance Cartridge Cover.

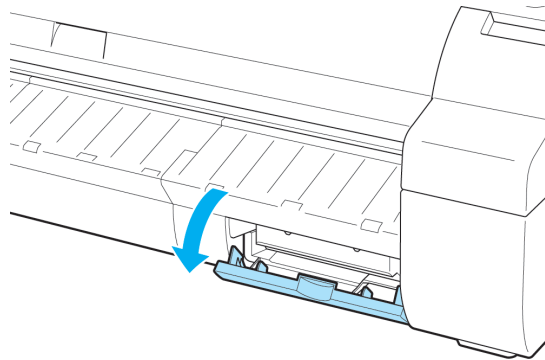

3. Hold the used Maintenance Cartridge by the grip (a) with one hand and put your other hand under the Maintenance Cartridge to hold it firmly on the bottom, keeping it level as you pull it out.

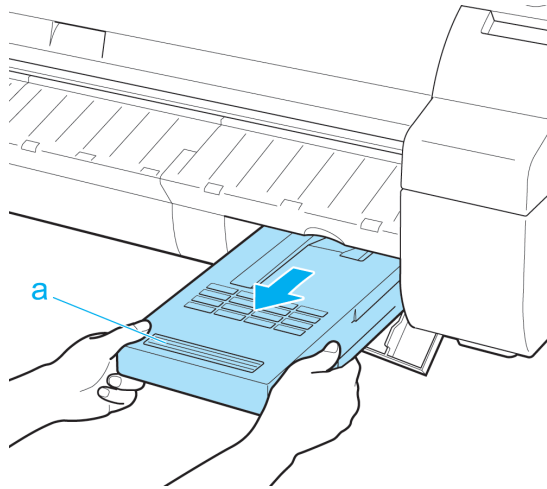

**Caution**

- Used maintenance cartridges are heavy. Always grasp the cartridge firmly and keep the cartridge level during removal and storage. If you drop a used Maintenance Cartridge or store it at an angle, ink may leak and cause stains.



**Important**

- The remaining Maintenance Cartridge capacity is recorded on each printer. Do not install a used Maintenance Cartridge in another printer.

4. Keep the used Maintenance Cartridge level as you put it in the plastic bag. Expel excess air from the plastic bag and seal the zipper.

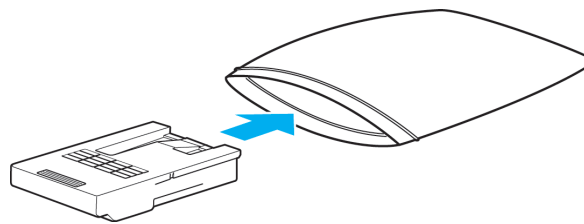

5. Confirm the Maintenance Cartridge is right-side up, put it in the box with the packaging material attached, and store it so that it stays level.

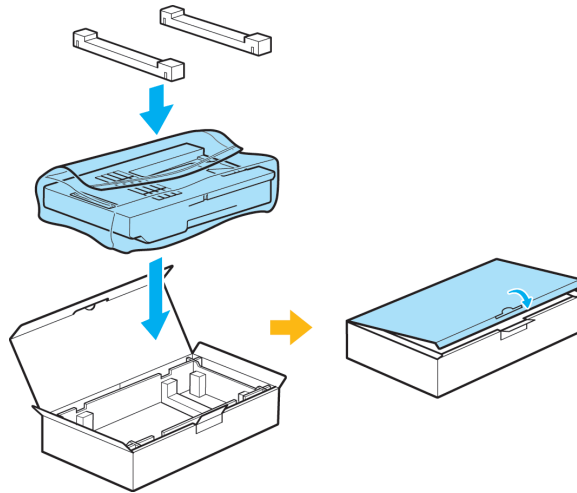
**Caution**

- Always put the used Maintenance Cartridge back in the box and store the box on a flat surface. Otherwise, ink may leak and cause stains.

**Note**

- In accordance with active and ongoing environmental programs, Canon supports recycling of used maintenance cartridges. Follow the instructions provided with the new Maintenance Cartridge that describe how to process the used Maintenance Cartridge.

6. Keeping the new Maintenance Cartridge level, insert it all the way in.

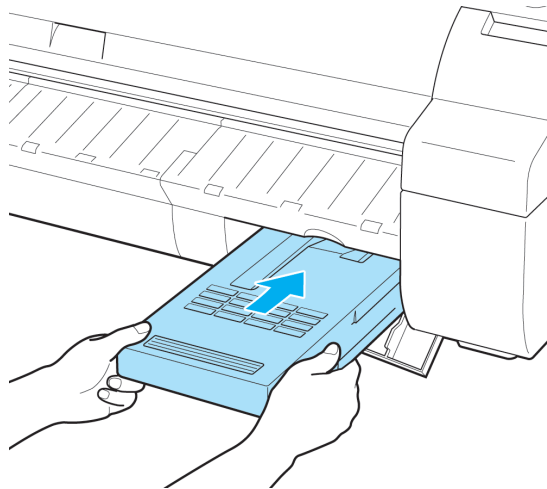

**7.** Close the Maintenance Cartridge Cover.

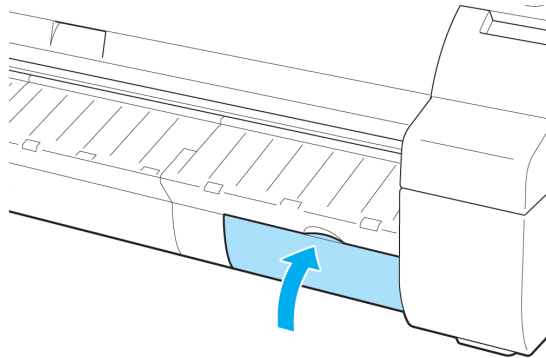

**8.** Press the **OK** button.

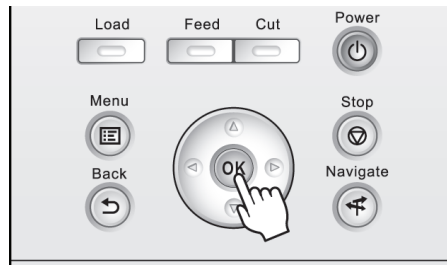

The printer now initializes the Maintenance Cartridge.

**10**

**Checking the Remaining Maintenance Cartridge Capacity**

The Maintenance Cartridge absorbs excess ink from borderless printing, printhead cleaning, and other processes. You can confirm the remaining capacity of the Maintenance Cartridge by checking the Maintenance Cartridge capacity shown on the Display Screen.

To check remaining Maintenance Cartridge capacity, access the **Tab Selection screen** on the Control Panel and press ◀ or ▶ to select the Settings/Adj. tab (  ).

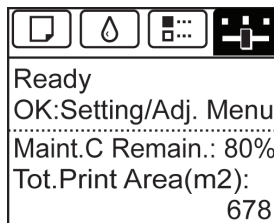

**Note**  
• If the **Tab Selection screen** is not displayed, press the **Menu** button.

If the Display Screen indicates to replace the Maintenance Cartridge, replace the Maintenance Cartridge. If a message is displayed indicating to check the remaining capacity of the Maintenance Cartridge, or before tasks that deplete much of the capacity such as head cleaning or preparations to move the printer, check the remaining Maintenance Cartridge capacity and prepare a new Maintenance Cartridge as needed. (See "Replacing the Maintenance Cartridge.") →P.749



## When to Replace the Maintenance Cartridge

Replace or prepare to replace the Maintenance Cartridge in the following situations.

### If a message for checking the Maintenance Cartridge is shown on the Display Screen

When the Maintenance Cartridge is almost full, the **Message Lamp** is lit and "**The level is low**" is shown on the Display Screen. You can continue to print, but check the remaining Maintenance Cartridge capacity and prepare to replace the Maintenance Cartridge with a new one. (See "Checking the Remaining Maintenance Cartridge Capacity." →P.754)

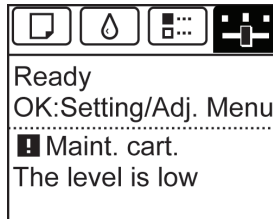

### When much of the Maintenance Cartridge capacity is depleted

Printhead cleaning, Printhead replacement, and preparations to transfer the printer deplete much of the Maintenance Cartridge capacity. (In particular, preparing to move the printer depletes a lot of the capacity.)

Check the remaining Maintenance Cartridge capacity before this maintenance and replace the Maintenance Cartridge if necessary.

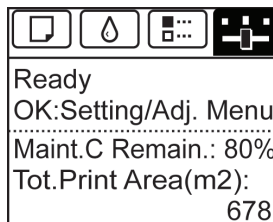

### If a message for the Maintenance Cartridge replacement is shown on the Display Screen

When the Maintenance Cartridge is full, the **Message Lamp** flashes and a message to replace the Maintenance Cartridge is shown on the Display Screen. Printing is disabled, and you cannot replace the Printhead or transfer the printer. Replace the Maintenance Cartridge with a new one.

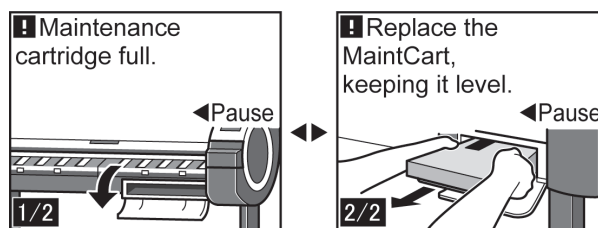

## Cleaning the Printer

Cleaning the Printer Exterior ..... 756  
Cleaning Inside the Top Cover ..... 756

### Cleaning the Printer Exterior

Clean the printer regularly to maintain better printing quality and help prevent problems. To ensure a comfortable working environment, clean the printer exterior about once a month.

1. Turn the printer off. (See "Turning the Printer On and Off.") →P.3
2. Unplug the power cord from the outlet.



**Caution**

- Always turn off the printer and unplug the power cord before cleaning or maintenance. Accidentally leaving the printer on poses a risk of injury if you touch moving parts inside the printer.

3. Using a damp cloth that you have wrung out completely, wipe the exterior surfaces of the printer. Dry the surfaces with a dry cloth.

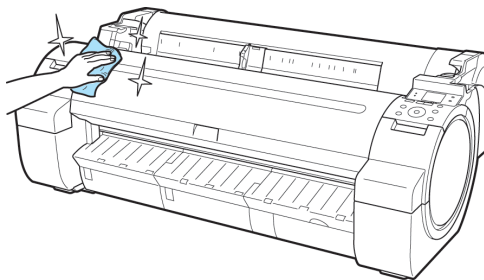

**Caution**

- Never use flammable solvents such as alcohol, benzene, or thinner. If these substances come into contact with electrical components inside the printer, there is a risk of fire or electrical shock.



**Important**

- If the Ejection Guide is dirty, it may soil the edge of the paper when the paper is cut. We recommend cleaning the Ejection Guide even if it does not appear dirty, because it may actually be covered with paper dust.

4. Plug the power cord into the outlet.

### Cleaning Inside the Top Cover

Clean inside the Top Cover about once a month to maintain better printing quality and help prevent problems. Also clean inside the Top Cover in the following situations to ensure optimal operation.

- If the printed surface or the underside of paper is dirty after printing

- After you have used up a roll
- After borderless printing
- After printing on small paper
- After printing on paper that generates a lot of cutting debris
- If you have replaced the roll
- After printing on paper that generates a lot of paper dust
- After printing on adhesive paper

**Important**

- If the Platen inside the Top Cover becomes dirty, it may soil the underside of paper. We recommend cleaning the Platen after borderless printing or printing on small paper.
- If the Ejection Guide is dirty, it may soil the edge of the paper when the paper is cut. We recommend cleaning the Ejection Guide even if it does not appear dirty, because it may actually be covered with paper dust.
- Printing on adhesive paper may leave adhesive on the Platen, Paper Retainer, or other parts. To prevent paper jams, we recommend cleaning inside the Top Cover after printing.

1. Open the Top Cover.

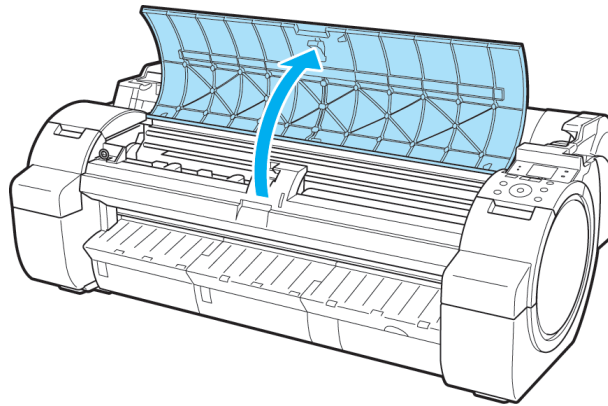

2. If paper dust has accumulated in the Vacuum holes (a) on the Platen or in the Borderless Printing Ink Grooves (b), use the Cleaning Brush (c), provided with the printer, to wipe it away.

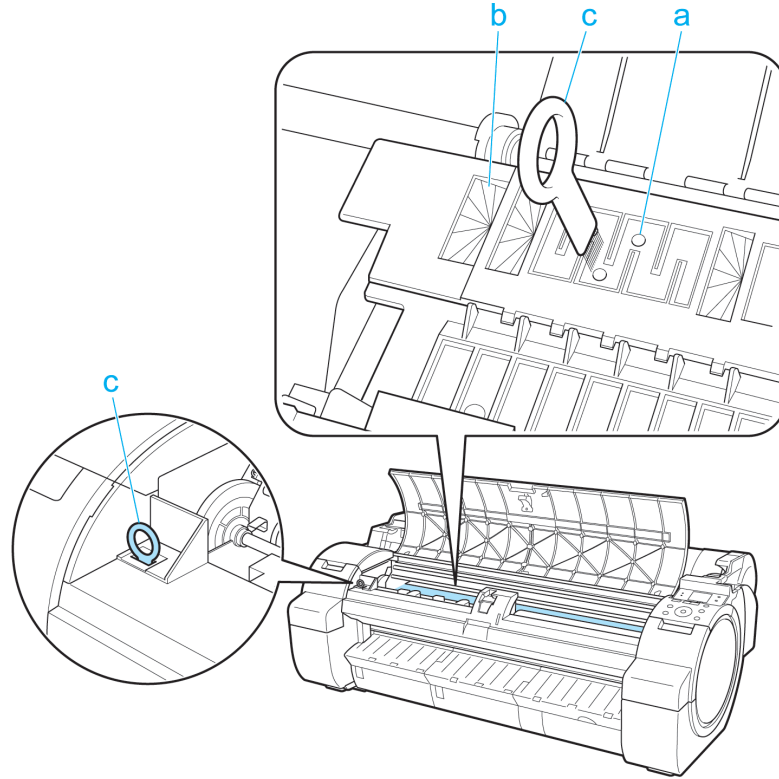

Note

- If the Cleaning Brush is dirty, rinse it in water.

- 3.** Using a damp cloth that you have wrung out completely, wipe inside the Top Cover to clean it. Wipe away any ink residue on the Platen as a whole (a), the Paper Retainer (b), Borderless Printing Ink Grooves (c), and Ejection Guide (d).

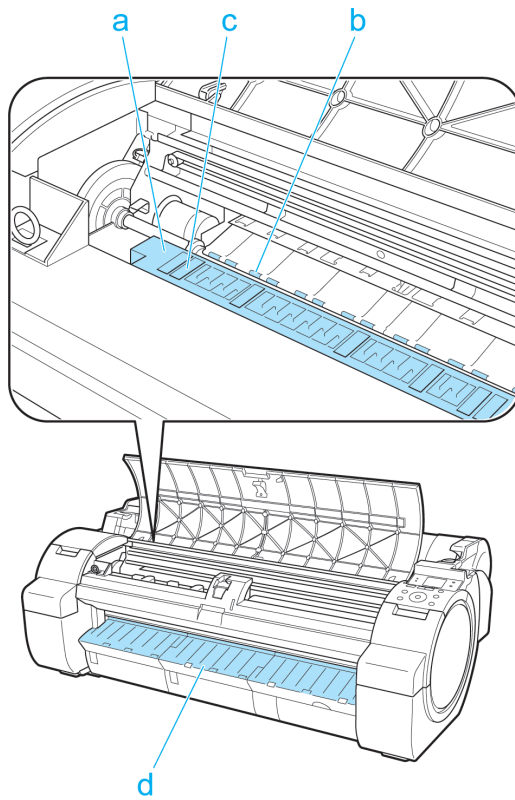



**Important**

- Do not use a dry cloth to wipe inside the Top Cover. This may create a static charge, which may attract dust and affect the printing quality.
- Never use flammable solvents such as alcohol, benzene, or thinner. If these substances come into contact with electrical components inside the printer, there is a risk of fire or electrical shock.
- Do not touch the Linear Scale (a) or Carriage Shaft (b).

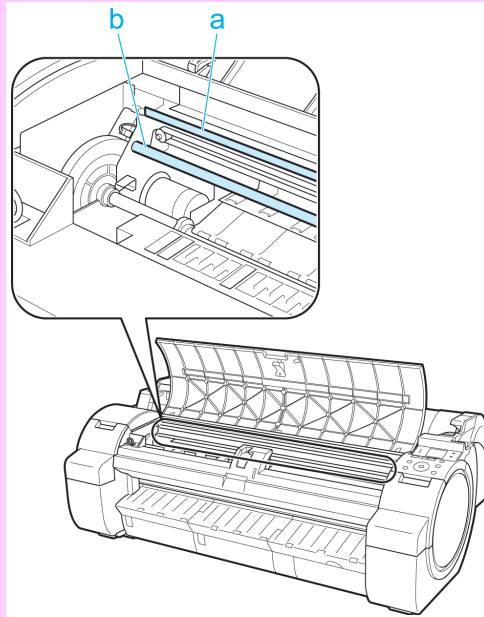

**Note**

- When cleaning between the Platen and Ejection Guide, use a damp cloth that you have wrung out completely to wipe over the Output Tray and along grooves.

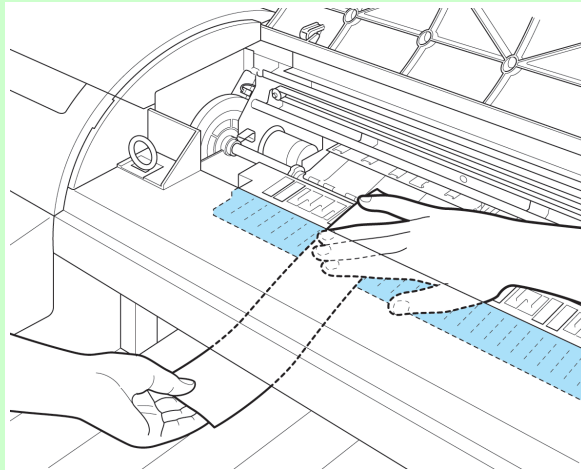

**4.** Close the Top Cover.

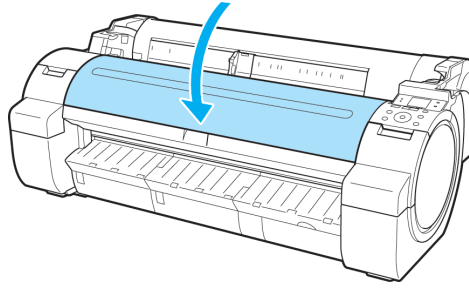

## Other Maintenance

Preparing to Transfer the Printer ..... 762  
 Updating the Firmware ..... 766

### Preparing to Transfer the Printer

To protect the internal parts in transit, always follow these steps before transferring the printer to a new location. Refer to the Setup Guide for details on packing the printer and installing it after transfer.



**Important**

- Avoid tilting the printer excessively in transit. This may cause ink in the printer to leak and cause stains. If it is necessary to tilt the printer in transit, contact your Canon dealer.



**Note**

- It is not possible to prepare the printer for transfer if the Display Screen requests you to replace the Maintenance Cartridge or check the remaining capacity. Replace the Maintenance Cartridge before transfer preparations. In this case, you will need one new Maintenance Cartridge. (See "Replacing the Maintenance Cartridge.") →P.749
- Depending on the state of the printer, part replacement may be necessary when preparing to transfer the printer (that is, when you execute the printer menu item to prepare for transfer).

#### Remove paper

1. Remove the paper.
  - Rolls (See "Removing the Roll from the Printer.") →P.585
  - Sheets (See "Removing Sheets.") →P.609

10

#### Access the Move Printer menu

1. On the **Tab Selection screen** of the Control Panel, press ◀ or ▶ to select the Settings/Adj. tab (  ).

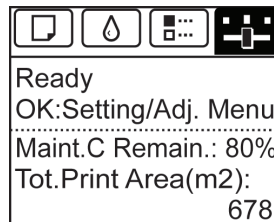

**Note**

- If the **Tab Selection screen** is not displayed, press the **Menu** button.

2. Press the **OK** button.  
The **Set./Adj. Menu** is displayed.

762



- Press ▲ or ▼ to select **Prep.MovePrinter**, and then press the **OK** button.  
Once preparations are finished, a message on the Display Screen requests you to open the Ink Tank Cover.

**Important**

- If consumables must be replaced, the message "**Consumables must be replaced. Call for service.**" is shown on the Display Screen and preparation is not possible. If this message is displayed, press the **OK** button and contact your Canon dealer for assistance.

## Remove the Ink Tank

- Open the Ink Tank Cover.

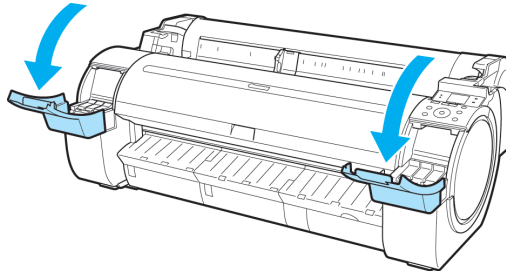

- Pressing the tip of the Ink Tank Lock Lever horizontally, lift the Ink Tank Lock Lever to release the lock.

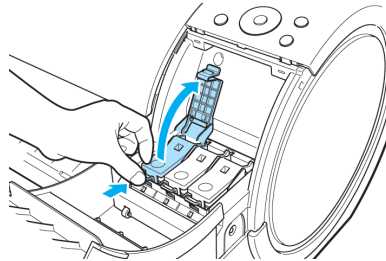

- Holding the ink tanks by the grips, remove them.

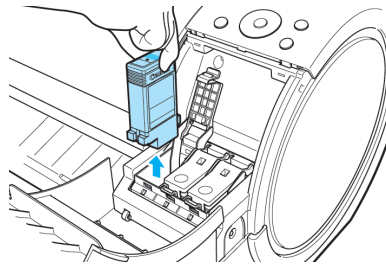



**Note**

- Store the ink tanks you removed with the ink holes (a) facing up. Otherwise, ink may leak and cause stains.

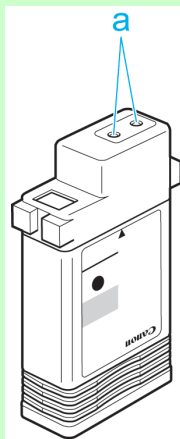

**4.** Repeat steps 2 and 3 to remove all ink tanks.

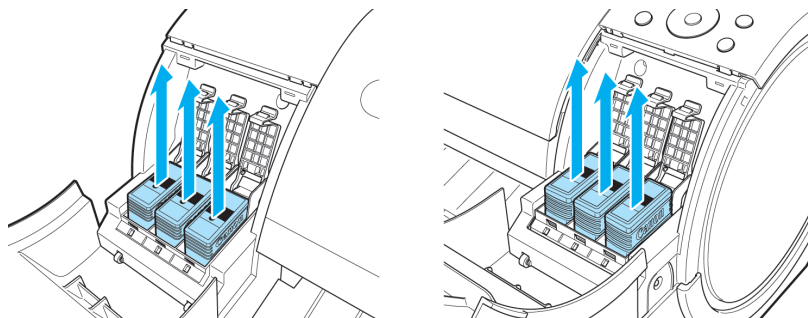

**5.** Push all ink tank lock levers closed until they click into place.

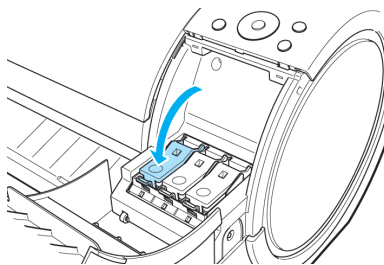

**6.** Close the Ink Tank Cover.

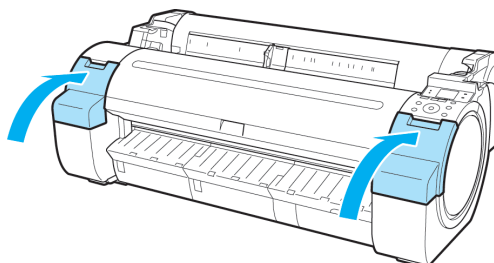

At this point, ink is drawn out from inside the tubes.



#### Important

- Do not remove the Maintenance Cartridge during this process.

When the process is finished, "**Completed! Turn Power Off!!**" is displayed.

## Pack the printer

1. Press the **Power** button and turn off the printer.



#### Important

- Turn off the printer before you unplug it. It may damage the printer if you unplug it before it is off and transfer it in that state. If you accidentally unplug the printer, plug it in again, reinstall the ink tanks, and follow this procedure again.

2. Disconnect the power cord and interface cable.
3. Tape down printer covers to secure them, in the reverse order of tape removal during installation.
4. Remove the Stand by reversing the installation procedure, when it was attached to the printer.
5. Disassemble and repackage the Stand by following the installation procedure in reverse.
6. Repack the Roll Holder, Holder Stopper, and printer in shipping materials, and then package them in a shipping box.

## Updating the Firmware

Update the printer firmware to take advantage of new and improved printer functions.

### Confirming the firmware version

1. On the **Tab Selection screen** of the Control Panel, press ◀ or ▶ to select the Settings/Adj. tab (  ).

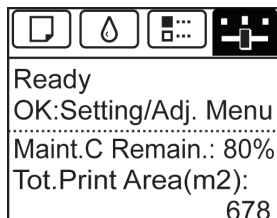

#### Note

- If the **Tab Selection screen** is not displayed, press the **Menu** button.

2. Press the **OK** button.  
The **Set./Adj. Menu** is displayed.
3. Press ▲ or ▼ to select **Printer Info**, and then press the **OK** button.
4. Press ▲ or ▼ to select **System Info**, and then press the **OK** button.  
The firmware version is displayed.

10

### Updating the Firmware

To obtain the latest firmware, visit the Canon website. If the firmware available online is newer than the installed firmware, update the printer firmware. For details on downloading and updating the firmware, visit the Canon website.

## Consumables

Ink Tanks .....	731
Printhead .....	739
Maintenance Cartridge .....	749

## Troubleshooting

Frequently Asked Questions	769
Problems Regarding Paper	771
Printing does not start	783
The printer stops during a print job	785
Problems with the printing quality	786
Cannot print over a network	795
Installation problems	797
HP-GL/2 problems	799
Other problems	802

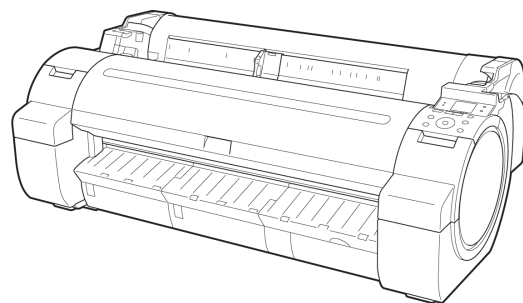

## Frequently Asked Questions

Frequently Asked Questions ..... 769

### Frequently Asked Questions

This section presents frequently asked questions and answers. To view more detailed explanations, click the hyperlinks in the answer column.

Question	Answer
How do I print on a roll?	When printing on rolls, after loading the roll, specify the paper type and length, both on the Control Panel and in the printer driver. ⇒"Loading and Printing on Rolls <a href="#">→P.6</a> "
How do I print on a sheet?	When printing on sheets, specify the paper type and size in the printer driver before loading the paper. ⇒"Loading and Printing on Sheets <a href="#">→P.9</a> "
How do I switch between printing on rolls and sheets?	When you complete operations on the Control Panel to load or replace paper, the paper source is automatically switched to the selected paper. ⇒"Loading Rolls in the Printer <a href="#">→P.579</a> " ⇒"Loading Sheets in the Printer <a href="#">→P.602</a> "
How do I change the paper type or size?	Specify the type and size of paper, both on the Control Panel and in the printer driver. <ul style="list-style-type: none"> <li>• Specifying it in the printer driver ⇒"Specifying Paper in the Printer Driver <a href="#">→P.21</a> "</li> <li>• Specifying it on the Control Panel Selecting the paper type ⇒"Changing the Type of Paper <a href="#">→P.583</a> " Selecting the paper size ⇒"Specifying the Paper Length <a href="#">→P.585</a> "</li> </ul>
How do I cut the roll paper after printing?	You can wait until ink dries before cutting the roll, and you can cut rolls at a desired position. ⇒"Specifying the Cutting Method for Rolls <a href="#">→P.594</a> "
How do I print without borders?	Borderless printing is possible on rolls. You can also specify borderless printing in the printer driver by adjusting the original size to match the paper size. Borderless printing is not supported on sheets. ⇒"Borderless Printing on Paper of Equivalent Size <a href="#">→P.104</a> " ⇒"Borderless Printing by Resizing Originals to Fit the Roll Width <a href="#">→P.111</a> " ⇒"Borderless Printing at Actual Size <a href="#">→P.95</a> "
How do I print an A4 original enlarged on A2 paper?	In the printer driver, you can adjust the original image to match the paper size or width, or you can specify enlargement or reduction before printing as desired. ⇒"Resizing Originals to Match the Paper Size <a href="#">→P.69</a> " ⇒"Resizing Originals to Fit the Roll Width <a href="#">→P.75</a> " ⇒"Resizing Originals by Entering a Scaling Value <a href="#">→P.81</a> "
How do I print without wasting paper?	To conserve paper, you can specify in the printer driver to rotate originals 90 degrees or to print without top and bottom margins. ⇒"Conserving Roll Paper by Rotating Originals 90 Degrees <a href="#">→P.174</a> " ⇒"Conserving Roll Paper by Printing Originals Without Top and Bottom Margins <a href="#">→P.180</a> "

Question	Answer
How do I print without wasting all the blank space on the right side when printing an A4-sized original at A3 size?	By specifying to rotate originals 90 degrees in the printer driver, you can print at A4 size to fill the width of A3 paper. ⇒"Conserving Roll Paper by Rotating Originals 90 Degrees →P.174 "
How do I print in landscape (or portrait) orientation?	You can print originals that are in landscape (or portrait) orientation automatically enlarged to fit the roll width. This is an easy way to create vertical or horizontal banners. ⇒"Printing Vertical or Horizontal Banners (Large-Format Printing) →P.120 "
How do I print on a custom paper size?	You can specify custom sizes temporarily in the printer driver. ⇒"Printing on Non-Standard Paper Sizes →P.130 "
How do I register custom paper sizes?	You can add desired sizes (Custom Media Sizes) in the <b>Size Options</b> dialog box of the printer driver. ⇒"Printing on Non-Standard Paper Sizes →P.130 "
How do I print lines thicker?	By specifying <b>Thicken Fine Lines</b> in the printer driver, you can print fine lines thicker to make them easier to see. ⇒"Giving Priority to Particular Graphic Elements and Colors for Printing →P.60 "
How do I modify how colors are printed?	You can adjust colors as desired in the printer driver before printing. ⇒"Adjusting the Color in the Printer Driver →P.51 "
How do I use printer driver settings again in subsequent jobs?	By saving settings information in a favorite, you can apply the settings again before printing anytime as needed. ⇒"Using Favorites →P.200 "
Can I use the printer in combination with a <b>Color imageRUNNER</b> ?	The printer can be used for automatic enlargement and printing of scanned originals from a <b>Color imageRUNNER</b> . ⇒"Printing Enlargements of Scanned Originals from a Color imageRUNNER →P.301 " ⇒"Printing Enlargements of Scanned Originals from a Color imageRUNNER →P.539 "
How do I print enlargements of scanned originals from a <b>Color imageRUNNER</b> ?	By using Color imageRUNNER Enlargement Copy (iR enlargement copy), you can automatically print enlargements of scanned originals from a <b>Color imageRUNNER</b> . ⇒"Printing Enlargements of Scanned Originals from a Color imageRUNNER →P.301 " ⇒"Printing Enlargements of Scanned Originals from a Color imageRUNNER →P.539 "



## Problems Regarding Paper

Clearing Jammed Paper (Paper Feed Slot) .....	771
Clearing Jammed Roll Paper .....	773
Clearing a Jammed Sheet .....	777
Roll paper cannot be inserted into the paper feed slot .....	780
Cannot load sheets .....	780
Paper is not cut neatly .....	781
Paper is not cut .....	781
Depression on the leading edge is left .....	781
The size of clear film cannot be detected .....	781
Roll Paper is Continuously Ejected .....	782

### Clearing Jammed Paper (Paper Feed Slot)

Follow these steps to remove any scraps left in the Paper Feed Slot after you clear jammed sheets or roll paper.

1. Turn the printer off. (See "Turning the Printer On and Off.") →P.3
2. Push the Release Lever back.

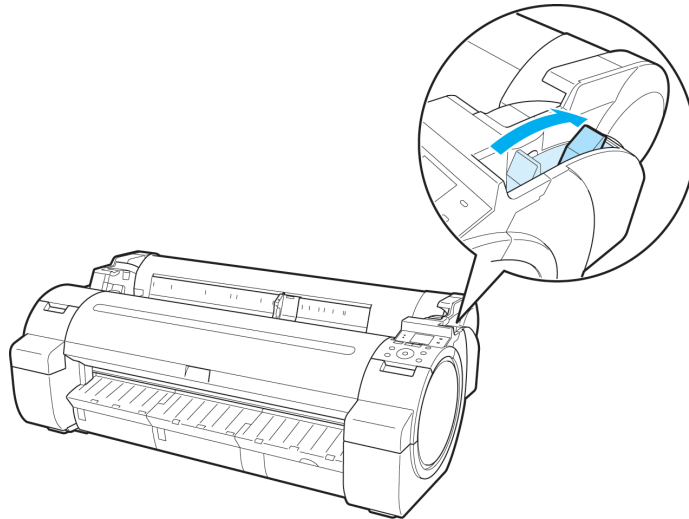

**3.** Positioning your hands as shown, open the Roll Cover.

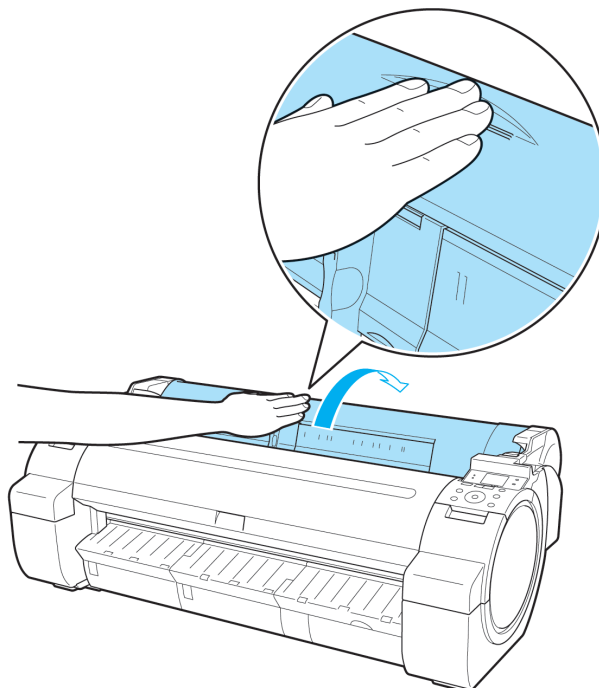

**4.** Fold an A4 sheet lengthwise four times and insert it through the gap of the Paper Feed Slot. Push the scrap out toward the Platen.

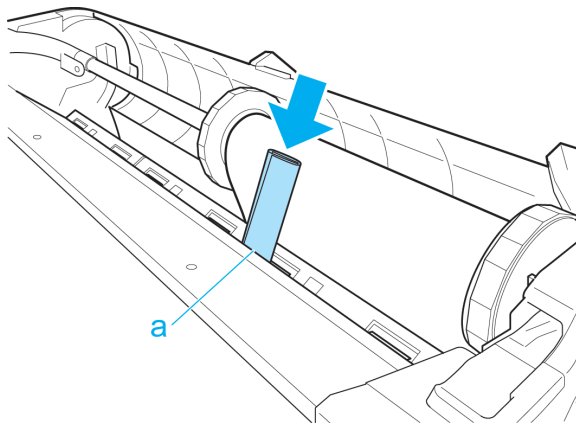

**5.** Remove the scrap when it is pushed out onto the Platen.

**6.** If any scraps remain inside the paper feed slot, repeat steps 4 and 5.

7. Holding it at the positions indicated, close the Roll Cover.

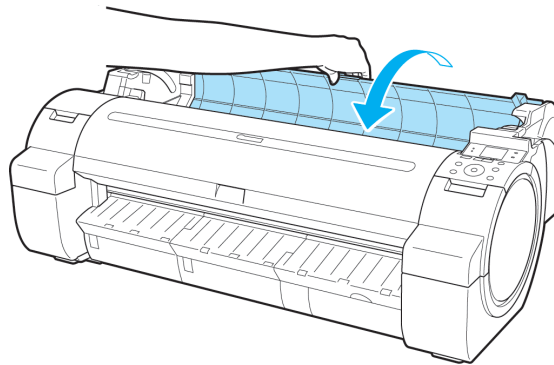

8. Pull the Release Lever forward.

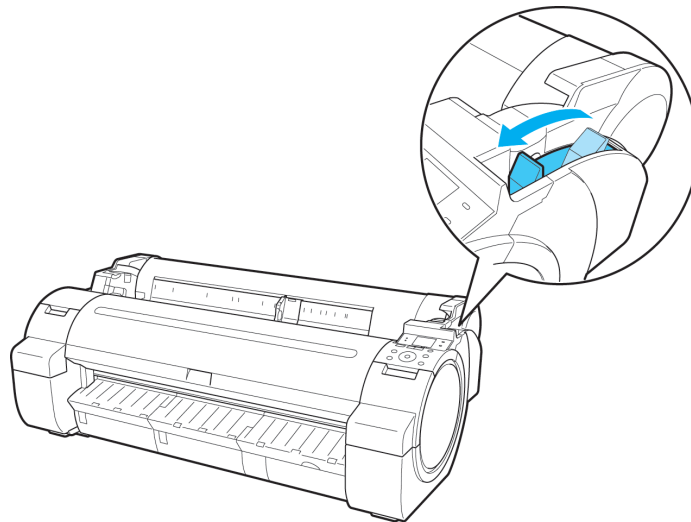

## Clearing Jammed Roll Paper

If paper from a roll becomes jammed, "**Paper jam.**" is shown on the Display Screen of the Control Panel. Remove the jammed paper as follows.

1. Open the Roll Cover. Use a commercially available cutter or the like to cut the paper of the loaded roll.

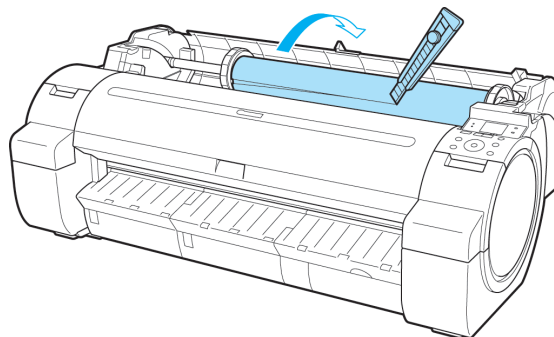



**Caution**

- When cutting paper, be careful to avoid injury or damage to the printer.

2. Push the Release Lever back.

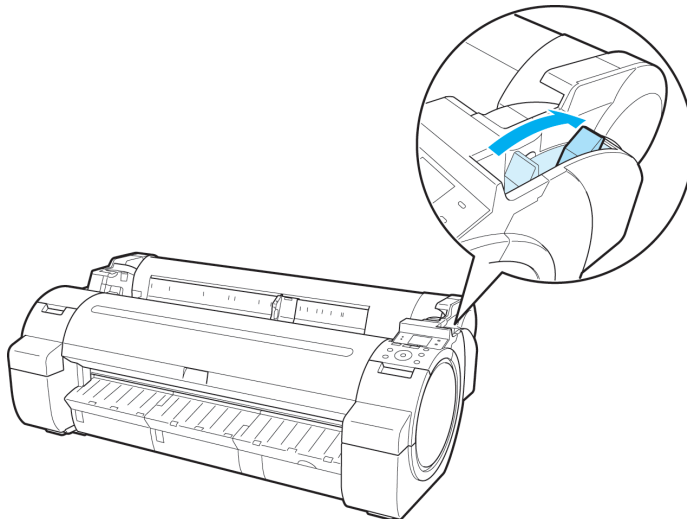

3. Remove the jammed paper.

- If paper is jammed inside the Top Cover

1. Open the Top Cover and move the Carriage to the left or right side manually, away from the jam.

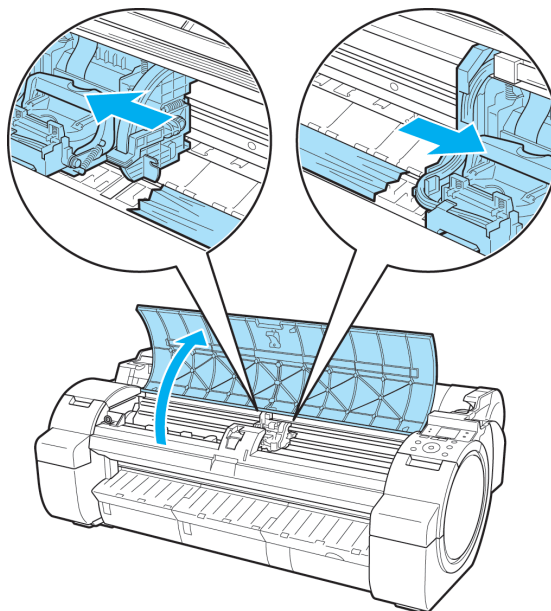

2. Clear any jammed paper from inside the Top Cover.  
After removing the paper, make sure there are no other scraps of paper in the printer.

**3.** Close the Top Cover.

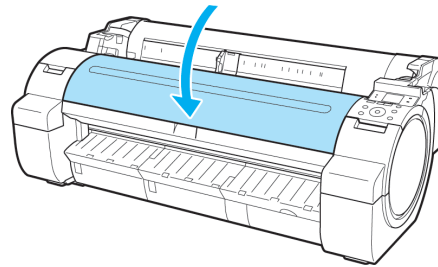

**Important**

- Do not move the Carriage over jammed paper. This may damage the Printhead.
- Do not touch the Linear Scale (a) or Carriage Shaft (b). This may stain your hands and damage the printer.

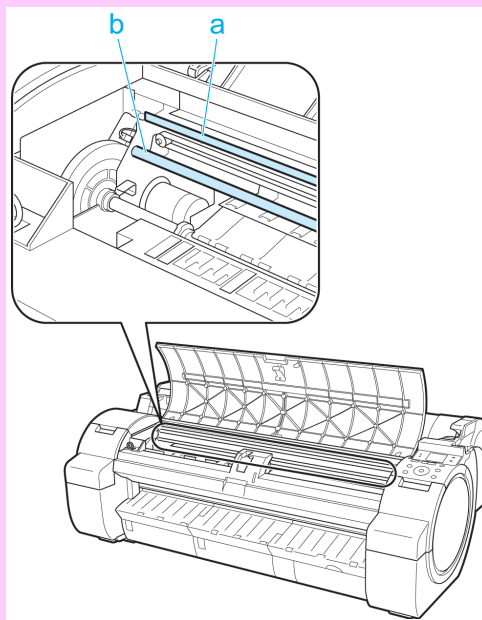

- If paper from a roll is jammed by the Paper Feed Slot

- 1.** Open the Roll Cover.
- 2.** Remove the jammed paper from the Paper Feed Slot.

After removing the paper, make sure there are no other scraps of paper in the printer.

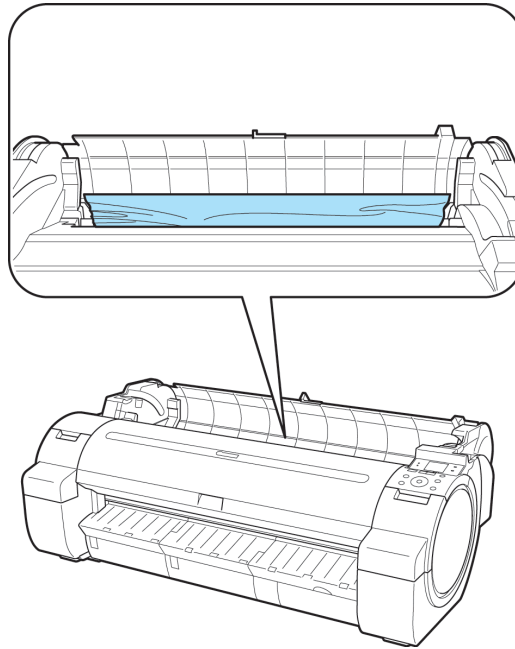

- If the paper is jammed by the Ejection Guide

Remove the jammed paper from the Output Tray.

After removing the paper, make sure there are no other scraps of paper in the printer.

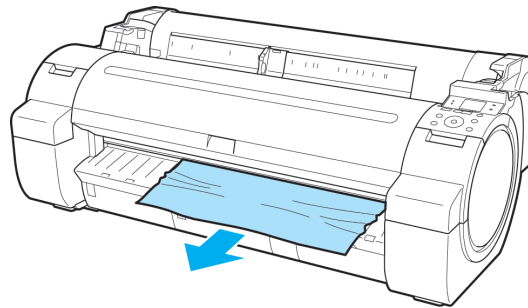

4. Pull the Release Lever forward.

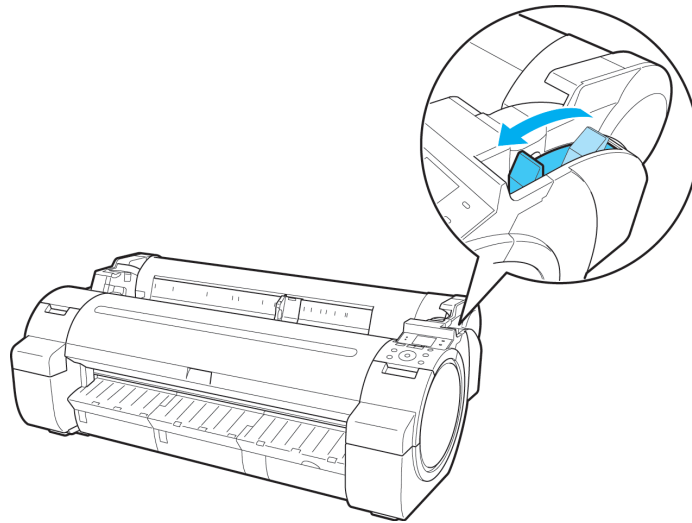

### Clearing a Jammed Sheet

If a sheet becomes jammed, "**Paper jam.**" is shown on the Display Screen of the Control Panel. Remove the jammed paper as follows.

1. Push the Release Lever back.

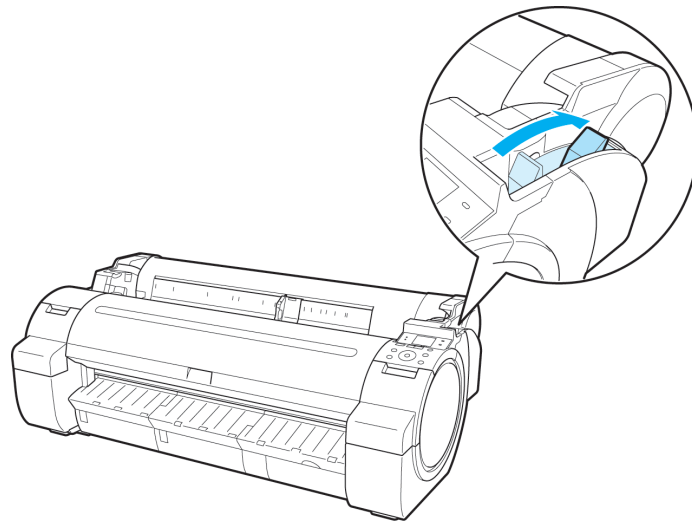

## 2. Remove the jammed paper.

- If paper is jammed inside the Top Cover

1. Open the Top Cover and move the Carriage to the left or right side manually, away from the jam.

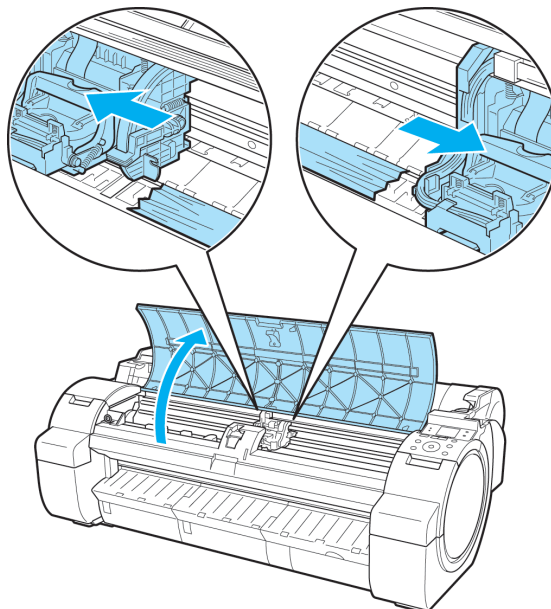

2. Clear any jammed paper from inside the Top Cover.  
After removing the paper, make sure there are no other scraps of paper in the printer.
3. Close the Top Cover.

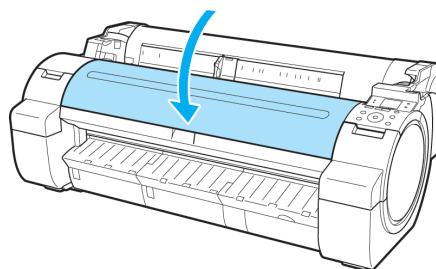





**Important**

- Do not move the Carriage over jammed paper. This may damage the Printhead.
- Do not touch the Linear Scale (a) or Carriage Shaft (b). This may stain your hands and damage the printer.

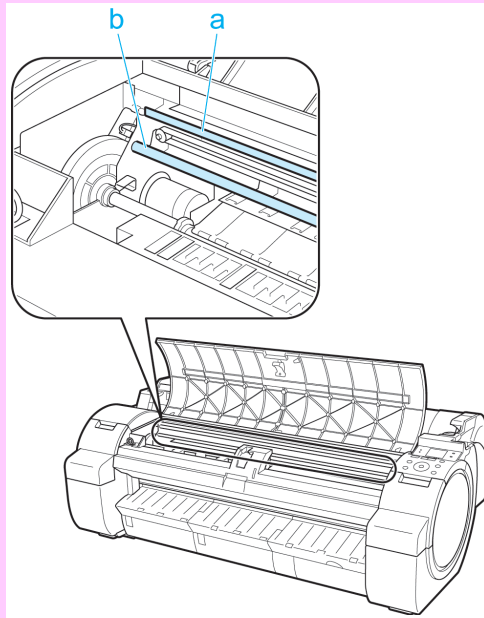

- **If the paper is jammed by the Paper Feed Slot**

Remove the jammed paper from the Paper Feed Slot.

After removing the paper, make sure there are no other scraps of paper in the printer.

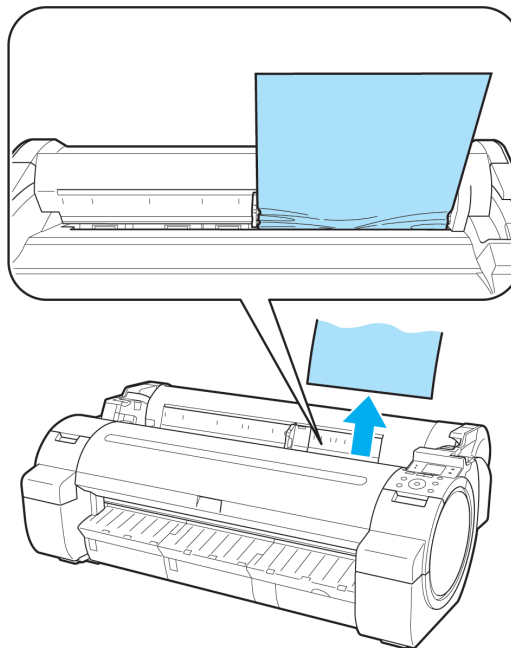

- **If the paper is jammed by the Ejection Guide**

Remove the jammed paper from the Output Tray.

After removing the paper, make sure there are no other scraps of paper in the printer.

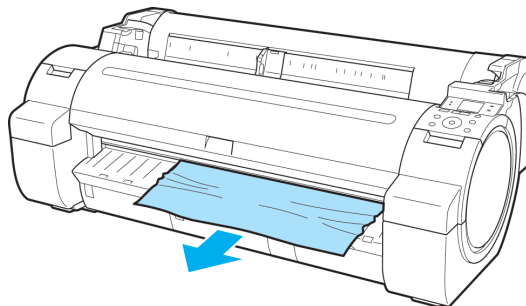

3. Pull the Release Lever forward.

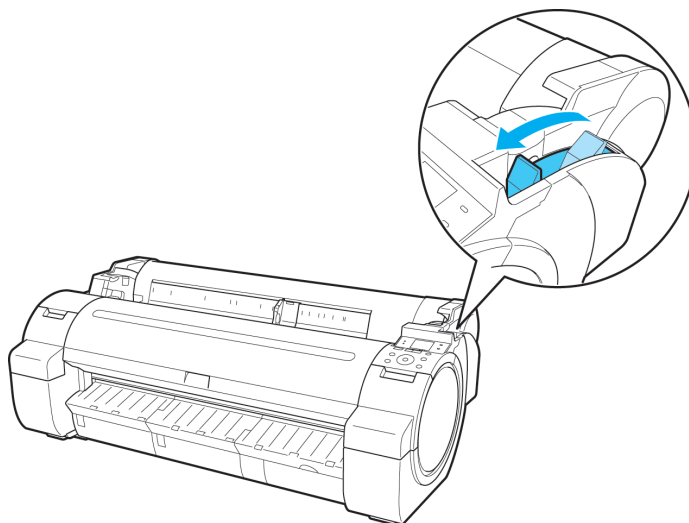

11

**Roll paper cannot be inserted into the paper feed slot**

Cause	Corrective Action
The roll paper is warped.	Straighten out curls and reload the roll.
Paper is jammed by the paper feed slot.	Remove the jammed paper. (See "Clearing Jammed Roll Paper.") →P.773 (See "Clearing a Jammed Sheet.") →P.777
The paper source selection is incorrect.	Press the <b>Load</b> button and select the paper source.

780

**Cannot load sheets**

Cause	Corrective Action
The paper source selection is incorrect.	Press the <b>Load</b> button and select the paper source.

## Paper is not cut neatly

Cause	Corrective Action
The paper is bent or curled at the cut position.	Straighten out any curling by the edges of the paper.
Paper rises by the ends of the cut position before it is cut.	Reload the paper correctly.
You are using paper that cannot be cut with the Cutter Unit.	Specify <b>Manual</b> in <b>Cutting Mode</b> in the Control Panel menu and use scissors or a cutting tool to cut the roll after printing. (See "Specifying the Cutting Method for Rolls.") →P.594
<b>Cut Speed</b> is not configured correctly in the Control Panel menu.	Change the <b>Cut Speed</b> setting in the Control Panel menu. (See "Menu Structure.") →P.663
During cutting, printed documents fall out at an angle.	In the Control Panel menu, set <b>Cutting Mode</b> to <b>Eject</b> . Hold documents after printing, as they are cut. (See "Specifying the Cutting Method for Rolls.") →P.594

## Paper is not cut

Cause	Corrective Action
In the printer driver, <b>No</b> or <b>Print Cut Guideline</b> is specified in <b>Auto Cut</b> .	Specify <b>Yes</b> in <b>Auto Cut</b> in the printer driver.
In the Control Panel menu, <b>Cutting Mode</b> is set to <b>Eject</b> or <b>Manual</b> .	If the <b>Cutting Mode</b> is <b>Eject</b> , press the <b>Cut</b> button to cut the paper. If the <b>Cutting Mode</b> is <b>Manual</b> , cut rolls with scissors or the like.

## Depression on the leading edge is left

Cause	Corrective Action
Keeping a roll in the printer for a long time without printing on it may leave a depression on the leading edge.	When printing quality is most important, we recommend setting <b>TrimEdge Reload</b> to <b>On</b> or <b>Automatic</b> so that the paper edge is automatically cut before printing. (See "Menu Structure.") →P.663

## The size of clear film cannot be detected

Cause	Corrective Action
The Platen is soiled with ink or other substances.	Open the Top Cover and clean the entire Platen. (See "Cleaning Inside the Top Cover.") →P.756

## Roll Paper is Continuously Ejected

Cause	Corrective Action
<p>Although sheets are selected as the paper source, a roll was advanced.</p>	<p>After roll ejection stops, follow these steps to reload the roll.</p> <ol style="list-style-type: none"> <li>1. Push the Release Lever back.</li> <li>2. Open the Roll Cover.</li> <li>3. Using both hands, rotate the Roll Holder toward the back to rewind the roll. At this time, ensure that both ends of the roll are rewound evenly.</li> <li>4. Pull the Release Lever forward.</li> <li>5. Load the roll. At this time, be sure to press the <b>Load</b> button and select <b>Load Roll Paper</b>. (See "Loading Rolls in the Printer.") <a href="#">→P.579</a></li> </ol>

## Printing does not start

The Data lamp on the Control Panel does not light up ..... 783  
 The printer does not respond even if print jobs are sent ..... 783  
 Ink Filling.. is displayed ..... 783  
 The display screen indicates Agitating ..... 784

### The Data lamp on the Control Panel does not light up

Cause	Corrective Action
The printer is not on.	Make sure the power cord is securely plugged in, all the way. Press the <b>Power</b> button to turn on the printer.
The target printer was not selected when printing. (The printer is in Sleep mode.)	In Windows, select the printer by clicking <b>Select Printer</b> or <b>Printer</b> in the printing dialog box and try printing again.
	In Mac OS X, open the dialog box of the printer driver, select the printer from the list of <b>Printer</b> , and try printing again.
The print job is paused. (The printer is in Sleep mode.)	In Windows, restart the print job as follows. <ol style="list-style-type: none"> <li>1. Select the printer icon in the <b>Printers and Faxes</b> (or <b>Printers</b>) window.</li> <li>2. Clear <b>Pause Printing</b> in the <b>File</b> menu to restart the print job.</li> </ol>
	In Mac OS X, restart the print job as follows. <ol style="list-style-type: none"> <li>1. Click <b>Print &amp; Fax</b>. (This is identified as <b>Printer Setup Utility</b> or <b>Print Center</b> in other versions of Mac OS X.)</li> <li>2. Select the printer, and then <b>Resume Printer</b> (or <b>Start Jobs</b>) in the <b>Printers</b> menu to restart the print job.</li> </ol>

### The printer does not respond even if print jobs are sent

Cause	Corrective Action
In the Control Panel menu, <b>Pause Print</b> is <b>On</b> .	Set <b>Pause Print</b> to <b>Off</b> . (See "Pausing Printing.") →P.19

### Ink Filling.. is displayed

Cause	Corrective Action
The printer was forced off during operation.	Wait until the system has been filled with ink. This process may take about seven and a half minutes.

## The display screen indicates Agitating

Cause	Corrective Action
Ink agitation is in progress.	Please wait until ink agitation is finished. The time for agitation varies depending on how long the printer has been off. (Between about 30 seconds and two minutes.)

## The printer stops during a print job

An error message is shown on the Display Screen ..... 785  
 The printer ejects blank, unprinted paper ..... 785

### An error message is shown on the Display Screen

Status	Corrective Action
An error message is displayed during printing.	Check the error message and take action as necessary. (See "Error Messages.") →P.809
The last portion of roll paper was used during a print job, and paper could not be advanced because the trailing edge is taped to the roll.	Remove the used roll and insert a new roll. (See "Removing the Roll from the Printer.") →P.585 (See "Removing the Roll Holder from Rolls.") →P.589 (See "Loading and Printing on Rolls.") →P.6

### The printer ejects blank, unprinted paper

Status	Corrective Action
The leading edge of the roll paper was cut to straighten it.	The leading edge of rolls may be cut to straighten it if you have selected <b>Trim Edge First &gt; On</b> or <b>Automatic</b> in the Control Panel menu. (See "Cutting the Leading Edge of Roll Paper Automatically.") →P.599
The Printhead nozzles are clogged.	Print a test pattern to check the nozzles and make sure the Printhead is in good condition for printing. (See "Checking for Nozzle Clogging.") →P.739
A print job was received from an incompatible printer driver.	Use the correct imagePROGRAF printer driver for the printer and try printing again.
The printer has received print data that includes HP RTL commands when <b>Auto Rotate</b> is <b>On</b> in the Control Panel menu.	In the Control Panel, set <b>Auto Rotate</b> to <b>Off</b> and print again. (See "Menu Settings.") →P.673
The printer is damaged.	Contact your Canon dealer for assistance.

## Problems with the printing quality

Printing is faint ..... 786

Paper rubs against the Printhead ..... 787

The edges of the paper are dirty ..... 788

The surface of the paper is dirty ..... 788

The back side of the paper is dirty ..... 789

Printed colors are inaccurate ..... 789

Banding in different colors occurs ..... 790

Colors in printed images are uneven ..... 790

Image edges are blurred or white banding occurs ..... 791

The contrast becomes uneven during printing ..... 792

The length of printed images is inaccurate in the feeding direction ..... 792

Images are printed crooked ..... 792

Documents are printed in monochrome ..... 793

Line thickness is not uniform ..... 793

Lines are misaligned ..... 793

Problems with the printing quality caused by the type of paper ..... 794

## Printing is faint

11

786

Cause	Corrective Action
You may be printing on the wrong side of the paper.	Print on the printing surface.
The Printhead nozzles are clogged.	Print a test pattern to check the nozzles and see if they are clogged. (See "Checking for Nozzle Clogging.") →P.739
Because the printer was left without ink tanks installed for some time, ink has become clogged in the ink supply system.	After the ink tanks have been installed for 24 hours, run <b>Head Cleaning B</b> from the Control Panel. (See "Cleaning the Printhead.") →P.740
Paper is jammed inside the Top Cover.	Follow the steps below to remove the jammed piece of paper inside the Top Cover.  <ol style="list-style-type: none"> <li>1. Open the Top Cover and make sure the Carriage is not over the Platen.</li> <li>2. Remove any scraps of paper inside the Top Cover. (See "Clearing Jammed Roll Paper.") →P.773 (See "Clearing a Jammed Sheet.") →P.777</li> <li>3. Close the Top Cover.</li> </ol>
The ink was not dry when paper was cut.	Specify a longer drying period in the Control Panel menu, in <b>Paper Details &gt; Roll DryingTime</b> . (See "Menu Settings.") →P.673
Printing may be faint if <b>Print Quality</b> in <b>Advanced Settings</b> in the printer driver is set to <b>Standard</b> or <b>Draft</b> .	In <b>Advanced Settings</b> of the printer driver, choose <b>Highest</b> or <b>High</b> in <b>Print Quality</b> . Printing in <b>Draft</b> or <b>Standard</b> mode is faster and consumes less ink than in <b>Highest</b> or <b>High</b> modes, but the printing quality is lower. (See "Giving Priority to Particular Graphic Elements and Colors for Printing.") →P.60



Cause	Corrective Action
You are printing on paper that tends to generate dust when cut.	In the Control Panel menu, set <b>CutDustReduct.</b> in <b>Paper Details</b> to <b>On</b> . (See "Reducing Dust from Cutting Rolls.") →P.601

## Paper rubs against the Printhead

Cause	Corrective Action
The type of paper specified in the printer driver does not match the type loaded in the printer.	Load paper of the same type as you have specified in the printer driver. (See "Loading Rolls in the Printer.") →P.579 (See "Loading Sheets in the Printer.") →P.602
	Make sure the same type of paper is specified in the printer driver as you have loaded in the printer.  <ol style="list-style-type: none"> <li>1. Press the <b>Stop</b> button and stop printing.</li> <li>2. Change the type of paper in the printer driver and try printing again.</li> </ol>
Paper has been loaded incorrectly, causing it to wrinkle.	Reload the paper. (See "Loading Rolls in the Printer.") →P.579 (See "Loading Sheets in the Printer.") →P.602
The Printhead is set too low in the Control Panel menu.	In the Control Panel menu, set <b>Head Height</b> to <b>Automatic</b> . (See "Troubleshooting Paper Abrasion and Blurry Images (Head Height).") →P.626
You are printing on heavyweight paper or paper that curls or wrinkles easily after absorbing ink.	When printing on Heavyweight Coated Paper or other paper-based media, choose a <b>VacuumStrngth</b> setting of <b>Strong</b> or <b>Strongest</b> in the Control Panel menu. If the paper still rubs, set <b>Head Height</b> to <b>Highest</b> in the Control Panel menu. (See "Adjusting the Vacuum Strength (VacuumStrngth).") →P.636 (See "Troubleshooting Paper Abrasion and Blurry Images (Head Height).") →P.626
	When printing on CAD Tracing Paper or other film-based media, choose a <b>VacuumStrngth</b> setting of <b>Standard</b> , <b>Strong</b> , or <b>Strongest</b> in the Control Panel menu. If the paper still rubs, set <b>Head Height</b> to <b>Highest</b> in the Control Panel menu. (See "Adjusting the Vacuum Strength (VacuumStrngth).") →P.636 (See "Troubleshooting Paper Abrasion and Blurry Images (Head Height).") →P.626
	When printing on paper 0.1 mm (0.004 in) thick or less, choose a <b>VacuumStrngth</b> setting of <b>Weakest</b> in the Control Panel menu. If the paper still rubs, set <b>Head Height</b> to <b>Highest</b> in the Control Panel menu. (See "Adjusting the Vacuum Strength (VacuumStrngth).") →P.636 (See "Troubleshooting Paper Abrasion and Blurry Images (Head Height).") →P.626
When you have loaded paper, the paper you have loaded does not match the type selected on the Control Panel.	Be sure to select the correct type of paper in the Control Panel menu when loading paper. (See "Loading Rolls in the Printer.") →P.579 (See "Loading Sheets in the Printer.") →P.602

## The edges of the paper are dirty

Cause	Corrective Action
The Platen has become dirty after borderless printing or printing on small paper.	Open the Top Cover and clean the Platen. (See "Cleaning Inside the Top Cover.") →P.756
The type of paper as specified on the printer does not match the type specified in the printer driver.	Make sure the same type of paper is specified on the printer as in the printer driver. (See "Changing the Type of Paper.") →P.583
	Make sure the same paper type is specified in the printer driver as on the printer.  1. Press the <b>Stop</b> button and stop printing. 2. Change the type of paper in the printer driver and try printing again.
The paper is wrinkled or warped.	Straighten out the wrinkles or curls and reload the paper. Do not use paper that has been printed on previously. (See "Loading Rolls in the Printer.") →P.579 (See "Loading Sheets in the Printer.") →P.602
A cut line is printed because <b>CutDustReduct.</b> is <b>On</b> in the Control Panel menu to reduce cutting dust.	If this function is not needed, set <b>CutDustReduct.</b> to <b>Off</b> in the Control Panel menu. (See "Menu Settings.") →P.673
The Printhead is set too low in the Control Panel menu.	In the Control Panel menu, set <b>Head Height</b> to <b>Automatic</b> . (See "Troubleshooting Paper Abrasion and Blurry Images (Head Height).") →P.626
You are printing on heavyweight paper or paper that curls or wrinkles easily after absorbing ink.	When printing on Heavyweight Coated Paper or other paper-based media, choose a <b>VacuumStrngth</b> setting of <b>Strong</b> or <b>Strongest</b> in the Control Panel menu. If the paper still rubs, set <b>Head Height</b> to <b>Highest</b> in the Control Panel menu. (See "Adjusting the Vacuum Strength (VacuumStrngth).") →P.636 (See "Troubleshooting Paper Abrasion and Blurry Images (Head Height).") →P.626
	When printing on CAD Tracing Paper or other film-based media, choose a <b>VacuumStrngth</b> setting of <b>Standard</b> , <b>Strong</b> , or <b>Strongest</b> in the Control Panel menu. If the paper still rubs, set <b>Head Height</b> to <b>Highest</b> in the Control Panel menu. (See "Adjusting the Vacuum Strength (VacuumStrngth).") →P.636 (See "Troubleshooting Paper Abrasion and Blurry Images (Head Height).") →P.626
The Ejection Guide is soiled.	Clean the Ejection Guide. (See "Cleaning the Printer Exterior.") →P.756

## The surface of the paper is dirty

Cause	Corrective Action
The Paper Retainer is soiled.	Clean the Paper Retainer. (See "Cleaning Inside the Top Cover.") →P.756

Cause	Corrective Action
You are using a paper that does not dry easily.	In the Control Panel menu, set <b>Roll DryingTime</b> to at least <b>1 min.</b> (See "Menu Settings.") →P.673
	When paper that does not dry easily is used for printing, it may curl during printing and touch the Output Tray. In this case, in the Control Panel menu, complete the settings for <b>Dry time</b> and <b>Area</b> in <b>Scan Wait Time</b> . However, note that printing will now take longer. (See "Menu Settings.") →P.673

### The back side of the paper is dirty

Cause	Corrective Action
The Platen has become dirty after borderless printing or printing on small paper.	Open the Top Cover and clean the Platen. (See "Cleaning Inside the Top Cover.") →P.756
The Platen has become soiled because you have set <b>Width Detection</b> to <b>Off</b> in the Control Panel menu.	Set <b>Width Detection</b> to <b>On</b> in the Control Panel menu, and then open the Top Cover and clean the Platen. (See "Cleaning Inside the Top Cover.") →P.756
	Open the Top Cover and clean the Platen. After this, manually advance the roll onto the Platen before printing. (See "Cleaning Inside the Top Cover.") →P.756 (See "Feeding Roll Paper Manually.") →P.590
The Paper Retainer is soiled.	Clean the Paper Retainer. (See "Cleaning Inside the Top Cover.") →P.756

### Printed colors are inaccurate

Cause	Corrective Action
Color adjustment has not been activated in the <b>Advanced Settings</b> of the printer driver.	In the <b>Advanced Settings</b> of the printer driver, access <b>Color Settings</b> in <b>Color Mode</b> to adjust colors.
Colors have not been adjusted on the computer or monitor.	Refer to the computer and monitor documentation to adjust the colors.
	Adjust the settings of the color management software, referring to the software documentation as needed.
The Printhead nozzles are clogged.	Print a test pattern to check the nozzles and see if they are clogged. (See "Checking for Nozzle Clogging.") →P.739
In the Windows printer driver, <b>Application Color Matching Priority</b> is not selected.	Click <b>Special Settings</b> on the <b>Layout</b> sheet of the printer driver and select <b>Application Color Matching Priority</b> in the dialog box.
Printhead characteristics gradually change through repeated use, and colors may change.	Adjust the Printhead alignment. (See "Automatic Adjustment to Straighten Lines and Colors (Head Posi. Adj.).") →P.619 (See "Manual Adjustment to Straighten Lines and Colors (Head Posi. Adj.).") →P.621

Cause	Corrective Action
Color may change slightly even on the same model of printer if you use a different version of the firmware or printer driver, or when you print under different settings or in a different printing environment.	Follow these steps to prepare the printing environment. <ol style="list-style-type: none"> <li>1. Use the same version of firmware or printer driver.</li> <li>2. Specify the same value for all settings items.</li> </ol>

## Banding in different colors occurs

Cause	Corrective Action
The paper feed amount is out of adjustment.	Adjust the feed amount. (See "Adjusting the Feed Amount.") →P.628
Printing does not proceed smoothly because print jobs are interrupted during transmission.	Exit other applications and cancel other print jobs.
In the Control Panel menu, <b>Adj. Priority</b> is set to <b>Print Length</b> .	Setting <b>Adj. Priority</b> to <b>Print Quality</b> in the Control Panel menu and adjusting the feed amount may improve results. (See "Adjusting the Feed Amount.") →P.628
The Printhead is out of alignment.	Adjust the Printhead alignment. (See "Automatic Adjustment to Straighten Lines and Colors (Head Posi. Adj.).") →P.619
The Printhead nozzles are clogged.	Print a test pattern to check the nozzles and see if they are clogged. (See "Checking for Nozzle Clogging.") →P.739
Streaks may occur if you set the <b>Print Quality</b> too low.	Choose a higher level of <b>Print Quality</b> in the <b>Advanced Settings</b> of the printer driver and try printing again. Printing in <b>Draft</b> or <b>Standard</b> mode is faster and consumes less ink than in <b>Highest</b> or <b>High</b> modes, but the printing quality is lower. (See "Giving Priority to Particular Graphic Elements and Colors for Printing.") →P.60
The type of paper specified in the printer driver does not match the type loaded in the printer.	Load paper of the same type as you have specified in the printer driver. (See "Loading Rolls in the Printer.") →P.579 (See "Loading Sheets in the Printer.") →P.602
	Make sure the same type of paper is specified in the printer driver as you have loaded in the printer. <ol style="list-style-type: none"> <li>1. Press the <b>Stop</b> button and stop printing.</li> <li>2. Change the type of paper in the printer driver and try printing again.</li> </ol>

## Colors in printed images are uneven

Cause	Corrective Action
<b>Line Drawing/Text</b> is selected when printing images in many solid colors.	In <b>Print Priority</b> in the <b>Advanced Settings</b> of the printer driver, choose <b>Image</b> .
You are printing on paper that curls easily.	Printed colors may appear uneven on the leading edge of paper that is susceptible to curling. Select a stronger level in <b>VacuumStrength</b> in the Control Panel menu to increase suction against the paper, or specify a leading margin of 20 mm (0.79 in) or more.

11

790

Cause	Corrective Action
You are printing on paper that curls easily.	(See "Adjusting the Vacuum Strength (VacuumStrngth).") →P.636
Printed colors may be uneven if you set the <b>Print Quality</b> too low.	Choose a higher level of <b>Print Quality</b> in the <b>Advanced Settings</b> of the printer driver. Printing in <b>Draft</b> or <b>Standard</b> mode is faster and consumes less ink than in <b>Highest</b> or <b>High</b> modes, but the printing quality is lower. (See "Giving Priority to Particular Graphic Elements and Colors for Printing.") →P.60
Color may be uneven between dark and light image areas.	Select <b>Unidirectional Printing</b> in the <b>Advanced Settings</b> of the printer driver.
When borderless printing is used, the edge of the paper is cut during printing. Thus, ink density may be slightly uneven at the leading edges.	Specify <b>No</b> in <b>Auto Cut</b> in the printer driver before printing. In this case, the paper can be printed without borders on the left and right sides only. Cut the printed document ejected from the printer, and then use scissors or a cutting tool to cut away the edges on the top and bottom.
	Choose a higher level of <b>Print Quality</b> in the <b>Advanced Settings</b> of the printer driver. (See "Giving Priority to Particular Graphic Elements and Colors for Printing.") →P.60
The Printhead is out of alignment.	Adjust the Printhead alignment. (See "Automatic Adjustment to Straighten Lines and Colors (Head Posi. Adj.).") →P.619
Allowing printed documents to dry on top of each other may cause uneven colors.	To avoid uneven colors, we recommend drying each sheet separately.
Density may be uneven if you use Glossy Paper or Coated Paper.	In <b>Advanced Settings</b> of the printer driver, choose <b>Highest</b> or <b>High</b> in <b>Print Quality</b> .
The type of paper specified in the printer driver does not match the type loaded in the printer.	Load paper of the same type as you have specified in the printer driver. (See "Loading Rolls in the Printer.") →P.579 (See "Loading Sheets in the Printer.") →P.602
	Make sure the same type of paper is specified in the printer driver as you have loaded in the printer.  <b>1.</b> Press the <b>Stop</b> button and stop printing. <b>2.</b> Change the type of paper in the printer driver and try printing again.
<b>Scan Wait Time &gt; Area</b> in the Control Panel menu is set to <b>Leading edge</b> .	When <b>Scan Wait Time &gt; Area</b> is set to <b>Leading edge</b> , colors may be uneven 110–140 mm from the leading edge. (The position varies depending on the <b>Print Quality</b> setting.) In this case, select <b>Scan Wait Time &gt; Area &gt; Entire area</b> . However, note that printing will now take longer. (See "Menu Settings.") →P.673

**Image edges are blurred or white banding occurs**

Cause	Corrective Action
The Platen suction is too strong.	In the Control Panel menu, set <b>VacuumStrngth</b> to <b>Weakest</b> . (See "Adjusting the Vacuum Strength (VacuumStrngth).") →P.636
The Printhead is set too high in the Control Panel menu.	In the Control Panel menu, set <b>Head Height</b> to <b>Lowest</b> .

Cause	Corrective Action
The Printhead is set too high in the Control Panel menu.	(See "Troubleshooting Paper Abrasion and Blurry Images (Head Height).") →P.626
The type of paper specified in the printer driver does not match the type loaded in the printer.	Load paper of the same type as you have specified in the printer driver. (See "Loading Rolls in the Printer.") →P.579 (See "Loading Sheets in the Printer.") →P.602
	Make sure the same type of paper is specified in the printer driver as you have loaded in the printer.  <ol style="list-style-type: none"> <li>1. Press the <b>Stop</b> button and stop printing.</li> <li>2. Change the type of paper in the printer driver and try printing again.</li> </ol>

### The contrast becomes uneven during printing

Cause	Corrective Action
The paper feed amount is out of adjustment.	Adjust the feed amount. (See "Adjusting the Feed Amount.") →P.628
The type of paper specified in the printer driver does not match the type loaded in the printer.	Load paper of the same type as you have specified in the printer driver. (See "Loading Rolls in the Printer.") →P.579 (See "Loading Sheets in the Printer.") →P.602
	Make sure the same type of paper is specified in the printer driver as you have loaded in the printer.  <ol style="list-style-type: none"> <li>1. Press the <b>Stop</b> button and stop printing.</li> <li>2. Change the type of paper in the printer driver and try printing again.</li> </ol>

### The length of printed images is inaccurate in the feeding direction

Cause	Corrective Action
In the Control Panel menu, <b>Adj. Priority</b> is set to <b>Print Quality</b> .	Set <b>Adj. Priority</b> to <b>Print Length</b> in the Control Panel menu, and then execute <b>Adjust Length</b> . (See "Adjusting the Feed Amount.") →P.628
The type of paper specified in the printer driver does not match the type loaded in the printer.	Load paper of the same type as you have specified in the printer driver. (See "Loading Rolls in the Printer.") →P.579 (See "Loading Sheets in the Printer.") →P.602
	Make sure the same type of paper is specified in the printer driver as you have loaded in the printer.  <ol style="list-style-type: none"> <li>1. Press the <b>Stop</b> button and stop printing.</li> <li>2. Change the type of paper in the printer driver and try printing again.</li> </ol>

### Images are printed crooked

Cause	Corrective Action
In the Control Panel menu, <b>Skew Check Lv.</b> is set to <b>Loose</b> or <b>Off</b> .	In the Control Panel menu, set <b>Skew Check Lv.</b> to <b>Standard</b> .

Cause	Corrective Action
In the Control Panel menu, <b>Width Detection</b> is set to <b>Off</b> .	Set <b>Width Detection</b> to <b>On</b> in the Control Panel menu.

## Documents are printed in monochrome

Cause	Corrective Action
In the <b>Advanced Settings</b> of the printer driver, <b>Monochrome</b> , <b>Monochrome (BK ink)</b> , or <b>Monochrome Bitmap</b> is specified in <b>Color Mode</b> .	In the <b>Advanced Settings</b> of the printer driver, specify <b>Color</b> in <b>Color Mode</b> and try printing again.
The Printhead nozzles are clogged.	Print a test pattern to check the color ink nozzles and see if they are clogged. (See "Checking for Nozzle Clogging.") →P.739

## Line thickness is not uniform

Cause	Corrective Action
In the <b>Special Settings</b> dialog box of the Windows printer driver, <b>Fast Graphic Process</b> is selected.	Access the printer driver <b>Properties</b> dialog box from <b>Print</b> in the <b>File</b> menu of the source application, and follow these steps to print. <ol style="list-style-type: none"> <li>1. Clear the option <b>Open Preview When Print Job Starts</b> on the <b>Main</b> sheet.</li> <li>2. Clear the option <b>Page Layout</b> on the <b>Layout</b> sheet.</li> <li>3. Click the <b>Special Settings</b> button in the <b>Layout</b> sheet to open the <b>Special Settings</b> dialog box, and remove the check from <b>Fast Graphic Process</b>.</li> </ol>
The type of paper specified in the printer driver does not match the type loaded in the printer.	Load paper of the same type as you have specified in the printer driver. (See "Loading Rolls in the Printer.") →P.579 (See "Loading Sheets in the Printer.") →P.602
	Make sure the same type of paper is specified in the printer driver as you have loaded in the printer. <ol style="list-style-type: none"> <li>1. Press the <b>Stop</b> button and stop printing.</li> <li>2. Change the type of paper in the printer driver and try printing again.</li> </ol>

11

## Lines are misaligned

Cause	Corrective Action
The Printhead alignment is not adjusted.	Adjust the Printhead alignment. (See "Automatic Adjustment to Straighten Lines and Colors (Head Posi. Adj.).") →P.619 (See "Manual Adjustment to Straighten Lines and Colors (Head Posi. Adj.).") →P.621 (See "Adjusting Line Misalignment (Head Inc. Adj.).") →P.623

793

Cause	Corrective Action
The type of paper specified in the printer driver does not match the type loaded in the printer.	Load paper of the same type as you have specified in the printer driver. (See "Loading Rolls in the Printer.") →P.579 (See "Loading Sheets in the Printer.") →P.602
	Make sure the same type of paper is specified in the printer driver as you have loaded in the printer.  1. Press the <b>Stop</b> button and stop printing. 2. Change the type of paper in the printer driver and try printing again.

**Problems with the printing quality caused by the type of paper**

For paper-specific troubleshooting tips to improve the printing quality, refer to the Paper Reference Guide. (See "Types of Paper.") →P.568



## Cannot print over a network

Cannot connect the printer to the network ..... 795  
 Cannot print over a TCP/IP network ..... 795  
 Cannot print over a NetWare network ..... 796  
 Cannot print over AppleTalk or Bonjour networks ..... 796

### Cannot connect the printer to the network

Cause	Corrective Action
The Ethernet cable is not connected correctly to the printer's Ethernet port.	<ol style="list-style-type: none"> <li>1. Make sure the printer is connected to the network with the correct Ethernet cable, and then turn the printer on. For instructions on connecting the cable, refer to the Setup Guide.</li> <li>2. Make sure the Link indicator is lit.                      The bottom indicator is green if the printer is connected via 1000Base-T, while the top indicator is orange if connected via 100Base-TX and the top indicator is green if connected via 10Base-T.                      If the Link indicator is not lit, check the following points.                     <ul style="list-style-type: none"> <li>• Make sure the hub is on.</li> <li>• Make sure the end of the Ethernet cable is connected correctly.                              Insert the Ethernet cable until it clicks and locks in place.</li> <li>• Make sure there is no problem with the Ethernet cable.                              If there is any problem, replace the Ethernet cable.</li> <li>• Check the communication mode with the hub.                              Although the printer normally detects the hub communication mode and transmission rate automatically (in auto negotiation mode), sometimes the hub settings cannot be detected. In this case, configure the connection method manually, specifying the communication mode in use.                              (See "Configuring the Communication Mode Manually.") →P.727</li> </ul> </li> </ol>

### Cannot print over a TCP/IP network

Cause	Corrective Action
The printer's IP address is not configured correctly.	Make sure the printer's IP address is configured correctly. (See "Configuring the IP Address Using imagePROGRAF Device Setup Utility.") →P.408 (See "Configuring the IP Address Using the Printer Control Panel.") →P.700
The printer's TCP/IP network settings are not configured correctly.	Make sure the printer's TCP/IP network settings are configured correctly. (See "Configuring the Printer's TCP/IP Network Settings With RemoteUI.") →P.704
The computer you are trying to print from is not configured correctly.	Make sure the computer's TCP/IP network settings are configured correctly. (See "Configuring the Printer Driver Destination (Windows).") →P.703 (See "Configuring the Destination in TCP/IP Networks.") →P.719

## Cannot print over a NetWare network

Cause	Corrective Action
The printer's NetWare settings are not configured correctly.	Make sure the printer's NetWare settings are configured correctly. In particular, make sure a valid frame type is selected. (See "Configuring the Printer's NetWare Network Settings With RemoteUI.") →P.716
The computer you are trying to print from is not configured correctly.	Make sure the computer's NetWare settings are configured correctly. (See "Configuring NetWare Network Settings.") →P.708
The NetWare server and services are not configured correctly.	Check the following points. <ol style="list-style-type: none"> <li>1. Make sure the NetWare file server is running.</li> <li>2. Make sure there is enough free disk space on the NetWare file server. Insufficient disk space may prevent you from processing large print jobs.</li> <li>3. Start NWADMIN or PCONSOLE and confirm that the print service is configured correctly and the print queue is available.</li> <li>4. If data transmission to a printer on another subnet fails, deactivate NCP burst mode in that printer's network protocol settings.</li> <li>5. If the printer is used in queue server mode, specify <b>Other/Unknown</b> as the printer type.</li> </ol>

## Cannot print over AppleTalk or Bonjour networks

Cause	Corrective Action
The AppleTalk protocol is not enabled on the printer.	Activate AppleTalk on the printer. (See "Configuring the Printer's AppleTalk Network Settings.") →P.725
The computer you are trying to print from is not configured correctly.	Make sure the computer's AppleTalk settings are configured correctly. (See "Configuring the Destination for AppleTalk Networks.") →P.723 (See "Configuring the Destination for Bonjour Network.") →P.721
The computer and printer are not on the same network.	Due to the nature of Bonjour, you cannot print if the printer is on another network behind a router. Make sure the computer and printer are on the same network. For information about network settings, ask your network administrator.

## Installation problems

Removing Installed Printer Drivers ..... 797

### Removing Installed Printer Drivers

Follow these steps to remove installed printer drivers and utilities.

#### Removing printer drivers (Windows)

Remove the printer driver as follows.



**Note**

- The following instructions are for Windows XP. The method of removing printer drivers varies depending on the version of Windows.

1. From the Windows **start** menu, select **Programs > Canon Printer Uninstaller > imagePROGRAF Printer Driver Uninstaller** to display the **Delete Printer** window.
2. Select the printer in the list and click **Delete**.
3. Click **Yes** after the **Warning** message is displayed.
4. Make sure that the printer has been removed from the list, and then click **Exit**.

#### Removing printer drivers and imagePROGRAF Printmonitor (Macintosh)

Remove the printer driver or imagePROGRAF Printmonitor as follows.

1. Insert the User Software CD-ROM provided with the printer in the CD-ROM drive.
2. Start the printer driver installer included in the User Software CD-ROM. Open the **OS X** folder and double-click **iPF Driver Installer X**.
3. In the upper left menu, choose **Uninstall**, and then click **Uninstall**.
4. Follow the instructions on the screen to remove the printer driver or imagePROGRAF Printmonitor.

#### Removing imagePROGRAF Status Monitor (Windows)

Remove imagePROGRAF Status Monitor as follows.



**Note**

- The following instructions are for Windows XP. The method of removing printer drivers varies depending on the version of Windows.

1. Select **Control Panel** from the **start** menu.
2. Select **Add or Remove Programs**.
3. Select **imagePROGRAF Status Monitor**, and then click the **Change/Remove** button.

### Removing imagePROGRAF Device Setup Utility (Windows)

Remove imagePROGRAF Device Setup Utility as follows.



**Note**

- The following instructions are for Windows XP. The method of removing printer drivers varies depending on the version of Windows.

1. From the Windows **start** menu, select **Programs > imagePROGRAF Device Setup Utility > Uninstaller (imagePROGRAF Device Setup Utility)** to start the wizard.
2. In the wizard window, click **Delete**, and then click **Next**.
3. Follow the instructions on the screen to remove imagePROGRAF Device Setup Utility.

## HP-GL/2 problems

With HP-GL/2, printing is misaligned ..... 799  
 Lines or images are missing in printed HP-GL/2 jobs. .... 799  
 Lines are printed too thick or thin in HP-GL/2 print jobs ..... 799  
 HP-GL/2 jobs are printed in monochrome (or color) ..... 800  
 Printed colors of lines are inaccurate during HP-GL/2 printing ..... 800  
 HP-GL/2 jobs are printed 6 mm larger than specified ..... 800  
 HP-GL/2 jobs are printed at maximum size, even if a standard size is specified ..... 800  
 HP-GL/2 printing takes a long time ..... 800  
 Replotting with HP-GL/2 jobs is not possible. .... 801  
 The printer stops when printing a HP-GL/2 job (the carriage stops moving) ..... 801

### With HP-GL/2, printing is misaligned

Cause	Corrective Action
The plotter origin is incorrect.	Check the printing commands.
The <b>Margin</b> setting in the Control Panel menu is incorrect.	Adjust the <b>Margin</b> setting values in the Control Panel menu.

### Lines or images are missing in printed HP-GL/2 jobs.

Cause	Corrective Action
The memory is full.	Check the size of the data in the print job.
An HP-GL/2 command not supported by this printer was received.	Check the print job and settings.
The printer has received print data that includes HP RTL commands when <b>Auto Rotate</b> is <b>On</b> in the Control Panel menu.	In the Control Panel, set <b>Auto Rotate</b> to <b>Off</b> and print again. (See "Menu Settings.") →P.673

### Lines are printed too thick or thin in HP-GL/2 print jobs

Cause	Corrective Action
The <b>Width</b> setting in the Control Panel menu is incorrect.	Check the <b>Width</b> setting value specified for <b>Pen no.</b> in <b>Palette A</b> or <b>Palette B</b> in the Control Panel menu. If fine lines are printed faintly, setting <b>ThickenFineLines</b> to <b>On</b> will print the lines more distinctly. (See "Menu Settings.") →P.673

### HP-GL/2 jobs are printed in monochrome (or color)

Cause	Corrective Action
The <b>Color Mode</b> setting in the Control Panel menu is incorrect.	Check the <b>Color Mode</b> setting in the Control Panel menu. (See "Menu Settings.") →P.673 However, for optimal Printhead performance, the printer consumes trace amounts of color ink even when <b>Monochrome</b> is selected as <b>Color Mode</b> .

### Printed colors of lines are inaccurate during HP-GL/2 printing

Cause	Corrective Action
<b>AdjustFaintLines</b> is <b>On</b> in the Control Panel menu.	Setting <b>AdjustFaintLines</b> to <b>Off</b> in the Control Panel menu may help produce the expected results. However, lines in some colors may appear broken.

### HP-GL/2 jobs are printed 6 mm larger than specified

Cause	Corrective Action
The page size of the HP-GL/2 print job, as created in the source application, is incorrect.	In the Control Panel menu, set <b>PageSizeProcess1</b> to <b>On</b> . (See "Menu Settings.") →P.673

### HP-GL/2 jobs are printed at maximum size, even if a standard size is specified

Cause	Corrective Action
The page size of the HP-GL/2 print job, as created in the source application, is incorrect.	In the Control Panel menu, set <b>PageSizeProcess2</b> or <b>Conserve Paper</b> to <b>On</b> . The layout will be changed to the optimal layout. (See "Menu Settings.") →P.673

### HP-GL/2 printing takes a long time

Cause	Corrective Action
Large print jobs with a lot of data take longer to print.	Please wait a while until printing is finished.
A job was printed when <b>Input Resolution</b> in the Control Panel menu was set to <b>600dpi</b> .	In the Control Panel menu, set <b>Input Resolution</b> to <b>300dpi</b> and print again. (See "Menu Settings.") →P.673

11

800

**Replotting with HP-GL/2 jobs is not possible.**

Cause	Corrective Action
The data was lost because of replotting.	Data for replotting is lost after the following operations. In this case, send the print job again. <ul style="list-style-type: none"> <li>• The memory buffer was cleared from the Control Panel.</li> <li>• The printer was turned off.</li> <li>• The printer has received a new HP-GL/2 print job.</li> <li>• Printing has been canceled</li> </ul>

**The printer stops when printing a HP-GL/2 job (the carriage stops moving)**

Cause	Corrective Action
The printer is analyzing the print job.	Please wait a while until printing is finished.
A job was printed when <b>Input Resolution</b> in the Control Panel menu was set to <b>600dpi</b> .	In the Control Panel menu, set <b>Input Resolution</b> to <b>300dpi</b> and print again. (See "Menu Settings.") →P.673

## Other problems

The printer does not go on ..... 802

If the Printer Makes a Strange Sound ..... 803

Messages advising to check the maintenance cartridge are not cleared ..... 803

The printer consumes a lot of ink ..... 803

Ink Level Detection ..... 804

### The printer does not go on

Cause	Corrective Action
The printer is unplugged.	Plug the power cord into the outlet, and then turn on the printer.
The specified voltage is not supplied.	Check the voltage of the outlet and breaker. (See "Specifications.") →P.835



## If the Printer Makes a Strange Sound

Cause	Corrective Action
<p>The printer makes a sound during operation.</p>	<p>The following sounds do not indicate a problem with the printer.</p> <ul style="list-style-type: none"> <li>• There is a sound of suction from the Platen To prevent paper from rising, paper is held against the Platen by suction from Vacuum holes under it.</li> <li>• There is a sound when a different size of paper is used and when the Carriage goes from side to side When paper of a different size is used, a valve is automatically activated to switch the area for paper suction, which may make a sound. This mechanism prevents suction from Vacuum holes where there is no paper. In addition, ink is ejected in sync with the movement of the Carriage back and forth to ensure optimal ink flow. At this time, the valve automatically switches the area for paper suction, which may make a sound.</li> <li>• Roll paper makes a fluttering sound during printing There may be a fluttering sound when large paper is advanced.</li> <li>• If you suddenly hear the tone for cleaning operations At regular intervals, for printer maintenance, cleaning operations will begin automatically, even if the printer is in Sleep mode.</li> <li>• If you suddenly hear the tone for ink agitation At regular intervals, to ensure optimal printing quality, the ink is agitated automatically, even if the printer is in Sleep mode. Ink agitation takes about 30 seconds. The ink is also agitated automatically under the following conditions. Note that other operations are not possible while "<b>Agitating</b>" is displayed on the control panel.                         <ul style="list-style-type: none"> <li>• After the printer is turned on. (The time for agitation varies depending on how long the printer was off—between about 30 seconds and two minutes.)</li> <li>• After data transmission. (After about a minute and a half, printing operations begin. However, printing may start later after data reception, depending on the size of print data.)</li> <li>• After ink tank replacement. (Ink agitation takes about three and a half minutes.)</li> </ul> </li> </ul> <p>In other cases, contact your Canon dealer.</p>

## Messages advising to check the maintenance cartridge are not cleared

Cause	Corrective Action
<p>The printer has not detected the new Maintenance Cartridge that was used to replace the old one.</p>	<p>Remove the new Maintenance Cartridge you have just installed and insert it again firmly.</p> <p>Restart the printer.</p>

## The printer consumes a lot of ink

Cause	Corrective Action
<p>Many full-page color images are printed.</p>	<p>In print jobs such as photos, images are filled with color. This consumes a lot of ink. This does not indicate a problem with the printer.</p>

Cause	Corrective Action
<b>Head Cleaning B</b> in the Control Panel menu is executed frequently.	<b>Head Cleaning B</b> in the Control Panel menu consumes a lot of ink. This does not indicate a problem with the printer. Unless the printer has been moved or stored for a long period or you are troubleshooting Printhead problems, we recommend not performing <b>Head Cleaning B</b> , to the extent possible.
You have just finished initial installation, when more ink is consumed to fill the system.	After initial installation or at the first-time use after transfer, ink flows into the system between the Ink Tank and Printhead, which may cause the ink level indicators to drop to 80%. This does not indicate a problem with the printer.
The Printhead nozzles are clogged.	Check for nozzle clogging. (See "Checking for Nozzle Clogging.") →P.739

## Ink Level Detection

Ink level detection will be deactivated if you load ink tanks once emptied.

### Ink level detection

Ink tanks specified for this printer feature an ink level detection function to prevent the ink from running out during printing, which prevents printer damage. (See "Ink Tanks.") →P.731

This function will not work correctly if you use refill ink tanks. As a result, printing stops. Thus, before using refill ink tanks, you must cancel the ink level detection.

Printing with the ink level detection canceled may lead to printer damage and printing problems. Canon Inc. is not liable for any damage that may occur as a result of refilling ink.



#### Important

- After ink level detection has been released, this function cannot be reactivated for currently loaded Ink Tank. To use ink level detection again, replace the Ink Tank with new ones specified for use with the printer.
- Repeatedly removing and inserting an Ink Tank may damage the connection between the Ink Tank and the printer, which may cause ink leakage from the Ink Tank and damage the printer.

## 11

### Releasing ink level detection

1. On the Display Screen, a message indicates that the ink level cannot be detected. After checking the message, press the ► button.

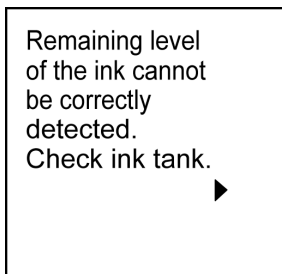

2. Press ▲ or ▼ to select **Information**, and then press the **OK** button.

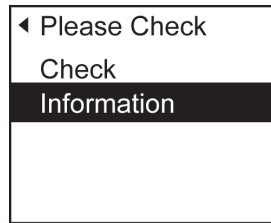

3. A confirmation message is shown on the Display Screen about releasing ink level detection. After checking the message, press the ► button.

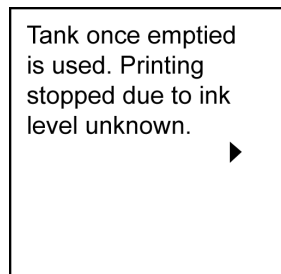

4. After checking the message, press the ► button.

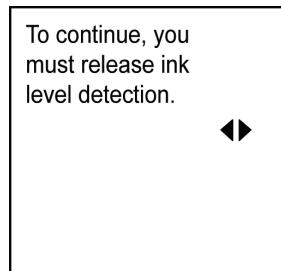

5. Press ▲ or ▼ to select **Yes**, and then press the **OK** button.

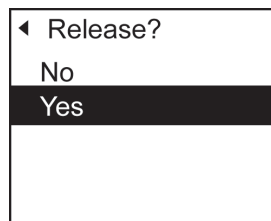

6. Check the message and press the ► button.

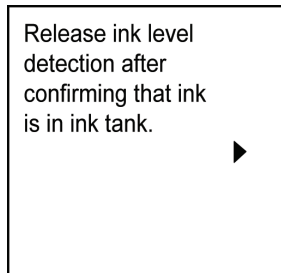

7. Check the message and press the ► button.

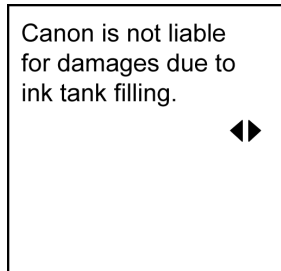

8. Press ▲ or ▼ to select Yes, and then press the OK button.

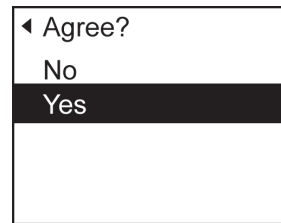

9. A confirmation message about updating ink information is shown on the Display Screen. After checking the message, press the ► button.

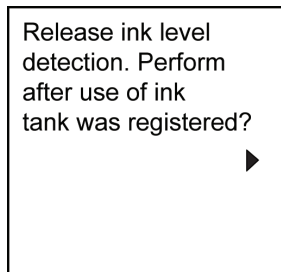

**10.** Press ▲ or ▼ to select **Yes**, and then press the **OK** button.

◀ Agree?
No
<b>Yes</b>

Ink level detection is now released.

## Error Message

Error Messages	809
Messages regarding paper	811
Messages regarding ink	822
Messages regarding printing or adjustment	825
Messages regarding printheads	826
Messages regarding the maintenance cartridge	828
Messages regarding HP-GL/2	830
Other Messages	831

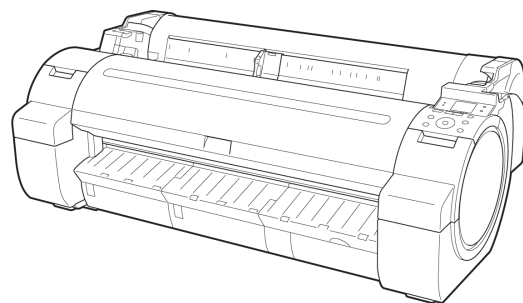

## Error Messages

Borderless printing not possible. ....	820
Cannot adjust paper feed. ....	825
Cannot adjust printhead. ....	826
Cannot detect paper. ....	819
Check printed document. ....	825
Close Ink Tank Cover. ....	823
Do not pull out ink tank. ....	824
End of paper feed. ....	820
ERROR Exxx-xxxx (x represents a letter or number) ....	831
Error in cutter position. ....	833
Execute printhead cleaning. ....	827
GARO Wxxxx (x represents a number) ....	831
GL2: W0502 The parameter is out of range. ....	830
GL2: W0504 This command is not supported. ....	830
GL2: Wxxxx The memory is full. (xxxx is 0501, 0903, or 0904) ....	830
Hardware error. xxxxxxxx-xxxx (x represents a letter or number) ....	831
Ink insufficient. ....	822
Ink tank is empty. ....	823
Insert the maintenance cartridge. ....	828
Insufficient paper for job. ....	815
Maint. cart. The level is low. ....	828
Maintenance cartridge full. ....	828
Maintenance cartridge problem. ....	829
MediaType Mismatch. ....	811
Multi-sensor error. ....	833
No ink left. ....	822
No ink tank loaded. ....	824
No Maintenance Cartridge capacity. ....	828
No printhead. ....	827
Not much ink is left. ....	823
Paper cutting failed. ....	819
Paper is crooked. ....	818
Paper jam. ....	817
Paper not aligned with right guide. ....	819
Paper position not suitable for borderless printing. ....	821
Paper size not detected. ....	814
PaperWidth Mismatch. ....	813
Parts replacement time has passed. ....	832
Prepare for parts replacement. ....	832
Printhead error. ....	826
Regular printing is selected, but a roll is loaded. ....	817
Rel lever is in wrong position. ....	820
Remaining level of the ink cannot be correctly detected. ....	822
Roll paper is not securely in contact with roll holder. ....	821
Roll printing is selected, but sheets are loaded. ....	816
Roll printing is selected. ....	815

Sheet printing is selected. ....	817
The paper is too small. ....	812
The paper is too small. ....	812
The roll is empty. ....	816
This paper cannot be used. ....	815
This type of paper is not compatible with HP-GL/2. ....	830
Top cover is open. ....	832
Unable to detect ink level correctly. ....	822
Unknown file. ....	832
Wrong ink tank. ....	824
Wrong maintenance cartridge. ....	828
Wrong printhead. ....	826



## Messages regarding paper

MediaType Mismatch .....	811
The paper is too small. ....	812
The paper is too small. ....	812
PaprWidth Mismatch .....	813
Paper size not detected. ....	814
Insufficient paper for job .....	815
This paper cannot be used. ....	815
Roll printing is selected. ....	815
Roll printing is selected, but sheets are loaded. ....	816
The roll is empty. ....	816
Sheet printing is selected. ....	817
Regular printing is selected, but a roll is loaded. ....	817
Paper jam .....	817
Paper is crooked. ....	818
Paper not aligned with right guide. ....	819
Cannot detect paper .....	819
Paper cutting failed. ....	819
End of paper feed. ....	820
Rel lever is in wrong position. ....	820
Borderless printng not possible. ....	820
Paper position not suitable for borderless printing. ....	821
Roll paper is not securely in contact with roll holder. ....	821

## MediaType Mismatch

Cause	Corrective Action
When <b>Detect Mismatch</b> in the Control Panel menu is set to <b>Pause</b> , the type of paper loaded does not match the type specified in the printer driver.	<p>Follow these steps to ensure the paper type matches on the printer and in the printer driver.</p> <ol style="list-style-type: none"> <li>1. Press <b>▲</b> or <b>▼</b> to select <b>Stop Printing</b>, and then press the <b>OK</b> button.</li> <li>2. Either change the type of paper specified in the printer driver settings or replace the loaded paper and change the paper type setting on the printer. (See "Loading and Printing on Rolls.") <b>→P.6</b> (See "Loading and Printing on Sheets.") <b>→P.9</b></li> </ol>
You tried to print a test pattern for printer adjustment on several sheets, but sheets of different types of paper were used.	<p>When printing a test pattern for adjustment, use sheets of the same type of paper, in the required quantity. Replace the paper as follows and perform adjustment again.</p> <ol style="list-style-type: none"> <li>1. Press <b>▲</b> or <b>▼</b> to select <b>Stop Printing</b>, and then press the <b>OK</b> button.</li> <li>2. Replace the paper. (See "Loading and Printing on Sheets.") <b>→P.9</b></li> <li>3. Execute adjustment again from the control panel menu.</li> </ol> <p>Press <b>▲</b> or <b>▼</b> to select <b>Print</b>, and then press the <b>OK</b> button to resume printing. However, note that this error may cause paper jams and affect the printing quality.</p>

Cause	Corrective Action
When <b>Detect Mismatch</b> in the Control Panel menu is set to <b>Warning</b> , the type of paper loaded does not match the type specified in the printer driver.	You can continue to print, but note that this error may cause problems in the printing results.

**The paper is too small.**

Cause	Corrective Action
When <b>Detect Mismatch</b> in the Control Panel menu is set to <b>Pause</b> or <b>Hold Job</b> , paper smaller than the size specified in the printer driver is loaded.	Press <b>▲</b> or <b>▼</b> to select <b>Print</b> , and then press the <b>OK</b> button to resume printing. However, note that this error may cause paper jams and affect the printing quality.
	Adjust the paper size setting in the printer driver to match the size loaded in the printer as follows.  <ol style="list-style-type: none"> <li>1. Press <b>▲</b> or <b>▼</b> to select <b>Stop Printing</b>, and then press the <b>OK</b> button.</li> <li>2. Change the paper size setting in the printer driver to the size loaded in the printer and try printing again.</li> </ol>
	Replace the loaded paper with paper of a size that matches the size setting in the printer driver as follows.  <ol style="list-style-type: none"> <li>1. Press <b>▲</b> or <b>▼</b> to select <b>Change Paper</b>, and then press the <b>OK</b> button to stop printing.</li> <li>2. Replace the loaded paper to match the paper width setting in the printer driver and try printing again.</li> </ol>
When <b>Detect Mismatch</b> in the Control Panel menu is set to <b>Warning</b> , paper smaller than the size specified in the printer driver is loaded.	You can continue to print, but note that this error may cause problems in the printing results.

**The paper is too small.**

**"Replace paper with A4/LTR (vertical) or larger"**

Cause	Corrective Action
The loaded paper is too small.	Replace the paper with paper of A4/Letter (vertical) size or larger as follows.  <ol style="list-style-type: none"> <li>1. Press <b>▲</b> or <b>▼</b> to select <b>Change Paper</b>, press the <b>OK</b> button, and remove the paper. (See "Removing Sheets.") →P.609</li> <li>2. Switch to paper A4/Letter (vertical) or larger. (See "Loading and Printing on Sheets.") →P.9 The printer will resume printing.</li> </ol>
	Press <b>▲</b> or <b>▼</b> to select <b>Stop Printing</b> , and then press the <b>OK</b> button.

**"Replace roll with 10 in. wide or larger roll."**

Cause	Corrective Action
The loaded paper is too small.	<p>Replace the roll with a roll 10 inches in width or larger as follows.</p> <ol style="list-style-type: none"> <li>1. Press ▲ or ▼ to select <b>Change Paper</b>, and then press the <b>OK</b> button. (See "Removing the Roll from the Printer.") →P.585 (See "Removing the Roll Holder from Rolls.") →P.589</li> <li>2. Replace the roll with a roll 10 inches wide or larger. (See "Attaching the Roll Holder to Rolls.") →P.575 (See "Loading Rolls in the Printer.") →P.579</li> </ol> <p>The printer will resume printing.</p>
	Press ▲ or ▼ to select <b>Stop Printing</b> , and then press the <b>OK</b> button.

**"Remove paper and check pap. size"**

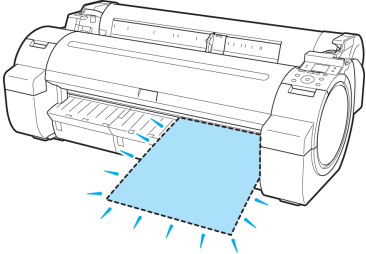
Cause	Corrective Action
<p>A sheet has come out of the printer during printing.</p> 	<ol style="list-style-type: none"> <li>1. Press the Release Lever back and remove the paper.</li> <li>2. Reload the sheet, aligning it with the guide on the right.</li> <li>3. Pull the Release Lever forward.</li> <li>4. If "<b>Not finished printing. Finish printing remaining jobs?</b>" is shown on the Display Screen, press the <b>OK</b> button. Printing will resume, starting from the page on which the error occurred.</li> </ol> <p>(See "Loading Sheets in the Printer.") →P.602</p>

**PaprWidth Mismatch**

Cause	Corrective Action
When <b>Detect Mismatch</b> in the Control Panel menu is set to <b>Pause</b> or <b>Warning</b> , the width of the loaded roll does not match the width specified in <b>Fit Roll Paper Width</b> in the printer driver.	<p>Press ▲ or ▼ to select <b>Print</b>, and then press the <b>OK</b> button to resume printing. However, note that this error may cause paper jams and affect the printing quality.</p>
	<p>Press ▲ or ▼ to select <b>Stop Printing</b>, and then press the <b>OK</b> button.</p>
	<p>Follow these steps to replace the roll to match the width specified in the printer driver.</p> <ol style="list-style-type: none"> <li>1. Press ▲ or ▼ to select <b>Change Paper</b>, and then press the <b>OK</b> button. (See "Removing the Roll from the Printer.") →P.585 (See "Removing the Roll Holder from Rolls.") →P.589</li> <li>2. Replace the paper with paper compatible for borderless printing. (See "Attaching the Roll Holder to Rolls.") →P.575 (See "Loading Rolls in the Printer.") →P.579</li> </ol> <p>The printer now starts printing the print job.</p>

Cause	Corrective Action
When <b>Detect Mismatch</b> in the Control Panel menu is set to <b>Pause</b> or <b>Warning</b> , the width of the loaded roll does not match the width specified in <b>Fit Roll Paper Width</b> in the printer driver.	Make sure the roll width selected in the dialog box displayed when you select <b>Fit Roll Paper Width</b> in the printer driver matches the width of the roll loaded in the printer, and then try printing again.

**Paper size not detected.**

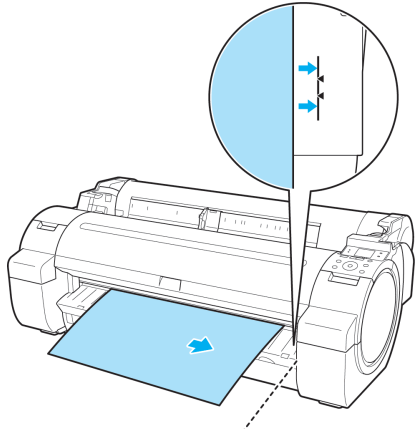
Cause	Corrective Action
<p>Paper has been loaded askew, or warped paper has been loaded.</p> 	<p>Follow these steps to reload the roll.</p> <ol style="list-style-type: none"> <li>1. Push the Release Lever back.</li> <li>2. Adjust the right edge of the roll to make it parallel to the orange Paper Alignment Line.</li> <li>3. Pull the Release Lever forward.</li> <li>4. If "<b>Not finished printing. Finish printing remaining jobs?</b>" is shown on the Display Screen, press the <b>OK</b> button. Printing will resume, starting from the page on which the error occurred.</li> </ol> <p>(See "Loading Rolls in the Printer.") →P.579</p> <p>If this error recurs after you reload the roll, remove the Roll Holder from the printer, push the roll firmly in until it touches the Roll Holder flange, and reload the Roll Holder in the printer. (See "Attaching the Roll Holder to Rolls.") →P.575</p> <p>Follow these step to reload a sheet.</p> <ol style="list-style-type: none"> <li>1. Push the Release Lever back.</li> <li>2. Load the sheet, aligning it with the guide on the right.</li> <li>3. Pull the Release Lever forward.</li> <li>4. If "<b>Not finished printing. Finish printing remaining jobs?</b>" is shown on the Display Screen, press the <b>OK</b> button. Printing will resume, starting from the page on which the error occurred.</li> </ol> <p>(See "Loading Sheets in the Printer.") →P.602</p>
Because the Platen is soiled with ink or other substances, the size of the clear film cannot be detected.	Open the Top Cover and clean the entire Platen. (See "Cleaning Inside the Top Cover.") →P.756

## Insufficient paper for job

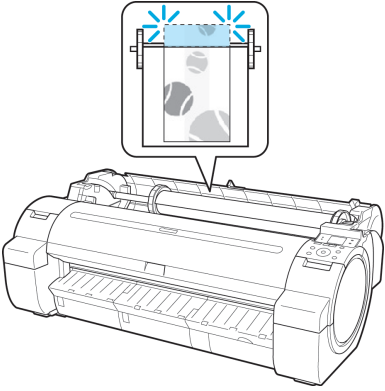
Cause	Corrective Action
<p>The printer has received a print job longer than the amount of roll paper left when <b>ManageRemainRoll</b> in the Control Panel menu is <b>On</b>.</p> 	<p>Press <b>▲</b> or <b>▼</b> to select <b>Print</b>, and then press the <b>OK</b> button to resume printing. However, the roll paper may run out during the print job and you may not be able to print all of the document.</p> <p>Press <b>▲</b> or <b>▼</b> to select <b>Change Paper</b>, and then press the <b>OK</b> button to stop printing. Either change the printer driver <b>Paper Source</b> setting or the <b>GL2 Settings &gt; Paper Source</b> setting in the printer menu or replace the roll with a roll that has enough paper for the print job, and then try printing again. (See "Removing the Roll from the Printer.") →P.585 (See "Loading Rolls in the Printer.") →P.579</p>

## This paper cannot be used.

Cause	Corrective Action
Paper smaller than the printer's minimum supported size has been loaded.	Push the Release Lever back and load paper of the correct size. (See "Paper Sizes.") →P.569
Paper has been loaded that is too small to print the test pattern for printhead adjustment or nozzle checking.	Push the Release Lever back and load unused paper of A4 size or larger. More than one sheet may be required depending on the adjustment.

## Roll printing is selected.

Cause	Corrective Action
You have attempted to print a test print sheet or other printer status information on a roll, but no roll is loaded.	<p>Press <b>▲</b> or <b>▼</b> to select <b>Load Roll Paper</b>, and then press the <b>OK</b> button. Load the roll, and then print. (See "Attaching the Roll Holder to Rolls.") →P.575 (See "Loading Rolls in the Printer.") →P.579</p> <p>To print on sheets, follow these steps.</p> <ol style="list-style-type: none"> <li>1. Press <b>▲</b> or <b>▼</b> to select <b>Stop Printing</b>, and then press the <b>OK</b> button to stop printing.</li> <li>2. Load a sheet and try printing again.</li> </ol> <p>(See "Loading and Printing on Sheets.") →P.9</p>

## Roll printing is selected, but sheets are loaded.

Cause	Corrective Action
A print job for rolls was received when a sheet is loaded.	<p>Follow these steps to load and print on a roll.</p> <ol style="list-style-type: none"> <li>1. Press ▲ or ▼ to select <b>Eject Cut Sheet</b>, press the <b>OK</b> button, and remove the sheet. (See "Removing Sheets.") →P.609</li> <li>2. Load a new roll. (See "Loading Rolls in the Printer.") →P.579 The printer now starts printing the print job.</li> </ol> <p>Press ▲ or ▼ to select <b>Stop Printing</b>, and then press the <b>OK</b> button.</p>

## The roll is empty.

Cause	Corrective Action
The roll is empty.	<p>Follow these steps to replace the used roll with a new roll of the same type and size.</p> <ol style="list-style-type: none"> <li>1. Press the Release Lever back and remove the roll. (See "Removing the Roll from the Printer.") →P.585 (See "Removing the Roll Holder from Rolls.") →P.589</li> <li>2. Load the new roll. (See "Attaching the Roll Holder to Rolls.") →P.575 (See "Loading Rolls in the Printer.") →P.579</li> <li>3. If no barcode was printed on the roll, specify the type of paper. (See "Changing the Type of Paper.") →P.583</li> <li>4. When you have selected <b>ManageRemainRoll &gt; On</b> in the control panel menu and a barcode is not printed on the roll, also specify the paper length. (See "Specifying the Paper Length.") →P.585</li> <li>5. If "<b>Not finished printing. Finish printing remaining jobs?</b>" is shown on the Display Screen, press the <b>OK</b> button. Printing will resume, starting from the page on which the error occurred. If no message appears, printing will continue from the next page.</li> </ol>
There is remaining roll paper, but because it could not be advanced, it could not be detected.	<p>The unused portion of the roll is heavy, and this is placing a burden on the printer. It may be helpful to change the printing mode, which will change the paper feed timing. Choose a higher level of <b>Print Quality</b> in the <b>Advanced Settings</b> of the printer driver. (See "Giving Priority to Particular Graphic Elements and Colors for Printing.") →P.60</p>

12

## Sheet printing is selected.

Cause	Corrective Action
You have attempted to print a test print sheet or other printer status information on a sheet, but no sheet is loaded.	Press ▲ or ▼ to select <b>Load Cut Sheet</b> , and then press the <b>OK</b> button. Load the sheet, and then print. (See "Loading and Printing on Sheets.") →P.9
	To print on rolls, follow these steps. <b>1.</b> Press ▲ or ▼ to select <b>Stop Printing</b> , and then press the <b>OK</b> button to stop printing. <b>2.</b> Load a roll and try printing again.  (See "Loading and Printing on Rolls.") →P.6

## Regular printing is selected, but a roll is loaded.

Cause	Corrective Action
A print job for printing on sheets was sent when a roll is loaded.	<b>1.</b> Press ▲ or ▼ to select <b>Remove Roll Paper</b> , and then press the <b>OK</b> button to stop printing. <b>2.</b> After removing the roll, load and print on a sheet of the type and size of paper you have specified in the printer driver. (See "Removing the Roll from the Printer.") →P.585 (See "Loading and Printing on Sheets.") →P.9

## Paper jam

### "Push the release lever back."

Cause	Corrective Action
A paper jam occurred in the printer during printing.	<b>1.</b> Push the Release Lever back and remove the jammed paper. (See "Clearing Jammed Roll Paper.") →P.773 (See "Clearing a Jammed Sheet.") →P.777 <b>2.</b> Load the paper. <b>3.</b> Pull the Release Lever forward. <b>4.</b> If " <b>Not finished printing. Finish printing remaining jobs?</b> " is shown on the Display Screen, press the <b>OK</b> button. Printing will resume, starting from the page on which the error occurred.  (See "Loading Rolls in the Printer.") →P.579 (See "Loading Sheets in the Printer.") →P.602

**"Manually rewind the roll all the way and press OK."**

Cause	Corrective Action
A paper jam occurred when advancing the paper.	<ol style="list-style-type: none"> <li>1. Rewind paper on the Roll Holder manually, all the way, and then press the <b>OK</b> button.</li> <li>2. Load the paper.</li> <li>3. If "<b>Not finished printing. Finish printing remaining jobs?</b>" is shown on the Display Screen, press the <b>OK</b> button. Printing will resume, starting from the page on which the error occurred.</li> </ol> <p>(See "Loading Rolls in the Printer.") →P.579</p>

**Paper is crooked.**

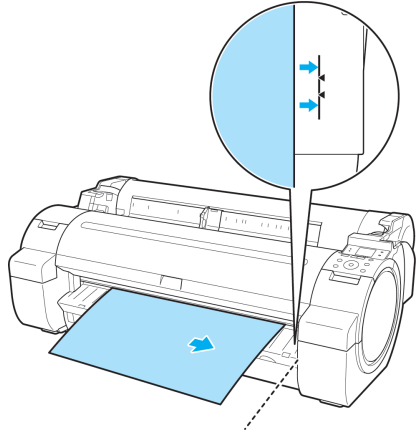
Cause	Corrective Action
<p>Paper loaded crooked was detected when the paper was advanced.</p> 	<p>Follow these steps to reload the roll.</p> <ol style="list-style-type: none"> <li>1. Push the Release Lever back.</li> <li>2. Adjust the right edge of the roll to make it parallel to the orange Paper Alignment Line.</li> <li>3. Pull the Release Lever forward.</li> </ol> <p>(See "Loading Rolls in the Printer.") →P.579</p> <p>If this error recurs after you reload the roll, remove the Roll Holder from the printer, push the roll firmly in until it touches the Roll Holder flange, and reload the Roll Holder in the printer. (See "Attaching the Roll Holder to Rolls.") →P.575</p> <p>Follow these step to reload a sheet.</p> <ol style="list-style-type: none"> <li>1. Push the Release Lever back.</li> <li>2. Pull out the sheet.</li> <li>3. Pull the Release Lever forward.</li> <li>4. Reload the sheet, aligning it with the guide on the right.</li> </ol> <p>(See "Loading Sheets in the Printer.") →P.602</p>

 **Important**

- To disable this message (if it is displayed repeatedly despite reloading paper, for example), choose **Off** or **Loose** in the **Skew Check Lv.** setting of the printer menu. However, this may cause jams and printing problems because paper may be askew when printed. Also, the Platen may become soiled, which may soil the back of the next document when it is printed.



## Paper not aligned with right guide.

Cause	Corrective Action
When paper was loaded, it was not aligned with the guide on the right side.	<p>Follow these step to reload a sheet.</p> <ol style="list-style-type: none"> <li>1. Push the Release Lever back.</li> <li>2. Pull out the sheet.</li> <li>3. Pull the Release Lever forward.</li> <li>4. Reload the sheet, aligning it with the guide on the right.</li> </ol>

## Cannot detect paper

Cause	Corrective Action
The paper has come out of the printer.	<p>Follow these step to reload a sheet.</p> <ol style="list-style-type: none"> <li>1. Remove the paper and press the <b>OK</b> button.</li> <li>2. Reload the sheet, aligning it with the guide on the right. (See "Loading Sheets in the Printer.") →P.602</li> </ol>
	<p>Follow these step to reload a sheet.</p> <ol style="list-style-type: none"> <li>1. Push the Release Lever back and remove the paper.</li> <li>2. Pull the Release Lever forward.</li> <li>3. Reload the sheet, aligning it with the guide on the right. (See "Loading Sheets in the Printer.") →P.602</li> </ol>

## Paper cutting failed.

Cause	Corrective Action
There are sheets left on the Ejection Guide.	<ol style="list-style-type: none"> <li>1. Push the Release Lever back and remove the paper.</li> <li>2. Load the paper.</li> <li>3. Pull the Release Lever forward.</li> <li>4. If "<b>Not finished printing. Finish printing remaining jobs?</b>" is shown on the Display Screen, press the <b>OK</b> button. Printing will resume, starting from the page on which the error occurred.</li> </ol> <p>(See "Loading Rolls in the Printer.") →P.579</p>
There is a foreign object by the Output Tray, obstructing the Cutter Unit.	<ol style="list-style-type: none"> <li>1. Lift the Top Cover and remove the foreign object.</li> <li>2. If "<b>Not finished printing. Finish printing remaining jobs?</b>" is shown on the Display Screen, press the <b>OK</b> button. Printing will resume, starting from the page on which the error occurred.</li> </ol>
You are not using the printer under the recommended environmental conditions for the paper.	<p>Use the printer only where the recommended environmental conditions for the paper are met. Note that various environmental conditions are recommended for various types of paper. For details on the recommended environmental conditions for paper, see Paper Reference Guide." (See Paper Reference Guide.)</p>
You are using paper that is not compatible with automatic cutting.	<ol style="list-style-type: none"> <li>1. Specify <b>Manual</b> as the cutting method and use scissors or a cutting tool to cut the roll. (See "Specifying the Cutting Method for Rolls.") →P.594</li> </ol>

Cause	Corrective Action
You are using paper that is not compatible with automatic cutting.	For information about paper that is compatible with automatic cutting, see the Paper Reference Guide. (See Paper Reference Guide.) <b>2.</b> Push the Release Lever back and remove the paper.
In other cases, the Cutter Unit may be damaged.	Contact your Canon dealer for assistance.

### End of paper feed.

Cause	Corrective Action
You are pressing the ▲ button on the Control Panel and trying to rewind the roll to the edge.	Release the ▲ button.

### Rel lever is in wrong position.

Cause	Corrective Action
The Release Lever is pushed back.	Pull the Release Lever forward. Turn off the printer and wait a while before restoring power.

### Borderless printing not possible.

Cause	Corrective Action
The print job received specifies a type or width of paper that is not compatible with borderless printing.	Follow these steps to change the settings of the print job to enable borderless printing. <b>1.</b> Press ▲ or ▼ to select <b>Stop Printing</b> , and then press the <b>OK</b> button. <b>2.</b> Make sure the correct printer driver for the printer is selected and try printing again. For information on types of paper compatible with borderless printing, refer to the Paper Reference Guide. (See Paper Reference Guide.)
	Select <b>None</b> when you have set <b>Detect Mismatch</b> on the control panel to <b>Warning</b> . However, note that this error may cause paper jams and affect the printing quality.
	Press ▲ or ▼ to select <b>Print With Border</b> , and then press the <b>OK</b> button to continue printing. The document will be printed with a border.
The loaded paper is a size not compatible with borderless printing.	Press ▲ or ▼ to select <b>Stop Printing</b> , and then press the <b>OK</b> button.
	Replace the paper with paper compatible for borderless printing as follows. <b>1.</b> Press ▲ or ▼ to select <b>Change Paper</b> , and then press the <b>OK</b> button. (See "Removing the Roll from the Printer.") →P.585 (See "Removing the Roll Holder from Rolls.") →P.589 <b>2.</b> Replace the paper with paper compatible for borderless printing. (See "Attaching the Roll Holder to Rolls.") →P.575 (See "Loading Rolls in the Printer.") →P.579 The printer now starts printing the print job. For information on types of paper compatible with borderless printing, refer to the Paper Reference Guide.

Cause	Corrective Action
The loaded paper is a size not compatible with borderless printing.	(See Paper Reference Guide.)
	Press ▲ or ▼ to select <b>Print With Border</b> , and then press the <b>OK</b> button to continue printing. The document will be printed with a border.

### Paper position not suitable for borderless printing.

Cause	Corrective Action
Because paper expands or contracts depending on the environment of use, it may become narrower or wider than the supported width for borderless printing.	Press ▲ or ▼ to select <b>Stop Printing</b> , and then press the <b>OK</b> button. Use each type of paper only where the recommended environmental conditions are met. For details on environmental conditions for various paper, see the Paper Reference Guide. (See Paper Reference Guide.)
	Select <b>None</b> when you have set <b>Detect Mismatch</b> in the Control Panel menu to <b>Warning</b> . However, note that this error may affect the printing quality.
The paper is loaded askew.	Press ▲ or ▼ to select <b>Fix Paper Position</b> and straighten the paper so that the edges are between the ink grooves for borderless printing. Insert the roll firmly until it touches the flange of the Roll Holder. (See "Attaching the Roll Holder to Rolls.") →P.575
	Select <b>None</b> when you have set <b>Detect Mismatch</b> in the Control Panel menu to <b>Warning</b> . However, note that this error may affect the printing quality.
	Press ▲ or ▼ to select <b>Print With Border</b> , and then press the <b>OK</b> button to continue printing. The document will be printed with a border.

### Roll paper is not securely in contact with roll holder.

Cause	Corrective Action
When the roll was loaded, the roll was not inserted firmly all the way on the Roll Holder.	Follow these steps to reload the roll. <ol style="list-style-type: none"> <li>1. Press the <b>OK</b> button and remove the roll holder from the printer.</li> <li>2. Insert the roll firmly on the Roll Holder until it touches the flange. (See "Attaching the Roll Holder to Rolls.") →P.575</li> <li>3. Load the Roll Holder in the printer.</li> </ol>

## Messages regarding ink

Ink insufficient. ....	822
No ink left. ....	822
Remaining level of the ink cannot be correctly detected. ....	822
Unable to detect ink level correctly. ....	822
Close Ink Tank Cover ....	823
Ink tank is empty. ....	823
Not much ink is left. ....	823
No ink tank loaded. ....	824
Wrong ink tank. ....	824
Do not pull out ink tank. ....	824

### Ink insufficient.

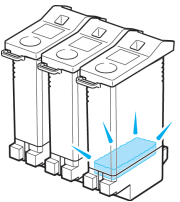
Cause	Corrective Action
<p>The ink level is low, so you cannot print, clean the Print-head, or do other operations that require ink.</p> 	<p>Press <b>▲</b> or <b>▼</b> to select <b>Rep. Ink Tank</b>, and then press the <b>OK</b> button. Replace the Ink Tank that is low with a new Ink Tank. (See "Replacing Ink Tanks.") →P.731</p> <p>Press <b>▲</b> or <b>▼</b> to select <b>Continue to print</b>, and then press the <b>OK</b> button to resume printing. However, note that this error may affect the printing quality.</p>

### No ink left.

Cause	Corrective Action
There is no ink left.	Open the Ink Tank Cover and replace the Ink Tank for which the Ink Lamp is flashing. (See "Replacing Ink Tanks.") →P.731

### Remaining level of the ink cannot be correctly detected.

Cause	Corrective Action
Ink level detection cannot work correctly if you use refill ink tanks.	The refill ink tank can no longer be used. See the section <b>Ink level detection</b> and take the appropriate action. (See "Ink Level Detection.") →P.804

### Unable to detect ink level correctly.

Cause	Corrective Action
The remaining ink level could not be correctly detected.	Close the Ink Tank Cover. The buzzer will stop once the error is cleared.

## Close Ink Tank Cover

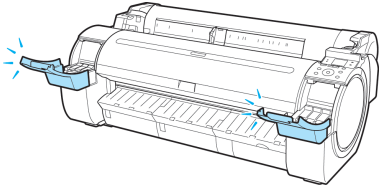
Cause	Corrective Action
<p>The Ink Tank Cover is open.</p> 	<p>Close the Ink Tank Cover.</p>

## Ink tank is empty.

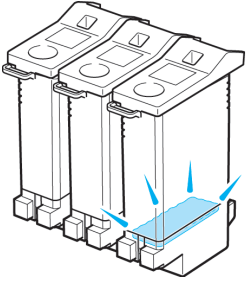
Cause	Corrective Action
<p>There is no ink left in an ink tank.</p> 	<p>Open the Ink Tank Cover and replace the Ink Tank for which the Ink Lamp is flashing. (See "Replacing Ink Tanks.") →P.731</p>

## Not much ink is left.

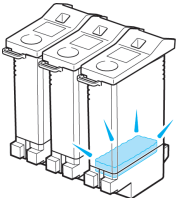
Cause	Corrective Action
<p>Not much ink is left.</p> 	<p>Prepare a new Ink Tank. We recommend replacing the Ink Tank with a new Ink Tank at this point if you plan to print large-format or high-quantity jobs.</p>

**No ink tank loaded.**

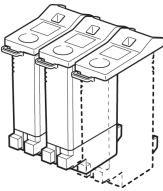
Cause	Corrective Action
<p>There is no Ink Tank of the indicated color in the printer.</p> 	<p>Load or reload the Ink Tank. (See "Replacing Ink Tanks.") →P.731</p>
<p>There is a problem with the Ink Tank.</p>	<p>Replace it with a new Ink Tank. (See "Replacing Ink Tanks.") →P.731</p>

**Wrong ink tank.**

Cause	Corrective Action
<p>The Ink Tank in the printer is incompatible.</p>	<p>Load an Ink Tank specified for use with the printer. (See "Replacing Ink Tanks.") →P.731</p>

**Do not pull out ink tank.**

Cause	Corrective Action
<p>The remaining ink level could not be correctly detected.</p>	<p>Install the Ink Tank that was removed. The buzzer will stop once the error is cleared.</p>

## Messages regarding printing or adjustment

Cannot adjust paper feed. ....	825
Check printed document. ....	825

### Cannot adjust paper feed.

Cause	Corrective Action
The Printhead nozzles are clogged.	Execute <b>Adj. Quality</b> again, as follows. <ol style="list-style-type: none"> <li>1. Press the <b>OK</b> button to clear the error.</li> <li>2. Print a test pattern to check the nozzles. (See "Checking for Nozzle Clogging.") →P.739</li> <li>3. Clean the Printhead if the nozzles are clogged. (See "Cleaning the Printhead.") →P.740</li> <li>4. Execute <b>Adj. Quality</b> again. (See "Automatic Banding Adjustment (Adj. Quality).") →P.630</li> </ol>
Highly transparent film is loaded that cannot be used for automatic feed amount adjustment.	Press the <b>OK</b> button to clear the error, and then adjust the feed amount manually. (See "Manual Banding Adjustment (Adj. Quality).") →P.631

### Check printed document.

Cause	Corrective Action
The Printhead nozzles are becoming clogged.	If printing is faint, clean the Printhead. (See "Cleaning the Printhead.") →P.740

## Messages regarding printheads

Cannot adjust printhead. .... 826  
 Wrong printhead. .... 826  
 Printhead error ..... 826  
 No printhead ..... 827  
 Execute printhead cleaning. .... 827

### Cannot adjust printhead.

Cause	Corrective Action
The Printhead nozzles are clogged.	Execute <b>Head Posi. Adj.</b> again, as follows. <ol style="list-style-type: none"> <li>1. Press the <b>OK</b> button to clear the error.</li> <li>2. Print a test pattern to check the nozzles.                      (See "Checking for Nozzle Clogging.") →P.739</li> <li>3. Clean the Printhead if the nozzles are clogged.                      (See "Cleaning the Printhead.") →P.740</li> <li>4. Execute <b>Head Posi. Adj.</b> again.                      (See "Automatic Adjustment to Straighten Lines and Colors (Head Posi. Adj.).") →P.619</li> </ol>
The Printhead cannot be aligned; highly transparent film is loaded.	Press the <b>OK</b> button to clear the error. We recommend using a type of paper that you often use, other than film, for Printhead adjustment. (See "Automatic Adjustment to Straighten Lines and Colors (Head Posi. Adj.).") →P.619
The Printhead is installed crooked.	Straighten the Printhead as follows, and then execute <b>Head Posi. Adj.</b> again. <ol style="list-style-type: none"> <li>1. Press the <b>OK</b> button to clear the error.</li> <li>2. Use <b>Head Inc. Adj.</b> to adjust the angle of inclination of the Printhead.                      (See "Adjusting Line Misalignment (Head Inc. Adj.).") →P.623</li> <li>3. Execute <b>Head Posi. Adj.</b> again.                      (See "Automatic Adjustment to Straighten Lines and Colors (Head Posi. Adj.).") →P.619</li> </ol>

12

### Wrong printhead.

Cause	Corrective Action
An incompatible Printhead has been installed.	Open the Top Cover and replace the Printhead with a new one. (See "Replacing the Printhead.") →P.741

826

### Printhead error

Cause	Corrective Action
There is a problem with the Printhead.	Open the Top Cover and replace the Printhead with a new one. (See "Replacing the Printhead.") →P.741



## No printhead

Cause	Corrective Action
No Printhead is installed.	Install the Printhead. (See "Replacing the Printhead.") →P.741

## Execute printhead cleaning.

Cause	Corrective Action
The Printhead nozzles are clogged.	Follow these steps to clean the Printhead. <ol style="list-style-type: none"> <li>1. Stop printing by pressing ▲ or ▼ to select <b>Stop Printing</b>.</li> <li>2. Clean the Printhead. (See "Cleaning the Printhead.") →P.740</li> </ol> <p>If the message is still displayed when printing, replace the Printhead. (See "Replacing the Printhead.") →P.741</p>
	Press ▲ or ▼ to select <b>Print</b> , and then press the <b>OK</b> button to resume printing. However, note that this error may affect the printing quality.
	If <b>OK</b> is shown on the Display Screen, clean the Printhead. <ol style="list-style-type: none"> <li>1. Press the <b>OK</b> button on the Control Panel to stop printing.</li> <li>2. Clean the Printhead. (See "Cleaning the Printhead.") →P.740</li> </ol> <p>If the message is still displayed when printing, replace the Printhead. (See "Replacing the Printhead.") →P.741</p>

## Messages regarding the maintenance cartridge

Insert the maintenance cartridge. .... 828  
 Wrong maintenance cartridge. .... 828  
 Maint. cart. The level is low ..... 828  
 No Maintenance Cartridge capacity. .... 828  
 Maintenance cartridge full. .... 828  
 Maintenance cartridge problem. .... 829

### Insert the maintenance cartridge.

Cause	Corrective Action
The Maintenance Cartridge is not installed.	Install the Maintenance Cartridge. (See "Replacing the Maintenance Cartridge.") →P.749

### Wrong maintenance cartridge.

Cause	Corrective Action
A Maintenance Cartridge for a different model of printer is installed.	Replace it with the Maintenance Cartridge for your particular model.

### Maint. cart. The level is low

Cause	Corrective Action
The Maintenance Cartridge is almost full.	You can continue to print, but prepare a new Maintenance Cartridge to use when the message for replacement is displayed.

12

### No Maintenance Cartridge capacity.

Cause	Corrective Action
The Maintenance Cartridge cannot absorb enough ink for Printhead cleaning or other operation.	After confirming that the printer has stopped operating, replace the Maintenance Cartridge. (See "Replacing the Maintenance Cartridge.") →P.749

828

### Maintenance cartridge full.

Cause	Corrective Action
The Maintenance Cartridge is full.	After confirming that the printer has stopped operating, replace the Maintenance Cartridge. (See "Replacing the Maintenance Cartridge.") →P.749

**Maintenance cartridge problem.**

Cause	Corrective Action
An incompatible or used Maintenance Cartridge has been installed.	Install an unused Maintenance Cartridge specified for use with the printer. (See "Replacing the Maintenance Cartridge.") →P.749

## Messages regarding HP-GL/2

This type of paper is not compatible with HP-GL/2. .... 830  
 GL2: Wxxxx The memory is full. (xxxx is 0501, 0903, or 0904) ..... 830  
 GL2: W0502 The parameter is out of range. .... 830  
 GL2: W0504 This command is not supported. .... 830

### This type of paper is not compatible with HP-GL/2.

Cause	Corrective Action
The printer has received a HP-GL/2 print job that cannot be printed on the paper that has been advanced.	<p>Follow these steps to replace the type of paper in the printer.</p> <ol style="list-style-type: none"> <li>1. Press ▲ or ▼ to select <b>Stop Printing</b>, and then press the <b>OK</b> button.</li> <li>2. Replace the paper with a type compatible with HP-GL/2. For details on paper compatible with HP-GL/2, refer to the Paper Reference Guide. (See "Types of Paper.") →P.568</li> </ol> <p>Press ▲ or ▼ to select <b>Print</b>, and then press the <b>OK</b> button to resume printing. However, note that this error may cause paper jams and affect the printing quality.</p>

### GL2: Wxxxx The memory is full. (xxxx is 0501, 0903, or 0904)

Cause	Corrective Action
The printer memory is full.	Because the entire print job could not be received, the printer may not be able to print the entire original. Check the printing results.

### GL2: W0502 The parameter is out of range.

Cause	Corrective Action
A parameter specified in a HP-GL/2 command is out of the supported range.	<p>Check the print job.</p> <p>If you have specified <b>ProcessingOption &gt; Warning &gt; On</b> in the Control Panel menu, set it to <b>Off</b> instead.</p>

### GL2: W0504 This command is not supported.

Cause	Corrective Action
The printer has received an unsupported HP-GL/2 command.	<p>Check the print job.</p> <p>If you have specified <b>ProcessingOption &gt; Warning &gt; On</b> in the Control Panel menu, set it to <b>Off</b> instead.</p>

12

830

## Other Messages

GARO Wxxxx (x represents a number) .....	831
ERROR Exxx-xxxx (x represents a letter or number) .....	831
Hardware error. xxxxxxxx-xxxx (x represents a letter or number) .....	831
Top cover is open. ....	832
Prepare for parts replacement. ....	832
Parts replacement time has passed. ....	832
Unknown file. ....	832
Multi-sensor error .....	833
Error in cutter position. ....	833

### GARO Wxxxx (x represents a number)

Cause	Corrective Action
There is a problem with the print job.	Try printing again, using the correct printer driver.
	It is also possible to continue printing in this state. However, you may not be able to obtain the desired printing results.

### ERROR Exxx-xxxx (x represents a letter or number)

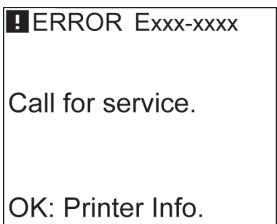
Cause	Corrective Action
An error requiring service may have occurred.  Call for service.  OK: Printer Info.	Write down the error code and message, turn off the printer, and contact your Canon dealer for assistance.

12

### Hardware error. xxxxxxxx-xxxx (x represents a letter or number)

Cause	Corrective Action
The last portion of roll paper was used during a print job. The paper was not advanced because the trailing edge is taped to the roll.	Turn off the printer and remove the roll from the printer before restoring power.
Fastening tape or the Belt Stopper has not been removed inside the Top Cover.	Turn off the printer, open the Top Cover and remove the tape or the Belt Stopper before restoring power.

831

Cause	Corrective Action
<p>An error requiring service may have occurred.</p> <div style="border: 1px solid black; padding: 5px; margin: 5px 0;"> <p><b>!</b> Hardware error. xxxxxxx-xxxx</p> <p>Turn off printer, wait, then turn on again. OK: Printer Info.</p> </div>	<p>Turn off the printer and wait at least three seconds before restoring the power. If the message is displayed again, write down the error code and message, turn off the printer, and contact your Canon dealer for assistance.</p>

### Top cover is open.

Cause	Corrective Action
<p>The printer has detected that the Top Cover is open.</p>	<p>Open the Top Cover fully, remove any foreign objects, and close the Top Cover again.</p>
	<p>If the error occurs again, close the Top Cover, turn off the printer, and wait a while before restoring power.</p>

### Prepare for parts replacement.

Cause	Corrective Action
<p>It is almost time to replace consumables for which service is required.</p>	<p>You can continue to use the printer for some time until "<b>Parts replacement time has passed.</b>" will be displayed. Contact your Canon dealer for assistance.</p>

### Parts replacement time has passed.

Cause	Corrective Action
<p>It is past the recommended time to replace consumables for which service is required.</p>	<p>Contact your Canon dealer for assistance.</p>

### Unknown file.

Cause	Corrective Action
<p>Data sent to keep the printer up to date (such as paper information) is in the wrong format.</p>	<p>Check the data. Turn off the printer and wait a while before restoring power, and then resend the data.</p>
<p>You have uploaded firmware for a different model.</p>	<p>Check the firmware version. Turn off the printer and wait a while before restoring power, and then resend the firmware.</p>
	<p>If the message is displayed again, contact your Canon dealer for assistance.</p>

12

832

## Multi-sensor error

Cause	Corrective Action
Direct sunlight or strong lighting may be shining on the printer and causing the sensor to malfunction.	Take steps to ensure the printer is not used when exposed to direct sunlight or strong lighting.
The performance of a sensor inside the printer may be impaired.	Turn off the printer and wait at least three seconds before restoring the power. If the message is displayed again, contact your Canon dealer for assistance.

## Error in cutter position.

Cause	Corrective Action
The Cutter Unit stops in the middle of cutting.	<ol style="list-style-type: none"> <li>1. Push the Release Lever back and remove the paper.</li> <li>2. Pull the Release Lever forward.</li> </ol>

## Specifications

Printer Specifications

835

13

834

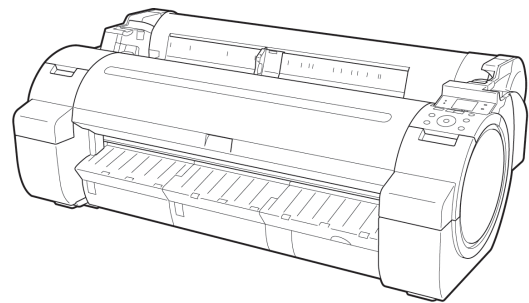



## Printer Specifications

Specifications .....	835
Print Area .....	837

## Specifications



### Important

- The following values may vary depending on the operating environment.

## Printer

Power supply	100–120 V AC (50/60 Hz), 220–240 V AC (50/60 Hz)		
Power consumption	During operation	140 W max.	
	Sleep mode	100–120 V: 5 W max. 220–240 V: 6 W max.	
	Off	1 W max. (*1 →P.835 )	
Operating noise (*2 →P.835 )	During operation (sound pressure level/LWAd)	Approx. 50 dB (A) (6.6 bels)	
	Standby	35 dB (A) max.	
Operating environment	Temperature	15–30°C (59–86°F)	
	Humidity	10–80%, non-condensing	
Dimensions (W × D × H)	Printer and Stand	When the Output Stacker is not used	1,304×708×1,062 mm (51.3×27.9×41.8 in)
		Regular position	1,304×887×1,062 mm (51.3×34.9×41.8 in)
		Extended position A	
		Extended position B	1,304×1,100×1,062 mm (51.3×43.3×41.8 in)
Weight	Printer and Stand (not including the Printhead and ink tanks)	Approx. 63.9 kg (140.9+ lb)	
Space for installation (W × D × H)	Printer and Stand	1,704×1,700×1,362 mm (67.1×66.9×53.6 in)	
Applicable standards	International Energy Star Program, Law on Promoting Green Purchasing, Eco Mark, GPN, RoHS, Eco Declaration, WEEE, U.S. presidential directives, Chinese RoHS		

\*1: The printer uses a trace amount of power even when turned off. To stop all power consumption, turn off the printer and unplug the power cord.

\*2: Calculation based on ISO 7779. Operating conditions: On the **Main** sheet of the printer driver, **Media Type** > Plain Paper, **Advanced Settings** > **Print Priority** > **Line Drawing/Text**, and **Print Quality** > **Standard**.

## Printing performance

Print method	Bubblejet
--------------	-----------

Maximum resolution	2400 dpi horizontally (*1 →P.836 ) × 1200 dpi vertically
Printhead	PF-04
Number of nozzles	MBK: 5120; Others: 2560 each color

\*1: Prints with a minimum 1/2400 inch dot pitch between ink droplets.

## Interface

USB	Format	Internal port
	Mode	Full-speed (12 Mbps), high-speed (480 Mbps), bulk transfer
	Connector	Series B (4-pin)
Ethernet	Format	Internal port
	Specification	IEEE 802.3 10Base-T, IEEE 802.3u 100Base-TX/Auto-Negotiation, IEEE 802.3ab1000Base-T/Auto-Negotiation, IEEE 802.3x Full Duplex
	Protocols	IPX/SPX (Netware 4.2, 5.1, 6.0), SNMP (Canon-MIB compatible), TCP/IP(IPv4/IPv6), AppleTalk, HTTP

## Ink

Ink Tank	MBK Ink Tank ( Matte Black Ink, or black ink for matte paper)	Pigment ink	PFI-102MBK
	BK Ink Tank ( Black Ink)	Dye ink	PFI-102BK
	C Ink Tank ( Cyan Ink)	Dye ink	PFI-102C
	M Ink Tank ( Magenta Ink)	Dye ink	PFI-104M
	Y Ink Tank ( Yellow Ink)	Dye ink	PFI-102Y
Capacity			130 ml (4.4 fl oz) per color (*1 →P.836 )

\*1: The provided Starter Ink Tanks contain 90 ml (3.0 fl oz) each.

## Paper

For information on the types of paper the printer supports, refer to the Paper Reference Guide. (See Paper Reference Guide.)

Paper width	Rolls	254.0–914.4 mm (10–36 in)
	Sheets	203.2–917.0 mm (8–36.1 in)
Length of one page(*2 →P.837 )	Rolls	203.2(*1 →P.837 )-18,000 mm (8–708.7 in)
	Sheets	279.4–1,600 mm (11–63 in)
Thickness	Rolls	0.07–0.8 mm (0.0028–0.031 in)
	Sheets	0.07–0.8 mm (0.0028–0.031 in)
Paper Size	Roll width	<b>36-in. Roll (914.4mm), ISO A0/A1 Roll (841.0mm), 30-in. Roll (762.0mm), JIS B1/B2 Roll (728.0mm), 24-in. Roll (609.6mm), ISO A1/A2 Roll (594.0mm), JIS B2/B3 Roll (515.0mm), 17-in. Roll (431.8mm), ISO A2/A3 Roll (420.0mm), 16-in. Roll (406.4mm), 14-in. Roll (355.6mm), 300mm Roll (300.0mm), ISO A3/A4 Roll (297.0mm), JIS B4 Roll (257.0mm), and 10-in. Roll (254.0mm)</b>

Paper Size	Sheets	ISO A0, ISO A1, ISO A2+, ISO A2, ISO A3+, ISO A3, ISO A4, ISO B1, ISO B2, ISO B3, ISO B4, JIS B1, JIS B2, JIS B3, JIS B4, 34"x44" (ANSI E), 28"x40" (ANSI F), 22"x34" (ANSI D), 17"x22" (ANSI C), 13"x19" (Super B), 11"x17" (Ledger), Legal (8.5"x14"), Letter (8.5"x11"), 36"x48" (ARCH E), 30"x42" (ARCH E1), 26"x38" (ARCH E2), 27"x39" (ARCH E3), 24"x36" (ARCH D), 18"x24" (ARCH C), 12"x18" (ARCH B), 9"x12" (ARCH A), DIN C0, DIN C1, DIN C2, DIN C3, DIN C4, 20"x24", 18"x22", 14"x17", 12"x16", 10"x12", 10"x15", US Photo 16"x20", Poster 20"x30", Poster 30"x40", 13"x22", and Poster 300x900mm
Print area	Normal size	Printable area <ul style="list-style-type: none"> <li>Rolls 3 mm (0.12 in) from each side</li> <li>Sheets 3 mm (0.12 in) from the top, 23 mm (0.91 in) from the bottom, and 3mm (0.12 in) from the left and right sides</li> </ul> For information on the recommended print area, see "Print Area." →P.837
	Borderless printing (*2 →P.837)	Printable area (rolls) 0 mm from the top, 0 from the bottom, and 0 mm from the left and right sides
Supported width for borderless printing	36-in. Roll (914.4mm), ISO A0/A1 Roll (841.0mm), JIS B1/B2 Roll (728.0mm), 24-in. Roll (609.6mm), ISO A1/A2 Roll (594.0mm), JIS B2/B3 Roll (515.0mm), 17-in. Roll (431.8mm), ISO A2/A3 Roll (420.0mm), 14-in. Roll (355.6mm), 300mm Roll (300.0mm), ISO A3/A4 Roll (297.0mm), JIS B4 Roll (257.0mm), and 10-in. Roll (254.0mm)	

\*1: Printing may not be possible in some cases, depending on the type and size of paper.

\*2: Varies depending on the operating system or application.

## Options

Roll Holder Set	RH2-33
-----------------	--------

13

## Print Area

A margin required by the printer is added with respect to the size of paper loaded in the printer. Except in borderless printing, the actual printing area corresponds to the paper size minus the space for this margin.



### Note

- Printable Area: The area that can be printed.
- There is no margin (that is, a margin of 0 mm) during borderless printing on rolls.
- Recommended Print Area: We recommend printing within this area.
- To print so that your original matches the print area exactly, use an oversized paper size that includes the required margin. (See "Printing on Oversized Paper.") →P.89

837

	Margins of Printable Area			Margins of Recommended Print Area		
	Top Edge	Bottom Edge	Sides	Top Edge	Bottom Edge	Sides
Sheets	3 mm (0.12 in)	23 mm (0.91 in)	3 mm (0.12 in)	20 mm (0.79 in)	23 mm (0.91 in)	5 mm (0.20 in)
Rolls	0/3 mm (0/0.12 in)	0/3 mm (0/0.12 in)	0/3 mm (0/0.12 in)	20 mm (0.79 in)	5 mm (0.20 in)	5 mm (0.20 in)

Sheets

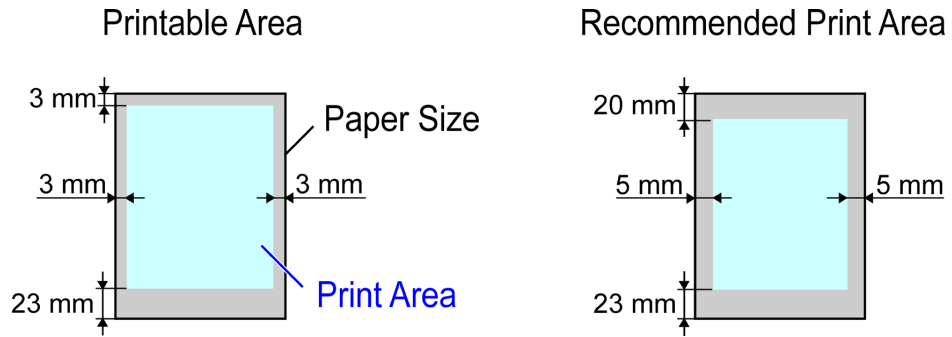

• Printable Area

a margin of 3 mm (0.12 in) on top, 23 mm (0.91 in) on bottom, and 3 mm (0.12 in) on left and right sides is required.

• Recommended Print Area

A margin of 20 mm (0.79 in) on top, 23 mm (0.91 in) on bottom, and 5 mm (0.20 in) on left and right sides is required.

Rolls



• Printable Area

A margin of 3 mm (0.12 in) on all sides is required. During borderless printing, the margin on all sides is 0 mm. For information on paper compatible with borderless printing, see the Paper Reference Guide. (See "Types of Paper.")

→P.568

• Recommended Print Area

A margin of 20 mm (0.79 in) on top, 5 mm (0.20 in) on bottom, and 5 mm (0.20 in) on left and right sides is required.

## Appendix

How to use this manual	840
Disposal of the product	850

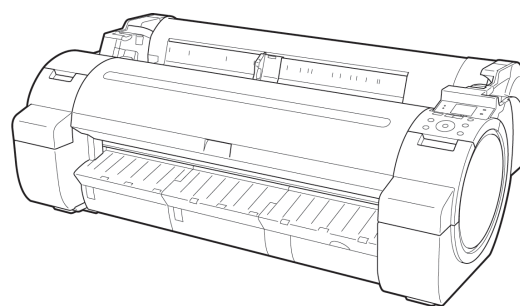



## How to use this manual

About This User Manual .....	840
Searching Topics .....	841
HTML Version of the Manual for Printing .....	843

## About This User Manual

### • Symbols

The following symbols are used in this User Manual to indicate safety information and explanations on restrictions or precautions in use.

	Important	Indicates important information that must be followed when using the printer. Be sure to read this information to prevent printer damage or operating errors.
	Caution	Indicates caution items for which operating error poses a risk of injury or damage to equipment or property. To ensure safe use, always follow these precautions.
	Note	Indicates helpful reference information and supplemental information on particular topics.

### • Button names and user interface elements

Key and button names on the control panel and user interface elements in software (such as menus and buttons) are indicated as follows in this User Manual.

Control panel buttons	Example: Press the <b>OK</b> button.
Control panel messages	Example: <b>Head Cleaning</b> is displayed.
Software interface items (Menus and Buttons)	Example: Click <b>OK</b> .
Keyboard keys	Example: Press the Tab key.

### • Part names

Names of printer parts are indicated as follows in this User Manual.

Printer part names	Example: Open the Top Cover.
--------------------	------------------------------

### • Cross-reference

Other pages or manuals that provide related information are indicated as follows in this User Manual.

Cross-reference in the same user manual	Example: see "Turning the Printer On and Off."  P.3 Click the link to jump to the corresponding page.
Cross-reference in related manuals	Example: See the Paper Reference Guide.
Other cross-reference	Example: See the printer driver help.

### • Figures and software screens

- Figures in this User Manual may be different from the actual appearance of the printer in some cases.
- Screens depicted in this User Manual for the printer driver or other software may be different from the actual screens because of subsequent updates.
- Windows XP screens are used in explanations of Windows operations in this User Manual.

## • Trademarks

- Canon, the Canon logo, and imagePROGRAF are trademarks or registered trademarks of Canon Inc.
- Microsoft and Windows are registered trademarks of Microsoft Corporation in the United States and other countries.
- Macintosh is a registered trademark of Apple Inc. in the United States and other countries.
- Other company and product names are trademarks or registered trademarks of their respective owners.

## • Copyright

© CANON INC. 2011

- Unauthorized reproduction of this User Manual in whole or part is prohibited.

## • May we request

- The information in this User Manual is subject to change without notice.
- We strive to ensure accuracy of information in this User Manual, but if you notice errors or omissions, please contact us.

## Searching Topics

You can find information in topics of this User Manual by searching for relevant terms.

1. Enter a term and click the **Search** button.



### Note

- To search for multiple terms at once, enter a space between each term.

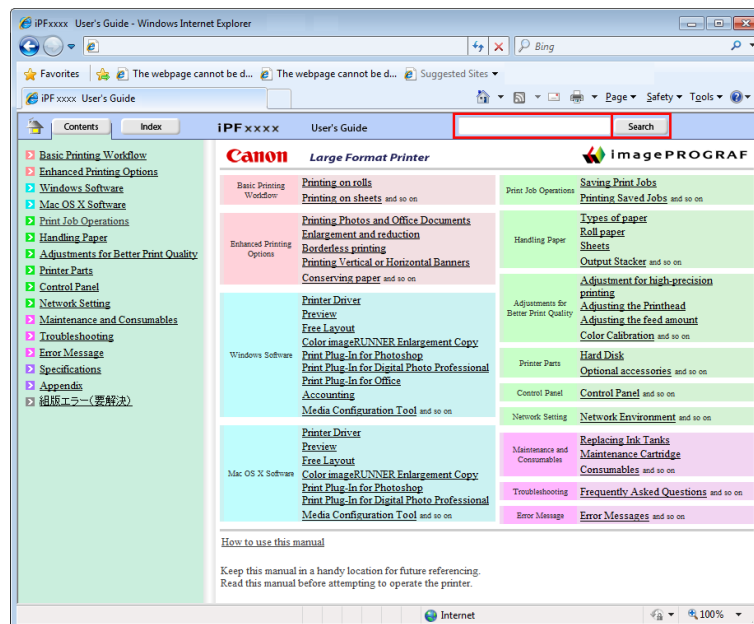

Search results are listed at left.

- Click a topic you want to read.  
The terms you searched for will be highlighted in the topic.

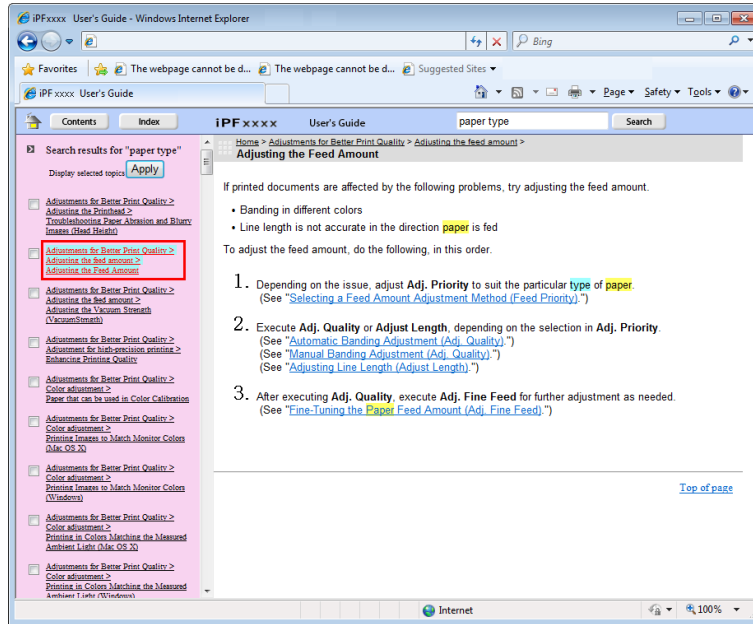

To review multiple topics at once, select the check box of desired topics and click the **Apply** button.

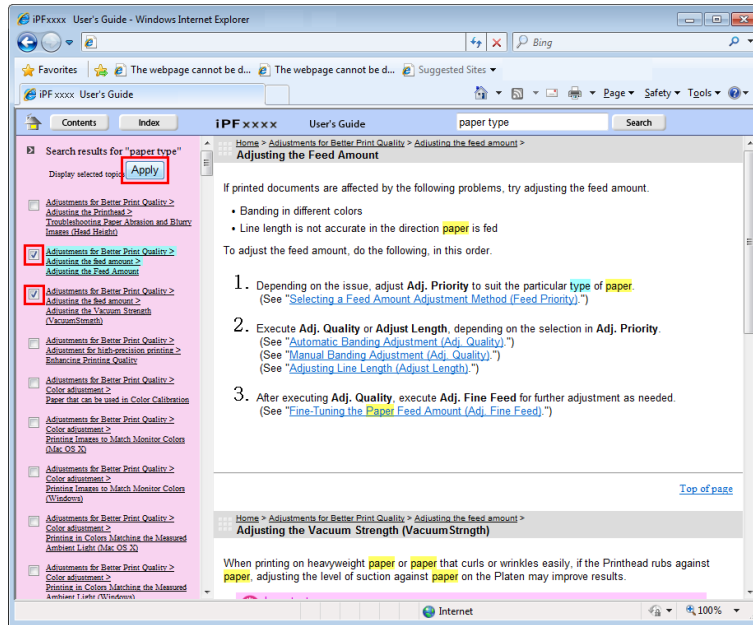



## HTML Version of the Manual for Printing

You can select a group of topics in the table of contents or individual topics in this manual for printing. The following procedure describes how to do this, using the information in **Basic Printing Workflow** as an example.

### Printing a group of topics in the manual

When you access printable HTML versions of the content from section titles in the table of contents, you can specify a group of topics to print.

1. Click a section title in the table of contents. Here, **Basic Printing Workflow** is used as an example.

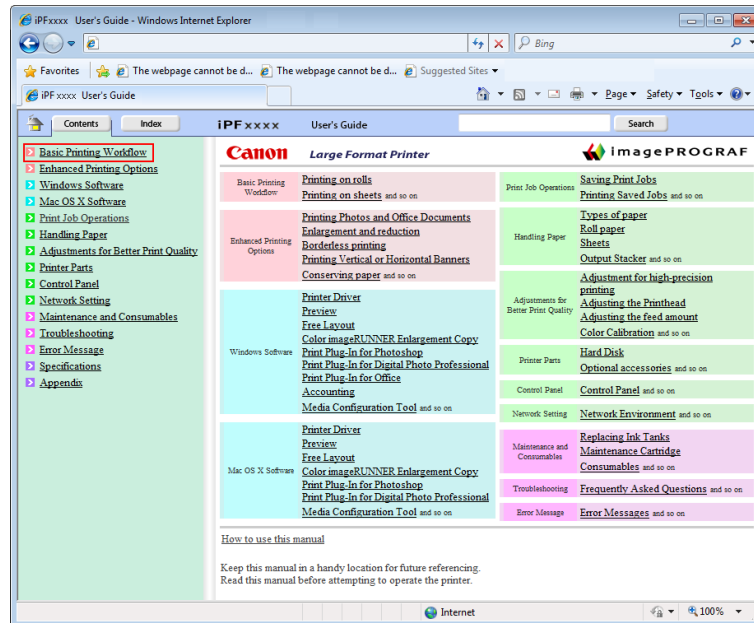

2. Click **Access to the HTML for printing** in the title area.

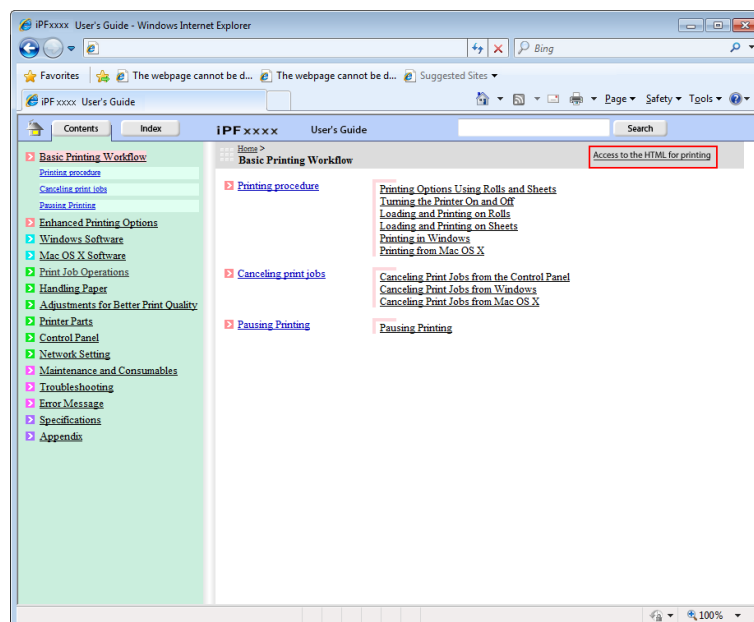

The topics in **Basic Printing Workflow** are displayed together in HTML format, ready for printing.

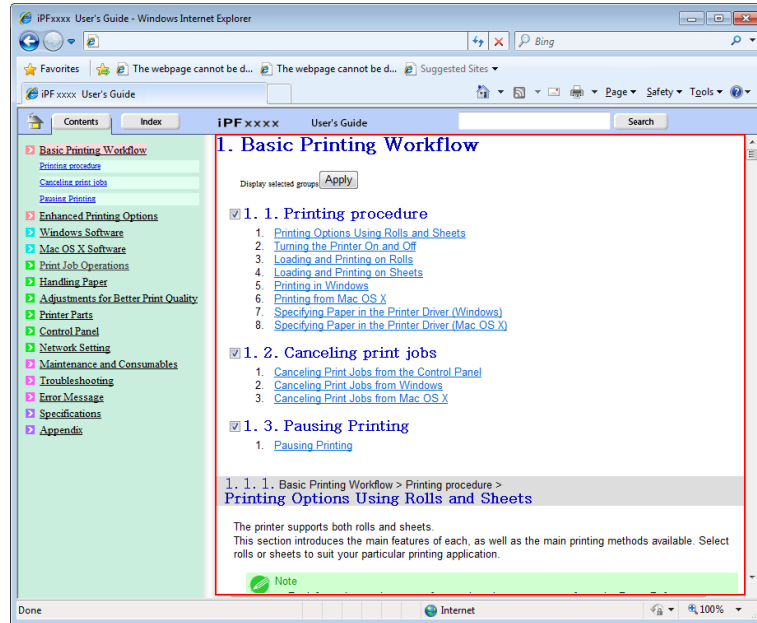

3. Clear the sections you will not print and click the **Apply** button.

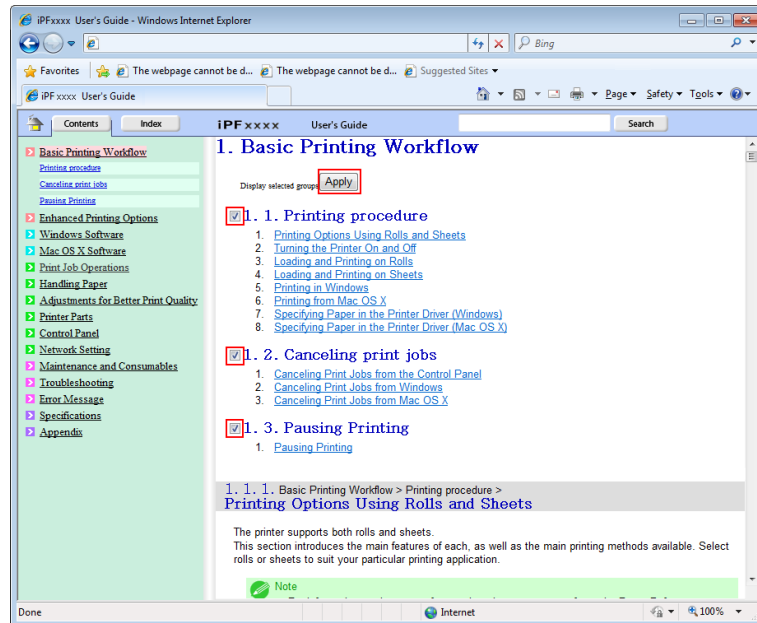

## Printing a group of individual topics in the manual

When you access printable HTML versions from subtitles in the table of contents, you can specify a group of topics to print.

1. Click a section title in the table of contents. Here, **Basic Printing Workflow** is used as an example.

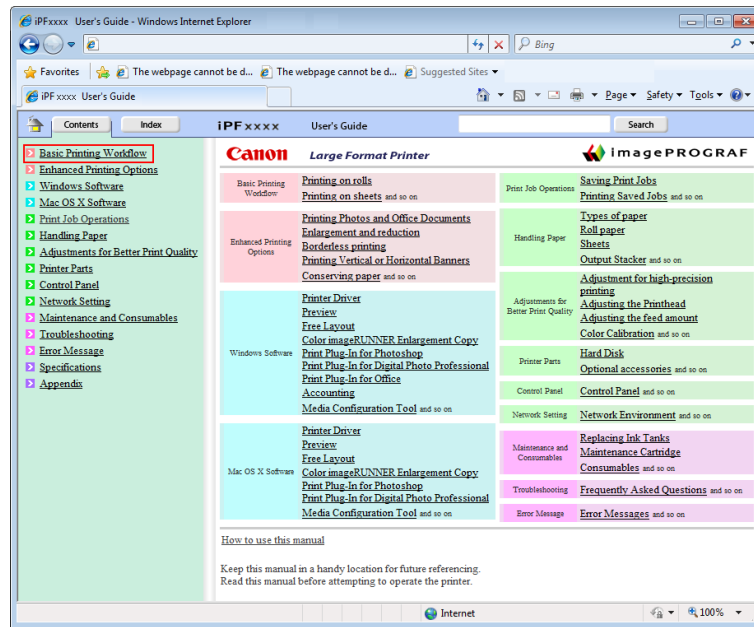

2. Under **Basic Printing Workflow**, click **Printing Procedure**.

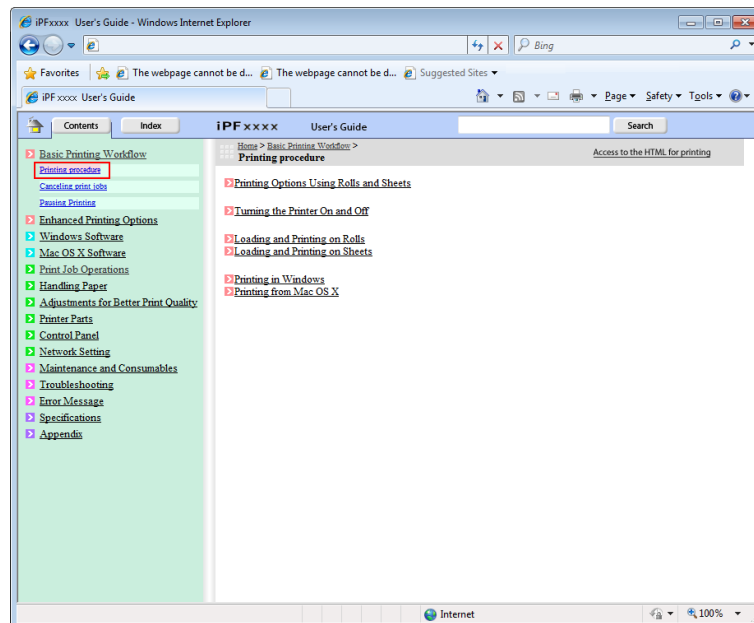

### 3. Click **Access to the HTML for printing** in the title area.

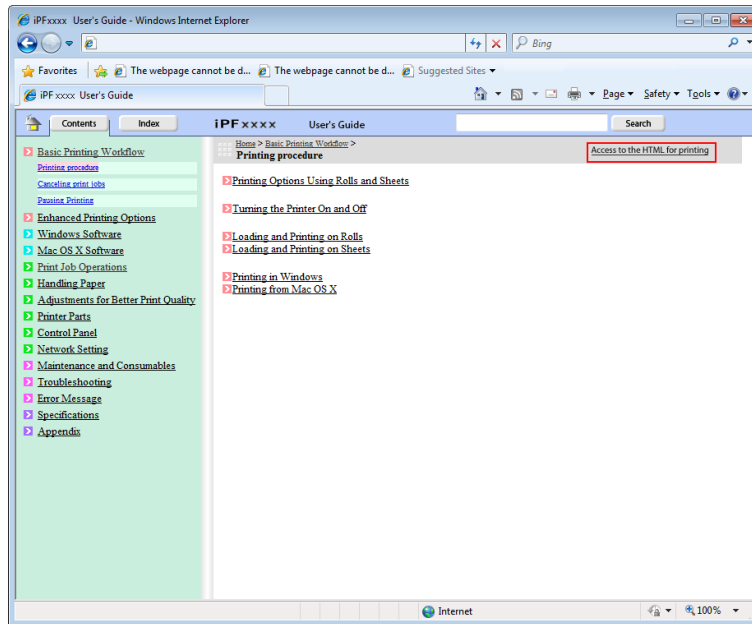

The topics in **Printing Procedure** are displayed together in HTML format, ready for printing.

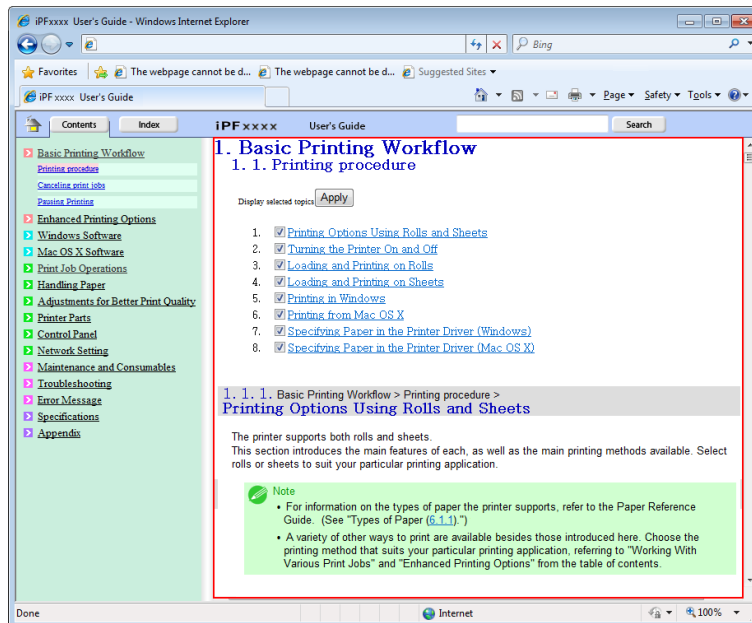

## 4. Clear the topics you will not print and click the **Apply** button.

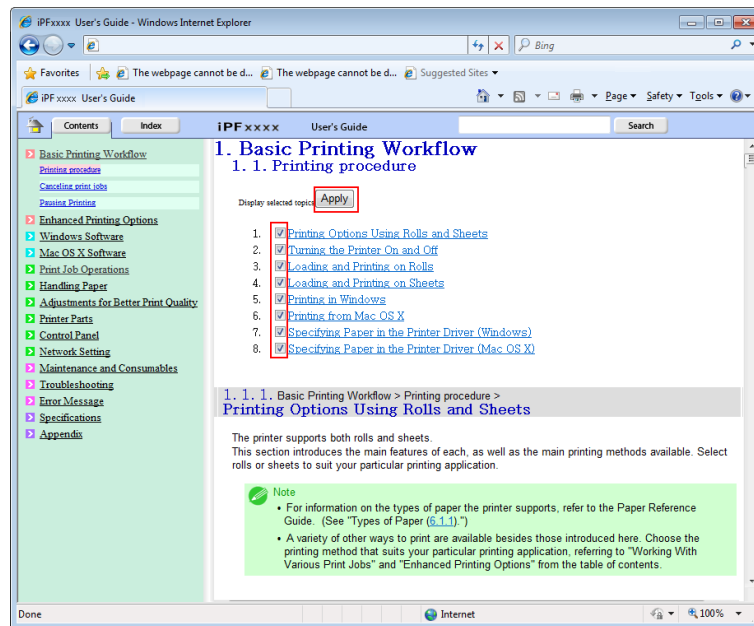

### Printing selected topics

Print selected topics as follows.

## 1. Access the printing dialog box as follows, depending on your computer's operating system.

- **Windows**

In Windows, right-click anywhere in the explanation area except on a figure or a link. In the shortcut menu, click **Print** to display the **Print** dialog box.

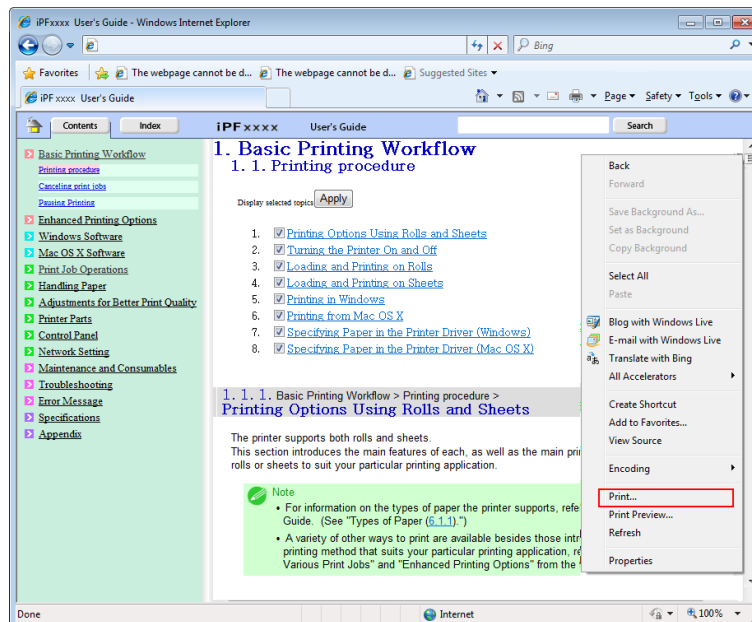

• Macintosh

On a Macintosh computer, click anywhere in the explanation area except on a figure or a link while holding the Ctrl key. In the shortcut menu, click **Print Frame** to display the **Print** dialog box.

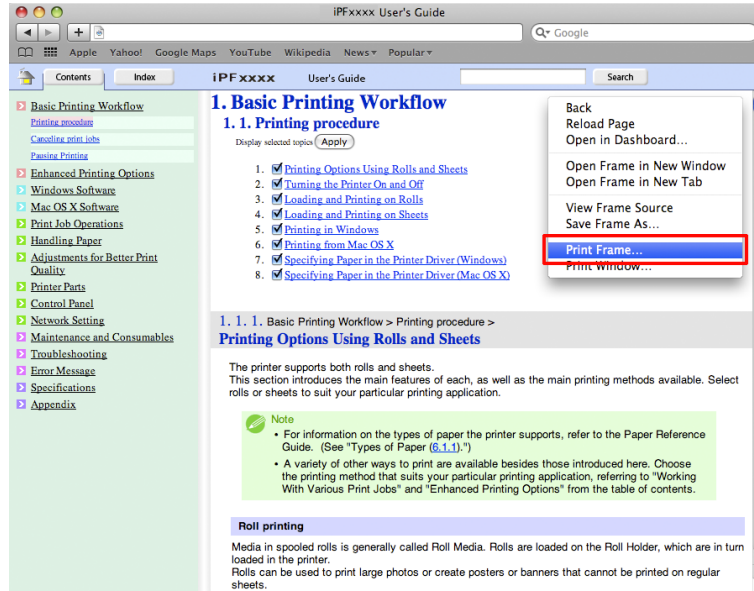

2. Specify conditions as needed, and then click **Print (Windows)** or **Print (Macintosh)**.

• Windows

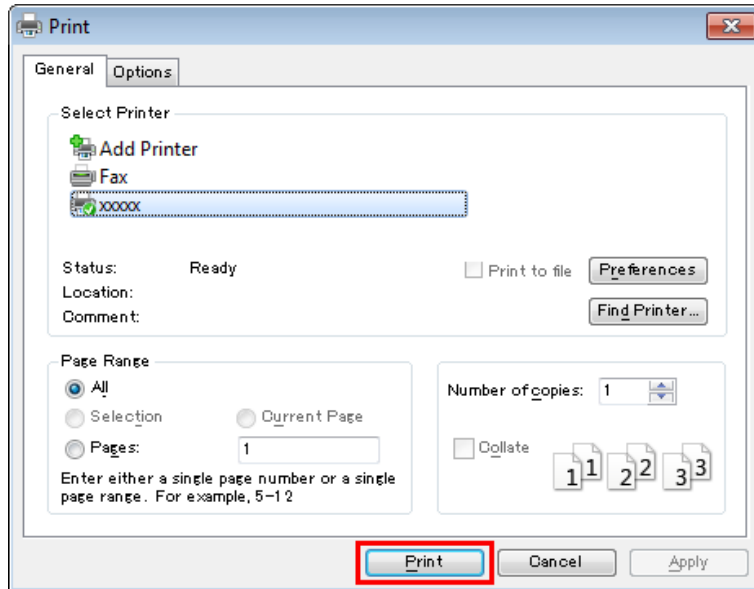

- Macintosh

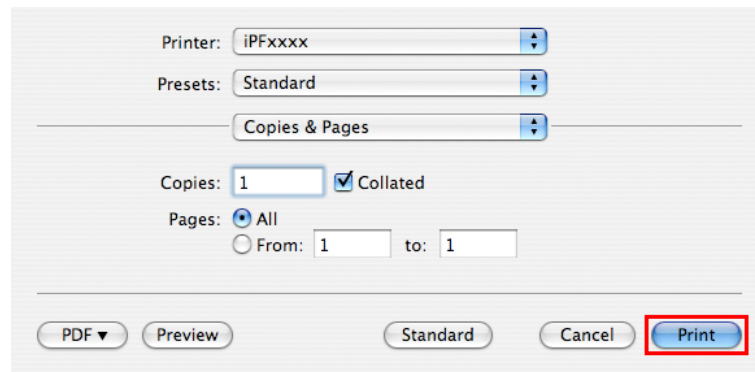
**Note**

- To print only individual topics that are displayed, use this method.

## Disposal of the product

WEEE Directive ..... 851



## WEEE Directive

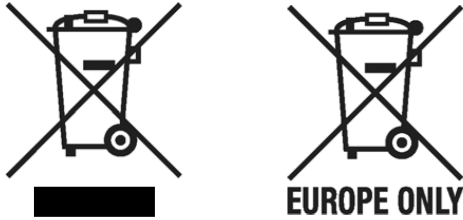

European Union (and EEA) only.

These symbols indicate that this product is not to be disposed of with your household waste, according to the WEEE Directive (2002/96/EC), the Battery Directive (2006/66/EC) and/or your national laws implementing those Directives. This product should be handed over to a designated collection point, e.g., on an authorized one-for-one basis when you buy a new similar product or to an authorized collection site for recycling waste electrical and electronic equipment (EEE) and batteries and accumulators. Improper handling of this type of waste could have a possible impact on the environment and human health due to potentially hazardous substances that are generally associated with EEE. Your cooperation in the correct disposal of this product will contribute to the effective usage of natural resources. For more information about the recycling of this product, please contact your local city office, waste authority, approved scheme or your household waste disposal service or visit [www.canon-europe.com/environment](http://www.canon-europe.com/environment).

(EEA: Norway, Iceland and Liechtenstein)

Uitsluitend bestemd voor de Europese Unie (en EER).

Met deze symbolen wordt aangegeven dat dit product in overeenstemming met de AEEA-richtlijn (2002/96/EC), de richtlijn 2006/66/EC betreffende batterijen en accu's en/of de plaatselijk geldende wetgeving waarin deze richtlijnen zijn geïmplementeerd, niet bij het normale huisvuil mag worden weggegooid. Dit product dient te worden ingeleverd bij een hiervoor aangewezen inzamelpunt, bijv. door dit in te leveren bij een hiertoe erkend verkooppunt bij aankoop van een gelijksoortig product, of bij een officiële inzameldienst voor de recycling van elektrische en elektronische apparatuur (EEA) en batterijen en accu's. Door de potentiële gevaarlijke stoffen die gewoonlijk gepaard gaan met EEA, kan onjuiste verwerking van dit type afval mogelijk nadelige gevolgen hebben voor het milieu en de menselijke gezondheid. Uw medewerking bij het op juiste wijze weggoeien van dit product draagt bij tot effectief gebruik van natuurlijke bronnen. Voor verdere informatie over recycling van dit product kunt u contact opnemen met uw plaatselijke gemeente, afvaldienst, officiële dienst voor klein chemisch afval of afvalstortplaats, of kunt u terecht op [www.canon-europe.com/environment](http://www.canon-europe.com/environment).

(EER: Noorwegen, IJsland en Liechtenstein)

Endast för EU (och EEA).

De här symbolerna anger att produkten inte får slängas i hushållssoporna enligt WEEE-direktivet (2002/96/EG), batteridirektivet (2006/66/EG) och/eller nationell lagstiftning som implementerar dessa direktiv. Produkten ska lämnas in på en där för anvisad insamlingsplats, t.ex. hos handlare som är auktoriserade att byta in varor då nya, liknande köps (en mot en) eller på en återvinningsstation auktoriserad att hantera elektrisk och elektronisk utrustning (EE-utrustning) samt batterier och ackumulatörer. Olämplig hantering av avfall av den här typen kan ha negativ inverkan på miljön och människors hälsa på grund av de potentiellt farliga ämnen som vanligen återfinns i elektrisk och elektronisk utrustning. Din medverkan till en korrekt avfallshantering av produkten bidrar till effektiv användning av naturresurserna. Om du vill ha mer information om var du kan lämna in den här produkten, kontakta ditt lokala kommunkontor, berörd myndighet eller företag för avfallshantering eller besök [www.canon-europe.com/environment](http://www.canon-europe.com/environment).

(EEA: Norge, Island och Liechtenstein)

---

 Pouze Evropská unie (a EHP)

Tento symbol znamená, že podle směrnice o OEEZ (2002/96/ES), směrnice o bateriích (2006/66/ES) a/nebo podle vnitrostátních právních prováděcích předpisů k těmto směrnici nemá být tento výrobek likvidován s odpadem z domácností. Tento výrobek má být vrácen do určeného sběrného místa, např. v rámci autorizovaného systému odběru jednoho výrobku za jeden nově prodaný podobný výrobek, nebo do autorizovaného sběrného místa pro recyklaci odpadních elektrických a elektronických zařízení (OEEZ) a baterií a akumulátorů. Nevhodné nakládání s tímto druhem odpadu by mohlo mít negativní dopad na životní prostředí a lidské zdraví, protože elektrická a elektronická zařízení zpravidla obsahují potenciálně nebezpečné látky. Vaše spolupráce na správné likvidaci tohoto výrobku napomůže efektivnímu využívání přírodních zdrojů. Chcete-li získat podrobné informace týkající se recyklace tohoto výrobku, obraťte se prosím na místní úřad, orgán pro nakládání s odpady, schválený systém nakládání s odpady či společnost zajišťující likvidaci domovního odpadu nebo navštivte webové stránky [www.canon-europe.com/environment](http://www.canon-europe.com/environment).

(EHP: Norsko, Island a Lichtenštejnsko)

---

## Gjelder kun EU (og EØS).

Disse symbolene indikerer at dette produktet ikke skal kastes sammen med husholdningsavfall, i henhold til WEEE-direktivet (2002/96/EF), batteridirektivet (2006/66/EF) og/eller nasjonal lov som har implementert disse direktivene. Produktet må leveres til et dertil egnet innsamlingspunkt, det vil si på en autorisert en-til-en-basis når en kjøper et nytt lignende produkt, eller til et autorisert innsamlingssted for resirkulering av avfall fra elektrisk og elektronisk utstyr (EE-utstyr) og batterier og akkumulatører. Feil håndtering av denne typen avfall kan være miljø- og helseskadelig på grunn av potensielt skadelige stoffer som ofte brukes i EE-utstyr. Din innsats for korrekt avhending av produktet vil bidra til effektiv bruk av naturressurser. Du kan få mer informasjon om resirkulering av dette produktet ved å kontakte lokale myndigheter, avfallsadministrasjonen, et godkjent program eller husholdningens renovasjonsselskap, eller gå til [www.canon-europe.com/environment](http://www.canon-europe.com/environment).

(EØS: Norge, Island og Liechtenstein)

---

## Len Európska únia (a EHP)

Tieto symboly označujú, že podľa smernice o odpade z elektrických a elektronických zariadení (OEEZ) 2002/96/ES, smernice o batériách (2006/66/ES) a/alebo podľa vnútroštátnych právnych predpisov zahŕňajúcich tieto smernice sa tento produkt nesmie likvidovať spolu s domácim odpadom. Tento produkt je potrebné odovzdať do určenej zberne, napr. prostredníctvom výmeny za kúpu nového podobného produktu, alebo do autorizovaného zberného miesta na recykláciu odpadu z elektrických a elektronických zariadení (EEZ) a batérií a akumulátorov. Nesprávna manipulácia s takýmto typom odpadu môže mať negatívny vplyv na životné prostredie a ľudské zdravie, pretože elektrické a elektronické zariadenia obsahujú potenciálne nebezpečné látky. Vašou spoluprácou na správnej likvidácii tohto produktu prispějete k účinnému využívaniu prírodných zdrojov. Ďalšie informácie o recyklácii tohto produktu získate od svojho miestneho úradu, úradu zodpovedného za odpad, zo schváleného plánu o OEEZ alebo od spoločnosti zaisťujúcej likvidáciu domáceho odpadu alebo na webovej stránke [www.canon-europe.com/environment](http://www.canon-europe.com/environment).

(EHP: Nórsko, Írsko a Lichtenštajnsko)

---

## Solo per l'Unione Europea e lo Spazio Economico Europeo.

Questi simboli indicano che il prodotto non può essere smaltito con i rifiuti domestici, ai sensi della Direttiva RAEE (2002/96/CE), della Direttiva sulle Batterie (2006/66/CE) e/o delle leggi nazionali che attuano tali Direttive. Il prodotto deve essere conferito a punto di raccolta designato, ad esempio il rivenditore in caso di acquisto di un nuovo prodotto simile oppure un centro di raccolta autorizzato per il riciclaggio di rifiuti di apparecchiature elettriche ed elettroniche (RAEE) nonché di batterie e accumulatori. Un trattamento improprio di questo tipo di rifiuti può avere conseguenze negative sull'ambiente e sulla salute umana a causa delle sostanze potenzialmente nocive solitamente contenute in tali rifiuti. La collaborazione dell'utente per il corretto smaltimento di questo prodotto contribuirà a un utilizzo efficace delle risorse naturali ed eviterà di incorrere in sanzioni amministrative ai sensi dell'art. 50 e successivi del Decreto Legislativo n. 22/97. Per ulteriori informazioni sul riciclaggio di questo prodotto, contattare le autorità locali, l'ente responsabile della raccolta dei rifiuti, un rivenditore autorizzato o il servizio di raccolta dei rifiuti domestici, oppure visitare il sito [www.canon-europe.com/environment](http://www.canon-europe.com/environment).

(Spazio Economico Europeo: Norvegia, Islanda e Liechtenstein)

---

Samo za Evropsko unijo (in Evropski gospodarski prostor).

Ti simboli pomenijo, da tega izdelka skladno z Direktivo OEE0 (2002/96/ES), Direktivo 2006/66/ES in/ali nacionalno zakonodajo, ki uvaja ti direktivi, ne smete odlagati z nesortiranimi gospodinjskimi odpadki. Ta izdelek je treba odnesti na izbrano zbirno mesto, t. j. pooblaščenno trgovino, kjer ob nakupu novega (podobnega) izdelka vrnete starega, ali na pooblaščenno zbirno mesto za ponovno uporabo odpadne električne in elektronske opreme (EEO) ter baterij in akumulatorjev. Neustrezno ravnanje s to vrsto odpadkov lahko negativno vpliva na okolje in človeško zdravje zaradi potencialno nevarnih snovi, ki so pogosto povezane z EEO. Vaše sodelovanje pri pravilnem odlaganju tega izdelka predstavlja pomemben prispevek k smotrni izrabi naravnih virov. Za več informacij o ponovni uporabi tega izdelka se obrnite na lokalni mestni urad, pristojno službo za odpadke, predstavnika pooblaščenega programa za obdelavo odpadkov ali na lokalno komunalno. Lahko pa tudi obiščete našo spletno stran [www.canon-europe.com/environment](http://www.canon-europe.com/environment).

(Evropski gospodarski prostor: Norveška, Islandija in Lihtenštajn)

Kizárólag az Európai Unió (valamint az EEA) részére.

Ezek a szimbólumok azt jelzik, hogy a termék hulladékkezelése a háztartási hulladéktól különválasztva, a WEEE - elektromos és elektronikus berendezések hulladékairól szóló (2002/96/EK) irányelvnek és, az elemekről és akkumulátorokról, valamint a hulladékelemekről és -akkumulátorokról szóló (2006/66/EK) irányelvnek megfelelően, és/vagy ezen irányelveknek megfelelő helyi előírások szerint történik. Ezen terméket az arra kijelölt gyűjtőhelyre kell juttatni, pl., hasonló termék vásárlásakor a régi becserélésére vonatkozó hivatalos program keretében, vagy az elektromos és elektronikus berendezések (EEE) hulladékainak gyűjtésére, valamint a hulladékelemek és hulladékakkumulátorok gyűjtésére kijelölt hivatalos gyűjtőhelyre. Az ilyen jellegű hulladékok nem előírás szerű kezelése az elektromos és elektronikus berendezésekhez (EEE) általánosan kapcsolható potenciálisan veszélyes anyagok révén hatással lehet a környezetre és az egészségre. Ezen termék megfelelő módon történő eltávolításával Ön is hozzájárul a természeti források hatékony használatához. A termék újrahasznosítását illetően informálódjon a helyi polgármesteri hivatalnál, a helyi közterület-fenntartó vállalatnál, a hivatalos hulladéklerakó telephelyen, vagy a háztartási hulladék begyűjtését végző szolgáltatónál, illetve látogasson el a [www.canon-europe.com/environment](http://www.canon-europe.com/environment) internetes oldalra.

(EEA : Norvégia, Izland és Liechtenstein)

Apenas para a União Europeia (e AEE)

Estes símbolos indicam que este produto não deve ser eliminado juntamente com o seu lixo doméstico, segundo a Directiva REEE de 2002/96/CE, a Directiva de Baterias (2006/66/CE) e / ou a sua legislação nacional que transponha estas Directivas. Este produto deve ser entregue num ponto de recolha designado, por exemplo num local autorizado de troca quando compra um equipamento novo idêntico, ou num local de recolha autorizado para reciclar equipamento eléctrico e electrónico (EEE) em fim de vida, bem como pilhas e baterias. O tratamento inadequado deste tipo de resíduos pode ter um impacto negativo no ambiente e na saúde humana, devido a substâncias potencialmente perigosas que estão associadas com equipamentos do tipo EEE. A sua cooperação no tratamento correcto deste produto irá contribuir para a utilização mais eficaz dos recursos naturais. Para obter mais informações acerca de como reciclar este produto, por favor contacte as suas autoridades locais responsáveis pela matéria, serviço de recolha aprovado para pilhas e baterias ou serviço de recolha de resíduos sólidos domésticos da sua municipalidade, ou visite [www.canon-europe.com/environment](http://www.canon-europe.com/environment).

(AEE: Noruega, Islândia, e Liechtenstein)

Üksnes Euroopa Liit (ja Euroopa Majanduspiirkond).

Antud sümbolid viitavad sellele, et vastavalt WEEE direktiivile (2002/96/EÜ), patareide direktiivile (2006/66/EÜ) ja/või nimetatud direktiive rakendavatele riiklikele õigusaktidele ei või seda toodet visata ära koos majapidamisjätmetega. Antud toode tuleb anda vastavasse kogumispunkti, nt üks ühe vastu, kui ostad uue sarnase toote, või vastavasse elektri- ja elektroonikaseadmete jäätmete ning patareide ja akude ümbertöötlemiseks mõeldud kogumispunkti. Antud liiki prügi vale käitlemine võib kahjustada keskkonda ja inimeste tervist elektri- ja elektroonikajätmetes tavaliselt leiduvate potentsiaalselt ohtlike ainete tõttu. Antud toote ettenähtud nõuete kohase kõrvaldamisega aitate efektiivselt kasutada loodusvarasid. Täiendava teabe saamiseks antud toote ringlussevõtu kohta võtke ühendust kohaliku linnavalitsusega, jäätmekäitlejaga, lubatud skeemiga või majapidamisjätmete prügilateenistusega või külastage Interneti-lehekülge [www.canon-europe.com/environment](http://www.canon-europe.com/environment).

(Euroopa Majanduspiirkond: Norra, Island ja Liechtenstein)

Paredzēts tikai Eiropas Savienības valstīm (un EVA).

Šie simboli norāda, ka atbilstoši ES direktīvai par izlietotu elektrisku un elektronisku aparāturu (2002/96/EK), direktīvai par baterijām un akumulatoriem (2006/66/EK) un vietējai likumdošanai no šī produkta nedrīkst atbrīvoties, izmetot to kopā ar sadzīves atkritumiem. Šis produkts ir jānodod piemērotā savākšanas punktā, piemēram, autorizētā veikalā, kur iegādājaties līdzīgu jaunu produktu un veco atstājat vietā, vai autorizētā dienestā, kas nodarbojas ar izlietotas elektriskās un elektroniskās aparatūras (waste electrical and electronic equipment — WEEE) otrreizēju pārstrādi. Nepareizi apejoties ar šāda veida izlietotu aparāturu, var apdraudēt vidi un cilvēka veselību potenciāli bīstamu vielu dēļ, kas parasti ietilpst elektriskajā un elektroniskajā aparatūrā lietotajos sakausējumos. Turklāt pareiza atbrīvošanās no šī produkta sekmē racionālu dabas resursu izlietojumu. Lai saņemtu plašāku informāciju par vietām, kur izlietotu aparāturu var nodot otrreizējai pārstrādei, sazinieties ar vietējās pašvaldības pārstāvjiem, dienestu, kas atbild par atkritumu savākšanu, pilnvarotu WEEE struktūru vai iestādi, kas veic atbrīvošanos no sadzīves atkritumiem vai apmeklējiet tīmekļa vietni [www.canon-europe.com/environment](http://www.canon-europe.com/environment).

(Eiropas Ekonomiskā zona: Norvēģija, Īslande un Lihtenšteina).

Tik Europos Sąjungai (ir Europos Ekonominei Zonai)

Šie simboli reiškia, kad šio gaminio negalima išmesti į buitines atliekas, kaip reikalauja WEEE Direktyva (2002/96/EB) ir Baterijų Direktyva (2006/66/EB) ir (ar) jūsų šalies nacionaliniai įstatymai, kuriais šios Direktyvos yra įgyvendinamos. Šį gaminį reikia pristatyti į specialų surinkimo punktą, pavyzdžiui, mainais, kai jūs perkate naują panašų gaminį arba į specialią surinkimo vietą, kuri perdirba elektrinės ir elektroninės įrangos atliekas bei naudotas baterijas ir akumulatorius. Dėl netinkamo šio tipo atliekų tvarkymo gali nukentėti aplinka bei iškyla grėsmė žmogaus sveikatai dėl potencialiai kenksmingų medžiagų, iš esmės susijusių su elektrine ir elektronine įranga. Bendradarbiaudami teisingai utilizuojant šiuos gaminius, jūs padėsite efektyviai naudoti gamtinius išteklius. Daugiau informacijos apie gaminio perdirbimą jums gali suteikti vietinis biuras, atliekų tvarkymo bendrovė, sertifikuoti organai ar buitinių atliekų surinkimo įmonės. Be to, aplankykite interneto svetainę [www.canon-europe.com/environment](http://www.canon-europe.com/environment).

(Europos Ekonominė Zona: Norvegija, Islandija ir Lichtenšteinas)

Union européenne (et Espace économique européen) uniquement.

Ces symboles indiquent que ce produit ne doit pas être mis au rebut avec les ordures ménagères, comme le spécifient la Directive européenne DEEE (2002/96/EC), la Directive européenne relative à l'élimination des piles et des accumulateurs usagés (2006/66/EC) et les lois en vigueur dans votre pays, appliquant ces directives. Ce produit doit être confié à un point de collecte désigné, par exemple, chaque fois que vous achetez un produit similaire neuf, ou à un point de collecte agréé pour le recyclage équipements électriques ou électroniques (EEE) et des piles et accumulateurs. Le traitement inapproprié de ce type de déchet risque d'avoir des répercussions sur l'environnement et la santé humaine, du fait de la présence de substances potentiellement dangereuses généralement associées aux équipements électriques ou électroniques. Votre coopération envers la mise au rebut correcte de ce produit contribuera à l'utilisation efficace des ressources naturelles. Pour de plus amples informations sur le recyclage de ce produit, veuillez contacter vos services municipaux, votre éco-organisme ou les autorités locales. Vous pouvez également vous rendre sur le site [www.canon-europe.com/environment](http://www.canon-europe.com/environment).

(Espace économique européen : Norvège, Islande et Liechtenstein)

Tylko kraje Unii Europejskiej (i Europejskiego Obszaru Gospodarczego).

Te symbole oznaczają, że produkt należy wyrzucać oddzielnie od odpadów domowych, zgodnie z dyrektywą WEEE w sprawie zużytego sprzętu elektrycznego i elektronicznego (2002/96/EC) lub dyrektywą w sprawie baterii (2006/66/EC) i/lub przepisami krajowymi, wdrażającymi te dyrektywy. Zużyty sprzęt powinien zostać przekazany do punktu zbiórki sprzętu (EEE), a w przypadku zakupu nowego na zasadzie wymiany jeden do jednego przy zakupie podobnego co do rodzaju produktu. Użytkownicy baterii i akumulatorów mają obowiązek korzystać z dostępnego programu zwrotu, recyklingu i utylizacji baterii i akumulatorów. Niewłaściwe postępowanie z tego typu odpadami może mieć wpływ na środowisko i zdrowie ludzi ze względu na substancje potencjalnie niebezpieczne ogólnie związane ze zużytym sprzętem elektrycznym i elektronicznym. Państwa współpraca w zakresie właściwej utylizacji tego produktu przyczyni się do efektywnego wykorzystania zasobów naturalnych. W celu uzyskania informacji o sposobie recyklingu tego produktu prosimy o kontakt z właściwym urzędem miejskim lub zakładem gospodarki komunalnej lub zapraszamy na stronę [www.canon-europe.com/environment](http://www.canon-europe.com/environment).

(Europejski Obszar Gospodarczy: Norwegia, Islandia i Liechtenstein)

Gælder kun i EU (og EØS).

Disse symboler betyder, at produktet ikke må bortskaffes sammen med husholdningsaffald i henhold til WEEE-direktivet (2002/96/EF), batteridirektivet (2006/66/EF) og/eller den lokale lovgivning, som disse direktiver er gennemført i. Produktet skal afleveres på et godkendt indsamlingssted, f.eks. i overensstemmelse med en godkendt én-for-én-procedure, når du indkøber et nyt tilsvarende produkt, eller på et godkendt indsamlingssted for genanvendeligt affald fra elektrisk og elektronisk udstyr samt for batterier og akkumulatorer. Forkert håndtering af denne type affald kan muligvis få negative konsekvenser for miljøet og menneskers helbred på grund af de potentielt sundhedsskadelige substanser, der generelt associeres med elektrisk og elektronisk udstyr. Når du foretager korrekt bortskaffelse af produktet, bidrager dette også til effektiv brug af naturressourcerne. Kontakt din kommune, den lokale affaldsmyndighed, forvalterne af en godkendt affaldsordning eller det lokale affaldsanlæg, eller besøg [www.canon-europe.com/environment](http://www.canon-europe.com/environment) for at få flere oplysninger om genbrug af dette produkt.

(EØS: Norge, Island og Liechtenstein)

Ευρωπαϊκή Ένωση (και ΕΟΧ) μόνο.

Αυτά τα σύμβολα υποδεικνύουν ότι αυτό το προϊόν δεν πρέπει να απορρίπτεται μαζί με τα οικιακά απορρίμματα, σύμφωνα με την Οδηγία για τα Απόβλητα Ηλεκτρικού και Ηλεκτρονικού Εξοπλισμού (ΑΗΗΕ) (2002/96/ΕΚ), την Οδηγία για τις Ηλεκτρικές Στήλες (2006/66/ΕΚ) ή/και την εθνική νομοθεσία που εφαρμόζει τις Οδηγίες εκείνες. Αυτό το προϊόν πρέπει να παραδίδεται σε καθορισμένο σημείο συλλογής, π.χ. σε μια εξουσιοδοτημένη βάση ανταλλαγής, όταν αγοράζετε ένα νέο παρόμοιο προϊόν ή σε μια εξουσιοδοτημένη θέση συλλογής για την ανακύκλωση των αποβλήτων ηλεκτρικού και ηλεκτρονικού εξοπλισμού (ΗΗΕ) και ηλεκτρικών στηλών και συσσωρευτών. Ο ακατάλληλος χειρισμός αυτού του τύπου αποβλήτων θα μπορούσε να έχει πιθανό αρνητικό αντίκτυπο στο περιβάλλον και την υγεία του ανθρώπου, λόγω δυνητικώς επικίνδυνων ουσιών που γενικά συνδέονται με τον ΗΗΕ. Η συνεργασία σας για τη σωστή απόρριψη αυτού του προϊόντος θα συμβάλει στην αποτελεσματική χρήση των φυσικών πόρων. Για περισσότερες πληροφορίες σχετικά με ανακύκλωση αυτού του προϊόντος, επικοινωνήστε με το τοπικό γραφείο της πόλης σας, την υπηρεσία απορριμμάτων, το εγκεκριμένο σχήμα ή την υπηρεσία απόρριψης οικιακών αποβλήτων ή επισκεφθείτε τη διεύθυνση [www.canon-europe.com/environment](http://www.canon-europe.com/environment).

(Ευρωπαϊκός Οικονομικός Χώρος: Νορβηγία, Ισλανδία και Λιχτενστάιν)



Sólo para la Unión Europea (y el Área Económica Europea).

Estos símbolos indican que este producto no debe desecharse con los residuos domésticos de acuerdo con la Directiva sobre RAEE (2002/96/CE) y la Directiva sobre Pilas y Acumuladores (2006/66/CE) y/o la legislación nacional que implemente dichas Directivas. Este producto deberá entregarse en un punto de recogida designado, por ejemplo, en un establecimiento autorizado al adquirir un producto nuevo similar o en un centro autorizado para la recogida de residuos de aparatos eléctricos y electrónicos (RAEE), baterías y acumuladores. La gestión incorrecta de este tipo de residuos puede afectar al medio ambiente y a la salud humana debido a las sustancias potencialmente nocivas que suelen contener estos aparatos. Su cooperación en la correcta eliminación de este producto contribuirá al correcto aprovechamiento de los recursos naturales. Los usuarios tienen derecho a devolver pilas, acumuladores o baterías usados sin coste alguno. El precio de venta de pilas, acumuladores y baterías incluye el coste de la gestión medioambiental de su desecho, y bajo ninguna circunstancia se indicará por separado la cuantía de dicho coste en la información y la factura suministradas a los usuarios finales. Si desea más información sobre el reciclado de este producto, póngase en contacto con el departamento municipal, el servicio o el organismo encargado de la gestión de residuos domésticos o visite [www.canon-europe.com/environment](http://www.canon-europe.com/environment).

(Área Económica Europea: Noruega, Islandia y Liechtenstein)

Vain EU- ja EEA-alueelle.

Nämä tunnukset osoittavat, että sähkö- ja elektroniikkalaiteromua koskeva direktiivi (WEEE-direktiivi, 2002/96/EY), paristoista ja akuista annettu direktiivi (2006/66/EY) sekä kansallinen lainsäädäntö kieltävät tuotteen hävittämisen talousjätteen mukana. Tuote on vietävä asianmukaiseen keräyspisteeseen, esimerkiksi kodinkoneliikkeeseen uutta vastaavaa tuotetta ostettaessa tai viralliseen sähkö- ja elektroniikkalaiteromun tai paristojen ja akkujen keräyspisteeseen. Sähkö- ja elektroniikkalaiteromun virheellinen käsittely voi vahingoittaa ympäristöä ja ihmisten terveyttä, koska laitteet saattavat sisältää ympäristölle ja terveydelle haitallisia aineita. Tuotteen asianmukainen hävittäminen säästää samalla luonnonvaroja. Jos haluat lisätietoja tämän tuotteen kierrätyksestä, ota yhteys kunnan jätehuoltoviranomaisiin tai käyttämäsi jätehuolto-yhtiöön tai käy osoitteessa [www.canon-europe.com/environment](http://www.canon-europe.com/environment).

(EEA-maat: Norja, Islanti ja Liechtenstein)

Samo za Europsku uniju (i Europski gospodarski prostor).

Oznaka pokazuje da se baterije i akumulatori, korišteni u ovom proizvodu, odlažu odvojeno od kućnog otpada, u skladu s direktivom 2002/96/ EZ-a ("Direktiva") i lokalnim zahtjevima koji primjenjuju te Direktive. Ovaj bi proizvod trebao biti prenesen do određene točke sakupljanja, npr. na neku dozvoljenu bazu u omjeru 1:1 kada kupite novi sličan proizvod, ili na ovlašteno mjesto za sakupljanje istrošene električne i elektronske opreme, (waste electrical and electronic equipment – EEE) baterija i akumulatora. Neodgovarajuće rukovanje ovim tipom otpada može utjecati na okoliš i ljudsko zdravlje zbog potencijalno opasnih supstanci koje se najčešće nalaze uz EEE. Vaša suradnja u pravilnom zbrinjavanju ovog proizvoda doprinijet će efikasnoj uporabi prirodnih resursa. Za više informacija o recikliranju ovog proizvoda, molimo vas da kontaktirate svoj lokalni gradski ured, lokalne vlasti, pogledate odobrenu shemu, kontaktirajte vašu komunalnu službu za uklanjanje radioaktivnog otpada ili posjetite [www.canon-europe.com/environment](http://www.canon-europe.com/environment).

(Europski gospodarski prostor: Norveška, Island i Lihtenštajn)

**Nur Europäische Union (und EWR)**

Diese Symbole weisen darauf hin, dass dieses Produkt gemäß WEEE-Richtlinie 2002/96/EG (Richtlinie über Elektro- und Elektronik-Altgeräte), Batterien-Richtlinie (2006/66/EG) und/oder nationalen Gesetzen zur Umsetzung dieser Richtlinien nicht über den Hausmüll entsorgt werden darf. Dieses Produkt muss bei einer dafür vorgesehenen Sammelstelle abgegeben werden. Dies kann z. B. durch Rückgabe beim Kauf eines neuen ähnlichen Produkts oder durch Abgabe bei einer autorisierten Sammelstelle für die Wiederaufbereitung von Elektro- und Elektronik-Altgeräten sowie Batterien und Akkumulatoren geschehen. Der unsachgemäße Umgang mit Altgeräten kann aufgrund potenziell gefährlicher Stoffe, die häufig in Elektro- und Elektronik-Altgeräte enthalten sind, negative Auswirkungen auf die Umwelt und die menschliche Gesundheit haben. Durch Ihre Mitarbeit bei der sachgemäßen Entsorgung dieses Produkts tragen Sie zu einer effektiven Nutzung natürlicher Ressourcen bei. Um weitere Informationen über die Wiederverwertung dieses Produkts zu erhalten, wenden Sie sich an Ihre Stadtverwaltung, den öffentlich-rechtlichen Entsorgungsträger, eine autorisierte Stelle für die Entsorgung von Elektro- und Elektronik-Altgeräten oder Ihre Müllabfuhr oder besuchen Sie [www.canon-europe.com/environment](http://www.canon-europe.com/environment).

(EWR: Norwegen, Island und Liechtenstein)

Только для Европейского Союза (Европейской экономической зоны).

Эти символы указывают, что данный продукт не должен утилизироваться вместе с хозяйственно-бытовыми отходами в соответствии с Директивой WEEE (2002/96/EC), Директивой об аккумуляторах 2006/66/EC и/или законами Вашей страны, осуществляющими данные Директивы. Данное изделие должно быть передано в предназначенный для этого пункт сбора, например, на основе авторизованного обмена «один к одному», когда Вы покупаете подобное новое изделие, или в авторизованное место сбора отходов электрического и электронного оборудования, батарей и аккумуляторов для переработки. Неправильное обращение с отходами подобного типа может иметь влияние на окружающую среду и здоровье человека из-за потенциально опасных для здоровья веществ, которые, как правило, тесно связаны с электрическим и электронным оборудованием. Ваше сотрудничество в области правильной утилизации данного изделия вносит вклад в рациональное использование природных ресурсов. Чтобы узнать больше информации о переработке отходов батарей и аккумуляторов, пожалуйста, обратитесь в местную городскую администрацию, орган по работе с отходами или предприятие по утилизации отходов, или зайдите на [www.canon-europe.com/environment](http://www.canon-europe.com/environment).

(Европейская экономическая зона: Норвегия, Исландия и Лихтенштейн)

**Només per a la Unió Europea (i EEA)**

Aquests símbols indiquen que aquest producte no s'ha de llençar amb les escombraries de la llar, d'acord amb la RAEE (2002/96/EC), la Directiva relativa a piles i acumuladors (2006/66/EC) i la legislació nacional que implementi aquestes directives. Aquest producte s'hauria de lliurar en un dels punts de recollida designats, com per exemple, intercanviant un per un en comprar un producte similar o lliurant-lo en un lloc de recollida autoritzat per al reciclatge de residus d'aparells elèctrics i electrònics (EEE) i piles i acumuladors. La manipulació inadequada d'aquest tipus de residus podria tenir un impacte negatiu en l'entorn i en la salut humana, a causa de les substàncies potencialment perilloses que normalment estan associades a l'EEE. La vostra cooperació a l'hora de rebutjar correctament aquest producte contribuirà a la utilització efectiva dels recursos naturals. Els usuaris tenen dret a retornar les bateries o els acumuladors usats sense cap càrrec. El preu de venda de les bateries i els acumuladors inclou el cost de la gestió ambiental dels residus i, sota cap circumstància, l'import d'aquest cost s'especificarà per separat en aquest fullet o en la factura que es lliuri a l'usuari final. Per a més informació sobre el reciclatge d'aquest producte, contacteu amb l'oficina municipal, les autoritats encarregades dels residus, el pla de residus homologat o el servei de recollida d'escombraries domèstiques de la vostra localitat o visiteu [www.canon-europe.com/environment](http://www.canon-europe.com/environment).

(EEA: Noruega, Islàndia i Liechtenstein)

Doar pentru Uniunea Europeană (și EEA).

Aceste simboluri indică faptul că acest produs nu trebuie evacuat împreună cu deșeurile menajere, în conformitate cu Directiva WEEE (2002/96/EC), Directiva referitoare la baterii (2006/66/EC) și/sau legile dvs. naționale ce implementează aceste Directive. Acest produs trebuie înmânat punctului de colectare adecvat, ex: printr-un schimb autorizat unu la unu atunci când cumpărați un produs nou similar sau la un sit de colecție autorizat pentru reciclarea reziduurilor de echipament electric și electronic (EEE) și baterii și acumulatori. Administrarea neadecvată a acestui tip de deșeuri, ar putea avea un impact asupra mediului și asupra sănătății umane datorită substanțelor cu potențial de risc care sunt în general asociate cu EEE. Cooperarea dvs. în direcția evacuării corecte a acestui produs va contribui la o utilizare eficientă a resurelor naturale. Pentru mai multe informații despre reciclarea acestui produs, vă rugăm să contactați biroul dvs. local, autoritățile responsabile cu deșeurile, schema aprobată sau serviciul dvs. responsabil cu deșeurile menajere sau vizitați-ne la [www.canon-europe.com/environment](http://www.canon-europe.com/environment).

(EEA: Norvegia, Islanda, Lichtenstein)

Yalnızca Avrupa Birliği (ve AEA).

Bu simgeler, WEEE Direktifi (2002/96/AT), Pil Direktifi (2006/66/AT) ve/veya bu Direktifleri uygulamaya koyan ulusal kanunlarınız uyarınca bu ürünün evsel atıklarınızla birlikte atılmaması gerektiğini gösterir. Bu ürün örneğin, benzer bir yeni ürün aldığınızda yetkili bir değiştirme esaslı toplama noktası veya elektrikli ve elektronik cihazlar (EEE) ile pil ve akü geri dönüşümü için yetkili bir toplama merkezi gibi belirlenmiş bir toplama noktasına götürülmelidir. Bu gibi atıkların gerektiği şekilde işlem görmemesi genel olarak EEE ile bağlantılı olan tehlikeli olabilecek maddeler nedeniyle çevre ve insan sağlığı üzerinde olumsuz etkiye yol açabilir. Bu ürünün düzgün şekilde atılması için işbirliği yapmanız doğal kaynakların verimli şekilde kullanımına katkıda bulunacaktır. Bu ürünün geri dönüşümü hakkında daha fazla bilgi için lütfen belediyeniz, atık merkeziniz, onaylı atık programı veya çöp toplama servisine başvurun ya da [www.canon-europe.com/environment](http://www.canon-europe.com/environment) adresini ziyaret edin.

(AEA: Norveç, İzlanda ve Lihtenştayn)

Тільки для Європейського Союзу (та Європейської економічної зони).

Ці символи вказують, що даний продукт не повинен утилізуватися разом з господарчо-побутовими відходами згідно Директиви WEEE (2002/96/EC), Директиви про батареї 2006/66/EC та/або законів Вашої країни, що реалізують ці Директиви. Даний виріб повинно бути передано до призначеного приймального пункту, наприклад, на базі авторизованого обміну «один до одного», якщо Ви купуєте подібний новий продукт, або до авторизованого місця збору відходів електричного та електронного обладнання, батарей та акумуляторів для подальшої переробки. Невідповідне обходження з подібними відходами може завдавати впливу на оточуюче середовище і здоров'я людини через присутність потенційно небезпечних речовин, які загалом тісно пов'язані з електричним та електронним обладнанням. Ваша співпраця щодо відповідної утилізації даного виробу робить внесок у раціональне використання природних ресурсів. Будь ласка, зверніться до місцевої адміністрації, органу по роботі з відходами або підприємства по утилізації відходів, щоб дізнатися більше про переробку даного виробу, або зверніться на [www.canon-europe.com/environment](http://www.canon-europe.com/environment).

(Європейська економічна зона: Норвегія, Ісландія та Ліхтенштейн)

Само за Европейския съюз (и ЕИП).

Тези символи указват, че този продукт не може да се изхвърля заедно с боклука от вашето домакинство, според Директивата ИУЕЕО (2002/96/EC), Директивата за батерии (2006/66/EC) и/или вашите национални закони, които изпълняват тези Директиви. Този продукт трябва да бъде предаден в обозначен събирателен пункт, т.е. в одобрена база, когато купувате нов подобен продукт или в одобрен събирателен пункт за рециклиране на отпадъци от електрическо и електронно оборудване (ЕЕО), батерии и акумулаторни батерии. Неправилното третиране на този вид отпадъци може да има потенциален вреден ефект върху околната среда и човешкото здраве, поради възможните опасни вещества, с които обикновено се свързва ЕЕО. Вашето съдействие за правилното изхвърляне на този продукт ще допринесе за ефективната употреба на естествените ресурси. За повече информация относно рециклирането на този продукт, моля свържете се с вашия местен офис, с органа, който отговаря за отпадъчните продукти, одобрената програма или учреждението по изхвърляне на боклука на вашето домакинство, или посетете [www.canon-europe.com/environment](http://www.canon-europe.com/environment).

(ЕИП: Норвегия, Исландия и Лихтенщайн)



الاتحاد الأوروبي (والمنطقة الاقتصادية الأوروبية) فقط

تشير هذه الرموز إلى عدم التخلص من هذا المنتج في النفايات المنزلية العادية طبقاً لتوجيه الاتحاد الأوروبي WEEE (الخاص بنفايات المعدات الكهربائية والإلكترونية) (EC/96/2002)، والتوجيه الخاص بالبطاريات (EC/66/2006)، و/أو القوانين المحلية التي تنطبق على تلك التوجيهات. يجب تقديم هذا المنتج إلى أحد مراكز تجميع النفايات المخصصة، على سبيل المثال، على أساس فردي عند شراء أحد المنتجات الجديدة المماثلة أو إلى موقع التجميع المعتمد الخاص بإعادة تدوير المعدات الكهربائية والإلكترونية (EEE) والبطاريات والمراكم. التعامل غير الصحيح مع هذا النوع من النفايات قد يكون له تأثيراً على البيئة وصحة الإنسان بسبب المواد الخطيرة المحتملة المرتبطة بشكل عام بتوجيه EEE (المعدات الكهربائية والإلكترونية). تعاونك في التخلص الملائم من هذا المنتج سيساهم في الاستعمال الفعال للمصادر الطبيعية. للحصول على مزيد من المعلومات حول إعادة تدوير هذا المنتج، برجاء الاتصال بمكتب المدينة المحلي الخاص بك، أو سلطة التخلص من النفايات أو البرنامج المعتمد أو مرفق خدمة التخلص من النفايات المنزلية أو التفضل بزيارة الموقع [www.canon-europe.com/environment](http://www.canon-europe.com/environment)

(المنطقة الاقتصادية الأوروبية : النرويج، وأيسلندا وليختنشتاين)

# Index

## 3

3-Inch Paper Core Attachment ..... 589

## A

Accounting ..... 391,393,394,397,398,402,404

Adjusting the Vacuum Strength ..... 636

AppleTalk Network ..... 725

## C

CAD ..... 39,40,42,47,48,634

Cleaning ..... 642,740,741,756

Color Adjustment ..... 226,231

Color imageRUNNER Enlargement Copy .....  
289,291,518,520

Configuring the IP Address ..... 408,699,700,701

## D

Drying Time ..... 592

## F

Feed amount ..... 242,454

Free Layout ..... 2,237,260,262,486,488

## G

Glossy Paper ..... 23,25

## H

HDI driver ..... 358,362

Head Cleaning ..... 740

## I

If a message is displayed ..... 750

Ink level ..... 804

Interface ..... 688,700,701,703,712,723,727

## L

Large-Format Printing ..... 316,328,332,344

## M

Maintenance Cartridge ..... 640,754,828

## N

Navigate ..... 719,721

NetWare print service ..... 708

Nozzle ..... 242,454,619,739

## O

Open Preview ..... 188,213,221,240,247

Orientation ..... 194,196,328,344

## P

PosterArtist ..... 36

Power ..... 641,765

Print Job Log ..... 393,403

Print area ..... 89

Printhead ..... 755,826

Printing Vertical or Horizontal Banners ..... 120,121,126

Printing at Actual Size ..... 97,99

Problems ..... 794

## R

Removing printer drivers ..... 797

Removing the Roll ..... 585,589

Roll Holder ..... 575,647

Rotate Page 90 degrees ..... 174,176,234

## S

Size Options ..... 235

Special Settings ..... 239

## T

Transfer ..... 762

## V

Vacuum Strength ..... 636

## W

When to replace ..... 741



